

CIRA ANNUAL REPORT FY 2015/2016
(Reporting Period April 1, 2015 – March 31, 2016)

COOPERATIVE INSTITUTE FOR RESEARCH IN THE ATMOSPHERE

DIRECTOR'S MESSAGE

The Cooperative Institute for Research in the Atmosphere (CIRA) at Colorado State University (CSU) is one of a number of cooperative institutes (CIs) that support NOAA's mission. Although this mission continues to evolve, there continue to be strong reasons for partnering between NOAA and the fundamental research being done in the University environment and the students it entrains into NOAA's mission. Strengthening these ties in satellite remote sensing and regional/global weather and climate prediction, as well as application development, education/training, data assimilation, and data distribution technology make CIRA a valuable asset to NOAA. As the Director of CIRA, I have tried to do everything possible to strengthen CIRA's ties not only among CSU's Department of Atmospheric Science, the College of Engineering, and the University but also the ties among the different groups within CIRA that now covers researchers in Fort Collins and College Park associated with NESDIS, researchers in Boulder working closely with OAR and researchers in Kansas City working with the National Weather Service. With a renewed emphasis on interactions and joint initiatives, we are focusing on Connecting Models and Observations as highlighted not only in our new CIRA logo but, more fundamentally, as a guiding principle that guides us in our daily decisions. With this, we hope to fulfill the promise of being the conduit for developing ground breaking research to address socially-relevant problems that face NOAA and our society today as well as to help train a new workforce that has a broader perspective needed to continue developing decision support tools guided by scientific advances.

CIRA is fortunate in that its corporate culture and proximity to many of the Nation's top research institutions have allowed it to work with talented researchers and support staff who continue to perform at the highest possible level. There are many important accomplishments that are highlighted in this report and summarized in the executive summary. Not as obvious, but equally important, are the activities that CIRA carries out with the National Park Service and the activities with NASA through the CloudSat data processing facility and OCO algorithm development. While not funded by NOAA, these activities are highly synergistic in the areas of algorithm development, modeling and data distribution. They allow CIRA researchers working on exciting new satellite data such as Himawari 8 and Suomi/NPP's VIIRS instruments to have access to other experts with whom they can consult as they develop their own projects. This progress report constitutes the second year of reporting under the second 5-year term of the Cooperative Agreement. With it, we again establish our commitment to the maintenance and growth of a strong collaborative relationship with NOAA, other National programs, the Department of Atmospheric Science at CSU, and the University as a whole.

Christian D. Kummerow

COOPERATIVE INSTITUTE FOR RESEARCH IN THE ATMOSPHERE

The Cooperative Institute for Research in the Atmosphere (CIRA) was established in 1980 at Colorado State University (CSU). CIRA serves as a mechanism to promote synergisms between University scientists and those in the National Oceanic and Atmospheric Administration (NOAA). Since its inception, CIRA has expanded and diversified its mission to coordinate with other Federal agencies, including the National Aeronautics and Space Administration (NASA), the National Park Service (NPS), the U.S. Forest Service, and the Department of Defense (DoD). CIRA is a multi-disciplinary research institute within the College of Engineering (CoE) and encompasses several cooperative agreements, as well as a substantial number of individual grants and contracts. The Institute's research for NOAA is concentrated in five theme areas and two cross-cutting research areas:

Satellite Algorithm Development, Training and Education - Research associated with development of satellite-based algorithms for weather forecasting, with emphasis on regional and mesoscale meteorological phenomenon. This work includes applications of basic satellite products such as feature track winds, thermodynamic retrievals, sea surface temperature, etc., in combination with model analyses and forecasts, as well as in situ and other remote sensing observations. Applications can be for current or future satellites. Also under this theme, satellite and related training material will be developed and delivered to a wide variety of users, with emphasis on operational forecasters. A variety of techniques can be used, including distance learning methods, web-based demonstration projects and instructor-led training.

Regional to Global Scale Modeling Systems - Research associated with the improvement of weather/climate models (minutes to months) that simulate and predict changes in the Earth system. Topics include atmospheric and ocean dynamics, radiative forcing, clouds and moist convection, land surface modeling, hydrology, and coupled modeling of the Earth system.

Data Assimilation - Research to develop and improve techniques to assimilate environmental observations, including satellite, terrestrial, oceanic, and biological observations, to produce the best estimate of the environmental state at the time of the observations for use in analysis, modeling, and prediction activities associated with weather/climate predictions (minutes to months) and analysis.

Climate-Weather Processes - Research focusing on using numerical models and environmental data, including satellite observations, to understand processes that are important to creating environmental changes on weather and short-term climate timescales (minutes to months) and the two-way interactions between weather systems and regional climate.

Data Distribution - Research focusing on identifying effective and efficient methods of quickly distributing and displaying very large sets of environmental and model data using data networks, using web map services, data compression algorithms, and other techniques.

Cross-Cutting Area 1: Assessing the Value of NOAA Research via Societal/Economic Impact Studies - Consideration for the direct and indirect impacts of weather and climate on society and infrastructure. Providing metrics for assessing the value of NOAA/CI research and tools for planners and decision makers. Achieving true 'end-to-end' systems through effective communication of information to policy makers and emergency managers.

Cross-Cutting Area 2: Promoting Education and Outreach on Behalf of NOAA and the University - Serving as a hub of environmental science excellence at CSU for networking resources and research activities that align with NOAA mission goals throughout the University and with its industrial partners. Engaging K-12 and the general public locally, regionally, nationally and internationally to promote both awareness and informed views on important topics in environmental science.

Annually, CIRA scientists produce over 200 scientific publications, 30% of which appear in peer-reviewed publications. Among the important research being performed at CIRA is its support of NESDIS' next-generation satellite programs: GOES-R and NPOESS. These two multi-billion dollar environmental satellite programs will support weather forecasting and climate monitoring for the next 2-3 decades. They will include vastly improved sensors and will offer higher-frequency data collection. CIRA research is building prototype products and developing training, based on the new sensor technology, to assure maximum exploitation of these data when the sensors are launched.

CIRA EDUCATION, TRAINING AND OUTREACH ACTIVITIES: 2015-2016

From the CIRA Mission Statement: *“Important bridging elements of the CI include the communication of research findings to the international scientific community, transition of applications and capabilities to NOAA operational users, education and training programs for operational user proficiency, outreach programs to K-12 education and the general public for environmental literacy, and understanding and quantifying the societal impacts of NOAA research.”*

Growth and Development of CIRA Outreach

CIRA Outreach efforts during 2015 focused on identified needs facing the nation: Improved professional development for standards-based education, addressing community resilience in the face of natural disasters, including wildfires, floods, and droughts, and increasing the visibility of NOAA-generated products in the public eye. Along with these efforts, CIRA continued supporting pre-existing programs and collaborations; leveraging partnerships between CIRA’s proven history with new opportunities will continue to define the direction of the E&O program for the next several years.

Teacher Professional Development

CIRA continued expanding professional development opportunities for fifth-grade teachers, especially with respect to meeting Next-Generation Science Standards (NGSS) and Colorado Department of Education requirements. As detailed previously, teachers are held to exacting standards and are required to provide students with sophisticated and detailed instruction regarding complex natural phenomena. An example of the standards teachers are held to, taken from the State of Colorado fifth-grade standard, is provided as Figure 1.

Note the subtle complexity in the standard: Students are expected to master the concept that weather conditions change ‘because of the uneven heating of Earth’s surface by the Sun’s energy.’ Included in this concept are the rotation of the Earth and the complex interactions of fluid- and thermodynamics, resulting in weather systems. Students are then expected to demonstrate an understanding of these weather systems as made evident by direct observation of temperature, pressure, wind direction and speed, etc.

The formal preparation for fifth-grade science teachers rarely goes into these kinds of detail in the Earth sciences; teachers are left to fend for themselves in getting up-to-speed in the background needed to teach this element of the standards (and with many of the other intensive standards in which they also lack a formal education). NOAA Cooperative Institutes can offer a formidable resource to meet these needs. In this role, CIRA has developed and implemented a formal fifth-grade weather protocol training course, which was presented at four different course dates during the year to approximately fifteen local teachers. CIRA is actively seeking funding opportunities to expand these training sessions statewide; continued development of the professional development method implemented in the program could also be used to inform professional development in other standards-based topics (biology, chemistry, etc.) allowing for other institutions with subject-matter experts to ‘plug in’ their knowledge set into the CIRA-derived method, greatly improving the state of professional development for K-12 teachers across the country. Significant work will continue on this program during 2016.

Grade Level Expectation: Fifth Grade	
Concepts and skills students master:	
3. Weather conditions change because of the uneven heating of Earth's surface by the Sun's energy. Weather changes are measured by differences in temperature, air pressure, wind and water in the atmosphere and type of precipitation	
Evidence Outcomes	21st Century Skills and Readiness Competencies
Students can: <ol style="list-style-type: none"> Develop and communicate an evidence-based scientific explanation for changes in weather conditions (DOK 1-3) Gather, analyze, and interpret data such as temperature, air pressure, wind, and humidity in relation to daily weather conditions (DOK 1-3) Describe weather conditions based on data collected using a variety of weather tools (DOK 1-2) Use data collection tools and measuring devices to gather, organize, and analyze data such as temperature, air pressure, wind, and humidity in relation to daily weather conditions (DOK 1-2) 	Inquiry Questions: <ol style="list-style-type: none"> Why does the Sun heat different surfaces at different rates? Why does the weather change from day to day? Relevance and Application: <ol style="list-style-type: none"> The Sun's energy helps change daily weather by influencing the water cycle, air movement, and temperature. Gliders and birds exploit updrafts created by thermals. Deicing airplanes in the winter is sometimes necessary so that they can fly. Weather satellites generate data that measure and monitor changes in weather. Nature of Science: <ol style="list-style-type: none"> Support explanations of weather using evidence. (DOK 2-3) Understand how weather maps are utilized to predict the weather from day to day. (DOK 1-2) Assess and provide feedback on other student's scientific explanations about weather, pushing for reasoning based on evidence and scientific principles. (DOK 2-3)

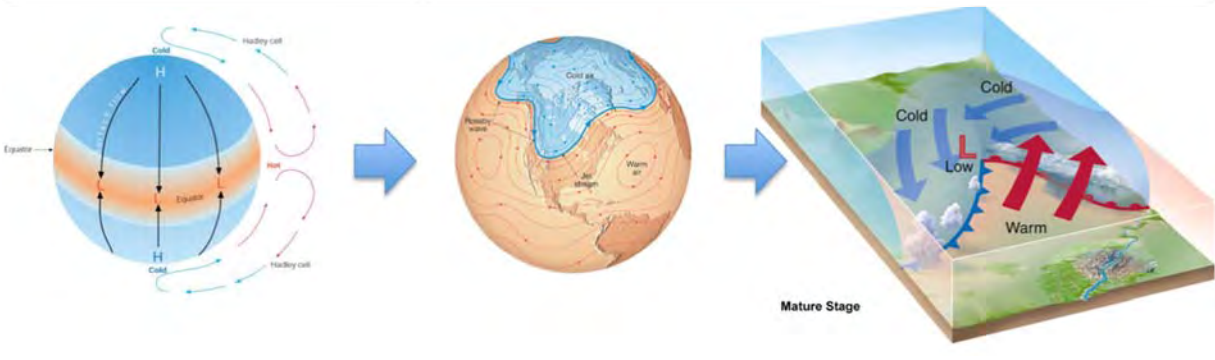

Figure 1. Fifth-grade weather standards and expectations, related through CIRA-developed professional development courses.

Social Media

Building on the growth of CIRA's social media campaign from 2015, CIRA launched a new Twitter feed, coordinating posts between the CIRA Facebook page, CIRA website, and the Twitter feed. CIRA is actively leveraging a network of over 100 followers, including several prominent NOAA feeds, to improve the brand recognition and visibility of CIRA and NOAA-derived products and, through the Twitter feed, has improved media relations and created new outlets for CIRA products to be featured in mass media. Follow CIRA online at @CIRA_CSU on Twitter.



Figure 2. Screenshot of CIRA Twitter feed. Follow CIRA online at @CIRA_CSU

JCSDA Workshop

The Joint Center for Satellite Data Assimilation (JCSDA), a cooperative program among NOAA, NASA, and the Department of Defense, coordinates data assimilation efforts among remote sensing specialists, model experts, data assimilation researchers, and end users with the goal of reducing lag between the launch of new satellite products and the use of those products in research and forecasting applications. To that end, the JCSDA coordinates several workshops across the country, as well as developing cross-platform products such as the Community Radiative Transfer Model (CRTM).

One of JCSDA's more well-known activities is the Summer Colloquium Program, a two-week intensive workshop where students and recent graduates in the atmospheric sciences can interact with leading experts in satellite data assimilation, working on projects collaboratively while learning about the latest techniques. The 2015 JCSDA Summer Colloquium on satellite data assimilation was hosted at CIRA during the last week of July and the first week of August.

Seventeen advanced study students and postdoctoral researchers from around the United States spent two weeks in intensive study of data assimilation techniques, including fundamental topics such as variational and ensemble assimilation, infrared and microwave remote sensing products, the unique issues facing assimilation of satellite data into NWP models, applications to atmospheric, oceanic, and land assimilation products, and a general overview of the global observing system. To provide this valuable information, CIRA also hosted nearly thirty experts in the field to provide lectures and examples. Participants in the workshop engaged with project based work and presented their own work.

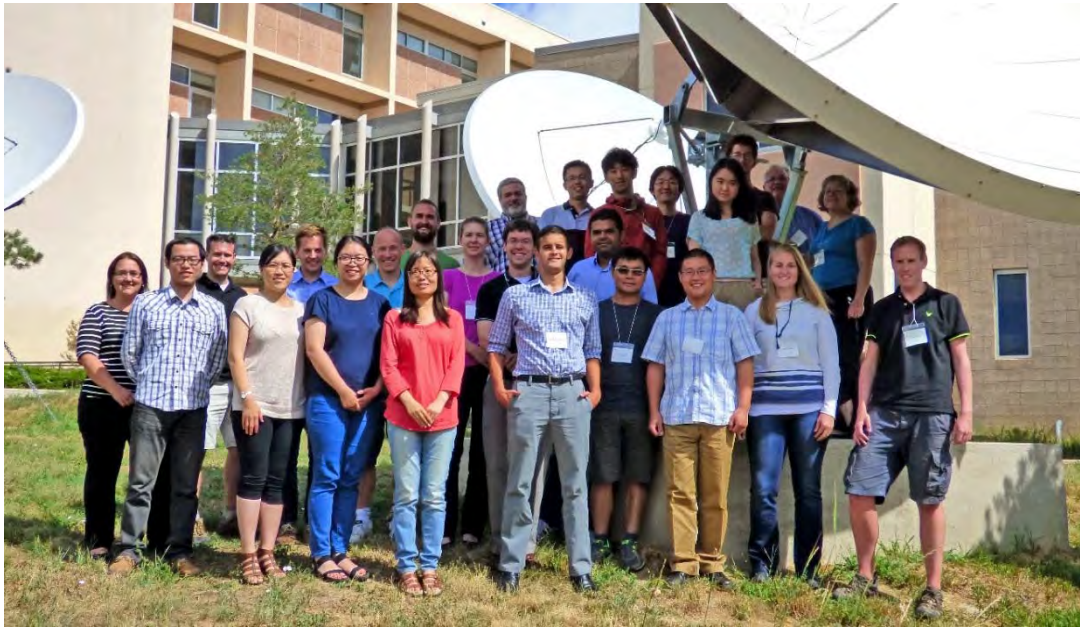

Figure 3. Participants and instructors from the Joint Center for Satellite Data Assimilation (JCSDA) Summer Colloquium program, hosted at CIRA in the last week of July and first week of August, 2015, pose for a photo between sessions.

Collaborations

Little Shop of Physics

CIRA continued its long and prosperous partnership with the Little Shop of Physics in 2015. Supported by the NSF-funded Center for Multiscale Modeling of Atmospheric Processes and the CSU Physics Department, the Little Shop of Physics develops hands-on demonstrations of physical concepts for the K-12 audience and supports professional development and science education for K-12 teachers. Utilizing undergraduate and graduate student volunteers, the Little Shop of Physics tours nationally and internationally (including a trip to Africa this year), bringing science demonstrations to a large audience. Additionally, the Little Shop produces a cable-access TV program, also available online, and presents demonstrations at national conferences including the AMS and NSTA Annual Meetings, and hosts an annual Open House on the CSU Campus that draws nearly 10,000 participants.



Figure 4. CIRA Volunteers staffing a satellite remote sensing and energy absorption/scattering/emission activity booth at the Little Shop of Physics Open House, held on February 27th, 2016.

Local Chapter of the American Meteorological Society: FORTCAST

CIRA continues to support the local chapter of the American Meteorological Society (AMS) through direct involvement with Chapter activities. The Chapter hosts quarterly meetings, and recently hosted the sitting President of the AMS, former NOAA Earth Systems Research Lab Director Dr. Sandy MacDonald as a guest speaker. Other topics included talks on hydrology from the Colorado State Climatologist and CoCoRaHS director, Nolan Doesken, and a talk on science communication from CSU researcher Dr. Laura Sample McMeeking.

Community Outreach

Scientists at CIRA and CSU students – all members of the local AMS chapter of Northern Colorado called FORTCAST (Fort Collins Atmospheric Scientists) volunteered for the weekly after-school weather club, called 'Club Trés', on Tuesdays for a local elementary school. Club Trés focuses on actively engaging K-5 students in extracurricular topics while serving as an after-school program, generally involving students from underrepresented minorities in science from lower socioeconomic backgrounds.

Students engage with CIRA researchers, led by Bernie Connell and Erin Dagg, and besides scientific exposure, get help with homework, a healthy snack, and a physical activity. The spring session ran for eight weeks during the beginning of 2016 and consisted of 90 minute sessions each week. Topics covered included wind speed and direction, clouds, colors of the rainbow, lightning, angular momentum, arctic ice, freezing solids (ice cream!), as well as measurements that are associated with these weather occurrences.



Interaction with World Meteorological Organization Regional Training Centers through the WMO Virtual Laboratory

CIRA is an active member of the World Meteorological Organization (WMO) Virtual Laboratory (VLab) and collaborates with WMO Regional Training Centers (RTC) in Costa Rica, Barbados, Argentina, and Brazil to promote satellite focused training activities. One of our most productive activities with these RTCs continues to be providing support to monthly virtual weather/satellite briefings.

Our group is the WMO Focus Group of the Americas and the Caribbean and we are a model group for other WMO countries. Participation in our monthly virtual satellite weather briefings is an easy and inexpensive way to simultaneously connect people from as many as 32 different countries, view imagery from Geostationary and polar orbiting satellites, and share information on global, regional, and local real time and climatic weather patterns, hurricanes, severe weather, flooding, and even volcanic eruptions. Forecasters and researchers are able to “build capacity” by being able to readily communicate with others in their discipline from different countries and discuss the impacts of their forecasts or impacts of broad reaching phenomena such as El Niño. Participants view the same imagery (geostationary and polar orbiting) using the VISITview tool and utilize GoToWebinar for voice over the Internet.

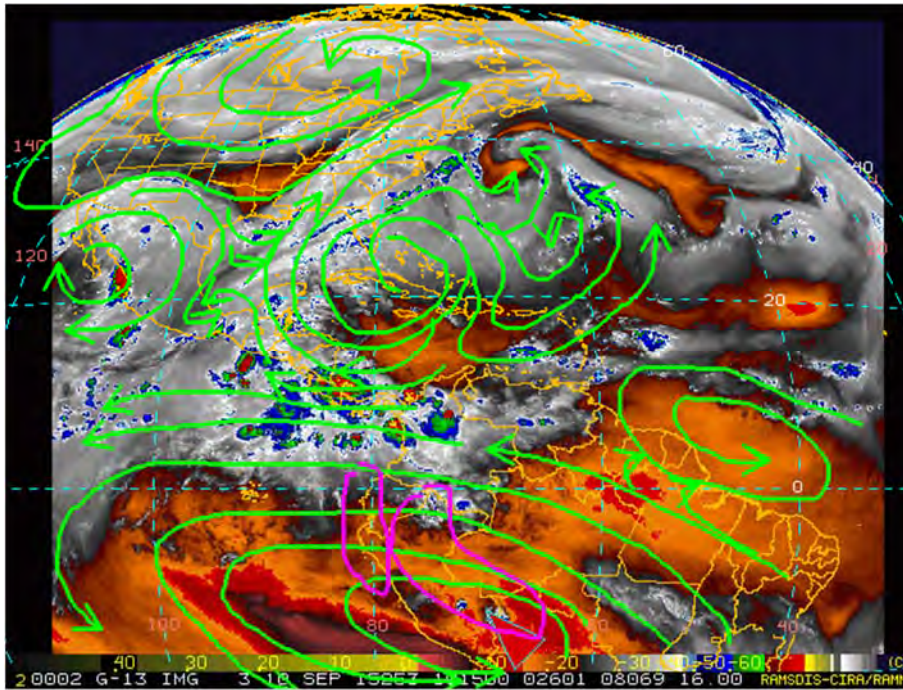

Figure 5. Water vapor imagery analysis from September 2015 used by VLab training as seen in the VISITView browser, which allows annotation of important weather features to be drawn on-screen to assist student learning.

For more information on various RTC activities and recording of the sessions, visit:

<http://rammb.cira.colostate.edu/training/rmtc/focusgroup.asp>

Science on a Sphere™ - K. Searight, S. Albers

During this reporting period, 16 new SOS systems were installed at sites in Texas, New York, Indiana, Connecticut, Columbia, China, Indonesia, Saudi Arabia, and Macau. The total number of SOS systems installed worldwide now exceeds 130.

In support of scientific education and outreach, portable SOS systems and SOS team members travelled to conferences and workshops around the world, including the World Science Festival (New York), Supercomputing (SC15) Conference, American Meteorological Society (AMS) Annual Meeting, Consumer Electronics Show (Las Vegas), the 7th SOS Users Collaborative Network Workshop (Portland, OR), National Center for Atmospheric Research (Boulder), Do Space (Omaha, NE), and the COP 21 Climate Change Conference (Paris).

NOAA SOS Public Kiosk: A widely requested SOS capability has been a project-supported public touch-screen kiosk for the general public to control the sphere when a presenter is not available. The first kiosk version runs on standard Windows hardware, has simulated track ball, has multi-language support, and easy and flexible configuration to customize the appearance and content for specific SOS sites.

Language Translation Support: SOS now supports localization to non-English languages using ISO industry standards for languages and country variants. Localization increases the reach of SOS into international audiences and for multilingual populations. The actual translations will be done mainly by distributors, content creators, or the sites themselves, although the SOS project will coordinate and facilitate the translation work.

Advanced High Performance Computing- T. Henderson, J. Middlecoff, J. Rosinski, N. Wang, J. Schramm, J. Smith

Serve on the GSD program review committee and the NOAA Earth Information System (NEIS) committee (a project listed in NOAA's 2011 Annual Guidance Memorandum as a priority for NOAA). CIRA researchers attended several meetings and gave talks on GPU and Xeon Phi research at the Programming Weather, Climate, and Earth Systems Models workshop, GPU Technology Conference, Xeon Phi Users Group Meeting, and Supercomputing 15.

Citizen Weather Observer Program (CWOP) - L. Cheatwood, R. Collander, T. Kent

There are currently 20,337 active stations (citizen and ham radio operators) out of a total of 33,142 stations in the CWOP database. CWOP members send their weather data via internet alone or internet-wireless combination to the findU (<http://www.findu.com>) server and then the data are sent from the findU server to the NOAA MADIS ingest server every five minutes. The data undergo quality checking and then are made available to users thru the MADIS distribution servers. CWOP is in the process of transitioning to operations within the NCO IDP MADIS system.

In 2015, there were approximately 2200 stations added to the database. Approximately 1200 revisions were made to site metadata. Adjustments include latitude, longitude and elevation changes in response to site moves, refinement of site location, and site status change (active to inactive, vice-versa).

Virtual Lab (VLab) - K. Sperow, M. Giebler

The NWS has created a service and IT framework that enables NOAA, in particular the NWS, and its partners to share ideas, collaborate, engage in software development, and conduct applied research from anywhere. Ken Sperow continued as the VLab technical lead, as well as the technical lead of the Virtual Lab Support Team (VLST). This team currently consists of 12 members to whom Ken provides support and training. Under Ken and Stephan Smith's (the NOAA PI) leadership, the VLab continues to grow in importance and visibility within the NWS and NOAA. Ken provided multiple demos and consultations to development and operational groups covering VLab's capabilities and how they can be leveraged to address the group's needs.

Autonowcaster (ANC) - J. Crockett

John traveled to Taipei, Taiwan and trained the CWB to build, install, configure, and run the MDL's version of ANC. He answered any and all questions as they arose and provided to the CWB a list of recommendations for them to consider with respect to their use of ANC. After the install, as the need arose, he investigated and fixed problems remotely

Organization of the Second NMMB Tutorial and all Supporting Documentation (DTC-task) – J. Beck, I. Jankov

Organize and carry out the second Non-Hydrostatic Multi-Scale Model on the B-grid (NMMB) user tutorial and practical session at EMC in Washington, DC. This was a two-day event starting on March 2, 2016. The objective of this event was to provide an introduction to the model, physics options, the NEMS system, UPP, as well as hurricane and aerosol modeling. A second goal of the tutorial was to allow participants to run an end-to-end NMMB modeling system, from initialization to visualization of results. Another aim was to engage the NMMB community through the development of a tutorial website where announcements and pertinent information was presented to inform participants and presenters.

Hydrologic Research and Water Resources Applications Outreach – L. Johnson

The primary objective is to provide support to and coordination between HMT and NOAA Partners and Stakeholders. Major activities include:

- Assist in coordination with water management stakeholders such as the Corps of Engineers, U.S. Geological Survey, and other federal, state, and local water management agencies.
- Act as a liaison across NOAA Line Offices, particularly between NWS-OHD, PSD, CNRFC, NMFS and Line Office Headquarters;
- Provide guidance to the NWC related to applicability of distributed hydrological modeling for NWS flash flood operations;
- Support the planning for an HMT/IWRSS Russian River and California Pilot Study;

Instructional Development for NOAA's OMAO- J. Dalton

OMAO Training Portal

The OMAO training portal is a Google site created as a "One Stop" site to assist OMAO staff by providing the who, what, when, where and why answers to training questions. It is updated daily with calendar events, links to various new and upcoming training opportunities and links directly to required and career development learning paths. Jenna Dalton, task lead, provides relevant content and training events in support of the OMAO scientific data collection mission and personnel needs to maintain a ready staff.

NOAA Diving Program

The NOAA Diving Program is in the process of redesigning their training courses and the OMAO CLO offered support resources involving instruction design and CLC administration. As a guide for future course development, the NOAA Oxygen Administration course, shown below in Figure 1, was published and tested in the CLC Pilot. This project will continue through the next fiscal year, requiring OMAO CLO resource support skills provided by Jenna Dalton, CIRA Associate.

Training Events

OMAO's internal leadership courses, Mid-Grade Week 1 and Week 2, fulfill the Office of Personnel Management (OPM), DOC, and NOAA requirements for new supervisor training and provide an additional cross mission development venue for the organization. These courses, held at the National Weather Service Training Center (NWSTC), include NOAA Corps Officers, waver mariners, and civilian staff. CIRA associate, Jenna Dalton, supported the leadership training as the resource manager of travel and budget, director of course logistic coordination, and course liaison.

Flow-following Finite-volume Icosahedral Model (FIM) Data Distribution Project- B. Jamison, N. Wang, E. Szoke

A dual-monitor hallway display on the second floor of the David Skaggs Research Center (DSRC) displays FIM model graphics for public viewing. Currently, a montage loop of four output fields is displayed and updated regularly.

A large touchscreen kiosk monitor in the second floor atrium area has been updated with added FIM graphic loops of 10-meter wind, precipitation and snowfall. New, larger, and more detailed images were created and are updated specifically for the kiosk.

Community Collaborative Rain, Hail, and Snow Network (CoCoRaHS)

CoCoRaHS, the Community Collaborative Rain, Hail and Snow network (<http://www.cocorahs.org/>) was founded by the Colorado Climate Center at Colorado State University. This citizen-science project started in Fort Collins, Colorado after a devastating flash flood in 1997. The flood caused over \$200 million in damages (including major damages to the CSU campus) and the loss of five lives, but also pointed out the need for timely and localized precipitation data. Precipitation is known to be extremely variable, and with the help of volunteers who are trained and equipped, the gaps between official weather stations are being supplemented by volunteer data. The network quickly grew and now consists of over 20,000 volunteers in all 50 States, Canada and Puerto Rico, U.S. Virgin Islands and The Bahamas with 10,000-12,000 reports submitted daily (Figure 6).

One key to the projects' success is that the data are used by the public as well as professionals including scientists and meteorologists at the National Weather Service. CoCoRaHS has continued to produce new educational materials, including animation based videos. In an effort to promote and facilitate how drought is assessed, CoCoRaHS released a new episode to the 'education' series, 'Assessing Drought in the United States' (Figure 7). This educational piece not only shows CoCoRaHS volunteers another way their data are used, but also helps the general public with understanding how drought is assessed and categorized.

Beginning in 2012, CoCoRaHS piloted an effort in to reach out to schools.

Initially in Colorado, where the Governor declared 2012 as the 'Year of Water', CoCoRaHS recruited nearly 150 schools around the state. Many of them submitted data, and even more success was realized by holding two campaigns per year called 'Rain Gauge Week'. After the initial pilot and proven success, the model expanded to all of CoCoRaHS and through 2015 there were nearly 1000 schools registered in the database with over 600 having entered data. The bi-annual 'Rain Gauge Week' occurs in May and September each year and has proved to be a good way to keep enthusiasm high throughout the school year. A new outside evaluator is conducting a new survey to all CoCoRaHS teachers and results will be included in this report next year.

An informal partnership with NASA Global Precipitation Measurement (GPM) has continued. Three webinars have been produced, hosted by CoCoRaHS and NASA to show the relationship between the satellite and ground observations. A field campaign in the Delmarva Peninsula began in late 2014, with a goal of asking existing CoCoRaHS volunteers in the area to collect data from nearby ground validation sites operated by NASA, and to also recruit new observers to add data to the existing campaign for ground validation purposes. Another field campaign was conducted in 2015 on the Olympic Peninsula in Washington State. Similar to Delmarva, ground validation sites through CoCoRaHS volunteers were sought, and data from existing CoCoRaHS volunteers were accessed throughout the campaign. Over 200 students, teachers and members of the public were reached through events and presentations throughout 2015.

Through a formal partnership with NEON Citizen Science Academy in Boulder, Colorado, CoCoRaHS is a featured project for an on-line Professional Development Course for teachers seeking credit on the topic of "Introduction to Citizen Science: Explorations in Educational Settings". CoCoRaHS has provided support for teachers in this bi-annual course since 2014.

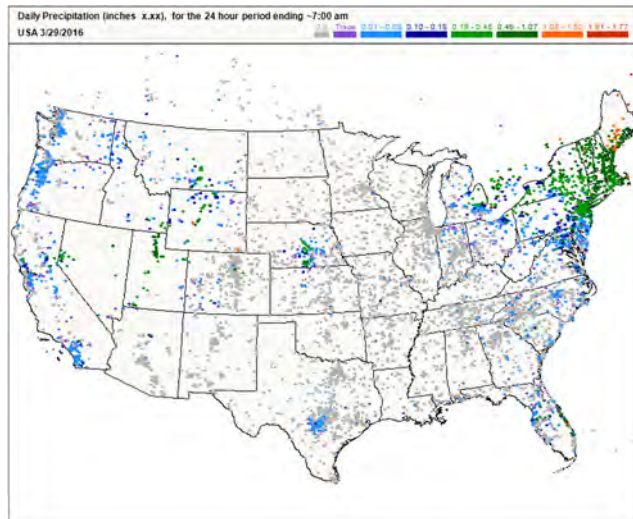

Figure 6. CoCoRaHS Reports, nationwide, from March 29th 2016



Figure 7. Scene from 'Addressing Drought in the United States', a CoCoRaHS-released media episode.

Summary

CIRA Education and Outreach initiatives continue to provide valuable education resources to the community and the nation, and will continue to develop new areas for education effort through 2016. CIRA has developed a program to continue education on resilience for local communities, and has applied for funding under the NOAA Office of Education to host workshops during 2017 and beyond to bring NOAA resources into the classroom. CIRA will continue to develop programs focusing on underrepresented minorities, and is looking at seeking funding for internships, pairing undergraduate students with CIRA researchers to showcase NOAA product development and operations. And as always, CIRA education efforts will continue to address evolving needs as they arise, helping to complete the goal of creating a truly weather-ready nation.

NOAA AWARD NUMBERS FOR CIRA

Award Number	Identifier	Project Title	Principal Investigators/ Project Directors
NA14OAR4320125	Cooperative Agreement	A Cooperative Institute to Investigate Satellite Applications for Regional/Global-Scale Forecasts	Chris Kummerow (Lead), Steven Miller
NA15OAR4590152	Competitive	Assessment of Gridded Hydrological Modeling for NWS Flash Flood Operations	L. Johnson
NA10SEC0080012	Competitive	CoCoRaHS: Capitalizing on Technological Advancements to Expand Environmental Literacy through a Successful Citizen Science Network	Chris Kummerow (Lead), Nolan Doesken
NA15OAR4310099	Competitive	Development of a Framework for Process-oriented Diagnosis of Global Models	Eric Maloney
NA14OAR4310148	Competitive	Following Emissions from Non-traditional Oil and Gas Development Through Their Impact on Tropospheric Ozone	Emily Fischer, Delphine Farmer
NA13OAR4590187	Competitive	Guidance on Intensity Guidance	Andrea Schumacher
NA15OAR4590200	Competitive	Improvement and Implementation of the Probability-based Microwave Ring Rapid Intensification Index for NHC/JTWC Forecast Basins	Kate Musgrave
NA15OAR4590202	Competitive	Improvement to the Tropical Cyclone Genesis Index (TCGI)	Andrea Schumacher
NA15OAR4590204	Competitive	Improvements to Operational Statistical Tropical Cyclone Intensity Forecast Models	Galena Chirokova, Andrea Schumacher
NA13OAR4310080	Competitive	Improving CarbonTracker Flux Estimates for North Americas Using Carbonyl Sulfide (OCS)	Ian Baker
NA12OAR4310077	Competitive	Intraseasonal to Interannual Variability in the Intra-Americas Sea in Climate Models	Eric Maloney
NA15OAR4590233	Competitive	Multi-disciplinary Investigation of Concurrent Tornadoes and Flash Floods in the Southeastern US	Russ Schumacher
NA14OAR4310141	Competitive	Observational Constraints on the Mechanisms that Control Size- and Chemistry-resolved Aerosol Fluxes Over a Colorado Forest	Delphine Farmer
NA13OAR4310103	Competitive	Research to Advance Climate and Earth System Models Collaborative Research: A CPT for Improving Turbulence and Cloud Processes in the NCEP Global Models	David Randall
NA13OAR4310077	Competitive	Towards Assimilation of Satellite, Aircraft and Other Upper-air CO2 Data into CarbonTracker	David Baker

NOAA AWARD NUMBERS FOR CIRA

NA13OAR4590190	Competitive	Upgrades to the Operational Monte Carlo Wind Speed Probability Program	Andrea Schumacher
NA13OAR4310163	Competitive	Use of the Ocean-Land-Atmosphere Model (OLAM) with Cloud System-resolving Refined Local Mesh to Study MJO Initiation	Eric Maloney
NA14OAR4830122	Competitive - Sandy	CIRA Assimilation of Moisture and Precipitation Observations in Cloudy Regions of Hurricane Inner Core Environments to Improve Hurricane Intensity, Structure and Precipitation	Chris Kummerow, Milija Zupanski
NA14NWS4830020	Competitive - Sandy	CIRA – Distance Learning Materials on Blended Numerical Guidance Products	Chris Kummerow, Bernie Connell
NA14NWS4830018	Competitive - Sandy	CIRA – Distance Learning Materials on Tropical Storm Forecasting and Threats	Chris Kummerow, Bernie Connell
NA14NWS4830056	Competitive - Sandy	CIRA Support to Monte Carlo Model-based Wind Arrival and Departure Estimates	Andrea Schumacher
NA14OAR4830110	Competitive - Sandy	ESRL/GSD Participation in the Establishment of a NOAA Lab Activity for OSSEs	Sher Schranz, Ning Wang
NA14OAR4830114	Competitive - Sandy	Evaluation of Earth Networks Total Lightning Products for NWS Warning Services in the Hazardous Weather Testbed	Sher Schranz
NA14NWS4830034	Competitive - Sandy	Incorporating the GOES-R Geostationary Lightning Mapper Assimilation into the GSI for Use in the NCEP Global System	Milija Zupanski, Karina Apodaca
NA14NWS4830009	Competitive - Sandy	MADIS Transition to NWS Operations	Sher Schranz, Tom Kent
NA14OAR4830111	Competitive - Sandy	NOAA's High Impact Weather Prediction Project (HIWPP) Test Program – Ensemble Statistical Post-processing	Sher Schranz, Isidora Jankov
NA14OAR4830109	Competitive - Sandy	NOAA's High Impact Weather Prediction Project (HIWPP) Test Program – Real-time IT Operations	Sher Schranz
NA14OAR4830112	Competitive - Sandy	NOAA's High Impact Weather Prediction Project (HIWPP) Test Program – Fine-grain Computing	Sher Schranz
NA14OAR4830113	Competitive - Sandy	NOAA's High Impact Weather Prediction Project (HIWPP) Test Program – Visualization and Extraction via NEIS	Sher Schranz
NA14OAR4830167	Competitive - Sandy	NOAA' S Observing System Experiments and Observing System Simulation Experiments in Support of the "Sensing Hazards with Operational Unmanned Technology" (SHOUT) Program – Development and Testing of Sampling Strategies for Unmanned Aerial Systems	Sher Schranz, Ning Wang
NA14OAR4830166	Competitive - Sandy	Sensing Hazards with Operational Unmanned Technology (SHOUT) – Data Management and Visualization	Sher Schranz, Jebb Stewart

VISION AND MISSION

The overarching Vision for CIRA is:

To conduct interdisciplinary research in the atmospheric sciences by entraining skills beyond the meteorological disciplines, exploiting advances in engineering and computer science, facilitating transitional activity between pure and applied research, leveraging both national and international resources and partnerships, and assisting NOAA, Colorado State University, the State of Colorado, and the Nation through the application of our research to areas of societal benefit.

Expanding on this Vision, our Mission is:

To serve as a nexus for multi-disciplinary cooperation among CI and NOAA research scientists, University faculty, staff and students in the context of NOAA-specified research theme areas in satellite applications for weather/climate forecasting. Important bridging elements of the Institute include the communication of research findings to the international scientific community, transition of applications and capabilities to NOAA operational users, education and training programs for operational user proficiency, outreach programs to K-12 education and the general public on environmental literacy, and understanding and quantifying the societal impacts of NOAA research.

CIRA Organizational Structure

April 2015

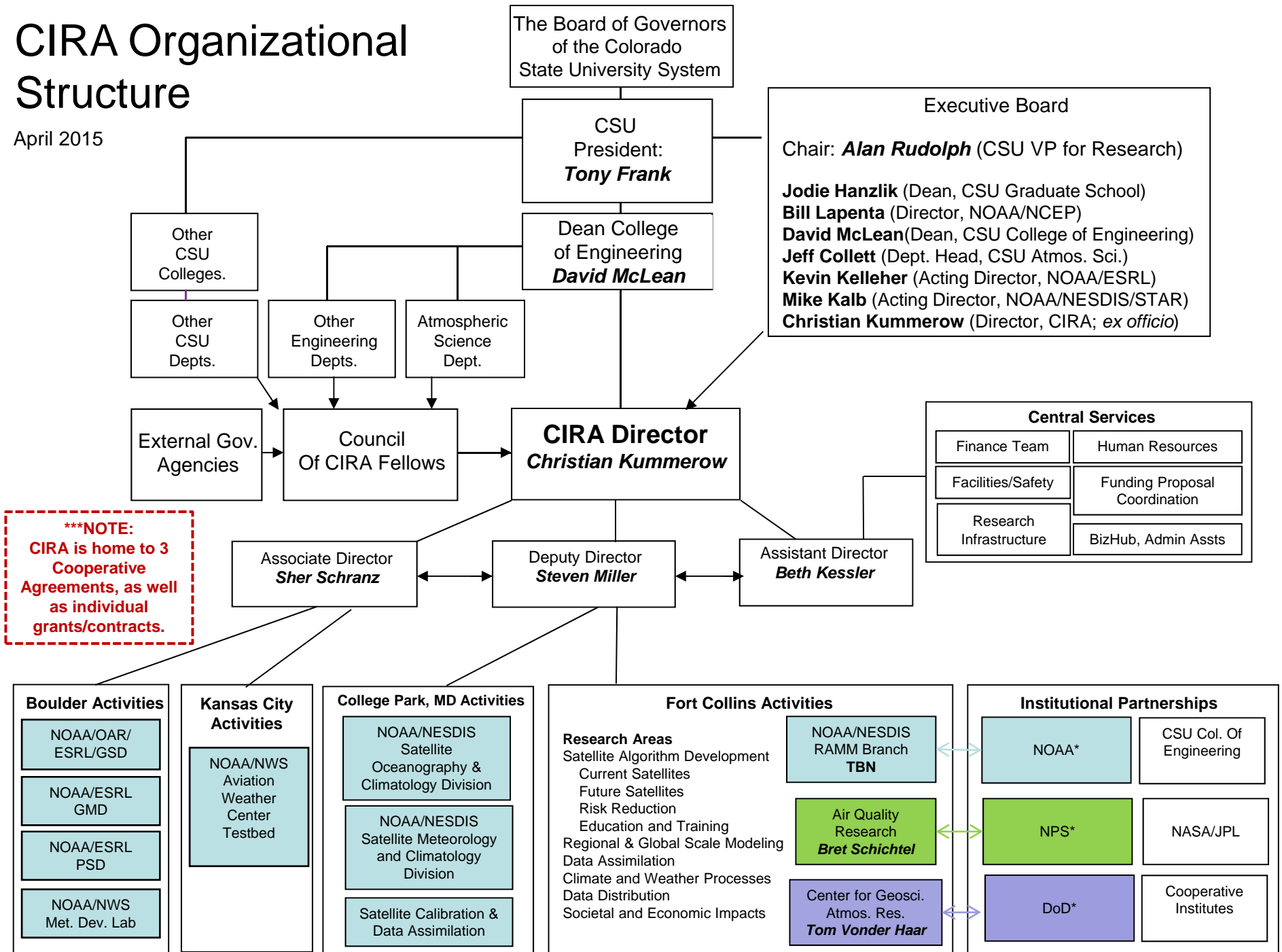

EXECUTIVE SUMMARY—Research Highlights

The Cooperative Institute for Research in the Atmosphere (CIRA) at Colorado State University (CSU) serves as both an active collaborator and formal interface between academic expertise and multiple agencies holding both basic and applied research interests in atmospheric science. Under its capacity as NOAA's Cooperative Institute for exploiting satellite applications for improvements in regional and global-scale forecasting, CIRA provides an important and practical connection between two NOAA line offices—Oceanic and Atmospheric Research (OAR) and the National Environmental Satellite, Data and Information Service (NESDIS). Diverse expertise in satellite remote sensing, science algorithm and application development, education/training, regional/global weather and climate modeling, data assimilation, and data distribution technology make CIRA a valuable asset to NOAA in terms of transitioning research concepts to operational stakeholders.

Outside of the core group in Fort Collins, CIRA's collaborations with the Global Systems Division (GSD), the Physical Sciences Division (PSD), and the Global Monitoring Division (GMD) of the NOAA Earth System Research Lab (ESRL) in Boulder continue to expand. CIRA researchers have established scientific and technology leadership roles in every branch and virtually every project in GSD. Technical and scientific leadership to develop global, regional and local scale forecast models such as the Flow Following Finite Icosahedral Model (FIM), the High Resolution Rapid Refresh Model (HRRR and HRRR/Chem) and the Local Analysis and Prediction System (LAPS) are primary focus areas for CIRA scientists in ESRL. GSI Data Assimilation systems to provide the best possible model initialization fields are a new area of focus for CIRA researchers within ESRL. Program management, engineering and research support were CIRA's contributions to quality assessment of NWS and FAA turbulence, precipitation and turbulence aviation weather forecasts products. Key research and development positions are held by CIRA researchers in programs that focus on the delivery and visualization of NOAA's data to research, operational and public users. Major projects include the NOAA Earth Information System (NEIS), the NWS AWIPS II Hazard Services, FxCAGE virtual client systems, the Meteorological Assimilation and Data Ingest System (MADIS), the NWS Virtual Laboratory (VLab), and the Integrated Dissemination Program (IDP). CIRA researchers are also leaders in the development of high performance computing software and firmware (especially related to GPU processing). CIRA researchers lead and contribute to the development of technology and scientific content for NOAA's premier education and outreach program, Science on a Sphere (SOS®).

The CIRA Annual Report provides summaries of the contributions emerging from our research partnership with NOAA, with more detail to be found in the peer reviewed and technical conference publications cited within this report as appropriate. Highlighted below are accomplishments from the current reporting period and drawn from both the NOAA reports contained herein as well as from the broader palette of research conducted at CIRA. Organized by CIRA's research themes, these examples underscore intra- and inter-agency partnerships that present opportunities for leveraging activities of other agencies.

Satellite Algorithm Development, Training and Education

- With the launch of GOES-R now imminent, and JPSS following shortly thereafter, much of the core focus in the satellite algorithm development and training work has focused on these two sensors. The GOES-R risk reduction, in particular, has a number of elements designed to prepare the community for the new data products, improve the prediction of tropical cyclone genesis, understanding its structure and changes in structure leading to improved predictions of both track and intensity forecasts using the enhanced GOES-R capabilities. Preparing forecasters to make optimal use of the new satellite radiances and products as soon after launch as possible has led to the creation of stunning imagery from JMA's Himawari-8 Advanced Baseline Imager. Another important aspect of this project is the synthetic imagery that uses cloud model output to extend the satellite radiances and thus provides an important tool for combining models and observations in a unique way that allows forecasters to assess forecast model quality by examining the continuity of the observed cloud fields as they loop from the present (observations) to the future (models). These

advances are further coupled to a strong program in education and training activities such as CIRA's participation in the Virtual Institute for Satellite Integration Training (VISIT), the Satellite Hydro-Meteorological training and education activity (SHyMET), and the International Virtual Laboratory (VLab)

- An area of great excitement continues to be the work being done with the Day/Night band of Suomi-NPP in preparation for JPSS. Not only is detection of smoke, dust, and fog possible at night but results appear far better than originally anticipated and have generated a lot of excitement in the community. Much work was done in this previous year related to quantifying the arctic winter clouds that are often difficult to detect with infra-red methods alone. The VIIRS Sensor is also being used extensively for more established applications related to Sea Surface Temperature and Ocean Color products produced by CIRA Research Scientists working directly with NOAA STAR employees in College Park, MD. Perhaps not evident when evaluating a single proposal, however, is the synergy that CIRA provides across projects through its internal communications and collaborations. A careful review of all the activities related to satellite algorithm development, training and education, however, clearly reveals these synergies and the benefits that these create on behalf of NOAA.
- A new area is the work being performed with NESDIS to support ATMS calibration standards. This work leverages strongly off CIRA's involvement with NASA's Global Precipitation Mission where significant effort was put into establishing a consistent calibration reference for microwave radiometers. Many of these methods are applicable to NOAA's mission as well and are being used to ensure that ATMS on JPSS is as accurately calibrated as possible.

NOAA Regional to Global Scale Model Research

- Vital collaboration with the ESRL Global Monitoring Division continued on CO₂ data assimilation and OSSE research as well as enhancements to the CarbonTracker (CT) program. Changes to the CT this year included a reworked architecture to separate the transport model from the flux inversion used to assimilate data. Portions of the PCTM and variational carbon data assimilation code were parallelized enabling faster turnaround on model results and analysis. Collaboration with the ESRL Physical Sciences Division was initiated on hydrologic research and applications development for the NOAA HMT, along with water resources applications outreach coordination involving the Russian River and California Integrated Water Resources Science and Services (IWRSS) Pilot and national-level eGIS activities.
- CIRA researchers took the lead in several technical and modeling programs within the Ensemble model research activities within the Developmental Testbed Center (DTC), the Aviation Weather Testbed (AWT) and the Hydro Met Testbed (HMT). CIRA researchers implemented changes to the HWRF work flow code to allow multiple storm information into the model. Research was begun to address what impact dynamic core adjustments have on the uncertainty in the NARRE (North American Rapid Refresh Ensemble) model. The NMMB research team created a user tutorial for model developers and advanced users. Along with NOAA researchers, the CIRA research team produced seven scientific presentations and tutorials.
- Project management, technical leadership and scientific research for the High Impact Weather Prediction Project (HIWPP), part of the Hurricane Sandy Supplemental funding work continued in 2015. Project reporting for this program is performed on a quarterly basis, with monthly updates provided during status phone calls. Research in OSSE's, high performance computing, information systems, global models, and model verification will be performed in 2016 for this program.
- CIRA researchers continue to provide scientific and technical leadership to the Flow Following Finite Icosahedral Model (FIM) research and development program. CIRA research focuses on forecast accuracy, high performance computing needed to execute this very large modeling system, and

methods required to diagnose and resolve atmospheric phenomenon using the FIM system. CIRA researchers also continued to develop, evaluate and support development of the NIM model.

- CIRA researchers are scientific and research team members who were awarded the prestigious Colorado Governor's CO-Labs research award for Scientific Sustainability for transitioning the High Resolution Rapid Refresh (HRRR) model into National Weather Service operations in 2015.
- Collaborative research with NOAA satellite testbeds (JCSDA, GRPG) continue to provide improved assimilation and understanding of the impact satellite observations have on predictive forecast models. GOES Satellite convective initiation information was assimilated into the RAP and HRRR models.
- Important model execution applications were developed by CIRA researchers to enable research to operations activities in the DTC. The Rocoto-based workflow was established on Zeus and Yellowstone supercomputers which provided enhanced model execution and evaluation.
- Contributions to NOAA's operational ensemble modeling systems were a focus for CIRA researchers who tested the use of stochastic physics in the NARRE ensemble models, and produced predictor criteria for a new set of ensemble-generated winter products (snow bands, precip type, etc.).

NOAA Data Distribution Research

- As part of the NWS NextGen Aviation Weather Program, CIRA researchers at ESRL continued their research into the technology and science of populating a four-dimensional airspace with atmospheric data, extraction methodologies, distribution formats, and input mechanisms to be used by aviation decision support systems. Technical and program leadership by CIRA researchers resulted in the assessment of real-time aviation weather forecast products and decision support tools that utilize verification information in a real-time, web-based tool (INSITE). Working with NOAA Subject Matter Experts (SMEs) they have automated the process to develop Product Description Documents (PDDs) describing the aviation weather parameters essential to the forecasters and end users of the NOAA and FAA NextGen weather information enterprise. Continued efforts to provide OGC compliant weather information saw CIRA researchers leading the effort to continue prototyping the IWXXM observation data format required by the international aviation weather community, including the transition of software to NOAA data providers and aviation weather users. In 2015, this program was integrated into MADIS and the NWS Integrated Dissemination Program (IDP).
- The MADIS (Meteorological Assimilation Data Ingest System) reached another critical milestone in 2015 by completing the final stage (Final Operating Capability) of a transition from research to NWS operations. The system has become an operational component of the NWS NCEP via the Integrated Dissemination Program (IDP).
- Via Sandy Supplemental and other NOAA programs, CIRA researchers have continued technical leadership and development of the NOAA Environmental Information System (NEIS). This capability relies on Unity3D, software that has traditionally been used for 3D video games, to present high-volume datasets in stunning displays. Important to the success of the NEIS system is the ability to manage and distribute real-time, global, high-resolution geophysical data. No other geophysical data system has the capabilities of NEIS. NEIS has been chosen as the primary method to distribute forecast model data from the High Impact Weather Prediction Project (HIWPP). Researchers and other trusted collaborators are using this system to visualize and evaluate global model data in real-time.
- The on-going partnership with the NWS Meteorological Development Lab continued on several fronts. CIRA researcher's program and technical leadership the Virtual Lab (VLab), the AutoNowCaster (ANC), Impacts Catalog and the new Weather Information Statistical Post Processing System

(WISPS) . VLab is now a required component in the transition of research to operations for the NWS AWIPS program. VLab Development Services established, developed and maintained by the CIRA research team has grown nearly 100% and now supports over 200 projects and 1400 developers. The CIRA research team members lead the design and development of the new Project Repository used by VLab developers. CIRA researchers are also leading the AWIPS II configuration management and governance system development.

- CIRA researchers continued close collaborations with research and operations personnel at the Aviation Weather Testbed at the NWS Aviation Weather Center in Kansas City, MO. Primary goals of the partnership are to actively engage in the research-to-operations process and to develop, test, and evaluate new and emerging scientific techniques, products, and services in support of the aviation weather community. Aviation Weather Research Program (AWRP) research and development efforts have been centered in two research areas; 1) Aviation Impact Variables (AIV's) which are tested during the AWC Summer and Winter Aviation Weather Experiments and include the development of the Collaborative Aviation Weather Statement (CAWS), and the development of International global turbulence algorithm development, 2) NWS NextGen aviation weather data format prototyping for international standards and efficient data and product distribution via the Integrated Dissemination Program (IDP) and the web. CIRA project lead at AWC, Ben Schewedler, won a CSU/CIRA special achievement award in 2015 for his work integrating research products into operational systems in the Aviation Weather Testbed.
- NextGen: CIRA researchers and software engineers at the AWC have led the effort to develop the tools to generate the forecast product, methods to disseminate the forecast information, and the web display capabilities for delivery to FAA and NWS operations. Research to operations development, testing and applications continue within the Integrated Dissemination Program (IDP), which has become the de facto operational data distribution and web hosting site for NWS public data delivery.

Climate and Weather Processes

- Much of this effort centered on getting better soil moisture using precipitation data from CIRA's "Citizen Science" project as well as improving drought and precipitation recurrence intervals from models and observations.

Data Assimilation

- Our Data Assimilation theme showcases developments of Ensemble Data Assimilation for Hurricane Forecasting as well as specific applications of these techniques with GOES data. While perhaps not completely evident from this report that focuses on accomplishments related to our NOAA grants, the Data Assimilation activity benefits tremendously from other funding sources that spur the theoretical innovation that is then applied to existing NOAA problems such as CO₂ data assimilation within NOAA's CarbonTracker program or the hybrid Variational-Ensemble Kalman Filter approach used to assimilate Lightning data

Our Outreach Program efforts continue to provide key technical and scientific leadership for the Science On a Sphere (SOS®) Program. While maintaining the continued production and delivery of real-time global weather models, researchers have developed additional real-time datasets including STEREO spacecraft data and the HIWPP global models. 16 new SOS systems were installed around the globe this year, bringing the total number of systems to over 130. Research was conducted to radically improve the SOS visual resolution by using a 4K projector. A NOAA/GSD Director's Fund Award was given to the SOS team to develop new higher resolution (8k) data sets for the Sphere.

Over the past year the CIRA group working with the National Park Service (NPS) continued its research on issues related to visibility and air quality at our Nation's National Parks. Their research, while focused on issues of importance to the National Park Service, overlaps considerably with a number of new CIRA

initiatives related to pollutant transport such as those related to fires that are of great interest to the Park Service and NOAA and thus continues to be an integral partner in what we do as CIRA.

The CloudSat Mission continues to enjoy strong support from NASA despite some anomalies with the spacecraft during the previous year. The CloudSat program, with its Data Processing Center running operationally at CIRA on behalf of NASA, has facilitated multiple research activities that are of benefit to NOAA. Chief among these is CIRA's ability to quickly make use of the CloudSat data to provide a unique validation for cloud base height retrievals produced by the VIIRS instrument on Suomi-NPP. In addition, CIRA has compiled a 6-year cloud-class dependent climatology of cloud geometric thickness, partitioned by season, latitude and surface type. This database will serve as an invaluable testbed for VIIRS Cloud retrievals that contains less information than is available for CloudSat.

Interspersed among these major research themes are important contributions from CIRA's NESDIS postdoctoral and young researcher program in data distribution, assimilation, and satellite algorithm development. Located in College Park, MD, and integrated closely with NOAA technical contacts at STAR, these scientists are immersed in research ranging from refinements to the Community Radiative Transfer Model (CRTM), data assimilation of cloudy radiances, satellite-based sea surface temperature (SST) algorithm development, techniques for monitoring and quality control of long term SST records, and ocean color algorithm development for global climate and coastal/in-land water ecosystem monitoring. Some of the techniques and web interfaces being developed by this outstanding group of Research Scientists is a constant reference source for other CIRA activities with similar objectives.

This Annual Report is the seventh in a series to be completed under CIRA's Cooperative Agreement established with NOAA. With this second report in the second five year lifecycle of the Cooperative Institute, we reestablish our commitment to the maintenance and growth of a strong collaborative relationship among NOAA, the Atmospheric Science Department at CSU, Departments of the University, and the other major programs within CIRA. As we pursue new directions of growth within our NOAA research themes, we look forward to the challenges and rewards for helping NOAA achieve its goals of understanding and predicting changes in climate, weather, oceans and coasts.

**CIRA'S NOAA TASK II RESEARCH ACTIVITY
APRIL 1, 2015 - MARCH 31, 2016**

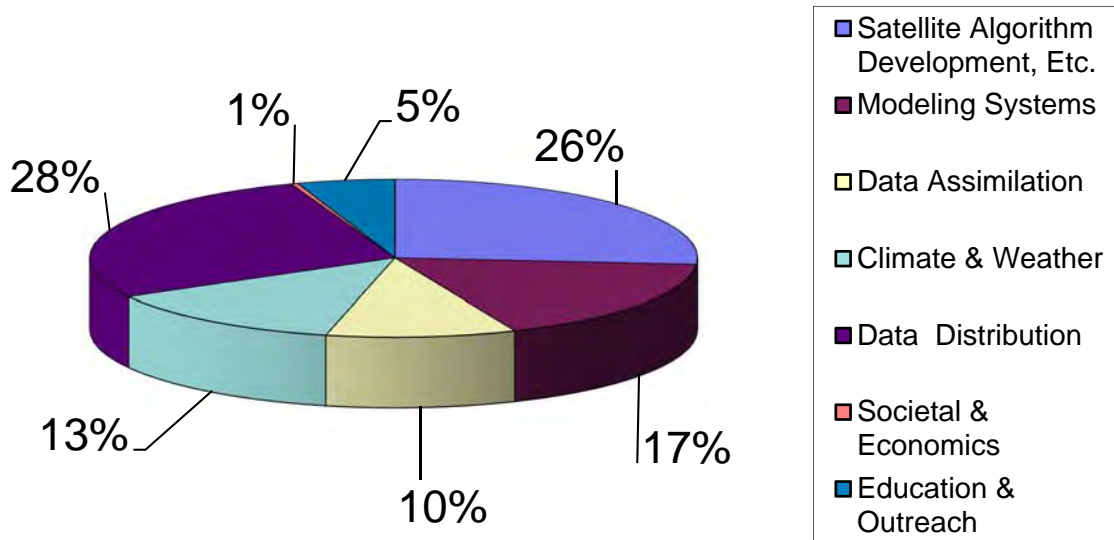

CIRA BOARD, COUNCIL, FELLOWS & BOARD MEETINGS

CIRA EXECUTIVE BOARD

Jeff Collett, Colorado State University
Department Head, Atmospheric Science
Jodie Hanzlik, Colorado State University
Dean, Graduate School
Mike Kalb, NOAA
Acting Director, NOAA/NESDIS/STAR
Kevin Kelleher, NOAA
Acting Director, ESRL
Christian Kummerow (ex officio), Colorado State University
Director, CIRA and Professor of Atmospheric Science
Bill Lapenta, NOAA
Director, National Centers for Environmental Prediction
David McLean, Colorado State University
Dean, Engineering
Alan Rudolph, Colorado State University
Vice President for Research

CIRA COUNCIL OF FELLOWS

V. Chandrasekar, Colorado State University
Department of Electrical and Computer Engineering
Don Hillger, Colorado State University
Acting Chief, NOAA/NESDIS/RAMM Branch
Sonia Kreidenweis-Dandy, Colorado State University
Professor, Department of Atmospheric Science
Christian Kummerow, Colorado State University
Director, CIRA and Professor of Atmospheric Science
John Schneider, NOAA
Chief, ESRL/GSD/Technology Outreach Branch
Pieter Tans, NOAA
Senior Scientist, Climate Monitoring and Diagnostics Lab
Fuzhong Weng, NOAA
Chief, NESDIS/STAR/Satellite Calibration and Data Assimilation Branch

CIRA FELLOWS

Mahmood Azimi-Sadjadi, Electrical & Computer Engineering, CSU
Daniel Birkenheuer, NOAA/ESRL/GSD
V. Chandrasekar, Electrical & Computer Engineering, CSU
Jeffrey Collett, Jr., Atmospheric Science Department, CSU
William Cotton, Atmospheric Science Department, CSU
Mark DeMaria, NOAA/NWS/NHC
Scott Denning, Atmospheric Science Department, CSU
Steven, Fassnacht, Ecosystem Science and Sustainability, CSU
Graham Feingold, NOAA/ESRL
Douglas Fox, Senior Research Scientist Emeritus, CIRA, CSU, USDA (Retired)
Jay Ham, Soil and Crop Sciences, CSU

Scott Hausman, NOAA/GSD
Richard Johnson, Atmospheric Science Department, CSU
Andrew Jones, Senior Research Scientist, CIRA, CSU
Pierre Y. Julien, Civil Engineering, CSU
Stanley Kidder, Senior Research Scientist, CIRA, CSU
Sonia Kreidenweis, Atmospheric Science Department, CSU
Christian Kummerow, CIRA Director, Atmospheric Science Department, CSU
Glen Liston, Senior Research Scientist, CIRA, CSU
Alexander "Sandy" MacDonald, NOAA
William Malm, Senior Research Scientist, CIRA; National Park Service (retired)
Steven Miller, CIRA Deputy Director, CSU
Roger Pielke, Sr., Senior Research Scientist, CIRES, U of Colorado
James Purdom, Senior Research Scientist, CIRA, CSU
Robert Rabin, NOAA/National Severe Storms Laboratory
Steven Rutledge, Atmospheric Science Department, CSU
John Schneider, NOAA/ESRL/Global Systems Division
George Smith, Riverside Technologies
Graeme Stephens, JPL and Atmospheric Science Department, CSU
Pieter Tans, NOAA/CMDL
Thomas Vonder Haar, CIRA Director Emeritus and Atmospheric Science Department, CSU
Fuzhong Weng, NOAA/NESDIS/STAR
Milija Zupanski, Senior Research Scientist, CIRA

Scheduled Meetings:

2015/16 Meeting of the CIRA Council – May 6, 2016
2015/16 Meeting of the CIRA Executive Board – May 26, 2016

TASK I – A COOPERATIVE INSTITUTE TO INVESTIGATE SATELLITE APPLICATIONS FOR REGIONAL/GLOBAL-SCALE FORECASTS

Task I activities are related to the administrative management of the CI. As reflected in the pie chart appearing earlier in this report, expenses covered by Task I are primarily salary and benefits, annual report production costs and some travel. This task also includes some support of postdoctoral and visiting scientists.

SEMINARS SUPPORTED BY TASK I

April 3, 2015, M.C. Facchini (NRC, Bologna). Aerosol Research at a Global Air Pollution Hotspot—The Po Valley, Italy.

April 10, 2015, C. Kutscher (NREL). Tackling Climate Change via the Rapid Transition to Energy Efficiency and Renewable Energy Technologies.

April 15, 2015, S. Longmore (CIRA). A Photo Storm Report Mobile Application, Processing/Distribution System, and AWIPS-II Display Concept.

April 17, 2015, J. Fleming (Colby College). The Emergence of Atmospheric Science.

April 20, 2015, S. Craig (Dalhousie University). Ocean Color: Photons, Phytoplankton and Climate.

April 23, 2015, R.M. Rauber (University of Illinois at Urbana-Champaign). Generating Cells and Elevated Convection in Winter Storms—Results from the Profiling of Winter Storms Experiment.

April 24, 2015, S. Freitas (NISR, Brazil). BRAMS Model Version 5.0: An Overview of the Model Development and Applications.

April 24, 2015, M. Steiner (NCAR). Lightning Impacts on Airline and Airport Operations.

May 1, 2015, C. Sorensen (Kansas State University). Of Soot and Sunflowers.

May 8, 2015, B. Geerts (University of Wyoming). Fine-scale Dynamical and Microphysical Processes of Snowfall from Shallow Orographic Clouds.

June 2, 2015, C. Hohenegger (Max Planck Institute). Convection and Land Sea Breezes.

July 9, 2015, T. L'Ecuyer (University of Wisconsin-Madison). New Satellite Perspectives on the Arctic Energy and Water Cycles.

August 26, 2015, A.O. Fierro (CIMMS). Explicit Electrification and Lightning in a 350m WRF-ARW Simulation of Hurricane Issac (2012): Comparisons with Observations and Relationships with Microphysics and Kinematics.

August 27, 2015, S. Albers (CIRA, Boulder/NOAA). Weather and All-Sky Imagery—A Comparison of Observed and Local Analysis and Prediction Systems (LAPS) Simulated Clouds.

September 4, 2015, D. Hillger, J. Knaff, D. Lindsey, S. Miller, M. Rogers, J. Hand, K. Apodaca (CIRA). Overview of Current Research Within CIRA.

September 11, 2015, R.A. Pielke, Sr. (University of Colorado/CIRES). Climate Threats: A More Inclusive Assessment is Needed.

September 18, 2015, E. Thoma (EPA). Next Generation Air Measurements for Fugitive, Area Source, and Fence Line Applications.

September 25, 2015, R. Randall and D. Doughty (ARL/ASC). Army Research Laboratory—Atmospheric Science Center’s Meteorological Sensor Array.

September 25, 2015, A. Koss (CIRES). Air Quality Impacts of Oil and Natural Gas Extraction.

September 28, 2015, B. Rabin (NSSL). Simultaneous 1-minute Observations of the 20-21 May 14 Colorado Supercell Storms from GOES-14, Lightning Mapping Array, TDWR and WSR-88D Data.

October 2, 2015, B. Bloodhart (CSU). The Psychology of Climate Change Communication: Motivations for Pro-environmental Attitudes and Behaviors.

October 3, 2015, S. Denning (CSU). Climate Change: Simple, Serious, and Solvable.

October 16, 2015, J.M. Keeler (University of Illinois). Radiative and Instability Forcing of Cloud-top Generating Cells in Winter Cyclones.

October 23, 2015, J.H. Richter (NCAR). Impacts of a Better-resolved Stratosphere on El Nino Teleconnections.

November 6, 2015, K. Schaefer (NOAA/NSIDC). The Impact of the Permafrost Carbon Feedback on Global Climate.

November 13, 2015, R. Aster (CSU). The Ubiquity of Seismology.

November 20, 2015, H. Vömel (UCAR). Stratospheric Water Vapor Processes and Trends from in situ Observations.

December 3, 2015, A.D. Nugent (NSF/NCAR). Orographic Convection and Precipitation in the Tropics: Wind Speed Control and Aerosol Interactions.

December 4, 2015, I. Simpson (NCAR). The Mid-latitude Circulation Response to Global Warming and Implications for Regional Hydroclimate.

December 11, 2015, L.E. Gratz (Colorado College). Atmospheric Mercury from the Boundary Layer to the Free Troposphere: Airborne Observations of Emissions, Transport, and Chemistry.

January 22, 2016, W. Cantrell (Michigan Technological University). Cloud Physics and Chemistry from Single Droplets and Crystals to a Few Cubic Centimeters.

January 26, 2016, L.A. Remer (JCET-UMBC). Aerosols and Climate Forcing: New Thoughts, Future Direction.

February 4, 2016, J. Burks (NASA). Just in Time Training Plugin Developed for AWIPS2.

February 4, 2016, K. Sperow (NWS/CIRA/MDL). New Features of the NWS Virtual Lab (VLAB).

February 5, 2016, C. Hoffman (CSU). Predicting the Spread of Wildfires: The Importance of Fire Interactions with the Atmosphere, Ecosystems, and Topography.

February 15, 2016, K. Rasmussen (NCAR). The Global Nature of Convection: Perspectives from the TRMM Satellite.

February 22, 2016, P. Gentine (Columbia University). Biosphere-atmosphere Interactions and Seasonability in the Continental Tropics.

February 25, 2016, B. Crawford (University of Reading). Surface-atmosphere Exchanges of Energy and Carbon in Urban Environments

March 7, 2016, M. Bell (University of Hawaii at Manoa). New Insights into Tropical Clouds and Hurricanes Using Polarimetric Radar.

March 21, 2016, A.A. Wing (NSF, Lamont-Doherty). Organization of Tropical Convection: Self-aggregation and Spontaneous Tropical Cyclogenesis.

March 31, 2016, P. Stoy (Montana State University). Toward an Improved Understanding of the Role of Surface-atmosphere Exchange in Climate Services.

**CIRA'S NOAA TASK I EXPENSES BY ACTIVITY
APRIL 1, 2015 - MARCH 31, 2016**

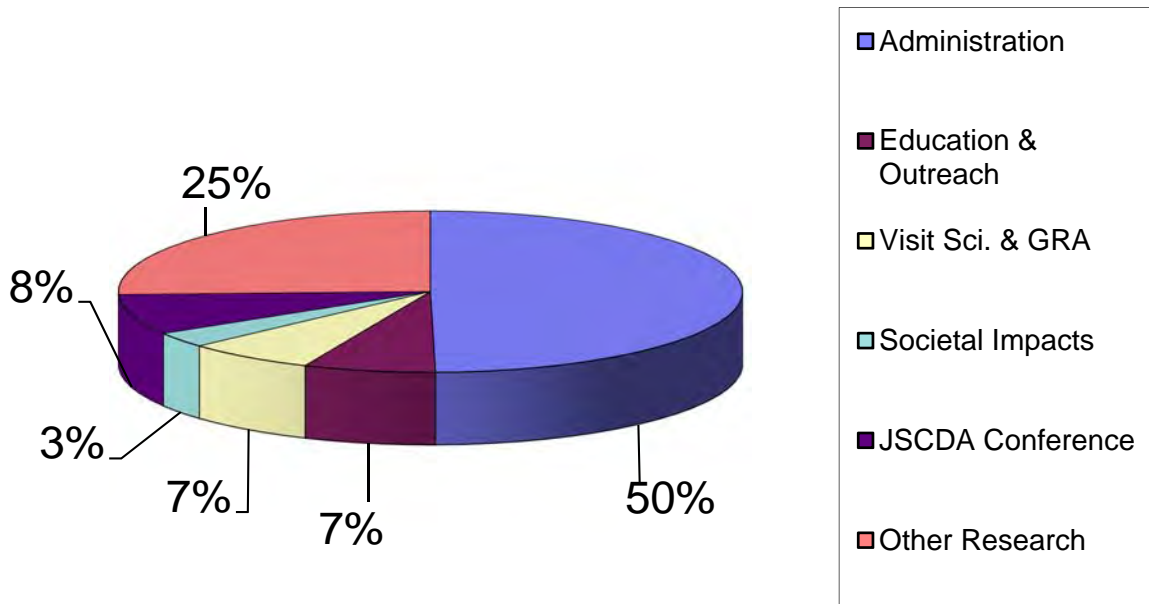

TABLE OF CONTENTS

INTRODUCTION

Director's Message	ii
Institute Description and Core Activities	iii
Education, Training and Outreach	iv
NOAA Award Numbers	xiv
Vision and Mission	xvi
Organizational Structure	xvii
Executive Summary	xviii
Task and Theme Pie Chart	xxiii
Board, Council, Fellows	xxiv
Task I Report and Pie Chart	xxvi
Table of Contents	xxx

NOAA AWARD NUMBERS AND AMENDMENTS FOR REPORT PROJECTS	1
--	----------

AWARDS ENDING PROJECT LIST	12
-----------------------------------	-----------

RESEARCH THEME REPORTS	13
-------------------------------	-----------

APPENDICES:

Publications Summary Matrix	323
Employee Matrix	324
Other Agency Awards	325
Projects by Title and Page Number	329
Competitive Project List and Reports	332

NOAA AWARD NUMBERS & AMENDMENTS FOR REPORT PROJECTS

NA14OAR4320125	Cooperative Agreement	A Cooperative Institute to Investigate Satellite Applications for Regional/Global-Scale Forecasts	Chris Kummerow (Lead), Steven Miller
NA15OAR4590152	Competitive	Assessment of Gridded Hydrological Modeling for NWS Flash Flood Operations	L. Johnson
NA10SEC0080012	Competitive	CoCoRaHs: Capitalizing on Technological Advancements to Expand Environmental Literacy through a Successful Citizen Science Network	Chris Kummerow (Lead), Nolan Doesken
NA15OAR4310099	Competitive	Development of a Framework for Process-oriented Diagnosis of Global Models	Eric Maloney
NA14OAR4310148	Competitive	Following Emissions from Non-traditional Oil and Gas Development Through Their Impact on Tropospheric Ozone	Emily Fischer, Delphine Farmer
NA13OAR4590187	Competitive	Guidance on Intensity Guidance	Andrea Schumacher
NA15OAR4590200	Competitive	Improvement and Implementation of the Probability-based Microwave Ring Rapid Intensification Index for NHC/JTWC Forecast Basins	Kate Musgrave
NA15OAR4590202	Competitive	Improvement to the Tropical Cyclone Genesis Index (TCGI)	Andrea Schumacher
NA15OAR4590204	Competitive	Improvements to Operational Statistical Tropical Cyclone Intensity Forecast Models	Galena Chirokova, Andrea Schumacher
NA13OAR4310080	Competitive	Improving CarbonTracker Flux Estimates for North Americas Using Carbonyl Sulfide (OCS)	Ian Baker
NA12OAR4310077	Competitive	Intraseasonal to Interannual Variability in the Intra-Americas Sea in Climate Models	Eric Maloney
NA15OAR4590233	Competitive	Multi-disciplinary Investigation of Concurrent Tornadoes and Flash Floods in the Southeastern US	Russ Schumacher
NA14OAR4310141	Competitive	Observational Constraints on the Mechanisms that Control Size- and Chemistry-resolved Aerosol Fluxes Over a Colorado Forest	Delphine Farmer
NA13OAR4310103	Competitive	Research to Advance Climate and Earth System Models Collaborative Research: A CPT for Improving Turbulence and Cloud Processes in the NCEP Global Models	David Randall

NOAA AWARD NUMBERS & AMENDMENTS FOR REPORT PROJECTS

NA13OAR4310077	Competitive	Towards Assimilation of Satellite, Aircraft and Other Upper-air CO2 Data into CarbonTracker	David Baker
NA13OAR4590190	Competitive	Upgrades to the Operational Monte Carlo Wind Speed Probability Program	Andrea Schumacher
NA13OAR4310163	Competitive	Use of the Ocean-Land-Atmosphere Model (OLAM) with Cloud System-resolving Refined Local Mesh to Study MJO Initiation	Eric Maloney

NOAA AWARD NUMBERS & AMENDMENTS FOR REPORT PROJECTS

[Amendments Award #NA14OAR4320125](#)

Type	ID	Title	Status
Award Package	2478931	A Cooperative Institute to Investigate Satellite Applications for Regional/Global-Scale Forecasts	Accepted
Special Award Condition Report	2478931	Special Award Condition Report	
Award File 0	2478815	A Cooperative Institute to Investigate Satellite Applications for Regional/Global-Scale Forecasts	Accepted
Award File 1	2486219	Blended Hydrometeorological Products	Accepted
Award File 2	2487155	CIRA support: Getting Ready for NOAA's Advanced Remote Sensing Programs	Accepted
Award File 3	2488641	A Satellite Hydro-Meteorology (SHyMet) Education and Outreach Proposal CIRA Support for the JPSS Proving Ground and Risk Reduction Program: Application of JPSS Imagers and Sounders to Tropical Cyclone Track and Intensity Forecasting	Accepted
Award File 4	2491422	A Cooperative Institute to Investigate Satellite Applications for Regional/Global-Scale Forecasts	Accepted
Award File 5	2489188	CIRA Support of NOAA's commitment to the Coordination Group for Meteorological Satellites: Enhancing the International Virtual Laboratory	Accepted
Award File 6	2495512	A Cooperative Institute to Investigate Satellite Applications for Regional/Global-Scale Forecasts	Accepted
Award File 7	2488558	CIRA Support to the JPSS Proving Ground and Risk Reduction Program: Seeing the Light: Exploiting VIIRS Day/Night Band	Accepted
Award File 8	2489265	CIRA Support of the Virtual Institute for Satellite Integration Training (VISIT)	Accepted
Award File 9	2488553	SSMI and SSMIS Fundamental Climate Data Record Sustainment and Maintenance	Accepted
Award File 10	2489670	Algorithm development for AMSR-2	Accepted
Award File 11	2489691	Weather Satellite Data and Analysis Equipment and Support for Research Activities	Accepted
Award File 12	2489082	CIRA Support for Feature-Based Validation of MIRS Soundings for Tropical Cyclone Analysis and Forecasting	Accepted
Award File 13	2489686	Support for the 2015 JCSDA Summer Colloquium to be hosted by CIRA	Accepted

NOAA AWARD NUMBERS & AMENDMENTS FOR REPORT PROJECTS

Award File 14	2489681	Applications of concurrent super rapid sampling from GOES-14 SRSOR, radar and lightning data	Accepted
Award File 15	2486813	CIRA Support to a GOES-R Proving Ground for National Weather Service Forecaster Readiness	Accepted
Award File 16	2486808	CIRA Support for Tropical Cyclone Model Diagnostics and Product Development	Accepted
Award File 17	2488603	CIRA Support to the JPSS Science Program: S-NPP VIIRS EDR Imagery Algorithm and Validation Activities and S-NPP VIIRS Cloud Validation	Accepted
Award File 18	2489060	CIRA Support for Research and Development for GOES-R Risk Reduction for Mesoscale Weather Analysis and Forecasting	Accepted
Award File 19	2496525	A Cooperative Institute to Investigate Satellite Applications for Regional/Global-Scale Forecasts	Accepted
Award File 20	2495520	CIRA Support to the NESDIS Cooperative Research Exchange Program	Accepted
Award File 21	2497195	A Cooperative Institute to Investigate Satellite Applications for Regional/Global-Scale Forecasts	Accepted
Award File 22	2497181	A Cooperative Institute to Investigate Satellite Applications for Regional/Global-Scale Forecasts	Accepted
Award File 23	2496807	A Cooperative Institute to Investigate Satellite Applications for Regional/Global-Scale Forecasts	Accepted
Award File 24	2495693	EOY CIRA Support to RAMMB Infrastructure for GOES-R Rebroadcast Data Collection at CIRA/CSU	Accepted
Award File 25	2496490	NESDIS Environmental Applications Team (NEAT)	Accepted
Award File 26	2496040	Explicit Forecasts of Recurrence Intervals for Rainfall: Evaluation and Implementation Using Convection-allowing Models	Accepted
Award File 27	2495157	Building a "citizen science" soil moisture monitoring system utilizing the Community Collaborative Rain, Hail and Snow Network (CoCoRaHS)	Accepted
Award File 28	2496378	Estimating Peatland Fire Emissions Using Nighttime Satellite Data	Accepted
Award File 29	2496383	Integrating GPM and Orographic Lifting into NOAA's QPE in Mountainous Terrain	Accepted
Award File 30	2495162	Instructional Development and Learning Support for NOAA's OMAO's Chief Learning Officer (CLO), OMAO Kansas City, Missouri	Accepted

NOAA AWARD NUMBERS & AMENDMENTS FOR REPORT PROJECTS

Award File 31	2465060	CIRA Research Collaborations with the NWS Meteorological Development Lab on Virtual Laboratory, Innovation Web Portal, and AWIPS II Projects	Accepted
Award File 32	2490588	CIRA Research Collaborations with the NWS Meteorological Development Lab on Virtual Laboratory, and AWIPS II Projects	Accepted
Award File 33	2491622	Environmental Applications Research (EAR)	Accepted
Award File 34	2491359	Research Collaboration at the NWS Aviation Weather Center in Support of the Aviation Weather Testbed, Aviation Weather Research Program, and the NextGen Weather Program	Accepted
Award File 35	2496023	Hydrologic and Water Resources Research and Applications Outreach	Accepted
Award File 36	2501944	A Cooperative Institute to Investigate Satellite Applications for Regional/Global-Scale Forecasts	Accepted
Award File 37	2514836	Research Collaboration at the NWS Aviation Weather Center in Support of the Aviation Weather Testbed, Aviation Weather Research Program, and the NextGen Weather Program	Accepted
Award File 38	2513184	Environmental Applications Research (EAR)	Accepted
Award File 39	2515553	A Cooperative Institute to Investigate Satellite Applications for Regional/Global-Scale Forecasts	Accepted
Award File 40	2522402	Environmental Applications Research (EAR)	Accepted
Award File 41	2523066	Research Collaboration at the NWS Aviation Weather Center in Support of the Aviation Weather Testbed, Aviation Weather Research Program, and the NextGen Weather Program	Accepted
Award File 42	2524140	A Cooperative Institute to Investigate Satellite Applications for Regional/Global-Scale Forecasts	Accepted
Award File 43	2526318	Environmental Applications Research (EAR)	Accepted
Award File 44	2534850	SSMI and SSMIS Fundamental Climate Data Record Sustainment and Maintenance	Accepted
Award File 45	2534835	Weather Satellite Data and Analysis Equipment and Support for Research Activities	Accepted
Award File 46	2527895	Hydrometeorological and Water Resources Research	Accepted
Award File 47	2528844	CIRA Support to a GOES-R Proving Ground for National Weather Service Forecaster Readiness	Accepted
Award File 48	2537730	Environmental Applications Research (EAR)	Accepted

NOAA AWARD NUMBERS & AMENDMENTS FOR REPORT PROJECTS

Award File 49	2529388	Blended Hydrometeorological Products	Accepted
Award File 50	2539333	Applications of concurrent super rapid sampling from GOES-14 SRSOR, radar and lightning data	Accepted
Award File 51	2534840	CIRA Support to RAMMB Infrastructure for GOES-R Rebroadcast Data Collection at CIRA/CSU	Accepted
Award File 52	2537750	CIRA Support for Research and Development for GOES-R Risk Reduction for Mesoscale Weather Analysis and Forecasting	Accepted
Award File 53	2534845	CSU/CIRA support for ATMS SI traceable calibration effort	Accepted
Award File 54	2541040	Instructional Development and Learning Support for NOAA's OMAO's Chief Learning Officer (CLO), OMAO Kansas City, Missouri	Accepted
Award File 55	2545352	Environmental Applications Research (EAR)	Accepted
Award File 56	2544741	Environmental Applications Research (EAR)	Accepted
Award File 57	2537745	CIRA Support to the JPSS Proving Ground and Risk Reduction Program: Seeing the Light: Exploiting VIIRS Day/Night Band	Accepted
Award File 58	2543413	Expanding precipitation measurements in the Commonwealth Of The Bahamas through the CoCoRaHS (Community Collaborative Rain, Hail and Snow) network	Accepted
Award File 59	2538448	JCSDA Observing System Assessment Standing Capability	Accepted
Award File 60	2539540	Enhancing NIDIS drought monitoring and early warning in the Upper Colorado River basin	Accepted
Award File 61	2540022	CIRA Support: Getting Ready for NOAA's Advanced Remote Sensing Programs. A Satellite Hydro-Meteorology (SHyMet)	Accepted
Award File 62	2543403	Tropical Cyclone Model Diagnostics and Product Development	Accepted
Award File 63	2547742	Hydrometeorological and Water Resources Research	Accepted
Award File 64	2539141	CIRA Support to the JPSS STAR Science Program: S-NPP VIIRS EDR Imagery Algorithm and Validation Activities	Accepted
Award File 65	2546014	NESDIS Environmental Applications Team (NEAT)	Accepted
Award File 66	2543660	CIRA Support to the JPSS Proving Ground and Risk Reduction Program: Integration of JPSS Experimental Products in AWIPS II through EPDT Code Sprints	Accepted
Award File 67	2543675	CIRA Support to the JPSS Proving Ground and Risk Reduction Program: Improving NUCAPS Soundings for CONUS Severe Weather Applications via Data Fusion	Accepted

NOAA AWARD NUMBERS & AMENDMENTS FOR REPORT PROJECTS

Award File 68	2543655	CIRA Support to the JPSS Proving Ground and Risk Reduction Program: Improving Tropical Cyclone Forecast Capabilities Using the JPSS Data Suite	Accepted
Award File 69	2543408	CIRA Support for Dynamical Core Selection for the Next Generation Global Prediction System (NGGPS)	Accepted
Award File 70	2543842	CIRA Support to the JPSS Proving Ground and Risk Reduction Program: JPSS Satellite Training for NOAA Users	Accepted
Award File 71	2546556	CIRA Support to the JPSS Proving Ground and Risk Reduction Program:	Accepted
Award File 72	2542195	Addressing NWS Desires for a Cloud Cover Layers Product using Merged VIIRS and ATMS Products CIRA Support of Virtual Institute for Satellite Integration Training (VISIT)	Accepted
Award File 73	2543680	Using JPSS Retrievals to Implement a Multisensor, Synoptic, Layered Water Vapor Product for Forecasters	Accepted
Award File 74	2548421	CIRA Support to the NESDIS Cooperative Research Exchange Program	Accepted
Award File 75	2547800	CIRA Research Collaborations with the NWS Meteorological Development Lab on Virtual Laboratory, and AWIPS II Projects	Accepted
Award File 76	2551024	CIRA Research Collaborations with the NWS Meteorological Development Lab on Virtual Laboratory, and AWIPS II Projects	Accepted
Award File 77	2548825	CIRA Support for Feature-Based Validation of MIRS Soundings for Tropical Cyclone Analysis and Forecasting	Accepted
Award File 78	2549707	NESDIS Environmental Applications Team (NEAT)	Accepted
Award File 79	2551561	A Cooperative Institute to Investigate Satellite Applications for Regional/Global-Scale Forecasts	Accepted
Award File 80	2539242	Research Collaboration at the NWS Aviation Weather Center in Support of the Aviation Weather Testbed	Accepted
Award File 81	2546546	EOY StAR Project: CIRA Support to RAMMB Infrastructure for GOES-R Rebroadcast Data Collection at CIRA/CSU	Accepted
Award File 82	2546551	CIRA Support of NOAA's commitment to the Coordination Group for Meteorological Satellites: Enhancing the International Virtual Laboratory	Accepted
Award File 83	2564667	Environmental Applications Research (EAR)	Accepted
Award File 84	2567423	Environmental Applications Research (EAR)	Accepted
Award File 85	2571981	A Cooperative Institute to Investigate Satellite Applications for Regional/Global-Scale Forecasts	Accepted
Award File 86	2573606	Hydrometeorological and Water Resources Research	Accepted

NOAA AWARD NUMBERS & AMENDMENTS FOR REPORT PROJECTS

Amendments Award #NA10SEC0080012

Type	ID	Title	Status
Award Package	2206902	CoCoRaHS: Capitalizing on Technological Advancements to Expand Environmental Literacy through a successful Citizen Science Network	Expired
Award File 0	2204691	CoCoRaHS: Capitalizing on Technological Advancements to Expand Environmental Literacy through a successful Citizen Science Network	Accepted
Award File 1	2235870	CoCoRaHS: Capitalizing on Technological Advancements to Expand Environmental Literacy through a successful Citizen Science Network	Accepted
Award File 2	2242430	CoCoRaHS: Capitalizing on Technological Advancements to Expand Environmental Literacy through a successful Citizen Science Network	Accepted
Award File 3	2501466	CoCoRaHS: Capitalizing on Technological Advancements to Expand Environmental Literacy through a successful Citizen Science Network	Accepted

Amendments Award #NA14OAR4310148

Type	ID	Title	Status
Award Package	2494494	Following Emissions from Non-Traditional Oil and Gas Development Through their Impact on Tropospheric Ozone	Accepted
Award File 0	2481822	Following Emissions from Non-Traditional Oil and Gas Development Through their Impact on Tropospheric Ozone	Accepted
Award File 1	2523977	Following Emissions from Non-Traditional Oil and Gas Development Through their Impact on Tropospheric Ozone	Accepted
Award File 2	2562067	Following Emissions from Non-Traditional Oil and Gas Development Through their Impact on Tropospheric Ozone	Accepted

NOAA AWARD NUMBERS & AMENDMENTS FOR REPORT PROJECTS

Amendments Award #NA13OAR4590187

Type	ID	Title	Status
Award Package		Guidance on Intensity Guidance	Accepted
Award File 0		Guidance on Intensity Guidance	Accepted
Award File 1		Guidance on Intensity Guidance	Accepted

Amendments Award #NA13OAR4310080

Type	ID	Title	Status
Award Package	2442452	Improving CarbonTracker Flux Estimates for North America using Carbonyl Sulfide (OCS)	Accepted
Award File 0	2428639	Improving CarbonTracker Flux Estimates for North America using Carbonyl Sulfide (OCS)	Accepted
Award File 1	2472074	Improving CarbonTracker Flux Estimates for North America using Carbonyl Sulfide (OCS)	Accepted
Award File 2	2523613	Improving CarbonTracker Flux Estimates for North America using Carbonyl Sulfide (OCS)	Accepted

Amendments Award #NA12OAR4310077

Type	ID	Title	Status
Award Package	2295418	Intraseasonal to Interannual Variability in the Intra-Americas Sea in Climate Models	Accepted
Award File 0	2286273	Intraseasonal to Interannual Variability in the Intra-Americas Sea in Climate Models	Accepted
Award File 1	2434069	Intraseasonal to Interannual Variability in the Intra-Americas Sea in Climate Models	Accepted
Award File 2	2473579	Intraseasonal to Interannual Variability in the Intra-Americas Sea in the Climate Models	Accepted
Award File 3	2485114	Intraseasonal to Interannual Variability in the Intra-Americas Sea in Climate Models	Accepted
Award File 4	2526903	Intraseasonal to Interannual Variability in the Intra-Americas Sea in the Climate Models	Accepted

NOAA AWARD NUMBERS & AMENDMENTS FOR REPORT PROJECTS

[Amendments Award #NA14OAR4310141](#)

Type	ID	Title	Status
Award Package	2495278	Observational constraints on the mechanisms that control size- and chemistry-resolved aerosol fluxes over a Colorado forest	Accepted
Award File 0	2481792	Observational constraints on the mechanisms that control size- and chemistry-resolved aerosol fluxes over a Colorado forest	Accepted
Award File 1	2523653	Observational constraints on the mechanisms that control size- and chemistry-resolved aerosol fluxes over a Colorado forest	Accepted
Award File 2	2562129	Observational constraints on the mechanisms that control size- and chemistry-resolved aerosol fluxes over a Colorado forest	Accepted

[Amendments Award #NA13OAR4310103](#)

Type	ID	Title	Status
Award Package	2445121	A CPT for Improving Turbulence and Cloud Processes in the NCEP Global Models	Accepted
Award File 0	2437060	A CPT for Improving Turbulence and Cloud Processes in the NCEP Global Models	Accepted
Award File 1	2479399	A CPT for Improving Turbulence and Cloud Processes in the NCEP Global Models	Accepted
Award File 2	2526839	A CPT for Improving Turbulence and Cloud Processes in the NCEP Global Models	Accepted

NOAA AWARD NUMBERS & AMENDMENTS FOR REPORT PROJECTS

Amendments Award #NA13OAR4310077

Type	ID	Title	Status
Award Package	2437319	Towards Assimilation of Satellite, Aircraft, and Other Upper-air CO2 Data into CarbonTracker	Accepted
Award File 0	2428619	Towards Assimilation of Satellite, Aircraft, and Other Upper-air CO2 Data into CarbonTracker	Accepted
Award File 1	2464196	Towards Assimilation of Satellite, Aircraft, and Other Upper-air CO2 Data into CarbonTracker	Accepted
Award File 2	2526909	Towards Assimilation of Satellite, Aircraft, and Other Upper-air CO2 Data into CarbonTracker	Accepted

Amendments Award #NA13OAR4590190

Type	ID	Title	Status
Award Package	2446617	Upgrades to the Operational Monte Carlo Wind Speed Probability Program	Accepted
Award File 0	2444326	Upgrades to the Operational Monte Carlo Wind Speed Probability Program	Accepted
Award File 1	2488670	Upgrades to the Operational Monte Carlo Wind Speed Probability Program	Accepted

Amendments Award #NA13OAR4310163

Type	ID	Title	Status
Award Package	2445809	Use of the Ocean-Land-Atmosphere Model (OLAM) with Cloud System-Resolving Refined Local Mesh to Study MJO Initiation.	Accepted
Award File 0	2441730	Use of the Ocean-Land-Atmosphere Model (OLAM) with Cloud System-Resolving Refined Local Mesh to Study MJO Initiation.	Accepted
Award File 1	2487251	Use of the Ocean-Land-Atmosphere Model (OLAM) with Cloud System-Resolving Refined Local Mesh to Study MJO Initiation.	Accepted

AWARDS ENDING PROJECT LIST

NA14OAR4320125

Algorithm Development for AMSR-2

CIRA Support to the JPSS Proving Ground and Risk Reduction Program: Addressing NWS Desires for a Cloud Cover Layers Product Using Merged VIIRS and ATMS Products

CIRA Support to the JPSS Proving Ground and Risk Reduction Program: Improving NUCAPS Soundings for CONUS Severe Weather Applications via Data Fusion

NA10SEC0080012

CoCoRaHS: Capitalizing on Technological Advancements to Expand Environmental Literacy Through a Successful Citizen Science Network

NA13OAR4590187

Guidance on Intensity Guidance

RESEARCH THEME REPORTS

Satellite Algorithm Development, Training and Education NOAA Goal 2: Weather Ready Nation	14
Regional to Global-scale Modeling Systems NOAA Goal 2: Weather Ready Nation	197
Data Assimilation NOAA Goal 2: Weather Ready Nation	213
Climate-Weather Processes NOAA Goal 3: Climate Adaptation and Mitigation	230
Data Distribution NOAA Goal 5: NOAA Enterprise-wide Capabilities: Science and Technology Enterprise, Engagement Enterprise, Organization and Administration Enterprise	247

SATELLITE ALGORITHM DEVELOPMENT, TRAINING & EDUCATION

Research associated with development of satellite-based algorithms for weather forecasting, with emphasis on regional and mesoscale meteorological phenomenon. This work includes applications of basic satellite products such as feature track winds, thermodynamic retrievals, sea surface temperature, etc., in combination with model analyses and forecasts, as well as in situ and other remote sensing observations. Applications can be for current or future satellites. Also under this theme, satellite and related training material will be developed and delivered to a wide variety of users, with emphasis on operational forecasters. A variety of techniques can be used, including distance learning methods, web-based demonstration projects and instructor-led training.

PROJECT TITLE: Algorithm Development for AMSR-2

PRINCIPAL INVESTIGATOR: Christian Kummerow

RESEARCH TEAM: David Duncan, ATS & David Randel, ATS

NOAA TECHNICAL CONTACT: Ralph Ferraro, NOAA NESDIS

NOAA RESEARCH TEAM: Ralph Ferraro, NOAA NESDIS

FISCAL YEAR FUNDING: \$0

PROJECT OBJECTIVE:

The Japanese Aerospace Exploration Agency (JAXA) launched the AMSR-2 instrument aboard its GCOM-W satellite in February 2012. This proposal consisted of an effort to (a) Assess the quality of the AMSR2 calibration and (b) adapt the Goddard Profiling Algorithm (GPROF) for use in the NESDIS AMSR-2 processing stream.

RESEARCH ACCOMPLISHMENTS:

The assessment of AMSR-2 calibration continued in light of the fact that rainfall retrievals from AMSR-E and AMSR-2 were quite different despite good agreement for non-raining parameters as reported in the previous year. While indications were that this was due to non-linearities in the calibration curve that have not been properly captured by the JAXA team, this non-linearity was finally established to be too small to significantly impact the algorithm.

While work is ongoing in the area of assessing the impact of calibration on the algorithm, a probability matching approach was used to deliver the AMSR-2 code to NESDIS. In this way, the same pdf of rain rates is retrieved for both AMSR-E and AMSR2 even if some of the basic differences are not yet fully understood. The code was made available to NESDIS in June 2015. We plan to continue supporting the delivery as needed.

Publications:

Kummerow, Christian D., David L. Randel, Mark Kulie, Nai-Yu Wang, Ralph Ferraro, S. Joseph Munchak, and Veljko Petkovic, 2015: The evolution of the goddard profiling algorithm to a fully parametric scheme. *J. Atmos. Oceanic Technol.*, **32**, 2265–2280.
doi: <http://dx.doi.org/10.1175/JTECH-D-15-0039.1>

PROJECT TITLE: Applications of Concurrent Super Rapid Sampling from GOES-14 SRSOR, Radar and Lightning Data

PRINCIPAL INVESTIGATOR: Sher Schranz

RESEARCH TEAM: Steve Albers

NOAA TECHNICAL CONTACT: Bob Rabin (NSSL)

FISCAL YEAR FUNDING: \$25,000

PROJECT OBJECTIVES:

Applications of Concurrent Super Rapid Sampling from GOES-14 SRSOR Radar and Lightning Data
CIRA is leading GSD's role as a Co-PI in a NESDIS funded project to utilize high-frequency radar and satellite data to initialize LAPS/WRF simulations. The main goal is to assess the impact of Atmospheric Motion Vector (AMV) data from the rapid scan GOES data to help preview what we'll be getting with GOES-R. This is in collaboration with NSSL. We have been gathering data for several Local Analysis and Prediction System (LAPS) case reruns, starting with the Moore tornado case from May 20, 2013. This involves retrieving routinely archived observational data from NOAA's High Performance Computing Mass Storage. In addition, Level-II Doppler radar data are being obtained from the National Climatic Data Center. Our processing scripts are being updated to support the new Java application for converting this into NetCDF. Special cloud-drift wind data from the 1-minute GOES-R data have also been reformatted to be readable by LAPS. Preliminary reanalysis runs with the routinely archived data have been performed. We've also tested with running the LAPS initialized WRF forecast on this case.

Additional cases have been selected for several days in 2014, and the GOES-R cloud-drift wind data have been processed. We ran the LAPS analyses for May 20 and May 21, and are presently assessing the results. Real-time analysis and possibly forecast runs are being planned during 2016 using the AMVs.

PROJECT TITLE: CIRA Support for Dynamical Core Selection for the Next Generation Global Prediction System (NGGPS)

PRINCIPAL INVESTIGATOR: Renate Brummer

RESEARCH TEAM: Renate Brummer, John Thurn

NOAA TECHNICAL CONTACT: Fred Toepfer (NOAA/NCEP/EMC) and Candice Jongsma (NOAA/OAR)

NOAA RESEARCH TEAM: Fred Toepfer (NOAA/NCEP/EMC)

FISCAL YEAR FUNDING: \$36,400

PROJECT OBJECTIVES:

As part of a Research to Operations (R2O) Initiative, the National Weather Service (NWS) plans to produce a state-of-the-art next generation global prediction system (NGGPS) which will be readily adaptable to and scalable on evolving high-performance computing (HPC) architectures. The NGGPS will be designed to produce useful forecast guidance to 30 days, as well as become the foundation for the operating forecast guidance system for the next several decades. Current research and development efforts both inside and outside NWS, including the Navy, NOAA laboratories, National Center for Atmospheric Research (NCAR), the university research community, and other partnership efforts, will contribute to the development of this prediction system.

Selecting a non-hydrostatic atmospheric dynamic core (dycore) was the first step in building the NGGPS. Six dycores currently being developed and modified from a variety of institutions are viewed as potential candidates to be evaluated for the new system. The NGGPS Dycore Testing Plan guided the testing of these dycores and leverage ongoing High-Impact Weather Prediction Project (HIWPP) activities in the evaluation of the dycores.

PROJECT ACCOMPLISHMENTS:

Objective and unbiased assessment of the test and evaluation results is essential to the selection of the future atmospheric model dynamic core for the NGGPS. A Dynamic core Test Group (DTG) was established to conduct this assessment. The DTG assessed the results of NGGPS testing and provided first assessment of the results to NOAA (NWS) management. This assessment, along with business considerations, was used in the development of the business case supporting the selection of the next dycore by NWS management.

The Draft Plan of the DTG called for two levels of testing, with Level 1 completed April 2015 and Level 2 completed March 2016. There was a computational line of testing to be performed by the Advanced Computing Evaluation Committee. After the completion of the prescribed testing suites, the dycores required further testing. This testing included accuracy with operational components (e.g. any future upgrade to physics, data assimilation), opportunities for accuracy tuning and evaluation of computational performance. Emphasis was put on testing under the conditions in which the chosen dycore will eventually operate. Details are still to be determined by the DTG and its sponsors.

John Thurn, an international recognized expert in this research area from the United Kingdom, participated in this project and has contributed to reports and presentations at all interim and major milestones. These reports were written in August 2015, with one more to follow in June 2016.

Publications: None

Presentations:

Thuburn, J., 2015: Consistent Energy, enthalpy and entropy budgets with simple moist physics. DTG Internal Presentation. 3 August 2015

PROJECT TITLE: CIRA Support for Feature-Based Validation of MIRS Soundings for Tropical Cyclone Analysis and Forecasting

PRINCIPAL INVESTIGATORS: Jack Dostalek and Galina Chirokova

RESEARCH TEAM: Robert DeMaria, Natalie Tourville

NOAA TECHNICAL CONTACT: Satya Kalluri (NOAA/NESDIS) and Candice Jongsma (NOAA/OAR)

NOAA RESEARCH TEAM: John Knaff (NOAA/NESDIS/STAR/RAMMB)

FISCAL YEAR FUNDING: \$75,000

PROJECT OBJECTIVES:

CIRA has been producing analyses of tropical cyclone (TC) intensity and structure based on microwave radiances measured from polar-orbiting satellites for well over a decade. Using knowledge gained from the FY14 CIRA StAR Cal/Val project and with the goal of improving the global utility of MIRS operational TC products, the objective of this work is to further calibrate and correct the ATMS and high-resolution AMSU profiles, as well as the operational TC intensity and structure algorithm (ISATC) using newly created databases. This effort will improve the accuracy of the operational estimates of TC intensity, central pressure and wind radii. Three objectives define this project.

The first objective consists of conducting additional research into improving the ISATC. This includes updating the bias adjustments to the MIRS retrievals, as the MIRS algorithm was designed for global use, so some modifications may be necessary when applying them to specific topics, such as tropical cyclones. The second objective involves supplementing our "ground truth" database of dropsonde profiles with radiosondes from island and coastal sites. Including radiosonde data is particularly important in the Pacific, where reconnaissance flights are rare. The final objective is to look into using NUCAPS retrievals in the ISATC. The NUCAPS algorithm combines both microwave and infrared measurements to retrieve profiles of temperature and moisture.

PROJECT ACCOMPLISHMENTS:

1-- Determine best use of the moisture information in regression analysis; recompute coefficients for the 2012-2013 seasons

The option to use virtual temperature instead of temperature in the calculation of the height field, which forms the basis of the intensity and structure code has been added to the TC intensity and structure code. Figure 1 shows example of the balanced winds produced by ISATC with the high-resolution AMSU (left) and ATMS (right). In addition, the TC intensity and structure code was updated to a more user-friendly format, with many input values now set in a configuration file instead of being hard-wired in the code. These values include the coefficients used in the final determination of intensity, central pressure, and the radii of the 34-, 50-, and 64-kt winds. The intensity and structure code has been rerun using virtual

temperature for all TCs worldwide from 2012-2014, and was used to recompute the coefficients discussed in tasks 2 and 4.

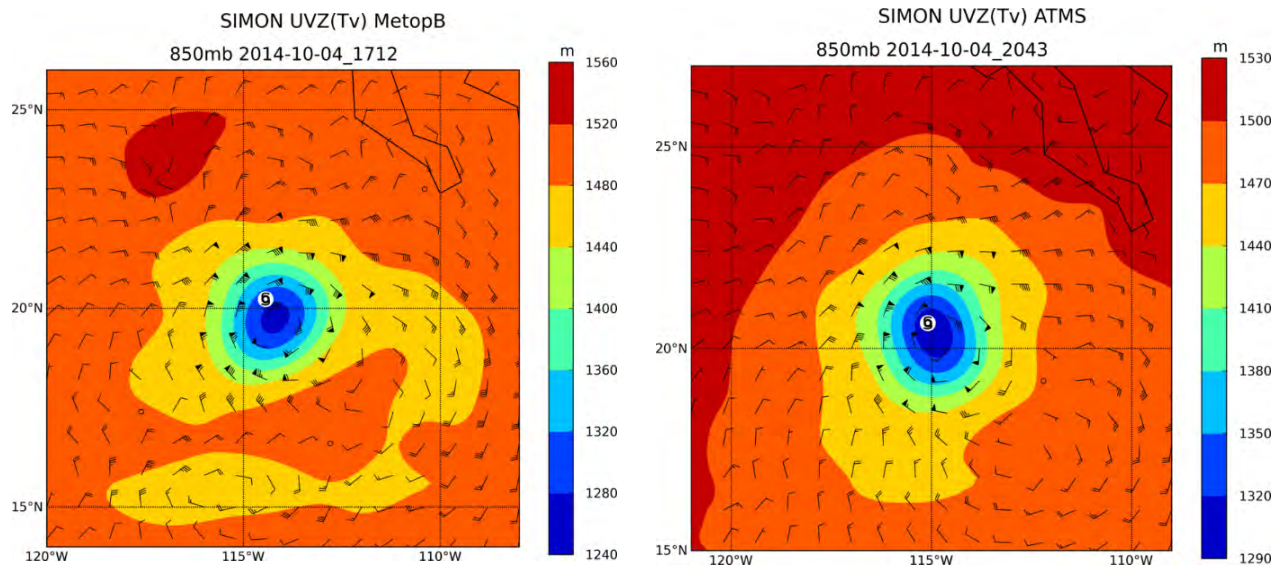

Figure 1. 850 mb winds and geopotential height for Hurricane Simon, ep192014 as calculated by the CIRA TC intensity and structure algorithm with virtual temperature. (a) estimated from high-resolution AMSU on-board of Metop-B, at 10/04/2014 17:12Z, and (b) estimated from ATMS on-board of SNPP at 10/04/2014 20:43Z

2-- Rerun coefficients for 2012-2014 seasons

The coefficients used in the final determination of intensity, central pressure, and the radii of the 34-, 50-, and 64-kt winds have been recalculated for the updated version of the code. The re-derived coefficients were provided to the CIRA teams working on the transition to operations of the ISATC analysis based on AMSU-MIRS and ATMS-MIRS retrievals. These new coefficients are now used in both products, which became operational in summer 2015.

3—Begin collecting data required for the project, such as NUCAPS and radiosonde data

The radiosonde database chosen to supplement dropsonde data is that maintained by NOAA's Earth System Research Laboratory. The database combines radiosonde data from the National Climatic Data Center's Integrated Global Radiosonde Archive and those from the North American Global Telecommunications Service. Gross error and hydrostatic consistency checks are performed on the data, which are then made available in a variety of formats. In order to minimize land effects, radiosondes only from island or coastal stations will be considered. This dataset is of particular importance to studies in the West Pacific, where reconnaissance flights (and thus dropsondes) are rare. Software for downloading past data from this archive (in either ASCII or netCDF format) has been developed, and is modifiable for real-time use. Global radiosonde data have been collected for the years 2012-2015. The real-time data feed of NUCAPS data has been setup with NDE. Work continues on automating the collecting and archiving of NUCAPS and radiosondes data.

4-- Evaluate the ISATC performance with high-resolution AMSU, and virtual temperature data as input

The ISATC analysis includes estimates of the maximum sustained wind (v_{max}), minimum central pressure (p_{min}), and the radii of the 34-, 50-, and 64-kt winds (r_{34} , r_{50} , r_{64} , respectively). The analysis begins with the temperature profiles retrieved from the satellites, which are used in conjunction with the assumption of a hydrostatic atmosphere to determine the height as a function of pressure in the TC and its near environment. In theory, using the virtual temperature instead of temperature in the determination of

height should produce a more accurate result. The performance of the analysis routine using temperature profiles as input was compared with the performance when virtual temperature was used. The dataset for v_{\max} and p_{\min} included TCs in all basins (Atlantic, East Pacific, Central Pacific, West Pacific, Indian Ocean, and Southern Hemisphere) compared to best-track data for the 2012-2014 seasons. Best track data were also used for verification of the wind radii, but for these variables only the Atlantic and East Pacific basins were used, as the wind fields in the other basins are not deemed as accurate. Retrievals from two different microwave instruments were used: AMSU (NOAA-18, NOAA-19, MetOp-A, MetOp-B), and ATMS (Soumi NPP). For both instruments the temperature retrievals were calculated using the MIRS algorithm. The AMSU data from the MetOp-B are processed using the MIRS high-resolution algorithm. Tables 1 and 2 show the bias and mean absolute error (MAE) of the temperature and virtual temperature processing, and Tables 3 and 4 display the number of observations that went into the statistics. Overall, the statistics are closer than expected. The bold-faced numbers indicate the entries which had a noticeable (not necessarily statistically significant) difference: r_{64} bias, and r_{34} , r_{50} , and r_{64} MAE. That all of these are from one satellite (MetOp-A) is a bit suspicious. The discrepancy between the number of MetOp-A observations seen in the second set of charts hints at a processing issue. The overall similarity between the results, as well as the possible issue with MetOp-A processing will continue to be investigated.

	Bias					MAE				
	v_{\max}	p_{\min}	r_{34}	r_{50}	r_{64}	v_{\max}	p_{\min}	r_{34}	r_{50}	r_{64}
NOAA18	1.2×10^{-6}	1.0	-4.8	2.2	4.7	12.6	7.9	21.6	10.0	10.3
NOAA19	-3.8×10^{-6}	0.9	-4.3	1.9	5.8	12.3	7.7	21.9	10.1	8.3
MetOpA	4.4×10^{-6}	0.9	-2.4	1.8	2.4	11.6	7.2	24.0	12.8	14.7
MetOpB	-1.3×10^{-6}	0.8	-3.7	1.9	5.5	11.3	7.0	18.7	8.8	6.8
SNPP	9.6×10^{-6}	0.7	-3.1	0.3	4.5	11.1	7.0	19.8	12.2	12.2

Table 1. ISATC results for different instruments. The reruns were made with re-derived coefficients and using temperature profiles. Shown are bias and MAE for v_{\max} , p_{\min} and wind radii.

	Bias					MAE				
	v_{\max}	p_{\min}	r_{34}	r_{50}	r_{64}	v_{\max}	p_{\min}	r_{34}	r_{50}	r_{64}
NOAA18	-1.1×10^{-6}	0.9	-4.9	2.1	4.7	12.4	7.7	21.8	10.0	10.3
NOAA19	8.6×10^{-6}	0.9	-4.2	1.8	5.8	12.1	7.6	22.1	10.2	8.3
MetOpA	-3.2×10^{-6}	0.9	-2.4	2.1	5.6	11.6	7.1	19.6	9.0	7.2
MetOpB	-1.0×10^{-5}	0.7	-3.6	1.8	5.4	11.2	6.9	18.3	8.7	6.7
SNPP	8.1×10^{-6}	0.7	-3.0	0.3	4.4	11.2	7.2	20.3	12.4	12.1

Table 2. Same as Table 1, but using virtual temperature and corresponding re-derived coefficients.

	Number of Observations				
	V _{max}	p _{min}	r ₃₄	r ₅₀	r ₆₄
NOAA18	3020	3020	672	377	209
NOAA19	3232	3232	714	395	209
MetOpA	1898	1898	439	220	99
MetOpB	1736	1736	409	199	115
SNPP	1558	1558	344	215	134

Table 3. Number of observations used for statistics shown in Table 1.

	Number of Observations				
	V _{max}	p _{min}	r ₃₄	r ₅₀	r ₆₄
NOAA18	3019	3019	672	377	209
NOAA19	3232	3232	714	395	209
MetOpA	1431	1431	339	162	75
MetOpB	1736	1736	409	199	115
SNPP	1558	1558	344	215	134

Table 4. Number of observations used for statistics shown in Table 2.

5—Bias-corrections for further algorithm improvement

An extensive dataset of dropsondes launched over Atlantic tropical cyclones has been collected. These dropsondes can serve as “ground truth” to examine the quality of satellite retrievals in the vicinity of tropical cyclones. In particular, the Microwave Integrated Retrieval System (MIRS) is of interest, as it is NESDIS’ current operational microwave retrieval system, and the information from this algorithm is being used in CIRA/RAMMB’s operational tropical cyclone intensity and structure algorithm. Using data from the 2012-2014 Atlantic hurricane seasons, basic statistics evaluating the performance of the MIRS temperature retrievals have been computed. MIRS data from the NOAA-18, NOAA-19, and MetOp-A satellites were compared to dropsondes launched from reconnaissance flights (C-130) and research missions (P-3 and Global Hawk). The satellite retrievals were restricted to be within 1 hour and 50 km of the collocated dropsonde. The temperature profiles of the dropsondes were interpolated to the MIRS pressure levels. The number of collocations varies with the pressure level as the various aircraft used typically fly at different altitudes. Up to about 700 mb, there were 100-300 collocations; in the middle and

upper atmosphere the number dropped to between 70 and 100. The performance of the retrievals were not only considered “en masse”, but also separated according to the MIRS classification of the field of view (fov): clear, cloudy, or rainy. The results of the analysis are given in the Figure 2, with the bias as the dashed line and the root mean square error (rmse) as the solid line. Beginning with the “All Sky” category, it is seen that the rmse in the lower atmosphere (1000-800 mb) is around 3 K, and reduces to 2-2.5 K for the rest of the atmosphere. The bias varies, alternating between negative and positive throughout the atmosphere. The largest biases reach a maximum magnitude of around 2 K, with a negative bias near the surface and in the 500-200 mb layer, and a positive bias between 175-125 mb. The smallest bias, approximately +1 K, occurred between 900 mb and 500 mb. Distinguishing among the fov types reveals that MIRS performs similarly in clear and cloudy conditions, with rmse values at or below 2 K throughout the troposphere, with a bit larger values near 150 mb. The bias profiles display the same shape as the All Sky case, alternating between positive and negative with magnitudes below 2 K. Rainy fovs appear to be more challenging for the MIRS algorithm, with rmse values near 4 K for most of the troposphere, with lower values above 200 mb and near the surface. Again, the bias profile assumes the same shape as the other 3 fov classifications, but with increased magnitude in the negative bias region from 600 mb to 175 mb. Here the bias reaches -4 K. Near the bottom and top of the troposphere the biases are comparable to the clear and cloudy cases. Work on comparing MIRS retrievals to dropsonde measurements will continue. Additional work may also be done in investigating the reason for the shape of the bias profile, which for the above cases is the same. It is due perhaps in part to various atmospheric features such as the trade-wind inversion, freezing level, and tropopause. This work will ultimately be used to adjust the MIRS profiles used in the tropical cyclone intensity and structure algorithm products run at CIRA/RAMMB, in order to improve their accuracy. Similar adjustments were performed on the statistical retrieval technique used prior to MIRS to generate the products.

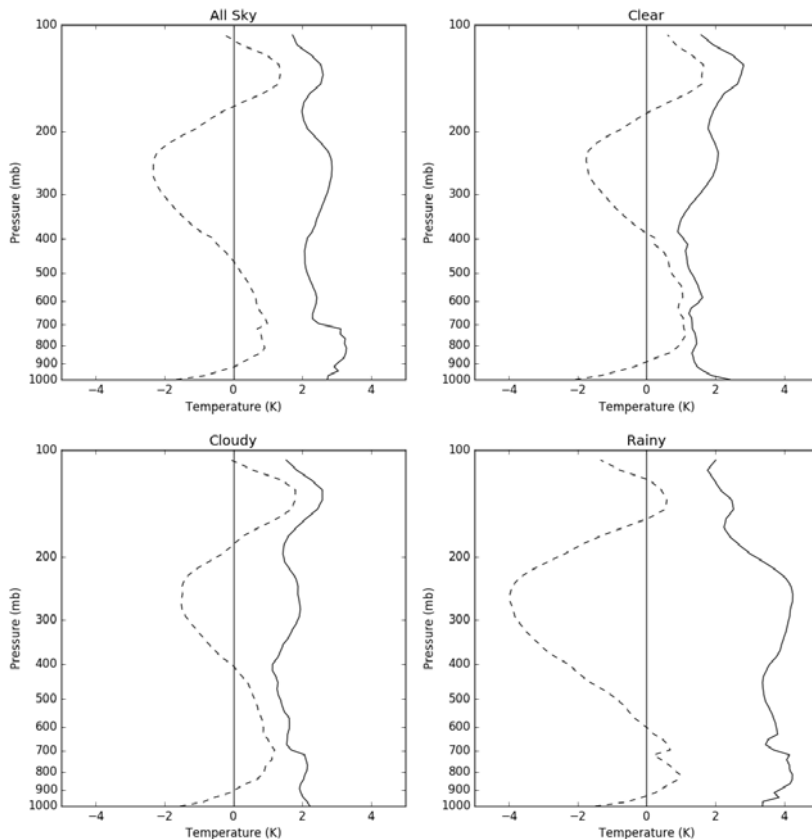

Figure 2. Bias (dashed) and rmse (solid) values of MIRS temperature profiles compared to collocated dropsondes for the 2012-2014 Atlantic hurricane season. Collocations were restricted to 1 hour and 50 km. The weather condition listed at the top of each of the four panels was determined by the MIRS algorithm.

Test runs of the ISATC code on selected cases were performed to evaluate the use of different algorithms for bias-correction. An example from Hurricane Edouard on 15 September 2014 demonstrates the effect of the application of a bias correction on the satellite-derived mean sea level pressure. The pressure field derived from MIRS retrievals from NOAA-19 passes at 0530 and 0700 UTC, overlaid on top of a GOES-13 infrared image of Edouard shown on Figure 3 does indicate a surface low of 1008 hPa associated with the hurricane, but also shows two adjacent high pressure regions of 1027 hPa and 1023 hPa which are inconsistent with current knowledge of the surface pressure field surrounding tropical cyclones. The 0600 UTC GFS analysis shown on Figure 4 (left) demonstrates the pressure field that would be expected. As can be seen on Figure 4 (right), with the bias correction, the satellite analysis provides a surface pressure field which better matches the GFS analysis, including a deeper surface low (1001 hPa), and the absence of the anomalous highs on the periphery of the hurricane.

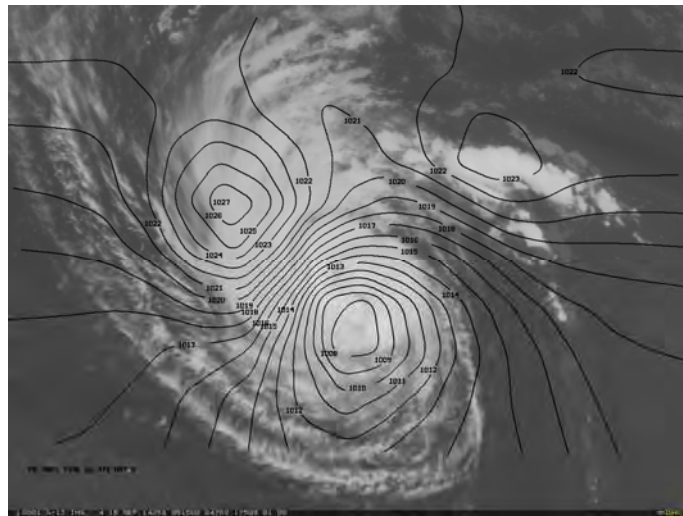

Figure 3. Initial pressure field derived from NOAA-19 MIRS analysis of Hurricane Edouard, ~0530 UTC 15 September 2014.

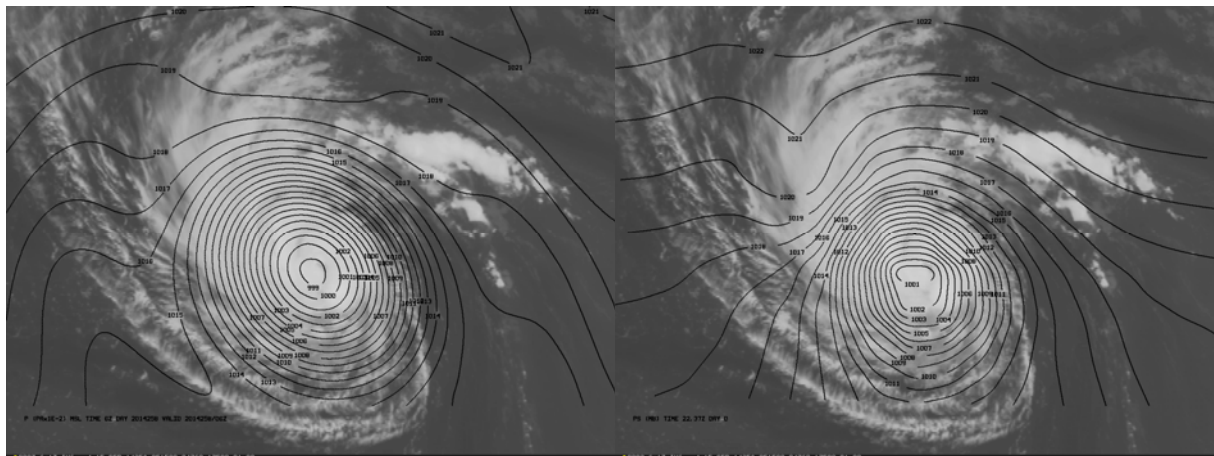

Figure 4. Left: Surface pressure field of Hurricane Edouard from the GFS analysis of 0600 UTC 15 September 2014. Right: Surface pressure analysis of Hurricane Edouard derived from MIRS retrievals with bias correction applied.

6-- Develop software for reading radiosonde data from various sources and comparing them to ATMS and high-resolution AMSU soundings

The real-time processing and display of dropsondes collocated to ATMS/AMSU soundings for TCs has been expanded to include the East and Central Pacific Basins. The EP/CP dropsondes for the years 2014-2015 have been downloaded from NHC and the decoding software has been modified to process these dropsondes in addition to Atlantic dropsondes. The python software performing the collocation of dropsondes with ATMS and AMSU has been modified accordingly. The real-time display of the collocated EP/CP dropsondes with ATMS/AMSU soundings has been added to the CIRA TC Real Time page, a screenshot is shown on Figure 5. The new dropsonde database will be used to complement the data for deriving the bias correction based on comparison with radiosondes, as radiosondes are rarely available in the east Pacific.

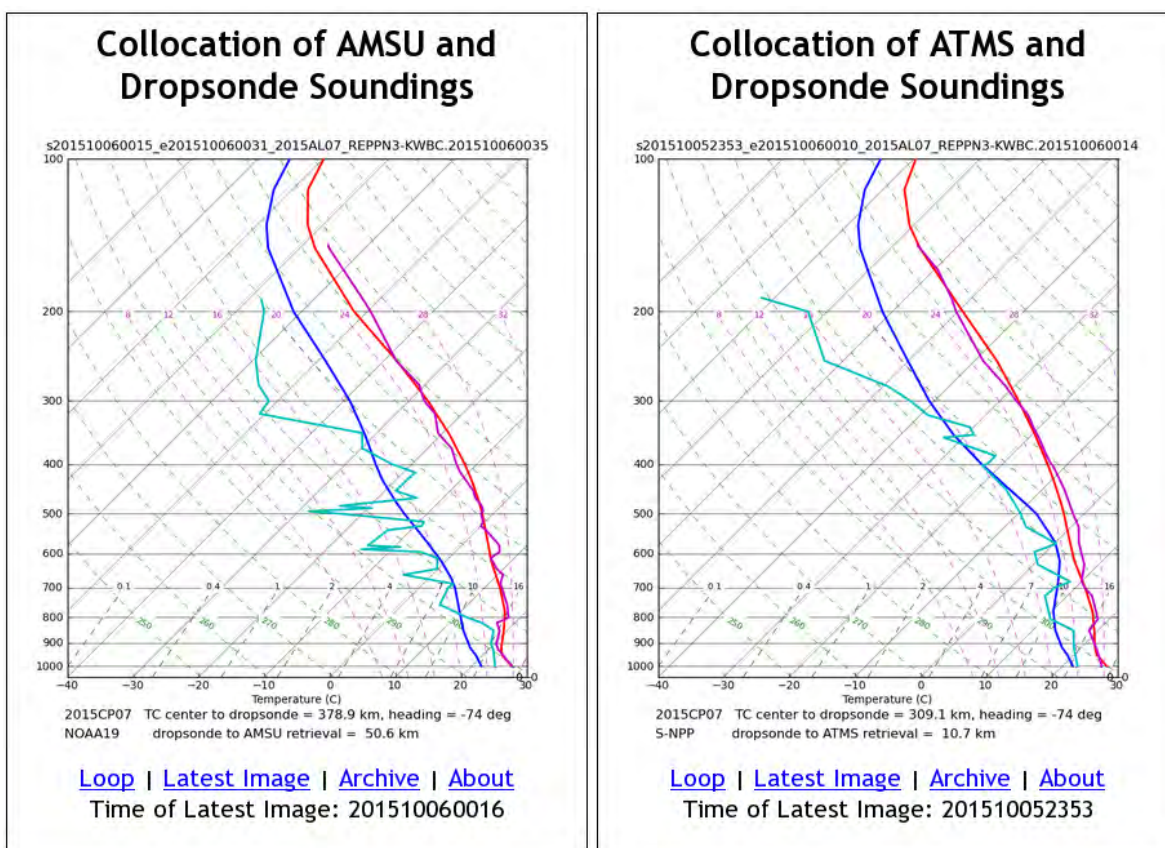

Figure 5. Collocation of AMSU (left) and ATMS (right) soundings to the dropsondes for hurricane OHO, CP072015. The purple and teal lines are the temperature and dewpoint traces, respectively, from the dropsondes, and the red and blue lines are the AMSU/ATMS temperature and dewpoint retrievals, respectively. Image is taken from CIRA TC Real Time page http://rammb.cira.colostate.edu/products/tc_realttime/storm.asp?storm_identifier=CP072015

The basic version of the software for efficient selection of data from polar-orbiting satellites in the vicinity of TCs has been developed. That software, referred as the “pool”, can be used to create a searchable database for any global dataset. The radiosondes plugin for the pool has also been developed. Use of the pool plugin with radiosondes allows users to efficiently search for radiosondes within specified spatial and temporal windows from ATMS/AMSU retrievals and tropical cyclones simultaneously. The output radiosonde soundings are in a format compatible with the previously used dropsonde format. The code is currently undergoing testing and will be used to develop a radiosonde-based bias correction to the ATMS/AMSU profiles in the West Pacific.

Publications: None

Presentations:

Chirokova G., M. DeMaria, J. Dostalek, R. DeMaria, and K. Musgrave, 2015: Quality of ATMS-MIRS retrievals for Atlantic tropical cyclones. Presentation at the NCAR/NOAA/CSU TC Workshop, July 21, 2015 Boulder, Colorado

Chirokova, G., M. DeMaria, R. DeMaria, J. Knaff, J. Dostalek, and J. L. Beven, 2015: Use of JPSS ATMS and VIIRS data to Improve Tropical Cyclone Track and Intensity Forecasting. Poster presentation at the 2015 NOAA Satellite Conference, April 27 - May 1, 2015 Greenbelt, Maryland.



PROJECT TITLE: CIRA Support: Getting Ready for NOAA's Advanced Remote Sensing Programs: A Satellite Hydro-Meteorology (SHyMet) Training and Education Proposal

PRINCIPAL INVESTIGATORS: Bernadette Connell, Dan Bikos

RESEARCH TEAM: Ed Szoke, Luciane Veeck

TECHNICAL CONTACT: Satya Kalluri (NOAA/NESDIS) and Candice Jongsma (NOAA/OAR)

NOAA RESEARCH TEAM: Tony Mostek (NOAA/NWS), Brian Motta (NOAA/NWS)

FISCAL YEAR FUNDING: \$185,000

PROJECT OBJECTIVES:

The overall objective of the SHyMet program is to develop and deliver comprehensive distance-learning courses on satellite hydrology and meteorology. This project leverages the structure of the VISIT training program but is distinct in that VISIT focuses on individual training modules, while SHyMet organizes modules into courses. SHyMet takes a topic approach and selects content for the topic. It is able to draw on training materials not only within the VISIT program, but outside the program as well. This work is being done in close collaboration with experts at CIRA, the Cooperative Institute for Meteorological Satellite Studies (CIMSS), the Cooperative Program for Operational Meteorology, Education and Training (COMET), the National Weather Service (NWS) Training Center (NWSTC), and the NWS Warning Decision Training Branch (WDTB). The challenge is to provide necessary background information to cover the many aspects of current image and product use and interpretation as well as evaluate data and products available from new satellite technologies and provide new training on these tools to be used operationally. Over this past year, this project also partially supported international efforts of the WMO VLab

Specific Objectives - National Focus:

- 1-- Interact with NWS Office of the Chief Learning Officer (OCLO), GOES-R, and JPSS Satellite Proving Ground Partners, and other education and outreach groups in the US. Continue to populate a SHyMet GOES-R Instruments, Products, and Operational Applications web page with content that has been identified and produce supplemental explanatory information where necessary.
- 2-- Virtual monthly real-time sessions: Contribute content to the VISIT Satellite Chat – interactive Webinar sessions that are aligned with NWS Satellite Training plan.

3-- Maintain and update the SHyMet Courses (Intern, Forecaster, Tropical, and Severe Thunderstorm) to align with the NWS Satellite Training Plan. Make sure that the course information is transferred to NOAA's new LMS.

4-- As part of the GOES-R training plan, implement a "satellite help desk" with the objective of forecasters being able to ask questions to a "satellite expert" in a near real-time setting. This will be done in collaboration with the VISIT team.

5-- Interact with customers and other education provider groups to keep abreast of activities and exchange information and ideas. Meet with OCLO managers to align SHyMet with NWS Satellite Training plan.

Specific Objectives - International Focus:

1-- Virtual monthly real-time sessions: Contribute content as well as partial support for organizing, executing, and processing recordings of the monthly international virtual Regional Focus Group sessions of the Americas and Caribbean.

2-- Provide 2 months of support for the WMO VLab Technical Support Officer to ensure exchange of satellite education training resources on the global scale.

3-- GEONETCast Americas (GNC-A) capabilities: Adapt existing instructional materials and add local case examples for GOES and GOES-R related data visualization using McIDAS-V.

PROJECT ACCOMPLISHMENTS: Past Fiscal Year by Objective – NATIONAL FOCUS:

1-- Interaction with partners to develop new content for the SHyMet GOES-R Instruments, Products, and Operational Applications Course:

-- New sessions developed in collaboration with the VISIT program:

- Can total lightning help with warnings for non-supercell tornadoes? By Ed Szoke and Dan Bikos (Figure 1a.).

http://rammb.cira.colostate.edu/training/visit/training_sessions/can_total_lightning_help_with_warnings_for_non_supercell_tornadoes/

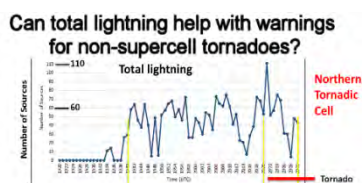

Figure 1a.

Tracking the Elevated Mixed Layer with a new GOES-R water vapor band

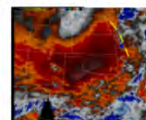

Figure 1b.

- Tracking the Elevated Mixed Layer with a new GOES-R Water Vapor Band. By Dan Bikos, Ed Szoke, and Dan Lindsey (Figure 1b)

http://rammb.cira.colostate.edu/training/visit/training_sessions/tracking_the_elevated_mixed_layer_with_a_new_goes_r_water_vapor_band/

2-- Virtual monthly real-time sessions: Contribute content to the VISIT Satellite Chat – interactive Webinar sessions that are aligned with NWS Satellite Training plan. In the past year, the following external presenters led these sessions:

- Todd Lindley (NOAA/NWS WFO Norman, OK) on utilization of GOES-14 SRSOR 1-minute imagery for fire weather applications. (Figure 2. At right)

- Rich Grumm (NOAA/NWS WFO State College, PA) on a recap of the 22-23 January 2016 Mid-Atlantic Blizzard.

- Curtis Seaman (CIRA) on an introduction to VIIRS DNB NCC imagery.

- Chris Landsea (NOAA/NWS/NHC) on African Easterly Wave Identification by satellite imagery.

- Sheldon Kusselson (retired NOAA/NESDIS/SAB) on the 3-4 October 2015 flood event over South Carolina.



Figure 2.

- Alex Tardy (NOAA/NWS WFO San Diego, CA) on wildfire, haboob and heavy rainfall associated with Hurricane Dolores on 17-19 July 2015.

Recorded sessions are located here: http://rammb.cira.colostate.edu/training/visit/satellite_chat/

3-- Maintain and update the SHyMet Courses (Intern, Forecaster, Tropical, and Severe Thunderstorm) to align with the NWS Satellite Training Plan. Make sure that the course information is transferred to NOAA's new LMS.

The following four courses continue to be administered:

- The SHyMet *Intern* course touches on Geostationary and Polar orbiting satellite basics (areal coverage and image frequency), identification of atmospheric and surface phenomena, and provides examples of the integration of meteorological techniques with satellite observing capabilities.

(http://rammb.cira.colostate.edu/training/shymet/intern_intro.asp).

This continues to be the most popular course.

- The SHyMet for *Forecaster* course covers satellite imagery interpretation and feature identification, water vapor channels, remote sensing applications for hydrometeorology, aviation hazards, and what to expect on future satellites. http://rammb.cira.colostate.edu/training/shymet/forecaster_intro.asp

- The *Tropical* track http://rammb.cira.colostate.edu/training/shymet/tropical_intro.asp of the SHyMet Course covers satellite imagery interpretation and application of satellite derived products in the tropics as well as the models used at NHC for tropical cyclone forecasting.

- The *Severe Thunderstorm Forecasting Course*

http://rammb.cira.colostate.edu/training/shymet/severe_intro.asp

covers how to integrate satellite imagery interpretation with other datasets in analyzing severe thunderstorm events.

SHyMet metrics are tracked by leveraging the expertise of the VISIT program and the NOAA Commerce Learn Center Learning Management System.

SHyMet Course	Total since debut		Jan 2015 - Feb 2016		Course Debut
	Registrations	Completions	Registrations	Completions	
Intern	492	372	30	24	April 2006
Forecaster	68	46	1	1	January 2010
Tropical	42	22	3	0	August 2010
Severe	62	40	2	2	March 2011

4-- As part of the GOES-R training plan, implement a “satellite help desk” with the objective of forecasters being able to ask questions to a “satellite expert” in a near real-time setting.

A satellite help desk was created in the NOAA Virtual Lab. It was launched in early December 2015.

This was done in collaboration with the VISIT team.

<http://rammb.cira.colostate.edu/training/visit/helpdesk.asp>

5-- Interact with customers and other education provider groups to keep abreast of activities and exchange information and ideas. Meet with OCLO managers to align SHyMet with NWS Satellite Training plan.

CIRA held monthly VISIT/SHyMet conference calls throughout the year. In additions, CIRA participated in COMET Monthly Satellite calls, quarterly GOES-R/JPSS Satellite Proving Ground teleconferences, and attended the GOES-R/JPSS Satellite Proving Ground meeting in Kansas City in June 2016. CIRA also participated in the meeting of the Satellite Training Advisory Team (STAT) (formerly the Satellite User Readiness Team (SURT)) in Boulder on 1-5 February. This STAT falls under the guidance of NOAA/NWS/OCLO.

PROJECT ACCOMPLISHMENTS: Past Fiscal Year by Objective – INTERNATIONAL FOCUS:

1-- Contribute support to virtual event weeks and virtual monthly real-time sessions:

-- Organization and Participation in Virtual Event Week "Preparing for Next Generation Satellite Imagery" that was held 16-20 November

<http://www.wmo-sat.info/vlab/next-generation-of-satellites/> There were 4 presentations from the US and 3 of them directly promoted aspects of GOES-R. CIRA arranged speakers for sessions 2 and 9 and delivered session 4.

- Session 2: GOES-R challenges and opportunities: Liaison perspectives from NOAA's Aviation Weather Center. Presenter: Amanda Terborg, CIMSS at NOAA/AWC (Figure 3a)

- Session 4: Training resources from the US and access to data and imagery: ways to find them in the acronym soup. Presenter: Bernie Connell, CIRA (Figure 3b)



Figure 3a

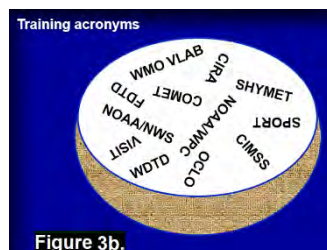

Figure 3b.

- Session 9: JPSS and beyond: Liaison perspectives from NOAA's Center for Weather and Climate Prediction. Presenter: Michael Folmer, ESSIC and CICS at NOAA CWCP

- Session 11: Getting the Most out of COMET Satellite Training Resources via MetEd. Presenter: Wendy Abshire, The COMET Program

- The WMO Virtual Laboratory Regional Focus Group of the Americas and Caribbean conducted 12 monthly bilingual (English/Spanish) weather briefings. The briefings made use of VISITview software to present GOES and POES satellite imagery from CIRA and GoToWebinar for voice communication over the Internet. Over the calendar year 2015, the participants from the U.S. included: CIRA, the NWS International Desk at NCEP/WPC, NWS/Office of the Chief Learning Officer (OCLO) Forecast Decision Training Division (FDTD), The State Department, the UCAR/JOSS-NWS International Activities Office, and UCAR/COMET. Twenty eight countries outside the US participated: Argentina, Bahamas, Barbados, Belize, Bolivia, Brazil, Cayman Islands, Chile, Colombia, Costa Rica, Dominica, Ecuador, El Salvador, Germany, Grenada, Haiti, Honduras, Nigeria, Panama, Paraguay, Peru, Saint Kitts and Nevis, South Africa, Spain, Suriname, Trinidad and Tobago, Uruguay, and Venezuela. M. Davison at the NCEP International Desk led the discussion. Participants offered comments for their regions and tended to also bring interesting questions to the discussion. The number of countries participating each month ranged between 9 and 16 (average 12); and the number of participants each month ranged between 19 and 63 (average 32). The sessions were recorded and can be accessed here:

http://rammb.cira.colostate.edu/training/rmtc/fg_recording.asp

2-- Provide 2 months of support for the WMO VLab Technical Support Officer, Luciane Veeck, to ensure exchange of satellite education training resources on the global scale. Her efforts provide a very important stabilizing factor for the global coordination of training efforts under the umbrella of the WMO VLab. Member countries have access to her resources through the entire year. Luciane was also supported under a WMO grant and another CIRA project during the past year. Highlights of her work that benefit the WMO community and the US include:

- Maintenance of the VLab central website and the VLab calendar of events <http://vlab.wmo.int>

- Virtual Event Week on the "Next Generation of Satellites" - Planning and execution of the 16-20 November 2015 event week. A total of 11 sessions were offered by the Japan Meteorological Agency (JMA), China Meteorological Administration (CMA), NOAA, the European Organisation for the Exploitation of Meteorological Satellites (EUMETSAT), Korean Meteorological Administration (KMA), The Brazilian National Institute for Space Research (INPE), CIRA, COMET, and India Meteorological

Department (IMD). Registration numbers varied from 53 to 109 per session; Total of 95 attendees; More than 50% of Participants attended more than one session.

- WMO Train the Trainer Course 2015 (WMO TtT) – The WMO Train the Trainer course 2015 (for Regional Association VI) ran 16 February - 31 May 2015. Planning and participation in synchronous online sessions and forum activities during Modules 1 and 2, with facilitation and direction of activities during Module 3, Unit 9 (18-24 May).

- WMO Education and Training (WMO-ETR) Moodle Users Course Development – Collaboration occurred throughout the past year with Maja Kuna, Vesa Nietosvaara and Ian Mills (EUMETSAT), Ivan Smiljanic (EUMeTrain), Pat Parrish and Mustafa Adiguzel (WMO-ETR) on the design of an online Moodle User course. The “pilot” course was offered from January to February 2016.

- VLab annual report to the WMO Inter-Programme Expert Team on Satellite Utilization and Products second session (IPET-SUP-2), which took place in Geneva, Switzerland (23-26 February 2016). The meeting was attended by the VLab co-chair Eduard Podgaiskii, who made the presentation.

- VLab annual to the WMO 43rd Plenary Session of the Coordinating Group for Meteorological Satellites (CGMS-43), which took place in Boulder, USA (18-22 May 2015). The full report can be downloaded from the VLab website listed above under Publications/Other reports. The meeting was attended by the VLab co-chair Kathy-Ann Caesar, who made the presentation.

- VLab Strategy 2015-2019 document –The document was presented to IPET-SUP-1 (March 2015) and CGMS-43 (May 2015) and endorsed by both groups. The full report can be downloaded from the VLab website listed above under Publications/Governance Documents.

- Prepared and assisted the VLMG online meetings in 7-8 July and 17-18 December 2015, and 9-10 March 2016. The meeting reports can be found in the WMO VLab site <http://www.wmo-sat.info/vlab/meeting-reports/>

3-- GEONETCast Americas (GNC-A) capabilities: Adapt existing instructional materials and add local case examples for GOES and GOES-R related data visualization using McIDAS-V.

-- CIRA was a collaborator in the planning and execution of the “NOAA/WMO Train the Trainer Workshop on Satellite Data Access, Application, and GEONETCast Americas”, 25-26 April. As part of the workshop, there were 2 afternoon sessions focusing on hands-on data access and display using McIDAS-V. Existing McIDAS-V scripts and plugins were adapted to greatly facilitate the viewing and manipulation of imagery for single channel and RGB composites of VIIRS imagery. The VIIRS instrument has many of the same channels that GOES-R will have. This method to display imagery is being used as a template for future training. This provides trainers and users with tools to aid in better identifying and distinguishing water and ice cloud, snow, dust, fires, volcanic ash, and other features.



Figure 4. Participants at the NOAA/WMO Train the Trainer Workshop on Satellite Data Access, Application, and GOENETCast Americas in College Park, Maryland, 25-26 April.

4--Community Outreach:

--After-school weather club: Scientists at CIRA and CSU students, who are also members of the local AMS chapter of Northern Colorado called FORTCAST (Fort Collins Atmospheric Scientists), volunteered for the after-school weather club on Tuesdays for Putnam Elementary (K-5). During the fall, 2 sessions were coordinated with the kindergarten/first grade Science Explorers club. The kids touched clouds and learned about cloud types, and also made pinwheel anemometers and learned about wind. The winter session ran for 8 weeks during January through early March 2016. There was a 90 minute session each week. Sessions included helping with homework, leading a physical activity and then focusing on a science activity. The topics covered included wind speed and direction, clouds, colors of the rainbow, snow, things that spin (tornado in a bottle and gyroscopes), freezing solids (ice cream!), as well as measurements that are associated with these weather occurrences. Volunteers included Bernie Connell, Matt Rogers, and Erin Dagg. Putnam has a coordinator who is responsible for matching students with clubs, assigning classrooms, providing snacks, and providing transportation – which is great!

Publications: None

Presentations:

Bikos, D., B. Connell, E. Szoke, S. Bachmeier, S. Lindstrom, A. Mostek, and B. Motta, 2015: VISIT and SHyMet Training in Preparing Forecasters for GOES-R. Poster, National Weather Association (NWA) Annual Meeting, 17-22 October, Oklahoma City, Oklahoma.

Connell, B., 2015: Satellite data processing and visualization software McIDAS-V. NOAA/WMO Train the Trainer Workshop on Satellite Data Access, Application, and GEONETCast Americas. College Park, Maryland, 25-26 April. Presentation and hands-on activity.

Connell, B., D. Bikos, E. Szoke, S. Lindstrom, and S. Bachmeier, 2015: Satellite Training from the Cooperative Institutes: VISIT and SHyMet Programs. Presentation, NOAA Satellite Conference, 27 April – 1 May, Greenbelt, Maryland.

Connell, B. 2015: Training resources from the US and access to data and imagery: ways to find them in the acronym soup. Virtual Presentation, WMO VLab Virtual Event Week “Preparing for the Next Generation Satellite Imagery”, 16-20 November, <http://www.wmo-sat.info/vlab/next-generation-of-satellites/>

Connell, B., S. Miller, D. Bikos, E. Szoke, S. Bachmeier, S. Lindstrom, A. Mostek, B. Motta, L. Veeck, 2016: JPSS and GOES-R User Readiness through Training: VISIT, SHyMet, WMO VLab and a new Liaison. 12th Annual Symposium on New Generation Operational Environmental Satellite Systems at the 96th AMS Annual Meeting, New Orleans, Louisiana, 10-14 January.

Davison, M., B. Connell, and K.-A. Caesar, 2015: Regional Focus Groups – Linking to GEONETCast Americas. NOAA/WMO Train the Trainer Workshop on Satellite Data Access, Application, and GEONETCast Americas. College Park, Maryland, 25-26 April. Presentation.

Szoke, E.J., 2016: Talks on GOES-R Proving Ground updates at the Boulder Weather Forecast Office (WFO) Spring Workshops on 4 & 11 March 2016. Community Outreach

Veeck, L., and Kuna, M. 2015: Glocalisation, glocalização, globalizacja - creating resources with “adaptation” in mind. 10th Eumetcal Workshop, 15-18 June, Reading, UK. Presentation.

PROJECT TITLE: CIRA Support to a GOES-R Proving Ground for National Weather Service Forecaster Readiness

PRINCIPAL INVESTIGATORS: Steve Miller, Renate Brummer, and Ed Szoke

RESEARCH TEAM: Steve Miller, Ed Szoke, Dan Bikos, Renate Brummer, Bernadette Connell, Greg DeMaria, Robert DeMaria, Jack Dostalek, Kathy Fryer, Hiro Gosden, Lewis Grasso, Stan Kidder, Kevin Micke, Andrea Schumacher, Dave Watson

NOAA TECHNICAL CONTACT: Satya Kalluri (NOAA/NESDIS) and Candice Jongsma (NOAA/OAR)

NOAA RESEARCH TEAM: Donald W. Hillger, John Knaff, Dan Lindsey, Deb Molenaar (NOAA/NESDIS/STAR)

FISCAL YEAR FUNDING: \$416,000

PROJECT OBJECTIVES:

The next generation GOES environmental satellite systems, beginning with GOES-R, will contain a number of advanced instruments including the Advanced Baseline Imager (ABI) and the Geostationary Lightning Mapper (GLM). The launch of GOES-R is scheduled for October 2016. Forecasters will be taking formal satellite training on the new satellite capabilities, now being developed in part by the CIRA team, beginning near the launch of GOES-R. The GOES-R Proving Ground was developed to begin the familiarization process with the new satellite capabilities long before the launch, by exposing forecasters to GOES-R like products through a number of different methods. The Proving Ground has been successful in introducing and helping to train National Weather Service (NWS) forecasters and other operational users of satellite data on the new capabilities in order to maximize the utility of GOES-R when it becomes operational. CIRA is leveraging its existing capabilities to provide experience with GOES-R capabilities directly to NWS forecasters through ongoing support of the NOAA Proving Ground project, where simulated and proxy GOES-R products are demonstrated at NWS Weather Forecast Offices (WFOs) in their native Advanced Weather Information Processing System (AWIPS) display systems, as well as at NOAA Operational Centers such as the National Hurricane Center (NHC), Storm Prediction Center (SPC), Aviation Weather Center (AWC), Ocean Prediction Center (OPC), and Weather Prediction Center (WPC). This project supports the following NOAA mission goals: Weather and Water, Commerce and Transportation and Climate. Enhanced training will also prepare the forecaster/manager on how to utilize imagery and products to provide services in these areas.

Most CIRA PG products are also made available in real time on the CIRA web page at http://rammb.cira.colostate.edu/ramsdisk/online/goes-r_proving_ground.asp. The web page provides much information on each of the CIRA Proving Ground (PG) products, includes the developer and point of contact as well as a concise but informative "Product Description" that details how the product is made, why it is a PG product, and how it can be used in operations. All of the products are available to forecasters through their AWIPS II system if requested, but typically interested National Weather Service (NWS) Weather Forecast Offices (WFOs) who work with CIRA will ingest only a few products at any one time for testing and evaluation. The web page however allows real-time access to all the products for quick viewing, as well as a 4-week archive. This enables forecasters to use them online, or decide if they would like to ingest them into the AWIPS at their WFO (we work with individual WFOs to provide instructions on how to do this). Bandwidth limitations, while improving at many WFOs during the past year, still prevent some WFOs from ingesting too many (or at times any) products, so having the web page presentations can be a useful alternative display mechanism.

CIRA works in collaboration with other Proving Ground partners at the Cooperative Institute for Meteorological Satellite Studies (CIMSS) at the University of Wisconsin-Madison, the NASA Short-term

Prediction Research and Transition (SPoRT) Center located in Huntsville, Alabama, and the GOES-R Proving Ground Satellite Liaisons.

PROJECT ACCOMPLISHMENTS:

Work was conducted in the following six areas:

1--Decision Aid Product Development:

--CIRA continued to generate and serve the following products to the NHC: RGB Airmass, DEBRA Dust, Lightning-based Tropical Cyclone Rapid Intensification Index (RII), GOES-R like Atmospheric Derived Motion Wind Vectors, Super Rapid Scan Operations (SRSOR), and the new GOES-R Natural Color Imagery Product using MODIS and VIIRS. CIRA's collaboration with SPoRT continued, with SPoRT making the RGB products available in NAWIPS, the display system at NHC.

--For the Pacific Proving Ground (the JTWC and WFO Guam) CIRA continued to provide products including RII, tropical cyclone structure information and PMI-IR-WV RGB imagery.

--With the availability of GOES-R like bands from the new Himawari-8 satellite, CIRA began to make some of the GOES-R demonstration products available using the Himawari AHI bands. Products made available online include True Color and GeoColor imagery, and these are being made available to the Pacific Proving Ground, the AWC, WPC and the OPC. An example of the GeoColor imagery using the AHI is shown in Figure 1. The CIRA Himawari-8 real-time Imagery webpage displays full-disk Himawari imagery as well as 15 different sectional views. The page can be found at this URL:

<http://rammb.cira.colostate.edu/ramsdisk/online/himawari-8.asp>

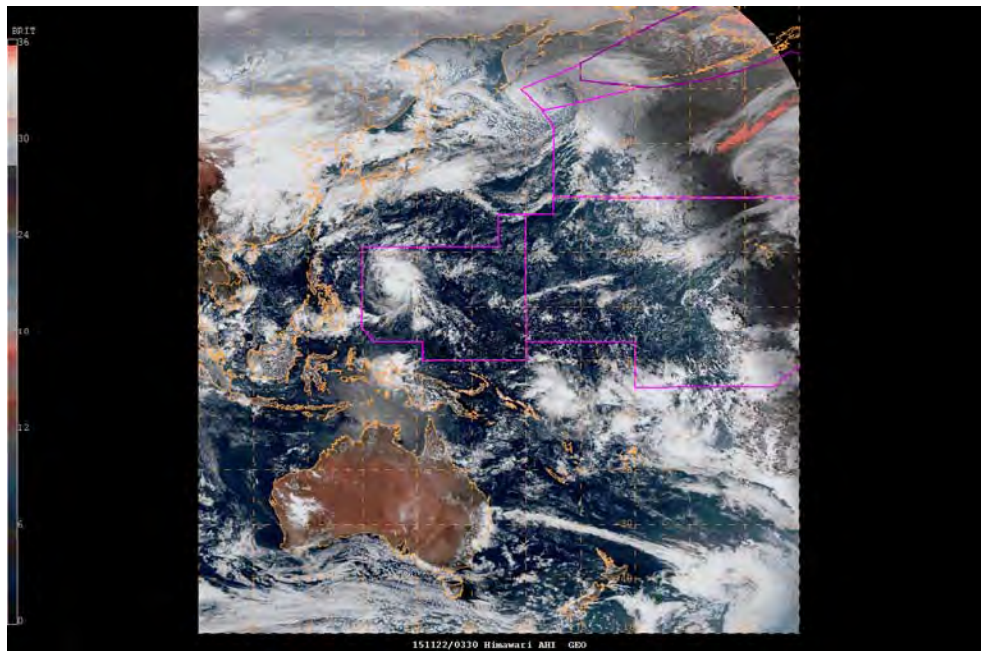

Figure 1. GeoColor imagery generated using the Himawari AHI centered over the west-central Pacific for 0330 UTC on 22 Nov 2015. The daylight portion is true color imagery while the nighttime section in the upper right utilizes the scheme in GeoColor that highlights lower clouds and fog in a pinkish color to distinguish these from higher level clouds in white.

--CIRA continued to generate GOES-R ABI synthetic imagery based on output from NSSL's 4-km WRF ARW. Throughout the year, imagery was produced for 6.2 μm , 6.95 μm , 7.34 μm , 8.50 μm , 10.35 μm , 12.3 μm and the visible band for forecast periods out to 36 hours. In addition, CIRA continued to simulate the thermal-only 3.9 μm band (i.e., neglecting the solar reflected component) and the band difference product 10.35 μm - 3.9 μm (referred to as the "fog product" by forecasters) in real-time. Additional band

differences created were 10.35 μm – 12.3 μm , 8.5 μm - 10.35 μm , and 8.5 μm - 12.3 μm . The real-time synthetic imagery is displayed at http://rammb.cira.colostate.edu/ramsd/online/goes-r_proving_ground.asp
 Figure 2 below depicts the synthetic ABI 10.35 -3.9 μm fog product from 9 March 2016 at 1200UTC.

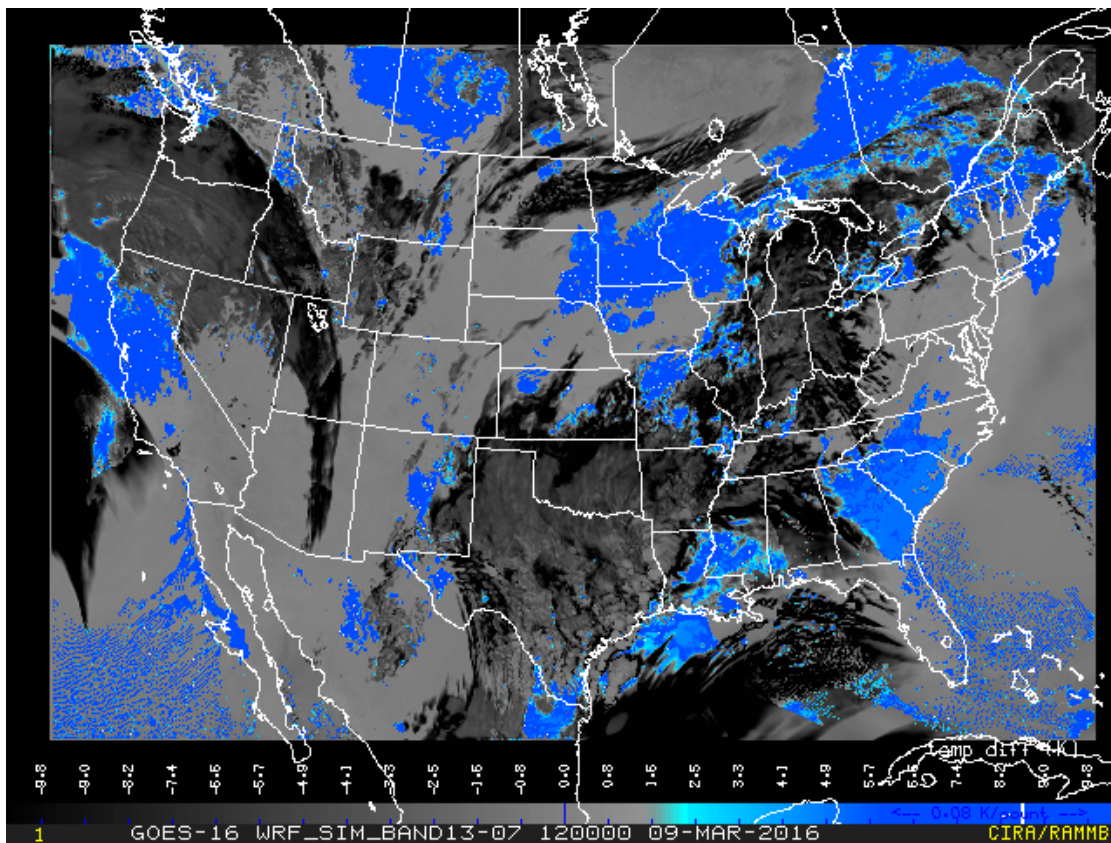

Figure 2. Example of a synthetic 10.35 minus 3.9 μm (low cloud/fog product) image from 9 March 2016 at 1200UTC. The image is based on a 9-hour forecast from NSSL's 4-km WRF-ARW.

CIRA also generated GOES-R ABI synthetic imagery based on output from the NCEP NAM Nest (CONUS scale 4-km model available to forecasters on AWIPS II) 00 UTC run. Bands were generated to produce the standard AWIPS IR and Water Vapor imagery, out to 60 hours. Synthetic imagery was also generated for Alaska and made available to forecasters using the 00 UTC run of the NCEP NAM Alaska Nest for 6.2 μm , 6.95 μm , 7.34 μm , 8.50 μm , and 10.35 μm and for the 10.35 μm - 3.9 μm fog product for forecast periods out to 60 hours. The synthetic imagery continued to receive very favorable feedback from forecasters at many different WFOs, SPC and AWC. Synthetic imagery represents one way to provide Proving Ground products for bands or combinations of bands that do not currently exist with the operational GOES satellites.

-- Additional Proving Ground products produced by CIRA over the past year include GOES blowing dust, MODIS-based dust enhancement, GOES cloud/snow discrimination (3-color technique), MODIS cloud/snow (binary) discriminator, MODIS cloud layers/snow discriminator, MODIS Cirrus, GOES low cloud/fog, GeoColor (with and without city lights, per user request), and the Orographic Rain Index (ORI). These products are generally generated using bands on Polar orbiting satellites, or in combination with current GOES imagery. Polar products represent another way to replicate GOES-R type products, since these satellites have many of the bands that will be available on GOES-R (though of course at limited time resolution). Most CIRA PG Decision Aid products were moved into AWIPS II and are being served to partnering WFOs as they are requested.

--The RGB Airmass GOES sounder product was also distributed to the NOAA Weather Prediction Center (WPC) and the Ocean Prediction Center (OPC). This product has gained popularity amongst forecasters

thanks to the close interaction with PG Satellite Liaison Michael Folmer. An updated version of this product uses the Himawari AHI to create the RGB Airmass product, and an example of this RGB Airmass imagery is shown in Figure 2.

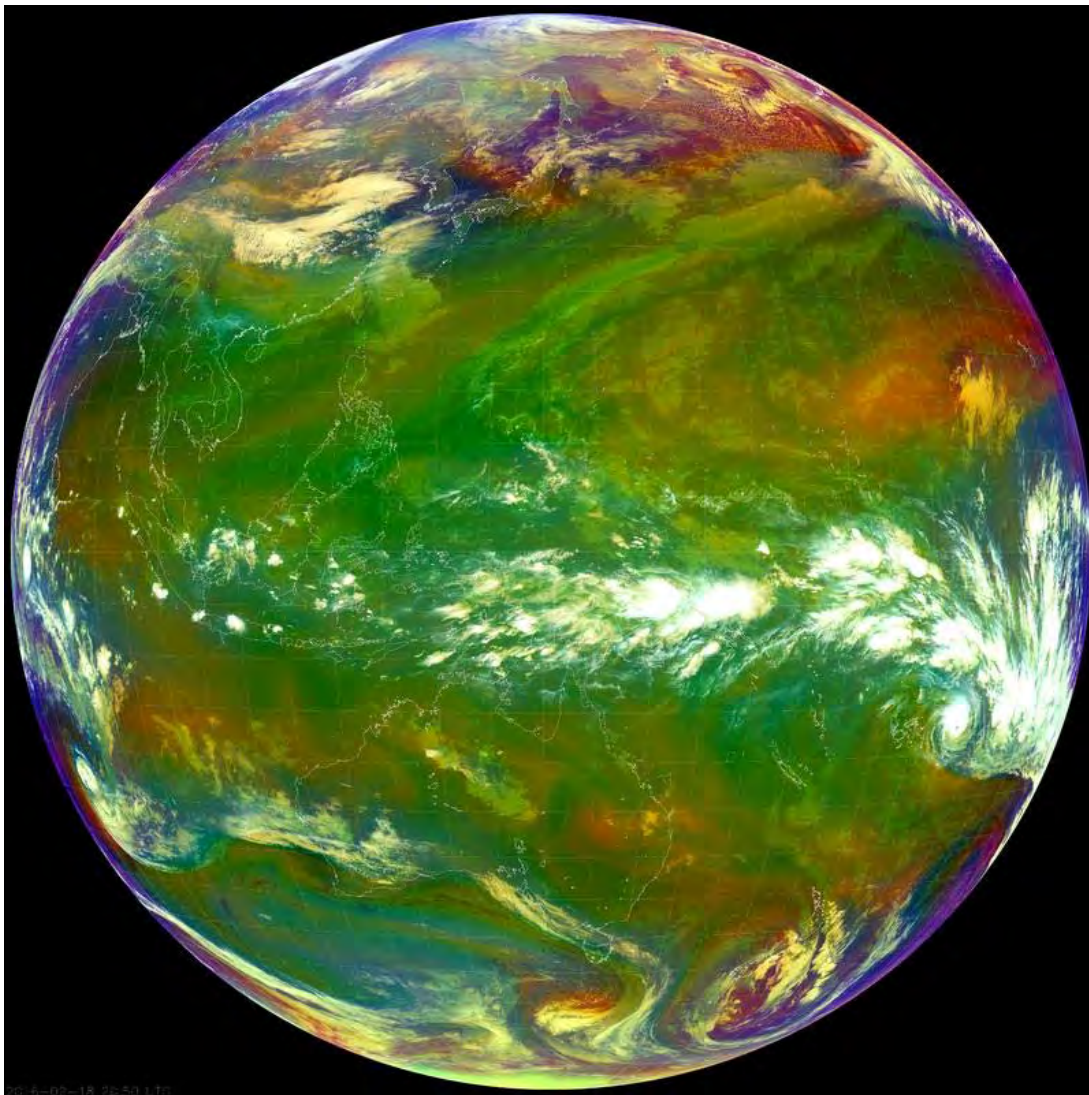

Figure 3. RGB Airmass image created using the Himawari AHI at 2050 UTC on 18 February 2016 centered over the Pacific. Powerful Typhoon Winston is seen in the far right.

2--Interaction with NWS Forecast Offices and National Centers:

- Participated in the 2015 High Impact Weather workshop in Norman, OK.
- Continued close working relationship with partner WFOs at Boulder and Cheyenne. CIRA's WFO Liaison Ed Szoke is also a NOAA/ESRL/GSD employee, and the Boulder WFO is located in the same building in Boulder. Ed interacts frequently with the Boulder WFO, including working occasional forecast shifts to gain a better appreciation of operational forecast problems and issues, as well as giving presentations at their semi-annual Forecaster Workshops. We also work closely with the Cheyenne WFO, and CIRA staff visited the WFO in April to coordinate on a cooperative project involving total lightning and non-supercell tornadoes..
- Expanded the distribution of PG products to additional WFOs. Many requests come after exposure via VISIT training or VISIT monthly Satellite Chat sessions that are open to all WFOs, as well as evaluation

exercises conducted by Satellite Liaison Chad Gravelle. Other requests come through interaction with neighboring WFOs or following CIRA blog postings.

-- Continued to emphasize the collection of forecaster feedback regarding CIRA PG products. Feedback is being received via email, AFDs, blogs, semi-annual National Center reports, shift logs, verbal communication, and specially created feedback links on our web pages. Feedback comments are being archived.

-- Worked closely with all the Proving Ground Liaisons. CIRA participates in the bi-monthly Proving Ground conference calls.

-- AWC Liaison Amanda Terborg continued to evaluate GeoColor at the AWC where the CIRA product is available on the operational floor. For that purpose, CIRA created a special new rectilinear CONUS GeoColor sector for AWC's NAWIPS system which is now being used to combine forecast models with GeoColor (see Figure 4 below).

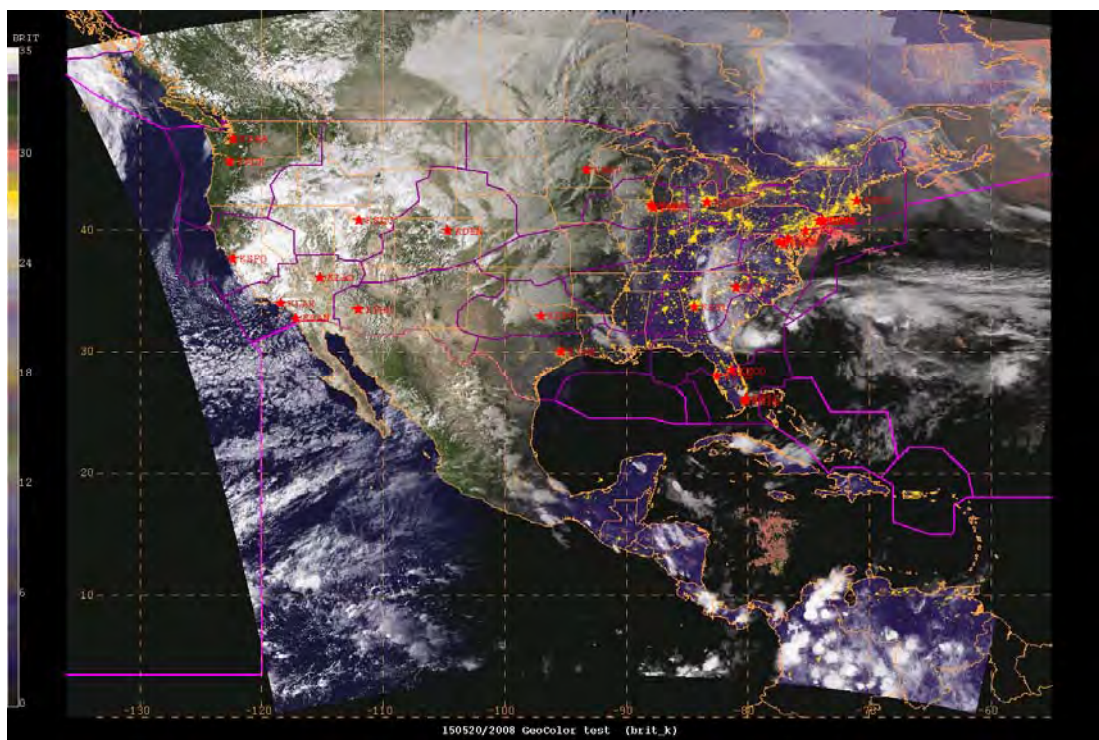

Figure 4. New rectilinear CONUS GeoColor sector for AWC's NAWIPS system depicting AWC usage of GeoColor in NAWIPS with model field overdrawn.

-- The AWC also began testing the MODIS-based CIRA dust discrimination product.

-- Continued to demonstrate and evaluate Total Lightning at both the Boulder and Cheyenne WFOs (in cooperation with SPoRT), using lightning data from the Colorado Lightning Mapping Array (CO LMA) maintained by Colorado State University.

-- Close interaction with the NWS Scientific Services Divisions (SSDs) ensured that the Regional Headquarters are well informed about PG product distribution to their WFOs.

-- Participation in the SPC Spring Experiment in Norman, Oklahoma in May-June to observe use of CIRA's WRF-ARW and NAM Nest based synthetic imagery products.

-- CIRA's close interaction with NHC continued; several visits to NHC offered good opportunities to conduct person-to-person training regarding our NHC PG products.

-- CIRA continued its close interaction with OPC and WPC primarily through their Satellite Proving Ground liaison Michael Folmer. Several products demonstrated to NHC are also demonstrated at OPC and WPC, including GeoColor and RGB Airmass imagery.

-- CIRA participated in the AWC Summer Experiment.

-- CIRA provided synthetic imagery in the form of the "fog product" for the AWC Winter Experiment.

3-- Proving Ground Website Development:

-- CIRA's real-time PG product webpage is continuously being updated to display the latest products and adhere to presentation formats endorsed by the PG program. The page can be seen here:
http://rammb.cira.colostate.edu/ramsd/online/goes-r_proving_ground.asp

4-- AWIPS I & II Development:

-- Continue support of CIRA AWIPS I, AWIPS II & NAWIPS PG products
-- Upgraded hardware used in real-time LDM GOES-R experimental product data service and worked with regional ITO's facilitate changeover to new equipment.
-- Assisted WFO sites with the addition of CIRA simulated WRF & NAM, GeoColor, and MODIS AWIPS II products.
-- Assisted National Centers with the addition of CIRA simulated WRF & NAM, GeoColor, and MODIS NAWIPS products. Worked with satellite liaisons to tune NAWIPS products to meet their needs.
-- Procured & implemented real-time NAWIPS workstation to support NHC Satellite Liaison stationed at CIRA.
-- Procured & implemented hardware to ingest & serve real-time Himawari 8 data to in-house research staff, National Centers, WFOs & SPoRT. Assisted same AWIPS II & NAWIPS ingest and display configuration.
-- Procured & implemented hardware to ingest, process and serve real-time GOES-14 1- minute data to WFO's & National Centers during 3 field experiments. Additional hardware was needed to perform real-time parallax correction on the data, which was also served to WFO & NC sites.
-- Terminated AWIPS I product generation & data service and repurposed hardware to provide additional AWIPS II support.
-- Continue hardware procurement and implementation to improve/expand in-house AWIPS II capabilities
-- Procured and implemented 4 new AWIPS II workstations for research staff use. Includes a pseudo-WES2 ingest and archive system.
-- Provided AWIPS II training and IT support to VISIT staff Himawari 8 case study development.
-- Procured high end AWIPS2 HP EDEX server.
-- Implemented 10 GB network cluster for Himawari 8 data processing and service. (provided beta test for proposed GOES-R cluster design Valuable lessons learned!)
-- Implemented ingest of real-time simulated L1B GRB data from NOAAPORT SBN to support ongoing work with the AWIPS II color table Working Group and VLAB.
-- Working closely with VLAB and OSG personnel to implement latest AWIPS II capabilities as they become available on VLAB. This includes efforts to transition products from McIDAS to netCDF4 formats.
-- Procured and configured 100+ TB NAS storage to support case study development
-- Implemented Himawari 8 raw HSD data archive. All data from StAR data dissemination has been archived to date.
-- Continue work to implement in house AWIPS II RGB display capabilities developed by the SPoRT EPDT. Work with research staff to test the EPDT implementation and develop new RGB image products.
-- Implemented EPDT real-time RGB display capabilities on Weather Lab AWIPS II workstation.
-- Provided training to training and research staff on configuration of RGB product display.
-- Procured & configured hardware needed to support real-time generation of H8 global GeoColor RGB products.
-- Working with National Centers to determine AWIPS II 8 bit RGB product display given that significant software development is needed to implement full 24 bit RGB display in the AWIPS II National Centers Perspective.
-- Continue collaboration with SPoRT on RGB Sounder Airmass N-AWIPS product processing and product dissemination
-- Worked with SPoRT staff to provide advanced Himawari products (Rayleigh corrected true-color and GeoColor) during spring 2016 Operations Proving Ground test.
-- Implemented real-time ingest SPoRT 8 bit NAWIPS pseudo-RGB Himawari products for NHC Satellite liaison evaluation.
-- Continue exchange of IT expertise with SPoRT

- Held 3 day working session at CIRA with Jason Burks (SPoRT) and Ken Sperow (VLAB) to test and improve documentation of VLAB python-based AWIPS II build application and Linux Docker container implementation.
- Continue participation in the AWIPS II-Raytheon working groups and attend AWIPS II workshops
- Ongoing participation in Raytheon AWIPS II Developer's Forum bi-weekly telecons
- Ongoing participation in SPoRT-led EPDT webex training sessions
- Participated in 2 EPDT code sprints in Huntsville, AL. Projects included review of GOES-R plugin and netCDF4 format data and point-set data plugin expansion.
- Ongoing work with VLAB to implement and test AWIPS II applications
- Continue collaborative work with CYS & BOU Forecast Offices and with the NWS National Centers.
- Participated in week long on-site NCO NHC/OPC/WPC Technical Meeting to develop NHC NAWIPS to AWIPS II transition requirements
- Participated in OPC NAWIPS to AWIPS II NCP transition fit test.
- Ongoing work with NHC/OPC staff to implement AWIPS II NCP N-Build updates on CIRA AWIPS II NCP workstations to maintain field compatibility.

5-- Product Documentation and User Readiness:

- CIRA continued to leverage VISIT and SHyMet in-house capabilities to demonstrate and provide exposure to some future bands on GOES-R and potential products.
- Monthly live VISIT "Satellite Chat" 30 minute sessions cover a variety of pertinent topics and are attended by forecasters from various WFOs, with forecasters occasionally presenting topics as well. GOES-R related imagery discussed include application of 1-minute SRSOR imagery to winter storms.
- CIRA continued to post BLOGS on CIRA's VISIT webpage
<http://rammb.cira.colostate.edu/training/visit/blogs.asp>
as well as on CIRA's GOESR-R Proving Ground Blog page:
http://rammb.cira.colostate.edu/research/goes-r/proving_ground/blog/
- CIRA continued to merge PG modules with on-going activities.
- CIRA collaborated closely with CIMSS, SPoRT and COMET on training activities, participating in a special session at the start of the June Proving Ground meeting in Kansas City as well as a February meeting at COMET. CIRA will be heavily involved in formal training development to be released to the NWS at the launch of GOES-R.

6-- Colorado Lightning Network (CO LMA):

- The CO LMA data stream is maintained by CSU with a communications contract has been established that is working well. All stations are currently on line and operating well. Live CO LMA data were ingested into the Boulder and Cheyenne WFOs and are being used by forecasters to help identify severe weather and rapidly evolving convective storms, as well as other applications that the forecasters have discovered. Displays of the data are available on AWIPS II through our arrangement with SPoRT, as well as on a situational awareness wall-mounted monitor that displays the CO LMA website.
- A new VISIT module was developed by Ed Szoke and Dan Bikos (and other collaborators) on the potential use of total lightning for the warning of non-supercell tornadoes. The session has been given live to a number of WFOs and is available as a live presentation 1 to 2 times per month.

Publications:

Bikos, D.E., J. Finch, J.L. Case, 2015: The environment associated with significant tornadoes in Bangladesh. *Atmos. Res.*, 167, 183-195.

Folmer, M, M. DeMaria, R. Ferraro, J. Beven, M. Brennan, J. Daniels, R. Kuligowski, H. Meng, S. Rudlosky, L. Zhao, J.A. Knaff, S. Kusselson, S.D. Miller, T. Schmit, C. Velden, and B. Zavadsky, 2015: Satellite tools to monitor and predict Hurricane Sandy (2012): Current and emerging products. *Atmospheric Research*, 166, 165-181.

Gladkova, I., A. Ignatov, F. Shahriar, Y. Kihai, D.W. Hillger, and B. Petrenko, 2016: Improved VIIRS and MODIS SST Imagery. *Remote Sensing*, 8:1, doi:10.3390/rs8010079

Gochis, D., R. Schumacher, K. Friedrich, N. Doesken, M. Kelsch, J. 4 Sun, K. Ikeda, D.T. Lindsey, A. Wood, B. Dolan, S. Matrosov, A. Newman, K. Mahoney, S. Rutledge, R. Johnson, P. Kucera, P.

Goni, G.J., J.A. Knaff, I-I. Lin, 2015: [The Tropics] Tropical Cyclone Heat Content [in "State of the Climate in 2014"]. *Bull. Amer. Meteor. Soc.*, 96:7, S121-S122.

Grasso, L.D., D.T. Lindsey, C.J. Seaman, B.Stocks, and R.M. Rabin, 2015: Satellite Observations of Plume-Like Streaks in a Cloud Field in Canada. *Pure Appl. Geo.* Doi:10.1007/s00024-015-1076-z

Hillger, D.W., T. Kopp, C. Seaman, S.D. Miller, D.T. Lindsey, E. Stevens, J. Solbrig, W. Straka III, M. Kreller, A. Kuciauskas, and A. Terborg, 2015: User Validation of VIIRS Satellite Imagery. *Remote Sensing*, 8:11, doi: 10.3390/rs8010011

Kaplan, J., C.M. Rozoff, M. DeMaria, C.R. Sampson, J.P. Kossin, C.S. Velden, J.J. Cione, J.P. Dunion, J.A. Knaff, J.A. Zhang, J.F. Dostalek, J. D. Hawkins, T.F. Lee, and J.E. Solbrig, 2015: Evaluating environmental impacts on tropical cyclone rapid intensification predictability utilizing statistical models. *Wea. Forecasting*, 30, 1374-1396. doi: <http://dx.doi.org/10.1175/WAF-D-15-0032.1>

Kennedy, D. Sempere-Torres, M. Steiner, R. Roberts, J. Wilson, W. Yu, V. Chandrasekar, R. Rasmussen, A. Anderson, B. Brown, 2015: The great Colorado flood of September 2013. *Bulletin of the American Meteorological Society*, 96:9, 1461-1487.

Knaff, J.A., S.P. Longmore, R.T. DeMaria, and D.A. Molenaar, 2015: Improved Tropical-Cyclone Flight-Level Wind Estimates Using Routine Infrared Satellite Reconnaissance. *J. Appl. Meteor. Climatol.*, 54, 463-478. doi: <http://dx.doi.org/10.1175/JAMC-D-14-0112.1>

Knaff, J.A. and C.R. Sampson, 2015: After a decade are atlantic tropical cyclone gale force wind radii forecasts now skillful?. *Wea. Forecasting*, 30:3, 702-709. doi: <http://dx.doi.org/10.1175/WAF-D-14-00149.1>

Knaff, J.A. , C.J. Slocum, K.D. Musgrave, C.R. Sampson, and B. Strahl: 2016: Using routinely available information to estimate tropical cyclone wind structure. *Mon. Wea. Rev.*, in press

Line, W.E., T.J. Schmit, D.T. Lindsey, and S.J. Goodman, 2016: Use of Geostationary Super Rapid Scan Satellite Imagery by the Storm Prediction Center. *Wea. Forecasting*, 31, 483-494. doi: <http://dx.doi.org/10.1175/WAF-D-15-0135.1>

Manion, A., C. Evans, T.L. Olander, C.S. Velden, and L.D. Grasso, 2015: An evaluation of advanced Dvorak technique-derived tropical cyclone intensity estimates during extratropical transition using synthetic satellite imagery. *Wea. Forecasting*, 30:4, 984-1009.

Miller, S.D., T.J. Schmit, C. Seaman, D. Lindsey, M. Gunshor, R. Kors, Y. Sumida, and D. Hillger, 2016: "A Sight for Sore Eyes - The Return of True Color to Geostationary Satellites," *Bulletin of the American Meteorological Society*, in press.

Miller, S.D., 2015: Night Watch. A satellite sensor that can see in the dark is revealing new information for meteorologists, firefighters, search teams and researchers worldwide. *Scientific American*, 312:5, 78-81.

Miller, S.D., W.C. Straka III, J.Yue, S.M.Smith, M.J.Alexander, L.Hoffmann, M.Setvak, and P.T.Partain, 2015: Upper atmospheric gravity wave details revealed in nightglow satellite imagery. *Proc. Nat. Acad. Sci.*, 112:49, E6728–E6735; doi: 10.1073/pnas.1508084112

Sampson C.R, and J.A. Knaff, 2015: A consensus forecast for tropical cyclone gale wind radii. *Wea. Forecasting*, 30, 1397-1403. doi: <http://dx.doi.org/10.1175/WAF-D-15-0009.1>

Schmit, T., S. Goodman, M. Gunshor, J. Sieglaff, A. Heidinger, S. Bachmeier, A. Terborg, J. Feltz, K. Ba, S. Rudlosky, D.T. Lindsey, R. Rabin, and C. Schmidt, 2015: Rapid refresh imagery of significant events: preparing users for the next generation of geostationary operational satellites. *Bulletin of the American Meteorological Society*. 96: 4, 561-576. /doi/full/10.1175/BAMS-D-13-00210.1 P

Seaman, C.J., D.W. Hillger, T. Kopp, R. Williams, S.D. Miller and D.T. Lindsey, 2015: Visible Infrared Imaging Radiometer Suite (VIIRS) Imagery Environmental Data Record (EDR) User's Guide. NOAA Technical Report NESDIS 147, 31 pp.

Seaman, C.J. and S.D. Miller, 2015: A dynamic scaling algorithm for the optimized digital display of VIIRS Day/Night Band imagery. *Int. J. Rem. Sens.*, 36:7, 1839-1854, doi: 10.1080/01431161.2015.1029100.

Straka, W.C., III; Seaman, C.J.; Baugh, K.; Cole, K.; Stevens, E.; Miller, S.D. Utilization of the Suomi National Polar-Orbiting Partnership (NPP) Visible Infrared Imaging Radiometer Suite (VIIRS) Day/Night Band for Arctic Ship Tracking and Fisheries Management. *Remote Sens.* 2015, 7(1), 971-989. <http://dx.doi.org/10.3390/rs70100971>

Presentations:

Brummer, R.L., E. Szoke, S.D. Miller, C. Seaman, D.T. Lindsey, G. Chirokova, A.B. Schumacher, D.W. Hillger, and D.A. Molenar, 2015: Proving Ground Activities at CIRA. 6th Asia Oceania Meteorological Satellite Users' Conference (AOMSUC), Tokyo, Japan, 9-13 November.

Grasso, L.D., D.T. Lindsey, Y-J Noh, 2015: Recent issues with the Community Radiative Transfer Model and Particle Size. Naval Research Lab, Monterey, CA, 15-19 June. (oral presentation)

Hillger, D.W., D. Kopp, 2015: EDR Imagery Overview, STAR 2nd Annual JPSS Science Meeting, College Park, MD, 26 August.

Knaff, J.A., 2015: Using Routinely Available Information to Estimate Tropical Cyclone Wind Structure. NOAA/NCAR/CSU TC Workshop, Boulder, CO, 21 July.

Lindsey, D.T., S.D. Miller, C.J. Seaman, D.A. Molenar, D. W. Hillger, T.J. Schmit, W. Straka and Y. Sumida, 2016: A First Look at Imagery from Himawari-8. 96th AMS Annual Meeting, New Orleans, LA, 10-14 January.

Miller, S.D., C. Seaman, D.T. Lindsey, T. Schmit, M. Gunshor, D.W. Hillger, and Y. Sumida, 2015: Multispectral Application Development for Himawari-8 AHI, 6th Asia Oceania Meteorological Satellite Users' Conference (AOMSUC), Tokyo, Japan, 9-13 November.

Miller, S.D., 2015: Validation and Refinement of a Lunar Irradiance Model for Suomi NPP VIIRS Day-Night Band Quantitative Nighttime Applications. AGU Annual Meeting, San Francisco, CA, 14-18 December.

Miller, S.D., T.J. Schmit, C.J. Seaman, M. Gunshor, D.T. Lindsey, D.W. Hillger, and Y. Sumida, 2016: The Return of True Color to Geostationary Satellites: Transitioning from Polar, to Himawari, to GOES-R. 96th AMS Annual Meeting, New Orleans, LA, 10-14 January.

Musgrave K.D., J.A. Knaff, C.J. Slocum, L.D. Grasso, and M. DeMaria 2016: Examination of Tropical Cyclone Structure Through Synthetic Satellite Brightness Temperatures. 20th Conference on Integrated Observing and Assimilation Systems for the Atmosphere, Oceans, and Land Surface, Phoenix, AZ, 4-8 January.

Musgrave, K.D., and C. Slocum, 2015: RAMMB/CIRA Website Upgrades and Products for the 2015 Hurricane Season. Hurricane Forecast Improvement Project (HFIP) Teleconference, 9 September.

Musgrave, K.D., 2015: Verification of HWRF Synthetic Satellite Brightness Temperatures. NOAA/NCAR/CSU TC Workshop, Boulder, CO, 21 July.

Musgrave, K.D., J.A. Knaff, M. DeMaria, C. Slocum, L.D. Grasso, A.B. Schumacher, and W. Schubert: 2015: Hurricane Forecast Improvement Project – Model Post-Processing and Evaluation. Center for Multi-scale Modeling of Atmospheric Processes (CMMAP) Annual Team Meeting, CSU, Fort Collins, CO, 6 August. (poster)

Musgrave, K.D., 2015: Status Briefing Provided for the Hurricane Forecast Improvement Project (HFIP) biweekly teleconference, CIRA, Fort Collins, CO, 12 August.

Noh, Y-J., J.M. Forsythe, C.J. Seaman, S.D. Miller, M. Rogers, D.T. Lindsey and A. Heidinger, 2015: Enterprise Cloud Base: VIIRS Cloud Base Height Improvement and Validation Using CloudSat. STAR 2nd Annual JPSS Science Meeting, College Park, MD, 27 August.

Schumacher, A.B., 2015: An examination of situation-specific hurricane forecast uncertainty statements in NHC Tropical Cyclone Discussions. National Hurricane Center, 12 November.

Seaman, C.J., G. Chirokova, J. Dostalek, L. Grasso, J. Knaff, D. Lindsey, S. Miller and A. Schumacher, 2016: "Satellite Proving Ground OCONUS Activities at CIRA." Invited oral presentation. 2015 OCONUS Technical Interchange Meeting, Anchorage, AK, 12-15 May.

Seaman, C.J., S.D. Miller and D.W. Hillger, 2015: On the Use of VIIRS Day/Night Band and Near Constant Contrast Imagery. STAR 2nd Annual JPSS Science Meeting, College Park, MD, 26 August

Slocum, C., 2015: Can Comparisons of Precipitable Water from Models and Satellite Provide Guidance on Guidance? NOAA/NCAR/CSU TC Workshop, Boulder, CO, 21 July.

Szoke, E.J., 2016: Talks on GOES-R Proving Ground updates at the Boulder Weather Forecast Office (WFO) Spring Workshops, 4 & 11 March.

Szoke, E.J., D. Bikos, R. Brummer, H. Gosden, D.T. Lindsey, D. A. Molenaar, D.W. Hillger, S.D. Miller and C.J. Seaman, 2015: An update on CIRA's Proving Ground efforts as we approach the launch of GOES-R. AMS 27th Conference on Weather Analysis and Forecasting/23rd Conference on Numerical Weather Prediction, Chicago, 29 June-3 July. (Talk 15B.5.)

Szoke, E., D. Bikos, R. Brummer, H. Gosden, D. Lindsey, D. Molenaar, D. Hillger, S. Miller, and C. Seaman, 2015: CIRA's NWS Proving Ground activities as we approach the launch of GOES-R, 40th Annual Meeting, Oklahoma City, Oklahoma, National Weather Association, 19-22 October. (Poster CP-55)

Trabing, B., 2015: Analysis of Hurricanes Using Long-Range Lightning Detection Networks. NOAA/NCAR/CSU TC Workshop, Boulder, CO, 21 July.

PROJECT TITLE: CIRA Support to Improving CRTM Solar Reflection

PRINCIPAL INVESTIGATOR: Louie Grasso

RESEARCH TEAM: Yoo-Jeong Noh, Renate Brummer, Kevin Micke

NOAA TECHNICAL CONTACT: Satya Kalluri (NOAA/NESDIS) and Candice Jongsma (NOAA/OAR)

NOAA RESEARCH TEAM: Dan Lindsey (NOAA/NESDIS/STAR/RAMMB)

FISCAL YEAR FUNDING: \$60,000

PROJECT OBJECTIVES:

The Cooperative Institute for Research in the Atmosphere (CIRA) together with the NOAA/NESDIS/StAR Regional and Mesoscale Meteorology Branch (RAMMB) have extensive experience using the Community Radiative Transfer Model (CRTM). A year ago, the CIRA/RAMMB synthetic imagery team noticed some significant errors (~50 K for the 3.9 μm band) in the CRTM solar reflective bands for clouds, particularly ice clouds. This was brought to the attention of the NESDIS/StAR CRTM team who looked into it and verified that the error exists. It was decided that the way reflection of solar radiation by clouds is handled in the CRTM needs to be overhauled. What the CRTM had was built on an original framework of clear sky, single line-of-sight radiative transfer with an effectively specular surface.

The CIRA/RAMMB team has extensive previous experience with solar scattering radiative transfer, after having developed a Radiative Transfer Model (RTM) that extends from visible wavelengths into the infrared over the last many years. Specifically, the RTM can successfully simulate the 3.9 μm band by using solar scattering lookup tables in a routine called SHDOM (developed by Frank Evans). The tables originated from Ping Yang's (Texas A&M) solar scattering lookup tables.

Research Objectives

In close collaboration with the NESDIS/StAR CRTM team members Tong Zhu, Mark Liu and Paul van Delst, the source of the error at 3.9 μm in the CRTM code was identified. Based on a several teleconference the CIRA/RAMMB team and the CRTM developers agreed on the following tasks do be conducted by the CIRA/RAMMB team:

- 1--Compare the Ping Yang lookup tables and associated solar scattering calculations between the CRTM and CIRA's SHDOM routine.
- 2-- Identify where in the CRTM code the error in the computation of the CRTM brightness temperature at 3.9 μm is occurring, and then determine what needs to be done in order to fix the error.
- 3--Depending on the nature of the problem, either update CRTM LUTs/fix CRTM code following the CRTM coding and performance guidelines **or** demonstrate an accurate result with a combined CRTM-SHDOM method.

Achievements

1--Synthetic imagery was produced from a WRF-ARW simulation that used the Thompson microphysics. In one case, synthetic imagery was calculated with the CRTM_v2.1.3 that uses scattering lookup tables that are generated by Ping Yang's group at Texas A&M (Fig. 1b). In another case, synthetic imagery was calculated with the CIRA RTM that uses SHDOM and associated lookup tables (Fig. 1c). Observations

(Fig. 1a) highlights the lack of solar reflection from the CRTM_v2.1.3 while supporting the results from the CIRA RTM.

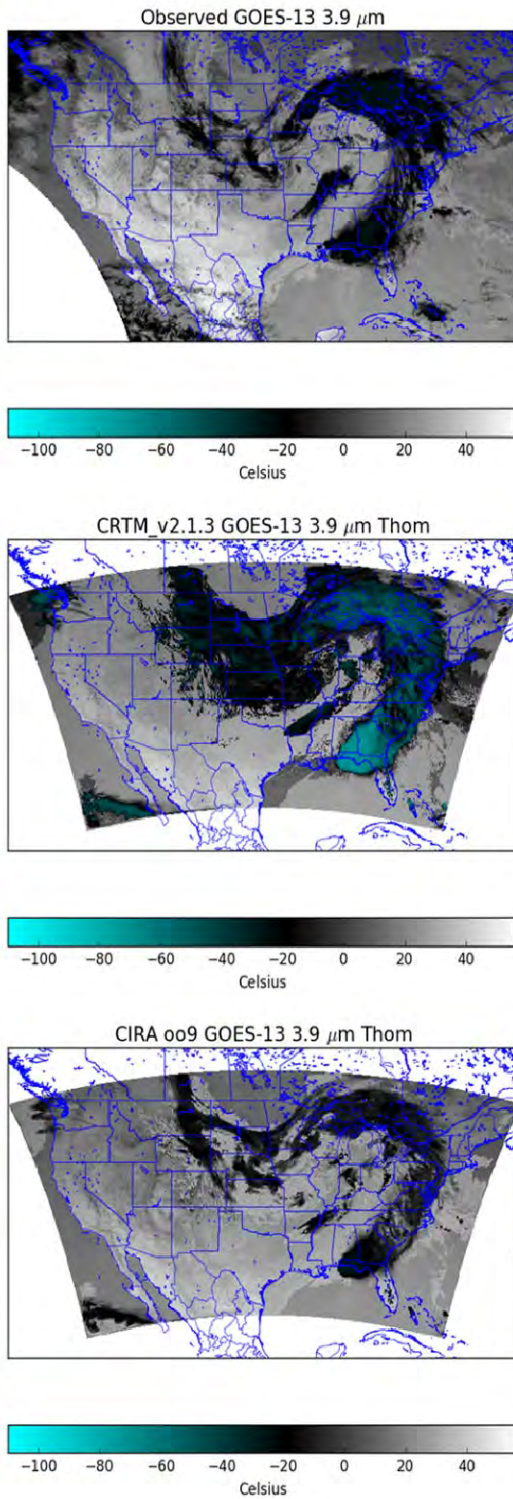

Figure 1. Comparisons between (a) observed GOES-13 3.9 μm (top figure), (b) CRTM (V2.1.3) with a lack of solar reflection (center figure), and (c) CIRA oo9 for 29 April 2014 at 18 Z (bottom figure). Compared to the CRTM, CIRA oo9 results are supported by observations. Both (b) and (c) are based on a WRF-ARW simulation that employed the Thompson microphysics.

2-- Together with the NESDIS CRTM developer team a coding error was located in routine ADA_Module.f90, line 448'ish, in version 2.1.3. Below is a summary.

Original: "if (RTV%Visible_Flag_true) then"
was replaced by the following Fix:
Fix: " if (RTV%Solar_Flag_true) then"

Further, the delta-fitted Legendre coefficients that are used to describe the Legendre Phase Function of pristine ice were in error in the cloud coefficient lookup table. This table is in the file CloudCoeff.bin version 3.04. An example of a set of six-stream coefficients that resulted from a quadratic interpolation in four wavelengths and four effective radii are the following:

Term l=:	1	pcoeff(l,m,kc,n):	-2.141713177739546E-002
Term l=:	2	pcoeff(l,m,kc,n):	-3.569515777398292E-002
Term l=:	3	pcoeff(l,m,kc,n):	-3.604496566266741E-002
Term l=:	4	pcoeff(l,m,kc,n):	-9.854570003897810E-002
Term l=:	5	pcoeff(l,m,kc,n):	-9.992454293002201E-002
Term l=:	6	pcoeff(l,m,kc,n):	1.405910709521107E-002

An updated CloudCoeff.bin version 3.07 was provided by the CRTM team that contained correct values. The updated set of Legendre coefficients of pristine ice from above then became the following:

Term l=:	1	pcoeff(l,m,kc,n):	0.840471362872913
Term l=:	2	pcoeff(l,m,kc,n):	0.904354761761248
Term l=:	3	pcoeff(l,m,kc,n):	0.725027547657389
Term l=:	4	pcoeff(l,m,kc,n):	0.477582211656941
Term l=:	5	pcoeff(l,m,kc,n):	0.176536461781458
Term l=:	6	pcoeff(l,m,kc,n):	0.705481548343187

In order to evaluate the values of the Legendre coefficients of pristine ice in the CloudCoeff.bin version 3.07, a comparison was made with Legendre coefficients that were used by the CIRA RTM (Fig. 1c). Although the CIRA RTM uses approximately 2500 Legendre coefficients, a technique was applied to extract the corresponding values for a six-stream approximation. Results of the comparison exhibited similar values between the CRTM and CIRA.

In summary, the above discussion applies only to the microphysical habit called pristine ice. As a result, we have communicated with Paul van Delst, via a telecom, our findings and recommendation thus far: Due to the relatively coarse spacing of the data in CloudCoeff.bin, we suggested reducing both the spacings between wavelengths and effective radii. That is, increase the resolution of the optical properties in the lookup table.

Brightness temperatures at 3.9 μm also exhibit discrepancies between the CRTM and observations. We are currently working on this issue.

3-- Depending on the nature of the CRTM problem, the CIRA team was tasked to either update CRTM LUTs/fix CRTM code following the CRTM coding and performance guidelines **or** demonstrate an accurate result with a combined CRTM-SHDOM method. The CIRA Team took the following action:

- We have included the code error that was outlined in ADA_Module.f90.
- We have pass along recommendations for updating the CRTM LUT for pristine ice.

-We updated the CRTM via a telecom in late January 2016 after which Paul van Delst send the following comment: *"Let me end by reiterating my thanks to you all at CIRA for doing this. Your work there will make a big difference in how well the CRTM, indeed *any* RT model, can simulate cloudy radiances"*.

The final CRTM task left for the CIRA Team is to investigate any CRTM cloud liquid water issues.

Publications: None

Presentations:

Lindsey, D.T., L.D. Grasso, Y-J Noh, 2016: Improvements to the CRTM for Cloudy Radiance Calculations. 4th Annual Symposium on the Joint Center for Satellite Data Assimilation (JCSDA), 96th AMS Annual Meeting, 10-14 January 2016, New Orleans, LA.

PROJECT TITLE: CIRA Support for the JPSS Proving Ground and Risk Reduction Program: Application of Joint Polar Satellite System (JPSS) Imagers and Sounders to Tropical Cyclone Track and Intensity Forecasting

PRINCIPAL INVESTIGATOR: Galina Chirokova

RESEARCH TEAM: Robert DeMaria, Jack Dostalek, Steve Finley, Kevin Micke

NOAA TECHNICAL CONTACT: Satya Kalluri (NOAA/NESDIS) and Candice Jongsma (NOAA/OAR)

NOAA RESEARCH TEAM: John Knaff (NOAA/NESDIS/STAR)

FISCAL YEAR FUNDING: \$116,250

PROJECT OBJECTIVES:

The ability to forecast tropical cyclone (TC) intensity changes has improved much more slowly than the ability to forecast TC tracks. An especially difficult but very important forecast problem is predicting rapid increases in TC intensity, that is Rapid Intensification (RI). Improving RI forecasts is one of the highest priorities within NOAA. The time scale of tropical cyclone track and intensity changes is on the order of 12 hours, which makes the JPSS instruments well suited for the forecasting of these parameters. Several tropical cyclone applications of JPSS data using S-NPP ATMS, CrIS, and VIIRS data will be developed. The first group of applications uses ATMS-MIRS and NUCAPS retrievals to improve the Rapid Intensification Index (RII). JPSS data will be used to develop new predictors for the RII as well as to improve existing predictors. As part of the development of the new predictors for the RII, two end user applications will be developed: (1) the moisture flux application that will allow for the detection of dry air intrusions that are an important factor for forecasting intensity; and (2) the improved eye-detection application. The objective automated eye-detection algorithm will be improved by using VIIRS data together with other ancillary data, and will be adapted to be used as an additional predictor in the RII. The newly developed and improved predictors will be incorporated into the NHC operational RII, and its performance with the new predictors will be evaluated. The second group of applications will develop

tools to better utilize VIIRS imagery, especially VIIRS DNB imagery, for tropical cyclone forecasting, and will include a proxy-visible imagery application and improved TC VIIRS DNB imagery.

The newly developed products will be made available via the satellite Proving Ground to operational forecasters at the National Hurricane Center (NHC) and Joint Typhoon Warning Center (JTWC) for evaluation and feedback. If the evaluation is positive, the products can be transitioned to NHC and JTWC operations.

PROJECT ACCOMPLISHMENTS:

1-- Complete MPI and RII algorithm testing using preliminary pre-operational dataset, perform algorithm testing and tuning using 2014 season TC data
Operations

The MPI and RII algorithm testing using preliminary pre-operation 2012-2013 dataset was completed, and algorithm testing using 2014 season AL data was performed.

1) ATMS soundings correction based on comparison to dropsondes.

The ATMS soundings were adjusted based on the comparison with dropsonde soundings. A database of approximately 350 Atlantic dropsondes collocated with ATMS and GFS soundings within 100 km was created. ATMS-MIRS, GFS, and dropsonde data for the years 2012-2014 were used to create this database. Figure 1 (Left) shows the number of dropsondes available as a function of distance from the storm center. All collocated dropsondes were split into 100 km bins, at distances from 0 to 1000 km from the storm center, and bias, MAE, and RMSE were calculated as a function of pressure and distance to the storm center. It was found that at the center of the storm (0-100 km) ATMS-MIRS soundings are usually better than the GFS ones. At 300-800 km from the storm center, the ATMS-MIRS soundings usually have a dry and cold bias at the surface, and usually have smaller errors than the GFS soundings. Closer to the surface, approximately below 800 hPa, GFS soundings tend to have smaller errors.

Figure 2 shows an example of how the warm core sounding changes as result of applying bias-correction to the ATMS-MIRS data for the AL basin. Figure 2 (Left) is produced from the original ATMS data, and Figure 2 (Right) is produced from bias-corrected ATMS data. The warm core signal becomes stronger at the upper levels in the bias-corrected version, which is more consistent with the warm core structure described in the literature (e.g. Hawkins and Rubsam 1968). In addition, the air temperature at the lower levels looks more realistic in the bias-corrected plot at a distance of 200-300 km from the storm center. Also, the cold anomaly in the center of the storm at the lower levels, when present, is removed by the bias corrections.

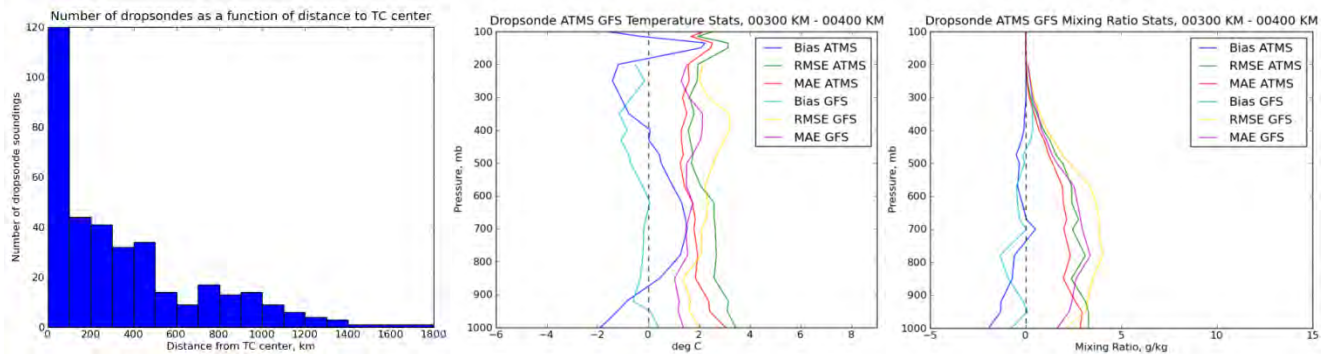

Figure 1. Left: Number of dropsondes available as a function of the distance from the storm center. Center: Temperature bias, MAE, and RMSE for GFS and ATMS-MIRS soundings relative to dropsondes. Shown are: blue, green, and magenta, correspondingly – bias, RMSE, and MAE for ATMS; and cyan, yellow, and magenta – corresponding values for GFS. Right: same as Center, but for mixing ratio.

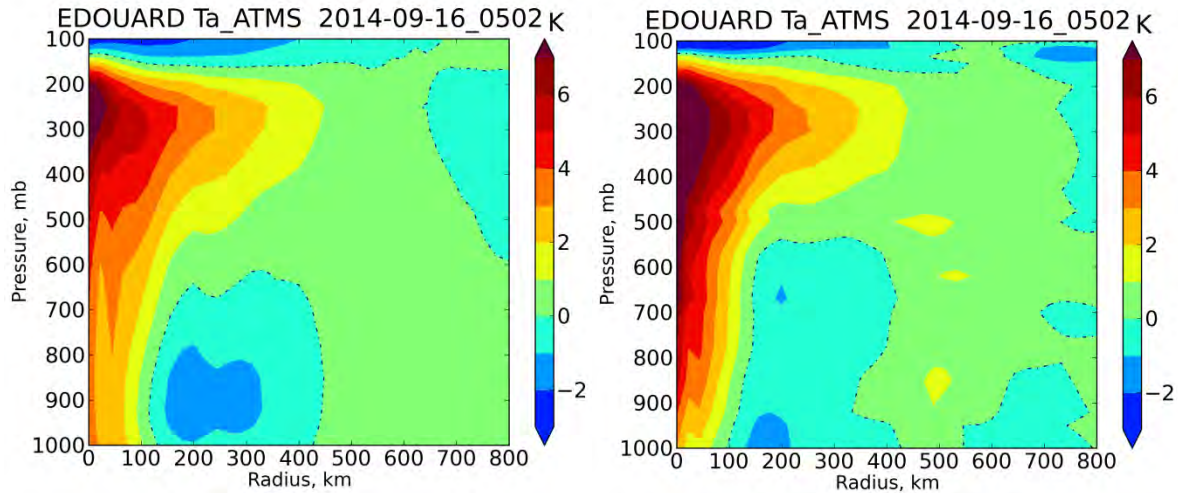

Figure 2. Warm core structure as depicted by ATMS-MIRS temperature retrievals. The left panel shows uncorrected plot. The right panel shows ATMS-MIRS temperature profile corrected by the bias relative to dropsondes. The corrected version provides more pronounced (larger amplitude) warm core at the upper levels, and removes some cool anomalies at the lower levels. The image is shown for the Hurricane Edouard, al062014.

The MPI estimates were recalculated based on bias corrected ATMS-MIRS soundings, and then averaged in radii between 300 – 600 km from the storm center. Figure 3 (Left) shows ATMS-only profiles originally used for MPI estimates, and bias-corrected ATMS profiles (Right). The bias-corrected soundings better represent the boundary layer. In addition, in the corrected soundings the environmental CAPE value is no longer equal to zero, as was always the case while using original ATMS profiles. The resulting temperature profiles also more closely follow the moist adiabat, as is expected for the tropical soundings. The MPI estimates based on the bias-corrected soundings tend to be smaller than the original MPI estimates.

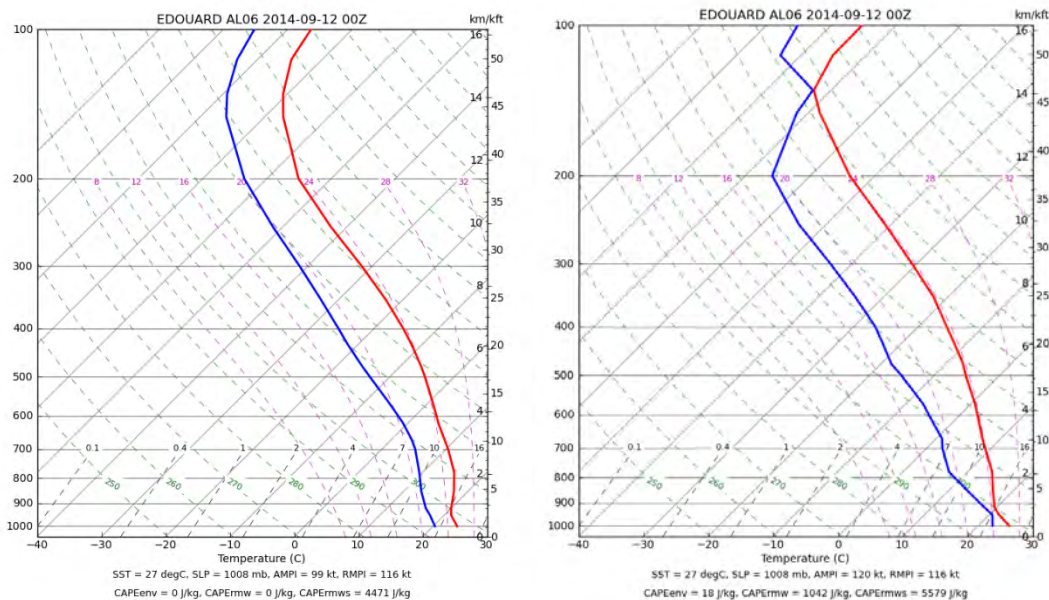

Figure 3. Left: T (red) and T_d (blue) as estimated from ATMS-MIRS data. Profiles are averaged in radii between 200 – 800 km from the storm center. Right: Same, but estimated from bias-corrected ATMS-MIRS soundings, and averaged in the radii between 300-600 km.

The ATMS profiles correction described above was obtained based on the statistical comparison of ATMS-MIRS profiles with Atlantic dropsondes. The same algorithm was tested with East Pacific and West Pacific storms, and it was found that it does not work as well. The average size of the TCs varies between different basins. It is likely that size differences are some of the reason why the correction does not work as well in EP and WP.

2-- Test and tune automated eye-detection algorithm using 2014 TC season high-resolution VIIRS data. (CIRA)

After the machine learning algorithm has been trained to perform automated eye/no-eye classification, a set of cases for which the automated eye-detection algorithm performed poorly on was examined. It was discovered that many cases where a small eye is present were incorrectly classified as having no eye. The original algorithm uses low-resolution GOES-IR data as input and as a result, much of the information around the eye is lost due to the low resolution of the data (see Figure 4). Work has been started on testing the automated eye-detection algorithm with high-resolution VIIRS data to overcome this limitation.

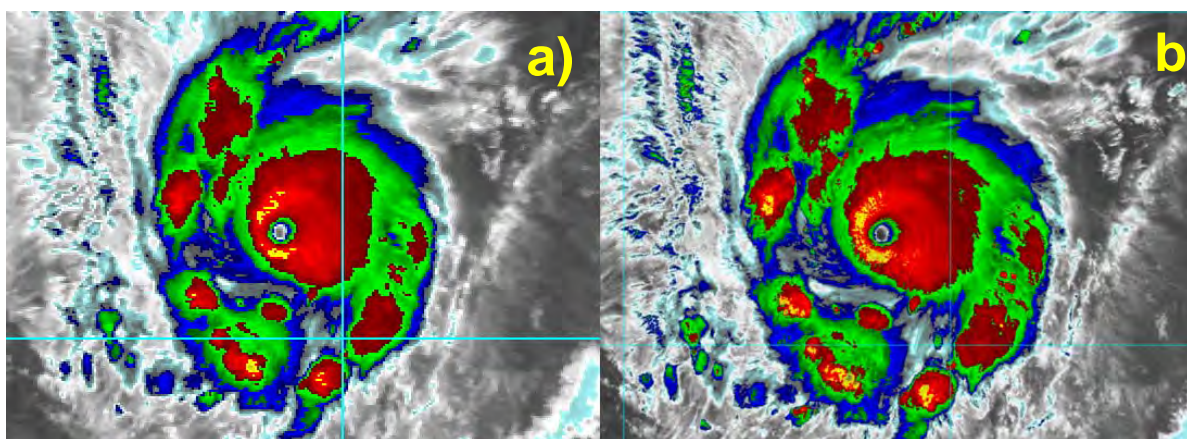

Figure 4. (a) The small eye as depicted by the GOES imagery (4 km resolution) and (b) the VIIRS I5-band imagery (375 m resolution; the image is shown at reduced resolution). The example is for hurricane Amanda, ep012014.

In order for a VIIRS image to be compatible with the algorithm's previous training, the data must be re-gridded to the GOES IR image grid. Prior to performing the re-gridding, each VIIRS latitude/ longitude point is converted from a spherical coordinate system to a Cartesian coordinate system. This conversion is performed in a simplified manner by assuming that each point lies on the surface of a unit sphere. It should be noted that error is introduced by the assumption that the earth is a unit sphere; however, for the purposes of developing initial test data to investigate the use of VIIRS data with the eye detection algorithm, the error is not significant. This coordinate conversion is also performed for each GOES latitude/longitude point. Within the Cartesian space the VIIRS points are subsequently re-gridded to the GOES points. To do this, the VIIRS data are organized within a KD tree to facilitate efficient search. Then the 10 closest VIIRS points are found for each GOES point. These 10 points are found using a nearest neighbor search. A weighted average of the VIIRS points is then generated to find the interpolated VIIRS value at the location of the GOES point. To calculate the average, each VIIRS point is weighted by the inverse of the squared distance between the GOES point and the VIIRS point. Thus, closer points are weighted much more heavily than distant points.

Once the VIIRS data have been re-gridded, a subset of the data centered near the tropical cyclone eye is fed into the algorithm to perform classification. Figure 5(a) shows an example of the unprojected SDR IR I5-band VIIRS imagery for hurricane Edouard, al06 2014. Figure 5(b) shows the same image re-gridded to the low-resolution 4 km GOES IR grid. Currently, no difference has been detected between the use of the algorithm with VIIRS data and IR data. However, only a very small set of VIIRS data have been used

so far. Using a larger set of images may show that the use of VIIRS data reduces incorrect classification. Additionally, the use of interpolation is likely not the most effective method of using the information contained in a VIIRS image that a GOES image may lack. An alternate scheme, such as taking the maximum VIIRS value in the set of nearest neighbors, may pass on more valuable information to the classification algorithm than the weighted average currently being used. Future work will involve creating a larger set of test data as well as testing alternate schemes for transforming VIIRS data to the format required by the eye detection algorithm.

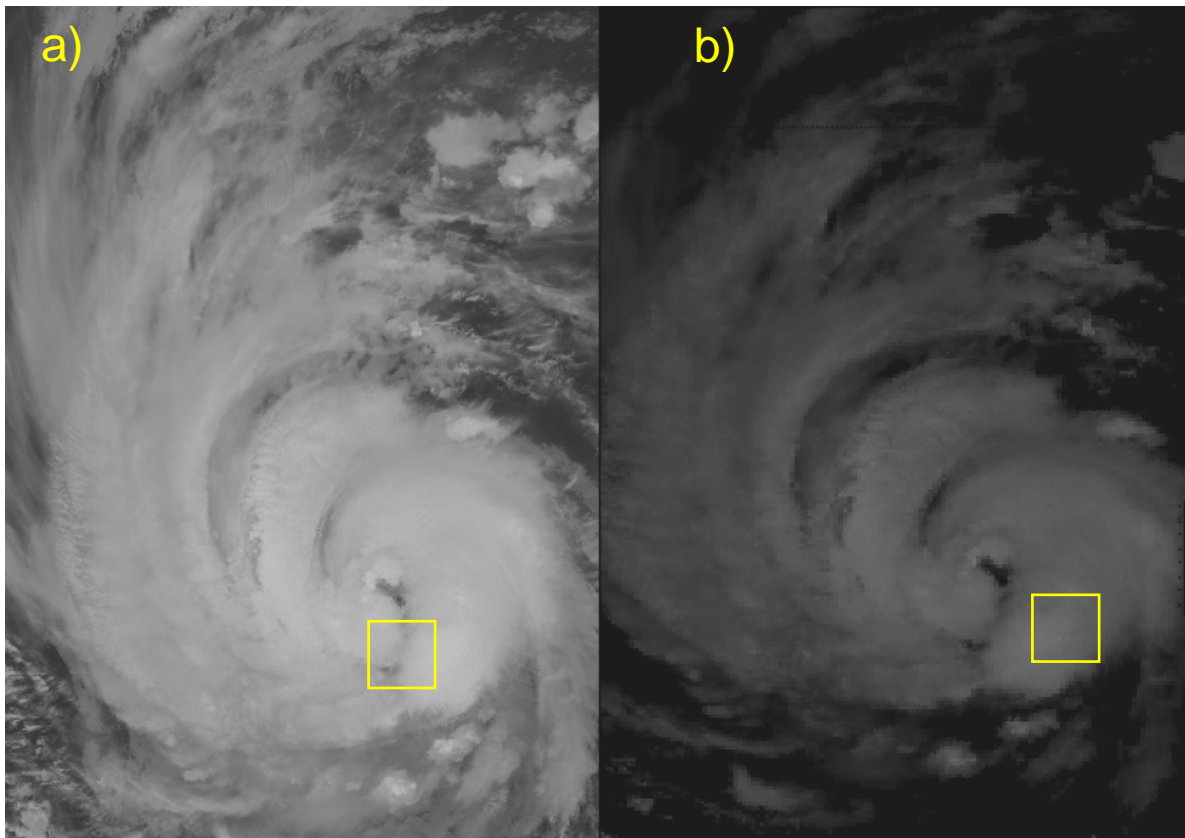

Figure 5. (a) Unprojected SDR VIIRS IR I5-band image (375 m resolution) of hurricane Edouard, a106 2014. This image is a typical example of an image with a small eye, which is incorrectly classified by the current automated eye-detection algorithm. (b) Same VIIRS image projected to Cylindrical Equidistant projection and re-gridded onto the low resolution 4 km GOES IR grid. Yellow box indicates area of pixels used as input into the eye detection algorithm.

3-- Run at CIRA a Real-Time demonstration of RII and LGEM forecasts with ATMS input

The real-time demonstration of RII and SHIPS/LGEM forecast with ATMS input has been setup at CIRA. Details are provided below.

1) Testing of the latest version of SHIPS/LGEM with corrected ATMS data

The NHC is in the process of switching to the new version of SHIPS/LGEM model. The newest version of the SHIPS/LGEM model has been tested with ATMS input for 2012-2014 for AL and EP. The final best track data are now available for EP, making it possible to run tests using 2014 EP data, which significantly increased the number of available EP cases, from 47 to 226. For the testing the SHIPS/LGEM model was run with the operational settings, where MPI is calculated from an empirical formula (runs LG61 and DS61); with GFS MPI (runs LG62 and DS62); and with ATMS MPI (bias-corrected runs LG63/64 and DS63/64, and without bias correction LG65 and DS65). The best results

were obtained by using bias corrected ATMS data for both AL and EP. For AL the best results are produced by using T, q averaged between 300-600 km from the storm center, and for EP - T, q averaged between 300-800 km from the storm center. Table 1 summarizes the settings used for different runs.

Run ID	Model	MPI Calculation Method
LG61/DS61	LGEM/SHIPS	Statistical MPI
LG62/DS62	LGEM/SHIPS	GFS MPI
LG63/DS63	LGEM/SHIPS	ATMS MPI, bias-corrected, averaged 300-600 km from the storm center
LG64/DS64	LGEM/SHIPS	ATMS MPI, bias-corrected, averaged 300-800 km from the storm center
LG65/DS65	LGEM/SHIPS	ATMS MPI, averaged 200-800 km from the storm center

Table 1. Settings for different SHIPS and LGEM runs.

Figure 6 shows forecast intensity errors for the test runs. For the AL the runs with ATMS input produce larger errors than both runs with operational settings and runs using GFS MPI estimate for long-range forecasts (more than 24 hours), but runs with ATMS input are similar or slightly better than GFS for short-term forecasts (less than 24 hours). For the GFS MPI estimates the GFS forecast fields up to 120 hours are used. Since ATMS MPI estimate is just a single value available only at the zero forecast hour, the most improvement is expected for the short-term forecast. That fully agrees with verification results. For LGEM the forecast with ATMS input is similar or slightly better than the forecast with GFS input for 0-24 hours. At longer forecast times the forecast with GFS input becomes better. That could possibly be improved by selecting a different method to interpolate ATMS-based MPI values for longer forecast times. For EP, both SHIPS and LGEM forecast errors are smaller when using ATMS MPI than when using GFS MPI. For LGEM, the results of the best ATMS run are similar to the operational errors for 0-48 hour forecasts. The TCs in the AL basin are affected by many factors in addition to thermodynamics, such as approaching land, or moving to high latitudes. Thus, it is expected that MPI estimates derived based on pure thermodynamic considerations will have a larger effect on the EP storms than AL storms. Also, EP storms tend to be closer to their MPI, which increases the sensitivity of the forecasts to the MPI value, especially for LGEM. That again fully agrees with the verification results.

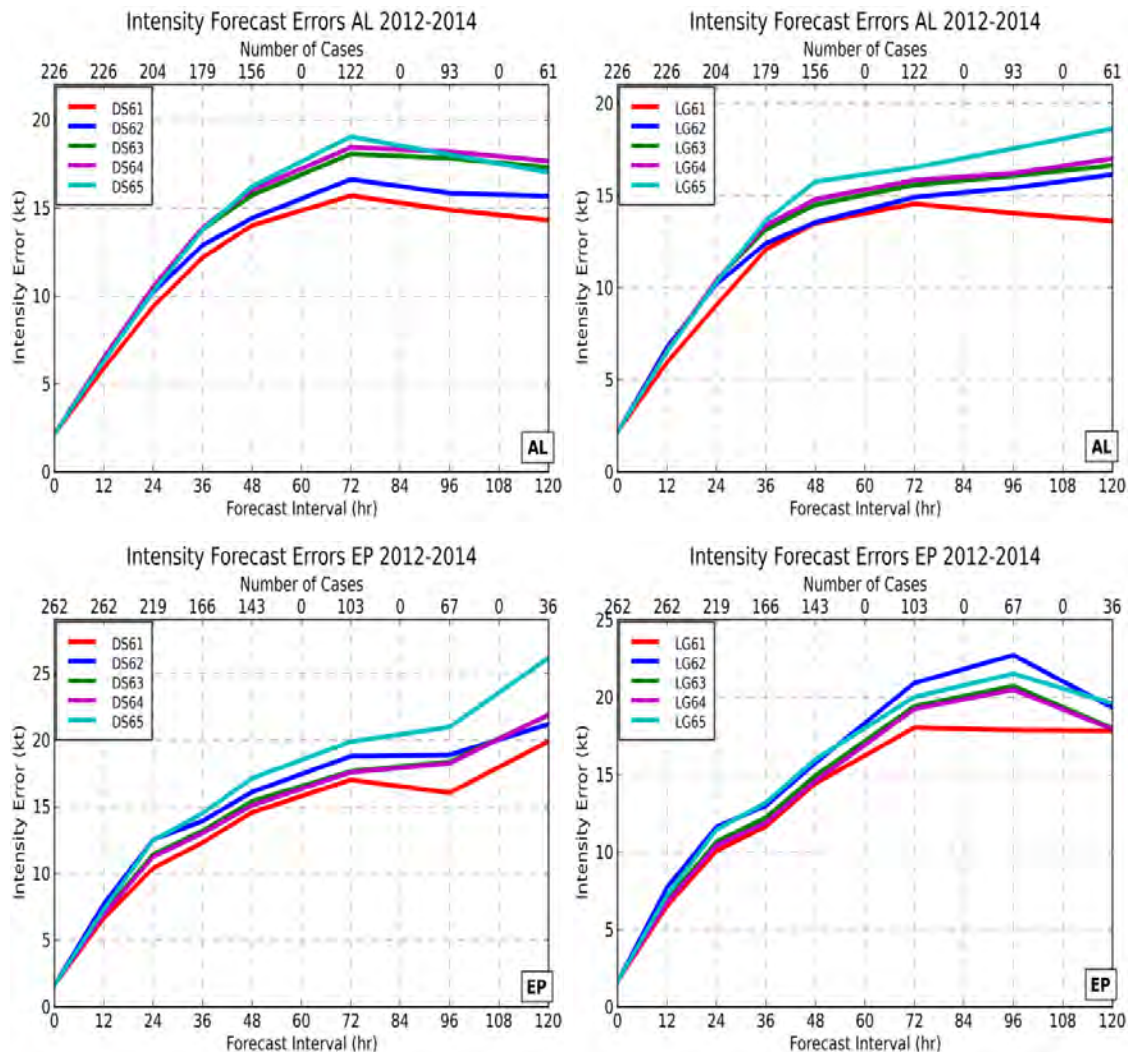

Figure 6. Forecast intensity errors for SHIPS/LGEM with ATMS input. Upper left: SHIPS for AL, upper right: LGEM for AL, lower left: SHIPS for EP, lower right: LGEM for EP. On all plots red line shows the run with the same settings as used operationally, which is LG61 for LGEM and DS61 for SHIPS. Blue line shows runs LG62/DS62 which use the GFS MPI. Green line shows runs LG63/DS63 which use the ATMS MPI estimated from the bias-adjusted ATMS profiles averaged between 300 - 600 km from the storm center. Magenta line shows runs LG64/DS64 which use the ATMS MPI estimated from the bias-adjusted ATMS profiles averaged between 300 -800 km from the storm center. Cyan line shows runs LG65/DS65 which use the ATMS MPI estimated from the ATMS profiles averaged between 200 -800 km from the storm center, without bias correction.

2) RII algorithm testing with final 2014 AL/EP best track data

The bias-corrected ATMS profiles were used to rerun RII for the years 2012-2014 for both Atlantic and east Pacific storms. The 2014 best track data became available for the EP making it possible to estimate RI statistics for the EP. Previously that was not possible due to the very limited number of 2012-2013 EP RI cases for which ATMS estimates are available. The final 2014 best tracks were also used for the AL, which results in slightly different statistics for the AL. For the ATMS runs, the RII statistics for both AL and EP are improved when using bias-corrected ATMS profiles. Some results are better with averaging ATMS T, q profiles between 300 - 600 km (run DS/LG63), and some results are better for averaging range 300 - 800 km (run DS/LG64). Table 2 below shows the results from the run LG/DS63. The most interesting

result for the EP is that both Brier Score (BS) and Brier Skill Score (BSS) are improved relative to the mean. That result is valid for both GFS and ATMS runs, and that is very different from AL and WP where none of the GFS or ATMS runs shows improvement relative to the mean. Preliminary tests (not shown) indicate that some statistics for the EP could also show improvement relative to the operational version. The plots of the RII for individual storms (see Figure 7) show that GFS and ATMS-based RII estimates for the AL are very close to each other. The statistics are based on a very small number of RI cases and should be considered preliminary. These results will be further investigated as part of the new, FY15-17 CIRA JPSS-PGRR TC project.

Basin	RI	BS			BSS			Bias		#Cases	
		GFS (G)	ATMS	Mean (M)	A/G	G/M	A/M	GFS	ATMS	ALL	RII
AL	25 kt	777.14	803.75	747.75	-3.43	-3.93	-7.49	1.87	2.00	251	22
AL	30 kt	487.40	495.42	475.34	-1.64	-2.54	-4.22	1.84	1.94	251	13
AL	35 kt	289.89	293.11	261.92	-1.11	-10.68	-11.91	1.91	2.01	251	7
AL	40 kt	101.95	103.08	80.21	-1.11	-27.10	-28.51	4.42	4.75	251	2
EP	25 kt	535.88	559.25	701.67	-4.36	23.63	20.30	1.86	2.06	336	26
EP	30 kt	396.17	401.69	463.59	-1.39	14.54	13.35	2.05	2.21	336	17
EP	35 kt	297.29	305.47	303.40	-2.75	2.01	-0.68	2.24	2.43	336	11
EP	40 kt	231.59	239.16	245.73	-3.27	5.75	2.67	1.83	2.07	336	9

Table 2. Statistics for RII for Atlantic and east Pacific storms. Brier Score (BS), Brier Skill Score (BSS), and Bias for predicted vs observed RI, as estimated by RII using MPI calculated using GFS (G) and ATMS (A) profiles. A/G is ATMS relative to GFS; G/M is GFS relative to Mean, and A/M is ATMS relative to Mean.

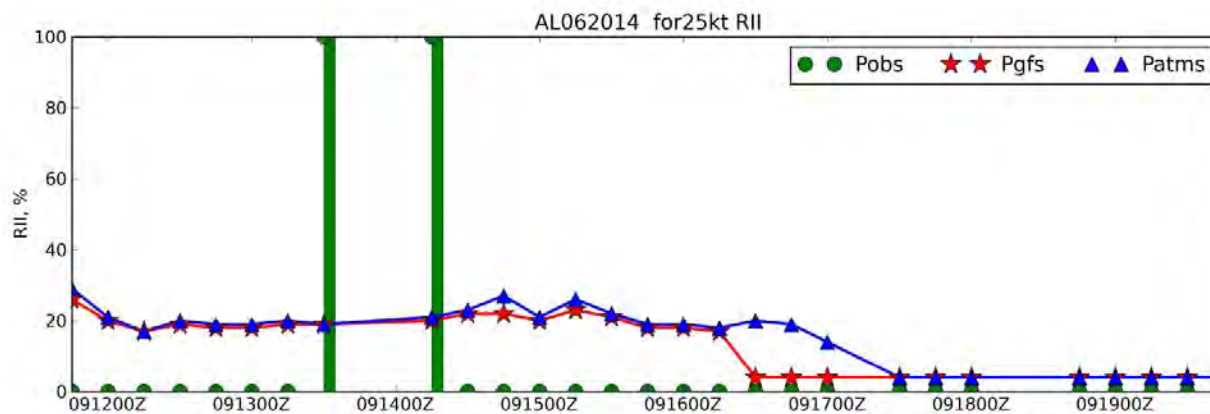

Figure 7. RII for 25 knots for Hurricane Edouard, AL06 2014. Green dots show observed RII index, which is 0 if no RI occurred, and 100% if RI occurred. Red line with stars shows RI forecast based on operational GFS model fields, and blue line with triangles shows RI forecast with MPI calculated from ATMS data.

3) The real-time demonstration of RII and SHIPS/LGEM forecast with ATMS input has been setup at CIRA.

The latest version of the SHIPS/LGEM/RII model, the same one that will be running at NHC for the 2015 AL hurricane season, was setup to run at CIRA. The model setup was coordinated with Mark DeMaria, and testing was performed to ensure that the results obtained at CIRA could be directly compared to the operational SHIPS/LGEM runs at NHC. Two versions of SHIPS/LGEM were setup to run at CIRA in near real-time demo mode. The 1st "control" version is intended to reproduce NHC runs, and to ensure that everything is working properly. The output of these runs is available via ftp, at ftp://ftp.cira.colostate.edu/ftp/Chirokova/SHIPS/real_time_experimental_m15_control/. Figure 8 shows an example of SHIPS output from the control run. This run also produces output of the additional RI estimate, different from the operational one. The statistics of these RII estimates obtained in real-time will be used for the FY15-17 JPSS PGRR-TC project.

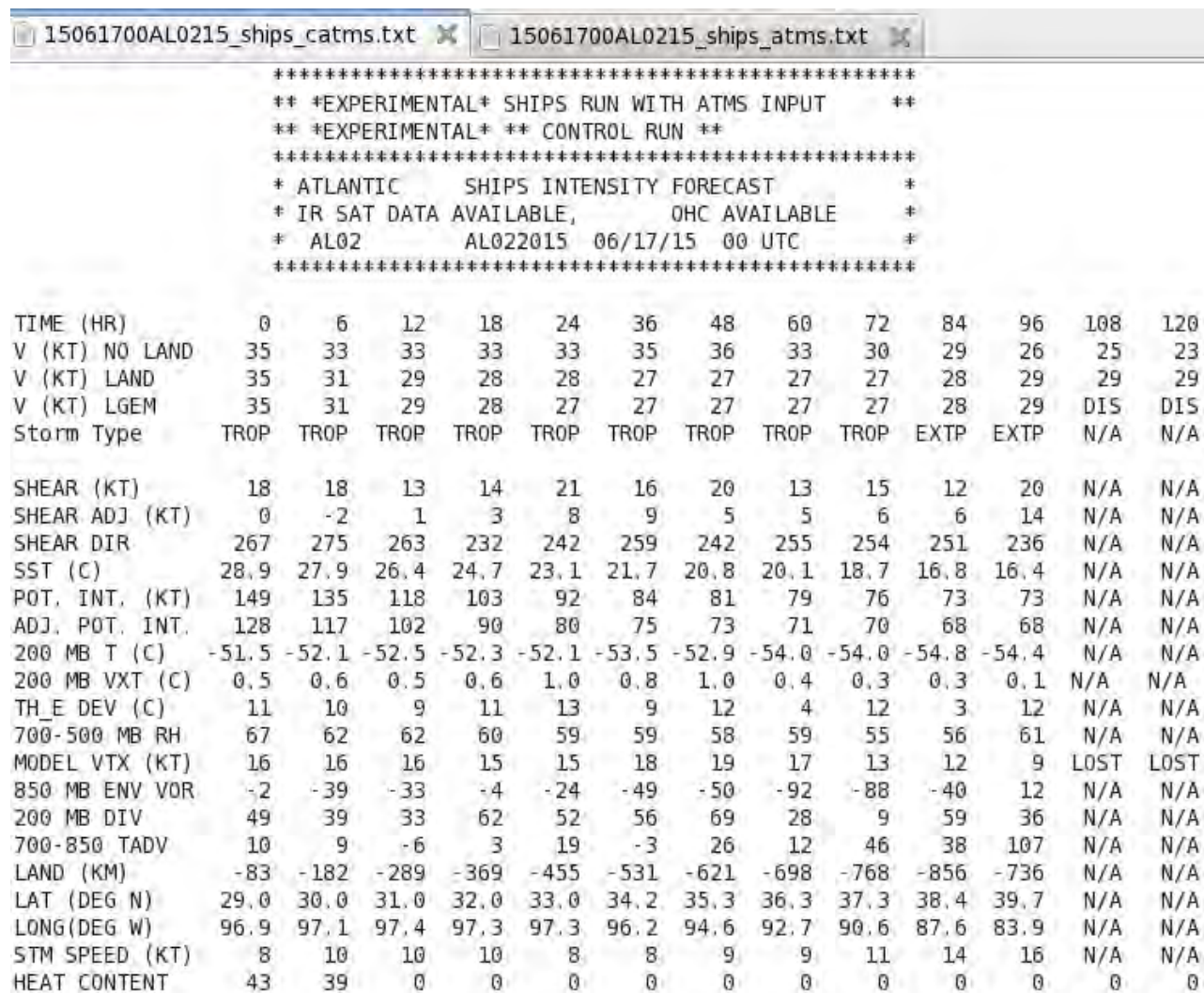

Figure 8. An example of SHIPS output from the control run. The example is for tropical Storm Bill, al02 2015.

The 2nd run uses ATMS MPI estimates as input to SHIPS, LGEM, and RII. The algorithm for estimating MPI from ATMS was adjusted based on the reruns with the latest version of the model discussed above. The real-time runs for both AL and EP/CP use bias-adjusted ATMS MPI estimates. However, based on

the results of the forecast verification for past cases, for the AL the MPI is calculated by averaging ATMS profiles between 300-600 km from the storm center; and for the EP/CP the averaging range is 300-800 km from the storm center. The SHIPS/LGEM/RII runs with ATMS input are available via ftp, at ftp://ftp.cira.colostate.edu/ftp/Chirokova/SHIPS/real_time_experimental_m15_atms/. Figure 9 shows an example of SHIPS output from the run with ATMS input.

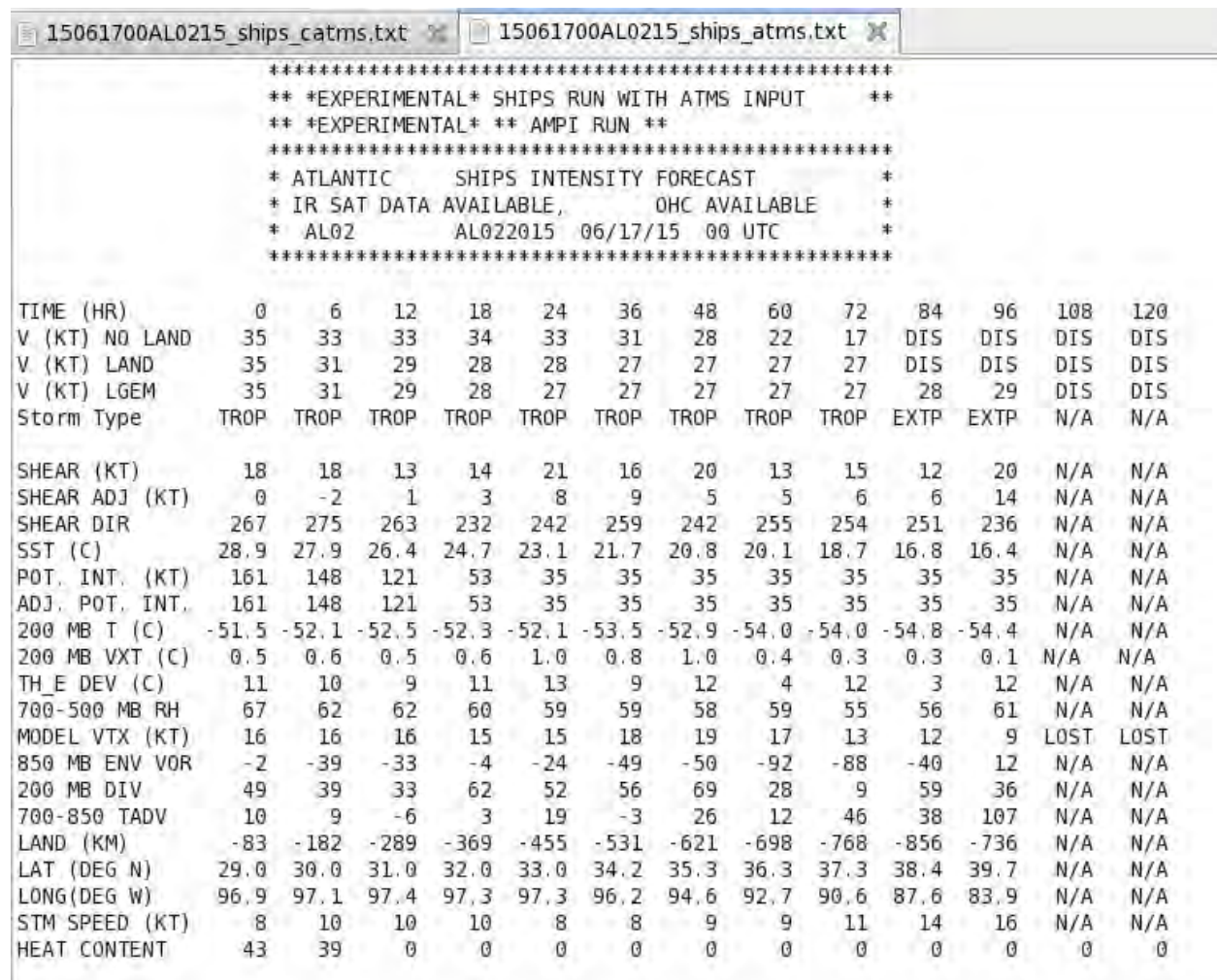

Figure 9. An example of SHIPS output from the SHIPS/LGEM/RII run with ATMS MPI used as input. The example is for Tropical Storm Bill, al02 2015, for the same case as shown in Figure 8.

4-- Continue developing database of ATMS-MIRS and VIIRS data for global TCs (ongoing from FY14 CIRA project)

The database of both ATMS-MIRS and VIIRS data for global TCs has been continuously developed since 2012. Currently the database includes 3 years of ATMS-MIRS and VIIRS data pre-selected to match the global TCs tracks, as well as the software package that allows for the efficient selection of ATMS-MIRS data matching global TCs. This quarter, an efficient algorithm for compressing and archiving ATMS-MIRS data has been created, and the process of archiving ATMS-MIRS data has been fully automated. The reduced-resolution imagery from the VIIRS TC database is posted in near-real time on the RAMMB-CIRA TC Real Time Page. This quarter, VIIRS processing has been modified to produce raw full-resolution images and save raw image data for each TC in addition to producing the reduced-resolution imagery. Past VIIRS TC data for 2015 have been reprocessed, raw imagery for DNB and high-resolution

IR data (band I05) has been created, and corresponding image data assembled from multiple granules have been saved for all available 2015 cases. Figure 10 shows an example of the raw, unprojected VIIRS DNB image. The archived raw imagery will be used for the development of an improved algorithm for displaying VIIRS TC DNB imagery, as well as for the development of VIIRS proxy-visible and eye-detection applications.

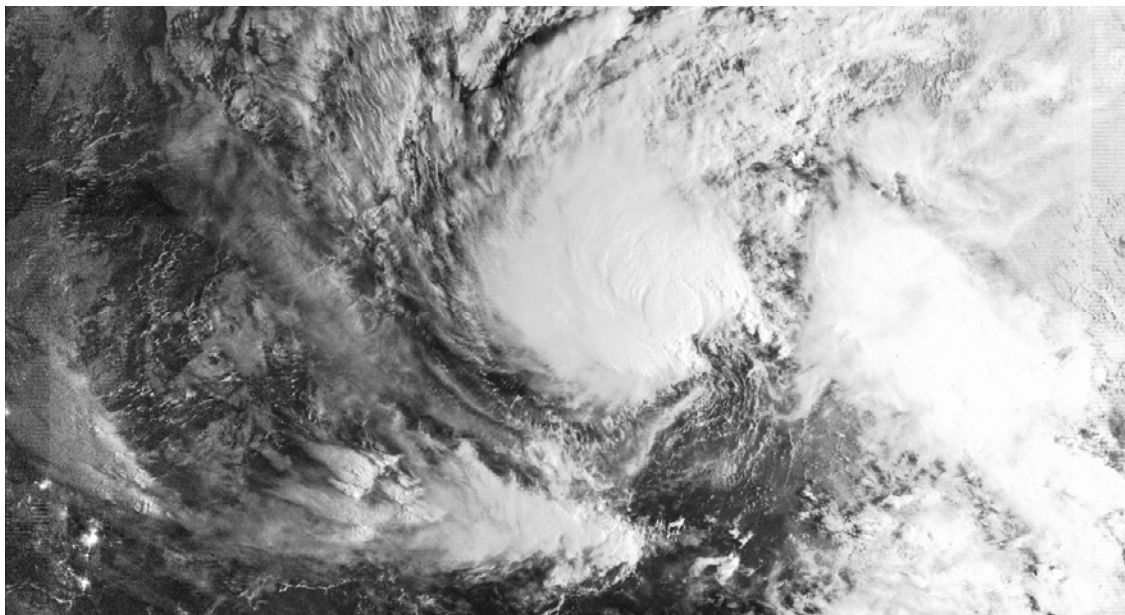

Figure 10. Unprojected SDR VIIRS DNB image of typhoon Mekkhala, wp01 2015. Image shows raw DNB data that will be used for the development of VIIRS proxy-visible and eye-detection applications.

5-- Rerun eye-detection algorithm (developed under FY14 CIRA project) on past cases and identify conditions that degrade algorithm performance

Until this quarter, the eye detection algorithm was trained and tested on a set of 2677 Atlantic basin IR images from CIRA's IR archive. These images were selected for use with the algorithm since they were used to produce Dvorak intensity fixes. As a result of performing the fix, a forecaster determines if each image contains an eye. This information provided the truth that the algorithm was trained and tested against. This quarter, the algorithm was run on the entire IR archive and a database of objective eye classifications has been produced. This database of hundreds of thousands of classified images may be used as input to an RI prediction scheme. After examining incorrectly classified imagery on the full archive, three conditions degrading algorithm performance have been identified:

First, it was found that one factor degrading algorithm performance are cases with a small eye: in many cases the algorithm would make a classification of "eye-absent" when a storm has a very small eye. Continuing work to incorporate higher resolution VIIRS data into the eye-detection algorithm may improve these results.

Second, it was found that the algorithm tends to produce false positives when the storm is gaining/losing intensity. In order to determine where errors were most likely to occur over a TC's lifetime, the algorithm's probability that an image contained an eye was examined over for Hurricane Floyd. In Figure 11 it can be seen that when temperatures inside the eye of Hurricane Floyd were high, the algorithm tended to agree with the Dvorak analyses. The region highlighted in red corresponds to cases where the algorithm incorrectly classified images as having an eye. At the moment, the algorithm only uses the temperatures contained in IR imagery as input. Effort is being made into using additional input in order to help the algorithm perform a better classification while the TCs are somewhat weak. An interesting side effect of these false positives is that they appear to predict the appearance of an eye. Future work may involve

slight modifications to the algorithm to investigate whether it can be used for eye prediction as well as eye detection.

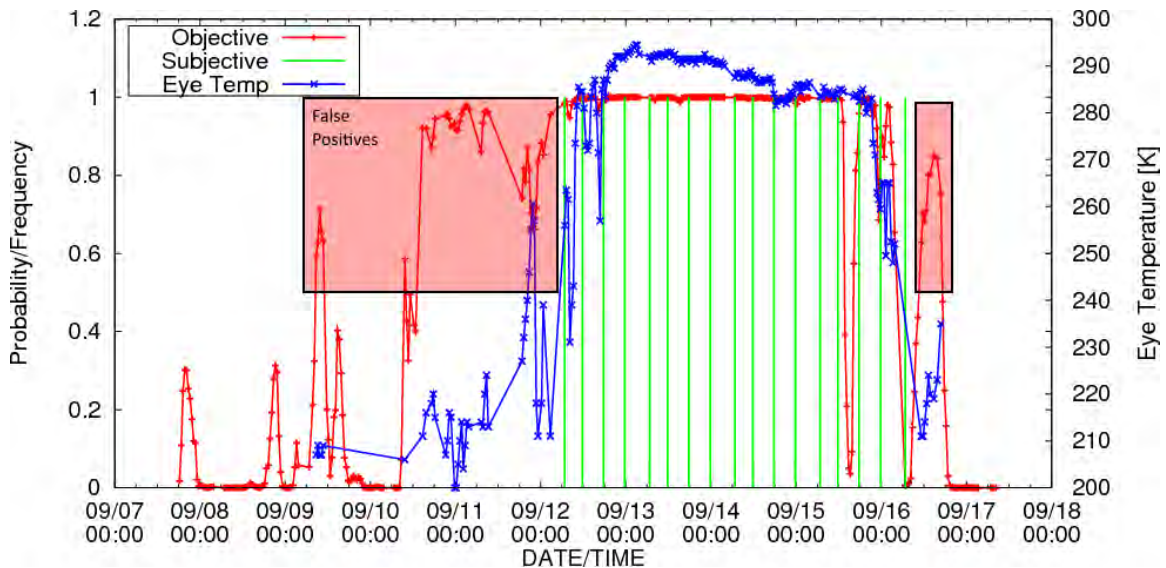

Figure 11. Subjective eye/no-eye probabilities from Dvorak analyses (green), objective eye probabilities (red) and eye temperature (blue) for hurricane Floyd September 7 – 18, 1999.

Third, it was found that the algorithm performance could be improved by lowering the intensity threshold for the training/testing dataset. Originally, images where the associated tropical cyclone had maximum winds beneath 50 kt were removed from the dataset. This was a somewhat arbitrarily selected threshold and several images with eyes were unnecessarily removed from the dataset as a result. The threshold was changed to 35 kt to correspond with the Saffir-Simpson definition of a tropical storm. This increased the set of images available for training/testing the algorithm from 2677 images to 4109 images and improved the overall accuracy of the algorithm from about 75% to 80%. Some of the improvement is simply because the dataset now has more images that are easy to classify. However, the fraction of true positive cases (the algorithm classified an image as having an eye and the image actually has an eye) also went up to 79% from 78%. This is a small improvement, but it indicates that the inclusion of the weak cases slightly improved the overall algorithm training.

6-- Begin collecting VIIRS cases for the development of the "proxy visible imagery"

In order to develop a proxy-visible VIIRS application, a training dataset is needed. To begin the development, about 20 VIIRS DNB images and corresponding high-resolution GOES IR images from several channels will be needed. GOES channels corresponding to GOES-R channels will be used so that in the future this application could be used with GOES-R data. The VIIRS cases need to cover a broad range of conditions typical for TCs, such as low-level and high-level clouds, deep convection in the well-developed system and developing convection in the new system, rain bands, transverse bands, etc. In addition, all cases need to have good illumination, which usually means close to a full moon, and be completely over the ocean. The collection of such cases has begun.

For example, we found that many good cases are available from June 29 to July 7 of this year. Figure 12 shows an example of a rare DNB image showing a concentric eyewall that will be included in the training set.

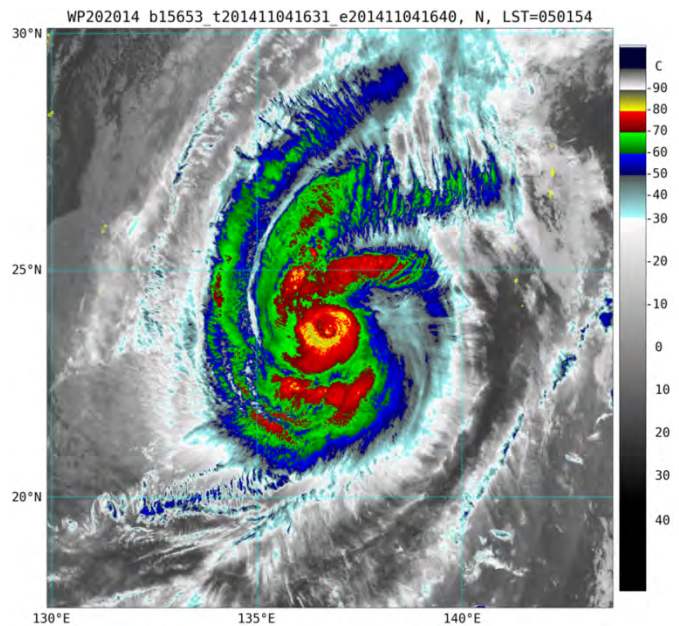

Figure 12. VIIRS DNB (left) and IR I5-band (right) image (375 m resolution, shown at reduced resolution) of Typhoon Rammasun, wp09 2014. The DNB image shows the relict eye and the surrounding moat, which is not visible in the IR image.

7-- Begin developing database of the ancillary data including SST, wind data, and GFS model data

Several ancillary data sets will be used by the project. These data include SST data, wind shear data, GFS model data, and infrared data from geostationary satellites. CIRA has been collecting GFS model data for other TC projects. Specifically, the developmental dataset for SHIPS includes multiple GFS derived parameters, such as wind shear, that will be used for the development of the eye-detection algorithm. The latest version of the SHIPS model has been rerun for the 2012-2014 seasons to ensure that we have a consistent set of these parameters. These are also saved by the SHIPS control run that has been setup as part of the previous JPSS-PGRR TC project, available via ftp, at ftp://ftp.cira.colostate.edu/ftp/Chirokova/SHIPS/real_time_experimental_m15_atms/. These data will be collected and later used by the eye-detection algorithm. The preliminary database of daily Reynolds SST data that will be used in the development of the RII applications has been created. These data will be required for the RII applications because SHIPS will be switching to use daily SST data in the future. In addition, the collection of Himawari data that will be used for the development and testing of the proxy visible algorithm has begun. CIRA is receiving full disk Himawari data. The software for efficient selection of TC data from the global datasets has been designed in such a way to allow it to work with data other than that from polar-orbiting satellites, such as SST, GFS, or Himawari data. The corresponding plugins will be developed as needed. The development of TC databases for all ancillary data needed for this project has begun, and will be continued during the application development. Figure 13 shows an example of a raw IR I5 VIIRS image, corresponding DNB VIIRS image, and Himawari IR image.

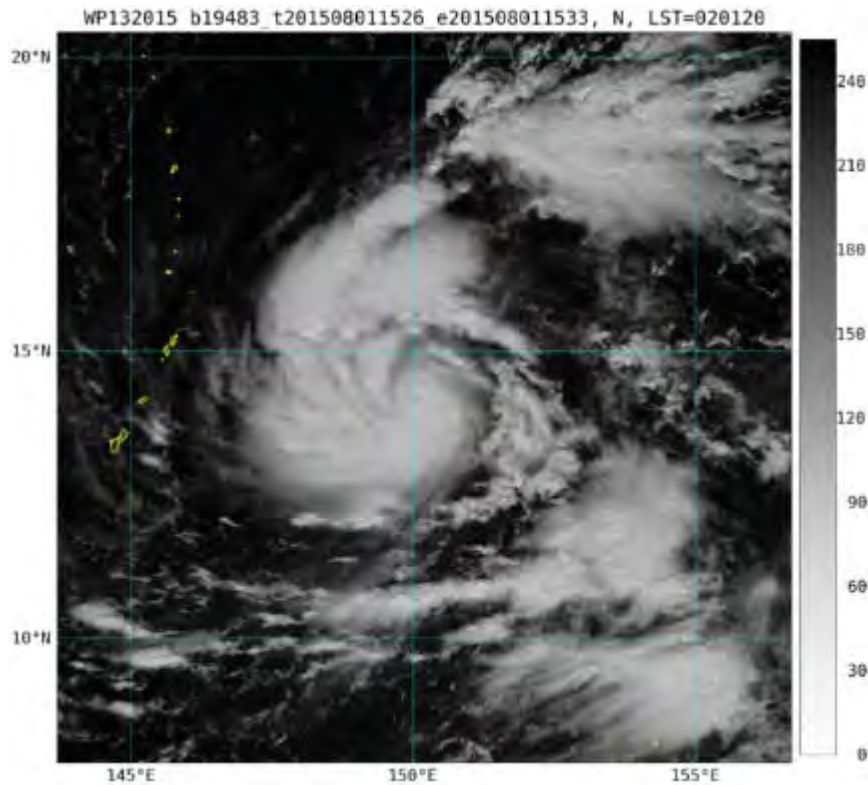
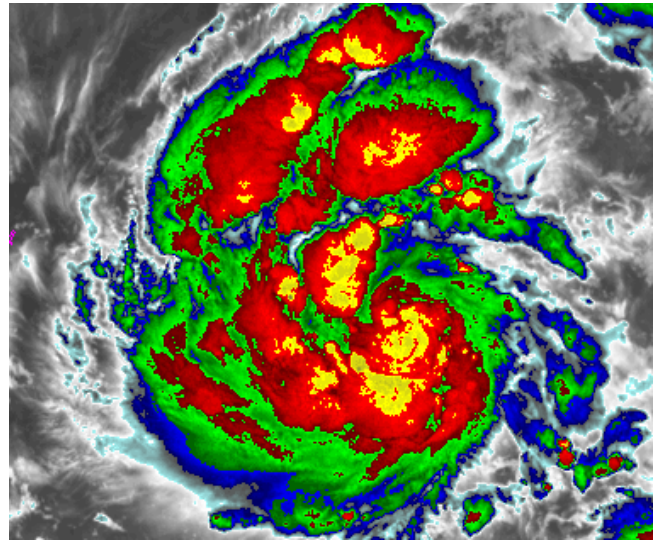
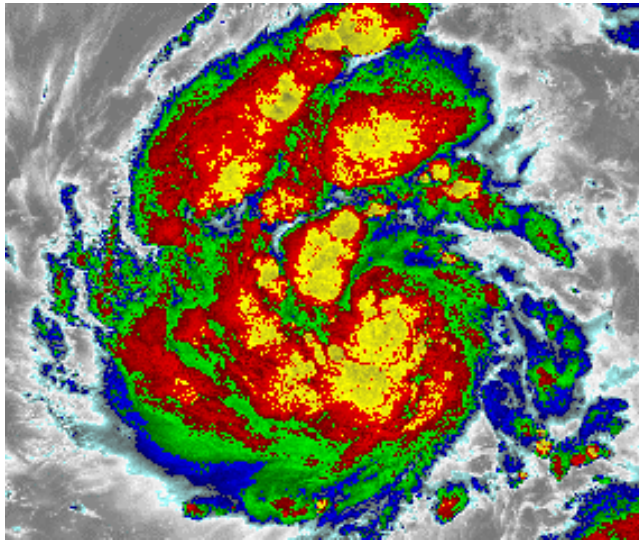

Figure 13. (a) Comparison of VIIRS high-resolution IR (upper left, I5, 11.45 μm , 375 m) and Himawari (upper right, Band 13, 10.4 μm , 2 km) images for typhoon Soudelor, wp13 2015. Corresponding VIIRS DNB image is shown on the lower panel. VIIRS image shows significantly more details as compared to Himawari image. This case will be used for the development of proxy-visible imagery.

8-- Begin collecting VIIRS cases for the development of the "proxy visible imagery"

Collection of VIIRS cases for the development of the "proxy visible imagery" has continued. The cases selected for the algorithm development should be good examples of DNB TC imagery meaning that all of these cases should be completely over the open ocean to exclude land and city light effects, and close to the full moon to ensure good illumination. Also, since the goal of the application is to display clouds, we need to exclude DNB images that have lightning in them, or are close to the terminator, or have moon glint. In addition, the developmental dataset should cover a broad range of conditions typical of the Tropics, including low-level and high-level clouds, deep convection in well-developed systems and developing convection in new systems, transverse bands, strongly sheared systems, etc. A total of 20 cases from 2015 AL, EP, CP, WP, and SH storms were selected as the starting developmental dataset

for the proxy-visible algorithm. This task has been somewhat complicated as in November 2015 a NAS drive was lost due to a power outage at CIRA, and that NAS drive had almost a year of storm-relative VIIRS TC data on it. We were able to restore a lot of data, but not all of them. The collection of the raw data for the selected cases has begun. If some raw data turns out to be unavailable for these cases, 2014 data will be used instead. Table 3 lists all selected cases, and Figure 14 shows DNB imagery for each case.

Case #	Year	Basin	Storm #	Image name
1	2015	AL	10	2015AL10_SRSNPPTN_201509260425.png
2	2015	AL	10	2015AL10_SRSNPPTN_201509270404.png
3	2015	AL	10	2015AL10_SRSNPPTN_201509280525.png
4	2015	CP	06	2015CP06_SRSNPPDV_201509251131.png
5	2015	EP	22	2015EP22_SRSNPPDV_201511250903.png
6	2015	EP	22	2015EP22_SRSNPPDV_201511260845.png
7	2015	SH	21	2015SH21_SRSNPPDV_201504051910.png
8	2015	SH	21	2015SH21_SRSNPPDV_201504061853.png
9	2015	SH	21	2015SH21_SRSNPPDV_201504071835.png
10	2015	WP	02	2015WP02_SRSNPPDV_201502071510.png
11	2015	WP	02	2015WP02_SRSNPPDV_201502081451.png
12	2015	WP	04	2015WP04_SRSNPPDV_201504011658.png
13	2015	WP	04	2015WP04_SRSNPPDV_201504021640.png
14	2015	WP	05	2015WP05_SRSNPPDV_201504041600.png
15	2015	WP	05	2015WP05_SRSNPPDV_201504051541.png
16	2015	WP	06	2015WP05_SRSNPPDV_201504061522.png
17	2015	WP	07	2015WP07_SRSNPPDV_201505071401.png
18	2015	WP	13	2015WP13_SRSNPPDV_201507311545.png
19	2015	WP	13	2015WP13_SRSNPPDV_201508011526.png
20	2015	WP	13	2015WP13_SRSNPPDV_201508031628.png

Table 3. 20 VIIRS DNB cases that will be used for the development of proxy-visible imagery.

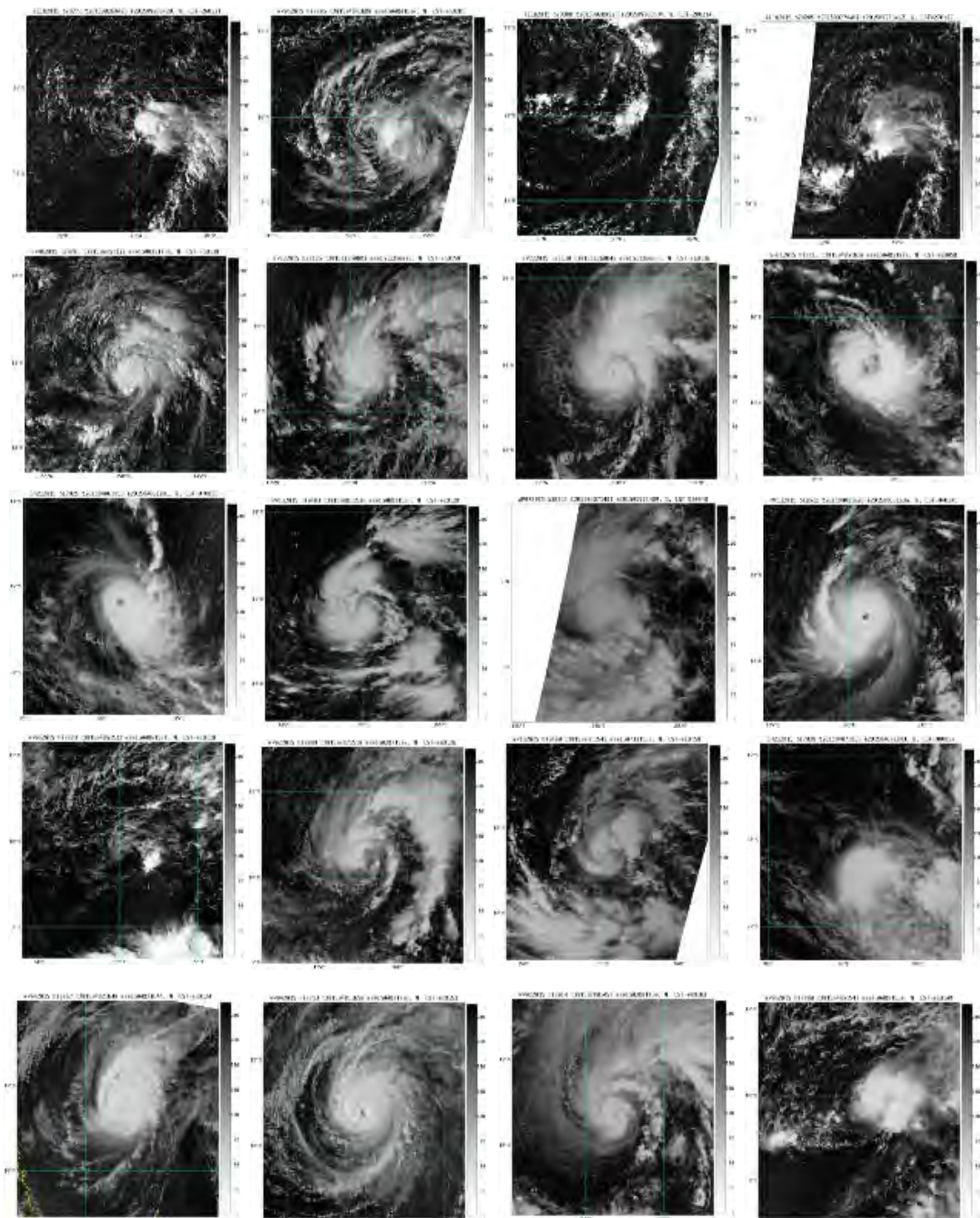

Figure 14. 20 VIIRS DNB cases that will be used for the development of proxy-visible imagery.

9-- Set up real-time data feeds

The real-time data feed of NUCAPS data has been setup with NDE. Currently CIRA is receiving both ATMS_MIRS and NUCAPS data from NDE with less than 2 hours latency. Collection and archiving of real-time ATMS-MIRS data, have been fully automated. The internal data transfer scripts have been

modified to ensure the data could be run with no additional latency. Table 4 shows data latency statistics based on a small number of files. Work continues on automating collecting and archiving NUCAPS data. In addition, the VIIRS real-time data collection has been modified. That included reorganizing the directory structure for storing VIIRS TC data and allowed to simplify the processing of VIIRS data. The collection of real-time dropsonde data for the east Pacific have been set up as well. These will be used for developing a bias-correction for ATMS-MIRS and NUCAPS T, q profiles. The SST real-time data feeds have been set up as well. That preliminary work should ensure that we have no data issues by the time we start creating the real-time applications demonstrations.

Dataset	Difference from Scan Time (HH:MM)			Difference From Creation Time (HH:MM)		
	Max	Min	Average	Max	Min	Average
ATMS-MIRS SND	2:49	0:49	1:46	2:10	0:09	0:43
ATMS-MIRS IMG	2:48	0:42	1:37	1:02	0:06	0:31
NUCAPS EDR	43:06	1:15	2:01	2:42	0:07	0:53
NUCAPS CCR	52:31	0:21	1:46	1:03	0:21	0:41
VIIRS DNB Low Latency	6:35	0:44	1:56	5:07	0:02	0:51
VIIRS DNB	44:52	0:41	6:08	44:44	0:02	1:15

Table 4. Current latency for real-time ATMS-MIRS and NUCAPS data at CIRA.

In addition, the real-time collocation of EP/CP dropsondes to ATMS soundings has been added to the CIRA TC Real Time page (http://rammb.cira.colostate.edu/products/tc_realtime/). The real-time processing and display of dropsondes collocated to ATMS soundings for TCs has been expanded to include the East and Central Pacific Basins. The EP/CP dropsondes for the years 2014-2015 have been downloaded from NHC and the decoding software has been modified to process these dropsondes in addition to the Atlantic dropsondes. The python software for collocation of dropsondes with ATMS has been modified accordingly. Figure 15 shows an example of the ATMS and AMSU collocation to dropsondes for hurricane OHO, cp072015.

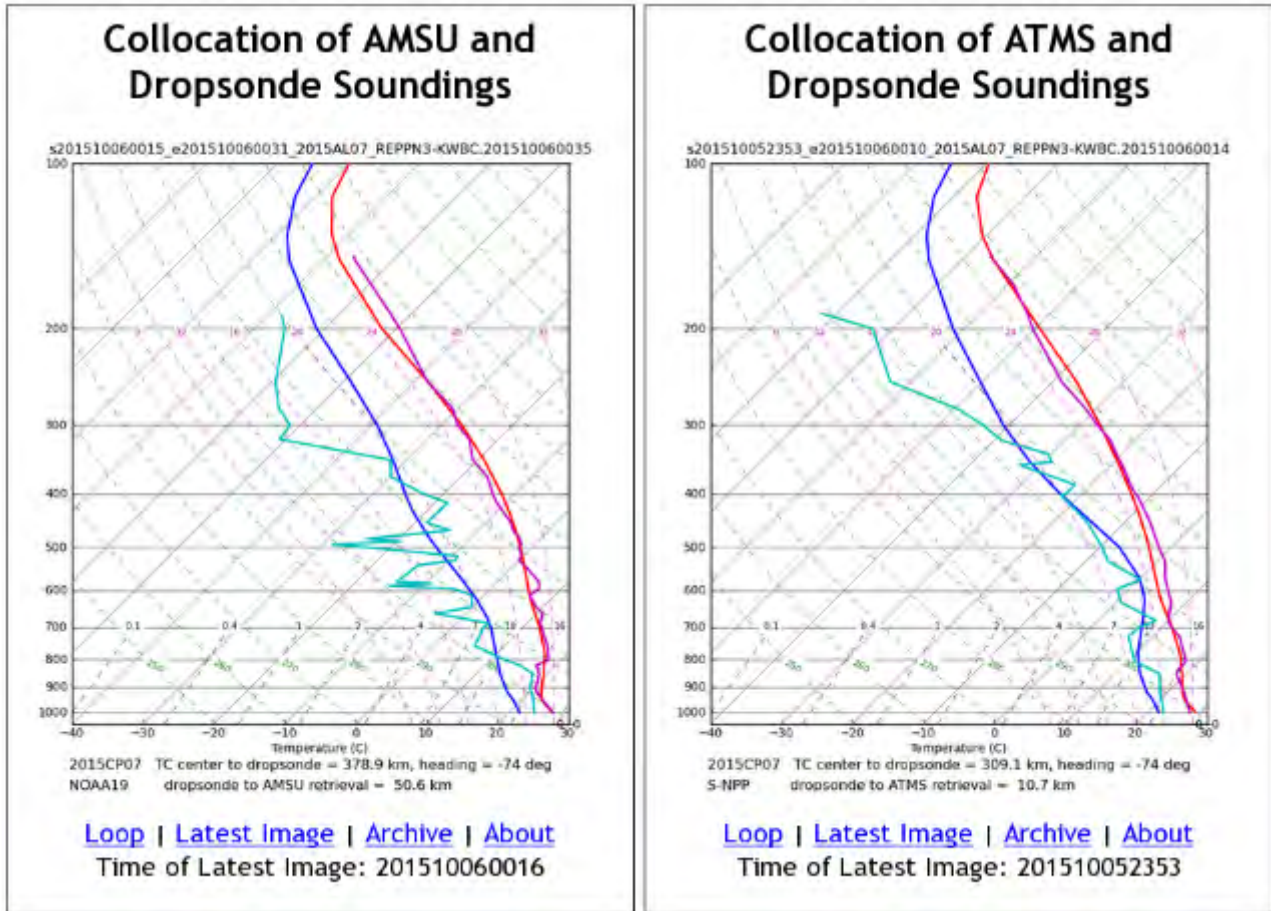

Figure 15. Collocation of AMSU (left) and ATMS (right) soundings to the dropsondes for hurricane OHO, CP072015. The purple and teal lines are the temperature and dewpoint traces, respectively, from the dropsondes, and the red and blue lines are the AMSU/ATMS temperature and dewpoint retrievals, respectively. Image is taken from CIRA TC Real Time page http://rammb.cira.colostate.edu/products/tc_realttime/storm.asp?storm_identifer=CP072015

10 -- Begin developing improved algorithm for displaying VIIRS TC DNB imagery

Work has begun on the development of the improved algorithm for VIIRS TC DNB imagery. Selected VIIRS data for the years 2012-2014 have been reprocessed, and the development of the database of the raw VIIRS TC DNB imagery has begun. Available data were split into several categories such as “blurry”, “too dark”, “too bright”, “city lights”, “uneven illumination”, “moon glint”, “good images”, etc. Further, different ways of scaling DNB images for each of the above categories will be tested in order to create the best way to scale images for each of the above categories. Figure 16 shows an example of a VIIRS DNB image close to the new moon, which also has a lot of city lights. The combination of very little illumination and significant amount of city lights confuses the current simple scaling algorithm and, even though the TC is present in the data, it does not show up on the image produced by the automated algorithm, but is clearly seen on the image with manually adjusted scaling.

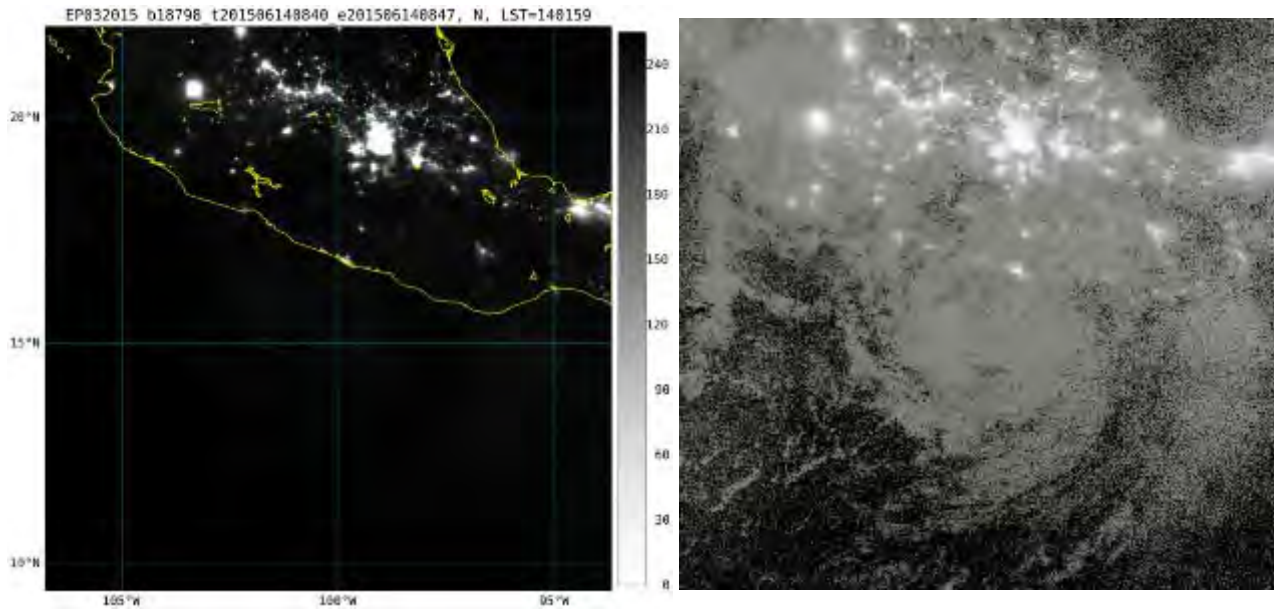

Figure 16. VIIRS DNB image for hurricane Carlos, al03 2015. Left: image with automated scaling. TC is not visible because the scaling is wrong due to the presence of large amount of city lights and the time of the image close to the new moon. Right: manual scaling of the same image, showing that TC is present in the data and can be seen with the proper scaling.

11-- Develop improved software for efficient selection of TC data from global S-NPP data

As part of the previous JPSS-TC project, software was developed for selection of ATMS-MIRS data in the vicinity of TCs. It was found that the selection software is inefficient in many ways and cannot be extended to be used with new datasets without significant modifications to the code. A new design for the selection software has been developed. One of the primary differences between the old and new design is that the new design utilizes plugin architecture. This allows the software to become compatible with new datasets with minimal new code. Plugins for ATMS-MIRS, NUCAPS, and VIIRS data are currently being developed. The new software generates a searchable database by storing time/location meta-data about each granule file. Previous versions of the software rewrote the data into a searchable format. However, as datasets evolved throughout the lifetime of the project, maintaining a consistent set of searchable data proved challenging and required substantial processing time. By storing only time/location meta-data, changes made to the datasets will not require any changes to be made to the searchable database. Figure 17 shows the activity diagram describing the workflow of the data selection software. The querying of the database is also being improved. In the improved algorithm, the data near the TC will be written in binary format (NetCDF) instead of ASCII. This improvement should significantly decrease the time needed to process data. Once this software is completed, it will greatly simplify access to NUCAPS, ATMS-MIRS, and VIIRS TC data.

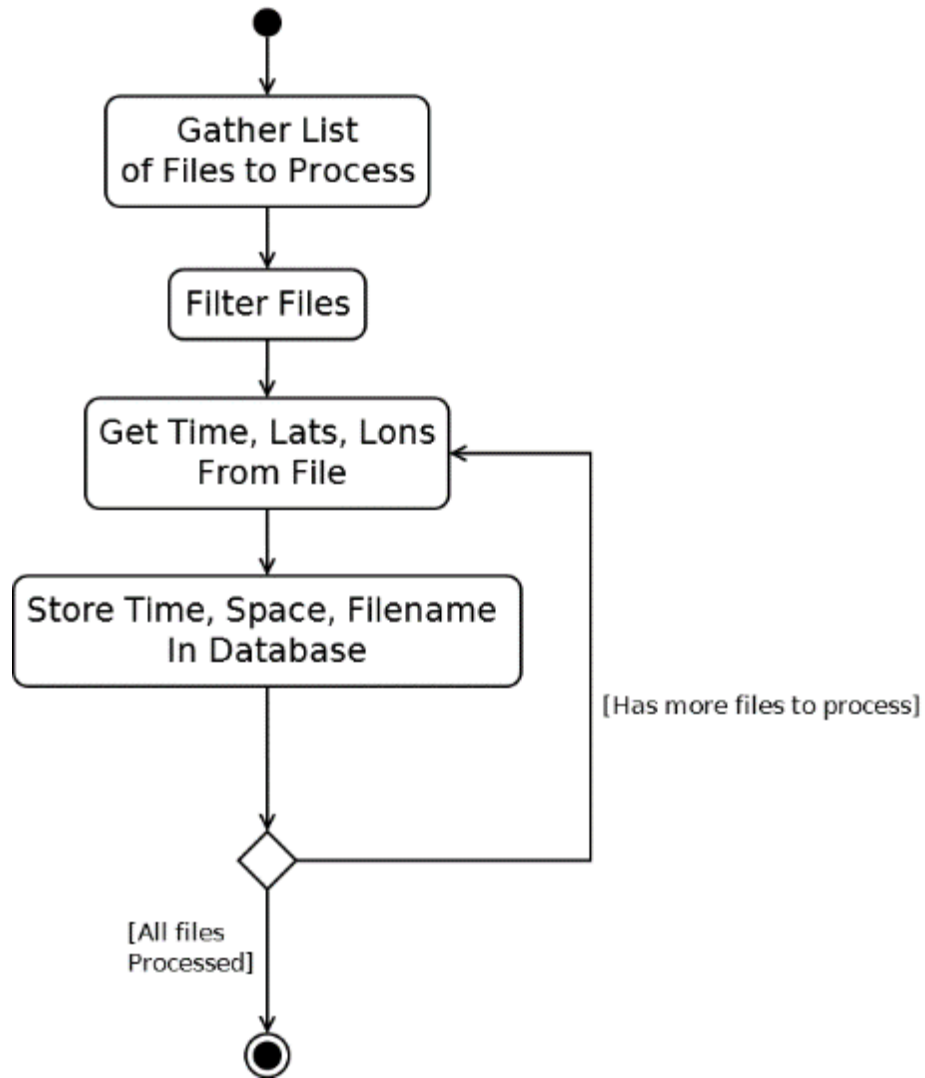

Figure 17. Activity diagram illustrating update of database. Each action is implemented with a swappable plugin.

12—Comparison of VIIRS and GOES images for the eye-detection algorithm

VIIRS and GOES images were compared for hurricane Danny, a104 2015. Hurricane Danny is a very interesting case because of its unusually small size, and a very small eye. The 4-km GOES imagery resolution is too coarse to resolve important details about the eye for small storms/eyes. Therefore, this is a very good case to test the eye detection algorithm using VIIRS data versus GOES data. The hurricane Danny case will be used for training the VIIRS version of the eye-detection algorithm. Figure 18 shows the comparison of VIIRS and GOES data for Hurricane Danny on Aug 21, 2015 at 04:03Z. Danny's intensity at that time was 75 kt based on aircraft reconnaissance. In this case, the elongated/elliptical shape of the eye is impossible to determine from GOES.

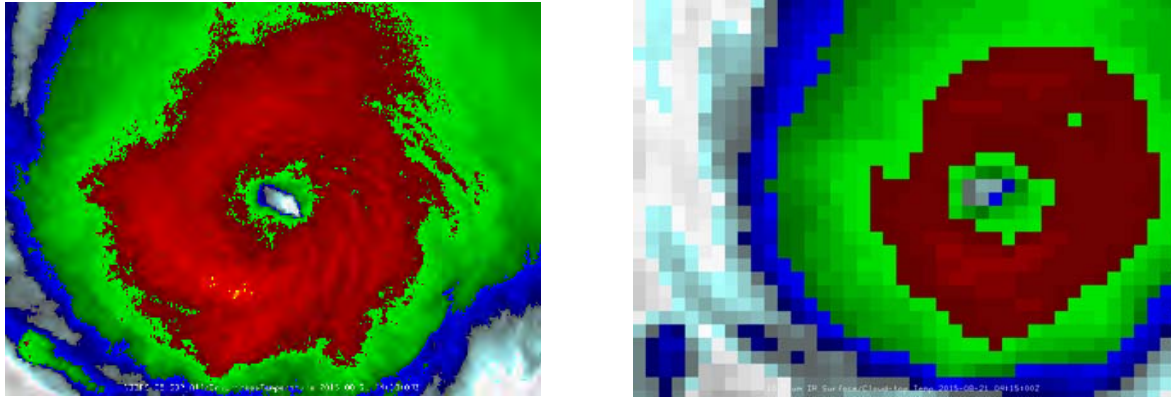

Figure 18. (a) Comparison of VIIRS (left, I5, 11.45 μm , 375 m) and GOES (right, Band 4, 10.7 μm , 4 km) images for hurricane Danny, a104 2015. The eye on the image is too small to be properly resolved by the GOES imagery, but is very well resolved by the VIIRS imagery.

13--Training

A training session on the use of VIIRS DNB imagery for TC forecasting has been included (by Dan Bikos) in the SHyMet Tropical course and published in the NOAA CLC.

Knaff J. and G. Chirokova, 2015: Use of VIIRS imagery for tropical cyclone forecasting. *VISIT Training Session is available online at*

http://rammb.cira.colostate.edu/training/visit/training_sessions/use_of_viirs_imagery_for_tropical_cyclone_forecasting. *SHyMet Tropical course is available online at*

http://rammb.cira.colostate.edu/training/shymet/tropical_topics.asp

Publications: None

Presentations:

Brummer R, E. Szoke, S. Miller, C. Seaman, D. Lindsey, G. Chirokova, A. Schumacher, D. Hillger, and D. Molenaar, 2015: Proving Ground Activities at CIRA. Poster presentation at the 6th Asia Oceania Meteorological Satellite Users' Conference (AOMSUC) in Tokyo, Japan, 9-13 November 2015

Chirokova, G., M. DeMaria, R. DeMaria, J. Knaff, J. Dostalek, K. Musgrave, and J. L. Beven, 2015: Use of JPSS ATMS, CrIS, and VIIRS data to Improve Tropical Cyclone Track and Intensity Forecasting. 2015 AGU Fall Meeting, December 14 – 18, 2015, San Francisco, California.

Chirokova, G., M. DeMaria, R. DeMaria, J. Knaff, J. Dostalek, and J. L. Beven, 2015: Use of JPSS ATMS and VIIRS data to Improve Tropical Cyclone Track and Intensity Forecasting. Poster presentation at the 2015 NOAA Satellite Conference, April 27 - May 1, 2015 Greenbelt, Maryland.

Chirokova G., M. DeMaria, J. Dostalek, R. DeMaria, and K. Musgrave, 2015: Quality of ATMS-MIRS retrievals for Atlantic tropical cyclones. Presentation at the NCAR/NOAA/CSU TC Workshop, July 21, 2015 Boulder, Colorado

DeMaria, R., 2015: Automated Tropical Cyclone Eye Detection Using Discriminant Analysis. Master's Thesis Defense. CSU, Department of Computer Science, October 28, 2015, Fort Collins, CO.

Seaman, C., G. Chirokova, J. Dostalek, L. Grasso, J. Knaff, D. Lindsey, S. Miller, and A. Schumacher, 2015: Satellite Proving Ground OCONUS Activities at CIRA. Presentation at 2015 OCONUS Technical Interchange Meeting, May 12 - 15, 2015, Anchorage AK

PROJECT TITLE: CIRA Support to the JPSS Proving Ground and Risk Reduction Program: Addressing NWS Desires for a Cloud Cover Layers Product using Merged VIIRS and ATMS Products

PRINCIPAL INVESTIGATOR: Steve Miller

RESEARCH TEAM: Yoo-Jeong Noh, Curtis Seaman, John Forsythe, Steve Finley, Renate Brummer

NOAA TECHNICAL CONTACT: Satya Kalluri (NOAA/NESDIS) and Candice Jongsma (NOAA/OAR)

NOAA RESEARCH TEAM: Dan Lindsey (NOAA/NESDIS/STAR/RAMMB)

FISCAL YEAR FUNDING: \$40,000

PROJECT OBJECTIVES:

This project is a collaboration between Andrew Heidinger of NOAA/NESDIS/STAR/ASPB and his colleagues at the Cooperative Institute for Meteorological Satellite Studies (CIMSS) and the Cooperative Institute for Research in the Atmosphere (CIRA), led by Steve Miller on the CIRA side. The ultimate goal was to address key challenges articulated by the National Weather Service (NWS) with regard to Cloud coverage and layers (CCL). The requirement was for improved plan-view imagery at 2 km spatial resolution reporting the presence of cloud, its classification, and an estimation of its phase at selected flight levels.

The CIRA team assisted CIMSS in the exploitation of Day/Night Band by supplying updated version of its lunar irradiance model for use in CLAVR-x cloud retrievals. Retrieval of cloud optical depth at night is enabled by the high sensitivity of visible light reflectance (in this case, moonlight), which requires the assistance of the lunar model to determine. In order to calculate the cloud geometric thickness (CGT) the CIRA team derived the cloud optical depth, particle size, and the cloud water path. The cloud water path was used to estimate cloud geometric thickness—a key parameter for an augmented CCL application.

Research Conducted during the first year

- 1-- Development of Cloud Geometric Thickness (CGT) Retrievals for Improved CCL
- 2-- Validation of CGT retrieval algorithm against CloudSat and comparison to other methods
- 3-- Initial CCL development and visualization

1-- As part of the JPSS Cloud Cal/Val efforts, we showed the operational VIIRS IDPS Cloud Base Height algorithm provided only marginal skill through validation using CloudSat data. CIRA team has developed a statistically based geometric thickness constrained by cloud top height and retrieved water path using A-Tran satellites with support from CIMSS colleagues. The new approach has less dependency on cloud type/phase and thus reduces the errors from the upstream input compared to the original IDPS CBH algorithm.

2-- The new algorithm has been implemented and run in the Clouds from AVHRR Extended (CLAVR-x) processing system for demonstration in the NOAA NDE system. We have been validating the output with the same strategies adopted for evaluation of the IDPS CHB algorithm using S-NPP and CloudSat matchups. Validation for selected intensive matchup periods shows that the new algorithm yields significantly improved performance over the original IDPS algorithm.

3-- The cloud geometric thickness information is employed to enhance the Cloud Cover-Layers product. We developed a beta version of the algorithm to provide lower-level cloud coverage information and added to the original CCL algorithm embedded in CLAVR-x which has been developed by Dr. Andy Heidinger and CIMSS colleagues. Cloud layers in the CCL algorithm are classified with cloud top

pressure (P_c) < 440 hPa as being in the high layer, clouds with $P_c > 680$ hPa as low layer, and clouds between 440 and 680 hPa as mid layer using the ISCCP definition. The beta version of the modified CCL algorithm has been applied to the CLAVR-x operation with VIIRS DNB over Alaska running in near time at CIRA. Figure 1 presents a sample result of the layered cloud fraction changes by utilizing cloud geometric thickness, which shows significant increases in mid- and low-level cloud fractions missed by the previous CCL retrieval.

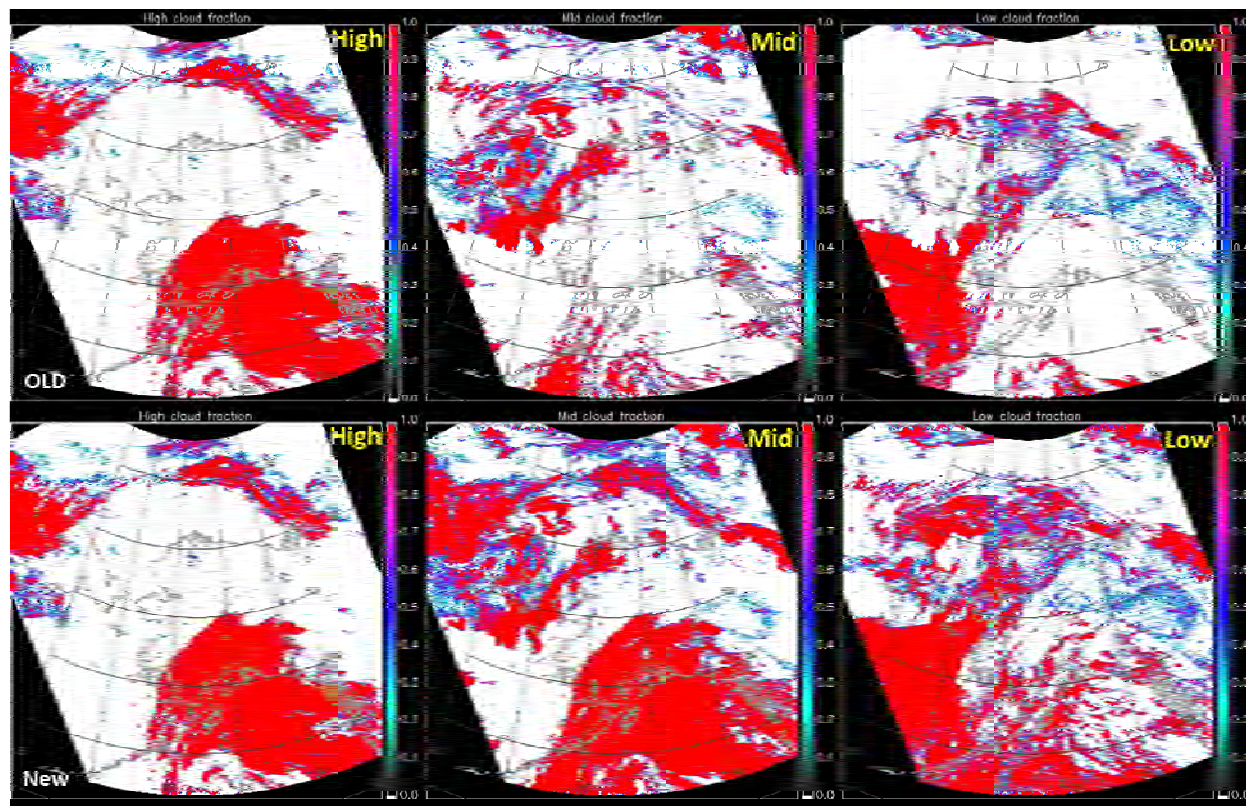

Figure 1. Sample results of the layered cloud fraction changes by utilizing cloud geometric thickness information (upper: the original CCL and bottom: the new CCL) at 2217-2228 UTC on 23 February 2016 over Alaska.

Publications: None

Presentations:

Noh, Y.J., J. Forsythe, C. Seaman, S. Miller, M. Rogers, D. Lindsey, and A. Heidinger, 2015: Enterprise Cloud Base: VIIRS Cloud Base Height Algorithm Improvement and Evaluation Using CloudSat. STAR JPSS Annual Science Team Meeting, College Park, MD, 24-28 August 2015.

Noh, Y.-J., S.D. Miller, and A. Heidinger, 2015: Detection of supercooled liquid water-topped mixed-phase clouds from shortwave-infrared satellite observations. 2015 AGU Fall Meeting, San Francisco, CA, 14-18 December 2015.

PROJECT TITLE: CIRA Support to the JPSS Proving Ground and Risk Reduction Program: Improving NUCAPS Soundings for CONUS Severe Weather Applications via Data Fusion

PRINCIPAL INVESTIGATOR: Jack Dostalek

RESEARCH TEAM: John Haynes, Renate Brummer, Rosemary Borger, Kevin Micke, Natalie Tourville, Dave Watson

NOAA TECHNICAL CONTACT: Satya Kalluri (NOAA/NESDIS) and Candice Jongsma (NOAA/OAR)

NOAA RESEARCH TEAM: Dan Lindsey (NOAA/NESDIS/STAR/RAMMB)

FISCAL YEAR FUNDING: \$75,000

PROJECT OBJECTIVES:

Currently, the only observational platform having adequate vertical resolution of temperature and moisture for severe thunderstorm applications is the radiosonde. The vertical resolution is sufficient to detect sharp low-level temperature inversions and vertical gradients in moisture common during severe weather events. However, the major limitation of radiosonde data is inadequate temporal and spatial resolution. Balloons are launched only at 00 and 12 UTC (and occasionally at 18 UTC), and the launch sites are 300-500 km apart in the central U.S.

As part of the JPSS mission, under the direction of Chris Barnet, Science and Technology Corporation developed the NOAA Unique CrIS/ATMS Processing System, or NUCAPS. This algorithm uses data from the Cross Track Infrared Sounder (CrIS) in clear sky conditions and from the Advanced Technology Microwave Sounder (ATMS) in cloudy regions to retrieve global vertical profiles of atmospheric temperature and water vapor. These instruments are aboard the SNPP satellite that was launched in November 2011, and are planned to be a part of the forthcoming JPSS satellites.

Given the requirement for NUCAPS to be available globally, it is a satellite-only retrieval and does not incorporate ancillary information other than surface pressure from the GFS model. The retrieved soundings are relatively smooth in the vertical and are unable to resolve sharp vertical gradients that are often found at the top of the boundary layers in a summertime severe weather environment.

NWP output continues to improve every year, especially with the advent of high resolution (e.g., <4 km grid spacing), convection-resolving models. But the models still struggle with important details such as surface to 850 mb moisture advection in the central plains of the CONUS. Surface analyses of temperature and water vapor are now available hourly at high resolution (2.5 km), from the Real-Time Mesoscale Analysis (RTMA). Strategically combining portions of the NWP output and RTMA data with the NUCAPS soundings will undoubtedly result in improved characterizations of the vertical profile of temperature and moisture than the NUCAPS soundings alone.

Research Objectives in Year 1 (July 2015 - March 2016)

The first task in this project is to better characterize the errors in the NUCAPS retrievals during the warm season over the CONUS. This will be accomplished by obtaining radiosonde data that was collected near the overpass time of SNPP, matching up the nearest NUCAPS sounding within a distance/time offset deemed to fall within the same convective environment, and calculating the errors and biases as a function of height (pressure).

Three sources will be used to create the radiosonde dataset. First, the NWS occasionally launches radiosondes at 18-20 UTC on days in which a Moderate Risk (or greater) of severe storms has been forecast by the Storm Prediction Center. The second dataset comes from the Atmospheric Radiation Measurement (ARM) Southern Great Plains (SGP) site which has launched many SNPP pass-timed radiosondes. The third data set leverages the Colorado State University (CSU) Department of

Atmospheric Science mobile radiosonde system by traveling east of Fort Collins to launch radiosondes on select days. The northeast plains of Colorado are a region that frequently experiences severe thunderstorms during May-August, and there is often uncertainty about the depth and magnitude of moisture return from the east in this region. Sufficient water vapor is regularly advected westward in post-frontal environments, but often the deepest moisture does not make it as far west as Denver, where the nearest radiosonde is launched. Special soundings in this data void region would be ideal. Graduate students in CSU's Atmospheric Science Department will assist with these special radiosonde launches. These launches will provide information about the performance of NUCAPS from a High Plains perspective, often a different convective environment than Central Plains locations such as Oklahoma. Sounding data collected in northeast Colorado will be immediately uploaded to a server and made available to the Storm Prediction Center, as well as the nearby National Weather Service Weather Forecast Offices (WFOs) such as Boulder, Cheyenne, Goodland, and North Platte. This supplementary data is a side-benefit of this proposal, and will be potentially very useful for severe weather analysis by the NWS.

NUCAPS data are currently being collected and archived at CIRA. In addition, the NUCAPS developers have agreed to re-run the upcoming new version of the algorithm for certain past orbits, and this data will also be archived.

NWP data, including from the Rapid Refresh (RAP), the High Resolution Rapid Refresh (HRRR), the North American Model (NAM), and the Weather Research and Forecast Model (WRF), will be collected (as available) for the selected comparison events. RTMA data will also be archived for the hour nearest the SNPP overpass.

Analysis of the data collected during the summer of 2015 will commence in the Fall and continue through the end of the Year 1 funding cycle in March 2016. The initial focus will be on matching up the radiosonde data with the NUCAPS retrievals and calculating errors of both the NUCAPS and the model soundings.

Individual Year 1 Milestones

1--Search special 18-20 UTC soundings launched in the warm season of 2014 and 2015 and collect those that correspond with SNPP passes.

2--Obtain SNPP-pass-timed radiosonde data that was collected at the ARM SGP site.

3--Launch radiosondes from northeast Colorado, timed with the SNPP overpass on days in which convection is likely during late July and August 2015.

4--Begin collecting corresponding NUCAPS, NWP soundings, and RTMA data that match with the radiosonde data obtained above.

5--Write and submit quarterly reports as required.

6--Attend any required JPSS Meetings to present results.

Achievements

Milestone 1: WFOs occasionally launch special afternoon soundings, particularly on days for which severe weather is likely in their area. Some of these special launches will match with SNPP's ~1930 UTC afternoon pass. We therefore have collected a total of 6339 observed soundings (Table 1) from between 2012-07-24 and 2015-10-31 and between 1400-2200 UTC as potential matches with the Suomi-SNPP overpasses, for comparison with the NUCAPS retrievals. Only a subset of these NWS sounding will be chosen for comparison based our selected time/space threshold.

Milestone 2: At the onset of this project, we were informed that balloons from the ARM SGP site were launched to time with the overpass of SNPP. The total number of ARM SGP soundings between 2012-07-24 and 2015-10-31 and between 1400-2200 UTC is 1599 (see Table 1).

Radiosonde Source	Location	Number of soundings
NOAA/NWS	Various CONUS locations	6339
ARM SGP	Oklahoma	1599

Table 1. Summary of the radiosonde data that has been collected for potential comparison with NUCAPS soundings. The period of interest is from 1400-2200 UTC and from 2012-07-24 through 2015-10-31. A subset of these will correspond with a SNPP pass.

Milestone 3: 20 radiosondes were purchased from Vaisala, and when severe weather season returns to eastern Colorado in Spring 2016, each of these soundings will be launched from a location within a few hours of Ft. Collins on days on which convection is possible, timed with the overpass of SNPP. The purpose of these launches is to supplement our validation dataset with cases in the High Plains of the CONUS. These launches fall into Year 2 of the project

Milestone 4: The goal of the comparisons between the NUCAPS retrievals and the observed radiosondes over the CONUS is to characterize the errors and identify any biases that exist. It is therefore critical to use the most recent version of the NUCAPS retrieval, because biases in an old version of the algorithm may now be gone, or new biases may have been introduced. Chris Barnet reported in Dec. 2015 that the newest version of NUCAPS is nearly ready for release, and after its release, old data will be reprocessed using the new algorithm. At that point, we will obtain the reprocessed data and begin the comparisons with the archived radiosonde data. We have begun writing code to perform the matchups between the observed raob data and the NUCAPS soundings. If the reprocessed data is not available in the next couple of months, we will attempt to obtain the data from the previous version and use that to calculate some "old" error statistics for the situations of interest (i.e., convectively unstable situations over the CONUS during the daytime). In addition, we are archiving Rapid Refresh Model (RAP) data in real time, and have an archive that extends back to the beginning of the radiosonde collection in 2012. Once the other data are ready, RAP soundings will also be included in the comparison.

Milestone 5: Quarterly reports have been composed and submitted at the end of each quarter.

Milestone 6: Teleconferences are occasionally held to discuss NUCAPS-related items, and we are calling into all of those for which we are available

Interaction with operational partners

Bill Line, liaison with the Hazardous Weather Testbed (HWT) and Storm Prediction Center, is very interested in getting the modified NUCAPS soundings in order to be compared with the original algorithm and evaluated at the Spring Experiment. The timeline of the current project is for these experimental soundings to be evaluated during the HWT Spring Experiment in Spring/Summer 2017.

Publications:

None

Presentations:

None

PROJECT TITLE: CIRA Support to the JPSS Proving Ground and Risk Reduction Program: JPSS Satellite Training for NOAA Users

PRINCIPAL INVESTIGATORS: Bernadette Connell and Steve Miller

RESEARCH TEAM: Jorel Torres, Ed Szoke, E. Dagg

TECHNICAL CONTACT: Satya Kalluri (NOAA/NESDIS) and Candice Jongsma (NOAA/OAR)

NOAA RESEARCH TEAM: Brian Motta and Anthony Mostek NOAA/ NWS/OCLO/ Forecast Decision Training Division, Leroy Spayd (NWS/OCLO)

FISCAL YEAR FUNDING: \$100,000

PROJECT OBJECTIVES:

This project establishes a Satellite Liaison at the Cooperative Institute for Research in the Atmosphere (CIRA) as a critical link between the Joint Polar Satellite System (JPSS) program and National Oceanic Atmospheric Administration (NOAA) operational end users primarily at National Weather Service (NWS) Offices and National Centers. The Satellite Liaison is devoted to connecting satellite algorithm developers, trainers, and forecasters, enhancing multi-path communication, ensuring that operational needs are not lost in translation, while also steering and focusing the research and training directions to best serve operational needs.

The Liaison will provide training for operational NWS forecast staff about multiple initiatives including NOAA-Unique Products, Day-Night Band, Visible Infrared Imaging Radiometer Suite (VIIRS) Imagery, Advanced Technology Microwave Sounder (ATMS), Cross-track Infrared Sounder (CrIS), NOAA Unique CrIS ATMS Products (NUCAPS), and Numerical Weather Prediction (NWP) data assimilation. This includes current JPSS Program initiatives such as Smoke and Fire, Hydrology and Flooding, Severe Convective Weather, Critical Weather Applications, and targeted specific NWS forecast and warning operations. The projects will be coordinated with the NWS Office of the Chief Learning Officer (OCLO) in particular the Forecast Decision Training Division (FDTD).

Specific Objectives:

- 1-- Recruit and hire Satellite Liaison.
- 2-- Begin rapid spin-up of Liaison on capabilities and establish network of users.
- 3-- Begin preparation of training materials based on preliminary interactions with users and understanding of short term training requirements.
- 4-- Participate in JPSS Initiative teleconferences and take inventory of both user needs and developer capabilities—begin to map possible connections between the two.
- 5-- Participate in Domestic Science Conferences (NWA/AGU/AMS) and travel locally to Boulder and Cheyenne WFOs.

PROJECT ACCOMPLISHMENTS:

- 1-- Recruit and hire Satellite Liaison.

The announcement for request for applications for the new Satellite Liaison position was posted via CIRA/CSU and other media on 15 July 2015. Review of applicants commenced on 3 August and interviews took place from mid to late August. The search committee recommended a candidate for hire to the CIRA Director in mid-September and this was forwarded to appropriate CSU officials for further approval and checking to meet Equal Employment Opportunity Requirements. The candidate was sent

the offer letter in October and accepted the offer with a start date in mid-December. The new JPSS Satellite liaison, Jorel Torres, started at CIRA on 17 December 2015.

Jorel's initiation process began by introducing him to various training modules from CIRA/VISIT, COMET, SPoRT, various scientific articles, the JPSS website, materials related to AWIPS II display of NCC, training/blog materials prepared by current trainers and Liaisons, and initial priorities for the position.

2-- Begin rapid spin-up of Liaison on capabilities and establish network of users.

- Rapid spin-up is in progress. Jorel experienced the introduction of NCC in to AWIPS II and a short training session delivered by Curtis Seaman through the VISIT Chat venue on 18 December 2015.

- Jorel attended the American Meteorological Society's 12th Annual Symposium on New Generation Operational Environmental Satellite Systems, which was part of the 96th Annual Meeting, Monday, 11 January 2016 to Thursday, 14 January 2016, in New Orleans, LA. He also attended the AMS Short Course on the Geostationary Operational Environmental Satellite (GOES)-R and Joint Polar Satellite System (JPSS) on the Sunday prior to the conference.

- Jorel attended the Advanced Baseline Imager (ABI) Training Workshop for Satellite Liaisons 1 to 3 March 2016 at the National Weather Service Training Center in Kansas City, Missouri. Many of the new channels on the ABI are already on the SNPP VIIRS instrument, so this training content provided satellite foundation basics for reference. He met with the other liaisons and was introduced to the Satellite Information Familiarization Tool (SIFT). A similar Workshop will be planned and offered in conjunction with the launch of JPSS-1 in January 2017.

3-- Begin preparation of training materials based on preliminary interactions with users and understanding of short term training requirements.

-- Members of the training team assisted developers Steve Miller, Dan Lindsey, and Curtis Seaman in the preparation of a quick guide for the release of NCC imagery via SBN into AWIPS in mid- December 2015.

- Trainers also assisted with the preparations necessary to deliver a short 30 minute introductory training session on NCC. The presentation was given by Curtis Seaman and the recording can be accessed here: Introduction to NCC in AWIPS - VISIT Satellite Chat on 18 December 2015

http://rammb.cira.colostate.edu/training/visit/satellite_chat/20151218/

- The quick guide can be found here:

https://vlab.ncep.noaa.gov/documents/portlet_file_entry/410847/VIIRS_NCC_Quick_Guide_Dec2015.pdf/29d199a6-0199-4bbe-be9b-d8ea697a3af7?download=true

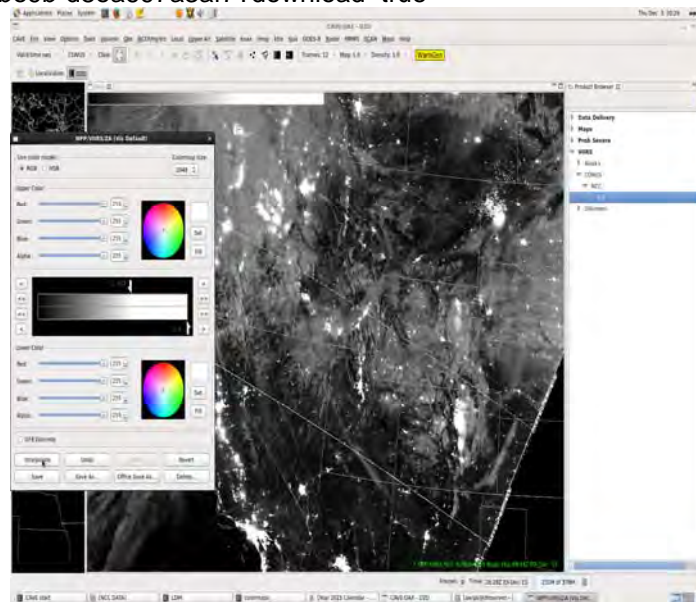

Figure 1. The AWIPS II display of the new DNB imagery made available in mid-December 2015.

-- Blogs that have been posted:

Cold Air Aloft Product: Arctic by J. Torres and J. Dostalek

<http://rammb.cira.colostate.edu/training/visit/blog/index.php/2016/01/22/cold-air-aloft-product-arctic/>

Suomi-NPP, VIIRS, Day-Night Band (DNB): Moon Phases by J. Torres and E. Dagg

<http://rammb.cira.colostate.edu/training/visit/blog/index.php/2016/02/16/suomi-npp-viirs-day-night-band-dnb-moon-phases/>

4-- Participate in JPSS Initiative teleconferences and take inventory of both user needs and developer capabilities—begin to map possible connections between the two.

J. Torres participated in the following JPSS Initiative teleconferences:

NUCAPS – 23 February

River and Ice Flooding – 27 January

Fire and Smoke – 21 January and 25 February

He also participated in the 28 January and 8 March JPSS Science Seminars.

5-- Participate in Domestic Science Conferences (NWA/AGU/AMS) and travel locally to Boulder and Cheyenne WFOs

- B. Connell prepared and presented "JPSS User Readiness through Training: VISIT, SHyMet, WMO VLab and a new Liaison" at the American Meteorological Society's 12th Annual Symposium on New Generation Operational Environmental Satellite Systems, which was part of the 96th Annual Meeting, Monday, 11 January 2016 to Thursday, 14 January 2016, in New Orleans, LA.

- S. Miller presented on "VIIRS Day/Night Band Capabilities for Night-time Imaging" at the AMS Short Course on the Geostationary Operational Environmental Satellite (GOES)-R and Joint Polar Satellite System (JPSS) on the Sunday prior to the conference.

- B. Connell, J. Torres, and E. Szoke participated in the meeting of the Satellite Training Advisory Team (STAT) (formerly the Satellite User Readiness Team (SURT)) in Boulder on 1-5 February. This STAT falls under the guidance of NOAA/NWS/OCLO.

Publications: None

Presentations:

Connell, B., S. Miller, D. Bikos, E. Szoke, S. Bachmeier, S. Lindstrom, A. Mostek, B. Motta, L. Veeck, 2016: JPSS and GOES-R User Readiness through Training: VISIT, SHyMet, WMO VLab and a new Liaison. 12th Annual Symposium on New Generation Operational Environmental Satellite Systems at the 96th AMS Annual Meeting, New Orleans, Louisiana, 10-14 January.

Connell, B. 2015: Training resources from the US and access to data and imagery: ways to find them in the acronym soup. WMO VLab Virtual Event Week "Preparing for the Next Generation Satellite Imagery", 16-20 November, <http://www.wmo-sat.info/vlab/next-generation-of-satellites/> Virtual Presentation.

Folmer, M. 2015: JPSS and beyond: Liaison perspectives from NOAA's Center for Weather and Climate Prediction. WMO VLab Virtual Event Week "Preparing for the Next Generation Satellite Imagery", 16-20 November, <http://www.wmo-sat.info/vlab/next-generation-of-satellites/> Virtual Presentation.

Miller, S. 2015: VIIRS Day/Night Band Capabilities for Night-time Imaging. AMS Short Course on the Geostationary Operational Environmental Satellite (GOES)-R and Joint Polar Satellite System (JPSS), New Orleans, Louisiana, 10 January.

PROJECT TITLE: CIRA Support to the JPSS Proving Ground and Risk Reduction Program: ‘Seeing the Light’: Exploiting VIIRS Day/Night Band Low Light Visible Measurements in the Arctic and Advancing Nighttime VIIRS Cloud Products with the Day/Night Band

PRINCIPAL INVESTIGATOR: Steve Miller

RESEARCH TEAM: Curtis Seaman, Yoo-Jeong Noh, Fang Wang, Scott Longmore, Renate Brummer, Steve Finley

NOAA TECHNICAL CONTACT: Satya Kalluri (NOAA/NESDIS) and Candice Jongsma (NOAA/OAR)

NOAA Research Team: Andy Heidinger (NESDIS/STAR/CRPD/ASPB); Project 2

FISCAL YEAR FUNDING: \$188,000

PROJECT OBJECTIVES:

There are two related projects reported on under this JPSS Proving Ground and Risk Reduction (PGRR) task. The first demonstrates the unique and unprecedented capabilities of the Visible/Infrared Imaging Radiometer Suite (VIIRS) Day/Night Band (DNB) low-light visible nighttime imagery in the Arctic, emphasizing the use of moonlight during the winter season when solar illumination is limited or unavailable and where polar-orbiter temporal refresh is most practical to operational users. These demonstrations are conducted in cooperation with University of Alaska-Fairbanks (UAF) Geographic Information Network of Alaska (GINA) and its suite of operational partners, and coordinated under the auspices of NOAA’s Satellite Proving Ground to ensure a connection and dialogue with end users. New capabilities for detecting low cloud/fog, snow cover, volcanic ash, sea ice and ice-free passages, auroral boundaries, and other parameters exploiting the 740 m spatial resolution of the VIIRS/DNB low-light visible measurements coupled for the first time with spatially/temporally co-located multi-spectral shortwave and thermal infrared bands, are demonstrated in near real-time. We leverage tools and techniques for lunar availability and irradiance prediction as well as hands-on experience with VIIRS/DNB data gained via concurrent participation in the JPSS VIIRS Cal/Val program. Training on DNB imagery capabilities and interpretation for these new observations is an implicit component of this work, and examples derived from this research will provide subject matter for those involved in formal training efforts connected with the Proving Ground and more generally with the environmental satellite user community.

The second project under this JPSS/PGRR task specializes in the quantitative exploitation of the DNB for cloud optical property information at night. Clouds are a fundamental meteorological parameter in describing the energy balance of the planet. Knowledge of cloud cover is critical not only to operational users in the context of characterizing current weather-related hazards, but also to the production of high quality climate data records. Beyond the characterization of cloud coverage itself, identification of cloudy scenes is a key first-level filter to numerous other satellite-derived products that must either require cloud-free conditions or knowledge of cloud presence in order to produce accurate retrievals. Without this a priori knowledge, retrievals will contain biases that can propagate to errors in numerical weather prediction models, climate prediction models, and introduce ambiguity to the long-term satellite record of key climate parameters. For these reasons, the critical task of cloud masking resides at a high level in the VIIRS EDR processing chain. This project modifies the baseline VIIRS cloud mask and properties algorithms to utilize moonlight reflectance, when it is available, in an effort to augment the capabilities of the nighttime cloud products in terms of improved cloud mask, microphysical and macrophysical properties (and indirectly, improving downstream products that are reliant on an accurate cloud mask). The improved performance will be validated using independent, active-based cloud detection from the CALIPSO lidar. Comparisons to the baseline VIIRS cloud parameters will be conducted both in terms of case studies and statistics to infer the benefits of nighttime visible data and postulate implications for the satellite-based climate data records predating the availability of this information.

These projects directly address NOAA’s Weather and Water Goal, which seeks to serve society’s needs for weather and water information. This research also falls within the NOAA-defined CIRA thematic area

of Satellite Algorithm Development, Training and Education, as new, multi-spectral applications involving the Day/Night Band are being designed and demonstrated.

Project 1:

'Seeing the Light' - Exploiting VIIRS Day/Night Band Low Light Visible Measurements in the Arctic

Research Objectives

- 1-- Continue demonstrations
 - Present at AGU Fall 2015 and at the next OCONUS meeting (May/June2016)
 - Continue to assist forecasters in use of DNB products (E. Stevens main POC)
 - Continue to develop DNB application blog/training materials
- 2-- Code updates / Developments
 - Continue to refine existing codes ported to GINA
 - Port revised lunar reflectance model upon successful updates
 - Conduct observations during winter
 - Identify candidate applications for transition to NWS Proving Ground
- 3-- Ongoing Demonstrations/Manuscript preparation on selected VIIRS/DNB topic/Quarterly Reports
 - General assessment of high-latitude DNB utility
 - Manuscript preparation
 - Quarterly Reports

Research Conducted

1-- Demonstrations of VIIRS DNB to various users continued along several fronts. We continue to interact with the GINA group, with Eric Stevens serving as our conduit to the user community. S. Miller visited GINA and the Fairbanks WFO and had valuable face-to-face meetings with NWS forecasters, including Fairbanks SOO Melissa Kreller, and our GINA collaborators involved in transitioning research to operations (R2O). They have provided valuable feedback on DNB products currently produced as well as products still in development. Through separate JPSS PGRR Visiting Scientist Proposal funding, C. Seaman was also able to visit GINA and the Fairbanks WFO, where he also had valuable face-to-face meetings and gave a seminar titled, "Three Years of VIIRS". Several NWS forecasters were in attendance. We have also presented talks on the use of the DNB at the JPSS Science Team Meeting ("On the use of VIIRS Day/Night Band and Near Constant Contrast Imagery") and at AGU ("Making Waves — The VIIRS Day/Night Band Reveals Upper Atmospheric Gravity Wave via Sensitivity to Nightglow Emissions"). We have developed a training guide on the use of the DNB-derived Near Constant Contrast (NCC) Imagery EDR product, which was released to forecasters in December 2015, and participated in a VISIT Satellite Chat to introduce users to the product. The training "Quick Guide" is available on the NOAA VLab website. C. Seaman and S. Miller were interviewed by WAG TV, a British production company, about DNB imagery applications for forthcoming episodes of the Science Channel series, "What on Earth?" and "NASA's Unexplained Files."

Blog entries on various topics of high-latitude relevance were delivered to the 'Seeing the Light' website. (<http://rammb.cira.colostate.edu/projects/alaska/blog/>). DNB-relevant entries for this period are:

- The Nice and Dedicated People of N-ICE*: ship tracking during the N-ICE arctic field experiment
- The Land of 10,000 Fires*: using VIIRS for fire detection during the active 2015 fire season in Alaska
- A Graduate Level Course on the DNB and NCC*: introducing NCC in AWIPS-II and the Auto Contrast algorithm for automated scaling of NCC imagery
- UHF/VHF*: the Aleutian Islands were hit by 4 "hurricane force" polar lows in less than a month

2-- With the assistance of Liam Gumley and Kathy Strabala, our Error Function Scaling for DNB imagery (ERF; Seaman and Miller, 2015) was added to the Community Satellite Processing Package (CSPP) and

publicly released in version 2.0 of the Polar2Grid software package. Figure 1 shows an example of the ERF scaling in comparison to a standard Near-Constant-Contrast (NCC) product for a scene over Alaska. GINA is now running this package and distributing ERF-scaled DNB imagery to Alaska Region WFOs through AWIPS-II.

We have developed the Auto Contrast method to automatically scale Near Constant Contrast imagery. Figure 2 compares the Auto Contrast method with the default NCC scaling used in AWIPS-II for an aurora over Alaska. Due to a software “freeze” (during the Raytheon “re-compete”), we have been unable to add the Auto Contrast algorithm into AWIPS-II, but it remains a goal for future work. In the meantime, we have developed training on the use of NCC in AWIPS-II (see item #1 above) with information on how users may manually adjust the scaling to highlight features of interest in the imagery and better fit their needs.

We continue to develop the DNB Snow/Cloud Discriminator, which is an RGB composite imagery product useful for discriminating clouds from snow. Figure 3 shows an example of the Snow/Cloud Discriminator highlighting clouds over ice at night in the Bering Sea. We are working to add this product to the near-real time processing we are running at GINA so that it may be distributed to Alaska Region users.

3-- During this period work proceeded on several DNB-related papers.

--A journal article on nightglow gravity waves has been published in the *Proceedings of the National Academy of Science (PNAS)*. The energy deposited by these waves influences the structure of the upper atmosphere and thus affects weather/climate in the full-system response, as well as immediate impacts to GPS performance.

--A paper on the error function scaling approach, which provides a fast and straightforward means to scaling the highly dynamic DNB imagery apart from the Near Constant Contrast (NCC) product, was published in *International Journal of Remote Sensing*.

--An article on revolutionary applications of the DNB - including firefighting, search and rescue operations, light pollution and ship tracking - was published in *Scientific American*.

--A manuscript discussing the value of high latitude users in the validation of VIIRS SDR and EDR imagery was published in *Remote Sensing*. This paper was the result of close collaboration between the VIIRS Imagery Team, CIRA, GINA, NRL Monterrey, the Aviation Weather Center, and NWS forecasters in Alaska.

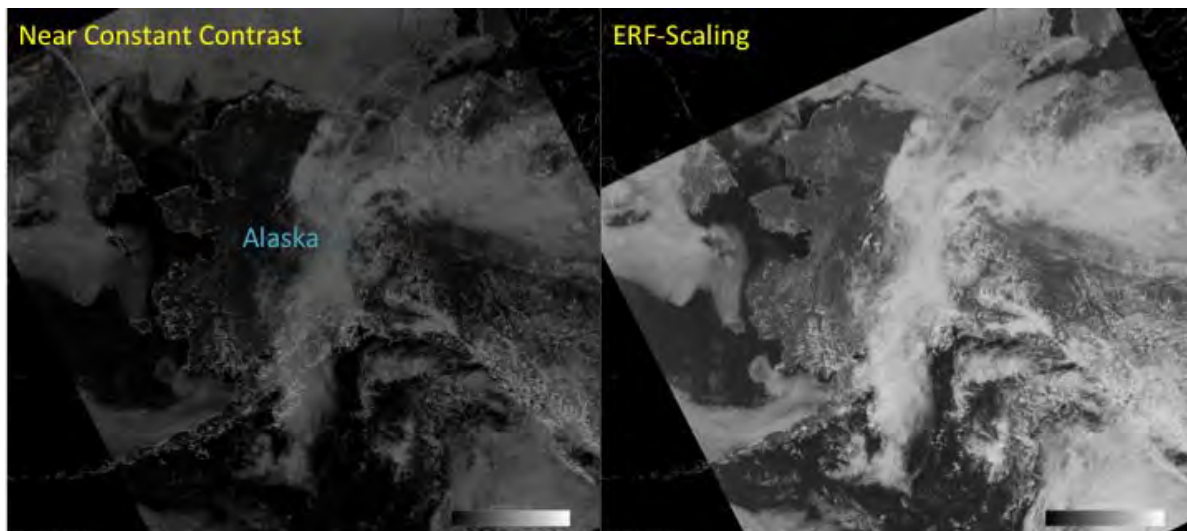

Figure 1. Example of Near Constant Contrast (NCC) and ERF-scaled imagery for an example scene over Alaska. The DNB also provides useful imagery during the Day, as shown in this example from 21 June 2014 (2201 UTC).

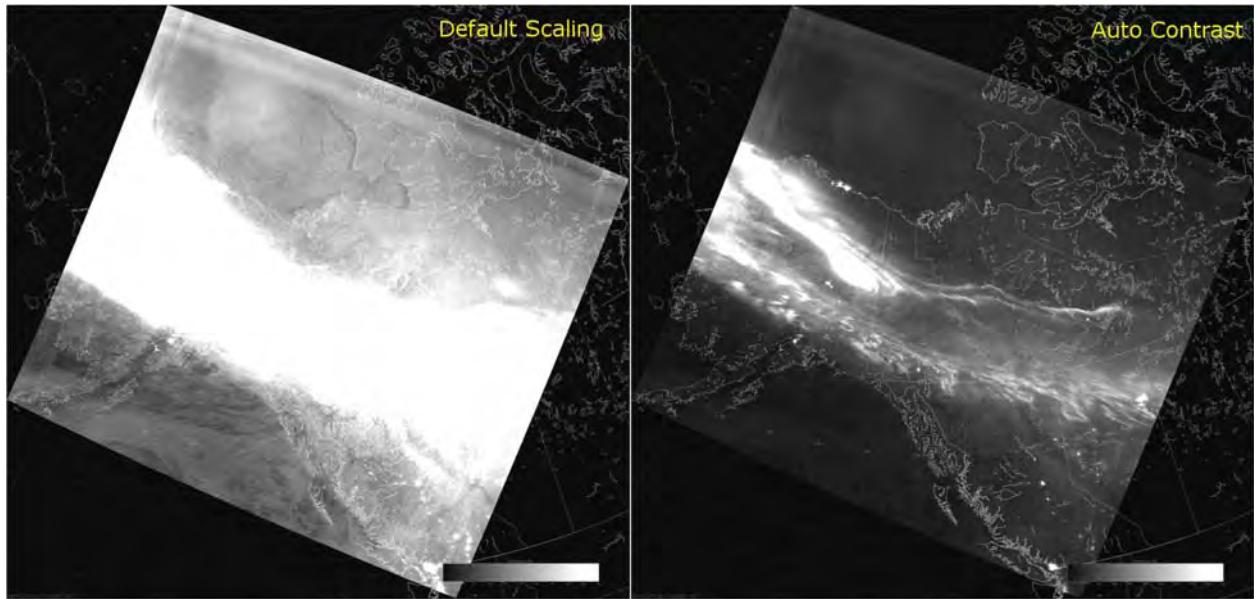

Figure 2. Example of Near Constant Contrast imagery displayed with the default AWIPS-II scaling (left) and Auto Contrast (right) for a case of an aurora over Alaska from 22 January 2015.

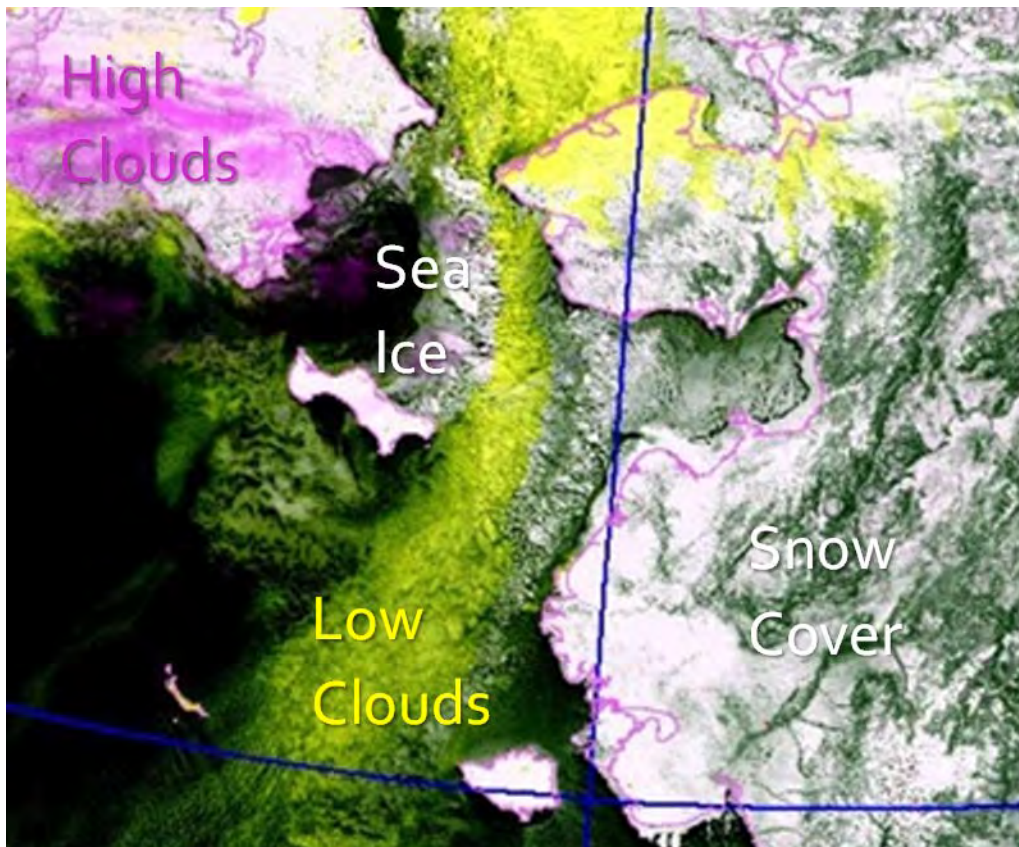

Figure 3. Example of the DNB Snow/Cloud Discriminator product. Low clouds over snow and ice are notoriously difficult to detect and discriminating clouds from snow and ice is valuable for numerous applications.

Project 2: Advancing Nighttime VIIRS Cloud Products with the Day/Night Band

Research Objectives

- 1-- Continue evaluation of NLCOMP
 - Evaluate cases of stratocumulus off S. America
 - Begin examining cloud properties in Arctic
 - Prepare manuscript on DNB nocturnal cloud detection via moonlight
- 2-- Continue support of lunar model development
 - Deliver updated lunar irradiance model for incorporation in NLCOMP.
 - Prepare/submit manuscript on DNB lunar model validation.
 - Begin distributing validated model to community users
- 3-- Write manuscript about NLCOMP global research results (with CIMSS)

Research Conducted

1-- Fundamental to this research is the conversion from DNB measurements of radiance to lunar reflectance. This conversion enlists a lunar irradiance model developed by the project PI in coordination with the Naval Research Laboratory. During this reporting period we continued the important work of validating this model and refining its performance across a range of lunar illumination scenarios.

a--Validation at White Sands, NM:

We have continued to add new data to the White Sands, NM analysis in order to build up statistical significance of the comparisons. Figure 4 shows the latest time series of day vs. night surface reflectance at a selected site on the eastern side of White Sands National Monument. Nighttime outliers have been previously diagnosed as being associated with the side-illumination of sand dunes for low lunar elevation angles.

b--Validation at Salar de Uyuni, Bolivia:

Additional data have been compiled for the dry season of Salar de Uyuni salt flat in Bolivia. The location is better suited than White Sands for validation, given its high altitude, high albedo, lack of vegetation, and nearly perfectly horizontal and uniform surfaces. However, with seasonal flooding modulating the surface albedo, the targets are not as stable over time as the dry gypsum dunes of White Sands. Figure 5 shows the latest results for day vs. night surface albedo over one of our selected test sites. Given the high variability, we also show a scatter diagram with linear fit, indicating a high correlation between day and night calculations that build confidence in the performance of the lunar model.

c--Validation Against Deep Convective Clouds:

Deep convective clouds (cloud top temperatures < 45 °C) have been used to examine instrument calibration in past studies. These clouds are optically thick with tops at the tropopause, reside above most of the tropospheric aerosol and rayleigh scattering atmosphere. Since an important application of the lunar reflectance model is the enabling of nighttime cloud optical depth retrievals, we have begun to examine performance of the lunar model over deep convection. For this exercise we are comparing daytime and nighttime deep convection for DNB reflectance. Figure 6 shows preliminary results from these comparisons for deep convective clouds over the equatorial Pacific Ocean. While these distributions are similar, there are some features that warrant further study. The slight positive bias of the nighttime data could point to phase-dependent issues in our model adjustments. We will continue to analyse these data and make further adjustments to improve model performance over time.

2-- We have produced and evaluated the VIIRS nocturnal cloud mask over the southeast Pacific (South America area) where there have been known problems with satellite cloud detection. The advanced cloud detection algorithm by utilizing the lunar reflectance from VIIRS/DNB which has been implemented to NOAA's CLAVR-x system is used for the study. The performance is evaluated against the collocated

CALIPSO CALIOP data (1-km Cloud Layer and 5-km VFM products) and also compared with conventional IR-only method with VIIRS (DNB off) and the operational GOES-E mask. Figure 7 shows example results that present the retrieved cloud mask probabilities with and without the addition of DNB information. Cloud imagery from VIIRS DNB and M-15 (10.76 microns) are also shown. For this case, we see that the DNB adds confidence to the cloudy mask with higher cloud probabilities close to 100 %. Through statistical comparisons with CALIPSO for selected cases, we found that utilizing lunar reflectance data from DNB observations reduces ambiguity of cloud detection and decreases the false alarm rate compared with the GOES-E cloud mask over this area. Based on the case study, we prepared a manuscript on DNB nocturnal cloud detection over South America (Noh, Y. J., S. D. Miller, A. Walther, A. K. Heidinger, M. Rogers, 2016: Nighttime cloud detection over South America using the VIIRS Day/Night Band. *To be submitted to J. Geophys. Res.*).

3-- We are processing VIIRS cloud retrieval products over the Alaska region in near real time using the CLAVR-x system and continue to examine selected products. Figure 8 shows sample VIIRS cloud products which include cloud mask, cloud type, top/base heights, cloud optical thickness and effective radius both from the NOAA AWG Cloud Height Algorithm (ACHA) and Nighttime Lunar Cloud Optical and Microphysical Properties (NLCOMP) algorithm.

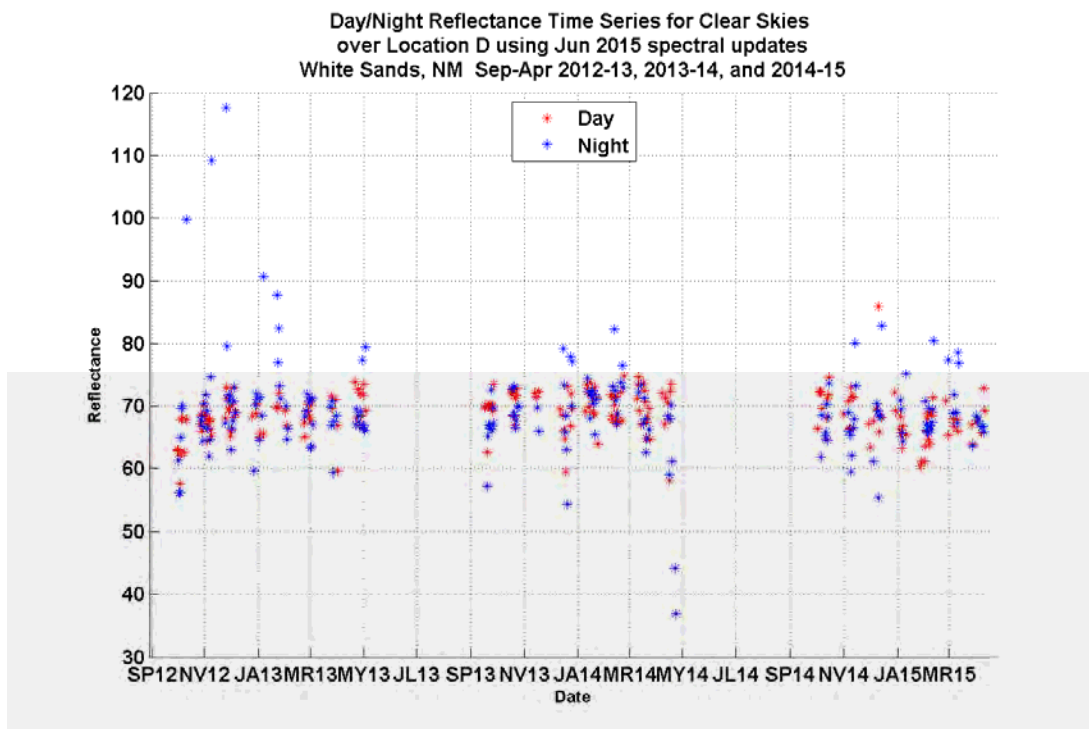

Figure 4. Time series of day (solar) vs. night (lunar) surface reflectance for an example site at White Sands, NM.

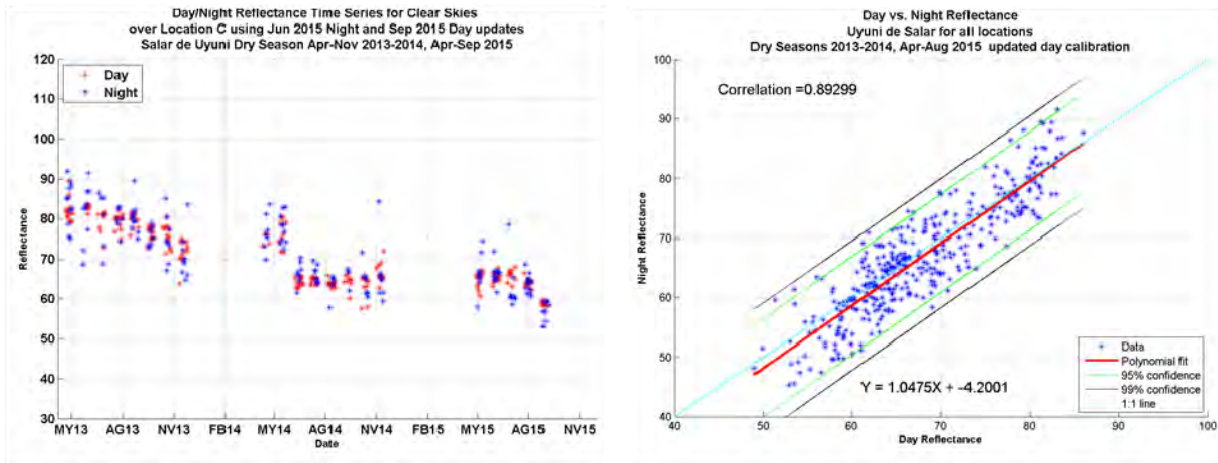

Figure 5. Left: time series of day (solar) vs. night (lunar) surface reflectance for an example site at Salar de Uyuni. Temporal variations arise from seasonal flooding of the basin. Right: scatter plot of Day/Night surface reflectance for quality-controlled data, showing correction of 0.89.

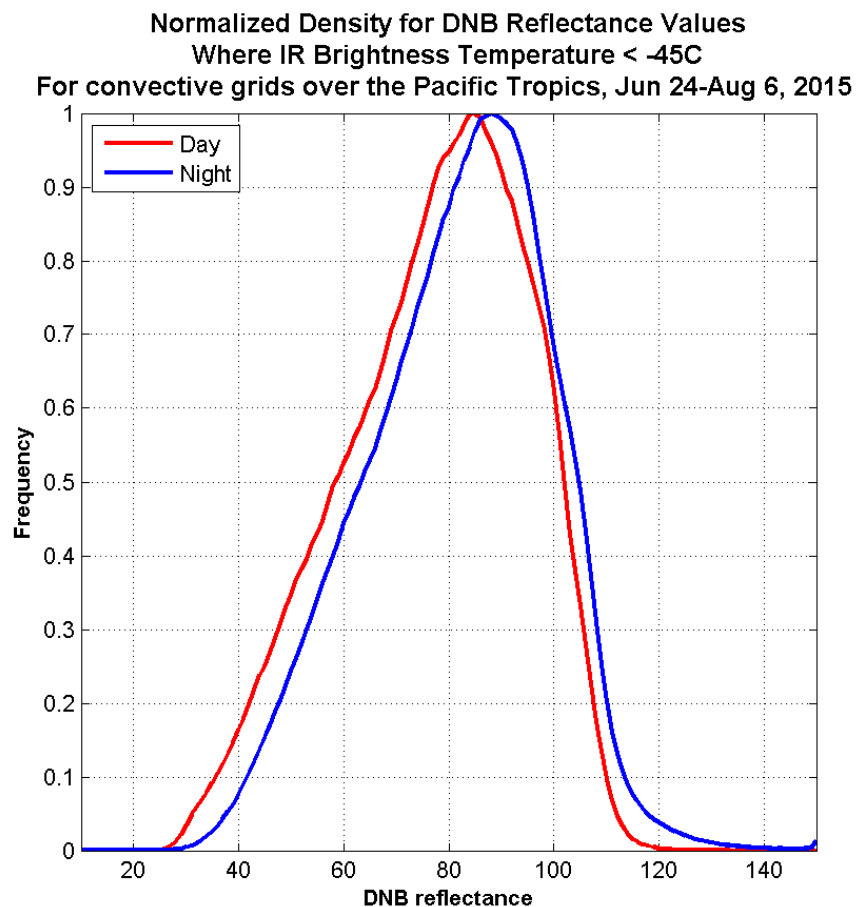

Figure 6. Comparison of day (red) and night (blue) distributions of reflectance for deep convective clouds (cloud top temperatures < -45 °C) over the tropical Pacific Ocean, accumulated over the period 24 June – 6 August, 2015

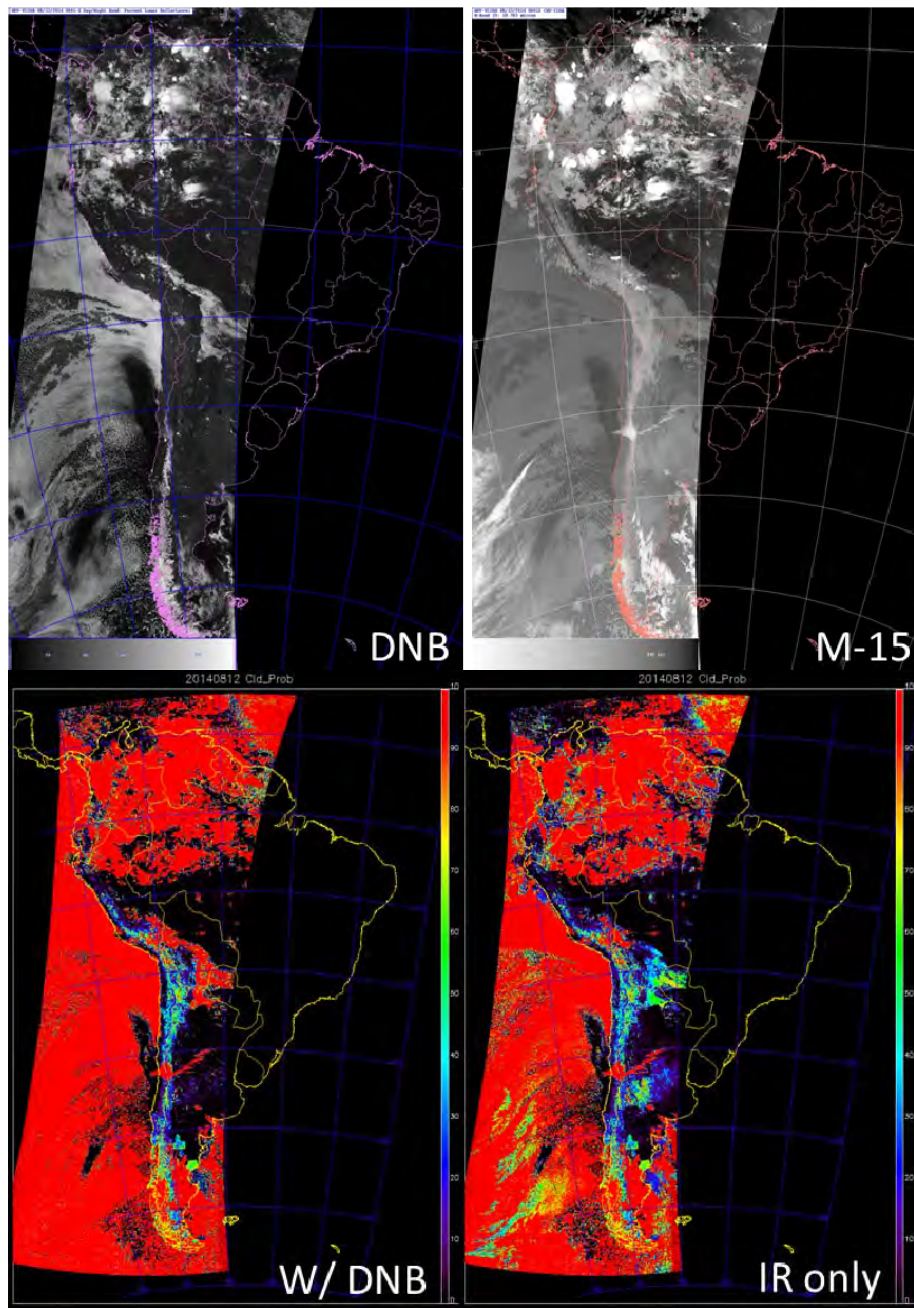

Figure 7. Example results of changes to VIIRS cloud mask when introducing DNB observations, for a case study in the southeast Pacific Ocean (0600-0621 UTC on 12 Aug 2014). The cloudy imagery from VIIRS DNB and M-15 (10.76 microns) are shown in the upper panels and cloud mask probabilities (100 % confidently cloudy in red) are also represented in the bottom panels with the DNB addition (left) and IR-only method (right), respectively.

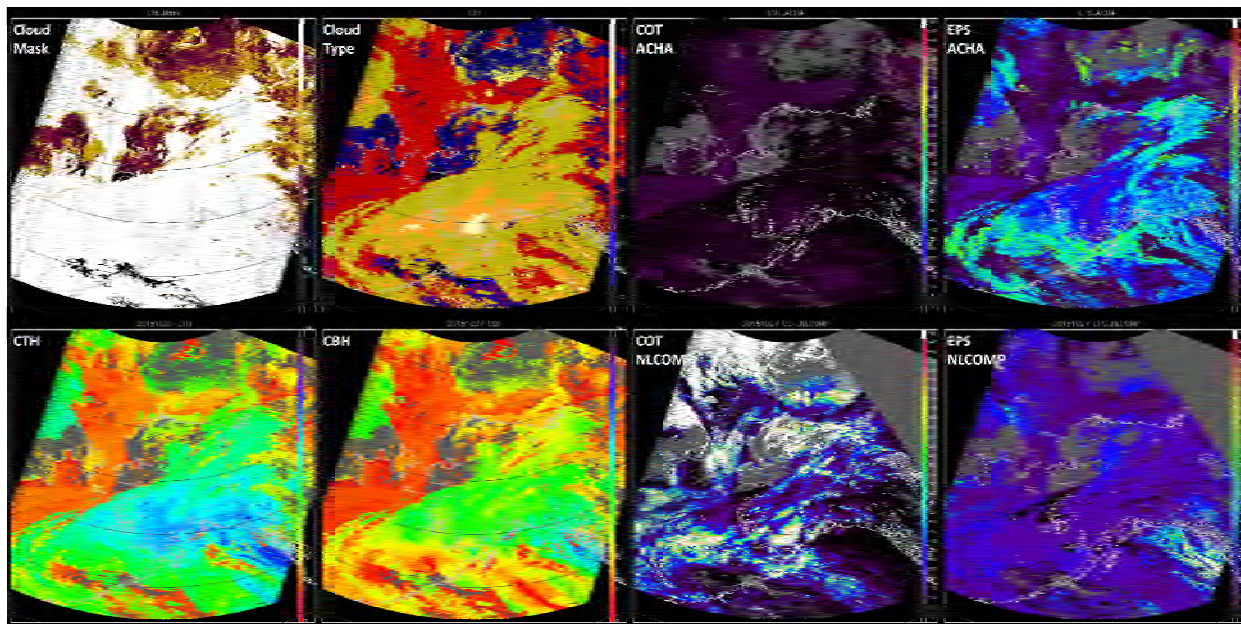

Figure 8. Sample VIIRS cloud retrieval products over the Alaska region which are processed in near real time at CIRA (1256-1305 UTC on 27 October 2015).

Publications:

Hillger, D., T. Kopp, C.J. Seaman, S.D. Miller, D.T. Lindsey, E. Stevens, J. Solbrig, W. Straka III, M. Kreller, A. Kuciauskas, and A. Terborg, 2016: User Validation of VIIRS Satellite Imagery. *Remote Sensing*, 8(1), 11; doi:10.3390/rs8010011.

Miller, S.D., 2015: Night Watch. A satellite sensor that can see in the dark is revealing new information for meteorologists, firefighters, search teams and researchers worldwide. *Scientific American*, 312 (5), pp 78-81.

Miller, S.D., W.C. Straka III, J. Yue, S.M. Smith, M.J. Alexander, L. Hoffmann, M. Setvak, and P.T. Partain, 2015: Upper atmospheric gravity wave details revealed in nightglow satellite imagery. *Proc. Nat. Acad. Sci.*, 112(49), E6728–E6735; doi: 10.1073/pnas.1508084112 **–with cover image!**

Seaman, C., and S.D. Miller, 2015: A Dynamic Scaling Algorithm for the Digital Display of VIIRS Day/Night Band Imagery. *Int. J. Rem. Sens.*, 36(7), 1839-1854, doi: 10.1080/01431161.2015.1029100.

Presentations:

Brummer, R., S.D. Miller, D. Bikos, B. Connell, D. Lindsey, A. Schumacher, C. Seaman, and E. Szoke, "GOES-R Proving Ground Activities at CIRA." Poster Presentation, 6th Asia/Oceania Meteorological Satellite Users' Conference, Tokyo, Japan, 9-13 November 2015.

Miller, S.D., C. Seaman, D.T. Lindsey, T. Schmit, M. Gunshor, D.W. Hillger, and Y. Sumida, "Multispectral Application Development for Himawari-8 AHI", Invited oral presentation, 6th Asia/Oceania Meteorological Satellite Users' Conference, Tokyo, Japan, 9-13 November 2015.

Miller, S.D., W.C. Straka, J. Yue, S.M. Smith, M.J. Alexander, L. Hoffmann, M. Setvak, and P. Partain, "Making Waves — The VIIRS Day/Night Band Reveals Upper Atmospheric Gravity Wave via Sensitivity to Nightglow Emissions." Invited oral presentation, AGU 2015 Fall Meeting, San Francisco, CA, 14-18 December 2015.

Miller, S.D., 2016, VIIRS Day/Night Band Capabilities for Nighttime Imaging. AMS Annual Meeting, New Orleans, 10-14 January 2016.

Miller S.D., T. Schmit, C. Seaman, M. Gunshor, D.T. Lindsey, D.W. Hillger, and Y. Sumida, "The Return of True Color to Geostationary Satellites: Transitioning from Polar, to Himawari-8, to GOES-R." Invited oral presentation, 96th AMS Annual Meeting, New Orleans, LA, 11-15 January 2016.

Seaman, C.J., G. Chirokova, J. Dostalek, L. Grasso, J. Knaff, D. Lindsey, S. Miller, and A. Schumacher, "Satellite Proving Ground OCONUS Activities at CIRA." Invited oral presentation. 2015 OCONUS Technical Interchange Meeting, Anchorage, AK, 12-15 May 2015.

Seaman, C.J., and S.D. Miller, "Into the Light: Illuminating the Capabilities of the VIIRS Day/Night Band." Invited oral presentation, 2015 OCONUS Technical Interchange Meeting, Anchorage, AK, 12-15 May 2015.

Seaman, C.J., "Three Years of VIIRS", Invited seminar. Geographic Information Network of Alaska (GINA), University of Alaska-Fairbanks, Fairbanks, AK. 20 May 2015.

Seaman, C.J., S.D. Miller and D. Hillger, "On the Use of the VIIRS Day/Night Band and Near Constant Contrast Imagery." Invited oral presentation, 2nd Annual STAR JPSS Science Team Meeting, College Park, MD, 24-28 August 2015.

Walther, A., S. D. Miller, and A. K. Heidinger, "The use of moonlight reflectance for improving cloud parameters at night." AGU Fall Meeting, San Francisco, CA, 14-18 December 2015.

PROJECT TITLE: CIRA Support to the JPSS Science Program: Science and Management Support for NPP VIIRS EDR Imagery Algorithm and Validation Activities and NPP VIIRS Cloud Validation

PRINCIPAL INVESTIGATOR: Steve Miller

RESEARCH TEAM: Yoo-Jeong Noh, Curtis Seaman, Matt Rogers, John Forsythe, Scott Longmore, Louie Grasso, Stan Kidder, Steve Finley, Natalie Tourville, Hiro Gosden, Dave Watson, Kevin Micke, Renate Brummer, Rosemary Borger

NOAA TECHNICAL CONTACT: Satya Kalluri (NOAA/NESDIS) and Candice Jongsma (NOAA/OAR)

NOAA RESEARCH TEAM: Don Hillger, Dan Lindsey (NOAA/NESDIS/STAR/RAMMB)

FISCAL YEAR FUNDING: \$403,794

PROJECT OBJECTIVES:

The Suomi National Polar-orbiting Partnership mission (NPP), serving as risk-reduction to the Joint Polar Satellite System (JPSS) and providing continuity to the National Aeronautics and Space Administration's

(NASA) Earth Observing System (EOS) climate mission, was launched successfully on 28 October 2011. The Visible/Infrared Imaging Radiometer Suite (VIIRS) on board Suomi NPP provides atmospheric, cloud, and surface imagery for both weather and climate applications. VIIRS is the next-generation to the Advanced Very High-Resolution Radiometer (AVHRR) that has flown on board the Polar-Orbiting Environmental Satellites (POES) since NOAA-15 in 1998. VIIRS was originally designed to merge the capabilities of the Defense Meteorological Satellite Program (DMSP) Operational Linescan System (OLS) and the NASA Moderate-resolution Imaging Spectroradiometer (MODIS).

This is a multi-agency research project with teams involved from NOAA/NESDIS/StAR, CIRA, CIMSS, NRL, NGDC, NGAS, and Aerospace. CIRA's research in this area is divided into two distinct elements: I) Support of VIIRS Imagery Validation Activities and II) Support of VIIRS Cloud Validation Activities. Progress on each element is detailed below.

These projects directly address NOAA's Weather and Water goal, which seeks to serve society's needs for weather and water information. This research also falls within the NOAA-defined CIRA thematic area of Satellite Algorithm Development, Training and Education, as calibration/validation is an integral and critical first step in the algorithm development process. Outcomes of the current research may in some cases lead to adjustments in the original algorithm to correct issues discovered during the calibration/validation analysis.

Project I: Support of VIIRS Imagery Validation Activities

Objectives

- 1-- Continue participation in monthly telcons related to all imagery-related items.
- 2-- Gather information on real/observed datasets and continue the improvement of display/visualization tools (such as McIDAS-V, McIDAS-X, and IDL) needed for checkout.
- 3-- Work with Team members to receive and display data sets from available sources (e.g. GRAVITE, Atmos PEATE, and CLASS, and direct broadcast).
- 4-- Coordinate activities to accomplish the long term monitoring of Imagery and Image product quality. (Quality of Imagery includes such things as: noise levels, detector-to-detector striping, sensor saturation levels, navigation and registration.)
- 5-- Coordinate with VIIRS SDR Team on Day/Night Band-specific performance issues and trade studies, providing recommendations from the perspective of impacts to imagery quality and user requirements. Participate in technical interchange meetings as necessary.
- 6-- During in-orbit sensor checkout, data and imagery will be analyzed and image products, including image combinations, will be generated, such as those used in the detection of fog/stratus, blowing dust, fires and smoke plumes, volcanic ash, aerosols, etc.)
- 7-- Explore and expand upon true-color and other RGB applications for assessing land and atmospheric phenomena (such as vegetation, blowing dust, smoke, ash, haze, etc.). VIIRS true-color/RGB imagery will also be used as training/proxy data for the application of true-color/RGB techniques to geostationary data.
- 8-- Real-time web displays of VIIRS imagery and image products will be a source of material for training of NWS and other meteorologists, especially for those spectral bands that are new to the operational satellite data stream.
- 9-- Push for continued lowest latency VIIRS Imagery delivery and user applications of Imagery (in particular via AWIPs or other realtime displays)

10-- Push for all VIIRS M-bands as EDRs, to enable further EDR product generation.

Research Conducted

1-- Monthly telecons were held with the distributed imagery cal/val team at every first Tuesday of the months. Topics related to imagery quality, outstanding discrepancy reports and waiver requests, and many other image-related items were discussed. The CIRA Team made important contributions to the Imagery Cal/Val Plan which was delivered to StAR end of December 2015. Lead by Don Hillger, the CIRA Team is also represented with three additional authors on a paper titled "User Validation of VIIRS Satellite Imagery" published in Remote Sensing in January 2016.

2-- The CIRA Team used McIDAS-V, McIDAS-X, and IDL extensively with VIIRS data sets. VIIRS Imagery products continue to be produced in near-realtime on the RAMMB/CIRA website, and these products are produced with IDL, McIDAS-X and, in some cases, Terrascan. Many of the images provided to social media and other media outlets are produced with McIDAS-V. The CIRA Team worked closely with CIMSS and the CSPP development team to improve the display of VIIRS Day/Night Band imagery produced through CSPP.

3-- CIRA IT team members spent a considerable amount of time optimizing the VIIRS data reception from GRAVITE, Atmos PEATE, and CLASS, and direct broadcast. Close collaboration with the University of Wisconsin/CIMSS and the University of Alaska - Fairbanks / GINA Team was essential to solve and improve existing data access problems.

4-- The long term monitoring of Imagery and Image product quality, such as noise levels, detector-to-detector striping, sensor saturation levels, navigation and registration has become a center point of CIRA's research over the past year. Particularly striping problems were studied in detail.

A special telecom meeting was held between CIRA and the StAR/JPSS team in early March to discuss future Long Term Monitoring plans. In particular, regular contribution to their JPSS Long Term Monitoring (LTM) website was discussed. CIRA's plan is to provide StAR with daily Alaska DNB Imagery. CIRA has been posting these products on the RAMMB/CIRA webpage for an extended period of time already.

5-- The CIRA Imagery Team participated in DNB Technical Interchange Meetings regarding increased aggregation of DNB on JPSS-1 due to edge-of-scan non-linearity issues. This involves assessing the impact, if any, to NCC Imagery product. This is part of CIRA's efforts to investigate Day/Night Band-specific performance issues and to provide recommendations from the perspective of impacts to imagery quality and user requirements. Member of the CIRA Team published a paper on "A Dynamic Scaling Algorithm for the Optimized Digital Display of VIIRS Day/Night Band Imagery" in the International Journal of Remote Sensing (Reference: Seaman, C., and S. D. Miller, 2015: A Dynamic Scaling Algorithm for the Optimized Digital Display of VIIRS Day/Night Band Imagery. Int. J. Rem. Sens.,36 [7], 1839-1854, doi: 10.1080/01431161.2015.1029100 online at <http://www.tandfonline.com/eprint/TPTzjwCC4HdKlhYZbHMy/full>)

6-- An important CIRA Imagery Team task is the in-orbit sensor checkout. CIRA scientists continue to generate a large variety of VIIRS image products. Many of these products are displayed in real-time at: http://rammb.cira.colostate.edu/ramsd/online/npp_viirs.asp
Products include: M-5 (visible), M-15 (IR), I-4 (high-resolution shortwave IR), I-5 (high-resolution IR), ERF-Scaled Day/Night Band, Day/Night Band Lunar Reflectance, Day/Night Band Solar Reflectance, Near Constant Contrast EDR, Shortwave Albedo (based on M-12), Natural Color RGB, True Color RGB, Fire Temperature RGB, Split Window Difference (M-15 – M-16), Snow/Cloud Discriminator, EUMETSAT Dust RGB, Bluelight Dust, DEBRA Dust, and VIS/IR Blended. These products are produced for sectors that cover CONUS, Alaska, Middle-East and parts of central Asia, South America and for random granules globally.

In addition, VIIRS visible, high-resolution IR and Day/Night Band imagery is produced in the area of tropical cyclones whenever and wherever they occur and this imagery is displayed on the RAMMB/CIRA TC Realtime website: http://rammb.cira.colostate.edu/products/tc_realtime/

7-- The large number of VIIRS bands offer opportunities for new RGB products for the assessment of land and atmospheric phenomena. Figure 1 shows an example of VIIRS RGB imagery products useful for the detection of fires and their impact. The Fire Temperature RGB composite example shown in Figure 1 is a new RGB product developed by the CIRA Team. Other multispectral imagery (including RGB) products developed by the CIRA Team for use with VIIRS include: Bluelight Dust and DEBRA Dust (for dust detection), Snow/Cloud Discriminator (Figure 2) and two Snow RGB composites (for snow/ice detection), as well as two RGB composites for volcanic ash detection.

8-- As mentioned under achievement task 6 and 7, the generation of VIIRS image products has been emphasized strongly by the CIRA team. Together with the CIRA Training Team, the Imagery Team has successfully used these products as educational/training material for NWS forecasters and other meteorologists. Emphasis was put on many of the spectral bands that are new to the operational satellite data stream. The training was conducted by generating training modules, via special quick guides, many oral presentation at conferences, meetings and teleconferences held for small specific groups, by writing a large number of educational blogs, and by publishing an impressive number of refereed research articles.

Several Imagery Team training modules were created by CIRA:

“Introduction to NCC DNB VIIRS Imagery in AWIPS” (created by Curtis Seaman and Dan Lindsey in January 2016) is a VISIT training module which can be accessed at:

http://rammb.cira.colostate.edu/training/visit/training_sessions/introduction_to_ncc_dnb_viirs_imagery_in_awips/

Another VISIT training module, created by John Knaff and Galina Chirokova in June 2015, focuses on the “Use of VIIRS imagery for Tropical Cyclone Forecasting”

http://rammb.cira.colostate.edu/training/visit/training_sessions/use_of_viirs_imagery_for_tropical_cyclone_forecasting/

Based on a request from the NWS, a “Quick Guide for NCC” training sheet was assembled and delivered for the VIIRS Near Constant Contrast (NCC) Imagery product (a derived product from the Day Night Band) by Dan Lindsey and Curtis Seaman in mid-December 2015. NCC data began flowing to the NWS for AWIPS-2 on 8 December 2015, and given that Day Night Band imagery is new to most forecasters, this information will be helpful to show them how to display NCC properly and scale the values to best enhance the meteorological features of interest.

Special educational oral presentations were given for GINA in October 2015 (new VIIRS products), at the AMS Annual Conference in New Orleans in Jan 2016 (AMS Short Course on Day/Night Band capabilities and VIIRS DNB enhanced application talk at the Exhibit Hall), at the AGU Fall Meeting in Dec 2015 (VIIRS Day/Night Band Reveals Upper Atmospheric Gravity Wave via Sensitivity to Nightglow Emissions), and many other meetings. For more VIIRS-related presentations see the presentations section of this Annual Report.

Media Interactions:

A TV interview on VIIRS imagery was given by Steve Miller to the Science Channel, covering an article he had written which described an Algerian Airlines crash seen by the Day/Night Band. This interview appeared on an episode of “What on Earth?” that aired on 29 February 2016.

Steve Miller and Curtis Seaman were interviewed by Wag TV about the case of a pilot reporting mysterious lights over the North Pacific Ocean on 24 August 2014. These lights were seen by the Day/Night Band. These interviews were conducted for the Science Channel and VIIRS imagery of this event is expected to appear on an upcoming episode of either “What on Earth?” or “NASA’s Unexplained Files.”

A “Wired” Magazine article by Betsy Mason (2 July 2015) covered Curtis Seaman’s VIIRS animation of auroras in a special feature on observing and mapping the auroras.

This article can be found at: <http://www.wired.com/2015/07/aurora-maps>

Numerous RAMMB/CIRA VIIRS images were shared on social media, including the @NOAASatellites Twitter page. RAMMB/CIRA VIIRS images have also been used by other media outlets including: *WIRED*, the Capital Weather Gang at *The Washington Post*, *Time*, *USA Today*, and The Weather Channel. The CIRA Team has also been providing Images of the Month to the STAR JPSS website.

Educational Publications:

An impressive number of publications were produced by members of the CIRA JPSS Imagery Team, several of those being highly educational. To highlight two of those:

A paper including the journal cover picture by Steve Miller et al. on “Upper atmospheric gravity wave details revealed in nightglow satellite imagery” published in the prestigious journal of *Proceeding of National Academy of Science* in December 2015.

A paper by Steve Miller on “Night Watch. A satellite sensor that can see in the dark is revealing new information for meteorologists, firefighters, search teams and researchers worldwide” was published in *Scientific American*, Vol 312.

For more VIIRS-related publications see the presentations and publications section of this Annual Report.

Education via Blogs:

CIRA VIIRS Imagery Team Blogs: eight highly educational VIIRS blogs were written over the past 12 months and posted on CIRA’s VIIRS Imagery Team Blog page at

<http://rammb.cira.colostate.edu/projects/npp/blog/>

The VIIRS imagery blogs cover a variety of interesting VIIRS-related topics like Auroras, the Indian Heat Wave in summer 2015, disappearing lakes in Oregon and California (due to drought conditions), Morning Glory Clouds over Northern Australia, super smog event in India, the great flood along the Mississippi at the end of December 2015, hurricane force wind events over Alaska in late December.

Many additional interesting blogs on VIIRS Imagery in the Arctic can be found at

<http://rammb.cira.colostate.edu/projects/alaska/blog/>

9-- The Imagery Team was successfully pushing for a reduction in VIIRS data latency to make the VIIRS-based imagery as applicable to forecasters as possible. The result of this involvement is that the lower-latency VIIRS on GRAVITE has returned permanently.

10-- Push for all VIIRS M-bands as EDRs, to enable further EDR product generation. Action on this initiative will not take place till the JPSS-1 or JPSS-2 era, because of the software changes that need to be tested and implemented into operations, but only after considering the potential impacts on all who might be affected by this change.

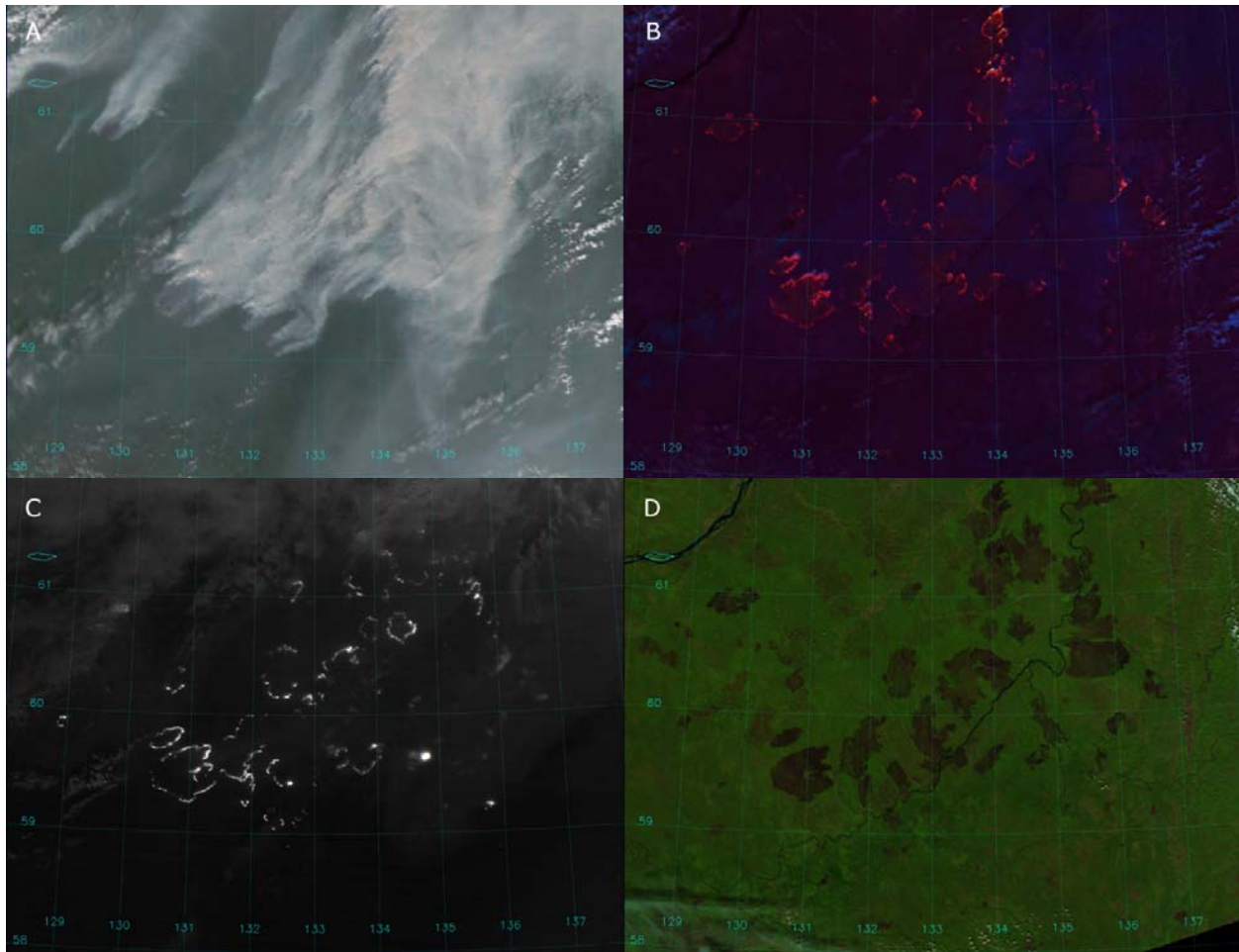

Figure 1. Examples of VIIRS Imagery products for fire detection and characterization. A) The True Color RGB composite detects the smoke; B) the CIRA Fire Temperature RGB composite can see through the smoke to detect the hotspots from the fires; C) the Day/Night Band detects the light emissions from the fires at night; and D) the Natural Color RGB composite shows the burn scars left by the fires and may be used to monitor vegetation health.

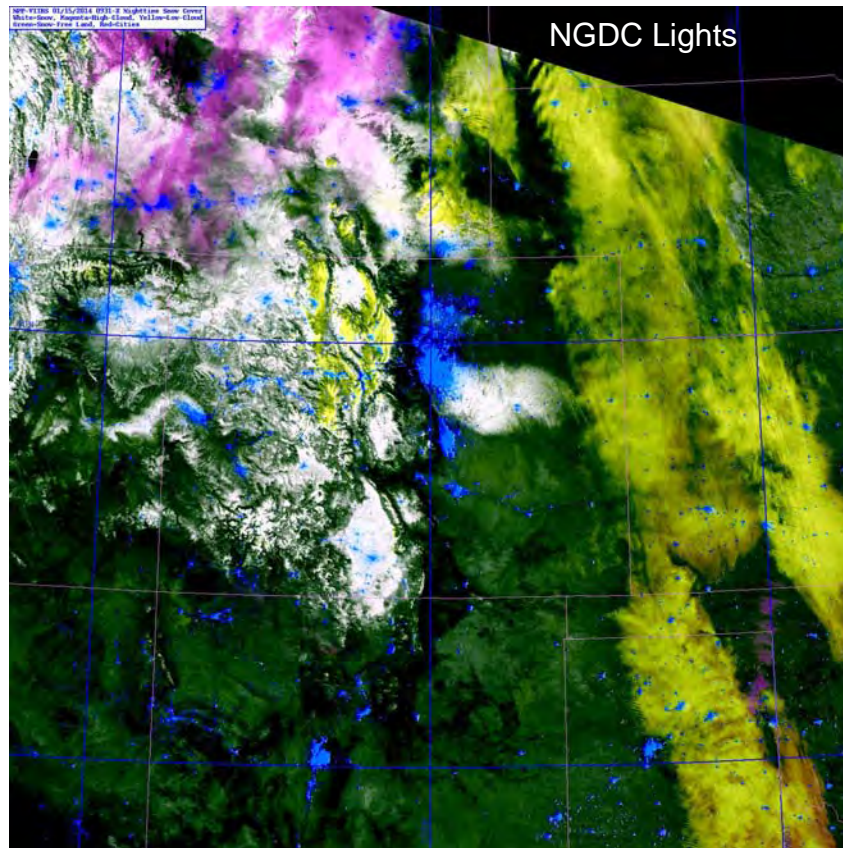

Figure 2. Example of the CIRA Snow/Cloud Discriminator product. This product utilizes the Day/Night Band and several IR bands to discriminate snow from clouds. In this composite product, snow appears white, bare ground appears green, low clouds appear yellow, high clouds appear pink and city lights are masked out in blue. We are now implementing the global Day/Night Band stable lights product instead of thresholding on pixel brightness or using the older (coarse resolution) Operational Linescan System lights mask. The new lights mask matches very well with the terrain-corrected VIIRS geolocation of the current scene, making it useful for a variety of products which must screen-out cities.

Project II: Support of the VIIRS Cloud Validation Activities

Objectives

1-- Complete beta-version evaluation of our new CloudSat-statistics and Water Path method of estimating the geometric cloud thickness. The non-linear relationships are stratified by cloud top height, which provides a de-facto proxy for cloud type without the need to introduce cloud typing discontinuities. Preliminary results work has been completed to obtain the statistical relationships between water path and cloud top/base heights by processing CloudSat and MODIS data. The statistics from CloudSat and Aqua MODIS, which fly together in the NASA A-Train, will provide statistically-robust datasets for building our CBH regressions.

2-- Continue the CloudSat/CALIPSO/S-NPP matched data collection for an extended period beyond the originally defined 'golden months' of September-October 2013. Evaluate the statistical method against IDPS CBH and the simple CTH-2 skill (which beats IDPS CBH in a statistical sense) against CloudSat data. Other upstream cloud property EDR performance for various cloud types will be also analyzed for the extended period.

3-- In coordination with CIMSS, we will continue to support NOAA team in analysis of CBH retrievals based on S-NPP Data Exploitation (NDE; legacy NOAA operational codes) cloud property retrieval algorithm with VIIRS data and validate the products. We will perform comparisons of statistical method against the adiabatic method (for low cloud) and extinction method (for cirrus) to determine which algorithm to adopt in each cloud regime. We will also explore use of model output (e.g. model convective condensation level [CCL] or lifted condensation level [LCL]) to improve CBH for deep convective clouds. These results will be validated against CloudSat data.

4-- Configure CLAVR-x to run with the stand-alone geometric thickness methods first. Our CBH improvement efforts will be integrated within the NDE frame as a hybrid method (i.e., a blend of the adiabatic, extinction, and CloudSat-based methodologies based on where each algorithm excels) if determined optimal via the analysis of the comparison results.

5-- Begin to develop a new Cloud Cover and Layers algorithm predicated on the additional information content provided by cloud geometric thickness.

6-- In coordination with CIMSS, explore nighttime CBH retrievals via leveraging of NLCOMP retrievals generated from CLAVR-x.

7-- Participate in and support science team meetings and reviews as required.

Research Conducted

1-- The CIRA Cal/Val team developed a new statistical CBH algorithm constrained by CTH and CWP using A-Train satellites. The statistical relationships between cloud water path and geometric thickness stratified by cloud top height were obtained from statistical analysis of CloudSat/CALIPSO and MODIS data. The statistical approach for CBH estimates has less dependency on the upstream cloud retrievals such as cloud type/phase which introduced major errors in the operational VIIRS IDPS CBH algorithm. The new algorithm has been tested as a stand-alone IDL code with both VIIRS IDPS and NDE upstream cloud data as input, and the performance has been evaluated using CloudSat. Comparisons with CloudSat showed that the statistical retrieval approach performs better than the original VIIRS IDPS CBH products. Through the comparison analysis, convective condensation level from NWP was employed to improve CBH retrievals for deep convective clouds. We also adopted an extinction-based method using CALIPSO developed by the CIMSS team for better CBH estimates of thin cirrus as shown in Figure 3.

2-- The algorithm code was successfully implemented to the Clouds from AVHRR Extended (CLAVR-x) processing system with support from CIMSS colleagues, and we continue the validation process in the same CLAVR-x frame. The CBH retrievals produced from CLAVR-x have been validated using VIIRS and CloudSat matchups with the same approaches for evaluation of the IDPS CHB algorithm. Initial validation results for Sept-Oct 2013 VIIRS-CloudSat matchups showed the statistical regression method outperforms the original IDPS CBH algorithm as shown in Figure 4. The validation effort was extended to a longer period for Jan-May 2015 cases, and the results showed good statistical correlations with CloudSat similar to the Sep-Oct 2013 comparisons. Further evaluation of the IDPS algorithm was also performed in parallel for month-long periods in each of four seasons spanning the period June 2014 and April 2015, which reconfirmed the IDPS CBH EDRs provided only marginal skill. The validation works show that the new algorithm based on statistical, semi-empirical, and model-fusion techniques supplants the operational VIIRS IDPS algorithm. Our further investigation on the outliers shown in the comparison results is ongoing for the algorithm refinements.

3-- A beta version code of a new Cloud Cover and Layers (CCL) algorithm was developed and tested within the CLAVR-x system. The new algorithm aims to provide the additional lower-level cloud coverage information by utilizing cloud geometric thickness. The code has been implemented to the original CCL algorithm embedded in CLAVR-x which has been developed by Dr. Andy Heidinger and CIMSS development team. High, mid and low cloud layers are classified with cloud top pressure of 680 hPa and 440 hPa (ISCCP). Figure 5 presents sample cloud layer fractions from the new CCL algorithm compared with the original CCL products. The results show the additional cloud base information can significantly increase lower cloud fractions which have been overlooked by the original algorithm.

4-- We evaluated nighttime CBHs generated from CLAVR-x by utilizing NLCOMP algorithm retrievals with supplementary data from NWP CWP. Ceilometer data from ARM SGP site was used in addition to ARM NSA data. Initial validation works for nighttime CBH performance have been done using ARM ceilometer data from the Southern Great Plains (SGP) and the North Slope of Alaska (NSA) sites. Preliminary results are shown in Figure 6. A matchup window of 1-km distance and 5-minute time lag is used between ARM and VIIRS data. Although further investigation is needed, it is found that the CBH algorithm also shows some skills for nighttime.

5-- An overview presentation of the CBH algorithm development and Cal/Val efforts was given at 2015 STAR JPSS Annual Science Team Meeting in August. Two papers were prepared to be submitted in March 2016, which are detailing: i) evaluation of the IDPS CBH environmental data record against CloudSat, and ii) description and demonstration of new algorithm for CBH estimation. The CIRA team participated in the VIIRS Cloud Cal/Val bi-weekly teleconference and regularly contributed input materials to Dr. Heidinger for team reviews and reports to support the JPSS VIIRS Cloud Cal/Val Team.

6-- The first version of the CBH algorithm to be adopted as one of the NOAA Enterprise algorithms was delivered to the STAR Algorithm Implementation Team (AIT) in February. The CIRA and CIMSS teams will continue to support AIT for its correct operation and long-term monitoring within the NDE frame.

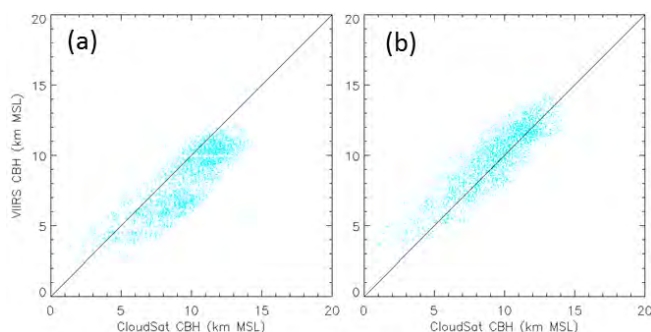

Figure 3. CBH comparisons between VIIRS and CloudSat for optically thin cirrus clouds during Sept-Oct 2013 matchups from (a) the original statistical regression method and (b) an extinction method using CALIPSO data when CTH is in an accurate range compared to CloudSat data.

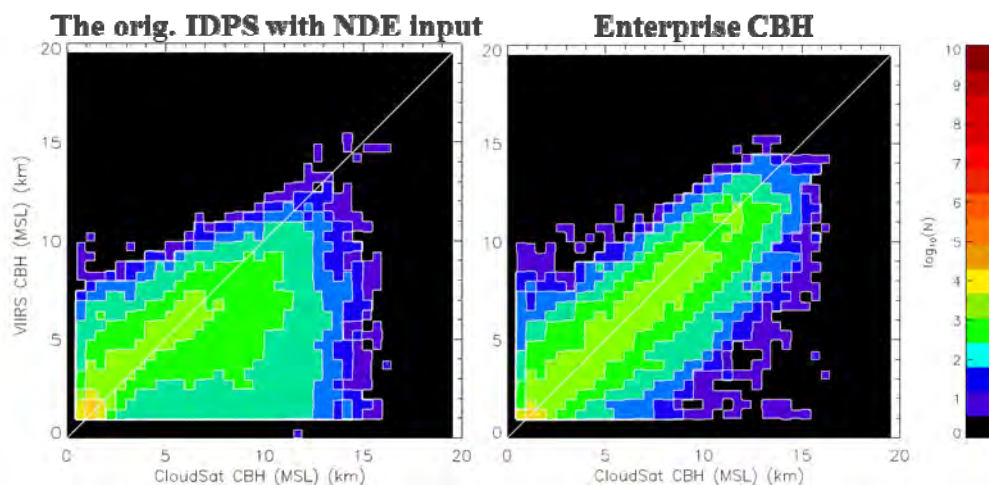

Figure 4. Two-dimensional histograms (scatterplots) of VIIRS-retrieved and CloudSat-observed CBH from the original VIIRS IDPS algorithm (left) and the Enterprise CBH algorithm (right) for September – October 2013 matchups (82599 matchup points). Colors represent the number of matching points (N) per bin on the logarithmic scale provided, and are valid for all cloud types globally where the cloud top height retrieval was accurate (Within Spec: CTH errors less than 1 km for optically thick clouds and less than 2 km for optically thin clouds).

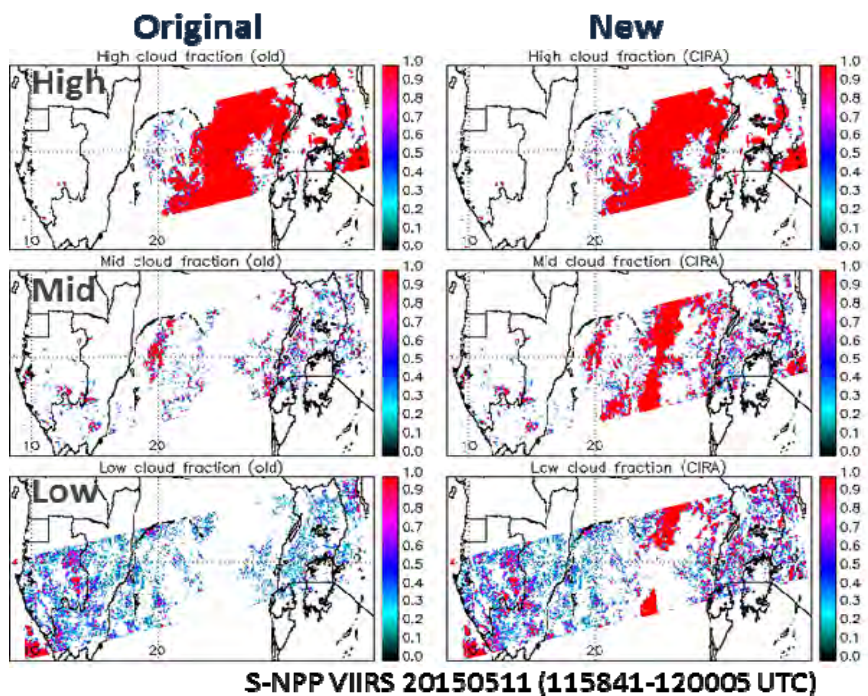

Figure 5. Sample cloud layer fractions from the new Cloud Cover-Layers (CCL) algorithm utilizing cloud base information (right) compared with the original CCL products (left) for a VIIRS granule on 11 May 2015 (1158 – 1200 UTC).

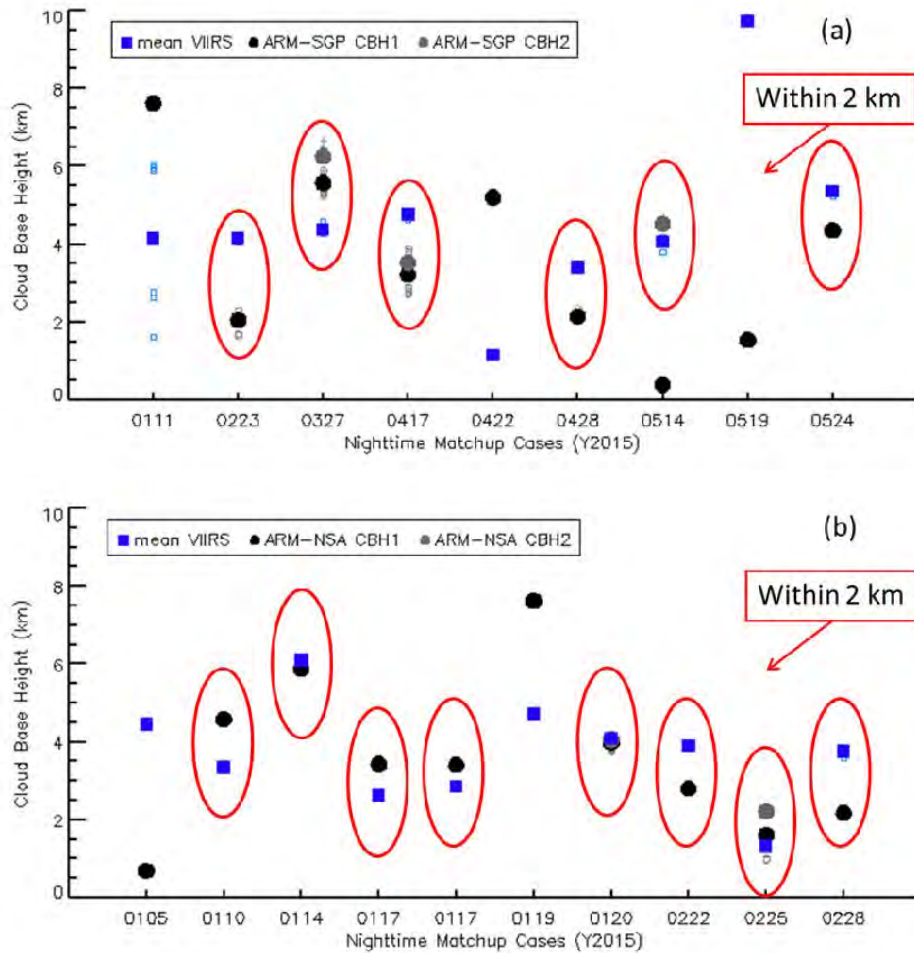

Figure 6. Initial evaluation results for nighttime CBH algorithm performance using ARM ceilometer data from (a) SPG and (b) NSA sites. The blue squares represent mean VIIRS CBHs and circles are mean ARM ceilometer CBHs (black for the first layer and gray for the second layer). The smaller symbols (same colored for ARM ceilometer and VIIRS, respectively) are for the individual measurement within the ARM-VIIRS matchup window (1 km and 5 minutes). The cases which have CBHs within the 2-km error range are circled in red. Note that ARM NSA case can have multiple matchups per one day during wintertime.

Publications:

Folmer, M. J., M. DeMaria, R. Ferraro, J. Beven, M. Brennan, J. Daniels, J. Knaff, R. Kuligowski, S. Kusselson, H. Meng, S. Miller, S. Rudlosky, T. Schmit, C. Velden, and B. Zavadsky, 2015: Use of satellite tools to monitor and predict “Super Storm Sandy 2012”—Current and emerging products. *Atmospheric Research*, 166, 165-181.

Gladkova, I., A. Ignatov, F. Shahriar, Y. Kihai, D.W. Hillger, and B. Petrenko, 2016: Improved VIIRS and MODIS SST Imagery. *Remote Sensing*, 8:1, doi:10.3390/rs8010079

Grasso, L., D. Lindsey, C. Seaman and B. Stocks, 2015: Satellite Observations of Plume-Like Streaks in a Cloud Field. *Pure and Applied Geophysics*, doi: 10.1007/s00024-015-1076-z.

Hillger, D., T. Kopp, C. J. Seaman, S. D. Miller, D. Lindsey, E. Stevens, J. Solbrig, W. Straka III, M. Kreller, A. Kuciauskas, and A. Terborg, 2015: User Validation of VIIRS Satellite Imagery. *Remote Sensing*, 8 [1]; doi:10.3390/rs8010011.

Miller, S., 2015: Night Watch. A satellite sensor that can see in the dark is revealing new information for meteorologists, firefighters, search teams and researchers worldwide. *Scientific American*, 312 [5], p 78-81.

Miller, S.D., W.C. Straka III, J. Yue, S.M. Smith, M.J. Alexander, L. Hoffmann, M. Setvak, and P.T. Partain, 2015: Upper atmospheric gravity wave details revealed in nightglow satellite imagery. *Proc. Nat. Acad. Sci.*, 112(49), E6728–E6735; doi: 10.1073/pnas.1508084112 with cover picture! [URL: http://www.pnas.org/content/112/49/E6728.full](http://www.pnas.org/content/112/49/E6728.full)

Seaman, C.J. and S.D. Miller, 2015: A dynamic scaling algorithm for the optimized digital display of VIIRS Day/Night Band imagery. *Int. J. Rem. Sens.*, 36 [7], 1839-1854, doi:10.1080/01431161.2015.1029100

Straka, W.C., III, C.J. Seaman, K. Baugh, K. Cole, E. Stevens and S.D. Miller, 2015: Utilization of the Suomi National Polar-Orbiting Partnership (NPP) Visible Infrared Imaging Radiometer Suite (VIIRS) Day/Night Band for Arctic Ship Tracking and Fisheries Management. *Rem. Sens.*, 7, 971-989, doi: 10.3390/rs70100971

Presentations:

Brummer, R., S. Miller, D. Bikos, B. Connell, D. Lindsey, A. Schumacher, C. Seaman, and E. Szoke, 2015: "GOES-R Proving Ground Activities at CIRA." Poster Presentation, 6th Asia/Oceania Meteorological Satellite Users' Conference, 9-13 November, Tokyo, Japan.

Hillger, D., and T. Kopp, 2015: EDR Imagery Overview, StAR JPSS Annual Science Meeting, 24-28 August, College Park, MD.

Hillger, D.W., T. J. Kopp, C. J. Seaman, S. D. Miller, and D. T. Lindsey, 2016: "How is VIIRS EDR Imagery Validated?" AMS Annual Meeting, 10-14 January, New Orleans, LA.

Miller, S. D., W. C. Straka, J. Yue, S. M. Smith, M. J. Alexander, L. Hoffmann, M. Setvak, and P. Partain, 2015: "Making Waves — The VIIRS Day/Night Band Reveals Upper Atmospheric Gravity Wave via Sensitivity to Nightglow Emissions." Invited oral presentation, AGU 2015 Fall Meeting, 14-18 December, San Francisco, CA.

Miller, S. D., C. Seaman, D. Lindsey, T. Schmit, M. Gunshor, D. Hillger, and Y. Sumida, 2015: "Multispectral Application Development for Himawari-8 AHI", Invited oral presentation, 6th Asia/Oceania Meteorological Satellite Users' Conference, 9-13 November, Tokyo, Japan.

Miller, S.D., 2016, "The Night is not so dark: VIIRS Day/Night Band enhanced applications." AMS Annual Meeting, 10-14 January, New Orleans, LA.

Miller, S.D., 2016, "VIIRS Day/Night Band Capabilities for Nighttime Imaging." AMS Annual Meeting 10-14 January, New Orleans, LA.

Miller S. D., T. Schmit, C. Seaman, M. Gunshor, D. Lindsey, D. Hillger, and Y. Sumida, 2016: "The Return of True Color to Geostationary Satellites: Transitioning from Polar, to Himawari-8, to GOES-R." Invited oral presentation, 96th AMS Annual Meeting, 10-14 January, New Orleans, LA.

Noh, Y.-J., S. D. Miller, and A. Heidinger, 2015: Detection of supercooled liquid water-topped mixed-phase clouds from shortwave-infrared satellite observations. 2015 AGU Fall Meeting, 14-18 December, San Francisco, CA.

Noh, Y.J, J. Forsythe, C. Seaman, S. Miller, M. Rogers, D. Lindsey, and A. Heidinger, 2015: Enterprise Cloud Base: VIIRS Cloud Base Height Algorithm Improvement and Evaluation Using CloudSat. 2nd Annual STAR JPSS Science Team Meeting, 24-28 August, College Park, MD.

Seaman, C. J., S. D. Miller and D. Hillger, 2015: "On the Use of the VIIRS Day/Night Band and Near Constant Contrast Imagery." Invited oral presentation, 2nd Annual STAR JPSS Science Team Meeting, 24-28 August, College Park, MD.

Seaman, C. J., G. Chirokova, J. Dostalek, L. Grasso, J. Knaff, D. Lindsey, S. Miller and A. Schumacher: "Satellite Proving Ground OCONUS Activities at CIRA." Invited oral presentation. 2015 OCONUS Technical Interchange Meeting, 12-15 May 2015, Anchorage, AK.

Seaman, C. J., and S. D. Miller, 2015: "Into the Light: Illuminating the Capabilities of the VIIRS Day/Night Band." Invited oral presentation, 2015 OCONUS Technical Interchange Meeting, 12-15 May, Anchorage, AK.

Seaman, C. J.: "Three Years of VIIRS", Invited seminar. Geographic Information Network of Alaska (GINA), University of Alaska-Fairbanks, 20 May 2015, Fairbanks, AK.

Walther, A., S. D. Miller, and A. K. Heidinger, 2015: "The use of moonlight reflectance for improving cloud parameters at night." AGU Fall Meeting, 14-18 December, San Francisco, CA.



PROJECT TITLE: CIRA's Support of NOAA's Commitment to the Coordination Group for Meteorological Satellites: Enhancing the International Virtual Laboratory

PRINCIPAL INVESTIGATORS: Bernadette Connell

RESEARCH TEAM: Luciane Veeck and Dan Bikos

TECHNICAL CONTACT: Satya Kalluri (NOAA/NESDIS) and Candice Jongsma (NOAA/OAR)

NOAA RESEARCH TEAM: Anthony Mostek NOAA/ NWS/OCWWS Training Division

FISCAL YEAR FUNDING: \$35,000

PROJECT OBJECTIVES:

The World Meteorological Organization (WMO) Virtual Laboratory for Education and Training in Satellite Meteorology (VLab) is a collaborative effort joining major operational satellite operators across the globe with WMO regional training centers of excellence in satellite meteorology. Those regional training centers serve as the satellite-focused training resource for WMO Members. Through its cooperative institute for

Research in the Atmosphere (CIRA) at Colorado State University (CSU), NOAA/NESDIS sponsors Regional Training Centers of Excellence (CoE) in Argentina, Barbados, Brazil, and Costa Rica. The top-level objectives of the VLab are:

- 1-- To provide high quality and up-to-date training and supporting resources on current and future meteorological and other environmental satellite systems, data, products and applications;
- 2-- To enable the regional training centers to facilitate and foster research and the development of socio-economic applications at the local level through the National Meteorological and Hydrological Services.

Enhanced training and coordination of training accomplished under this project will prepare forecasters, researchers, and managers on how to utilize imagery and products to provide services and training in these areas.

Specific Objectives:

- 1-- Participate in virtual meetings of the WMO VLab Management Group.
- 2-- Provide partial support for the WMO Technical Support Officer position.
- 3-- Provide virtual JPSS lectures and partial support for international virtual Regional Focus Group sessions.
- 4-- Participate in the GNC-A coordination group, update GEONETCast instructional material and disseminate it along with other instructional material through GEONETCast.
- 5-- Prepare VIIRS related instruction materials and lab examples for data visualization workshop.

PROJECT ACCOMPLISHMENTS:

- 1-- Participate in virtual meetings of the WMO VLab Management Group.

CIRA participated in virtual VLMG meetings on 7 July and 17 December 2015 and 9 March 2016. The meetings were organized by the TSO mentioned below and the meeting reports can be found in the WMO VLab site <http://www.wmo-sat.info/vlab/meeting-reports/>

- 2-- This project provides partial monetary support (2 months) for a WMO VLab Technical Support Officer (TSO), Luciane Veeck. Her efforts provide a very important stabilizing factor for the global coordination of training efforts under the umbrella of the WMO VLab. Member countries have access to her resources through the entire year. Luciane was also supported under a WMO grant and another CIRA project during the past year. Highlights of her work that benefit the WMO community and the US include:

- Maintenance of the VLab central website and the VLab calendar of events <http://vlab.wmo.int>
- Virtual Event Week on the "Next Generation of Satellites" - Planning and execution of the 16-20 November 2015 event week. A total of 11 sessions were offered by the Japan Meteorological Agency (JMA), China Meteorological Administration (CMA), NOAA, the European Organisation for the Exploitation of Meteorological Satellites (EUMETSAT), Korean Meteorological Administration (KMA), The Brazilian National Institute for Space Research (INPE), CIRA, COMET, and India Meteorological Department (IMD). Registration numbers varied from 53 to 109 per session; Total of 95 attendees; More than 50% of Participants attended more than one session.
- WMO Train the Trainer Course 2015 (WMO TtT) – The WMO Train the Trainer course 2015 (for Regional Association VI) ran 16 February - 31 May 2015. Planning and participation in synchronous online sessions and forum activities during Modules 1 and 2, with facilitation and direction of activities during Module 3, Unit 9 (18-24 May).
- WMO Education and Training (WMO-ETR) Moodle Users Course Development – Collaboration occurred throughout the past year with Maja Kuna, Vesa Nietosvaara and Ian Mills (EUMETSAT), Ivan Smiljanic (EUMeTrain), Pat Parrish and Mustafa Adiguzel (WMO-ETR) on the design of an online Moodle User course. The "pilot" course was offered from January to February 2016.
- VLab annual report to the WMO Inter-Programme Expert Team on Satellite Utilization and Products second session (IPET-SUP-2), which took place in Geneva, Switzerland (23-26 February 2016). The meeting was attended by the VLab co-chair Eduard Podgaiskii, who made the presentation.

- VLab annual to the WMO 43rd Plenary Session of the Coordinating Group for Meteorological Satellites (CGMS-43), which took place in Boulder, USA (18-22 May 2015). The full report can be downloaded from the VLab website listed above under Publications/Other reports. The meeting was attended by the VLab co-chair Kathy-Ann Caesar, who made the presentation.
- VLab Strategy 2015-2019 document –The document was presented to IPET-SUP-1 (March 2015) and CGMS-43 (May 2015) and endorsed by both groups. The full report can be downloaded from the VLab website listed above under Publications/Governance Documents.
- Prepared and assisted the VLMG online meetings in 7-8 July and 17-18 December 2015, and 9-10 March 2016. The meeting reports can be found in the WMO VLab site <http://www.wmo-sat.info/vlab/meeting-reports/>

3-- Provide virtual JPSS lectures and partial support for international virtual Regional Focus Group sessions.

- Organization and Participation in Virtual Event Week "Preparing for Next Generation Satellite Imagery" that was held 16-20 November

<http://www.wmo-sat.info/vlab/next-generation-of-satellites/> There were 4 presentations from the US and 3 of them directly promoted aspects of JPSS. CIRA arranged speakers for sessions 2 and 9 and delivered session 4.

- Session 2: GOES-R challenges and opportunities: Liaison perspectives from NOAA's Aviation Weather Center. Presenter: Amanda Terborg, CIMSS at NOAA/AWC

- Session 4: Training resources from the US and access to data and imagery: ways to find them in the acronym soup. Presenter: Bernie Connell, CIRA

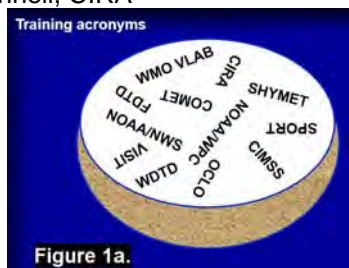
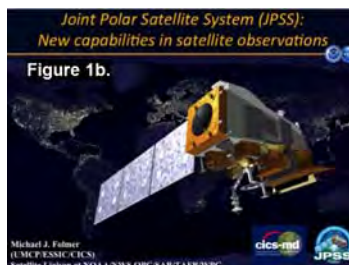

Figure 1a.

- Session 9: JPSS and beyond: Liaison perspectives from NOAA's Center for Weather and Climate Prediction. Presenter: Michael Folmer, ESSIC and CICS at NOAA CWCP



- Session 11: Getting the Most out of COMET Satellite Training Resources via MetEd. Presenter: Wendy Abshire, The COMET Program

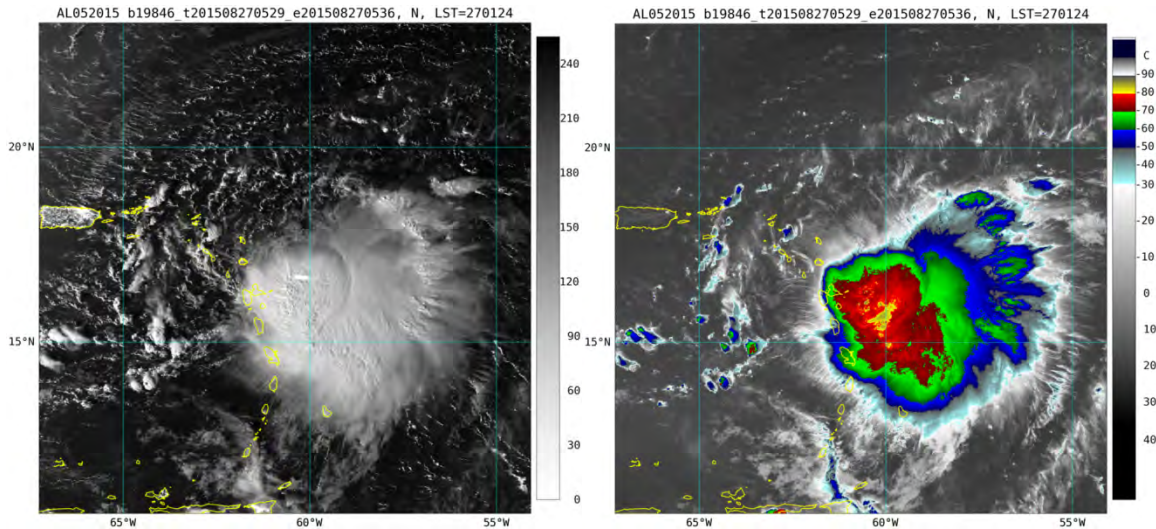

Figure 2. Day/Night (left) and IR imagery (right) of Tropical Storm Erika just to the east of the Leeward Islands at 05:36 UTC on 27 August 2015. Dominica experienced heavy rains as this storm passed over. These were presented during the August monthly virtual session of the Regional Focus Group of the Americas and the Caribbean.

- The WMO Virtual Laboratory Regional Focus Group of the Americas and Caribbean conducted 12 monthly bilingual (English/Spanish) weather briefings. The briefings made use of VISITview software to present GOES and POES satellite imagery from CIRA and GoToWebinar for voice communication over the Internet. Over the calendar year 2015, the participants from the U.S. included: CIRA, the NWS International Desk at NCEP/WPC, NWS/Office of the Chief Learning Officer (OCLO) Forecast Decision Training Division (FDTD), The State Department, the UCAR/JOSS-NWS International Activities Office, and UCAR/COMET. Twenty eight countries outside the US participated: Argentina, Bahamas, Barbados, Belize, Bolivia, Brazil, Cayman Islands, Chile, Colombia, Costa Rica, Dominica, Ecuador, El Salvador, Germany, Grenada, Haiti, Honduras, Nigeria, Panama, Paraguay, Peru, Saint Kitts and Nevis, South Africa, Spain, Suriname, Trinidad and Tobago, Uruguay, and Venezuela. M. Davison at the NCEP International Desk led the discussion. Participants offered comments for their regions and tended to also bring interesting questions to the discussion. The number of countries participating each month ranged between 9 and 16 (average 12); and the number of participants each month ranged between 19 and 63 (average 32).

The sessions were recorded and can be accessed here:
http://rammb.cira.colostate.edu/training/rmtc/fg_recording.asp

4-- Participate in the GNC-A coordination group

GEONETCast-Americas (GNC-A) is a great way to provide instructional material to users as well as provide products. It is a low cost alternative to many users in countries that still do not have adequate internet access. It is also a good backup for emergency preparedness.

--CIRA participated in and provided GoToMeeting support for the GEONETCast Americas (GNC-A) Coordination Group Teleconference on 1 July 2015, and the GNC-A Content Sub-Committee virtual meeting on 29 October 2015. CIRA lead the virtual meeting for the User Sub-Committee of GNC-A on 11 November 2015.

-- In support of GEONETCast activities, planning support and delivery was provided for a NOAA/WMO Train the Trainers GEONETCast workshop held 25-26 April 2015 prior to the NOAA Satellite Conference (27 April – 1 May 2015). The workshop focused on the many aspects of GNC-A, including software packages to view and do simple manipulations with the data. The report from the workshop can be found here on p 89 (APPENDIX J): http://satelliteconferences.noaa.gov/2015/doc/NSC2015_Final_Report.pdf

5-- Prepare VIIRS related instruction materials and lab examples for data visualization workshop. CIRA was a collaborator in the planning and execution of the “NOAA/WMO Train the Trainer Workshop on Satellite Data Access, Application, and GEONETCast Americas”, 25-26 April. This weekend workshop occurred prior to the NOAA Satellite Conference 27 April to 1 May in Greenbelt, MD. Travel funds were used to support 3 trainers from the CoEs in Costa Rica, Barbados, and Brazil to attend the workshop and conference. As part of the workshop, there were 2 afternoon sessions focusing on hands-on data access and display using McIDAS-V. Existing McIDAS-V scripts and plugins were adapted to greatly facilitate the viewing and manipulation of imagery for single channel and RGB composites of VIIRS imagery. This is being used as a template for future training. This provides trainers and users with tools to aid in better identifying and distinguishing water and ice cloud, snow, dust, fires, volcanic ash, and other features.



Figure 3. Participants at the NOAA/WMO Train the Trainer Workshop on Satellite Data Access, Application, and GOENETCast Americas in College Park, Maryland, 25-26 April.

Publications: None

Presentations:

Connell, B. 2015: Training resources from the US and access to data and imagery: ways to find them in the acronym soup. WMO VLab Virtual Event Week “Preparing for the Next Generation Satellite Imagery”, 16-20 November, <http://www.wmo-sat.info/vlab/next-generation-of-satellites/> Virtual Presentation.

Connell, B., S. Miller, D. Bikos, E. Szoke, S. Bachmeier, S. Lindstrom, A. Mostek, B. Motta, L. Veeck, 2016: JPSS and GOES-R User Readiness through Training: VISIT, SHyMet, WMO VLab and a new Liaison. 12th Annual Symposium on New Generation Operational Environmental Satellite Systems at the 96th AMS Annual Meeting, New Orleans, Louisiana, 10-14 January.

Connell, B., 2015: Satellite data processing and visualization software McIDAS-V. NOAA/WMO Train the Trainer Workshop on Satellite Data Access, Application, and GEONETCast Americas. College Park, Maryland, 25-26 April. Presentation and hands-on activity.

Davison, M., B. Connell, and K.-A. Caesar, 2015: Regional Focus Groups – Linking to GEONETCast Americas. NOAA/WMO Train the Trainer Workshop on Satellite Data Access, Application, and GEONETCast Americas. College Park, Maryland, 25-26 April. Presentation.

Veeck, L., and Kuna, M. 2015: Glocalisation, glocalização, glocalizacja - creating resources with “adaptation” in mind. 10th Eumetcal Workshop, 15-18 June, Reading, UK. Presentation.

Related Project Funded by the WMO: Tasks Related to Technical Support of the WMO-CGMS Virtual Laboratory for Education and Training in Satellite Meteorology (VLab)

PRINCIPAL INVESTIGATORS: Bernadette Connell

RESEARCH TEAM: Luciane Veeck

TECHNICAL CONTACT: NA

NOAA RESEARCH TEAM: NA

WMO FUNDED: \$90,000

PROJECT OBJECTIVES:

The World Meteorological Organization (WMO), based on the availability of funds in the WMO Space Program Virtual Laboratory (VLab) trust fund, has signed a contract with CIRA for technical support of the WMO-Coordination Group for Meteorological Satellites (CGMS) Virtual Laboratory for Education and Training in Satellite Meteorology (VLab). The following activities are supported:

- 1-- Support the planning of regional training events by:
 - Ensuring that these events have a virtual component;
 - Providing advanced information for students;
 - Ensuring the appropriate level of student participation;
 - Ensuring that course material is distributed prior to and after the events;
- 2-- Assist the establishment and maintenance of Regional Focus Groups and their activities in WMO member countries;
- 3-- Maintain and enhance the VLab Web presence and Moodle website;
- 4-- Keep the VLab community updated on evolving training technologies;
- 5-- Emphasize education, training, and outreach directed towards polar orbiting and geostationary satellites;
- 6-- Organize the VLMG online meetings in cooperation with the VLMG Co-Chairs;
- 7-- Based on information collected from VLab Centres of Excellence in Satellite Meteorology (CoEs) and activities registered in the VLab calendar and in coordination with the VLMG Co-Chairs, prepare the VLab annual report to CGMS and WMO (CBS);
- 8-- Identify training opportunities, in particular in support of all CoEs;
- 9-- Provide any other support to the VLab, as appropriate;
- 10-- Provide written quarterly updates on activities.

PROJECT ACCOMPLISHMENTS:

The following coordination activities of Luciane Veeck, VLab Technical Support Officer, support the top level objectives



- Virtual Event Week on the “Next Generation of Satellites” - Planning and execution of the 16-20 November 2015 event week that included setting up the web page, monitoring registration, performing speaker pre-check, monitoring the sessions, and processing and uploading recordings and presentations to the web site. A total of 11 sessions were offered by the Japan Meteorological Agency (JMA), China Meteorological Administration (CMA), NOAA, the European Organisation for the Exploitation of Meteorological Satellites (EUMETSAT), Korean Meteorological Administration (KMA), The Brazilian National Institute for Space Research (INPE), CIRA, COMET, and India Meteorological Department (IMD).

Registration numbers varied from 53 to 109 per session

Highest attendance what 35 in a single session.

Total of 95 attendees

More than 50% of Participants attended more than one session.

- WMO Train the Trainer Course 2015 (WMO TtT) – The WMO Train the Trainer course 2015 (for Regional Association VI) ran 16 February - 31 May 2015. The TSO participated in synchronous online sessions and forum activities during Modules 1 and 2. In collaboration with Vesa Nietosvaara (EUMETSAT), the TSO organized and delivered the session “How do you make training sessions more active?” on 27 April, 2015. In collaboration with Maja Kuna-Parrish (EUMETSAT), the TSO organized and facilitated the content and activities delivered in Module 3, Unit 9 (18-24 May).

- WMO Education and Training (WMO-ETR) Moodle Users Course Development – Collaboration occurred throughout the past year with Maja Kuna, Vesa Nietosvaara and Ian Mills (EUMETSAT), Ivan Smiljanic (EUMeTrain), Pat Parrish and Mustafa Adiguzel (WMO-ETR) on the design of an online Moodle User course. The “pilot” course was offered from January to February 2016.

- Monitor CoEs’ activities by keeping in constant communication with people involved, exchanging ideas for possible VLab events, updating contact’s lists, and investigating the main needs and expertise of each CoE;

- VLab Report to WMO IPET-SUP-2 – A report and presentation of VLab activities over the previous year was drafted by the TSO, approved by the co-chairs, and submitted to the WMO Inter-Programme Expert Team on Satellite Utilization and Products second session (IPET-SUP-2), which took place in Geneva, Switzerland (23-26 February 2016). The meeting was attended by the VLab co-chair Eduard Podgaiskii, who made the presentation.

- VLab Report to WMO CGMS-43 - A report and presentation of VLab activities over the previous year was drafted by the TSO, approved by the co-chairs, and submitted to the 43rd Plenary Session of the Coordinating Group for Meteorological Satellites” (CGMS-43), which took place in Boulder, USA (18-22 May 2015). The full report can be downloaded from the VLab website listed above under Publications/Other reports. The meeting was attended by the VLab co-chair Kathy-Ann Caesar, who made the presentation.

- VLab Strategy 2015-2019 – The TSO worked closely with the co-chairs in order to finalize the writing of the new VLab Strategy document 2015-2019. This document was circulated within members of the Coordinating Committee of Heads of Training Institutions of National Meteorological Services (CO-COM), receiving comments and suggestions that were considered in the final version. The document was presented to IPET-SUP-1 (March 2015) and CGMS-43 (May 2015) and endorsed by both groups. The full report can be downloaded from the VLab website listed above under Publications/Governance Documents.

- Preparation of informational presentations, reports, and posters for various groups:

The Community for the Advancement of Learning in Meteorology (CALMet) conference in Seoul, South Korea (8-11 September 2015). Poster.

WMO Committee on Earth Observation Satellites (CEOS) Working Group on Capacity Building and Democracy (WGCapD), South Africa, March 2015. Virtual Presentation.

- Maintenance of the VLab central website and the VLab calendar of events <http://vlab.wmo.int>

- Prepared and assisted the VLMG online meetings in 7-8 July and 17-18 December 2015, and 9-10 March 2016. The meeting reports can be found in the WMO VLab site <http://www.wmo-sat.info/vlab/meeting-reports/>

Publications: None

Presentations:

Veeck, L., and Kuna, M. 2015: Glocalisation, glocalização, globalizacja - creating resources with "adaptation" in mind. 10th Eumetcal Workshop, 15-18 June, Reading, UK. Presentation.

Connell, B. 2015: Training resources from the US and access to data and imagery: ways to find them in the acronym soup. WMO VLab Virtual Event Week "Preparing for the Next Generation Satellite Imagery", 16-20 November, <http://www.wmo-sat.info/vlab/next-generation-of-satellites/> Virtual Presentation.

Connell, B., S. Miller, D. Bikos, E. Szoke, S. Bachmeier, S. Lindstrom, A. Mostek, B. Motta, L. Veeck, 2016: JPSS and GOES-R User Readiness through Training: VISIT, SHyMet, WMO VLab and a new Liaison. 12th Annual Symposium on New Generation Operational Environmental Satellite Systems at the 96th AMS Annual Meeting, New Orleans, Louisiana, 10-14 January.

PROJECT TITLE: CIRA Support to RAMMB Infrastructure for GOES-R Rebroadcast Data Collection at CIRA/CSU

PRINCIPAL INVESTIGATOR: Renate Brummer and Michael Hiatt

RESEARCH TEAM: Renate Brummer, Michael Hiatt, Natalie Tourville

NOAA TECHNICAL CONTACT: Satya Kalluri (NOAA/NESDIS) and Candice Jongsma (NOAA/OAR)

NOAA RESEARCH TEAM: Dan Lindsey and Deb Molenaar (NESDIS/STAR/RAMMB)

FISCAL YEAR FUNDING: \$75,000

PROJECT OBJECTIVES:

CIRA and RAMMB are key players in the GOES-R Proving Ground, GOES-R Risk Reduction activities, and GOES-R algorithm development. Up to this point, algorithm development has required the use of proxy GOES-R data. This includes current GOES data, data from instruments such as MODIS and VIIRS aboard polar-orbiting satellites, and model-simulated data. After GOES-R is launched and the real data begins flowing, having access to a real-time feed from its Advanced Baseline Imager (ABI) will be critical. The volume of data will be far too large to obtain from offsite servers via the web, so having the ability to collect the GOES-R rebroadcast data here at CIRA is a necessity. CIRA's current ground station collects rebroadcast data from NOAA's geostationary satellites. Two years ago, work began at CIRA on a significant upgrade to the system in preparation to collect data from GOES-R after it got launched.

PROJECT ACCOMPLISHMENTS:

This project requested funds for CIRA to continue the building of a new GOES-R ground station. The new GOESR ground station contains the following parts to support reception, processing, distribution, and archiving of GOES-R data:

4.5 Meter S-Band Antenna, High Performance Low Noise Amplifier (LNA), Antenna Installation including Foundation, Cables, and Conduits, GOES-R Receiver, GOES-R SDI Pre-processor, GOES-R Ingest Server /Processor computers, and an Archive and Distribution System.

Colorado State University provided matching funds which supported CIRA's GOES-R Groundsystem Infrastructure efforts with \$75,000.00 for purchasing the 4.5 Meter S-Band Antenna. The antenna was installed in early fall 2015.

FY15 Funds received under this GOESR Ground System project were used to purchase and set up the computer equipment listed above. Note that CIRA's Primary Ground Station Engineer has the technical expertise to build the equipment needed for the ground system in-house at CIRA, which cost significantly less than buying any of the equipment.

The grant amount requested for this proposal was specifically used to cover the cost for:

- Two Ingest Server/Processor
- Two High Speed User Storage Devices
- Two NAS Storage Devices (96 TB) for data archiving

At the time of this report, some storage devices were already purchased. The delay of the GOESR launch made us decide to wait with some of these purchases, so we can benefit from the latest technology available for the server/processor and high-speed storage devices. Purchase times will be after the current annual reporting period ends. After being build, the equipment will undergo rigorous testing cycle.

The plan is to have the GOES-R Groundstation fully completed in time for receiving operational GOES-R data.

Publications: None

Presentations: None

PROJECT TITLE: CIRA Support to RAMMB Infrastructure for GOES-R Rebroadcast Data Collection at CIRA/CSU. EOY StAR Project

PRINCIPAL INVESTIGATOR: Renate Brummer and Michael Hiatt

RESEARCH TEAM: Renate Brummer, Michael Hiatt, Natalie Tourville

NOAA TECHNICAL CONTACT: Satya Kalluri (NOAA/NESDIS) and Candice Jongsma (NOAA/OAR)

NOAA RESEARCH TEAM: Don Hillger and Deb Molenaar (NESDIS/STAR/RAMMB)

FISCAL YEAR FUNDING: \$75,000

PROJECT OBJECTIVES:

CIRA and RAMMB are key players in the GOES-R Proving Ground, GOES-R Risk Reduction activities, and GOES-R algorithm development. Up to this point, algorithm development has required the use of proxy GOES-R data. This includes current GOES data, data from instruments such as MODIS and VIIRS aboard polar-orbiting satellites, and model-simulated data. After GOES-R is launched and the real data begins flowing, having access to a real-time feed from its Advanced Baseline Imager (ABI) will be critical. The volume of data will be far too large to obtain from offsite servers via the web, so having the ability to collect the GOES-R rebroadcast data here at CIRA is a necessity. CIRA's current ground station collects rebroadcast data from NOAA's geostationary satellites. Two years ago, work began at CIRA on a significant upgrade to the system in preparation to collect data from GOES-R after it got launched.

PROJECT ACCOMPLISHMENTS:

EOY StAR funds received in FY15 were used to upgrade the network line between two CIRA buildings from 1 GB to 10 GB. Additionally, many GOES-R development systems were upgraded to 10GB network. Some of the high-end servers and storage devices needed to support GOES-R data processing are still to be specified, purchased, and built. One server and associated storage was purchased to evaluate the GOES-R CSPP software and test different data transfer scenarios. Additional equipment purchases are still in progress beyond this annual report progress reporting period.

In addition, Colorado State University provided matching funds which supported CIRA's GOES-R Groundsystem Infrastructure efforts with \$75,000.00 for purchasing the 4.5 Meter S-Band Antenna. The antenna was installed in early fall 2015.

The plan is to have the GOES-R Groundstation fully completed in time for receiving operational GOES-R data.

Publications: None

Presentations: None

PROJECT TITLE: CIRA Support for Research and Development for GOES-R Risk Reduction for Mesoscale Weather Analysis and Forecasting

PRINCIPAL INVESTIGATOR: Steve Miller

RESEARCH TEAM: Renate Brummer, Cindy Combs, Jack Dostalek, Louie Grasso, Andrea Schumacher, Kevin Micke, Bernie Connell, Dan Bikos, Jeff Braun, Hiro Gosden, Dave Watson, Mike Hiatt

NOAA TECHNICAL CONTACT: Chris Brown (NOAA/NESDIS) and Phil Hoffman (NOAA/OAR)

NOAA RESEARCH TEAM: Mark DeMaria, Donald W. Hillger, John Knaff, Dan Lindsey, Deb Molenaar (NESDIS/STAR)

FISCAL YEAR FUNDING: \$539,205

PROJECT OBJECTIVES:

The next generation GOES satellites (beginning with GOES-R) will include the Advanced Baseline Imager (ABI) with vastly improved spectral, spatial and temporal resolution relative to the current GOES I-P series satellites. It will also include a Geostationary Lightning Mapper (GLM) which, together with the ABI, offers the potential to significantly improve the analysis and forecasts of mesoscale weather and natural hazards. The GOES-R era will begin in the middle of this decade, and will be part of a global observing system that includes polar-orbiting satellites with comparable spatial and spectral resolution instrumentation. This annual report combines CIRA's different projects conducted in the areas of GOES-R Risk Reduction (R3). The overall goal of these science studies is to contribute to the reduction of time needed to fully utilize GOES-R as soon as possible after launch and to provide the necessary proxy data to the algorithm groups for testing proposed algorithms and therefore to contribute to an improved algorithm selection and algorithm refinement.

GOES-R3 Research Areas

CIRA's GOES-R3 work can be divided into the following nine different projects:

Project 1-- Infrastructure - RGB Products in AWIPS II. (*third year project*)

Project 2-- -- Diagnosis and Anticipation of Tropical Cyclone Behavior from New and Enhanced GOESR Capabilities. (*second year project*)

Project 3-- Synthetic Imagery Generation over Alaska and Hawaii for GOES-R Product Development. (*second year project*)

Project 4-- Using total lightning data from GLM/GOES-R to improve real-time tropical cyclone genesis and intensity forecasts. (*second year project*)

Project 5 -- GOES-R ABI Multi-Spectral Imagery for Visibility Hazard Assessment via Himawari AHI. (*first year new start project*)

Project 6 -- Probabilistic Forecasting of Severe Convection through Data Fusion (*first year new start project*)

Project 7: -- GOESR AWG Imagery Team. (*continuation project*)

Project 8: -- GOESR Program ADEB Senior Advisory Support.

Project 9: -- GOESR/RAMMB Administrative Support.

PROJECT ACCOMPLISHMENTS

Project 1-- Infrastructure - RGB Products in AWIPS II. (third year project)

RGB products have been demonstrated within AWIPS at WFOs and N-AWIPS at National Centers. The products are created from single and multi-band satellite imagery to produce a single 8-bit image file external to the AWIPS environment. A fundamental requirement to augment the AWIPS II capabilities for 24-bit RGB imagery is to develop a satellite visualization plugin or tool that can access individual satellite channels, paired channel differences, or comparable measurements from the AWIPS II database for assignment to the RGB intensities.

Previous year's activities documented the entire D2D and NCP software framework, determining that there is a significant infrastructure difference between D2D & NCP visualization software which will be addressed this year. CIRA software developer met with the RGB project team (SPoRT, CIMSS) in Summer 2015 to define NCP RGB implementation steps. As a result of this meeting, Scott Longmore, Kaba Bah (CIMSS), Kevin McGrath (NASA SPoRT), Michael Folmer (Satellite Liaison, WPC/OPC/TAFB/SAB), and Steven Gilbert (NCEP) documented the details of the D2D software components needed to do full 24 bit RGB displays in NCP. RGB (red, green, blue) satellite imagery products (CIMSS example, SPoRT example, CIRA GeoColor) were successfully ingested, and displayed utilizing the True Color 24-bit (8-bit red, green, blue, and alpha) and on-the-fly derived parameter capabilities within the AWIPS II Display 2 Dimensions (D2D) perspective which was deployed to WFOs in build 14.4.1 (12/2014).

The AWIPS II National Centers Perspective (NCP) display currently only supports 8-bit color for limited pre-defined RGB satellite imagery data. After a code review of the existing RGB satellite imagery ingest and display capabilities in AWIPS II, the RGB team concluded that the best forward path to add RGB display capabilities to the National Center Perspective (NCP) is to port and refactor the Display 2 Dimensions (D2D) WFO perspective True Color (24bit) and Derived Parameter (on-the-fly) sets of modules into the NCP architecture.

Final consensus of the RGB team was that this work would require a full-time software developer (Java, Python) for approximately 2+ years software development, testing, and integration time. It would also require coordination with NCEP AWIPS II NCP developers who are currently scheduled with other projects for FY16-17. The AWIPS II RGB NCP team, comprised of liaisons from CIMSS, CIRA, SPoRT and the national centers (WPC, OPC, HPC, SPC, etc) would work with this full-time developer on testing of the NCP RGB display capabilities and the development of derived parameter python plug-ins for the manipulations of RGB display satellite imagery. At this time, NCO does not have the funds to support that effort.

Project 2-- Diagnosis and Anticipation of Tropical Cyclone Behavior from New and Enhanced GOESR Capabilities. (second year project)

This project builds on previous tropical cyclone (TC) research, makes use of unique datasets, and leverages the NOAA Hurricane Forecast Improvement Project (HFIP) resources. Here we propose to learn how to better diagnose and anticipate TC behavior with the new and enhanced capabilities of the next generation of GOES satellites. Our work addresses three important aspects of TC behavior. The first topic (Topic 1) addresses how to interpret the occasional variations of cloud-top microphysics associated with TCs. GOES-R products include cloud effective particle size (EPS) estimates and the precision of the Advanced Baseline Imager (ABI) will enable many qualitative products (e.g., RGB combinations) that provide users with information about EPS. GOES-R will greatly enhance our ability to see where and when small ice particles are being generated atop the TC. In this work we describe efforts to interpret such observations. The second topic (Topic 2) attempts to better statistically infer the TC

structure from IR imagery. In the past, such work relied heavily on composited aircraft reconnaissance data to provide the necessary inferences. HWRF model output from NOAA's HFIP program provides both simulated IR imagery and instantaneous ground truth at multiple levels. If successful, these relationships will allow the inference TC wind structure from a combination of observed IR imagery and routinely available information (intensity and translation). The final area (Topic 3) of work investigates methods to anticipate TC eye formation. Eye formation has long been known to indicate that a TC has reached hurricane intensity and is a primary pattern used to infer tropical cyclone intensity. In fact, the appearance of a clear eye can result in Dvorak-based intensity estimate increases of more than 40 knots in 24 hours. These topics have the potential to enhance our understanding and improve our ability to forecast tropical cyclones using GOES-R data.

Topic 1: Interpretation of variations of cloud-top microphysics associated with TCs

Investigate the relationships between regions of small ice particles, updraft intensity, aerosol concentration, and vertical wind shear. Two separate methods were used to identify where clouds exist (CloudSat, CloudSat+Calipso). We then created composite averages based on the cloud top effective radius, intensity and vertical wind shear. Composites based on effective radius, despite variations in intensity and vertical wind shear, show a consistent and not unexpected signal showing that the smallest cloud-top effective radius composites has larger reflectivity throughout the atmosphere. Results show that the CFAD differences between the 25 and 75 percentile composites for various intensity and vertical wind shear cases using method 2 (combined CloudSat/CALIPSO) were nearly identical to using method 1. This simply suggests that convection may be more vigorous when small particles present at cloud top.

Topic 2: Improve the statistically inference of TC structure from IR imagery

Finalized development of statistical relationships between the winds and the IR imagery. The collection of model output has taken much longer than expected. As of this reporting time, all of the fields and derived products associated with the rerun cases of the 2014 version of HWRF were collected. These have been readied for statistical analysis, which will begin in the latter half of this project year.

Topic 3: Methods to anticipate TC eye formation

Develop and test deterministic and probabilistic statistical methods to make forecasts of eye development. Deterministic models were created, but performed poorly and are not being pursued further. Probabilistic models based on logistic regression and Atlantic developmental data have been created. These showed the potential for skill in the 0-36h time periods. Individual (best) models were developed for 6, 12, 24, and 36h forecast. The predictors for 6-18h were similar and primarily driven by information in the IR imagery and whether an eye existed at $t=0$, and predictors for the 18-36 hour time periods were more heavily weighted toward environmental factors. For 18h we chose to take an equally weighted consensus of two models that use quite different predictors. These methods have been coded and tested using independent data (east and central Pacific). Figure 1 below shows the reliability diagrams associated with these techniques. The bottom line is this method appears to be both potentially useful to forecasters and viable for operational transition.

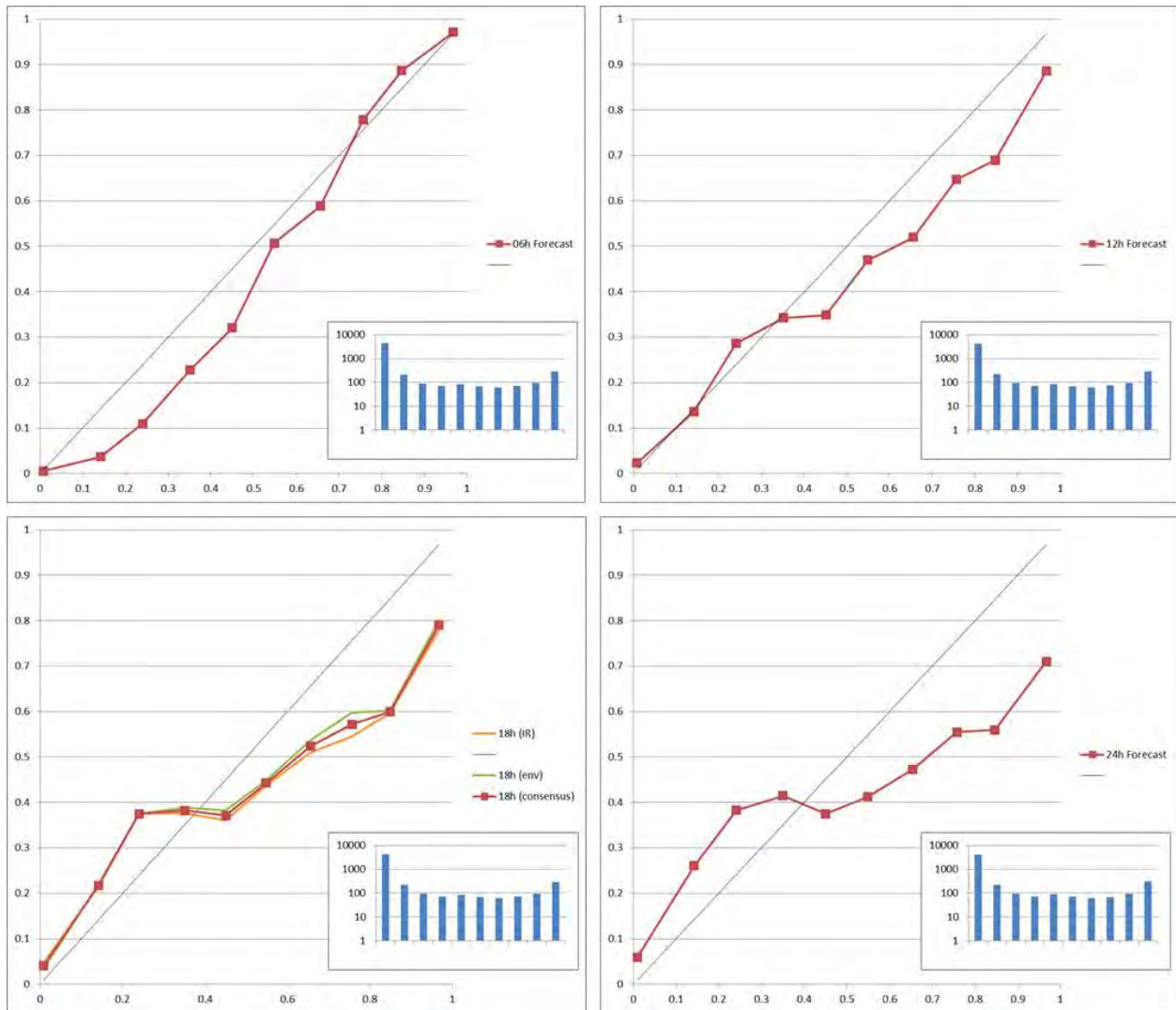

Figure 1. Reliability diagrams showing the calibration of the probabilistic schemes used to predict the probability of an eye forming in 6, 12, 18 and 24 hours. These forecasts were developed using Atlantic Basin tropical cyclones (1996-2013). The forecast scheme was then applied to eastern and central Pacific tropical cyclones (1996-2014). The results are thus completely independent (no tricks).

Previous GOES-R research

We are proud to report that our previous GOES-R research has led to publications and testing of results in operational environments. Publications include methods to estimate wind radii from observed intensity, location, motion and a single IR image, how those IR-based wind radii can be used in an operational consensus.

We are also testing the wind radii (t=0) consensus at JTWC. This product will provide an initial estimate of the wind radii for use in the TC Vitals. This is important because wind radii are the last part of the TC vitals calculated and there are few tools that the forecasters trust or have time to analyse. Preliminary results suggest that providing a first guess is making operational wind radii vary more consistently over time and there is also evidence from modelling studies that better and more realistically varying TC vitals produce better intensity forecasts in the GFDL and COAMPS modelling systems.

This year we are also testing a statistical-dynamical wind radii forecast method in the Joint Hurricane Testbed.

Project 3-- Synthetic Imagery Generation over Alaska and Hawaii for GOES-R Product Development. (second year project)

The generation of GOES-R synthetic Advanced Baseline Imager (ABI) data has been an important part of several previous GOES-R Risk Reduction projects. The imagery has provided several major benefits, including: 1) It serves as proxy data for the GOES-R ABI and can therefore be used to develop GOES-R products using the new ABI spectral bands, 2) Forecasters have provided overwhelmingly positive feedback on the helpfulness of synthetic imagery in visualizing Numerical Weather Prediction (NWP) model forecast output (Bikos et al. 2012), and 3) Forecasters can become accustomed to how the new bands on the ABI will look. Continued support for synthetic imagery generation will allow for additional product development and tools to assist in NWP model improvement and visualization for forecasters.

Up to the beginning of this project, all synthetic imagery from high resolution NWP models has been over the Continental U.S. (CONUS) and has excluded both Alaska and Hawaii. This project has begun generating synthetic imagery of GOES-R ABI bands over these two new domains. The synthetic data can then be used in GOES-R product development, be used to evaluate the model from which the data is generated, and be sent to National Weather Service (NWS) offices as a visualization tool of the model output. Alaska synthetic imagery is being created and sent out via LDM, and Hawaii synthetic imagery is being created but not yet sent out.

Milestone 1: Work with EMC to set up the staging and delivery of the NAM Hawaii Nest data

Daily output from the 00Z run of the NAM Hawaii Nest is being staged on NCEP's ftp site for our use. We grab the data every night.

Milestone 2: Configure CRTM to read the NAM Hawaii Nest input data, and set up scripts to begin simulating the 3.9, 6.95, and 10.35 μm bands

In addition to these three bands, we are also simulating the ABI 6.2, 7.3, 8.5, and 12.3 μm bands. See Figure 2 below for an example forecast image at 10.35 μm .

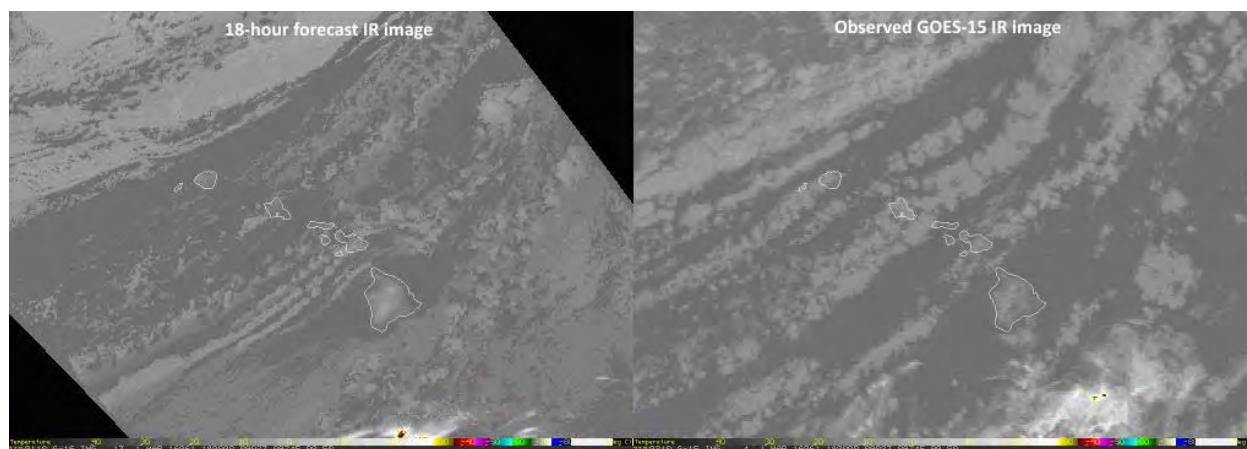

Figure 2. Synthetic 10.4 μm image based on an 18-hour forecast of the NAM Hawaii Nest model (left), and the corresponding observed GOES-15 IR image valid at 18 UTC on 2 March 2016 (right). There were very few deep/high clouds during this particular forecast period.

Milestone 3: Make the real-time Hawaii synthetic imagery forecast imagery available on the web, convert it to AWIPS and/or AWIPS-2, and send to Pacific Region via the LDM

This work is currently in progress. The output will be on CIRA's GOES-R Proving Ground page within the next 2 months. At that point, we will contact the Honolulu NWS office and ask if they're interested in receiving the data via LDM for AWIPS-2. Now that Himawari has been launched and is providing imagery over Hawaii (even though it's on the limb), one of the original goals of letting forecasters know what the new GOES-R bands will look like is moot. However, CONUS forecasters really like the imagery as a means to visualize the cloud output, so there's a chance the Hawaii forecasters will want the imagery for this purpose.

Milestone 4: Evaluate machine workload, and consider adding additional bands to both the Alaska and Hawaii processing

As noted above, four additional bands have been added and are being generated in real time.

Milestone 5: Routinely qualitatively compare synthetic imagery to observed GOES imagery over Alaska and Hawaii, investigate any obvious biases in cloud cover, etc., and report these findings to the NAM developers at EMC

As soon as the imagery goes on the web, we will begin this qualitative monitoring and will report any biases to the model developers at EMC.

Milestone 6: Develop a VISIT teletraining module on Alaska and Hawaii synthetic imagery and deliver the training to forecasters

The VISIT training team is working with Eric Stevens, the Alaska GOES-R liaison, to see whether Alaska forecasters are interested in a training session. If Hawaii ends up wanting the data feed, we will work with them as well.

Project 4-- Using total lightning data from GLM/GOES-R to improve real-time tropical cyclone genesis and intensity forecasts. (second year project)

Determining how lightning activity within the inner core or the rainbands of TCs is related to intensity change(s) has been hampered by an overall lack of observations of *total* lightning activity within these systems. Both theory and observations, however, suggest that total lightning flash rates in the TC's inner core depict when and where convective hot towers develop. The purpose of this project is to improve our knowledge of these relationships and, ultimately, use them to improve our ability to forecast the genesis and intensity changes of TCs. Two lines of research are being conducted to achieve this objective; one builds upon recent TC modeling research led by Dr. Fierro and a second is based on statistical approaches applied on observational data led by A. Schumacher at CIRA and M. DeMaria at NHC. This project report covers the work conducted at CIRA in collaboration with NHC.

The CIRA line of research is to develop an asymmetric total lightning predictor for the operational Rapid Intensification Index (RII) for TCs by using retrospective studies of the relatively large sample of tropical mesoscale convective systems (tropical depressions, tropical storms and TCs). An experimental version of the RII that includes lightning density input from the ground-based World Wide Lightning Location Network (WWLLN) has already been developed and is being tested in the Satellite Proving Ground at the National Hurricane Center (NHC). However, the WWLLN dataset is still dominated by cloud to ground strikes, and, thus, is not an optimal proxy for the Geostationary Lightning Mapper (GLM). The next step towards improving the RII with total lightning information input from the GLM is to test a synthetic RII based on total lightning data from Earth Networks. Inter-comparisons with the WWLLN data will be performed to begin the development and optimization of a total-lightning RII. Also, the proper utilization of the total lightning requires an improved understanding of the relationships between storm intensity and total lightning, which will be achieved through high-resolution simulations by Dr. Fierro. The chief rationale for developing enhanced operational predictors for total lightning arises from the upcoming launch of the GLM on the Geostationary Operational Environmental Satellite R series (GOES-R) in FY2016. The GLM will be capable of mapping both cloud-to-ground and in-cloud lightning day and night, year-round, with a spatial resolution of 8 and 12 km over the Americas and surrounding oceans. Progress

towards three project milestones are described below:

1--Continued evaluating viability of using ENTLN data:

Recent work has been released that examines the detection efficiency of ENTLN (Rudlosky 2015). Our original plan was to use ENTLN for this analysis because of its larger detection efficiency (with respect to WWLLN) over portions of the Atlantic tropical basin. Even though the intracloud detection efficiency had been found to decrease rapidly away from the U.S. coast, we hoped that the small amounts of intracloud lightning present in the ENTLN flash data might provide a lightning data source closer in nature to the GLM to investigate these relationships. Unfortunately, the detection efficiency of the ENTLN has large spatial variability over the Atlantic and we were unable to develop a suitable methodology for standardizing lightning data between TCs in different parts of the basin. Since we are seeking out relationships to incorporate into current statistical TC models, we have decided to proceed with this project using the WWLLN dataset.

2--Investigated asymmetric predictors for use in statistical TC intensity models:

The lightning-based RII includes an azimuthal average inner core lightning predictor and an azimuthal average rainband lightning predictor. However, lightning activity in TCs is often asymmetric in nature, especially in TCs experiencing vertical wind shear, interacting with land, and/or with a fast forward motion. In the first half of FY15, we investigated statistical relationships between asymmetric inner core and rainband lightning activity and TC intensity change in 2005-2014 Atlantic TCs using WWLLN data. Our main goal was to identify situations where asymmetric lightning density may provide a stronger signal for discriminating between intensifying and non-intensifying TCs than the azimuthal average values currently used in statistical TC intensity models.

Since convective activity in the inner core region of sheared TCs tends to be focused in the downshear-left quadrant, we calculated the shear-relative inner core lightning density in each of the four quadrants shown below in Figure 3.

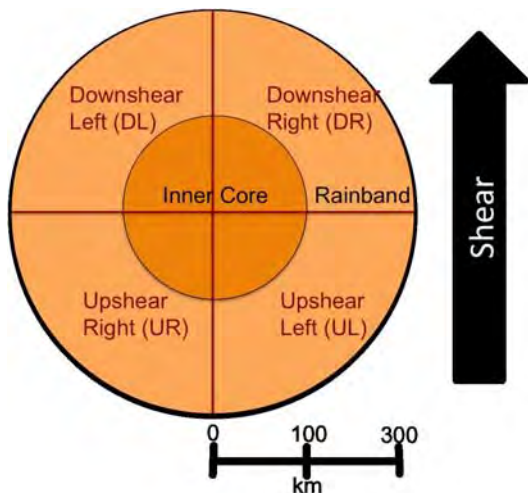

Figure 3. Schematic depicting the regions over which lightning density was calculated.

Azimuthal average and quadrant average lightning density values for the inner core region ($r=0-100\text{km}$) for intensifying, weakening, and all TCs are shown below in Figure 4 (left). The signal of larger average inner core lightning density seen in the azimuthal average data appears to be more pronounced in the downshear-left quadrant. This finding supports the development and testing of an asymmetric lightning predictor that uses downshear-left lightning density for possible incorporation into SHIPS and/or LGEM. In looking at rainband lightning (Figure 4, right), however, we found a consistent positive relationship between lightning and TC intensification in all quadrants that was similar to that found for the azimuthal average. As such, it is likely that the azimuthal average rainband lightning predictor currently being used in the lightning-based RII is sufficient.

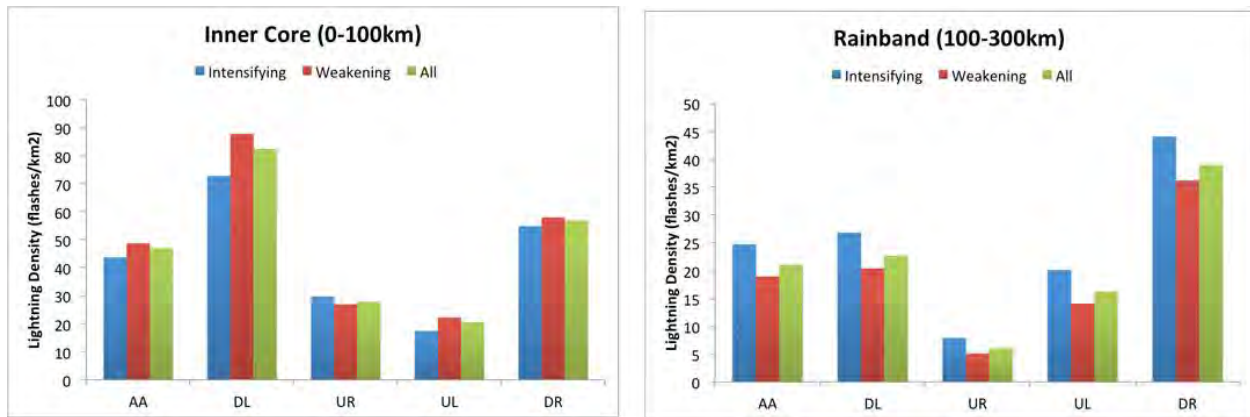

Figure 4. Inner core (left) and rainband (right) lightning density for intensifying (blue), weakening (red) and all (green) 2005-2014 Atlantic TCs. AA = azimuthal average and quadrant abbreviations are shown in Figure 3.

Similar quadrant analyses were performed for cases that underwent rapid intensification (RI) and rapid weakening (RW, Figure 5). Much like the analysis of all intensifying and non-intensifying cases, there TCs that were rapidly intensifying (weakening) appear to have a larger amount of inner core (rainband) lightning. However, the results of the shear-based quadrant analyses for RI/RW cases are quite different. The relationship between enhanced inner core lightning and subsequent rapid weakening is much more pronounced in the upshear quadrants. In the rainband, the positive relationship between enhanced lightning activity and subsequent rapid intensification can be seen the strongest in the downshear-right quadrant. The physical reasons for these quadrant preferences are not clear and will be studied further in the 2nd half of FY15.

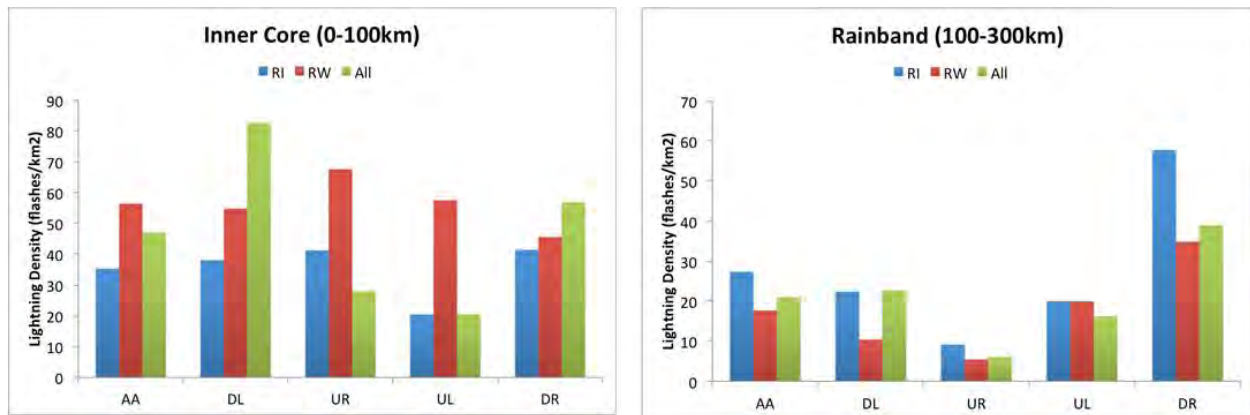

Figure 5. Inner core (left) and rainband (right) lightning density for rapidly intensifying (blue, $\Delta v_{max} \geq 25$ kt in 24 hours), weakening (red, $\Delta v_{max} \leq 20$ kt in 24 hours), and all (green) 2005-2014 Atlantic TCs. AA = azimuthal average and quadrant abbreviations are shown in Figure 3.

3--Investigated lightning predictors for use in statistical TC genesis models:

Potential predictors for the Tropical Cyclone Genesis Index were also investigated in the 1st half of FY15. Azimuthal average and shear-based quadrant average lightning activity for developing and non-developing tropical disturbances are shown below in Figure 6.

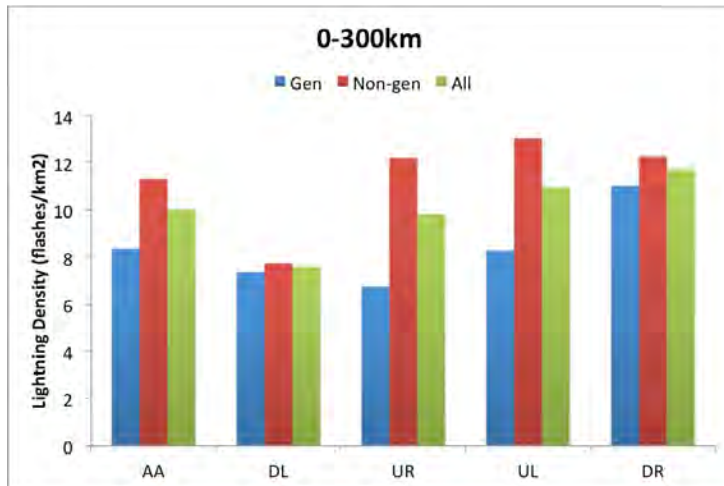

Figure 6. Lightning density for developing (blue), non-developing (red), and all (green) 2005-2010 Atlantic tropical disturbances. AA = azimuthal average and quadrant abbreviations are shown in Figure 3.

The azimuthal average lightning density (Figure 6, far left) for non-developing (non-gen) cases appears to be larger than those disturbances that did develop. This result is consistent with the observation that highly sheared, weaker TCs tend to experience large amounts of lightning. The shear-based quadrant analysis shows this signal to be strongest in the upshear quadrants. If the increased lightning activity in non-developing systems is due to increased vertical wind shear, one would expect the lightning to be located preferentially in the downshear quadrants. The reasons for the upshear maxima in non-developing disturbances is unclear and will be studied further in the 2nd half of FY15.

Project 5 -- GOES-R ABI Multi-Spectral Imagery for Visibility Hazard Assessment via Himawari AHI. (first year new start project)

This project develops multi-spectral lofted dust, snow cover, and blended imagery products tailored to the GOES-R Advanced Baseline Imager (ABI), using the Advanced Himawari Imager (AHI) as a material test bed. These value-added applications translate complex/ambiguous scenes into visually intuitive graphical depictions that enhance the target parameter while preserving the meteorological context and full spatial resolution of the sensor. They bear direct relevance to the challenges of visibility hazard forecasting and both complement and augment high-priority baseline products. The applications realize the promise of 10+ years of research and development on the polar-orbiting satellite constellation (including the MODerate-resolution Imaging Spectroradiometer [MODIS] sensors on Terra and Aqua, and the Visible/Infrared Imaging Radiometer Suite [VIIRS] on the Suomi National Polar-orbiting Partnership satellite). Demonstrated to National Weather Service (NWS) forecasters in AWIPS via the GOES-R Satellite Proving Ground (PG; Goodman et al., 2012), these applications exemplify the power of multi-spectral imagery for scene characterization, albeit at the sampling limitations of the polar-orbiting platform. For the first time, they will be available to the geostationary platform via the AHI (on Himawari-8 at the end of CY2014, and Himawari-9 in CY2016). The new algorithms will require some modification to account for differences in the response functions of AHI/ABI vs. the heritage polar-orbiting sensors. Anticipated availability of GOES-R ABI in year 2 of this project (2QFY2016) will enable software transition and direct comparisons between the AHI and ABI.

CIRA has been acquiring Himawari-8 AHI data from the NOAA/NESDIS/STAR data feed since July 2015, and a suite of AHI imagery products have been developed and are produced in real time. A webpage dedicated to real time AHI imagery products has been added to CIRA's RAMSDIS Online website (<http://rammb.cira.colostate.edu/ramsdisk/online/himawari-8.asp>) and has quickly become a very popular page on the website. Requests for imagery products and sectors have come from wide variety of users, including: NWS (Alaska Region, Pacific Region, AWC and OPC/WPC), the Anchorage Volcanic Ash Advisory Center (VAAC), as well as international users from Australia, Japan, the Philippines, portions of southeast Asia, Indonesia, and even Europe.

Project Achievements

At the time of this report, the following AHI imagery products have been developed at CIRA and are available on the RAMSDIS Online website:

1--Hybrid, Atmospherically Corrected (HAC) True Color, useful for detecting dust, smoke, smog, volcanic ash and other air quality hazards (Figure 7).



Figure 7. Example HAC True Color image from AHI (25 January 2015, 0230 UTC). This image will be featured in an upcoming BAMS article that has been accepted for publication (Miller et al. 2016).

2--Geocolor, a blend of HAC True Color during the day and a multi-spectral Low Cloud/Fog Product at night; used heavily by AWC for discrimination of low clouds at night, as well as for continuity with daytime True Color capability. (Figure 8)

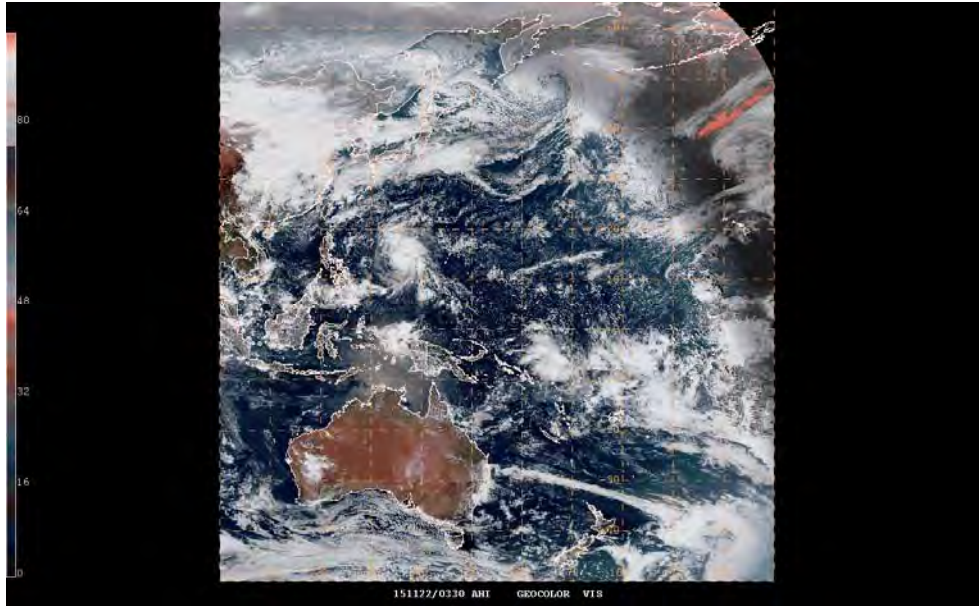

Figure 8. Screen capture of CIRA's Geocolor product from Himawari as viewed in NAWIPS, the operational display software used by the NWS Ocean Prediction Center.

3--Fire Temperature RGB, useful for detection of fires. Originally developed at CIRA for use with VIIRS, and now applied to a geostationary satellite for the first time. (Figure 9)

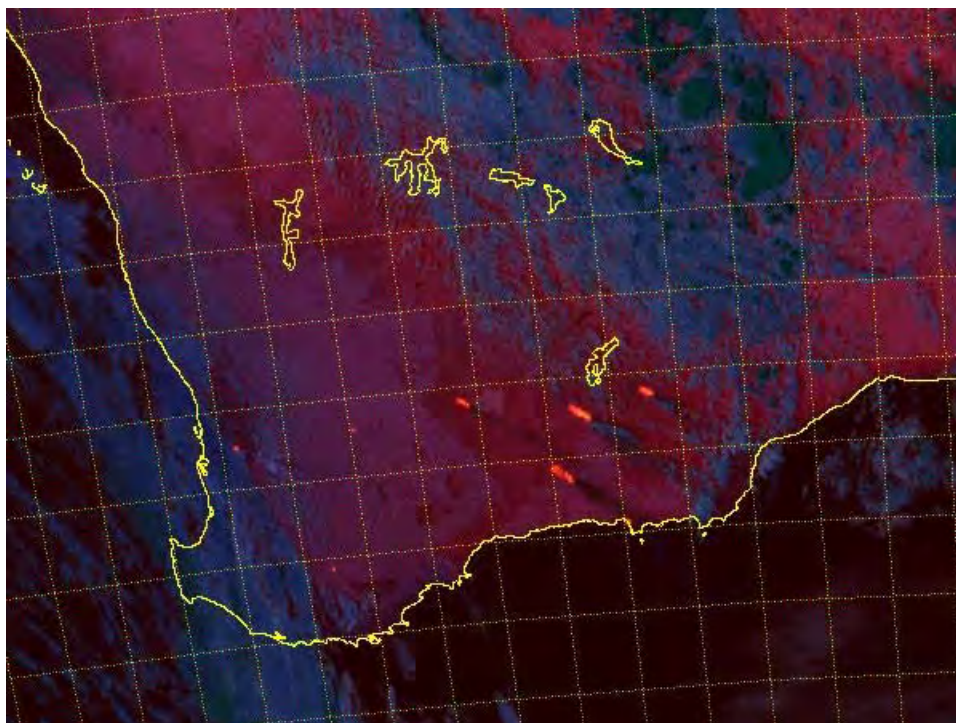

Figure 9. Example AHI Fire Temperature RGB image showing fires over southwestern Australia (17 November 2015). In this RGB composite, fires appear bright red, orange or yellow, depending on fire intensity.

4—DEBRA Dust Enhancement: We have computed surface emissivity for the AHI spectral bands and have adapted a code designed originally for Meteosat Second Generation (MSG) to run on the AHI imagery. We have produced the necessary land/sea masks and ancillary sun/sensor geometry files necessary to apply this algorithm 24-hr/day (Figure 10).

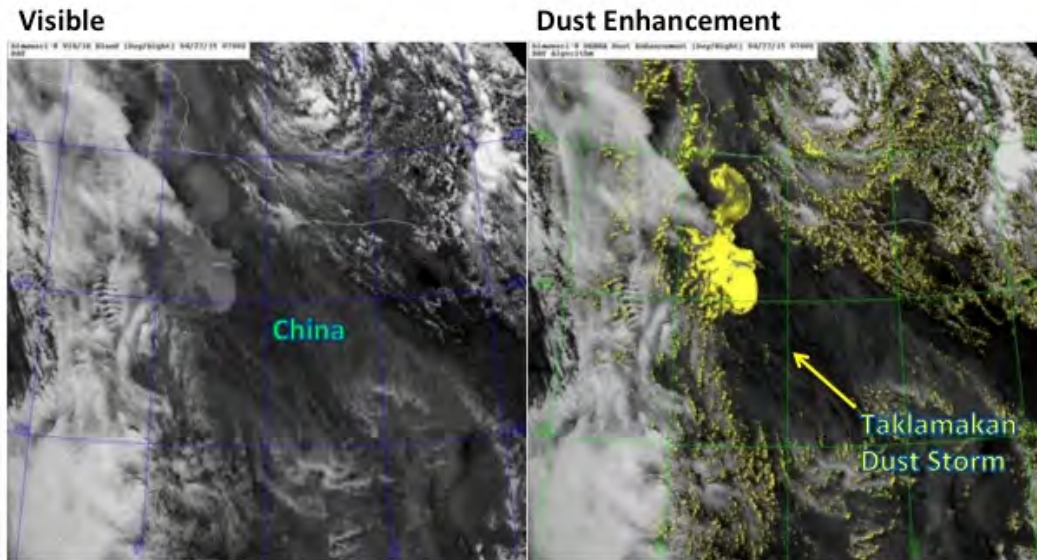

Figure 10. Example of AHI visible band (B03) imagery (left) and multispectral DEBRA dust enhancement (dust = yellow; right) for an emergent dust outbreak over China. Small band to band registration issues, corrected by Japan Meteorological Agency on March 2016, appear as cloud-edge artifacts here.

4--Natural Color, useful for discriminating liquid clouds from ice clouds, snow and ice during daytime. May be used to monitor Hawaiian VOG. Also highly sensitive to vegetation and may be used to monitor vegetation health. Based on the EUMETSAT recipe.

5--RGB Airmass, useful for monitoring the development of mid-latitude cyclones and characterizing airmass properties. Used heavily by OPC/WPC. Follows EUMETSAT recipe.

6--Two RGB composites useful for detecting volcanic ash. One is based on the 3.9 μm band for detection of small ash particles; the other is based on the 8.6 μm band for detection of SO_2 plumes. Based on CIMSS recipes that were applied to MODIS.

AHI Geocolor is being produced with a degraded color palette and distributed through NAWIPS for use by the National Centers. We have also worked with JMA to improve their True Color imagery with the HAC algorithm developed at CIRA. See *Interaction with Operational Partners* section below.

We are in the process of transitioning the Miller DEBRA dust algorithm to AHI. The Proving Ground snow/cloud discrimination algorithm for AHI is also under development at this time and is expected to be complete by late Quarter 3 or early Quarter 4.

Additional Achievements

--In October 2015, CIRA's AHI true-color product was covered in Greg Mandt's GOES-R Series Quarterly Newsletter at http://www.goes-r.gov/resources/newsletters/docs/3Q2015_FINAL.pdf

--In October 2015, Australian scientist Roger Smith who is professor at the Atmospheric Science Department at the University of Munich, Germany, contacted CIRA regarding "Morning Glory Clouds"

visible in some of our Himawari products. A special Himawari sector was set up over Australia to look for this type of cloud feature. A Morning Glory was seen AHI and VIIRS imagery on October 26th and a blog post was written about it:

<http://rammb.cira.colostate.edu/projects/npp/blog/index.php/uncategorized/whats-the-story-middle-of-the-night-glory/>

AHI imagery was able to capture the full life cycle of the Morning Glory.

--In November 2015: Michelle Smith (GOES-R Program Support Specialist NOAA/NASA) contacted CIRA asking for "some high impact visuals/animations from recent Himawari data/imagery to generate excitement for the GOES-R launch".

The following CIRA/RAMMB compilation of Himawari animations was made available for this purpose:ftp://rammftp.cira.colostate.edu/Lindsey/AHI_imagery_RAMMB-CIRA_19nov15.pptx

--In early December 2015, the CIRA team built a new webpage called the "Himawari Loop of the Day"

http://rammb.cira.colostate.edu/ramsd/online/loop_of_the_day.asp

Each loop is provided in 3 formats:

- i) HTML5 for easy web viewing at full resolution
- ii) animated .gif - these can be downloaded and inserted into powerpoint presentations, but the true color loops may be degraded a bit in quality
- iii) mp4 - also a bit degraded, but good for social media (twitter, facebook etc.)

Project 6 -- Probabilistic Forecasting of Severe Convection through Data Fusion (*first year new start project*)

Probabilistic Forecasting of Severe Convection through Data Fusion project is based on an experimental statistical model ("Prob Severe") that uses information from radar, satellite, and numerical weather models to predict the probability that a storm will eventually produce severe weather, including high winds, large hail, or a tornado. The near storm environment information is currently only Convective Available Potential Energy (CAPE) and effective bulk shear, but CIRA is currently working to investigate additional predictors. When this experimental product was tested as the 2015 Hazardous Weather Testbed Spring Experiment, many forecasters requested that instead of predicting the probability of any severe, the model should predict the probability of each individual hazard (hail, wind, tornadoes). In general, each of these hazards should have its own set of environmental parameters, so CIRA is working to isolate which predictor is best for which hazard, with the ultimate goal of improving Prob Severe by having forecasts of probability of hail, wind, and tornadoes.

Project 7 -- GOESR AWG Imagery Team. (*continuation project*)

Despite true color imagery being a flagship graphic of the GOES-R program (appearing on most of its public relations materials and serving as the background of the www.goes-r.gov home page) true color imagery is not a native capability of the ABI. Miller et al. (2012) outlined a methodology for approximating the 0.55 μm (green) band, not included on ABI but required (along with red and blue bands) to produce true color. Hillger et al. (2011) demonstrated the basic function of this algorithm on synthetic ABI data. As demonstrated recently in translation of true color processing from MODIS to Suomi NPP VIIRS, the lookup tables for green mapping as well as the atmospheric corrections for the individual red, green, and blue component bands are a strong function of the sensor response. The existing tables and atmospheric correction codes are suitable for MODIS-based proxy demonstrations of ABI performance, but are not optimized to the ABI. Hence, an ABI-specific version of the algorithm will be established.

The GOES-R Algorithm Working Group's objective is the development of Rayleigh-corrected look-up tables for producing an ABI Synthetic Green Band, thereby enabling production of GOES-R True Color imagery. Specifically, the necessary steps in this process are as follows:

--Refine the Rayleigh atmospheric corrections to match AHI response functions. ABI response functions for these same bands are expected to be very similar, but this will be checked when the information becomes available.

--When sufficient Himawari-8 data become available, construct new green LUT based on multi-scene/multi-seasonal AHI data.

--Evaluate performance against the actual green band (available on AHI) for scenes independent of the training.

--Investigate algorithm performance improvements via stratifying the LUTs based on scene type (as a way of mitigating potential scene-dependent weak-correlation issues).

Project Achievements

The CIRA AWG Imagery Team successfully developed and tested a new "hybrid green" method for improving the display of True Color imagery from AHI. This development allowed for this project to transition to a focus on the development of the "synthetic green" band that will be applied to the ABI on GOES-R. The "synthetic green" band for the ABI will be based on the hybrid green approach developed for AHI. We now refer to our AHI True Color imagery as "Hybrid, Atmospherically Corrected" (HAC) True Color, as it uses the "hybrid green" band and each component band is corrected for atmospheric scattering (Rayleigh scattering).

The CIRA AWG Imagery Team also put intensive efforts into the development of the look-up tables for the AHI native (0.51 μm) green band. The focus on synthesizing the native green band will allow for more freedom in the application of the F-factors used in the weighting between the native Band 2 and Band 4 for the hybrid (HAC) green band. Early analysis of the look-up tables shows promising performance, but a full analysis based on mature look-up-tables remains pending. We have found that increasing the table population tends to corrupt the darkest over-water pixels, imparting an undesirable false green artifact. There are a few hypotheses as to what is causing this behavior and we are in the process of setting up tests to evaluate them. This work is expected to last for the remainder of the project period and possibly beyond (pending future funding)—as the challenges related to capturing maximum information content in different scenes (particularly shallow water coastal zones) are high.

HAC True Color imagery is being produced in real time on CIRA's RAMSDIS Online web server, located at: <http://rammb.cira.colostate.edu/ramsdis/online/himawari-8.asp>. HAC True Color products continue to be produced for the full disk (at reduced spatial resolution) and several smaller sectors (at 1 km resolution). HAC Himawari imagery generated at RAMMB/CIRA has been implemented in AWIPS2 D2D utilizing the true color software application developed by the SPoRT Experimental Products Development team. The current implementation utilizes pre-generated HAC red, green and blue imagery for the 24 bit display. We continue to evaluate the feasibility of applying the HAC mathematical algorithms to generate the display 'on-the-fly' using baseline NWS imagery and the AWIPS2 derived parameter calculation capability.

New Geocolor Product from Himawari. CIRA/RAMMB is producing a new experimental product known as Geocolor from Himawari-8 data. During the daytime, it's HAC true color imagery, but at night, it transitions to a multispectral IR product that includes city lights and a differentiation between ice clouds and lower liquid water clouds. The GOES-R ABI will allow for a similar product, so the Himawari version will be perfected over the next year and eventually an ABI version will be developed. A nighttime example is shown in Figure 11 below, and an animation showing the transition from day to night is here: http://rammb.cira.colostate.edu/templates/loop_directory.asp?data_folder=dev/lindsey/loops/12nov15_geocolor&image_width=1020&image_height=720&loop_speed_ms=100

All of the HAC true color imagery from Himawari has been transitioned to Geocolor and made available on the RAMSDIS Online website: <http://rammb.cira.colostate.edu/ramsdis/online/himawari-8.asp> (D. Lindsey and D. Hillger, E/RA1, S. Miller and C. Seaman, CIRA, 970-491-8446, Dan.Lindsey@noaa.gov, Don.Hillger@noaa.gov, Steven.Miller@colostate.edu, Curtis.Seaman@colostate.edu)

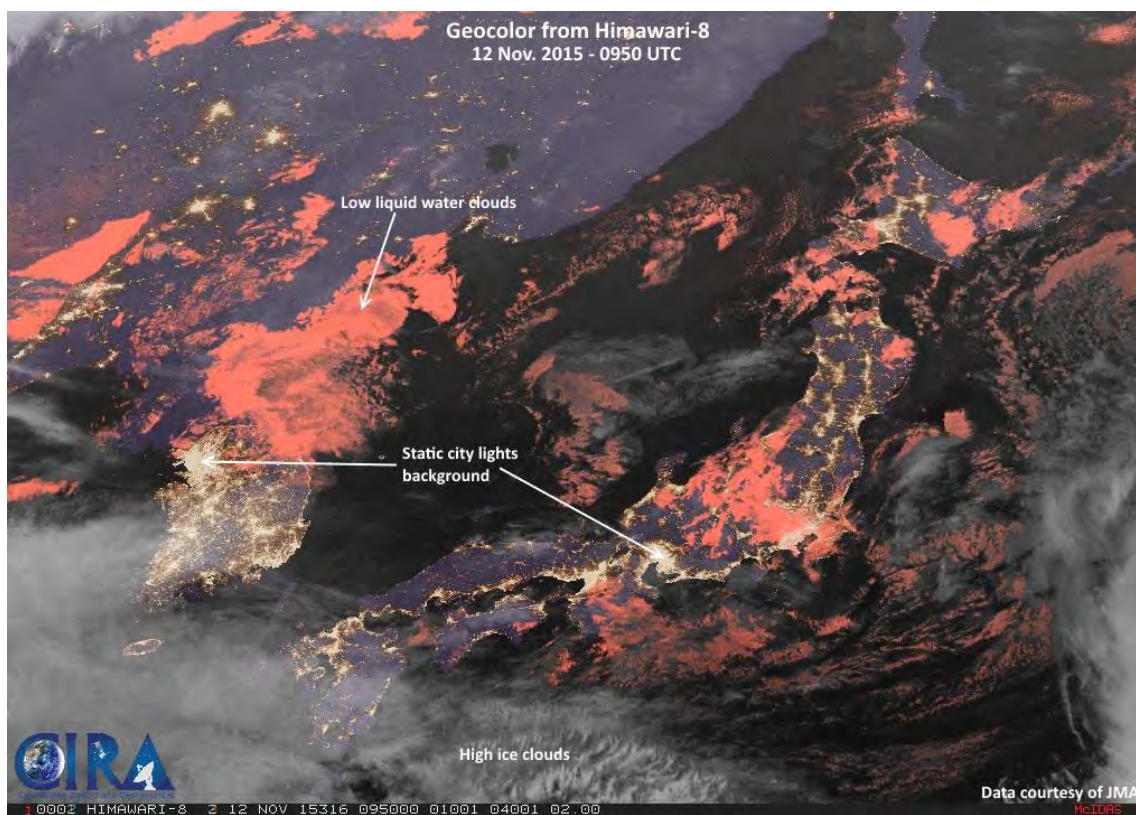

Figure 11. Example nighttime Geocolor image from 12 November 2015 at 0950 UTC over Japan and the Korean peninsula. City lights are yellow/gold, ice clouds are white, and liquid water clouds are red/pink.

New Himawari Products added to RAMSDIS Online: Several new Himawari-8 imagery products have been added to RAMSDIS Online. These include full disk RGB Airmass images, two different Ash RGB composites originally developed by Mike Pavolonis, and additional sectors for Natural Color, True Color and Fire Temperature RGB composites. Of particular interest to this group is the addition of the Eastern China HAC True Color/Geocolor sector. Figure 12 below shows the nearly constant poor air quality in the region. The smog is often of sufficient optical thickness to completely obscure the background surface. An example is provided below. All of CIRA's Himawari imagery products may be viewed on RAMSDIS Online at this link: <http://rammb.cira.colostate.edu/ramsdis/online/himawari-8.asp>

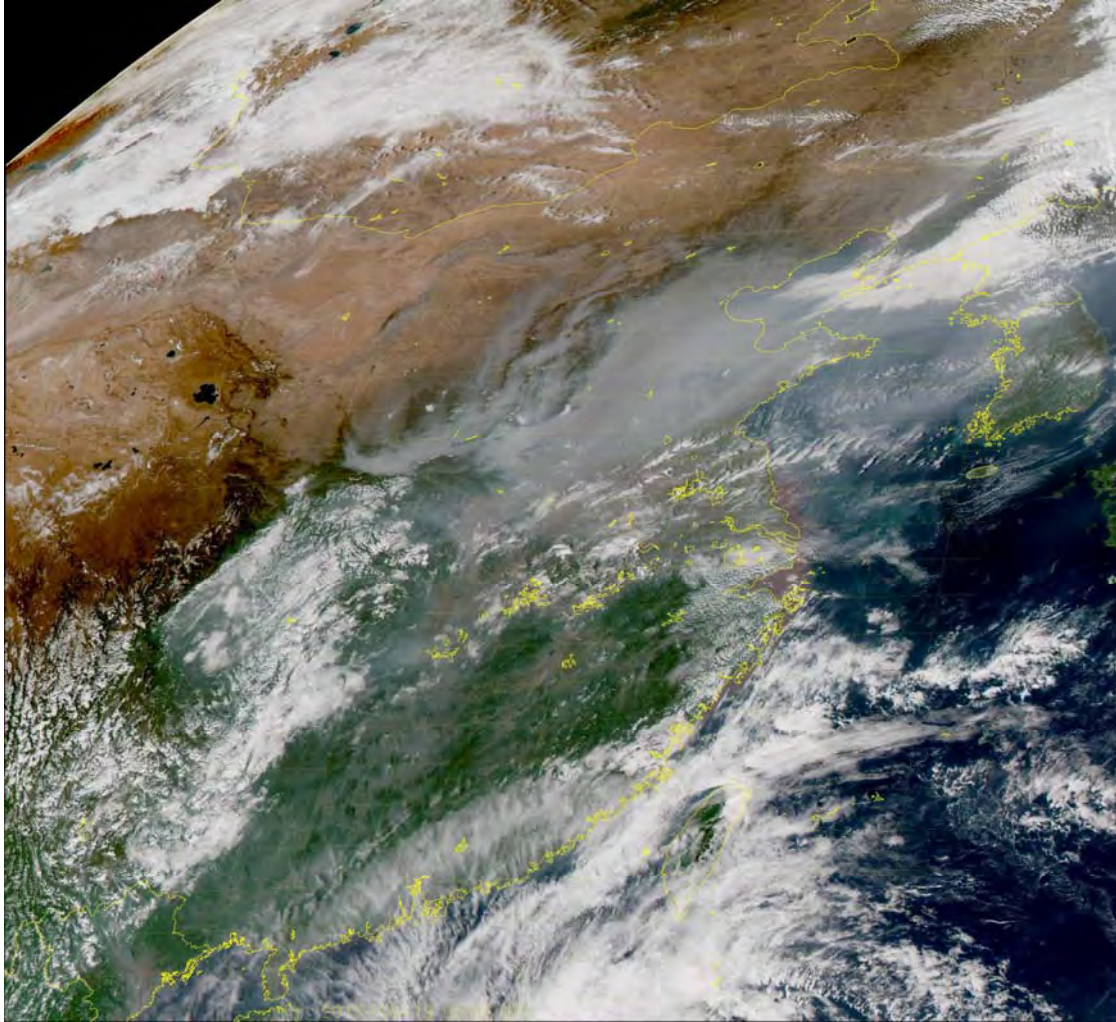

Figure 12. HAC True Color image of eastern China (05:00 UTC 19 October 2015), highlighting the intense smog that is common in the region.

Intensive efforts were put into converting Steve Miller's GeoColor product to work with AHI data. This work is now completed and first results were presented at the 6th Asia-Oceanic Meteorological Satellite Users Conference (AOMSUC) in Tokyo (10-13 Nov 2015). The GeoColor product is part of a GOES-R Risk Reduction effort, but leverages the true color work of this project for the daytime component of the product.

Himawari True Color Imagery used to Observe Indonesian Fires: Himawari imagery from RAMMB/CIRA's webpage (<http://rammb.cira.colostate.edu/ramsd/online/himawari-8.asp>) is being used by many national and international research and forecasting groups. An example from Dr. Robert Field (Columbia Univ.) is shown in the Figure 13 below. Portions of Indonesia are experiencing severe drought, and the true color imagery shows multiple fires currently burning in that region.

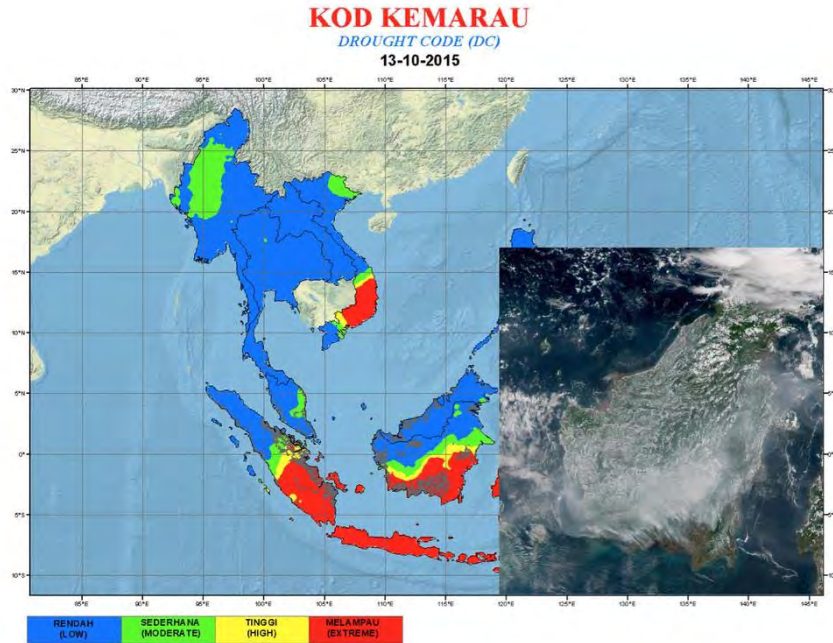

Figure 13. Drought assessment from portions of Southeast Asia, with an inlaid true color image from CIRA's Himawari webpage. Multiple smoke plumes can be seen on the southern portion of the island of Borneo; this corresponds to an area experiencing severe drought. Figure courtesy of Dr. Robert Field, Columbia University.

Transformation of RGB into HSV space for AHI True-Color product: Figure 14 below depicts an RGB to HSV (Hue/Saturation/Value) color-space transformation, with the Hue component being the primary color at full saturation. Hue imagery derived from AHI true-color imagery gives an enhanced indication of the shift towards green by use of the hybrid green band vs. the original AHI green band. While the change in true-color imagery may sometimes be subtle; the change in the Hue images is a dramatic confirmation of that color shift.

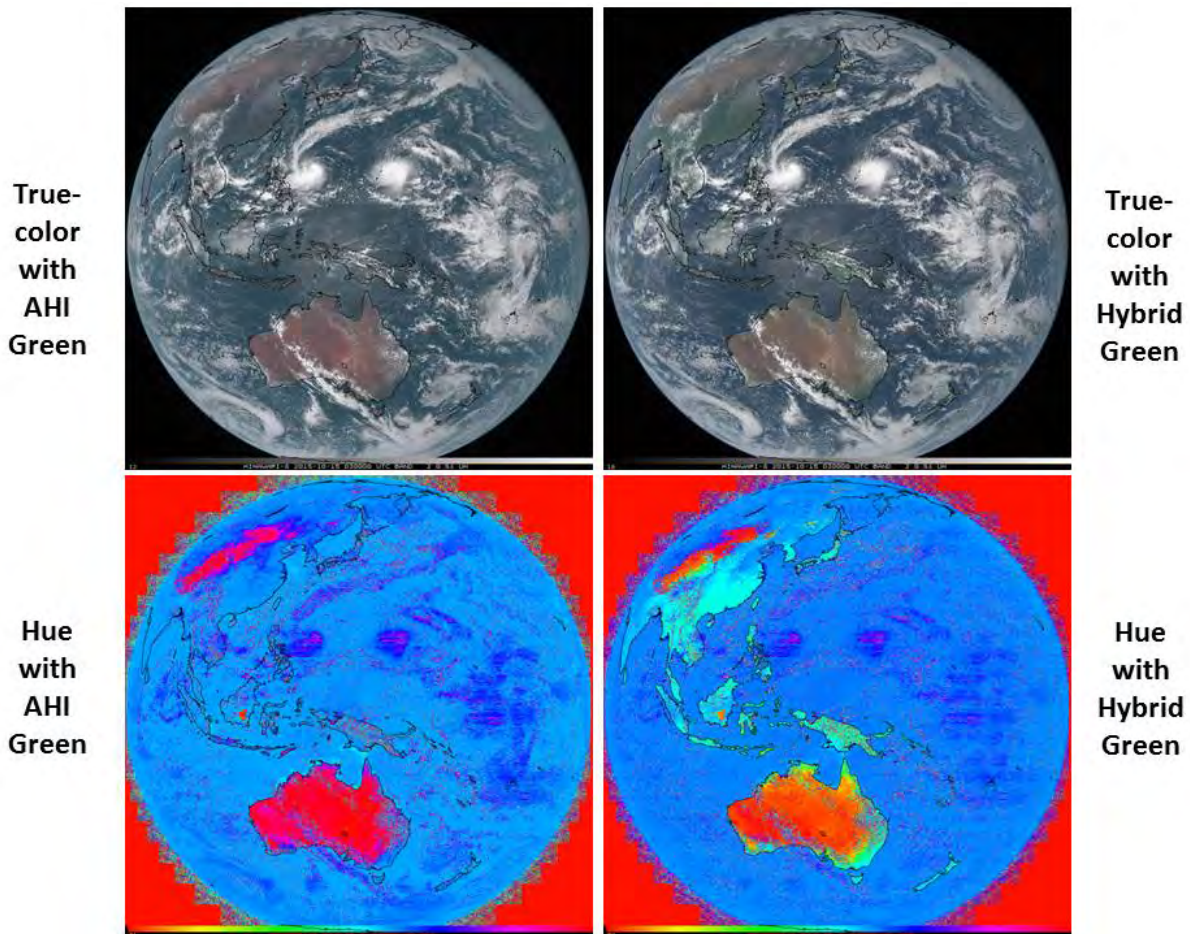

Figure 14. RGB transformation to HSV (**Hue**/Saturation/Value) space shows more dramatically the change from mostly blue hues to green/cyan hues for vegetated land surfaces. The fact that the green land appears cyan is an indication of blue-light scattering that remains in these non-Rayleigh-corrected examples.

Yasuhiko Sumida (JMA) visited CIRA for two weeks in early October 2015. During that time he met with most CIRA/RAMMB scientists to discuss their research. He also worked with our team to understand the software implementation of HAC, with the intent of transitioning to operational processing at JMA.

Project 8 -- GOESR Program ADEB Senior Advisory Support.

Professor Thomas H. Vonder Haar (CSU/Atmospheric Science), continues to be a Senior Advisor to the GOESR Program. During the reporting period, he attended meetings and telecons of the Independent Advisory Committee (IAC) for GOES-R, He also submitted a joint annual report to Dr. Steve Goodman. In addition, he attended GOESS and JPSS sessions at the Annual Meeting of the AMS and at the NOAA Satellite Science Symposium in Boulder. At the Science Symposium I presented the invited paper “The 50 year Heritage of Cloud Observations from NOAA Operational Satellites and Challenges for New Cloud Science and Applications”.

Project 9 -- GOESR/RAMMB Administrative Support.

In a basis consistent with our long-standing Memorandum of Understanding between NOAA and Colorado State University, the CIRA GOES- R3 enclosed budget specifically included support for administrative and clerical personnel directly associated with the technical and managerial administration of this project. This support is "quid pro quo" for the reduced indirect cost rate agreed upon in the long-standing subject memoranda. CIRA's administrative support person provided communication and collaboration support, assisted in the acquisition and distribution of reference materials relevant to the conception and execution of the project, technical editing of scientific manuscripts, specialized reports and conference papers. CIRA also continues to provide some administrative support for the wider GOES-R program, including planning for the annual review and tracking of project progress.

Publications:

Folmer, M, M. DeMaria, R. Ferraro, J. Beven, M. Brennan, J. Daniels, R. Kuligowski, H. Meng, S. Rudlosky, L. Zhao, J.A. Knaff, S. Kusselson, S. Miller, T. Schmit, C. Velden, and B. Zavadsky, 2015: Satellite tools to monitor and predict Hurricane Sandy (2012): Current and emerging products. *Atmospheric Research*, 166, 165-181.

Knaff, J.A. , C.J. Slocum, K.D. Musgrave, C.R. Sampson, and B. Strahl: 2016: Using routinely available information to estimate tropical cyclone wind structure. *Mon. Wea. Rev.*, in press

Line, W., T. J. Schmit, D. Lindsey, and S. Goodman, 2016: "Use of Geostationary Super Rapid Scan Satellite Imagery by the Storm Prediction Center," (accepted) *Weather and Forecasting*, to be published in April 2016.

Miller, S.D, T.J. Schmit, C. Seaman, D. Lindsey, M. Gunshor, R. Kors, Y. Sumida, and D. Hillger, 2016: "A Sight for Sore Eyes - The Return of True Color to Geostationary Satellites," (in press) *Bulletin of the American Meteorological Society*.

Presentations:

DeMaria, R.T., G. Chirokova, J.A. Knaff, and J.F. Dostalek, 2016: Machine Learning Algorithms for Tropical Cyclone Center Fixing and Eye Detection. 20th Conference on Satellite Meteorology and Oceanography, 11th Annual Symposium on New Generation Operational Environmental Satellite Systems, Phoenix, AZ, 4-8 January.

Lindsey, D., L. Grasso, and D. Bikos, 2015: Synthetic Satellite Imagery: A New Tool for GOES-R User Readiness and Cloud Forecast Visualization. 2015 NOAA Satellite Conference, April 2015.

Lindsey, D.T., S. D. Miller, C. J. Seaman, D. A. Molenar, D. W. Hillger, T. J. Schmit, W. Straka and Y. Sumida, 2016: A First Look at Imagery from Himawari-8. 96th AMS Annual Meeting, New Orleans, LA, 10-14 January 2016.

Miller, S.D., T. J. Schmit, C. J. Seaman, M. Gunshor, D. T. Lindsey, D. W. Hillger, and Y. Sumida, 2016: The Return of True Color to Geostationary Satellites: Transitioning from Polar, to Himawari, to GOES-R, AMS Annual Meeting, New Orleans, LA, 10-14 January 2016.

Miller, S.D., C. Seaman, D. Lindsey, T. J. Schmit, M. Gunshor, D. Hillger, and Y. Sumida, 2015: Multispectral Application Development for Himawari-8 AHI, 6th Asia/Oceania Meteorological Satellite Users' Conference, Tokyo, Japan, 9-13 November 2015.

Miller, S.D., C. Seaman, D. Lindsey, T. J. Schmit, M. Gunshor, D. Hillger, and Y. Sumida, 2015: Multispectral Application Development for Himawari-8 AHI, 6th Asia/Oceania Meteorological Satellite Users' Conference, Tokyo, Japan, 9-13 November 2015.

Musgrave K. D. ,J. A. Knaff, C. J. Slocum, L. D. Grasso, and M. DeMaria 2016: Examination of Tropical Cyclone Structure Through Synthetic Satellite Brightness Temperatures. 20th Conference on Integrated Observing and Assimilation Systems for the Atmosphere, Oceans, and Land Surface, Phoenix, AZ, 4-8 January.

Schumacher, A., 2016: Using Total Lightning Data to Improve Real-Time Tropical Cyclone Intensity Forecasts. AMS Annual Meeting, New Orleans, LA, 10-14 January 2016.

Tourville, N. and J. A. Knaff, 2015: Understanding tropical cyclone cloud-top microphysical relationships using CloudSat and A-Train data, AGU Fall Meeting, San Francisco, CA, 14-18 December. <https://agu.confex.com/agu/fm15/meetingapp.cgi/Paper/83055>

PROJECT TITLE: CIRA Support for Tropical Cyclone Model Diagnostics and Product Development - Hurricane Forecast Improvement Project (HFIP)

PRINCIPAL INVESTIGATOR(S): Wayne Schubert, Kate Musgrave

RESEARCH TEAM: Andrea Schumacher, Robert DeMaria, Chris Slocum, Jack Dostalek

TECHNICAL CONTACT: Fred Toepfer (NOAA/NCEP/EMC) and Candice Jongsma (NOAA/OAR)

NOAA RESEARCH TEAM: John Knaff (NOAA/NESDIS/STAR)

FISCAL YEAR FUNDING: \$330,650

PROJECT OBJECTIVES:

The National Oceanic and Atmospheric Administration (NOAA) initiated the Hurricane Forecast Improvement Project (HFIP) to reduce the errors in tropical cyclone track and intensity forecasts. This reduction will be accomplished through improved coupled ocean-atmosphere numerical hurricane models, better use of observations through advanced data assimilation techniques and ensemble forecasts. Model diagnostic techniques will also be developed to determine the sources of model errors and guide future improvements. The CIRA team performed tasks for four objectives that contribute to this HFIP effort. Details on these tasks are described in the next section.

The CIRA HFIP activities directly address NOAA's Weather Ready Nation objectives. This research falls within the NOAA-defined CIRA thematic area of Satellite Algorithm Development.

PROJECT ACCOMPLISHMENTS: Covering July 2015-March 2016 by Objective:

1— SHIPS/LGEM/RII Improvements

-- Tasks associated with this objective fall into three general areas. The first area involves updating the SHIPS/LGEM/RII database for the 2015 season, and is ongoing. The second area focuses on implementing the ECMWF version of SHIPS/LGEM/RII on WCOSS. This was completed in August 2015,

with cases run on WCOSS in the Atlantic and East Pacific basins during August-November 2015. A patch to account for the ECMWF upgrade was implemented March 2016. Preliminary evaluation of the differences between ECMWF-based SHIPS/LGEM/RII and GFS-based SHIPS/LGEM/RII has been performed. Figure 1 displays an example of the results, comparing mid-level relative humidity between GFS and ECMWF. Along the same track, differences could exceed 30% for a 120 hr forecast. The third area focuses on developing the RII to run from multiple dynamical models. The additional datasets needed to run the RII along with SHIPS and LGEM have been identified and acquired, and development and testing are underway. This effort is also being leveraged for the HFIP Ensemble Product Tiger Team, which was formed after the HFIP Annual Meeting in November 2015.

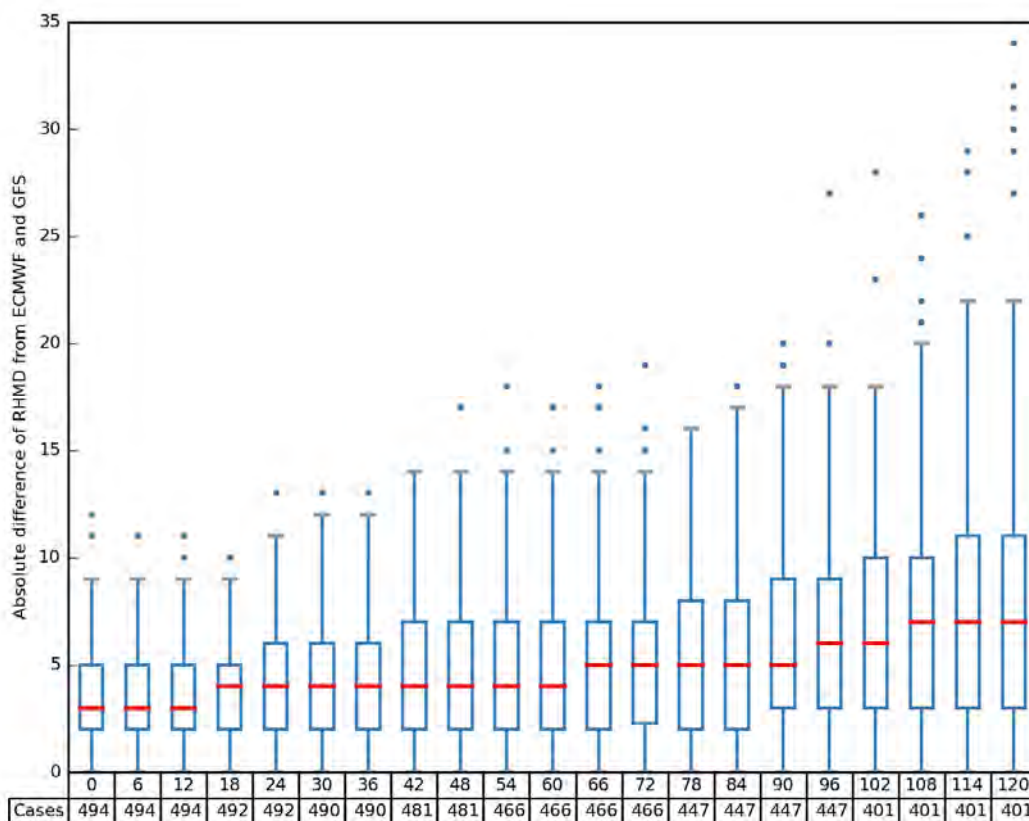

Figure 1. The distribution of absolute difference of mid-level relative humidity (RHMD, in percent) between the GFS and ECMWF forecast fields during the Atlantic and East Pacific 2015 hurricane season. RHMD is calculated between 500 hPa and 700 hPa, in an annular region extending from 200km to 800km from the designated track location, at each forecast hour in six-hour increments out to 120 hr. The official track is used to provide the track points for both models. The number of cases available for comparison is listed underneath the corresponding forecast hour.

2— Monte Carlo Wind Speed Probability Model Improvements

-- Work is ongoing on three separate tasks related to the Monte Carlo Wind Speed Probability (MCWSP) model. The first involves improving the representation of tracks in the model. A second-order auto-regression technique is currently being incorporated into the MCWSP model, and will be tested for smoother track realizations. The second task involves the representation of the intensity uncertainty in the MCWSP model. Testing using the intensity version of the Goerss Predicted Consensus Error (GPCE)

is underway. The third task is producing an updated climatological wind speed probability study for the Atlantic basin, for which datasets are being determined and collected.

3— Investigation of Rapid Intensification and Boundary Layer Shocks

-- Theoretical tropical cyclone work has shown that the formation of shock-like structures in the tropical cyclone boundary layer can influence storm intensity. To understand the degree to which the boundary layer assists in rapid intensification, work on shock development using a simple dynamical framework has shown that wind profile shape plays a large role in determining the placement of Ekman pumping from the tropical cyclone boundary layer in relation to the eyewall. This work indicates that boundary layer processes may play an important role in rapid intensification during tropical cyclone development. Figure 2 shows two idealized wind profiles (black) and the development of boundary layer winds. The orange curve shows development of boundary layer radial inflow but lacks a shock. The blue curve shows the development of a shock which is collocated with strong Ekman pumping inside the tropical cyclone eyewall.

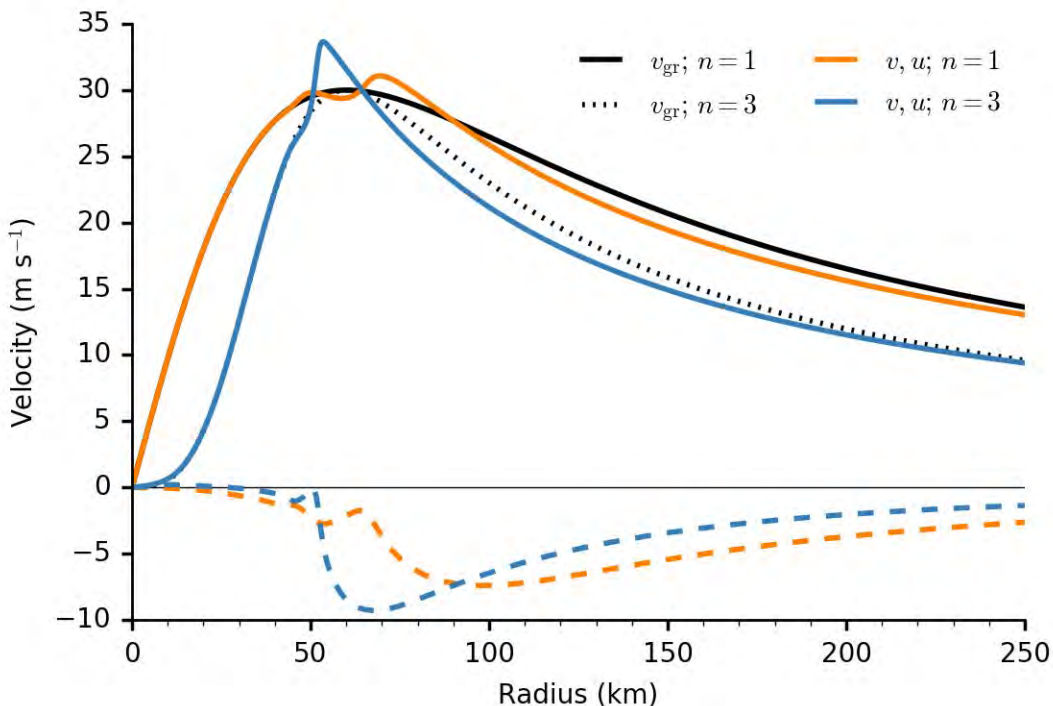

Figure 2. Model output for two idealized wind profiles (black) used to initialize and force a simple dynamical framework. The boundary layer response is shown for shock developing (blue) and non-shock developing (orange) cases.

4— Verification of Large-scale HWRF Synthetic Total Precipitable Water

-- One of the difficulties of hurricane model verification is the lack of traditional observations near the storm. Moisture fields at all levels are extremely sparse in the vicinity of tropical cyclones. Routine measurements of total precipitable water are made by polar orbiting, microwave-based satellites giving a picture of low level moisture. To provide feedback on HWRF model forecasts of moisture, software has been developed for the HWRF Development Team to assess synthetic total precipitable water using a mean square error skill score with climatological references as a performance metric. Figure 3 shows the

mean absolute error, bias, and skill score by forecast hour for the Atlantic and Eastern Pacific basins during the 2015 hurricane season.

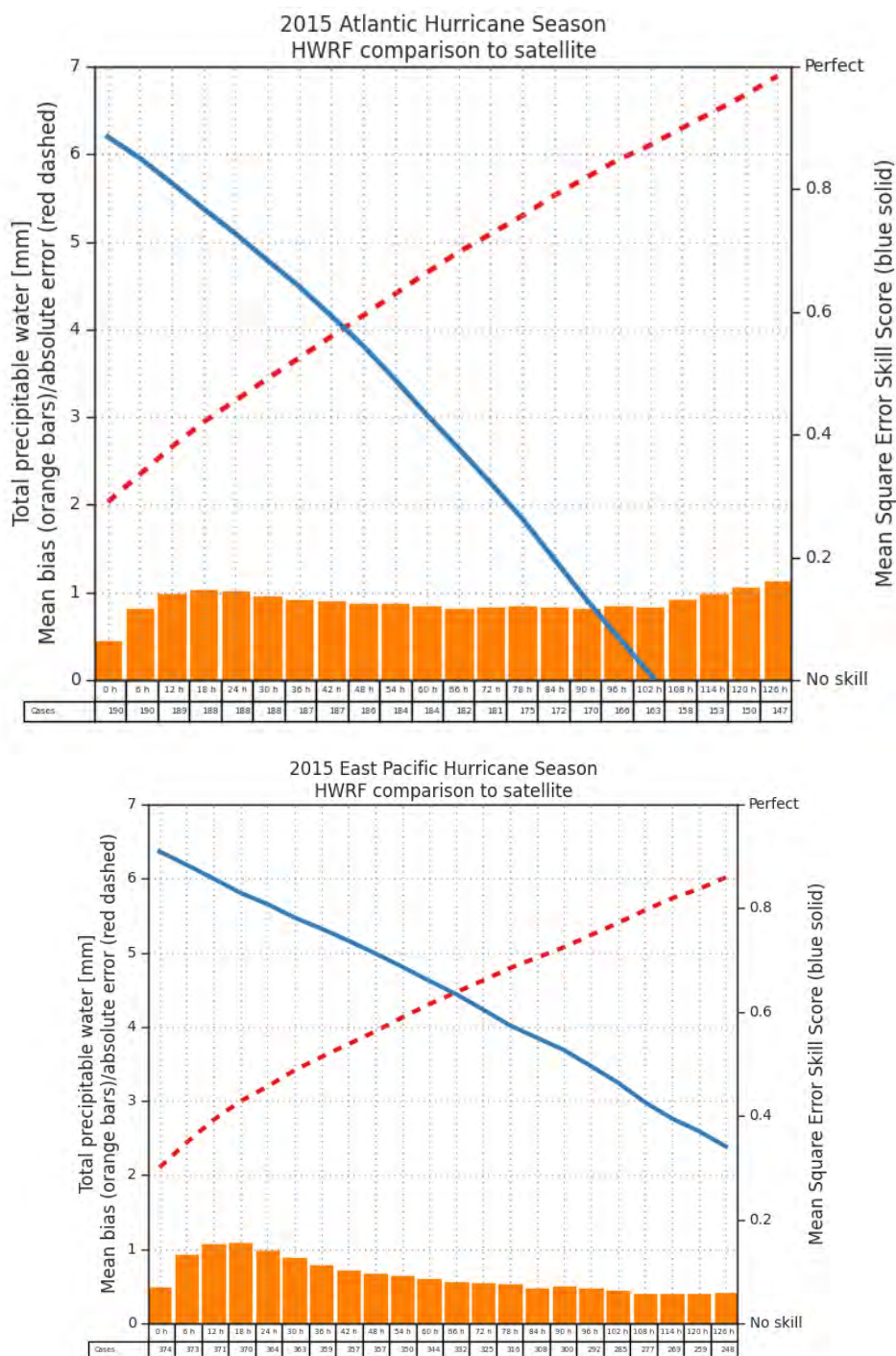

Figure 3. Mean absolute error (red dashed), bias (orange bar), and mean square error skill score (blue) for HWRf evaluated against blended satellite total precipitable water, for the Atlantic (top) and East Pacific (bottom) during August-November 2015. The number of cases available for comparison is listed underneath the corresponding forecast hour.

Publications:

Knaff, J. A., S. P. Longmore, R. T. DeMaria, and D. A. Molenaar, 2015: Improved Tropical-Cyclone Flight-Level Wind Estimates Using Routine Infrared Satellite Reconnaissance. *Journal of Applied Meteorology and Climatology*, **54**:2, 463-478. doi: <http://dx.doi.org/10.1175/JAMC-D-14-0112.1>

Knaff, J. A., C. J. Slocum, K. D. Musgrave, C. R. Sampson, and B. Strahl, 2016: Using routinely available information to estimate tropical cyclone wind structure. *Mon. Wea. Rev.*, in press. doi: <http://dx.doi.org/10.1175/MWR-D-15-0267.1>

Presentations:

Knaff, J. A., 2015: Using routinely available information to estimate tropical cyclone wind structure. NCAR/NOAA/CSU Tropical Cyclone Workshop, July 21, Boulder, CO.

Musgrave, K. D., C. J. Slocum, J. A. Knaff, and L. D. Grasso, 2015: Verification of HWRF synthetic satellite brightness temperatures. NCAR/NOAA/CSU Tropical Cyclone Workshop, July 21, Boulder, CO.

Musgrave, K. D., J. A. Knaff, M. DeMaria, C. J. Slocum, L. D. Grasso, A. Schumacher, W. H. Schubert, 2015: Hurricane Forecast Improvement Project – Model post-processing and evaluation. CMMAP Team Meeting, August 6, Fort Collins, CO.

Musgrave, K. D., C. J. Slocum, and A. Schumacher, 2015: Updated real-time website and new products for the 2015 hurricane season. HFIP bi-weekly teleconference, September 9, remote.

Musgrave, K. D., and M. DeMaria, 2015: Development and performance of a statistical-dynamical ensemble technique for tropical cyclone intensity guidance. Workshop on Effective Use of Hurricane Ensembles, November 17, Miami, FL.

Musgrave, K. D., J. A. Knaff, C. J. Slocum, L. D. Grasso, and M. DeMaria, 2016: Examination of tropical cyclone structure through synthetic satellite brightness temperatures. 96th AMS Annual Meeting, January 11-14, New Orleans, LA.

Slocum, C. J., 2015: Diagnosing large-scale tropical cyclone moisture and exploring potential impacts on track and intensity. Young Scientists Student Symposium, October 9, Fort Collins, CO.

Slocum, C. J., W. H. Schubert, and R. K. Taft, 2015: Forced, balanced model of tropical cyclone intensification. CMMAP Team Meeting, August 6, Fort Collins, CO.

Slocum, C. J., 2015: Can comparisons of precipitable water from models and satellite provide guidance on guidance? NCAR/NOAA/CSU Tropical Cyclone Workshop, July 21, Boulder, CO.

PROJECT TITLE: CIRA Support of the Virtual Institute for Satellite Integration Training (VISIT)

PRINCIPAL INVESTIGATORS: Dan Bikos and Bernadette Connell

RESEARCH TEAM: Edward Szoke, Kevin Micke, Elizabeth Little, Isabelle Granger-Frye, Rosemary Borger.

NOAA TECHNICAL CONTACT: Satya Kalluri (NOAA/NESDIS) and Candice Jongsma (NOAA/OAR)

NOAA RESEARCH TEAM: Dan Lindsey (NOAA/NESDIS/STAR/RAMMB)

FISCAL YEAR FUNDING: \$200,000

PROJECT OBJECTIVES:

The primary objective of the VISIT program is to accelerate the transfer of research results based on atmospheric remote sensing data into National Weather Service (NWS) operations. This transfer is accomplished through web based distance learning modules developed at CIRA and delivered to NWS forecasters. There are two types of distance learning methods. The first is teletraining, which is a “live” training session utilizing the VISITview software and a conference call so that there is interaction between instructor and students. The second type is an audio / video playback format that plays within a web-browser. The later type is popular because it may be taken by a student individually whenever they choose. The combination of live teletraining and audio / video playback versions (Fig. 1) reaches out to as broad an audience as possible given the busy schedule of NWS forecasters. Over 25,000 participants have completed VISIT training since April 1999, and most student feedback suggests a direct applicability to current forecast problems. CIRA is also actively involved in tracking of participants, and the collection and summarization of course feedback material. Because the VISIT program has been so successful within the NWS, it is being leveraged for other training activities in the US (Satellite Hydrology and Meteorology Courses (SHyMet), and the GOES-R Proving Ground) and is being utilized by the International community in training programs under the World Meteorological Organization (WMO). For more information on the VISIT program, see: <http://rammb.cira.colostate.edu/visit/>

Specific Objectives:

- 1--Develop and deliver teletraining, recorded modules, and blog entries on the utilization of new satellite products that are available on AWIPS. This includes collaborating with and offering assistance to the GOES-R and JPSS satellite proving ground projects and other NOAA offices in the development and delivery of training materials.
- 2--Conduct monthly virtual “VISIT Satellite Chat” sessions.
- 3--Keep training participation metrics through the NOAA Commerce Learning Center
- 4--Attend meteorological and education conferences and symposiums and participate in other relevant organizational meetings. Engage in Community Outreach.

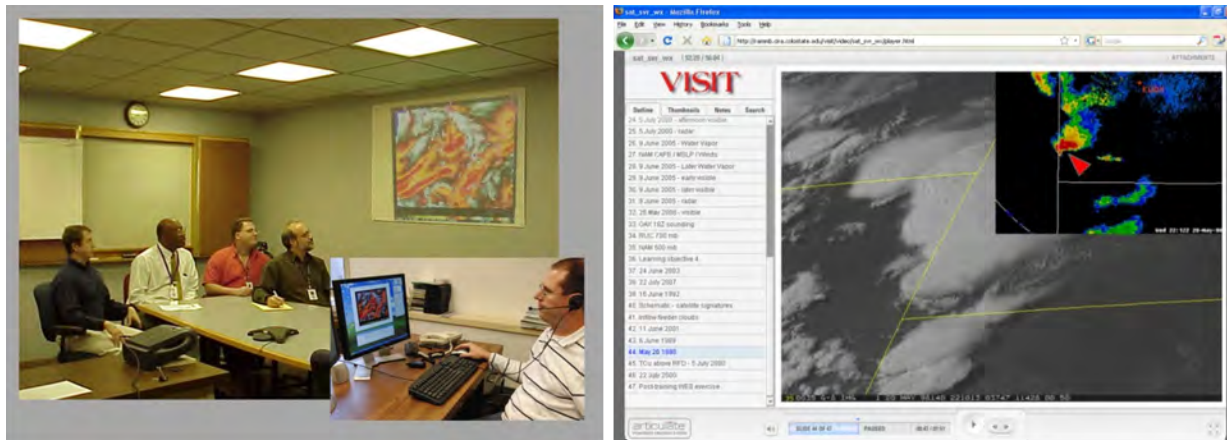

Figure 1. Live VISIT teletraining (left), and audio / video playback VISIT training module (right).

PROJECT ACCOMPLISHMENTS:

1--Training sessions:

- Delivered the training session titled “Applications of RSO Satellite Imagery for Winter Storms”.
- Delivered the training session titled “Introduction to NCC DNB VIIRS imagery in AWIPS” based on a recent VISIT satellite chat session.
- Delivered the training session titled “A Brief Introduction to Social Science: A course for physical scientists”.
- Delivered the training session titled “Use of VIIRS imagery for Tropical Cyclone Forecasting”.
- Delivered the training session titled “Can total lightning help with warnings for non-supercell tornadoes”?
- Delivered the training session titled “Tracking the Elevated Mixed Layer with a new GOES-R water vapor band”.
- Updated the training session titled “An Overview of Tropical Cyclone Track Guidance Models used by NHC”.
- Updated the training session titled “An Overview of the Tropical Cyclone Intensity Guidance Models used by NHC”.

VISIT blog:

- The blog is intended to open the doors of communication between the Operational, Academic and Training Meteorology communities. The blog averages around 300 views per week and is located here: <http://rammb.cira.colostate.edu/training/visit/blog/>

2--VISIT Satellite Chat:

- Since February 2012, the VISIT team has led monthly chat sessions to discuss recent significant weather events with the objective of demonstrating satellite products that can be applied to operational forecasting. These sessions are brief and often lead to products being made available or further discussed in the VISIT blog. In the past year, the following external presenters led these sessions:
 - Todd Lindley (NOAA/NWS WFO Norman, OK) on utilization of GOES-14 SRSOR 1-minute imagery for fire weather applications.
 - Rich Grumm (NOAA/NWS WFO State College, PA) on a recap of the 22-23 January 2016 Mid-Atlantic Blizzard.
 - Curtis Seaman (CIRA) on an introduction to VIIRS DNB NCC imagery.
 - Chris Landsea (NOAA/NWS/NHC) on African Easterly Wave Identification by satellite imagery.
 - Sheldon Kusselson (retired NOAA/NESDIS/SAB) on the 3-4 October 2015 flood event over South Carolina.
 - Alex Tardy (NOAA/NWS WFO San Diego, CA) on wildfire, haboob and heavy rainfall associated with Hurricane Dolores on 17-19 July 2015.

Recorded sessions are located here: http://rammb.cira.colostate.edu/training/visit/satellite_chat/

3--VISIT training metrics April 1, 2015 – March 2, 2016:

--Live teletraining: 60 sessions delivered to 271 participants.

Audio / video playback (through NOAA's Learning Management System as well as directly through CIRA's web interface): 344 participants.

4--Community Outreach:

--After-school weather club: Scientists at CIRA and CSU students, who are also members of the local AMS chapter of Northern Colorado called FORTCAST (Fort Collins Atmospheric Scientists), volunteered for the after-school weather club on Tuesdays for Putnam Elementary (K-5). During the fall, 2 sessions were coordinated with the kindergarten/first grade Science Explorers club. The kids touched clouds and learned about cloud types, and also made pinwheel anemometers and learned about wind. The winter session ran for 8 weeks during January through early March 2016. There was a 90 minute session each week. Sessions included helping with homework, leading a physical activity and then focusing on a science activity. The topics covered included wind speed and direction, clouds, colors of the rainbow, snow, things that spin (tornado in a bottle and gyroscopes), freezing solids (ice cream!), as well as measurements that are associated with these weather occurrences. Volunteers included Bernie Connell, Matt Rogers, and Erin Dagg. Putnam has a coordinator who is responsible for matching students with clubs, assigning classrooms, providing snacks, and providing transportation – which is great!

Publications:

Bikos, D., Finch, J., Case, J.L., 2016: The environment associated with significant tornadoes in Bangladesh. *Atmos. Res.*, 167, 183-195. doi: 10.1016/j.atmosres.2015.08.002.

Longmore, S.P., S.D. Miller, D. Bikos, D.T. Lindsey, E.J. Szoke, D.A. Molenaar, D.W. Hillger, R.L. Brummer and J.A. Knaff, 2015: An Automated Mobile Phone Photo Relay and Display Concept Applicable to Operational Severe Weather Monitoring. *J. Atmos. Oceanic Technol.*, 32, 1356–1363.

Presentations:

Bikos, D., S. Lindstrom, S. Bachmeier, B. Connell, and E. Szoke, 2015: 1-minute Imagery Training Resources available from VISIT/SHyMet. NOAA Satellite Proving Ground / User Readiness Week, 15-19 June, Kansas City, Missouri.

Bikos, D., B. Connell, E. Szoke, S. Bachmeier, S. Lindstrom, A. Mostek, and B. Motta, 2015: VISIT and SHyMet Training in Preparing Forecasters for GOES-R. Poster, National Weather Association (NWA) Annual Meeting, 17-22 October, Oklahoma City, Oklahoma.

Connell, B. 2015: Training resources from the US and access to data and imagery: ways to find them in the acronym soup. Virtual Presentation, WMO VLab Virtual Event Week "Preparing for the Next Generation Satellite Imagery", 16-20 November, <http://www.wmo-sat.info/vlab/next-generation-of-satellites/>

Connell, B., S. Miller, D. Bikos, E. Szoke, S. Bachmeier, S. Lindstrom, A. Mostek, B. Motta, L. Veeck, 2016: JPSS and GOES-R User Readiness through Training: VISIT, SHyMet, WMO VLab and a new Liaison. 12th Annual Symposium on New Generation Operational Environmental Satellite Systems at the 96th AMS Annual Meeting, New Orleans, Louisiana, 10-14 January.

Connell, B., D. Bikos, E. Szoke, S. Lindstrom, and S. Bachmeier, 2015: Satellite Training from the Cooperative Institutes: VISIT and SHyMet Programs. Presentation, NOAA Satellite Conference, 27 April – 1 May, Greenbelt, Maryland.

Szoke, E.J., 2016: Talks on GOES-R Proving Ground updates at the Boulder Weather Forecast Office (WFO) Spring Workshops on 4 & 11 March 2016.

Szoke, E., D. Bikos, R Brummer, H. Gosden, D. Lindsey, D. Molenaar, D. Hillger, S. Miller, and C. Seaman, 2015: CIRA's NWS Proving Ground activities as we approach the launch of GOES-R, 40th Annual Meeting, Oklahoma City, Oklahoma, 19-22 October, National Weather Association. Poster CP-55.

Szoke, E.J., D. Bikos, R. Brummer, H. Gosden, D.T. Lindsey, D. A. Molenaar, D.W. Hillger, S.D. Miller and C.J. Seaman, 2015: An update on CIRA's Proving Ground efforts as we approach the launch of GOES-R. AMS 27th Conference on Weather Analysis and Forecasting/23rd Conference on Numerical Weather Prediction, 29 June-3 July, Chicago, Talk 15B.5.

PROJECT TITLE: CSU/CIRA Support for ATMS SI Traceable Calibration Effort

PRINCIPAL INVESTIGATORS: Christian Kummerow, Thomas VonderHaar

RESEARCH TEAM: Wes Berg, ATS, John Forsythe and Heather Cronk

NOAA TECHNICAL CONTACT: Fuzhong Weng, NOAA/NESDIS

NOAA RESEARCH TEAM: Ninghai.Sun NOAA/NESDIS/STAR/SMCD

FISCAL YEAR FUNDING: \$100,000

PROJECT OBJECTIVE(S):

To assess the calibration differences between ATMS water vapor channels and the corresponding channels on the newly available GMI instrument on board the GPM satellite. Given GPM's 65° inclination, frequent coincident overpasses are available with NPP/ATMS. We plan to use a double difference approach to compare radiances during these satellite coincidences. Specifically, we will perform the following tasks:

- 1--Apply geophysical retrievals from a 1DVAR retrieval developed for GPM GMI as a basis for double difference computations to assess the accuracy and stability of ATMS and GMI channel differences. Compare with double difference results based on geophysical parameters from ECMWF interim reanalysis.
- 2--Investigate calibration changes/differences using specified double difference approach for both NPP ATMS SDR reprocessing and ATMS on board JPSS1 once data becomes available.
- 3--Double differences between ATMS and SAPHIR data from Megha-Tropiques will also be computed to investigate calibration consistency for channels without GMI counterparts.
- 4--Investigate impact of differences between state-of-the-art radiative transfer models on the resulting double differences. This will include both ocean emissivity models for window and/or semi-transparent water vapor channels as well as atmospheric absorption models.

- 5--Use in-situ observed from field programs including DYNAMO in late 2011 to investigate differences between simulated and observed brightness temperatures over clear-sky and non-precipitating ocean scenes to compare with 1DVAR results (using TRMM TMI) and investigate radiative model sensitivities.
- 6--Report results to the ATMS SDR team.

PROJECT ACCOMPLISHMENTS:

During the past year much of the focus of this project has been on developing and adapting a 1DVAR geophysical retrieval algorithm for non-precipitating ocean scenes and using the retrieved parameters to investigate double differences between GPM GMI and NPP ATMS. Previous double difference comparisons have relied on geophysical parameters from global model analyses such as the ECMWF Interim reanalysis. Results to date indicate that geophysical parameters including water vapor profile information from the 1DVAR retrieval significantly reduce the scatter in the double differences between sensors versus using model analyses. This is particularly important for channels with significant sensitivity to water vapor and the associated vertical profile. Figure 1 shows a comparison between using the 1DVAR versus ECMWF Interim reanalysis for a 3-month comparison of double differences between GPM GMI and MHS on board METOP-A.

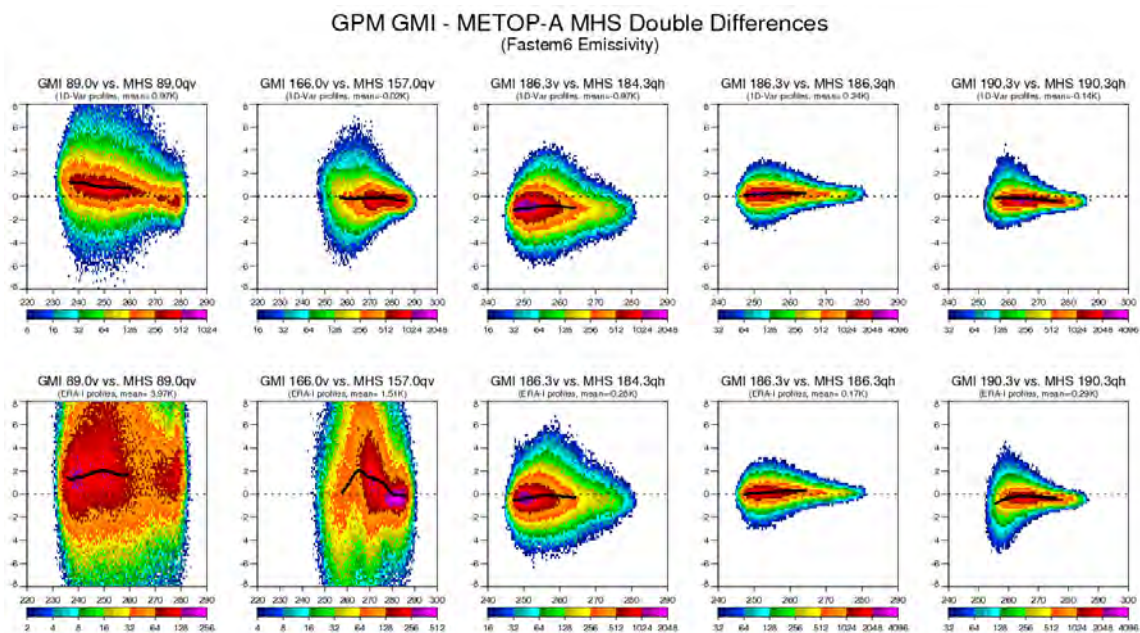

Figure 1. Comparison of double difference results between GPM GMI and METOP-A MHS using 1DVAR retrievals (top row) and ECMWF Interim reanalysis (bottom row). Colors indicate density of individual values while black line shows mean double difference values binned by GMI Tb (x-axis).

Initial comparisons between GPM GMI and NPP ATMS were done using both the 1DVAR and ERA-Interim parameters. In addition, two different ocean surface emissivity models were used include one from Remote Sensing Systems (RSS) and the latest FASTEM6 model in the Community Radiative Transfer Model (CRTM). Results are shown in Table 1.

Table1. Double differences between GPM GMI and NPP ATMS using different geophysical parameters (1DVAR and ERA-Interim) and ocean emissivity models (RSS and FASTEM6).

Geophys Params	Emis Model	23qv	31qv	88qv	165qh	183±1qh	183±1.8qh	183±3qh	183±4.5qh	183±7qh
1D-Var	FASTEM6	-1.51	-1.61	1.05	0.27	-1.88	-0.46	0.56	1.20	0.42
1D-Var	RSS	-0.14	-0.42	-0.31	1.03	-1.89	-0.47	0.56	1.20	0.40
ERA-Interim	FASTEM6	-1.25	-1.90	4.43	0.88	-1.37	-0.33	0.38	0.72	0.15
ERA-Interim	RSS	0.11	-0.67	3.13	1.57	-1.39	-0.33	0.37	0.73	0.13

The results shown in Table 1 indicate significant sensitivity to the ocean emissivity model for the window channels. The results also show that the 1DVAR retrievals have the most impact on the 88 and 165 GHz channels, which have significant sensitivity to water vapor as well as the ocean surface. Investigation of the model and parameter sensitivity is ongoing using in-situ surface flux and radiosonde observations taken during the DYNAMO campaign over the equatorial Indian ocean in late 2011.

Finally, Figure 2 shows a comparison of double differences as a function of ATMS scan position using the RSS and FASTEM6 emissivity models. While the opaque water vapor channels show no sensitivity as expected, there are significant differences in both the mean and cross-track patterns for the window and semi-transparent water vapor channels.

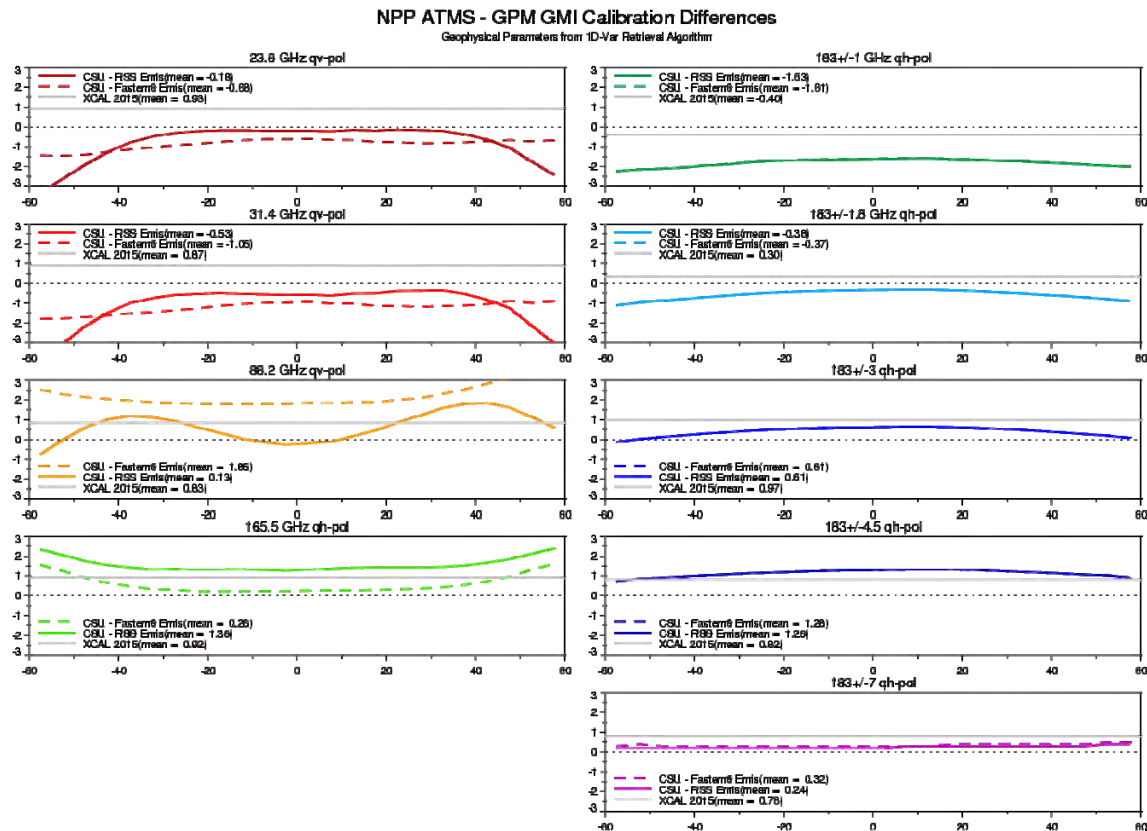

Figure 2. Double differences between GPM GMI and NPP ATMS as a function of ATMS scan position using both the RSS and FASTEM6 ocean emissivity models.

During the past year we have also regularly attended the ATMS SDR bi-weekly telecons and have presented some results from the GPM XCAL team and a workshop on errors and uncertainties in the 183 GHz channels.

PROJECT TITLE: CSU/CIRA Support for ATMS SI Traceable Calibration Effort.

Part 2: Demonstration of a Global Total Precipitable Water Climate Data Record

PRINCIPAL INVESTIGATORS: Chris Kummerow / Tom Vonder Haar

RESEARCH TEAM: Heather Cronk, Chris Kummerow, Tom Vonder Haar, Wes Berg, John Forsythe

NOAA TECHNICAL CONTACT: Fuzhong Weng, NOAA/NESDIS/STAR/SMCD

NOAA RESEARCH TEAM: Fuzhong Weng, NOAA/NESDIS/STAR/SMCD

PROJECT OBJECTIVES:

1--Examine differences in total precipitable water (TPW) retrievals between various passive microwave retrieval algorithms which may be used in reference environmental data record creation. The retrievals which were compared are the 1DVAR method of Elsaesser and Kummerow (2008; referred to as EK2008), the NOAA Microwave Integrated Retrieval System (MIRS, Boukabara et al. 2011), and the 1DVAR GPM GMI retrieval developed at CSU (Duncan and Kummerow, 2016).

2--Demonstrate creation of global TPW fields using current a current operational sensor (DMSP F18 SSMIS) and quantify the impact of sensor intercalibration on TPW retrievals via the new GPM GMI sensor.

PROJECT ACCOMPLISHMENTS:

1--Daily fields of TPW were retrieved for July 2014 and January 2015 from DMSP F18 and GPM GMI. A series of difference maps and scatter plots were created for the three algorithms compared.

2--Using monthly average difference maps (Figure 1), our investigation revealed regional biases in TPW introduced by the assumptions in the EK2008 retrieval. As compared to the MIRS retrievals, EK2008 TPW is higher along the ITCZ region and lower in the mid-latitudes. As compared to GMI, EK2008 retrieves higher values of TPW at almost all latitudes, with a particularly high bias in the ITCZ region. There are pockets in the Northern Hemisphere mid-latitudes and near Antarctica where EK2008 values of TPW are less than GMI. These areas are more pronounced in January 2015.

3--Monthly average scatter plots (shown in Figure 2) reveal that, compared to MIRS in the same location, EK2008 retrieved TPW is generally higher for high (> 50mm) values. For mid-values of TPW (30-35mm), the MIRS retrieved TPW tends to be higher than EK2008, a phenomenon that is more apparent in the monthly averages. When comparing EK2008 to GMI retrievals, there is a much less coherent correlation in the daily TPW values but for the monthly averages, there is a tendency for the EK2008 TPW value to be higher than GMI as values of TPW increase.

4--These results provide valuable insights into the regional difference of passive microwave retrievals of TPW which could be used to guide future construction of multidecadal reference environmental data records.

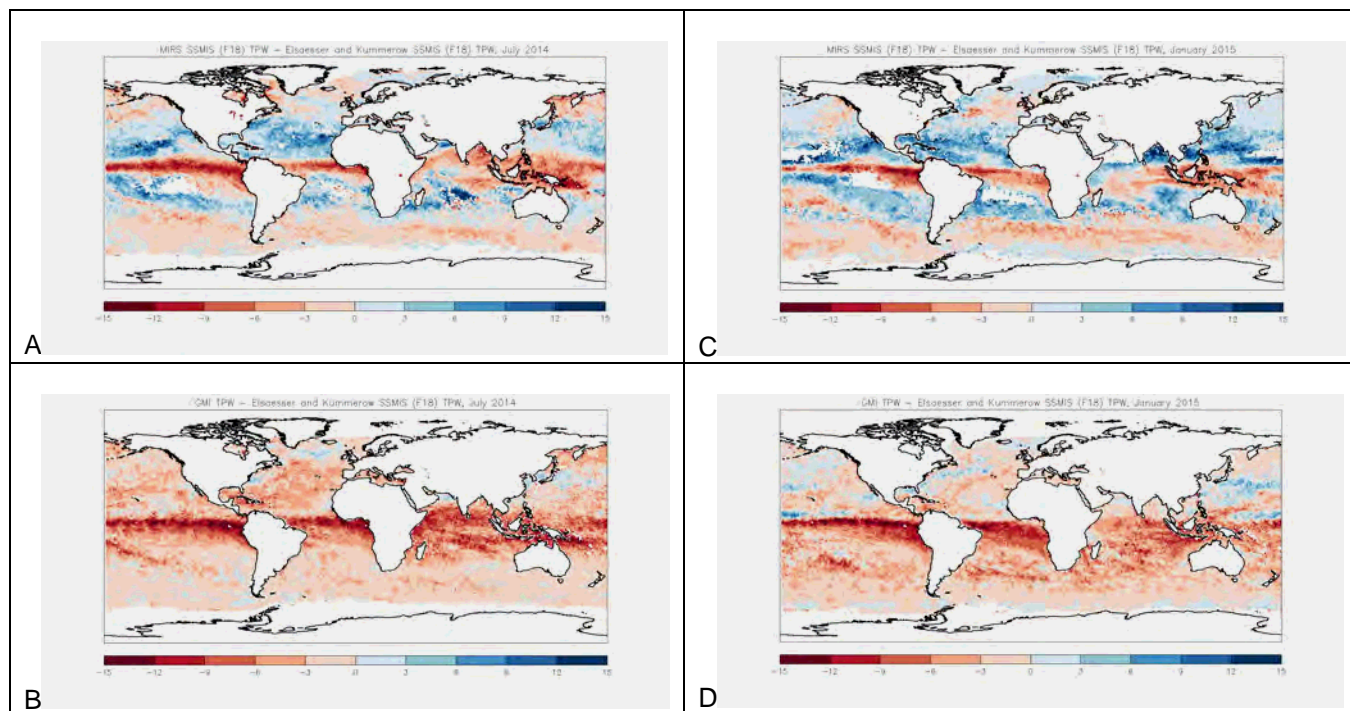

Figure 1. Monthly average TPW difference maps for MIRS F18 - EK2008 and GMI - EK2008 for July 2014 (A and B, respectively) and January 2015 (C and D, respectively).

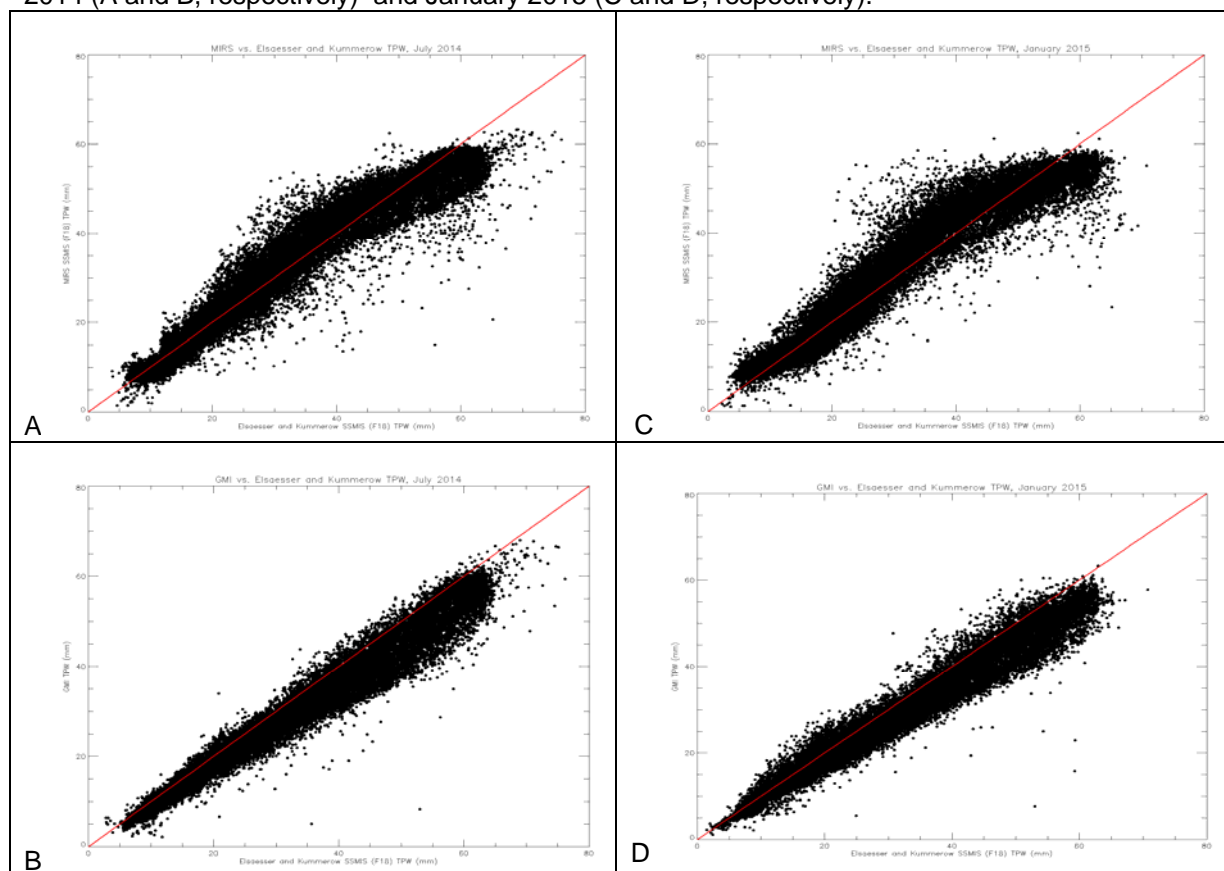

Figure 2. Monthly average TPW scatter plots for MIRS F18 - EK2008 and GMI - EK2008 for July 2014 (A and B, respectively) and January 2015 (C and D, respectively). EK2008 plotted on abscissa.

References:

- Boukabara, S.-A., et al., 2011: MiRS: An All-Weather 1DVAR Satellite Data Assimilation and Retrieval System. *IEEE Trans. Geosci. Remote Sens.*, **49**, 3249-3272.
- Duncan, D. I., and C. D. Kummerow, 2016: A 1DVAR Retrieval Applied to GMI: Algorithm Description, Validation, and Sensitivities. *Submitted to Journal of Geophysical Research: Atmospheres*.
- Elsaesser, G. S. and C. D. Kummerow, 2008: Towards a fully parametric retrieval of the non-raining parameters over the global ocean. *J. Appl. Meteor. & Climatol.*, **47**, 1590 – 1598.

Publications:

Brognez, H., English, S., Mahfouf, J.-F., Behrendt, A., Berg, W., Boukabara, S., Buehler, S. A., Chambon, P., Gambacorta, A., Geer, A., Ingram, W., Kursinski, E. R., Matricardi, M., Odintsova, T., Payne, V., Thorne, P., Tretyakov, M., and Wang, J.: A review of sources of systematic errors and uncertainties in observations and simulations at 183GHz, *Atmos. Meas. Tech. Discuss.*, doi:10.5194/amt-2016-9, in review, 2016.

Duncan, David and Christian D. Kummerow, A 1DVAR Retrieval Applied to GMI: Algorithm Description, Validation, and Sensitivities, submitted January 2016 to *J. Geophys. Res. Atmospheres*.

PROJECT TITLE: Integrating GPM and Orographic Lifting into NOAA's QPE in Mountainous Terrain

PRINCIPAL INVESTIGATORS: Edward Szoke, Dan Bikos, Steve Miller, Christian Kummerow

RESEARCH TEAM: Stanley Kidder, Cindy Combs, Paula Brown, Mel Nordquist

NOAA TECHNICAL CONTACT: Paul Neiman (NOAA/ESRL/PSD)

NOAA RESEARCH TEAM: Paul Neiman (NOAA/ESRL/PSD)

FISCAL YEAR FUNDING: \$0

PROJECT OBJECTIVES:

This project sought to improve the quantitative precipitation estimate (QPE) over mountainous terrain by combining the Global Precipitation Mission (GPM) satellite precipitation estimate with the Orographic Rain Index (ORI). The GPM consists of a dual frequency radar and microwave radiometers for precipitation estimates. Over mountainous terrain, the microwave radiometer estimate has limitations where orographic enhancement may not correlate with an abundance of additional ice particle production in certain atmospheric conditions (i.e., warm rain, high precipitation efficiency processes). The dual frequency radar, however, does not have these limitations since its retrievals are nearly insensitive to the character of the underlying surface. Over mountainous terrain, the only negative impact caused by the surface is clutter. There were two objectives of this study: 1) to compare estimates of precipitation from the dual frequency radar with the microwave radiometer for Atmospheric River events along the West Coast in regions where terrain is significant (i.e. coastal mountain ranges), and 2) to compare ORI with the estimates of precipitation over coastal mountain ranges to assess if ORI can add value to the microwave radiometer estimates. Two measures of "ground truth" were used, 1) the land-based radar estimate of precipitation rate from the NMQ (National Mosaic and Q2 system) and 2) the GPM dual frequency radar. We were able to collect two fairly complete cases and these are illustrated below. More cases would have been desirable, but it turned out to be another abnormally dry rainy season for the

West Coast. Complicating matters further, when the limited number of events did arrive they were not timed well with GPM passes. As a result we can only make limited assessments regarding the objectives noted above, with our main conclusion that the GPM precipitation estimates were not ideal over mountainous terrain and that ORI did show potential to positively modify these estimates.

PROJECT ACCOMPLISHMENTS:

This project was mostly completed by the end of last year. The project objectives/milestones were:

1-- Collect cases of Atmospheric River events along the West Coast as GPM passes were available.

The team monitored the West Coast for Atmospheric River events. During these events, it was determined if a GPM pass was available, if so, then it was analyzed (for accomplishment #2).

2-- Analysis of available cases, compare GPM dual frequency radar with microwave radiometer precipitation estimate.

From the available cases, the GPM dual frequency radar was compared with the microwave radiometer precipitation estimate. These were compared over ocean and coastal mountain ranges as available. An example case study from 12 December 2014 is shown in Figs. 1-2.

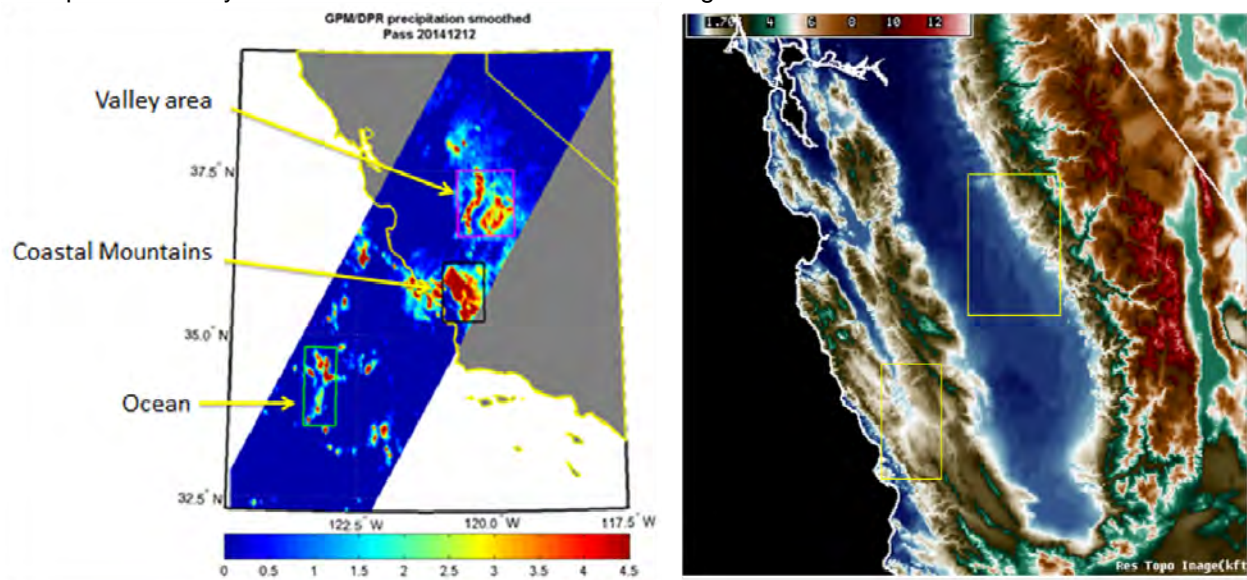

Figure 1. GPM dual frequency radar pass at 1500 UTC 12 December 2014 (left) and terrain (right; kft.). This identifies the 3 boxes that were selected, 2 of which are detailed in Fig. 2.

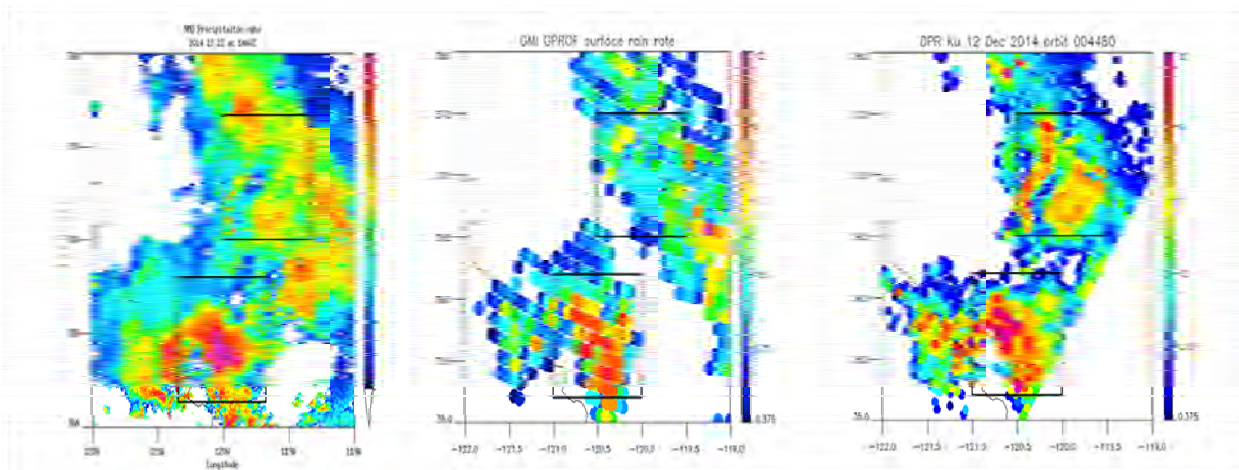

Figure 2. NMQ precipitation rate at 1444 UTC 12 December 2014 (left), GPM microwave radiometer pass at 1500 UTC 12 December 2014 (middle), GPM dual frequency radar pass at 1500 UTC 12 December 2014 (right). This illustrates some of the issues with the microwave radiometer over higher terrain, note the lower precipitation rates in the middle panel compared to the left / right panels.

3-- Compare ORI with GPM precipitation estimates from the microwave radiometer

Assess the impact of ORI on GPM precipitation estimates from the microwave radiometer. Could the ORI product add value to the GPM microwave radiometer estimates over regions of terrain? An example case study from an Atmospheric River event on 7 February 2015 is shown in Fig. 3-4.

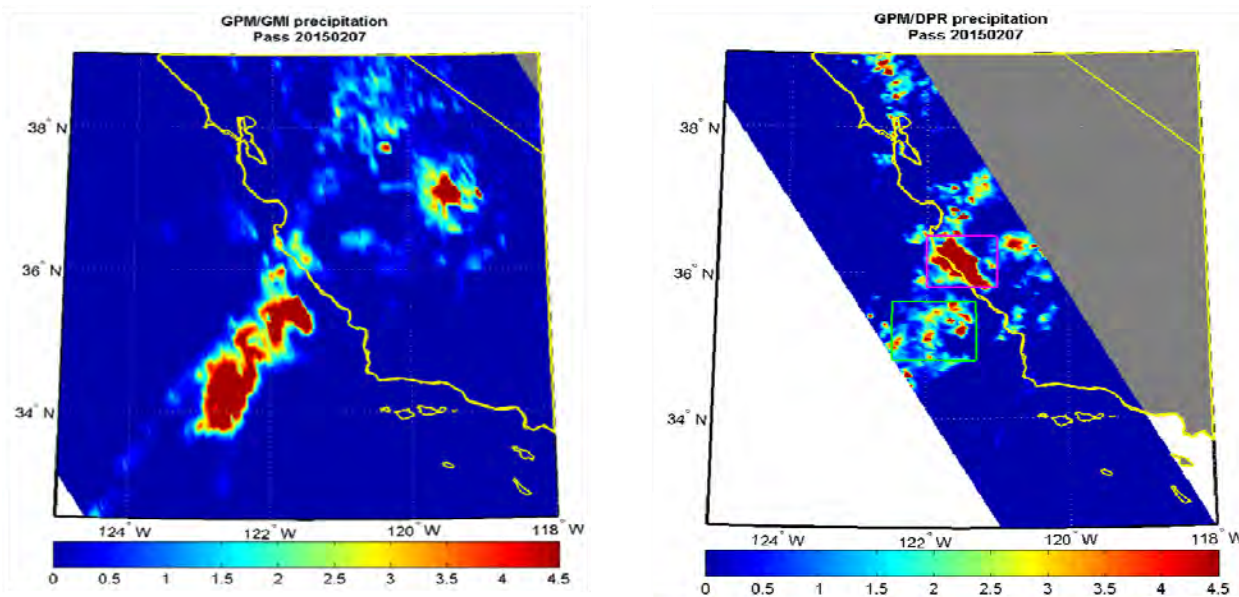

Figure 3. GPM precipitation from the microwave radiometer (left) and dual frequency radar (right) approximately 1500 UTC 7 February 2015. This sector is over central coastal California. For this case, over the magenta box, we see that precipitation rates are lower from the microwave radiometer compared to the dual frequency radar within this region of coastal mountains. This is an area where ORI has the potential to add value (increase) to the microwave radiometer precipitation rate estimates.

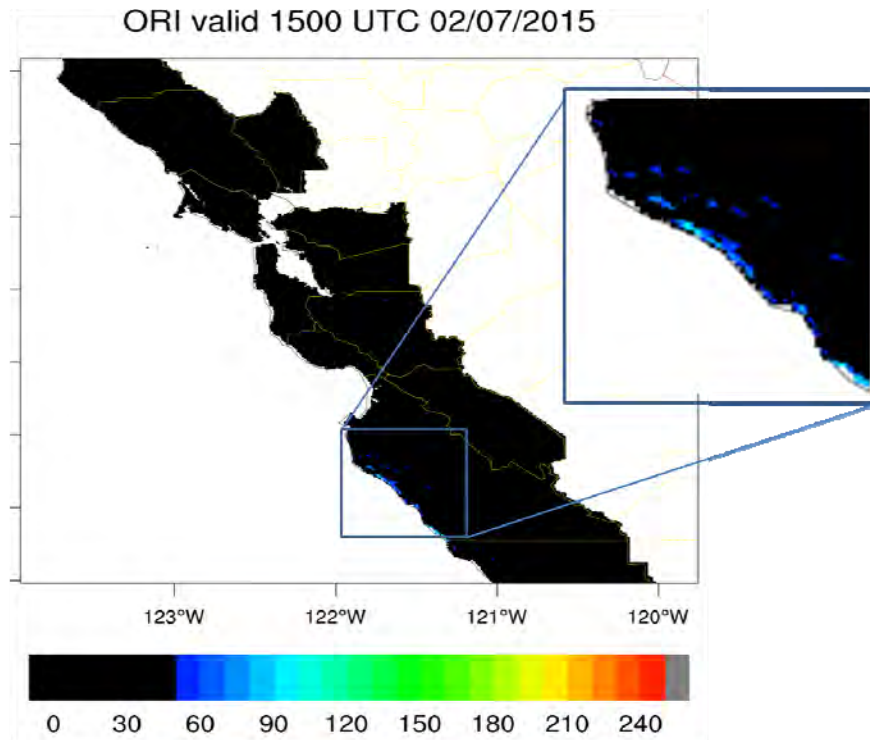

Figure 4. ORI product valid 1500 UTC 7 February 2015 (same time as Fig. 3) over central coastal region of California. Higher ORI values are observed within the box where the coastal range rises abruptly (highlighted insert). This suggests that ORI could adjust the microwave radiometer precipitation rate estimates upward, where they were observed to be too low.

Publications: None

Presentations:

Bikos, D., E. Szoke, S. Miller, S. Kidder, C. Kummerow, C. Combs, S. Longmore, and P. Brown, 2015: An orographically adjusted GPM precipitation retrieval for NOAA's QPE over mountainous terrain. Poster, NOAA Satellite Science Week, 23-27 February 2015, Boulder, Colorado.

PROJECT TITLE: NESDIS Environmental Applications Team – Prasanjit Dash, Research Scientist - NOAA SST Quality Monitor (SQUAM)

PRINCIPAL INVESTIGATOR(S): Steve Miller/Cliff Matsumoto

RESEARCH TEAM: Prasanjit Dash

NOAA TECHNICAL CONTACT: Alexander Ignatov

NOAA RESEARCH TEAM: Yury Kihai, John Stroup

FISCAL YEAR FUNDING (NEAT Total): \$1,764,742

PROJECT OBJECTIVE(S):

- 1--Work on initial set up of geo SQUAM for
 - a. Himawari-8 AHI products – NOAA ACSPO (primary focus)
 - b. Himawari-8 AHI products – JAXA, Japan (secondary focus)
 - c. Himawari-7 (MTSAT2) – NOAA OSPO (tertiary focus)
- 2--ACSPO VIIRS L2P in SQUAM against L4 & *in situ* (primary focus)
 - d. Sustain NRT production
 - e. Support ACSPO VIIRS L2P stewardship (efforts with Univ. of Wisconsin)
- 3--Collaborate with John Stroup to establish ACSPO VIIRS L3U in SQUAM against L4/*in situ*
- 4--Coordinate with Xinjia Zhou on redesign of AVHRR GAC SQUAM module, display GAC RAN data
- 5--Sustain community VIIRS L2P in SQUAM against L4 & *in situ* (secondary focus)
 - f. NAVO
 - g. Sustain IDPS as long as it is produced. Consider discontinuing after that.
- 6--Support evaluation of skin and bulk SSTs developed by Boris Petrenko, for both HR/FRAC and GAC. Provide support to analyze performances of these experimental products offline. Consider making operational as deemed necessary.
- 7--Work with Yury Kihai and Xinjia Zhou on updated validation using new match-up code, and iQuam2
- 8--Watch for data outages in SQUAM (gaps, incompleteness) and individually replace for those selected days (technical real-life issues), with a primary focus on ACSPO products.
- 9--Uniformly regenerate *in situ* validation for AVHRR GAC (HR is complete).
- 10--Technical support/development as required (new browsers compatibility, SQUAM framework, functionality, automation *etc.*)
- 11--Explore reinstatement of L4 SQUAM module. Consider including newer SSTs (incremental work).
- 12--Explore including Sentinel-3 SLSTR SST, when available, against L4 & *in situ*.
- 13--Additional research (non routine) and support to the team/PI
- 14--Other professional activities (routine and/or based on external requests, professional participation).

PROJECT ACCOMPLISHMENTS:

1--Work on initial set up of geo SQUAM for ...

1 (a, b and c): Designed and implemented a set-up for monitoring of geostationary SST products in the SST Quality Monitor (SQUAM), keeping in view long-term sustainability and expandability to multi-mission products. The URL for the GEO SQUAM is: <http://www.star.nesdis.noaa.gov/sod/sst/squam/GEO/>

Currently the following SST products have been included to generate maps, histograms and time-series of standard statistical parameters: Himawari-8 (H8) AHI NOAA ACSPO, H8 JAXA and Himawari-7 (MTSAT2) NOAA OSPO products. The historical MTSAT2 product was officially discontinued at NOAA on Dec-04, 2015.

This work, in general, is heavy because of data volume; also including external products (e.g., JAXA) is important because of partnerships and for intercomparison of in-house ACSPO products with others.

Time series plots of intercomparison of 3 GEO products are shown below in Figure 1.

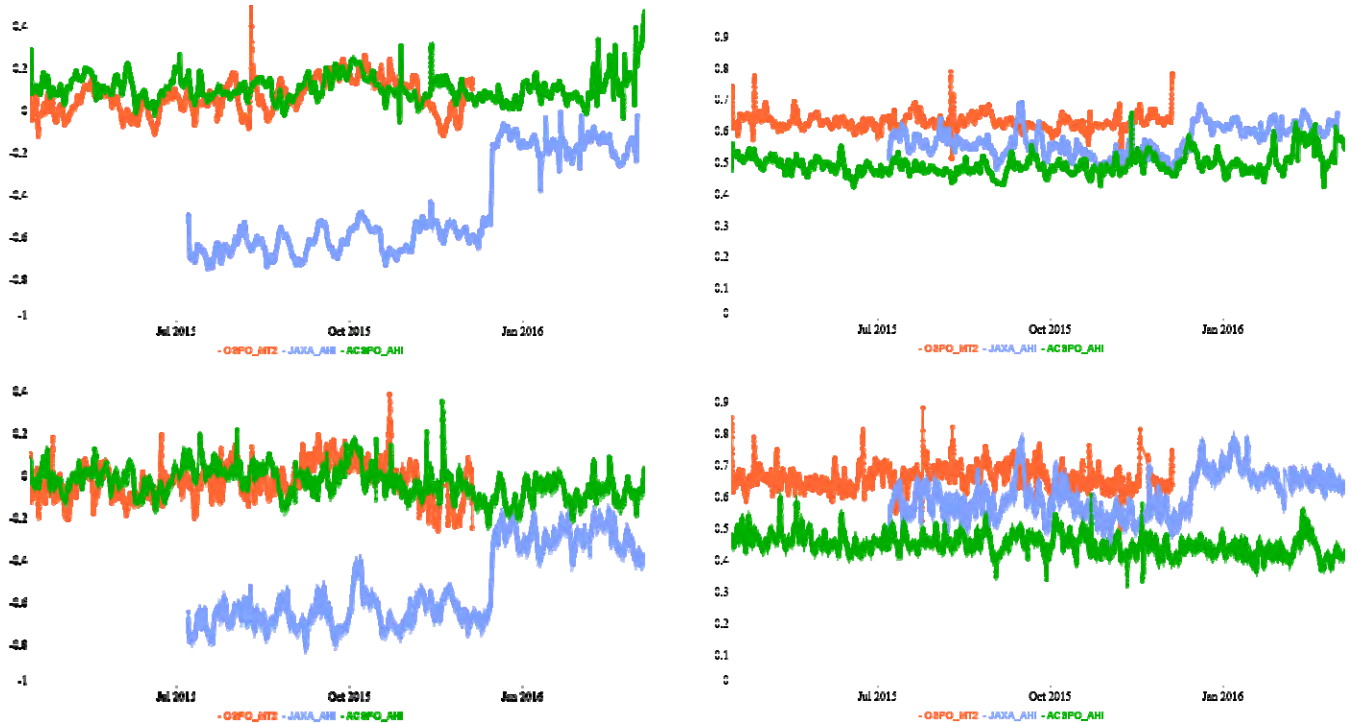

Figure 1. Comparison of MTSAT2 (OSPO) and Himawari-8 (ACSPO and JAXA) SSTs. The plots have been smoothed for a better visual representation of representative values. Top-panel: comparison against OSTIA; Bottom-panel: wrt. Drifters+Tropical moorings. Left-panel: mean SST differences; Right-panel: standard deviation.

A typical diurnal variation of Geostationary SSTs over a period of 24hours is shown in Figure 2. The reference used here is OSTIA (which is a daily product). An average variation for the full-disk is seen to be about 0.3K (max – min).

Figure 2 also shows that while the shapes of the two diurnal variation curves are similar, the magnitudes are different. Put simply, JAXA SST values are colder than those of ACSPO (Figure 2), which is due to two reasons: (a) JAXA SSTs are skin-SSTs and is expected to be colder by ~0.17K (b) there was a cold bias in JAXA product, which they corrected after we informed them based on these analyses.

The effect of this correction (mean time-series before and after this recovery) is shown in Figure 3.

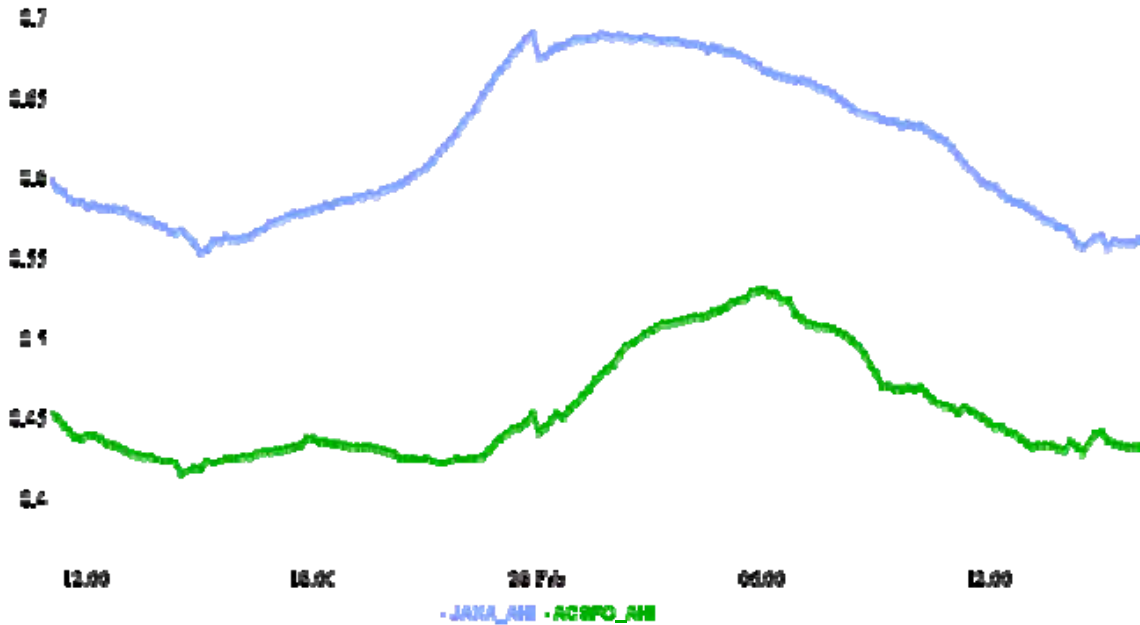

Figure 2. Typical diurnal variations within a 24h period seen from Himawari-8 SSTs produced by NOAA ACSPO and JAXA processor. In general, the shapes of the curves are identical, but the values differ with JAXA being colder.

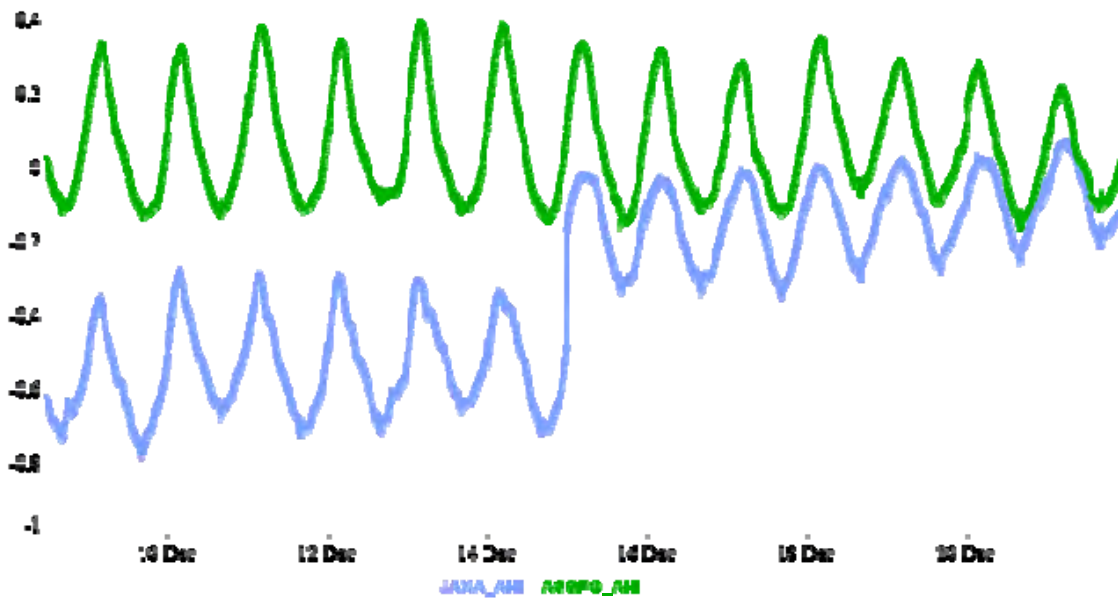

Figure 3. Mean SST differences (Himawari-8 SST – OSTIA) for ACSPO and JAXA. Initially, JAXA had an inexplicable cold bias. It was noticed and notified after SQUAM analyses and our JAXA colleagues identified the cause and fixed it. The effect of the recovery is seen on Dec-15, 2015.

2 ACSPO VIIRS L2P in SQUAM against L4 & in situ (primary focus)

2a--Sustained <http://www.star.nesdis.noaa.gov/sod/sst/squam/HR/>

2b--I supported monitoring and analyses of ACSPO VIIRS L2P stewardship: generated codes to perform the stewardships monitoring in SQUAM, created web presentation facilities and made test runs. Also, performed trouble shooting under tight deadlines (e.g., find leaking non-sense values in data due to the effect of machines and reported to John Stroup).

I have provided the Univ. of Wisconsin Stewardship SQUAM processing package to John Stroup in mid-2015, who runs it on UW super-computation facilities.
(Viewgraphs are excluded here, which are similar to standard HR-SQUAM diagnostics).

3--Collaborate with John Stroup to establish ACSPO VIIRS L3U in SQUAM against L4/in situ

I have developed the web facilities and codes for this purpose, did initial processing for several months, and then provided a package to John Stroup. Yury Kihai generated the codes necessary for creating *in situ* matches. All the results are available at: <http://www.star.nesdis.noaa.gov/sod/sst/squam/L3/>
(newer results are excluded from here as they are available online following the link given above)

4--Coordinate with X. Zhou on redesign of AVHRR GAC SQUAM module, display GAC RAN data

Done – provided the necessary support.

(Real-time ACSPO GAC analyses has been suspended and will be replaced with results of reanalyzed GAC products that will have an improved quality and longer time series – Xinjia Zhou and Sasha Ignatov are coordinating this RAN effort)

5--Sustain community VIIRS L2P in SQUAM against L4 & in situ (secondary focus)

5a--NAVO: sustained. It also involved some code changes to accommodate for changes in NAVO data that initially had a zenith angle cut-off. This cut-off was lifted off in Jun, 2015.
<http://www.star.nesdis.noaa.gov/sod/sst/squam/HR/>

5b--IDPS sustained

6--Support evaluation of skin and bulk SSTs developed by Boris Petrenko, for both HR/FRAC and GAC. Provide support to analyze performances of these experimental products offline. Consider making operational as deemed necessary.

Done – This was a heavy lifting as well, as both GAC and HR products generated by ACSPO are analyzed for two additional 'experimental' products. The term RBR denotes 'SST with SSES bias applied' and the term HYB indicates 'Hybrid' algorithm.

Experimental ACSPO GAC products are monitored at:
http://www.star.nesdis.noaa.gov/sod/sst/squam/ACSPOGAC/index_exp.html

Figure 4 shows nighttime validation of ACSPO GAC Experimental products with 'SSES bias applied - RBR'.

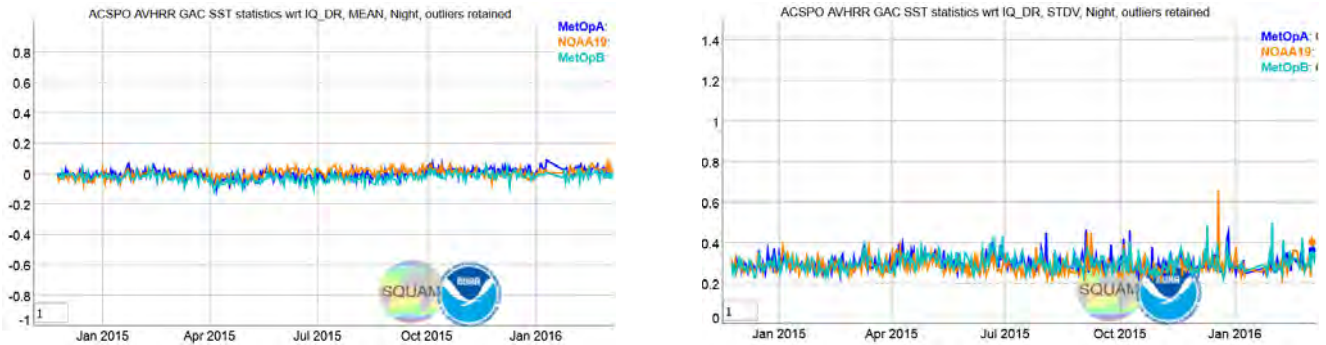

Figure 4. Nighttime validation of ACSPO experimental GAC products against drifters. Left: mean SST biases; Right: standard deviation (NOAA 18 is excluded due to degraded quality of the AVHRR sensor).

Experimental ACSPO HR products are monitored at:
http://www.star.nesdis.noaa.gov/sod/sst/squam/HR/index_exp.html

Time series plots for HR experimental products, similar to those for GAC as shown in Figure 4, are available at the web-link provided above. Figure 5 shows density distribution of NRT ACSPO and Experimental ACSPO (RBR) SST against CMC SST, for comparison purposes.

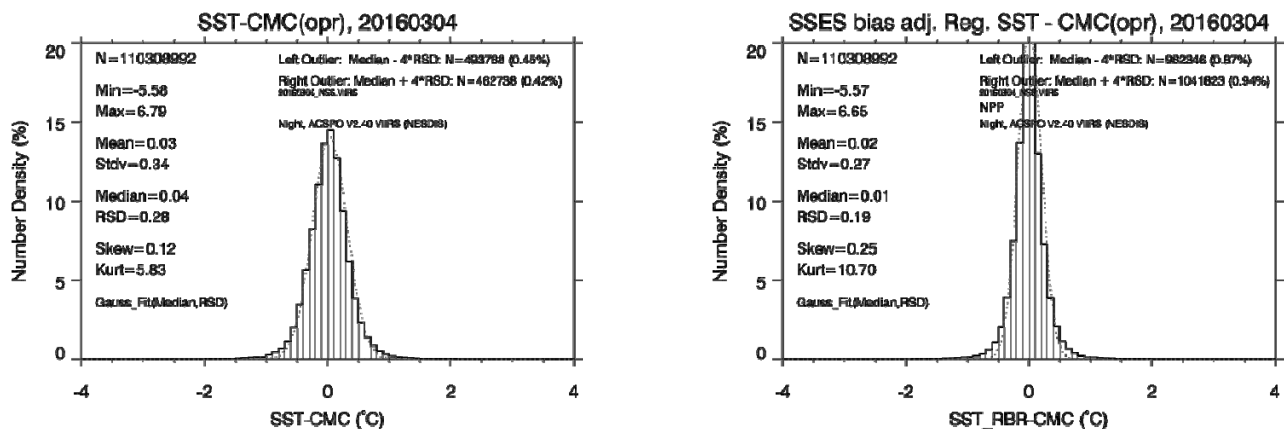

Figure 5. Nighttime comparison of ACSPO VIIRS NRT (left) and Experimental (right) SSTs against CMC. The annotated statistical parameters indicate the improvement in experimental product when SSES (single sensor error statistics) biases are applied. (This work of generating SSES parameters is performed by Boris Petrenko and Yury Kihai and I have contributed to routinely monitoring the improvements).

7--Work with Y. Kihai and X. Zhou on updated validation using new match-up code, and iQuam2.

Partially Done – I have implemented using the in situ matches generated by an improved philosophy for GEO-SQUAM module. For polar orbiters, this needs to be done by someone else and the GEO code may be used as a template.

8--Watch for data outages in SQUAM (gaps, incompleteness) and individually replace for those selected days (technical real-life issues), with a primary focus on ACSPO products. This was done as much as was possible. There likely will be some remaining or newer artifact that has to be attended as will be possible.

9--Uniformly regenerate in situ validation for AVHRR GAC (HR is complete).

It was done preliminarily. But recently match-ups have been generated using a newer philosophy by Yuri Kihai and the work will be continued by some team member that the PI may assign to.

10--Technical support/development as required (new browsers compatibility, SQUAM framework, functionality, automation etc.).

Done: The GEO module required newer scripting for its display where some data come at 10 minute interval and some at an hour interval. Accordingly, suitable modifications have been made that can accommodate any fractional hour interval (will be helpful for GOES-R era in my absence).

11--Explore reinstatement of L4 SQUAM. Consider including newer SSTs (incremental work).

With all the numerous polar data streams and newer GEO data (three products), I have been able to sustain the L4-SQUAM as is, without any additional expansion.

12--Explore including Sentinel-3 SLSTR SST, when available, against L4 & in situ.

Partly done while my 2-week visit to EUMETSAT past November (see other professional activities). The details have to be worked out by the PI at a later stage, depending on resources and willingness.

13--Additional offline research (non-routine – beyond SQUAM)

Analyzed the sensitivity of validation statistics on space-time collocation criteria for both polar (NPP VIIRS) and geostationary (Himawari-8 AHI) SST products. While this work is not complete as we had to later change the 'philosophy of match-up procedure', it created a solid foundation for such studies. Now that newer matches are available, this work may be repeated easily for a conclusive write-up. This was presented at the 2015 GHRSSST science team meeting:
http://www.star.nesdis.noaa.gov/sod/sst/squam/documents/GHRSSST16_BeyondSQUAM_CollocationEffect_v02.pdf

13 a.--Additional support to the team: Provided support to run the previous version of iQuam (iQuam v1) from 2010 until Jan, 2016. It now may be discontinued or be maintained by other team members.

13 b.--Additional support to PI for programmatic presentations: Provided customized viewgraphs as requested for NOAA internal requirements.

14--Other professional activities (routine and/or based on external requests, professional participation)

14 a--Elected to the GHRSSST Science Team <https://www.ghrsst.org/ghrsst/science-team/>
This is based on nomination and election via an email ballot with requirement of a simple majority of votes. The term is for 3 years for new science team members and they are allowed to re-apply.

14 b--Visiting Scientist at EUMETSAT for 2 weeks (invited and sponsored by the then Head of the Remote Sensing Division, EUMETSAT, while NOAA continued the base funding for the 10 working days). A work report was submitted afterwards (available upon request) and the corresponding presentation is posted at EUMETSAT website based on the initial proposal submitted and the presentation made there:
https://www.eumetsat.int/website/home/TechnicalBulletins/EUMETSATUsers/DAT_2908128.html

Within the 10 working days, EUMETSAT IASI data were preliminarily analyzed and I took a quick look at Sentinel-3A SLSTR test (synthetic) data. The IASI data are preliminarily included in a test page in SQUAM: http://www.star.nesdis.noaa.gov/sod/sst/squam/HR/index_eum.html

14 c--Attended the GHRSSST Science Team meeting (multiple presentations, co-chaired AUS-TAG and served as a rapporteur):
<https://www.ghrsst.org/ghrsst/Meetings-and-workshops/ghrsst-xvi-esa-estec-the-netherlands/>

14 d--Contributed to coordinating the GHRSSST Booth at Ocean Sciences Meeting (<http://osm.agu.org/2016/>), New Orleans, Louisiana, 21-26 Feb 2016 (assisted in collecting animations and finalizing the booth logistics)

14 e--Reviewed multiple papers for: Journal of Climate (AMS), Int. J of Remote Sensing (Taylor & Francis), Geophysical Research Letters (AGU JGR), Journal of Selected Topics in Applied Earth Observations and Remote Sensing (IEEE), and Remote Sensing of Environment (Elsevier).

Publications:

Petrenko, Ignatov, Kihai, Dash. Sensor-Specific Error Statistics for SST in the Advanced Clear-Sky Processor for Oceans. JTech, 2016 <http://dx.doi.org/10.1175/JTECH-D-15-0166.1>

Presentations:

NOAA/NESDIS SST Quality Monitor (SQUAM). Dash and Ignatov. Satellite Oceanography Users Workshop, 9-10 November, 2015. Melbourne, Australia. (presented by Helen Beggs, Australian Bureau of Meteorology)

NOAA SST Quality Monitor (SQUAM). Dash, Ignatov, Kihai, Visiting Scientist Talk, 19 November 2015, EUMETSAT, Darmstadt, Germany

Updates towards ST-VAL since GHRSSST XV (SQUAM and beyond-SQUAM). Dash and Ignatov. 16th International Science Team Meeting (GHRSSST XVI), 20-24 July 2015, European Space Agency ESTEC, The Netherlands (presented by Helen Beggs, ABoM).

Validation of SST against in situ data: effect of space-time collocation criteria, Dash, Ignatov, Kihai, Petrenko et al. 16th International Science Team Meeting (GHRSSST XVI), 20-24 July 2015, European Space Agency ESTEC, The Netherlands

Identifying Gaps in GHRSSST services to: the users and their applications. Dash, Vazquez and Corlett, 16th International Science Team Meeting (GHRSSST XVI), 20-24 July 2015.

ACSPO SST Products at NOAA STAR and OSPO. Ignatov et al., 2016. 16th International Science Team Meeting (GHRSSST XVI), 20-24 July 2015.

SST Quality Monitor (SQUAM) and In situ SST Quality Monitor (iQuam). Ignatov Dash, Zhou, and Xu. 16th International Science Team Meeting (GHRSSST XVI), 20-24 July 2015.

Redesigned SSES in the Advanced Clear-Sky Processor for Oceans, Petrenko, Ignatov, Kihai, Dash et al. 16th International Science Team Meeting (GHRSSST XVI), 20-24 July 2015.

JPSS and GOES-R SST Products at NOAA. Ignatov, Petrenko, Kihai, Stroup et al. 2016. Ocean Sci. Meet., New Orleans, Louisiana, 21-26 Feb 2016

VIIRS SST Products and Monitoring at NOAA. Ignatov, Stroup, Kihai, Petrenko et al., SPIE Defense + Security + Sensing Technology 22 April 2015, Baltimore, MD

Monitoring and validation of AVHRR FRAC, MODIS, (A)ATSR and VIIRS high-resolution sea surface temperatures. Dash, Ignatov, Kihai, Stroup et al., SPIE Defense + Security + Sensing Technology 22 April 2015, Baltimore, MD (presented by B. Petrenko)

AVHRR GAC SST Reprocessing: Linking Instabilities in SST Time Series with Brightness Temperatures and Calibration. Ignatov, Zhou, Petrenko, He et al., 2015 EUMETSAT Conference 21-25 September 2015, Toulouse, France

JPSS SST Products at NOAA. Ignatov, Petrenko, Kihai, Stroup He et al., 2015 EUMETSAT Conference 21-25 September 2015, Toulouse, France

JPSS SST. Ignatov, Stroup, Kihai Petrenko et al., 2015 JPSS Annual Meeting 24-28 August 2015, NCWCP, College Park, USA

Status of ACSPO VIIRS SST Reanalysis. Stroup, Ignatov, Liang, Dash et al., 2015 JPSS Annual Meeting 24-28 August 2015, NCWCP, College Park, USA

PROJECT TITLE: NESDIS Environmental Applications Team – Yanni Ding, Post Doc

PRINCIPAL INVESTIGATOR(S): Steve Miller/Cliff Matsumoto

RESEARCH TEAM: Yanni Ding

NOAA TECHNICAL CONTACT: Alexander Ignatov

NOAA RESEARCH TEAM: Alexander Ignatov, Irina Gladkova, Michael Grossberg, Calvin Chu, Fazlul Shahriar, Boris Petrenko, Yury Kihai, Peter Hollemans, Kai He

FISCAL YEAR FUNDING (NEAT Total): \$1,764,742

PROJECT OBJECTIVES:

Develop and improve NOAA ACSPO (Advanced Clear-Sky Processor for Ocean) Regional Monitor for SST (Sea Surface Temperature) system (ARMS); Use ARMS to identify ACSPO SST algorithm limitations; Develop a new ACSPO Level 3U (U=Uncollated) (L3U) algorithm.

PROJECT ACCOMPLISHMENTS:

The work focused on two projects during the reporting period: ARMS and L3U.

A new NOAA ACSPO regional monitor for SST (ARMS: www.star.nesdis.noaa.gov/sod/sst/arms/) was developed. The ARMS system is designed to monitor the performance of ACSPO SST in selected challenging regions of the ocean, including dynamic and coastal zones, cloudy areas, and high latitudes. Figure 1 shows a screenshot of the ARMS system. On the left is the control panel, and on the right is the SST map generated using the NOAA CoastWatch Data Analysis Tool (CDAT).

Currently, 19 special regions of the Atlantic, Pacific and Arctic Oceans are monitored ARMS, from the equator to high latitudes. One inland sea, the Black Sea, is also included. If the whole special region is covered by one ACSPO granule, only the starting time of the granule is shown. If it is found in two adjacent granules, the two granules are stitched together to produce the full look. The starting time of the two granules are marked as “Start time” and “End time”, respectively.

ARMS is designed to monitor all-sky and clear-sky ACSPO SST, Δ SST (SST minus reference SST; currently Canadian Met Centre L4 analysis) from several polar platforms and sensors, including VIIRS onboard S-NPP, MODISs onboard Terra and Aqua, and AVHRRs onboard NOAA18/19 and Metop A/B. For Metop A/B, both GAC and FRAC products are included. Geostationary ACSPO SST from AH1 onboard Himawari-8 can also be displayed in three special regions (South China Sea, Kuroshio Current and Korea Strait) falling in its retrieval domain, for comparison with the polar satellites.

SSTs are displayed in 3 groups: “day”, “night” (note that different clear-sky masking and SST algorithms are used during the day and night) and “day/night” group (if the pass includes both daytime and nighttime pixels over the region). The “day/night” is especially useful in the high latitudes, like the Bering Strait and Greenland-Norwegian Seas, to identify SST algorithm limitations in day/night transition region. Figure 2 shows an example of discontinuity in both SST algorithm and cloud mask in the day/night transition area, identified in ARMS. The discontinuous SST is a result of different selection of bands used during daytime and nighttime. The discontinuous clear-sky mask could be improved, if the Reflectance Ratio Contrast Filter (RRCT) is used in the twilight zone, instead of the Reflectance Gross Contrast Test (RGCT). Work is underway to address these two problems.

Currently ARMS monitors several Level 2 (L2) ACSPO products from AVHRRs, VIIRS, and MODISs and one Level 3 uncollated (L3U) product from VIIRS. Because current L3U product only produces SST with best quality level (QL; QL=5), only clear-sky SST and Δ SST are available for L3U. Meanwhile, various masking flags (cloud mask, ice mask, etc.) are missing for this L3U version. All L3U SSTs with low QL are shown as missing here (left panel of Figure 3).

The ARMS system was presented at the 11th Annual Student Science Symposium from 16-17 September 2015 (see <http://cicsmd.umd.edu/outreach/cor/>).

The second project is developing an improved ACSPO VIIRS L3U product. Two improvements have been identified in the L3U version 1 (v1) product, including adding the clear-sky mask, and resolving some small biases compared with the L2 product. The L3U v2 product aims to address these artifacts.

In the L3U v2, the nearest neighbor method is employed to re-grid the swath L2 to L3U grid (0.02°×0.02°). For each L3U grid, up to 4 nearest L2 pixels are searched, and a weighted value is calculated based on the geographic distance. Only data with best quality (QL=5) are kept in both v1 and v2, but a complete set of masking flags is additionally added in v2. Figure 3 shows an example of the new L3U provides cloud mask, ice mask and missing information, which are all treated as missing in the current L3U v1.

When comparing the two L3U products with L2, the L3U v2 shows less bias compared with the current L3U v1 (Figure 4). The improvements in Δ SST and SSES standard deviation are most significant, with a reduction of 0.02K and 0.07K of bias, respectively. For SST and SSES bias, the reduction in bias is smaller, but the data are better clustered around 0, indicating less bias compared to L2 product.

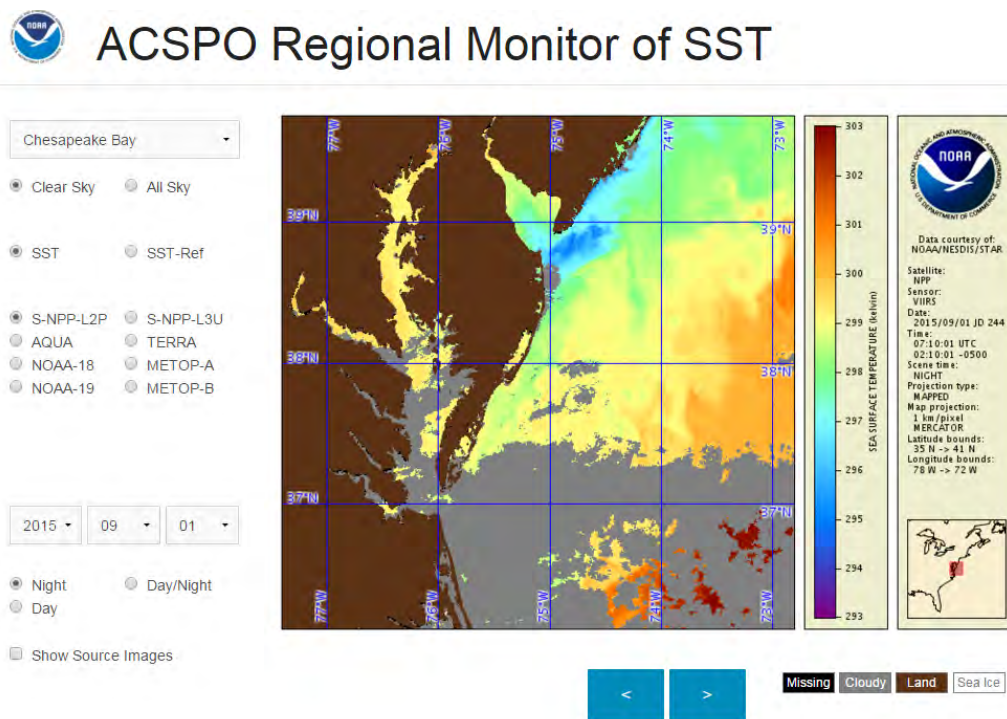

Figure 1. A screenshot of the ARMS system.

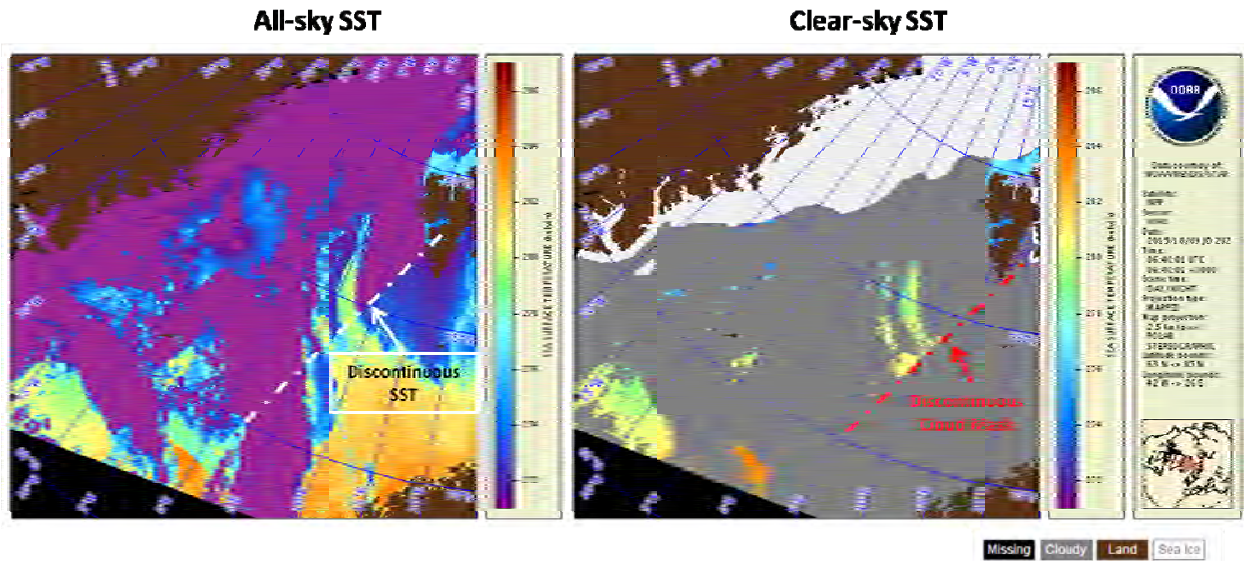

Figure 2. Left panel: An example of discontinuity in SST algorithm in the day/night transition zone. Right panel: An example of discontinuity in clear-sky mask.

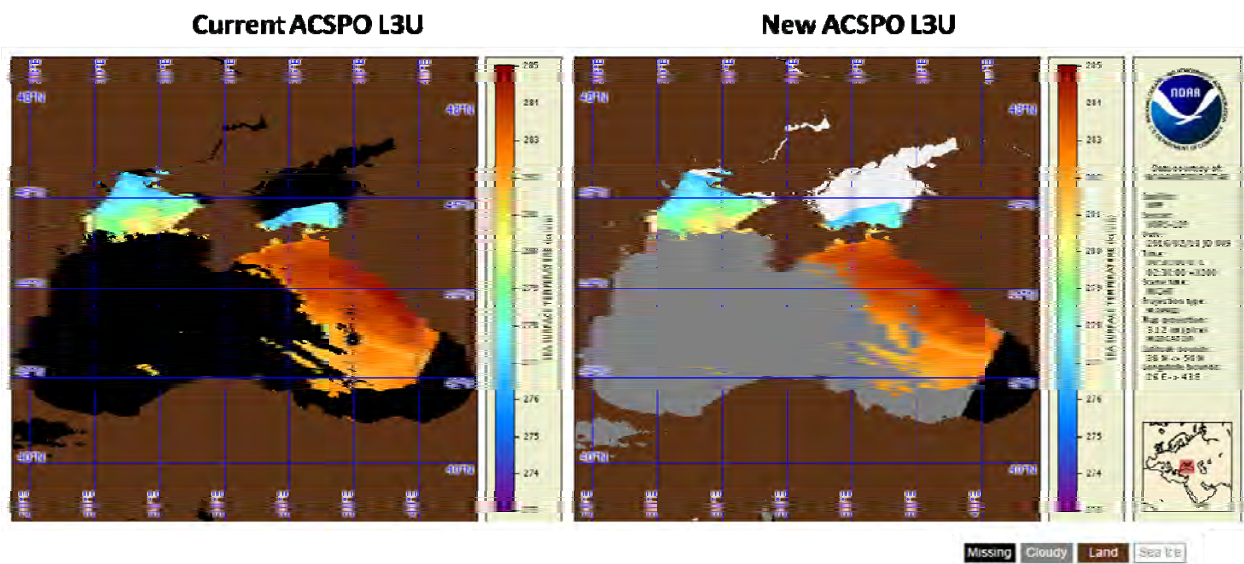

Figure 3. An example showing the masking flag difference between the (left) current L3U v1 product and (right) the new L3U v2 product.

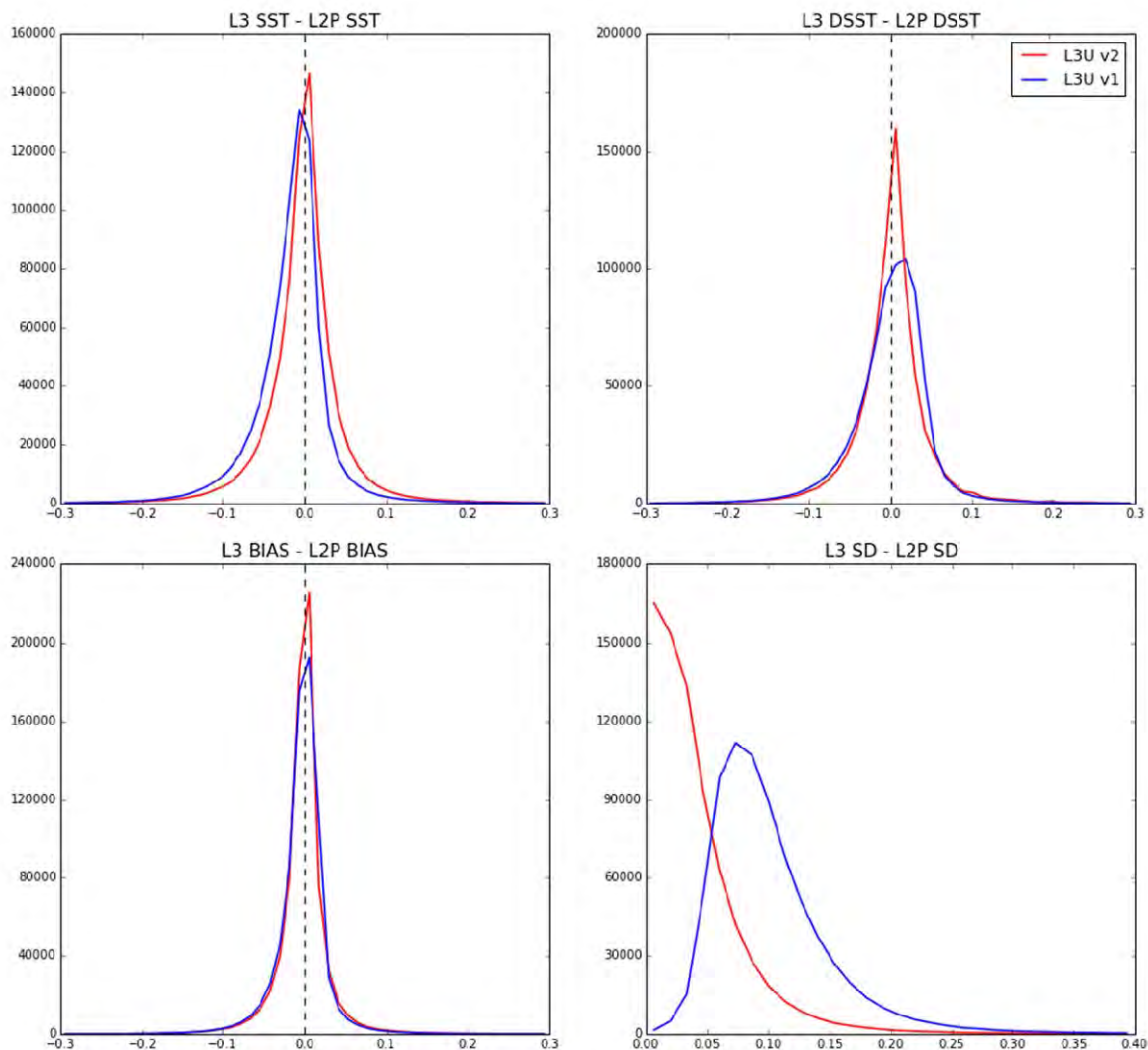

Figure 4. Histogram of differences between L3U and L2 variables (SST, Δ SST, Single-Scanner Error Statistics (SSES) bias and standard deviation, SD). Blue lines are differences between L3U v1 and L2, and red lines are differences between L3U v2 and L2. Difference of SD is calculated in a root-mean squared sense as square-root of the absolute difference between SD_{L3}^2 and SD_{L2}^2 . The data shown are from February 18, 2016.

Presentations:

Ding, Y., A. Ignatov, M. Grossberg, I. Gladkova, and C. Chu: Toward Regional Validation and Potential Enhancements to NOAA Polar SST Products, CoRP, Sep. 2015, College Park, MD (Oral).

Ignatov, A., J. Stroup, Y. Kihai, B. Petrenko, P. Dash, I. Gladkova, M. Kramar, X. Zhou, X. Liang, J. Sapper, Y. Huang, Y. Ding, F. Xu, M. Bouali, K. Mikelsons. ACSP0 SST Products at NOAA. XVI GHRSSST Meeting, Jul 2015, ESA/ESTEC, Netherlands. (Oral.)

Ignatov, A., J. Stroup, Y. Kihai, B. Petrenko, P. Dash, I. Gladkova, M. Kramar, X. Zhou, X. Liang, J. Sapper, Y. Huang, Y. Ding, F. Xu, M. Bouali, K. Mikelsons. JPSS SST. 2015 JPSS Annual Science Team meeting, Aug 2015, NCWCP, College Park, MD. (Oral.)

PROJECT TITLE: NESDIS Environmental Applications Team – Lide Jiang, Post Doc

PRINCIPAL INVESTIGATOR(S): Steve Miller/Cliff Matsumoto

RESEARCH TEAM: Lide Jiang

NOAA TECHNICAL CONTACT: Menghua Wang, STAR/SOCD/MECB

NOAA RESEARCH TEAM: Menghua Wang

FISCAL YEAR FUNDING (NEAT Total): \$1,764,742

PROJECT OBJECTIVE(S):

- 1--JPSS NPP VIIRS project support, including VIIRS ocean color Level-1 -> Level-2 -> Level-3 data processing, reprocessing and distribution
- 2--Implement new and improved ocean color algorithms in MSL12 and apply them to ocean color related studies
- 3--OMS GOCI ocean color data application study - surface current derivation with feature tracking method
- 4--Near-real-time and science quality ocean color data support

PROJECT ACCOMPLISHMENTS: (Research Conducted) Past Fiscal Year by Objective:

- 1--JPSS NPP VIIRS project support, including VIIRS ocean color Level-1 -> Level-2 -> Level-3 data processing, reprocessing and distribution:
 - 1.1--Completed assessment of fast F-factor ratio based RDR-SDR processing and identified and resolved discrepancies found;
 - 1.2--Provided a missing/bad RDR granule list to JPSS Cal/Val team and contacted CLASS on missing/bad RDR issues;
 - 1.3--Routinely retrieved daily IDPS operational F-factors and F-factor ratios for calibration monitoring;
 - 1.4--Began the routine of daily generation of science quality VIIRS ocean color data based on STAR ocean color team's calibration;
 - 1.5--Added science quality data global and regional stream (NIR, SWIR & NIR-SWIR) to ocean color global composite images on STAR ocean color team's website;
 - 1.6--Added near-real-time (1 day delay) ocean color data global and regional stream (NIR only) to the website;
 - 1.7--Improved the appearance of the website and made it compliant to NOAA STAR web design guidelines (Fig.1);
 - 1.8--Change the output format of all Level-2 and Level-3 files into NetCDF to comply with NOAA STAR standards.
 - 1.9--Finished VIIRS-NPP whole mission reprocessing with newest MSL12 package.

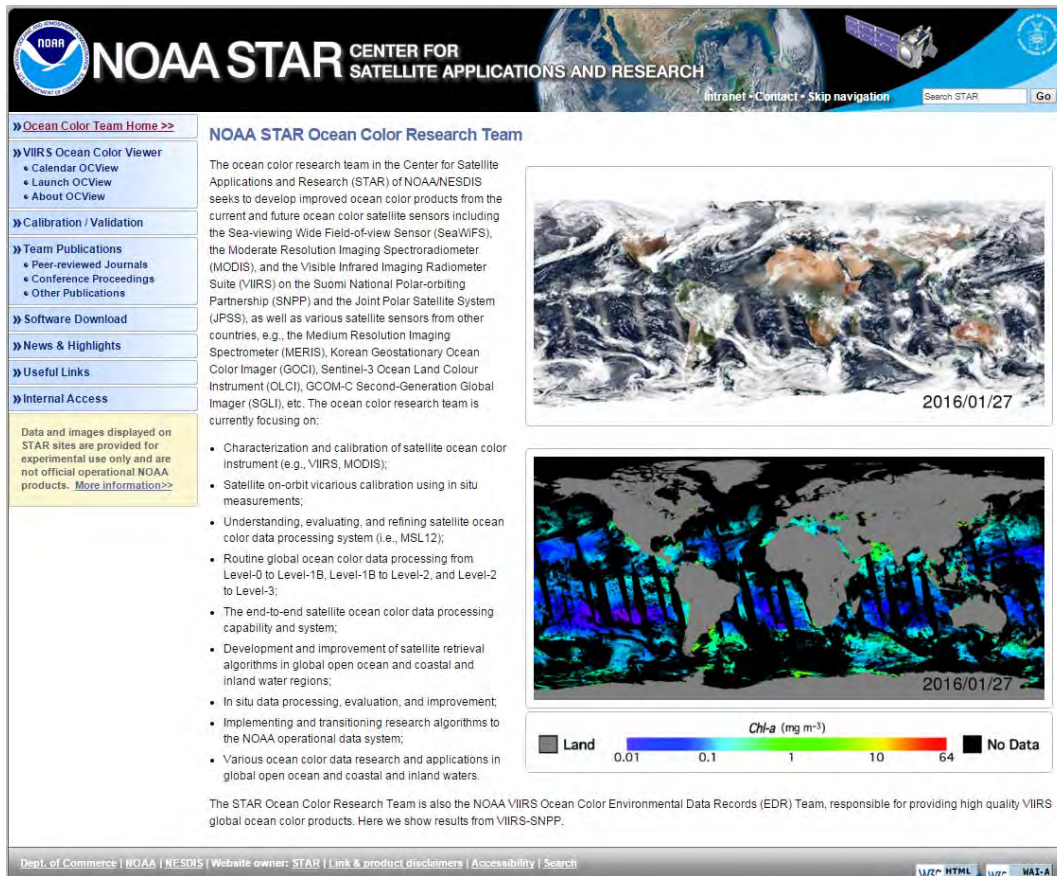

Figure 1. New appearance of the ocean color team website.

2--Implement new and improved ocean color algorithms in MSL12 and apply them to ocean color related studies:

2.1--Identified and resolved the polarization correction bug for VIIRS-SNPP ocean color EDR in MSL12;

2.2--Finalize the metadata information for the NetCDF format of MSL12 L2 files;

2.3--Completed new MSL12 version 1.01 code delivery to CoastWatch in April 2015;

2.4--Implemented GIOP algorithms for IOP into MSL12 version 1.02;

2.5--Implemented NetCDF format quality-improved land mask (data obtained from MOD44W landmask), which can resolve inland lakes and rivers, into MSL12 version 1.02;

2.6--Implemented dual aerosol models with fixed ratio in MSL12 atmospheric correction code to increase the flexibility of vicarious calibration;

2.7--Implemented iterative scheme for consistent vicarious calibration in MSL12;

2.8--Implemented two-iteration scheme for the SWIR data processing of glint pixels in MSL12;

2.9--Fixed bugs in MSL12 code for aerosol reflectance conversion between single and multiple scattering;

2.10--Improved cloud shadow / straylight flagging in MSL12 code by using bi-linear interpolation and high-resolution VIIRS nLw(551) climatology;

2.11--Rebuilt L2bin and L3bin to add NetCDF compatibility;

3--COMS GOCI ocean color data application study - surface current derivation with feature tracking method

3.1--Retrieve diurnal hourly current maps (Fig.2) in Bohai Sea from GOCI Kd(490) product using Maximum Cross-Correlation feature tracking method and evaluate its performance using in-situ measurement and modeled data;

3.2--Presented the research results in 2016 Ocean Science meeting in New Orleans, LA and submitted a manuscript to Remote Sensing of Environment.

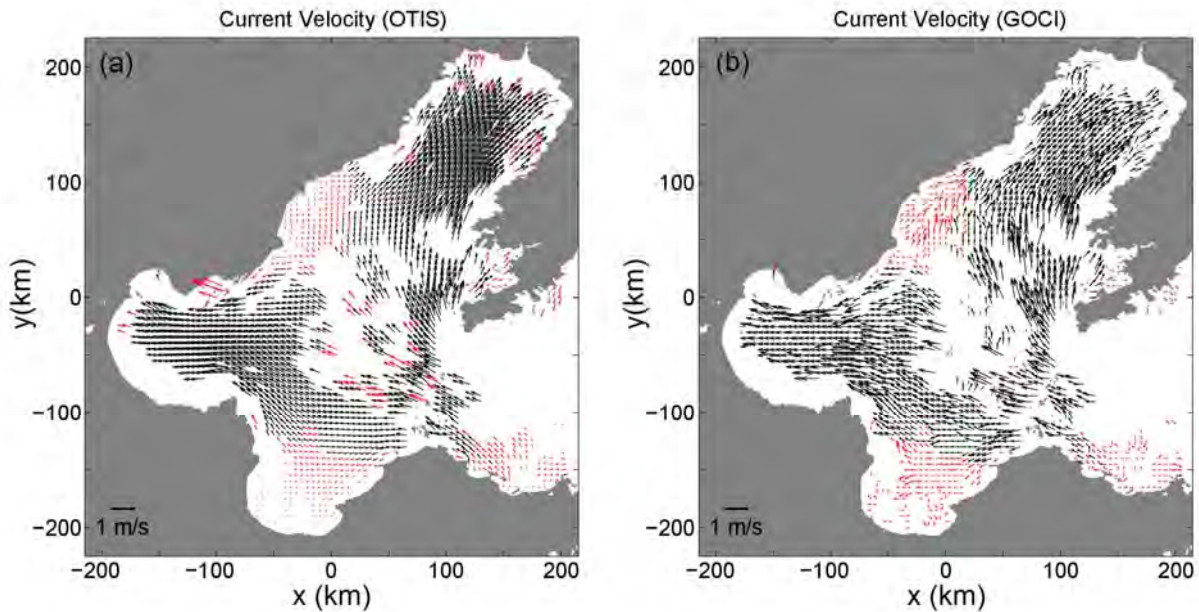

Figure 2. Surface current maps derived from (a) GOCI-measured Kd(490) using the MCC, (b) regional OTIS tidal solutions in the Bohai Sea. The maps are in Mercator projection and axes indicate distances from the center location at 39°N and 119.8°E.

4--Near-real-time and science quality ocean color data support

4.1--Routinely generated chlorophyll-a images automatically for Caribbean Sea north and Gulf of Mexico areas (Fig. 3) in near-real-time on our website in support of NOAA NMFS Research Cruise 2015 members during April–May, 2015;

4.2--Provided science-quality VIIRS Level-2 data to NOAA Research Cruise in December 2015, and ocean color Cal/Val teams including City College of New York, Naval Research Laboratory, University of Massachusetts Boston, University of South Florida, and University of Southern Mississippi.

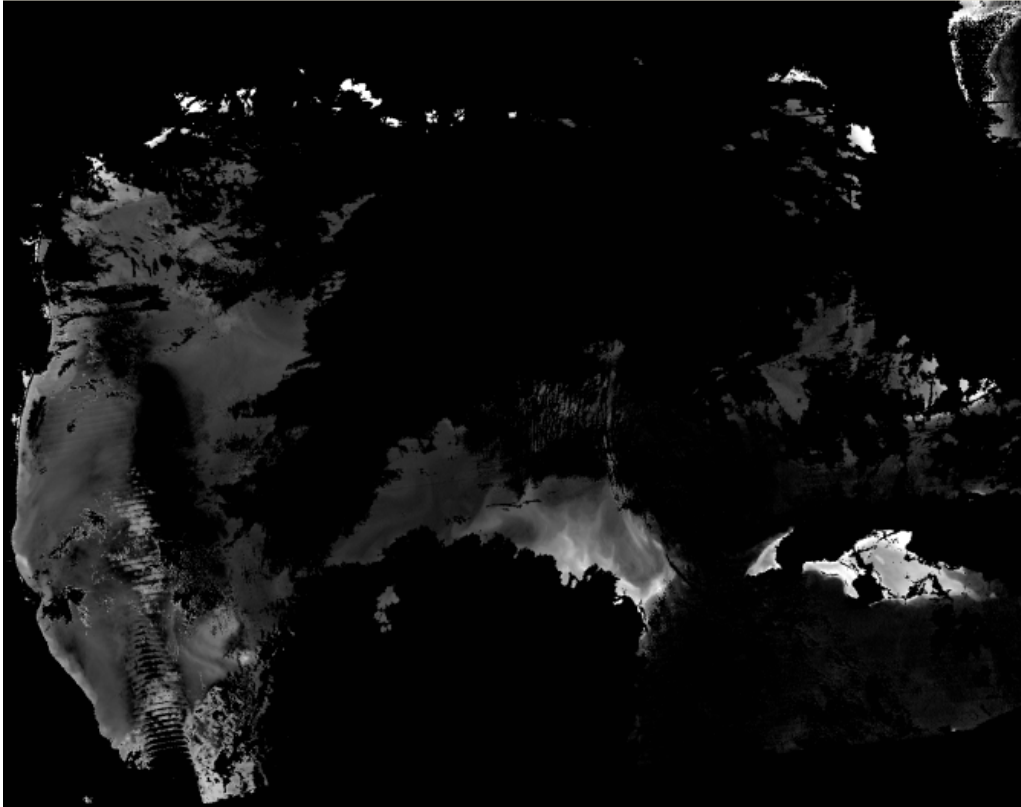

Figure 3. Example image provided daily in NRT to NMFS research cruise. The users requested this grayscale format.

Publications:

Jiang, L. and M. Wang, "Ocean Diurnal Currents Derived from the Korean Geostationary Ocean Color Imager", *Remote Sens. Environ.*, submitted

Wang, M., W. Shi, L. Jiang, X. Liu, S. Son, and K. Voss, "Technique for monitoring performance of VIIRS reflective solar bands for ocean color data processing", *Opt. Express*, 23, 14446-14460 (2015).
doi:10.1364/OE.23.014446

Wang, M., X. Liu, L. Jiang, S. Son, J. Sun, W. Shi, L. Tan, P. Naik, K. Mikelsons, X. Wang, and V. Lance, "VIIRS ocean color research and applications", *Proc. IGARSS '15*, pp.2911-2914 (2015).
doi:10.1109/IGARSS.2015.7326424this link opens in a new window

PROJECT TITLE: NESDIS Environmental Applications Team – Xingming Laing, Research Scientist

PRINCIPAL INVESTIGATOR(S): Steve Miller/Cliff Matsumoto

RESEARCH TEAM: Xingming Laing

NOAA TECHNICAL CONTACT: Alexander Ignatov

NOAA RESEARCH TEAM: Xingming Liang, Alexander Ignatov, John Sapper, Maxim Kramar, Irina Gladkova, John Stroup, Kai He, Xinjia Zhou, Boris Petrenko, Yury Kihai of STAR/NESDIS.

FISCAL YEAR FUNDING (NEAT Total): \$1,764,742

PROJECT OBJECTIVES:

Assess Himawari-8/AHI radiometric accuracy and stability for SST retrievals and the cross-platform consistency with VIIRS and MODIS; Prepare for GOES-R/ABI SST processing (planned launch in Oct 2016); Develop geo-MICROS system, establish real-time monitoring of AHI brightness temperatures (BT), be ready for GOES-R ABI launch.

PROJECT ACCOMPLISHMENTS:

To support the NOAA Advanced Clear-Sky Processor for Ocean (ACSPO) SST retrievals from the Advanced Himawari Imager (AHI) onboard Himawari-8 launched in Oct 2014, observation minus model (O-M) biases for 5 AHI IR SST bands centered at 3.9, 8.6, 10.4, 11.2, and 12.4 μm (IR37, IR86, IR10, IR11 and IR12, respectively) were calculated and compared against the better understood and characterized VIIRS onboard S-NPP and MODISs onboard Terra and Aqua. The objectives are to understand the accuracy and stability of the AHI BTs and check them for consistency with polar SST sensors. Another objective is to prepare for the launch of the next-generation US geostationary satellite, GOES-R in Oct 2016, which will carry the Advanced Baseline Imager (ABI) sensor similar to the AHI. These analyses are critically important to ensure accuracy, stability, and consistency of the different NOAA geostationary and polar SST products. For the first time, two additional SST bands, IR86 and IR10, were analyzed, to facilitate their use in the ACSPO clear-sky mask and improved SST algorithms.

All AHI bands are largely in-family with their polar counterparts, but biased cold from -0.25 to -0.50 K, depending upon the band [Table 1, Figures 1-2]. The negative O-M biases may be due to the uncertainties in AHI calibration and characterization or in CRTM simulation. The time series of O-M biases and double differences indicate that the AHI data are relatively stable and the temporal day-to-day variations are due to the unstable “M” term [Figure 3]. Further work is needed with the AHI sensor calibration team to understand the root cause of the cold AHI sensor BT biases and minimize. The results have been published in (Liang et al., 2016).

Similar with the original MICROS system (www.star.nesdis.noaa.gov/sod/sst/micros/) used to evaluate and monitor polar sensor BTs, the geo-MICROS system is being developed to monitor AHI and ABI BTs [Figures 4-5]. Optimization of the MICROS core processor was required to process significantly larger geo data, the main daily processing time was reduced to ensure the real-time capability. The geo core processor was integrated in the original MICROS system to facilitate maintenance for both polar and geo MICROS. The Himawari-8 AHI is currently monitored in geo-MICROS version beta 1. The GOES-R ABI will be added when it is launched and the ABI data are available.

Publications:

He, K., A. Ignatov, Y. Kihai, X. Liang, C. Cao, and J. Stroup, 2015: Sensor Stability for SST (3S) monitoring system. *Proc. SPIE* 9459, Ocean Sensing and Monitoring VII, 94590Z (19 May 2015); doi:10.1117/12.2177292.

Ignatov, A., X. Zhou, B. Petrenko, X. Liang, Y. Kihai, P. Dash, J. Stroup, J. Sapper, P. DiGiacomo. AVHRR GAC SST Reanalysis version 1 (RAN1), *Remote Sens.* 2016 (under review).

Liang, X, A. Ignatov, M. Kramar, and F. Yu. Preliminary Inter-Comparison between AHI, VIIRS and MODIS Clear-Sky Ocean Radiances for Accurate SST Retrievals, *Remote Sens.*, 8, 2016.[doi:10.3390/rs8030203]

Presentations:

He, K., A. Ignatov, Y. Kihai, X. Liang, C. Cao, and J. Stroup. Sensor Stability for SST (3S) monitoring system. 2015 SPIE Defense, Security and Sensing Conf, Baltimore, Apr 2015. (Oral.)

Huang, Y., X. Liang, A. Ignatov, M. Kramar. Monitoring of IR Clear-sky Radiances over Oceans for SST (MICROS) for Himawari-8 AHI. 11th Annual NOAA Cooperative Research Program Science Symposium, 16-17 Sep 2015, UMD, College Park, USA. (Oral.)

Ignatov, A., B. Petrenko, Y. Kihai, J. Stroup, P. Dash, X. Liang, I. Gladkova, X. Zhou, J. Sapper, F. Xu. JPSS SST Product at NOAA. 2015 EUMETSAT Conf, Toulouse, Sep 2015. (Oral.)

Ignatov, A., J. Stroup, Y. Kihai, B. Petrenko, I. Gladkova, P. Dash, X. Liang, F. Xu, X. Zhou, K. Mielsons, J. Sapper. VIIRS SST products and monitoring at NOAA. 2015 SPIE Defense, Security and Sensing Conf, Baltimore, Apr 2015. (Oral.)

Ignatov, A., X. Zhou, B. Petrenko, K. He, X. Liang, Y. Kihai, C. Cao, J. Stroup, P. Dash, J. Sapper. AVHRR SST Reprocessing: Linking Instabilities in SST Time Series with Brightness Temperatures and calibration. 2015 EUMETSAT Conf, Toulouse, Sep 2015. (Oral.)

Ignatov, A., J. Stroup, Y. Kihai, B. Petrenko, P. Dash, I. Gladkova, M. Kramar, X. Zhou, X. Liang, J. Sapper, Y. Huang, Y. Ding, F. Xu, M. Bouali, K. Mielsons. ACSPO SST Products at NOAA. XVI GHRSSST Meeting, Jul 2015, ESA/ESTEC, Netherlands. (Oral.)

Ignatov, A., J. Stroup, Y. Kihai, B. Petrenko, P. Dash, I. Gladkova, M. Kramar, X. Zhou, X. Liang, J. Sapper, Y. Huang, Y. Ding, F. Xu, M. Bouali, K. Mielsons. JPSS SST. 2015 JPSS Annual Science Team meeting, Aug 2015, NCWCP, College Park, MD. (Oral.)

Liang, X., and A. Ignatov. Assimilation of ECMWF versus GFS profiles in fast CRTM for SST retrievals at NOAA. 2015 SPIE Defense, Security and Sensing Conf, Baltimore, Apr 2015. (Oral.)

Stroup, J., A. Ignatov, X. Liang, P. Dash, Y. Kihai, I. Gladkova, L. Gumley, S. Dutcher. Status of ACSPO VIIRS SST Reanalysis. 2015 JPSS Annual Science Team meeting, Aug 2015, NCWCP, College Park, MD. (Oral.)

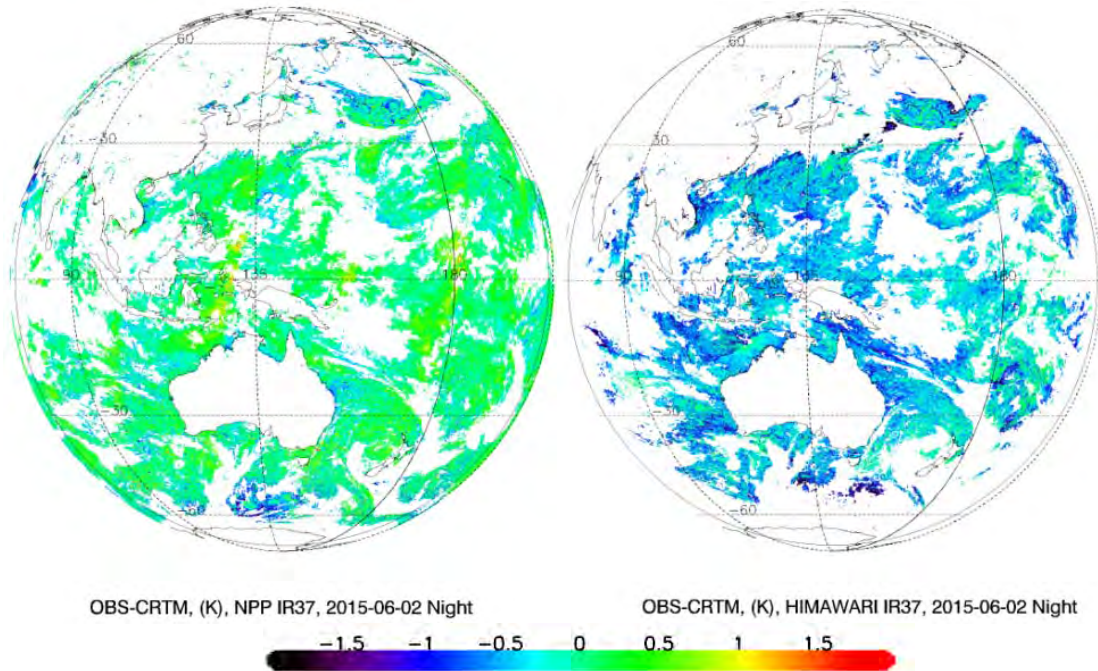

Figure 1. Nighttime O-M biases in IR37 for S-NPP VIIRS and H8 AHI. Data are gridded to $1^\circ \times 1^\circ$. For VIIRS, nighttime data are defined as those with solar zenith angle, SZA $> 90^\circ$. For AHI, only data from 1–2 a.m. LT were used (which come from different FD images taken at different UTC times). If more than one VIIRS overpass or AHI FD image satisfying these conditions were available, they were all averaged within a 1° box, for mapping purposes.

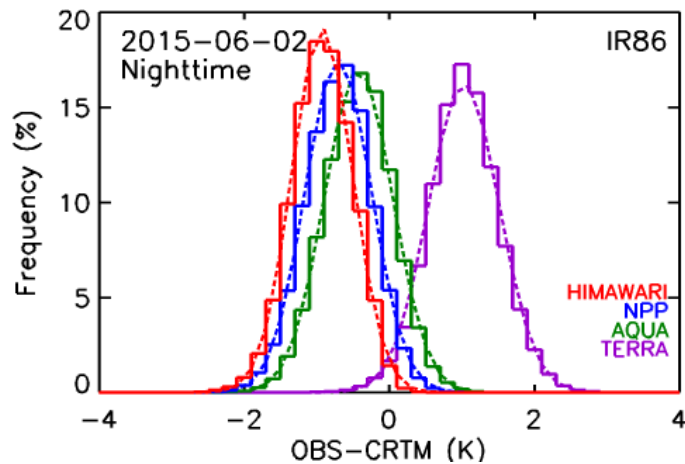

Figure 2. Histograms of the nighttime O-M biases in IR86. Corresponding statistics are listed in Table 1. The dotted lines are Gaussian fits corresponding to the median and robust standard deviation.

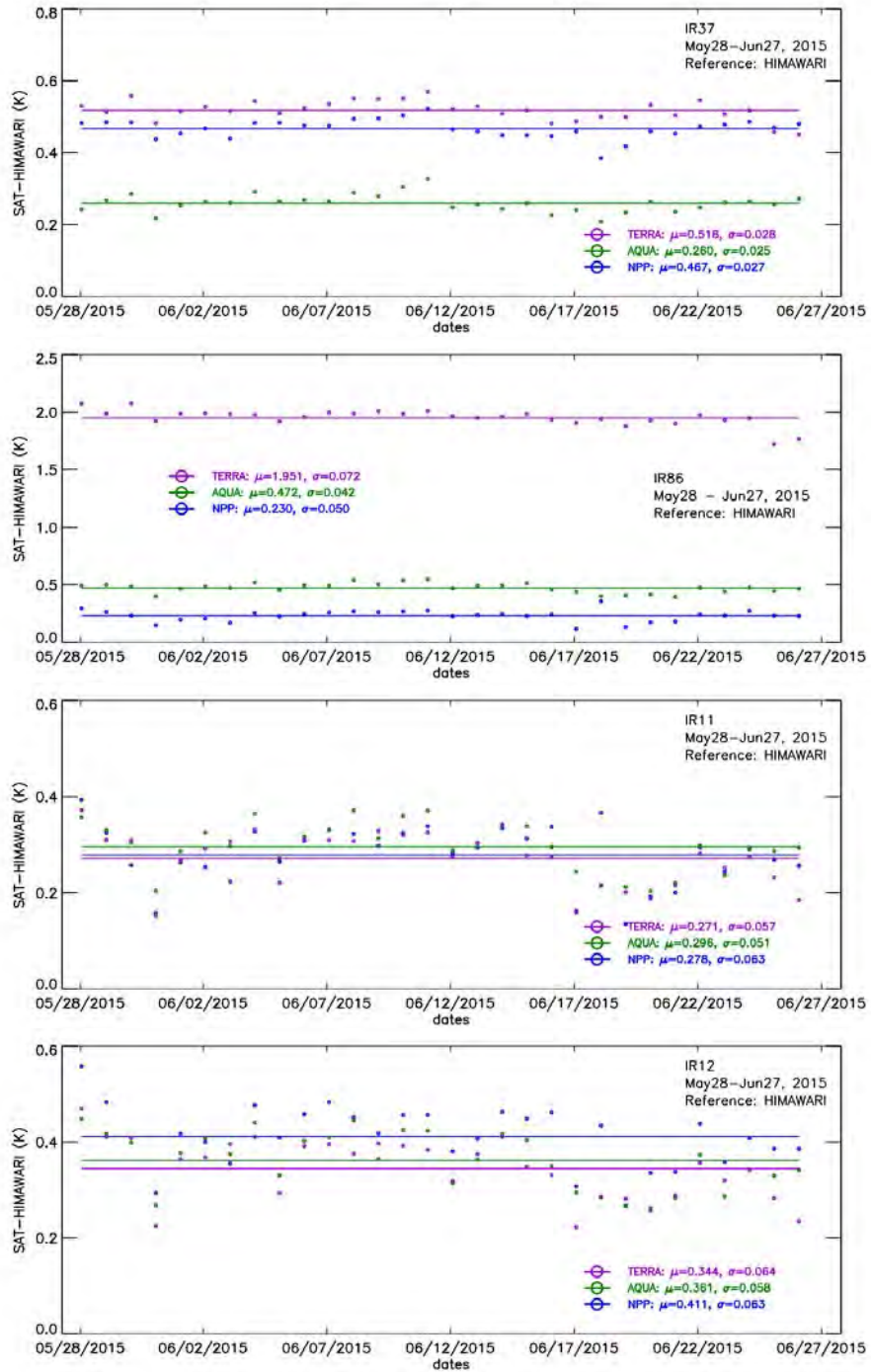

Figure 3. Double differences (DDs). For each day, only one data point (out of 24 in Figure 6) is saved corresponding to the most populated polar nighttime bin (which is always 1:30 a.m. for the S-NPP and Aqua and 10:30 p.m. for the Terra). Horizontal lines represent mean values over the 30 days. Corresponding mean and standard deviation statistics are also superimposed.

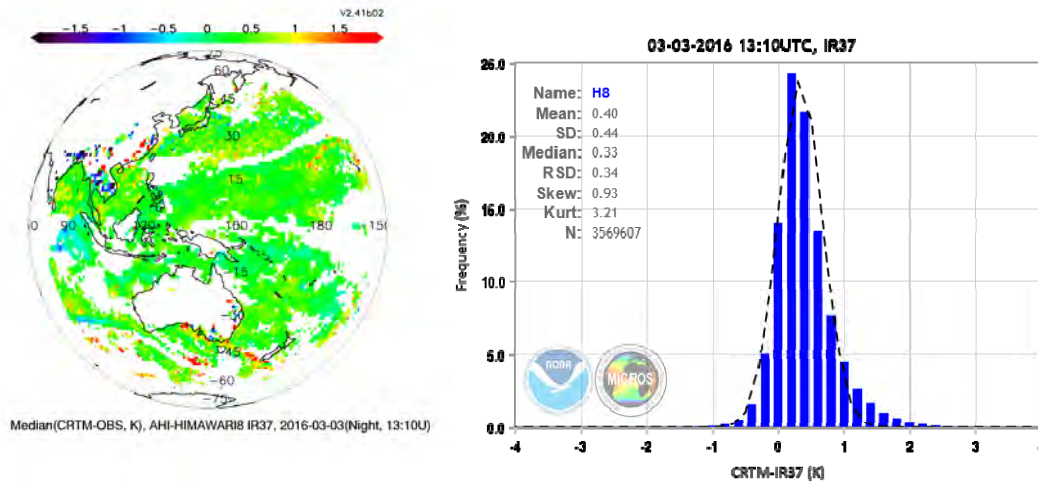

Figure 4. Global distribution of M-O biases and the corresponding histogram for the AHI band 3.9um (denote IR37) from MICROS-GEO web page.

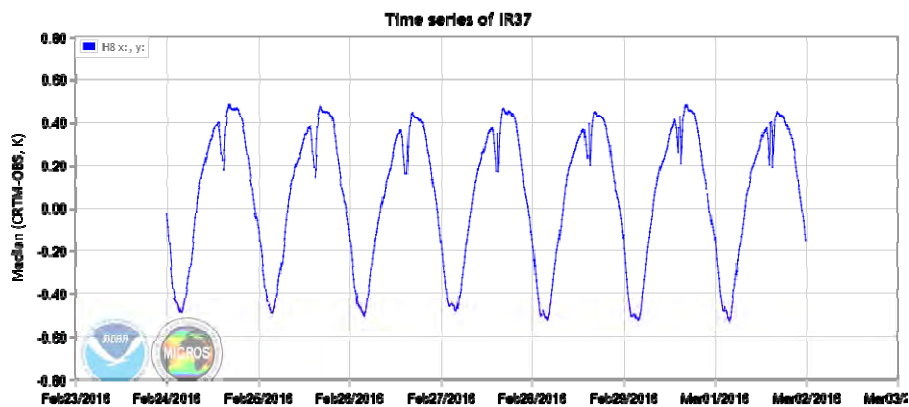

Figure 5. Time series of M-O biases for the AHI band 3.9um (denote IR37) from MICROS-GEO web page.

Table 1. The nighttime O-M mean biases, standard deviations, and number of clear-sky ocean pixels (NCSOP) for 2 June 2015.

Band Name	Mean, K				SD, K			
	H-8	S-NPP	Aqua	Terra	H-8	S-NPP	Aqua	Terra
IR37	-0.51	-0.04	-0.26	0.02	0.39	0.33	0.33	0.32
IR86	-0.82	-0.60	-0.33	1.13	0.42	0.46	0.47	0.49
IR10	-0.79				0.50			
IR11	-0.86	-0.54	-0.51	-0.54	0.60	0.53	0.54	0.52
IR12	-1.09	-0.64	-0.67	-0.70	0.69	0.63	0.62	0.59
NCSOP (million)					18.6	46.9	18.2	17.8

PROJECT TITLE: NESDIS Environmental Applications Team - Shuyan Liu - Tropical Cyclone Model Diagnostics and Product Development

PRINCIPAL INVESTIGATOR(S): Steve Miller/Cliff Matsumoto

RESEARCH TEAM: (CIRA/CSU Staff involved in the project listed in order of staffing time on project, contribution level, or other): Cliff Matsumoto, Shuyan Liu

NOAA TECHNICAL CONTACT: Quanhua Liu, NOAA/NESDIS/STAR

NOAA RESEARCH TEAM: Christopher Grassotti, Cooperative Institute for Climate and Satellites-MD/Earth System Science Interdisciplinary Center, University of Maryland

FISCAL YEAR FUNDING (NEAT Total): \$1,764,742

PROJECT OBJECTIVE(S):

- 1--Developing, extending, improving, and validating all data products from MiRS
- 2--Managing the MiRS software and website.

PROJECT ACCOMPLISHMENTS:

- 1--Extended MiRS to GPM/GMI radiance and retrieved parameters such as temperature, rain rate etc
- 2--Validated MiRS retrieved rain rate by NCEP Stage-IV rain rate data.
- 3--Upgraded the products publishing on MiRS website at daily basis from V9.2 to V11.1.

Publications: None

PROJECT TITLE: NESDIS Environmental Applications Team – Xiaoming Liu, Research Scientist - Ocean Color Algorithm Development and Ocean Process Study with Satellite Ocean Color Remote Sensing

PRINCIPAL INVESTIGATOR(S): Steve Miller/Cliff Matsumoto

RESEARCH TEAM: Xiaoming Liu

NOAA TECHNICAL CONTACT: Menghua Wang

NOAA RESEARCH TEAM: Menghua Wang

FISCAL YEAR FUNDING (NEAT Total): \$1,764,742

PROJECT OBJECTIVES:

- 1--Calibration/Validation and monitoring of VIIRS ocean color products
- 2--Conduct ocean color related applications and research

PROJECT ACCOMPLISHMENTS:

- 1--Calibration/Validation and monitoring of VIIRS ocean color products

--Time series of VIIRS ocean color data products in Hawaii, South Pacific Gyre, Chesapeake Bay and U.S. east coast regions are continuously monitored. These regions are important to validate the quality of the VIIRS ocean color products in open ocean, coastal ocean and estuaries. In addition, in situ data at four stations including MOBY, AERONET-CSI, AERONET-LISCO and AERONET-USC, are compared with VIIRS ocean color products. These processes are automated on our Linux servers and posted on the web weekly: (<http://www.star.nesdis.noaa.gov/sod/mecb/color/CalVal.php>). Figure 1 shows the time series of ocean color products at South Pacific Gyre as an example.

--Routinely monitoring the VIIRS ocean color products in the global oligotrophic waters and deep waters to evaluate the VIIRS ocean color calibrations. The global mean of ocean color products in the global oligotrophic waters and deep waters are very sensitive to VIIRS calibrations, and the anomalies in the calibration can be detected from the time series of the global mean. Figure 2 shows the time series of nLw(551) in the global oligotrophic waters (top panel) and global deep waters (lower panel) as examples. A significant downward trend in the nLw(551) based on IDPS SDR (red line in both panel) can be seen clearly. In comparison, the two versions of nLw(551) based on science quality Ocean Color SDR (green and black) are significantly improved. The global monitoring process are automatically generated on Linux server and put on the web server for online access.

--Continue monitoring VIIRS SDR for bands M1-11 at Libya and the South Pacific Gyre. This is also an automated process, and the results are posted on our internal web sites. Figure 3 show the SDR time series at Libya site as examples.

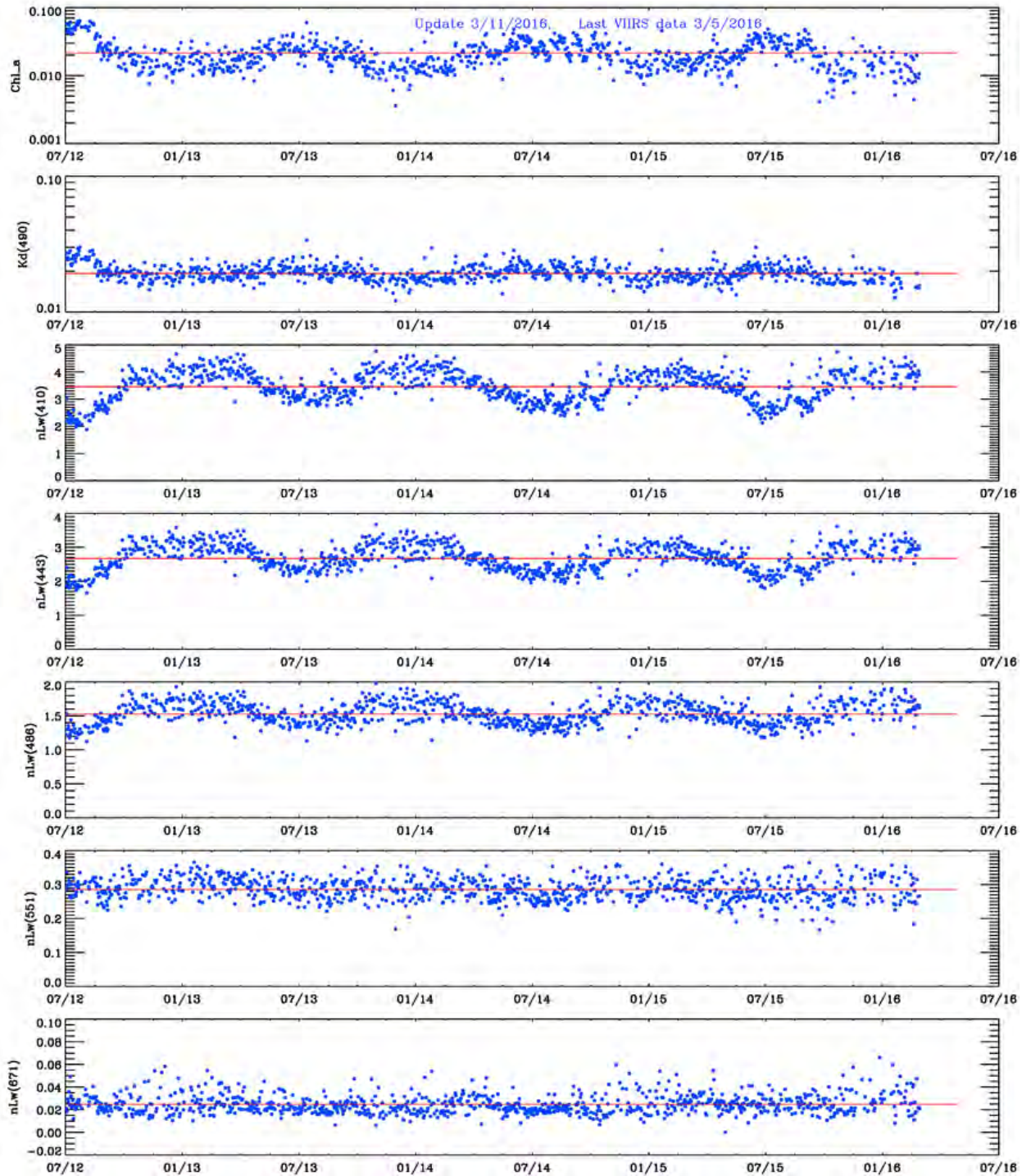
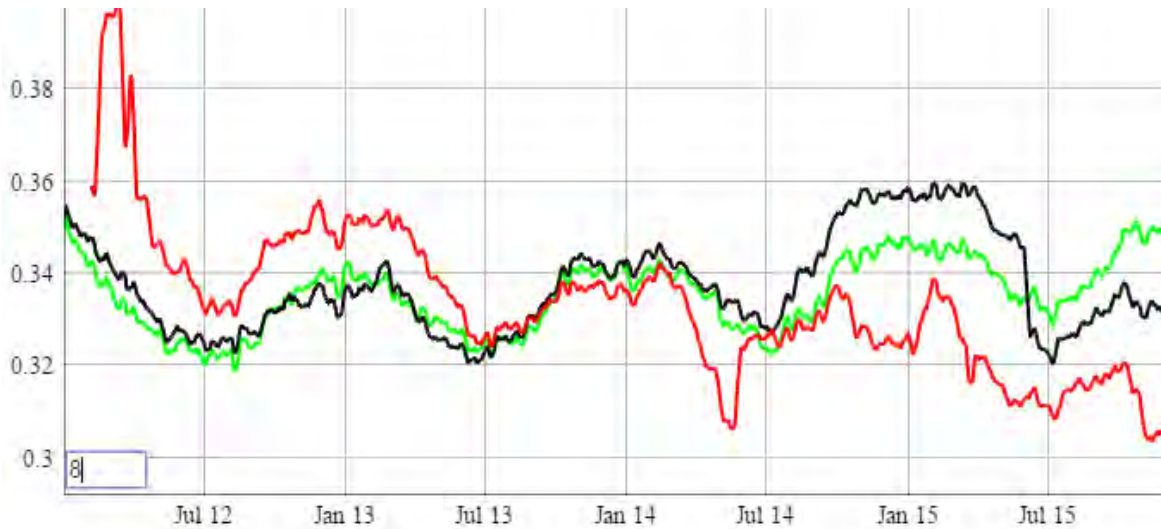

Figure 1. Near-real-time monitoring of VIIRS ocean color data of the South Pacific Gyre (<http://www.star.nesdis.noaa.gov/sod/mecc/color/CalVal.php>).



(a)



(b)

Figure 2. Time series of $nLw(551)$ in (a) global oligotrophic waters and (b) global deep waters. In both panels, red line is $nLw(551)$ generated from the IDPS SDR, and the green and black line are from two versions of science quality Ocean Color SDR (OC-SDR). A significant downward trend can be seen in the red line, which indicates a calibration error in the IDPS SDR. This is corrected in the OC-SDR as can be seen in the green and black lines. In addition, the lunar calibration data was added in later 2015 (green line), which significantly improves the quality comparing the black line with missing lunar calibration data in later 2015.

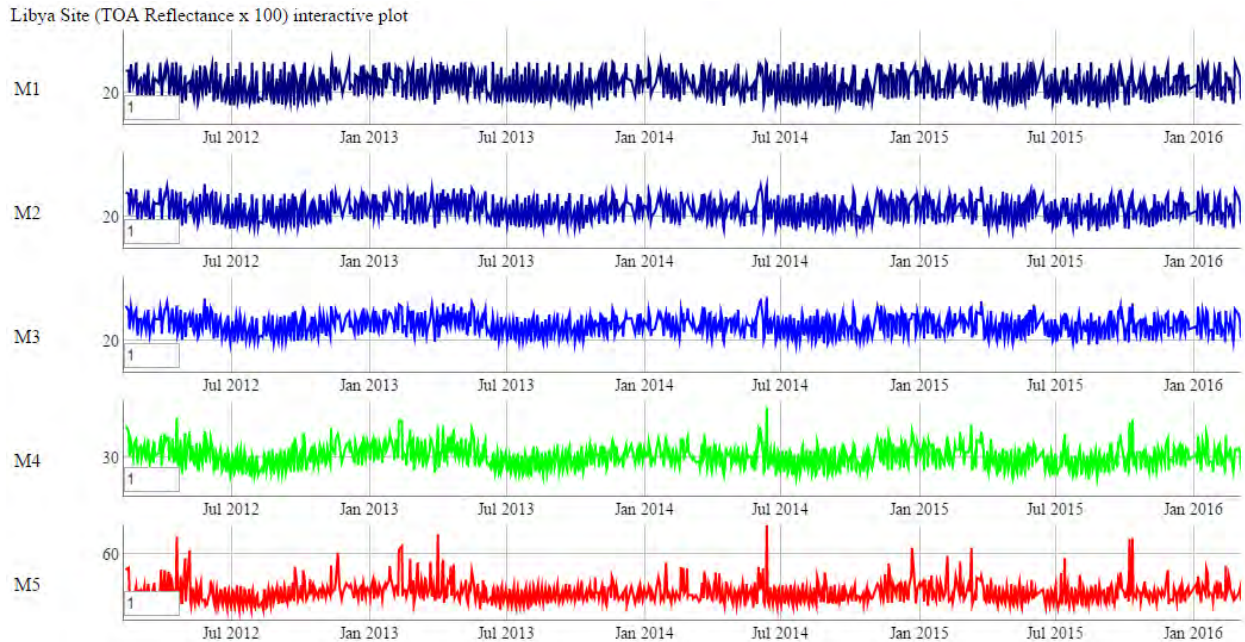

Figure 3. Near-real-time monitoring VIIRS SDR TOA reflectance at Libya site (24.42 °N, 13.35 °E).

2--Conduct ocean color related applications and research

--Reconstruction of Missing Pixels in Satellite Images Using the Data Interpolating Empirical Orthogonal Function (DINEOF), Xiaoming Liu and Menghua Wang, Ocean Science Meeting, Feb. 21-26, 2016, New Orleans, LA

Abstract: For coastal and inland waters, complete (in spatial) and frequent satellite measurements are important in order to monitor and understand coastal biological and ecological processes and phenomena, such as diurnal variations. High-frequency images of the water diffuse attenuation coefficient at the wavelength of 490 nm ($K_d(490)$) derived from the Korean Geostationary Ocean Color Imager (GOCI) provide a unique opportunity to study diurnal variation of the water turbidity in coastal regions of the Bohai Sea, Yellow Sea, and East China Sea. However, there are lots of missing pixels in the original GOCI-derived $K_d(490)$ images due to clouds and various other reasons. Data Interpolating Empirical Orthogonal Function (DINEOF) is a method to reconstruct missing data in geophysical datasets based on Empirical Orthogonal Function (EOF). In this study, the DINEOF is applied to GOCI-derived $K_d(490)$ data in the Yangtze River mouth and the Yellow River mouth regions, the DINEOF reconstructed $K_d(490)$ data are used to fill in the missing pixels, and the spatial patterns and temporal functions of the first three EOF modes are also used to investigate the sub-diurnal variation due to the tidal forcing. In addition, DINEOF method is also applied to the Visible Infrared Imaging Radiometer Suite (VIIRS) on board the Suomi National Polar-orbiting Partnership (SNPP) satellite to reconstruct missing pixels in the daily $K_d(490)$ and chlorophyll-a concentration images, and some application examples in the Chesapeake Bay and the Gulf of Mexico will be presented.

--Wang, M., L. Jiang, X. Liu, S. Son, J. Sun, W. Shi, L. Tan, K. Mikelsons, X. Wang, and V. LancVIIRS Ocean Color Products over Turbid Coastal and Inland Waters, Ocean Science Meeting, Feb. 21-26, 2016, New Orleans, LA

--Wang, M., W. Shi, L. Jiang, X. Liu, S. Son, and K. Voss, "Technique for monitoring performance of VIIRS reflective solar bands for ocean color data processing", *Opt. Express*, 23, 14446-14460 (2015). doi:10.1364/OE.23.014446.

--Wang, M., X. Liu, L. Jiang, S. Son, J. Sun, W. Shi, L. Tan, P. Naik, K. Mikelsons, X. Wang, and V. Lance, "VIIRS ocean color research and applications", *Proc. IGARSS '15*, pp.2911-2914 (2015).

PROJECT TITLE: NESDIS Environmental Applications Team, Wei Shi, Research Scientist - NPP VIIRS Calibration and Validation, Ocean Color Algorithm Development and Ocean Process Study with Satellite Ocean Color Remote Sensing

PRINCIPAL INVESTIGATORS: Steve Miller/Cliff Matsumoto

RESEARCH TEAM: Wei Shi CIRA/CSU

NOAA TECHNICAL CONTACT: Menghua Wang (NESDIS)

NOAA RESEARCH TEAM: Menghua Wang (NOAA)

FISCAL YEAR FUNDING (NEAT Total): \$1,764,742

PROJECT OBJECTIVES:

- Development of new satellite ocean color algorithm
- NPP VIIRS calibration and validation
- Application of satellite ocean color data for coastal and in-land water ecosystem monitoring

PROJECT ACCOMPLISHMENTS:

During this period, I studied long-term ecosystem changes of the Aral Sea observed by satellites. I also conducted research on the vicarious calibration technique to monitor the stability of the satellite ocean color sensor. Research was also conducted to study the cryospheric and hydrological changes over Tibet Plateau in the period between 1982 and 2013 using AVHRR data. Following is the summary of accomplishments.

- Long-term ecosystem changes of the Aral Sea observed by Satellites
- Technique for monitoring performance of VIIRS reflective solar bands for ocean color data processing
- Derive the vicarious gains for VIIRS ocean color data processing
- Study of cryospheric and hydrological changes over Tibet Plateau using AVHRR data

Publications:

Decadal changes of water properties in the Aral Sea observed by MODIS-Aqua

Author(s): Shi, Wei; Wang, Menghua

J. Geophys. Res. Oceans, **120**, 4687-4708 (2015)

Abstract: Twelve-year satellite observations between 2002 and 2013 from the Moderate Resolution Imaging Spectroradiometer (MODIS) onboard the satellite Aqua are used to quantitatively assess the water property changes in the Aral Sea. The shortwave infrared (SWIR) atmospheric correction algorithm is required and used to derive normalized water-leaving radiance spectra $nL_w(\lambda)$ in the Aral Sea. We used

radiance ratio $nL_w(555)/nL_w(443)$ as a surrogate to characterize the spatial and temporal variations of chlorophyll-a (Chl-a) in the Aral Sea. Both seasonal variability and significant interannual changes were observed when the Aral Sea desiccated between 2002 and 2013. All three separated regions of the Aral Sea show increased $nL_w(555)/nL_w(443)$ ratio (a surrogate for Chl-a) and the diffuse attenuation coefficient at the wavelength of 490 nm ($K_d(490)$) during the fall season. Of the three regions, the North Aral Sea has had the least interannual variability, while South-East (SE) Aral Sea experienced drastic changes. Waters in the SE Aral Sea are the most turbid with significantly higher $K_d(490)$ than those in the other two subregions. $K_d(490)$ gradually increased from $\sim 2 \text{ m}^{-1}$ in 2002 to $\sim 3.5 \text{ m}^{-1}$ after 2008 in the SE Aral Sea. In comparison, both radiance ratio $nL_w(555)/nL_w(443)$ and $K_d(490)$ were relatively stable for the North Aral Sea. In the South-West (SW) Aral Sea, however, $nL_w(555)/nL_w(443)$ values reached peaks in the fall of 2007 and 2010. A possible link between the Aral Sea water property change and the regional climate variation is also discussed.

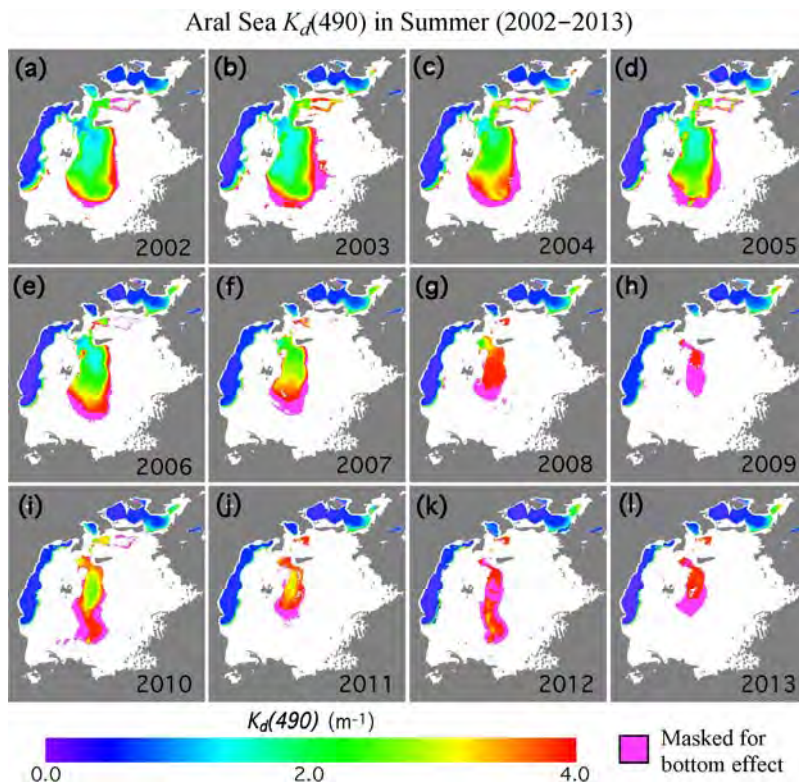

MODIS-Aqua-derived $K_d(490)$ composite images in summers (June–August) for (a–l) the corresponding years of 2002–2013. $K_d(490)$ data are not valid and excluded in the pink regions due to the bottom effect.

Title: Technique for monitoring performance of VIIRS reflective solar bands for ocean color data processing

Author(s): Wang, M., W. Shi et al.

Opt. Express, 23, 14446-14460 (2015)

Abstract: A technique for monitoring and evaluating the performance of on-orbit calibration for satellite ocean color sensors has been developed. The method is based on the sensor on-orbit vicarious calibration approach using in situ ocean optics measurements and radiative transfer simulations to predict (calculate) sensor-measured top-of-atmosphere spectral radiances. Using this monitoring method with in situ normalized water-leaving radiance $nL_w(\lambda)$ data from the Marine Optical Buoy (MOBY) in waters off Hawaii, we show that the root-cause for an abnormal inter-annual difference of chlorophyll-a data over global oligotrophic waters between 2012 and 2013 from the Visible Infrared Imaging Radiometer Suite (VIIRS) is primarily due to the VIIRS on-orbit calibration performance. In particular, VIIRS-produced

Sensor Data Records (SDR) (or Level-1B data) are biased low by ~1% at the wavelength of 551 nm in 2013 compared with those in 2012. The VIIRS calibration uncertainty led to biased low chlorophyll-a data in 2013 by ~30–40% over global oligotrophic waters. The methodology developed in this study can be implemented for the routine monitoring of on-orbit satellite sensor performance (such as VIIRS). Particularly, long-term Chl-a data over open oceans can also be used as an additional source to evaluate ocean color satellite sensor performance. We show that accurate long-term and consistent MOBY in situ measurements can be used not only for the required system vicarious calibration for satellite ocean color data processing, but also can be used to characterize and monitor both the short-term and long-term sensor on-orbit performances.

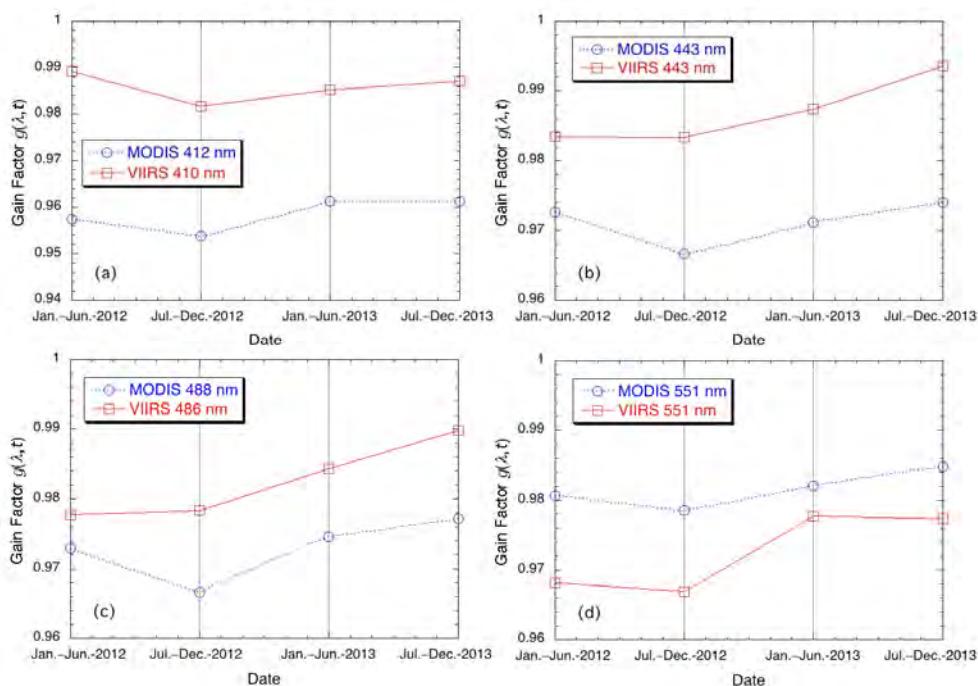

The derived gain factor $g(\lambda, t)$ as a function of time (6-month median) from 2012 to 2013 for different spectral bands (a) MODIS 412 nm and VIIRS 410 nm, (b) MODIS and VIIRS 443 nm, (c) MODIS 488 nm and VIIRS 486 nm, and (d) MODIS and VIIRS 551 nm.

Title: Consistency of NIR-based and SWIR-based Vicarious Calibration for Satellite Ocean Color Sensors

Author(s): Wang, M. and W. Shi

In progress

Abstract: NIR-based atmospheric correction algorithm and SWIR-based atmospheric correction algorithm are both commonly used in satellite ocean color data processing. In this study, we compare the NIR-based vicarious calibration and SWIR-based vicarious calibration with Aqua MODIS and SNPP VIIRS. Vicarious calibration gains in each band for MODIS and VIIRS are derived from in-situ normalized water-leaving radiance $nL_w(\lambda)$ data from the Marine Optical Buoy (MOBY) in the waters off Hawaii. Vicarious gains at 412 nm, 443 nm, 488 nm, 531 nm, 551 nm, 667nm derived from NIR and SWIR methods for MODIS are [0.961493, 0.976751, 0.977268, 0.984455, 0.988861, 0.986872] and [0.961912, 0.977914, 0.978786, 0.985651, 0.990002, 0.986889], respectively. Vicarious gains at 410 nm, 443 nm, 486 nm, 551 nm, 671nm derived from NIR and SWIR methods for VIIRS are [0.979370, 0.974632, 0.973753, 0.966902, 0.978097] and [0.980321, 0.975834, 0.97473, 0.967773, 0.979654], respectively. NIR-based vicarious calibration gains are consistent with SWIR-based vicarious calibration gains with a discrepancy

~0.1% for both MODIS and VIIRS. The difference of SWIR-derived and NIR-derived water-leaving radiance is trivial after applying respective vicarious calibration gains in the data processing. We demonstrate that a uniform vicarious calibration gain set can be applied to both SWIR-based and NIR-based satellite ocean color data processing for Aqua MODIS, SNPP VIIRS and future ocean color sensors such as PACE mission.

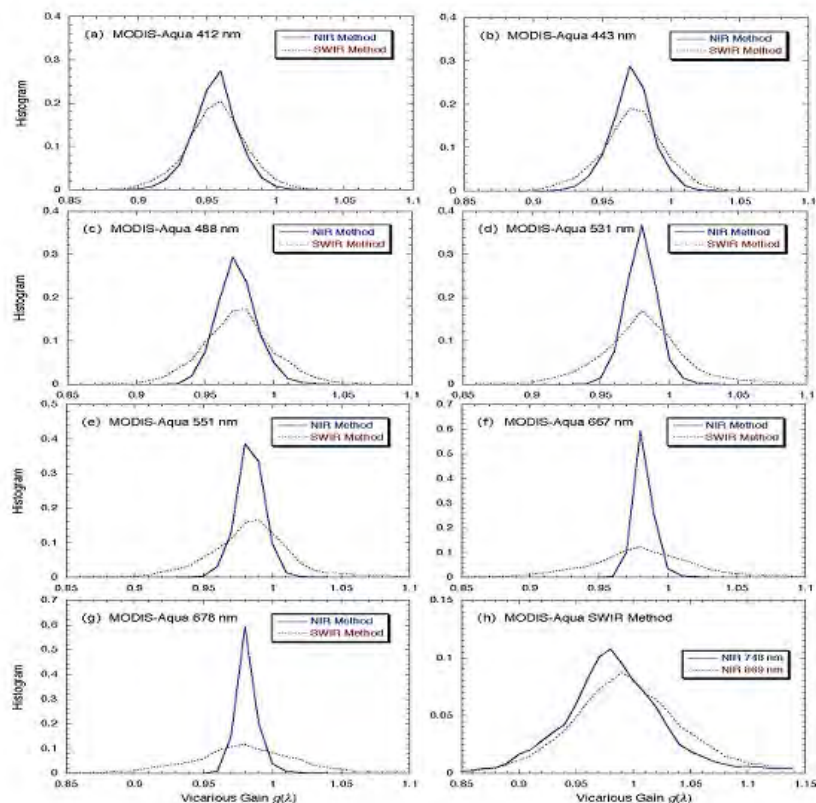

Histogram of vicarious calibration coefficients $g(\lambda)$ derived with NIR and SWIR methods for MODIS band at (a) 412 nm, (b) 443 nm, (c) 488 nm, (d) 531 nm, (e) 551 nm, (f) 667 nm, (g) 678 nm, and (h) 748 nm and 869 nm.

Title: Cryospheric and Hydrological Changes in the Tibetan Plateau Since 1981

Author(s): Shi, W. and M. Wang
In progress

Abstract: Using long-term satellite observations, we report drastic hydrological changes over the Tibetan Plateau (TP) since 1981. Comparison between 1.1-km AVHRR and 4-km AVHRR observations over TP shows that NDVI derived from 4-km AVHRR data can be used to assess long-term hydrological changes with reasonable accuracy. In the period between 1981 and 2014, the area with NDVI < -0.16 increased about 50% over the TP from 4-km AVHRR observations. In 2014, the total area for NDVI < -0.16 was 60% larger than the water coverage in 1981 over TP. Most of the hydrological changes over TP occurred at the elevations over 4.5 km. Hydrological changes for major lakes over TP were different in the period between 1981 and 2014. There was no significant change of the water coverage at Lake Kokonor while the dramatic water coverage expansion was observed in Lake Ziling. Climate data analysis suggests that precipitation increase since 1981 led to the increase of water areal coverage over the TP.

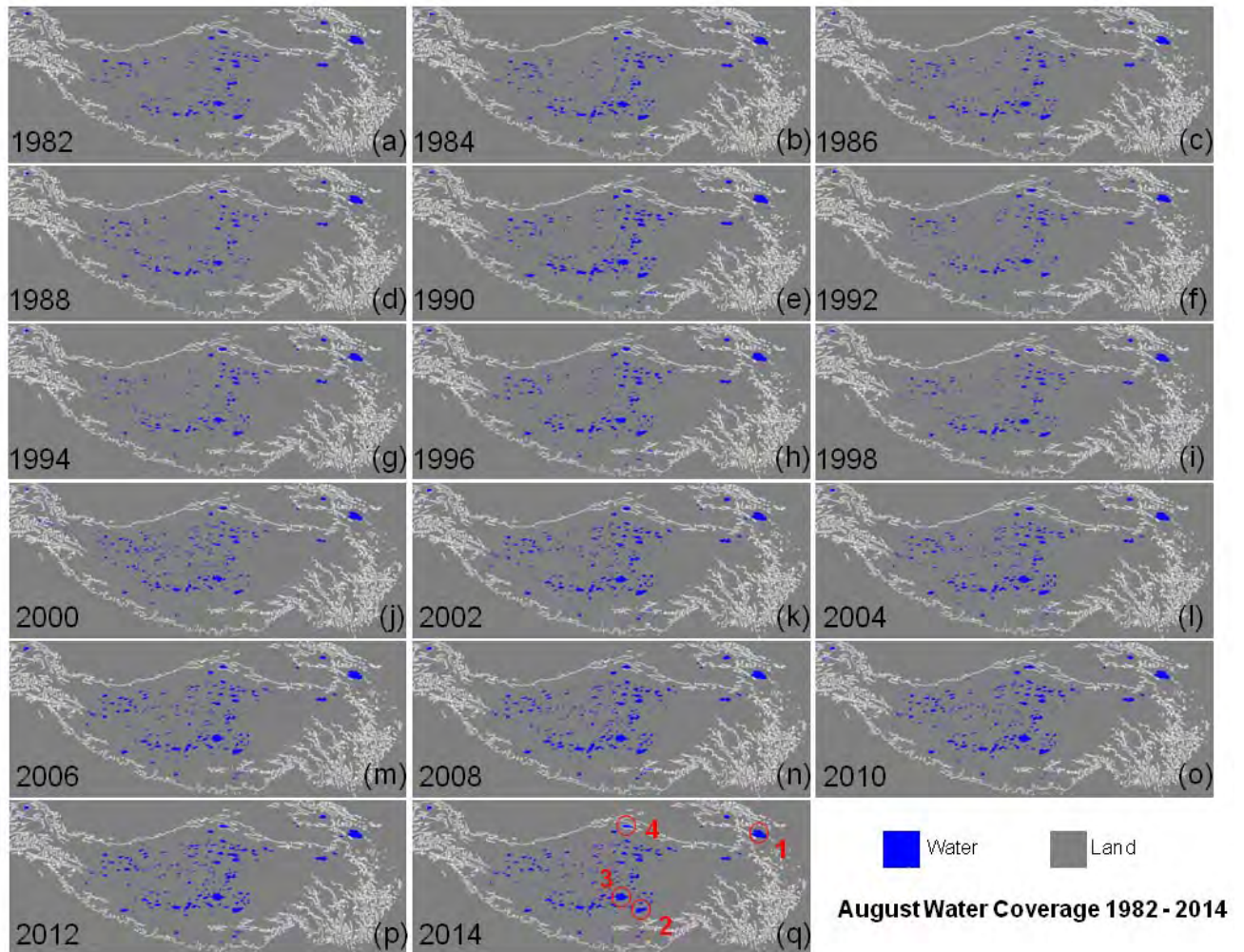

Images (a–q) of water coverage in the month of August for the corresponding year of 1982–2014. Dark blue and gray denote water and land coverage, respectively. Red circles mark (1) Lake Kokonor, (2) Lake Namco, (3) Lake Ziling, and (4) Lake Ayakkum, which are the major lakes in the TP. The white line is the contour line of elevation 3 km.

PROJECT TITLE: NESDIS Environmental Applications Team, Seunghyun Son, Research Scientist

PRINCIPAL INVESTIGATOR(S): Steve Miller/Cliff Matsumoto

RESEARCH TEAM: Seunghyun Son

NOAA TECHNICAL CONTACT: Menghua Wang, STAR/SOCD/MEB

NOAA RESEARCH TEAM: Dr. Menghua Wang

FISCAL YEAR FUNDING (NEAT Total): \$1,764,742

PROJECT OBJECTIVES:

- 1--Processing and validation/evaluation of the JPSS VIIRS data
- 2--Development of bio-optical and biogeochemical algorithms for the satellite ocean color data use in the various ocean waters (clear open ocean, coastal and inland waters).

PROJECT ACCOMPLISHMENTS:

1--The VIIRS data sets from various processing methods (e.g., IDPS-EDR, OC-SDR-EDR, NOAA-MSL12) have been being processed over the various ocean waters (Hawaii region, South Pacific Gyre, US east coast, Yellow & East China seas, Mediterranean Sea, etc.). In situ bio-optical data were compared for validation of the VIIRS data in various regions.

2--Regional algorithms for Sea-Ice mask and turbidity for use of satellite ocean color data in the Great Lakes are developed and updated, and the optical properties in the Great Lakes are characterized. The results were presented in an international conference and will be submitted to a peer-reviewed journal.

3--A paper about out-of-band effects for ocean color satellite sensors has been submitted to a scientific journal and is now in press.

4--Existing chlorophyll-a algorithms were evaluated (particularly for the very clear open ocean waters). Modified chl-a algorithm has been developed for VIIRS data in the global open ocean waters and a manuscript using the results has been submitted to a scientific journal and is now under revision.

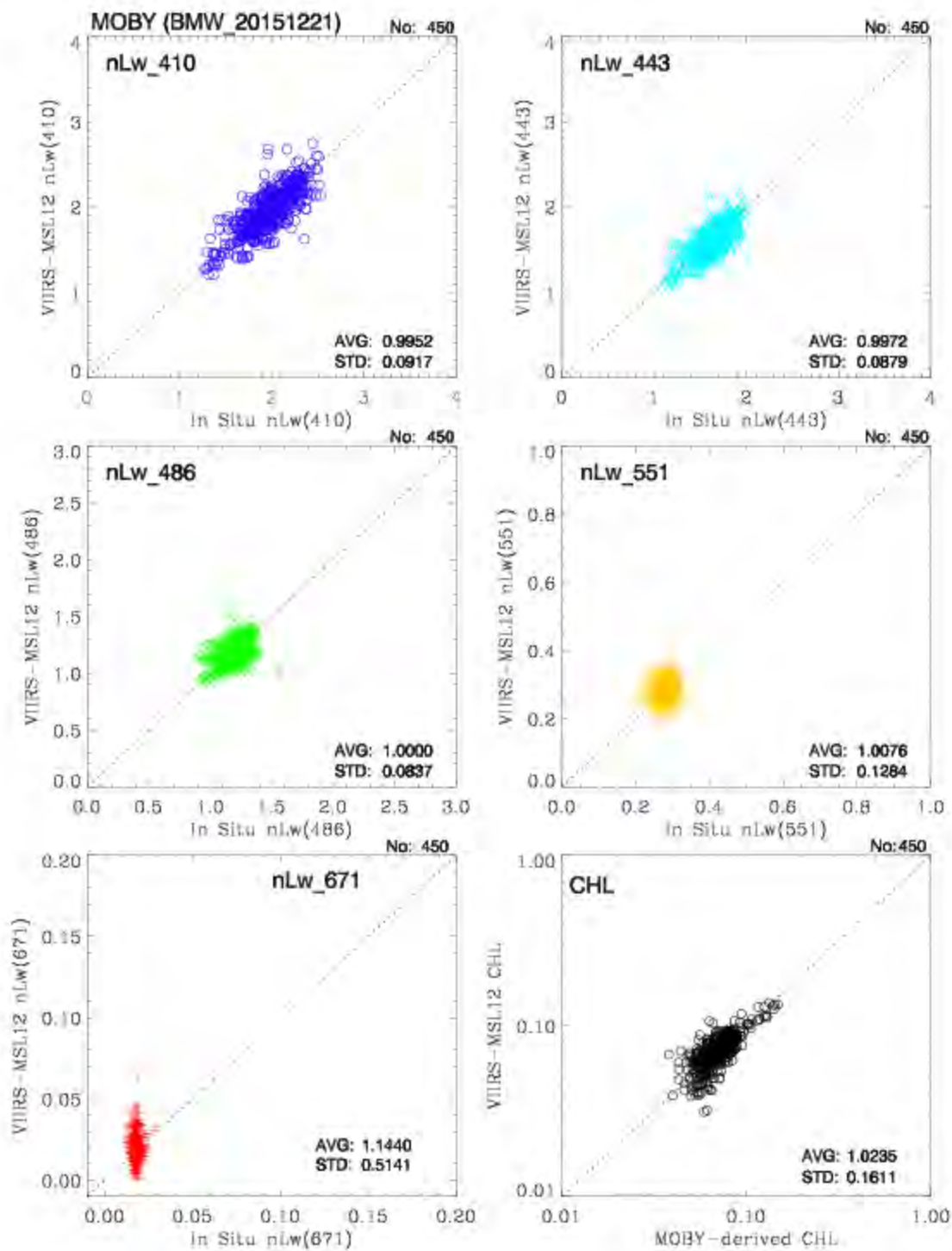

Figure 1. Matchup comparison between MOBY in situ and VIIRS-derived $nL_{dw}(\lambda)$ and Chl-a measurements using the OC-SDR/EDR processing.

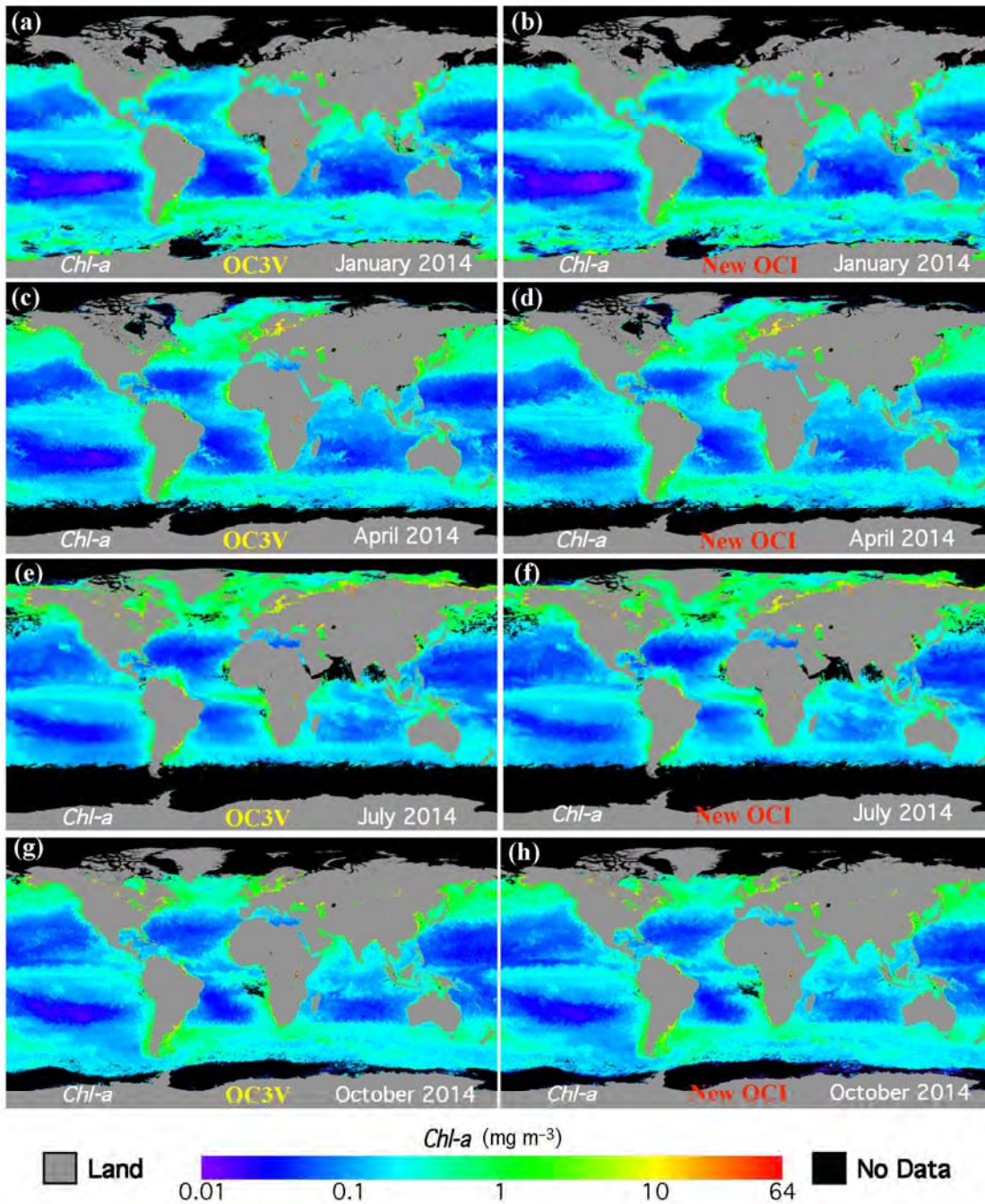

Figure 2. VIIRS-derived global Chl-a monthly composite images for the months of January (a & b), April (c & d), July (e & f), and October (g & h), respectively. Global Chl-a images in panels a, c, e, and g are derived using the OC3V algorithm, while panels b, d, f, and h are from the new OCI algorithm.

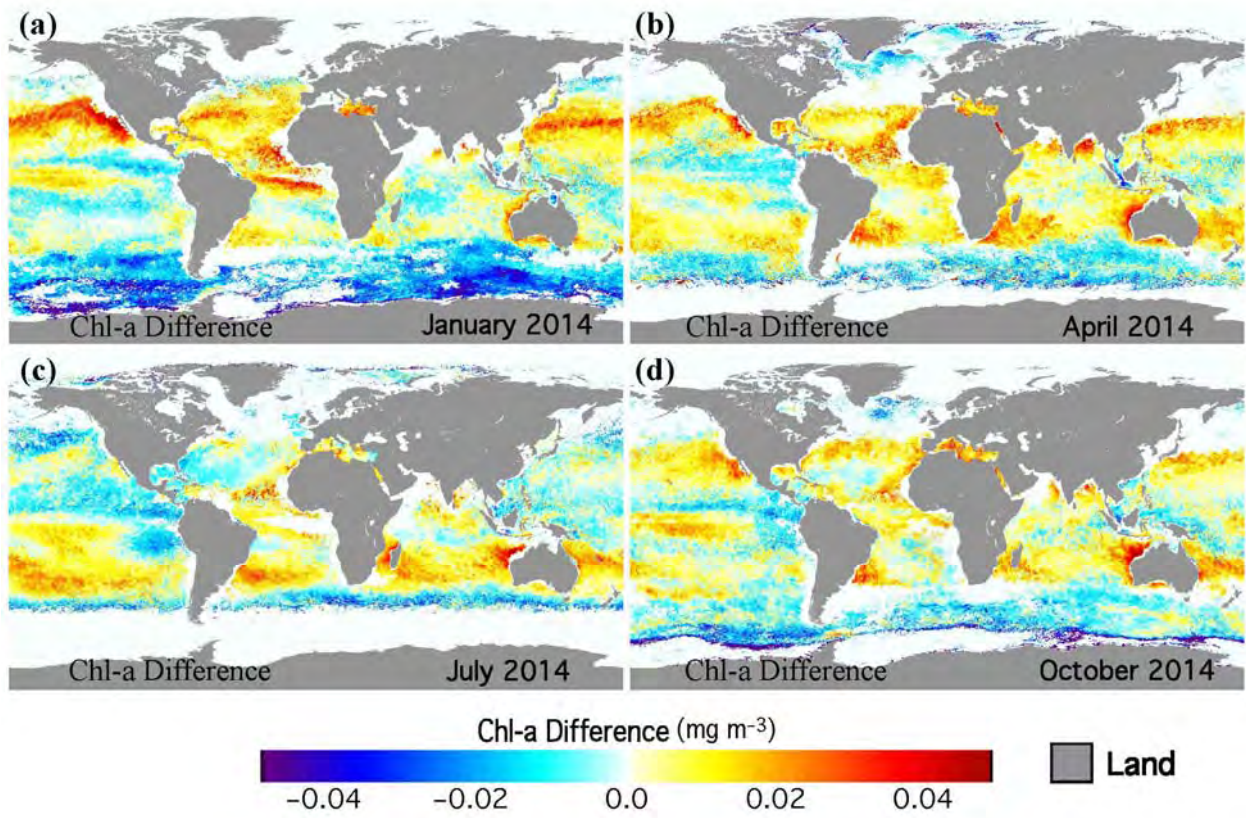

Figure 3. VIIRS-derived global monthly composite images of $K_d(\text{PAR})$ from the new $K_d(\text{PAR})$ model.

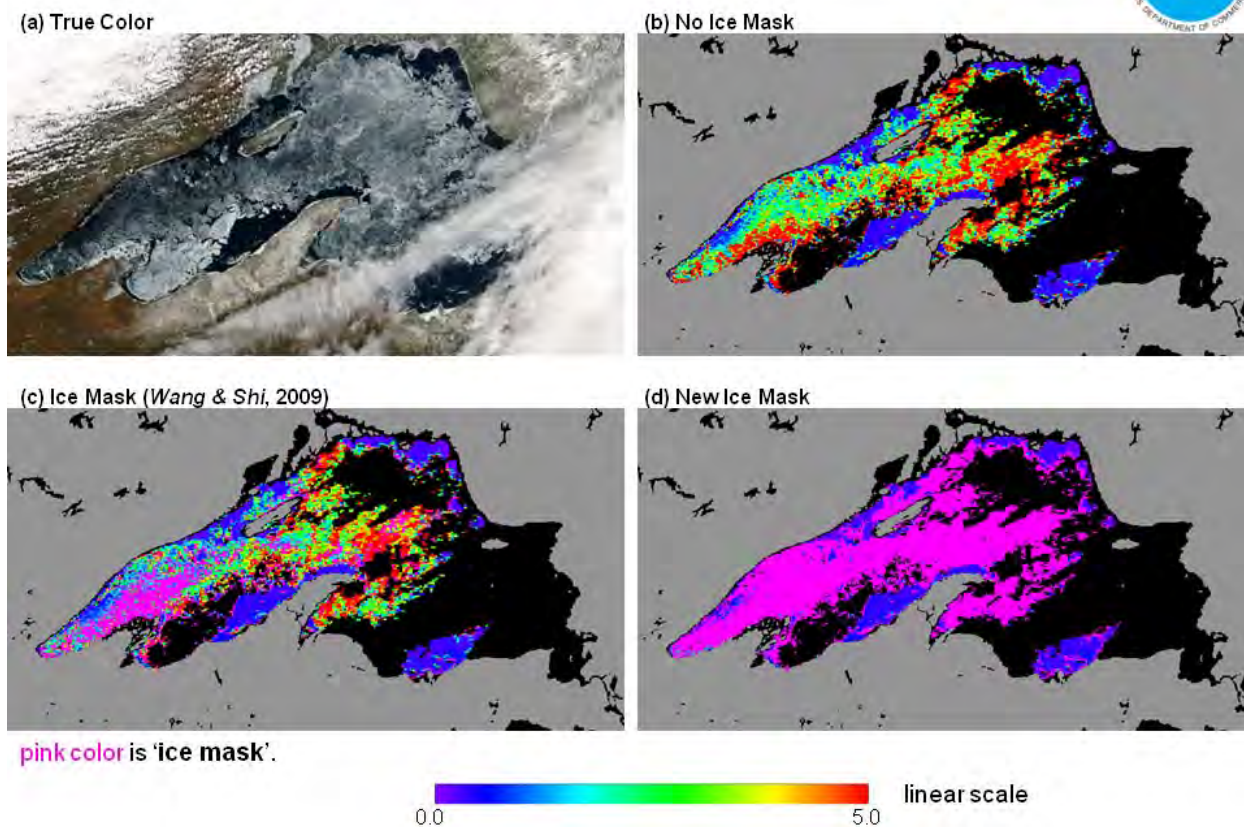
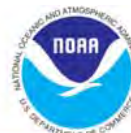

Figure 4. MODIS-Aqua-derived (a) true color image, and normalized water-leaving radiance at 551 nm, $nL_w(551)$, using (b) without an ice masking method, (c) with ice detection masking from Wang & Shi (2009) (pink), and (d) a new ice masking (pink) in the Great Lakes acquired on March 4th, 2003.

MODIS-Aqua Climatology Images

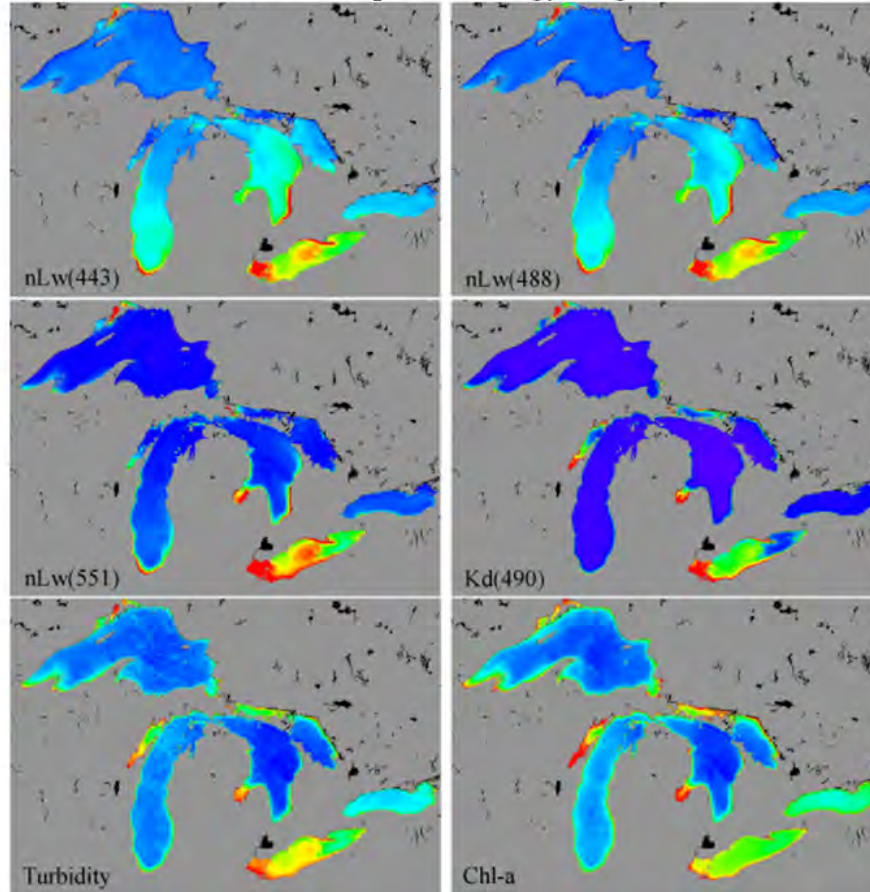

Figure 5. MODIS-Aqua-measured climatology composite images of $nL_w(443)$, $nL_w(488)$, $nL_w(551)$, Turbidity, and Chl-a in the Great Lakes.

Publications:

Wang, M. & S. Son (in revision), VIIRS-derived chlorophyll-a using the ocean color index method, Remote Sensing of Environment.

Wang, M., P. Naik, & S. Son (in press), Out-of-Band effects of satellite ocean color sensors, Applied Optics.

Wang, M., W. Shi, L. Jiang, X. Liu, S. Son, & K. Voss (2015), Technique for monitoring performance of VIIRS reflective solar bands for ocean color data processing, Optics Express, 23(10), 14445-14460, doi:10.1364/OE.23.014446.

Presentations:

Son, S. & M. Wang, Water properties in the Great Lakes from satellite ocean color measurements (at the Ocean Science Meeting 2016, New Orleans, USA) (2016) Feb 22–26.

Son, S., M. Wang & L. Harding, Satellite-measured net primary production in the Chesapeake Bay from MODIS and VIIRS (at NASA Ocean Science Research Meeting 2014, Silver Spring, MD, USA) (2015) May 5–7.

Son, S. & M. Wang, Water diffuse attenuation coefficient of the photosynthetically available radiation $K_d(\text{PAR})$ for global open ocean and coastal waters (Invited talk at the 3rd Asia Workshop on Ocean Color 2015, JAMSTEC, Yokohama, JAPAN) (2015) Dec 8–10.

Son, S., M. Wang & L. Jiang, Seasonal and interannual variations in water optical and biogeochemical properties measured by the Geostationary Ocean Color Imager (GOCI) (at the 2nd International Ocean Colour Remote Sensing, San Francisco, USA) (2015) Jun 15–18.

Son, S. & M. Wang, Diffuse attenuation coefficient of the photosynthetically available radiation $K_d(\text{PAR})$ for global ocean and coastal waters (at the 2nd International Ocean Colour Remote Sensing, San Francisco, USA) (2015) Jun 15–18.

Wang, M., L. Liang, X. Liu, S. Son, J. Sun, W. Shi, L. Tan, K. Mielsons, X. Wang, & V. Lance, VIIRS ocean color products over turbid coastal and inland waters (at the Ocean Science Meeting 2016, New Orleans, USA) (2016) Feb 22–26.

Wang, M., J. Lide, X. Liu, S. Son, W. Shi, P. Naik, J. Sun, X. Wang & V. Lance, Evaluation of VIIRS Ocean Color Products (at SPIE Asia-Pacific Remote Sensing 2014 Conference, Beijing, China) (2015) Oct 13–16.

Wang, M., S. Son, L. Liang, X. Liu, J. Sun, W. Shi, L. Tan, K. Mielsons, X. Wang, & V. Lance, VIIRS ocean color research and applications (Invited talk at the 3rd Asia Workshop on Ocean Color 2015, JAMSTEC, Yokohama, JAPAN) (2015) Dec 8–10.

Wang, M., X. Liu, J. Lide, S. Son, J. Sun, W. Shi, L. Tan, P. Naik, K. Mielsons, X. Wang & V. Lance, VIIRS Ocean Color Research and Applications Products (at the IGARRS 2015 Meeting, Milan, ITALY) (2015) Jul 27–31.

Wang, M., J. Lide, X. Liu, S. Son, W. Shi, J. Sun, L. Tan, P. Naik, K. Mielsons, X. Wang & V. Lance, VIIRS Ocean Color Products (at the 2nd International Ocean Colour Remote Sensing, San Francisco, USA) (2015) Jun 15–18.

PROJECT TITLE: NESDIS Environmental Applications Team – Liqin Tan, Research Associate - CIRA Support to the JPSS Science Program: S-NPP VIIRS EDR Imagery Algorithm and Validation Activities and S-NPP VIIRS Cloud Validation and CIRA Support to the JPSS Proving Ground and Risk Reduction Program

PRINCIPAL INVESTIGATORS: Steve Miller/Cliff Matsumoto

RESEARCH TEAM: Liqin Tan (CIRA/CSU)

NOAA TECHNICAL CONTACT: Menghua Wang (NOAA)

NOAA RESEARCH TEAM: Menghua Wang (NOAA team lead)

FISCAL YEAR FUNDING (NEAT Total): \$1,764,742

PROJECT OBJECTIVES:

--Performing VIIRS instrument characterization and calibration for ocean color (OC) data processing and applications. Evaluating the effect of VIIRS instrument performance on the science data quality and quantify the impact

--Understanding, evaluation, and refining VIIRS ocean color (OC) data processing system

PROJECT ACCOMPLISHMENTS:

1--Collaborated with VIIRS SDR team to monitoring the development of VIIRS instrument calibration activities, operational IDPS SDR production, and Discrepancy Records (DRs). Participated in VIIRS SDR team weekly teleconference.

2--Responsible for communicating, searching and routing downloading of SNPP and JPSS-1 VIIRS instrument calibration analysis and SDR data processing required data, including raw data and ancillary/auxiliary supporting data (such as IDPS Fast-Track VIIRS SDR GEO/Calibration Looking-Up Tables(LUTs), SNPP VIIRS RSBAutoCal History Aux (F factors) data, VIIRS RDR, Predicted SNPP Ephemeris data, NASA's 5-min VIIRS Verified RDR granules for the lunar events, JPSS-1 VIIRS SDR GEO/Calibration and RSBAutoCal LUTs, relative spectral response (RSR) and polarization testing data etc.) from all the data sources (Raytheon Common CM, NOAA GRAVITE, NASA eRoom and LandPEATE, U. of Wisconsin, etc).

3--Enhanced our ADL based RDR to SDR data reprocessing tool and updated it with option of ADL4.2 Mx8.10. Performed test run on ADL RSBAutoCal.

4--Developed tools to run the ADL RSBAutoCal module and generate VIIRS-RSBAUTOCAL-HISTORY-AUX from VIIRS OBC-IP.

5--Assessed the VIIRS SDR AUTOCAL and its possible impact on the Ocean Color EDR products.

6--Reprocessed MOBY site and Aeronet-OC VIIRS SDR data for ocean color (OC-SDR) using updated ADL4.1_Mx7.1 code (solar vector angle corrected and "c0=0") with our in-house new F factor LUTs.

7--Finished reprocessing of global NPP VIIRS OC-SDR for the first three years of the mission using our in-house new F factor LUTs and ADL code (solar vector angle corrected and "c0=0") with our in-house new F factor LUTs.

8--Generated different versions of daily F factor ratio of our new developed F LUTs and IDPS operational F LUTs to support our ratio approach OC-SDR data reprocessing.

9--Generated SNPP VIIRS OBC-IP data (sweet-spots and one-orbit-per-month) since the launch to support out in-house SNPP VIIRS RSB calibration.

Publications:

Wang, M., X. Liu, L. Jiang, S. Son, J. Sun, W. Shi, L. Tan, P. Naik, K. Mielsons, X. Wang, **and** V. Lance, "VIIRS ocean color research and applications", *Proc. IGARSS '15*, pp.2911-2914 (2015).
doi:10.1109/IGARSS.2015.7326424 

Title: VIIRS ocean color research and applications

Author(s):

Wang, M., X. Liu, L. Jiang, S. Son, J. Sun, W. Shi, L. Tan, P. Naik, K. Mielsons, X. Wang, and V. Lance

Status:

Published. Geoscience and Remote Sensing Symposium (IGARSS), 2015 IEEE International

Abstract:

In this paper, we provide evaluations and assessments of the Visible Infrared Imaging Radiometer Suite (VIIRS) ocean color products, including normalized water-leaving radiance spectra $nL_w(\lambda)$ at VIIRS five spectral bands, chlorophyll-a concentration (Chl-a), water diffuse attenuation coefficients at the wavelength of 490 nm, $K_d(490)$, and at the domain of photosynthetically available radiation (PAR), $K_d(PAR)$. Specifically, VIIRS ocean color products derived from the NOAA Multi-Sensor Level-1 to Level-2 (MSL12) ocean color data processing system are evaluated and compared with in situ data from the Marine Optical Buoy (MOBY) and measurements from the Moderate Resolution Imaging Spectroradiometer (MODIS). In general, VIIRS ocean color products are matched well with MOBY in situ measurements, and are also consistent with those from MODIS-Aqua. Ocean color products were found to be highly sensitive to some operational sensor calibration issues. We have improved sensor calibration by combining the lunar calibration into the current calibration method. Here, the ocean color products based on the new sensor calibration are evaluated. Our results show that VIIRS is capable of providing high-quality global ocean color products in support of the scientific research and operational applications.

PROJECT TITLE: NESDIS Environmental Applications Team, Sirish Uprety, Research Associate - Suomi NPP VIIRS Calibration and Validation

PRINCIPAL INVESTIGATOR(S): Steven Miller/Cliff Matsumoto

RESEARCH TEAM: Sirish Uprety

NOAA TECHNICAL CONTACT: Changyong Cao

NOAA RESEARCH TEAM: Changyong Cao (NOAA/NESDIS/STAR) and Sirish Uprety (CIRA, CSU)

FISCAL YEAR FUNDING (NEAT Total): \$1,764,742

PROJECT OBJECTIVES:

On-orbit calibration and validation of Suomi NPP VIIRS:

1--S-NPP VIIRS radiometric performance monitoring and evaluation using SNO-x.

- 2--Analyze the radiometric accuracy and stability of VIIRS using vicarious calibration sites.
- 3--Evaluate the radiometric performance of VIIRS M11 band (2.25 μm).
- 4--Characterize the VIIRS DNB modulated RSR
- 5--Develop the capability to generate and analyze the VIIRS DNB monthly calibration parameters using VROP.
- 6--Provide the feedbacks on VIIRS performance on regular basis to VIIRS cal/val team and through publications.
- 7--VIIRS SDR team reporting (weekly and quarterly)

PROJECT ACCOMPLISHMENTS:

- 1--S-NPP VIIRS radiometric performance monitoring and evaluation using SNO-x.

The VIIRS radiometric stability and accuracy are continuously monitored using independent techniques such as intercomparison with AQUA MODIS using SNO-x. Figure 1a shows the VIIRS bias estimated since early launch for blue bands M1-3. The figure shows that the temporal trends of bias are not stable and suggest a number of ups and down during the mission. There are instants for M1 when the bias changes by more than 4%. Frequent jumps in bias are mainly caused by the major look-up-table updates and calibration anomalies. In order to confirm that the change in bias is mainly due to VIIRS and not due to MODIS, a separate analysis is performed by comparing VIIRS data from NOAA IDPS with the NASA LandPEATE (Figure 1b). It is to be noted that LandPEATE data are reprocessed. Thus its comparison with VIIRS SDR data from IDPS shows how well the IDPS version of VIIRS calibration is performing over time. In addition, the large changes observed in bias trends can also be explained using the ratio of VIIRS data from IDPS and LandPEATE.

- 2--Analyze the radiometric accuracy and stability of VIIRS using vicarious calibration sites

Radiometric performance of VIIRS is analyzed using well characterized desert calibration sites Libya-4, Sudan-1 and the Antarctica Dome C site. The study shows that VIIRS calibration stability and radiometric accuracy at Libya-4 and Sudan-1 sites agree very well to within 1%. VIIRS moderate resolution reflective solar bands analyzed are temporally stable with radiometric stability within 1% for most of the bands except bands M7 and M11 with nearly 1.5%. The calibration uncertainty for all the bands is on the order of 0.5% or less except M11 (1%). VIIRS radiometric bias (analyzed after accounting for spectral differences) relative to MODIS at three sites agrees to within 1%. VIIRS and MODIS agree to within $2\% \pm 1\%$ for bands M1 through M5 while M7 and M8 suggest larger bias of nearly 3%.

- 3--Evaluate the radiometric performance of VIIRS M11 band (2.25 μm).

The radiometric bias of the VIIRS SWIR band M11 (2.25 μm) has been analyzed using MODIS and OLI instruments over Libya-4 desert (Figure 2). Even if the M11 radiance is very small over ocean compared to desert, the study assumes that M11 detectors behave linearly and the results are equally valid over ocean as well. The VIIRS bias relative to OLI after accounting for the spectral differences is nearly 5.4%. VIIRS bias is small (0.2%) relative to MODIS. However, MODIS RSR doesn't match with VIIRS and the uncertainty in the spectral bias is larger than 3%.

- 4--Characterize the VIIRS DNB modulated RSR

VIIRS RTA degradation causes the DNB relative spectral response to change over time. DNB RSRs were updated in IDPS only once in April 2013. Since the degradation is a continuous function of time, the onetime update caused the step change in calibration. This study characterizes the DNB modulated RSRs using F factors of moderate resolution bands M4-7. Since the physical model of RTA degradation follows nearly linear trend for the DNB spectral coverage, bands M4-M7 are used to estimate and analyze the modulated RSR. The results were compared with DNB modulated RSR generated on April 04, 2013 for IDPS LUT update. The two RSRs generated using two different techniques agree very well (Figure 3).

5--Develop the capability to generate and analyze the VIIRS DNB monthly calibration parameters using VROP.

Developed the capability to generate and analyze monthly VIIRS DNB calibration coefficients using VROP based monthly data collection. DNB offsets and gain ratios are computed every month during new moon. VROP 702 and 705 data were processed and analyzed for a number of months. DNB dark offsets and gain ratio coefficients were determined for all three gain stages. Comparison of DNB target offset and gain ratio with IDPS operational LUTs suggests a very good agreement among each other (Figure 4). The study helps to analyze and prepare current NPP VIIRS DNB data for reprocessing. In addition, the study will be helpful for analyzing J1 VIIRS DNB calibration after launch.

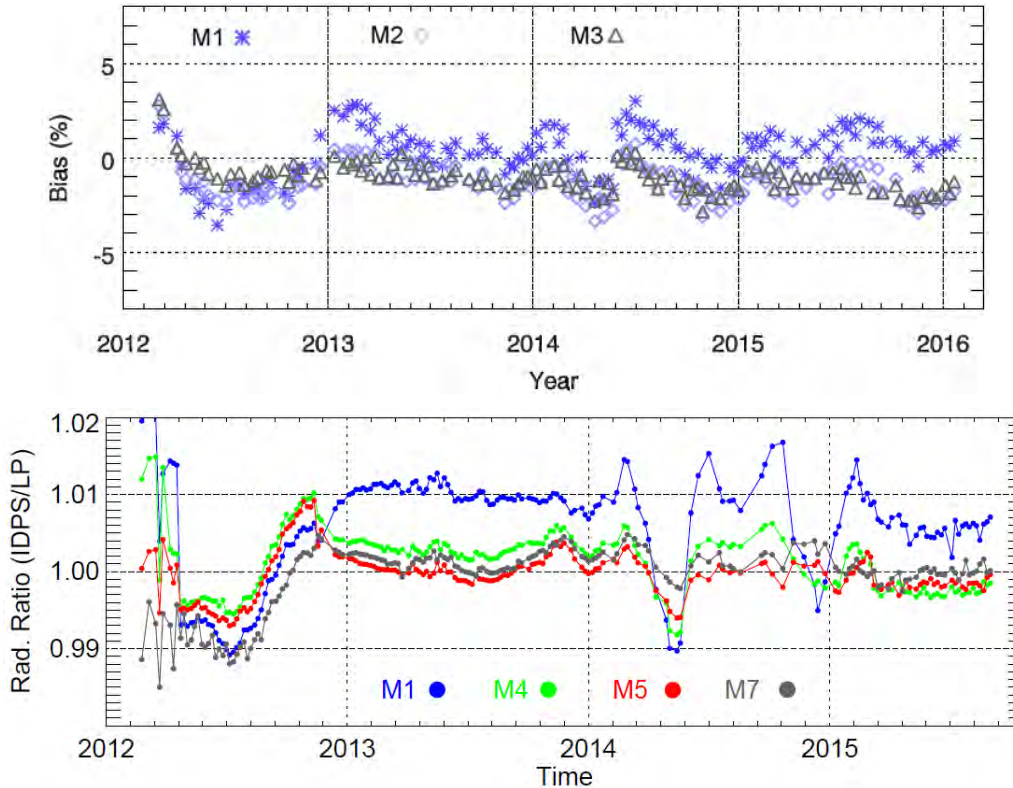

Figure 1. a) VIIRS bias estimated over desert for M1-3 using extended SNOs b) Ratio of VIIRS SDR data generated from IDPS and Land PEATE/SIPS

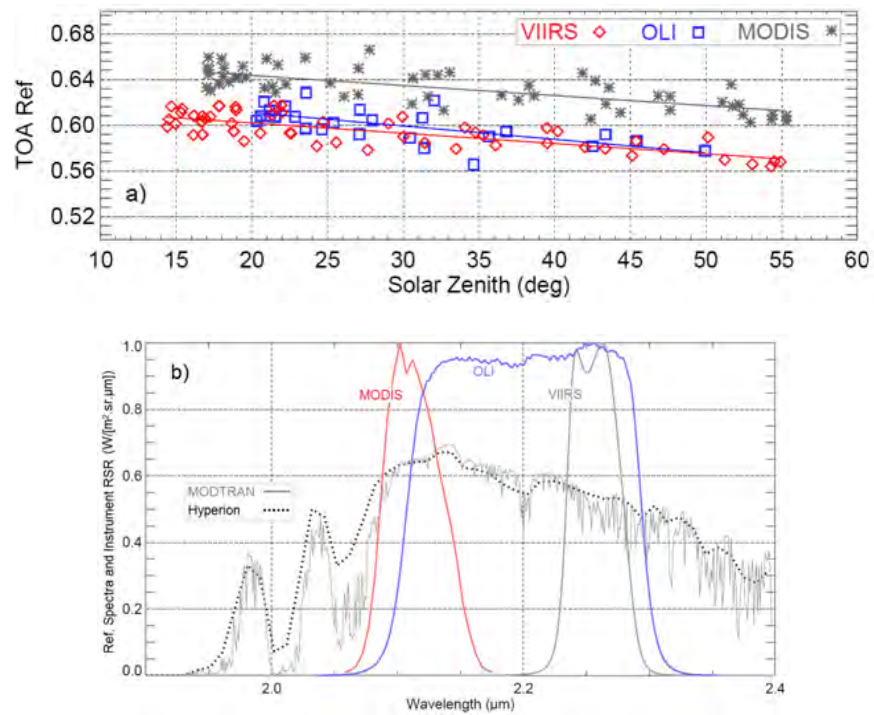

Figure 2. a) VIIRS M11 bias relative to OLI and MODIS reflectance as a function of solar zenith b) Reflectance spectra using Hyperion over Libya-4 and MODTRAN. VIIRS band M11 along with closest matching MODIS and OLI bands are also shown.

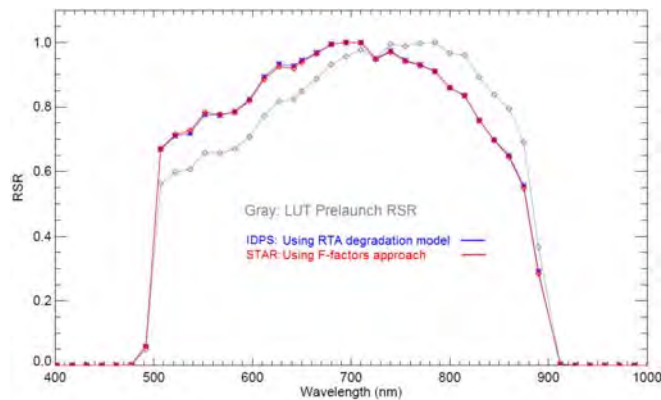

Figure 3. DNB RSRs generated prelaunch (gray color) and modulated RSRs.

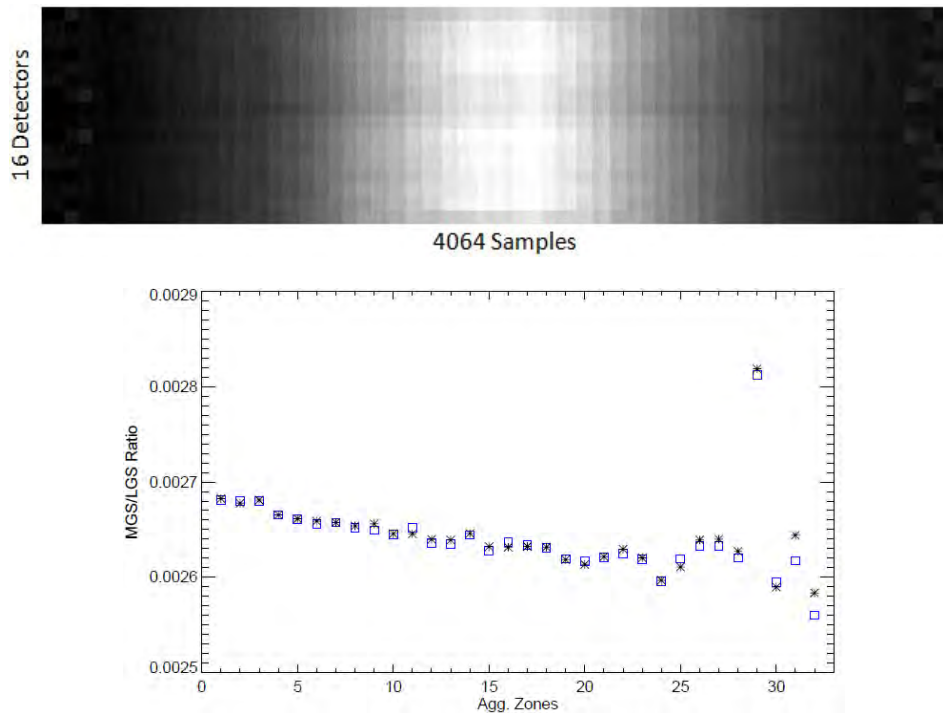

Figure 4. Top: VIIRS DNB HGS dark offset for ground table. Bottom: MGS/LGS Slope ratio computed at STAR (blue box) and that from IDPS LUTs (black)

Publications:

Qiu, S., Xi Shao, Changyong Cao, and Sirish Uprety. (2015). Feasibility demonstration for calibrating Suomi-NPP VIIRS Day/Night Band using Dome C and Greenland under moon light. *Journal of Applied Remote Sensing (Accepted)*.

Uprety, S., & Cao, C. (2015). Suomi NPP VIIRS reflective solar band on-orbit radiometric stability and accuracy assessment using desert and Antarctica Dome C sites. *Remote Sensing of Environment*, 166, 106-115.

Uprety, S., & Cao, C. (2015, September). Radiometric performance assessment of Suomi NPP VIIRS SWIR Band (2.25 μm). *SPIE Optical Engineering+ Applications* (pp. 96072C-96072C).

Uprety, S., & Cao, C. (2015). Radiometric comparison of Greenhouse Gases Observing Satellite (GOSAT) TANSO-FTS and Suomi NPP VIIRS 1.6 μm CO₂ absorption band. *Journal of Atmospheric and Oceanic Technology (Submitted)*

Uprety, S., Cao, C., & Blonski, S. (2015). Retrospective analysis of Suomi NPP VIIRS radiometric bias for reflective solar bands due to operational calibration changes. *International Journal of Remote Sensing (Submitted)*

Project Title: NESDIS Environmental Applications Team – Xiao-Long Wang, Research Associate - Software Development for Satellite Data Analysis and Processing

PRINCIPAL INVESTIGATORS: Steve Miller/Cliff Matsumoto

RESEARCH TEAM: Xiao-Long Wang, Lide Jiang, Xiaoming Liu, Wei Shi, Liqin Tan, SeungHyun Son and Mike Chu

NOAA TECHNICAL CONTACT: Menghua Wang

NOAA RESEARCH TEAM: NOAA SOCD

FISCAL YEAR FUNDING (NEAT Total): \$1,764,742

PROJECT OBJECTIVE(S):

Develop Ocean Color Data Application & Processing System (OCDAPS) to support NPP VIIRS, MODIS, and GOCI Ocean color products visualization, data manipulation and data processing.

Research Conducted (Accomplishments) Past Fiscal Year by Objective:

Actively made progresses on VIIRS image visualization for various products (SDR/EDR, NOAA-MSL12, L2bin, L3bin, Quality Flags, Masks etc.) and data analysis/processing.

1--Continuously improve VIIRS SDR/EDR and NOAA-MSL12 image data visualization with IDL based satellite data processing system. Supported VIIRS, GOCI and MODIS Ocean Color products in image visualization, image data manipulation, multiple band image difference computation, geo-registration, image mapping/re-projection, graphic utility, true-color image generation and new netCDF input/output,

2--Realized satellite data format transaction from HDF4/HDF5 to netCDF4 in OCDAPS data processing, data mapping and data input/output. Support various options in data output (data and navigation info, data only or navigation info only).

3--Implemented batch command mode mapping and data extraction for new L2 netCDF image files to support regional environmental monitoring and data comparison.

4--Supported OCDAPS L2bin and L3bin function running for routine global and regional VIIRS L2/L3 binning processing and mapping with new netCDF format output.

5--Provided and supported batch command scripts to Implement routine run global L3 data regional data extraction and computation to monitor trends of various ocean-color products. Enabled automatic routine operation for daily VIIRS data analysis and validation.

6--Create OCDAPS system documentation and user guide in HTML files. Provide expandable web-links for user help.

7--Updated and supported VIIRS/MODIS multiple granule image data aggregation and image composition for large scale marine environmental monitoring.

8--Supported routine run in global regional ocean color monitoring with daily automatically generated true-color images from multiple VIIRS spectrum band data. Enabled near-realtime automatic routine operation to support daily coastal data analysis and marine reef monitoring.

9--Continuously provided convenient GUI mode and command mode support to perform existing and future new satellite data computations and image data analysis and processing for group user's routine batch jobs and command scripts.

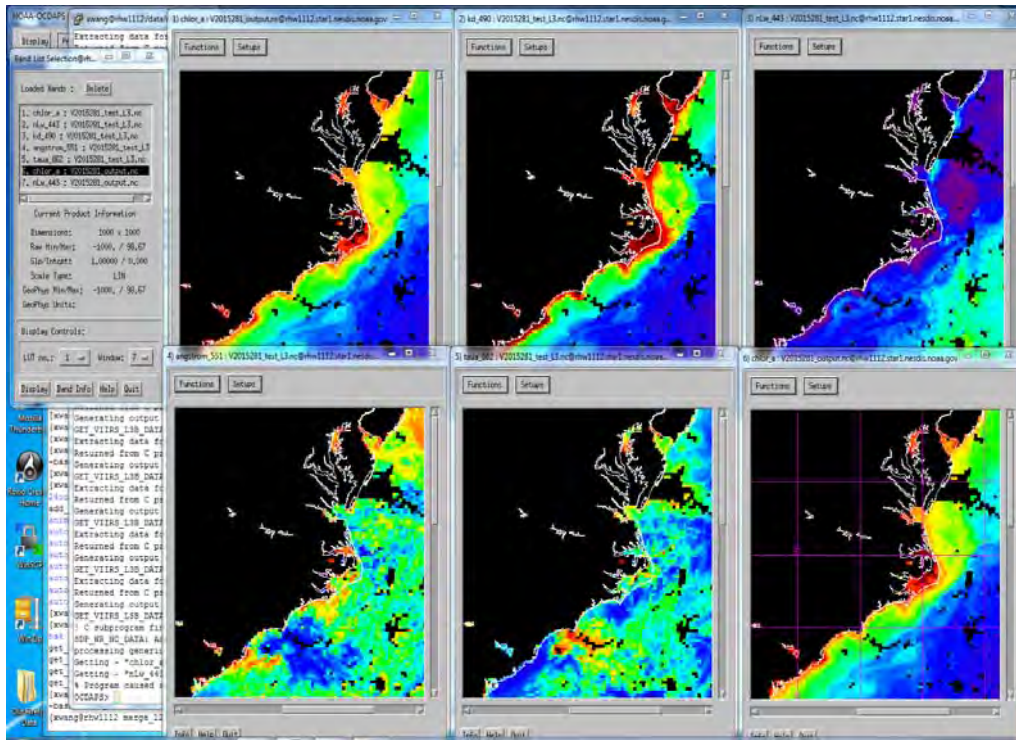

Figure 1. Batch mode VIIRS L2 data mapping with netCDF format output.



Figure 2. System documentation and user guide for system functions.

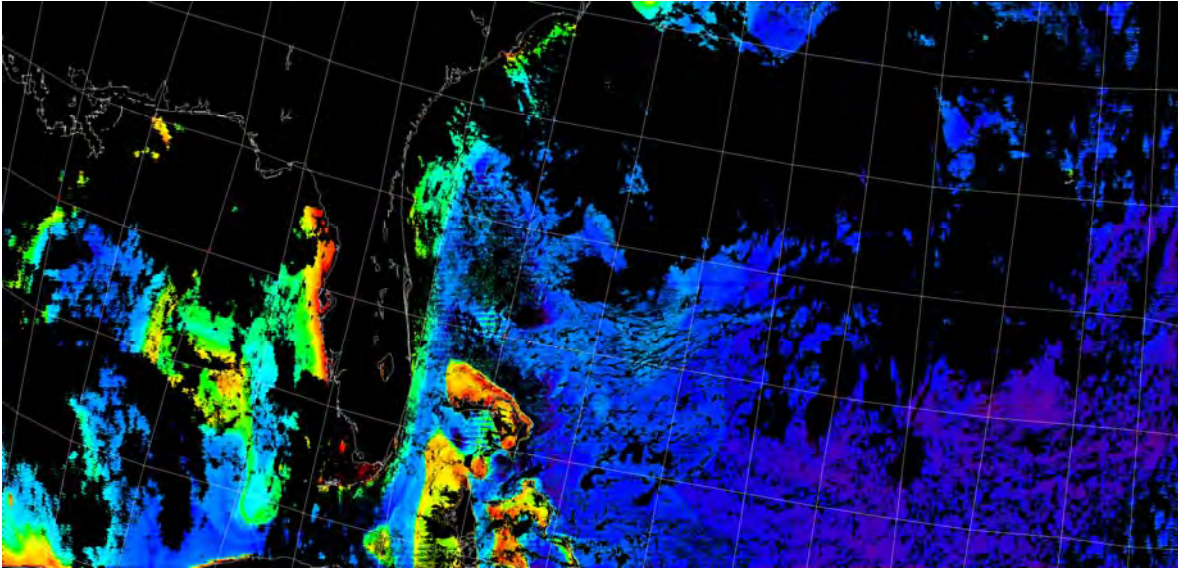

Figure 3. VIIRS multiple granule image (merged) display for large region coverage

PROJECT TITLE: NESDIS Environmental Applications Team – Xingjia Zhou, Research Associate - AVHRR GAC SST Reanalysis and Validation

PRINCIPAL INVESTIGATOR(S): Steve Miller/Cliff Matsumoto

RESEARCH TEAM: Xingjia Zhou, Prasanjit Dash, Xingming Liang, Yanni Ding

NOAA TECHNICAL CONTACT: Alexander Ignatov

NOAA RESEARCH TEAM: Alexander Ignatov, Boris Petrenko, Yury Kihai, John Stroup, Feng Xu, Kai He

FISCAL YEAR FUNDING (NEAT Total): \$1,764,742

PROJECT OBJECTIVE(S):

1--In conjunction with A. Ignatov and B. Petrenko, perform Advanced Clear-Sky Processor for Oceans (ACSPO) Reanalysis v1 (RAN1) of AVHRR GAC Sea Surface Temperature (SST) and display results online;

2--In conjunction with Kai He, assume responsibility (after departing Prasanjit Dash) for the monitoring polar SST in the NOAA SST Quality Monitor (SQUAM) system. Expand SQUAM functionality and accommodate more community SST product www.star.nesdis.noaa.gov/socd/sst/squam/polar/;

3--In conjunction with Feng Xu, improve the NOAA in-situ SST Quality Monitor v2 (iQuam2; www.star.nesdis.noaa.gov/sod/sst/iquam/v2/) and support routine operations.

PROJECT ACCOMPLISHMENTS:

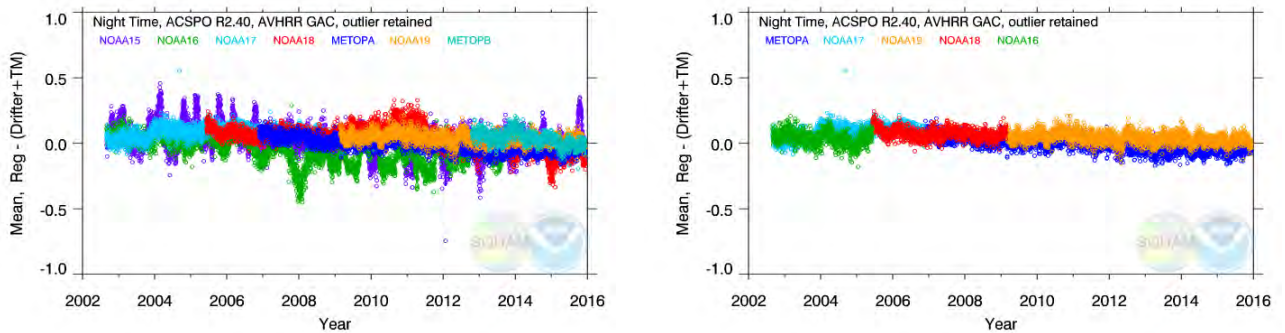

Figure 1. Mean nighttime $\Delta T_S = T_S - T_{in\ situ}$ ACSPO SST derived using static regression coefficients: (a; left) all data from Aug 2002 – pr; (b; right) subset used in RAN1. Each data point represents a daily statistic based on matchups with *in situ* SSTs (from <1,000 to >3,000).

In conjunction with A. Ignatov and B. Petrenko, AVHRR GAC L1b data from seven AVHRR/3s onboard Metop-A, -B and NOAA-15 to -19 have been processed with the NOAA Advanced Clear-Sky Processor for Oceans (ACSPO) v2.40 code, and match-ups with iQuam data generated. The RAN1 data are currently being archived with PO.DAAC and NOAA NCEI. The SQUAM code (initially developed by P. Dash) was updated and used to display the RAN1 data www.star.nesdis.noaa.gov/sod/sst/squam/polar. Example of initial results of RAN1 SST monitoring against iQuam *in situ* SST is shown in Figure 1.

In conjunction with X. Liang, the ACSPO GAC RAN1 data have been also displayed in another NOAA system which monitors brightness temperatures (BTs), Monitoring of IR Clear-sky Radiances for SST (MICROS; www.star.nesdis.noaa.gov/sod/sst/micros/). Example of RAN1 SST monitoring in MICROS (against Canadian Met Centre L4 SST), and BTs against simulated BTs using the NOAA community radiative transfer model, are shown in Figure 2.

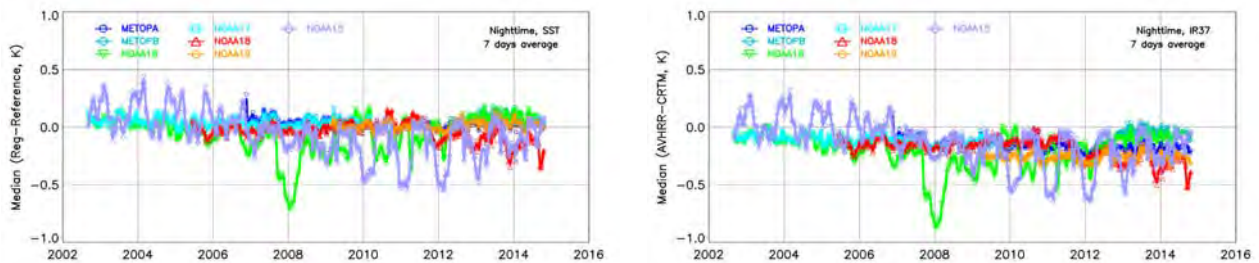

Figure 2. Mean nighttime (a; left) $\Delta T_S = T_S - T_{L4}$ and (b; right) $\Delta T_B = T_O - T_M$ corresponding to Figure 1a. Each data point represents a daily statistic based on matchups with CMC L4 SST (2-3 million matchups).

Unstable SSTs in Figure 1 have been stabilized by recalculating SST regression coefficients against *in situ* data (similarly to how it was done in another long-term AVHRR SST data record, Pathfinder SST). The time series of ACSPO RAN1 and Pathfinder (PFV5.2) SST are shown in Figure 3. Note that ACSPO RAN1 time series are more stable in time than PFV5.2, and RAN1 reports data from two satellites at all times (compared to only one satellite in PFV5.2).

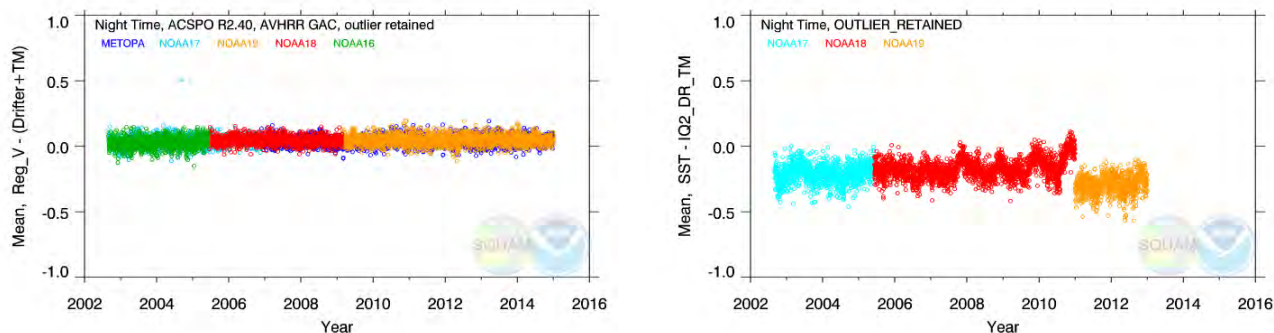

Figure 3. Mean nighttime biases $\Delta T_S = T_S - T_{in\ situ}$: (a; left) RAN1; (b; right) PFV5.2. (Note that the skin SST data in PFV5.2 should be bias-corrected by +0.17K to represent the bulk *in situ* data).

In conjunction with Kai He, work is underway to assume responsibility for the polar SQUAM after Prasanjit Dash who is moving to EUMETSAT. This work includes redesign and optimization of the SQUAM IDL code, consolidation of several SQUAM elements, adding new functionalities, and including in SQUAM several additional community SST products. This time consuming work is currently underway and its results will be reported elsewhere.

In conjunction with A. Ignatov and F. Xu, and with web development help from K. He, substantial effort has been also underway to clean up the iQuam v2 (iQuam2), transition to iQuam2 from the current iQuam1, and document the new iQuam2 system. The paper is currently in preparation and results will be reported in 2017.

Publications:

Ignatov, A., X. Zhou, Petrenko, B., et al. AVHRR GAC SST Reanalysis version 1 (RAN1) (Submitted), *Remote Sens.* 2016, 5, 1-x manuscripts; doi:10.3390/rs50x000x.

Ignatov, A., F. Xu, X. Zhou, Redesigned *in situ* SST Quality Monitor: iQuam version 2, *JTech* (In preparation).

Presentations:

Ignatov, A., J. Stroup, Y. Kihai, B. Petrenko, I. Gladkova, P. Dash, X. Liang, F. Xu, X. Zhou, K. Mikelsons, J. Sapper. VIIRS SST products and monitoring at NOAA. 2015 SPIE Defense, Security and Sensing Conf, Baltimore, Apr 2015. (Oral.)

Ignatov, A., B. Petrenko, Y. Kihai, J. Stroup, P. Dash, X. Liang, I. Gladkova, X. Zhou, J. Sapper, F. Xu. JPSS SST Product at NOAA. 2015 EUMETSAT Conf, Toulouse, Sep 2015. (Oral.)

Ignatov, A., X. Zhou, B. Petrenko, K. He, X. Liang, Y. Kihai, C. Cao, J. Stroup, P. Dash, J. Sapper. AVHRR SST Reprocessing: Linking Instabilities in SST Time Series with Brightness Temperatures and calibration. 2015 EUMETSAT Conf, Toulouse, Sep 2015. (Oral.)

Ignatov, A., J. Stroup, Y. Kihai, B. Petrenko, P. Dash, I. Gladkova, M. Kramar, X. Zhou, X. Liang, J. Sapper, Y. Huang, Y. Ding, F. Xu, M. Bouali, K. Mikelsons. ACSPO SST Products at NOAA. XVI GHRSSST Meeting, Jul 2015, ESA/ESTEC, Netherlands. (Oral.)

Ignatov, A., J. Stroup, Y. Kihai, B. Petrenko, P. Dash, I. Gladkova, M. Kramar, X. Zhou, X. Liang, J. Sapper, Y. Huang, Y. Ding, F. Xu, M. Bouali, K. Mikelsons. JPSS SST. 2015 JPSS Annual Science Team meeting, Aug 2015, NCWCP, College Park, MD. (Oral.)

Ignatov, A., P. Dash, X. Zhou, and F. Xu. SST Quality Monitor (SQUAM) and In situ SST Quality Monitor (iQuam). 16th International Science Team Meeting (GHRSSST XVI), 20-24 July 2015.

Ignatov, Petrenko, Kihai, Stroup et al. 2016. JPSS and GOES-R SST Products at NOAA.. Ocean Sci. Meet., New Orleans, Louisiana, 21-26 Feb 2016.

Ignatov, Zhou, Petrenko, He et al. AVHRR GAC SST Reprocessing: Linking Instabilities in SST Time Series with Brightness Temperatures and Calibration., 2015 EUMETSAT Conference 21-25 September 2015, Toulouse, France.

Ignatov, Petrenko, Kihai, Stroup He et al. JPSS SST Products at NOAA., 2015 EUMETSAT Conference 21-25 September 2015, Toulouse, France.

Zhou, Z., A. Ignatov, F. Xu. From iQuam1 to iQuam2, CoRP, Sep. 2015, College Park, MD (Oral).

Zhou, X., A. Ignatov, F. Xu, in situ SST Quality Monitor version2 (iQuam2), GHRSSST Science Team Meeting, Noordwijk, 20-24 July 2015. (Poster).

PROJECT TITLE: NESDIS Environmental Applications Team – Tong Zhu -Community Radiative Transfer Model Improvement and Assessment

PRINCIPAL INVESTIGATOR(S): Steve Miller/Cliff Matsumoto

RESEARCH TEAM: Tong Zhu

NOAA TECHNICAL CONTACT: Sid Boukabara (NOAA/NESDIS/STAR/JCSDA)

NOAA RESEARCH TEAM: Paul van Delst (IMSG/EMC@JCSDA), Kevin Garrett (Riverside@NOAA/NESDIS/STAR/JCSDA)

FISCAL YEAR FUNDING (NEAT Total): \$1,764,742

PROJECT OBJECTIVE(S):

- 1--CRTM maintenance, upgrade, and support
- 2--CRTM science implementation
- 3--CRTM support for satellite radiance assimilation
- 4--Support JCSDA OSSE and OSE projects

PROJECT ACCOMPLISHMENTS:

1-During the past year, we have worked on the implementation of the Optimal Spectral Sampling (OSS) model into CRTM v2.2.0. The Optimal Spectral Sampling (OSS) approach is a fast and accurate method for calculating molecular absorption in radiative transfer calculations. The OSS is conceptually a simple

approach for extending the k-distribution or exponential sum fitting of transmittance techniques to vertically inhomogeneous atmospheres. In practice, a monochromatic node loop is processed in order of increasing wavenumber, as the outer loop in the forward module. A channel loop is inserted within the node loop to perform the mapping of the node radiances produced by the RT solver into the channel radiances. The CRTM unit tests were performed to examine the consistency of Jacobians calculated by OSS K-Matrix, Tangent Linear and Forward Finite Difference modules. The results showed that the OSS K-Matrix and Tangent Linear can generate the same temperature, water vapor, and ozone Jacobians. There are small differences between K-Matrix and Forward Finite Difference calculations, but they are within reasonable range. After passing the unit tests, the Cross-track Infrared Sounder (CrIS) Band1 radiances were simulated using the CRTM-OSS method, and were compared to simulations from the CRTM-Optical Depth in Pressure Space (ODPS) transmittance methods. Figure 1 clearly shows the OSS capabilities in simulating unapodized radiance, which is one of the important benefits of the OSS method and should enhance spectral sensitivities to the retrievals of trace gases.

2--We have also worked on the CRTM transmittance coefficient generation package. To support the application of CRTM for the simulation of new instruments or updated sensor Spectral Response Function (SRF), it is necessary to rebuild the CRTM capability for generating transmittance coefficients. We have prepared the Tape5 files for LNFL model, and generated the Tape3 file for the input of LBLRTM. The generation of LBLRTM Tape5 files based on ECMWF/UMBC profiles was also completed. Now we are working on the generation of high-resolution transmittance spectra with LBLRTM for the molecules combinations for ODPS and ODAS methods.

3--We have performed the independent assessment of the Community Line-by-Line Model (CLBLM), which is still under development by AER. For each of the version delivered to JCSDA, we performed quick assessment and provided feedback to AER working group. We have also coordinated the activities for the CLBLM implementation. The CLBLM will serve as the new LBLRTM, which will be used to train CRTM coefficients. We will keep working on the assessment, which includes the tests of atmospheric path calculation, line-by-line convolution, along-view-path radiance and transmittance calculations, scanning and filtering modules. The results will be compared with those obtained from LBLRTM. The computational speed will be examined.

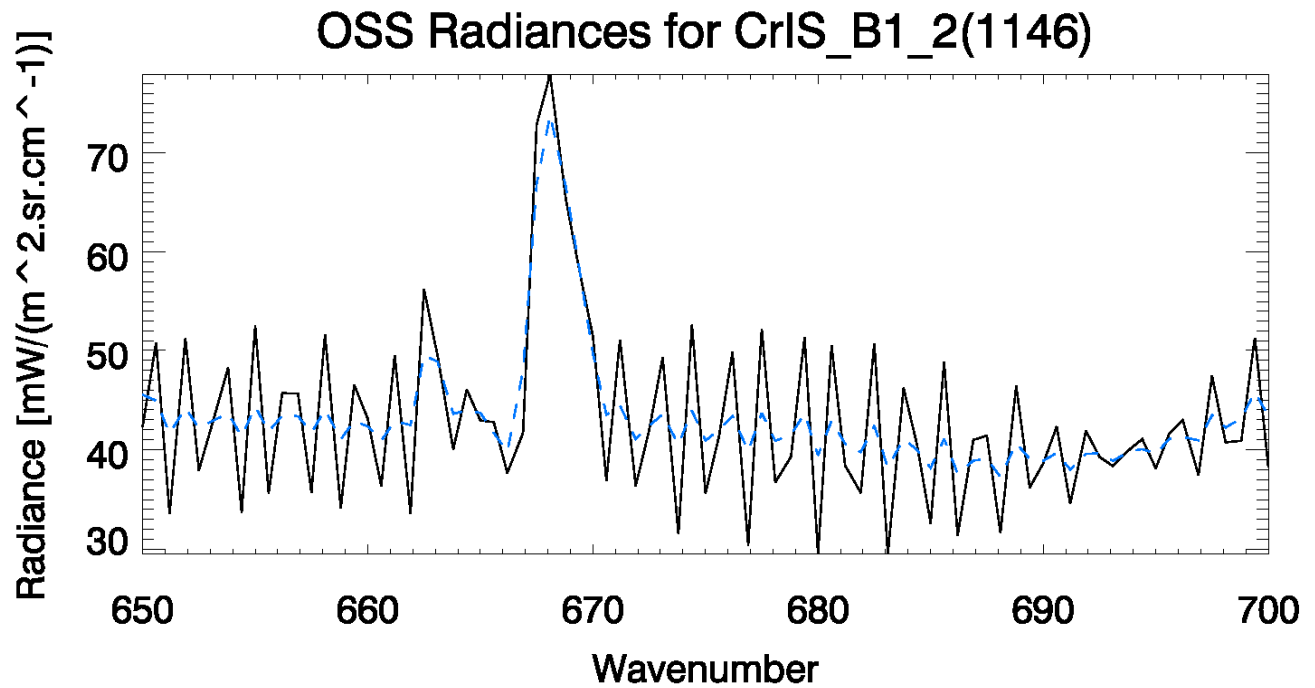

Figure 1. The comparison of the CrIS_B1_2 radiances simulated by CRTM-OSS (solid black line) and CRTM-ODPS (dashed blue line) methods for a clear-sky profile with WV and O3 absorbers over ocean.

Publications:

Boukabara, S., T. Zhu, H. Tolman, S. Lord, S. Goodman, et. al. (2016) S4: An O2R/R2O Infrastructure for Optimizing Satellite Data Utilization in NOAA Numerical Modeling Systems: A Significant Step Towards Bridging the Gap between Research and Operations. *Bulletin of American Meteorological Society*.(Accepted with minor revision).

Zhu, T., S. Boukabara, and K. Garrett, (2016) Comparing Impacts of Satellite Data Assimilation and Lateral Boundary Conditions on Regional Model Forecasting: Case Study of Hurricane Sandy. To be submitted to *Weather and Forecasting*.

PROJECT TITLE: Polar-Geo Blended Hydrometeorological Products

PRINCIPAL INVESTIGATOR: Stan Kidder

RESEARCH TEAM: Andy Jones/John Forsythe

NOAA TECHNICAL CONTACT: Limin Zhao (NESDIS/OSPO/SPSD/SPB)

NOAA RESEARCH TEAM: Limin Zhao (NESDIS/OSPO/SPSD/SPB), Sheldon Kusselson (NESDIS/OSPO/SPSD/SAB, retired), John Paquette (NESDIS/OSPO/SPSD), Ralph Ferraro (NESDIS/STAR/CRPD/SCSB), and others

FISCAL YEAR FUNDING: \$162,000

PROJECT OBJECTIVE: Develop Enhanced Blended TPW, TPW anomaly and Rain Rate products with Global Precipitation Mission (GPM) Microwave Imager (GMI) data.

PROJECT ACCOMPLISHMENTS:

- 1--We set up a real-time GPM/GMI/GPROF data feed from NESDIS
- 2--We wrote the code to ingest the real-time GPM data (in HDF5 format) into DPEAS.
- 3--We learned that the GPROF algorithm does not retrieve TPW, only Rain Rate. Therefore we have concentrated on Rain Rate, and we leave TPW for possible future algorithms (perhaps MIRS).
- 4--We modified existing code to apply the histogram correction to the GPM data. (The DPEAS mapping and compositing code did not need to be changed.)
- 5--The Rain Rate processing is run hourly at CIRA. Figure 1 shows one day's GPM Rain Rate data. Figure 2 shows Blended Rain Rate using eight satellites (NOAA 18, NOAA 19, Metop-B, DMSP F17, DMSP F18, Suomi NPP, GCOM-W1, and GPM). Figure 3 shows which satellite observes each point. "Movies" of the images may be viewed at http://cat.cira.colostate.edu/BRR/Blended_RR.htm.
- 6--The code is ready for transition to NESDIS/OSPO.
- 7--Note that GPM is the 16th satellite to be added to Blended Rain Rate since 2009. The others are NOAA 15–19, DMSP F13–18, Metop-A, Metop-B, Suomi NPP, and GCOM-W1. In addition, the HDF5 format of GPM data is the third major input format, the others being HDF-EOS and netCDF.

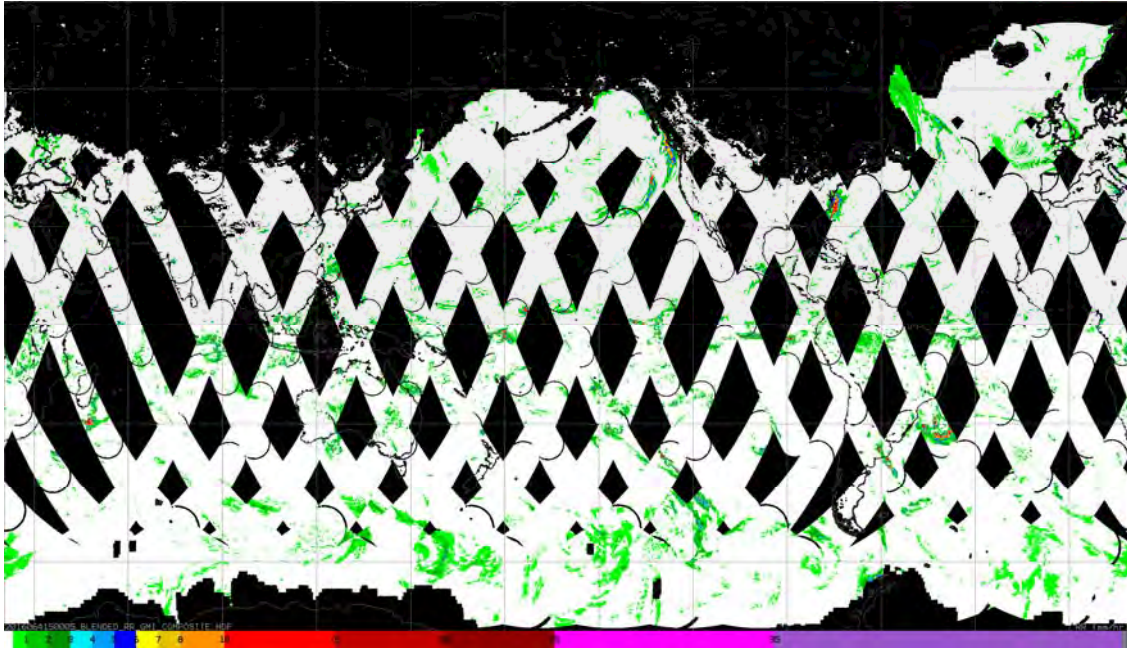

Figure 1. One day's GPM/GMI/GPROF Rain Rate data (mm/hr).

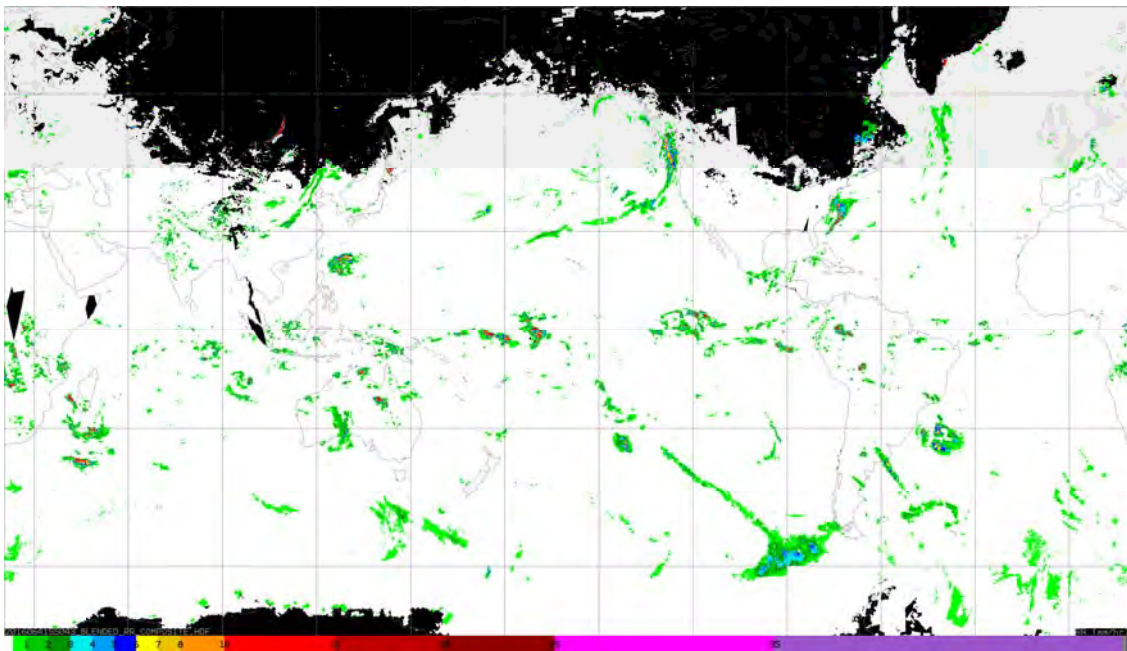

Figure 2. An example of an hourly Blended Rain Rate image produced using eight satellites (NOAA 18, NOAA 19, Metop-B, DMSP F17, DMSP F18, Suomi NPP, GCOM-W1, and GPM). Only the most recent observation is shown. Units: mm/hr.

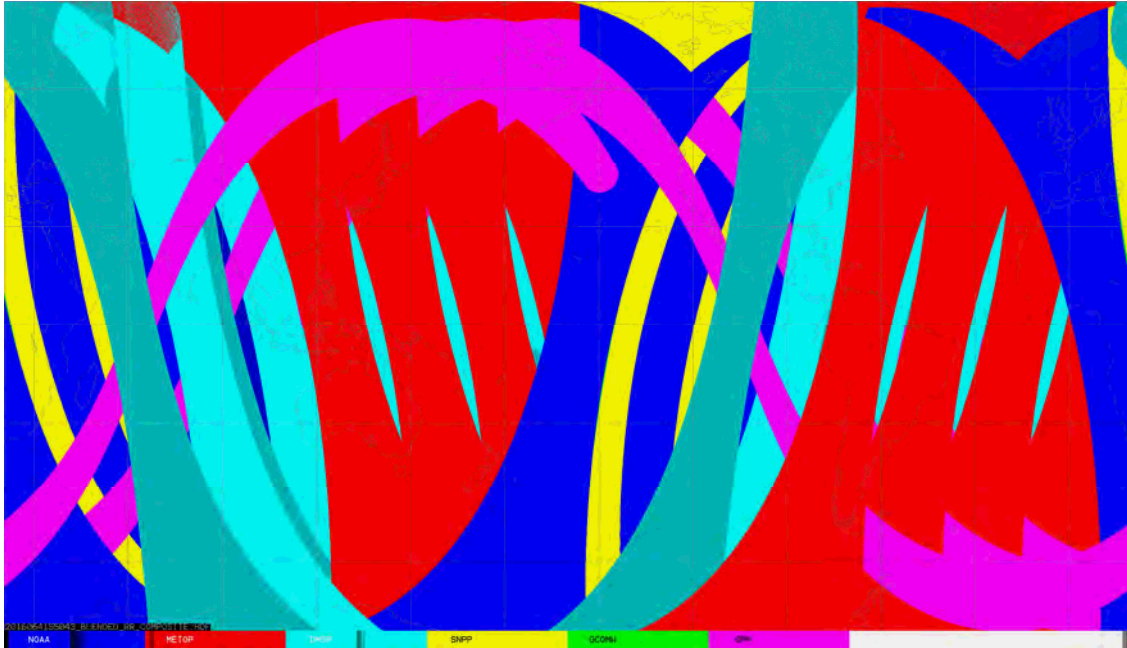

Figure 3. The satellites which were used to construct the composite shown in Fig. 2. Note that GPM is in a non-sunsynchronous orbit; therefore, it is more visible than some other satellites.

PROJECT TITLE: Using JPSS Retrievals to Implement a Multisensor, Synoptic, Layered Water Vapor Product for Forecasters

PRINCIPAL INVESTIGATOR: John Forsythe

RESEARCH TEAM: Andy Jones, Stan Kidder, Dan Bikos, Ed Szoke

NOAA TECHNICAL CONTACT: Ralph Ferraro, NOAA/NESDIS/STAR Satellite Climate Studies Branch

NOAA RESEARCH TEAM: Ralph Ferraro (NOAA/NESDIS/STAR), Michael Folmer (Satellite Liaison at NOAA/NWS WPC/OPC/TAFB)

FISCAL YEAR FUNDING: \$125,000

PROJECT OBJECTIVES:

This JPSS/PGRR project began in August 2015 with an objective of developing new multisatellite, blended, layered water vapor products and delivering them to forecasters at national centers. To achieve this goal, NOAA Microwave Integrated Retrieval System (MIRS) satellite soundings from multiple polar orbiting spacecraft (NOAA-18/19, Metop-A/B, DMSP F18 and Suomi-NPP) are blended together every three hours to create a near-global, four-layer, four-dimensional view of precipitable water vapor. These products are highly complementary to the CIRA-developed blended total precipitable water (TPW), TPW anomaly and blended rain rate products which were successfully transitioned to NOAA operations in 2009

and are used throughout the NWS (supported by CIRA project 5300378 - Blended Hydrometeorological Products). Layered precipitable water (LPW) allows forecasters to understand the vertical distribution of water vapor not apparent from TPW, particularly over the data-sparse oceans. The product leverages the existing Data Processing and Error Analysis System (DPEAS) processing tool to enable seamless research-to-operations transitions.

Work in progress focuses on advective blending of the product using model winds, to create a product at synoptic times. Prototype advected products will be delivered to national centers in later 2016.

PROJECT ACCOMPLISHMENTS:

1--Precipitable water vapor in four layers (surface - 850 mb, 850 – 700 mb, 700 – 500 mb, and 500 – 300 mb) are created in near-realtime at CIRA and distributed to NOAA WPC, TAFB, NHC and OPC, via NASA SPoRT. Forecasters are using the products to support forecasting of heavy rains, as connections to tropical moisture serve to fuel extreme floods. The products are currently being used in a variety of forecast applications, including atmospheric rivers impacting the west coast and analysis of tropical waves in NHC tropical outlook discussions.

2--The product drew wide attention for the historic, devastating floods in the southeastern U.S. associated with deep tropical around Hurricane Joaquin. The blended LPW captured several sources of converging moisture, including at upper levels moisture from the Pacific Ocean and tropical storm Marty south of Mexico (Figures 1 and 2).

3--A VISIT chat briefing on October 7 illustrating the usefulness of blended LPW for the record-setting South Carolina floods of early October. Eight WFO's from the SE U.S. and their respective Science and Operations Officers (SOO's) attended this hour-long virtual session.

4--Suomi-NPP retrievals from the ATMS instrument are now being incorporated into the product in near-realtime.

5--A journal article summarizing NWS forecaster evaluations of the product, developed under initial NASA funding, was published in 2015. For 76.4% of the events surveyed, forecasters stated that blended LPW had "large" to "very large" value over traditional total precipitable water products.

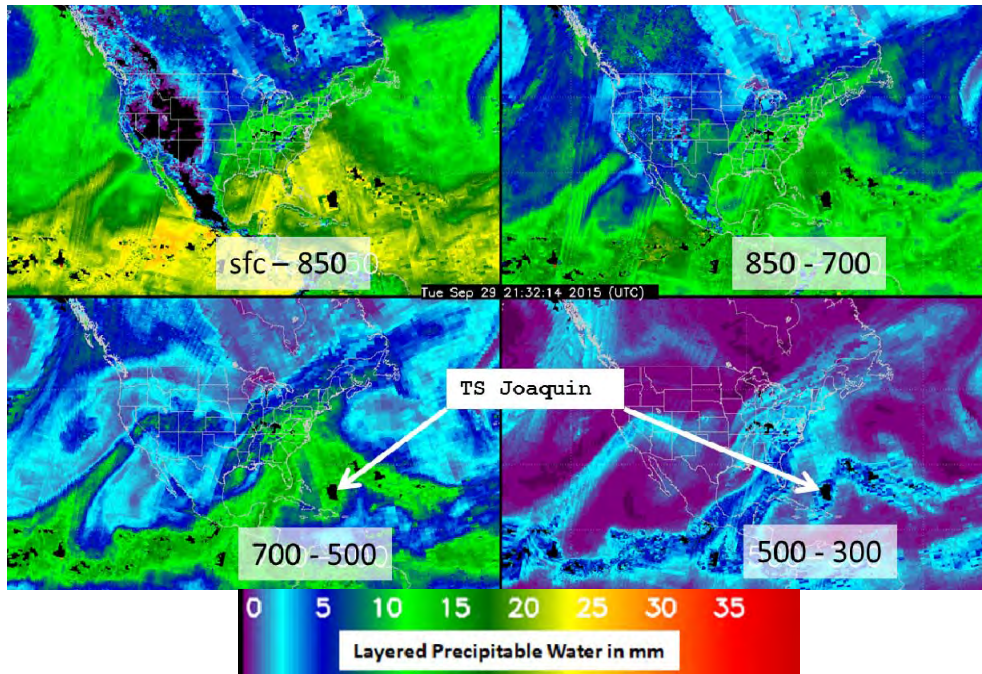

Figure 1. Four-panel blended LPW from 2100 UTC 29 Sep 2015. Tropical Storm (at that time) Joaquin is indicated. Black areas are either missing due to topography in the surface – 850 mb layer, or not retrieved due to heavy rain.

MESOSCALE PRECIPITATION DISCUSSION 0530
 NWS WEATHER PREDICTION CENTER COLLEGE PARK MD
 1016 AM EDT TUE SEP 29 2015

AREAS AFFECTED...SOUTHWEST VIRGINIA

CONCERNING...HEAVY RAINFALL...FLASH FLOODING LIKELY

SUMMARY...A TROPICAL AIRMASS WITH NEAR RECORD PRECIPITABLE WATER WILL RESULT IN A CONTINUED FLOOD AND FLASH FLOOD THREAT INTO THIS AFTERNOON.

...
 FORCING FROM THE SHORTWAVE IN GA AND A GENERALLY DIVERGENT PATTERN ALOFT IS HELPING FORCE ASCENT ON THE LARGE SCALE...WITH 20-30 KTS OF LOW LEVEL UPSLOPE FLOW AIDING IN LIFT. **LAYERED PRECIPITABLE WATER PRODUCTS SHOW AN IMPRESSIVE COMBINATION OF FACTORS CONTRIBUTING TO THE NEAR RECORD PRECIPITABLE WATER VALUES ACROSS THIS REGION. A CONNECTION TO THE PACIFIC AND TROPICAL STORM MARTY CAN BE SEEN IN THE MID/UPPER LEVELS...WITH A DEEP LAYER CONNECTION TO THE GULF OF MEXICO AND ALSO TROPICAL STORM JOAQUIN IN THE ATLANTIC. THIS IS ALL RESULTING IN A VERY EFFICIENT ATMOSPHERE FOR HEAVY RAIN RATES.** THE ONE THING LACKING IS INSTABILITY...BUT AT LEAST SOME DOES EXIST ACROSS THE AREA AS NOTED BY SOME LIGHTNING AND COLDER CLOUD TOPS...

Figure 2. Excerpt from WPC mesoscale precipitation discussion on flooding showing the value of the blended LPW products.

Publications:

Forsythe, J.M., A. S. Jones, S. Q. Kidder, D. Bikos, E. Szoke, 2015: Using JPSS Retrievals to Implement a Multisensor, Synoptic, Layered Water Vapor Product for Forecasters". Oral presentation at American Geophysical Union (AGU) Fall meeting, December 2015.

LeRoy, A., K. K. Fuell, A. L. Molthan, G. J. Jedlovec, J. M. Forsythe, S. Q. Kidder, and A. S. Jones, 2015: The Operational Use and Assessment of a Layered Precipitable Water Product for Weather Forecasting. *J. Operational Meteor.*, **2** (1), 1–7, <http://www.nwas.org/jom/abstracts/2016/2016-JOM2/abstract.php>.

REGIONAL TO GLOBAL SCALE MODELING SYSTEMS

Research associated with the improvement of weather/climate models (minutes to months) that simulate and predict changes in the Earth system. Topics include atmospheric and ocean dynamics, radiative forcing, clouds and moist convection, land surface modeling, hydrology, and coupled modeling of the Earth system.

PROJECT: ENVIRONMENTAL APPLICATIONS RESEARCH

FISCAL YEAR FUNDING (EAR Total): \$5,480,143

PROJECT TITLE: EAR - Flow-following Icosahedral Model (FIM) Development Project

PRINCIPAL INVESTIGATOR: Sher Schranz

RESEARCH TEAM: Ning Wang, James Rosinski, Jacques Middlecoff, Haidao Lin, Julie Schramm

NOAA TECHNICAL CONTACT: Stan Benjamin (OAR/ESRL/GSD/AMB Chief)

NOAA RESEARCH TEAM: Jian-Wen Bao (OAR/ESRL/PSD), Mark Govett (OAR/ESRL/GSD/ATO)

PROJECT OBJECTIVES:

Tasks for this project include: developing and improving FIM for global and continental scale weather prediction, developing and implementing accurate and efficient numerical schemes for FIM on massive parallel computer systems, and designing and developing a data assimilation system for weather forecast.

PROJECT ACCOMPLISHMENTS:

A new higher-order flux computation scheme for mass and tracer transport has been implemented. The new scheme has finished retro-run for the year of 2015, and results are mostly positive for 5-7 days forecast skills. The new scheme has been integrated into the new version of the model, and ready for operational use.

Along with the new higher-order flux, a new flux-limited advection scheme is implemented to take advantage of the numerical accuracy brought by the higher order flux computation. The new scheme is currently under various numerical tests.

To take advantage of modern high performance computing systems, which offer a larger number of processing cores and larger size of shared memory on each node, CIRA researchers have created a more efficient OpenMP version of FIM. The new version saves significant computational resources for high resolution model runs, especially for ensemble forecasts and seasonal to subseasonal forecasts.

In addition to OpenMP threading efforts on the FIM atmospheric model, CIRA researchers implemented OpenMP parallelism in the iHYCOM ocean model, which runs in coupled mode alongside FIM. The modified code runs much faster on the latest computational architectures.

To optimize computational performance of the GFS physics package employed in FIM, CIRA researchers designed and implemented a scheme which enables many of the individual parameterizations to vectorize. The size of vector registers on modern computers continues to increase, meaning that vectorization has become ever more important to overall computational performance.

CIRA researchers continued to follow scientific developments with the GFS physics package from NCEP. Specifically, the NUOPC group has defined an init/run/finalize interface to the package and implemented it in the full GFS model. CIRA researchers are implementing this package in FIM.

To improve the coarse-grain parallel computation a new 2D filling curve, called the spiral curve, was designed and implemented. The new curve lays out the grid in such a way that data can be sent directly between processors (exchanged) without the requirement of packing and unpacking the data. The previously required packing and unpacking took about half the time required for exchanges between processors so the spiral curve cuts the exchange time in half. Also, the new method of doing exchanges allows for complete overlapping of the exchange time with computation time. Consequently, the code runs much faster and scales better.

A data compression technique has been implemented to reduce the data volume of the model output from the seasonal to subseasonal forecast experiment. The preliminary tests show that the technique achieves great data reduction and maintains high fidelity of the compressed data sets.

A new data assimilation scheme has been proposed for FIM to improve the model initial condition. The new scheme is based on Ensemble Kalman Filter technique, with assimilated real-time conventional and satellite observations. The preparation work for the project has started.

PROJECT TITLE: EAR - Nonhydrostatic Icosahedral Model (NIM) Project

PRINCIPAL INVESTIGATOR: Sher Schranz

RESEARCH TEAM: Ning Wang, Ka Yee Wong, Thomas Henderson, Jacques Middlecoff, and James Rosinski

NOAA TECHNICAL CONTACT: Jin Luen Lee (OAR/ESRL/GSD/EMB)

NOAA RESEARCH TEAM: Jian-Wen Bao (OAR/ESRL/PSD), Mark Govett (OAR/ESRL/GSD/ATO)

PROJECT OBJECTIVES:

--Develop Nonhydrostatic Icosahedral Model (NIM) for kilometer-scale resolution on multiple Central Processing Units (CPUs) and multiple Graphical Processing Units (GPUs) computing systems

--Explicit prediction of small-scale weather systems such as topographic precipitation as well as convective macro-phenomenon like the Madden-Julian Oscillation (MJO)

--Diagnose and resolve atmospheric phenomenon using the NIM modeling system

PROJECT ACCOMPLISHMENTS:

-- Optimized and tested dynamics and physics software for parallel CPU and GPU processing (via MPI and OpenMP), for NGGPS experiment.

-- Participated NWS NGGPS phase 1 experiment, demonstrated good performance for analytic case simulation tests. The model ran successfully for the selected real data cases at 3 km resolution. It also achieves outstanding computational performance on HPCS running at this ultra-high resolution.

-- Completed integration of all parts of the modelling system, including dynamic core, physics parameterization, pre-processing, and post-processing software, for real data runs. The preliminary result of the test runs show that NIM performs well in the simulation of precipitation events for several high impact weather cases.

PROJECT TITLE: EAR - Advanced High Performance Computing

PRINCIPAL INVESTIGATOR: Sher Schranz

RESEARCH TEAM: Thomas Henderson, Jacques Middlecoff, James Rosinski, Jeff Smith, Ning Wang, Julie Schramm

NOAA TECHNICAL CONTACT: Mark Govett (OAR/ESRL/GSD/ATO)

PROJECT OBJECTIVES:

--Collaborate with ESRL meteorologists on the objective of running the Non-hydrostatic Icosahedral Model (NIM) at sub 5KM global resolution. Running at 5KM resolution requires accelerator technology and research in the area of grid generation and optimization, pre- and post-processing, and development of numerical algorithms. Running NIM at 5KM resolution also requires the enhancement of the software suite known as the Scalable Modeling System (SMS).

--Provide software support to ESRL scientists including software design advice and expertise on a variety of software/web/database technologies. CIRA researchers continue to modify the Flow-following, Finite volume Icosahedral Model (FIM) software to enhance interoperability with National Center for Environmental Prediction's (NCEP's) NEMS architecture implemented via the ESMF and continue to collaborate closely with Tom Black and others at NCEP to further generalize the NEMS ESMF approach so it meets requirements of NCEP models (GFS, NMMB) as well as FIM.

--Interact with the ESMF Core development team to specify requirements for features needed by FIM, NIM, and other NOAA codes.

--Serve on the National Unified Operational Prediction Capability (NUOPC) Common Model Architecture (CMA) and Content Standards subcommittees.

--Fine-tune software engineering processes used during FIM development, ensuring that these processes remain suitable for a candidate production NWP code, optimize FIM run-time performance, port FIM to new machines, and incorporate new features such as the ongoing integration of WRF-CHEM and WRF-ARW physics into FIM.

--Collaborate with the Developmental Testbed Center Ensemble Team (DTC/DET) to modify WRF Portal to support running complex WRF ensembles on the GSD Jet and TACC Ranger supercomputers. Also develop, improve, and support WRF Portal, FIM Portal, and WRF Domain Wizard.

--Develop improved capabilities in the (NextGen) NNEW Testing Portal—a Flash web application (with server side Java) that tests NextGen OGC web services (WFS, WCS, and RegRep), performs load tests, generates graphs and reports, and enables guided ad-hoc querying of these web services.

--Serve on the GSD program review committee and the NOAA Earth Information System (NEIS) committee (a project listed in NOAA's 2011 Annual Guidance Memorandum as a priority for NOAA).

--Collaborate with CIRES researchers to develop TerraViz—a 3D visualization application for environmental datasets (similar in some respects to Google Earth) that is a core component of NEIS.

--Assist the Space Weather Prediction Center in maintaining the Ionosphere Plasmasphere Electrodynamics (IPE) code.

PROJECT ACCOMPLISHMENTS:

CIRA researchers continued to optimize serial and parallel NIM on NVIDIA GPU, Intel's® Xeon® Phi, and CPUs from Intel® and AMD®. They continued to use NIM as a test case to investigate the stability and features of new commercial OpenACC GPU compilers from Portland Group and Cray and for the Intel compiler for the Xeon Phi. Many compiler bugs and limitations were found and fed back to the vendors yielding improved products that better address our needs. CIRA researchers improved I/O and OpenMP performance of NIM. They repeatedly integrated major changes from the model developers onto the NIM trunk and parallelized for both distributed-memory parallel and fine-grained architectures.

CIRA researchers supported the rapid push to increase resolution of NIM real-data forecasts to 3km as part of the Next Generation Global Prediction System (NGGPS) project, a multi-model evaluation effort. Several scaling issues were overcome on a tight schedule while simultaneously integrating rapidly changing scientific improvements. The NIM dynamical core reached the 3km real-data milestone in time to participate in the AVEC model comparison. Thanks to the efforts of CIRA researchers, the NIM dynamical core was recognized as using the most advanced high-performance computing techniques, allowing performance-portability across GPU, Xeon Phi, and traditional CPUs. No other competing models achieved this goal.

CIRA researchers also assisted FV3 developers from GFDL and MPAS developers from NCAR with performance tuning of their NGGPS finalist models using techniques honed during NIM development. They ported FV3 to jet and theia. They improved performance of the three most expensive MPAS dynamics routines by a factor of two on NCAR's "yellowstone" supercomputer. These changes were incorporated into the MPAS github repository and the techniques were applied to the remaining MPAS dynamics routines by NCAR software engineers.

CIRA researchers enhanced the capabilities of SMS including processor-to-processor communication (exchange). The SMS exchange function was optimized to completely eliminate memory copies induced by pack and unpack routines. The approach from last year was replaced with an even simpler approach that does not require insertion of extra "dummy" columns. With this simplification, the copy-free ("spiral") exchanges have now replaced traditional exchanges on the main NIM and FIM development branches. CIRA researchers continue to assist SMS users and to find and fix bugs.

CIRA researchers assisted FIM developers with integration, parallelization errors, test suite issues, I/O issues, repository issues, interruptions in real-time runs, and general debugging. They assisted the FIM team with several time-critical tasks required to meet FIM project deadlines. CIRA researchers completed serial and parallel ports to the NAG compiler and added NAG tests to the FIM test suite. They also created a test suite for the coupled FIM-HYCOM system which is now in regular use by model developers. CIRA researchers continued to extend and maintain the automated overnight continuous integration testing for FIM.

CIRA researchers continued collaborating with NCEP, Navy, NCAR, and NASA to define aspects of a Common Modeling Architecture (CMA) for the National Unified Operational Prediction Capability (NUOPC). The primary objective of the NUOPC's CMA is to reduce long-term costs of integrating and sharing software between the nation's three operational global weather prediction centers; Air Force Weather Agency (AFWA), Fleet Numerical Meteorology and Oceanography Center (FNMOOC), and NCEP. They also served on the NUOPC Physics Interface to define APIs and conventions to allow easier sharing

of physical parameterizations among NWP modeling systems. They continued collaborating with NCEP's John Michalakes on porting NWP codes to Intel Xeon Phi. And they continued attending NCEP's weekly UMIG meetings to discuss ongoing upgrades to NEMS and ensure that FIM continues to be NEMS-compliant.

CIRA researchers continued evaluating Intel's® Xeon® Phi (a.k.a. MIC, a.k.a. KNC) for the FIM and NIM models. We continue to work closely with an Intel team led by Mike Greenfield to tune performance of NIM on Xeon Phi without adversely impacting performance on traditional CPU architectures. CIRA researchers completed performance tuning of WSM6 scheme (used in MPAS, GRIMS, and NIM) and wrote a chapter describing this work for a book about Xeon Phi programming techniques (see below).

CIRA researchers supported the GSD Lab Review by preparing presentations, participating in numerous dry runs, and giving talks and serving on panels during the Lab Review. The reviewers identified our HPC efforts as a key area of strength for GSD that is unique within NOAA.

CIRA researchers continued to improve software engineering processes for FIM and NIM.

CIRA researchers continued to assist the Space Weather Prediction Center in maintaining the Ionosphere Plasmasphere Electrodynamics (IPE) code.

CIRA researchers assisted with the GSD transition from GSDForge to the NWS's VLab code management system.

CIRA researchers attended several meetings and gave talks on GPU and Xeon Phi research at the Programming Weather, Climate, and Earth Systems Models workshop, GPU Technology Conference, Xeon Phi Users Group Meeting, and Supercomputing 15.

PROJECT TITLE: EAR – Rapid Update Cycle (RUC), Rapid Refresh (RAP) and High Resolution Rapid Refresh (HRRR) Model Development and Enhancement

PRINCIPAL INVESTIGATOR: Sher Schranz

RESEARCH TEAM: Tracy Lorraine Smith, Haidao Lin

NOAA TECHNICAL CONTACT: Stanley Benjamin (OAR/ESRL/GSD/EMB Chief)

NOAA RESEARCH TEAM: Curtis Alexander (CIRES), Steve Weygandt (OAR/ESRL/GSD/EMB)

PROJECT OBJECTIVES:

The primary focus of the GSD Earth Modeling Branch (EMB) is the refinement and enhancement of the Rapid Refresh, High Resolution Rapid Refresh (RAP and HRRR) and development of the Weather Research and Forecast (WRF) model. In addition to refinement and enhancements of the RR and HRRR, CIRA researchers collaborate on the development of the Weather Research and Forecast (WRF) model used by CIRA and GSD researchers.

The HRRR is a NOAA real-time 3-km resolution, hourly updated, cloud-resolving atmospheric model, initialized by 3km grids with 3km radar assimilation over a 1-h period (since 5 April 2013), adding further detail to the HRRR initial conditions otherwise determined by the hourly data assimilation from the 13km radar-enhanced [Rapid Refresh](#)

The primary goal this year was to assimilate convective initiation information derived from GOES satellite data into the Rapid Refresh and HRRR forecast systems.

PROJECT ACCOMPLISHMENTS:

For this year's research goals, GOES cloud-top cooling rate data provided by the University of Alabama Huntsville (UAH) have been assimilated into experimental versions of the Rapid Refresh (RAP) and High Resolution Rapid Refresh (HRRR) at GSD. Within this RAP modeling framework, the cloud-top cooling rate data are mapped to latent heating profiles and are applied as prescribed heating during the diabatic forward model integration part of the RAP digital filter initialization (DFI). A similar forward integration only procedure is used to prescribe heating in the HRRR one-hour pre-forecast cycle. For both the RAP and the HRRR, the GOES-satellite-based cloud-top cooling rate information is blended with data from radar reflectivity and lightning flash density to create a unified convective heating rate field. In the current HRRR configuration, four 15-min cycles of latent heating are applied during a pre-forecast hour of integration. This is followed by a final application of GSI at 3-km to fit the latest conventional observation data.

Previous work on this project has demonstrated that these cloud-top cooling rates can help with the location and intensity of storms in the RAP and HRRR systems. A retrospective period of May 24- June 5, 2015 was chosen to continue investigation of the use of cloud top cooling rates in partnership with other satellite derived convective initiation indicators in the HRRR forecasts. This period was quite active with severe storms, with numerous tornadoes and large hail reports over the period. In addition to the RAP model, we are also investigating the impact of the satellite derived cloud-top cooling rates in the HRRR model that uses the RAP for boundary conditions. Other parameters to be evaluated are the CI probability information provided by UAH and the impact in variation in the vertical structure of the assumed heating profile using information on the cumulus clouds as derived from GOES.

The HRRR Version 2 and RAP Version 3 are due to become operational at NCEP mid May 2016 with significant improvements to the assimilation and modelling components.

PROJECT TITLE: EAR - NARRE Repository Maintenance and Rocoto End-to-end Workflow (DTC-Task)

PRINCIPAL INVESTIGATOR: Sher Schranz

RESEARCH TEAM: Isidora Jankov, James Frimel and Jeff Beck

NOAA TECHNICAL CONTACT: Stan Benjamin (OAR/ESRL/GSD/EMB Chief)

NOAA RESEARCH TEAM: John Brown (OAR/ESRL/GSD/EMB), Ligia Bernardet (CIRES)

PROJECT OBJECTIVE:

The North American Rapid Refresh Ensemble (NARRE) is a complex system currently consisting of seven software components including data assimilation (GSI), two pre-processing systems (NPS and WPS), two different dynamic cores (NEMS-NMMB and WRF-ARW) and a post-processing system (UPP). In order to ensure coordinated research, development, and transition of new or enhanced techniques to operations for the various system components, it is critical to establish and maintain a NARRE repository for use among various centers, including EMC, ESRL/GSD, and NCAR.

Workflow management systems make executing large testing and evaluation activities more efficient through managing complex interdependencies and requirements. NARRE is one such complex system that requires workflow management to effectively execute the large number of tasks. When factoring in the pre-processing, including data assimilation, running the model itself, post-processing, calculating

verification scores, and visualizing the results, one “run” of the ensemble modeling system can entail hundreds of individual calls to different software system components and scripts.

PROJECT ACCOMPLISHMENTS:

--NARRE repository established and maintained for use by EMC, ESRL/GSD and NCAR.
--NARRE Rocoto-based workflow established on Zeus and Yellowstone supercomputers.

PROJECT TITLE: EAR - Organization of the Second NMMB Tutorial and All Supporting Documentation (DTC-task)

PRINCIPAL INVESTIGATOR: Sher Schranz

RESEARCH TEAM: Jeff Beck, Isidora Jankov

NOAA TECHNICAL CONTACT: Stan Benjamin (OAR/ESRL/GSD/EMB Chief), John Brown (OAR/ESRL/GSD/EMB)

NOAA RESEARCH TEAM: Ligia Bernardet (CIRES)

PROJECT OBJECTIVES:

Organize and carry out the second Non-Hydrostatic Multi-Scale Model on the B-grid (NMMB) user tutorial and practical session at EMC in Washington, DC. This was a two-day event starting on March 2, 2016. The objective of this event was to provide an introduction to the model, physics options, the NEMS system, UPP, as well as hurricane and aerosol modeling. A second goal of the tutorial was to allow participants to run an end-to-end NMMB modeling system, from initialization to visualization of results. Another aim was to engage the NMMB community through the development of a tutorial website where announcements and pertinent information was presented to inform participants and presenters.

PROJECT ACCOMPLISHMENTS:

Prior to the tutorial taking place, the newest version of the NMMB model and UPP were compiled and tested on Yellowstone to ensure participants were able to run the latest version of the code. A test case was then designed for the practical session in order for participants to run an end-to-end simulation. During the first day of the tutorial, model developers and advanced users provided lectures on various aspects of the model. The following day was reserved for the practical session, where participants were helped to run the NMMB model. In addition, the NMMB Users' Guide, detailed practical session instructions, and the tutorial website were modified and updated to coincide with the release of the new version of the NMMB code and this year's tutorial. All documentation can be found on the tutorial website, located [here](#).

PROJECT TITLE: EAR - Refinement and Evaluation of Automated High-Resolution Ensemble-Based Hazard Detection Guidance Tools for Transition to NWS Operations (GSD-Task)

PRINCIPAL INVESTIGATOR: Sher Schranz

RESEARCH TEAM: Isidora Jankov

NOAA TECHNICAL CONTACT: Stan Benjamin (OAR/ESRL/GSD/EMB Chief)

NOAA RESEARCH TEAM: Trevor Alcott (OAR/ESRL/GSD/EMB), Curtis Alexander (CIRES)

PROJECT OBJECTIVE:

The overarching goal of this work is to transition a well-tested system for generation of ensemble post-processed hazard guidance products to operational status within the National Weather Service (product generation within NCEP and dissemination of hazard grids to NWS operational forecasters). A direct outcome of the project will be improved ensemble hazard guidance tools for operational forecasters that will reduce the ensemble information overload problem and enable a more efficient and accurate characterization of forecast uncertainty. Ultimately, the quality and usefulness of the weather guidance information provided by the NWS to the public will increase. Success in this project will also enable follow-up work to significantly expand the scope of ensemble hazard guidance product generation.

A main objective for this project is to expand an existing model-ensemble probabilistic product generation capability into a set of algorithms for creating a variety of different automated model ensemble-based hazard guidance tools that will be of maximum utility to NWS forecasters. The existing capability uses a time-lagged sequence of successive HRRR output grids, more details on the algorithm and how it will be adapted in this project are included in the next section. The idea is to develop a continuum of automated hazard-specific guidance tools, ranging from pure probabilistic guidance (e.g., probability of rain or snow rate exceeding a certain threshold, probability of freezing rain accumulation exceeding a certain threshold, probability of thunderstorm surface winds exceeding a certain threshold, etc.) to automated application of more geometric feature detection algorithms (e.g., identifying persistent edges of heavy snow bands, identifying tracks of large values of updraft helicity indicative of rotating thunderstorms and a potentially enhanced risk of tornadoes, etc.). Figure 1 provides an example of this approach for the New England blizzard of 27 Jan. 2015. The storm posed a significant forecast challenge as a very sharp western edge of the heavy snow shield was forecast across the densely populated New York City metropolitan area, with large variation among many different models. As can be seen in Fig. 1, the 12-h HRRR time-lagged ensemble (HRRR-TLE) probability forecasts of a heavy snowfall rates indicated the sharp western edge of the heavy snow, and, in turn, correctly predicted the western edge to the east of New York City.

PROJECT ACCOMPLISHMENTS:

- Coordination meeting amongst participating organizations to ensure roles, responsibilities, reporting, etc. (GSD, EMC, NCAR, WPC, WFOs).
- Establish SVN code repository for initial version of hazard generation software.
- Produce initial set of test products with time-lagged ensemble HRRR.
- Modify code to include additional input datasets (EMC NAM CONUSnest).
- Modify code to include additional predictors/criteria for initial set of winter products (snow bands, precipitation type, etc.), targeting WPC WWE, Jan. 2016.
- Transfer grib2 format grids to WPC and NWS forecast offices for forecaster use and to NCAR for MODE verification (GSD, WPC, NCAR).
- Develop preliminary verification system on NOAA supercomputer (e.g. Zeus or Theia) for 1-2 ensemble products and initial operating capability for Ensemble-MODE evaluation of snowbands.
- Visit WPC to observe use of uncertainty in forecast process and interview forecasters.
- Prepare and execute evaluation of initial set of cold season products during 2016 WPC Winter Weather experiment (WPC ~ 4 mos. effort).
- Participation in WPC WWE, Jan/Feb 2016 (GSD, NCAR, EMC).

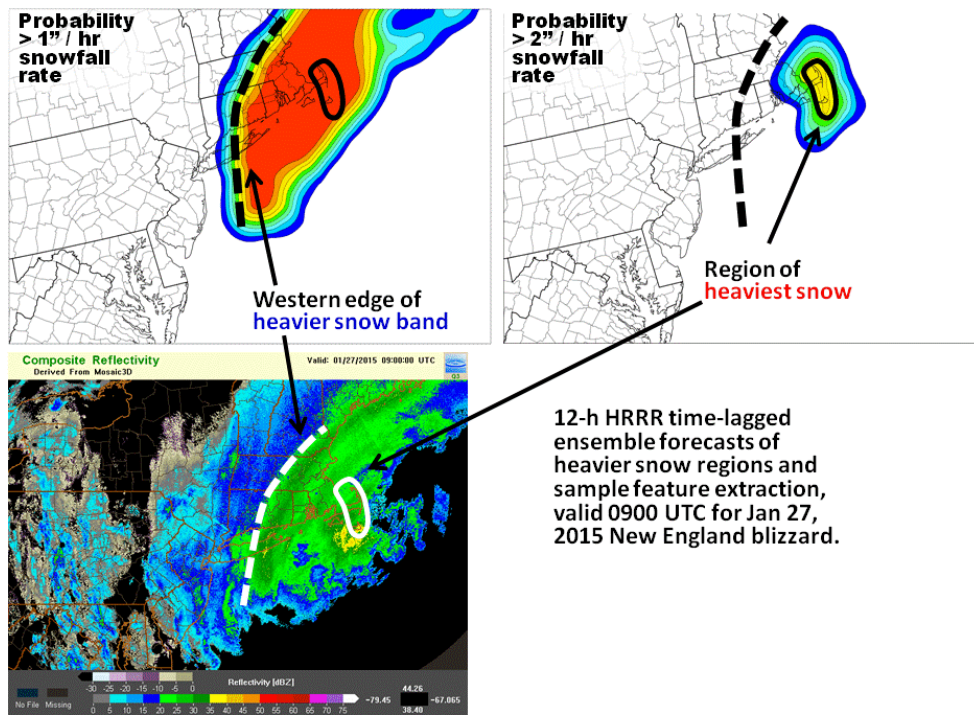

Figure 1. Sample heavy snowfall hazard guidance tool for the 27 Jan. 2015 New England blizzard (12-h forecast valid 09 UTC). Top panels show HRRR time-lagged ensemble probability of heavy snow rates (1" and 2" per hour). Dashed line and black ring indicate features that could be automatically detected by the proposed system. Bottom panel shows features overlaid on radar, indicating accurate depiction of western snow band edge.

PROJECT TITLE: EAR - Testing of Stochastic Physics Approach for Use in NARRE (DTC-Task)

PRINCIPAL INVESTIGATOR: Sher Schranz

RESEARCH TEAM: Isidora Jankov, Jeff Beck and Hongli Jiang

NOAA TECHNICAL CONTACT: Stan Benjamin (OAR/ESRL/GSD/EMB Chief)

NOAA RESEARCH TEAM: John Brown (OAR/ESRL/GSD/EMB)

PROJECT OBJECTIVES:

Currently in NARRE, the model-related uncertainty is addressed by using a multi-dycore and multi-physics approach. The multi-dycore includes use of the WRF-ARW and NEMS-NMMB dynamic cores. In terms of physics packages, suites used in current operational systems and the variations from them (e.g., RAP and NAM) are included. Mixed-physics approach has proven to perform well, but there are theoretical as well as practical issues associated with this approach. In terms of practical issues, this approach is very costly and hard to maintain, making it less attractive for operational use. Furthermore

this type of system is not consistent ensemble system with some parameterizations being closer related than others. Also, post-processing of this system is much harder when each member of the ensemble has a unique climatology and error. In order to address these issues in the next generation ensemble system, the ultimate goal is to move toward a stochastic physics approach. The main objective of this project is to compare performance of an ensemble that includes multi-physics approach versus one that employs a stochastic physics approach or multiple approaches.

PROJECT ACCOMPLISHMENTS:

For the purpose of this project we performed 24hr long simulations twice a day for 7 days. For the stochastic ensemble design we used three different approaches: stochastic parameter perturbation, Stochastic Kinetic Energy Backscatter (SKEB) and Stochastic Perturbation of Physics Tendencies (SPPT). This year we were able to perform somewhat limited tests in terms of not having an opportunity to tune either magnitude or space/time de-correlation of perturbations and we were able to test only one set of parameters. Despite the experiment's limitations, important findings were obtained. It was found that precipitation simulations were very similar between the mixed-physics ensemble and ensembles using stochastic approach. Furthermore, stochastic ensembles outperformed the mixed-physics ensemble in certain aspects. For other variables, it was found that using parameter perturbation approach only resulted in an insufficient spread. The spread issue was eliminated by employing SKEB and SPPT. Overall, the best performance was observed for an ensemble employing all three stochastic approaches together. These results were presented at both DTC Science and Management Board meeting resulting in extension of funding into the next year. These results will play a critical role in design of the next generation ensemble system running operationally at NCEP.

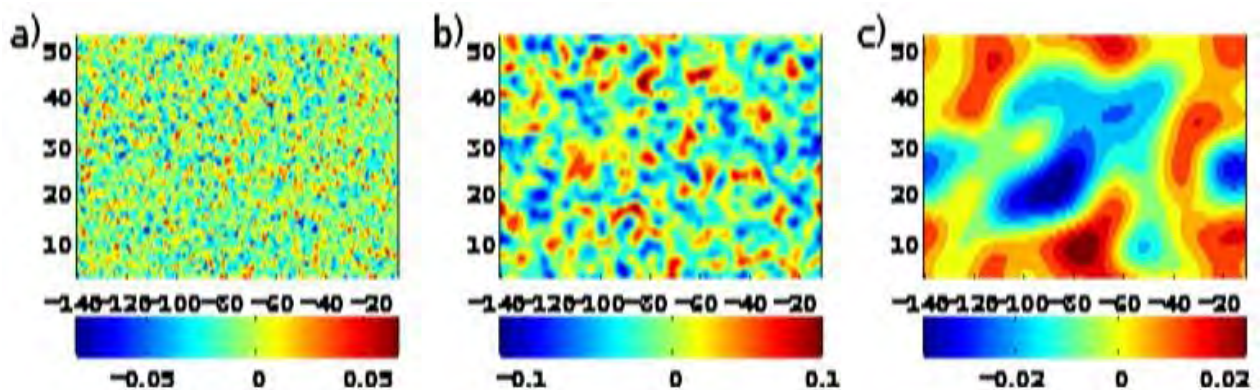

Figure 1. Snapshot of the Stochastic Perturbations Pattern for the RUC Land Surface Model a), the GF Convection Scheme.

PROJECT TITLE: EAR - RAP Ensemble Generation and Testing within GSI (3DVar/Ensemble hybrid) for Future Implementation in the Deterministic, Real-time RAP

PRINCIPAL INVESTIGATOR: Sher Schranz

RESEARCH TEAM: Jeff Beck

NOAA TECHNICAL CONTACT: Stan Benjamin (OAR/ESRL/GSD/EMB Chief), John Brown (OAR/ESRL/GSD/EMB)

NOAA RESEARCH TEAM: Ming Hu (CIRES), Christina Holt (CIRES), Xin Zhang (CIRES)

PROJECT OBJECTIVES:

The GFS ensemble that is currently used for real-time RAP DA provides for accurate verification of upper-air variables, but poor performance near the surface. As a result, variables such as ceiling, 2-m temperature, 10-m wind, and precipitation, suffer from consistently large RMSE. A regional, higher-resolution ensemble could serve to improve forecast skill near the surface.

Therefore, the objective of this work is to use GFS perturbations to create a RAP ensemble that could eventually be used in the 3DVar/Ensemble hybrid DA for the real-time RAP. Testing and evaluation of deterministic RAP simulations using this new ensemble will reveal whether there is an added advantage to using a RAP ensemble over the current GFS ensemble. Ensemble metrics will be analyzed to assess the quality of the newly created RAP ensemble and to analyze whether the GFS perturbations provide an adequate amount of spread within the higher-resolution, regional RAP ensemble.

PROJECT ACCOMPLISHMENTS:

Perturbations from GFS ensemble six-hour forecasts were used to initialize an 80-member RAP ensemble, which was then run out to 12 hours for a three-day period in August, 2014. A convectively active storm system was located in the Plains during this period and produced a number of tornadoes, providing an opportunity to test whether the RAP ensemble could resolve certain small-scale features.

Average spread from the RAP ensemble at all model levels was then plotted (Figure 1) for a number of important surface variables for different lead times. Spread can be seen to increase with time for upper level temperature (Figure 1a), mid-level water vapor (Figure 1b) and upper level values of the u-component of the wind (Figure 1c), however, elsewhere, spread decreases with time. Decreasing spread with time in the lower levels of the RAP ensemble is troublesome, but not unexpected. Given the detrimental impact of the GFS ensemble on low-level verification scores in the deterministic RAP, one can see that these effects are then inherited in the RAP ensemble through use of the GFS perturbations.

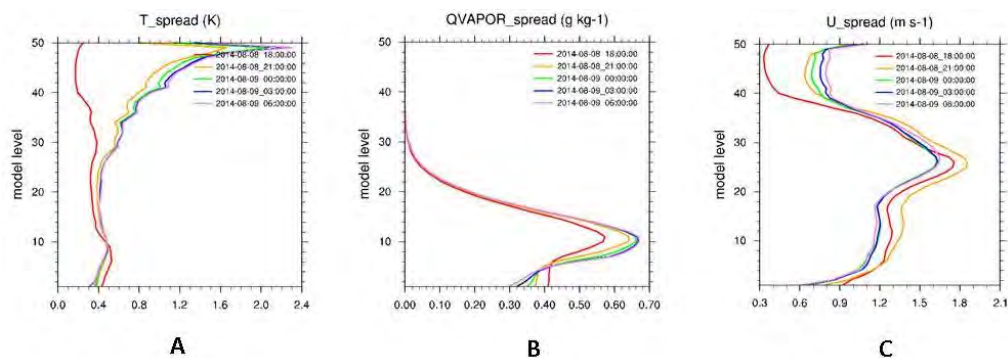

Figure 1. Average spread at all model levels for (a) temperature, (b) water vapor, and (c) the u-component of the wind for the RAP ensemble at different forecast lead times.

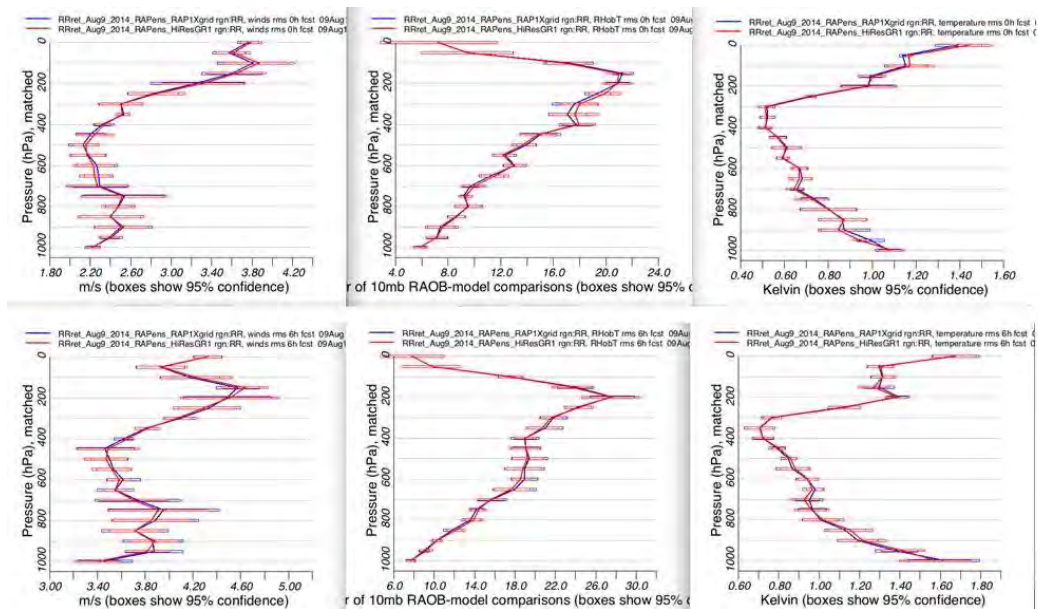

Figure 2. Mean vertical profiles of RMSE from initialization (top row) and from six-hour forecasts (bottom row) for the u-component of the wind (left), relative humidity (center), and temperature (right). Red (blue) lines indicate the deterministic RAP using the GFS (RAP) ensemble.

Even with these findings, vertical profiles of RMSE from the deterministic RAP using the RAP ensemble (Figure 2) do not show any deterioration in the forecast, yet they do not show any improvement either when compared with the RAP using the GFS ensemble data. While low level temperatures did not improve (Figure 2, right), it may seem surprising that even upper-level temperature, relative humidity (Figure 2, center), or the u-component of the wind (Figure 2, left) also did not improve.

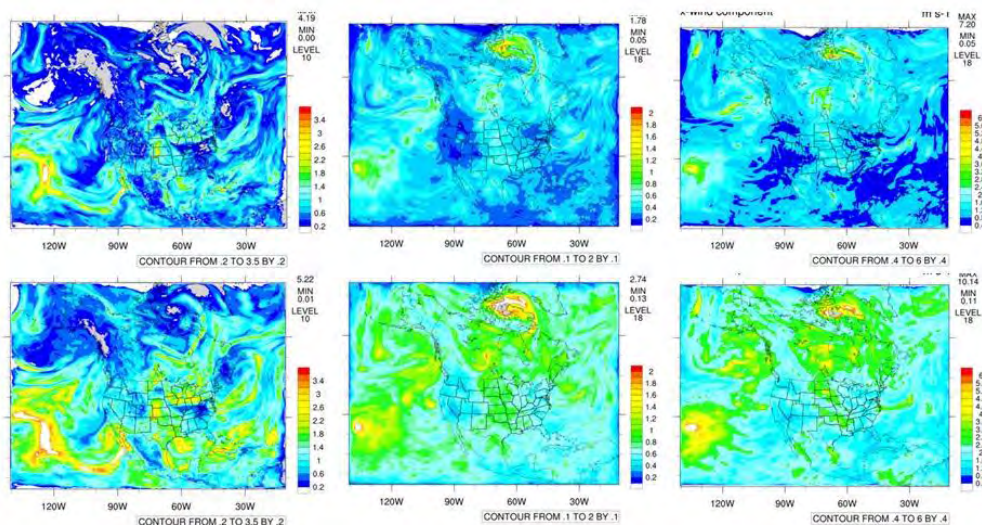

Figure 3. Spread for water vapor (left, 850 mb), temperature (center, 500 mb), and the u-component of the wind (right, 500 mb), for original magnitude perturbations (top) and two times the original perturbation (bottom) for nine-hour RAP ensemble forecasts.

With the possibility that the original GFS perturbations were not sufficiently large for a regional, higher-resolution ensemble, the magnitude of the GFS perturbations in the RAP ensemble were increased and tested with the deterministic RAP. The resulting spread was effectively increased (Figure 3), especially for temperature (Figure 3, center) and the u-component of the wind (Figure 3, right). The resulting verification showed that the increased perturbations helped improve the upper-air variables in the deterministic RAP (Figure 4), yet, results near the surface were again very similar to those when using the GFS ensemble or RAP ensemble with the original, smaller perturbations.

Given these results, future work could focus on alterations to the GFS perturbations only at specific levels. One possibility would be to increase perturbations at lower levels, in an attempt to improve the deterministic RAP near the surface. However, prior to continuing, a consensus was reached to first evaluate the ensembles (both GFS and RAP) with alternative metrics, such as spread/skill scores, reliability plots, rank histograms and other traditional ensemble scores. The goal is to first understand where the ensemble is performing poorly prior to assessing results from the deterministic RAP. Therefore, an assessment of how well spread relates to model error (spread/skill) or the reliability of the ensemble will allow for a more targeted approach to modifying the perturbations and will hopefully lead to a better overall improvement in the deterministic RAP.

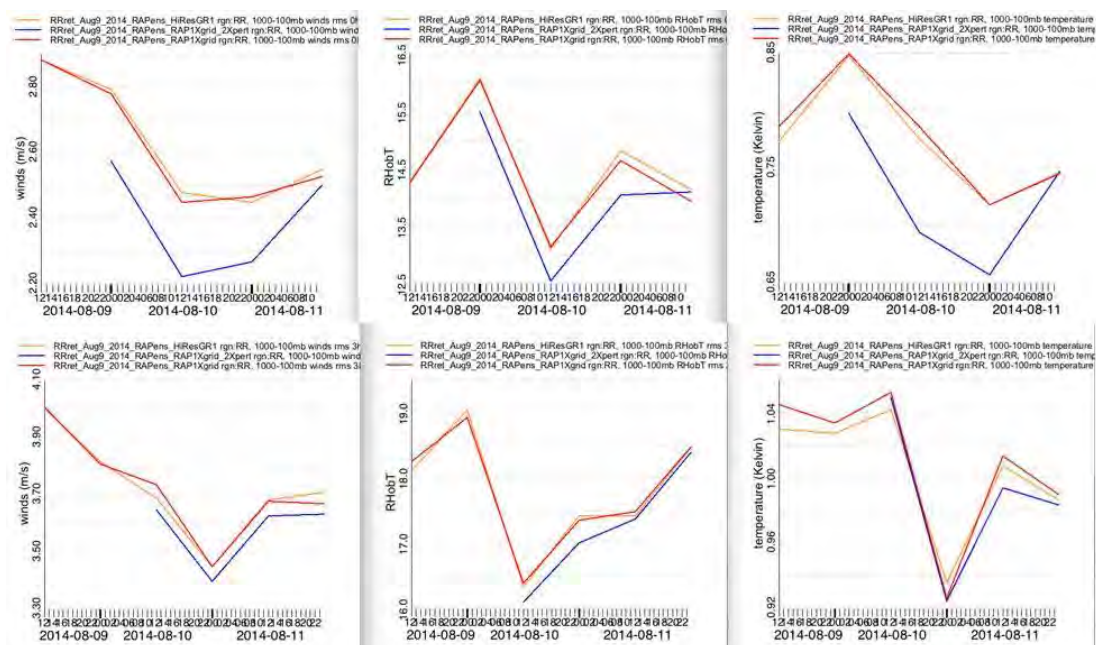

Figure 4. Average upper-air RMSE time series for the u-component of the wind (left), relative humidity (center), and temperature (right), for initialization (top) and six-hour forecasts (bottom) from the deterministic RAP using the inflated GFS perturbations.

PROJECT TITLE: EAR - Improving Short-Range Forecasts of Severe Weather and Aviation Weather from Enhancements to the Assimilation of Satellite Infrared Radiance Data from SEVIRI and GOES-R ABI

PRINCIPAL INVESTIGATOR: Sher Schranz

RESEARCH TEAM: Haidao Lin

NOAA TECHNICAL CONTACT: Stan Benjamin (OAR/ESRL/GSD/EMB Chief)

NOAA RESEARCH TEAM: Steven Weygandt (OAR/ESRL/GSD/EMB)

PROJECT OBJECTIVES:

Investigate the impact from satellite hyperspectral and infrared data on severe storm forecasts in the Rapid Refresh and global models and the increase in accuracy of short-range mesoscale model forecasts from the assimilation of satellite data into the Rapid Refresh and global models

PROJECT ACCOMPLISHMENTS:

Over the past year, work has continued on 1) evaluating the radiance data impact within the Rapid Refresh (RAP) model, focusing on evaluation of the overall radiance data impact through a series of one-month data denial retrospective experiments, 2) raising the RAP model top and investigating impacts on RAP radiance assimilation, 3) assessing the SEVIRI data impact in RAP, and starting the work toward building the Global Rapid Refresh data assimilation model system.

A series of one-month data denial retrospective runs were performed to evaluate the overall radiance data impact within the RAP. The control experiment included all conventional and radiance data. Figure 1 shows the normalized RMS errors reduction (1-18 hour forecasts are verified against rawinsonde observations) for different atmospheric layers from denial of all radiance data. As can be seen in Figure 1, inclusion of satellite radiance data produces a small positive impact for all forecast hours and for all variables (temperature, relative humidity, and wind). It can be seen that for temperature (Figure 1a), the largest normalized impact occurs within the 400-100-hPa layer with a normalized improvement of more than 3%. For relative humidity (Figure 1b), the biggest impact occurs within the 800-400-hPa layer with the biggest normalized impact of more than 1.5%. For wind (Figure 1c), the biggest impact came from the 400-100 hPa with the biggest normalized impact of more than 2.5%. It is expected that the biggest impact from the radiance data will occur in the upper levels (e.g., above 400 hPa for temperature and wind) and middle levels (relative humidity) since conventional data are usually sparse in the upper atmosphere.

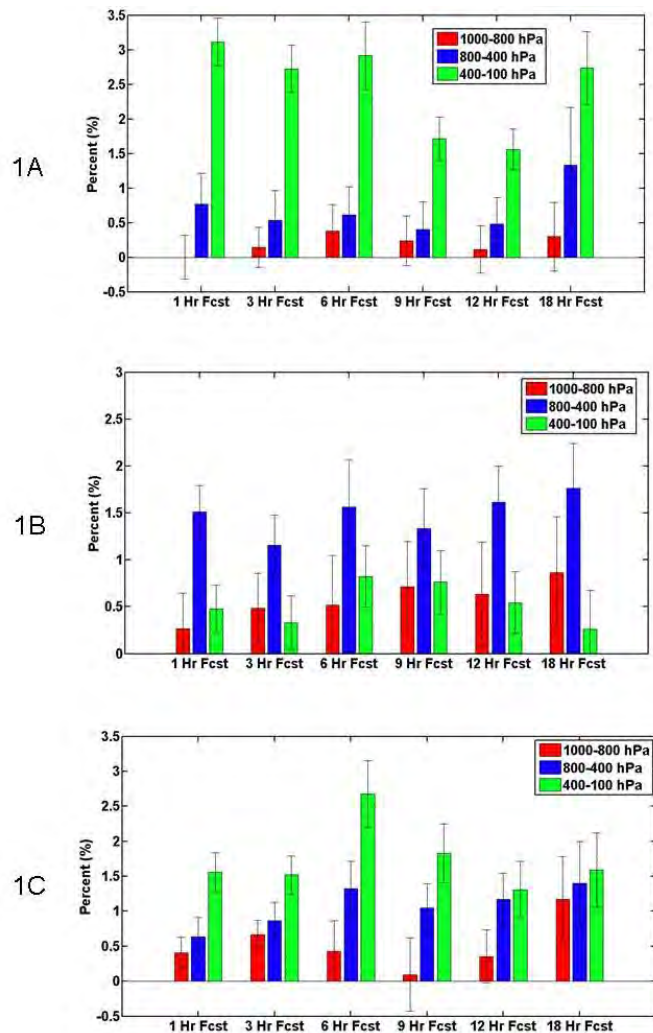

Figure 1 (A, B, C). Normalized RMS errors reduction [(EXPT – CNTL)/CNTL] (%) [temperature (°C) 1A, relative humidity (%) 1B, vector wind (m s^{-1}) 1C] for 1000-800 hPa layer (red), 800-400 hPa layer (blue), and 400-100 hPa layer (green), from all radiance denial run 1-18 hour forecasts against rawinsonde observations. Statistics are computed over the RAP domain. The retrospective period is from May 01 to May 31 2013. The error bar indicates the ± 1.96 standard error from the mean impact, representing the 95% confidence threshold for significance. The control run includes all conventional and radiance data. The experiment is the radiance data denial run, removing all radiance data.

In order to incorporate more satellite radiance data into RAP and for better radiance bias correction, a preliminary study on raising the RAP model top from 10 hPa to 2 hPa was performed. Raising the RAP model to 2 hPa could result in the reduction in mean O-B bias, especially for AMSU-A middle-high channels, such as channels 9 and 10 (Fig. 2). A neutral forecast impact is seen (figures omitted) through 7-day retrospective runs after raising the RAP model top. By raising the RAP model top, RAP has the potential ability to include more radiance data especially for hyperspectral radiance data, but this comes with a non-trivial increase in computational cost associated with the increased number of model gridpoints.

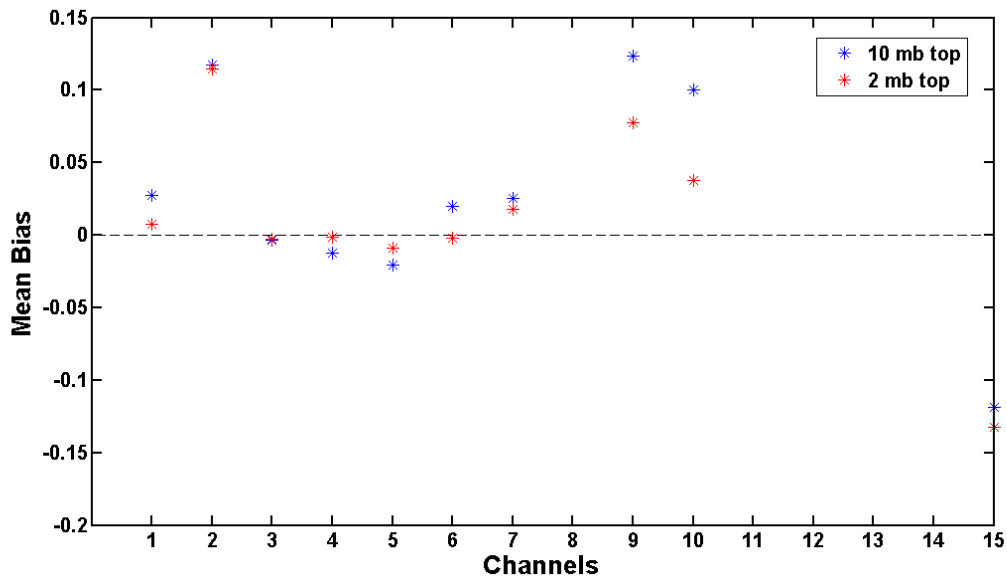

Figure 2. Mean AMSU-A (NOAA-19) O-B bias (K) from 10 hPa model top (blue) and 2 hPa model top (red) one-week (05/01/2013-05/07/2013) RAP retrospective runs.

Additional preliminary work has been completed to assess the impact from SEVIRI clear sky radiance data, a proxy to GOES-R ABI data, on the RAP. The expanded RAP domain makes it possible to assimilate SEVIRI data into RAP. SEVIRI data have limited data coverage on the east oceans of the RAP domain. Two SEVIRI water vapor channels are assimilated into RAP. Two 9-day RAP retrospective runs (01/06/2016-01/14/2016) with and without SEVIRI data show that SEVIRI data have neutral impact based on rawinsonde observation verification (figures omitted).

Finally, initial work toward building a Global Refresh Refresh data assimilation system based on the Flow-following Icosahedral Model (FIM) has been started. A data assimilation scheme initially based on Ensemble Kalman Filter (EnKF) is proposed to improve the FIM initial conditions with conventional and satellite observations.

DATA ASSIMILATION

Research to develop and improve techniques to assimilate environmental observations, including satellite, terrestrial, oceanic, and biological observations, to produce the best estimate of the environmental state at the time of the observations for use in analysis, modeling, and prediction activities associated with weather/climate predictions (minutes to months) and analysis.

PROJECT: ENVIRONMENTAL APPLICATIONS RESEARCH

FISCAL YEAR FUNDING (EAR Total): \$5,480,143

PROJECT TITLE: EAR - Toward a Unified National Dust Modeling Capability: Data Assimilation

PRINCIPAL INVESTIGATOR: Sher Schranz

RESEARCH TEAM: Mariusz Pagowski

NOAA TECHNICAL CONTACT: Georg Grell (OAR/ESRL/GSD/AMB)

NOAA RESEARCH TEAM: Stuart McKeen (CIRES)

PROJECT OBJECTIVES:

Develop data assimilation for satellite dust observations.

PROJECT ACCOMPLISHMENTS:

Our efforts concentrated on developing and updating GSI code for the assimilation of 550 nm aerosol optical depth (AOD) and dust products derived from MODIS and VIIRS satellite retrievals. The computer code for MODIS AOD, which has been updated to the recent trunk, has been submitted to DTC and the GSI review committee for examination with the purpose to be included with the standard GSI distribution. Separately, we developed a branch that includes assimilation of MODIS dust product. However, testing of the assimilation algorithm has not yet been performed because we have not received dust masks from our collaborators. Development of VIIRS AOD and VIIRS dust product within the GSI is on-going. We received sample VIIRS AOD and VIIRS dust masks from our collaborators and developed computer code for converting hdf files to bufr as required by the GSI. We also developed computer code within the GSI to read and process VIIRS AOD and its dust product. However, the assimilation algorithm has not yet been completed. Assimilation of VIIRS and its dust product in GSI is similar to that of MODIS except for interfacing with the Community Radiative Transfer Model (CRTM). We initiated collaboration with Mark Liu (NOAA/NESDIS) to help with the implementation of this new interface and plan to have this task finalized by the due date of the project.

The CRTM includes only GOCART aerosol parameterization that we currently rely on in our assimilation approach. With the help of the collaborator we plan to implement the new aerosol parameterization in the CRTM. This will be achieved either off-line or within the CRTM model itself. We expect to have this task completed by the due date of the project.

We have collected data from IMPROVE (speciated) and AQS (PM_{2.5}, PM₁₀) sites for the evaluation of the models for the test period May 6-14, 2014 when a dust episode occurred. We are in the process of assembling input data for models to perform simulations for the test period. The simulations and assimilation tests will be performed with WRF-Chem and CMAQ.

Milestones Completed

- Updated MODIS AOD assimilation to the recent GSI trunk and submitted the code for committee review.
- Developed code to assimilate MODIS dust product.
- Obtained sample VIIRS AOD and VIIRS dust mask and developed code to convert hdf to prepbufr to comply with GSI standard.
- Developed interface to read MODIS and VIIRS AODs and dust products.
- Assembled observations for model evaluation.

To be completed

- Develop on-line or off-line parameterization of new dust module in CRTM.
- Perform forecasting/assimilation tests for May 6-14, 2014 period.
- Perform evaluations against observations.
- We are currently waiting to obtain from our collaborators VIIRS products for the test period, and CMAQ input files.

PROJECT TITLE: EAR - Evaluation of Chemical Data Assimilation Systems for PM_{2.5} Observations Using WRF-Chem and CMAQ

PRINCIPAL INVESTIGATOR: Sher Schranz

RESEARCH TEAM: Mariusz Pagowski

NOAA TECHNICAL CONTACT: Georg Grell (OAR/ESRL/GSD/EMB), Steven Peckham (CIRES)

PROJECT OBJECTIVES:

Improve and evaluate aerosol data assimilation methods for air quality forecasting.

PROJECT ACCOMPLISHMENTS:

Our activities concentrated on development of systems for PM_{2.5} assimilation within the Gridpoint Statistical Interpolation (GSI) using WRF-Chem (RAP-Chem) and CMAQ and the operational implementation of the systems. Also, we developed a verification system for these systems. Results of our work were presented at the EGU General Assembly in Vienna, 7th International Workshop on Air Quality Forecasting Research in College Park, MD, 08/2015, and at the Meteorology And Climate - Modeling for Air Quality Conference (MAC-MAQ) in Sacramento, CA, 09/2015. During the reporting period we calculated background error statistics for WRF-Chem and CMAQ. These statistics were used to perform an evaluation study on the impact of the PM_{2.5} assimilation during SENEX (Sothern Nexus) experiment in summer 2013. 24-hour control and assimilated forecasts were issued for the period of June 10 to July 19, 2013 for both models (five-day spin-up period shifts the effective beginning of the evaluation to June 15, 2013). Parameterizations employed by both models include aqueous chemistry and secondary aerosol formation. By matching horizontal domains of the operational CMAQ and WRF-Chem and using the same meteorology to drive the models, we attempted a fair comparison of the performance of both models. In Figures 1 and 2, surface concentrations of the control forecasts and increments averaged over the period are shown. It is remarkable that concentration patterns in all these figures remain very similar suggesting that both models have comparable prediction skills and that they are limited by the quality of emission inputs.

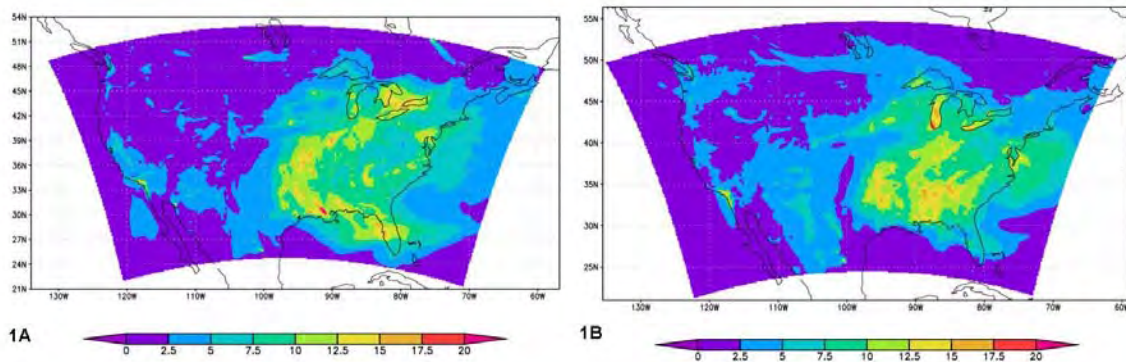

Figure 1. CMAQ (1a) and WRF-Chem (1b) average PM2.5 concentrations over period of June 15-July 19, 2015.

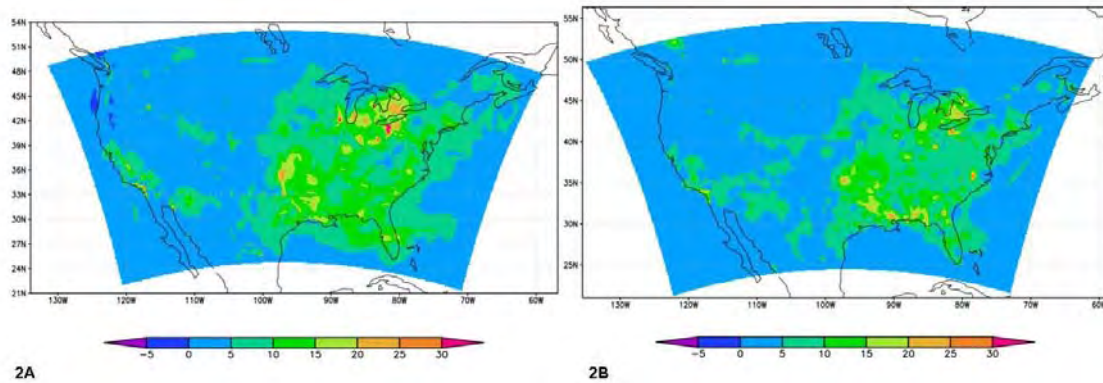

Figure 2. CMAQ (2a) and WRF-Chem (2b) average PM2.5 increments over period of June 15-July 19, 2015.

To facilitate the comparison of the models we also developed computer code for verification of the both systems. The code is coupled to the Model Evaluation Tools (MET) from Development Testbed Center (DTC) at NCAR. In Figure 3 biases, RMSEs, and correlations for all simulations are plotted. Except for higher biases for CMAQ, these plots also demonstrate that forecasting skill of the models remains similar. Also, for both models impact of the assimilation is significant, though limited in extent to approximately 12 hours.

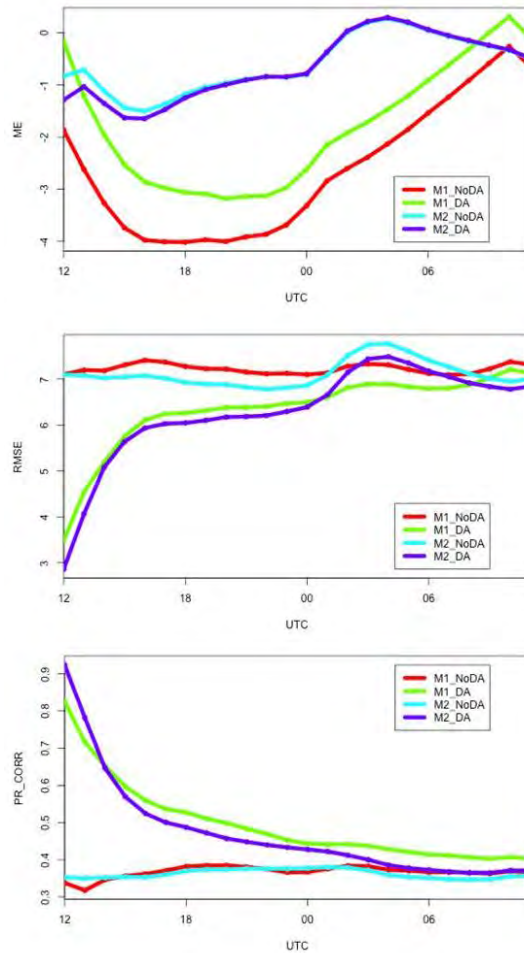

Figure 3. Bias, RMSE, and correlation for CMAQ, and WRF-Chem PM2.5 forecasts with and without assimilation over period of June 15-July 19, 2015.

PM2.5 control and assimilated forecast are issued in real-time with RAP-Chem, an implementation of WRF-Chem over the continental domain that is shown in Figure 4. Model forecasts can be viewed on-line along with the evaluation of the past forecasts.

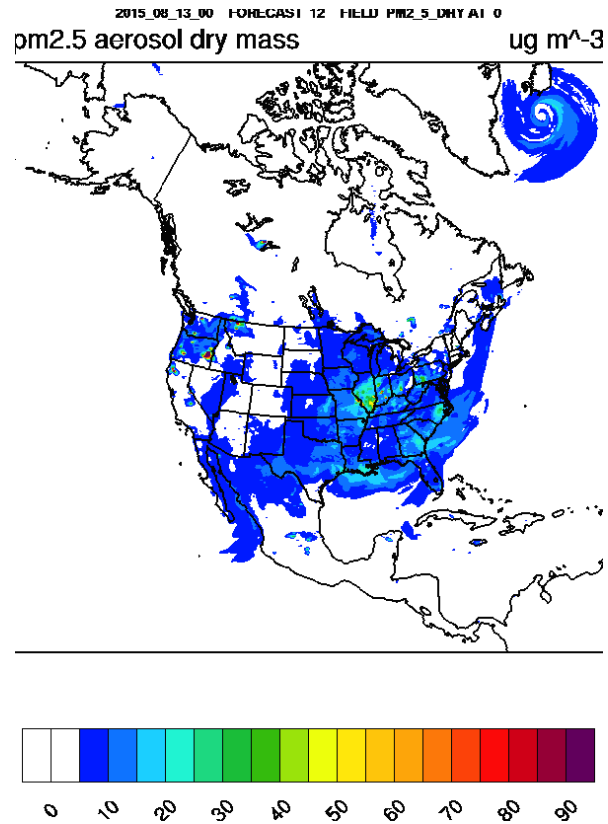

Figure 4. Horizontal domain of RAP-Chem real-time forecasting and assimilation system.

PM2.5 assimilation code for CMAQ is available and could be used for operational purposes. The assimilation procedure has been developed on NOAA's computers Zeus and Theia. We do not have access to WCOSS computers and thus cannot implement the assimilation in NCEP's operational setting though remain open to any collaboration.

Transition to Operations

A--We performed evaluation study that has been described in Section 1.

B-- Assimilation procedure is now used for real-time forecasting with RAP-Chem as described in Section 1. The assimilation code is available for operational implementation with CMAQ at NCEP.

PROJECT TITLE: EAR- Local Analysis and Prediction System (LAPS)

PRINCIPAL INVESTIGATOR: Sher Schranz

RESEARCH TEAM: Steve Albers, Hongli Jiang

NOAA TECHNICAL CONTACT: Stan Benjamin (OAR/ESRL/GSD/EMB Chief)

NOAA RESEARCH TEAM: Yuanfu Xie (OAR/ESRL/GSD/EMB)

PROJECT OBJECTIVES:

Improvement and enhancement of the LAPS in providing real-time, three-dimensional, local-scale analyses and short-range forecasts for domestic and international operational weather offices, academia, private sector, aviation and other field operations.

Examine and evaluate issues associated with model initialization and cycling process, and work towards improvement of these processes.

Study improvements to analysis techniques, diabatic initialization and balance package, WRF model initialization, ensemble forecasting techniques as well as model forecast verification at various LAPS sites.

Continue long-term collaboration with GSD to have LAPS (also referred to as the traditional LAPS to distinguish from vLAPS) and variational LAPS (aka STMAS, hereafter denoted as vLAPS) software running in the National Weather Service Weather Forecast Offices (WFOs) for evaluation and use by operational forecasters in both AWIPS and AWIPS II.

Use knowledge and software from LAPS to improve other systems such as HRRR, RAP, global models. One tool to do this is a modular software design, including object oriented techniques.

PROJECT ACCOMPLISHMENTS:

1--LAPS/WRF Improvements

Within EMB, CIRA personnel continue to play a leading role in development and implementation of meteorological analyses (e.g. wind, clouds, temperature, and precipitation), data ingest, and auxiliary processing, and web displays within LAPS. This includes overall management of the configuration, updates, and distribution of the LAPS (including vLAPS) system. We've thus been highly motivated to lead the coordination of new ideas for development in LAPS including variational LAPS. For LAPS and vLAPS, we worked to improve the analyses with a particular focus in the following areas:

- First Guess Processing
- Observational Data Sets
- Cloud / Precipitation Analyses
- LAPS/vLAPS Model Initialization/Post Processing
- General Software Improvements & Portability
- LAPS Implementation

We maintain the LAPS software distribution and the associated web site. This involves more than 100 users both in the U.S. and internationally.

Various in-house runs are being supported including a high-resolution 500m LAPS 3D analysis with a 15-min cycle. A global analysis is also being run. Other analysis/forecast runs are using the HPCC, including 3km CONUS and relocatable 1km domains.

All-sky Camera

CIRA continues conducting exploratory development in the use of all-sky and other digital cameras, along with an attendant visualization package, for model validation, assimilation, and communication of model output. This package can be applied to any model (e.g. HRRR, FIM) and we are presently testing it with LAPS. The LAPS cloud analysis uses satellite (including IR and 1-km resolution visible imagery, updated every 15-min), METARs, radar, aircraft and model first guess information to produce 3-D fields of cloud fraction, cloud liquid, cloud ice, rain, snow, and precipitating ice. This analysis is currently being done by the long-standing, largely sequential data insertion procedure developed within LAPS, though we are presently developing a variational version of this procedure. To help visualize and validate the cloud analysis we continue to develop and refine a ray-tracing procedure to construct simulated all-sky (e.g. hemispherical and full spherical) imagery. The visualization procedure efficiently considers various aspects of radiative transfer in clouds, precipitation, and aerosols. The terrain is also visualized. Vantage points can be located on the Earth's surface, above ground inside the atmosphere, or from space. The all-sky imagery, in either a polar or cylindrical projection can show either analysis or forecast fields. We have been examining ongoing results of this simulated imagery, along with comparisons to actual images produced by several sky cameras located within our Colorado 500m resolution domain. These comparisons check the skill of the existing analysis at high-resolution, and help communicate the model results in a visual manner to scientific and lay audiences. LAPS/WRF hot-started forecasts are also being visualized, one example being the case of the Moore, Oklahoma tornado on May 20, 2013. The simulated images can be made any time of the day or night, using sunlight, twilight, moonlight, airglow or city lights (now from VIIRS) as light sources.

As mentioned, visualizations can be performed at essentially any altitude (looking up and/or down) from the surface up to geosynchronous orbit and beyond. We are starting to compare full-disk visualizations with the full-color imagery from the DSCOVR satellite. This provides a powerful independent validation of global (e.g. global LAPS) analyses of clouds and other fields and forecasts. This will be providing important insights for improvements in cloud data assimilation and modeling.

Our plans include using all-sky cameras directly in data assimilation to help fill observational gaps at small-scales. We are interacting with several companies, such as EKO instruments and Harris Corporation, to look for synergies including evaluation of cameras and image processing technologies. This work was presented in two AMS conferences during the past year, and led to winning a CIRA Research Initiative Award at which a seminar was given. It is helping to foster additional collaboration, such as in CIRA's development of a low-light forward model for use with geosynchronous satellites.

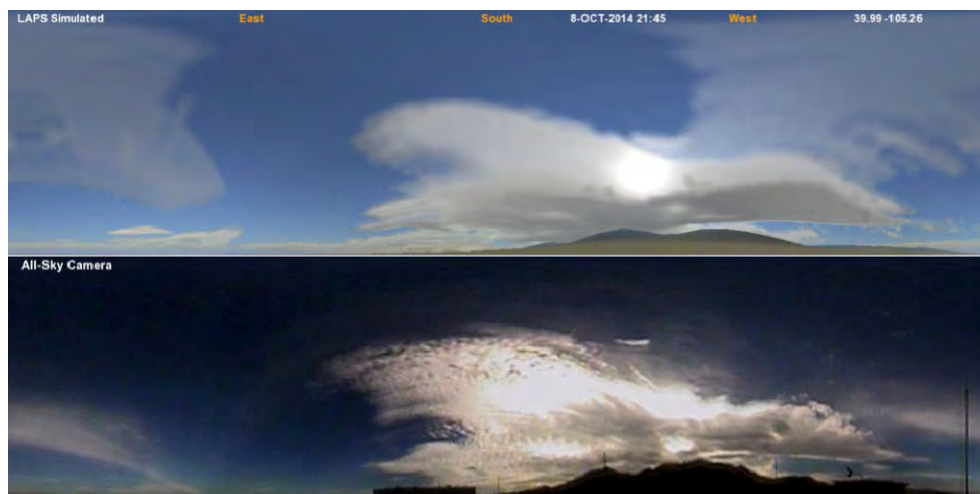

Figure 1. In these 360 degree panoramic views, the top is a simulated LAPS image and bottom is a remapped camera image (independent from the analysis) taken by an all-sky camera maintained by the Earth Systems Research Laboratory. South is at the center of each image and north is at the edges. Images are valid at 2145 UTC 8 October 2014.

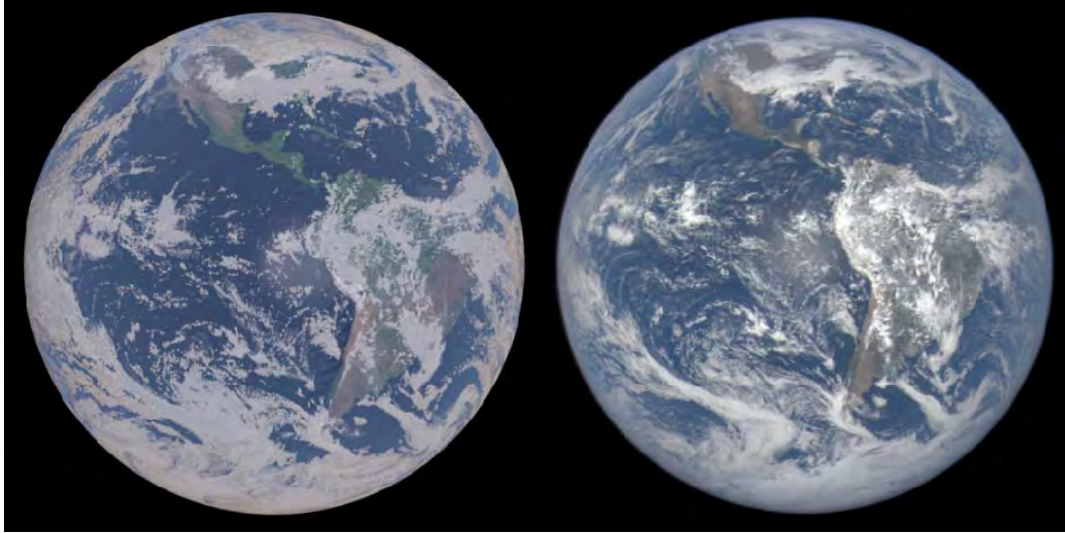

Figure 2. Looking from space at NWP analysis-based simulated (left, LAPS) and satellite-based (DSCOVR) observed images (right, both valid at 1800 UTC 23 February 2016) of the Earth with its cloud structures. We can evaluate the correspondence of cloud structures and brightness, land color, ocean sun glint, Rayleigh scattering, and ozone absorption on the limb.

2--VLAPS-3D Development and Improvements and Analysis and Data-Assimilation improvements
We are running a hybrid system with vLAPS where analysis modules from both the new variational LAPS software are combined with some from "traditional" LAPS. This provides an ideal testing platform as we phase in vLAPS improvements.

Cloud analysis improvements are continuing based largely on validation independent data from sky cameras. We are also starting to run the visualization from outside the atmosphere, so satellites such as DSCOVR can be used to validate and help improve the analysis. Blending between model first guess, METAR, and visible/IR satellite (including cloud albedo and optical depth) were all improved to be done in a more consistent manner to produce microphysical analysis fields. We continue to look at the use of satellite products such as cloud optical thickness and liquid water path to help provide input to the variational cost function. Observation operators for the cloud optical path assimilation has been developed and incorporated into the vLAPS system. Additionally we are setting up an option to use CRTM or similar radiative transfer models as forward models working more directly with satellite radiances in the cloudy areas.

In connection with the all-sky camera work mentioned in section 1, we are planning and testing development using our object oriented software design. This can give us a good strategy for actually assimilating camera images in the variational cloud analysis, using a forward operator derived from our all-sky visualization data. Hopefully CRTM can be improved to allow all-sky (and full-color multispectral) camera assimilation similar to what can be done with satellite data. This would include a greater choice of visible wavelengths and the ability to look up from the ground in addition to down from space. Thus a unified set of libraries is supporting image/radiance data from both cameras and satellites. This software is being designed to be interoperable with various analysis systems including LAPS and GSI, and global 4DVAR analysis.

EMB LAPS & HRRR Cloud Analysis Assessment

To help with the goal of merging cloud analysis efforts between LAPS and the HRRR, a series of meetings is being held to compare LAPS & HRRR cloud analysis results on a test case. A series of runs is being performed with varying first guess and observational data inputs. Results are being visually compared with fields such as cloud base and simulated visible satellite. We can evaluate various

strengths and weaknesses of each analysis. We are also setting up to port the LAPS simulated visible satellite software over to the HRRR to help with cloud displays in NWS offices.

Plans and initial work with the LAPS variational cloud analysis have been further documented and presented at EMB and CIRA meetings, to help define a roadmap for testing and implementing various strategies for improving cloud analysis in NWP systems.

We are presently collaborating with Dr. Yuanfu Xie to utilize portions of the all-sky software in a forward model that can assimilate camera images into NWP models. This is being written in a generic modular design so it can fit into both the GSI and in LAPS. One of the first planned capabilities is using binary yes/no cloud information from cameras in GSI.

3--NWS Interaction, AWIPS and AWIPS-II

CIRA continued to participate in a long-term effort to have LAPS software running in the National Weather Service WFO's (on AWIPS) for evaluation and use by operational forecasters. There are two AWIPS-II builds where LAPS analysis is included as an operational system and LAPS is being supported in some legacy AWIPS-I WFO locations. We're presently assisting with trouble shooting of the second AWIPS-II version of LAPS. The variational version of LAPS (vLAPS) can potentially be introduced into the AWIPS-II development and testing cycle.

--EFF Activities

We continued our interaction with the local NWS WFO in Boulder, located within the David Skaggs Research Center. CIRA researchers took part in presenting weather briefings.

4--Hazardous Weather Testbed (HWT) Experimental Warning Program (EWP)

In recent years, CIRA helped to run 1km/3km analyses and forecasts for the HWT experiment. Having our forecasts looked at by a large number of people in this type of testbed gives us invaluable feedback that we can channel back into improvements of the system. We wrote a journal article on this project that was published in December, 2015. The relocatable domain capability we developed for this project continues to be valuable for testing in various locations, including Alaska.

5--Army Research Lab (ARL)

In collaboration with NOAA colleagues, CIRA is working with ARL to perform case reruns of the LAPS/WRF system. Various nudging and assimilation techniques are being tested to see which ones produce optimal forecasts.

6--Victoria Cloud Project

CIRA is leading a potentially funded project to refine a version of vLAPS for implementation over the Lake Victoria region of Africa. Discussions have continued with NOAA and WMO officials on the best ways for CIRA to contribute. There are two areas of Africa that would be of interest, one near Lake Victoria and another in and around South Africa.

7--Global Precipitation Measurement (GPM / PMM)

CIRA continued to participate in a project supporting the Global Precipitation Measurement mission. Several GSD collaborators are on the team. We acquired TRMM radar data and used this in the LAPS cloud analysis used for initializing a WRF forecast. Results were very good in our case study for the model initialization through the first 15 minutes of the forecast. It became somewhat unstable after that. This was however an important proof of concept for using GPM data in NWP forecasts. We gave an oral presentation on this research at the 2015 AGU Fall Meeting in the GPM session, and a poster at the June 2015 PPM Science Meeting in Baltimore. The GPM principal scientist looks forward to our continued work in this area, though interest in GSD for further work on this is somewhat uncertain.

8--Applications of Concurrent Super Rapid Sampling from GOES-14 SRSOR Radar and Lightning Data
CIRA is leading GSD's role as a Co-PI in a NESDIS funded project to utilize high-frequency radar and satellite data to initialize LAPS/WRF simulations. The main goal is to assess the impact of Atmospheric Motion Vector (AMV) data from the rapid scan GOES data to help preview what we'll be getting with

GOES-R. This is in collaboration with NSSL. We have been gathering data for several Local Analysis and Prediction System (LAPS) case reruns, starting with the Moore tornado case from May 20, 2013. This involves retrieving routinely archived observational data from NOAA's High Performance Computing Mass Storage. In addition, Level-II Doppler radar data are being obtained from the National Climatic Data Center. Our processing scripts are being updated to support the new Java application for converting this into NetCDF. Special cloud-drift wind data from the 1-minute GOES-R data have also been reformatted to be readable by LAPS. Preliminary reanalysis runs with the routinely archived data have been performed. We've also tested with running the LAPS initialized WRF forecast on this case.

Additional cases have been selected for several days in 2014, and the GOES-R cloud-drift wind data have been processed. We ran the LAPS analyses for May 20 and May 21, and are presently assessing the results. Real-time analysis and possibly forecast runs are being planned during 2016 using the AMVs.

9--Other activities

A project is being developed with a company in Colorado Springs called PEMDAS using the LAPS cloud analysis and possibly forecasts. This is in support of US Air Force drone operations. Other potential projects are being discussed with the Korean Meteorological Agency (KMA), China Meteorological Agency (CMA), and the Office of Naval Research (MURI).

In collaboration with the GSD/ATO branch, a director's discretionary fund proposal has been submitted for visualization of clouds and related fields from model data in a computer display system capable of a fly through environment (TerraViz).

PROJECT TITLE: Hydrometeorological and Water Resources Research

PRINCIPAL INVESTIGATOR: V.Chandrasekar

RESEARCH TEAM: Haonan Chen, Delbert Willie, Jungho Kim

NOAA TECHNICAL CONTACT: Robert Cifelli

NOAA RESEARCH TEAM: Robert Cifelli

FISCAL YEAR FUNDING: \$245,236

PROJECT OBJECTIVE:

- 1--Evaluation of Quantitative Precipitation Estimation for NOAA HMT-West
- 2--RAMS QPE Improvement and Application to the NOAA HMT-SEPS Domain
- 3--Assess performance of ModClark versus RDHM

PROJECT ACCOMPLISHMENTS: (Research Conducted) Past Fiscal Year by Objective:

PROJECT 1: Evaluation of Quantitative Precipitation Estimation for NOAA HMT-West

This project implemented and evaluated the bias correction techniques in the Multisensor Precipitation Estimator (MPE) system. Rainfall error characteristics associated with rain gauge distributions (i.e., density, elevation, etc.) were investigated. The MPE system (Lawrence et al. 2003; Seo et al., 2010;

NWS 2010) was developed by the National Weather Service (NWS) Office of Hydrologic Development (OHD) and was officially released to River Forecast Centers (RFCs) in 2001 as part of the Advanced Interactive Processing System (AWIPS) for producing hourly precipitation amounts. The MPE is currently used at most NWS RFCs and produces a suite of regional rainfall products valid at the top of each hour using single- or multisensor analysis techniques. This project focused on comparing the efficacy of different bias correction mechanisms in MPE and determination of the proper correction techniques for different rainfall regimes.

Methodologies

1--Mean Field Bias Correction

Given the hourly rain gage and radar rainfall data up to and including the current hour, the mean field bias at hour k , $\beta(k)$, is defined as follows:

$$\beta(k) = \frac{\int_{A_c(k)} G(k,u) du}{\int_{A_c(k)} R(k,u) du} \quad (1)$$

where $A_c(k)$ is the area within the radar umbrella, which both the radar and gauge network would commonly identify as raining at hour k ; $R(k, u)$ and $G(k, u)$ denote the hourly rainfall from radar and gauge, respectively, at hour k at location u within $A_c(k)$.

In MPE, the mean field bias at hour k is estimated as:

$$\beta(k|k) = \frac{G_m(k|k)}{R_m(k|k)} \quad (2)$$

where $G_m(k|k)$ and $R_m(k|k)$ represent the 'best' estimates, given all the available gauge and radar rainfall data up to and including hour k , of the spatial averages of positive gauge and radar rainfall at hour k within $A_c(k)$,

$$G_m(k) = \frac{1}{A_c(k)} \int_{A_c(k)} g(k, u) du \quad (3)$$

$$R_m(k) = \frac{1}{A_c(k)} \int_{A_c(k)} r(k, u) du \quad (4)$$

The detailed estimation of bias can be found in Seo et al. (1999). The estimated bias then can be applied to the raw radar rainfall estimates to get the gauge based mean-field-bias corrected radar QPEs.

2--Local Bias Correction

The local bias at the radar bin at location u_0 at hour k , β_{0k} , is defined as follows:

$$\beta_{0k} = G_{0k}/R_{0k} \quad (5)$$

where G_{0k} and R_{0k} , respectively, denote the bin-averaged gauge and radar hourly rainfall accumulations at the k th hour at the radar bin centered at u_0 .

The gauge rainfall G_{0k} in equation (5) can be estimated as:

$$G_{0k} = \|A_0\|^{-1} \int_{A_0} P_k(u) du \quad (6)$$

where $\|A_0\|$ denotes the area of the radar bin centered at u_0 , and $P_k(u)$ denotes the hourly gauge rainfall at location u in A_0 at the k th hour. As shown in equation (6), G_{0k} may be considered measurable only if there exists a sufficiently large number of gauges within A_0 to capture the microscale variability of rainfall.

The radar rainfall R_{0k} in equation (5) is estimated as:

$$R_{0k} = \int_T Q_0(t) dt \quad (7)$$

where T denotes the duration of an hour, and $Q_0(t)$ denotes the bin-averaged radar rainfall rate at time t at the bin centered at location u_0 .

The gauge measurement of G_{0k} is subject to spatial sampling errors due to micro- and macroscale variability of rainfall, and the radar estimate of R_{0k} is also subject to spatial and temporal sampling errors from various sources. Therefore, β_{0k} in equation (5) is not a deterministic quantity and can only be estimated in a statistical sense. The simplest form that a local bias estimator can assume is as follows:

$$\beta_{0k}^* = E(G_{0k})/E(R_{0k}) \quad (8)$$

where the asterisk signifies that the variable superscripted is an estimate, and $E(\cdot)$ is the expectation operator. The bias-corrected radar rainfall estimate at hour k at the bin centered at u_0 is then given by the product of β_{0k}^* and r_{0k} , where r_{0k} denotes the raw radar-rainfall estimate at hour k at the bin centered at u_0 .

However, as described in Seo and Breidenbach (2002), equation (8) is not wholly appropriate for bias correction of radar rainfall data because it reflects not only the bias in radar-rainfall estimates given that the radar successfully detected rainfall [the first term in equation (9) below] but also the bias in radar detection of rainfall [the second term in equation (9)]:

$$\beta_{0k}^* = \frac{E(G_{0k}|G_{0k} > 0)Pr(G_{0k} > 0)}{E(R_{0k}|R_{0k} > 0)Pr(G_{0k} > 0)} \quad (9)$$

where Pr() denotes the probability of occurrence of the event bracketed.

In practical, correcting biases in radar detection of rainfall is a challenging problem (Seo and Breidenbach, 2002). In MPE, the use of radar-rainfall data is limited to that within the “effective coverage” of radar where we can assume:

$$Pr(G_{0k} > 0) \approx Pr(R_{0k} > 0) \quad (10)$$

Under this restriction, equation (9) yields:

$$\beta_{0k}^* = E(G_{0k}|G_{0k} > 0)/E(R_{0k}|R_{0k} > 0) \quad (11)$$

The particular procedure, in MPE system, to estimate the conditional expectations in equation (11) can be found in Seo and Breidenbach (2002).

References

- [1] Lawrence, B., Shebsovich, M., Gludemans, M., and Tilles, P., 2003: Enhancing precipitation estimation capabilities at National Weather Service field offices using multisensor precipitation data mosaics. Proc., 19th Conf. on Interactive Information Processing Systems, American Meteorological Society, Boston, 15.1.
- [2] National Weather Service, Office of Hydrologic Development, 2010: MPE Editor Users Guide, Build 9.2., Report, NWS Office of Hydrologic Development, January 7, 2010, [http://www.nws.noaa.gov/os/water/WFO_support/MPE_Editor/MPE_Editor_Users_Guide_VerOB9.2.doc]
- [3] Smith, J. A., and W. F. Krajewski, 1991: Estimation of the mean field bias of radar rainfall estimates. J. Appl. Meteor., 30, 397-412.
- [4] Seo, D.-J., J. P. Breidenbach, and E. R. Johnson, 1999: Real-time estimation of mean field bias in radar rainfall data. J. Hydrol., 223, 131-147.
- [5] Seo, D.-J. and J. P. Breidenbach, 2002: Real-Time Correction of Spatially Nonuniform Bias in Radar Rainfall Data Using Rain Gauge Measurements. J. Hydrometeor., 3, 93-111.
- [6] Seo, D. J., Seed, A., and Delrieu, G., 2010: Radar and multisensor rainfall estimation for hydrologic applications. State of the Science, Geophysical Monograph Series, F. Y. Testik and M. Gebremichael, eds., 191, 79-104, AGU, Washington, DC.

PROJECT 2: RAMS QPE Improvement and Application to the NOAA HMT-SEPS Domain

Applied RAMS QPE to both NOAA HMT-SEPS and Charleston, SC. QPE performance is evaluated using surrounding NOAA HMT HADS gauge networks. The RAMS QPE results are benchmarked against the National Weather Service Multi-Radar Multi-Sensor radar-only QPE products. In general, the RAMS QPE performance is better than the MRMS radar-only products at ranges less than 100km.

PROJECT 3: Assess performance of ModClark versus RDHM (Jun. 2015 – Jan. 2016)

Table 1. Timeline to Assess performance of ModClark vs RDHM

Detailed Tasks	Progress (%) / Research Period				
	20	40	60	80	100
● Construct ModClark model for NAPA basin	Jun.-Aug. 2015				
● Force Model with MRMS and MPE	Jun.-Aug. 2015		Sep.2015	Oct. 2015	Nov. 2015
● Calibrate ModClark model	Jun.-Aug. 2015		Sep.2015	Oct. 2015	
● RDHM/CHPS training and operation	Jun.-Aug. 2015	Oct. 2015	Dec. 2016	Jan. 2016	
● Compare ModClark and RDHM	Sep.2015	Oct. 2015	Nov. 2015		Dec. 2016
● Conference (AWRA, AGU, AMS)	Jun.-Aug. 2015		Nov. 2015		Jan. 2016

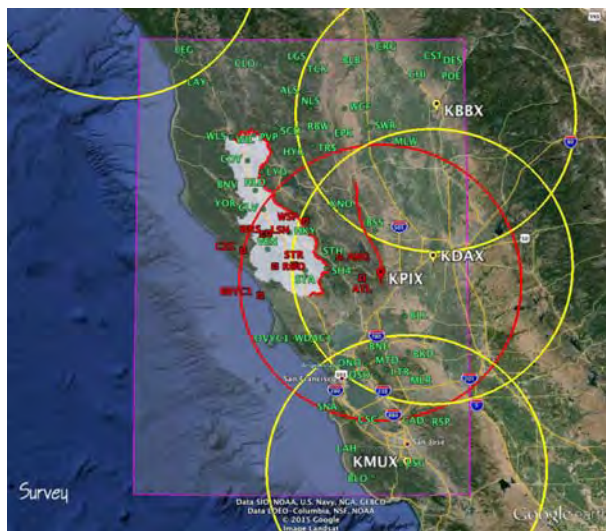

Figure 1. Study Domain of Project 1

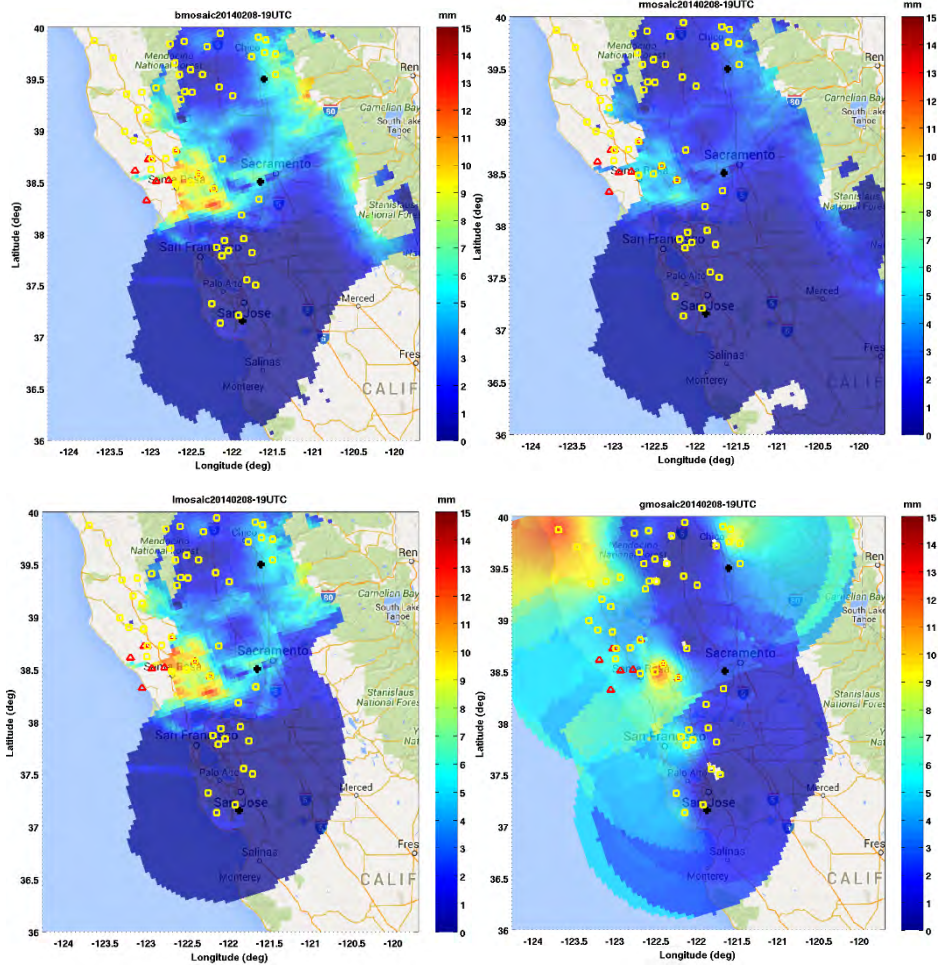

Figure 2. Sample hourly rainfall products at 19:00UTC, Feb 8, 2014. (upper left) mean-field-bias corrected (lower left) local bias corrected (upper right) radar based (lower right) gauge based.

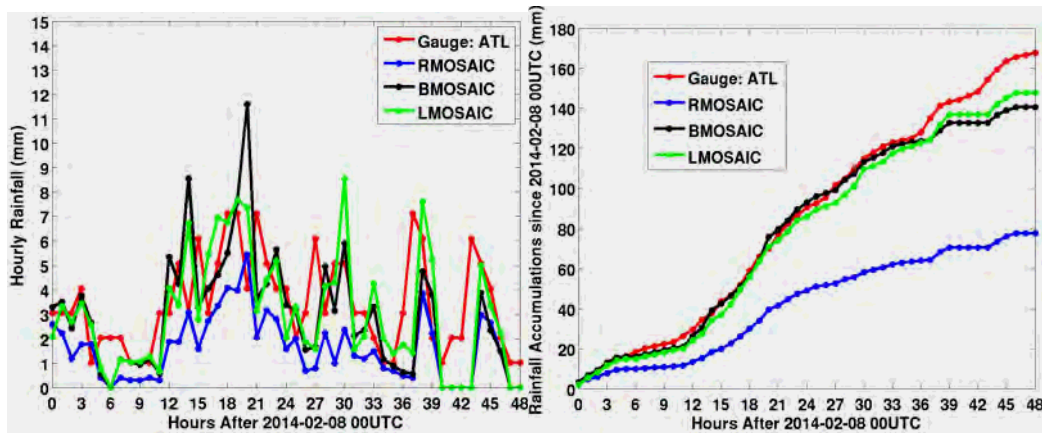

Figure 3. Sample rainfall observations at gauge ATL. (left) time series of hourly rainfall (right) rainfall accumulations.

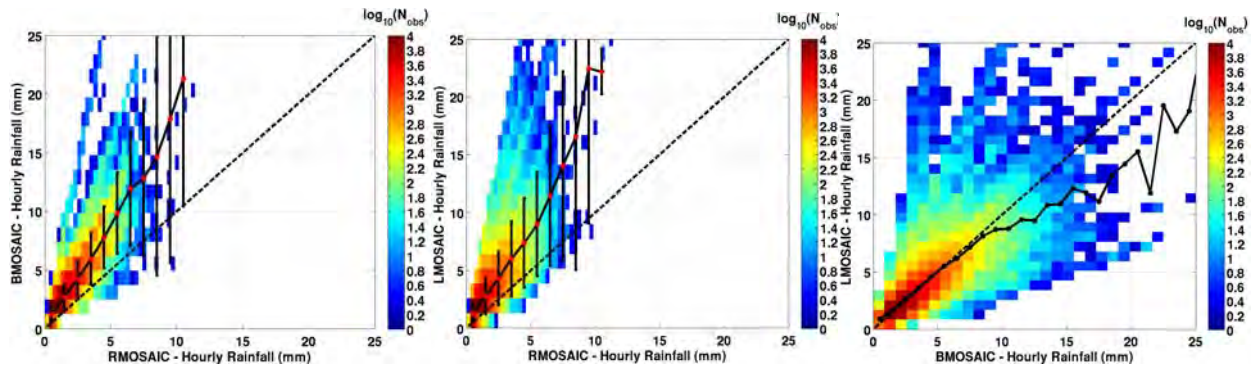

Figure 4. Scattergram of (left) BMOSAIC vs. RMOSAIC (middle) LMOSAIC vs. RMOSAIC (right) LMOSAIC vs. BMOSAIC. BMOSAIC: mean-field-bias corrected; RMOSAIC: radar based; LMOSAIC: lobal bias corrected.

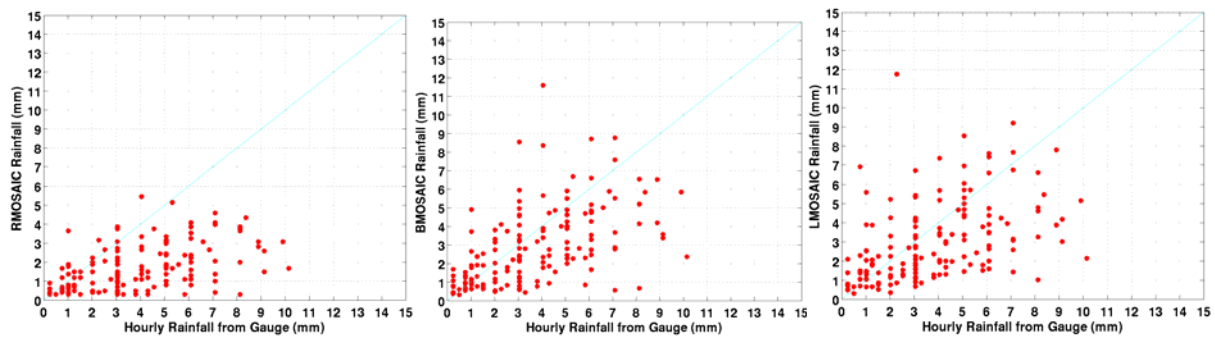

Figure 5. Scatter plots of (left) RMOSAIC, (middle) BMOSAIC, and (right) LMOSAIC, versus gauge observations.

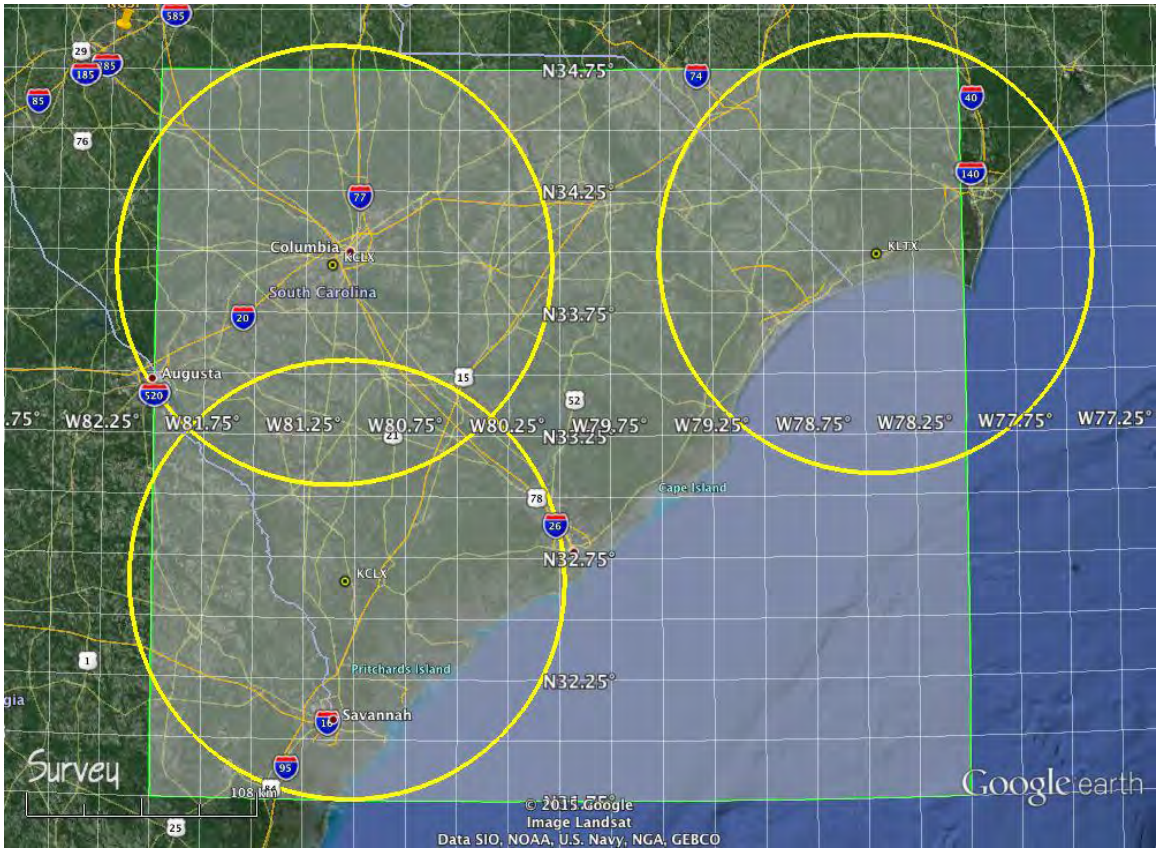

Figure 6. RAMS QPE domain over Charleston, SC, for Project 2.

Table 2. RAMS QPE vs MRMS QPE radar-only performance with respect to distance (for Project 2).

Ranges	MRMS Radar-Only NB	MRMS Radar-Only NSE	RAMS QPE NB	RAMS QPE NSE
< 160 km	10.20	47.81	-34.80	46.36
< 100 km	15.14	51.66	-30.29	44.69
< 60 km	26.16	53.30	-27.49	42.28
< 40 km	40.70	65.00	-25.48	42.03

Publications:

Chen, H., V. Chandrasekar, Delbert Willie, Sanghun Lim, Robert Cifelli, Walter A. Petersen, and David B. Wolff, 2015: Application and Evaluation of A Dual-polarization Radar Rainfall Algorithm in Complex Terrain During NASA IPHEX Field Campaign, 37th Conference on Radar Meteorology, Norman, OK, USA.

Kim, J., R. Cifelli, Lynn E. Johnson, Ben Livneh, and V. Chandrasekar, 2015: Comparison of Distributed Rainfall-Runoff Models: A Case Study for the Storm Event on December 10, 2014, 2015, *AWRA Annual Water Resources Conference*, Denver, CO, USA.

Kim, J., R. Cifelli, Lynn E. Johnson, Ben Livneh, and V. Chandrasekar, 2015: Effect of Rainfall Spatial Distribution on Flood Forecasting in Complex Terrain, American Geophysical Union (AGU) Fall Meeting, San Francisco, CA, USA.

Kim, J., R. Cifelli, Lynn E. Johnson, Ben Livneh, and V. Chandrasekar, 2016: Comparison of Semi-Distributed and Fully Distributed Hydrological Models in Complex Terrain, American Meteorological Annual Meeting, New Orleans, LA, USA.

Willie, D., H. Chen, V. Chandrasekar, and R. Cifelli, 2015: Regional Application of a Dual Polarization Quantitative Precipitation Estimation System Over the Pigeon River Basin, *AMS 37th Conference on Radar Meteorology*, Norman, OK, USA.

Willie, D., and V. Chandrasekar, 2015: Regional Polarimetric Quantitative Precipitation Estimation over the Pigeon River Basin, *International Geoscience and Remote Sensing Symposium*, Milan, Italy.

Willie, D., H. Chen, V. Chandrasekar, R. Cifelli, C. Campbell, D. Reynolds, S. Matrosov, Y. Zhang, 2015: Evaluation of Multisensor Quantitative Precipitation Estimation in the Russian River Basin, *Journal of Hydrologic Engineering* (under review)

CLIMATE-WEATHER PROCESSES

Research focusing on using numerical models and environmental data, including satellite observations, to understand processes that are important to creating environmental changes on weather and short-term climate timescales (minutes to months) and the two-way interactions between weather systems and regional climate.

PROJECT TITLE: Building a “Citizen Science” Soil Moisture Monitoring System Utilizing the Community Collaborative Rain, Hail and Snow Network (CoCoRaHS)

PRINCIPAL INVESTIGATOR: Nolan Doesken, Dept. of Atmospheric Science, CSU

RESEARCH TEAM: Julian Turner, Noah Newman, Zach Schwalbe, Peter Goble, Henry Reges, Wendy Ryan

NOAA TECHNICAL CONTACT: Veve Dehaza, NOAA NIDIS Program Office, Boulder, CO

NOAA RESEARCH TEAM: NA

FISCAL YEAR FUNDING: \$0

PROJECT OBJECTIVE(S):

Soil moisture is a key lead indicator in the development, severity and impact of drought but is not adequately monitored in most parts of the country. A new NASA satellite mission – the Soil Moisture Active Passive (SMAP) satellite has recently been launched and will be capable of sensing soil moisture near the skin surface of the earth but not in the root zone of most plants.

The objective of this project is to develop and propagate a low cost, low tech, soil moisture monitoring program utilizing the existing cyberinfrastructure and human resources of the Community Collaborative Rain, Hail and Snow network (CoCoRaHS). The goal is to provide useful information to support calibration and validation for SMAP while also producing root zone soil moisture estimates to support U.S. Drought Monitoring and early warning efforts. An equally important objective is education – demonstrating the variability and seasonality of volumetric soil moisture and how this varies geographically across the country. If this small demonstration proves successful, we hope this effort could lead to greater citizen participation in drought monitoring and more timely warnings of the onset of significant drought.

PROJECT ACCOMPLISHMENTS:

Soil moisture monitoring; be it with electronic sensors or with basic manual methods, is much more challenging than meets the eye. The following activities have taken place in our effort to develop a simple and low cost approach to measuring soil moisture that still yields specific, quantitative results needed for several science applications.

- 1--Reviewed classical approaches to qualitative soil moisture monitoring using guidance from USDA and Extension soil scientists
- 2--Purchased and/or acquired soil coring tubes, sampling canisters, soil heating/drying devices
- 3--Advised by Dr. Greg Butters (Colorado State University professor of Soil Physics) and Dr. Jose Chavez, (Colorado State University professor of Civil and Environmental Engineering) on protocol development
- 4--Participated in several phone meetings with Tony Murphy, the director of NASA's GLOBE program
- 5--Measured soil moisture on a nearby plot at 0-2" depth on 20 days during the fall of 2015 using 3 gravimetric approaches
- 6--Measured soil moisture on a nearby plot at 7-9" depth on seven days during the fall of 2015 using 3 gravimetric approaches
- 7--Determined the error associated with a gravimetric measurement cannot be directly quantified using a calibrated Stevens Water Hydra Probe sensor as a measure of ground truth
- 8--Peter successfully defended his masters thesis including results from soil moisture coring protocol development
- 9--Converged on a gravimetric soil moisture measurement protocol that allows volunteers to participate at the cost of \$50 assuming participants own an oven, and are willing to use it to dry soil. The protocol is outlined below
- 10--Shared information with the Office of Science and Technology Policy who is working with federal agencies and innovators to attempt to advance public interest and awareness in the importance of soil.

CoCoRaHS Gravimetric Measurement Pilot Protocol:

Before beginning taking soil cores estimate the dry density of your soil samples in two ways as a cross check for one another: using the web soil survey provided by the United States Department of Agriculture, and using the field soil texture test from the Colorado Master Gardener Program. The bulk density obtained by your soil samples will likely be lower than your estimated bulk density near the surface due to the presence of organic material. Dry bulk densities of soils (density of solids plus air with no water in pore space) should typically range between 1.1 and 1.6 $\frac{g}{cm^3}$. You won't be able to determine to any remarkable precision what the density of your samples when dried should be, but the main takeaway from a soil type calibration is to narrow down your expected range. Generally, more coarse soils with larger particles have less pore space and thus higher dry bulk densities. Clay-heavy soils can be expected to have dry densities closer to 1.2, loams average 1.36, and sandy soils can have dry densities over 1.5 (Hillel 1980). If your soil sample dry density is not within + or - 0.2 $\frac{g}{cm^3}$ of what is predicted by your soil type this likely indicates a problem with the sample.

Estimation of soil type by web soil survey:

- 1--Navigate to websoilsurvey.sc.egov.usda.gov/App/HomePage.htm. This should be the first result from most internet search engines if you type in "web soil survey."
- 2--Once on the page click on the green button labeled "Start WSS."
- 3--At the upper left portion of the page you should see five tabs labeled "Area of Interest (AOI)," "Soil Map," "Soil Data Explorer," "Download Soils Data," "Shopping Cart (Free)." Make sure you are on the "Area of Interest (AOI)" tab.
- 4--Zoom in on the map to the plot where you plan to take soil samples (this may take a few minutes).
- 5--Click on the tool labeled "AOI" at the top of your screen under the heading "Area of Interest Interactive Map." Using this tool outline the area of the map in which you intend to take soil cores and then release the mouse. The area you have selected should appear in cross hatching now. Once again, this may take a minute.
- 6--At the top of the page switch from the "Area of Interest (AOI)" tab to the "Soil Map" tab. The area you highlighted should now appear on the left-hand side of your screen in a box marked "Map Unit Legend." There should be a soil type listed under "Map Unit Name" with a link provided. Click on it.

7--This link should provide some estimated specifics about your soil type at both above and below 7". This is useful since you will be taking soil samples at 0-2" and 7-9". Mark down the soil types for the 0-7" and 7-60" range.

Estimation of Soil Type by Master Gardner Field Test:

- 1--Soil Texture by Feel instructions can be found at www.ext.colostate.edu/mg/gardennotes/214.pdf. Print these instructions.
- 2--Go to your measurement site with a trowel when conditions have been wet, or bring a coffee mug with some water if soils are dry.
- 3--Dig out a sample of roughly golf ball size from the top two inches of soil and then follow the flow chart instructions from Figure 5.4 of the "Estimating Soil Texture" printout to determine soil type.
- 4--Repeat the process for soil of 7-9" depth.

If both of the soil type estimation techniques indicate that there is a significant amount of clay or silt in your soil (ie clay, silty clay) expect dry density of your samples to be $< 1.3 \frac{\text{g}}{\text{cm}^3}$. If both of the soil type estimation techniques indicate that there is a large amount of sand (ie sand, loamy sand) in your soil expect dry density measures to be $> 1.4 \frac{\text{g}}{\text{cm}^3}$. For loam-heavy types such as loam, clay loam, and silt loam a range between about $1.25-1.45 \frac{\text{g}}{\text{cm}^3}$ is to be expected, once again weighting things on the more dense side if you see "sand" in the name, and on the less dense side if you see "clay," or "silt" in the name. If there is disagreement between the two estimation techniques on your soil type you may proceed, but with less confidence about what dry density measurements you may obtain.

Soil Coring Instructions:

Site Requirements:

- 1--The location which you choose to dig must be flat, or close to flat, as must the area around it. Because of runoff, soil moisture may be lower than representative of average at the top of mounds or hills, and higher than representative of average at local minima in elevation.
- 2--THE SITE CANNOT BE IRRIGATED: This is not to say there's no benefit in soil coring irrigated land as this can help track if lawns/plants/crops are receiving appropriate water levels, but CoCoRaHS aims to depict conditions representative of a natural environment, and help to ground validate NASA's new SMAP satellite.
- 3--Your dig site does not have to be barren, but surface vegetation should be pulled before taking a core sample. This helps to keep the proportion of organic matter in the sample as low as possible.

Sampling Depths:

- 1--0-2"
- 2--7-9"

Necessary Materials:

- 1--Pad, paper, and pencil/pen
- 2--Rule
- 3--Level, or straight edge
- 4--2" (50.8 mm) height 3.125" (69.4 mm) diameter brass ring available from onlinemetals.com
- 5--Metric Scale (precision to at least the nearest tenth of a gram desired)
- 6--Trowel

- 7--Tin foil, cookie sheet, or pot pie holder
- 8--Oven
- 9--Gloves (optional)
- 10--Sharpie (or similar labeling device)
- 11--Masking Tape (optional)
- 12--Rag or paper towel
- 13--Shovel
- 14--Bucket scoop
- 15--Ziploc bag
- 16--Wood block
- 17--Water bottle
- 18--Graduated cylinder

Soil Coring:

1--Measure the cut length of your brass ring to the nearest millimeter. Rings should have been cut to 2" (50.8mm), but the ring you ordered may vary slightly in length.

2--The ring has a radius of 39.69mm, so you can find the total volume your core will have using the volume of a cylinder is $V = \pi r^2 h$. If your cylinder was cut to exactly 50.8mm it will have a volume of 251.4 cm³.

3--Bring your pencil, paper, ruler, level (straight edge), brass ring, bucket scoop (or similar thin, flat surface), scale, Ziploc bag, sharpie, masking tape, hammer, wooden block, and trowel to your selected dig site.

4--Weigh the bag with which you wish to contain your soil core, so that this weight can be subtracted when weighing the sample.

5--Remove surface vegetation from your dig site as well as possible by pulling it from the ground. You only need to do this right where you are digging. You do not need to clear a large area around the dig site. About one square foot should be fine.

6--Place the brass ring on a flat portion of soil and twist it into the ground a bit to clearly designate a core site.

7--Put the wood block on top of the brass ring, and then hammer it into the ground until it is flat against the surface.

8--Using the trowel, excavate the soil on one half of your brass ring down to the depth of the bottom of your sample. Make sure you have excavated enough area to lay the bucket scoop flat in the pit.

9--Slide your soil core contained by the brass ring horizontally over the surface of the bucket scoop. Be careful not to lose any of your soil core out of the bottom, especially if soils are dry.

10--Slide the soil core into your Ziploc bag.

11--Weigh your soil sample from the 0-2" depth and record it being sure to tare the weight of the bag.

12--Break up the soil core, and remove any rocks larger than a pea, or any relatively large roots.

13--Squirt some water from your water bottle into your graduated cylinder, and measure that volume.

14--Now drop the rocks and roots you removed into the graduated cylinder and read the volume again.

The difference in volume between these two measurements will be subtracted from your container volume when determining bulk density and volumetric water content.

15--At this point you may want to label your canister with the date, time, volume of rocks and roots removed, and depth of measurement. You may prefer doing this with masking tape, and a sharpie or pen to avoid marking directly on the bag.

16--Clean off your trowel with a dry rag or paper towel to avoid sample cross-contamination.

17--In order to help sanity check measurements we do prefer that 2, or better yet, 3 samples be taken from each depth, so now you're ready to repeat steps 5-14 one, or two times if desired. Keep the samples

separated by several feet to avoid cross-contamination of samples, but close enough that all dig sites meet the site finding guidelines outlined above.

18--Now it's time to get your 7-9" depth samples. It's unlikely that you will be able to core straight down from the surface to 9", so plan on digging out about a square foot of surface area down to 7" in order to take the measurement. These measurements should be taken directly below where you took your 0-2" measurements.

19--Be conscientious of how far you've dug. You can use the ruler to measure the depth, and a level, or just a straight edge, to make sure the ruler is lined up perpendicular to the ground.

20--Once you have dug out soil to 7" depth repeat steps 5-14 for your deeper samples. It is more crucial now that you have dug out a significant amount of soil to take samples that are actually representative of that depth rather than including chunks of soil that have fallen into your hole from the surface. Remember to weigh samples quickly after coring so that as little moisture escapes as possible. This is especially important for the deeper samples as this soil is not exposed to sunlight at all in its natural environment.

The Drying Process (Oven):

1--After collecting your soil samples the goal is to dry all the water out of them without igniting any of the leftover organic material. For this, make sure to have the following materials on hand: pencil and paper, drying surface (ie tin foil, cookie sheet, pot pie holder), and scale.

2--Set and your oven to 210-215 F and let it preheat.

3--Weigh the flat surface you wish to dry your soil sample on, so that this weight can be subtracted in your calculation.

4--Carefully pour your soil sample from the canister onto the drying surface, and spread it out. If you are using tin foil, fold up the corners before pouring the soil to avoid mass loss. Soil has very low conductivity, so drying the sample in the canister will lead to a very slow, and likely incomplete, drying process.

5--Weigh your sample again before placing it in the oven. A small amount of water may have already been lost having evaporated and condensed on the canister.

6--Once the oven has preheated place the soil sample in the oven, and wait!

7--Remove the soil from the oven occasionally to weigh it. Intervals of every half hour are recommended, but you may develop a more efficient system where the soil is weighed less frequently at first, and more frequently as it reaches its dry weight.

8--Once the soil weight no longer changes over at least a half hour period it is done.

9--Repeat steps 1-8 as needed in order to dry all your samples. There's no limit to how many you're allowed to oven-dry at once so long as it can be done without sample cross-contamination. The average oven probably won't hold more than two on each rack.

Bulk Density and Volumetric Water Content Calculations:

--A density is simply a mass divided by a volume. The bulk density of your sample is the weight of the contents of the canister once dried divided by the volume of the canister.

$$\text{Bulk Density} = \text{dried soil mass} / (\text{container volume} - \text{volume of rocks and roots})$$

--Since fresh water has a density of 1 gram/cm³ the volumetric water content can be obtained by dividing the difference in wet and dry weight by the volume of your canister, and then multiplying by 100. This is expressed in the following simple formula:

$$\text{VWC (\%)} = 100 * [(\text{wet weight}) - (\text{dry weight})] / (\text{container volume} - \text{volume of rocks and roots})$$

Make sure you have converted your container volume to cm³ so that the expression is unitless!

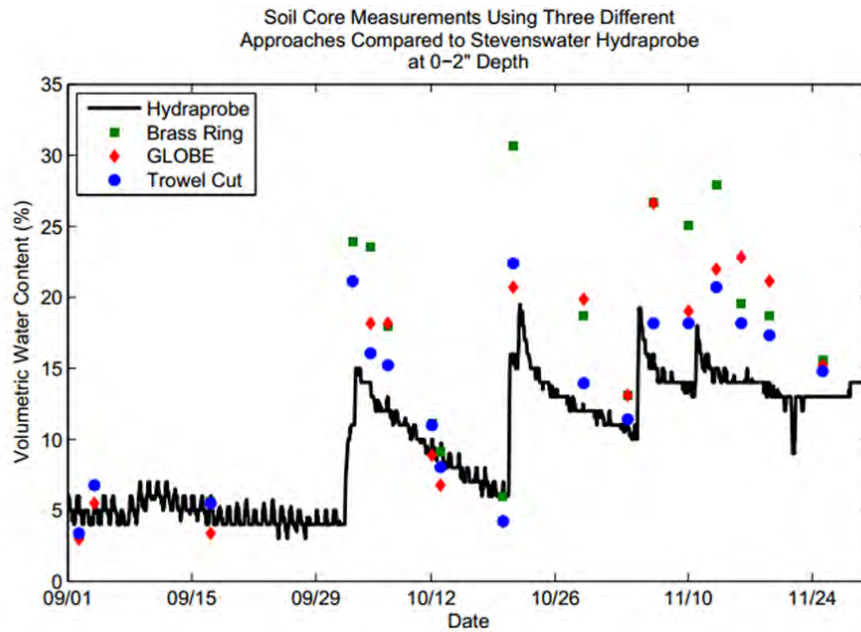

Figure 1. Volumetric water content of soil (%) is displayed above as a function of date for each of the three tested soil core measurement protocols for a coring depth of 0-2". For reference, measurements from the Stevenswater Hydra Probe sensor at 2" depth have been included in black. Measurements shown for 18/20 days measurements were taken.

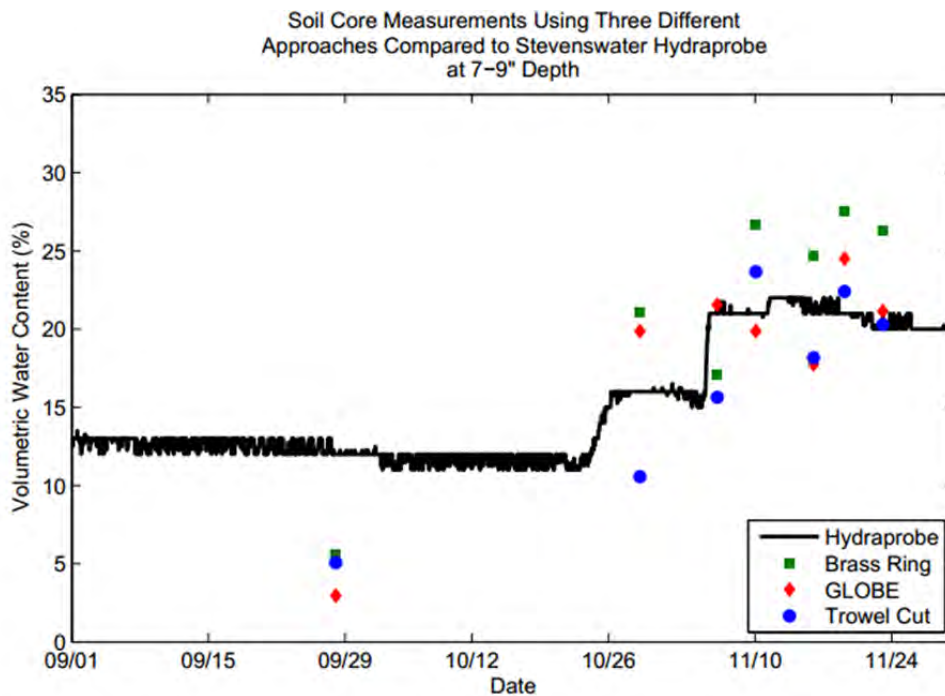

Figure 2. Volumetric water content of soil (%) is displayed above as a function of date for each of the three tested soil core measurement protocols for a coring depth of 7-9". For reference, measurements from the Stevenswater Hydra Probe sensor at 8" depth have been included in black.

PROJECT TITLE: Enhancing NIDIS Drought Monitoring and Early Warning in the Upper Colorado River Basin

PRINCIPAL INVESTIGATOR: Nolan Doesken

RESEARCH TEAM: Nolan Doesken (State Climatologist and Principle Investigator), Zachary Schwalbe (GIS specialist, weekly monitoring, data display), Peter Goble (Soil Moisture integration), Henry Reges (communications and outreach), Noah Newman (social media, webinar, metrics)

NOAA TECHNICAL CONTACT: Veva De Heza, NIDIS Program Office, Boulder, CO;
Allan.Schmidt@noaa.gov

NOAA RESEARCH TEAM: Alicia Marrs, Kathleen Bogan (NIDIS program office, Boulder CO)

FISCAL YEAR FUNDING: \$100,000

PROJECT OBJECTIVES:

- 1--Continue to provide and improve *weekly drought assessment services*.
- 2--Incorporate and promote the new “Evaporative Demand Drought Index” (EDDI)
- 3--Assess and incorporate soil moisture monitoring capabilities as a means of enhancing drought early warning.
- 4--Continue efforts to better engage key representatives (National Weather Service, U.S. Bureau of Reclamation, State Engineers Offices and local River Commissioners, etc.) from the UCRB and surrounding regions in effective drought monitoring, early warning and coordination. In particular, identify effective partners in WY and UT.

Other activities as time/resources allow –

- 1--Maintain a two-tiered UCRB DEWS communications and contact list – refreshed quarterly
- 2--Meet primary stakeholders – discuss special needs and drought early warning opportunities associated with hitting potential shortage criteria in Lake Powell-Lake Mead in the near future
- 3--Participate in the NIDIS-supported and WWA-lead snow monitoring assessment activity.
- 4--Explore and improve drought impact reporting

PROJECT ACCOMPLISHMENTS:

This project began 1 July 2015 and took the place of our previous NOAA NIDIS Project reported on in previous years.

We continued to provide weekly climate/water/drought updates throughout the past year and hosted 15 webinars during this reporting period. Drought conditions were expanding quickly last spring (April 2015), but an extremely wet May and early June reversed all drought conditions throughout the region. There was some drying again in late summer and early autumn, but for the most part the 3-state area of the Upper Colorado River Basin remained relatively drought free. The exception has been portions of central Utah which continued in moderate drought associated with the ongoing SW drought affecting CA. Reference evaporation during the 2015 growing season was one of the lowest on record over the past 20 years – consistent with the heavy spring precipitation, high humidity, above average cloudiness and lighter than normal winds.

As observed previously, the best attended webinars were those that included a seasonal prediction emphasis. We introduced some new reservoir graphics to our climate monitoring efforts. We also began, consistent with Objective 2, to systematically incorporate the Evaporative Demand Drought Index (EDDI) into monitoring activities.

We experimented with a shorter format for future webinars. Most likely this will need to be a separate taped and recorded “TV-weather broadcast” style format and made available separately. The discussion-style webinar format is still needed to accommodate open discussion and more in-depth details.

For objective 2, in addition to increasing our use and presentation of EDDI, we also held a webinar on June 9th, 2015, where Mike Hobbins, the creator of the EDDI, described the model, its inputs, function and performance so far. Figure 1 shows an example of the EDDI product.

In support of the weekly monitoring process, we also beefed up outreach. We identified dozens more water and natural resource managers across the region and invited them to be on our weekly update e-mail list. The result was the addition of about 150 new subscribers. In an outreach effort to educate and engage our stakeholders as well as the general public, we worked with a professional animator to create a six-minute production that was published on YouTube in June, 2015 (<https://youtu.be/i7F6QwRqyVI>). “Assessing Drought in the United States” shows how the drought categories are determined and how drought conditions are assessed by using a combination of data and in-person reports (figure 2). Outreach also included targeted recruiting for Wyoming – more details below.

Peter’s work on soil moisture monitoring continued throughout the year. He developed a graphical display for SNOTEL soil moisture, but we did not feel ready to introduce it broadly. It will begin to be included in routine weekly drought monitoring during the 2016 growing season (figure 3).

We made reasonable progress on several other of the second tier of objectives. For example, we have become more familiar with the agricultural water conservation plans, and water banking strategies being researched by the US Bureau of Reclamation and the Upper Colorado River Commission as a strategy to avoid triggering shortage criteria rules in the event that stored water in Lake Powell falls below the minimum power-generation pool. We have been in discussion with the UCRC and USBR’s AGRIMET program and are currently in the planning stage for deploying 10 new Colorado Agricultural Meteorological Network (CoAgMet) stations in western Colorado in the next few months. These stations will be used to improve estimates of crop water use in hay meadow environments in agricultural valleys of western Colorado.

Several of our team attended NIDIS-supported snow measurement workshops held in August and September. Nolan presented an invited update on our DEWS activities. This also resulted in a few more contacts and subscribers including several more from SW Wyoming. The Lander snow meeting proved particularly useful, giving us the opportunity to meet with the Riverton NWS staff and gain more appreciation for their relative lack of involvement, up to this point. They let us know that they provide timely data to the Wyoming Water Resources Data System in Laramie and entrust them with assessing drought conditions. The office was in leadership transition, so we will re-evaluate after the new MIC has a year under his belt. The involvement of Wyoming weather and water interests in the Upper Missouri River Basin DEWS may also require re-evaluation.

Working with the Carolina’s Integrated Science Assessment, we made slow but steady progress on modifying our CoCoRaHS drought impact report to be more general and flexible. The CISA staff have tested and evaluated a “Condition Monitoring Report” with a sample of about two dozen volunteers. It appears to have great promise to increase drought awareness over a full range of wet, average and dry conditions -- at least for highly engaged citizen volunteers. We will introduce a “scale bar” approach and make this (and associated vetted training materials) available this next year to a much larger community of CoCoRaHS volunteers.

Although this is not listed as one of our proposed project objectives, we are beginning a thorough strategic planning process for the UCRB DEWS. This was highly recommended by the evaluation conducted two years ago by the NIDIS Program Office. The UCRB DEWS was the first in the nation and has helped shape the priorities and activities of NIDIS supported activities in other parts of the country. Now that NIDIS DEWS is nearly nationwide it is time to take a fresh look at activities and opportunities. Compared to where we were 7 years ago, considerable progress has been made. What stakeholders crave, of course, are “accurate” 1 month to 3 year seasonal water supply and water demand predictions.

While that is beyond our local DEWS scope of work, larger national and international seasonal prediction research continues and is making slow but measurable progress. We will be focusing on outputs with potentially measurable outcomes that can be accomplished locally (within the UCRB) on improved monitoring, communication, awareness and preparation.

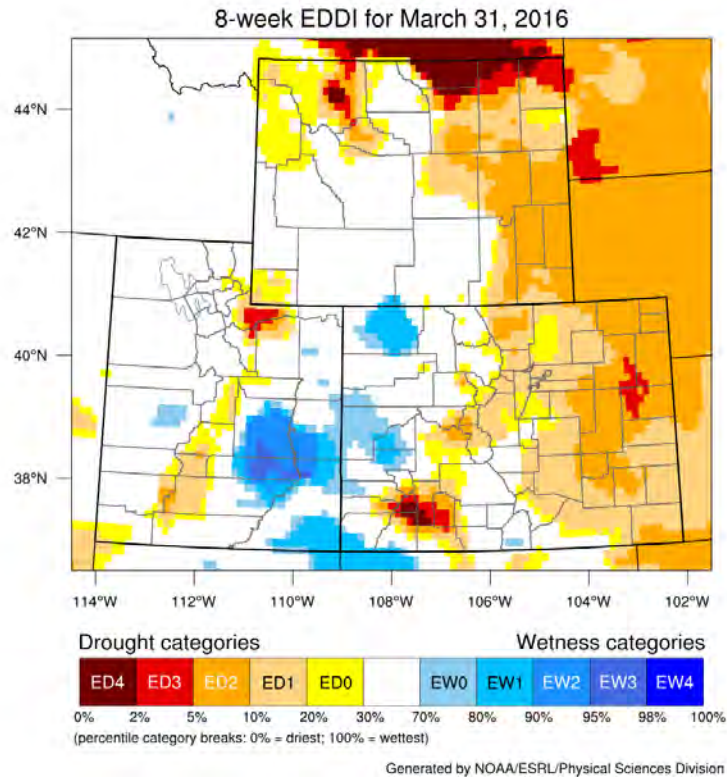

Figure 1



Figure 2

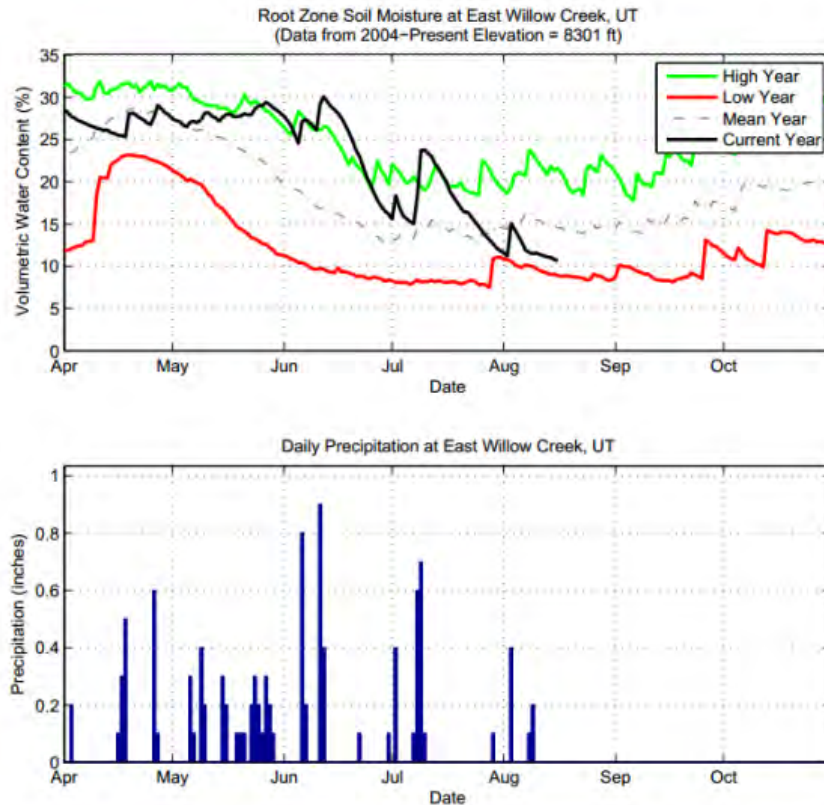

Figure 3

Publications:

Goble, P., Nolan Doesken and Russ Schumacher, 2015. Assessing Soil Moisture-Temperature Feedbacks: Will Increased Surface Heating Exacerbate Drought? Colorado Water, Newsletter of the Water Center of Colorado State University, vol. 32, 2 (May/June), pp. 27-30.

Goble, Peter. Doesken, Nolan J., Schumacher, Russ S. 4/1/2016. Master's Thesis. "Maximizing the Utility of Available Root Zone Soil Moisture Data for Drought Monitoring Purposes in the Upper Colorado River Basin and Western High Plains, and Assessing the Interregional Importance of Root Zone Soil Moisture on Warm Season Water Balance." Colorado State University.

PROJECT TITLE: Expanding Precipitation Measurements in the Commonwealth of the Bahamas through the CoCoRaHS (Community Collaborative Rain, Hail and Snow) Network.

PRINCIPAL INVESTIGATOR: Nolan Doesken

RESEARCH TEAM: Henry Reges, Julian Turner and Nolan Doesken

NOAA TECHNICAL CONTACT: Thomas Peterson (With NOAA NCEI but has recently retired – but still working with us through his involvement in the World Meteorological Organization); Roger Pulwarty

NOAA RESEARCH TEAM: Thomas Peterson (With NOAA NCEI but has recently retired – but still working with us through his involvement in the World Meteorological Organization,) Other NOAA entities are peripherally involved such as David Brown, Regional Climate Services Director, Southern Region NOAA National Centers for Environmental Information (NCEI), and Meredith Muth, International Programs Manager with NOAA's Climate Program Office.

FISCAL YEAR FUNDING: \$25,500

PROJECT OBJECTIVES:

Scope of Work

1--Working with the Bahamas Meteorological Service, the first step would be to develop a leadership team composed of Bahamas nationals with members residing on several different islands ideally. Henry Reges will be serving as the CoCoRaHS liaison to the Bahamas for this project.

2--While travel funds are not requested in this proposal, a face-to-face meeting with CoCoRaHS leadership, the Bahamas Meteorological Service (BMS) and the NCEI representative to the World Meteorological Society's Committee on Climatology is highly recommended. Ideas for funding this meeting will be explored. The purpose of this meeting would be to set goals for number and locations of rain gauges and plan strategies for recruiting, training and feedback to participants. This would also be an ideal opportunity for doing an initial training session for BMS and partner organizations of their choosing. If travel is not possible, then electronic communications will be employed.

3--Set a target date for launch – hopefully sometime before 2016 hurricane season

4--Acquire and distribute CoCoRaHS 4" diameter, high capacity rain gauges (will provide 60 as part of this request) and training resources to the Bahamas CoCoRaHS leadership team.

5--While background work is being done in the Bahamas, Julian Turner at CoCoRaHS headquarters will be developing the website, database, data mapping and data export capabilities to support the CoCoRaHS Bahamas project. The scope of this effort is large and likely beyond the immediate budget, but CoCoRaHS will make some in-kind program investments to support this pilot/demonstration project. This effort requires the implementation of a robust international station naming and numbering system as well as metadata creation, archive and retrieval including the tracking of station status (open, active, inactive, closed). This will be patterned after the U.S.- Canada expansion but must accommodate or establish certain international CoCoRaHS standards.

6--When launch date has been selected and infrastructure is in place, promote a coordinated launch of the Bahamas CoCoRaHS demonstration.

7--Recruit, train and engage volunteers. Emphasize recruiting volunteers who have personal or professional interests in weather and water (this approach helps link data collectors and users as demonstrated by years of CoCoRaHS experience). Display and track data, encouraging participants to view their rainfall observations to see variations and extremes in Bahamas precipitation and comparisons

with Florida. Provide feedback to volunteers. This will all be done jointly between CoCoRaHS headquarters, the Bahamas Meteorological Service and other appropriate partners. We will encourage the Met Service to take the lead in providing support to volunteers.

8--One year from beginning, conduct assessment of numbers of participants, quantity and quality of reports, challenges and opportunities, as well as usefulness and accessibility of precipitation data.

9--Recognizing the scope and budget of this project, CoCoRaHS headquarters will pursue outside funding sources and/or additional partners if needed.

PROJECT ACCOMPLISHMENTS:

To enable the addition of the Bahamas to the CoCoRaHS network, the following improvements were made to the CoCoRaHS cyber-infrastructure.

- Support for the Bahamas and its 32 administrative districts was added to the CoCoRaHS database.
- 138 city naming points were identified, Geo-located, and added to the CoCoRaHS database to support the generation of station names for CoCoRaHS stations in the Bahamas.
- A Bahamas specific application form was added to the website to enable people to sign up to create their observer accounts and stations.
- The user, observer, and station management pages were updated to accommodate addresses in the Bahamas that have different requirements from the existing American and Canadian addresses.
- The ability to filter stations, observers, observations, and data summary reports by the Bahamas and its administrative districts was added throughout the CoCoRaHS website.
- A custom Bahamas home page was added to the CoCoRaHS website with corresponding support added to the content management system so that this page and others can be maintained by the Bahamas coordinators.
- Support for the Bahamas was added to the CoCoRaHS data export API.
 - Support for the Bahamas and its administrative districts was added to the CoCoRaHS mapping system.
- Interactions took place with Bahamas Department of Meteorology to develop appropriate training materials and web page graphics appropriate to their country
- Official launch date of June 1, 2016 was set with earlier soft roll out beginning March 1, 2016.
- Initial visit to the Islands of the Bahamas (early March) to meet with local leadership/stakeholders, deploy gauges, conduct training and develop recruiting strategies of new observers.
- Shipping of five dozen (60) 4" gauges to the Bahamas CoCoRaHS leadership team.
- Developed a Bahamas leadership team which includes a country coordinator and three regional coordinators. The leadership is made up of Bahamas nationals employed by the Bahamas Department of Meteorology.
- CoCoRaHS has pursued outside funding sources for travel to the islands via GCOS and has successfully procured an additional \$10K. This was critical for completing the development of the local leadership team and the launch of recruiting and training activities later this spring.

The following graphics represent some of our recent accomplishments. The project is well underway and somewhat ahead of schedule.

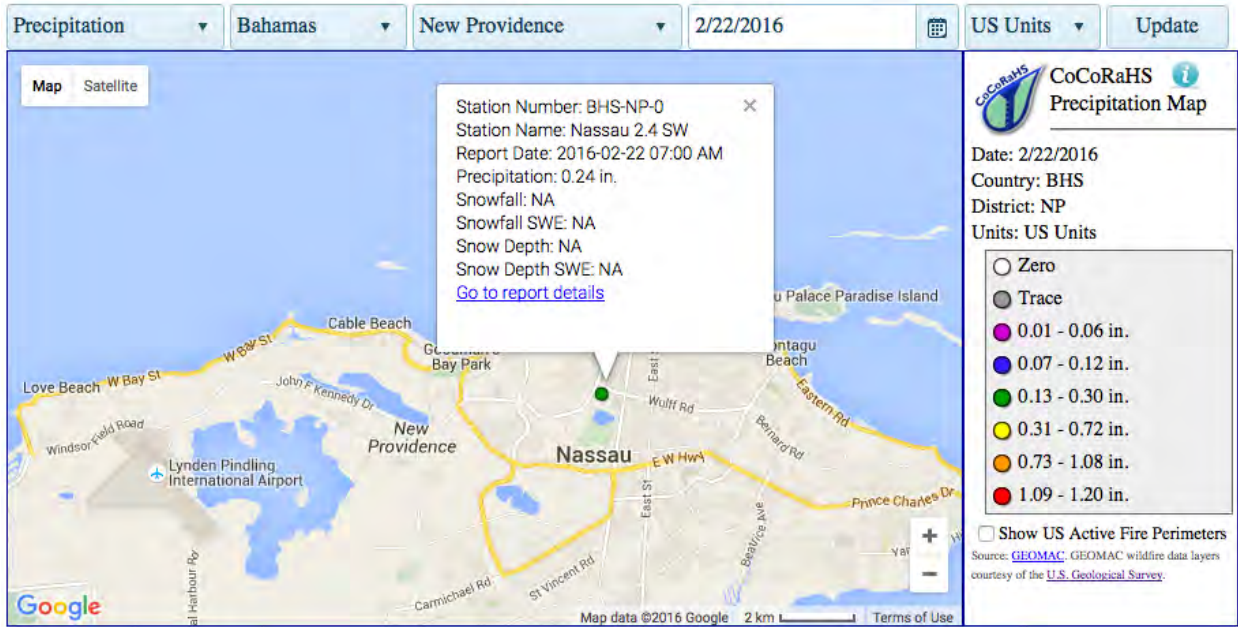

Bahamas Mapping graphics

CoCoRaHS COMMUNITY COLLABORATIVE RAIN, HAIL & SNOW NETWORK
 "Measure every drop counts!"

Home | Countries | States | View Data | Apps | My Data | My Account | Admin | Logout

The Bahamas

View the CoCoRaHS Bahamas Precipitation Map

Help measure Rain!

CoCoRaHS Bahamas COMING IN 2016

Welcome to CoCoRaHS Bahamas!

The Bahamas Islands are delighted to be participating in the growing CoCoRaHS network. Bahamas CoCoRaHS observers provide important information about rainfall that is used by meteorologists, hydrologists, farmers, water resource managers, and your friends and neighbors. This effort in the Bahamas is especially important given the great variation in rainfall across the islands from Grand Bahama to Great Inagua.

What are the benefits of being a CoCoRaHS observer? By participating in the CoCoRaHS network you will make an important contribution that helps others, especially during flood situations. By providing your daily rainfall data, you will also assist in filling in important pieces of the puzzle that will contribute to the knowledge of the islands' climate.

CoCoRaHS Bahamas Web Page

CoCoRaHS Bahamas Regions

Northwest Bahamas Region

- Bimini and Cat Cay
- Berry Islands
- Central Eleuthera
- Central Abaco
- Central Andros
- East Grand Bahama
- City of Freeport, Grand Bahama
- Grand Cay, Abaco
- Harbour Island
- Hope Town, Abaco
- Mangrove Cay, Andros
- Moore's Island, Abaco
- North Eleuthera
- North Andros
- New Providence
- North Andros
- South Andros
- South Eleuthera
- South Abaco
- Spanish Wells, Eleuthera
- West Grand Bahama

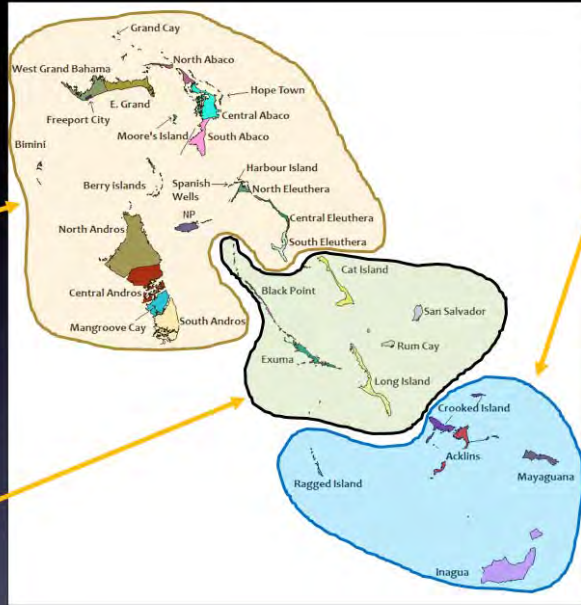

Southeast Bahamas Region

- Acklins Islands
- Crooked Island and Long Cay
- Inagua
- Mayaguana
- Ragged Island

Central Bahamas Region

- Black Point, Exuma
- Cat Island
- Exuma
- Long Island
- Rum Cay
- San Salvador

Bahamas CoCoRaHS Regions – Overseen by regional coordinators



CoCoRaHS Bahamas Training Materials



CoCoRaHS National Coordinator, Henry Reges meeting with Bahamas Department of Meteorology Acting Director, Trevor Basden.

Publications:

This publication was not funded by this project but represents relevant work.

Reges, H., N. Doesken, J. Turner, N. Newman, A. Bergantino, and Z. Schwalbe, 2016: COCORAHHS: The evolution and accomplishments of a volunteer rain gauge network. Bull. Amer. Meteor. Soc. doi:10.1175/BAMS-D-14-00213.1, in press.

PROJECT TITLE: Explicit Forecasts of Recurrence Intervals for Rainfall: Evaluation and Implementation Using Convection-allowing Models

PRINCIPAL INVESTIGATOR: Russ Schumacher

RESEARCH TEAM: Greg Herman (graduate student)

NOAA TECHNICAL CONTACT: Gary Wick, ESRL

NOAA RESEARCH TEAM: Kelly Mahoney, CIRES (collaborator), Gary Wick, ESRL (collaborator); Rob Cifelli, ESRL (collaborator)

FISCAL YEAR FUNDING: \$65,970

PROJECT OBJECTIVE(S):

The primary objective of this project is to evaluate high-resolution numerical model forecasts of heavy precipitation by comparing the quantitative precipitation forecast (QPF) values against observed historical recurrence intervals for precipitation (i.e., the “100-year rain event, etc.) This method offers additional insight into the magnitude of the rainfall being predicted by the model, heightens situational awareness for forecasters, and allows for the identification of model biases.

PROJECT ACCOMPLISHMENTS:

The milestones for this project listed in the original proposal were:

- Prepare basic real-time maps for evaluation at the WPC/HMT FFaIR experiment
- Participate in FFaIR and evaluate these approaches with other researchers and forecasters
- Conduct evaluation of model forecasts from 2012-2013 (and possibly 2014 if time allows).
- Develop real-time analysis and visualization of model forecasts
- Summarize results into a final report and possibly, depending on the results, a peer-reviewed publication.

All of these milestones have been completed, with the exception of the last one (peer-reviewed publication), which is currently being prepared for submission.

We submitted our final report to NOAA in September 2015, and this project is considered complete.

Presentations:

Herman, G., Generating Skillful and Reliable Probabilistic Forecasts for Locally Extreme Rainfall, 27th Conference On Weather Analysis And Forecasting/23rd Conference On Numerical Weather Prediction, Chicago, IL, July 2015 (oral presentation by Greg Herman, available online at: <https://ams.confex.com/ams/27WAF23NWP/webprogram/Paper273812.html>)

Herman, G., Forecast Improvement of Locally Heavy Rainfall Events Through Diagnosis and Examination of Model Precipitation Climatologies, Special Symposium on Model Postprocessing and Downscaling, 95th AMS Annual Meeting, Phoenix, AZ, January 2015 (poster presentation by Greg Herman)

PROJECT TITLE: Hydrologic Research and Water Resources Applications Outreach Coordination

PRINCIPAL INVESTIGATOR: Sher Schranz

RESEARCH TEAM: Lynn E. Johnson

NOAA TECHNICAL CONTACT: Rob Cifelli (NOAA/OAR/ESRL/PSD/HMA)

NOAA RESEARCH TEAM: Allen White (NOAA/OAR/ESRL/PSD/HMO)

FISCAL YEAR FUNDING: \$91,041

PROJECT OBJECTIVES:

Hydrologic Research and Applications Development

Objective: Provide expert guidance and consultation on hydrologic applications in HMT

Major activities include:

- Assist in the design, coordination and development of hydrological modeling and water resources management applications for regional demonstrations with the Hydrometeorological Testbed (HMT) and NWS National Water Center (NWC);
- Provide guidance and leadership in carrying forward the hydrological research agenda defined in the HMA, including publication in technical reports, peer-reviewed journals, and conferences;
- Support the HMA Project Manager in identifying and tracking candidate (and past) tools, techniques and knowledge transfers to NWS and key stakeholders.

Water Resources Applications Outreach Coordination

Objective: Provide support to and coordination between HMT and NOAA Partners and Stakeholders
Major activities include:

- Assist in coordination with water management stakeholders such as the Corps of Engineers, U.S. Geological Survey, and other federal, state, and local water management agencies.
- Act as a liaison across NOAA Line Offices, particularly between NWS-OHD, PSD, CNRFC, NMFS and Line Office Headquarters;
- Provide guidance to the NWC related to applicability of distributed hydrological modeling for NWS flash flood operations;
- Support the planning for an HMT/IWRSS Russian River and California Pilot Study;

PROJECT ACCOMPLISHMENTS:

Hydrologic Research and Applications Development

On the topic of hydrologic research and applications development for the HMT, several sub-topics were addressed, including advancement of the distributed hydrologic model (DHM) of the Russian-Napa Rivers, CA. The DHM accounts for the spatial distribution of rain, topography, soils, land use and runoff. It is a primary tool to assess the quality of precipitation nowcasts and forecasts products, and is being prototyped for deployment in real time forecast operations. The DHM has been calibrated for several tributary watersheds in the Russian-Napa river basins for the full range of flows – flood peaks and volumes, and low flows. The DHM has been integrated into the CHPS-FEWS hydrologic operations system for prototyping real-time operations for NWS flash flood operations. Application of the DHM is anticipated to be extended to the San Francisco Bay area beginning in summer 2016 in support of the Advanced Quantitative Precipitation Information (AQPI) project.

Water Resources Applications Outreach Coordination

On the topic of water resources applications outreach, there are several sub-topics being addressed, including the Russian River and California Integrated Water Resources Science and Services (IWRSS) Pilot and the NMFS Habitat Blueprint Focus Area (HBFA). The Russian River IWRSS Pilot involves representatives from federal, state and local agencies assembled to consider approaches and benefits that could accrue through coordinated water data exchange and decision support. The HBFA activities include funded projects for a) DHM for endangered fisheries habitat assessment and restoration, and b) forecast-based reservoir operations modeling for flood control water supply and fisheries habitat enhancement.

Publications:

Johnson, LE, C. Hsu, R. Zamora, and R. Cifelli 2016: Assessment and Applications of Distributed Hydrologic Model - Russian-Napa River Basins, CA. NOAA Technical Memorandum PSD-316, NOAA Printing Office, Silver Spring, MD, 90 pp. February. (in press)

Johnson, LE, R. Zamora, C. Hsu, R. Cifelli, C. Shobe, 2015. Comparing Distributed Hydrological Model Simulations of Soil Moisture with Observations in the Russian River Basin. submitted J. Hydromet.

Johnson, LE, R. Cifelli, A. White (2015) Benefits of an Advanced Quantitative Precipitation Information System: San Francisco Bay Area Case Study. NOAA Technical Memorandum PSD-315, NOAA Printing Office, Silver Spring, MD, 59 pp. May. <http://dx.doi.org/10.7289/V5WS8R6X>. Available at: http://docs.lib.noaa.gov/noaa_documents/OAR/PSD/TM_OAR_PSD_315.pdf

DATA DISTRIBUTION

Research focusing on identifying effective and efficient methods of quickly distributing and displaying very large sets of environmental and model data using data networks, using web map services, data compression algorithms, and other techniques.

PROJECT TITLE: CIRA Research Collaborations with the NWS Meteorological Development Lab on Virtual Laboratory, Innovation Web Portal, Impacts Catalog and AWIPS II Projects

PRINCIPAL INVESTIGATOR: Sher Schranz

RESEARCH TEAM: Kenneth Sperow, John Crockett, Michael Giebler, Jason Levit

NOAA TECHNICAL CONTACT: Stephan Smith (NOAA/NWS/OSTI/MDL)

NOAA RESEARCH TEAM: Mamoudou Ba (NOAA/NWS/OSTI/MDL), Lingyan Xin (NOAA/NWS/OSTI/MDL), Matthew Davis (NOAA/NWS/OSTI/MDL), Kenneth Howard (NSSL), Ryan Solomon (NOAA/NWS/AWC), John Schattel (NOAA/NWS/OSTI/MDL), Michael Churma (NOAA/NWS/OSTI/MDL), Tom Filiaggi (NOAA/NWS/OSTI/MDL), Matthew Peroutka (NOAA/NWS/OSTI/MDL)

FISCAL YEAR FUNDING: \$1,398,701

PROJECT OBJECTIVES:



Virtual Lab (VLab) <https://vlab.ncep.noaa.gov>

The NWS has created a service and IT framework that enables NOAA, in particular the NWS, and its partners to share ideas, collaborate, engage in software development, and conduct applied research from anywhere. The project's objectives are the following:

- 1--Reduce the time and cost of transitions of NWS field innovations to enterprise operations;
- 2--Minimize redundancy and leverage complementary, yet physically separated, skill sets;
- 3--Forge scientific and technical solutions based on a broad, diverse consensus; and
- 4--Promote a NOAA/NWS culture based on collaboration and trust.

AWIPS II

The NWS is in the process of evolving AWIPS to an open source, service oriented architecture (SOA). The major objective of this project is to provide the functionality of AWIPS build OB9 in this new SOA infrastructure.

The MDL is not directly responsible for the migration of its applications from AWIPS to AWIPS II; this is the responsibility of Raytheon, the prime contractor. However, the MDL will be overseeing the migration of its current applications, developing new applications in the new framework, and enhancing existing applications beyond OB9, which falls outside the scope of Raytheon's migration. AWIPS II uses many technologies (JAVA, Mule, Hibernate, JavaScript, JMS, JMX, etc.) that are new to the MDL and the NWS. In order for the MDL to be in a position to add value, they need people who have a working understanding of these technologies.

AutoNowCaster (ANC)

Originally developed by the Research Applications Laboratory (RAL) at the National Center for Atmospheric Research (NCAR), ANC nowcasts convective initiation. It is currently experimental and runs solely at the MDL. The project's objectives are the following:

- 1--Develop a more complete understanding of ANC's architecture and configuration, and document that understanding.
- 2--Where possible and/or necessary, optimize ANC's software and streamline its configuration.
- 3--Contribute to experiments designed to improve, better understand, or showcase ANC.
- 4--Transition ANC to operations so that its nowcasts of convective initiation are available to interested entities.

Impacts Catalog / Integrated Real-time Impact Services (IRIS) / iNWS

The National Weather Service's Weather-Ready Nation Roadmap calls out the creation of a national Impacts Catalog, a system whereby the NWS can improve its Impact-based Decision Support Services (IDSS) to its core partners by providing those partners information regarding the impacts which relevant meteorological variables will have on those partners' operations. The project's objectives are the following:

- 1--Provide leadership and technical expertise.
- 2--Contribute to the engineering of the Impacts Catalog's software, including that of its framework system, IRIS, and its corollary system, iNWS.

Weather Information Statistical Post Processing System (WISPS)

WISPS is a new statistical post-processing software system being designed by MDL, to replace the current operational Model Output Statistics system, MOS-2000. MOS-2000 is an impressive software system by many benchmarks. Its limitations, however, have become problematic, and the NWS needs to invest in a replacement system. The WISPS Project is a 3-year effort to develop the framework that will take the inaugural version of WISPS to Technical Readiness Level 9 (i.e., operational implementation on NOAA's Weather and Climate Operational Supercomputing System, WCOS) for some portion of the NWS's statistical postprocessing mission. The project will emphasize suitability for supercomputer operations, multiple statistical postprocessing methods, data formats that are self-describing and embrace widely-accepted standards, and software systems that are flexible, extensible, and shareable. The project's objectives are the following:

- 1--Co-lead the development of WISPS with a team of experts provided by MDL.
- 2--Lead and oversee the process that gathers and documents requirements for WISPS.
- 3--Lead and oversee the investigation of useful pre-existing technologies that are suitable for WISPS.
- 4--Lead and oversee the design and development of data storage technologies and data modeling strategies for WISPS.

PROJECT ACCOMPLISHMENTS:

VLab

A--Ken Sperow continued as the VLab technical lead, as well as the technical lead of the Virtual Lab Support Team (VLST). This team currently consists of 12 members to whom Ken provides support and training. Ken not only is the technical lead but also is the deployment manager for VLab, overseeing and conducting all upgrades, security and feature updates within VLab.

B--Under Ken Sperow's and Stephan Smith's (the NOAA PI) leadership, the VLab continues to grow in importance and visibility within the NWS and NOAA again this year.

1--VLDS Provides web-based services to help manage projects via issue tracking, source control sharing, code review, and continuous integration, VLab Development Services (VLDS) has grown by over 100% again this year to support over 200 projects and 1400 developers.

2--Ken provided multiple demos and consultations to development and operational groups covering VLab's capabilities and how they can be leveraged to address the groups needs.

C--Under Ken Sperow's leadership, the VLab continues to be an essential and required component in the transition of research to operations for the NWS AWIPS. All development organizations must use VLab to check in, review, and verify AWIPS II code before it is included in the operational baseline.

D--Ken Sperow outlined a Dev/OPS scheme using VLab's Gerrit backed git repositories that NCEP/NCO is using in coordination with development teams for development, onboarding to IDP, and coordinated deployments within IDP.

E--Ken Sperow continues to be the VLab expert, which includes providing guidance on Gerrit, Jenkins, Liferay, and Redmine, but also git expertise.

F--Michael Giebler provided the following excellent support and development to the VLab this year:

1--The NOAA Projects Repository that Mike developed went live in May. The Project Repository provides an interface for all of the NOAA to enter project information into the VLab, enabling tracking of projects' transitions from research and development to operations, commercialization, and other uses. To date information for 443 projects have been entered into the repository.

2--The success of the NOAA Projects Repository has generated interest in similar projects including the Ideas Marketplace and the SOO-DOH Dashboard. These projects have potential integration points with the Project Repository. Michael completed the initial development of the Ideas Marketplace and we have already put in production an instance of the SOO-DOH Dashboard.

3--Enhancements to VLab Collaboration Services to provide more functionality and better user experiences. These enhancements include:

a--Creation of Team portlet to provide greater visibility of teams within Collaboration Services.

b--Redmine portlet provides a means of providing an integration point between Collaboration Services and Development Services by making Development Services projects visible within the collaboration portal.

c--Made enhancements to the User Summary Profile portlet to allow users to enter more meaningful information into their user profile. This in conjunction with creating a User Search portlet provides a means for finding subject matter experts within the Virtual Lab.

4--Created a web content template that loops through a web content root folder to provide an easy navigation mechanism for web content. This has been found useful for providing a means of navigating and presenting documentation and training materials.

5--Improved workflows within Collaboration Services - added functionality to some workflows that provides better information within email notifications that are sent during the workflow process. This functionality is serving as a model for improvements to other workflow processes that are being created/enhanced.

6--Created a Redmine task import process. This process provides a means for importing tasks from legacy project management systems into the VLab Redmine project management system.

a--Michael Giebler was awarded the CIRA Exceptional Service Award for his work on the NOAA Projects Repository.

AWIPS II

A--Ken Sperow assisted NWS Systems Engineering Center management with the high-level design of AWIPS II configuration management and governance in addition to defining tasks necessary to improve development of AWIPS II.

B--Ken continues to provide technical assistance to the AWIPS II community on building and deploying AWIPS II and assisted Joe Zajic with the testing of Python scripts written by Joe that simplified development of A2.

C--Ken continued to provide AWIPS II support to MDL developers and to install new releases of the AWIPS II software on the system for knowledge transfer and development activities.

D--Ken Sperow continued to lead the development of a meteogram tool within AWIPS II in coordination with the NASA Short-term Prediction Research and Transition Center (SPoRT) within the VLab. As of build 15.1.1 Tracking Meteogram is operational in AWIPS II.

E--Ken Sperow worked with the AWIPS Program Office (APO) to provide access to VLab from the AWIPS network.

F--Ken Sperow worked with Ira Graffman, NCEP, and NSSL to host AWIPS shapefiles and NDM files within the VLab. Both sets of data were being provided on an out of date server that needed to be decommissioned.

G--Ken Sperow worked with NASA SPoRT and other CIRA collaborators to investigate the use of docker for building and running of AWIPS II.

ANC

A--John Crockett continued to support the day-to-day running of ANC at the MDL.

B--John Crockett continued to maintain and update all of the documentation related to ANC.

C--John Crockett continued to modify ANC applications in order to reduce overall CPU and disk usage, finding and fixing software bugs as needed.

D--John Crockett continued the process of transitioning ANC from an experimental system at the MDL to an operational system at the National Centers for Environmental Prediction (NCEP). As part of this work, John Crockett carried out the following tasks:

1--Modified ANC to make use of the Multi-Radar/Multi-Sensor (MRMS) system's new, single composite reflectivity mosaic from 2.0 to 4.5 km, rather than using and compositing MRMS's eight separate reflectivity mosaics from 2.0 to 4.5 km.

2--Modified ANC so that it is able to ingest and use the GOES East and GOES West data from the MRMS system. As part of this work, re-engineered cloud classification software from the Naval Research Laboratory (NRL) in Monterey, California.

3--Worked with MRMS team members in order to build, install, configure, and run ANC at the National Severe Storms Laboratory (NSSL) in preparation for its inclusion as part of the operational MRMS system at NCEP.

4--Coordinated with Aviation Weather Center (AWC) team members in order to prepare the AWC for the replacement of the MDL's experimental products with the operational system's products.

E--John Crockett again assisted Taiwan's Central Weather Bureau (CWB) with its understanding and use of ANC. As part of this work, John Crockett carried out the following tasks:

1--Created the new LapsToMdv application so that the CWB could convert NetCDF files output by its Local Analysis and Prediction System (LAPS) into the proprietary Meteorological Data Volume (MDV) format used by ANC, and provided the CWB with the documentation needed to use it.

- 2--Created the new CwbQpeSumCompRefToMdv application so that the CWB could convert binary files output by its Quantitative Precipitation Estimation and Segregation Using Multiple Sensors (QPE-SUMS) system into the proprietary Meteorological Data Volume (MDV) format used by ANC, and provided the CWB with the documentation needed to use it.
- 3--Created the new "Taiwan add-on" to the MDL's version of ANC, and provided the CWB with the corresponding documentation.
- 4--Traveled to Taipei, Taiwan and trained the CWB to build, install, configure, and run the MDL's version of ANC.
- 5--Answered any and all questions as they arose, and provided to the CWB a list of recommendations for them to consider with respect to their use of ANC.
- 6--As the need arose, investigated and fixed problems remotely.

Impacts Catalog / IRIS / iNWS

A--As Deputy Technical Lead of the national Impacts Catalog Project, John Crockett carried out the following tasks:

- 1--Helped coordinate the transition of IRIS from an experimental system hosted at Central Region Headquarters to an operational system hosted on the Information Dissemination Program (IDP) platform at NCEP Central Operations (NCO). This included participating in weekly teleconferences with both NCO leadership and IDP personnel.
- 2--Reviewed and consolidated the requirements of the Impacts Catalog, IRIS, and iNWS into a single set of requirements to guide the future development of those systems, and, along with NOAA research team member Matt Davis and the project's Integrated Working Team (IWT), finalized those requirements needed to develop the beta version of the Impacts Catalog.
- 3--Initiated and helped lead the transition of IRIS into a map-centric application framework with a more AWIPS-like menu and display system, and took on the primary responsibility for consolidating and making more modular all of the OpenLayers functionality.
- 4--Continued having the primary responsibility for the engineering and further development of the system's contact management application.
- 5--Helped create and present a project-related poster for the National SOO-DOH Meeting at NCEP in September.
- 6--Participated in a three-day project Design and Development Conference at the NWS Training Center in Kansas City, MO.
- 7--Participated in, and sometimes led, weekly Development Team teleconferences.
- 8--Developed the material for, and conducted, a "Coding for Efficiency" training session for the Development Team.

B--John Crockett continued to function as a manager of the Virtual Laboratory's Impacts Catalog Community. This included writing periodic blog posts so that the community was kept abreast of the project's status.

C--John Crockett continued to function as a member of the project's IWT.

D--John Crockett was nominated by NOAA research team member Matt Davis for, and was awarded, the CIRA Exceptional Service Award.

WISPS

A--Jason Levit started working for CIRA in early January as co-lead for the WISPS project. Jason completed the following tasks between January and March:

- 1--Obtained initial computer accounts and received training on MDLNet.
- 2--Attended the Jan 19-22 NOAA Statistical Post Processing workshop in College Park, MD
- 3--Completed initial investigation into software and data design, training on MOS-2000 code.
- 4--Finished initial WISPS project plans, with notional project charter, schedule, and scope.
- 5--Spun-up on WISPS project documentation and review of MDL's project plans.
- 6--Investigated the UKMET IRIS software for statistical post-processing, and attempted an MDLNet install of the software.
- 7--Received training on NOAA VLab and became site admin for WISPS VLab site.

- 8--Installed the UKMET IRIS post processing software on the RDHPCS.
- 9--Submitted a WISPS National Weather Association abstract for September's annual meeting.
- 10--Created a small WISPS test code project, investigating netCDF for data format.

PROJECT TITLE: CIRA Support to the JPSS Proving Ground and Risk Reduction Program: Integration of JPSS Experimental Products in AWIPS II through EPDT Code Sprints

PRINCIPAL INVESTIGATOR: Scott Longmore

RESEARCH TEAM: Scott Longmore

NOAA TECHNICAL CONTACT: Satya Kalluri (NOAA/NESDIS) and Candice Jongsma (NOAA/OAR)

NOAA RESEARCH TEAM: Deb Molenaar (NOAA/NESDIS/STAR/RAMMB)

FISCAL YEAR FUNDING: \$18,000

PROJECT OBJECTIVES:

The Experimental Product Development Team (EPDT) is an AWIPS II developer training and collaboration project which is organized by NASA SPoRT and has been running for the last three years. EPDT brings together developers from various agencies such as NASA, NWS, various cooperative institutes to learn to develop plug-ins for the AWIPS II system. EPDT has helped various groups develop a deep understanding of the AWIPS II architecture and methods to extend it to enable new and innovative data and displays. Part of the learning process within EPDT is to facilitate EPDT groups to work on projects of common interest and to provide the environment and access to knowledge that allows these groups to successfully develop plug-ins for their groups as well as groups such as GOES-R Proving Ground. For the past year CIRA's AWIPS II Team has been working closely with the NASA SPoRT Team by leveraging the EPDT team to develop plug-ins to ingest and create innovative displays of JPSS data. The two teams worked closely with end-users and JPSS to develop high-impact plug-ins to enable the NWS to fully utilize JPSS products within the AWIPS II system.

Research Objectives:

The main objectives of this project were for participants in EPDT to learn to configure and/or develop plug-ins for ingest, model, and display of JPSS data within the AWIPS II system.

Achievements during this Annual Report period:

The work would was performed in the following manner:

- 1- EPDT facilitators (i.e the SPoRT and CIRA EDPT team) identified and selected past EPDT participants to work on JPSS projects.
- 2- EPDT facilitators and selected participants met with JPSS program scientists to identify data and displays needs of JPSS to be integrated into the AWIPS II platforms.
- 3- EPDT facilitators scheduled code sprints for the plug-in development.
- 4- EPDT facilitators and participants executed work during a code sprints to accomplish the work needed to create configuration and plug-ins to enable the new JPSS products. An example of one set of JPSS similar products (SNPP, AMSR-2) ingested and displayed into AWIPS II during this code sprint by Kevin McGrath (SPoRT) and Scott Longmore (CIRA) utilizing the PointSet plug-in is show in Figure 1.
- 5- Quarterly reports were submitted

This project has been funded for a second year (FY16). Next year's goal will be for the EPDT facilitators to work with the NWS Systems Engineering Center Development Branch to integrate the new plug-ins into the baseline architecture and ensure that it passes the test and code delivery requirements.

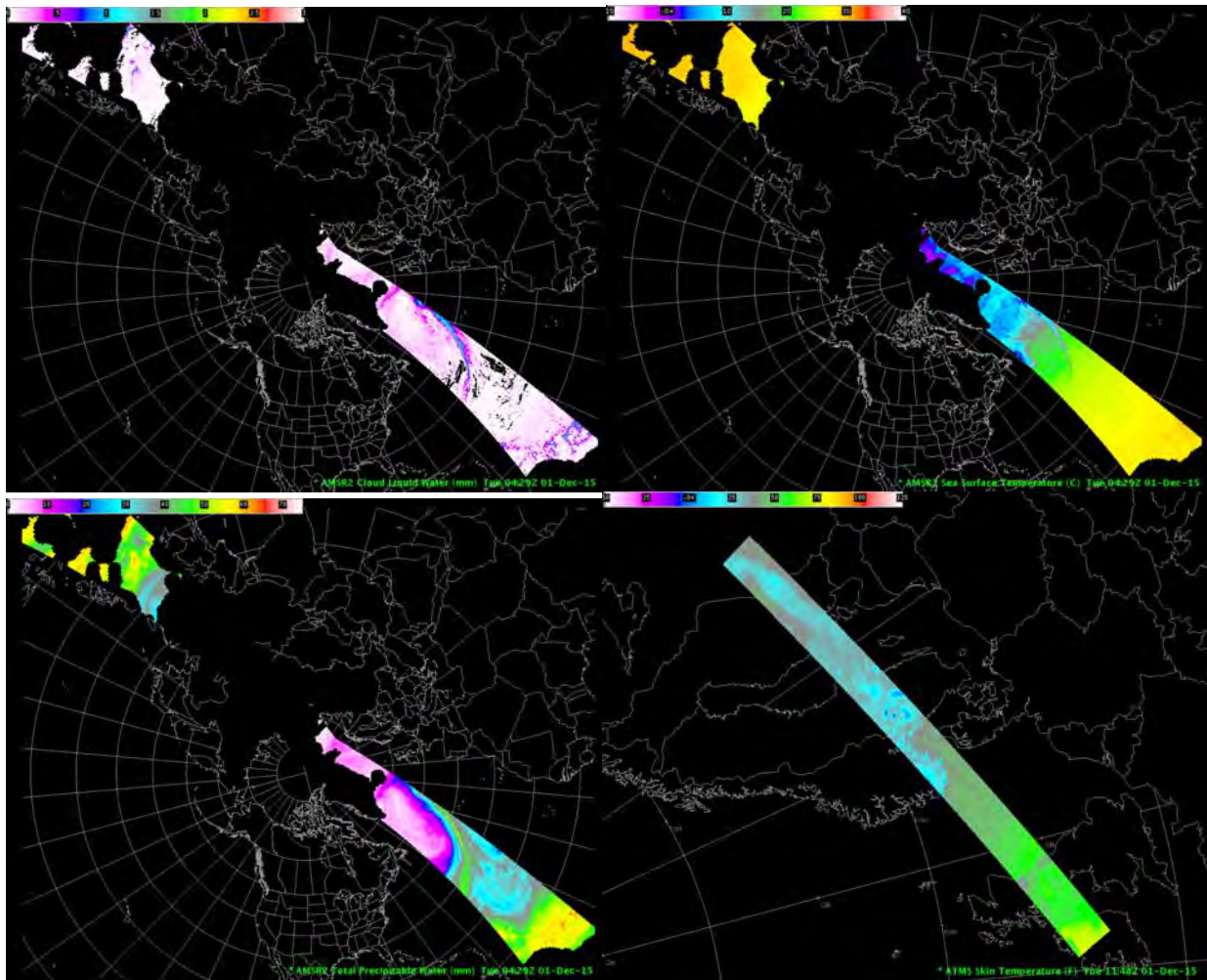

Figure 1. GCOM AMSR-2 Ocean Products: (top left) cloud liquid water, (top right) sea surface temperature (bottom left) total perceptible water and (bottom right) S-NPP ATMS MIRS land surface (skin) temperature.

Publications: None

Presentations: None

PROJECT: ENVIRONMENTAL APPLICATIONS RESEARCH

FISCAL YEAR BUDGET (EAR Total): \$5,480,143

PROJECT TITLE: EAR - Flow-following finite-volume Icosahedral Model (FIM) Data Distribution Project

PRINCIPAL INVESTIGATOR: Sher Schranz

RESEARCH TEAM: Brian Jamison, Ning Wang, Ed Szoke

NOAA TECHNICAL CONTACT: Stanley Benjamin (OAR/ESRL/GSD/EMB Chief)

NOAA RESEARCH TEAM: Jian-Wen Bao (OAR/ESRL/PSD), Mark Govett (OAR/ESRL/GSD/ATO)

PROJECT OBJECTIVES:

- 1--Generate graphics of output fields, creation and management of web sites for display of those graphics.
- 2--Create and manage graphics for public displays, including software for automatic real-time updates.

PROJECT ACCOMPLISHMENTS:

A web site for display of FIM model output <http://fim.noaa.gov/FIM/> was updated and currently has 7 separate versions of FIM with up to 63 products available in 21 regions for perusal with 6-hourly forecasts going out to 14 days. Many regions have improved resolution by using direct interpolation from the native icosahedral grid to a 0.125 degree global grid (approximately 14 km grid spacing).

Difference plots are generated and available, as are plots of forecast error. New plots have been added of forecast error from a single run for all of the FIM models. Cross sections are also being generated and are available at <http://fim.noaa.gov/FIMxs/>. Plot loops that show the progression of forecasts from model runs with the same valid time (dProg/dt) can be viewed at <http://fim.noaa.gov/FIMdpdt/>.

A new version of the GFS model with 0.25 degree resolution was released by NCEP. GSD receives the operational data and creates graphics for the global domain and domains similar to some of the FIM subdomains, for comparison.

A new Southern Hemisphere domain was added to the FIM suite of domains, and a new time-lagged 6-hour precipitation graphic was added, showing the progression of the precipitation over the last 3 runs (Figure 1).

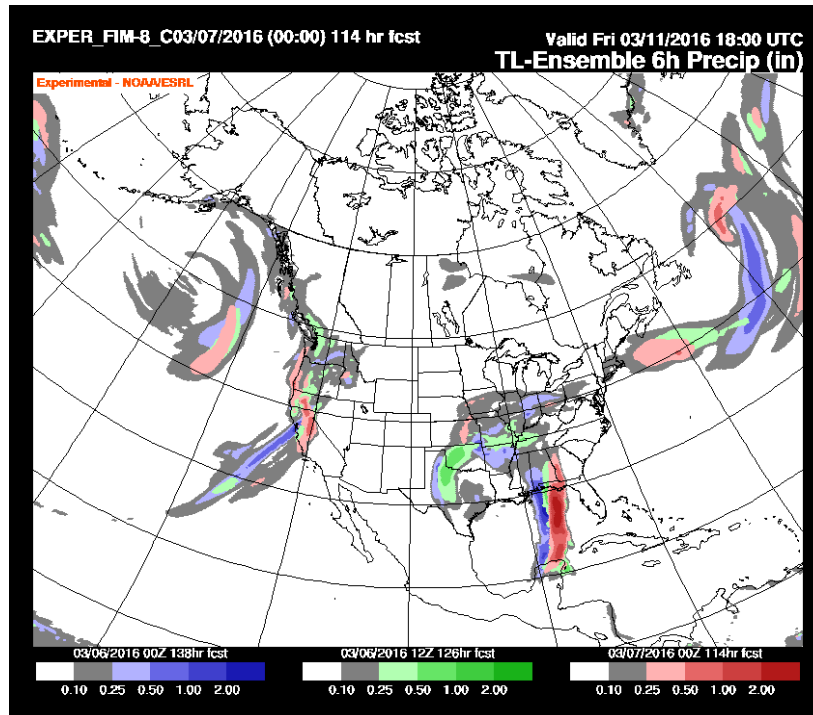

Figure 1. FIM subdomain showing time-lagged 6-hour precipitation over N. America.

A dual-monitor hallway display on the second floor of the David Skaggs Research Center (DSRC) displays FIM model graphics for public viewing. Currently, a montage loop of four output fields is displayed and updated regularly.

A large touchscreen kiosk monitor in the second floor atrium area has been updated with added FIM graphic loops of 10-meter wind, precipitation and snowfall. New, larger, and more detailed images were created and are updated specifically for the kiosk.

PROJECT TITLE: EAR – Aviation Weather Forecast Impact and Quality Assessment

PRINCIPAL INVESTIGATOR: Sher Schranz

RESEARCH TEAM: Melissa Petty, Paul Hamer, Michael Turpin, Daniel Schaffer

NOAA TECHNICAL CONTACT: Michael Kraus (OAR/ESRL/GSD/EDS Chief)

NOAA RESEARCH TEAM: Brian Etherton (OAR/ESRL/GSD/EDS), Matt Wandishin (CIRES), Geary Layne (CIRES), Joan Hart (CIRES), Michael Rabellino (CIRES), Laura Paulik (CIRES)

PROJECT OBJECTIVES:

- 1--Scientific research and quality assessments
- 2--Technology development

PROJECT ACCOMPLISHMENTS:

Scientific Research and Quality Assessments:

Program management and engineering support was provided to FIQAS scientific research and quality assessment activities. The primary sponsors for these activities in 2015/16 were the FAA Aviation

Weather Research Program (AWRP), where FIQAS serves as the Quality Assessment Product Development Team (QA PDT), and the NWS Aviation and Space Weather Services Branch (ASWSB).

Accomplishments under the sponsorship of FAA AWRP include:

Completion of the evaluation of the Graphical Turbulence Guidance Nowcast (GTGN):

GTGN is the first Nowcast component of the GTG system developed by the Turbulence Product Development Team (PDT) within NCAR's Research Application Laboratory (RAL). FIQAS performed a quality assessment of this product as part of the AWRP formal transition process. In this assessment, GTGN and GTG3 were compared as competing products, even though GTGN is a nowcast product to be used for tactical decisions, and GTG3 provides forecasts out to 18h to support strategic decision-making. Prior to GTGN, the short-term GTG3 forecast was the best available gridded product for real-time situational awareness, and therefore served as the baseline product for comparison. The activities for 2015/16 included finalization of the verification techniques, adaptation of existing techniques to the nowcast component, data collection and processing, analysis of results, and reporting of findings and conclusions.

Overall findings were that GTGN outperforms the GTG3 short term forecast (2 hour lead) for real time situational awareness. Results were presented to AWRP management and the Turbulence PDT in early February 2016, with the written report submitted in early March 2016. Findings were presented to an independent Technical Review Panel as input to their decision of GTGN readiness to continue through the transition process into NWS operations.

Preparation for the evaluation of the GTG Global Turbulence product:

The GTG Global turbulence product, also developed by NCAR's Turbulence PDT, is a global extension of the GTG forecast system. The activities for 2015/16 included: coordination with the Turbulence PDT, the Aviation Weather Center, and AWRP to determine the goals for the assessment, investigation of new global observation sets for potential use in turbulence verification, development of verification techniques, and developing and finalizing the overall approach for the assessment. Presentation of the verification plan to AWRP management and the Turbulence PDT for review and feedback is planned for early summer 2016.

Completion of the evaluation of the Offshore Precipitation Capability (OPC):

FIQAS completed an evaluation of the Offshore Precipitation Capability developed by Massachusetts Institute of Technology (MIT) Lincoln Laboratory (LL) under the sponsorship of AWRP. The OPC is a new capability, derived from satellite and lightning data, that provides proxy radar precipitation data over the Southeastern US, Gulf of Mexico, Caribbean, and western Atlantic. The proxy radar data is merged with Corridor Integrated Weather System (CIWS) radar mosaic where ground radar coverage exists. The assessment incorporated analysis fields from OPC and CIWS, as well as observational data from the Global Precipitation Mission (GPM), the NEXRAD ground radar network, and routine surface reports (METARs) to establish a performance baseline for this product.

Activities for 2015/16 included review of the verification plan with MIT/LL and AWRP, implementation to support the assessment, data collection and processing, analysis of results, and reporting of findings and conclusions. The QA evaluation identified the strengths and weaknesses of the product, in particular, finding that while OPC was very similar in characteristics to CIWS over land (or regions where radar was available), it had notably different characteristics over water that could impact how the product should be used operationally. The results from this assessment also serve as a baseline of performance against which future enhancements of this product can be measured.

Preparation for additional assessment of the CDM Convective Forecast Planning Guidance (CCFP):

In Feb 2015, FIQAS completed an evaluation of the CCFP, which is an automated convective forecast product produced at the Aviation Weather Center (AWC). The evaluation included a comparison between this product and the one it ultimately replaced: the human-generated Collaborative Convective Forecast Product (also known as CCFP) produced by the AWC forecasters. The assessment provided findings on the skill of the products based upon their meteorological characteristics, and is now being extended to a more operationally-focused evaluation by utilizing the Flow Constraint Index (FCI). The FCI translates

convective weather information into a measure of airspace constraint, highlighting mode and orientation of convective weather more impactful to operations, as well as high-traffic areas and times of day. The FCI-based approach allows for evaluation of forecast performance for characteristics, regions, and times of day most important to aviation operations. This evaluation will be performed for the 2014 convective season, the same season for which the original, meteorologically-based assessment was performed, and will be extended to include the 2015 season and part of the 2016 season.

Activities for 2015/16 included development of the verification plan for the FCI-based assessment, review of the plan with AWRP and AWC for feedback and comment, and implementation and data processing for the assessment. Presentation of preliminary results is planned for July 2016, with a final presentation to incorporate the 2016 season in Sept 2016.

Completion of the evaluation of the Icing Product Alaska (IPA):

FIQAS was tasked to assess the quality of Icing Product Alaska (IPA) developed by the In Flight Icing Product Development Team (IFI PDT) of NCAR/RAL. The IPA domain covers Alaska as well as a portion of the Pacific Northwest, and is adapted from the CONUS-based Forecast Icing Product (FIP) in that RAP model output is used in the algorithm to produce hourly forecasts of icing probability, severity, and super-cooled large drop (SLD) potential out to 18 hours.

The assessment examined IPA forecasts for the period of February-May 2014 and also included output from AIRMETs produced by the Alaskan Aviation Weather Unit (AAWU) as well as the CONUS-based FIP forecast over the Pacific Northwest Region. The assessment utilized PIREPs, METARs, satellite data, and soundings as observation sets. Activities for 2015/16 included analysis of results, reporting of findings and conclusions, and preparation for a revised assessment based upon the recommendation of the Technical Review Panel.

The evaluation found that the climatological characteristics of IPA were qualitatively as expected, but that in general IPA was less skillful than FIP. The TRP determined that a more representative season of icing was needed for the assessment, as well as more focus of the evaluation over Alaska proper, and in comparison to other icing products used by the AAWU, rather than to the CONUS FIP. The implementation for this second assessment is currently underway, utilizing data over the period of September 2015 through January 2016, and additional forecast datasets provided by the AAWU, for comparison.

Accomplishments under the sponsorship of the NWS Aviation and Space Weather Services Branch (ASWSB) include:

Completion of event-based assessment of NWS wind forecast products:

FIQAS performed research and development of event-based verification techniques for wind forecasts in the context of aviation operations at the terminal. Metrics and techniques were framed by the functional requirements defined by the Aviation Weather Requirements Working Group (ARWG) and formalized by the FAA for NWS products as part of their services to the FAA. Terminal events were defined by a change in wind direction of 30 degrees or more with a wind speed greater than or equal to 12 knots—events that are considered impactful to terminal operations as they potentially necessitate a runway configuration change.

As part of the assessment, techniques were implemented to identify when such events occur according to specific automated NWS forecast products as well as observations. Performance metrics were developed to evaluate forecast skill in identifying the occurrence of these wind events. The primary finding was that the information currently provided in the forecast products is at a coarser granularity than what is expected by the current requirements. Furthermore, all forecast products possess a substantial low bias for wind speed forecasts, which results in too few forecast events. It is possible that more sophisticated post-processing of these products could determine a signal more consistent with observed wind shifts. The assessment is currently being extended to include the Terminal Aerodrome Forecast (TAF) produced by NWS forecasters, to examine performance as compared to the automated forecasts. Preliminary results indicate that the TAF is superior to all other forecast products examined, including the

NDFD forecast produced by the same forecast office. In addition, the TAF has a smaller forecast bias for the wind speed.

Technology Development:

CIRA was responsible for application development in support of FIQAS activities, including FIQAS assessments as well as the development of technologies for external users. The primary sponsors for these activities in 2015/16 were FAA AWRP, NWS ASWSB, and the NWS NextGen Program.

Accomplishments for FAA AWRP activities include:

Verification and Requirements Monitoring Capability (VRMC, Figure 1):

The VRMC is a web-based application developed and maintained by FIQAS, and provides ongoing verification metrics for the operational GTG and CIP/FIP products as well as verification capabilities to support FIQAS assessments performed prior to the transition of these products into operations. Activities for 2015/16 included completion of assessment components for both Icing Product Alaska and GTGN, both of which were used for their respective assessments, and implementation of general techniques to support grid-to-grid verification.

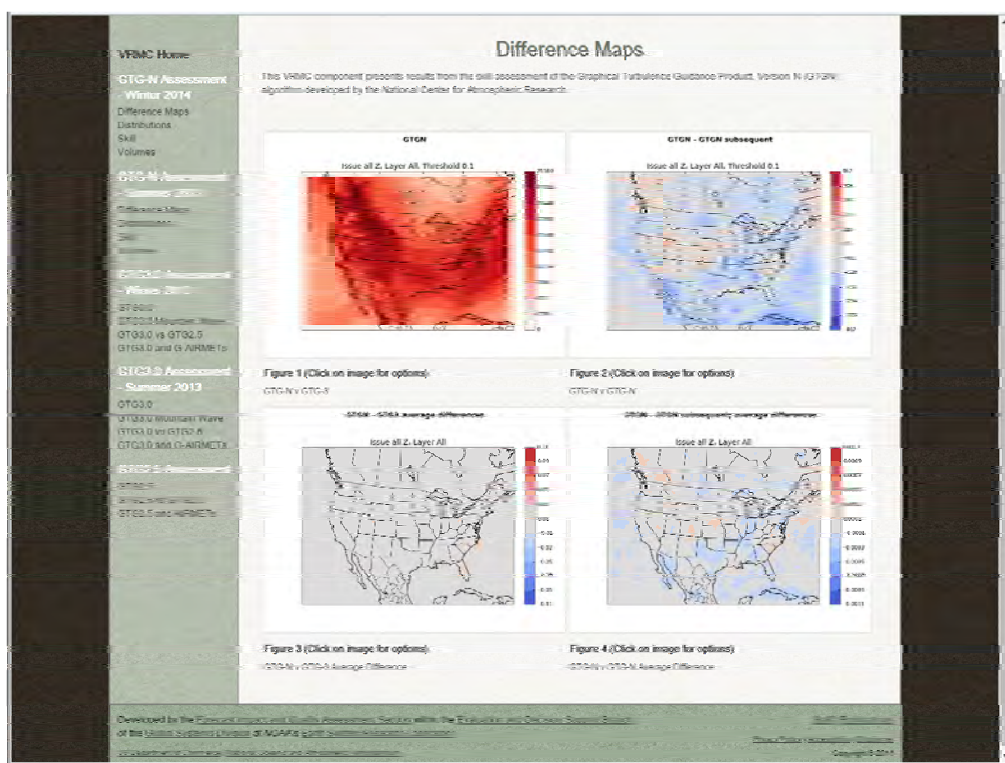

Figure 1. VRMC GTGN Assessment Component.

Accomplishments for NWS NextGen include:

Integrated Support for Impacted air-Traffic Environments (INSITE; Figure 2):

INSITE is a web-based application developed for use in the convective weather forecast process. It aligns with NWS Weather Ready Nation initiatives to provide Impact Based Decision Support Services by blending raw convective weather information with traffic data to highlight potential weather-related impacts to aviation operations. INSITE is targeted for use by NWS AWC forecasters, National Aviation Meteorologists, and CWSUs as part of their general weather services to the FAA, as well as to support a new process known as Operational Bridging, the output of which is an event-driven product known as the

Collaborative Aviation Weather Statement, to communicate potential impacts to aviation operations due to convective weather.

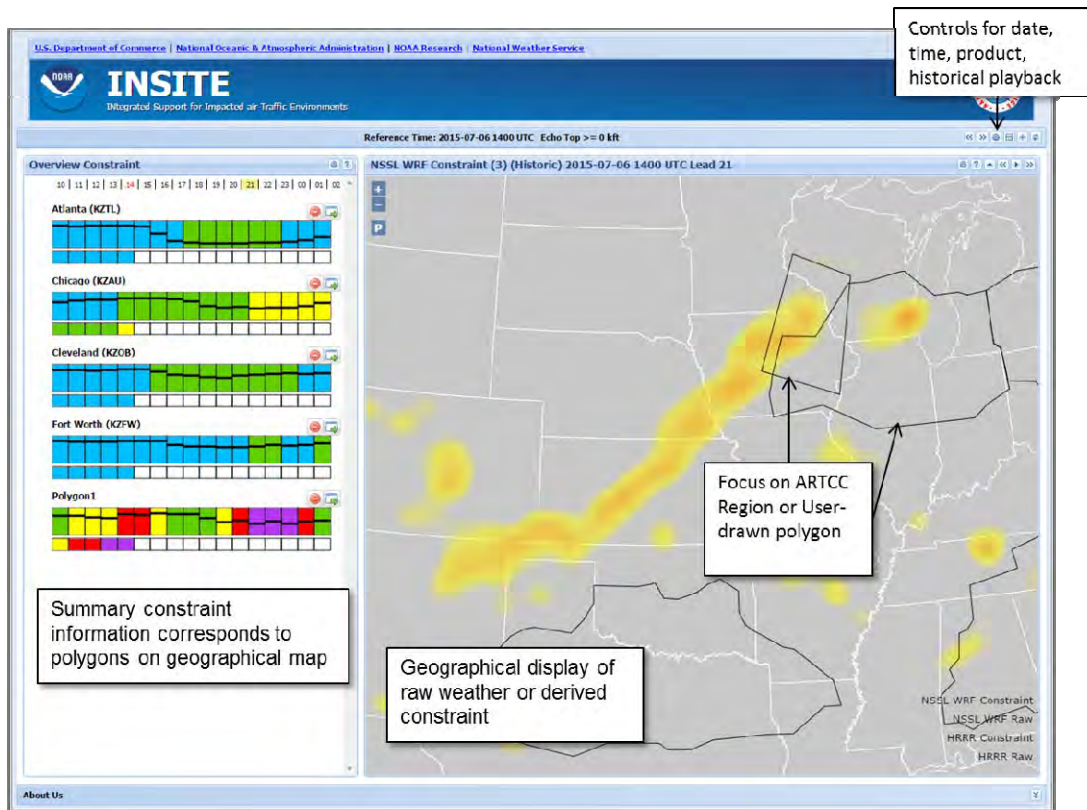

Figure 2. INSITE main page.

INSITE version 3.5 was released June 2015, the primary enhancement to 3.0 being the inclusion of current and planned traffic data as an option for computing airspace constraints, in addition to the existing capability utilizing historical traffic data for the computation. Feature enhancements are currently being incorporated into version 4.0 based upon user feedback collected at the end of the 2015 convective season, and include enhancements to the user interface as well as the addition of a feature that will alert users when the derived constraint for a specific product has exceeded a specified threshold.

The release of INSITE 4.0 is planned for May 2016, and will be the base version transitioned to NWS operations. FIQAS has begun preparatory activities for transition of INSITE to NWS operations, with the Integrated Dissemination Program (IDP) as the planned host of the operational solution. Initial Operating Capability (IOC) for INSITE at IDP is planned for May 2017.

Accomplishments for NWS ASWSB include:

CWSU Briefing and Verification Tool (CBVT; Figure 3):

NWS CWSUs (National Weather Service, Center Weather Service Units) provide decision support services at FAA Air Route Traffic Control Centers. The CWSU meteorologists provide briefings containing weather forecast information critical to FAA Traffic Flow Management decisions. FIQAS was tasked to develop an automated verification tool to allow user entry of briefing information and provide ongoing forecast performance results to replace what is currently a manual verification process performed by the individual CWSU. A prototype tool for a specific focus group was established in May 2015, and activities for 2015/16 included extension of the concepts for the focus group to the full set of 21 CSWUs. The tool will include capabilities for forecasters to record the forecasts used for their wind event briefings,

automated capabilities to identify observed wind events and verify the forecasts input into the system, and reporting capabilities for NWS Headquarters to track performance.

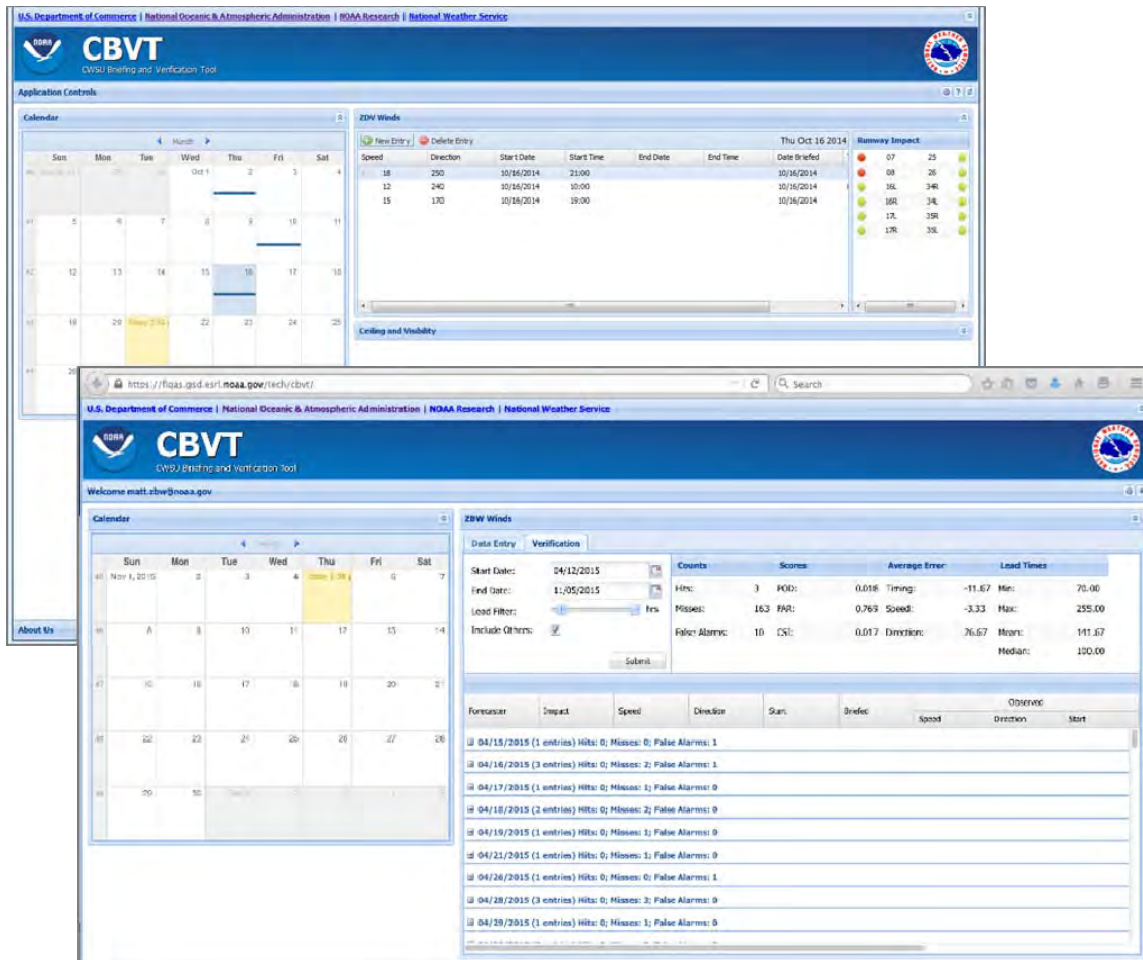

Figure 3. CBVT Briefing Entry (top) and Verification (bottom) pages.

TRACON (Terminal Radar Approach Control Facilities) Gate Forecast Verification Tool (TFVT; Figure 4): TRACON Approach and Departure gate forecasts are being produced by CWSUs to provide greater detail of convective occurrence with respect to TRACON activities. A centralized version of this product is has been developed by AWC to produce forecasts for a predefined set of CWSUs. FIQAS was tasked with the development of verification techniques and implementation of an automated verification tool to support ongoing monitoring of performance of this forecast product. Activities for 2015/16 included completion of a prototype tool of the automated forecast produced by AWC, extension of the tool to additional airports once implemented into the AWC product, and preparation of the tool to include verification of forecaster modifications to the automated AWC forecast.



Figure 4. Example of TRACON Gate forecast (top) and TFVT web page (bottom).

PROJECT TITLE: EAR – Developmental Testbed Center (DTC) Support

PRINCIPAL INVESTIGATOR: Sher Schranz

RESEARCH TEAM: Jim Frimel, Isidora Jankov

NOAA TECHNICAL CONTACT: Stan Benjamin (OAR/ESRL/GSD/EMB Chief), Kevin Kelleher (OAR/ESRL/GSD Chief)

NOAA RESEARCH TEAM: Christina Holt (CIRES), Ligia Bernardet (CIRES), Timothy Brown (University of Colorado)

PROJECT OBJECTIVE:

CIRA is implementing changes to the HWRF work flow code base to support the research and meet the needs of the scientific community. Changes this year were to implement the Atlantic Oceanographic & Meteorological Laboratory Hurricane Research Division's multiple storm basin scale software within the new HWRF python code base. This will provide a framework using the current HWRF front end python scripts and allow for running the HWRF model with input from multiple storms.

PROJECT ACCOMPLISHMENTS:

Under the Hurricane Forecast Improvement Program (HFIP) supported by HRD/AOML along with partners at NCEP/EMC and the Developmental Testbed Center (DTC), CIRA completed changes to the HWRF work flow code base to support the research and meet the needs of the scientific community. An implementation of the Atlantic Oceanographic & Meteorological Laboratory Hurricane Research Division's multiple storm basin scale software within the new HWRF python code base was completed. This provides a framework using the current HWRF front end python scripts and allows for running the HWRF model with input from multiple storms. Work continued with ongoing software lifecycle maintenance and support of the basin scale implementation.

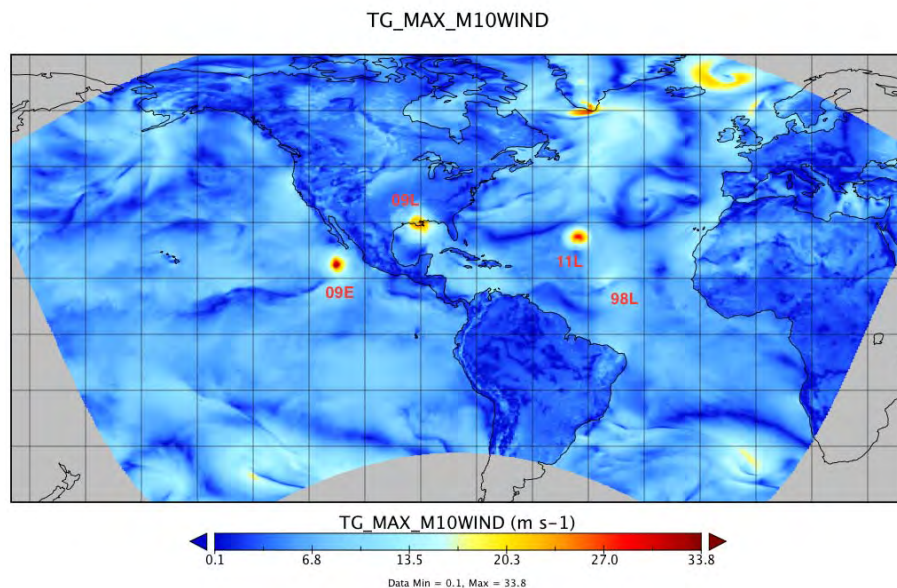

Figure 1. Displays the general map extents of the multiple storm basin scale for domain 1. The variable displayed is 10 meter max winds from a retrospective run of the 2015 HWRF multiple storm basin scale implementation for a 4 storm case at 2012-08-30-03Z. Storm names are: 09L - Isaac, 11L - Kirk, 09E – Ileana, 98L(12L) – Leslie

PROJECT TITLE: EAR - Rapid Update Cycle (RUC) Rapid Refresh (RAP) and High-Resolution Rapid Refresh (HRRR) Models Project, Data Distribution and Visualization

PRINCIPAL INVESTIGATOR: Sher Schranz

RESEARCH TEAM: Brian Jamison, Ed Szoke

NOAA TECHNICAL CONTACT: Stanley Benjamin (OAR/ESRL/GSD/EMB Chief)

NOAA RESEARCH TEAM: Curtis Alexander (CIRES), Steve Weygandt (OAR/ESRL/GSD/EMB)

PROJECT OBJECTIVES:

Tasks for this project include: creation and management of automated scripts that generate real-time graphics of output fields, management of web sites for display of those graphics, and management of graphics for hallway public displays.

PROJECT ACCOMPLISHMENTS:

Each of the web pages for RAP <http://rapidrefresh.noaa.gov/RAP/>, HRRR <http://rapidrefresh.noaa.gov/HRRR/>, and RUC <http://ruc.noaa.gov/RUC/> have been refined with new developmental model versions, difference plots, better graphics and new fields.

The HRRR is now an operational NWS model, and is run at The National Centers for Environmental Prediction (NCEP). GSD receives the operational data, and creates all graphics for GSD's HRRR web page, including all subdomains and soundings. The in-house HRRR was renamed HRRR Experimental (HRRRX) to distinguish it from the operational version.

The HRRR team won the CO-LABS Governor's Award for High-Impact Research for 2015, for providing more accurate depictions of hazardous weather to forecasters, emergency managers, pilots, farm operators, and air traffic managers.

The RAP version 3 and HRRR version 2 were released by The National Centers for Environmental Prediction (NCEP) and are received operationally at GSD. Graphics are created from these models and displayed on GSD's RAP and HRRR web pages, along with difference plots for comparison.

Many improvements and some new products were added to the model suites, including two new subdomains for RAP centered over Hawaii and Alaska (Figure 1). Improvements were also made to the graphics workflow to improve speed and availability, while also increasing web security.

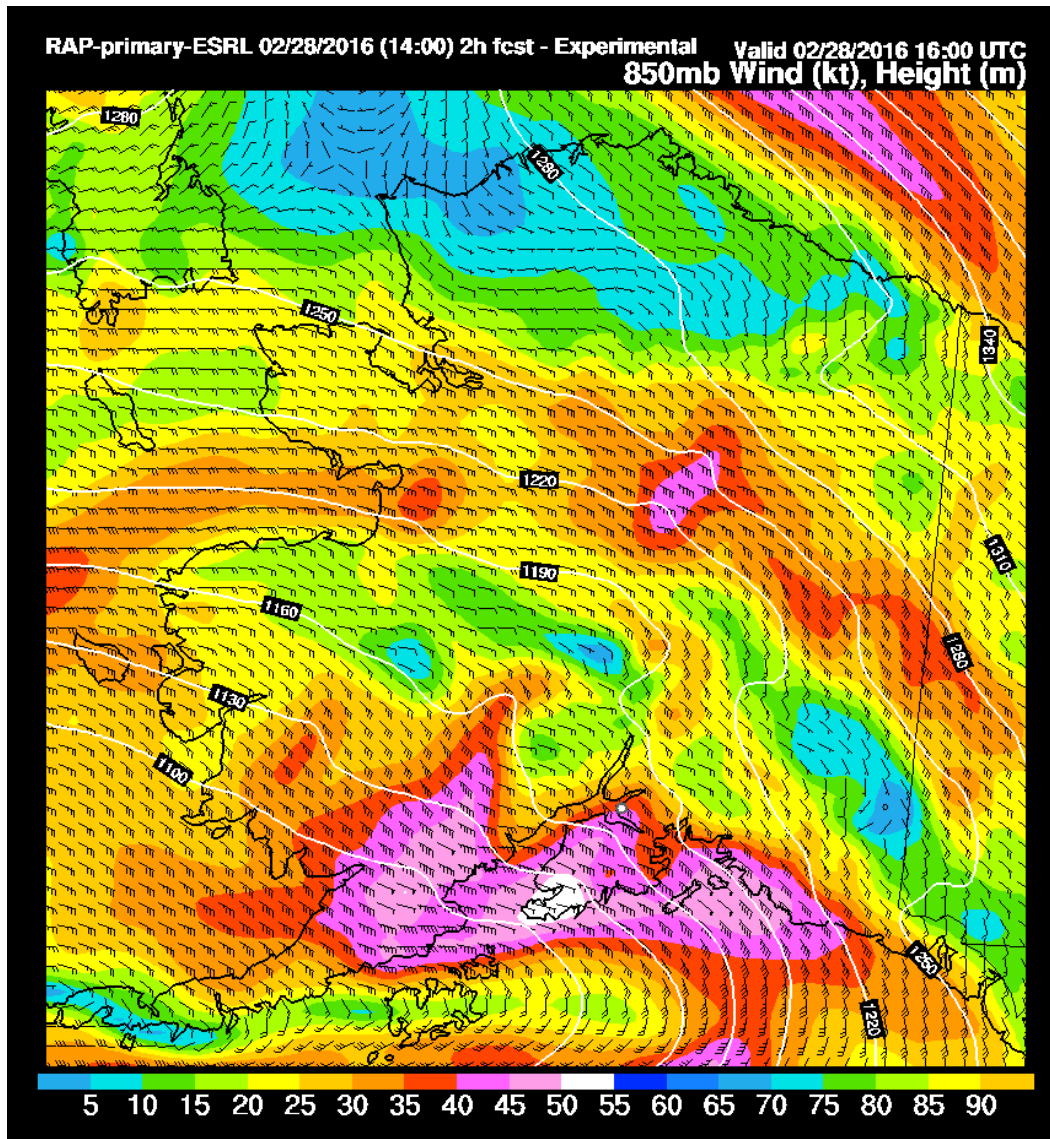

Figure 1. 850mb wind and height over RAP Alaska subdomain.

A dual-monitor hallway display on the second floor of the David Skaggs Research Center (DSRC) displays HRRR model graphics for public viewing. Currently, a montage loop of four output fields is regularly displayed and updated automatically.

A large touchscreen kiosk monitor in the second floor atrium area has been updated with added HRRR graphic loops of composite reflectivity, precipitation and precipitation type. New, larger, and more detailed images were created and are updated specifically for the kiosk.

PROJECT TITLE: EAR – AWIPS I & AWIPS II Workstation Development

PRINCIPAL INVESTIGATOR: Sher Schranz

RESEARCH TEAM: Daniel Schaffer, James Ramer, U Herb Grote, Evan Polster, Amenda Stanley, Kevin Manross, Sarah Pontius, Nathan Hardin

NOAA TECHNICAL CONTACT: Woody Roberts(OAR/ESRL/GSD/EDS)

NOAA RESEARCH TEAM: Tracy Hansen - NOAA Federal, Thomas LeFebvre -NOAA Federal, Joseph Wakefield - NOAA Federal, Susan Williams - NOAA Federal, Chris Golden - CIRES, Isidora Jankov - CIRA, Paul Schultz - CIRES, Xiangbao Jing - CIRES, Vivian LeFebvre - NOAA Federal, Woody Roberts - NOAA Federal

PROJECT OBJECTIVES:

The ongoing objective of this program is to research and maintain AWIPS-related service solutions for researchers and operational field personnel using those solutions, as well as supporting the NWS in the future development and delivery of those solutions. AWIPS I is the original Advance Weather Information Processing System used by the NWS Weather Forecast Offices (WFO) since the 1990's. AWIPS II (also known as A2) is the re-factored version of the AWIPS I system.

The long-term objective of this project is to develop a forecast workstation with advanced interactive display capabilities that includes inter-office and external collaboration, and integrates existing hazard services. The collaboration capability can improve forecast consistency between offices and permit better coordination with external partners.

PROJECT ACCOMPLISHMENTS:

AWIPS II Extended Task – Hazard Services Project

The goal of the hazard services project is to integrate current AWIPS applications that are used to generate hazard weather watches, warnings, and advisories. These discrete applications are WarnGen, Graphical Hazard Generator, RiverPro, and the NWS National Center hazard generation functionality.

The hazard services project is a multi-year effort to integrate the various warning, watch, and advisory tools used by the NWS. In the process, CIRA staff sought to transition the current hazard generation programs from a paradigm of issuing products to one of decision support.

This effort is multi-faceted. The first facet is the continued vetting of requirements with Hazard Services users. CIRA personnel participated in weekly discussions including the presentation of code designs and implementations. These meetings then rolled over into more formal Integrated Working Team meetings starting in early 2015.

A second facet is the continued development of code that implements the requirements for Hazard Services. CIRA personnel assisted in this development process. The team helped to deliver an initial operating version of Hazard Services as part of the A2 15.1.1 version made available to forecasters in September, 2015. This delivery included the following items:

- Migration of legacy metadata formats into the Hazard Services format.
- Development of part of the product generation functionality included in Hazard Services.
- Adding capabilities to the Hazard Services Spatial Display such as the ability to add and remove counties from hazard events.
- Fixing a variety of bugs and making enhancements to the previously developed code.

A third aspect is continued support of operational testing of Hazard Services. This effort included providing input to the NWS-led operational test team along with the development of the capability for testing to be done remotely using the NoMachine technology. An instance of Hazard Services has now

been deployed to the GSD Demilitarized Zone (DMZ). Any tester with a good internet connection can log on to this machine and test Hazard Services via NoMachine.

In support of efforts to test Hazard Services, work has begun to be able to build A-II review cases for some significant weather events that exercise the various aspects of Hazard Services. The plan is to be able to both build historical cases based on ITS archived NOAAPORT data, and to build cases based on an ongoing event by picking up selected data sets from the archive partition on a2dp in real time. A 5 hour case covering the September 2013 Boulder, CO flood event was constructed and deployed on the NoMachine server. It is hoped that the ability to build A-II review cases will be useful for other development efforts related to A-II.

The team collaborates closely with the AWIPS II contractor, who is responsible for developing specific portions of the code and also for ensuring that the software will work in the AWIPS II environment. Regularly scheduled coordination meetings allow all members of the team to be properly informed on the software development tasks.

NWS funding for work on Hazard Services for FY15 reduced the overall role of GSD/CIRA personnel for development. A few additional "Recommenders" were developed or updated, and a couple of migration tools were developed. In the case of the latter, a UCAR SOARS <<https://www.soars.ucar.edu/>> student was mentored and given the task.

AWIPS II Transition Task - Migrate LAPS and MSAS to AWIPS-II

This work continued at a high level of effort this year, and can be broken down into these major subtasks:

Respond to trouble reports from sites that already have the A2 LAPS/MSAS running.

Develop scripting that grabs selected real-time data sets from our production clustered EDEX and pushes them through a local EDEX. This allows one to work on LAPS & MSAS easily in a standalone development environment, and there was a great deal of synergy between this work and the effort to develop a review case capability for Hazard Services.

Update the LAPS/MSAS install such that it can be installed on computers that were not previously legacy system computers. This work was originally requested by the training branch, but was also key for allowing one to work on LAPS & MSAS in a standalone development environment.

Update the workset used to build the LAPS/MSAS install tars such that the LAPS executables are built from source code as part of the process that creates the install tars, instead of putting LAPS executables directly into CM. Building LAPS executables directly made it practical to begin the effort to hand the LAPS/MSAS code off to Raytheon.

Add the ability to switch to DAF access for LAPS/MSAS. (The DAF version of the access scripts were provided to us by RTS).

Continued work on the new version of the A2 LAPS with a domain change GUI and ability to read most EDEX datasets in real time instead of converting to legacy system format by cron.

The LAPS/MSAS task is a joint effort with government staff from GSD's Evaluation and Decision Support Branch and the Earth Modeling Branch.

AWIPS I and II Formatters Task -

For HLS/TCV; improved the quality of the output produced by fixing bugs that were found during testing and simplifying the process for the forecasters to work with by adding checks which alert them to required missing information and the solution so that they'll know how to correct it and add the appropriate grids. This year's work was mostly about improving the quality of the formatters based on what was learned when using them during actual hurricane and tropical storm events.

For the TAF; improved the quality of the output produced, adding new features such as support for multiple-hour TEMPO/PROB groups and using the Visibility grid instead of visibility from Wx grids. These are two of the newest features just released the first week of March 2016. Sarah fixed many bugs and started refactoring the code to improve maintainability as well as extending the code to drastically improve debugging output to make it more efficient to find and fix bugs.

Feedback from multiple sources on the formatter has greatly improved the quality of output as well as improved validation scores (meaning the quality of the TAF output is much better and better portrays the meteorological situation). Before the TAF formatter, forecasters had to create TAFs by hand, but now the formatter creates TAFs and they can modify/tweak the output. Having the formatter reduces the amount of work for the forecasters and reactions from clients are positive with the new way of producing TAFs.

Probability of What (PHI into AWIPS2 Hazard Services)

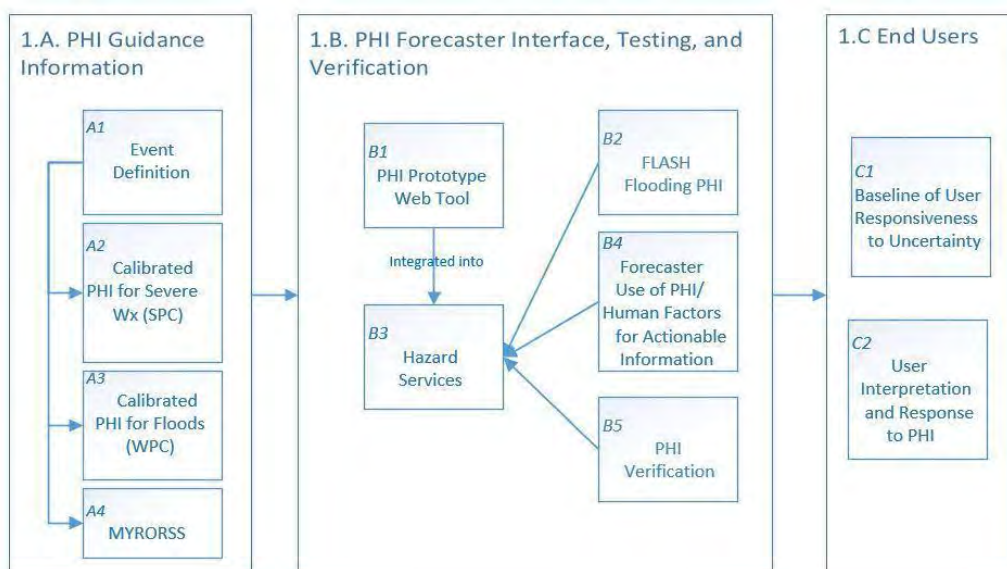

Figure 1. “Probability of What” concept map.

Forecasting a Continuum of Environmental Threats (FACETs) is a proposed next-generation severe weather watch and warning framework that is modern, flexible, and designed to communicate clear and simple hazardous weather information to serve the public. <<http://www.nssl.noaa.gov/projects/facets/>> FACETs supports NOAA's Weather-Ready Nation initiative to build community resilience in the face of increasing vulnerability to extreme weather and water events.

The US Weather Research Program (USWRP) awarded funding (for three years: June 2015 through May 2018) to support the “Probability of What” - a collaborative effort between NSSL, WPC, SPC, GSD, University of Oklahoma, University of Akron. This Research to Operations effort is the first to implement the (FACETs) concept into the National Weather Service. A key aspect of implementing the various subtasks of this project to operations is leveraging the AWIPSII Hazard Services plugin as a conduit.

The specific focus of CIRA/GSD personnel has been task B3 (Figure 1): integrating the functionality of NSSL’s Probabilistic Hazards Information (PHI) web prototype tool into Hazard Services. The “PHI into Hazard Services” work is the backbone of the FACETs initiative. The general PHI concept is that NWS forecasters, as well as objectively analyzed output, provide uncertainty information for impact weather in the form of a geospatial probabilistic grid that would be available to end users. The NSSL prototype functionality has several years of NWS forecaster and human factors expert input.

GSD is leveraging a branch of Hazard Services to implement the functionality of the NSSL prototype which would allow forecasters to analyze impact weather and produce PHI grids within AWIPS2. Specifically, CIRA/GSD personnel have done the following:

- Collaborate with partners to submit proposal
- Work closely with partners to transfer knowledge of prototype functionality
- Code design
- Develop AWIPS2 Hazard Services tools (known as “Recommenders”) to perform these tasks:
- Ingest automated analyses of convective impact weather and produce Hazard Events

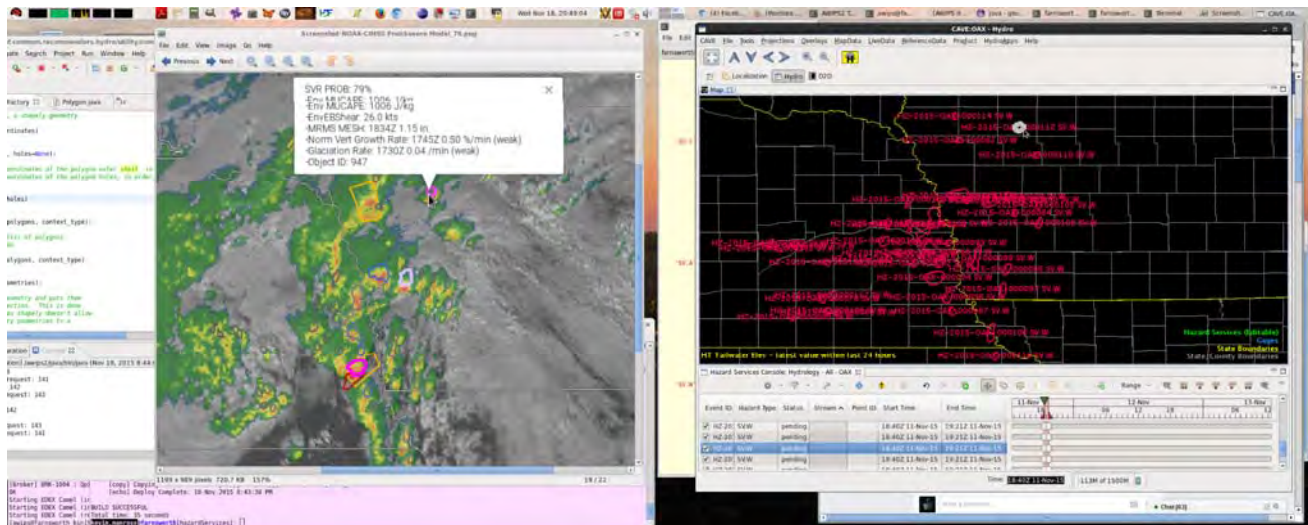

Figure 2. (Left)CIMSS/Wisconsin “ProbSevere” storm cell identification and evaluation algorithm product and display. (Right)GSD ingest and display of ProbSevere in AWIPS2 Hazard Services.

- Produce downstream geospatial “swaths” of expected impact
- User Interfaces (UIs) that allow forecasters to interact with automated, and user-defined, Hazard Events metadata

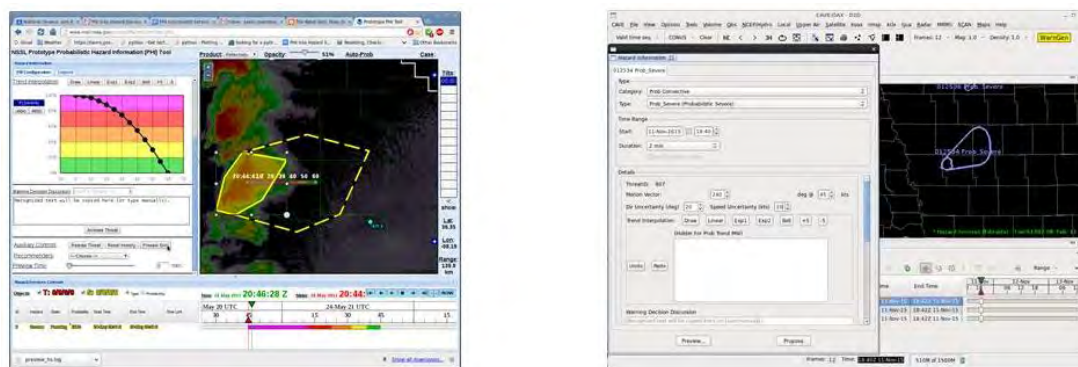

Figure 3. (left)NSSL’s Probabilistic Hazard Information (PHI) web browser based prototype tool. (right) GSD’s implementation of the user interface and display of the PHI concept in AWIPS2 Hazard Services.

- Produce gridded geospatial output (“PHI grids”)
- Configure AWIPS2 to display PHI grids

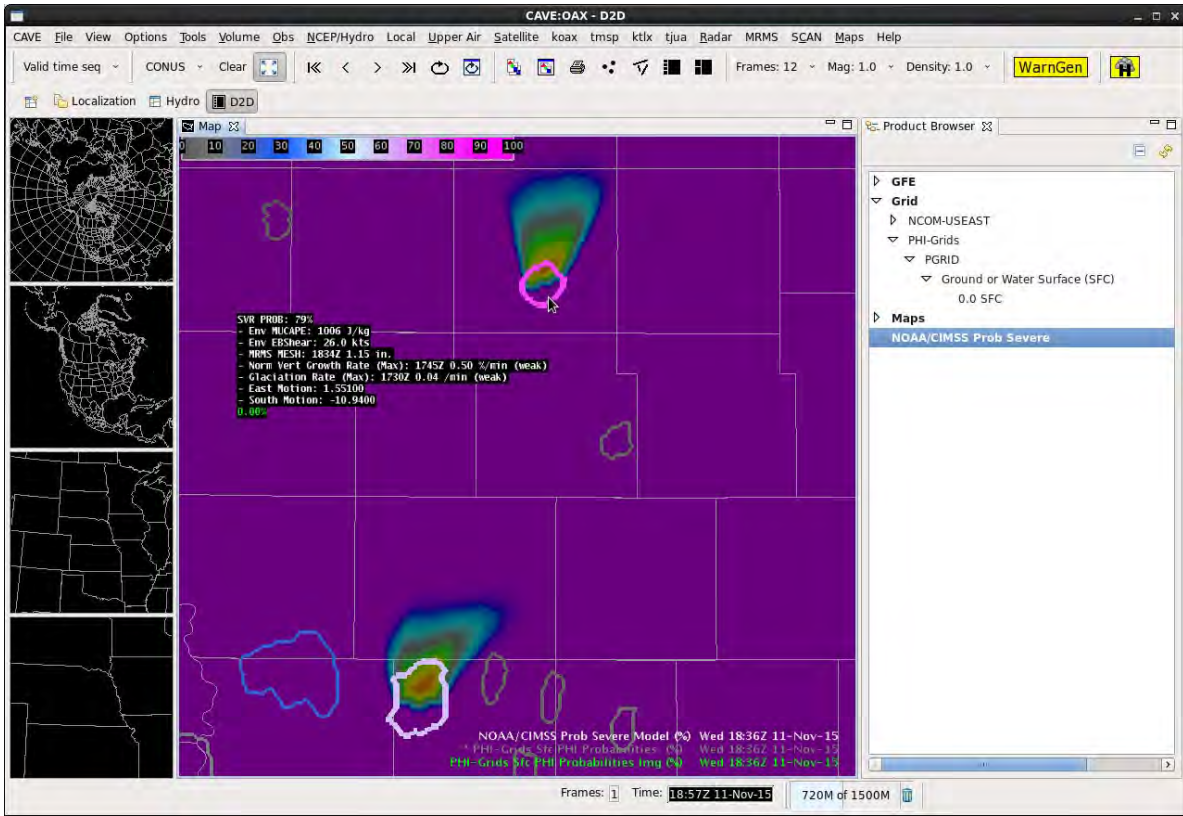

Figure 4. Display of ProbSevere icons (open polygons) along with PHI Grids displayed in AWIPS2 D2D perspective. PHI grids were calculated and produced via AWIPS2 Hazard Services “recommender” implemented by GSD.

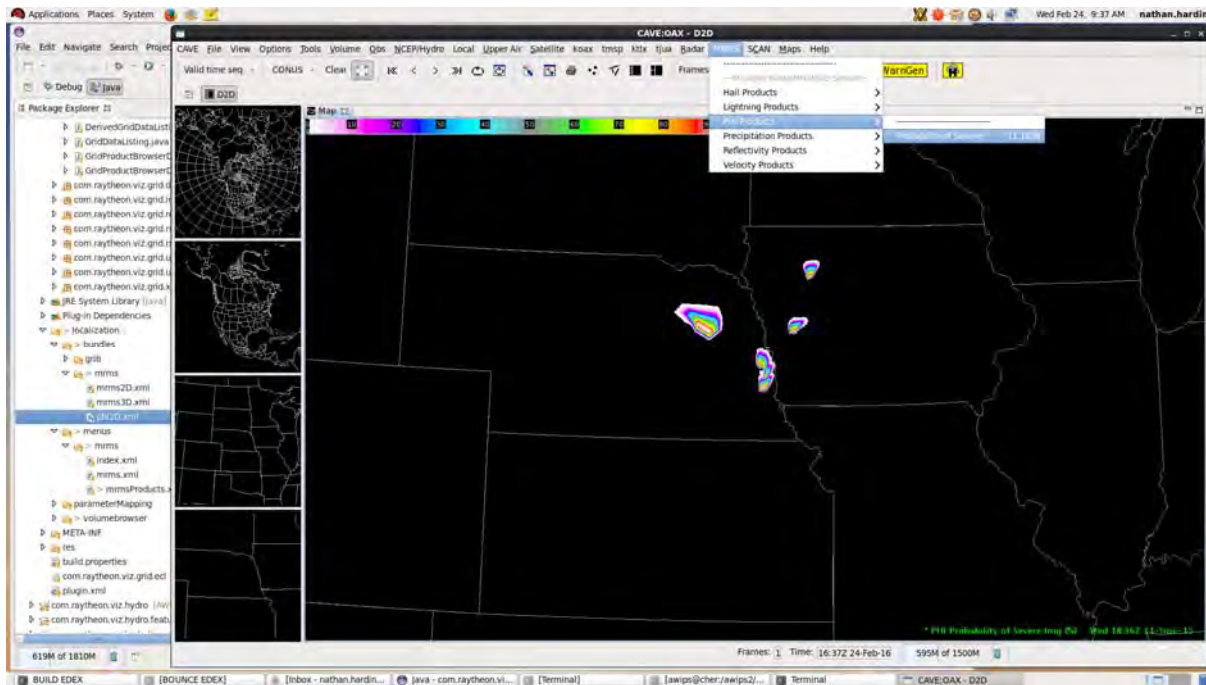

Figure 5. Refinement of PHI grids displayed in AWIPS2 D2D including configuration of menu items.

By the fourth quarter of Year 1 of the USWRP funding cycle (March-May 2016), GSD's initial implementation of the PHI concept into AWIPS2 Hazard Services will be delivered and tested in the NOAA Hazardous Weather Testbed in Norman, OK in front of NWS forecasters for evaluation and feedback.

AWIPS - Additional R&D

CIRA staff began work on a GSD Director's Directed Research Fund (DDRF), entitled "An AWIPS-II interface to NOMADS via web services." The short term objective is to make available in the AWIPS-II Volume Browser displays of meteorological datasets obtained from the world-wide-web. These datasets will be obtained by web service calls. The long term objective of the R&D is to investigate the feasibility of creating a browser based version of AWIPS II that could be used, for example, by regional emergency management personnel to view AWIPS data.

AWIPS II Transition Task - Forecast Decision Support Environment - Ensemble Feature Migration Referred to as the Ensemble Tool project, CIRA personnel were tasked with migrating Ensemble application features from the AWIPS-I ALPS D/2D workstation into the AWIPS-II CAVE workstation, and to add new two new tool features: the Matrix navigation tool and the Distribution tool.

The following new development took place on the Ensemble Tool project over the past 12 months:

--Delivery of a functional integrated tool/viewer for both plan view and plume diagram editors.

--Delivery of the first operational release of the Ensemble Tool was delivered to the NWS in version OB 15.1.

--Delivery of a second release for version OB 16.2.2 which includes:

----Matrix navigation feature: This tool allows users to load multiple model sources in order to conveniently do A-B comparisons between field/plane pairs, which allows the forecaster to quickly intercompare model solutions with a single click and thereby assess and communicate alternative forecast scenarios.

----Distribution viewer feature: This tool allows users to sample the loaded ensemble members at a particular spatial point and display a histogram chart with distribution functions overlaid. The forecaster can then interactively read threshold exceedance probabilities off the chart.

--Source code management and project support for task/issue tracking, code-review processes, continuous integration, and personnel guidance and support.

AWIPS II Transition Task - Migrate existing user created procedures and color tables.

The basic development for this task has been done for over a year, but there are still occasional trouble tickets to respond to in this area. During this evaluation period, this work has averaged about a half day per month, but is trending downward. Once the deployments are finished later this year, we may well close the book on this task for good.

AWIPS I Ongoing Task - FX-Net Project

The FX-Net project continues on its 18+ year journey.

FX-Net as a service solution is in its planned obsolescence phase, with an expected end date of early 2017, to be replaced by AWIPS II based solutions (see FxCave Project below).

The FX-Net service includes two fielded meteorological workstation solutions, FX-Net and Gridded FX-Net. Both workstations are fed by an AWIPS I data ingest infrastructure which includes a fault-tolerant pair of four server hosts: communications processor, data server, application server, and load balancer. The Gridded-Fx-Net workstation is additionally fed by a spooler, compression manager, and ldm server. Ongoing maintenance includes maintaining a high-availability meteorological data service for our field customers who include the National Interagency Fire Center, Colorado Water Board, and the Chief Presidential Support Element in charge of the Executive Fleet at Andrews AFB, as well as local laboratory researchers.

Demand for this support over the past 12 months was above normal as the underlying hardware and software systems are becoming outdated; mean-time between hardware failures are on the rise.

AWIPS II Extended Task - FxCAVE Project

The FxCAVE project is the name of the AWIPS II thin-client service/workstation which will replace the AWIPS I FX-Net service/workstation.

The FxCAVE mission includes:

- Provide AWIPS II services and applications to customers (field personnel).
- Provision physical hardware (on behalf of customers) with FxCAVE meteorological workstation.
- Provide maintenance and support of research-regular production-based EDEX servers.
- Provide maintenance and support of fielded FxCAVE workstations.
- Provide data ingest for third-party, research-regular, meteorological data.

FxCAVE as a service solution is composed of the AWIPS II application (EDEX) servers and a pared-down version of the Common AWIPS Visualization Environment (CAVE) meteorological workstation, which has been rebranded to the Forecast eXperimental CAVE (FxCAVE).

These services include continual support of the National Interagency Fire Center (NIFC) and their satellite Geographical Area Coordination Center (GACC) offices.

For FxCAVE project, the following accomplishments have been made over the past 16 months:

- Provisioned 10 (ten) physical desktop FxCAVE workstations for the NIFC/GACC.
- Provisioned, maintained and supported 3 (three) EDEX servers including AWIPS II OB 14.4 through OB 15.2.
- Provisioned and maintained FxCAVE workstation on Linux and Windows 7 through versions AWIPS II OB 14.4 through OB 15.2.
- Continued research on Virtualization ("FxCAVE in the Cloud"):
- Successfully provisioned the OB 15.2 EDEX server as a VM (virtual machine).
- Successfully provisioned the OB 15.2 FxCAVE client (Windows 7) using Virtualization.
- Research includes performance and usability testing.

The FxCAVE project now maintains all of its documentation and status on a NOAA-provided Google Site.

PROJECT TITLE: EAR - Meteorological Assimilation Data Ingest System (MADIS)

PRINCIPAL INVESTIGATORS: Sher Shranz

RESEARCH TEAM: Tom Kent, Leigh Cheatwood-Harris, Randall Collander, Michael Leon, Amenda Stanley, Richard Ryan, Glenn Pankow, and Patrick Hildreth

NOAA TECHNICAL CONTACT: Greg Pratt (OAR/ESRL/GSD/ATO)

NOAA RESEARCH TEAM: Leon Benjamin (CIRES), Gopa Padmanabhan (CIRES), Michael Vrencur (ACEINFO)

PROJECT OBJECTIVES:

MADIS is dedicated toward making value-added QC data available for the purpose of improving weather forecasting. MADIS data helps to provide support for use in local weather warnings and products, data assimilation, numerical weather prediction, and the whole meteorological community in general. This is accomplished by partnerships with both federal and state government agencies, universities, airlines, private companies, and individual citizens.

Project Objectives:

To continue to add new functionality and data sources to MADIS.

To provide support to the user community.

Continue to transition new and enhanced MADIS research to operations at NWS NCEP.

PROJECT ACCOMPLISHMENTS:

CIRA researchers continue working on a suite of research to operations tasks with varying degrees of completion. MADIS has or is in the process of integrating ASOS, IOOS, HAD, AFWS, CLARUS, SNOTEL, NGITWS, and NWS Data Delivery systems into MADIS IDP operations at NCO. Many new data providers were added as well as a more automated testing and implementation process to improve future release efficiency.

MADIS achieved Final Operating Capability (FOC) at the NWS National Centers for Environmental Prediction (NCEP) Central Operations (NCO) in Jan, 2015. The NCO facility is located in College Park, MD and is the center of operations with its new Integrated Dissemination Program (IDP) infrastructure for NOAA wide data dissemination. With a couple of new software releases in 2015 for the IDP, MADIS has some new high profile additions:

ASOS (Automated Surface Observing System) - In September 2015 a real-time connection for 1 minute ASOS data was established between the FAA operational data facilities and NWS-MADIS. This valuable and highly reliable data set is coveted by the WFOs for support in forecasting. MADIS is the only non-FAA entity getting this binary data in real time.

IOOS (Integrated Ocean Observing System) - MADIS began handling IOOS data with a new decoder developed in conjunction with some of the National Mesonet Program data providers. The MADIS decoder leveraged work done by the NMP partners which included standardizing the CSV data and header formats so that future IOOS formatted data can quickly be added to the system due to the self-describing nature of the IOOS standard. More work is continuing on the standards for the IOOS metadata using *FL (Starfish Fungus Language) which is part of a larger MADIS effort on standardizing all metadata.

CLARUS - A lot of work was done by MADIS to integrate CLARUS into MADIS to transition Department of Transportation (DoT) data, metadata, and QC algorithms to operations at NCO. The CLARUS QC will be applied to data in addition to the MADIS QC. This work will continue in 2016.

HADS (Hydrometeorological Automated Data System) and AFWS (Automated Flood Warning System) - These very reliable and important hydro systems are being migrated into MADIS to achieve cost efficiencies and consolidation for NOAA. The HADS is a mission essential function that acquires, processes, and disseminates critical hydrological and meteorological data to the National Weather Service (NWS) Field Offices to protect life and property. The AFWS was added in 2013 to include ALERT, ALERT2, and IFLOWS hydro data into the HADS system. HADS produces tailored Standard Hydrometeorological Exchange Format (SHEF) text products for the River Forecast Centers (RFCs), Weather Forecast Offices (WFOs), and for National Centers for Environmental Prediction (NCEP) from GOES DCP data. HADS also processes the AFWS data to produce both SHEF encoded text products as well as Hydrologic Markup Language (HML) products. These products are disseminated through the NWS Telecommunications Gateway infrastructure. Additionally, HADS maintains a web site where GOES DCP meta-data and decoded data are made available to the NWS, HADS stakeholders, all levels of governments, as well as the general public. There has been a lot of progress to integrate these systems into MADIS and the complex nature of multiple databases, data clients, and web interfaces took a lot of effort and collaboration with many different groups within NWS.

NGITWS (NextGen IT Web Services) - The NextGen congressionally mandated requirement is to provide enhanced weather forecast information required for integration into an air traffic management system, using an Open Geospatial Consortium (OGC)-compliant net-centric weather information dissemination capability. This year efforts focused on the delivery of all Product Data Descriptions documents for all products listed in the NOAA/FAA Product Delivery List. The MADIS team has created three OGC templates for this data delivery:

Web Coverage Service Data
Web Feature Service Data

Web Mapping Service Data

The MADIS team has also worked on automating the creation of these PDD documents and worked to define a process that efficiently and cost effectively allows these documents to be maintained by NWS and incrementally improved as required. The definitions and processes the MADIS team created for PDD development can be used to handle all metadata creation and improvements and will be briefed to NWSHQ later this year.

NWS DATA DELIVERY - MADIS has worked with Raytheon to reconfigure the MADIS Data Provider Agent for release to run at NCO. While waiting for NCO operational VMs to become available in 2017, these DPA capabilities are hosted at GSD on MADIS systems that both NWS AWIPS test and operational systems have access to.

PROJECT TITLE: EAR - Citizen Weather Observer Program (CWOP)

PRINCIPAL INVESTIGATORS: Sher Shranz

RESEARCH TEAM: Leigh Cheatwood-Harris, Randall Collander, and Tom Kent

NOAA TECHNICAL CONTACT: Greg Pratt (OAR/ESRL/GSD/ATO)

NOAA RESEARCH TEAM: Leon Benjamin (CIRES), Gopa Padmanabhan (CIRES), Michael Vrencur (ACEINFO)

PROJECT OBJECTIVES:

The Citizen Weather Observer Program (CWOP) database is now maintained by the MADIS Staff. CIRA researchers administer the CWOP through database updates (adding new stations, removing stations no longer reporting data, and maintaining accurate site location information), interactions with CWOP members (answering questions and discussing suggestions, and investigating data ingest and dissemination issues), refreshing related web pages and documents, verifying that station listings and other reference data required by MADIS are complete and accurate, and confirming that routine backups of database and related files are performed. The CWOP is a public-private partnership with three main goals:

- 1--Collect weather data contributed by citizens.
- 2--Make these data available for weather services and homeland security.
- 3--Provide feedback to the data contributors so that they have the tools to check and improve their data quality.

There are currently 20,337 active stations (citizen and ham radio operators) out of a total of 33,142 stations in the CWOP database. CWOP members send their weather data via internet alone or internet-wireless combination to the findU (<http://www.findu.com>) server and then the data are sent from the findU server to the NOAA MADIS ingest server every five minutes. The data undergo quality checking and then are made available to users thru the MADIS distribution servers. CWOP is in the process of transitioning to operations within the NCO IDP MADIS system.

PROJECT ACCOMPLISHMENTS:

This past year the process of transitioning CWOP to run inside MADIS began. The first major step was taking the hundreds of thousands of links from the CWOP web site and organizing them to streamline the same capability within the MADIS web domain. This resulted in the reduction of thousands of links as well as a more clearly defined interface to search for information about CWOP and its data. More database procedures were enhanced through development and implementation of scripts to auto-correct missing

and typographical errors in new member sign-up requests, and through introduction of automated site geographic location and elevation verification algorithms. Interactions occurred with users via email regarding site setup, data transmission issues, quality control and general meteorology. Various web-based documents and databases were updated on a daily, weekly or monthly basis depending on content, and statistics and other informational graphics revised and posted. These improvements were all done with the intent to mesh with the current and future work on standardization of MADIS metadata.

In 2015, there were approximately 2200 stations added to the database. Approximately 1200 revisions were made to site metadata. Adjustments include latitude, longitude and elevation changes in response to site moves, refinement of site location, and site status change (active to inactive, vice-versa).

PROJECT TITLE: EAR - Research Collaborations with Information and Technology Services

PRINCIPAL INVESTIGATOR: Sher Schranz

RESEARCH TEAM: Leslie Ewy, Patrick Hildreth, Robert Lipschutz, Christopher MacDermaid, Glen Pankow, Richard Ryan, Amenda Stanley, and Jennifer Valdez

NOAA TECHNICAL CONTACT: Scott Nahman (OAR/ESRL/GSD/ITS Chief)

PROJECT OBJECTIVES:

CIRA researchers in the GSD Information and Technology Services (ITS) group develop and maintain systems that acquire, process, store, and distribute global meteorological data in support of weather model and application R&D projects throughout GSD. CIRA researchers collaborate with ITS and other GSD researchers to provide services that meet the specified requirements. CIRA staff also participate as team members of several projects within other GSD branches.

PROJECT ACCOMPLISHMENTS:

--GSD Central Facility - CIRA researchers continued to manage a 6-host data processing cluster that acquires, processes, and transports data to meet GSD requirements. By the end of the year, the system was handling over 2.5 TB of meteorological data daily for users within GSD and on the NOAA R&D High Performance Computing Systems (RDHPCS), theia and jet. Selected GSD data sets were also made available through FTP, Local Data Manager (LDM) and web services established and maintained by the CIRA ITS team. In addition, a variety of data saved to the HPSS mass storage system were retrieved on behalf of GSD users for their retrospective studies. The system was also configured to acquire a number of new data sets, including experimental RAP Version 3 and HRRR version 2 model data from NCEP, Himawari-8 and VIIRS satellite data from NESDIS, and TAMDAR aircraft observations from a commercial data provider. The group extended data decoding methods to handle several new data types, and completed a project to port its C++ software to use NetCDF (network Common Data Form) version 4 libraries.

CIRA researchers continued the process of transitioning services from physical computers to virtual systems, and facilitated the decommissioning of a legacy storage device by implementing a new method to efficiently transport model graphics and manage them on an alternate storage server. Finally, toward replacing the legacy data cluster hardware, the CIRA team developed system requirements and design documentation for a new virtual Central Facility Data (CFD) system, and began implementing the first development component.

--MADIS (Meteorological Assimilation Data Ingest System) - The CIRA ITS team provided direct support to the MADIS project in several areas. Of particular note, they began an effort to port National Weather Service Hydrometeorological Automated Data System (HADS) and Automated Flood Warning Systems

(AFWS) software to operate within NOAA's Integrated Dissemination Program (IDP) environment. The team also implemented acquisition methods for various Local Data Acquisition and Dissemination (LDAD) data sets.

--High-Impact Weather Prediction Project (HIWPP) - CIRA team members collaborated with researchers across NOAA, and with others outside NOAA, in support of the development and evaluation of high-resolution global weather models. CIRA researchers continued implementing and supporting data services for this project, including methods to efficiently transfer large model datasets from the NOAA RDHPCS systems to the HIWPP data distribution and visualization systems. In close collaboration with the GSD Earth Modeling Branch, CIRA researchers in ITS also continued developing a web framework, dubbed the Model Analysis Tool Suite (MATS), that will allow GSD scientists to access and display verification statistics in new ways that will overcome several limitations of the legacy methods.

--NextGen IT Web Services Program (NGITWS) – CIRA researchers continued to collaborate with researchers from NOAA's Meteorological Development Laboratory, NOAA's Aviation Weather Center, and NCAR to develop web-based data dissemination services. CIRA researchers provided subject matter expertise to the program on data translation services, data dissemination services, and data formats. The team developed Product Description Documents (PDDs) for a number of data types, and explored methods for automating the process of generating PDDs.

--NOAA Earth Information System (NEIS) - This year a CIRA team member in ITS extended the image handling software to accommodate a new requirement for handling the DDS image format.

--GSD Web Services - CIRA researcher, Jennifer Valdez, serves as GSD Webmaster, providing numerous services to GSD scientists, RDHPCS management, and external community members. Her activities included continuing to develop and support the RDHPCS Account Information Management system, substantially revamping the GSD website, and developing a new website in preparation for the 5-year GSD Science Review.

PROJECT TITLE: EAR - NextGen IT Web Services/Integrated Dissemination Program (IDP), (Formerly NGITWS)

PRINCIPAL INVESTIGATOR: Sher Schranz

RESEARCH TEAM: Michael Leon, Glen Pankow and Patrick Hildreth

NOAA TECHNICAL CONTACT: Greg Pratt (OAR/ESRL/GSD/ATO), Ryan Solomon (NOAA/NWS/AWC)

NOAA RESEARCH TEAM: Leon Benjamin (CIRES)

PROJECT OBJECTIVES:

CIRA researchers are providing subject matter expertise and developing documentation for the NextGen IT Web Services Program (NGITWS). The National Oceanic and Atmospheric Administration (NOAA) Integrated Dissemination Program (IDP) is fielding NGITWS, a web-based data dissemination service that will revolutionize the accessibility, discoverability, and machine-to-machine communication and processing of National Weather Service (NWS) data sets. Focused on Open Geospatial Consortium (OGC) standard services and data formats for maximum interoperability, initial operational capabilities will be available from two geographically-diverse state-of-the-art data centers in College Park, Maryland, and Boulder, Colorado. While the initial deployment will focus on aviation-centric data sets to support the Federal Aviation Administration (FAA) Next Generation Air Transportation (NextGen) system, others are preparing to take advantage of this new service including the NWS Advanced Weather Interactive Processing System (AWIPS) and Aviation Weather Center (AWC) Web Services.

PROJECT ACCOMPLISHMENTS:

--CIRA researchers delivered Product Data Description (PDD) documents for multiple data sets related to model (gridded) data as well as non-gridded data. PDDs were revised with the information from the reviews. These PDD deliveries, reviews, and revisions are ongoing and expected to continue through the following year.

--CIRA researchers completed development on the AMDAR (Aircraft Meteorological Data Relay) PDD and created the initial version of a MADIS (Meteorological Assimilation Data Ingest System) AMDAR WXXM (Weather Information Exchange Model) 2.0 mapping – including a live feed of AMDAR WXXM data being used by the NGITWS Program.

--CIRA researchers attended technical interchange meetings with the FAA, the National Weather Service (NWS), and the National Center for Atmospheric Research (NCAR) in their role as subject matter experts to discuss dissemination techniques, atmospheric data formats, and web services. CIRA researchers also presented on NGITWS at the NOAA Environmental Data Committee Workshop.

PROJECT TITLE: EAR - Science on a Sphere® (SOS) Development

PRINCIPAL INVESTIGATOR: Sher Schranz

RESEARCH TEAM: Keith Searight, Steve Albers

NOAA TECHNICAL CONTACT: John Schneider (OAR/ESRL/GSD/ATO Chief)

NOAA RESEARCH TEAM: Shilpi Gupta (CIRES), Vincent Keller (CIRES), Ian McGinnis (CIRES), Stephen Kasica (CIRES), Dr. Tony Liao (NOAA visitor)

PROJECT OBJECTIVES:

- 1--Continue to develop and enhance near-real-time and other global data sets for use at SOS sites
- 2--Provide software and technical support for existing SOS systems sites, new and proposed SOS installations, and travelling SOS exhibits that conduct scientific education and outreach
- 3--Plan and release new versions of the SOS system software with prioritized features
- 4--Research new technologies and configurations for future innovations in SOS

PROJECT ACCOMPLISHMENTS:

The Science on a Sphere® (SOS) Development project advances NOAA's crosscutting priority of promoting environmental literacy. SOS displays and animates global data sets in a spatially accurate and visually compelling way on a 6-foot diameter spherical screen. CIRA provides key technical leadership and developments to the SOS project, particularly research and implementation of effective controls and user interfaces for the system, new visualization techniques, and new data sets.

1-- Near-real-time and other global data sets

The SOS team continued to support the automated transfer of large volumes of near-real-time weather model data to SOS sites via private FTP. Recently collected statistics have documented a monthly average of over 14 TB of SOS datasets downloaded, which doubled in volume over the previous year. Highlights for this reporting period included:

--Continued maintaining real-time weather models (Global LAPS, FIM, GFS) on SOS. Other real-time datasets being developed and maintained include global weather satellite, earthquakes, and solar extreme ultraviolet images from the STEREO spacecraft.

--Created global mosaics for images of Pluto from New Horizons in high resolution (16K) for display on SOS (Figure 1).

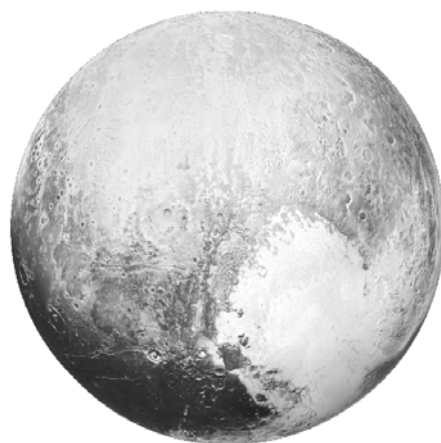

Figure 1. Pluto.

--Worked with SOS colleagues to set up high resolution versions of a number of datasets, including Solar System objects.
--Set up images and animations of new data from the NOAA/NASA DSCOVR satellite, providing unique views of planet Earth.
--Improved a real-time dataset that shows trajectory wind streamers from the FIM model, so that it has higher resolution (4K) and shows the jet stream at the 250mb level.
--Helped to update datasets for Saturn's moons using new maps created at the Lunar and Planetary Institute.
--Gave a presentation about recent datasets at the SOS Workshop in Portland, OR where there was much useful interaction with a wide variety of SOS collaborators.
--Participated in real-time weather demonstrations at the AMS 2016 conference in New Orleans, AZ.
--Submitted a successful proposal to the NOAA GSD Director's Directed Research Fund (DDRF) entitled "Creating High Resolution Content for the Next Generation Science On a Sphere®" with Keith Searight as Principal Investigator and Steve Albers as a Co-Investigator. Awarded \$20K to develop new datasets for display on 4K SOS systems with at least 8K resolution. Results are planned to be presented to the GSD Director in April 2016.

2--Software and technical support for SOS systems

The SOS team provided regular support to SOS sites by e-mail and telephone. The issues handled included upgrades and problems with the SOS software, hardware, and equipment, finding and accessing datasets, and questions about operating the SOS system.

During this reporting period, 16 new SOS systems were installed at sites in Texas, New York, Indiana, Connecticut, Columbia, China, Indonesia, Saudi Arabia, and Macau. The total number of SOS systems installed worldwide now exceeds 130.

In support of scientific education and outreach, portable SOS systems and SOS team members travelled to conferences and workshops around the world, including the World Science Festival (New York), Supercomputing (SC15) Conference, American Meteorological Society (AMS) Annual Meeting, Consumer Electronics Show (Las Vegas), the 7th SOS Users Collaborative Network Workshop (Portland, OR), National Center for Atmospheric Research (Boulder), Do Space (Omaha, NE), and the COP 21 Climate Change Conference (Paris) (Figure 2).

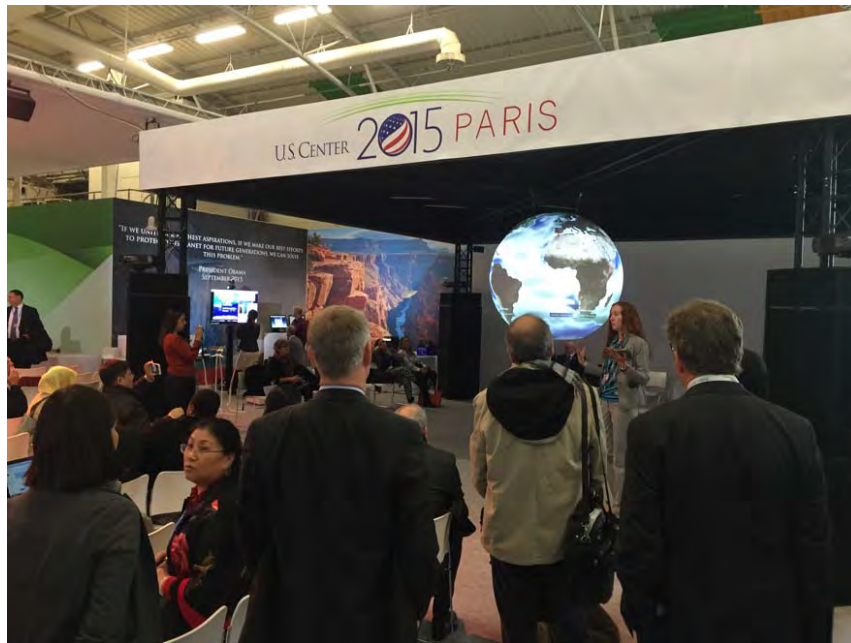

Figure 2. SOS presentation at COP 21.

At the SOS Workshop in Portland, Keith Searight presented a number of technical “how to” sessions, including “How to Use Non-English Languages in SOS”, “New SOS Technologies Demonstration”, “The iPad SOS Remote App: An Overview of Recent and New Capabilities”, and “Customizing the NOAA SOS Public Kiosk”.

3--Plan and release new SOS capabilities

Under CIRA staff’s leadership, the SOS team planned and executed a major software release with many new features and capabilities. SOS v5.0 (Nov. 2015) met all planned objectives on schedule. Major highlights were:

--NOAA SOS Public Kiosk (Figure 3): A widely requested SOS capability has been a project-supported public touch-screen kiosk for the general public to control the sphere when a presenter is not available. The first kiosk version runs on standard Windows hardware, has simulated track ball, has multi-language support, and easy and flexible configuration to customize the appearance and content for specific SOS sites.



Figure 3. NOAA SOS Public Kiosk, demonstrating multi-language support.

--Language Translation Support: SOS now supports localization to non-English languages using ISO industry standards for languages and country variants. Localization increases the reach of SOS into international audiences and for multilingual populations. The actual translations will be done mainly by distributors, content creators, or the sites themselves, although the SOS project will coordinate and facilitate the translation work.

--SphereCasting Update: The SphereCast software's underlying infrastructure was very old and was significantly upgraded. A new SphereCasting server was also deployed to replace an aging system that could no longer have security patches applied.

--Interactive Splitter (Figure 4): A new visualization feature splits the sphere into 2-4 slices that replicates the area in front of the presenter. This popular capability is very useful for presenting to audiences positioned on all sides of SOS and avoids the need to rotate datasets and repeating an explanation multiple times.

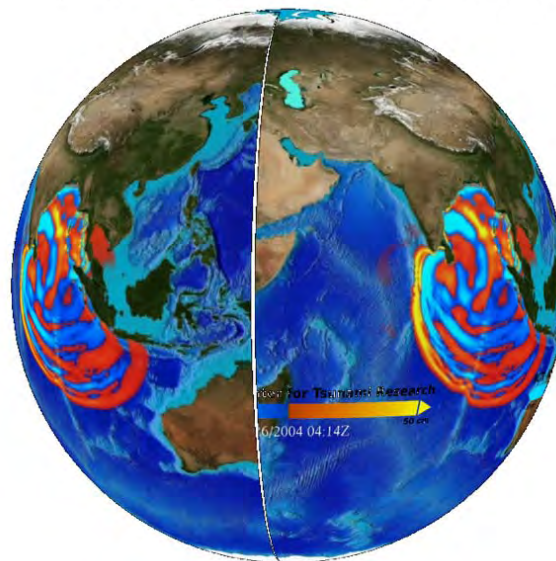

Figure 4. Splitting the sphere.

--Visual Playlist Editor: A "preview edition" of a new playlist editor that creates, modifies, and displays SOS datasets using an intuitive, visual user interface.

--Improved Auto Alignment: The experimental version released last year to automatically align the four SOS projectors using computer vision was made more accurate using higher resolution cameras. The algorithms were also made more tolerant of differences in color and ambient lighting.

--SOS Website: The project website has become a key resource to the community for finding new and interesting datasets, as well as distributing release documentation. Responsive design was implemented to easily and efficiently scale the site's appearance on different devices including phones, tablets, and desktops. Google Analytics were expanded to gauge site performance and SOS data catalog browse and filter capabilities were expanded.

4--Research new technologies and configurations for future innovations in SOS

To keep SOS at the forefront of spherical display quality, a prototype 4K SOS system was tested and innovative new ways for creating better SOS content more easily were investigated:

--4K Projector Support: 4K projection technology is now available in the marketplace, though it is still relatively expensive compared to regular HD. The SOS team borrowed several different graphics cards from vendors and purchased 2 4K projectors to evaluate the feasibility of a full 4K SOS system. A hybrid system with 2 HD and 2 4K projectors was set up and provided a very effective contrast with the 4x better 4K resolution. The 4K projectors had much sharper imagery, especially for text and linear features, better zoom quality, and less image flickering when rotating an image. The SOS software will be enhanced to increase performance, but the current system is now ready to drive a full 4K SOS system. The SOS project is approved and funded to the purchase of a full 4K SOS system for use at the NOAA SOS site in Boulder later in CY 2016.

--Visual Playlist Editor: Having great content to show on SOS is a key to its impact as a scientific education tool. The new Visual Playlist Editor (VPLE) is the beginning of a new, more powerful application for SOS content providers to put together media and construct a high quality presentation. The SOS team researched different ways to rapidly create and modify datasets and presentations and investigated software toolkits to support implementation of those features, and these ideas will be incorporated in new VPLE during the next year and beyond.

EAR PUBLICATIONS:

Albers, S., K. Holub, Y. Xie, Z. Toth, 2016: Visualization and Validation of NWP Cloud and other Fields with Simulated Weather Imagery. Proceedings, 20th Conference on Integrated Observing and Assimilation Systems for the Atmosphere, Oceans, and Land Surface (IOAS-AOLS), New Orleans, LA, Amer. Met. Soc., 5.6.

Albers, S. C. K. Holub, Y. Xie, 2015: GPM: Radar Observations and Simulations with the Local Analysis and Prediction System (LAPS). Proceedings, Global Precipitation Measurement, Validation and Applications, San Francisco, CA, Amer.Geophys. Union, H21M-03.

Alcott, T., C.R. Alexander, I. Jankov, 2016: Better Living Through Post-Processing: Improving Probabilistic Heavy Rainfall Prediction. Proceedings, 14th Conference on Artificial and Computational Intelligence and its Applications to the Environmental Sciences, New Orleans, LA, Amer. Met. Soc., J21.2.

Alcott, T., C.R. Alexander, and I. Jankov, 2016: Probabilistic Hazard Detection using Time-lagged Ensemble. Proceedings, 23rd Conference on Probability and Statistics in the Atmospheric Sciences, New Orleans, LA, Amer. Met. Soc., 2.4.

Alexander, C.R., T. Alcott, I Jankov, S.S. Weygandt, and S.G. Benjamin, 2016: Probabilistic Hazard Products using time-lagged HRRR ensemble. Proceedings, 32nd Conference on Environmental Information Processing Technologies, New Orleans, LA, Amer. Met. Soc.,9.5.

Benjamin, S. G., S. S. Weygandt, J. M. Brown, M. Hu, C. Alexander, T. G. Smirnova, J. B. Olson, E. James, D. C. Dowell, G. A. Grell, H. Lin, S. E. Peckham, T. L. Smith, W. R. Moninger, J. Kenyon, and G. S. Manikin, 2016: A North American Hourly Assimilation and Model Forecast Cycle: The Rapid Refresh, *Mon Wea Rev*, in press. <http://ruc.noaa.gov/pdf/RAP-paper-9dec2015.pdf>

Bocquet, M., H. Elbern, H. Eskes, M. Hirtl, R. Zabkar, G.R. Carmichael, J. Flemming, A. Innes, M. Pagowski, J.L. Pérez Camaño, P.E. Saide, R. San Jose, M. Sofiev, J. Vira, A. Baklanov, C. Carnevale, G. Grell, and C. Seigneur, 2015: Data assimilation in atmospheric chemistry models: current status and future prospects for coupled chemistry meteorology models. *Atmos. Chem. Phys.*, 15, 5325-5358, doi:10.5194/acp-15-5325-2015.

Etherton, B. J., G.J. Layne, P. Hamer, and M. A. Petty, 2016: Aviation Weather Decision Support: INSITE. Proceedings, 32nd Conference on Environmental Information Processing Technologies, New Orleans, LA, Amer. Met. Soc., 9.6.

Govett, M, J. Rosinski, J. Middlecoff, T. Henderson, J. Lee, A. MacDonald, P. Madden, J. Schramm, and A. Duarte, 2016: Parallelization and Performance of the NIM Weather Model for CPU, GPU and MIC Processors. *Bull. Amer. Meteor. Soc.*, submitted.

Henderson, T. B., Michalakes, J., Gokhale, I., Jha, A., "Chapter 2 - Numerical Weather Prediction Optimization." High Performance Parallelism Pearls Volume Two: Multicore and Many-core Programming Approaches. Morgan Kaufmann, 2015. pp. 7-23. doi: 10.1016/B978-0-12-803819-2.00016-1

Hu, M., J. Beck, S.S. Weygandt, D. Dowell, S.G. Benjamin, J.S. Whitaker, and C. Alexander, 2016: Progress of GSI 3D 1VAR-Ensemble Hybrid Data Assimilation for Rapid Refresh with Regional Ensembles. Proceedings, 20th Conference on IOAS-AOLS, New Orleans, LA, Amer. Met. Soc., J.43.

Jiang, H., S. Albers, Y. Xie, Z. Toth, I. Jankov, D. Birkenheuer, B. Motta, M. Scotten, J. Picca, et al., 2015: Real-Time Applications of the Variational Version of the Local Analysis and Prediction System (vLAPS). *Bull. Amer. Meteor. Soc.*, 96, 2045–2057. doi: <http://dx.doi.org/10.1175/BAMS-D-13-00185.1>.

Lin, H., S. S. Weygandt, M. Hu, S. G. Benjamin, and C. Alexander, 2016: Sensitivity of the RAP satellite radiance assimilation to the model top and other factors. Proceedings, Fourth AMS Symposium on the Joint Center for Satellite Data Assimilation (JCSDA), New Orleans, LA, Amer. Met. Soc., 2.2.

Nance, L., Y.H. Kuo, L.R. Bernardet, T. Jensen, K.M. Newman, H. Shao, I. Jankov, J.K. Wolff, 2016: Developmental Testbed Center: Facilitating R20 for Numerical Weather Prediction. Proceedings, 6th Conference on Transition of Research to Operations, New Orleans, LA, Amer. Met. Soc., 8.4.

Paulik, L., B. J. Etherton, M. S. Wandishin, M. A. Petty, 2016: Assessing Global Precipitation Mission (GPM) data for use by the Aviation Community. Proceedings, 18th Symposium on Meteorological Observation and Instrumentation, New Orleans, LA, Amer. Met. Soc., 11.6.

Wang, N., J.-W. Bao, J. Lee, F. Moeng, and C. Matsumoto, 2015: Wavelet compression technique for high-resolution global model data on an icosahedral grid. *J. Atmos. Oceanic Technol.*, 32, 1650-1667. <http://dx.doi.org/10.1175/JTECH-D-14-00217.1>

Weygandt, S. S., C.R. Alexander, S.G. Benjamin, T. G. Smirnova, D.C. Dowell, M. Hu, J.B. Olson, J. Kenyon, E.P. James, H. Lin, and I. Jankov, 2016: Improvements in Forecasting Regions of Aviation Hazard Impact from Advances in the HRRR and RAP Models. Proceedings, 5th Aviation, Range, and Aerospace Meteorology Special Symposium, New Orleans, LA, Amer. Met. Soc., 2.2.

Wu, J. B., J. Xu, M. Pagowski, F. Geng, S. Gu, G. Zhou, Y. Xie, and Z. Yu, 2015: Modeling study of a severe aerosol pollution event in December 2013 over Shanghai China: An application of chemical data assimilation. *Partic.*, 20, 41-51, doi: 10.1016/j.partic.2014.10.008.

PROJECT TITLE: Instructional Development and Learning

PRINCIPAL INVESTIGATOR: Sher Schranz

RESEARCH TEAM: Jenna E. Dalton

NOAA TECHNICAL CONTACT: Scott Tessmer (NOAA/OMAO/Chief Learning Officer)

FISCAL YEAR FUNDING: \$160,000

PROJECT OBJECTIVES:

Provide comprehensive on-site technical and administrative support to the OMAO CLO. Support tasks fall into four capacities:

- 1--Instructional Development for OMAO mission specific training in collaboration with subject matter experts for course content.
- 2--NOAA OMAO Commerce Learning Center (CLC) Administrator supports OMAO Learning Coordinators and test tools and products within the system to support the transition to the new Cornerstone OnDemand (CSOD) system.
- 3--OMAO Training Portal content, management and maintenance provides research, development and maintenance of learning content for OMAO employees on the OMAO CLO Training Portal.
- 4--Resource management for the OMAO Chief Learning Officer (CLO) including budget, travel, document analysis, program and administrative support as well as provide administrative support for our collaborative partnership with the National Weather Service Training Center (NWSTC).

PROJECT ACCOMPLISHMENTS:

CIRA support for this project in four primary areas:

Instructional Development for OMAO mission specific training in collaboration with subject matter experts for course content.

-NOAA Diving Program

The NOAA Diving Program (NDP), is administered by the U.S. Department of Commerce, National Oceanic and Atmospheric Administration (NOAA), and is headquartered at the NOAA Diving Center in Seattle, Washington. The NOAA Diving Program trains and certifies scientists, engineers and technicians to perform the variety of tasks carried out underwater to support NOAA's mission. With more than 400 divers, NOAA has the largest complement of divers of any civilian federal agency. In addition, NOAA's reputation as a leader in diving and safety training has led to frequent requests from other governmental agencies to participate in NOAA diver training courses.

The NOAA Diving Program is in the process of redesigning their training courses and the OMAO CLO offered support resources involving instruction design and CLC administration. As a guide for future course development, the NOAA Oxygen Administration course, shown below in Figure 1, was published and tested in the CLC Pilot. This project will continue through the next fiscal year, requiring OMAO CLO resource support skills provided by Jenna Dalton, CIRA Associate.

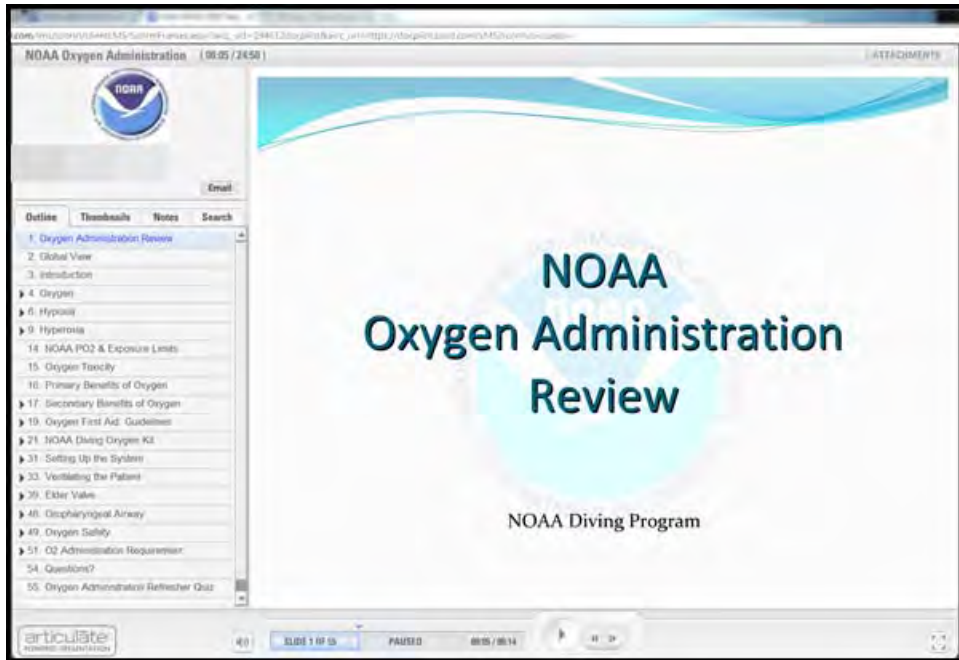

Figure 1. NOAA Oxygen Administration Course in CLC Pilot.

NOAA OMAO Commerce Learning Center (CLC) Administrator supports OMAO Learning Coordinators, manages course entry in the CLC, test tools and supports the transition to the new Cornerstone OnDemand (CSOD) system.

The Department of Commerce, parent organization for NOAA and OMAO, transitioned from an Oracle LMS to the Cornerstone OnDemand (CSOD) LMS on June 1, 2015. OMAO's Chief Learning Officer, Scott Tessmer, leads OMAO's transition as the project manager. The development, administration, and management of the new LMS requires multiple levels of administrative permissions. OMAO's highest level support positions are CLC Administrator followed by local support learning coordinators. Jenna Dalton will be supporting OMAO as a CLC Administrator providing technical and administrative system support.

The image shown in Figure 2 is part of ongoing training for the NOAA OMAO CLC Administrator role. The curriculum topics are updated regularly and represent one of the main projects for the OMAO CLO support staff.

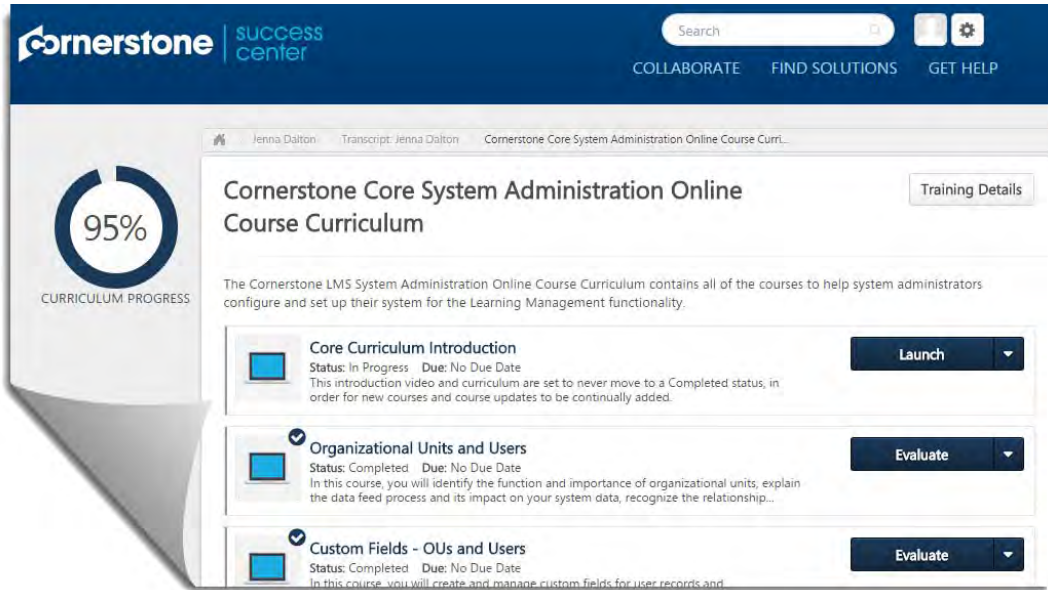

Figure 2. Cornerstone OnDemand Client Success Center Core System Administrator Online Course Curriculum.

The image shown in Figure 3 is part of the NOAA Corps LTJG curriculum training in the CLC and has an error for the final assessment. The OMAO CLO support staff provides CLC User support by marking the course complete, therefore updating their transcripts and allowing the user to continue with further course material.



Figure 3. CSOD OMAO CLC Administrator program support.

The image shown below in Figure 4, represents one of the CLC Administrator roles, the development of Instructor Lead Training (ILT) Events. These events and sessions, when populated with attendee rosters,

allow the existing and legacy Leadership training to be tracked as courses in OMAO CLC employees' transcripts.

Event Name	Subjects	Vendor
OMAO MidGrade Leadership Week 1	Leadership	NOAA (NATIONAL OCEANIC AND ATMOSPHERIC ADMINISTRATION)
OMAO MidGrade Leadership Week 2	Leadership	NOAA (NATIONAL OCEANIC AND ATMOSPHERIC ADMINISTRATION)
OMAO MidGrade Legacy - 40 HR	Leadership	NOAA (NATIONAL OCEANIC AND ATMOSPHERIC ADMINISTRATION)
OMAO MidGrade Legacy - 72 HR	Leadership	NOAA (NATIONAL OCEANIC AND ATMOSPHERIC ADMINISTRATION)

Figure 4. Instructor Lead Training (ILT) established in CLC with associated sessions and rosters.

Other OMAO CLO CLC project support:

--Marine Operations Center - Atlantic - Provide collaborative system administration support for the CLC transition from the previous Gyrus LMS to the new DOC CSOD OMAO CLC, with OMAO CLC System Administrator, Kevin Fleming (NOAA/OMAO/MOC Fleeting Training Coordinator and CLC System Administrator).

--Aviation Operations Center- Provide custom page, ILT and Reports training to Learning Coordinator POCs.

OMAO Training Portal content, management and maintenance

The OMAO training portal is a Google site created as a "One Stop" site to assist OMAO staff by providing the who, what, when, where and why answers to training questions. It is updated daily with calendar events, links to new and upcoming training opportunities, and links to required and career development courses. Jenna Dalton, task lead, provides relevant content and training events in support of the OMAO scientific data collection mission and personnel needs to maintain a ready staff.

Shown in the Figure 5, an additional section was added as a sidebar, titled "Quick Links" as a quick reference to more pages than listed in the top tab section, this was an added feature in 2015/2016 to the OMAO Training Portal Home page.

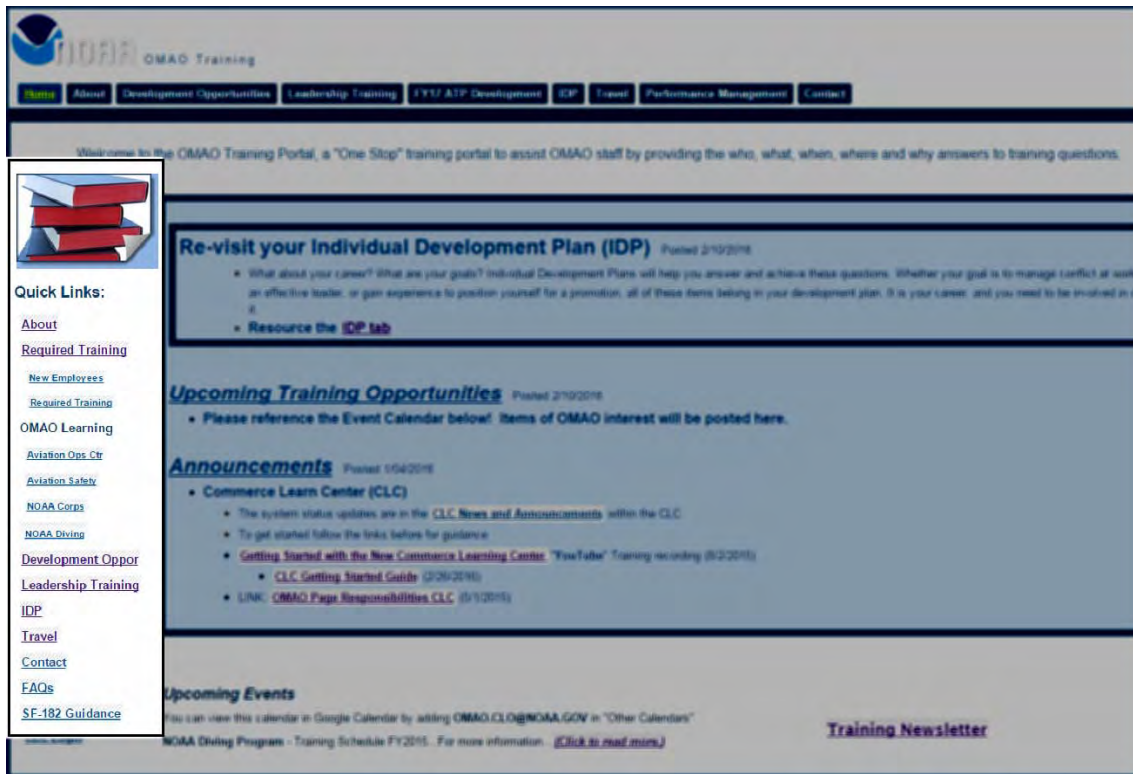

Figure 5. OMAO Training Portal - content diagram for Home/Announcements page.

Shown in Figure 6, is a page tab established for Performance Management guidance and various linked resources for OMAO personnel. This product was created through research to develop an overall view of Performance Management and how, with an effective process in place, it can improve organizational effectiveness in the accomplishment of agency mission and goals. Performance Management is a continuous process in planning, monitoring, developing, rewarding and rating the activities and skills of your employees.

What is Performance Management?

Performance management is the systematic process by which an agency involves its employees, as individuals and members of a group, in improving organizational effectiveness in the accomplishment of agency mission and goals.

Employee performance management includes:

- planning work and setting expectations,
- continually monitoring performance,
- developing the capacity to perform,
- periodically rating performance in a summary fashion, and
- rewarding good performance.

The Performance Management Cycle

Performance Management is much more than just rating performance once a year. In fact, Performance Management is an ongoing and continuous process that should be on a supervisor's mind every day! Typically, the activities associated with Performance Management are shown as a cycle with tasks involved in:

- Planning work and setting expectations.
- Monitoring performance and making adjustments.
- Developing knowledge and skills.
- Rewarding good performance, and finally,
- Rating performance.

Figure 6. OMAO Training Portal - content diagram for Performance Management resource page

Shown in Figure 7, at the request the OMAO Information System Security Officer, this page was established to contain OMAO IT Security Role Based Training references and resources regarding the mandatory training and/or professional certification for Department of Commerce (DOC) individuals with significant information system security responsibilities. Information system security workforce is critical to assuring that the DOC/NOAA/OMAO has adequate security measures to protect and defend its information and information systems. It has been placed on hold as OMAO transitions to a new Employee Intranet site that will house OMAO resources.

Why promote Cybersecurity training?

Securing, protecting, and defending our nation's digital information and associated systems and infrastructure require building and retaining an agile, highly skilled workforce that can respond flexibly to dynamic requirements.

Figure 7. OMAO IT Security Role Based Training resource page

Resource management for the OMAO Chief Learning Officer (CLO) including budget, travel, document analysis, program, administrative support and administrative support for our collaborative partnership with the National Weather Service Training Center (NWSTC).

Mid-Grade Week 1 & 2 Leadership Training:

OMAO's Leadership courses, Mid-Grade Week 1 and Week 2, fulfill the Office of Personnel Management (OPM), DOC, and NOAA requirements for new supervisor training and provide an additional cross mission development venue for the organization. These courses, held at the National Weather Service Training Center (NWSTC), include NOAA Corps Officers, wayer mariners, and civilian staff. CIRA associate, Jenna Dalton, supported the leadership training as the resource manager of travel and budget, director of course logistic coordination and course liaison.

NOAA OMAO CLO FY15/FY16 Budget Analyst:

In collaboration with the OMAO CLO, Jenna Dalton assisted in the creation of the fiscal budget, the monthly reconciliation of the budget and the reporting of the CLO monthly budget to OMAO Headquarter office.

NOAA OMAO CLO Travel Processor:

Processed (14) travel orders for OMAO in 2015/2016.

OMAO CLO document analysis, program and administrative support:

Jenna Dalton participated in administrative efforts under the Office of OMAO CLO in the following activities:

- FUT/PUT/SUT - OMAO University training program guidance.
- Created Budget Operating Plan (BOP) training - budget analys.
- CLC FAQs for transcripts and certificates.
- CLC Learning Coordinator FAQs for Welcome Page edits, updating links and system administration guidance.
- Wage Marine New Employee Orientation Training - Spring 2015, provided class administrative support, see Figure 8.
- NWS Training Center Projects Support involving new employee administrative forms, document and educational material analysis, CLC collaboration and resident course preparation, see Figure 9.

Training Participation

- CSOD CLC System Administrator Core training (online)
- CSOD CLC Learning Coordinator training (online)
- Classroom Instructor NWSTC on-site training (3 days)
- ITM - Gelco Travel Manager - Intermediate training (4 hours)
- SIDLIT - Summer Institute on Distance Learning and Instructional Technology - Johnson County Community College (2 day)
- Writing Grammar Basics - NWSTC on site (bi-weekly)
- Articulate - Beginners - NWSTC on site (2 day)
- PowerPoint Advanced - NWSTC on site (1 day)
- Instructional Design Overview - NWSTC (1 day)



Figure 8. Wage Marine New Employee Orientation Training



Figure 9. National Weather Service Training Center

PROJECT TITLE: Research Collaboration at the NWS Aviation Weather Center in Support of the Aviation Weather Testbed, Aviation Weather Research Program, and the NextGen Weather Program

FISCAL YEAR FUNDING: \$1,755,474

PROJECT TITLE: National Weather Service NextGen Integrated Dissemination Program (IDP), (formerly NextGen 4D Data Cube)

PRINCIPAL INVESTIGATOR: Sher Schranz

RESEARCH TEAM: Benjamin R. J. Schwedler, Renee A. Walton, Robyn Tessmer

NOAA TECHNICAL CONTACT: Joshua Scheck (NOAA/NWS/AWC Chief)

NOAA RESEARCH TEAM: Ryan L. Solomon (NOAA/NWS/AWC/ASB), Steve A. Lack (NOAA/NWS/AWC/ASB), Austin E. Cross (NOAA/NWS/AWC/ASB)

PROJECT OBJECTIVES:

CIRA support for this project is in four primary areas:

- NextGen Content & Dissemination - Guiding the implementation and development of content and data dissemination technologies for population of NextGen database
- Cloud & Visibility (C&V) forecast improvement - Improvements to C&V forecast guidance, as well as collaboration on a consistent national picture of cloud-based aviation hazards
- Aviation Weather Testbed (AWT) - Development, maintenance, and testing of tools and products within the AWT for implementation into Aviation Weather Center (AWC) forecast operations
- Operational and Technical Support - Support and maintenance of the software and data flows to support AWC forecast operations

NextGen Content & Dissemination

As a Meteorological Watch Office, the AWC produces the US-AIRMET feature. The feature forecasts are to be disseminated via a Web Feature Service (WFS), also an Open Geospatial Consortium (OGC) standard. To represent the features, US-AIRMET data models using Unified Modeling Language (UML) were developed by Meteorological Development Lab (MDL). CIRA staff at the AWC were actively involved in providing feedback on the schema. These data models translate to XML schema that are part of the IWXXM-US (ICAO Meteorological Information Exchange Model) 1.0 release.

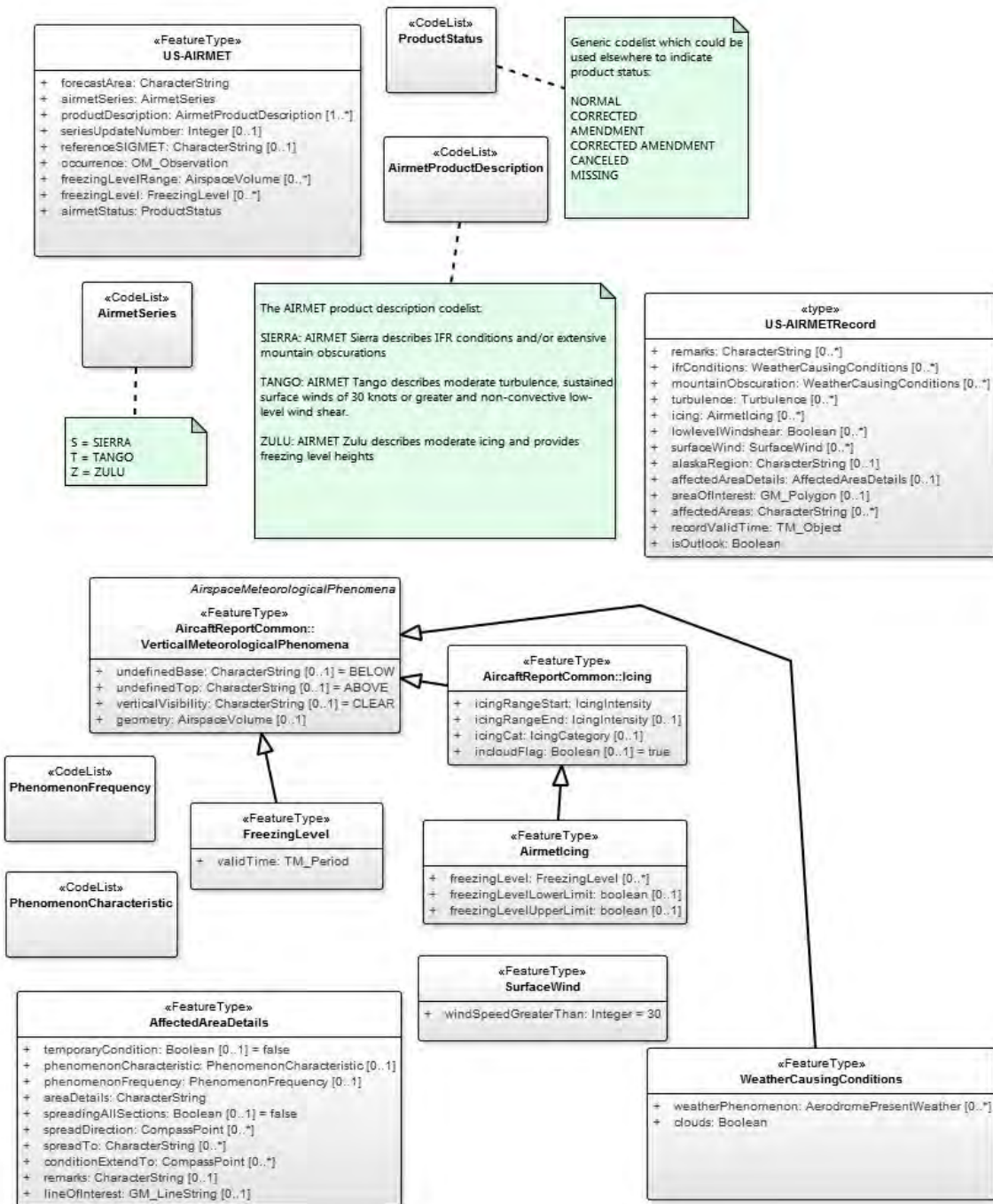

Figure 1. UML Context diagram for the US AIRMETs that have been included in IWXXM-US 1.0.

CIRA AWC staff also provided subject matter expertise to MDL regarding data formats and metadata content. AWC staff created and edited metadata records for products produced at AWC as well as other NCEP centers such as the Storm Prediction Center (SPC). In addition to providing metadata records, CIRA AWC staff debugged NCAR's GRIB2 to NetCDF conversion software. This software allowed CIRA AWC staff to collaborate with Global Systems Division (GSD) to create sample files for product description documents.

Cloud & Visibility forecast improvement

Cloud and visibility hazards have a daily impact on aviation operations from terminal operations affecting commercial carriers to instrument meteorological conditions (IMC) grounding general aviation pilots. According to the National Transportation Safety Board (NTSB) approximately two-thirds of aviation fatalities due to weather can be attributed to low visibility and cloud ceilings. Even though this is the case, the rate of improvement in numerical cloud and visibility forecasts lags behind other aviation hazards.

The AWC is an integral partner in several efforts to improve cloud and visibility forecasts and analyses. The NWS is currently focusing many resources on the national Digital Aviation Services (DAS) effort. DAS builds on the enhanced short-term paradigm of updating National Digital Forecast Database (NDFD) grids more frequently for short-fused hazards to provide better decision support services. The goal of DAS is to provide a nationally consistent set of NDFD fields for aviation, including visibility, cloud ceiling, and other cloud decks. From this gridded database, products like the TAF and G-AIRMET can be derived to ensure that there is a consistent picture for all aviation customers. DAS is a collaborative effort involving AWC, NWS regions, the NWS Operations Proving Ground (OPG), the Alaskan Aviation Weather Unit and the Honolulu Weather Forecast Office (WFO.) AWC CIRA developers have been helping drive the AWC vision of digital aviation services for the past year.

In order to support the DAS paradigm, improved consensus model guidance is needed to populate the fields needed to support Terminal Aerodrome Forecast (TAF) production. CIRA staff at AWC have been working with model and product developers at ESRL/GSD, NCEP/EMC, and MDL on improvements to cloud fields, including the development of consistent 3D cloud fraction guidance that will diagnose multiple cloud decks in addition to the cloud ceilings. In addition to guidance that will allow initial population of the NDFD grids, probabilistic guidance is being developed by CIRA developers for dissemination to the WFOs. The AWT is a central hub where this guidance can be evaluated through objective verification as well as subjective analysis by aviation meteorologists, product developers, and aviation end-users. This includes collaboration with the FAA Aviation Weather Demonstration and Evaluation (AWDE) group to test how these fields might be used by aviation end users.

AWT/GFE 2016020818f18

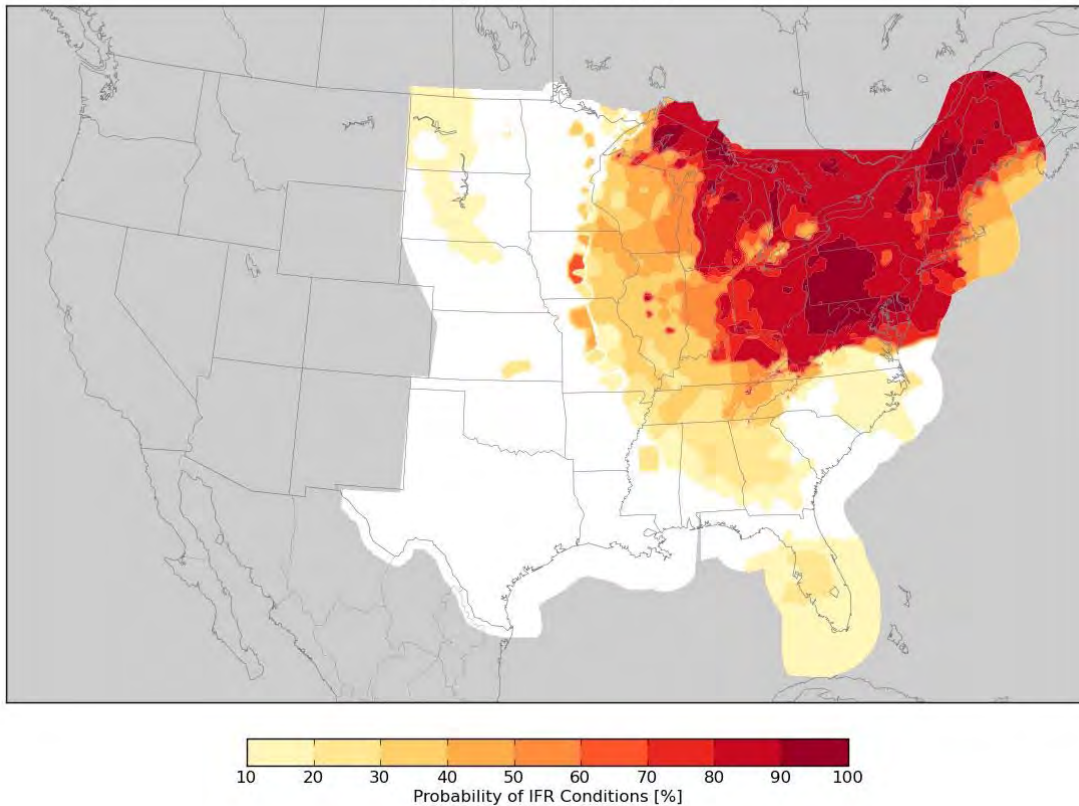

Figure 2. Example of probabilistic forecast for aviation. Shown here is the probability of Instrument Flight Rule (IFR) conditions.

Another portion of the cloud and visibility forecast improvement effort is related to the replacement of the text Area Forecast that is issued for the contiguous United States. This product provides general aviation pilots and flight service stations - who provide flight briefing services - with a summary of conditions that they will encounter when flying over a specified area. By replacing this antiquated text product with something graphical, pilots and briefers will have access to cloud information within the dynamic framework available on the AWC website. Graphical information is presented for flight category, visibility, cloud cover, cloud ceilings and bases, and cloud tops. CIRA staff at AWC are developing the GFA web interface and are integral in providing data and visualizations for this tool. (See Web Group Annual Report).

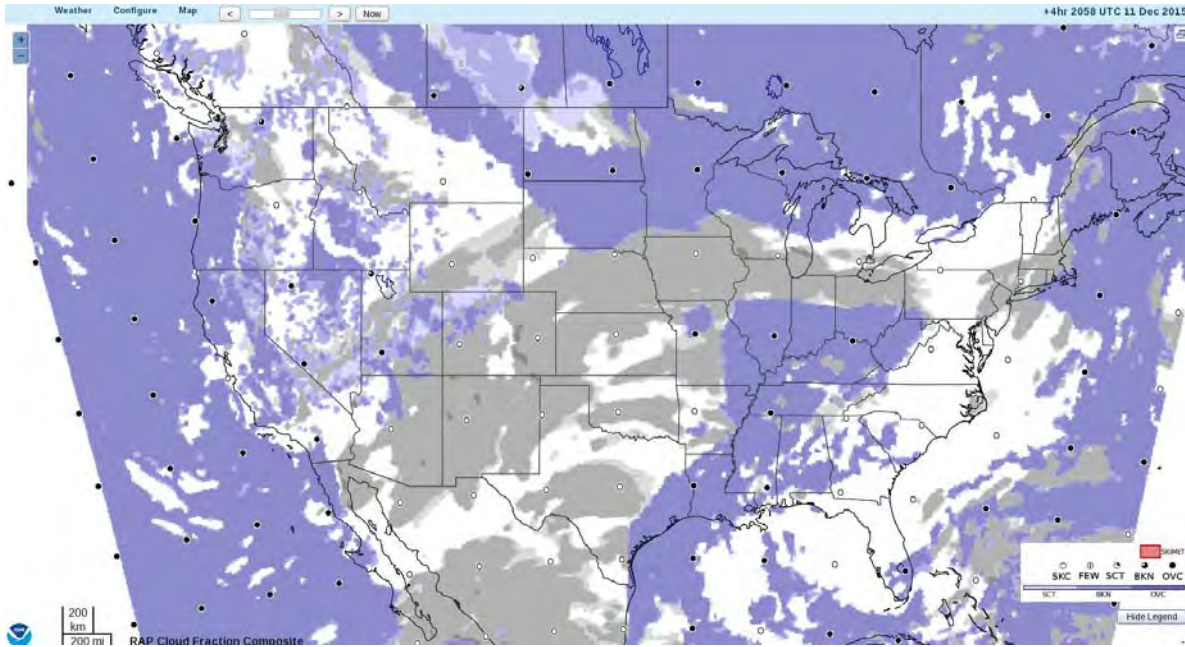

Figure 3. Cloud fraction composite from the RAP 3D cloud fraction. Purple areas represent Few, Scattered, Broken, and Overcast cloud decks below Flight level 180 (FL180, or 18,000 ft MSL). Grey regions represent the same cloud concentrations above FL180.

Aviation Weather Testbed

This year, CIRA staff at the AWC contributed to many AWT projects including two testbed experiments. The 2015 AWT Summer Experiment was held at the Aviation Weather Center (AWC) in Kansas City, MO cooperatively with the FAA's William J. Hughes Technical Center (WJHTC) in Atlantic City, NJ over two weeks from 10 August 2015 until 21 August 2015. There were over 100 participants, including: FAA and AWC employees, CWSU meteorologists, WFO meteorologists, industry meteorologists, and academia. The major topics for this experiment included cloud and visibility gridded forecast creation, improvements to the Collaborative Aviation Weather Statement (CAWS), new forecasting techniques over the Gulf of Mexico and Caribbean Sea, and verification techniques for aviation forecasts.

The cloud and visibility portion of the experiment focused on assessing the ability of creating gridded cloud and visibility products by using a variety of model data in the AWIPS2 Graphical Forecast Editor (GFE). The grids created over the conterminous U.S. would potentially be used as part of Digital Aviation Services to drive local forecasts of cloud and visibility at the NWS WFOs. Use of these grids would improve consistency between locally produced products such as the TAF and larger scale forecasts such as the Area Forecast (FA) and graphical AIRMETs.

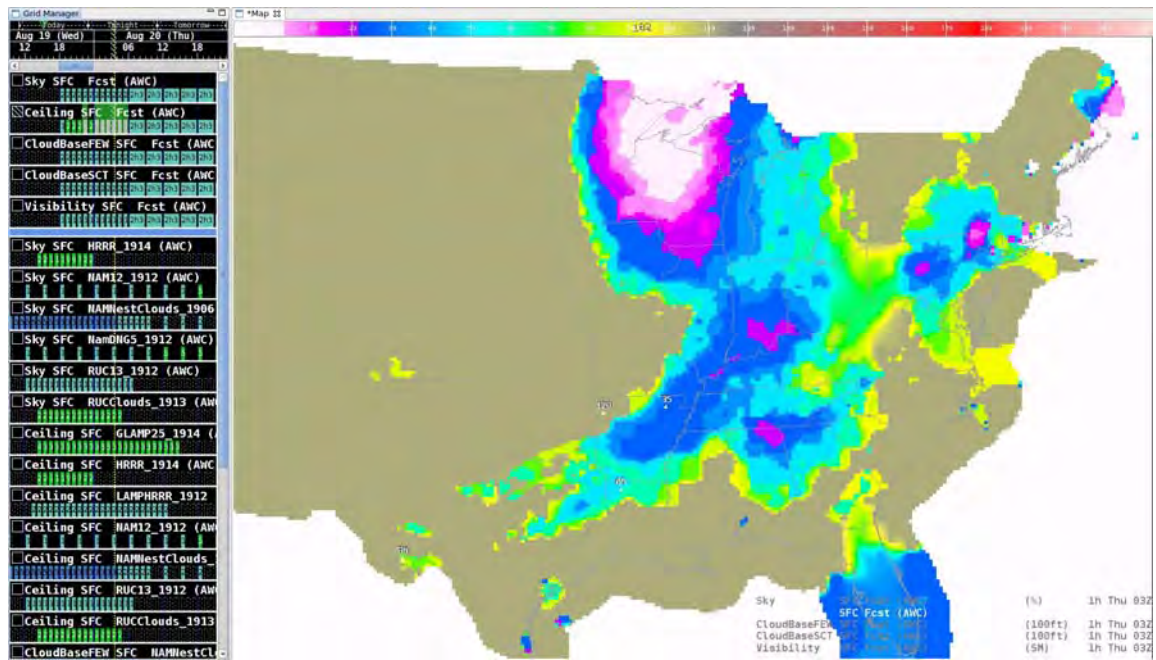

Figure 4. Cloud ceiling field within the Graphical Forecast Editor (GFE) produced during the 2015 AWT Summer Experiment.

The primary goal of the experimental CAWS desks were to produce CAWS that have focused impacts to a specific area instead of creating similar areas to the Experimental CDM Convective Forecast Planning (CCFP) guidance; this means leveraging the best forecasting practices using the highest resolution forecast models. The resultant experimental CAWS issued during the AWT experiment were compared against operational CAWS during this time. The end result was the creation of enhanced training surrounding the CAWS process. In addition, having a direct connection with the Aviation Weather Demonstration and Evaluation (AWDE) group provided immediate feedback from aviation end-users on the interpretation of graphical representations within the CAWS.

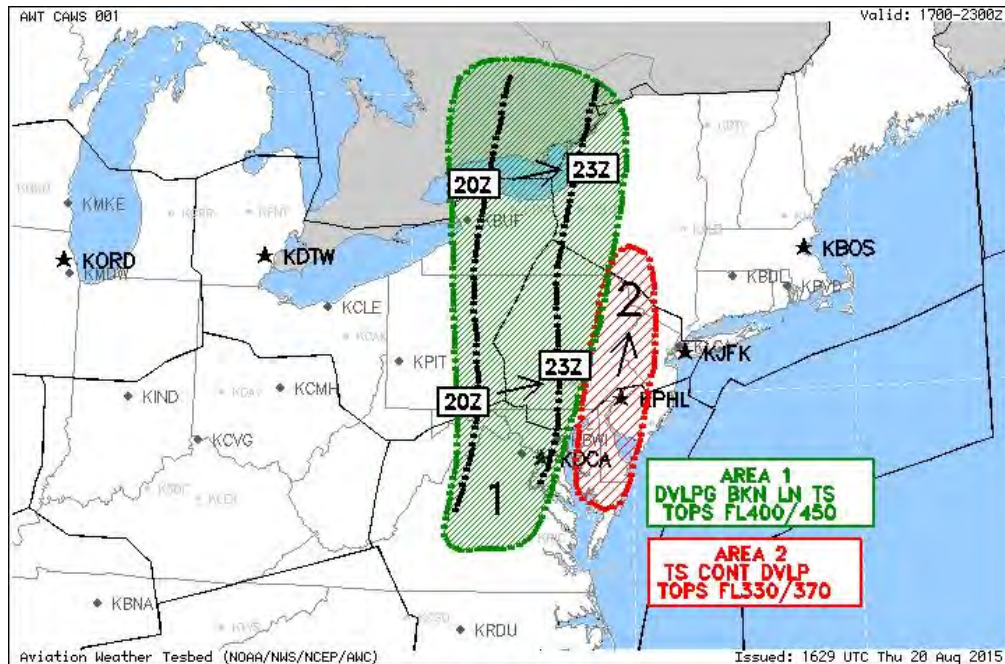

Figure 5. Experimental CAWS graphic demonstrating amendment capabilities, different color representations, and notation enhancements.

Finally, graphical forecasts over the Gulf of Mexico and Caribbean Sea were tested as a potential way forward from the text-based Area Forecast (FA). In addition, several verification studies both quantitative and qualitative were performed on the experimental guidance issued in all parts of the experiment.

During the Winter Experiment held in February 2016 forecasters emulated operational production of global graphics, a non-convective CAWS and used the AWIPS2 GFE to modify grids of clouds and visibility. This built on the work performed during the 2015 Summer Experiment by providing higher resolution guidance across 3 domains in the contiguous United States. Gridded data produced during this experiment will be used during the NWS OPG tests of Digital Aviation Services during June and July.

CIRA AWC staff modified the operational CAWS production software to be used for icing and turbulence with the goal of adding value to AIRMETs. CIRA AWC staff also tested the use of a white board to improve collaboration with stakeholders when issuing the CAWS. This effort would increase efficiency by allowing forecasters to reduce the number of preliminary products they submit.

20160209 - 001 (TB) FINAL CCA

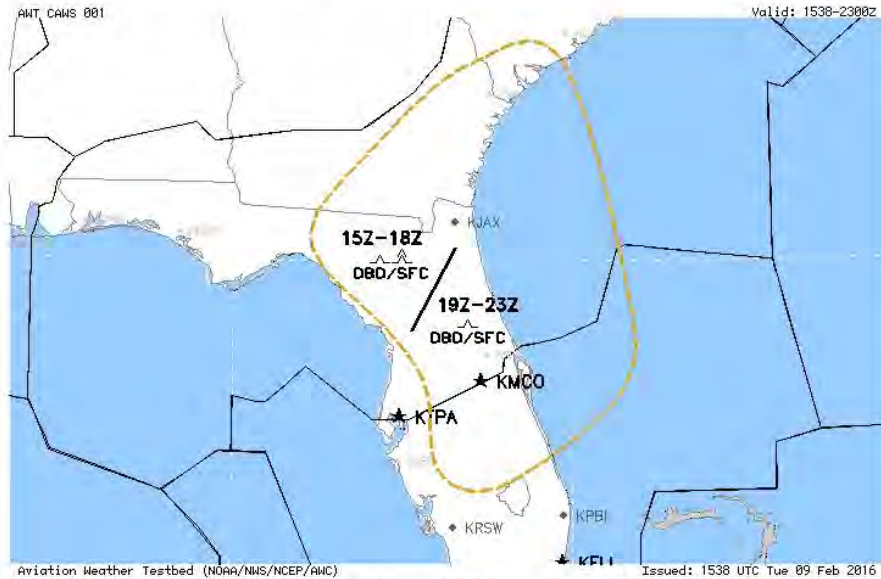

Collaborative Aviation Weather Statement 001
NWS Aviation Weather Center Kansas City MO
1538 UTC Tue 09 Feb 2016

Correction to CAWS 001 - 20160209

Weather: Turbulence
Valid: 1538-2300Z

ARTCCs affected: ZJX, ZMA
Terminals affected: KMCO, KJAX, KPIE, KSAV, KSPB

SUMMARY: MOD OCNL SEV TURB SERN GA AND FL.

DISCUSSION: Between 15Z-18Z Turbulence will initially be moderate to severe below 080 then becoming moderate after 19Z continuing through 23Z.

Surface wind gusts are possible to 35-40KTS which may result in low-level wind shear near buildings and/or obstructions.

Corrected for color and text.

BOUNDING BOX: 29.84,-85.18 25.97,-82.69 27.16,-78.23 32.93,-79.28 33.03,-81.53
29.84,-85.18

Figure 6. Turbulence CAWS issued during the AWT Winter Experiment.

AWC forecasters produced the CAWS operationally through October 2015. For the 2016 demonstration starting in March, CIRA AWC staff modified the CAWS production software to include reference to the CCFP. This change will allow forecasters to issue a CAWS as an enhancement of the CCFP guidance. CIRA AWC staff also modified the web page for the CAWS to allow end users to see the CCFP and the CAWS on the same screen.

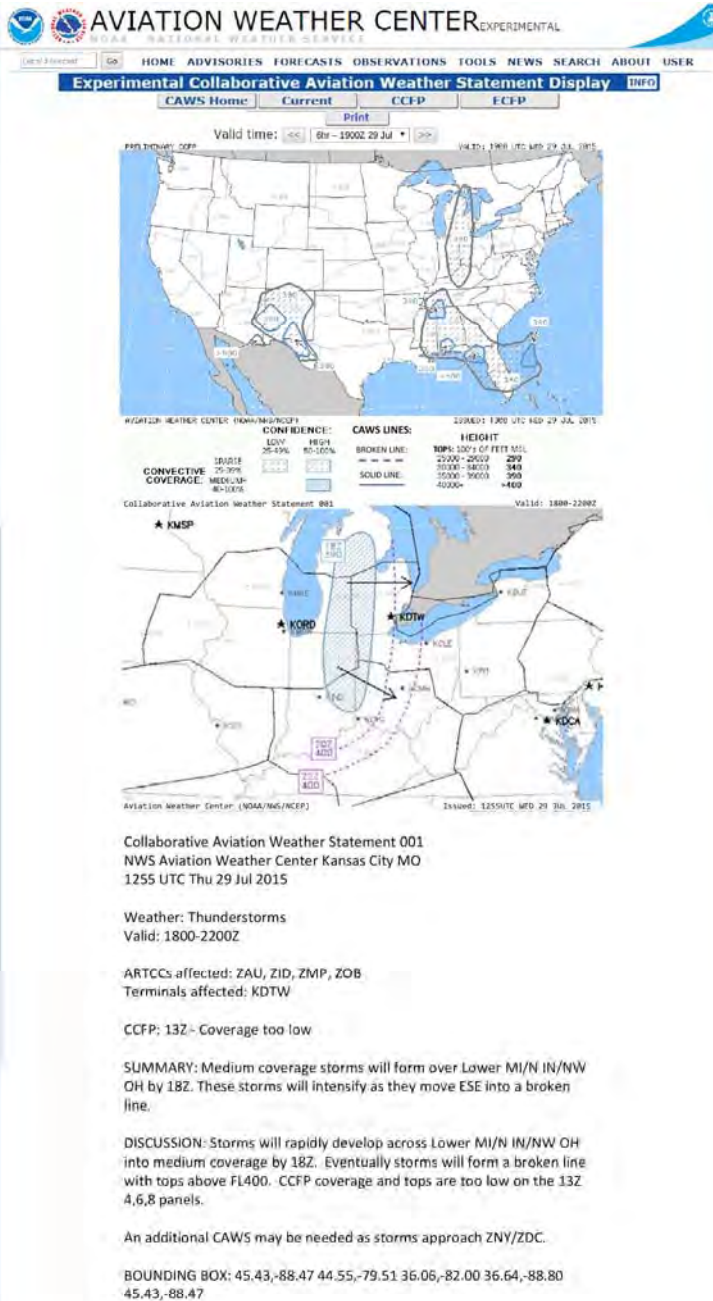

Figure 7. CAWS and CCFP presented on the same web page for aviation end-users.

In an effort to reduce the impact of thunderstorms on planes, CIRA AWC staff worked on developing a tool which combines the probability of a plane being in a certain location with model probability of thunderstorm occurrence. To develop this tool, CIRA AWC staff created a two week climatology of top of the hour plane locations over the continental US. This was then used to determine the probability of a plane being at a given location at a given time. After those calculations were completed, they could be combined with the model probability of thunderstorm occurrence to create a heat map of plane impacts. This method provided extremely low probabilities so CIRA AWC staff are working on creating a two year climatology of plane locations to increase probabilities.

Operational and Technical Support

Over the past two years, AWC has been moving to a computer infrastructure that heavily utilizes server virtualization. This effort has involved efforts from IT, development, and scientific staff. CIRA development and scientific staff were integral to the planning, testing, and cutovers for each of the new Virtual Machines (VMs). This effort is still ongoing, with development systems still in the queue to be migrated to VMs. In addition to migration to VMs and the transition of the operational systems to a new enterprise filer, a large effort is underway to reorganize and simplify the complex dataflow supporting the operational and development systems within the AWC, including the research and experimental efforts in the AWT.

National Weather Service NextGen 4D Data Cube Project Publications:

Cross, A., S. A. Lack, and B. R. J. Schwedler, 2016: Ceiling and Visibility Forecasting with the Graphical Forecast Editor at the Aviation Weather Testbed. Proceedings, Fifth Aviation, Range, and Aerospace Meteorology Special Symposium, New Orleans, LA, Amer. Meteor. Soc., 842.

Lack, S. A. and B. R. J. Schwedler, 2016: Exploring Variants of the Experimental Collaborative Decision Making (CDM) Convective Forecast Planning (CCFP) Guidance. Proceedings, Fifth Aviation, Range, and Aerospace Meteorology Special Symposium, New Orleans, LA, Amer. Meteor. Soc., 821.

Schwedler, B. R. J., S. A. Lack, and A. Cross, 2016: Recent Efforts in Cloud & Visibility Forecast Techniques at the Aviation Weather Testbed. Proceedings, Fifth Aviation, Range, and Aerospace Meteorology Special Symposium, New Orleans, LA, Amer. Meteor. Soc., 839.

Steiner, M., A. R. S. Anderson, S. Landolt, and B. R. J. Schwedler, 2015: Coping with adverse winter weather: emerging capabilities in support of airport and airline operations, Journal of Air Traffic Control, 57 (3), 36–45.

PROJECT TITLE: International Aviation Forecast Guidance

PRINCIPAL INVESTIGATOR: Sher Schranz

RESEARCH TEAM: Jung-Hoon Kim, Robyn Tessmer

NOAA TECHNICAL CONTACT: Matt Strahan (NOAA/NWS/AWC/AOB Chief)

PROJECT OBJECTIVES:

- 1--Setup the Aircraft-Based Observation (ABO) and NWP model output database.
- 2--Development of Eddy Dissipation Rate (EDR)-scale turbulence algorithm.
- 3--Preliminary evaluation of new global turbulence guidance.
- 4--Implementation of global turbulence guidance to Aviation Weather Center Testbed.
- 5--Publications in Scientific Journals, Book, and Conferences

PROJECT ACCOMPLISHMENTS:

1--Setup the Aircraft-Based Observation (ABO) and NWP model output database (Accomplishment: 100%)

An automatic ABO data archiving system has been created at AWC so that various ABO data like Pilot Reports (PIREPs), Eddy Dissipation Rate (EDR) data, and Derived Equivalent Vertical Gust (DEVG) from NOAA MADIS server can be archived. This archive starts 18 Sep 2015. An automatic NWP model archiving system in the extra 20TB WAFS disk in AWC, so that GFS and GEFS output data has been archived from 18 Sep 2015. In addition, a review paper for the status of ABO data and its importance for the development of global turbulence guidance was created so that Matt Strahan (NOAA technical contact) could present this information to the WMO/ICAO meeting in Geneva in 2015.

2--Development of EDR-scale turbulence algorithm (Accomplishment: 100%)

New Global Turbulence Guidance includes several individual turbulence diagnostics based on different generation mechanisms of turbulence. Mechanisms for Clear-Air Turbulence (CAT) include shear instability above/below upper-level jet stream, frontogenesis, inertia instability in geostrophic adjustment, gravity wave emission through spontaneous imbalance. Additionally mountain-wave turbulence (MWT) are also considered convective turbulence. The final forecast product should be EDR-scale, because it is physical term of atmospheric turbulence directly affecting cruising aircraft. The newest Graphical Turbulence Guidance (GTG3) system in AWC includes all of individual turbulence diagnostics of CAT and MWT algorithms as well as EDR conversion.

AWC WAFS Meteorologists visited NCAR/RAL for 1-week (29 Nov – 5 Dec 2015). With Dr. Bob Sharman at NCAR/RAL, looking at all component algorithms that are accurately translated into the programs and looked for any inconsistency. We also discussed the EDR conversion techniques and ensemble probabilistic forecast techniques for the future consistency between the GTG3 systems in domestic and global areas. Individual component diagnostics are then combined optimally to either deterministic EDR ensemble forecast or probabilistic forecast for turbulence intensities based on the previously established log-normal Probability Density Function (PDFs) from the historical GFS model data, which will be updated more appropriately in the future using recently archived GEFS data.

3--Preliminary evaluation of new global turbulence guidance (Accomplishment: 100%)

Newly developed Global Turbulence Guidance has been tested primarily for the MWT event periods to see how new guidance capture well the MWT outbreaks. On 30 Dec 2015 (Fig. 1 left), MWT events are aloft over the southern mountain region in Alaska, as a developed surface low-pressure system in Bering Sea makes strong southerly low-level winds toward zonally elongated southern mountains in Alaska. On 6 Jan 2016 (Fig. 1 right), another MWT events are reported in southern tip of Greenland, as a developed Iceland low triggered strong low-level Easterly flow across the mountains in Southern Greenland. In both cases, newly developed Global Turbulence Guidance captures well both severe-level MWT events, which confirms that the new guidance will be obviously beneficial for current AWC operations, because there is no MWT guidance in international forecasts.

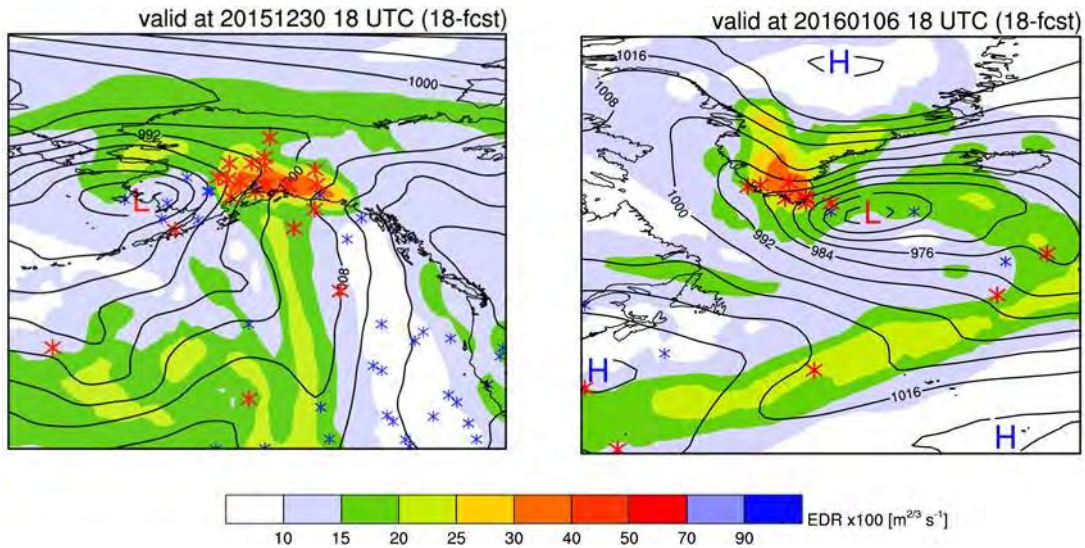

Figure 1. Deterministic ensemble EDR (color shading) max between 200 and 400 hPa level and Sea-Level Pressure (SLP; contours with 8 hPa interval) at 18 UTC 30 Dec 2015 (left) and at 18 UTC 6 Jan 2016 (right). PIREPs around the valid time are also shown as red (MOG) and blue (null) asterisks.

During 1-month (October 2015), a total of 559,003 EDR observations over the world are archived in the database. GEFS NWP model outputs are also archived in the 20TB WAFS disk in AWC. To evaluate the new turbulence guidance using this archived ABO data and NWP model outputs, several procedures were set up for an objective evaluation toolkit. First, Quality Control (QC) is done to exclude redundant, spurious, and duplicated ABO data. Second, all of ABO data are paired to the nearest grid points of archived NWP forecast data. Third, calculated new turbulence guidance from the nearest NWP grids are directly compared and verified using statistical methodology (POD: Probability of Detection) exclusively for moderate-or-greater (MOG) turbulence (EDR > 0.1) and null turbulence (EDR < 0.01). Comparison of current WAFS blending CAT max (Figure 2 left) with newly developed global turbulence guidance in Fig. 2 (right) is done to confirm that the new guidance performs better, which eventually gives the improvement of AWC operations.

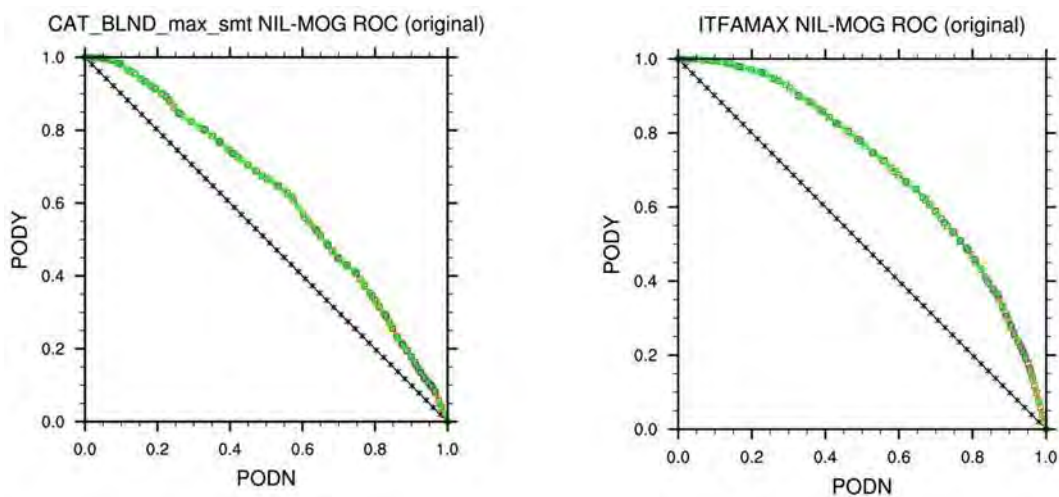

Figure 2. Statistics of Probability of Detection (POD) for “yes (MOG turb)” and “no (null turb)” using the current WAFS BLND CAT (left) and new Global Guidance (left) for 1-month (October 2015). Performance

becomes higher as curve stretches toward upper-right corner. Note that the performance value of Area Under Curve (AUC) for the current WAFC BLND CAT (left) is 0.6175, while AUC for new turbulence guidance (right) is 0.7074, showing the new guidance are superior to the current one.

4--Implementation of global turbulence guidance to Aviation Weather Center Testbed (Accomplishment: 100%).

Newly developed turbulence guidance is finally implemented to the AWC Testbed and tested during the 2016 winter experiment (8 – 12 Feb 2016) in AWC. Forecasters (JoAnn Becker, Katherine Deroche, and Steven Silberberg) in AWC tested new global turbulence guidance for their global upper-level significant weather chart (SIGWX) forecasts. They applied new guidance to map out their official weather chart as a test and compared newly guidance with their own guidance. Consequently, they gave feedback that this new guidance will be beneficial for their operations.

National Weather Service International Aviation Project Publications:

Kim, J.-H., W. N. Chan, B. Sridhar, R. D. Sharman, P. D. Williams, and M. Strahan, 2016: Impact of North Atlantic Oscillation on Transatlantic Flight Routes and Clear Air Turbulence, *J. of Appl. Meteor. Climatol.* Early Online Release.

doi: <http://dx.doi.org/10.1175/JAMC-D-15-0261.1>

PROJECT TITLE: Research Collaboration at the NWS Aviation Weather Center (AWC) in Support of the Aviation Weather Testbed (AWT), Aviation Weather Research Program (AWRP), and the NextGen Weather Program

PRINCIPAL INVESTIGATOR: Sher Schranz

RESEARCH TEAM: Daniel Vietor, Larry Greenwood, Adrian Noland, Brian Pettegrew, Matt Sienkiewicz, Jeff Smith, Robyn Tessmer

TECHNICAL CONTACT: Clinton Wallace (NOAA/NWS/AWC)

NOAA RESEARCH TEAM: Steven A. Lack (NOAA/NWS/AWC)

PROJECT OBJECTIVES:

The Aviation Weather Center (AWC) Aviation Support Branch (ASB) is responsible for providing support to the research and operations processes, maintaining server and networking infrastructure, and supporting the www.aviationweather.gov website.

The primary goal of the ASB is to maintain the internal network, servers and workstations at the AWC to ensure continuity of operations. The 24x7 support is critical to AWC forecast and web operations. The ASB collaborates with the other National Center for Environmental Prediction (NCEP) centers and the NWS to provide data and research to operations support. The branch supports the research operations at the AWC, headed by a team of Technique Development Meteorologists (TDMs). This includes support for the Testbed (AWT) as well as support for AWRP. The AWRP products include Current and Forecast Icing Products (CIP/FIP), Graphical Turbulence Guidance (GTG), National Ceiling and Visibility Analysis (NCVA), and the National Convective Weather Diagnostic/Forecast (NCWD/F). The ASB also supports

the AWC website which includes Aviation Digital Display Service (ADDS), World Area Forecast System (WAFS) Internet File service (WIFS) and the International Flight Folder Program (IFFDP).

As part of the CIRA effort, the ASB has close links to the research and development projects going on at the AWC. This includes:

- supporting NextGen and AWRP,
- providing better tools to decrease weather impacts to the National Airspace System (NAS) including efforts at the FAA Command Center and the Traffic Flow Management (TFM) project,
- providing direct support to the TDMs at the AWC for ongoing research projects including GOES-R, ensemble model diagnostics and product verification,
- expanding its collaboration efforts with the other testbeds within NOAA and the NWS focusing on R2O projects.

PROJECT ACCOMPLISHMENTS:

In the past year efforts have been centered on five primary projects:

- 1--Transition of the web site to the Integrated Dissemination Program (IDP) hosting facility.
- 2--Graphical Forecast for Aviation (GFA) tool
- 3--Graphical Turbulence Guidance (GTG) version 3
- 4--Ensemble Post Processor (EPP) tool
- 5--Groupboard chat tool.

1--Transition of the Web Site to IDP

In September 2014, support for the website at the NOAA Web Operations Center (WOC) ended and even though limited maintenance was provided through September 2015, a new hosting facility needed to be found. At the same time, the NWS was establishing a new web hosting service as part of the IDP so that existing NWS sites could migrate to IDP. By early Summer 2015, IDP was ready to transition the AWC website off the WOC. This was a two part effort. First, it was necessary to establish guidelines for operating the website at IDP and developing a working relationship with IT staff there. Second, a development environment needed to be created at the AWC that would mimic the IDP configuration. The development servers were built over the summer allowing rapid development of web frontend and back-end code and also helped with the creation of installation scripts and procedures that would eventually be used at IDP. The transition of code to the IDP development servers began in September, first on a set of development servers and then on a Quality Assurance (QA) tier where load testing could be performed. Functionality testing continued throughout the Fall with the website going live in mid-November.

As part of the move to IDP, data flow to the website was streamlined through a single set of servers housed on the operations network at the AWC (Figure 1).

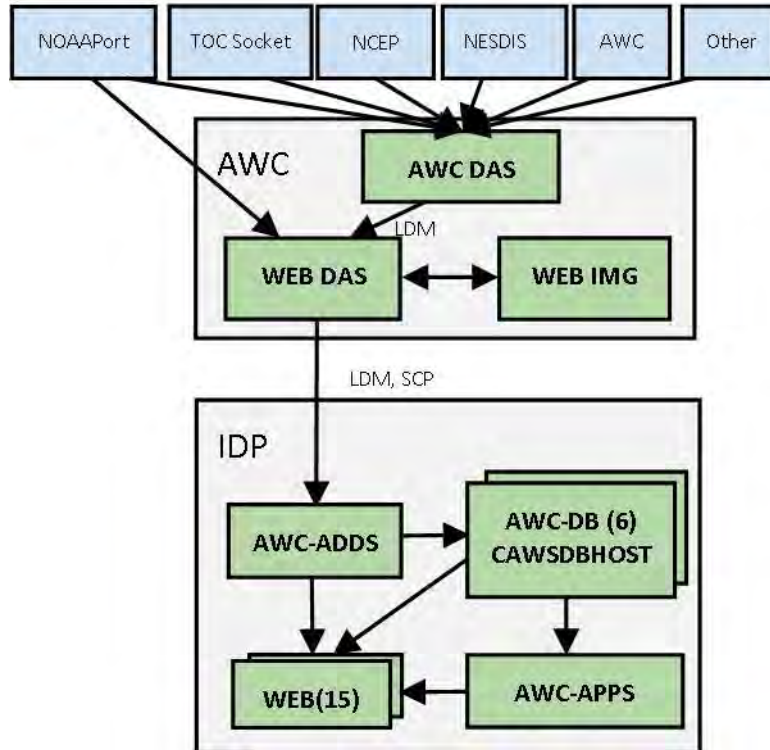

Figure 1. Data Flow to the IDP web environment.

The transmission of data to the WOC had several points of failure resulting from data flowing through AWC development servers and over the open Internet in order to get to the WOC. The move to IDP substantially improves reliability by moving data flow to the operational network at the AWC and using the NWS network backbone to send data to IDP directly.

Backend reliability was improved by separating database and web applications from the ADDS server so that they could be scaled. This was essential for making sure IDP servers could handle the data requests coming into ADDS.

By early December, the IDP website was stable and WOC servers were discontinued.

New Web Functionality

As part of the new website rollout in March 2014, new Javascript based interactive tools using the OpenLayers toolkit were added to the site. The tools were simple at first but more advanced functionality and access to more products was needed. Also, there needed to be a way to integrate all the products in a tool aimed at specific user bases.

The first such product was the HEMS (Helicopter and Emergency Medical Services) Tool which combined about a dozen products into a single tool aimed at helicopter operations. This tool became operational in May 2015 and offered radar, satellite, ceiling and visibility analyses, icing severity, temperature, relative humidity, winds, METARs, TAFs, SIGMETs, G-AIRMETs and Center Weather Advisories (CWA) aimed at low level, short distance flights.

In 2015, work began on expanding the product set (Figure 2). New cloud parameters from the Rapid Refresh (RAP) model included low, middle and high clouds, cloud bases and tops. Issues quickly arose from cirrus contamination so a low cloud top product was developed to show low cumulus and stratus tops to aid general aviation. Also, there was a need for cloud fraction (scattered, broken, overcast)

information at specific flight levels so experimental layer products were developed from the raw RAP model data.



Figure 2. New web products for interactive displays.

Imagery from the National Digital Forecast Database (NDFD) was added for high resolution surface information. To handle the lack of forecast data, Localized Aviation Model output Program (LAMP) imagery was added for ceiling, visibility forecasts, simulated satellite and radar imagery was added from the RAP model.

The functionality of the OpenLayers interactive tools was also addressed. A new more modern look and feel was tested (Figure 3). This included:

- addition of time and level sliders,
- in screen legends for full screen mode,
- distance scales in miles and kilometers,
- product valid information showing when a product was valid and when it was not available,
- additional configuration menu items,
- user configurable views.

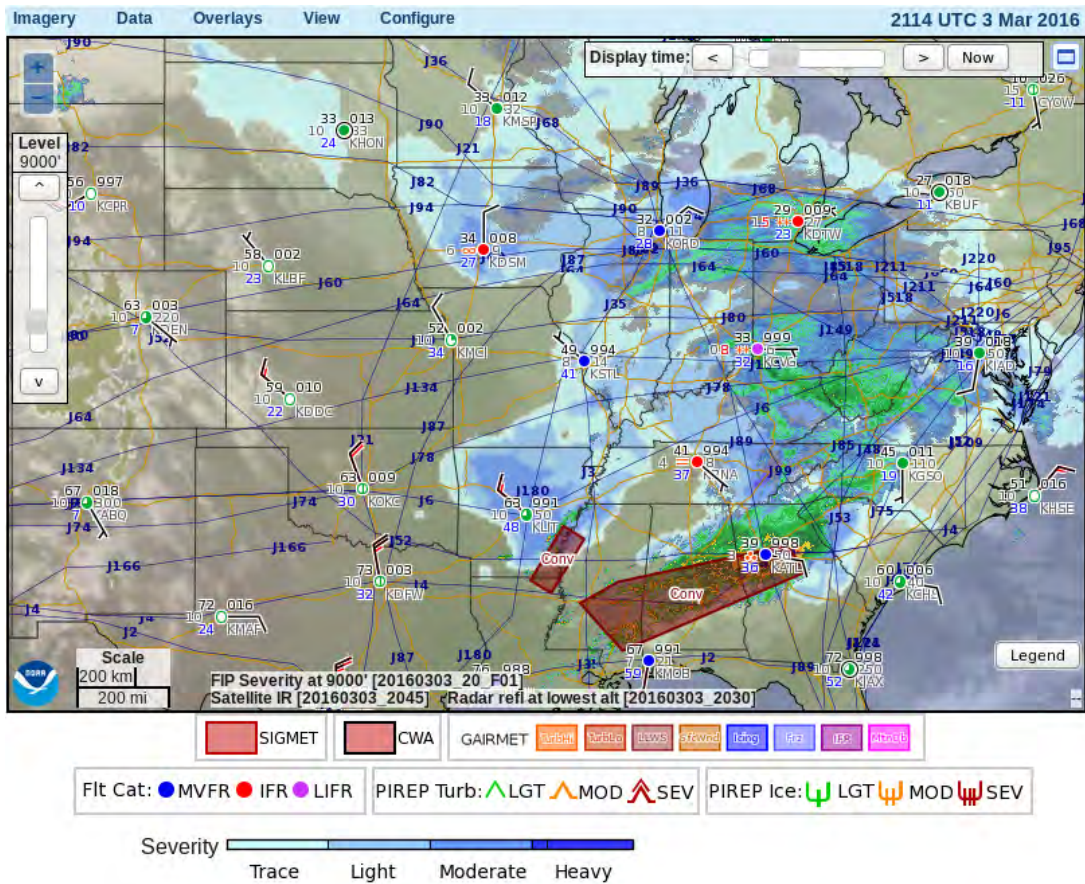

Figure 3. Development user interface for OpenLayers.

In addition, more navigation data was added to the display (Figure 4) including:

- jet routes,
- victor airways,
- navigation aides such as VORs,
- enroute navigational fixes,
- airport and heliport locations,
- detailed runway and terminal configurations.

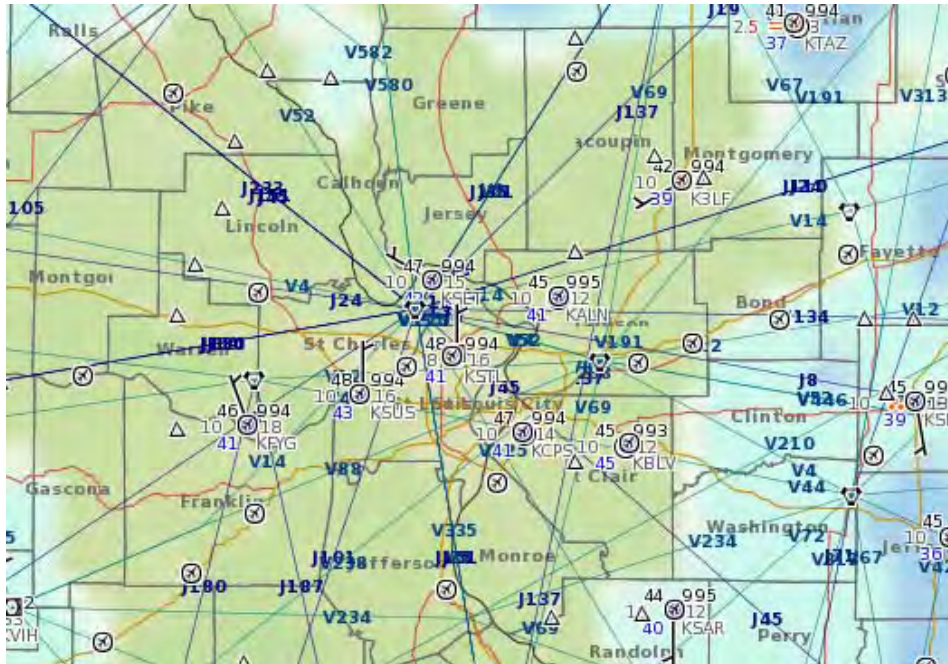

Figure 4. New navigation overlays.

2--Graphical Forecast for Aviation Tool

The FAA gave the approval to end the generation of the text area forecasts pending a viable replacement product could be developed. The task at AWC was to provide a graphical tool based on tools like the HEMS Tool that would be first simple, but also provide enough information in a fashion familiar to pilots, dispatchers and flight service that it could augment, if not replace the text area forecast.

Several iterations of the tool were tested over the Fall 2015. The decision was made to break the tool into eight preset user views which could be quickly navigated to obtain a quick assessment of various aviation conditions:

- Observations and Warnings: Satellite and radar, METARs/TAFs, PIREPs, SIGMETs, NWS Warnings
- Thunderstorms: Satellite and radar, Convective SIGMETs, NWS Warnings (tornado and severe thunderstorm), NDFD convective forecasts
- Precipitation: Satellite and radar, METARs/TAFs, Convective SIGMETs, NDFD weather forecasts
- Ceiling and Visibility: Graphical AIRMETs (G-AIRMET) IFR advisories, Flight category information, LAMP flight category forecasts
- Clouds: G-AIRMET mountain obscuration advisories, RAP cloud base, tops and fraction forecasts, Point cloud layer queries
- Icing: METAR/TAF weather, Icing SIGMETs, G-AIRMET icing advisories, Icing PIREPs, FIP icing severity forecasts
- Turbulence: Turbulence SIGMETs, G-AIRMET turbulence advisories, Turbulence PIREPs, GTG forecasts
- Winds: METAR/TAF winds, RAP forecasted winds, G-AIRMET low level wind shear and strong surface wind advisories

By December the tool was ready for external evaluation (Figure 5).

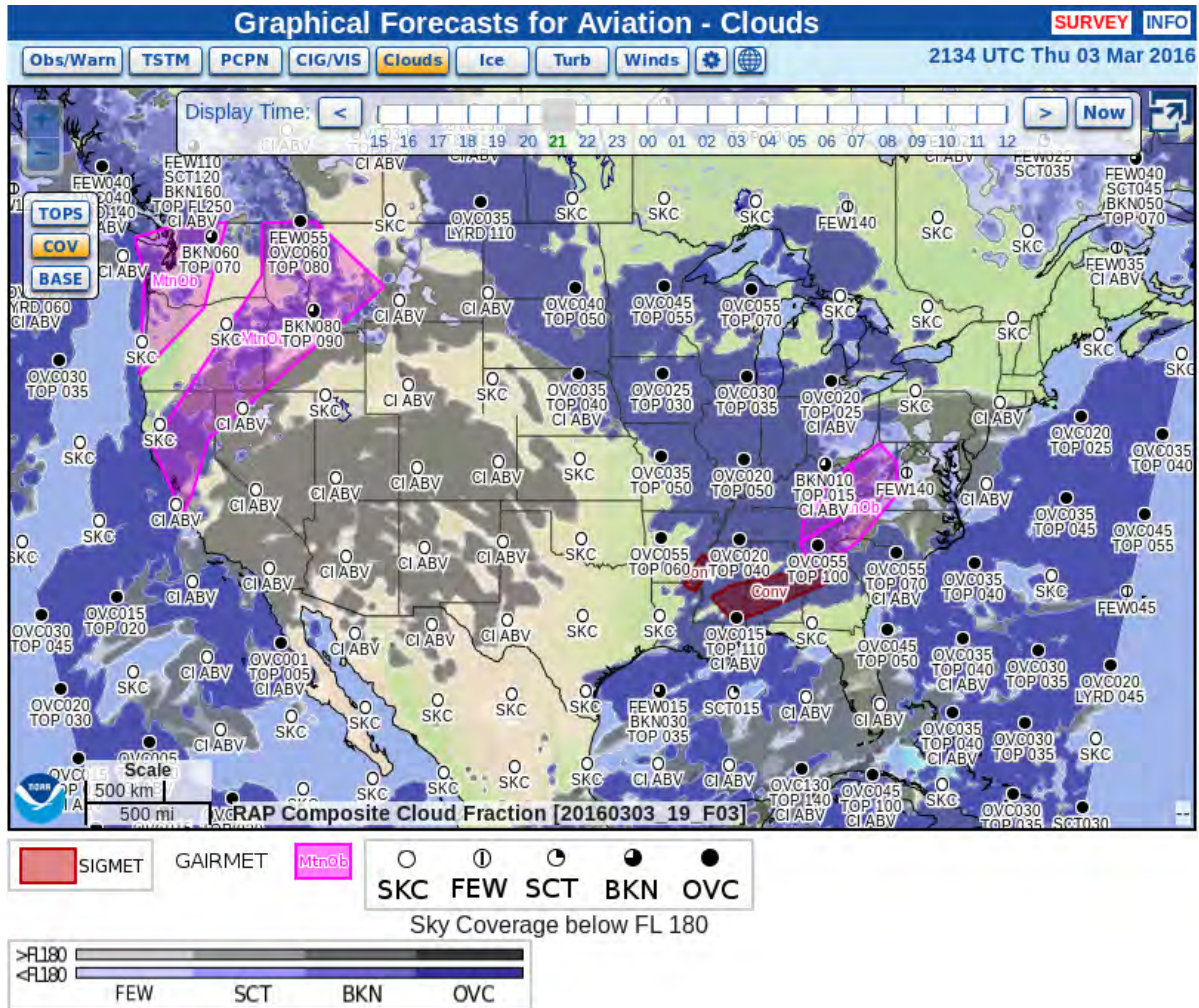

Figure 5. Graphical Forecast for Aviation Tool – Cloud view.

3--Graphical Turbulence Guidance (GTG) version 3

A new version of the GTG algorithm was released by NCAR in 2015. In the past, the GTG code was run on servers at the AWC but the goal for this release was to run GTG on WCOSS (Weather and Climate Operational Supercomputer System). GTG was reworked by NCAR at the direction of the AWC to get it on-boarded into the WCOSS infrastructure. This effort continued through much of late 2014 and into early 2015. By summer of 2015, GTG version 3 was running at WCOSS.

In the past, GTG only computed clear air turbulence but in version 3, mountain wave turbulence was added (Figure 6). In addition, the new algorithm is calibrated to output Eddy Dissipation Rate (EDR) values. EDR is derived from in-situ aircraft measurements, so direct comparisons for validation are now possible. The ADDS graphical displays now show EDR output rather than categorical intensities (light, moderate or greater). An aircraft dependent set of EDR thresholds have been provided (Figure 7).

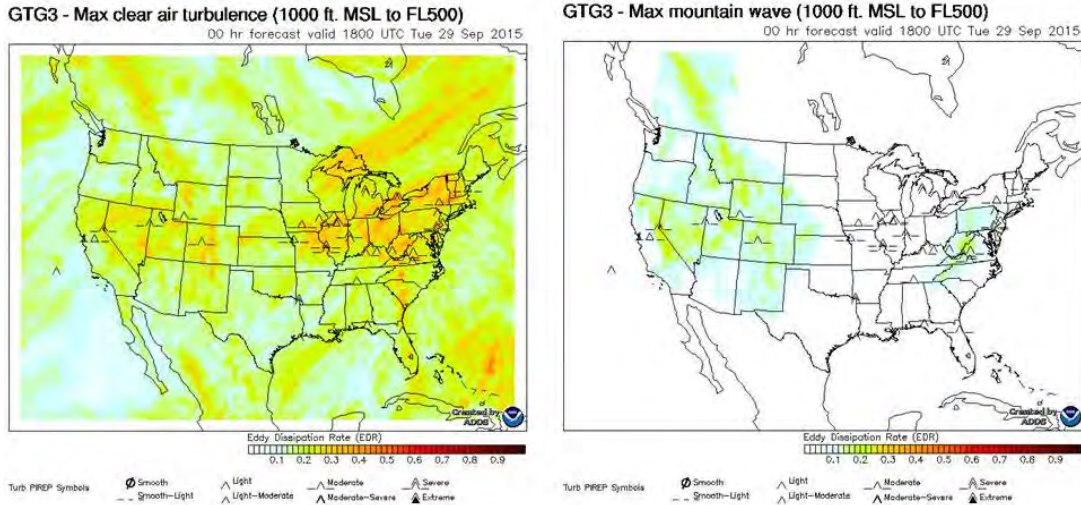

Figure 6. GTG version 3 output for clear air turbulence (left) and mountain wave turbulence (right).

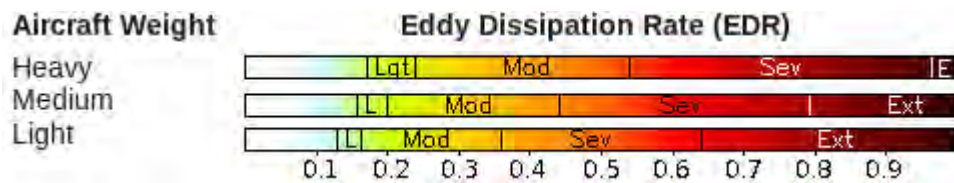

Figure 7. EDR thresholds by aircraft weight class.

4--Ensemble Post Processor Tool

The Ensemble Post-Processor (EPP), a web-based tool allowing users to perform user-specified ensemble calculations on NCEP ensemble and deterministic model members, has been transformed from its original Java-based state to a more lightweight Python version. The goal of the transition is to ensure an application is written in a way that will allow for continual improvements in the future.

The web application (Figure 8) connects to a SQL database that is continuously updated with the latest model information. There is a configuration file which controls how the model data are imported into the database, and therefore accessible by the user via the web application. The tool uses standard modules to read and write grids in GRIB2 format. The user has the ability to select any number of members from a particular model cycle for a particle forecast hour, and perform ensemble calculations such as mean, spread, maximum and minimum for any fields that exist within the model files. In addition, there is the ability to perform probability calculations for a user-supplied threshold on a specified field. Once a particular query is chosen and submitted by the user, a server-side program retrieves the selected grids from the model, performs the ensemble calculations, and returns the information to the user in the form of a PNG image containing a color-filled contour plot as well as a GRIB2 file containing the resultant grid field. The Ensemble Processor was updated to support changes to both the 40K and 16KM SREF in September 2015. The new 26 supported ensemble members include 13 NMMB members and 13 ARW members, and the vertical resolution was increased from 35 to 40 layers in the 40 KM output files.

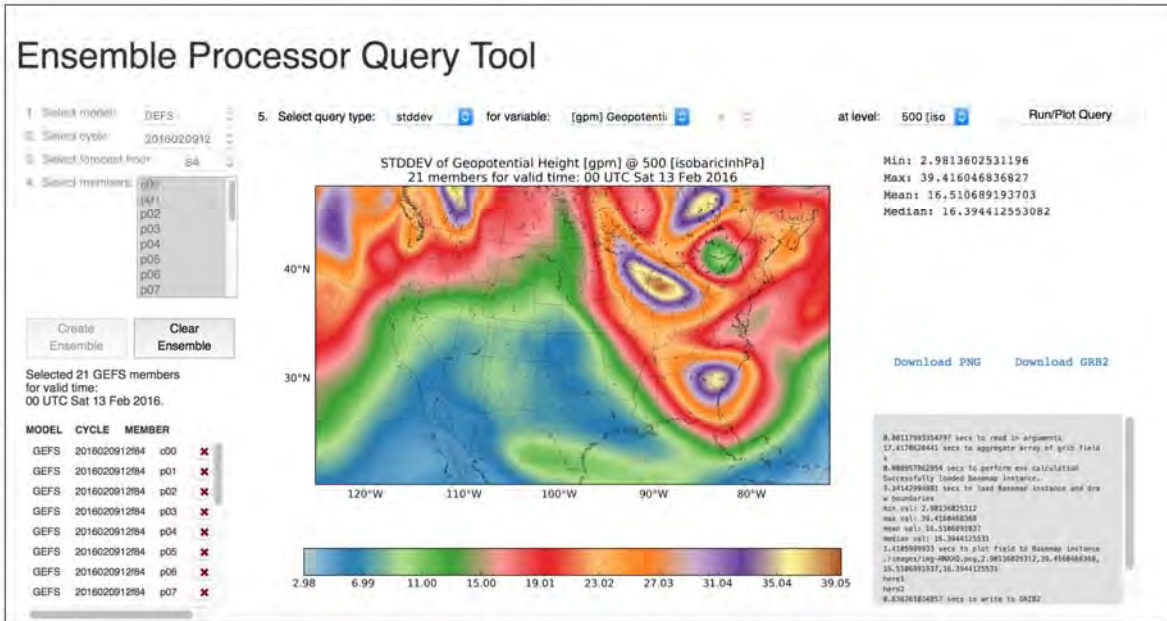

Figure 8. Web based Ensemble Processor tool based on Python.

Currently, the tool is restricted to a single model cycle from a single model. In 2016, the ability to perform calculations on time-lagged ensembles within a given model, and ultimately multi-model ensembles (which requires interpolation between model grids), will be implemented. In addition to horizontal plan-view plots, a plume-viewer functionality is also being worked on. This will allow the user to plot a variable with respect to time at a single point in space, very similar to the SPC SREF Plumes webpage. Finally, the addition of aviation-related derived variables in support of AWC operations such as turbulence, icing, mountain obscuration and mountain waves is being assessed.

The EPP is currently accessible at Stony Brook University (<http://noreaster.somas.stonybrook.edu/epc>) with a goal to have it available on an AWC website soon. Matt Sienkiewicz is the lead on this project.

5--Groupboard Chat

The Groupboard tool has been used in the past for products like Collaborative Convective Forecast Product (CCFP). With the addition of Collaborative Aviation Weather Statement (CAWS), the chat tool needed to be expanded to allow a broader set of users by adding NWS chat to the tool. The Groupboard developers in conjunction with AWC worked on integrating the new client into the drawing tool so that it could be used in the operational collaborative efforts at the AWC (Figure 9).

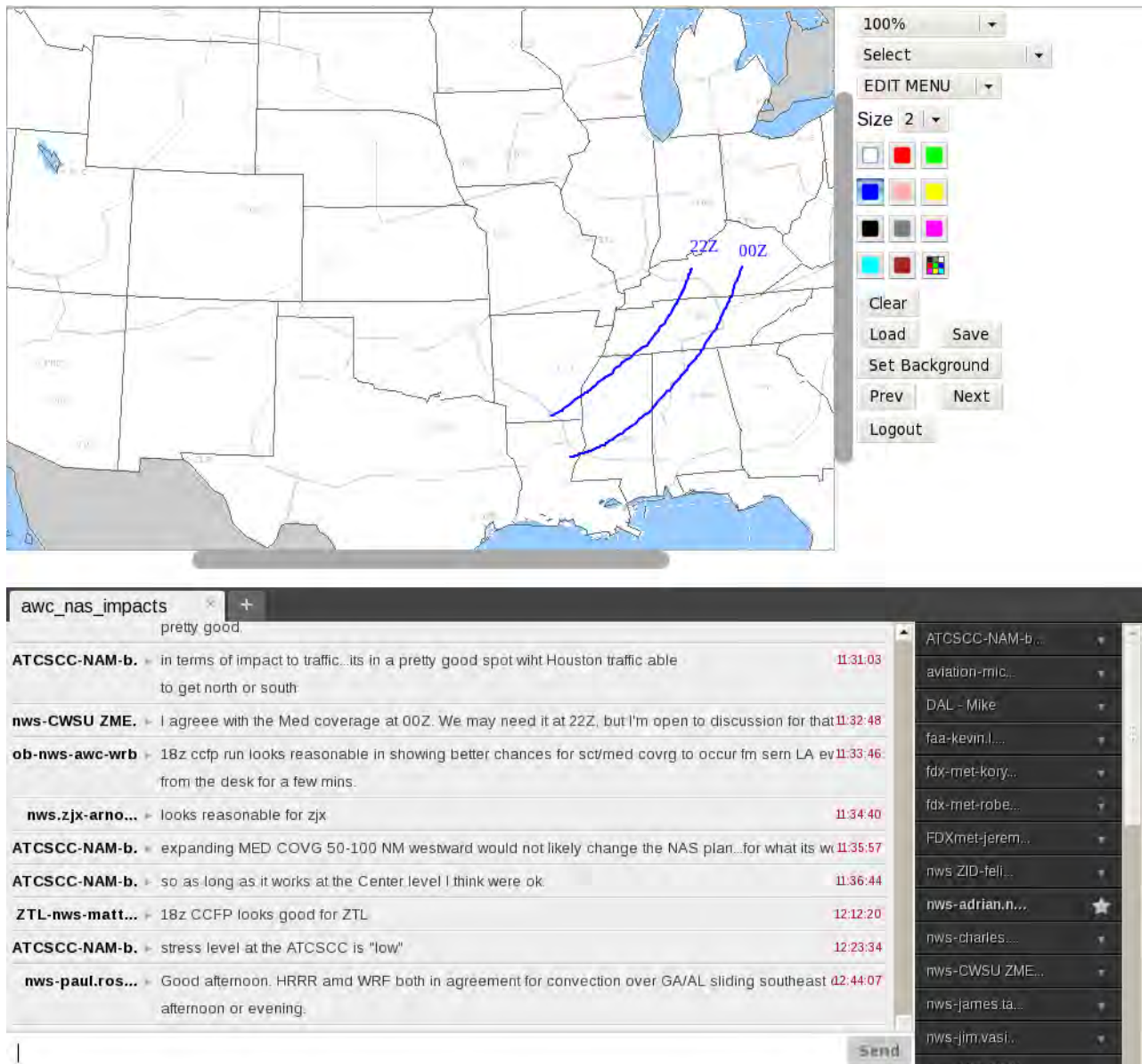

Figure 9. Groupboard application with interactive drawing tools (above) and NWS chat window (below)

Initial efforts to integrate NWS chat have shown promise even though browser limitations have affected the usability of the chat client. Work is continuing to make this into an operational chat tool. Adrian Noland has been the lead on this project.

Aviation Weather Research Program (AWRP)

The AWRP project had three objectives this year. The first was to make the HEMS Tool operational. After a two month review period, the tool went operational in May 2015. Several incremental updates were applied to the tool over the summer based on user feedback. Newer interactive functionality that has been developed for the GFA and other tools are being assessed for incorporation in the HEMS Tool in 2016.

The second effort was to get GTG version 3 operational on WCOSS. By late summer, the code was transitioned to operations and grids started being broadcast on NOAAPort in October.

The third effort is to transition CIP and FIP icing algorithms to WCOSS. Initial efforts began in late 2015 with a goal of having the code on WCOSS in late 2016. In the meantime, a new version of CIP and FIP was delivered to the AWC for local implementation in December. The new versions are still being tested and are slated to be available by mid-2016.

Brian Pettegrew is the lead on the AWRP project and continues to work with NCEP and NCAR on AWRP development and testing.

Traffic Flow Management (TFM) project update

The TFM project has two main deliverables. The first is the Tactical Decision Aid (TDA) tool. Even though no work was done on the web interface, the National Aviation Meteorologists (NAMs) developed an impacts catalog over the summer and fall of 2015. This catalog is an airport by airport definition of aviation impacts resulting from wind direction and speed, ceiling, visibility and weather conditions. The output has three classifications: low, medium and high impact along with the type of condition creating the highest impact (e.g. winds, ceiling). Integration of the catalog into the TDA and TAF board displays began in early 2016.

The second is the gate forecast tool. A gate forecast is a sector based forecast for thunderstorm threat. Using the High Resolution Rapid Refresh (HRRR) model, the percentage coverage of thunderstorms in either an arrival or departure sector (or gates) for an airport is turned into an impact level. Each airport can have anywhere from four to eight gates. The display shows each gate color coded for impact plus a matrix of impacts for the next nine hours (Figure 10). The gate forecast web page was made available in an experimental status in early 2015 for Atlanta, Charlotte and Dallas Fort Worth. Over the course of 2015, additional airports were added including Denver, Las Vegas, Chicago, Minneapolis, Houston, Memphis, Detroit, Miami, Washington DC and New York City. In addition to the forecast, an edit tool is being developed that would allow forecasters at Center Weather Service Units (CWSUs) to update or change the forecast if needed or add a forecast if the HRRR model data were not available. The edit tool is being tested for operational use in 2016.

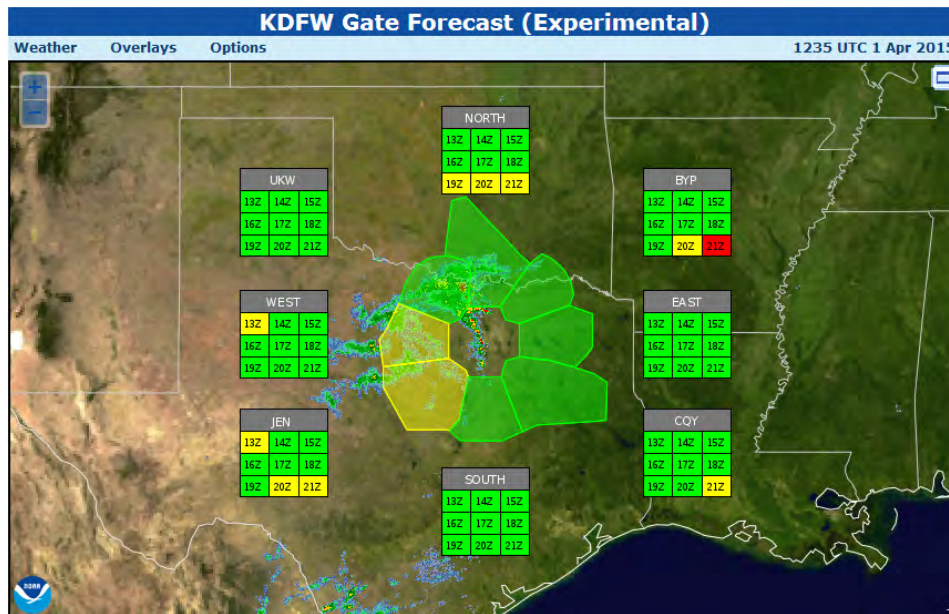

Figure 10. Sample gate forecast showing possible moderate impacts to west and southwest (JEN) gates as well as severe impact to the northeast (BYP) gate at 21Z.

Other Accomplishments

- Adrian Noland and Larry Greenwood helped with responding to user inquiries related to the new web site and were key in updating code and fixing bugs.
- Brian Pettegrew and Larry Greenwood worked on a model diagnostic tool for aviation data that was put on the testbed web site in the Summer of 2015.
- Brian Pettegrew was active in the WAFS community working on new global aviation diagnostic tools.
- Brian Pettegrew continued work on clear air turbulence algorithms using ensemble model output.
- Brian Pettegrew continued work on global lightning density products (Figure 11).

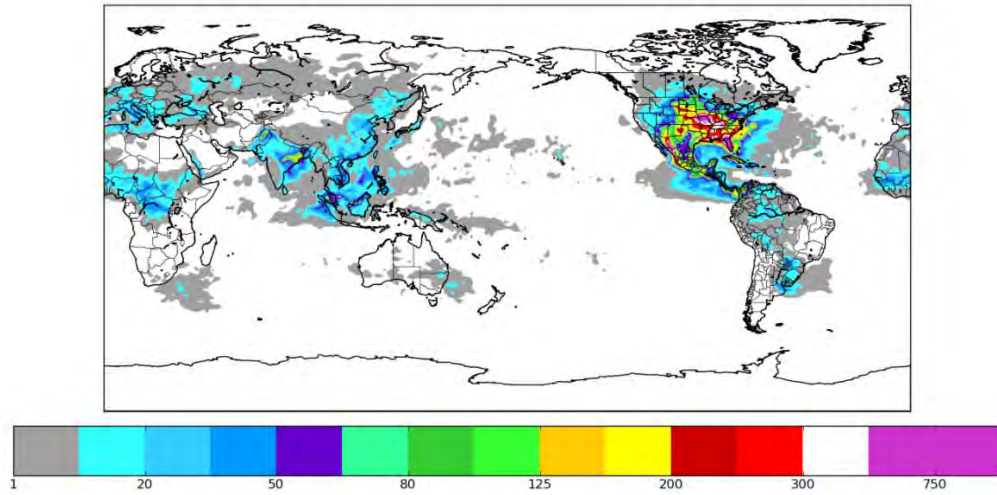

Figure 11. Sample global lightning density plot.

- Brian Pettegrew worked on new in-situ turbulence products based on aircraft EDR data into operations at the AWC.
- Adrian Noland worked with NCEP to integrate the AWC web code base into their VLAB repository.
- Larry Greenwood continued to monitor WIFS (WAFS Internet File Service) usage and produce timeliness statistics.
- The group provided support to the AWT for the 2015 Summer and the 2016 Winter Experiments.

PROJECT TITLE: Research Collaboration at the NWS Aviation Weather Center (AWC) in Support of the Aviation Weather Testbed (AWT), Aviation Weather Research Program (AWRP), and the NextGen Weather Program

PRINCIPAL INVESTIGATOR: Sher Schranz

RESEARCH TEAM: Chad Hill, Anders (Mick) Ohrberg, Lee Powell, Robyn Tessmer

NOAA TECHNICAL CONTACT: Joshua Scheck (NOAA/NWS/AWC/ASB Chief)

NOAA RESEARCH TEAM: Steven A. Lack (NOAA/NWS/AWC)

PROJECT OBJECTIVES:

AWC Aviation Support Branch is primarily responsible for providing support to the www.aviationweather.gov web site which includes maintaining the network and the server infrastructure at the AWC as well as supporting the research to operations processes.

The primary goal of the ASB is to develop and maintain the internal network, servers and workstations at the AWC to ensure continuity of operations. Research, development and operational systems support is critical to the AWC's forecast and web services. The ASB collaborates with the other National Center for Environmental Prediction (NCEP) centers and the National Weather Service (NWS) to provide data and research for operational support. The branch is headed by a team of Technique Development Meteorologists (TDMs). This includes support for the AWT and FAAAWRP. The AWRP products include Current and Forecasted Icing Products (CIP, FIP) and Graphical Turbulence Guidance (GTG). The ASB also supports the AWC website which includes the Aviation Digital Data Service (ADDS), the World Area Forecast System (WAFS) Internet File service (WIFS) and the International Flight Folder Document Program (IFFDP).

Operations Floor Reimagined

A complete teardown and rebuild of the Operations floor (OPS) was required to enhance the AWC's professional appearance and provided an ergonomic work setting for the OPS forecasters. As the old cubes aged it became nearly impossible to achieve acceptable cable management, and the old desks were out-of-date and showed considerable wear and tear.

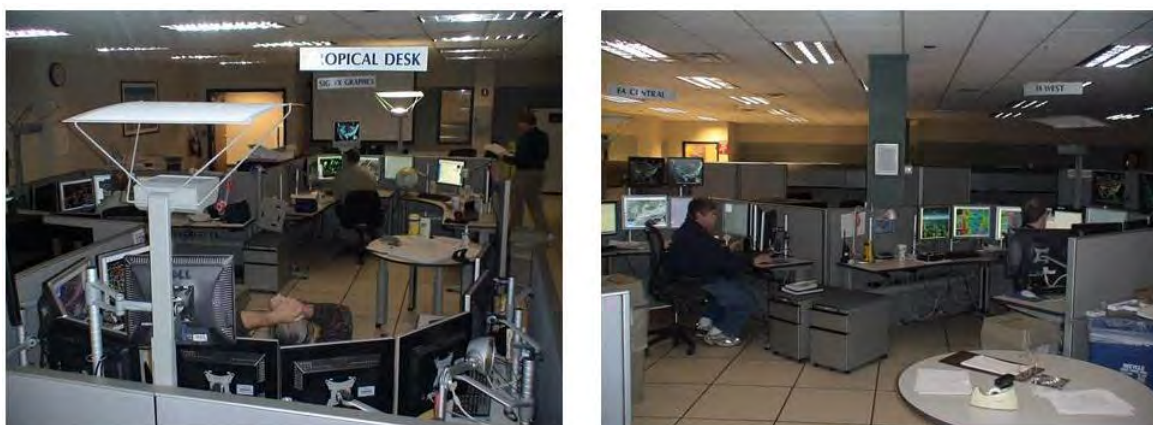

Figure 1. Before: Operations floor cubicles.

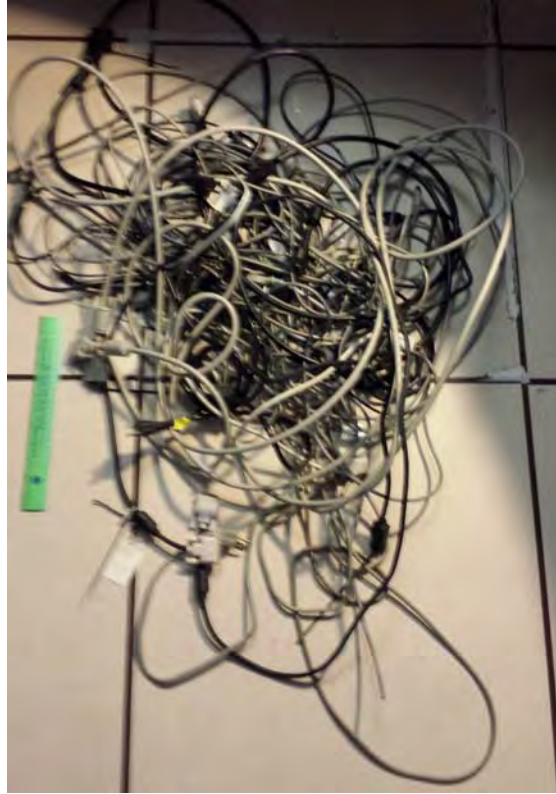

Figure 2. Cable from one cube clean out (pre-OPS rebuild).

Hundreds of pounds of old cabling were removed during the cable redesign and modernization of the AWC. Currently, there is now less than 10% percent of cable waste under the drop floors in the data center and OPS floor.



Figure 3. Complete tear down of OPS floor.

The ASB team worked closely with Management and the furniture design company to determine all electrical and cable management needs. Temporary OPS work areas were relocated to the AWT and the large AWC conference room. A large electrical team was brought in to deliver “dirty power” not on UPS

for basic non-operational electrical needs to the new cubes; phone chargers, heaters, electric pencil sharpeners, etc.

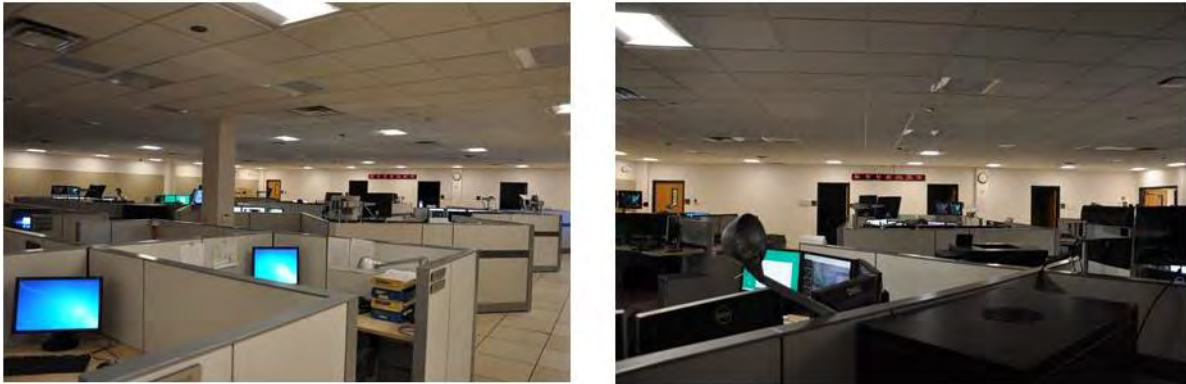

Figure 4. After: Completed pods and OPS cubicles

An enormous amount of time was expended to ensure networking and VOIP changes remained operational in order to keep OPS requirements at a 24\7 status. There were many challenges moving the forecasters to a new environment, but all pitched in to make this difficult transition occur.

All OPS cubicles each received 9 new 24 inch monitors with two separate “Lightning and Radar” displays. All of the pods will receive new 24 inch monitors and Dell Wyse virtual desktops. The new look is sleek and each individual area is capable of controlling their lighting conditions.

Aviation Weather Testbed Quad-Monitor Rig

To assist the AWT Summer Experiment we provided a quad-monitor rig to allow for long distance interactive communication.



Figure 5. Quad-Monitor Rig (bottom left screen you can see the remote location participating).

This simple but effective tool was well received, and we plan to set up additional quad-monitor rigs for future use.

Satellite Training to Support Three New WxConnect-GRB 6.5 Meter System Dishes

The Satellite team from Harris and NOAA came in two waves. The first did all the necessary power, wiring and construction of the new three 6.5 meter dishes.



Figure 6. One of three 6.5 meter dishes.

The second wave installed and configured three racks to manage and control the dishes. The training provided consisted of everything we need to maintain and troubleshoot issues. We were instructed on the internal and external mechanisms required for continuous data flow.



Figure 7. Satellite Antenna Rack controllers.

The above rack controllers allow for movement of the dishes, remote monitoring, spectrum analysis, demodulation (front end processing), and network attached storage (NAS) to improve data flow and integrity



Figure 8. Satellite farm.

Other Accomplishments

- KTOM Television services replaced with 13 HD Dish satellite receivers.
- 80% of KTOM pulled from two racks and condensed to approximately 8 rack units in a single rack for security camera feeds.
- Support for the 2015 Summer experiment.
- New video conference system build.
- Designed and created a VM for the Xibo signage server to replace an old sub-par NWS system.
- Sharepoint 2013 upgraded from 2007.
- Sharepoint 2013 server migrated from physical to virtual.

- Implementation of enterprise class backup system (Tivoli Storage Manager, or TSM) for off-site backups of Linux files to NCO.
- Virtualization continues for servers and workstation. AWC is a recognized leader in this field by NCEP and the NWS.
- Implemented new Subversion Source Control repository to replace the old CVS repository.
- Training was a large part of 2015. All ASB Support staff had numerous classes in a wide range of technical specialties: networking, virtualization, Linux RHEL7, and security.
- Created and maintained highly detailed documentation of network and file server infrastructure.
- Building wide security camera access tested as a concept. Project submitted.
- Replacement servers for Lighting and Radar display for OPS.
- Replaced AWIPS II CPSBN server to get involved in a beta program to improve operations.
- New power and cable management for OPS floor situational awareness displays.
- Support for the 2016 Winter Experiment.
- Two large pallets of excess inventory out to recycle.
- Critical operational component (shiftlog) was migrated to a separate virtual server for higher accessibility and reliability.

We all would like to welcome Joshua Scheck, the new ASB Chief. His newly appointed leadership will be a great fit to our team dynamic.

Research Collaboration at the NWS Aviation Weather Center (AWC) In Support of the Aviation Weather Testbed (AWT), Aviation Weather Research Program (AWRP) and the NextGen Weather Program Project Publications:

Kim, J.H, B.P. Pettegrew and M. Strahan, 2016: World Area Forecast System Updates for Medium and Long Term Goals. Proceedings, Fifth Symposium on Aviation, Range and Aerospace Meteorology, New Orleans, LA., Amer. Meteor. Soc., 832.

Pettegrew, B.P., B. Entwistle, and and S. A. Lack, 2016: Evaluation of Total Lightning Data in the Aviation Weather Testbed. Proceedings, Fifth Symposium on Aviation, Range and Aerospace Meteorology, New Orleans, LA , Amer. Meteor. Soc., 830.

Pettegrew, B.P., 2016: Probability of Turbulence in the Aviation Weather Testbed. Proceedings, Fifth Symposium on Aviation, Range and Aerospace Meteorology, New Orleans, LA. Amer. Meteor. Soc., 831.

PROJECT TITLE: SSMI and SSMIS Fundamental Climate Data Record Sustainment and Maintenance

PRINCIPAL INVESTIGATOR: Christian Kummerow

RESEARCH TEAM: Wes Berg, ATS

NOAA TECHNICAL CONTACT: Zuepeng (Tom) Zhao

NOAA RESEARCH TEAM: Hilawe Semunegus

FISCAL YEAR FUNDING: \$50,000

PROJECT OBJECTIVE(S):

The Climate Data Record Program (CDRP) leads NOAA's development and provision of authoritative satellite climate data records (CDRs) for the atmospheres, oceans and land. This project's objective is to provide NOAA with a fundamental climate Data record of Special Sensor Microwave/Imager (SSMI) and Special Sensor Microwave Imager and Sounder (SSMIS) data records. For the currently orbiting SSMIS sensors, the records are broken into Interim Climate Data Records (ICDR) produced rapidly using automated QC and trending information as well as the fundamental data record (FCDR) produced roughly six months after acquisition. In addition, gridded ICDR/FCDR files are provided over the entire data record. The objectives further relate to distribution of data, interface for the community, and including new satellite data streams when these become available.

PROJECT ACCOMPLISHMENTS:

An updated SSMI(S) Brightness Temperature Implementation Plan that describes the deliverables and major tasks for this period was delivered December 17, 2015. It specifies ongoing monitoring of ICDR products posted to FCDR website, ongoing production and delivery of daily ICDR updates to NCEI, ongoing production and delivery of gridded ICDR updates to NCEI, evaluation and conversion of ICDR to FCDR files, and development of F19 corrections/intercalibration for FCDR release. In the past year we worked with NCEI to develop a daily gridded Tb dataset. Once the format for the gridded files was agreed upon, we processed and delivered gridded files corresponding to the entire FCDR data record. In addition, we added daily production and delivery of the ICDR gridded files for all of the operational sensors. We are currently producing and delivering daily updates (via ftp pull from NCEI) of the pixel level and gridded ICDR products for F15, F16, F17, F18 and F19.

Another task specified in the implementation plan involves the evaluation of the F19 ICDR data, and the development of corrections and calibration updates for FCDR release. Note that data from F19 stopped on February 11, 2016 due to an anomaly with the command receivers. It is not clear whether this development is temporary or if it marks the end of the F19 data record. Development and delivery of FCDR files will require much more data than the few months currently available. Regardless, we are working on updates to the F19 processing for FCDR release.

The implementation plan also details the external dependencies, and details the quality control procedure we have implemented. We also provided a quality assurance document back in August of 2014 that highlights the progress made in monitoring the quality of the intercalibrated Tb, although this effort is ongoing. Part of the quality assurance involves evaluation of retrieved geophysical products as shown in the following comparison of F17 and F19 precipitation estimates. In addition, we have been working on the development on a 1D variational retrieval algorithm for non-precipitating ocean scenes, to retrieve total precipitable water and vertical profile information, ocean surface wind speed, and cloud water. This retrieval algorithm was developed for application to the Global Precipitation Mission (GPM) microwave imager (GMI), however, we plan to adapt it for use to the SSMI and SSMIS sensors. This retrieval is very

sensitive to calibration errors and will provide another useful tool for quality assurance of the SSMI(S) FCDR dataset.

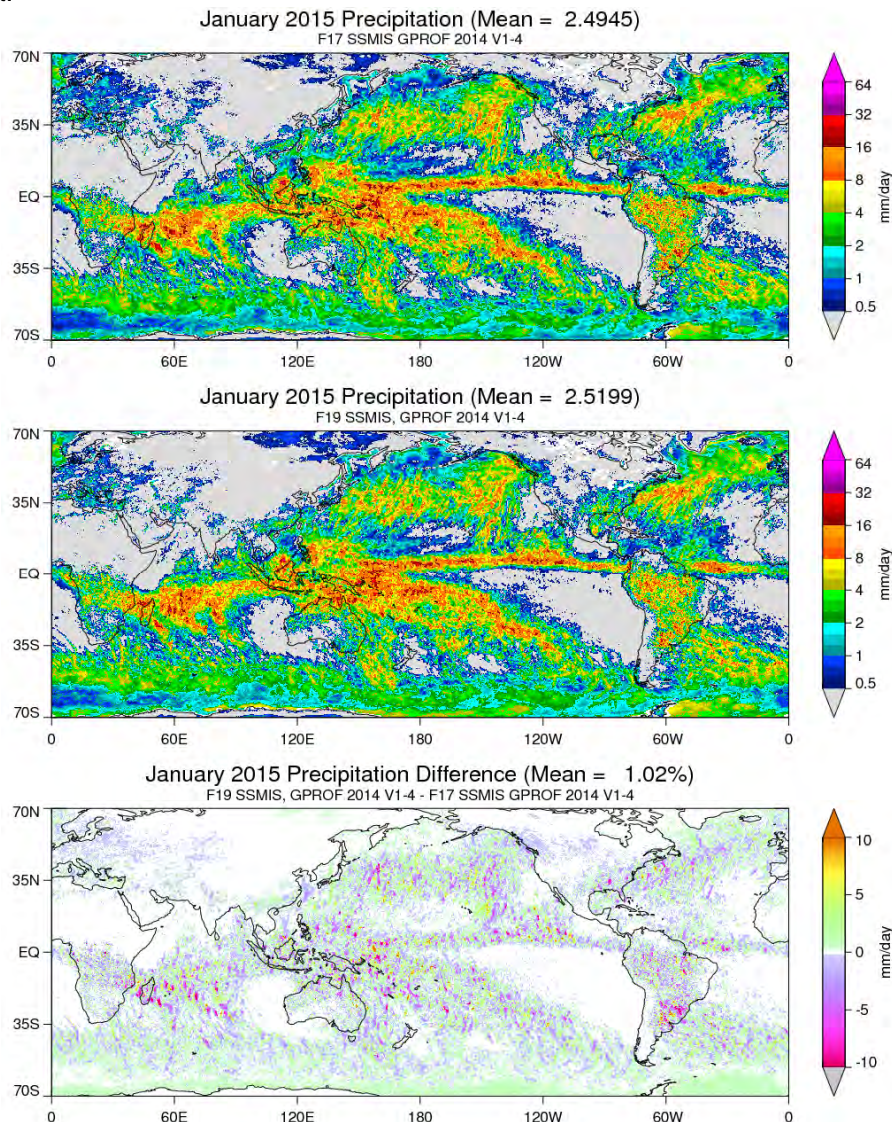

Figure 1. January 2015 monthly mean precipitation from the operational GPM retrieval algorithm for the SSMIS sensors on board a) F17, b) F19, and c) F19 – F17. Preliminary corrections have been developed and applied for cross-track biases, geolocation/pointing errors, and intercalibration adjustments over both cold and warm scenes. The comparison with F17 is shows as the local ascending equatorial crossing time is very similar, but not identical, between these two sensors. As a result, some residual differences due to diurnal cycle effects is expected, particularly over land.

Publications:

Berg, W. and Chris Kummerow, A 27-Year Climate Data Record of Intercalibrated Brightness Temperatures and Precipitation Estimates from the DMSP Microwave Imagers, presented at the 20th AMS Satellite Conference, Phoenix, Arizona, 4-8 January, 2015.

Berg, Wesley and Chris Kummerow, CSU SSMI(S) FCDR, presented at the NOAA Climate Data Record annual meeting in Asheville, North Carolina, August 4-6, 2015.

PROJECT TITLE: Weather Satellite Data and Analysis Equipment and Support for Research Activities

PRINCIPAL INVESTIGATORS: Chris Kummerow/Michael Hiatt

RESEARCH TEAM: Michael Hiatt

NOAA TECHNICAL CONTACT:

NOAA RESEARCH TEAM: None

FISCAL YEAR FUNDING: \$75,000

PROJECT OBJECTIVES:

- 1--Earthstation: Operations and maintenance for 4 antennas and associated telemetry, network, ingest, processing, distribution, and archive
- 2--Data Collection: All direct readout GOES GVAR via 3 GOES systems, GOES special collections, MSG via 7M DOMSAT system, and 21 project products via Internet
- 3--Data Distribution and Archive: Blu-ray media, archive writers, and online RAID storage
- 4--Personnel Salary: Part time coverage for one Electrical Engineer

PROJECT ACCOMPLISHMENTS:

- All data sets collected, processed, cataloged, distributed, and archived at 99.9% level. Online archive now spans from 1987-2016 with approximately 450TB online data and Blu-ray backups.
- Added GOES-7 into archives
- 1 large RAID NAS units added for additional storage
- 2 Blu-ray writers, one upgrade and one replacement
- 1 processing server upgraded
- Telemetry maintenance

Publications: N/A

PUBLICATIONS MATRIX

	2011	2012	2013	2014	2015
CI Lead Author	21 Peer Reviewed 71 Non-peer Reviewed	31 Peer Reviewed 114 Non-peer Reviewed	23 Peer Reviewed 98 Non-peer Reviewed	28 Peer Reviewed 13 Non-peer Reviewed	48 Peer Reviewed 49 Non-peer Reviewed
NOAA Lead Author	23 Peer Reviewed 70 Non-peer Reviewed	25 Peer Reviewed 69 Non-peer Reviewed	28 Peer Reviewed 40 Non-peer Reviewed	21 Peer Reviewed 17 Non-peer Reviewed	48 Peer Reviewed 15 Non-peer Reviewed
Other Lead Author	29 Peer Reviewed 35 Non-peer Reviewed	30 Peer Reviewed 43 Non-peer Reviewed	31 Peer Reviewed 33 Non-peer Reviewed	51 Peer Reviewed 5 Non-peer Reviewed	50 Peer Reviewed 19 Non-Peer Reviewed

CIRA EMPLOYEE MATRIX

CIRA Personnel					
Category	Number	None	B.S.	M.S.	PhD.
Research Scientist	27	0	0	0	27
Visiting Scientist	0	0	0	0	0
Postdoctoral Fellow	2	0	0	0	2
Research Support Staff	70	3	25	33	9
Administrative	5	0	3	2	0
Total (≥ 50% support)	104	3	28	35	38
Undergraduate Students	5	0	5	0	0
Graduate Students	16	0	0	11	5
Employees that receive < 50% NOAA Funding (not including students)	67	14	14	22	17
		ESRL	MDL	AWC	NESDIS
Located at Lab (name of lab)	73	48	4	12	9
Obtained NOAA employment with the last year	3				

Other Agency Awards 2015/16
(Sorted by Awarding Agency)

	Title	Lead NOAA Collaborator	Awarding Agency	Fiscal Year Funding
Connell	CIRA Support to Building Regional Climate Capacity in the Caribbean	No	Caribbean Institute for Meteorology & Hydrology	\$30,000
Miller	Advanced Algorithm Development for Next-Generation Satellite Systems	No	Department of Defense NRL	\$0
Liston	Changes in Climate and Its Effect on Timing of Snowmelt and Intensity Duration Frequency Curves	No	Department of Defense	\$124,609
Wang	Estimation of Initial and Forecast Error Variances for the NCEP's Operational Short-Range Ensemble Forecast (SREF) System	No	DTC Visitor Program	\$0
Hand	Air Quality & Climate Change Interpretive Kiosk Project	No	FWS	\$0
Jones	Agricultural Re-Analysis of Precipitation Data	No	Global Dev. Analytics (BMGF prime)	\$0
Miller	CIRA Data Processing Center Support for the CloudSat Mission	No	JPL	\$437,012
Zupanski	Advancing Coupled Land-atmosphere Modeling with the NASA-unified WRF via Process Studies and Satellite-scale Data Assimilation	No	NASA	\$23,883
O'Dell	Enhancing OCO-2's Observational Capabilities Under Partly and Fully Cloudy Con	No	NASA	\$31,312
Zupanski	Ensemble-based Assimilation and Downscaling of the GPM Satellite Precipitation Information: Further Development and Improvements of WRF-EDAS	No	NASA	\$93,258
Baker	Fine Resolution CO ₂ Flux Estimates from AIRS and GOSAT CO ₂ Retrievals: Data Validation and Assimilation	No	NASA	\$0

Other Agency Awards 2015/16
(Sorted by Awarding Agency)

	Title	Lead NOAA Collaborator	Awarding Agency	Fiscal Year Funding
Baker	GOES-CARB: A Framework for Monitoring Carbon Concentrations and Fluxes	No	NASA (via Pawson)	\$0
Baker	GEOS-Carb II: Delivering Carbon Flux and Concentration Products Based on the GEOS Modeling System	No	NASA	\$29,955
Schuh	Improved Parameterization of Carbon Cycle Models Across Scales Using OCO-2 Measurements of XCO2	No	NASA	\$50,000
O'Dell	Orbiting Carbon Observatory (OCO-2) Task	No	NASA	\$300,000
Liston	Snow on Sea Ice: Data Fusion Using Remote Sensing and Modeling	No	NASA	\$161,506
O'Dell	Tackling Aerosol and CO2 Uncertainties through the Synergistic Use of MODIS and OCO-2 Observations	No	NASA	\$141,158
Schranz	Wildland Fire Behavior and Risk Forecasting	No	NASA	\$151,743
Miller	Satellite Techniques for Improving the Accuracy of Solar Forecasting	No	NCAR (DoE)	\$51,617
Liston	Norwegian Young Sea Ice Cruise	No	NPI	\$0
Hand	Assistance for Instrument Development to Measure the Relationship of Air Quality with Night Sky Visibility	No	NPS	\$0
Hand	Assistance for Visibility Data Analysis and Image Display Techniques	No	NPS	\$0
Hand	Assistance for Visibility Data Analysis and Image Display Techniques	No	NPS	\$895,976
McClure	Data Warehouse for Air Quality Modeling in the Oil and Gas Regions of Wyoming, Utah, and Colorado	No	NPS	\$0
Hand	Engaging and Training Citizens in Stewardship of Night Skies	No	NPS	\$0

Other Agency Awards 2015/16
(Sorted by Awarding Agency)

	Title	Lead NOAA Collaborator	Awarding Agency	Fiscal Year Funding
McClure	Intermountain West Data Warehouse for Air Quality Modeling in the Oil and Gas Regions of Wyoming, Utah and Colorado	No	NPS	\$236,000
Chirokova	Conversion of CIRA's AMSU-based Wind Retrieval Algorithm into a Real-time Pre-operational NRL SSMIS Application	No	NRL	\$0
Fletcher/ Jones	Analyzing the Impacts of Non-Gaussian Errors in Gaussian Data Assimilation Systems	No	NSF	\$0
Liston, Hiemstra	Collaborative Research: AON A Snow Observing Network to Detect Arctic Climate Change-Snow Net II	No	NSF	\$0
Lu	Collaborative Research: Sensitivity of Regional Climate Due to Land-cover Changes in the Eastern U.S. Since 1650	No	NSF	\$0
Lu	Investigating Feedbacks Between Vegetation, Aerosol and Cloud Processes Using Observations and a Unified Regional Climate Model	No	NSF	\$218,446
Fletcher	Regional, Seasonal and Large Dynamical Scale Based Covariance and Humidity Control Variable Transform Implementation into NAVDAS-AR	No	ONR	\$117,356
Miller	Advancing Littoral Zone Aerosol Prediction via Holistic Studies in Regime-dependent Flows	No	ONR/MURI	\$1,100,000
Schranz	CIRA Evaluation, Research and Development in Support of the PEMDAS Technologies and Innovations NOWcasting System	No	PEMDAS	\$104,089
Baker	Atmospheric Carbon and Transport Study – America (ACT – America)	No	Penn State Univ (NASA Prime)	\$117,582
Schuh, Ogle	Quantification of the Regional Impact of Terrestrial Processes on the Carbon Cycle Using Atmospheric Inversions	No	Penn State (NASA)	\$33,773

Other Agency Awards 2015/16
(Sorted by Awarding Agency)

	Title	Lead NOAA Collaborator	Awarding Agency	Fiscal Year Funding
Kummerow	Subaward for Advancing Water Supply Forecasts in the Colorado River Basin for Improved Decision Making	No	Riverside Technology (NASA)	\$56,819
Liston	Blending Fine-scale Terrestrial Snow Information with Coarse-scale Remote Sensing Data Using Inferential and Modeling Methods	No	UAF	\$0
Miller	CIRA Support of Alaska Direct Broadcast at GINA	No	UAF	\$35,000
McClure	Intermountain West Data Warehouse Development and Operations Support	No	WESTAR	\$25,155
Connell	Tasks Related to Technical Support of the WMO-GGMS Virtual Lab for Education and Training	No	WMO	\$90,000
Kummerow	A Collaborative Effort to Improve Geostationary Products of Hydrologic Variables	No	Yonsei University	\$0

NOAA PROJECTS BY TITLE

	Page
A Cooperative Institute to Investigate Satellite Applications for Regional/global-scale Forecasts	xxvi
Algorithm Development for AMSR-2	14
Applications of Concurrent Super Rapid Sampling from GOES-14 SRSOR, Radar and Lightning Data	15
Building a "Citizen Science" Soil Moisture Monitoring System Utilizing the CoCoRaHS Network	220
CIRA Research Collaborations with the NWS Meteorological Development Lab on Virtual Laboratory, Innovation Web Portal, Impacts Catalog and AWIPS II Projects	247
CIRA Support for Dynamical Core Selection for the Next Generation Global Prediction System (NGGPS)	16
CIRA Support for Feature-Based Validation of MIRS Soundings for Tropical Cyclone Analysis and Forecasting	17
CIRA Support for Research and Development for GOES-R Risk Reduction for Mesoscale Weather Analysis and Forecasting	103
CIRA Support for the JPSS Proving Ground and Risk Reduction Program: Application of JPSS Imagers and Sounders to Tropical Cyclone Track and Intensity Forecasting	43
CIRA Support for Tropical Cyclone Model Diagnostics and Product Development – HFIP	122
CIRA Support of NOAA's commitment to the Coordination Group for Meteorological Satellites: Enhancing the International Virtual Laboratory	93
CIRA Support of the Virtual Institute for Satellite Integration Training (VISIT)	127
CIRA support to a GOES-R Proving Ground for National Weather Service Forecaster Readiness	30
CIRA Support to RAMMB Infrastructure for GOES-R Rebroadcast Data Collection at CIRA/CSU	100
CIRA Support to RAMMB Infrastructure for GOES-R Rebroadcast Data Collection at CIRA/CSU EOY StAR Project	102
CIRA Support to the JPSS Proving Ground and Risk Reduction Program: Addressing NWS Desires for a Cloud Cover Layers Product using Merged VIIRS and ATMS Products	64
CIRA Support to the JPSS Proving Ground and Risk Reduction Program: 'Seeing the Light': Exploiting VIIRS Day/Night Band Low Light Visible Measurements in the Arctic and Advancing Nighttime VIIRS Cloud Products with the Day/Night Band	72
CIRA Support to the JPSS Proving Ground and Risk Reduction Program: Improving NUCAPS Soundings for CONUS Severe Weather Applications via Data Fusion	66

CIRA Support to the JPSS Proving Ground and Risk Reduction Program: Integration of JPSS Experimental Products in AWIPS II through EPDT Code Sprints	252
CIRA Support for Research and Development for GOES-R Risk Reduction for Mesoscale Weather Analysis and Forecasting	103
CIRA Support to the JPSS Proving Ground and Risk Reduction Program: JPSS Satellite Training for NOAA Users	69
CIRA Support to the JPSS Science Program: S-NPP VIIRS EDR Imagery Algorithm and Validation Activities and S-NPP VIIRS Cloud Validation	81
CIRA Support: Getting Ready for NOAA's Advanced Remote Sensing Programs A Satellite Hydro-Meteorology (SHyMet) Education and Outreach Proposal	24
CIRA Support to Improving CRTM Solar Reflection	40
CSU/CIRA Support for ATMS SI Traceable Calibration Effort	130
CIRA Research Collaborations with the NWS Meteorological Development Lab on Virtual Laboratory, Innovation Web Portal, Impacts Catalog and AWIPS II Projects	247
<u>Environmental Applications Research (EAR)</u>	
<i>Advanced High Performance Computing</i>	199
<i>Aviation Weather Forecast Impact and Quality Assessment</i>	255
<i>AWIPS I and AWIPS II Workstation Development</i>	265
<i>Citizen Weather Observer Program</i>	273
<i>Developmental Testbed Center Support</i>	262
<i>Evaluation of Chemical Data Assimilation Systems for PM2.5 Observations</i>	214
<i>Flow-following Finite-volume Icosahedral Model (FIM) Development Project</i>	197
<i>Flow-following Finite-volume Icosahedral Model (FIM) Data Distribution</i>	254
<i>Improving Short-range Forecasts of Severe Weather and Aviation Weather</i>	210
<i>Local Analysis and Prediction System (LAPS)</i>	218
<i>Meteorological Assimilation Data Ingest System (MADIS)</i>	271
<i>NextGen IT Web Services/Integrated Dissemination Program (IDP)</i>	275
<i>NARRE Repository Maintenance and Rocoto End-to-end Workflow (DTC Task)</i>	202
<i>Nonhydrostatic Icosahedral Model (NIM) Project</i>	198
<i>Organization of the Second NMMB Tutorial and All Supporting Documentation (DTC Task)</i>	203
<i>RAP Ensemble Generation and Testing within GSI for Future Implementation</i>	
<i> In the Deterministic, Real-time RAP</i>	207
<i>Rapid Update Cycle Rapid Refresh (RAP) and High-resolution Rapid Refresh (HRRR)</i>	
<i> Models Development and Enhancement</i>	201
<i>Rapid Update Cycle (RUC) Rapid Refresh (RAP) and High-resolution Rapid Refresh (HRRR) Models Project, Data Distribution and Visualization</i>	263
<i>Refinement and Evaluation of Automated High-resolution Ensemble-based Hazard</i>	
<i> Detection Guidance Tools for Transition to NWS Operations (GSD-Task)</i>	204
<i>Research Collaboration with Information and Technology Services</i>	274
<i>Science on a Sphere (SOS®) Development</i>	276
<i>Testing of Stochastic Physics Approach for Use in NARRE (DTC Task)</i>	205
<i>Toward a Unified National Dust Modeling Capability: Data Assimilation</i>	213
Enhancing NIDIS Drought Monitoring and Early Warning in the Upper Colorado River Basin	236
Expanding Precipitation Measurements in the Commonwealth of the Bahamas through the CoCoRaHS (Community Collaborative Rain, Hail and Snow) Network	240

Explicit Forecasts of Recurrence Intervals for Rainfall: Evaluation and Implementation Using Convection-allowing Models	244
Hydrological Research and Water Resources Applications Outreach Coordination	245
Hydrometeorological and Water Resources Research	222
Instructional Development and Learning Support for NOAA's OMAO's Chief Learning Officer (CLO), OMAO Kansas City Missouri	282
Integrating GPM and Orographic Lifting into NOAA's QPE in Mountainous Terrain	135
NESDIS Environmental Applications Team (NEAT)	
<i>Prasanjit Dash, Research Scientist</i>	139
<i>Yanni Ding, Post Doc</i>	146
<i>Lide Jiang, Post Doc</i>	150
<i>Xingming Liang, Research Scientist</i>	154
<i>Shuyan Liu, Research Scientist</i>	159
<i>Xiaoming Liu, Research Scientist</i>	150
<i>Wei Shi, Research Scientist</i>	164
<i>SeungHyun Son, Research Scientist</i>	169
<i>Liqin Tan, Research Associate</i>	176
<i>Sirish Uprety, Research Associate</i>	177
<i>Xiao-Long Wang, Research Associate</i>	182
<i>Xinjia Zhou, Research Associate</i>	185
<i>Tong Zhu, Research Scientist</i>	188
Polar-Geo Blended Hydrometeorological Products	191
Research Collaboration at the NWS Aviation Weather Center in Support of the Aviation Weather Testbed, Aviation Weather Research Program, and the NextGen Weather Program	290
SSM/I and SSM/IS Fundamental Climate Data Record Sustainment and Maintenance	320
CIRA Support for Tropical Cyclone Model Diagnostics and Product Development	122
Using JPSS Retrievals to Implement a Multisensor, Synoptic, Layered Water Vapor Product for Forecasters	193
Weather Satellite Data and Analysis Equipment and Support for Research Activities	322

COMPETITIVE PROJECTS

- 1—Assessment of Gridded Hydrological Modeling for NWS Flash Flood Operations (NA15OAR4590152)
- 2--CoCoRaHS: Capitalizing on Technological Advancements to Expand Environmental Literacy Through a Successful Citizen Science Network (NA10SEC0080012)
- 3—Development of a Framework for Process-oriented Diagnosis of Global Models (NA15OAR4310099)
- 4--Following Emissions from Non-traditional Oil and Gas Development through Their Impact on Tropospheric Ozone (NA14OAR4310148)
- 5--Guidance on Intensity Guidance (NA13OAR4590187)
- 6—Improvement and Implementation of the Probability-based Microwave Ring Rapid Intensification Index for NHC/JTWC Forecast Basins (NA15OAR4590200)
- 7—Improvement to the Tropical Cyclone Genesis Index (TCGI) (NA15OAR4590202)
- 8—Improvements to Operational Statistical Tropical Cyclone Intensity Forecast Models (NA15OAR4590204)
- 9—Improving CarbonTracker Flux Estimates for North America Using Carbonyl Sulfide (OCS) (NA13OAR4310080)
- 10--Intraseasonal to Interannual Variability in the Intra-Americas Sea in Climate Models (NA12OAR4310077)
- 11—Multi-disciplinary Investigation of Concurrent Tornadoes and Flash Floods in the Southeastern US (NA15OAR4590233)
- 12--Observational Constraints on the Mechanisms that Control Size- and Chemistry-resolved Aerosol Fluxes Over a Colorado Forest (NA14OAR4310141)
- 13—Research to Advance Climate and Earth System Models Collaborative Research: A CPT for Improving Turbulence and Cloud Processes in the NCEP Global Models (NA13OAR4310103)
- 14—Towards Assimilation of Satellite, Aircraft, and Other Upper-air CO₂ Data into CarbonTracker (NA13OAR4310077)
- 15--Upgrades to the Operational Monte Carlo Wind Speed Probability Program (NA13OAR4590190)
- 16—Use of the Ocean-Land-Atmosphere Model (OLAM) with Cloud System-resolving Refined Local Mesh to Study MJO Initiation (NA13OAR4310163)

Annual Report Information Template
For Use by Principal Investigators and Contributors
Timeframe April 1, 2015 – March 31, 2016

PROJECT TITLE: Assessment of Gridded Hydrological Modeling for NWS Flash Flood Operations (Grant Award # NA15OAR4590151)

PRINCIPAL INVESTIGATOR(S) (CIRA/CSU PI):

Lynn E. Johnson, Ph.D., P.E., Senior Research Hydrologist
Physical Sciences Division, NOAA Earth System Research Laboratory
CSU Cooperative Institute for Research in the Atmosphere
325 Broadway, Boulder, CO 80305-3328
Office: (303) 497-5322, Mobile: (303) 775-5544
Lynn.E.Johnson@noaa.gov

Co-PI: James S. Halgren, Ph.D., Senior Scientist
Riverside Technology, inc.
2950 E Harmony Road, Suite 390, Fort Collins, CO 80528
Phone: (970) 498-1837
James.Halgren@riverside.com

RESEARCH TEAM: (CIRA/CSU Staff involved in the project listed in order of staffing time on project, contribution level, or other):

Joy Labadie, Research Associate, CSU Dept. Civil and Environmental Engineering

NOAA TECHNICAL CONTACT: (Main NOAA PI on the project and specific office affiliation):

Rob Cifelli, Ph.D., Lead, Hydrometeorology Modeling and Applications Team
Physical Sciences Division, NOAA Earth System Research Laboratory
R/PSD2, 325 Broadway, Boulder, CO 80305-3337
(303) 497-7369
rob.cifelli@noaa.gov

NOAA RESEARCH TEAM (The equivalent of CIRA Research Team for NOAA Staff involved in the project and their affiliations):

Tim Coleman, Data Manager, Physical Sciences Division, NOAA Earth System Research Laboratory

PROJECT OBJECTIVE(S) (list 1 or more):

- A primary objective of this work is to prototype and demonstrate the ability to provide flood information at scales and at locations not currently served by RFC operations.
- Another objective is to inform the ongoing effort within OHD and National Water Center to develop a concept of operations, requirements specification, and toolkit for Distributed Hydrologic Model (DHM) implementation and application for RFC operations.
- Ancillary objectives include:
 - Enhancing the prototype DHM capability for (near) real-time operations and retrospective case studies within the ESRL test environment
 - Development of new visualization techniques for distributed hydrometeorology fields and testing methods for distributed state editing
 - Examine WFO flash flood operations concept-of-operations to include interactions between the WFO and RFC

PROJECT ACCOMPLISHMENTS: (Research Conducted) Past Fiscal Year by Objective:

- Sub-task 1: Coordination
 - Description of Work Performed:
 - Organized an advisory panel (AP) with the following members
 - Rob Hartman (NWS CNRFC) - robert.hartman@noaa.gov
 - Mark Strudley (NWS WFO-MTR) - mark.strudley@noaa.gov
 - Rob Cifelli (ESRL/PSD) - rob.cifelli@noaa.gov
 - Chad Kahler (NWS Western Region) - chad.kahler@noaa.gov
 - Mike Smith (NWS NWC) - Michael.Smith@noaa.gov
 - Ed Clark (NWS NWC) – edward.clark@noaa.gov (unable to attend kickoff)
 - Mike Anderson (CaDWR) - Michael.L.Anderson@water.ca.gov (unable to attend kickoff)
 - Chris Delaney (SCWA) - Chris.Delaney@scwa.ca.gov (unable to attend kickoff)
 - Josh Fuller (NMFS) - joshua.fuller@noaa.gov
 - Nezette Rydell (NWS-DEN) – nezette.rydell@noaa.gov
 - Jay Day (Riverside) - Jay.Day@riverside.com
 - The AP participants were provided with a series of one page descriptions of key aspects of the project including: the Hydro-meteorological Viewing Tool (HVT); the CHPS-FEWS implementation of the Russian River RDHM Model; assessment approach; and an overall project summary. After conferring with the AP members, a kickoff meeting was held on 12 February 2016 to describe the prototype distributed modeling application, the prototype HVT interface, and to propose the assessment concept.
 - Problems or Delays and Recommended Solutions: None
 - Work Planned for Next Reporting Period: Incorporate feedback and comments from the kickoff meeting; Prepare and provide detailed assessment plan to Advisory Panel participants; Invite AP to suggest specific individuals to receive assessment material.
 - Deliverables: One page summary documents
- Sub-task 2: Assessment
 - Description of Work Performed: The five intended user groups were identified and a user-centered approach involving identification of users, and their needs and requirements was outlined. The user groups include the 1) NWS California-Nevada River Forecast Center (CNRFC), 2) NWS Weather Forecast Office – San Francisco-Monterrey (WFO-MTR), 3) Emergency Management Agencies (EMAs), 4) General Public, and 5) National Marine Fisheries Service (NMFS).
 - Problems or Delays and Recommended Solutions: None
 - Work Planned for Next Reporting Period: Finalize the assessment plan and prepare storyboards of assessment scenarios.
 - Deliverables: In progress
- Sub-task 3: Prototype
 - Description of Work Performed: Riverside evaluated the condition of the CHPS-FEWS instance, which was unmonitored since June 2015 and brought the model back up to a current state from the June 2015 run. Riverside also upgraded the FEWS architecture to version 2015.01 (version currently in use at RFCs). With those updates, the RDHM model now executes hourly without assimilation using the disaggregated CNRFC QPE as the observed precipitation forcing and with forecasts based on the GFS precipitation fields. Cron scripts trigger a simulation every hour using 48-hour old states and forecast out to 48 hours. Model states have been developed from simulations extending back to October 2013. The system has simulated system response during significant events in December 2014, February 2015, and December-January 2015-2016. Based on the CNRFC-QPE forced simulations, a suite of model performance statistics for the most recent event was prepared and evaluated. In order to prepare model statistics, a FEWS module was prepared to incorporate the complete length of the historic simulation time series.

- Problems or Delays and Recommended Solutions: The HRRR datasets have presented a number of challenges as the input format has changed and as we have considered the need for retrospective forecasts (which require archived HRRR data). Some issues should be resolved by upgrading the CHPS workstation to CentOS 7, which allows for the latest netcdf libraries to be used for manipulation of the HRRR grids. Likewise, upon upgrading to the later version of FEWS, there was an incompatibility with the formatting of the CNRFC grids. This incompatibility should be fully resolved with the OS and associated library upgrades.
- Work Planned for Next Reporting Period: Finalize QPF/QPE workflows; export additional data for use in HVT; ensure all data in place for retrospective assessment.
- Deliverables: Provide simulation results for December-January 2015-2016 event.
- Sub-task 4: Interface
 - Description of Work Performed: The HVT is being developed using a Google Maps interface so that it can be widely deployed and accessed using a commonly available interface familiar to most users. HVT will build on existing functionality for loading RDHM grid data into Google Maps. This functionality loads the RDHM grid data from the NetCDF format using routines written in Python scripts and Matlab to convert the data into a raster image and KML file, which is then displayed in Google Maps in continuous animation using Javascript. To facilitate eventual use as part of the retrospective assessment, capability was added to the HVT to select a historic date for viewing model results from historic forecast sequences.
 - Problems or Delays and Recommended Solutions: Problems resolved as described.
 - Work Planned for Next Reporting Period: Develop capability to compute and display at-risk road crossings on user request. Incorporate additional data display capabilities including precipitation and point hydrographs.
 - Deliverables: Updated
- Sub-task 5: Evaluate
 - Description of Work Performed: This task is intended to be addressed near the end of the project. Established foundation for eventual evaluation by establishing and communicating with Advisory Panel, establishing DHM in CHPS/FEWS, and advancing work plan for assessment forums and tools.
 - Problems or Delays and Recommended Solutions: None
 - Work Planned for Next Reporting Period: Continuing to operate the DHM in CHPS/FEWS for the remainder of winter rainy season, and through the summer-fall 2016 flow recession period.
 - Deliverables: None at this time

Project Publications from Past Fiscal Year (including Conferences):

- Following are one-page summaries of project task activities provided to the AP members as part of the project kickoff GoToMeeting. These include:
 - Overall project summary
 - DHM in CHPS/FEWS summary
 - Hydromet Visualization Tool summary
 - User Forums for Assessment summary
- A poster on the project is to be presented at the 7th NOAA Testbed and Proving Grounds Workshop, at NCWCP Apr 5-6, 2016.

Project Summary

Assessment of Distributed Hydrological Modeling for NWS Flash Flood Operations

National Weather Service (NWS) forecasters at the River Forecast Centers (RFCs) and Weather Forecast Offices (WFOs) provide timely and reliable severe weather and hydrological forecast services. There is potential that NWS flash flood operations can be improved through application of advances in distributed hydrological modeling (DHM). Our project extends on-going DHM research and development efforts within the NOAA HMT and NWS OHD/NWC to conduct a USWRP sponsored assessment of the DHM for flash flood forecast and warning operations.

The HMT has worked with the OHD/NWC to implement their most recent DHM, the Research Distributed Hydrological Model (RDHM), to support research on evaluation of various precipitation monitoring, data assimilation and forecasting techniques. We have applied the RDHM to the Russian-Napa Rivers (RR-N) basin to support assessment of model accuracy; that work has characterized the uncertainty of flood peak predictions and water budget. We have used gap-filling weather radars to examine uncertainties of precipitation nowcasting and forecasting, and resultant surface flows.

Most recently the HMT-West and Riverside have implemented RR-N RDHM in the CHPS-FEWS computing environment which allows a streamlined, near-real time data ingest and simulation capability. The CHPS-FEWS instance has been configured to ingest multiple Quantitative Precipitation Estimations (QPE) and Quantitative Precipitation Forecasts (QPF) forcings; including radar-rainfall products generated by the MRMS and HRRR systems. We have developed a Hydromet Visualization Tool (HVT) in Google Maps to accept gridded and time series data exported from CHPS for enhanced display as animations in a user-accessible interface. The HVT also displays at-risk road crossings on user request. The system is now ready to support an R2O assessment of the DHM approach for WFO flash flood operations.

For this project we will develop and deploy a prototype to illustrate flood threat information at local scales and at locations not currently served by RFC operations. Case study storms and DHM performance will be provided. Feedback from forecasters will be summarized, with the intent to identify highly rated products to be enhanced. There is the equally important aim to examine WFO flash flood operations concept-of-operations to include interactions between the WFO and RFC; this objective involves close coordination with the responsible offices.

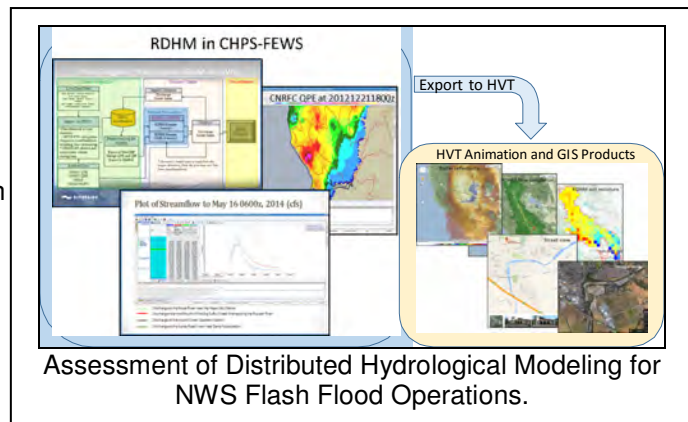

ESRL Distributed Hydrologic Modeling on the Russian River: CHPS-FEWS Implementation

Riverside Technology, inc. (Riverside) has supported the NOAA Hydrometeorology Testbed (HMT) within the Earth System Research Laboratory (ESRL) in implementing an instance of the Research Distributed Hydrological Model (RDHM) on the Russian-Napa River system in California. Riverside is supporting ongoing work with the Russian River RDHM model with the objective to prototype and demonstrate the ability to provide flash flood information at scales and at locations not currently served by RFC operations.

Implementation within a CHPS-FEWS computing environment facilitates automated RDHM model execution and near-real time data ingest. CHPS has been developed by the NWS in collaboration with Deltares in the Netherlands. The Delft-Flood Early Warning System (FEWS) serves as the infrastructure for CHPS with NWS hydrologic models and United States Army Corps of Engineers (USACE) hydraulic models providing the forecasting core.

Riverside configured CHPS-FEWS to ingest multiple Quantitative Precipitation Estimations (QPE) and Quantitative Precipitation Forecasts (QPF) including the High Resolution Rapid Refresh (HRRR) dataset as forcings for the RDHM model. The CHPS-FEWS setup supports visualizations of input datasets and RDHM outputs including precipitation, surface runoff and soil moisture grids, as well as animations of these.

The RDHM model executes without assimilation using the disaggregated CNRFC QPE as the observed precipitation forcing and with forecasts based on the HRRR dataset, extended to 48 hours with WPC and GFS precipitation fields. Cron scripts trigger a simulation every hour using 48-hour old states and forecast out to 48 hours. Model states have been developed for simulations extending back to October 2013. Simulations have run through significant events in December 2014, February 2015, and January 2016. Riverside is currently preparing an assessment of model performance including those events.

A Hydrometeorological Visualization Tool (HVT) Web-oriented displays of RDHM output have been developed to provide animations of precipitation, flood runoff and soil moisture, and ancillary GIS mappings; the HVT is described in a companion document

During implementation of CHPS-FEWS and RDHM at ESRL-PSD, there has been ongoing coordination with the NWS forecast operations agencies having operational jurisdiction over the Russian River basin. These include the NWS' WFO-MTR, WR and the CNRFC. Communications with the operational agencies have involved remote access and training for ESRL-PSD staff, the WFO MTR Service Hydrologist and Western Region.

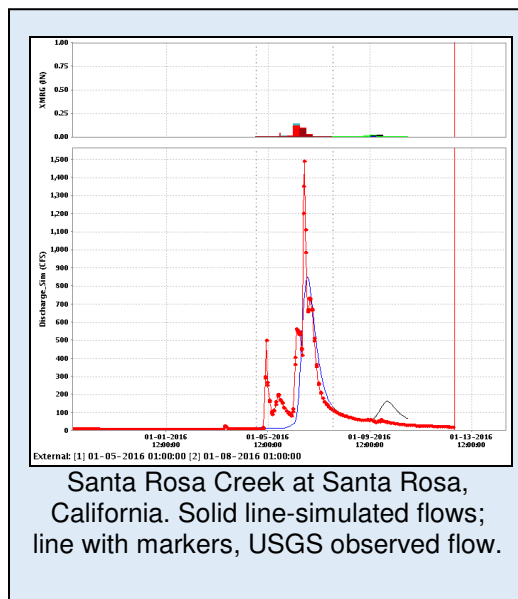
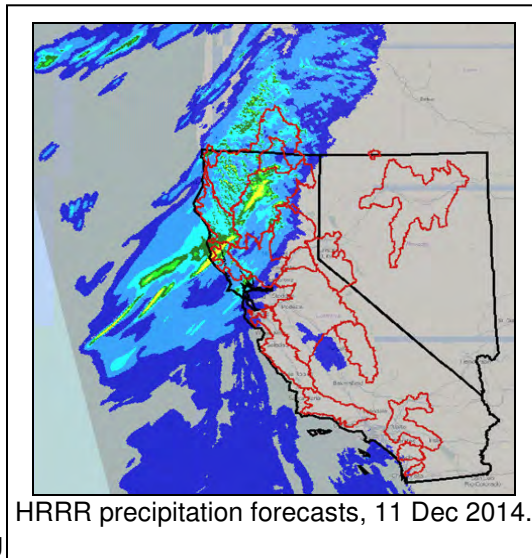

Reference: Halgren, J., L. Johnson, T. Coleman and R. Cifelli. 2015: RDHM-CHPS Research-to-Operations Demonstration, Russian-Napa River Basins, CA. Poster for 6th NOAA Testbed and Operational Proving Ground Workshop. April 14.

Project Element Hydrometeorological Visualization Tool

The objective of the Hydrometeorological Visualization Tool (HVT) is to provide an online interface for flash flood managers to view and interact with (near) real-time data and information generated by the RDHM CHPS-FEWS. The HVT online interface is intended to: (1) provide users with a quick snapshot of the water conditions in the specified region in an ongoing and historical basis; and (2) allow users to view other GIS data on flood impact features. Flood impact features include road crossings where drivers may be at risk, as well as critical facilities such as schools and hospitals.

The RDHM implementation is in the CHPS-FEWS computing environment which allows for a streamlined, near-real time data ingest and simulation capability. The CHPS-FEWS has been configured to ingest multiple Quantitative Precipitation Estimations (QPE) and Quantitative Precipitation Forecasts (QPF) forcings; including radar-rainfall products generated by the MRMS and HRRR systems. The CHPS-FEWS supports export of gridded data using NetCDF formats which can be scheduled for automatic generation at specified time intervals.

The CHPS-FEWS has intrinsic capabilities for display of hydromet data and simulation products; including grids of precipitation and surface runoff, and hydrographs at selected points. However, it has limited user access GIS display functions for other information that may of interest for flash flood forecasters and emergency managers. To address these limitations, the HVT is being developed to provide a web-based portal for animated display of RDHM simulation products and flood impact features.

The HVT is being developed using a Google Maps interface so that it can be widely deployed and accessed using a commonly available interface familiar to most users. HVT will build on existing functionality for loading RDHM grid data into Google Maps. This functionality loads the RDHM grid data from the NetCDF format using routines written in Python scripts and NCL to convert the data into a raster image and KML file, which is then displayed in Google Maps in continuous animation using Javascript. An itemized description of HVT functions is summarized in general terms here:

- The tool will be made available online via the web, without requiring software downloads by the user.
- The tool will display GIS layers along with RDHM grid results in raster KML format overlaying a Google Maps view of the study region.
- RDHM data will be automatically loaded into the interface as it is made available by CHPS-FEWS, which will be running 24-7.
- By default, the tool will animate RDHM results over the past 24 observations and 48 hour forecast hours in an endless loop until users specify a specific range of dates. These animations provide a quick snapshot of precipitation and other specified variables in the region. The user will have the ability to select which variable they want to see animated in this fashion.
- Plans are that the user will have the ability to look at specific day/time combinations and interact with the RDHM data for specific grids. Popups will be provided for specific grid points to allow users to view and interact with the data in graph and tabular format. The user will have the ability to export the RDHM data and turn on and off different views of the data as is their preference.
- The HVT will also display at-risk road crossings and other flood impact features (e.g. schools) on user request.

The HVT can be seen here: <http://www.esrl.noaa.gov/psd/data/obs/sitemap/Anim/rdhm.php>

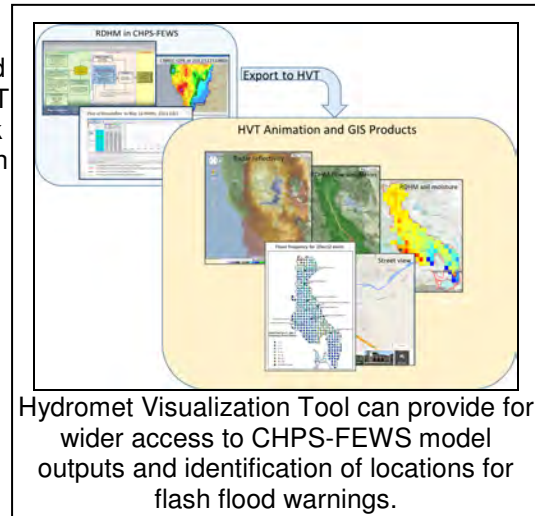

Hydromet Visualization Tool can provide for wider access to CHPS-FEWS model outputs and identification of locations for flash flood warnings.

Project Element User Needs and Interaction Modes

National Weather Service (NWS) forecasters at the River Forecast Centers (RFCs) and Weather Forecast Offices (WFOs) provide timely and reliable severe weather and hydrological forecast services. There is potential that NWS flash flood operations can be improved through application of advances in distributed hydrological modeling (DHM). Our project extends on-going DHM research and development efforts within the NOAA HMT and NWS OHD/NWC to conduct a USWRP sponsored assessment of the DHM for flash flood forecast and warning operations.

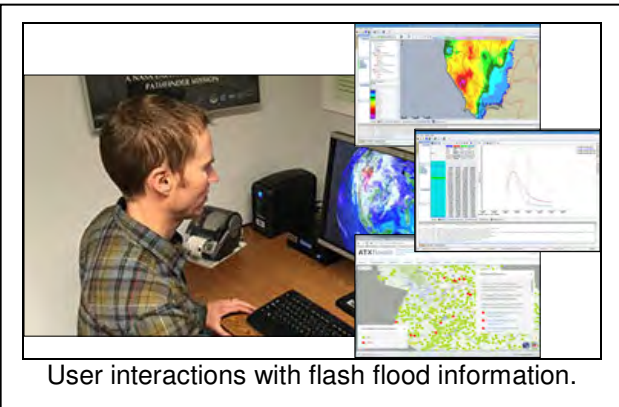

User interactions with flash flood information.

To effect forecasters' and other users' interaction with the RDHM in CHPS/FEWS, the Hydromet Visualization Tool, and some other flash flood monitoring and warning functions, we need to establish several user modes or forums. These forums are to provide opportunity to review and understand the tools and information, in order that they can provide informed feedback for the assessment. Different forums would be tailored to the various user groups. For example, some NWS forecasters may want to have direct access to the RDHM in CHPS/FEWS. Other users, such as county emergency response staff may want only web displays of current and forecast flash flood conditions.

A user-centered approach involving identification of users, and their needs and requirements, will lead to design of the interface and forums. User groups include the 1) NWS California-Nevada River Forecast Center (CNRFC), 2) NWS Weather Forecast Office – San Francisco-Monterrey (WFO-MTR), 3) Emergency Management Agencies (EMAs), 4) General Public, and 5) National Marine Fisheries Service (NMFS). A listing of these user group requirements follows.

CNRFC

- Responsibilities
 - Issues river flood and flow forecasts. Conducts severe weather assessment, precipitation forecasts, and hydrological modeling for river forecasts. Provides Flash Flood Guidance to WFOs
- FFO Requirements
 - Prepare flash flood guidance
 - Provide FF forecasts to WFOs
- DHM Needs
 - Couple DHM with River Model to provide coordinated hydro forecasts
 - Interface to precipitation fields, data scheduling and quality control, forecasts, and product dissemination
 - Conduct DHM parameter estimation, data scheduling and quality control, forecasts, and product dissemination
 - Edit grids of DHM parameters, precip., soil moisture (initial states)
- Assessment Forums
 - Retrospective of archived FF event with direct user access to CHPS/FEWS
 - Real time with direct user access during rainfall events

WFO-MTR

- Responsibilities
 - Conducts severe weather assessment, precipitation forecasts, and issues flash flood watches and warnings. Provides support to EMAs
- FFO Requirements
 - Review FF Guidance, precip., soil moisture
 - Prepare flash flood watches and warnings
 - Provide FF forecasts to EMAs

- DHM Needs
 - Identify locations at threat for flash flood; less than 6-hour time step needed
 - Interface to AWIPS functions for precipitation fields, data scheduling and quality control, forecasts, and product dissemination
 - Interface to Hydro Database and related WFO data management procedures.
 - Provide feedback to CNRFC on FF observations, DHM performance, RFC products, and EMA interactions
- Assessment Forums
 - Retrospective reviews keyed to RDHM in CHPS/FEWS
 - Real-time web access to the Hydromet Visualization Tool

EMAs and General Public

- Responsibilities
 - Assess FF threats, stage EM resources, deploy EM responses (e.g. close bridges, warn at risk places and populace)
 - Provide feedback to WFO on FF conditions and impacts
- FFO Requirements
 - Access flash flood watches and warnings
 - Disseminate FF messages to at risk places and populace
 - Take EM response actions
 - Provide feedback on FF conditions and impacts
- DHM Needs
 - Identify locations at threat for flash flood; less than 6-hour time step needed
 - Point to location for FF threat assessment, obtain address, threat score, contact information
 - Coordinate with other WFO FFO AWIPS messages
- Assessment Forums
 - Retrospective reviews keyed to HVT at office and smart phone
 - Real-time web access to the HVT at office and smart phone

NMFS

- Responsibilities
 - Assess fisheries habitat status
 - Plan restoration field activities
- Fisheries Management Requirements
 - Access flow status at locations and along reaches
- DHM Needs
 - Identify locations and stream flow conditions (current and forecast)
 - Point to location for flow assessment; plot flow profile
- Assessment Forums
 - Retrospective reviews keyed to Hydromet Visualization Tool
 - Real-time web access to the Hydromet Visualization Tool

DHM for FFO Deployment Options

RDHM in CHPS/FEWS

- Retrospective reviews of archived FF events with GoToMeeting recording of exercise by HMT staff. Establish script of FF forecast operations. Using phone conference and e-mail, users can ask questions, make suggestions. This forum is for all users and interested persons.
- Retrospective reviews of archived FF event with GoToMeeting run by HMT staff. Establish script of FF forecast operations. With audio, user can ask questions and make suggestions. This forum is for all users and interested persons.
- Retrospective of archived FF event with direct user access to CHPS/FEWS. Some users can be granted access to log into the HMT-West Hydro Server so that they can exercise the RDHM. Establish script of FF forecast operations. Using phone conference and e-mail, users can ask questions, make suggestions. This forum is primarily for NWS forecasters.

- Real time with GoToMeeting Flash Flood briefing run by HMT staff. Establish script of FF forecast operations. With audio, user can ask questions, make suggestions. This forum is for all users and interested persons.
- Real time with direct user access during rainfall events. User gains experience with the CHPS/FEWS as a tool for flash flood operations per their job. Disadvantages are that most users have little time nor training to use the CHPS during flood events. This forum is primarily for NWS forecasters.

Hydromet Visualization Tool Using Web Services

- Real-time web access to the Hydromet Visualization Tool. Displayable for current and forecast conditions using export from RDHM in CHPS/FEWS. This forum is for all users and interested persons. Link to <http://www.esrl.noaa.gov/psd/data/obs/sitemap/Anim/rdhm.php>
- Retrospective reviews keyed to RDHM in CHPS/FEWS. This forum is for all users and interested persons.

NOAA Office of Education
Grant Performance Progress Report (GPPR)
Mark (X) only one box per Program Office instructions.
[] Semi-Annual Report [X] Final Report

*The following progress report is an optional template for your Grant Project Progress Report (GPPR) to NOAA's Office of Education.
Please contact the Office of Education's Grants Team (oed.grants@noaa.gov) if you have any questions.*

General Information

Award Number: NA10SEC0080012

Project Title: Capitalizing on Technological Advancements to Expand Environmental Literacy through a Successful citizen Science Network

Funded Institution(s): Colorado State University

Total Annual Visitorship per Year to Funded Institution(s) (if applicable): NA

PI Name: Nolan Doesken

Phone #: (970) 491-3690 or (970) 491-8545

Ext: ()

Email Address: Nolan@atmos.colostate.edu

Project Website (if applicable): <http://www.cocorahs.org>

Reporting Period Information

Award Period: From: _10__/_01__/_2010_ To: __09__/_30__/_2013_ (mm/dd/yyyy)

Reporting Period: From: _04__/_01__/_2015__ To: __09__/_30__/_2015__ (mm/dd/yyyy)

Progress Narrative and Final Report

- 1) For the **semi-annual report**, the narrative should include the goals for the project, details on progress achieved towards those goals during the reporting period, the audience(s) served (including the geographic scope and demographic information, if available), and potential challenges and roadblocks to future progress. For the **final report**, **also** include the relevance of the project to [NOAA's mission](#), a reflection on the extent to which the goals of the project were met, the challenges the project has addressed, and the lessons learned.

Relevance of this work to NOAA's mission.

As our final report on this project, I am happy to say that much of our work over the past 5 years (3-year project plus two one-year no cost extensions) has been closely aligned with NOAA's mission.

To understand and predict changes in climate, weather, oceans, and coasts.

To share that knowledge and information with others.

To conserve and manage coastal and marine ecosystems and resources.

The detailed day by day picture of rain, hail and snow across the country that this project is providing allows both NOAA scientists and the public to see weather patterns in action through the high impact climate element – precipitation. Floods, drought, seasonal patterns and inter-annual variability all come to life through the CoCoRaHS precipitation maps and related climate summaries. This provides data to NOAA scientists to help verify and improve weather forecasts. Now that we have six consecutive full and complete years of daily nationwide precipitation data (as of the end of December 2015) from more than double the number of reporting stations as the NWS Cooperative Observer Program, we are also able to refine our knowledge of local patterns and variability in precipitation and show these patterns to our participants. Precipitation varies so much that it takes many, many years to confidently detect trends and confirm changes, so this project is not able to address issues of climate change per se. But this information, in combination with the long-term historic NOAA data sets, provides an excellent background for assessing current variations, extreme events and future changes. CoCoRaHS data sets are particularly rich and dense in the many populated coastal areas of our country – some of our most complex and stressed ecosystems. Throughout the history of this project we have aggressively and continuously introduced our thousands of participants to NOAA resources and have shared weather and climate information broadly and successfully. A testimony to the value of CoCoRaHS to NOAA is the fact that our data, without our request, is already used across NOAA and is archived and disseminated as a part of the Global Historic Climate Network at NOAA's National Center for Environmental Information.

Goals and details on progress achieved during reporting period.

As with each of our previous progress reports and our original proposal, this report is structured based on sequence presented in the "Citizen Science Toolkit". In each section below, we first list our accomplishments during the final 6 months of this grant. We then follow that with a topical reflection on accomplishments over the full duration of the project, experiences, challenges and lessons learned.

- Refine Protocols

6-month progress

- Continuing collaboration with USDA, NIDIS, NASA/GLOBE on soil moisture protocol
- In collaboration with NIDIS, CISA, and other CoCoRaHS stakeholders at the WERA conference, it has been determined that the "Drought Impacts Report" protocol, should be amended to broaden its scope and applicability to data users. The name of the protocol will be changed to "Condition Monitoring Report" and it reflects a change in the focus of the report. While the data collection related to the impacts of drought conditions will remain, additional fields will be added to quantify the relative and absolute climate conditions of an area over time. This will increase the utility of the protocol to data users and reduce confusion among observers as to what constitutes drought conditions and when they should submit reports. A draft of the new protocol has been implemented as a GeoJSON feed in the data export api and updates to the observer form are pending until a final version of the protocol has reached consensus among the relevant stakeholders.
- Additional validation has been added to the user interface for the multiple day precipitation protocol based on feedback from QC staff, data users, and coordinators. These additional validation checks block common errors that have been identified by the WERA QC/Data Quality committee.

Final Report narrative

Over the duration of this project we clarified the precipitation measurement protocol for situations of fog and dew, we added drought impact reports, we developed an ice accretion protocol, we made subtle changes to our snow measurement protocol, we introduced evapotranspiration measurements and we are in the process of attempting a soil moisture monitoring methodology near the end of this grant. Both adding protocols and altering existing protocols presented greater challenges than expected. For example, the older CoCoRaHS gets, the more inertia there is to resist change. Getting consensus among myriad stakeholders became harder as the number of interested stakeholders increased over this 5-year period. We have done our best to reach consensus by getting the stakeholders together

through online meetings and at our annual WERA conference/workshop each May. There is often a natural opposition between making the protocols as simple as possible for the observers and collecting all of the information that data users would like to have. In these cases we usually side in favor of collecting valuable data over simplicity but this has consequences affecting training processes and level of participation. We know that usage of the data is one of the strongest motivators for observers and try and make up for complexity in the protocols through training materials and interface design.

A minor but significant challenge that we have dealt with for the duration of the project is how strictly to enforce adherence to protocols. This became an issue for both recruiting and retention. Having specific and clear observation protocols are very important for CoCoRaHS and those who use our data. Strict adherence results in the highest quality data. But fewer participants are able to accommodate this. Do observers actually need to report every single day and precisely at 7 AM as our protocol suggests? Maintaining standards but allowing some acceptable level of flexibility has been a delicate and difficult balancing act. This has required consistent, repeated, time consuming personalized communication. We've had the luxury of a Help Desk staff to do this, but going forward we may not be adequately resourced for this.

We experienced many external pressures that appeared in the form of "opportunities" either to expand geographically beyond the U.S. or to add additional climate variables to our measurement suite. In the end, what we do best is simply measure precipitation – especially just plain rain.

- Recruit Participants

6-month progress

- Passive and active recruiting continued with a total of 1,801 new volunteers signed up during this 6-month period. Sixty-nine percent (1,235) of these new recruits have begun reporting precipitation. This is a slower recruiting rate as we have scaled back recruiting efforts at this stage of the project. We continue to see about the same rate of new sign ups successfully become active observers as in the past and this has remained fairly steady throughout.
- Continued our collaboration with Univ. of Oklahoma and SCIPP - Field Photo Weekends - May, Sept 2015 (not specifically a part of "recruiting" but fits here as well as anywhere else)
- The work on the data infrastructure has begun to add the Bahamas to the network.
- The website has been updated to support French versions of the CoCoRaHS Canada content pages. This supports the requirements of national and Provincial Canadian institutions such as Environment Canada as well as promotes the recruitment of French speaking Canadians in Quebec
- Data entry apps are in place and being upgraded. This is essential for recruiting new observers at this time.

Final Report summary

We have learned that it takes a lot of ongoing recruiting to keep this project going. We track recruiting and retention state by state across the U.S. and Canada each year and we are able to see which states are still growing in terms of number of active participants, which are stable, and which are shrinking. States with little or no active recruiting are now shrinking in terms of number of active volunteers. While 1801 new recruits for the past 6 months (reported in our 6-month progress above) may sound like a lot, at our national scale (about 20,000 total participants of which 11,000 – 12,000 report their daily precipitation on any given day) this is about the number we need every six months just to counteract normal attrition. With our national infrastructure of volunteer leaders, we are still able to achieve this rate of recruiting without much specialized effort.

By far our most successful recruiting effort, in terms of numbers of people who sign up, is our annual "March Madness" campaign. This rouses some friendly competition among our volunteer leaders across the country. But like other efforts, it has its shortcomings. A March recruiting campaign makes sense for areas east of the Rocky Mountains but for the Western States, March is the beginning of their dry time of year and not the best time to recruit new volunteers. We've also learned that there is a lower retention rate among March madness recruits especially in the states with the highest recruiting success.

We continue to track how people find out about CoCoRaHS when they initially register. It has been fascinating to see the many and varied ways the word now gets out. Much recruiting is now far beyond our control. Henry Reges puts together a short summary of new recruits every 2-3 weeks and we see concentrations of new recruits from anything from state and regional teacher workshops, Master Gardener classes, Museum exhibits, Facebook posts, public talks by climatologists, and some miscellaneous methods that really make us laugh. For example, one was "searching for 'Meniscus' on the internet". That search somehow lead them to our CoCoRaHS "how to read a rain gauge" training resource. Many NWS offices routinely help with recruiting in their local areas (NWS recruiting accounts for close to 40% of annual recruiting nationally) often associated with their webpages, social media, or (most importantly) weather spotter training classes. Word of mouth, spread by our large community of volunteers, has grown to be the next largest means of recruiting and seems steady or still growing. But this is not sufficient to organically continue to grow the project. Traditional media (TV and newspapers in particular) used to represent a larger fraction of nationwide recruiting, but this required concerted and organized publicity campaigns and press releases, which we have found increasingly difficult and ineffective on a national scale even when aided by major media support. For example, the Weather Channel did an on-air live promotion of CoCoRaHS this past year with one of their popular on-camera meteorologists (albeit at off hours early one Saturday AM). Likewise, CoCoRaHS was mentioned by a contestant on Jeopardy two years ago. In both cases, there was

an immediate spike in nationwide recruiting – but only accounting for a few dozen new volunteers nationally.

Overall, the lessons we've learned here is that there are some means of recruiting via known interested groups – weather spotters, gardeners, naturalists, that seem most effective. But potential volunteers are many and varied, and many and varied ways are needed to reach them. We've also learned that weather enthusiasm does not guarantee that a volunteer will become a solid long-term participant. Sometimes it is personality more than interest that is a controlling factor. Some people really enjoy the routine and the responsibility while others quickly tire of that. It is much easier to recruit by area of interest than by personality type, but if we could figure out the latter, it might pay big long-term dividends in terms of retention.

An interesting observation – qualitative at this time but an area of concern – is that despite our nationwide network of volunteer leaders/recruiters, it appears to be getting harder, not easier, to recruit additional observers. A theory that we have (not yet tested) is that over the duration of this project there is a growing sector of the population that believes there is now continuous tech-based observations of all weather elements and expects automation and remote sensing to take care of scientific measurements like this. While we know that automated measurements of precipitation tend to be inferior in quality to manual measurements, most others do not. As such, this is not as convincing of an argument as it once was for recruiting potential volunteers. We would like to follow up more on this in the future.

At this stage of the project, we've been giving somewhat less attention to recruiting new observers and more attention towards retaining those that we already have, or striving to get a larger percentages of those who have signed up to measure and report data. Our core "engagement and retention" efforts throughout the project have been and continue to be Nolan's periodic e-newsletter, Henry's daily "Message of the Day" and Noah's social media outreach. Evaluation results showed these are all important factors, but they are so engrained in the project that it is fully taken for granted.

A fascinating and significant challenge that we faced from the beginning but has become even more apparent as the program and it is our participants "age". We, quite frankly, have many older participants and we are all aging together. How to appropriately deal with volunteers whose heart is in the project but whose bodies and/or minds may not be up for the task is something we can't ignore. In any given year, a few hundred of our volunteers need to step down, sometimes unwillingly, due to health or mobility concerns or because they have to move out of their own home. If they don't, they risk injuring themselves in the simple but somewhat physical effort required to go outside early each morning to check the gauge. We have handled this simply by attempting to be inclusive and understanding, but also proactive. Several times each fall in our mass e-mails we encourage our older and less mobile volunteers to "take a break for the winter" and then reconsider the next spring. This seems to give them a gentle way of bowing out without feeling guilty. Of course there is another side to this story. The need to check the gauge is also a major motivating factor for many of our older volunteers providing them a real sense of being important, needed and appreciated. We don't want to deny them of this – but we need to be sensitive to their physical and mental limitations – all via the "faceless" world of web communications. To this end, we try our darndest to be as personal and responsive as possible to each and every one of our volunteers.

Year in and year out, we see 60-70% of those that initially sign up to go ahead and begin collecting data. And of those that begin, 60-70% are still active after one year. This means that of all the several thousand new recruits who make the effort to fill out the registration form each year (signing up is a nontrivial hurdle), less than 50% are actively engaged in precipitation measurements a year later. But those that get started and continue reporting for at least a year are then at least 80% likely to continue participating in future years. These statistics have been hard to budge. Despite different approaches and our improvements to our cyberinfrastructure, these retention rates have stayed about the same. Likewise, from the survey results reported in previous reports, we know we still have a largely white, more than 70% male, mostly over 45 years old, and quite well educated corps of volunteers. The most time-effective way we've succeeded in adding younger and more culturally diverse participants is via schools, but school participants tend not to be long-term participants. We did find that by personal e-mail follow up first by Nolan Doesken, the CoCoRaHS founder, and then followed by correspondence from state and local coordinators, we can increase the number of initial sign ups who make their first data report by nearly 10 percent. This is significant – but so is the time commitment involved. Therefore we've limited this focused follow up on new applicants from more rural and sparsely populated areas of the country where new volunteers are particularly needed.

We know that the cost of purchasing and the challenge of acquiring and installing the CoCoRaHS rain gauge remains a significant barrier to participation. This hurdle may weed out at least 20% of those that sign up and likely scares off many more from signing up in the first place. This challenge does not have a simple solution. We can't afford to buy gauges for each new observer, and observers seem to take CoCoRaHS participation more seriously when they've invested their own resources into getting set up. Moving forward, we hope to do more targeted recruiting in rural and agricultural areas. To succeed, we may need to find sponsors and invest resources toward purchasing or sharing the cost of gauges for these candidates.

The role of the ~250 state and regional CoCoRaHS volunteer coordinators, many of whom are NWS forecast office employees or state climate office personnel cannot be understated. These are the individuals who helped rapidly launch CoCoRaHS to become a nationwide project. Now we rely on these same people to carry the flag for CoCoRaHS in terms of ongoing recruiting and retention. NOAA Office of Education funding has provided the resources of one staff position, Henry Reges our National CoCoRaHS Coordinator, to lead this team of volunteer coordinators. He has been able to dedicate a portion of his job to recruiting, training and engaging this team of leaders. We have found it particularly advantageous to try to meet as many of these CoCoRaHS volunteer coordinators in person which Henry has accomplished with strategic and well-planned travel to conferences throughout regions of the country. Coordinating the coordinators has been a challenge of its own since we have very little to provide in terms of incentives to these volunteer leaders. Henry has diligently maintained a list of these leaders and keeps track of changes. Some coordinators are incredibly involved, some somewhat involved, and

others seem inactive or at least not responsive to our communications. Henry strives to keep this important community of volunteer leaders “engaged”, but we have no authority to do any more than just encourage them with e-mail pats on the back and an occasional phone call or a CoCoRaHS t-shirt. Overall, it’s sort of amazing that things run as well as they do and continue after all these years. The value of the data to some of the volunteer leaders is apparently an adequate incentive in and of itself.

- Train Participants

Six-month progress

- The new “welcome letters” customized for each state and completed in February and March have proven to be excellent initial comprehensive communication and training tools for new recruits
- Data quality control (QC) -- We continue with our semi-annual, semi-automated distributed approach to data quality control with a concerted effort to contact volunteers individually when possible data reporting errors are made. This is a time consuming effort but one that allow volunteers to learn from experience and learn from their mistakes. Our undergraduate student QC specialist is running out of gas for this critical but never-ending task, so less individual contact is being made. We do continue to encourage our team of volunteer coordinators across the country to participate in this process. Some do so heartily and others don’t, so our QC efforts are good but somewhat inconsistent.
- New training videos were deployed. Canada for schools added some extra animation to existing materials using chocolate chip cookies as a metaphor. Our two-minute tutorial for how to enter data was published and the U.S. version was also updated and published.
- Our webinar series was scaled back to give staff a break realizing funding for this effort is expended: Only one webinar was conducted during this period: Webinar #40 - September 2015: "The history and uses of volunteer weather observations in the United States" Interestingly, we did have people express concern and encouraged us to keep the series going.
- Update on Water Cycle animation. New views during period = 47,800
- Update on Weather Vs. Climate animation. New views during period = 16,500
- Tutorial – How the Rain Gauge works had 5,000 new views during period
- Other online training materials – narrative description, slide shows, videos and animations continue to be used regularly. Very few face to face training sessions have been offered this year. Most all training is now online.
- Help Desk, which has been handled well by Zach Schwalbe for the duration of this project, has now been turned over to Noah Newman. Since Noah has many other responsibilities he has enlisted help from an experienced long-time volunteer and soon-to-be retired science teacher. We have reduced the overall time commitment dedicated both to data QC and to the Help Desk out of financial necessity.
- Continued collaborations with the NDMC regarding Drought Impact reporting.
- Messages of the Day: Continued daily messages via website and data entry apps after each data submission. Many subjects reviewed for the sake of newer and less experienced participants, but some new materials presented.

Final Report summary

Over the five year duration of this project, training specific to CoCoRaHS data collection protocols and broader education related to public climate literacy have been primary focuses of this project. Thanks in a large part of the NOAA OED funding, we’ve had adequate resources for a full time Web Developer, a National Coordinator, a part time education specialist and a staffed “help desk”. All of these have worked much of their time on training. We’ve been able, in many cases, to personally answer each individual question received from our thousands of volunteers. This has provided years of ongoing training for our volunteers and years of development and implementation of training materials. Also, through our student-staffed data quality control processes, we’ve personally followed up with hundreds (probably thousands) of volunteers providing guidance and direction to volunteers when data entry errors have been made.

As the size of the CoCoRaHS network has grown and as our budgets are now decreased, the luxury of personnel providing individualized training support may be a thing of the past. We have increasingly relied on our online materials, particularly our cartoon animated training materials to communicate to our volunteers. We still provide the original written and slide show PPT-style training, but based on feedback from our volunteers fewer and fewer of the new recruits seem inclined to spend time reading instructions or even asking questions. More prefer just quick, short online answers and video trainings. We continue to send each new observer detailed instructions and links to all of our training resources, but for the most part the bulk of learning seems to occur “by experience”. Does this type of training suffice and is it effective? Experience is likely the best teacher but it puts pressure on our quality control processes and our on-the-fly training materials. We hope to soon have the opportunity to evaluate quantitatively if our animated cartoon trainings are as effective - from a learning perspective - as our narrative instructions, our annotated training slide shows, and our traditional face to face training used much more during the earlier years of the project.

Here are a few additional findings and observations.

- We found it was relatively easy to communicate the basics. The difficult thing was the many special or complex situations. It was difficult to bundle these into a quick and easy answers.

- We thought we could put together a FAQ (Frequently Asked Questions) section that anyone could use. We did, but it was not nearly as effective as we hoped. As a result our “help desk” continues to have to give the same answers out hundreds of times for some of the common questions that arise. Perhaps we would have benefited from professional help with this phase of the work.
- Both in terms of training and volunteer retention, the best motivations we’ve found is to show early and often the many ways that CoCoRaHS data are used professionally. When people know that what they do may be used and publicized by scientists and media, they seem more motivated to make sure they are reporting correctly and accurately. Volunteers get especially excited when they see their data on TV. This does happen from time to time – but the less obvious but arguably much more important uses are the nearly continuous use of CoCoRaHS by the National Weather Service in forecast verification, weather warnings, and background climate information along with the many research and business uses that have developed. Observers still have trouble believing us that their backyard data are of such value and use, so we just have to keep repeating. For example, we point out that even NASA needs their observations. Satellites see what they see, but it only makes sense when translated through calibration and validation algorithms which CoCoRaHS data feed into.
- We have certainly learned that "communicating the message" is harder than we expected. Looking back we can see many points where we made a decision (whether it is refining a protocol or training new volunteers or recruiting new participants) and then planned ways to get the word out. Despite thoughtful and coordinated efforts, we learned that overall - people just don't listen, they have no time, they want everything to be easy and they want it to work the way they think it should work. Getting the message out is easy - but paring it down to 140 characters is much tougher. That seems to be the typical attention span now, especially of the young (under 55 years of age 😊) crowd. Regardless, what our volunteers have appreciated most is quick response, and short, well-explained answers.
- We also have expectations or at least the hope that people read all of our many messages and types of messaging. All this being said, the lessons learned is that we needed to have these expectations in mind, and be prepared to get the message out in multiple ways, i.e. 'message of the day', Facebook, Twitter and 'The Catch'. With skill and strategy, we might have been better coordinated with each other to assure better communication especially when it came to getting important messages to our audience.
- We have an ongoing issue with bringing on new volunteers who are just first learning and engaging them with the same messaging with our long-term volunteers who are used to seeing our messaging. How to keep it relevant for new volunteers while keeping it fresh for the older ones was best done through 'The Catch' (Nolan’s e-newsletter) but it is difficult to reach such broad age, gender, cultural and geographic ranges with a single and probably too wordy newsletter format.
- Training participants in K-12 settings can be challenging due to the turnover - not just the new incoming students each year but also particular teachers who move on or are reassigned to other classes. Communication was key to meeting this challenge, keeping in close contact with each teacher at least twice/year via our 'Rain Gauge Week' campaign allowed us to continuously update teachers, provide observation tips and making sure that each classroom was still interested in participating. Teachers have many demands and therefore can't be expected to participate throughout the entire year. This adds to the challenge of keeping everyone up-to-speed. Also, since we were only staffed to work about 25% of one staff person’s time on outreach to schools and teachers, we simply couldn’t dig as far or as deep into training teachers and students on a national scale as we might wish.
- Our WxTalk Webinar series may have been one of our best efforts towards climate literacy on wide ranging topics and not just precipitation. That being said, it was a challenge to come up with topics of broad interest and to find speakers capable of communicating well to public audiences. So far as of September 30, 2015 we’ve had 40 webinars. Interest remains strong and several more have now been scheduled. Based on exit surveys, I think we found the sweet spot of being technically sound but not too technical, proven by comments in post-webinar surveys where it went over some people’s heads and bored others. With the topics and high quality speakers we were disappointed when, despite strong advertisement well in advance, our typical attendance rarely exceeded 200 and sometimes only reached 100. When you add in those that viewed the webinars via our YouTube channel we would get a few hundred more viewers for most shows. But based on quality of presentation we felt we should have reached broader audiences. I guess the moral of this story is that 60 to 75 minute webinars, regardless of quality, are just too long to secure large audiences.
- On several occasions we developed new training materials in support of new or modified protocols – such as Evapotranspiration measurements and Drought Impact reports. Despite putting a great deal of effort into these additions, we found it was quite difficult to interest observers in these additional reporting opportunities.
- Overall, our biggest frustration with training was that it often seemed that with our reliance on e-mail, social media, and standard web communications, it seemed that so much of our messaging simply was not being read by many of our volunteers. No matter how good our training efforts and resources are, they only have impact if they are applied. But on the flip side (and maybe we shouldn’t be complaining) day in and day out, the vast majority (close to 99% on many days) of the daily precipitation reports being submitted have been accurate and consistent. This is the reason that CoCoRaHS data have become some useful and trusted.

- Accept Data

- Six-month progress

- During the last six month period the numbers of daily precipitation reports have increased to an average of 360,000 reports per month, up from 320,000 over the previous six month period.
 - The iOS and Android applications have been updated to keep pace with changes to the mobile environments and in response to

user feedback. This includes updates to the mobile applications to support French and Spanish versions of the apps.

- o 20,222 active observers
- o 164 ET stations submitted at least one report of evapotranspiration during the past 6 months
- o The number of drought impact reports has been fewer than in past years. This appears to be partially because many agricultural areas of the country were not experiencing drought or worsening drought in 2015 and partially because it has been difficult to maintain keen interest in drought impact reports without doing a lot of targeted reminders (which we haven't been doing). We are working to make some changes based on input from the Carolinas Integrated Science Assessment project that has been doing in-depth research on climate impact reporting.
- o We navigated two more "field photo weekends" in collaboration with the Univ. of Oklahoma. Several hundred photos were taken by our community of volunteers to help document the appearance of natural and managed landscapes under varieties of both wet and dry conditions. We recently learned that this effort has been noticed by NOAA and will now be receiving two years of NOAA SARP funding.

Final report summary

Our multiyear effort to improve our cyber infrastructure for training volunteers and accepting data has continued to pay dividends. The past year or two have run particularly smoothly with almost no computer down time and generally quick and agile database performance.

- o 30,653,814 daily precipitation reports in the archive along with thousands of multiday precipitation reports, hail, significant weather, drought impact reports, etc.
- o 56,088 observers have submitted at least one report since the project began. Holy Cow, I didn't realize we've engaged that many. That's a lot!

While data collection has been operating smoothly, there have been challenges. We developed but did not implement the versatile mapping system that we hoped for. We failed to get the quick performance we feel is needed to satisfy users these days. Volunteers seem to have less and less patience these days (consistent with a digital society at large). The variety of digital proficiency among observers and the variety of their devices is a challenge that has become more difficult over time. Some observers are using computers and software that are more than ten years old, while others use the latest smart phones and tablets. We are doing our best to accommodate the range of methods people try to interact with CoCoRaHS and have supported legacy systems while adding support for iOS and Android devices. However we have not been able to provide native support devices with low or dwindling market share like Windows Phone and Blackberry, although those users can access the site via the browsers on those devices.

Accepting data for CoCoRaHS also means screening for errors. Because CoCoRaHS data are so quickly and continuously used by a wide base of users, there is a high expectation for top quality data. Yet, every day we are encouraging new people to join CoCoRaHS who may have never before had a rain gauge or entered scientific data online. Errors are inevitable and ongoing. Some are typos. Some are decimal points. Some are reports entered on the wrong day or multiday accumulations entered as a single day value. Some are good entries but reported for the wrong location. In Canada, some metric units mistakenly entered as English unit values. Overall they make up a very small fraction of the total number of data entries – typically less than 1%. And yet, with over 10,000 reports per day there are dozens of mistakes to deal with – and even more during adverse and complex weather such as freezing rain, sleet and blizzard snows.

As a climate literacy project we did not propose much time and effort go into data quality control. But looking back, data quality control is perhaps an area where our hands-on personal-touch approach to citizen science that we've employed may have been inadequate and possibly a mistake. Knowing what we know now, we might have placed more of our cyberinfrastructure investment and more initial planning efforts in designing and implementing a system-wide professional QA/QC process. Mistakes happen, and correcting all errors can't be done by a computer program. Precipitation varies so much from place to place naturally that it is nearly impossible to spot all errors and make appropriate corrections to all data errors without risking changing accurate data. However, there were, and still are several steps that can be taken to alleviate much of the time that is being spent every week of the project identifying and correcting errors. We know that spotting errors and working with volunteers to correct them are great 'teachable moments'. However, in retrospect, prioritizing and implementing more automated 'data checks' at the time participants first type in their entries may have been a better allocation of our time.

We have noticed that school participants are particularly prone to data entry errors. School participants are typically much younger, much less experienced with data handling and likely do not 'practice' every day by reading the gauge and entering data. If groups of two students take measurements just once per month (a schedule that many schools use to allow large numbers of students to participate during the school year), many more mistakes are bound to happen. Then, the following year, a brand new set of students are now learning all over again. So as long as we are encouraging hundreds of schools and students to participate, we will need to be prepared to address data quality issues.

Some additional findings include:

Regardless of importance, it has been difficult to get a large number of volunteers to take on additional reporting activities such as evapotranspiration (ET) measurements, drought impact reports or even just the much needed “Hail” and “Significant Weather Reports”. The latter information, heavily relied upon by NWS during severe weather, would be a huge boon to NWS local situational awareness and their severe weather warning processes. But despite our many and repeated requests to our volunteers, their response rate remains relatively low.

- Analyze Data

- Six-month progress

- While the new mapping system has not yet been released to the general public, it is now being used by CoCoRaHS staff and CoCoRaHS state and regional coordinators. The feedback from these users is being incorporated into the system to prepare it for a potential future public launch. The mapping system was used to produce extreme precipitation analysis maps for the nation covering data from 2010 through 2014. This demonstrated capabilities that were previously unavailable for CoCoRaHS.
 - The Water Year Summary reports were generated for the past six water years, which go from October through September of the following year. This provides data summaries for every station that include HTML and Excel versions of the data analysis that includes the reports, monthly and yearly summaries, comparisons with PRISM 30 year normals, and a variety of charts. With the scale of the network, these reports now amount to over 330,000 files totaling 31GB. More important than the number of files is the resulting QC that results from observers and coordinators reviewing the water year summaries and the motivation the data visualizations provide the observers to report consistently.
 - Published new page on how volunteers can access CoCoRaHS Data via NOAA NOWData and other Regional Climate Center tools: http://www.cocorahs.org/Content.aspx?page=Resources_viewingdata

- Final report Summary

We’ve done a lot in the category of “analyze data” and yet we’ve only scratched the surface. There are so many ways that CoCoRaHS data could be analyzed that it would be impossible for CoCoRaHS to provide them all. To address this we provide data analysis and visualization tools that we know some people will use on a daily basis such as the maps, and tools that will help them put their data in a historic perspective such as the water year summary reports. We also provide tools that support our climate literacy goals, like explaining the water cycle through the water balance analysis that combines the precipitation and evapotranspiration data. We also address this challenge by making the data as easily accessible as possible for the data users, and then direct the public to the data analysis and visualization tools our data users have created. This has several benefits including informing the public about the valuable tools available to them, putting CoCoRaHS data in context with other data sets we do not have access to, and demonstrating the value of CoCoRaHS data. When a CoCoRaHS observer can see their data as part of a NOAA data product, they know their efforts are valued.

From the very start, Water Year Summary reports and the PRISM – CoCoRaHS climate portal have been extraordinary but probably under-appreciated data analysis tools. They were designed for volunteers to explore their own data extensively or examine precipitation characteristics anywhere else in the country. Our more advanced and less time constrained volunteers have taken advantage of these tools, but based on webpage hits probably less than 25% of our volunteers have made use of these tools in anyway despite years of our urging and encouraging. Somehow we think that if it’s exciting to us it will be exciting to all of our volunteers, but that is apparently not true. Maybe in the big scheme of things, 25% is good and represents high impact, but we just wish that more of our family of volunteers would follow our lead and encouragement.

Now that we have six full years of nationwide data, we have great opportunities for exploring data. Based on requests from graduate students, we know that there are research explorations of heavy precipitation, snow, freezing rain, and hail. Perhaps more of our volunteers are doing their own little projects, too. When we conducted our large participant survey 2 years ago we did not dig deeply into this. The potential here remains high. Our recent study of “Maximum daily precipitation” presented at the 2015 annual meeting of the National Weather Association provided a great example of the potential uses of the data in applied research as well as the relative ease in accessing and using point or regional CoCoRaHS data.

- Disseminate Results

- Six-month Progress

- Presentations
 - Nolan Doesken. The Small data Frontier: Crowd-sourcing and Citizen Scientists. Intelligence for Water Sustainability, The Power of Citizen Science and Crowd-Sourced Data. Aspen-Nicholas Water Forum, Aspen, CO May 29, 2015.
 - Reges, Henry W, CoCoRaHS/Colorado State Univ., Fort Collins, CO; and N. Doesken, Z. Schwalbe, J. Turner, and N. Newman, 2015: “How a National Meteorological and Hydrological Service (NMHS) or other Institution can create a Volunteer Observing Network”. Seventeenth World Meteorological Congress (Cg-17), Geneva, Switzerland, May 2015.
 - Poster presentation at STEM Library conference, Denver, Colorado, August 20-22, 2015.
 - Senate staffers briefing. Washington DC September 22, 2015

- Of the people, for the people, by the people, Washington DC Sept 30, 2015
 - Open Science and innovation -- All hands on deck, Washington DC Sept 30, 2015
- Events:
 - Successful WERA 1012 conference in May 2015
 - Met with and encouraged numerous CoCoRaHS coordinators and collaborative organizations at American Association of State Climatologists - Cape May, NJ - June 2015
- Overall FB, Twitter, Instagram, YouTube stats
 - FB: 5,780 likes – up 270 since last report
 - Twitter: 4,229 followers – up approx. 600
 - YouTube: 1423 subscribers – up approx. 300
 - Instagram: 67 followers – up approx. 25 followers; also 281 photos tagged – up approx. 100 since last report
- Articles
 - Turner, Julian, 2015: “Bring Climate Literacy to Your Library Through a Popular Citizen Science Project”.STAR-NET library blog: <http://community.starnetlibraries.org/2015/10/bring-climate-literacy-to-your-library-through-a-popular-citizen-science-project/>
- One new publication referring to CoCoRaHS was added. http://www.cocorahs.org/Content.aspx?page=publications_citizen_science

Final Report Summary

From the traditional academic perspective (i.e. peer reviewed publications) CoCoRaHS has not been a glowing success. We have a few publications and more in the works, but overall publication productively has been low. But by many other metrics, CoCoRaHS has been prolific in dissemination. Volunteers can and do access their data and the data of others. Julian Turner, our web developer, has always given his highest priority to making sure the CoCoRaHS data export function works well to make sure users can efficiently download CoCoRaHS data manually or in scheduled automated ways. The dissemination of volunteer-collected precipitation data is really at the root of CoCoRaHS’ success and contributed to our selection by the American Meteorological Society as their 2014 Special Award recipient. Almost anywhere we go in either the meteorological or citizen science arenas, CoCoRaHS is well known. There is room for improvement, though, and hopefully we will still have opportunities to publish more of our findings including evaluation results in peer reviewed literature.

- Measure Effects

Six-month progress

- David Heil and Associates – Summative evaluation was completed and submitted with previous report
- “Collaborative Research – Exploring Engagement and Science Identity through Participation: A Meta-Analysis of Citizen Science Outcomes”, Cornell Univ. and U.C. Davis. CoCoRaHS is one of 6 citizen science projects that is the focus of this large evaluation effort. They have completed a first round of phone interviews with several highly engaged and moderately engaged volunteers, and are assembling comparative data at this time. We met in Davis, CA in June 2015 to discuss preliminary findings and subsequent plans.

Final report summary

Our summative evaluation was submitted last year when the work was completed and the evaluation budget fully spent. We have continued to actively track indicators of participation.

As described in previous progress reports, we had a bit of a rough ride in the area of “measuring effects” thanks to several staff changes at David Heil and Associates throughout the course of the project. Their staff were all competent in evaluation and summarization, so a fairly rigorous, professional and largely satisfactory evaluation was performed. But we feel that opportunities may have been lost along the way – particularly opportunities to assemble and publish our key evaluation findings in appropriate literature. This deficiency may be offset by the fact that other projects focused on the benefits and opportunities and impacts of citizen science have included CoCoRaHS as an example in their evaluation efforts.

As the project matured, we became increasingly interested in the outcomes from evaluation. Our single strongest measure of project success was something we could and did track ourselves -- the number of data points on the map each day and the quality of the data being collected. From that information alone, a great deal could be inferred regarding progress and accomplishments and even, to some extent, learning and climate literacy outcomes. But more rigorous evaluation tools and techniques were needed than what we ourselves could provide.

Measuring the learning outcomes from schools was difficult because teachers have so many demands that we had a hard time getting a strong response rate to our surveys and focus groups. They were completed, but we would have liked to see a larger sample size to analyze for dissemination outside our own project.

Project Partnerships

- 2) Briefly **describe** the activities of the original, any new and/or previously reported project partner(s) contributing to or involved with the project during the reporting period. Please also describe project partners no longer participating in the project, if applicable.

Partners were key to the breadth, width and reach of this project. To accomplish a nationwide project with a very small staff and a modest budget required enthusiastic partners across the country. If there is anything about this project that has amazed us, it has been the large number of willing and capable partners who, in a variety of ways, rallied around the lowly plastic rain gauge as a lowest common denominator in weather, climate and water research. For example, over 30 State Climatologist offices, many at State Universities and some at State Offices, volunteer significant time and effort to promote CoCoRaHS in their states and link us to additional partners (such as Master Gardeners groups, agricultural organizations, watershed management and protection groups, etc.). And then there is the National Weather Service and its nationwide network of local weather forecast offices. While far from uniform in their level of engagement, they nevertheless provided incredible help in reaching out to a diverse public over the huge geographic extent of our country. Many other partners played a role in CoCoRaHS growth, expansion and acceptance, such as the National Association of Conservation Districts and the U.S. Department of Agriculture's Natural Resource Conservation Service. One of our other high-impact partnerships over the entire duration of this project was the PRISM Climate Group at Oregon State University. Initially we provided funding for them to develop climate data analysis tools to support the education goals of this project. But later they actually funded us to provide them the reliable precipitation data they need for their daily precipitation mapping projects. This allowed us flexible resources that extended our proposed 3-year project into five years with many more accomplishments and impacts than initially proposed.

The moral of the story here is that partners are essential for this type of project and we were blessed with a wonderful team to work with.

- 3) Briefly **list** new partnerships that have been formed as part of, or as a result of, your project during the reporting period. Please list partner(s) by name. (Please add additional rows to the table as needed.)

Note: Do not list partners included in your original project narrative or previous reports.

<u>Name of Partner</u>	<u>Partner's State</u>	<u>Role of Partner</u>
Bahamas Dept of Meteorology (via phone) — Nassau, Bahamas	Bahamas	Initial discussions to begin the process of adding Bahamas to CoCoRaHS.
ALA — American Library Association	National	Just forming the beginning of a partnership
ARSL — Association of Rural and Small Libraries	National	Just forming the beginning of a partnership
Pine River Library	Colorado	Rural library with large STEM component — forming new partnership

Project Outputs

- 4) Indicate specific outputs related to and produced during the period covered by this progress report (see definition of outputs below). Record your outputs in the table provided, selecting from the output type categories listed below the table. Also, include the aggregated total of these outputs produced during the full award period. You may add additional rows to the table as needed. An example has been provided for you. **Note:** if one or more output types do not fit any of the suggested categories, please contact the NOAA Office of Education Grants Team at oed.grants@noaa.gov or 202-482-0793

Outputs¹: the immediate results of an action (e.g., services, events, and products) that document the extent of implementation of a particular activity. They are typically expressed numerically — e.g., the number of persons who visit a museum exhibit or listen to a radio program or the number who attend a series of professional development workshops, etc.

<u>Output Type</u>	<u>Output Count</u>		<u>Audience</u>	<u>Audience Count</u>		<u>Contact Hours*</u>	
	<i>Past 6 Months</i>	<i>Cumulative</i>		<i>Past 6 Months</i>	<i>Cumulative</i>	<i>Past 6 Months</i>	<i>Cumulative</i>
<i>Professional</i>	<i>1</i>	<i>5</i>	<i>Educators</i>	<i>50</i>	<i>250</i>	<i>6.25</i>	<i>31.25</i>

<i>Development</i>							

*Contact hours are defined as the length of the program in hours, or fraction of an hour, per participant.

Output Types

- Experiential Activity (activities, trips, programs, etc.)
- Exhibit Installation (spheres, domes, panels, kiosks, stations, etc.)
- Exhibit Upgrade (equipment upgrades, structural upgrades, layout upgrades)
- Professional Development (conferences, workshops, courses, teacher educator programs, etc.)
- Curriculum (lesson plans, units, modules, frameworks, standards, toolkits, etc.)
- Web/Multimedia (websites, webinars, videos, broadcasts, podcasts, games, etc.)
- Educational Research (reports, surveys, etc.)
- Visualization (data visualizations, spherical display modules, etc.)
- Data Development (hardware packages, software packages, etc.)
- Network Development (networks, network members)

Audience Types

- Informal Educators in Professional Development Programs
- PreK-12 In-service Educators in Professional Development Programs
- PreK-12 Preservice Educators in Professional Development/Teacher Education Programs
- PreK-12 Students in Formal Education Programs
- Lifelong Learners in Informal Education Programs
- Postsecondary Students (Non-Educators) in Higher Education Programs
- Institutions with Increased Educational Capacity
- Visitors to Informal Education Institutions

Comments

See narrative above

Project Outcomes

- 5) Indicate any specific outcomes achieved (see definition below). Record outcomes in the table provided, selecting from the outcome type categories listed below the table. You may add additional rows to the table as needed. An example has been provided for you. **Note that outcomes are often determined through independent evaluation, and projects in their early stages may not yet have outcomes to report.**

Outcomesⁱⁱ: the changes that show movement toward achieving ultimate goals and objectives - e.g., the number of persons who, as a result of their participation in a project, demonstrate changes in: awareness and knowledge of specific concepts and/or issues; interest in and/or attitudes toward certain issues, careers, or courses of action; and behavior or skills.

<u>Outcome</u>	<u>Outcome Type</u>	<u>Activity/Activities leading to the outcome</u>	<u>Target Audience/Participants</u>	<u>How the outcome was measured?</u>
<i>75% of workshop participants showed increased understanding of ocean science topics</i>	<i>Awareness, knowledge or understanding (of)</i>	<i>Ocean Sciences workshop</i>	<i>PreK-12 Inservice Educators in Professional Development Programs</i>	<i>Pre- and post-assessments</i>

- 7) Briefly describe the reason(s) why an established milestone(s) was/were not met, if applicable.
 - a. For the **semi-annual report**, also describe what will be done during the next reporting period to meet these milestones.
 - b. For the **final report**, describe any adjustments made to the original milestone(s).

A number of adjustments were made over the duration of this project to our original proposed schedule and milestones. We were able to exceed expectations and complete work ahead of schedule on some of our data analysis products and tools. We made some significant changes to our original plans for training materials as we increasingly placed emphasis on cartoon animations rather than other training assets. We spread some tasks and activities over 5 years rather than 3. We adjusted some aspects of our cyberinfrastructure and database hardware/software and priorities compared to our original proposal and moved away from cloud computing and towards a more dedicated server environment, which seemed to meet our computation needs. We placed higher emphasis than planned on providing efficient data export to diverse users. We fell behind our proposed milestone schedule for external evaluation, but eventually got the work done. We were slow in starting our WxTalk Webinar series but ended up doing more and higher quality webinars than we originally envisioned. We did not adequately emphasize data quality management in our initial proposal and learned along the way the priority it deserved. A disappointment that we still hope to overcome is that we were never able to implement the full, versatile user-controllable click/zoom/accumulated mapping system that we envisioned. It was developed and it is used by staff, but it simply did not have the speed and robustness to accommodate the demands of thousands of potentially simultaneous users.

NOAA Assets Narrative

- 8) For the **semi-annual report**, the narrative should briefly describe how the project incorporated NOAA assets and/or involved NOAA partners in project activities during the reporting period. For the **final report**, also describe how the project utilized NOAA assets and/or involved NOAA partners to achieve project goals and objectives. *Note: NOAA's assets are resources, services, or sites that communicate NOAA research, data, information, and knowledge to the public and support NOAA's mission. These include education materials and programs, datasets and visualizations, facilities, subject matter experts, and managed natural resource areas.*

This project, from beginning to end leveraged NOAA assets and utilized NOAA partners. To begin with, dozens of our volunteers across the country were present or past NOAA employees. National Weather Service offices across the country provided staff support in limited to extensive ways to help locally recruit, train and retain volunteers. NOAA (both NWS and NCEI and some other NOAA groups as well) were, or became regular users of CoCoRaHS data, integrating it with existing NOAA climate data resources.

Time after time during the project we directed our volunteers to NOAA products and services such as NWS weather forecasts, river forecasts, surface weather observations, NOWData, Severe weather outlooks, hurricane forecasts, storm reports, satellite and radar products, snow and ice products, and even specialized products like Tsunami warnings.

A number of NOAA scientists were invited speakers for our WxTalk Webinars. We frequently referred our volunteers to online and occasionally printed weather, climate and coastal educational resources.

Overall, this project would not have been nearly as successful without the great relationships we enjoyed with our NOAA partners. Likewise, we hope that our efforts have aided NOAA in accomplishing their key missions.

Stewardship Narrative

- 9) Did your project include any environmental stewardship activities? *Such activities are conducted by actively engaged participants who work to prevent or minimize negative impact on the environment, maximize positive impact on the natural resource system, or directly improve environmental quality. By "active engagement" we mean activities that actively and interactively engage participants.* If so, please describe:

We have anecdotal evidence that CoCoRaHS participation motivated environmental stewardship – particularly in the area of flood and drought preparedness and water conservation. Several local watershed protection groups participating in CoCoRaHS learned and then utilized the direct connection between rainfall quantity, intensity and subsequent runoff of nutrient enriched topsoil to strive to improve land use practices to minimize soil erosion and nutrient runoff. However, we did not specifically lead or organize stewardship activities.

Budgetary Information

- 10) Explain any change(s) from the approved budget of the project that occurred during this reporting period that may have a significant impact on the project's current and/or planned expenditures. Briefly describe what will be done during the next reporting period to address the change(s). *Note: Some budget changes require prior approval from NOAA. Please review NOAA Administrative Standard Award*

Conditions, Section D: Budget and Program Revisions for Non-Construction Awards, for more information. If there have been no significant change(s) from the project's approved budget, please state: *"To-Date, our budget has been executed as outlined in our application that was approved by the NOAA Grants Officer."*

The project is over and the funds have been expended. Our whole team thanks the NOAA Office of Education for this grand opportunity and adventure in citizen science.

Progress Report Prepared By: Nolan Doesken and Noah Newman

Date: Dec. 29, 2015

You are encouraged to submit a highlight from the work your project has accomplished. Highlights help the Office of Education to publicly acknowledge and share the great work being done by our grantees. For the final report, your summative evaluation report should be attached.

ⁱ [Adapted from the Framework for Evaluating Impacts of Informal Science Education Projects Report from a National Science Foundation Workshop](#)

ⁱⁱ [Adapted from the Framework for Evaluating Impacts of Informal Science Education Projects Report from a National Science Foundation Workshop](#)

Project Title: Development of a Framework for Process-Oriented Diagnosis of Global Models

Project Number: NA15OAR4310099

PIs: Eric D. Maloney (Colorado State University), Andrew Gettelman (NCAR), Yi Ming (GFDL), David Neelin (UCLA)

Report Type: Year 1 Report

Results and Accomplishments

This project is just in its first half year, and so a report on preliminary work in progress for the first 6 months will be reported here.

Weak temperature gradient diagnostics of the MJO applied to SP-CESM (Wolding and Maloney 2016)

New process-oriented diagnostics using the concept of weak tropical temperature gradients are being developed. These diagnostics can be applied in three dimensions, and extend the 2-D moist static energy budget diagnostics that have been used by the PI and collaborators over the last several years. These higher order diagnostics are being prepared for inclusion in the diagnostics packages of NCAR and GFDL, with the hope of broader application across a more extensive suite of models. We discuss some application of these diagnostics here to the SP_CESM, results contained in a paper that is soon to be submitted.

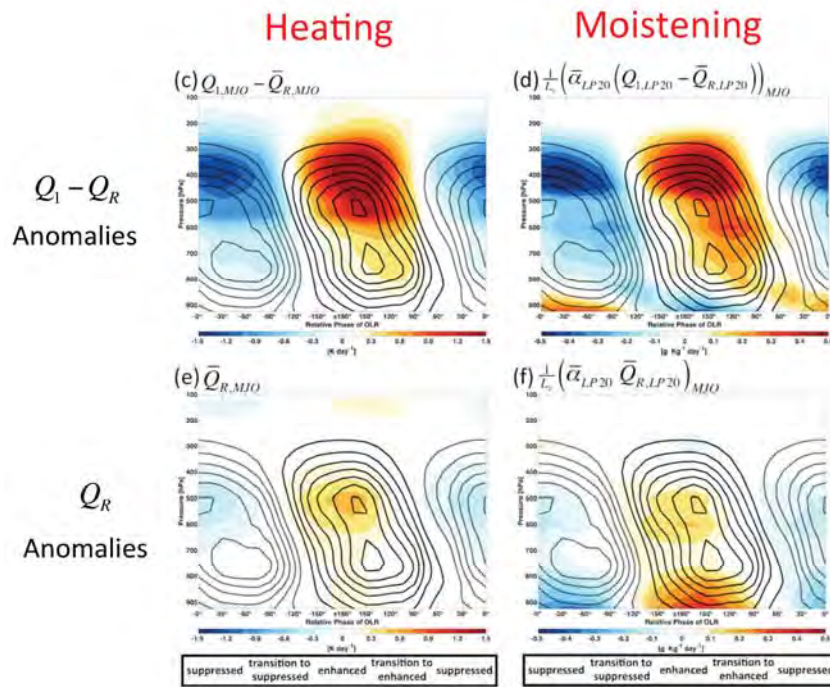

Figure 1. Composite vertical structure of condensational heating and radiative heating anomalies (left) and their moistening effect as determined through the assumption of WTG balance (right).

Multi-decade runs of the NCAR CESM are conducted to examine the initiation and maintenance mechanisms associated with the MJO. In particular, the moisture budget diagnostics of Wolding and Maloney (2015b) that take advantage of the weak temperature gradient nature of the tropical atmosphere are used to understand moistening processes. It is shown that the net effects of diabatic processes, including radiative feedbacks, are to destabilize the MJO through

supporting growth of moisture anomalies. The vertical profile of moistening by diabatic processes is shown in **Figure 1**, with the left panels providing the diabatic heating anomalies, and the right panels the vertical advective moistening produced by the diabatic heating anomalies. Horizontal advection provides a stabilizing influence on the growth of water vapor anomalies, which would grow without check without this negative feedback. A paper describing these results will be submitted to *Journal of Climate* by the end of March. More detail on results will be described in future reports.

The NOAA MAPP Model Diagnostics Task Force

The NOAA MAPP MDTF was initiated in Fall of 2015, led by chair Maloney, and co-chairs Gettelman, Ming, and Aiguo Dai. Regular telecons have been initiated on the first Monday of each month. The following task force activities have been initiated:

- 1) A software framework to allow expanded process-oriented diagnosis of global models is being developed through consultation with GFDL, NCAR, and other centers. Initial discussions have consolidated around a Python-based software framework with the flexibility to embed non-proprietary diagnostic code seamlessly within the package.
- 2) Convective onset diagnostics developed by co-PI Neelin have been implemented at GFDL and NCAR and will serve as the initial test diagnostic for the diagnostic framework discussed in 1).
- 3) A moist static energy budget subgroup has been formed within the TF to provide a mechanism for in-code calculation of vertical and horizontal MSE advection and their vertical integrals to allow more accurate calculations and to reduce data storage requirements. Jack Chen at NCAR is currently testing a proposed framework to conduct such calculations in the NCAR model.
- 4) Timeslice experiments have been designed with the NCAR and GFDL models to provide high time and space frequency resolution output to kick start task force diagnostics efforts. The specifications of this design are:

Timeslices of free running models

Specified SSTs: 1993-2012 with limited output, 2008-2012 with high frequency output

Models

NCAR (1 deg, possible short run of 0.25 deg)

GFDL (1 deg, possible short 0.5 deg run)

Output schemes

1. 20-year (1993-2012) simulation: Daily, a handful set of 2D variables

2. 5-year (2008-2012) sub period: 6-hourly, comprehensive list

3. 2-year (2011-2012) sub period: hourly, variables for diurnal cycle study

5) Plans are being made for team meetings of the task force at the 2016 CESM Annual Workshop in Breckenridge, and a dedicated process-oriented diagnostics session at the 2016 AGU meeting in San Francisco.

Highlights of Accomplishments

- 3-D process oriented diagnostics to understand MJO moistening processes based on weak tropical temperature gradients have been developed and successfully applied to SP-CESM and other models. These diagnostics build on the 2D MSE budget diagnostics developed by the PI and collaborators
- The PI has led the successful launching of the NOAA MAPP Model Diagnostics Task Force as chair. Gettelman and Ming are co-chairs
- Accomplishments of the task force to date include: 1) development of a draft software framework to enable rapid dissemination of diagnostics, 2) completion of an experiment design for timeslice experiments with the GFDL and NCAR models, 3) Formation of a MSE diagnostics subgroup, 4) implementation of convective onset diagnostics into the GFDL and NCAR models, and 5) tentative plans for team meetings in Breckenridge, CO and the 2016 AGU annual meeting.

Publications From the Project

Wolding, B. O., and E. D. Maloney, 2016: Weak temperature gradient diagnostics of the MJO applied to SP-CESM. *J. Climate*, to be submitted 3/16.

PIs Contact Information

Eric D. Maloney (lead PI)
Department of Atmospheric Science
Colorado State University
1371 Campus Delivery
Fort Collins, CO 80523-1371
Phone: (970) 491-3368
emaloney@atmos.colostate.edu

Yi Ming (co-PI)
NOAA Geophysical Fluid Dynamics
Laboratory
Princeton University, 201 Forrester Rd
Princeton, NJ 08542
Phone: 609-452-5338
Yi.Ming@noaa.gov

Andrew Gettelman (co-PI)
National Center for Atmospheric Research
PO Box 3000,
Boulder, CO 80307-3000
Phone: (303)497-1887
andrew@ucar.edu

J. David Neelin (co-PI)
Dept. of Atmospheric and Oceanic Sciences
University of California, Los Angeles
405 Hilgard Ave.
Los Angeles, CA 90095-1565
Phone: 310-206-3734
neelin@atmos.ucla.edu

6. Budget for the Coming Year

The budget for the coming year is unchanged from that in the submitted proposal.

7. Future Work

The plan for future work has not changed from the original proposal.

Annual Progress Report

Following emissions from Non-Traditional Oil and Gas Development Through their Impact on Tropospheric Ozone

Award Number: NA14OAR4310148
Principal Investigator: Dr. Emily V. Fischer
Institution: Colorado State University, Fort Collins, CO 80521
Co-investigators: Dr. Delphine K. Farmer, Dr. Chris Kummerow
Start Date: August 1, 2014
Period Covered: May 30, 2015 – March 15, 2016

I Project Statement

This project is focused on investigating how emissions from current oil and gas development are changing patterns of tropospheric ozone production at the local, continental and global scale. The proposed work tackles these scientific questions:

1. What are characteristic ozone production rates and efficiencies in air masses influenced by emissions from oil and gas production?
2. To what extent have emissions from oil and gas production impacted the extent of NO_x versus NMVOC limited ozone production?
3. Through which chemical pathways do emissions from oil and gas production propagate most efficiently to global ozone production?
4. How do emissions from this sector affect radiative forcing through perturbations to tropospheric ozone, methane, and remote aerosol formation?

II Accomplishments

Summary: Significant progress has been achieved during the second year of research including (A) completing both measurement intensives at the NOAA BAO tower in northeastern Colorado, (B) finalizing all data for both the spring and summer field intensives, (C) beginning analysis of the field data, and (D) contributing to an analysis of ethane trends across the northern hemisphere.

Results from 2015 Measurement Intensives

The springtime measurement intensive ran from 20 March through 17 May, and overlapped with the NOAA Shale Oil and Natural Gas Nexus (SONGNEX) field study. The summertime measurement intensive ran from 3 July through 7 September. Both campaigns were highly successful, and final data has been posted to the SONGNEX data archive. Figure 1 provides a graphical summary of the observations collected during these two campaigns. In addition to the proposed measurements, we were able to also make measurements of nitric acid (HNO₃) fluxes and daily >C₆ volatile organic compounds (VOCs) through collaborations with Aerodyne and Yale University, respectively. Ozone production was measured via in collaboration with Penn State using their latest iteration of the Measurement of Ozone Production Sensor (MOPS) system.

We have made significant progress on data analysis, and aspects of our early results were presented at the Fall AGU Meeting in December 2015.

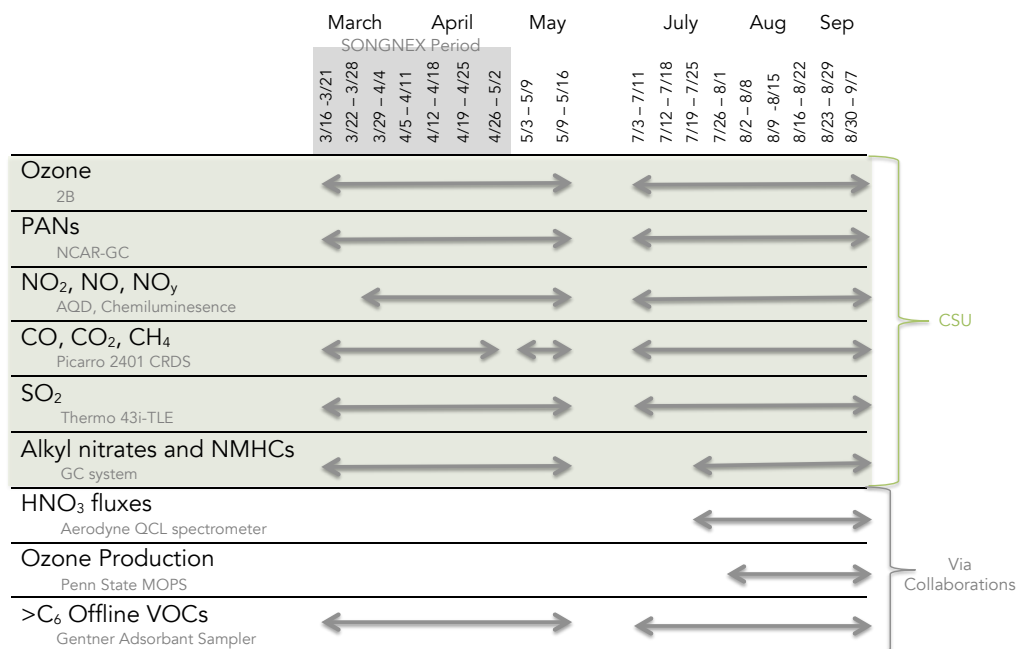

Figure 1: Summary of measurements from the BAO field intensives. Final data has been posted to the SONGNEX data archive (<http://www.esrl.noaa.gov/csd/projects/songnex/>).

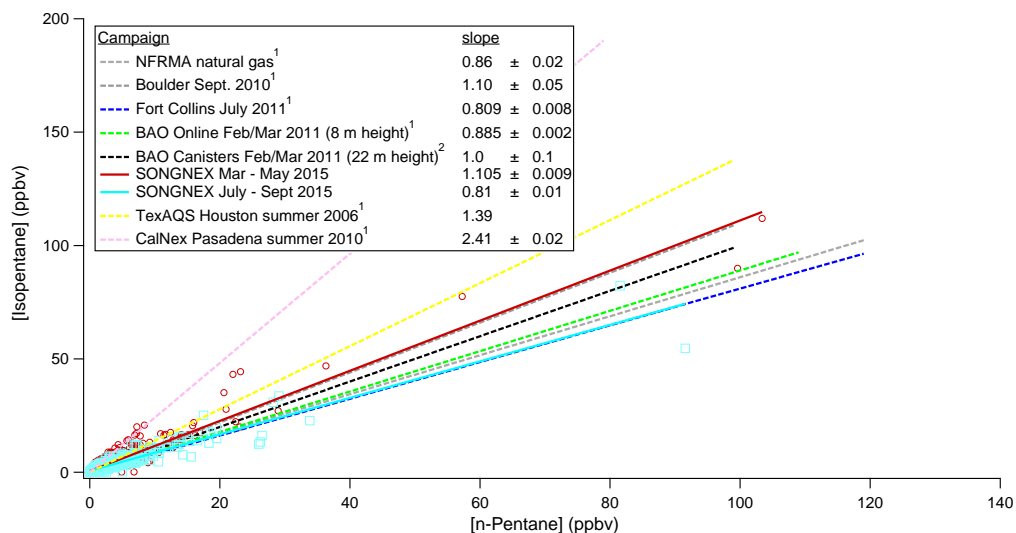
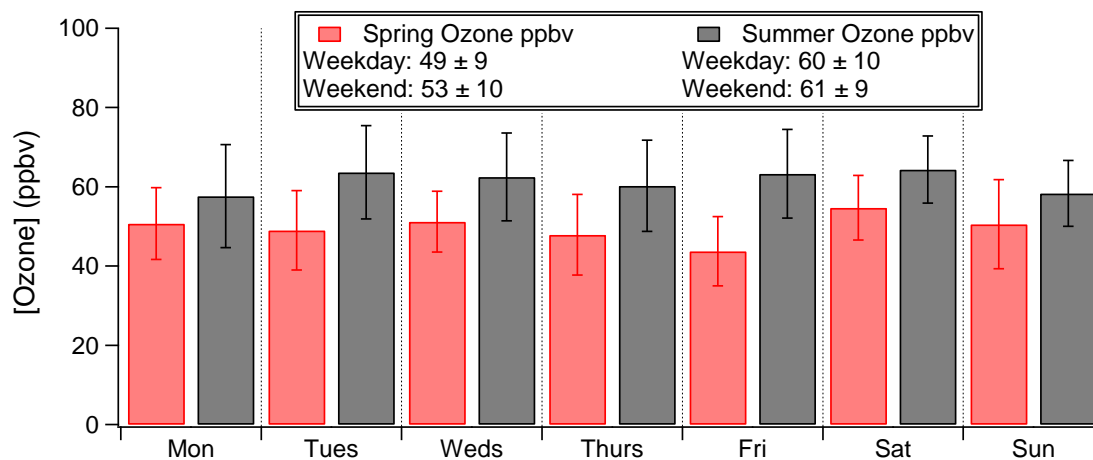

Figure 2: Summary of our field measurements (red and turquoise) of iso- and n-pentane in relation to previous observations.

Our data show that the Northern Front Range Metropolitan Area (NFRMA) was clearly impacted by emissions from oil and gas operations in 2015 despite VOC emission reductions from these activities mandated by the Colorado Department of Public Health in 2008 and 2014. Figure 2 presents iso-pentane to n-pentane ratios from ambient sampling between 2010 and 2015. The figure indicates slopes between 0.8 and 1.10. As of 2011, raw natural gas produced from gas fields in NFRMA yielded a slope of 0.86. When compared to values in areas with VOC composition dominated by transportation related activities (e.g. Pasadena, CA slope = 2.4) we observed a significant depression attributed to emissions from oil and gas activities. As seen in

previous studies [Gilman *et al.*, 2013; Swarthout *et al.*, 2013; Thompson *et al.*, 2014] C₂-C₆ alkanes were tightly correlated ($R^2 > 0.85$) with propane (with exception of ethane $R^2 = 0.52$), and not well correlated with ethyne ($R^2 < 0.16$) indicating a common oil and natural gas source with minimal automobile related activity source. The potential sources of aromatics are less clearly defined in our datasets. The observed benzene can likely be attributed to a combination of oil and gas activities and automobile exhaust ($R^2 = 0.68$ and 0.35 for propane and ethyne respectively), but toluene and ortho-xylene are only weakly correlated to either source marker. This indicates the potential for an additional source of these compounds. Potential sources include various industrial operations or solvent evaporation. These compounds also have much faster loss rates (> 2 orders of magnitude) via reaction with OH than ethyne, and we are exploring the implications of this. We found that during summer 2015, isoprene made up 14% – 40% of the average calculated VOC reactivity depending on time of day. This indicates the potential importance of isoprene as an ozone precursor during summer 2015. We examined the role of isoprene in ozone production using the ratios of the PAN family members measured at BAO during summer 2014 (FRAPPÉ period), and we found MPAN/PAN ratios $< 5\%$, indicating very little influence of isoprene chemistry compared to published datasets in other regions [Roberts *et al.*, 2003; Roberts *et al.*, 2004; Roberts *et al.*, 2007; Roberts *et al.*, 1998]. During summer 2014, we found that the contribution to total O₃ from isoprene was always $< 20\%$. We plan to re-do this analysis with the 2015 data.

We have begun two other approaches to understand ozone production in the region, and these include weekend-weekday and wind-sector analyses. We find an enhancement of ozone from weekdays to weekends in spring, but not during summer (Figure 3). There is a slight depression of NO_x from weekdays to weekends in spring, and a clear depression during summer (Figure 3). There is no discernable weekday-weekend effect for observed (*i.e.* calculated from VOC observations) VOC reactivity, indicating that the assumptions inherent in the analysis are valid, and that the variation in NO_x can be considered to shift ozone production along the same reactivity. Together, a small weekend spring ozone enhancement combined with a small NO_x depression, and no summer weekend ozone enhancement with a strong NO_x depression, indicate that the NFRMA may be at or near peak ozone production – and that simultaneous reductions in NO_x and VOC reactivity would be required to substantially suppress O₃ production in the airmasses observed during SONGNEX. We are currently working on a quantitative modeling approach to complement this analysis.



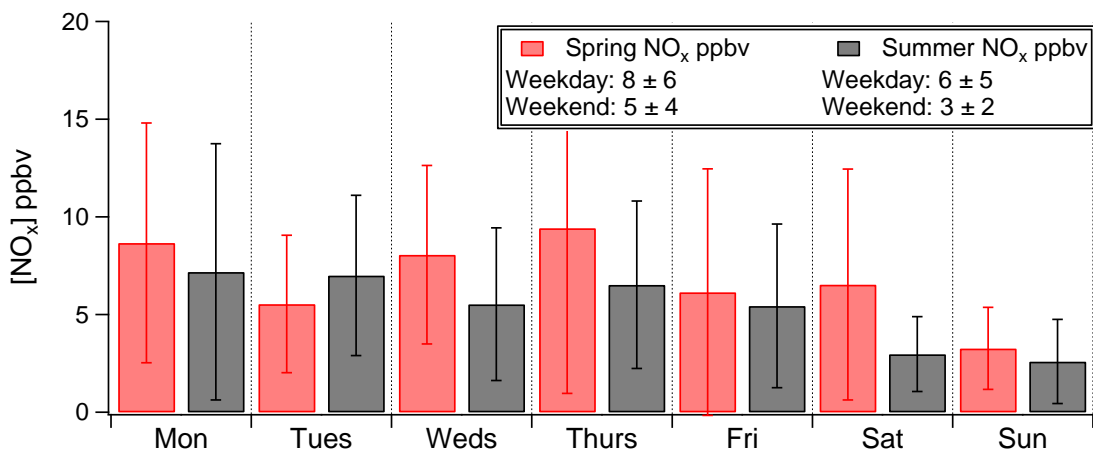

Figure 3: Top: Afternoon (12 – 4 PM Local Time) average ozone mixing ratios. Bottom: Afternoon (12 – 4 PM Local Time) average NO_x mixing ratios.

Figure 4 shows plots of BAO ozone versus NO_z (NO_y – NO_x) for summertime. BAO is located 25 km east-northeast of Boulder and 35 km north of Denver. It is situated on the southwestern edge of the Denver-Julesburg Fossil Fuel Basin. The slope of these lines represents one estimate of ozone production efficiency (OPE). We do not see a clear relationship between wind sector and OPE.

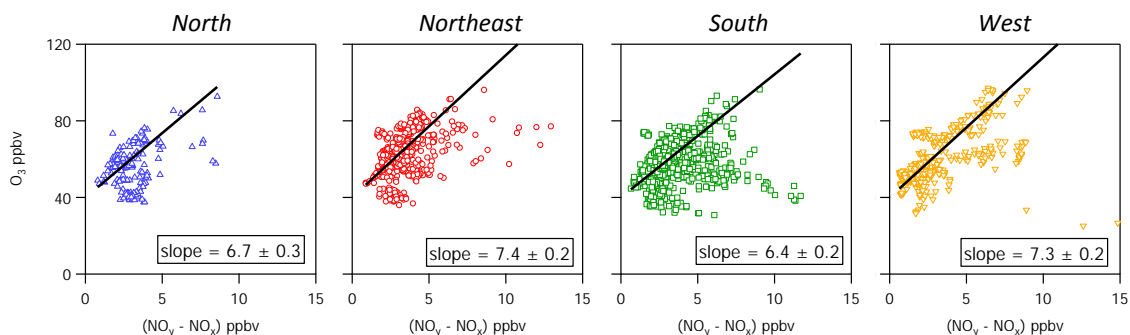

Figure 4: Summertime weekday 5-min average ozone versus NO_z (NO_y – NO_x) for afternoon periods (12 – 6 PM Local Time). The slopes were calculated with a 2-sided linear least squares fit assuming a background ozone of 40 ppbv.

Chemical Transport Modeling and Global Ethane Trends

Many locations in the Northern Hemisphere show a statistically significant sharp increase in measurements of ethane since 2009 [e.g. Franco et al., 2015]. We have developed a global simulation of ethane for 2010 that largely reproduces observed inter-hemispheric and averaged vertical gradients (Figure 5). We have explored several different possible U.S. emissions scenarios including 1) basing ethane emissions on a methane emissions inventory built on observations from the Greenhouse Gases Observing SATellite (GOSAT) [Turner et al., 2015], and 2) basing emissions on the spatial distribution in the NEI2011, but with a higher magnitude flux.

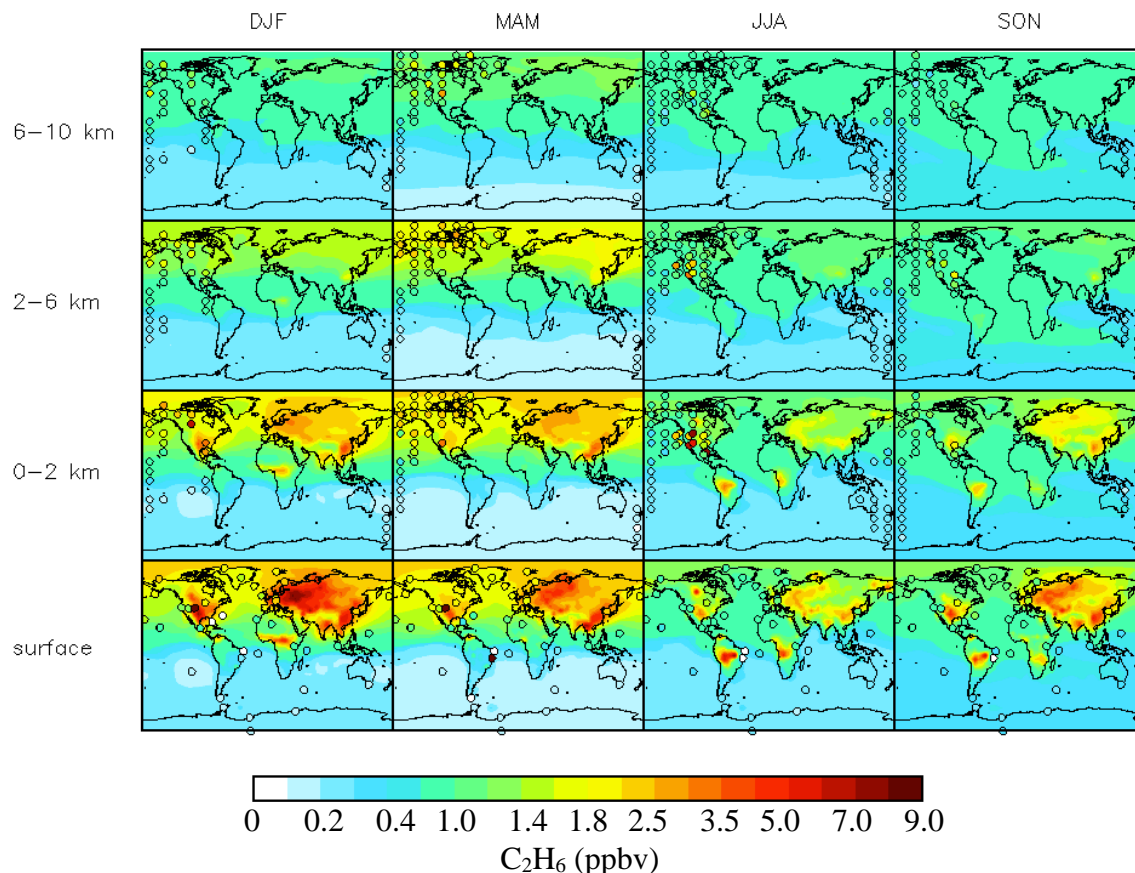

Figure 5: Global mean distribution of C_2H_6 for different seasons and altitude ranges compared to observations from a suite of surface sites and airborne campaigns. Background solid contours are model outputs from 2010 for one emission scenario. Filled circles represent seasonal averages from observations. Aircraft measurements (panels 0-2, 2-6, and 6-10 km) were averaged vertically for each range of altitude.

We have used this simulation, in collaboration with research groups responsible for ground-based Fourier Transform InfraRed (FTIR) observations of ethane, to show that GEOS-Chem is able to reproduce FTIR measurements at the mid-latitude sites. This underscores the impact of the North American oil and gas development on the current ethane abundance. Based on our analysis using the model, we also estimate that the North American oil and gas emissions of methane, grew from 20 to 35 $Tg\ yr^{-1}$ over the period 2008 to 2014, in association with the ethane rise [Franco *et al.*, 2016].

III Work Plan for Year 3

Year 3 will be devoted to analysis of the data and the preparation of publications. The modeling efforts will focus on resolving issues in the global budgets of propane and higher alkanes, with the goal of using GEOS-Chem to assess the overall impact of oil and gas activities on global ozone production. We also plan to do trend analyses of the global dataset of ground based light alkane measurements.

IV Presentations and Publications

Publications:

Angevine, W., J. Brioude, S. McKeen, Y.Y. Cui, T. Campos, G. Diskin, E. V. Fischer, J. Peischl, C. Sweeney, G. Petron, T. Ryerson, and J. Zaragoza (2016), *Methane emissions from the Denver-Julesburg Basin of Colorado estimated by Bayesian inversion with five datasets*, under review at Journal of Geophysical Research.

Franco, B., W. Badger, G. C. Toon, C. Bray, A. Perrin, E.V. Fischer, K. Sudo, C.D. Boone, B. Bovy, B. Lejeune, C. Servais, and E. Mathieu (2015), *Retrieval of ethane from ground-based FTIR solar spectra using improved spectroscopy: Recent burden increase above Jungfrauoch*, J. of Quant. Spect. Rad. Trans., 150, 36-49.

Franco, B. E. Mahieu, L. Emmons, Z. Tzompa-Sosa, E. V. Fischer, K. Sudo, B. Bovy, S. Conway, D. Griffin, J. Hannigan, K. Strong and K. Walker (2016), *Evaluating ethane and methane emissions associated with the development of oil and natural gas extraction in North America*, Environmental Research Letters, accepted.

Tzompa Sosa, Z, C. Keller, A. Turner, E. Mahieu, B. Franco, and E.V.Fischer, (2016), *The global budget of ethane*, in preparation for Journal of Geophysical Research.

Presentations:

4/15/2015, Franco, B., W. Bader, B. Bovy, E. Mahieu, E. V. Fischer, K. Strong, S. Conway, J. W. Hannigan, E. Nussbaumer, P. F. Bernarth, C. D. Boone, K. A. Walker, *Recent increase of ethane detected in the remote atmosphere of the Northern Hemisphere*, EGU General Assembly, Vienna, Austria.

12/14/15, Pollack, I., J. Zaragoza, A. Abeleira, F. Flocke, D.K. Farmer, and E. V. Fischer, *Identifying ozone production from oil and gas versus urban emissions sources in the Denver Metro Area and North Front Range of Colorado*, A11M-0259, AGU Fall Meeting, San Francisco, CA.

12/14/15, Tzompa Sosa, Z, C. Keller, A. Turner, E. Mahieu, B. Franco, and E.V.Fischer, *Investigating model deficiencies in the global budget of ethane*, A11M-0236, AGU Fall Meeting, San Francisco, CA.

12/14/15, Zaragoza, J, E. V. Fischer, E. McDuffie, W. Dube, S. Brown, D. Farmer, F. Flocke, *Summertime Acyl peroxy nitrates (PANs) in the Colorado Front Range*, A12A-06, AGU Fall Meeting, San Francisco, CA.

12/15/15, Abeleira, A., D.K. Farmer, E. V. Fischer, I. Pollack, J. Zaragoza, *VOC Measurements in the Northern Colorado Front Range Metropolitan Area: Investigating the Impact of Oil and Natural Gas Emissions on O₃ Production*, A21A-0014, AGU Fall Meeting, San Francisco, CA.

12/16/15, Roscioli, J., S. Herndon, M. Zahniser, D. Nelson, J. Zaragoza, I. Pollack and E.V. Fischer, *Demonstration of HNO₃ Eddy Flux Measurements at the Boulder Atmospheric Observatory Using Active Passivation*, A31F-07, AGU Fall Meeting, San Francisco, CA.

References Cited in Report:

Franco, B., W. Badger, G. C. Toon, C. Bray, A. Perrin, E.V. Fischer, K. Sudo, C.D. Boone, B. Bovy, B. Lejeune, C. Servais, and E. Mathieu (2015), *Retrieval of ethane from ground-based*

FTIR solar spectra using improved spectroscopy: Recent burden increase above Jungfraujoeh, *J. Quant. Spect. Rad. Trans.*, 150, 36-49.

Gilman, J. B., B. M. Lerner, W. C. Kuster, and J. de Gouw (2013), Source signature of volatile organic compounds (VOCs) from oil and natural gas operations in northeastern Colorado, *Environ. Sci. Tech.*, 10.1021/es304119a.

Roberts, J. M., et al. (2003), An examination of the chemistry of peroxy-carboxylic nitric anhydrides and related volatile organic compounds during Texas Air Quality Study 2000 using ground-based measurements, *Journal of Geophysical Research: Atmospheres*, 108(D16), 4495.

Roberts, J. M., et al. (2007), Measurements of PANs during the New England Air Quality Study 2002, *Journal of Geophysical Research: Atmospheres*, 112(D20), D20306.

Roberts, J. M., et al. (2004), Measurement of peroxy-carboxylic nitric anhydrides (PANs) during the ITCT 2K2 aircraft intensive experiment, *Journal of Geophysical Research: Atmospheres*, 109(D23), D23S21.

Roberts, J. M., et al. (1998), Measurements of PAN, PPN, and MPAN made during the 1994 and 1995 Nashville Intensives of the Southern Oxidant Study: Implications for regional ozone production from biogenic hydrocarbons, *Journal of Geophysical Research: Atmospheres*, 103(D17), 22473-22490.

Swarthout, R. F., R. S. Russo, Y. Zhou, A. H. Hart, and B. C. Sive (2013), Volatile organic compound distributions during the NACHTT campaign at the Boulder Atmospheric Observatory: Influence of urban and natural gas sources, *J. Geophys. Res. Atmos.*, 118,10,614–10,637, doi:[10.1002/jgrd.50722](https://doi.org/10.1002/jgrd.50722).

Thompson CR, Hueber J, Helmig D. (2014), Influence of oil and gas emissions on ambient atmospheric non-methane hydrocarbons in residential areas of Northeastern Colorado. *Elem. Sci. Anth.* 2: 000035. doi: 10.12952/journal.elementa.000035

Turner, A. J., Jacob, D. J., Wecht, K. J., Maasakkers, J. D., Lundgren, E., Andrews, A. E., Biraud, S. C., Boesch, H., Bowman, K. W., Deutscher, N. M., Dubey, M. K., Griffith, D. W. T., Hase, F., Kuze, A., Notholt, J., Ohyama, H., Parker, R., Payne, V. H., Sussmann, R., Sweeney, C., Velasco, V. A., Warneke, T., Wennberg, P. O., and Wunch, D. (2015), Estimating global and North American methane emissions with high spatial resolution using GOSAT satellite data, *Atmos. Chem. Phys.*, 15, 7049-7069, doi:10.5194/acp-15-7049-2015.

NOAA Joint Hurricane Testbed (JHT) Final Report

Date: February 29, 2015
Reporting Period: September 1, 2013 – December 31, 2015
Project Title: *Guidance on Intensity Guidance*
Principal Investigators: David S. Nolan, RSMAS, University of Miami, and
Andrea Schumacher, CIRA, Colorado State University
Award Period: September 1, 2013 – December 31, 2015

1. Long-term Objectives and Specific Plans to Achieve Them:

The goal of this project is to develop a system for real-time prediction of the expected errors of individual hurricane intensity forecast models and to use this information to improve operational forecasts. In the first year of the project, we built on the results of Bhatia and Nolan (2013) to construct a model that predicts the error of each intensity forecast model at each forecast interval. Error prediction models were developed for each of the “early” intensity forecast models that are available to forecasters: DSHP, LGEM, GHMI, and HWFI. During the second year, the models were fully developed and began running operationally in real-time from June 1st. The system makes predictions of both absolute error (AE) and bias for each of the four official intensity forecast models, as well as bias corrected forecasts for each model, and a weighted consensus model that weights each model according to its predicted AE. All of these outputs were made available in graphical and text form in real time at the CIRA model products web page.

2. PRIME and R-PRIME

a. How it works

The Prediction of Intensity Model Error (PRIME) is very similar to the highly successful SHIPS model (DeMaria and Kaplan 1994, 2005). It uses multivariate linear regression to make predictions of the absolute error (AE) and bias of each of the 4 early intensity models at each forecast time. The predictors are chosen from a long list of potential predictors, which include synoptic information such as environmental wind shear and MPI, and also information from the other models, such as the difference between an individual model intensity forecast and the mean of the four-model ensemble. For almost all predictors, both the 0-hour value and the mean

value over the forecast period (e.g., shear at 0 h, and shear averaged over 72 h) are considered as possible predictors. The predictors related to the dynamical features of the storm and the surrounding synoptic environment are available in the stext (SHIPS) files. The intensity forecasts for the models are located in the ATCF “a deck” files, while the intensity verification is in the NHC best-track digital database (Landsea and Franklin 2013).

The model is trained on several years of forecasts. Using the standard approach, the least significant predictor is eliminated and the regression is repeated until only predictors with impacts that are statistically significant over one or more of the forecast hours remain. The distribution of the AE predictand for a given time interval is not normal and causes errors that are heteroscedastic. As a result, a power transformation is necessary to transform the positively skewed AE distribution to an approximately Gaussian distribution, creating more homoscedastic data for the linear regressions. In the final step, the predictands are transformed back to their physical values. We also experimented with nonlinear transformations of some of the predictors. For example, small positive values of the distance to land predictor (DIST) have the largest correlations with high errors. Therefore the variable is transformed to a predictor that has its largest value when the distance to land is around 50 km. The particulars of these transformations and the development of the model are described in great detail in the recently published article by Bhatia and Nolan (2015).

PRIME as such only uses intensity forecast data from the real-time models in past hurricane seasons. This can not account for yearly changes to each model, which can be substantial, especially for the dynamical models. Fortunately, the outcome of retrospective forecasts using the 2015 versions of the models on several years of forecasts were made available to us, from which we were able to develop a retrospective version, R-PRIME. R-PRIME was generally more accurate than PRIME, although not always more skillful, because the retrospective intensity forecasts are more accurate so their average errors (“climatological errors”) are smaller. Another trade-off is that there are not as many years of forecasts of R-PRIME as there are for PRIME which simply uses all the past forecasts as far back as 2007.

Unfortunately, only the 2014 retrospective runs were available to us before the start of the 2015 hurricane season. Despite having used models one year out of date, R-PRIME performed better in cross-validation (“leave one year out”) testing, so it was used as the basis for the 2015 operational system.

b. Corrected-consensus models

Another goal of the project was to produce unequally-weighted ensemble forecasts based on the expected error of each model, i.e., the models with larger predicted absolute error are given less weight, and vice-versa. We also experimented with a bias-corrected ensemble, where the predicted bias is removed from each forecast before they are then averaged with equal weights. When using the version of PRIME based on the past forecasts, we found that the bias-corrected ensemble produces the most accurate forecasts. However, when using R-PRIME we found the most accurate forecasts were made using an unequally weighted ensemble where each member is weighted by the inverse of its predicted error squared. This is the version that was applied operationally in 2015.

c. Implementation and operational appearance

The PIs (Nolan and Schumacher) and the graduate student (Kieran Bhatia) worked together to make PRIME and the corrected consensus models work in parallel with other real-time systems such as SHIPS. While PRIME was developed entirely using Matlab software at the University of Miami, calculation of the real-time error forecasts is straightforward and Fortran code that works on systems at NOAA has been developed to reproduce the results from UM. PRIME error and corrected consensus forecasts were available in real time from the CIRA web page. Six plots were produced for each forecast: 1) The corrected consensus using the inverse AE-squared weighting; 2) A histogram showing the predicted AE of each model for each forecast time; and (3)-(6) were bias-corrected forecasts for each of the four models. Examples of these figures (taken from the 30 Sept. 12Z forecasts of Joaquin) are shown below. A text file summarizing the forecasts, along with the values of the leading predictors, is also produced for each forecast. The example shown in Figure 2 shows the portion of the text file with HWFI results and the corrected consensus prediction. The data for the other models also appears in this file.

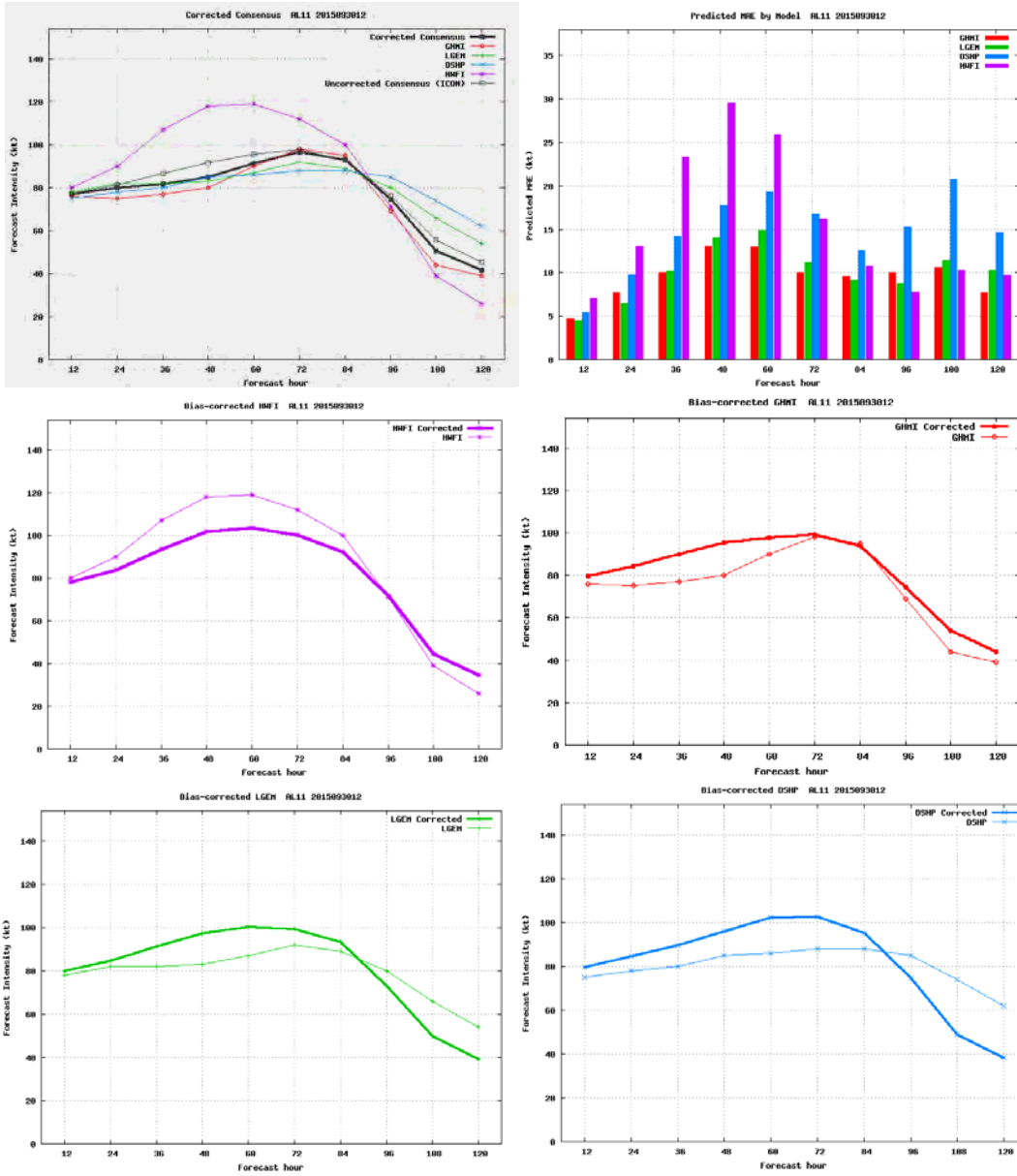

Fig. 1: Real-time output from PRIME taken from the CIRA web page for the Hurricane Joaquin 12Z forecasts on September 30.

	* PRedicted Intensity Model Error (PRIME) *									
	* AL112015 09/30/15 12 UTC *									
	* HWFI *									
TIME (HR)	12	24	36	48	60	72	84	96	108	120
V (KT) HWFI	80	90	107	118	119	112	100	71	39	26
V (KT) HWFI_BC	78	84	93	102	103	100	92	71	44	34
AERR (KT) PRED	7	13	23	29	25	16	10	7	10	9
AERR (KT) CLIM	5	7	8	9	10	10	9	10	10	11
BIAS PREDICTORS:										
INIT DTL (NMI)	532.0	532.0	532.0	532.0	532.0	532.0	532.0	532.0	532.0	532.0
AVG LAT (N)	24.6	24.4	24.4	24.5	24.8	25.2	25.8	26.5	27.3	28.1
ENSMN V (KT)	2.8	8.8	20.5	26.5	23.5	14.5	7.0	-5.3	-16.8	-19.3
AERR PREDICTORS:										
AVG LAT (N)	24.6	24.4	24.4	24.5	24.8	25.2	25.8	26.5	27.3	28.1
AVG MPI (KT)	163.7	163.4	163.2	163.3	163.4	162.3	160.0	157.8	155.1	151.7
STDEV BT (C)	-2.0	-2.0	-2.0	-2.0	-2.0	-2.0	-2.0	-2.0	-2.0	-2.0
VMX CHANGE (KT)	10.0	20.0	37.0	48.0	49.0	42.0	30.0	1.0	-31.0	-44.0
T=0 V (KT) HWFI	70.0	70.0	70.0	70.0	70.0	70.0	70.0	70.0	70.0	70.0
V (KT) HWFI	80.0	90.0	107.0	118.0	119.0	112.0	100.0	71.0	39.0	26.0
ENSMN V (KT)	2.8	8.8	20.5	26.5	23.5	14.5	7.0	-5.3	-16.8	-19.3
* PRedicted Intensity Model Error (PRIME) *										
* Corrected Consensus *										
ICON (KT)	77.2	81.2	86.5	91.5	95.5	97.5	93.0	76.2	55.8	45.2
CCON (KT)	77.0	80.0	81.5	84.9	91.3	96.8	93.1	74.6	50.8	41.7

Fig. 2: A portion of the text file that is also produced in real time.

3. Outcome and Validation

In the following sections, we assess a) how well the operational version of PRIME worked in real-time in 2015; b) how well future versions of PRIME might work; and c) results for PRIME developed for the East Pacific.

a. Real-time, operational PRIME in 2015: Error forecasts and weighted ensembles

As noted above, the operational version of PRIME used in 2015 is based on R-PRIME, but using retrospective forecasts from the 2014 models, not the 2015 models. The results of the AE forecasts are summarized in Fig. 2. The plots show mean absolute error of forecasts of AE for each of the 4 models, for each forecast time. The dashed lines show the mean absolute error of error forecasts that simply use the average error based on the 4 years of retrospective forecasts; this mean error is the “climatological error” and will hereafter be referred to as “climatology.” Assessments of skill are made by comparing the mean AE or bias of PRIME to climatology.

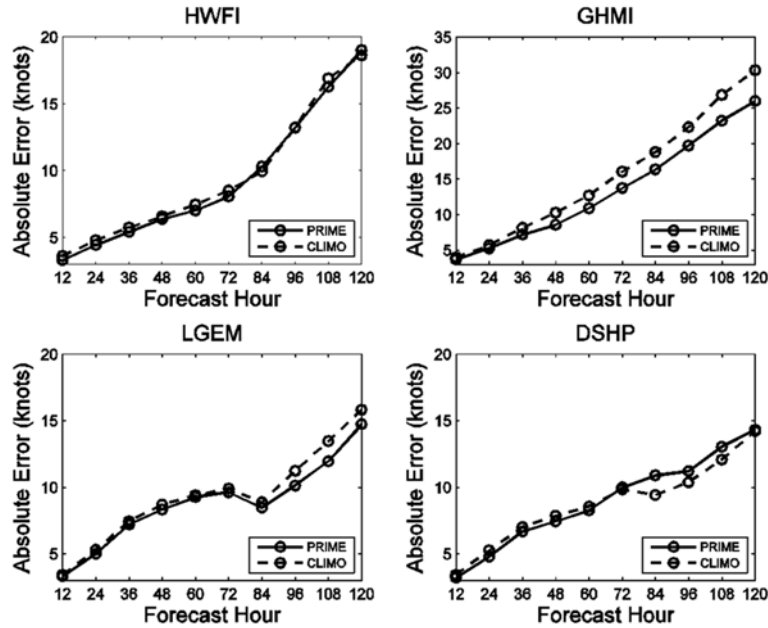

Fig. 3: Mean absolute error of forecasts of absolute error (AE) by PRIME (solid lines) for each model, along with the mean absolute error of AE forecasts using the climatology (mean errors) of each model. Note that the axes are different for GHMI.

Figure 3 shows mixed to positive results for PRIME forecasts of AE. Between 12 and 60 h, PRIME forecasts for all models show lower AE than climatology. Beyond 60 h, PRIME struggles for all models besides GHMI. The GHMI error forecasts are significantly better (at the 95% level, and hereafter all further significance comments will refer to this confidence level) at all times (note that the y axis extends to higher values). This is not surprising, as GHMI performed terribly in 2015. PRIME was correctly identifying its forecasts as likely to be erroneous, and therefore easily exceeded predictions based on the average error of GHMI.

Figure 4 shows the same results but for the absolute error of forecasts of model bias. Again, PRIME was very skillful at predicting the bias of GHMI, having correctly anticipated its very poor (usually overly intense) forecasts in 2015. Unfortunately, PRIME had negative skill for HWFI and LGEM, and mixed results for DSHP. In fact, the poor performance of GHMI is part of the reason that PRIME did not perform well predicting bias for the other models: one of the leading predictors for the bias of each model is its difference from the ensemble mean. If one model is consistently far from the other three, it will skew the bias forecasts of those models.

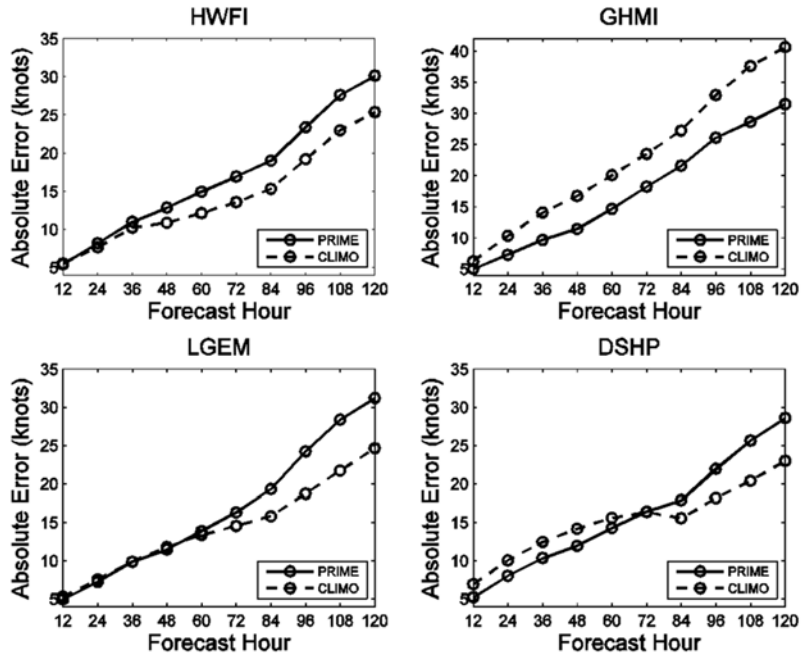

Fig. 4: Mean absolute error of forecasts of intensity model bias by PRIME (solid lines) for each model, along with mean (climatological) errors of each model. Note that the axes are different for GHMI.

The corrected consensus model operational in 2015 was based on each model weighted by the inverse square of its forecasted AE. PRIME AE forecasts weighted each model with the equation:

$$W_m = \frac{\frac{1}{(\text{PRIME_AE})_m^2}}{\sum_{m=1}^M \frac{1}{(\text{PRIME_AE})_m^2}},$$

where M is equal to 4, the number of models. This creates “CCON” which can be compared to the standard, equally-weighted ICON, as shown in Figure 5. The performances of ICON and CCON are nearly identical out to 84 h, but for longer times CCON did perform better, with an improvement of 2 knots at 120 h. At 108-120 hr, these results are statistically significant.

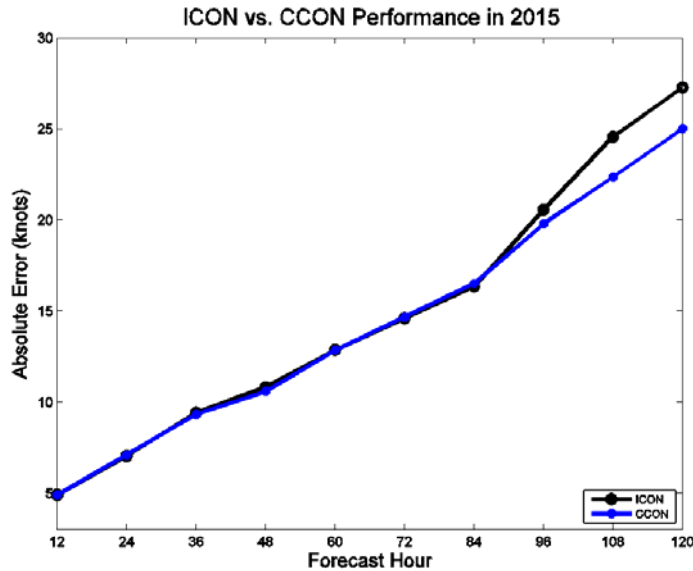

Fig. 5: Mean error of consensus forecast models of intensity: the standard ICON and the corrected consensus (CCON) using unequal weights.

b. Likely success of future implementations of PRIME

In a perfect world and with sufficient resources, PRIME would be updated before each hurricane season, much like the operational models. The choices of predictors and their coefficients would be recomputed based on the retrospective forecasts of the operational intensity models that are going to be used for that same hurricane season. In addition, these retrospective forecasts would be available for all 4 models for at least 4 full hurricane seasons.

Under those circumstances, how well would PRIME perform? Alternatively, how would PRIME perform if it were only based on real-time forecasts, without use of retrospectives?

To answer these questions, we repeated the development of PRIME using data from 2011 to 2015. Both PRIME and R-PRIME were developed: the former uses only data available in real time from each season, while the latter uses the retrospective forecasts of the 2015 models which became available to us later this past season. The following results use the standard “leave one year out” validation: the model is tested on each one of the years in 2011 to 2015 year using predictors and coefficients derived from the other 4 years, and the results are averaged over this process repeated over all 5 years. Figure 6 and Figure 7 show the results for AE and for bias.

Both figures show that both PRIME and R-PRIME have positive skill at all times for all models. Note that each version of the model is compared to its own climatology. While R-PRIME makes

more accurate forecasts of AE and bias, it is generally not more skillful, because the retrospective (updated) models have less error variance in their forecasts. A paired t test, adjusted for serial correlation, determined that the differences between PRIME and climatology errors for all forecast intervals, predictands, models, and versions of PRIME were significant at the 95% level except 108-120 h AE forecasts of PRIME and R-PRIME for DSHP, LGEM, HWFI and 96-120 h bias forecasts of R-PRIME for HWFI bias. Additionally, both versions of PRIME were able to forecast the AE of the models' intensity forecasts significantly better than the models forecasted intensity.

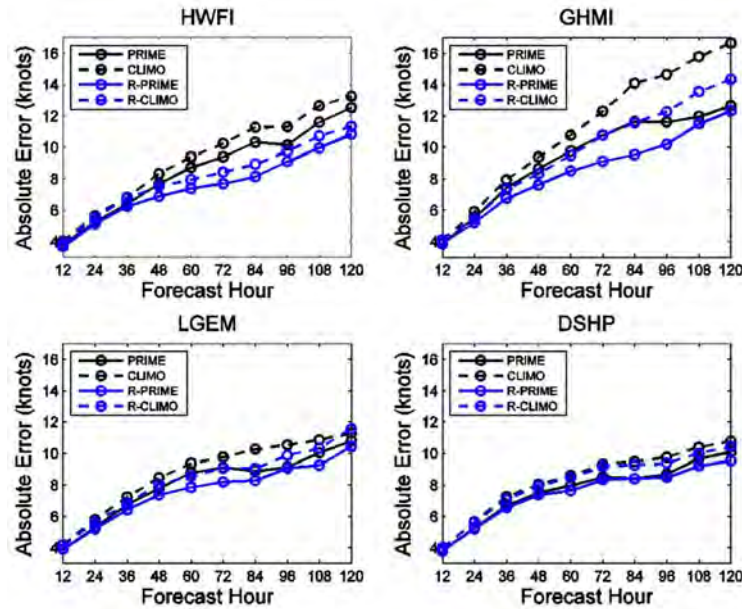

Fig. 6: Results for absolute error of forecasts of absolute error (AE) by PRIME (black curves) and R-PRIME (blue curves) developed using data from 2011-2015.

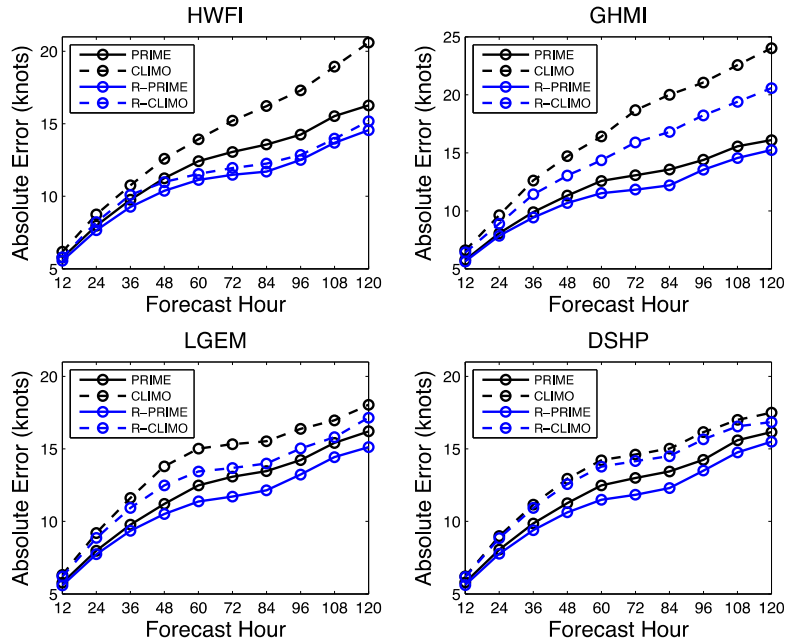

Fig. 7: As in Fig. 6, but for forecasts of model bias.

We also evaluate potential implementations of CCON for PRIME and R-PRIME, for each of the three different methods: bias correction before averaging with equal weights, unequal weighting by the inverse of AE, and unequal weighting by the squared inverse of AE. These are shown below in Fig. 8. All versions of CCON make small improvements over ICON for forecasts longer than 72 h, with average improvements reaching about 1 knot at 120 h. The PRIME modified ensembles are significantly better than ICON between 72-120 h. The R-PRIME modified Unequal SQR (MAE) ensemble is significantly better than ICON for 96-120 h (the other R-PRIME ensembles show no significant results).

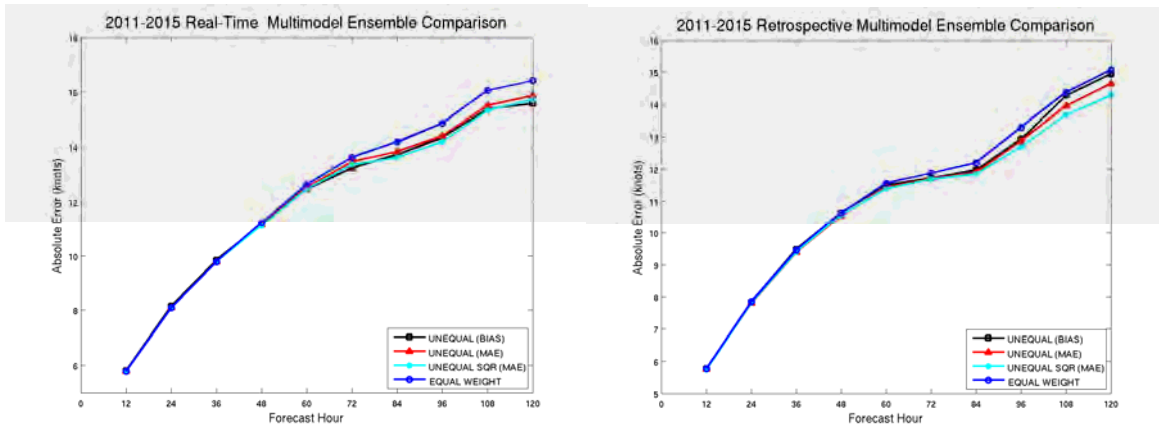

Fig. 8: Various versions of corrected consensus (CCON) models compared to ICON (blue curve) for PRIME (left) and R-PRIME (right). Note axes are different.

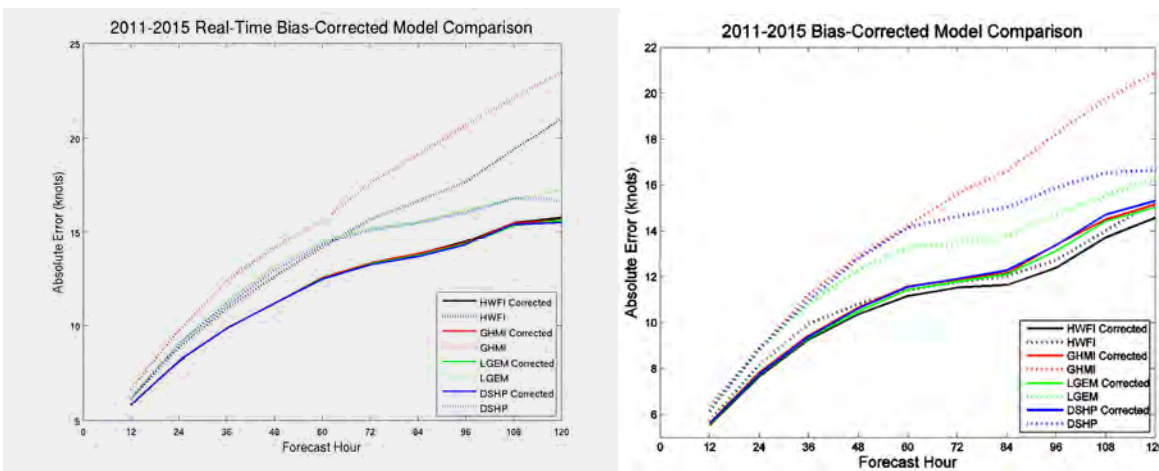

Fig. 9: Mean AE of forecast models, 2011-2015, after bias correction by PRIME (left) and R-PRIME (right). Note axes are different.

Finally, another way to see the potential impact of PRIME is to look at the mean errors of the forecast models after being bias-corrected by PRIME (or R-PRIME). These are shown in Fig. 9. Bias corrections lead to significant improvements in forecast error for every intensity model, with large improvements for the dynamical models at 120 h. The only exception appears to be for the retrospective HWFI forecasts. However, this is a result of the very good performance for HWFI on the right side of Figure 9. The upgrades to retrospective HWFI results in very low AE, which makes it very difficult for PRIME to detect significant error trends in the data.

Comparing the results of Figures 8 and 9, one might wonder why the CCON forecasts, especially those based on bias correction, do not lead to larger improvements over ICON. The reason is that the leading predictor of bias is the difference from the mean of the four intensity models. In other words, the models are all being adjusted towards the ensemble mean. Thus, CCON is often similar to ICON.

c. East Pacific PRIME

Although it was not available for real-time operations in 2015, in the last few months we have developed equivalent versions of PRIME and R-PRIME for the East Pacific. Fig 10 shows the mean errors of the AE and bias forecasts. The improvements over climatological error are almost uniformly positive, and are highly skillful for the dynamical models.

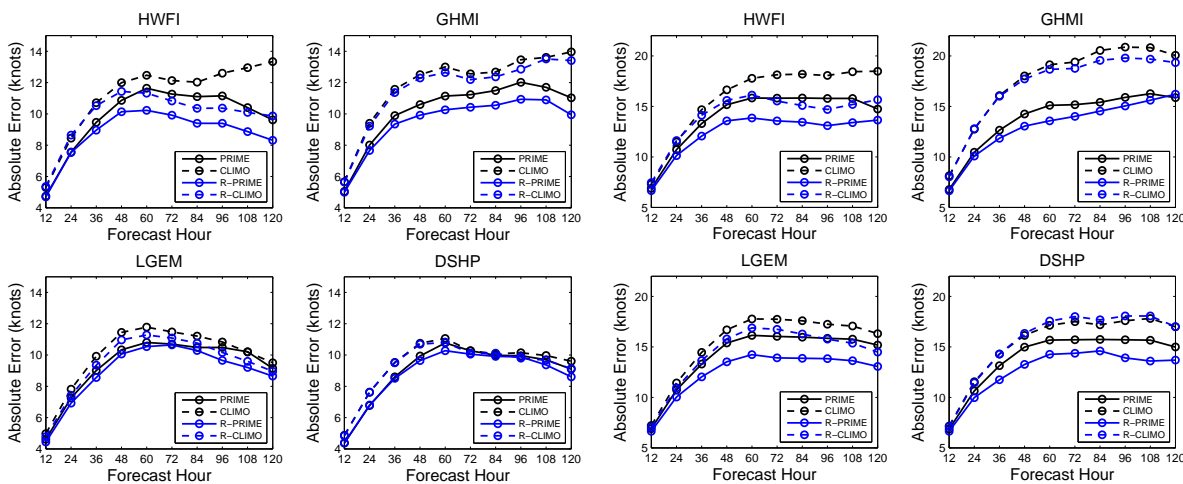

Fig. 10: Mean error of AE forecasts (left) and bias forecasts (right) for PRIME and R-PRIME developed for the East Pacific for 2011-2015.

4. Developer Recommendations

At the present time, NHC has no objective system to anticipate the errors and skill of the operational models on a forecast-by-forecast basis. In some forecast discussions, forecasts are described as “low-confidence” or “high-confidence” based on the situational awareness and experience of the forecasters. We do not discount the validity of these statements. Similarly, forecasters often use their own intuition to weight some models more heavily than others, especially when one of them appears to be an outlier. Operational implementation of PRIME

would provide objective guidance for statements of confidence and for model selection. Of course, an experience forecaster would always have the option to deviate from these forecasts (of error) as well.

Being a second-order modeling system (a forecast model of forecast errors of other models), PRIME is more complicated to update than first order models, like SHIPS and LGEM. A reliance on retrospective forecasts could be particularly problematic, because 1) the update cannot occur until after the retrospectives are completed, and 2) the potential benefits of retrospectives are greatly diminished because they are not generated for every storm and may not be generated for three or more hurricane seasons. We have been informed that the retrospectives for the coming season will only be performed for the previous two seasons. An additional complication is the use of nonlinear adjustments to the predictors and predictands, which ideally would be updated every year for every model.

Nonetheless, given the relatively low activity of the 2015 Hurricane Season, and the potential benefits of PRIME, it is clearly worthwhile to evaluate PRIME operationally for an additional year. Therefore, we recommend that a simpler version of PRIME be developed that will be available in 2016 for the Atlantic. This version will 1) only use real-time forecasts, and 2) use only modifications to the predictors and predictands that are either very simple to update, or do not need to be updated for the foreseeable future. PRIME forecasts will be set up to appear with the operational model products on the CIRA web page just as they did in 2015. Without need for the retrospective forecasts and extensive tuning, we expect that these can be implemented in the next few weeks.

We are currently not aware to what extent PRIME was used by forecasters in 2015. Another recommendation is for the developers and the JHT contacts at NHC to work together in the coming spring and summer to make PRIME better-known among the hurricane specialists.

5. References

- Bhatia, K. T., and D. S. Nolan, 2013: Relating the skill of tropical cyclone intensity forecasts to the synoptic environment. *Wea. Forecasting*, **28**, 961–980.
- Bhatia, K. T., and D. S. Nolan, 2015: Prediction of intensity model error (PRIME) for Atlantic Tropical Cyclones. *Wea. Forecasting*, **30**, 1845-1865.

DeMaria, M., and J. Kaplan, 1994: A statistical hurricane intensity prediction scheme (SHIPS) for the Atlantic basin. *Wea. Forecasting*, **9**, 209-220.

DeMaria, M., M. Mainelli, L. K. Shay, J. A. Knaff, and J. Kaplan, 2005: Further improvement to the Statistical Hurricane Intensity Prediction Scheme (SHIPS). *Wea. Forecasting*, **20**, 531–543.

NOAA AWARD NUMBER: NA15OAR4590200 (FY15 Joint Hurricane Testbed)

**Mid-year Progress Report for Year-1 (Sep. 1, 2015 – Feb. 29, 2016)
& Work Plan for the rest of Year-1 (Mar. 1, 2016 –Aug. 31, 2016)**

**Project Title: Improvement and Implementation of the Probability-based Microwave Ring
Rapid Intensification Index for NHC/JTWC Forecast Basins**

PI: Haiyan Jiang, Florida International University

Co-PI: Kate Musgrave, CIRA, Colorado State University

Unfunded Collaborator: John Knaff, NOAA/NESDIS, Fort Collins, CO

1. Progress on Year 1 Milestones

(COMPLETE) *Sep 2015* *FIU: Generate the developmental microwave data including TMI, AMSR-E, SSM/I, and SSMIS data for ATL, EPA, NWP and NIO basins; CIRA: Generate the developmental SHIPS RII dataset for NWP and NIO basins*

The developmental microwave datasets have been created for TMI, AMSR-E, and SSMIS for all basins for which the PMWRing RII will be run: ATL (Atlantic), EPA (East Pacific), NWP (Northwest Pacific), NIO (Northern Indian) and SH (Southern Hemisphere) [preparation of the developmental dataset for the SH also accomplishes the first milestone in Year 2, September 2016]. The TMI developmental dataset, which will be used to assess probabilities for GMI overpasses, consists of cases between 1997 and 2013. The AMSR-E dataset, which will be used to assess probabilities for AMSR2 overpasses, consists of the complete sensor data record between 2002 and 2011, while SSMIS includes all available sensors (F-16, F-17, F-18) available between 2007 (first availability of SSMIS-16) and 2013. Considering that DMSP-13 is the only remaining platform that supports SSMI, that sensor will not be included in the real-time algorithm.

Although the proposal indicated that an intercalibration between the sensors would be applied for the developmental dataset, we have subsequently decided that this is not necessary for the real-time algorithm. Instead, each sensor will be treated independently in the algorithm (e.g., when an SSMIS overpass is detected, probabilities will be specifically drawn from the SSMIS portion of the developmental dataset only).

Similar to the previous versions, overpasses that contribute to the developmental dataset must be over water (includes the location 24 h later), have an increase in intensity during the previous 6 hours, have an intensity between 45 and 100 kt, have a center location below latitude 30°N, and contain complete data with 100 km. However, in contrast to past versions of the developmental dataset that used interpolated centers from the best track, which caused a high number of false alarms, center locations were determined using the CIMSS Automated Rotational Center Hurricane Eye Retrieval (ARCHER) algorithm for 37 GHz. This should reduce the high number of false alarms that was a consequence of using the less accurate,

interpolated best-track centers. Statistics for each predictor are only quantified for locations in which ARCHER is able to determine a center location.

SHIPS developmental datasets (for 2004–2014) were provided by CIRA for not only the NWP and NIO, but also (updated) for the ATL and EPA. For basins under NHC responsibility (ATL, EPA) probabilities for all SHIPS intensity change rates (25, 30, 35, and 40 kt day⁻¹) were provided. For basins under JTWC responsibility, SHIPS developmental data was only provided for 30 kt day⁻¹. The SHIPS probability, if available, for each intensity change rate was interpolated to the microwave overpass time.

(COMPLETE) *Nov 2015 FIU: develop RI thresholds for SHIPS RII and microwave predictors for ATL, EPA, NWP and NIO basins*

As in previous versions of the TMI developmental dataset, the thresholds for each high frequency (i.e., 85–91-GHz) and ring-related (fraction of the “Dark” and “Bright” cyan definitions in the 37-GHz color composite) predictor are computed as the mean value for all overpasses meeting a certain RI intensity change rate (i.e., 25, 30, 35, and 40 kt day⁻¹). Note that the “Dark” and “Bright” cyan definitions have been modified from those shown in the proposal. Figure 1 is an update of Figure 3 from the proposal and shows how the individual “37color” regions are separated by horizontal and vertical-polarized brightness temperature (T_B), as well as 37-GHz polarization corrected temperature (PCT). The new thresholds (compared to the old in Table 1) are shown in Table 2.

Table 1: Previous definitions for the six color categories and their corresponding brightness temperature ranges.

Region	Definition (T_B 's are in K)
(a) Green	$37PCT > 260 \ \& \ 37H \leq 225$
(b) Weak Cyan	$37PCT > 275 \ \& \ 225 < 37H \leq 255$
(c) Bright Cyan	$37PCT > 275 \ \& \ 37H > 255$
(d) Weak Cyan/Pink	$260 < 37PCT \leq 275 \ \& \ 225 < 37H \leq 255$
(e) Bright Cyan/Pink	$260 < 37PCT \leq 275 \ \& \ 37H > 255$
(f) Pink	$37PCT \leq 260$

Table 2: Current definitions for the seven color categories and their corresponding brightness temperature ranges as defined in Fig. 1.

Region	Definition (T_B 's are in K)
1 (green)	$PCT37 > 270 \ \& \ H37 < 225$
2 (weak cyan)	$PCT37 > 275 \ \& \ 225 \leq H37 < 255$
3 (bright cyan)	$PCT37 > 275 \ \& \ H37 \geq 255$
4 (green/pink)	$260 < PCT37 \leq 270 \ \& \ H37 < 225$
5 (weak cyan/pink)	$260 < PCT37 \leq 275 \ \& \ 225 \leq H37 < 255$
6 (bright cyan/pink)	$260 < PCT37 \leq 275 \ \& \ H37 \geq 255$
7 (pink)	$PCT37 \leq 260$

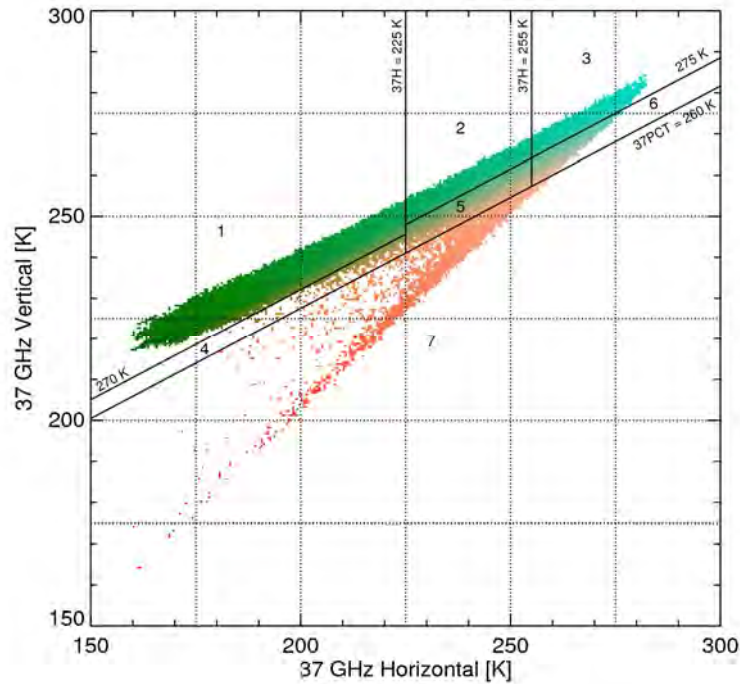

Figure 1: Scatter plot of real colors in the NRL 37color product as a function of 37H and 37V derived from the inner core region of TCs directly observed by the TRMM PR and TMI during 1998-2011. Seven color categories are defined as 1-7 regions with the corresponding colors and brightness temperature ranges shown in Table 2. Constant 37PCT=270 K is shown as the tilted solid black line.

The RI thresholds quantified for each predictor and intensity change rate, individualized by sensor, are provided in tables in the Appendix. The “Probability of RI” is computed as the fraction of cases that satisfy the RI threshold divided by the total number in the available dataset that satisfy the RI threshold. Tables 3–5 below show the sample size of overpasses available in the developmental dataset that meet our requirements ($< 30^\circ$ latitude, over ocean, intensification in previous 6 h, and initial intensity between 45 and 100 kt), as well as the number of overpasses from that sample that meet each intensity change rate. The individualized-sensor RI probabilities, which will be used in the real-time PMWRing RII algorithm, are provided in tables that follow those that list the accompanying RI thresholds.

Table 3: Sample size of AMSRE overpasses that meet the requirements

	ATL	EPA	NWP+NIO	SH
Number of overpasses that meet the requirements	146	136	339	248
Number of overpasses with 25 kt intensity change	34	41	117	89
Number of overpasses with 30 kt intensity change	25	26	81	71
Number of overpasses with 35 kt intensity change	18	22	62	49
Number of overpasses with 40 kt intensity change	14	16	44	31

Table 4: Sample size of SSMIS overpasses that meet the requirements

	ATL	EPA	NWP+NIO	SH
Number of overpasses that meet the requirements	190	222	390	324
Number of overpasses with 25 kt intensity change	45	59	153	89
Number of overpasses with 30 kt intensity change	34	41	126	72
Number of overpasses with 35 kt intensity change	20	27	103	47
Number of overpasses with 40 kt intensity change	13	22	76	31

Table 5: Sample size of TMI overpasses that meet the requirements

	ATL	EPA	NWP+NIO	SH
Number of overpasses that meet the requirements	139	85	249	269
Number of overpasses with 25 kt intensity change	34	9	27	22
Number of overpasses with 30 kt intensity change	30	6	18	18
Number of overpasses with 35 kt intensity change	17	4	11	5
Number of overpasses with 40 kt intensity change	13	2	7	2

Figures showing the RI probabilities (“Satisfied RI Threshold”) of 30-kt for each sensor are also provided below. A figure showing the “Hits”, which is defined as the percentage of cases that underwent 30-kt intensity change that satisfied the threshold, as well as “Misses,” which is defined as the fraction of cases that underwent 30-kt RI that did not meet the threshold, are shown following the figures for the RI probabilities. The accompanying RI probabilities for

each predictor+SHIPS are also provided (note that for the ATL and EPA, 25, 35, and 40 kt are also available, while in the NIO and NWP only 30 kt are available. SHIPS developmental data for the SH have not yet been provided, but will be, as proposed, in Year 2).

Based on these figures and tables, a few observations and conclusions can be made, particularly about the sensitivity to the choice of predictors and their thresholds:

- Although the probabilities for meeting the RI threshold for the fraction of the “Bright” ring definition are slightly greater in each basin (and for each sensor, as well) than for the “Dark” definition of a ring, there does not appear to be an appreciable benefit for using one over the other.
- Compared to the climatological RI probability, the probabilities quantified from the 85–91-GHz predictors (areal fractions of PCT \leq 275, 250, 225 K) could provide some added value over the contributions from just the ring predictors, but this is not universal between each sensor and basin. In another metric — the “hit” and “miss” percentages — the ring-based predictors are demonstrably more useful than the 85–91-GHz predictors. Note that for the 85–91-GHz predictors the percentage of “hits” (percent of RI cases that meet the RI threshold) is nearly similar to the “miss” percentage (percent of RI cases that do not meet the threshold) for 85–91-GHz predictors. This suggests that using the RI threshold (defined as the average value) for those predictors is being skewed towards a higher fraction that many of the RI cases do not meet. The “hits” percentages, in contrast, for the ring-based predictors are significantly greater than the “miss” percentage, which reinforces their critical importance as a symptom that RI is occurring.
- There is little sensitivity to the choice of requiring an 80, 90, or 100% “Dark” cyan ring, given that the RI probabilities for each (regardless of choice of sensor or basin) vary little from one another.
- For each sensor, small sample sizes are generally a problem for cases of 35- and 40-kt RI, particularly when the additional requirement for exceeding a SHIPS probability threshold of 15% is added (i.e., for the “predictor+SHIPS”). An issue with sample sizes is even apparent when requiring a SHIPS probability of at least 5% for 35- and 40-kt RI for TMI overpasses.
- As a result of small sample sizes, many of the RI probabilities (tables given in the Appendix) are 100%. This means that of the few cases in the dataset that meet the thresholds for both the microwave and SHIPS probability, every one also undergoes RI.

(IN PROGRESS) Jan 2016 Begin development of the PMWRing RII for ATL, EPA, and NWP/NIO basins

Given the completion of both the microwave and SHIPS developmental datasets, as well as the calculation of all of the RI probabilities, work is in progress on preparing the PMWRing RII for the upcoming season.

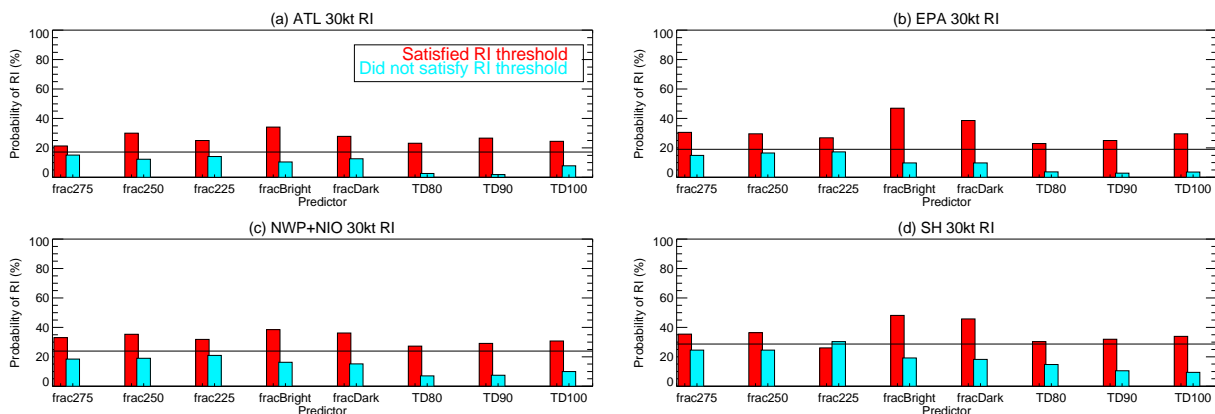

Figure 2a: For the AMSRE developmental dataset, the probability of RI (for 30-kt RI category only) for predictors satisfying and not satisfying RI thresholds for (a) ATL, (b) EPA, (c) NWP+NIO, and (d) SH basin. The climatological probability of RI is indicated by the solid horizontal line. “TD” represents the percentage coverage for the “Dark” definition of the cyan ring.

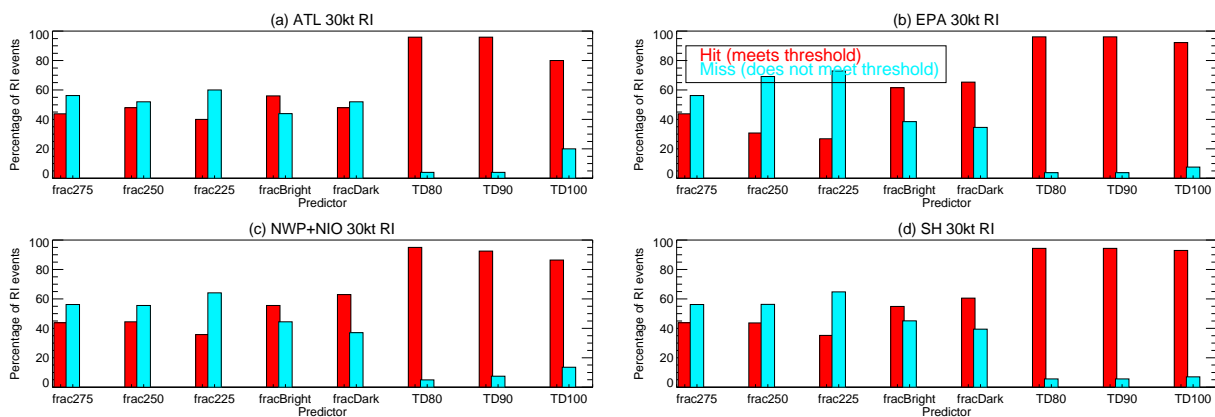

Figure 2b: For the AMSRE developmental dataset, the percentage of “hits” (for 30-kt RI category only) and “misses” for predictors satisfying RI thresholds for (a) ATL, (b) EPA, (c) NWP+NIO, and (d) SH basin.

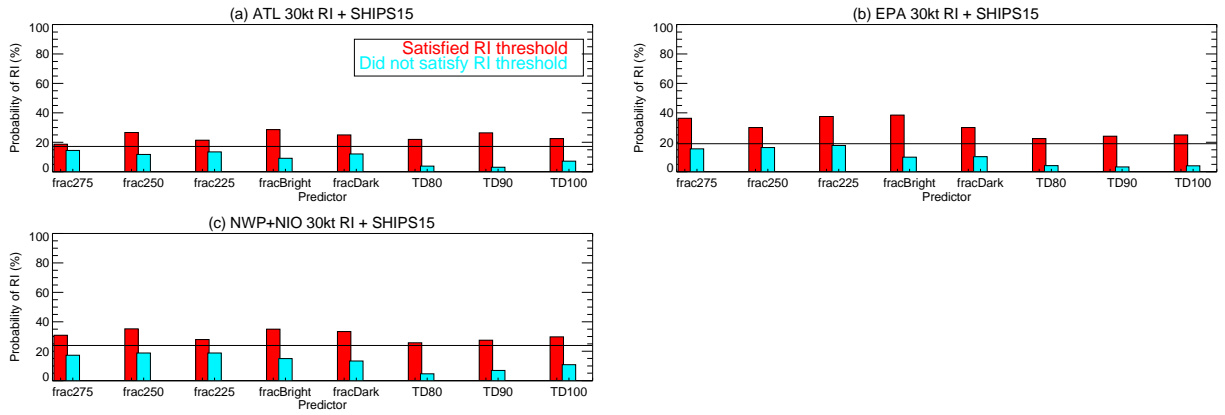

Figure 2c: For the AMSRE developmental dataset, the probability of RI (for 30-kt RI category only) for predictors satisfying and not satisfying RI thresholds for (a) ATL, (b) EPA, and (c) NWP+NIO, including the requirement for the SHIPS 30 kt RI probability to be at least 15%. The climatological probability of RI is indicated by the solid horizontal line.

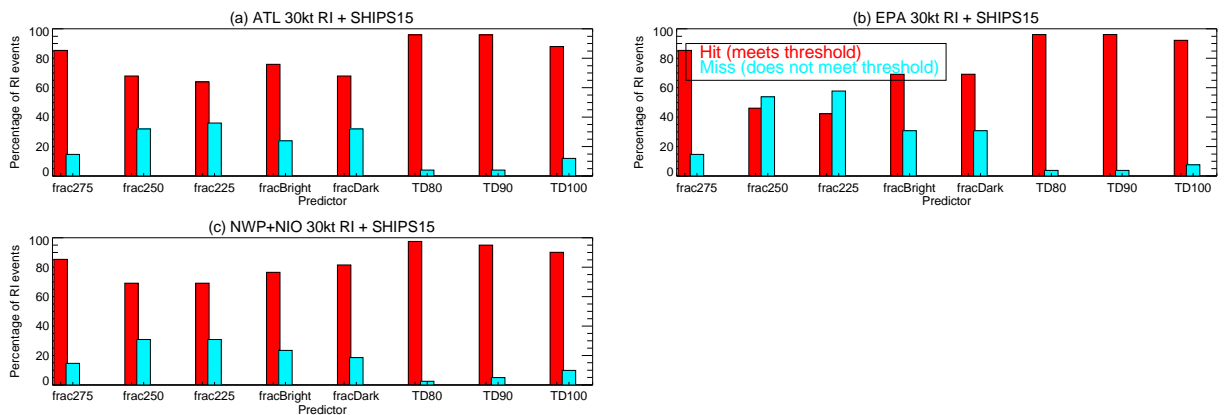

Figure 2d: For the AMSRE developmental dataset, the percentage of “hits” (for 30-kt RI category only) and “misses” for predictors satisfying RI thresholds for (a) ATL, (b) EPA, (c) NWP+NIO, and (d) SH basin, including the requirement for the SHIPS 30 kt RI probability to be at least 15%.

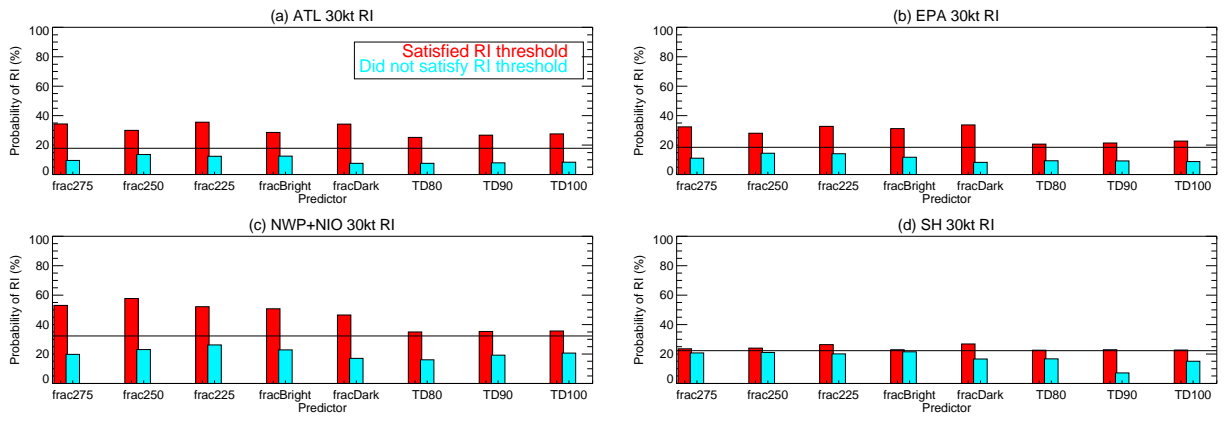

Figure 3a: Same as Figure 2a, except for the SSMIS developmental dataset

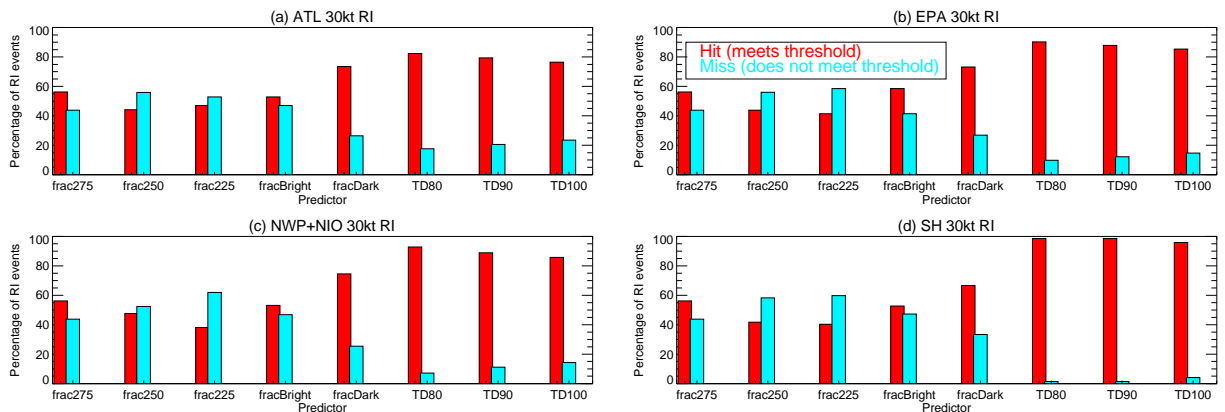

Figure 3b: Same as Figure 2b, except for the SSMIS developmental dataset

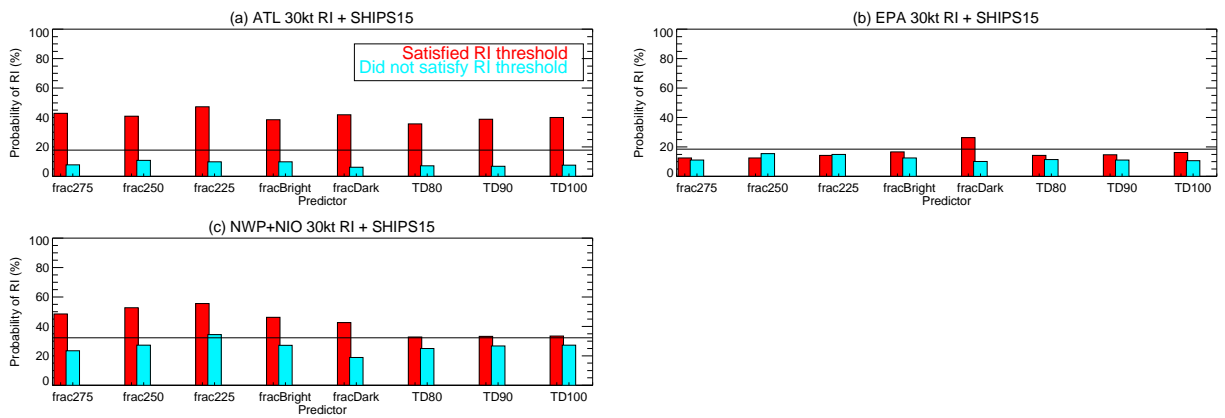

Figure 3c: Same as Figure 2c, except for the SSMIS developmental dataset

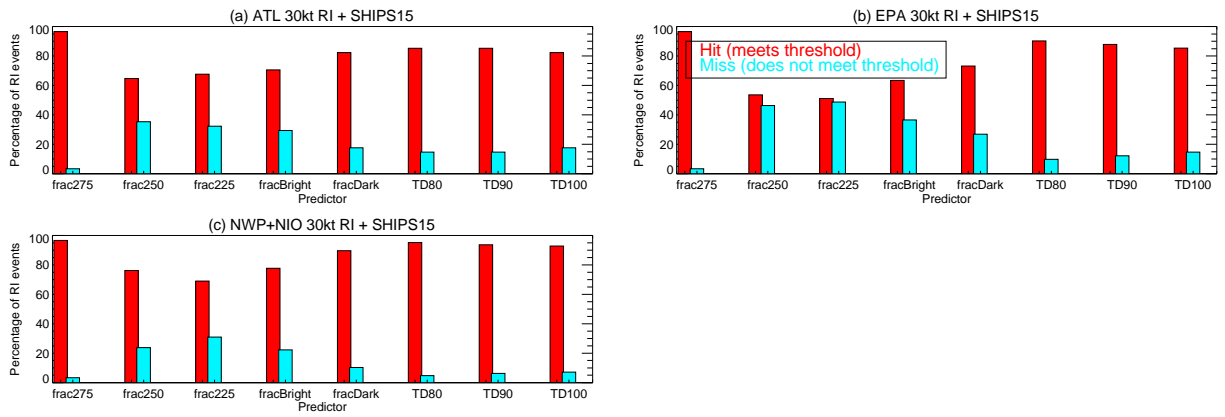

Figure 3d: Same as Figure 2d, except for the SSMIS developmental dataset

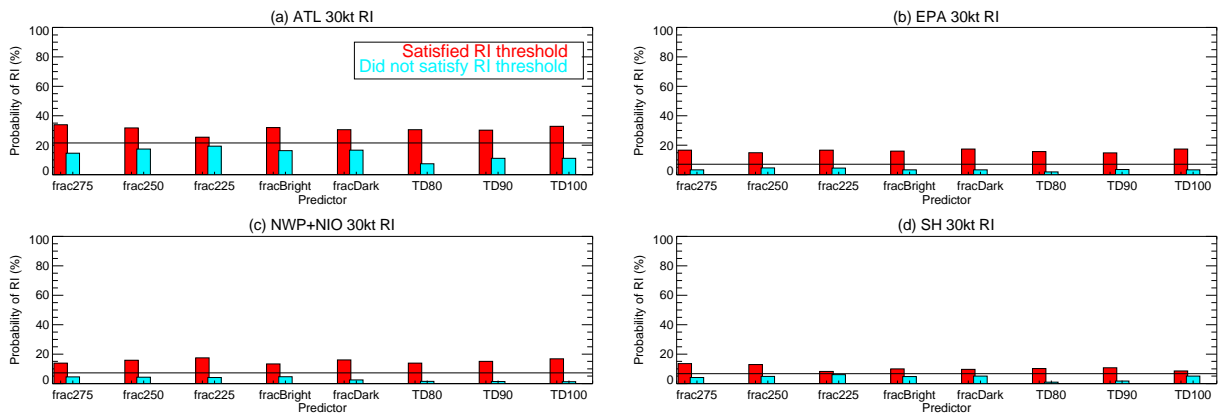

Figure 4a: Same as Figure 2a, except for the TMI developmental dataset

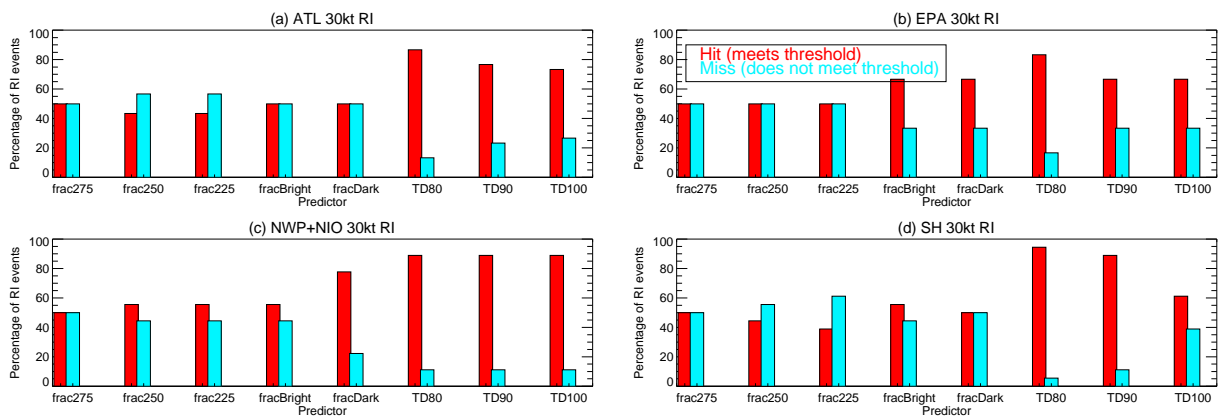

Figure 4b: Same as Figure 2b, except for the TMI developmental dataset

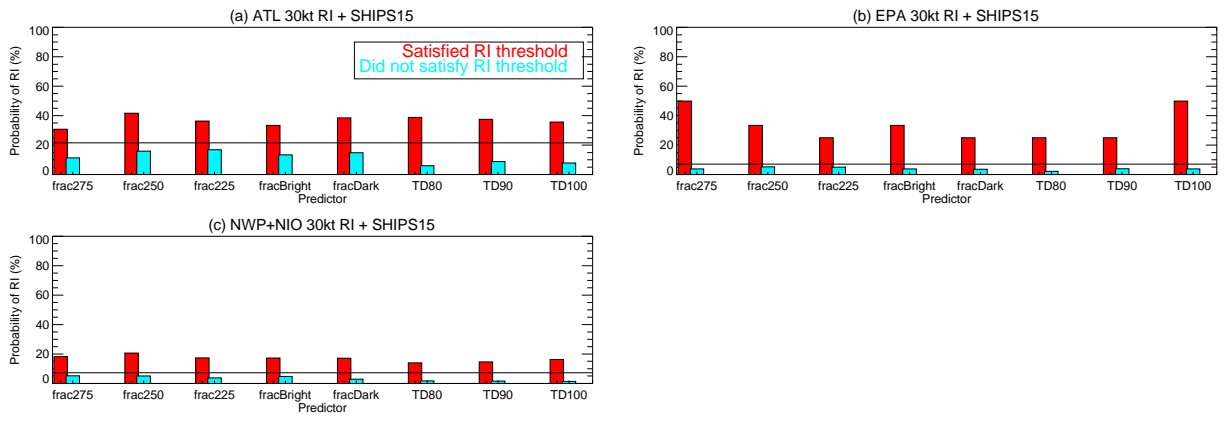

Figure 4c: Same as Figure 2c, except for the TMI developmental dataset

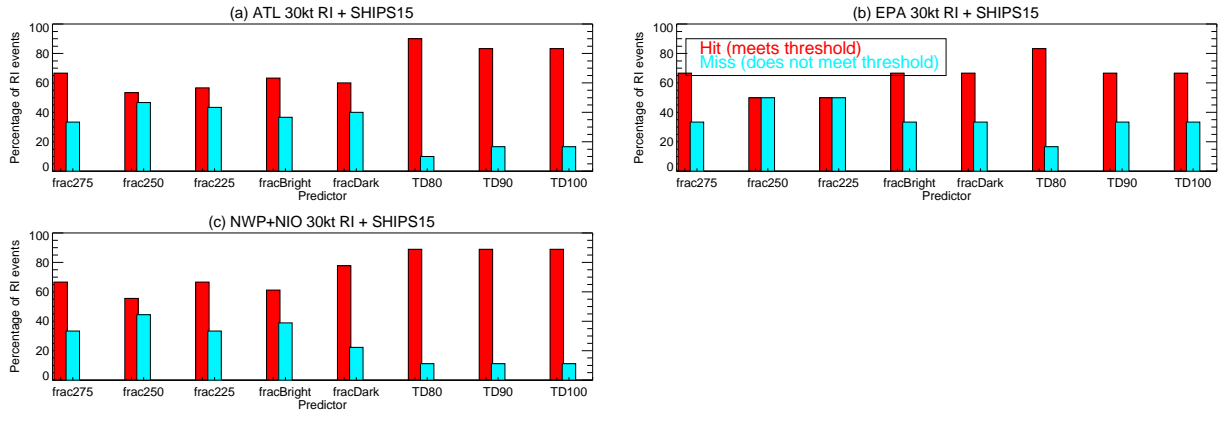

Figure 4d: Same as Figure 2d, except for the TMI developmental dataset

APPENDIX

AMSRE RI Thresholds

RI Thresholds for an intensity change of 25 kt for AMSRE overpasses

Threshold of 25 kt Intensity Change	ATL	EPA	NWP + NIO	SH
frac275	0.76	0.70	0.74	0.80
frac250	0.37	0.31	0.37	0.38
frac225	0.13	0.11	0.14	0.12
fracBright	0.63	0.60	0.64	0.70
fracDark	0.82	0.79	0.82	0.88
ring_TD80	y/n	y/n	y/n	y/n
ring_TD90	y/n	y/n	y/n	y/n
ring_TD100	y/n	y/n	y/n	y/n

RI Thresholds for an intensity change of 30 kt for AMSRE overpasses

Threshold of 30 kt Intensity Change	ATL	EPA	NWP + NIO	SH
frac275	0.73	0.74	0.75	0.81
frac250	0.36	0.33	0.38	0.39
frac225	0.13	0.12	0.15	0.12
fracBright	0.63	0.64	0.66	0.71
fracDark	0.82	0.83	0.84	0.88
ring_TD80	y/n	y/n	y/n	y/n
ring_TD90	y/n	y/n	y/n	y/n
ring_TD100	y/n	y/n	y/n	y/n

RI Thresholds for an intensity change of 35 kt for AMSRE overpasses

Threshold of 35 kt Intensity Change	ATL	EPA	NWP + NIO	SH
frac275	0.75	0.74	0.77	0.81
frac250	0.37	0.35	0.39	0.40
frac225	0.13	0.13	0.15	0.12
fracBright	0.64	0.64	0.68	0.70
fracDark	0.84	0.83	0.85	0.89
ring_TD80	y/n	y/n	y/n	y/n
ring_TD90	y/n	y/n	y/n	y/n
ring_TD100	y/n	y/n	y/n	y/n

RI Thresholds for an intensity change of 40 kt for AMSRE overpasses

Threshold of 40 kt Intensity Change	ATL	EPA	NWP + NIO	SH
frac275	0.77	0.77	0.77	0.84
frac250	0.39	0.35	0.39	0.43
frac225	0.14	0.13	0.15	0.13
fracBright	0.65	0.70	0.68	0.73
fracDark	0.85	0.87	0.85	0.91
ring_TD80	y/n	y/n	y/n	y/n
ring_TD90	y/n	y/n	y/n	y/n
ring_TD100	y/n	y/n	y/n	y/n

AMSRE RI Probabilities

RI Probability [%] of an intensity change of 25 kt for AMSRE overpass

Probability of 25 kt Intensity Change	ATL	EPA	NWP + NIO	SH
frac275	43	42	48	42
frac250	41	42	47	43
frac225	35	45	45	32
fracBright	44	49	48	53
fracDark	42	47	48	54
ring_TD80	31	36	39	38
ring_TD90	34	38	41	40
ring_TD100	33	42	43	42

RI Probability [%], which includes also meeting the thresholds of 5, 10, 15, 20, 25% (each comma delimited number) SHIPS 25-kt RI probability, for an intensity change of 25 kt for AMSRE overpasses

Probability of 25 kt Intensity Change	ATL	EPA	NWP + NIO	SH
frac275+SHIPS	43, 44, 46, 40, 42	42, 42, 44, 42, 33	-	-
frac250+SHIPS	39, 37, 38, 36, 36	37, 37, 40, 35, 27	-	-
frac225+SHIPS	32, 28, 29, 33, 36	40, 40, 40, 47, 40	-	-
fracBright+SHIPS	45, 44, 44, 41, 36	46, 46, 47, 44, 33	-	-
fracDark+SHIPS	43, 42, 41, 36, 31	48, 48, 48, 45, 36	-	-
ring_TD80+SHIPS	31, 30, 29, 27, 26	34, 34, 35, 33, 31	-	-
ring_TD90+SHIPS	34, 34, 33, 30, 28	36, 36, 37, 36, 34	-	-
ring_TD100+SHIPS	33, 33, 33, 28, 24	40, 40, 42, 41, 37	-	-

RI Probability [%] of an intensity change of 30 kt for AMSRE overpass

Probability of 30 kt Intensity Change	ATL	EPA	NWP + NIO	SH
frac275	21	31	33	35
frac250	30	30	35	36
frac225	25	27	32	26
fracBright	34	47	38	48
fracDark	28	39	36	46
ring_TD80	23	23	27	30
ring_TD90	27	25	29	32
ring_TD100	24	30	31	34

RI Probability [%], which includes also meeting the thresholds of 5, 10, 15, 20, 25% (each comma delimited number) SHIPS 30-kt RI probability, for an intensity change of 30 kt for AMSRE overpasses

Probability of 30 kt Intensity Change	ATL	EPA	NWP + NIO	SH
frac275+SHIPS	21, 22, 19, 17, 50	28, 32, 36, 100, 100	34, 32, 31, 30, 28	-
frac250+SHIPS	28, 30, 27, 40, 50	23, 26, 30, 100, 100	36, 36, 36, 37, 32	-
frac225+SHIPS	19, 19, 21, 20, 100	17, 19, 38, 100, 100	32, 30, 29, 33, 26	-
fracBright+SHIPS	36, 36, 29, 40, 33	43, 43, 38, 100, 100	38, 38, 35, 35, 31	-
fracDark+SHIPS	28, 28, 25, 25, 50	36, 36, 30, 100, 100	37, 35, 33, 32, 27	-
ring_TD80+SHIPS	23, 22, 22, 21, 14	20, 21, 23, 33, 100	30, 28, 27, 26, 25	-
ring_TD90+SHIPS	27, 26, 26, 27, 20	21, 23, 24, 50, 100	31, 29, 28, 26, 25	-
ring_TD100+SHIPS	25, 24, 23, 23, 25	27, 29, 25, 50, 100	33, 31, 30, 29, 26	-

RI Probability [%] of an intensity change of 35 kt for AMSRE overpass

Probability of 35 kt Intensity Change	ATL	EPA	NWP + NIO	SH
frac275	20	29	28	28
frac250	22	32	29	30
frac225	18	26	25	20
fracBright	24	41	30	34
fracDark	23	33	30	33
ring_TD80	17	19	21	22
ring_TD90	19	21	22	23
ring_TD100	20	25	25	24

RI Probability [%], which includes also meeting the thresholds of 5, 10, 15, 20, 25% (each comma delimited number) SHIPS 35-kt RI probability, for an intensity change of 35 kt for AMSRE overpasses

Probability of 35 kt Intensity Change	ATL	EPA	NWP + NIO	SH
frac275+SHIPS	19, 50, 100, 100, 100	29, 67, 100, 100, 100	-	-
frac250+SHIPS	21, 25, 100, 100, 100	29, 60, 100, 100, 100	-	-
frac225+SHIPS	12, 33, 100, 100, 100	21, 100, 100, 100, 100	-	-
fracBright+SHIPS	28, 33, 100, 100, 100	37, 57, 100, 100, 100	-	-
fracDark+SHIPS	27, 33, 100, 100, 100	29, 40, 100, 100, 100	-	-
ring_TD80+SHIPS	17, 26, 100, 100, 100	16, 31, 100, 100, 100	-	-
ring_TD90+SHIPS	20, 31, 100, 100, 100	17, 36, 100, 100, 100	-	-
ring_TD100+SHIPS	21, 29, 100, 100, 100	22, 36, 100, 100, 100	-	-

RI Probability [%] of an intensity change of 40 kt for AMSRE overpass

Probability of 40 kt Intensity Change	ATL	EPA	NWP + NIO	SH
frac275	15	24	22	22
frac250	19	22	20	21
frac225	17	17	19	13
fracBright	21	43	23	22
fracDark	19	33	20	23
ring_TD80	13	15	15	14
ring_TD90	15	16	16	15
ring_TD100	15	20	18	16

RI Probability [%], which includes also meeting the thresholds of 5, 10, 15, 20, 25% (each comma delimited number) SHIPS 40-kt RI probability, for an intensity change of 40 kt for AMSRE overpasses

Probability of 40 kt Intensity Change	ATL	EPA	NWP + NIO	SH
frac275+SHIPS	18, 100, 100, 100, 100	23, 100, 100, 100, 100	-	-
frac250+SHIPS	18, 100, 100, 100, 100	17, 100, 100, 100, 100	-	-
frac225+SHIPS	11, 100, 100, 100, 100	25, 100, 100, 100, 100	-	-
fracBright+SHIPS	25, 100, 100, 100, 100	42, 100, 100, 100, 100	-	-
fracDark+SHIPS	26, 100, 100, 100, 100	28, 100, 100, 100, 100	-	-
ring_TD80+SHIPS	15, 25, 100, 100, 100	13, 50, 100, 100, 100	-	-
ring_TD90+SHIPS	18, 25, 100, 100, 100	15, 100, 100, 100, 100	-	-
ring_TD100+SHIPS	18, 33, 100, 100, 100	17, 100, 100, 100, 100	-	-

SSMIS RI Thresholds

RI Thresholds for an intensity change of 25 kt for SSMIS overpasses

Threshold of 25 kt Intensity Change	ATL	EPA	NWP + NIO	SH
frac275	0.76	0.78	0.79	0.86
frac250	0.36	0.41	0.41	0.46
frac225	0.11	0.14	0.13	0.16
fracBright	0.54	0.59	0.60	0.68
fracDark	0.80	0.85	0.87	0.95
ring_TD80	y/n	y/n	y/n	y/n
ring_TD90	y/n	y/n	y/n	y/n
ring_TD100	y/n	y/n	y/n	y/n

RI Thresholds for an intensity change of 30 kt for SSMIS overpasses

Threshold of 30 kt Intensity Change	ATL	EPA	NWP + NIO	SH
frac275	0.77	0.81	0.82	0.86
frac250	0.36	0.41	0.43	0.47
frac225	0.11	0.15	0.14	0.16
fracBright	0.54	0.58	0.63	0.68
fracDark	0.81	0.87	0.89	0.95
ring_TD80	y/n	y/n	y/n	y/n
ring_TD90	y/n	y/n	y/n	y/n
ring_TD100	y/n	y/n	y/n	y/n

RI Thresholds for an intensity change of 35 kt for SSMIS overpasses

Threshold of 35 kt Intensity Change	ATL	EPA	NWP + NIO	SH
frac275	0.85	0.81	0.85	0.89
frac250	0.43	0.40	0.45	0.48
frac225	0.13	0.14	0.15	0.16
fracBright	0.60	0.54	0.64	0.70
fracDark	0.89	0.86	0.90	0.96
ring_TD80	y/n	y/n	y/n	y/n
ring_TD90	y/n	y/n	y/n	y/n
ring_TD100	y/n	y/n	y/n	y/n

RI Thresholds for an intensity change of 40 kt for SSMIS overpasses

Threshold of 40 kt Intensity Change	ATL	EPA	NWP + NIO	SH
frac275	0.86	0.83	0.86	0.88
frac250	0.43	0.43	0.46	0.46
frac225	0.14	0.16	0.15	0.14
fracBright	0.56	0.59	0.65	0.70
fracDark	0.89	0.87	0.91	0.97
ring_TD80	y/n	y/n	y/n	y/n
ring_TD90	y/n	y/n	y/n	y/n
ring_TD100	y/n	y/n	y/n	y/n

SSMIS RI Probabilities

RI Probability [%] for an intensity change of 25 kt for SSMIS overpasses

Probability of 25 kt Intensity Change	ATL	EPA	NWP + NIO	SH
frac275	43	42	59	29
frac250	38	42	61	32
frac225	44	44	60	32
fracBright	38	45	53	28
fracDark	45	45	52	32
ring_TD80	34	29	42	28
ring_TD90	36	30	42	28
ring_TD100	36	32	43	28

RI Probability [%], which includes also meeting the thresholds of 5, 10, 15, 20, 25% (each comma delimited number) SHIPS 25-kt RI probability, for an intensity change of 25 kt for SSMIS overpasses

Probability of 25 kt Intensity Change	ATL	EPA	NWP + NIO	SH
frac275+SHIPS	43, 43, 43, 42, 48	41, 39, 40, 40, 30	-	-
frac250+SHIPS	38, 39, 39, 40, 43	42, 40, 42, 42, 31	-	-
frac225+SHIPS	44, 44, 44, 47, 50	45, 43, 45, 45, 36	-	-
fracBright+SHIPS	38, 39, 40, 42, 48	42, 41, 42, 39, 26	-	-
fracDark+SHIPS	45, 45, 47, 45, 50	44, 43, 43, 42, 35	-	-
ring_TD80+SHIPS	36, 36, 37, 38, 42	29, 28, 30, 27, 26	-	-
ring_TD90+SHIPS	37, 37, 38, 39, 46	30, 29, 30, 28, 24	-	-
ring_TD100+SHIPS	37, 37, 38, 39, 47	32, 31, 33, 30, 27	-	-

RI Probability [%] for an intensity change of 30 kt for SSMIS overpasses

Probability of 30 kt Intensity Change	ATL	EPA	NWP + NIO	SH
frac275	34	32	53	24
frac250	30	28	58	24
frac225	36	33	52	26
fracBright	29	31	51	23
fracDark	34	34	47	27
ring_TD80	25	21	35	23
ring_TD90	27	21	35	23
ring_TD100	28	23	36	23

RI Probability [%], which includes also meeting the thresholds of 5, 10, 15, 20, 25% (each comma delimited number) SHIPS 30-kt RI probability, for an intensity change of 30 kt for SSMIS overpasses

Probability of 30 kt Intensity Change	ATL	EPA	NWP + NIO	SH
frac275+SHIPS	33, 32, 43, 60, 100	32, 32, 13, 33, 100	53, 50, 48, 46, 42	-
frac250+SHIPS	30, 30, 41, 67, 100	29, 29, 13, 50, 100	58, 55, 53, 48, 46	-
frac225+SHIPS	34, 34, 47, 75, 100	34, 35, 14, 50, 100	53, 55, 56, 51, 47	-
fracBright+SHIPS	30, 29, 38, 60, 100	31, 31, 17, 29, 100	51, 50, 46, 43, 34	-
fracDark+SHIPS	35, 35, 42, 55, 100	35, 34, 26, 38, 100	47, 47, 43, 40, 39	-
ring_TD80+SHIPS	27, 27, 36, 43, 100	21, 22, 14, 23, 100	35, 35, 33, 32, 27	-
ring_TD90+SHIPS	28, 28, 39, 43, 100	22, 22, 15, 25, 100	36, 35, 33, 31, 27	-
ring_TD100+SHIPS	29, 29, 40, 46, 100	23, 23, 16, 27, 100	36, 36, 34, 31, 27	-

RI Probability [%] for an intensity change of 35 kt for SSMIS overpasses

Probability of 35 kt Intensity Change	ATL	EPA	NWP + NIO	SH
frac275	20	19	49	17
frac250	24	16	49	17
frac225	24	21	46	18
fracBright	26	16	43	15
fracDark	20	21	41	19
ring_TD80	17	13	29	15
ring_TD90	19	14	30	15
ring_TD100	19	15	30	15

RI Probability [%], which includes also meeting the thresholds of 5, 10, 15, 20, 25% (each comma delimited number) SHIPS 35-kt RI probability, for an intensity change of 35 kt for SSMIS overpasses

Probability of 35 kt Intensity Change	ATL	EPA	NWP + NIO	SH
frac275+SHIPS	18, 23, 100, 100, 100	23, 25, 100, 100, 100	-	-
frac250+SHIPS	20, 30, 100, 100, 100	20, 25, 100, 100, 100	-	-
frac225+SHIPS	22, 22, 100, 100, 100	28, 33, 100, 100, 100	-	-
fracBright+SHIPS	23, 22, 100, 100, 100	20, 27, 100, 100, 100	-	-
fracDark+SHIPS	20, 15, 100, 100, 100	24, 33, 100, 100, 100	-	-
ring_TD80+SHIPS	18, 15, 100, 100, 100	15, 20, 100, 100, 100	-	-
ring_TD90+SHIPS	19, 15, 100, 100, 100	16, 21, 100, 100, 100	-	-
ring_TD100+SHIPS	19, 16, 100, 100, 100	17, 22, 100, 100, 100	-	-

RI Probability [%] for an intensity change of 40 kt for SSMIS overpasses

Probability of 40 kt Intensity Change	ATL	EPA	NWP + NIO	SH
frac275	17	18	41	10
frac250	19	16	39	10
frac225	15	19	35	9
fracBright	13	17	33	10
fracDark	15	19	32	13
ring_TD80	11	11	22	10
ring_TD90	12	11	22	10
ring_TD100	12	12	23	10

RI Probability [%], which includes also meeting the thresholds of 5, 10, 15, 20, 25% (each comma delimited number) SHIPS 40-kt RI probability, for an intensity change of 40 kt for SSMIS overpasses

Probability of 40 kt Intensity Change	ATL	EPA	NWP + NIO	SH
frac275+SHIPS	18, 50, 100, 100, 100	23, 100, 100, 100, 100	-	-
frac250+SHIPS	21, 100, 100, 100, 100	25, 100, 100, 100, 100	-	-
frac225+SHIPS	15, 40, 100, 100, 100	32, 100, 100, 100, 100	-	-
fracBright+SHIPS	12, 40, 100, 100, 100	23, 33, 100, 100, 100	-	-
fracDark+SHIPS	18, 25, 100, 100, 100	27, 33, 100, 100, 100	-	-
ring_TD80+SHIPS	12, 29, 100, 100, 100	14, 25, 100, 100, 100	-	-
ring_TD90+SHIPS	14, 29, 100, 100, 100	14, 25, 100, 100, 100	-	-
ring_TD100+SHIPS	14, 29, 100, 100, 100	16, 25, 100, 100, 100	-	-

TMI RI Thresholds

RI Thresholds for an intensity change of 25 kt for TMI overpasses

Threshold of 25 kt Intensity Change	ATL	EPA	NWP + NIO	SH
frac275	0.69	0.64	0.69	0.66
frac250	0.32	0.26	0.32	0.29
frac225	0.10	0.06	0.10	0.09
fracBright	0.58	0.49	0.57	0.61
fracDark	0.74	0.68	0.75	0.79
ring_TD80	y/n	y/n	y/n	y/n
ring_TD90	y/n	y/n	y/n	y/n
ring_TD100	y/n	y/n	y/n	y/n

RI Thresholds for an intensity change of 30 kt for TMI overpasses

Threshold of 30 kt Intensity Change	ATL	EPA	NWP + NIO	SH
frac275	0.71	0.60	0.71	0.69
frac250	0.33	0.25	0.34	0.29
frac225	0.10	0.08	0.10	0.08
fracBright	0.61	0.46	0.62	0.62
fracDark	0.77	0.68	0.80	0.80
ring_TD80	y/n	y/n	y/n	y/n
ring_TD90	y/n	y/n	y/n	y/n
ring_TD100	y/n	y/n	y/n	y/n

RI Thresholds for an intensity change of 35 kt for TMI overpasses

Threshold of 35 kt Intensity Change	ATL	EPA	NWP + NIO	SH
frac275	0.73	0.56	0.76	0.75
frac250	0.35	0.23	0.38	0.30
frac225	0.13	0.07	0.11	0.05
fracBright	0.64	0.40	0.70	0.70
fracDark	0.79	0.60	0.88	0.86
ring_TD80	y/n	y/n	y/n	y/n
ring_TD90	y/n	y/n	y/n	y/n
ring_TD100	y/n	y/n	y/n	y/n

RI Thresholds for an intensity change of 40 kt for TMI overpasses

Threshold of 40 kt Intensity Change	ATL	EPA	NWP + NIO	SH
frac275	0.74	0.69	0.73	0.72
frac250	0.34	0.31	0.37	0.19
frac225	0.12	0.10	0.12	0.02
fracBright	0.65	0.61	0.68	0.67
fracDark	0.82	0.82	0.85	0.82
ring_TD80	y/n	y/n	y/n	y/n
ring_TD90	y/n	y/n	y/n	y/n
ring_TD100	y/n	y/n	y/n	y/n

TMI RI Probabilities

RI Probability [%] for an intensity change of 25 kt for TMI overpasses

Probability of 25 kt Intensity Change	ATL	EPA	NWP + NIO	SH
frac275	35	29	22	14
frac250	32	26	22	15
frac225	27	15	23	11
fracBright	34	25	20	11
fracDark	37	26	18	12
ring_TD80	33	25	18	13
ring_TD90	33	26	19	13
ring_TD100	36	26	21	12

RI Probability [%], which includes also meeting the thresholds of 5, 10, 15, 20, 25% (each comma delimited number) SHIPS 25-kt RI probability, for an intensity change of 25 kt for TMI overpasses

Probability of 25 kt Intensity Change	ATL	EPA	NWP + NIO	SH
frac275+SHIPS	36, 37, 37, 35, 32	13, 13, 14, 25, 50	-	-
frac250+SHIPS	32, 32, 33, 32, 33	17, 17, 17, 25, 33	-	-
frac225+SHIPS	28, 28, 29, 35, 33	10, 10, 11, 17, 20	-	-
fracBright+SHIPS	34, 35, 35, 36, 29	11, 11, 11, 17, 33	-	-
fracDark+SHIPS	37, 38, 38, 39, 33	10, 10, 11, 17, 25	-	-
ring_TD80+SHIPS	33, 34, 34, 34, 32	9, 9, 10, 14, 25	-	-
ring_TD90+SHIPS	33, 33, 33, 33, 30	10, 10, 10, 14, 54	-	-
ring_TD100+SHIPS	35, 35, 35, 33, 30	17, 17, 17, 25, 50	-	-

RI Probability [%] for an intensity change of 30 kt for TMI overpasses

Probability of 30 kt Intensity Change	ATL	EPA	NWP + NIO	SH
frac275	34	17	14	14
frac250	32	15	16	13
frac225	25	17	18	8
fracBright	32	16	13	10
fracDark	31	17	16	10
ring_TD80	31	16	14	10
ring_TD90	30	15	15	11
ring_TD100	33	17	17	9

RI Probability [%], which includes also meeting the thresholds of 5, 10, 15, 20, 25% (each comma delimited number) SHIPS 30-kt RI probability, for an intensity change of 30 kt for TMI overpasses

Probability of 30 kt Intensity Change	ATL	EPA	NWP + NIO	SH
frac275+SHIPS	35, 35, 31, 43, 100	13, 14, 50, 100, 100	19, 17, 18, 17, 12	-
frac250+SHIPS	32, 30, 42, 75, 100	14, 14, 33, 100, 100	20, 20, 21, 19, 13	-
frac225+SHIPS	26, 24, 36, 40, 100	13, 14, 25, 50, 100	20, 16, 17, 20, 17	-
fracBright+SHIPS	30, 32, 33, 43, 100	11, 11, 33, 100, 100	17, 19, 17, 15, 11	-
fracDark+SHIPS	30, 32, 38, 43, 100	10, 11, 25, 100, 100	16, 18, 17, 16, 11	-
ring_TD80+SHIPS	30, 31, 39, 43, 100	9, 10, 25, 100, 100	14, 15, 14, 13, 10	-
ring_TD90+SHIPS	29, 31, 38, 43, 100	10, 10, 25, 100, 100	15, 16, 15, 13, 10	-
ring_TD100+SHIPS	31, 32, 36, 43, 100	17, 17, 50, 100, 100	16, 17, 16, 15, 10	-

RI Probability [%] for an intensity change of 35 kt for TMI overpasses

Probability of 35 kt Intensity Change	ATL	EPA	NWP + NIO	SH
frac275	20	7	6	5
frac250	23	8	10	3
frac225	18	13	9	2
fracBright	20	7	8	4
fracDark	23	7	9	4
ring_TD80	18	9	10	3
ring_TD90	18	7	10	3
ring_TD100	19	9	12	2

RI Probability [%], which includes also meeting the thresholds of 5, 10, 15, 20, 25% (each comma delimited number) SHIPS 35-kt RI probability, for an intensity change of 35 kt for TMI overpasses

Probability of 35 kt Intensity Change	ATL	EPA	NWP + NIO	SH
frac275+SHIPS	15, 40, 100, 100, 100	13, 100, 100, 100, 100	-	-
frac250+SHIPS	13, 67, 100, 100, 100	13, 100, 100, 100, 100	-	-
frac225+SHIPS	11, 100, 100, 100, 100	13, 33, 100, 100, 100	-	-
fracBright+SHIPS	20, 50, 100, 100, 100	11, 100, 100, 100, 100	-	-
fracDark+SHIPS	25, 57, 100, 100, 100	11, 100, 100, 100, 100	-	-
ring_TD80+SHIPS	19, 67, 100, 100, 100	11, 100, 100, 100, 100	-	-
ring_TD90+SHIPS	18, 63, 100, 100, 100	11, 100, 100, 100, 100	-	-
ring_TD100+SHIPS	18, 57, 100, 100, 100	20, 100, 100, 100, 100	-	-

RI Probability [%] for an intensity change of 40 kt for TMI overpasses

Probability of 40 kt Intensity Change	ATL	EPA	NWP + NIO	SH
frac275	16	6	6	2
frac250	14	7	7	1
frac225	15	8	8	1
fracBright	17	8	5	1
fracDark	20	9	6	1
ring_TD80	14	6	6	1
ring_TD90	16	7	7	1
ring_TD100	16	9	7	1

RI Probability [%], which includes also meeting the thresholds of 5, 10, 15, 20, 25% (each comma delimited number) SHIPS 40-kt RI probability, for an intensity change of 40 kt for TMI overpasses

Probability of 40 kt Intensity Change	ATL	EPA	NWP + NIO	SH
frac275+SHIPS	20, 100, 100, 100, 100	50, 100, 100, 100, 100	-	-
frac250+SHIPS	15, 100, 100, 100, 100	33, 100, 100, 100, 100	-	-
frac225+SHIPS	18, 100, 100, 100, 100	50, 100, 100, 100, 100	-	-
fracBright+SHIPS	27, 100, 100, 100, 100	50, 100, 100, 100, 100	-	-
fracDark+SHIPS	33, 100, 100, 100, 100	100, 100, 100, 100, 100	-	-
ring_TD80+SHIPS	21, 100, 100, 100, 100	17, 100, 100, 100, 100	-	-
ring_TD90+SHIPS	23, 100, 100, 100, 100	17, 100, 100, 100, 100	-	-
ring_TD100+SHIPS	23, 100, 100, 100, 100	33, 100, 100, 100, 100	-	-

Title: Improvement to the Tropical Cyclone Genesis Index (TCGI)

Principal Investigator

Jason Dunion, University of Miami/CIMAS – NOAA/HRD, jason.dunion@noaa.gov

Co-PIs

John Kaplan, NOAA/AOML/Hurricane Research Division, john.kaplan@noaa.gov
Andrea Schumacher, Colorado State University/CIRA, schumacher@cira.colostate.edu
Joshua Cossuth, Naval Research Laboratory-Monterey, Joshua.Cossuth.ctr@nrlmry.navy.mil

Co-Is

Paul Leighton, NOAA/AOML/Hurricane Research Division, paul.leighton@noaa.gov
Kate Musgrave, Colorado State University/CIRA, Kate.Musgrave@colostate.edu

This Progress Report Period: 9/1/2015 – 3/30/2016

Entire Project Period: 9/1/2015 – 8/31/2017

1. General Description of Progress

The main goal of this project is to implement improvements to the Tropical Cyclone (TC) Genesis Index (TCGI) that was transitioned to operations at the NOAA National Hurricane Center (NHC) in October 2014. TCGI is a disturbance-following scheme designed to provide forecasters with an objective tool for identifying the 0-48hr and 0-120hr probability of TC genesis in the North Atlantic basin. Progress made under this current funded project includes expanding the TCGI North Atlantic database to include the years 2001-2014, developing a new 2001-2014 Pacific (eastern north Pacific (EPAC) and central North Pacific (CPAC)) TCGI database, identifying new predictors to test in both the Atlantic and Pacific versions of TCGI, deriving an eastern/central Pacific basin TCGI utilizing predictors that were employed in the previously developed Atlantic basin version and developing an ECMWF-based Atlantic TCGI using predictors and predictor weights that were developed for the GFS version of TCGI.

2. Transition to Operations

a. Summary of testbed-related activities and outcomes

TCGI was originally funded as a 2-year NOAA JHT project that began in September 2011. An Atlantic version of TCGI was successfully transitioned to operations at NHC in October 2014 and the current project objectives include improving TCGI and expanding it to the Pacific.

b. What was transitioned?

The operational code to run the Atlantic TCGI was transitioned to operations at NHC in October 2014 and is currently running on the NOAA NCEP Weather & Climate Operational Supercomputing System (WCOSS).

c. TRL current vs. start of project*

TCGI is currently at TRL 8 (actual system completed and "mission qualified" through test and demonstration in an operational environment). The current project efforts to improve and expand TCGI began at TRL 3 (analytical and experimental critical function and/or characteristic proof-of-concept) are currently at TRL 4 (component/subsystem validation in laboratory environment). We anticipated this project to be at TRL 7 (system prototyping demonstration in an operational environment) by August 2017.

d. Lessons learned

If this project is accepted we will apply the lessons learned from the previous TCGI JHT project regarding the challenge of converting the new TCGI code to an operational environment (i.e. the NCEP WCOSS).

e. Next steps – future plans (has it been approved for transition yet? Plans for future transition?)

Although TCGI has been successfully transitioned to operations at NHC, the current TCGI project efforts are in their early stages and have not been approved for transition yet. We will complete the following deliverables outlined in the timeline below to help ensure that this project can be completed and considered for transition to operations at NHC:

April 2016	Begin development of an ECMWF-based Atlantic TCGI using predictors and predictor weights that were developed for the GFS version of TCGI
June-Nov 2016	Begin sensitivity testing for optimal combinations of Atlantic and eastern/central Pacific TCGI predictors (GFS version)
Aug-Oct 2016	Develop and test graphical TCGI products with real-time cases
Dec 2016	Develop code for running a real-time version of the Atlantic and eastern/central Pacific TCGI (GFS version)
March 2017	Present year-2 results at IHC
April 2017	Based on POC and IHC feedback, refine TCGI graphical products.
June-Aug 2017	Perform real-time tests of TCGI graphical products in-house at NHC or online at: http://rammb.cira.colostate.edu/realtime_data/nhc/tcgi/
May-Aug 2017	Perform real-time tests of 0-48 and 0-120 h Atlantic and eastern/central Pacific TCGI (GFS version) on NESDIS computers at CIRA with output being made available online at: http://rammb.cira.colostate.edu/realtime_data/nhc/tcgi/ Perform real-time tests of 0-48 and 0-120 h Atlantic and eastern/central Pacific TCGI (ECMWF version) at NHC (requires computing and IT support from NHC)
May-Aug 2017	Finish development/evaluation of prototype ECMWF-based TCGI for Atlantic
Aug 2017	Final code for running both the Atlantic and eastern/central Pacific TCGI on operational NCEP computers will be provided to NHC/NCEP IT personnel if the project is accepted for operational transition.

3. Milestones

a. Completed

i. Collect, quality control, and format 2011-2014 Atlantic Dvorak information

This element of the proposal effort (led by Co-PI Cossuth) involved expanding the current TCGI NHC invest database by an additional 4 years (2011-2014). The new 2001-2014 database includes 6-hourly information including Dvorak T-number, CI number, and invest position for all Atlantic disturbances that were tracked by NHC over the 14-year period. This now-

completed 2001-2014 Atlantic invest database will provide two vital components to TCGI project: 1) a climatology of developing and non-developing tropical disturbances that were tracked by NHC in the Atlantic (including 6-hourly positions). This information will be used as a training set for the improved TCGI; and 2) Dvorak T-numbers (i.e. satellite-derived intensity estimates) for these developing and non-developing tropical disturbances. “*T-Num*” is one of the predictors currently used in the operational version of TCGI and one of the top predictors for determining TC genesis in the 2-day timeframe.

ii. Collect, quality control, and format 2011-2014 EPAC/CPAC Dvorak information

This element of the proposal effort involved developing a 2001-2014 TCGI NHC invest database for the Pacific basin. The new 2001-2014 database includes 6-hourly information including Dvorak T-number, CI number, and invest position for all Pacific (EPAC and CPAC) disturbances that were tracked by NHC over the aforementioned 14-year period. This 2001-2014 Pacific invest database will provide two vital components to TCGI project:

- 1) A climatology of developing and non-developing tropical disturbances that were tracked by NHC in the Pacific (including 6-hourly positions). This information will be used as a training set for the new Pacific TCGI;
- 2) Dvorak T-numbers (i.e. satellite-derived intensity estimates) for these developing and non-developing tropical disturbances. Dvorak *T-Num* is one of the predictors currently used in the operational version of the Atlantic TCGI and one of the top predictors for determining TC genesis in the 2-day timeframe. Preliminary tests of the Pacific version of TCGI suggest that Dvorak *T-Num* is an important predictor in this basin as well.

b. Not Completed:

i. Complete identification/development of new Atlantic and eastern/central Pacific TCGI predictors (this effort is nearing completion (anticipated to be complete in May 2016) and will not impact the timeline of year-1 deliverables)

The TCGI project requires a complete set of forecast positions out to five days for every Dvorak database disturbance at each 6-hourly synoptic time. Unfortunately, the dataset described above contains discontinuities and missing values, especially for entries in which the disturbance does not eventually form into a TC. To fill these missing forecast positions, a combination of Best Track and Dvorak positions and positions obtained from a BAMM type model (BAMG) were used to construct complete versions of the Atlantic and eastern/central Pacific TCGI NHC invest databases. The six predictors that are currently used in the operational version of the TCGI were tested with the newly expanded 2001-2014 Atlantic and eastern/central Pacific TCGI invest databases (Fig. 1.) This figure suggests that the relative weights of the current Atlantic TCGI predictors are markedly different when analyzed with the 2001-2014 Atlantic versus Pacific TCGI databases and may not be entirely surprising given the kinematic, thermodynamic, and sea surface temperature differences between these two basins. However, these tests do provide potential insight as to which predictor combinations may be more effective in each basin and whether or not some predictors should be targeted for possible replacement with new predictors.

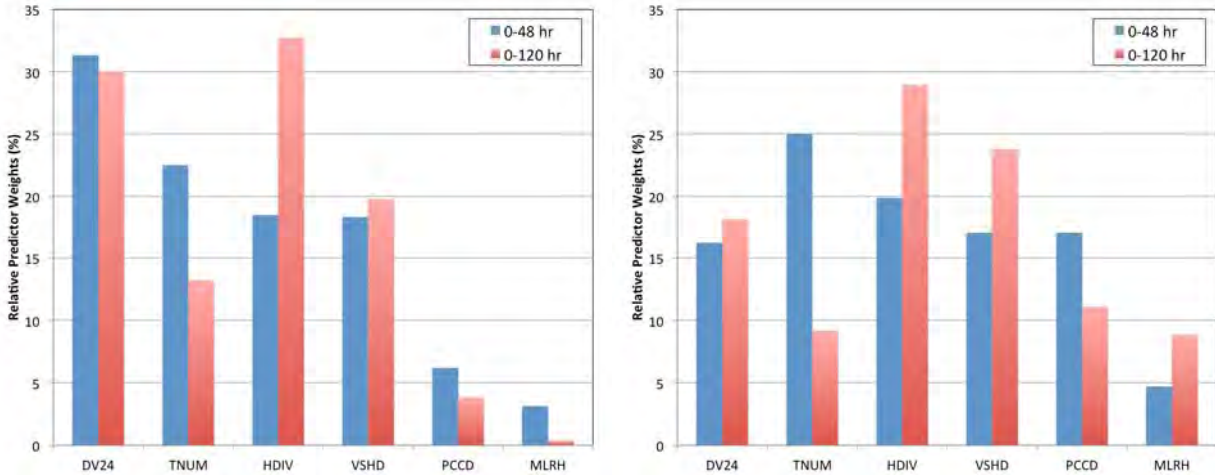

Figure 1: Relative predictor weights derived from the (left) newly expanded 2001-2014 Atlantic and (right) newly developed 2001-2014 Pacific TCGI invest databases. Blue and red bars indicate predictor weights for the 0-48 and 0-120 hr genesis forecasts respectively. The tested predictors include DV24 (24-hr change in GFS 850 hPa vorticity, TNUM (NOAA TAFB Dvorak T-number), HDIV (GFS 850 hPa horizontal divergence, VSHD (GFS 200-850 hPa vertical shear), PCCD (percent GOES water vapor pixels <-40 C), and MLRH (GFS 600 hPa RH).

Although the final list of optimal predictors for the new Atlantic and eastern/central Pacific versions of TCGI may change after further testing, the preliminary tests that were conducted to provide a means of testing the TCGI code on data from a new basin and of assessing the relative baseline skill level for both of the aforementioned basins. Figure 2 shows the cross-validated Brier Skill Score for the Atlantic and eastern/central Pacific TCGI. It can be seen that although the TCGI has slightly more skill in the Pacific, the performance in each basin is quite similar at both lead times.

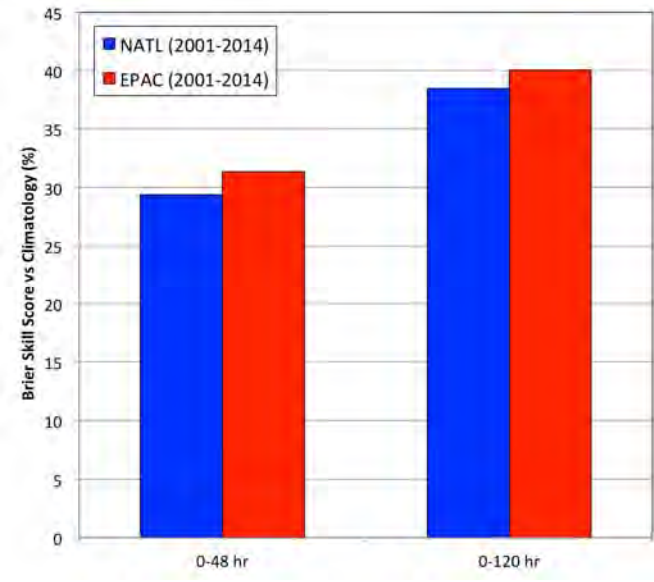

Figure 2: Cross-validated Brier Skill Score (relative to climatology) for the newly expanded 2001-2014 Atlantic (blue shading) and the newly developed 2001-2014 eastern/central Pacific (red shading) TCGI invest databases. The skill for (left) 0-48 hr and (right) 0-120 hr was determined using the six predictors that are currently used in the operational TCGI.

With the completion of the TCGI Atlantic and eastern/central Pacific invest database and preliminary testing of the current operational predictors in each version, efforts have recently focused on examining the predictors that will be tested and eventually implemented in the new Atlantic and eastern/central Pacific versions of TCGI. We have begun examining the original 60 predictors that were tested in the original TCGI, several new predictors (Table 1), and a variable predictor search area that is smaller for the 0-48 hr forecast period (e.g. R=0-200 km or 0-300 km) and larger for the 0-120 hr forecast period (e.g. R=0-500 km).

New TCGI Predictor	Data Source
600-800 hPa RH	GFS/ECMWF model
925-1000 hPa RH	GFS/ECMWF model
Theta-E excess	GFS/ECMWF model
850 hPa vorticity	GFS/ECMWF model
850 hPa vorticity x divergence	GFS/ECMWF model
850 hPa moisture convergence	GFS/ECMWF model
Tropical Overshooting Tops (TOTs)	GOES/Meteosat (UW-CIMSS)
Lightning Strike Density	World Wide Lightning Location Network (WWLLN)

Table 1. New predictors being tested in the Atlantic and Pacific versions of TCGI.

4. Publications

a. Journal articles published

n/a

b. Journal articles in process (what stage?)

n/a

c. Other publications/presentations

Dunion, J.P., J. Kaplan, A.B. Schumacher, J. Cossuth, K.D. Musgrave, and P. Leighton, 2016: Improvements to the Tropical Cyclone Genesis Index (TCGI). *70th Interdepartmental Hurricane Conference - Tropical Cyclone Operations and Research Forum*, Miami, FL, Office of Fed. Coord. For Meteor. Services and Supporting Research, NOAA.

Dunion, J.P., J. Kaplan, A. B. Schumacher, J. Cossuth, K.D. Musgrave, and P. Leighton, 2016: The Tropical Cyclone Genesis Index (TCGI), *32nd Amer. Meteor. Soc. Conf. on Hurricanes and Tropical Meteor.*, San Juan, Puerto Rico.

Improvements to Operational Statistical Tropical Cyclone Intensity Forecast Models

Principal Investigator(s): Galina Chirokova: Galina.Chirokova@colostate.edu

Andrea Schumacher: Andrea.Schumacher@colostate.edu

CIRA/CSU, Fort Collins CO

Collaborator: John Knaff: John.Knaff@noaa.gov

NOAA/NESDIS/STAR, Fort Collins, CO

This Progress Report Period – 09/01/2015 – 03/30/2016

Entire Project Period – 09/01/2015 – 08/31/2017

1. General Description of Progress

Databases of tropical cyclone (TC) size parameters and daily Reynolds Sea Surface Temperature (SST) have been created. The 2015 version of the Statistical Hurricane Intensity Prediction Scheme (SHIPS)/ Logistic Growth Equation Model (LGEM)/ Rapid Intensification Index (RII) code has been modified to work with daily SST and dependent sample testing and retrospective reruns of the modified code have been completed. A statistical-dynamical method for forecasting TC structure and minimum sea level pressure (MSLP) has been developed and tested. The parallel runs of SHIPS/LGEM/RII and TC-size forecasts are planned to be setup at CIRA for the 2016 hurricane season. The modified SHIPS version producing the best forecasts will also be implemented in the quasi-production version of SHIPS on Weather and Climate Operational Supercomputing System (WCOSS) for the 2016 season.

2. Transition to Operations

a. Summary of testbed-related activities and outcomes

The following testbed-related activities are ongoing and planned:

- 1) TC-size estimates for 2013-2014 were provided to National Hurricane Center (NHC) in December 2015.
- 2) The possibility of including Decay SHIPS Wind Radii (DSWR) and MSLP estimates in operational Automated Tropical Cyclone Forecast System (ATCF) A-decks is being discussed with NHC points of contact (POCs).
- 3) SHIPS/LGEM parallel runs with daily SST and constant depth-averaged temperature will be set up at CIRA for the 2016 hurricane season. The modified SHIPS version producing the best forecasts will be also be implemented in the quasi-production version of SHIPS on WCOSS for the 2016 season.

b. What was transitioned?

The transition to operations for this project is scheduled at the end of Year 2 (see item e below). However, some minor computer bugs in the SHIPS/LGEM/RII processing were identified in the course of this work, and will be corrected in the 2016 operational version of the NHC guidance suite on WCOSS.

c. TRL* current vs. start of project

The start of project was TRL3, current level is TRL5.

d. Lessons learned

The project is on schedule and all milestones have been completed as planned. Independent testing on limited number of cases showed larger biases than expected for DSRW TC-size estimates. These biases will be addressed and corrected if possible.

e. Next steps – future plans

i. Has it been approved for transition yet? Plans for future transition?

The transition to operations for this project is scheduled at the end of Year 2, in summer of 2017, if accepted by NHC. The project is on schedule and both the upgraded SHIPS/LGEM/RII code and new TC-structure forecast code will be ready for operational transition by summer 2017. The timing of the final transition will depend on the availability of NHC Technology and Science Branch (TSB) resources.

3. Milestones

a. Completed

1) Create databases of TC size parameters and daily Reynolds SST (Oct 2015)

TC size parameters were calculated from the most recently collected infrared (IR) imagery in the CIRA TC IR image archive. These were used to create an independent variable (the normalized temporal variation of TC size) for the Atlantic, East/Central Pacific, Western North Pacific and Southern Hemisphere TC basins.

The database of daily Reynolds Sea Surface Temperature (DSST) with daily 0.25° resolution (Reynolds et al., 2007) has been created. Data in NetCDF format have been downloaded from

<ftp://eclipse.ncdc.noaa.gov/pub/OI-daily-v2/NetCDF/>. Python and FORTRAN code has been developed for downloading, reading, and interpolating data. Weekly Reynolds SST (RSST) are provided with missing and land values filled. DSST, however have missing values, land, and ice values. These missing values were filled using very simple nearest neighbor interpolation scheme. The purpose of that interpolation is to simplify further processing and to make the dataset independent of the specific land mask used. Finally, interpolated data were converted to the ASCII data format that is currently used for the RSST data used by the operational SHIPS/LGEM models. All available data, from 1981 to 2016 were processed. That allowed for the creation of data for the full time period used by the SHIPS developmental database, currently 1982 - 2015.

2) Modify SHIPS code to use daily, 0.25° Reynolds SST (Nov 2015)

The most current, 2015 version of the SHIPS/LGEM code has been modified to use daily, 0.25° Reynolds SST. The new variable, observed SST, together with the flag to use either weekly or daily SST, has been added to the code. In addition, necessary modifications have been added to the code to make sure SST data are processed in a consistent manner by different pieces of the code. Multiple test runs, including several reruns for the years 2004 - 2015 have been completed to make sure that the code has not been broken by the additions and produces the same results as before while using weekly SST data. It is not possible to make reruns prior to the year 2004 because full model forecast data are not available prior to 2004.

3) Adapt SHIPS statistical code to predict storm structure (Dec 2015)

Using the TC size database, the independent variable (ΔF_{R5} ; the change of normalized TC size from the initial time) was used to create separate linear regression models to predict ΔF_{R5} in the Atlantic, East/Central Pacific, Western North Pacific and Southern Hemisphere TC basins. Findings suggest that other than SST, potential intensity and initial intensity, which suggest that storms generally grow over warm and warming SSTs, the most important environmental factors are mid-level moisture (+), initial size (-), and divergence at 200 hPa (+), sign of the relationship provided in the parentheses. Average storm latitude also is important for TC growth.

The FORTRAN code has been written that 1) applies the multiple regression coefficients to predict ΔF_{R5} from SHIPS large-scale diagnostics and the advisory information and Decay SHIPS/SHIPS (DSHP/DSHA ATCF tech names) track and intensity forecasts, 2) uses the SHIPS intensity forecast, associated track forecast, and the initial wind radii and estimates the parameters associated with a modified Rankine vortex, 3) creates wind radii estimates from the vortex information, and 4) estimates the MSLP based on the intensity, wind radii, motion, and latitude. The methodology of how estimates of TC size ($R5$) which are created by combining forecasts of ΔF_{R5} with forecasts of intensity, and the initial TC size ($R5(t=0)$), can be used to construct the modified Rankine vortex used in the work can be found in Knaff et al. (2016).

Results of independent forecasts for the Atlantic and East Pacific (2013 - 2014) were presented at the Interdepartmental Hurricane Conference (IHC) on 15-17 March in Miami, Florida. An example of the output displayed using the web ATCF and a lot of help from C. R. Sampson (Naval Research Laboratory) is shown in Figure 1. No validation of MSLP has been done at this time.

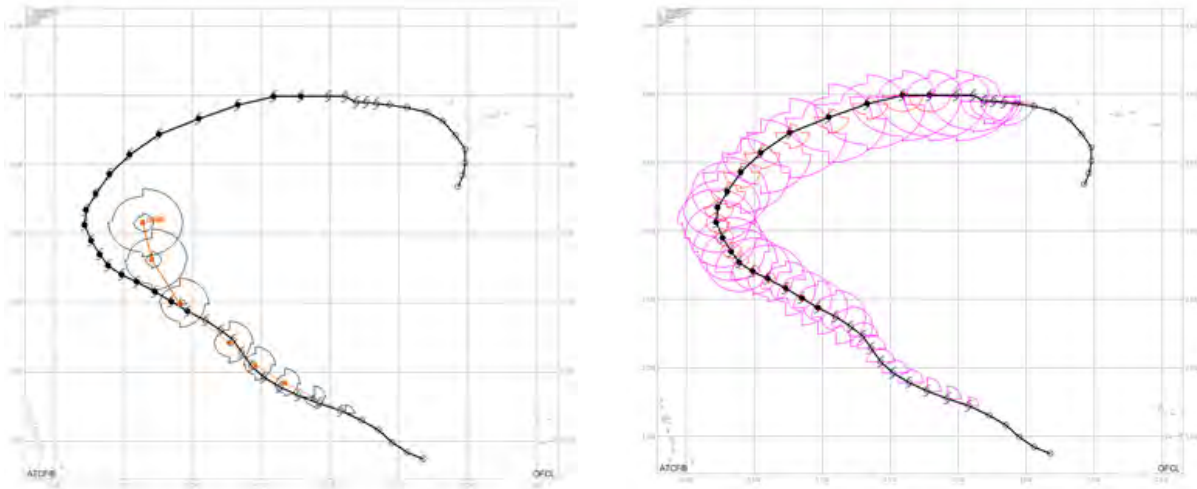

Figure 1: Example of DSWR wind radii forecasts for Hurricane Edouard (2014) initialized on 12 September 00 UTC.

Scripts that collect real-time SHIPS forecasts in the Atlantic, East/Central Pacific, Western North Pacific and Southern Hemisphere TC basins, apply this FORTRAN code, and create forecasts in the ATCF format (ATCF tech name DSWR) have been developed and are running at CIRA. We have begun the coordination with NHC (M. DeMaria, M. Bozeman, C. Mattocks) to get these experimental forecasts in the real time ATCF A-decks.

4) Run SHIPS dependent sample statistics for the years 2005-2013 and complete retrospective SHIPS runs with daily SST (Jan 2016)

1) SHIPS dependent sample statistics runs for the years 1982 - 2014 have been completed. The dependent sample statistic tests are conducted using model analysis rather than forecast fields. The SHIPS diagnostic files for the years 1982 - 2014 for the Atlantic and East Pacific basins have been created, and DSST data for each case have been added to these files. New coefficients for both SHIPS and LGEM for use with DSST were developed from multiple regression. Interestingly, it was found that in approximately 70% of the cases' daily SST along the storm track is colder than weekly SST. One possible explanation is that the SST is cooled by the winds ahead of the storm, and weekly SST are most of the time too old to capture that effect.

2) Retrospective runs of SHIPS/LGEM with new coefficients have been completed for Atlantic (AL) and East and Central Pacific (EP and CP) basins. Figure 2 shows mean absolute errors (MAE) for the results of the run with new coefficients using dependent data for 2004 - 2014. For SHIPS for both AL and EP there are no significant changes in MAE. The same is true for LGEM in the AL. The most interesting result here is the LGEM forecast improvement for the EP, with almost 4% improvement for 108 - 120 hr forecast times. There are only a very small number of CP cases available, but these data are shown for completeness. Biases are slightly improved for SHIPS for both AL and EP, and for LGEM for EP (not shown).

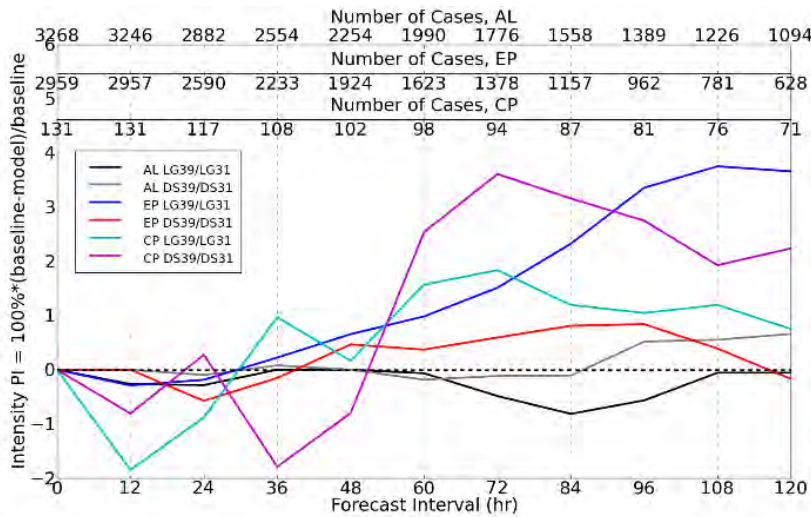

Figure 2. MAE for retrospective SHIPS/LGEM runs for 2004-2014, using coefficients derived for daily SST based on the 1982-2014 dependent sample statistics. Percent improvement is shown for the updated model (Run 39) with daily SST relative to the baseline model with weekly SST and old coefficients (Run 31).

Retrospective runs for the independent 2015 data show similar results, with most significant MAE improvement for LGEM for the EP (Figure 3, upper). Most of the biases are slightly improved for short-time forecasts (up to 72 hours), but AL biases are getting worse after 72-96 hours (Figure 3, lower). The effect of using daily SST has been also evaluated by looking at individual storms from 2015 season. The results were consistent with the overall statistics. For example, it was found, that for Hurricane Blanca, ep022015, there is no significant improvement. Slight improvement in both MAE and biases were found for Hurricane Patricia, ep202015, the strongest AL/EP storm on record. These improvements, however, were relatively small compared to the overall forecast errors for that case.

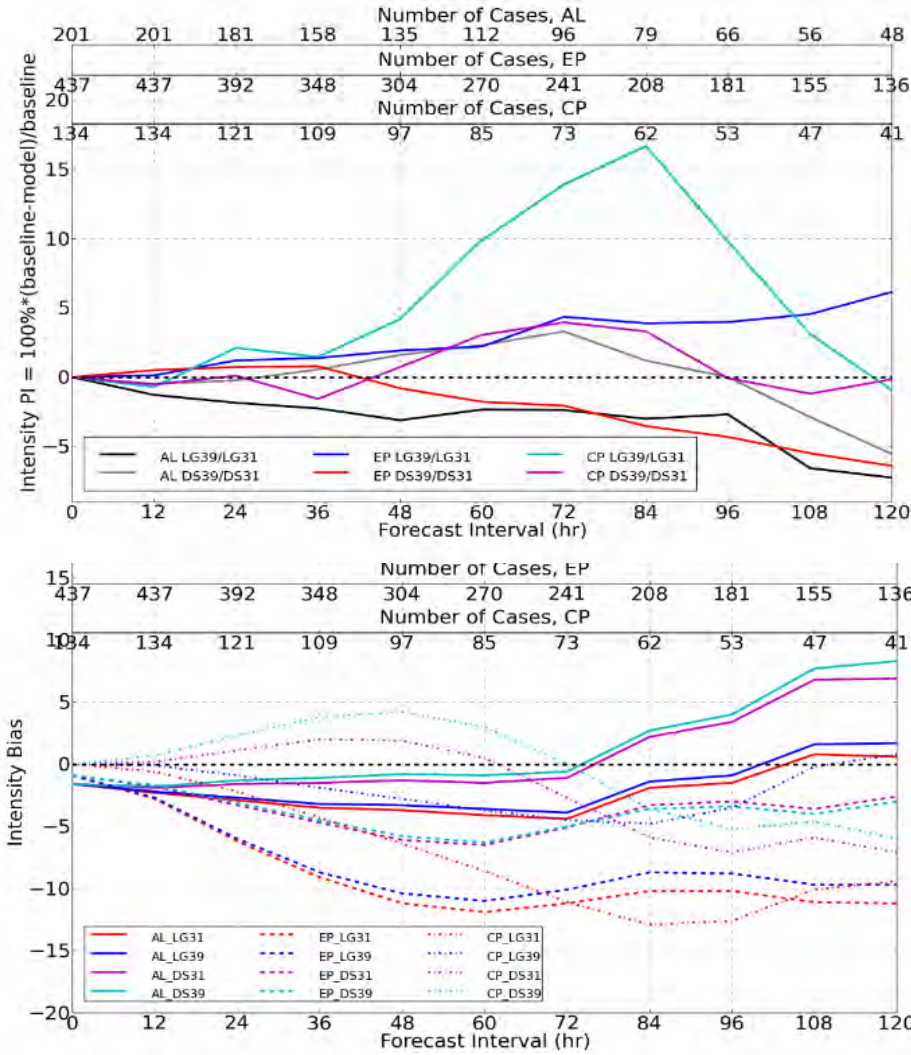

Figure 3. MAE (Left) and bias (Right) for retrospective SHIPS/LGEM runs for independent 2015 data, using coefficients derived for use with daily SST based on the 1982-2014 dependent sample statistics. Percent improvement is shown for the updated model (Run 39) with daily SST relative to the baseline model with weekly SST and old coefficients (Run 31).

3) The next step will be to use daily SST to add ocean depth-averaged temperature to SHIPS/LGEM, which is a better estimate of ocean-TC interaction than ocean heat content (OHC), as described by Lin (2013) and Price (2009). The depth-averaged temperature can be estimated as

$$T_d(x, y) = \frac{1}{d} \int_{-d}^0 T_i(x, y, z) dz,$$

where d is the depth of vertical mixing caused by TC. Preliminary dependent sample tests using 2005 - 2013 data show that including depth-averaged temperature assuming constant mixing depth should result in up to 3.8 % forecast improvements for SHIPS (see Figure 4). In the second year, the mixing depth for calculating depth-averaged temperature will be parameterized as a function of basic storm parameters such as translational speed and latitude.

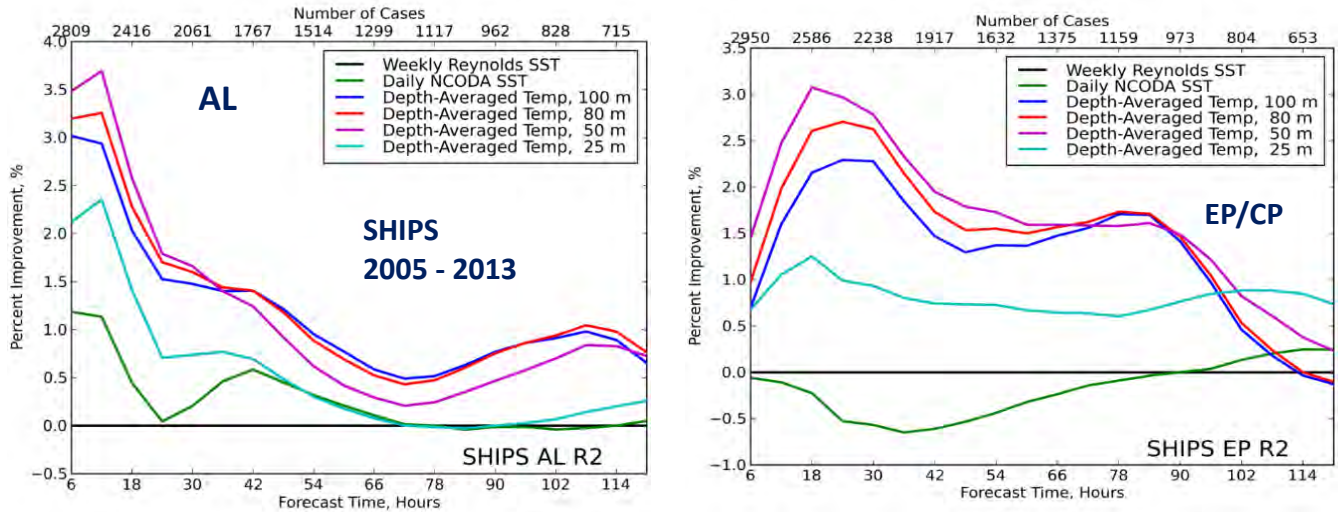

Figure 4. Results of the dependent sample statistics for SHIPS using 2005 - 2013 constant depth depth-averaged temperature for Atlantic (left) and East and Central Pacific (right) basins. These results show that use of temperature averaged over the upper 50 m of the ocean could result in up to 3.8 % MAE improvement for Atlantic and up to 3 % improvement for East Pacific basin.

5) Present year 1 results at IHC and gather feedback (Mar 2016)

G. Chirokova (PI) presented a talk at the IHC (listed in presentations section). In addition, G. Chirokova and J. Knaff discussed project progress with Christopher Landsea and Daniel Brown. It was suggested that the effect of the radius of maximum winds (RMW) on the RII may be investigated to complement the part of the project related to the addition of TC size forecasts to SHIPS/LGEM. This will be investigated if time permits.

b. Not completed

- None -

i. Reasons

ii. Mitigation plan

4. Publications

a. Journal articles published**

Knaff, J.A., C. J. Slocum, K. D. Musgrave, C. R. Sampson, and B. R. Strahl, 2016: Using routinely available information to estimate tropical cyclone wind structure. *Mon. Wea. Rev.*, **144**:4, 1233-1247. DOI: <http://dx.doi.org/10.1175/MWR-D-15-0267.1>

b. Journal articles in process (what stage?)

- None -

c. Other publications/presentations

Chirokova, G., J. Knaff, and A. Schumacher, 2015: Improvements to Operational Statistical Tropical Cyclone Intensity Forecast Models. Presentation at IHC, March 15 - 17, 2016, Miami, Florida. *This material is based upon work supported by the U.S. Weather Research Program within NOAA/OAR Office of Weather and Air Quality under Grant No. NA15OAR4590204.*

5. References

- I.-I. Lin, P. Black, J. F. Price, C.-Y. Yang, S. S. Chen, C.-C. Lien, P. Harr, N.-H. Chi, C.-C. Wu and E. A. D'Asaro, 2013: An ocean coupling potential intensity index for tropical cyclones. *Geophysical Res. Letters*, **40**, 1878–1882. DOI: 10.1002/grl.50091
- Price, J. F., 2009: Metrics of hurricane-ocean interaction: vertically-integrated or vertically-averaged ocean temperature. *Ocean Sci.*, **5**, 351-368, doi:10.5194/os-5-351-2009.
- Reynolds, R. W., T. M. Smith, C. Liu, D. B. Chelton, K. S. Casey, and M. G. Schlax, 2007: Daily high-resolution blended analyses for sea surface temperature. *J. Climate*, **20**, 5473-5496.

*Technical Readiness Levels (TRLs) are defined below:

- TRL 1: Basic principles observed and reported
TRL 2: Technology concept and/or application formulated
TRL 3: Analytical and experimental critical function and/or characteristic proof-of-concept
TRL 4: Component/subsystem validation in laboratory environment
TRL 5: System/subsystem/component validation in relevant environment
TRL 6: System/subsystem model or prototyping demonstration in a relevant end-to-end environment
TRL 7: System prototyping demonstration in an operational environment
TRL 8: Actual system completed and "mission qualified" through test and demonstration in an operational environment
TRL 9: Actual system "mission proven" through successful mission operations

** Please include full reference and DOI (<http://www.apastyle.org/learn/faqs/what-is-doi.aspx>). For your publications and presentations, please include language crediting NOAA/OAR and the USWRP for supporting your projects. Suggested language is as follows:

"This material is based upon work supported by the U.S. Weather Research Program within NOAA/OAR Office of Weather and Air Quality under Grant No. XXXXXXXX."

If your project does not have a grant number, then you can exclude that part of the statement.

Annual Report Information Template For Use by Principal Investigators and Contributors

PROJECT TITLE: Improving CarbonTracker Flux Estimates for North America Using Carbonyl Sulfide (OCS)

PRINCIPAL INVESTIGATOR(S) (CIRA/CSU PI): Ian Baker

RESEARCH TEAM: (CIRA/CSU Staff involved in the project listed in order of staffing time on project, contribution level, or other): Ian Baker

NOAA TECHNICAL CONTACT: (Main NOAA PI on the project and specific office affiliation): Huilin Chen (project PI)

NOAA RESEARCH TEAM (The equivalent of CIRA Research Team for NOAA Staff involved in the project and their affiliations): Andrew Jacobson

PROJECT OBJECTIVE(S) (list 1 or more):

- 1: Develop and test mechanistic representations of carbonyl sulfide (OCS) within landsurface models.
- 2: Evaluate and quantify relationships between OCS flux and CO₂ biophysics.
- 3: Exploit results from 1 and 2 to constrain continental-scale CO₂ flux in a data-assimilation framework.

PROJECT ACCOMPLISHMENTS: (Research Conducted) Past Fiscal Year by Objective: We can illustrate this best in the context of project goals described in last year's report, reproduced in the following text, taken verbatim:

We will simulate regional CO₂ and OCS flux in an ensemble of simulations, and these surface fluxes will be advected within a transport model (STILT) to allow comparison of CO₂ and OCS concentrations with observations from towers, flasks, and aircraft. The initial ensembles will span reasonable values in parameter space for a yet-to-be determined number of critical model parameters. As the evaluation and parameter estimation process continues, PDFs of parameter values will be 'tightened' until an optimized solution in parameter space is determined. The values obtained in the regional experiment will then be utilized in a global simulation.

The regional model domain will be North America (-50 to -170 West Longitude, 10 to 80 North Latitude) as shown in Figure 1. We will prepare a simulation framework, including the following elements:

1. Surface parameter files, including information on vegetation and soil type
2. Fully spun-up carbon pools (vegetation, debris, soil) for year 2000.
3. Optimized output; As multiple ensembles will be run, we will want to streamline diagnostics. Output will be confined to CO₂ and OCS fluxes on an hourly- or 3-hourly basis.
4. Parameter estimation: We will provide 'hooks' in the code for modifying parameter values as a means to improve model performance.
5. Grid: we will have the model set up to run on either a 1-degree or 0.5 degree grid.

Final selection of several aspects of model configuration will be determined by computing resources at PI Chen's institution. Therefore, we will maintain flexibility in choosing the number of parameters estimated and/or grid resolution as a means to facilitate adaptability. We will address points 1-5 above in the next few months.

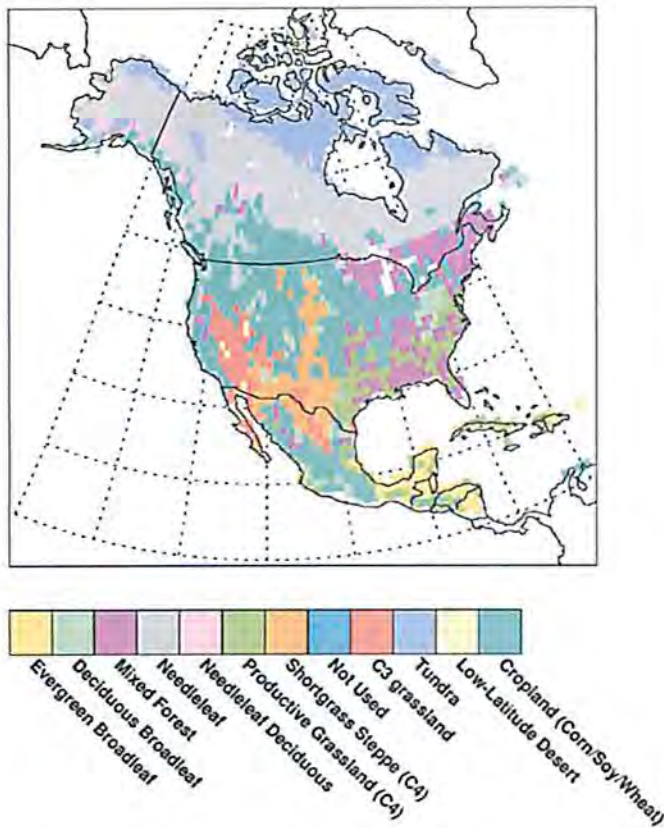

Figure 1: Model domain, showing vegetation type

We have completed items 1-5, and have been collaborating with Huilin Chen and his team to facilitate their implementation of the model into their computing environment. We are also collaborating with them in interpretation of their results. We have completed our target objectives, and are moving the research beyond what we promised to achieve for year 2.

In addition to the technical objectives described above, we are conducting ongoing research into the physical mechanisms that control the exchange of OCS between the atmosphere and land surface. For example, in the current version of the model, OCS is consumed by the soil as a function of temperature and moisture in near-surface layers. In actuality, soil has been observed to be a source or sink of OCS depending on composition and temperature. We are currently confronting our model of OCS exchange with several different observational products, in an effort to provide the best possible physical representation into the assimilation framework of Chen and his team.

We have been collaborating with researchers on a study at Harvard Forest, where OCS exchange has been observed in forest setting. Figure 2 shows observations (top, Panel A) and simulations of forest behavior for 2011. While the model generally follows the observed annual cycle, there is a large efflux of OCS during July that is not reproduced by the model. This outgassing was associated with a hot and dry period. Current thinking is that under normal conditions there is a continuous interplay of OCS uptake and efflux in the soil, with uptake overwhelming efflux during 'normal' conditions. During times of intense heat, however, the uptake terms are thought to subside, leaving the efflux as the dominant process. We are in the process of quantifying this idea, and incorporating it into the model. At this time, results have been indifferent.

We are also looking at other physical representations in the model, such as the interaction between carbon and OCS flux, as well as the representation of OCS uptake through incompletely closed stomates at night. The use of site-level observations to constrain the model will make the continental-scale simulations used in the assimilation framework more robust.

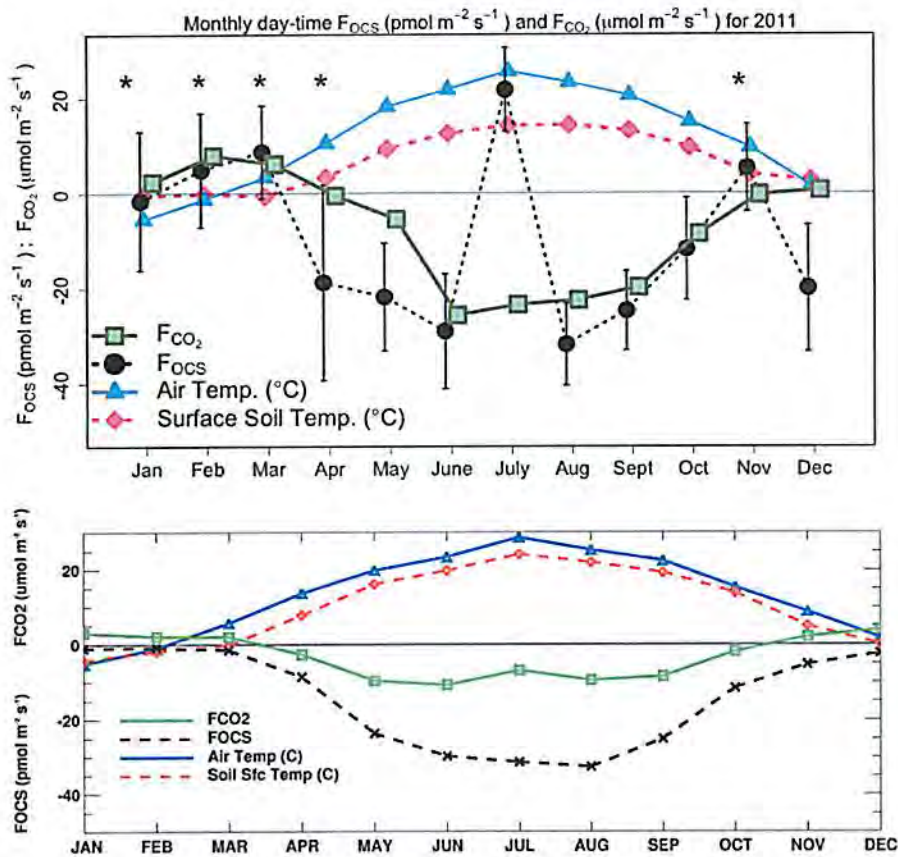

Figure 2: Observations (Panel A) and simulations (Panel B) of monthly-mean carbon and OCS flux, air and soil temperature for 2011 at Harvard Forest

We continue to collaborate with researchers worldwide in the study of OCS flux and its use as a constraint on photosynthesis. We have made global maps of OCS flux available to researchers in the U.S. and abroad. At the University of Bremen (Germany), Yuting Wang has taken SiB surface flux of CO_2 and OCS and put them through a transport model for comparison to flask observations. Figure 3 shows an example of simulated CO_2 and OCS concentration, generated using SiB surface flux run through the GEOS-CHEM transport model. In this case, the CO_2 concentration generated using SiB compares more closely with observations than the OCS does. Note, however, the amplitude of the annual cycle; CO_2 has amplitude of $\sim 20\text{ppm}$ (5%), while the amplitude of the OCS can be 20% or more. This is the lever we hope to apply to our understanding of canopy processes. If we can use large residuals in OCS to constrain our understanding of photosynthesis, we hope to be able to further reduce the model-data mismatch in CO_2 concentration.

Comparison with model simulation with SiB

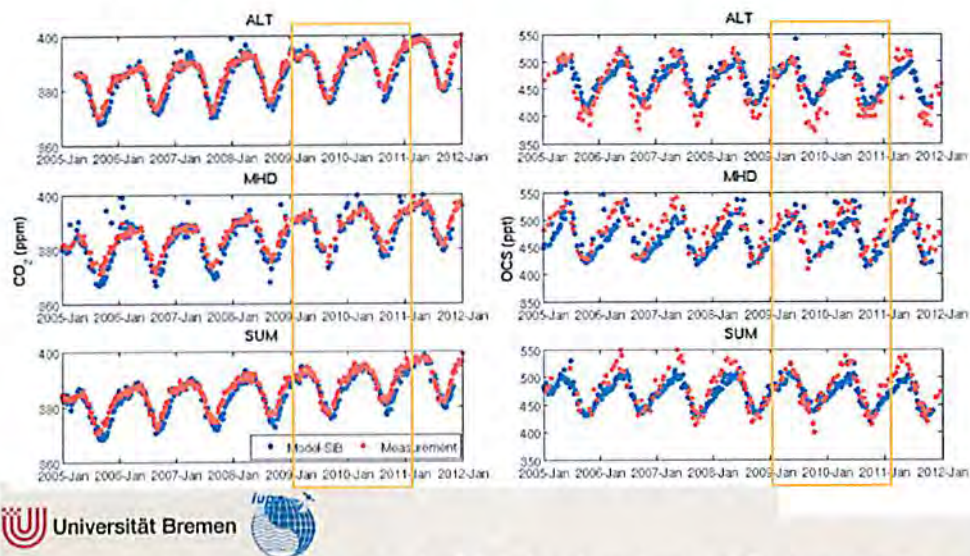

Figure 3: Comparison of simulated CO₂ (left column) and OCS concentrations at 3 sites in the northern hemisphere.

We have also provided surface terrestrial CO₂/OCS flux to a group at NASA JPL that is performing retrievals for OCS from satellite. Their focus is currently on oceans, but they hope to be looking at land soon. We are co-authors on a manuscript currently in review.

We are also unfunded collaborators on a project to measure ecosystem flux from aircraft in the Amazon Basin. We will compare model diagnostics to their suite of measurements, which includes (but is not limited to) OCS and CO₂.

Model-data mismatch can be a result of 1) limitations or errors in the physical processes represented in the model, or 2) erroneous or inappropriate parameter values. This project specifically addresses 2), but limitations in model physics will hinder our ability to retrieve parameter values. Therefore, we are continuously evaluating all aspects of model structure through comparison with observational products across spatiotemporal scales. This evaluation is not limited to CO₂ and OCS. We are also evaluating the model with respect to Solar-Induced Fluorescence (SIF), carbon isotopes, canopy albedo, and surface soil moisture.

Research goals for 2015:

The model framework is in place, and Huilin Chen and his team are currently running simulations. We are conducting ongoing research to evaluate the relationships between OCS flux and CO₂ biophysics (Objective 2), which we will use to update model physics independently of what Huilin Chen determines from his research. We make model updates available to Huilin and his team as they become available. We anticipate using

our findings in support of Objective 3, constraining continental-scale OCS and CO₂ flux over North America.

At this point in the project, we are actively pursuing all 3 project objectives. Therefore, a list of goals for the final year of the project seems unnecessary. However, results from the first 2 years of the project bring up some research issues that we hope to be able to address, at least partially:

1. We are finding that OCS seems a better constraint on stomatal conductance than on CO₂ assimilation. These processes, while related, are not interchangeable. Recently, it has been popular to calculate GPP using a model and calculate OCS uptake by multiplying GPP by a ratio of CO₂/OCS uptake known as an LRU, or Leaf Relative Uptake. We are finding that this is inappropriate. We anticipate that in the final year of the project we will explore this issue further.
2. Stomates don't close completely at night, and there is a small OCS uptake at night while CO₂ uptake is zero. Inaccurate representation of this process will introduce uncertainty into overall OCS budgets.
3. We do not completely understand soil OCS uptake and efflux, even to the point of being able to predict the sign of this flux with certainty. Soil flux is usually, but not always, much smaller than leaf uptake. However, this process is currently our largest uncertainty in simulating OCS flux.

At first glance, this list may seem unrelated to the project goal of using simulations of OCS behavior to constrain CO₂ flux. However, the role of CSU in the project is to provide state-of-the-science OCS and CO₂ fluxes to Huilin Chen and his team so that their inversion system has the best opportunity for success. We are meeting this target.

Project Publications from Past Fiscal Year (including Conferences):

Commane, R., I. Baker, J. Berry, J.W. Munger, S. Wofsy, 2014: Understanding processes contributing to the ecosystem flux of carbonyl sulfide and carbon dioxide in a mixed forest. Oral presentation, American Geophysical Union Fall Meeting, San Francisco CA, 15-19 December 2014.

Commane, R., L.K. Meredith, I.T. Baker, J.A. Berry, J.W. Munger, S.A. Montzka, P.H. Templer, S.M. Juice, M.S. Zahniser, S.C. Wofsy, 2015: Seasonal fluxes of carbonyl sulfide in a mid-latitude forest. Proc. Natl. Acad. Sci., in review.

Kuai, L., J.R. Worden, J.E. Campbell, S.S. Kulawik, M. Lee, K.-F. Li, S.A. Montzka, J.A. Berry, I. Baker, S. Denning, R. Kawa, H. Bian, K. Bowman, J. Liu, Y.L. Yung, 2015: Estimate of Carbonyl Sulfide Tropical Ocean Surface Fluxes using Aura Tropospheric Emission Spectrometer Observations. J. Geophys. Res., in review.

Project Title: Intraseasonal to Interannual Variability in the Intra-Americas Sea in Climate Models

Project Number: GC12-433 (NA12OAR4310077, NA13OAR4310092)

PIs: Eric D. Maloney (Colorado State University) and Shang-Ping Xie (Scripps Oceanographic Institute)

Report Type: Year 4 Report

Results and Accomplishments

The following sections list the accomplishments primarily for the last 2 years of the study, with the 26 publications accumulated for Years 1-4 of the project listed in the publication list at the end of the document. Unfortunately, we cannot be comprehensive given space constraints for all publications, but please contact me for more details if you are interested in anything that was missed. Again, results from the last 2 years will be emphasized.

North American climate in CMIP5 experiments: Assessment of 21st Century projections. (Maloney et al. 2014a)

This is the third of a three part series of review papers led by the NOAA MAPP CMIP5 Task Force on CMIP5 models and North American climate. In Part 3 of this three-part study on North American climate in Coupled Model Intercomparison project (CMIP5) models, we examine projections of 21st century climate in the RCP8.5 emission experiments. This paper summarizes and synthesizes results from several coordinated studies by the authors. Aspects of North American climate change that are examined include changes in continental-scale temperature and the hydrologic cycle, extremes events, and storm tracks, as well as regional manifestations of these climate variables. We also examine changes in eastern north Pacific and north Atlantic tropical cyclone activity and North American intraseasonal to decadal variability, including changes in teleconnections to other regions of the globe.

Projected changes are generally consistent with those previously published for CMIP3, although CMIP5 model projections differ importantly from those of CMIP3 in some aspects, including CMIP5 model agreement on increased central California precipitation. The paper also highlights uncertainties and limitations based on current results as priorities for further research. Although many projected changes in North American climate are consistent across CMIP5 models, substantial intermodel disagreement exists in other aspects. Areas of disagreement include projections of changes in snow water equivalent on a regional basis, summer Arctic sea ice extent, the magnitude and sign of regional precipitation changes, extreme heat events across the Northern U.S., and Atlantic and east Pacific tropical cyclone activity.

The first and second parts of the three part series of papers described at the top of this section are Sheffield et al. (2013 a,b), which provide an assessment of the ability of CMIP5 models to simulate current North American climate and related processes.

Gross moist stability and MJO simulation skill in three full-physics GCMs (Benedict et al. 2014).

This paper describes development of a process-oriented model diagnostic that attempts to explain why some models produce a good MJO simulation, and why others do not. Previous studies have demonstrated a link between gross moist stability (GMS) and intraseasonal variability in theoretical and reduced-complexity models. GMS essentially gives a measure of how efficiently convection discharges moisture from the column. In such simplified models, moisture modes—convectively coupled tropical disturbances that are hypothesized to be dynamical relatives of the

MJO and whose formation and dynamics are closely linked to moisture perturbations—develop only when GMS is either negative or “effectively” negative when considering additional sources of moist entropy. In most cases, these simplified models use a prescribed GMS value or otherwise assume it is a temporally independent property of the simulation. Limited work has been done to assess the GMS and its connection to intraseasonal variability in full-physics general circulation models (GCMs).

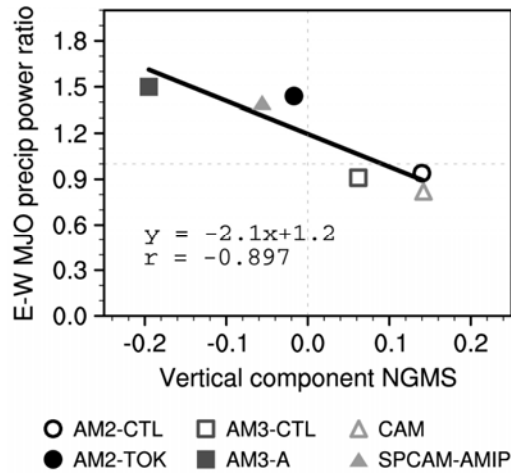

Figure 2. The relationship between October-April mean vertical component of gross moist stability and one metric of the robustness of MJO eastward propagation. The MJO metric is the ratio of eastward to westward tropical rainfall power within the MJO spectral region [periods 30-96 days, zonal wavenumbers +1 to +3 (eastward) or -1 to -3 (westward)]. Also shown are the best-fit line equation and correlation coefficient r .

The time-mean and intraseasonal behavior of GMS and its normalized version (NGMS) are examined in three pairs of GCMs to elucidate the possible importance of NGMS for MJO simulation. In each GCM pair, one member produces weak intraseasonal variability while the other produces stronger intraseasonal variability and robust MJO disturbances due to a change in the treatment of deep convection. A highly correlated linear relationship between time-mean NGMS and MJO simulation skill is observed, such that GCMs with less positive NGMS produce more robust MJO eastward propagation. The reduction in time-mean NGMS is primarily due to a sharp drop to negative values in the component of NGMS related to vertical advection (**Figure 2**), while the component related to horizontal advection has a less clear relationship with MJO simulation. Intraseasonal fluctuations of anomalous NGMS modulate the magnitude of background NGMS but, for the most part, do not change the sign of background NGMS. NGMS is reduced ahead of peak MJO rainfall and is increased during and after the heaviest precipitation. Total NGMS fluctuates during MJO passage but remains positive, suggesting that other sources of moist entropy are required to generate an effectively negative NGMS.

Process-oriented diagnosis of east Pacific warm pool ISV (Maloney et al. 2014b).

June-October east Pacific warm pool intraseasonal variability is assessed in eight atmospheric general circulation simulations. Complex empirical orthogonal function analysis is used to document the leading mode of 30-90 day precipitation variability in the models and Tropical Rainfall Measuring Mission observations. The models exhibit a large spread in amplitude of the leading mode about the observed amplitude. Little relationship is demonstrated between amplitude of the leading mode and ability to simulate the observed propagation characteristics.

Several process-oriented diagnostics are explored that attempt to distinguish why some models

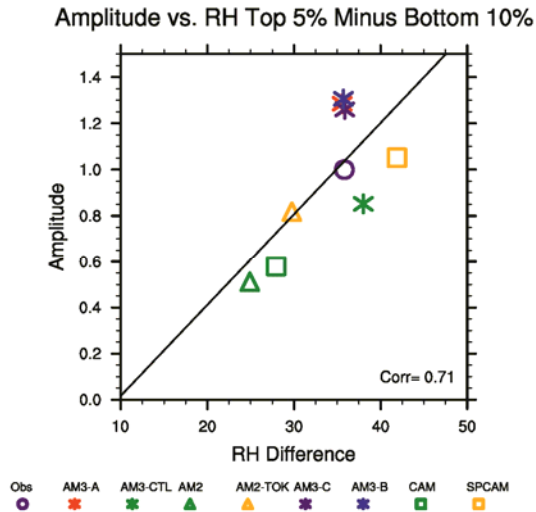

Figure 3. Amplitude of the leading CEOF mode versus the divergence in June-October average 500-850 hPa mass weighted relative humidity between the top 5% and bottom 10% of daily averaged precipitation events . Amplitude is averaged over the domain 5N-20N, 120W-90W, and relative humidity and precipitation are considered on a point-by-point basis in the same domain. Amplitude is normalized by the TRMM amplitude. The correlation is shown in the bottom right, and the least squares regression line is also shown.

produce a better representation of intraseasonal variability than others. A diagnostic based on the difference in 500-850 hPa averaged relative humidity between the top 5% and the top 10% of precipitation events exhibits a significant correlation with leading mode amplitude (**Figure 3**). Diagnostics based on the vertically-integrated moist static energy budget also demonstrate success at discriminating models with strong and weak variability. In particular, the vertical component of gross moist stability (GMS) exhibits a correlation with amplitude of -0.9, suggesting that models in which convection and associated divergent circulations are less efficient at discharging moisture from the column are more able to sustain strong intraseasonal variability. The horizontal component of GMS exhibits a significant positive correlation with amplitude. Consequences of these successful diagnostics for the dynamics of east Pacific intraseasonal variability are discussed.

Several other diagnostics were tested including the warm pool mean surface zonal wind, the strength of surface flux feedbacks, and 500-850 hPa averaged relative humidity for the top 1% of rainfall events, but these diagnostics showed no significant relationship to leading mode amplitude. Vertical zonal wind shear does not appear to be a good predictor of model success at simulating the observed northward propagation pattern. Introduction of ocean coupling to one model with strong intraseasonal variability also did not improve the pattern of propagation.

Climate model evaluation (Li and Xie 2014)

Errors of coupled general circulation models (CGCMs) limit their utility for climate prediction and projection. Origins of and feedback for tropical biases are investigated in the historical climate simulations from the Coupled Model Intercomparison Project phase 5 (CMIP5), together with the available Atmospheric Model Intercomparison Project (AMIP) simulations. The excessive equatorial Pacific cold tongue and double intertropical convergence zone (ITCZ) stand

out as the most prominent errors of the current generation of CGCMs. The comparison of CMIP-AMIP pairs enables us to identify whether a given type of errors originates from atmospheric models. The equatorial Pacific cold tongue bias is associated with deficient precipitation and surface easterly wind bias in the western half of the basin in CGCMs, but these errors are absent in atmosphere-only models, indicating that the errors arise from the interaction with the ocean via Bjerknes feedback. For the double ITCZ problem, excessive precipitation south of the equator correlates well with excessive downward solar radiation in the Southern Hemisphere midlatitudes, an error traced back to atmospheric model simulations of cloud during austral spring and summer. This extratropical forcing of the ITCZ displacements is mediated by tropical ocean-atmosphere interaction, and is consistent with recent studies of ocean-atmospheric energy transport balance.

El Niño teleconnections in a warming climate (Zhou et al. 2014)

Atmospheric general circulation model simulations are used to investigate how ENSO-induced teleconnection patterns during boreal winter might change in response to global warming in the Pacific–North American sector. As models disagree on changes in the amplitude and spatial pattern of ENSO in response to global warming, for simplicity the same sea surface temperature (SST) pattern of ENSO is prescribed before and after the climate warming. In a warmer climate, precipitation anomalies intensify and move eastward over the equatorial Pacific during El Niño because the enhanced mean SST warming reduces the barrier to deep convection in the eastern basin. Associated with the eastward shift of tropical convective anomalies, the ENSO-forced Pacific–North American (PNA) teleconnection pattern moves eastward and intensifies under the climate warming. As a result, rainfall anomalies are expected to intensify on the west coast of North America, and the El Niño–induced surface warming to expand eastward and occupy all of northern North America.

Review of Tropical Intraseasonal Modes of the Atmosphere (Serra et al. 2014)

Tropical intraseasonal variability (TISV) of the atmosphere describes the coherent variability in basic state variables, including pressure, wind, temperature, and humidity, as well as in the physical phenomena associated with the covariability of these parameters, such as rainfall and cloudiness, over synoptic (1,000 km, 1–10 days) to planetary (10,000 km, 10–100 days) scales. In the past, the characteristics of individual TISV modes were studied separately, and much has been learned from this approach. More recent studies have increasingly focused on the multiscale nature of these modes, leading to exciting new developments in our understanding of tropical meteorology. This article reviews the most recent observations of TISV and its associated impacts on regional weather, short-term climate patterns, and atmospheric chemical transports, as well as the ability of numerical models to capture these interacting modes of variability. We also suggest where the field might focus its efforts in the future.

Convective Coupling and Moisture Organization of East Pacific Easterly Waves (Rydbeck and Maloney 2015)

Processes associated with local amplification of easterly waves (EWs) in the east Pacific warm pool are explored. Developing EWs favor convection in the southwest and northeast quadrants of the disturbance. In nascent EWs, convection favors the southwest quadrant, whereas convection in the northeast quadrant becomes increasingly prominent and southwest quadrant convection wanes as the EW lifecycle progresses. The EW moisture budget reveals that

perturbation meridional winds acting on the mean meridional moisture gradient of the ITCZ produce moisture anomalies supportive of convection in the southwest quadrant early in the EW lifecycle. As EWs mature, moisture anomalies on the poleward side of the EW begin to grow and are supported by the advection of anomalous moisture by the mean zonal wind.

In southwest and northeast portions of the wave where convection anomalies are favored, lower tropospheric vorticity is generated locally through vertical stretching that supports a horizontal tilt of the wave from the southwest to the northeast. EWs with such tilts are then able to draw energy via barotropic conversion from the background cyclonic zonal wind shear present in the east Pacific. Convection anomalies associated with EWs vary strongly with changes in the background intraseasonal state. EWs during westerly and neutral intraseasonal periods are associated with robust convection anomalies. Easterly intraseasonal periods are, at times, associated with very weak EW convection anomalies due to weaker moisture and diluted CAPE variations.

In Situ Initiation of East Pacific Easterly Waves in a Regional Model (Rydbeck and Maloney 2016)

The in situ generation of easterly waves (EWs) in the east Pacific (EPAC) is investigated using the Weather Research and Forecasting Model (WRF). The model's sensitivity to the suppression of EW forcing by locally generated convective disturbances is examined. Specifically, local forcing of EWs is removed by reducing the terrain height in portions of Central and South America to suppress robust sources of diurnal convective variability, most notably in the Panama Bight. The regions of high terrain are associated with mesoscale convective systems that routinely initiate in the early morning and propagate westward into the EPAC warm pool. When such mesoscale convective systems are suppressed in the model, EW variance is significantly reduced. This result suggests that EPAC EWs can be generated locally in association with higher frequency convective disturbances, and these disturbances are determined to be an important source of EPAC EW variability. However, EPAC EW variability is not completely eliminated in such sensitivity experiments, indicating the importance for other sources of EW forcing, namely EWs propagating into the EPAC from west Africa.

A mechanism is proposed to explain the in situ generation of EPAC EWs. Serial mid-level diurnal vorticity and divergence anomalies generated in association with deep convection and originating in the Panama Bight underpin the local generation, intensification, and spatial scale selection of EW vorticity through vertical vorticity stretching. Diurnal vorticity anomalies in the Panama Bight are able to initiate disturbances capable of growing into robust EWs by a mechanism of upscale vorticity organization. This paper is in the process of being submitted to *Journal of the Atmospheric Sciences*.

Initiation and Intensification of East Pacific Easterly Waves (Rydbeck 2016)

Adam Rydbeck is a CSU graduate student who completed his Ph.D research under this project under the advising of PI Eric Maloney. This work also featured in 3 publications noted in this report (Rydbeck and Maloney 2014; 2015; 2016). Hence, we will not repeat the information on these publications here.

NOAA MAPP CMIP5 Task Force

Eric Maloney has completed his term as co-chair, and Shang-Ping Xie finished his term as a member, of the NOAA MAPP CMIP5 Task Force. Accomplishments have included generation of

a *Journal of Climate* special collection on North American Climate in CMIP5 Models, which includes the overview papers discussed in the report on Maloney et al. (2014a) above. Recent task force activities included thrusts related to 1) use of CMIP5 models to inform climate applications [see Sheffield et al. (2014) report in reference list below] and 2) process-oriented model diagnostics to inform model development and applications. Regarding point #2, the process-oriented diagnostics effort of the CMIP5 TF has laid the groundwork for a new task force called the NOAA MAPP Model Diagnostics Task Force that is currently being lead by the PI Maloney. The task force will develop a common software framework to allow rapid dissemination of process-oriented diagnostics into the evaluation packages of global climate and forecasting models. More discussion of this task will take place in the project report for a separate NOAA grant.

Highlights of Accomplishments

- We developed a *Journal of Climate* special collection on North American climate in CMIP5 models, including a lead-author comprehensive paper by the PI (Maloney) examining CMIP5 projections of North American climate.
- We developed several successful process-oriented model diagnostics that can distinguish between models with good and poor intraseasonal variability, and applied these diagnostics to several versions of the GFDL AM2 and AM3, and the NCAR CAM and SP-CAM. This analysis extended to the tropical Americas. These metrics should help inform model development.
- We have contributed to the NOAA MAPP CMIP5 Task Force process-oriented model diagnostics effort, successful engaging NCAR and GFDL and making plans for incorporating our diagnostics into their standard model diagnostics packages.
- The process-oriented diagnostics effort in this project has laid the groundwork for a new NOAA MAPP Model Diagnostics Task Force being led by the PI Maloney to continue process-oriented diagnostics development.
- We have diagnosed reasons for CMIP5 model bias in the ITCZ and cold tongue regions of the Pacific, helping to inform model development
- We have shown that the ENSO-forced Pacific–North American (PNA) teleconnection pattern is projected to move eastward and intensify under the climate warming, intensifying rainfall anomalies on the west coast of North America
- We have demonstrated that east Pacific easterly waves can be generated in isolation from Atlantic disturbances, with convective variability in the Panama Bight region playing a key role in forcing east Pacific disturbances.

Publications From the Project

- 1) Ma, J., S.-P. Xie, and Y. Kosaka, 2012: Mechanisms for tropical tropospheric circulation change in response to global warming. *J. Climate*, **25**, 2979–2994.
- 2) Maloney, E. D., and S.-P. Xie, 2013: Sensitivity of MJO activity to the pattern of climate warming. *J. Adv. Modeling Earth Sys.*, **5**, 32-47.
- 3) Richter, I., S.-P. Xie, A.T. Wittenberg, and Y. Masumoto, 2012: Tropical Atlantic biases and their relation to surface wind stress and terrestrial precipitation. *Clim. Dyn.*, **38**, 985-1001, doi:10.1007/s00382-011-1038-9.
- 4) Rydbeck, R. V., 2012: *Remote versus Local Forcing of East Pacific Intraseasonal Variability*. M.S. thesis, Colorado State University, 126pp.

- 5) Shaman, J., and E. D. Maloney, 2012: Shortcomings in climate model simulations of the ENSO-Atlantic hurricane teleconnection. *Climate Dynamics*, **38**, 1973-1988.
- 6) Slade, S. A., 2012: *A Statistical Prediction Model for East Pacific and Atlantic Tropical Cyclone Genesis*. M.S. thesis, Colorado State University, 126pp.
- 7) Van Roedel, L. P., and E. D. Maloney, 2012: Mixed layer modeling in the east Pacific warm pool during 2002. *Climate Dynamics*, **38**, 2559-2573.
- 8) Rydbeck, R. V., E. D. Maloney, S.-P. Xie, and Jeffrey Shaman, 2013: Remote versus local forcing of east Pacific intraseasonal variability. *J. Climate*, **26**, 3575-3596.
- 9) Slade, S. A., and E. D. Maloney, 2013: A Statistical Prediction Model for East Pacific and Atlantic Tropical Cyclone Genesis. *Mon. Wea. Rev.*, **141**, 1925-1942.
- 10) Jiang, X.-A., E. D. Maloney, J.-L. F. Li, and D. E. Waliser, 2013: Simulations of the eastern north Pacific intraseasonal variability in CMIP5 GCMs. *J. Climate*, **26**, 3489-3510.
- 11) Rydbeck, A. V., and E. D. Maloney, 2014: Energetics of east Pacific easterly waves during intraseasonal events. *J. Climate*, **27**, 7603-7621.
- 12) Maloney, E. D., and C. Zhang, 2015: Dr. Yanai's contribution to the discovery and science of the MJO. *Meteor. Monographs*, in press.
- 13) Sheffield, J., A. Barrett, B. Colle, R. Fu, K. L. Geil, Q. Hu, J. Kinter, S. Kumar, B. Langenbrunner, K. Lombardo, L. N. Long, E. Maloney, A. Mariotti, J. E. Meyerson, K. C. Mo, J. D. Neelin, Z. Pan, A. Ruiz-Barradas, Y. L. Serra, A. Seth, J. M. Thibeault, J. C. Stroeve, 2013: North American climate in CMIP5 experiments. Part I: Evaluation of 20th Century continental and regional climatology. *J. Climate*, **26**, 9209-9245.
- 14) Sheffield, J., S. J. Camargo, R. Fu, Q. Hu, X. Jiang, N. Johnson, K. B. Karnauskas, J. Kinter, S. Kumar, B. Langenbrunner, E. Maloney, A. Mariotti, J. E. Meyerson, J. D. Neelin, Z. Pan, A. Ruiz-Barradas, R. Seager, Y. L. Serra, D.-Z. Sun, C. Wang, S.-P. Xie, J.-Y. Yu, T. Zhang, M. Zhao, 2013: North American climate in CMIP5 experiments. Part II: Evaluation of 20th Century intra-seasonal to decadal variability. *J. Climate*, **26**, 9247-9290.
- 15) Maloney, E. D., S. J. Camargo, E. Chang, B. Colle, R. Fu, K. L. Geil, Q. Hu, X. Jiang, N. Johnson, K. B. Karnauskas, J. Kinter, B. Kirtman, S. Kumar, B. Langenbrunner, K. Lombardo, L. N. Long, A. Mariotti, J. E. Meyerson, K. C. Mo, J. D. Neelin, Z. Pan, R. Seager, Y. Serra, A. Seth, J. Sheffield, J. Stroeve, J. Thibeault, S.-P. Xie, C. Wang, B. Wyman, and M. Zhao, 2014a: North American climate in CMIP5 experiments: Part III: Assessment of 21st Century projections. *J. Climate*, **27**, 2230-2270.
- 16) Benedict, J. J. E. D. Maloney, A. H. Sobel, and D. M. Frierson, 2014: Gross moist stability and MJO simulation skill in three full-physics GCMs. *J. Atmos. Sci.*, **71**, 3327-3349.
- 17) Kim, D, P. Xavier, E. Maloney, M. Wheeler, D. Waliser, K. Sperber, H. Hendon, C. Zhang, R. Neale, Y.-T. Hwang, and H. Liu, 2014: Process-oriented MJO simulation diagnostic: Moisture sensitivity of simulated convection. *J. Climate*, **27**, 5379-5395.
- 18) Maloney, E. D., X. Jiang, S.-P. Xie, and J. J. Benedict, 2014b: Process-oriented diagnosis of east Pacific warm pool intraseasonal variability. *J. Climate*, **27**, 6305-6324.
- 19) Serra, Y. L., X. Jiang, B. Tian, J. Amador Astua, E. D. Maloney, and G. N. Kiladis, 2014: Tropical intra-seasonal oscillations and synoptic variability. *Annual Review of Environment and Resources*, **39**, 189-215.
- 20) Kosaka, Y., and S.-P. Xie, 2013: Recent global-warming hiatus tied to equatorial Pacific surface cooling. *Nature*, **501**, 403-407.
- 21) Li, G., and S.-P. Xie, 2014: Tropical biases in CMIP5 multi-model ensemble: The excessive equatorial Pacific cold tongue and double ITCZ problems. *J. Climate*, **27**, 1765-1780.

- 22) Zhou, Z.-Q., S.-P. Xie, X.-T. Zheng, Q. Liu, and H. Wang, 2014: Global warming-induced changes in El Nino teleconnections over the North Pacific and North America. *J. Climate*, 27, 9050-9064, doi: 10.1175/JCLI-D-14-00254.1.
- 23) Rydbeck, A. V., and E. D. Maloney, 2015: On the Convective Coupling and Moisture Organization of East Pacific Easterly Waves. *J. Atmos. Sci.*, **72**, 3850-3870.
- 24) Sheffield, J., and others, 2014: Regional climate processes and projections for North America: CMIP3/CMIP5 differences, attribution and outstanding issues. *NOAA Technical Report*, OAR CPO-2, Climate Program Office, December 2014.
- 25) Rydbeck, A. V., 2016: *Initiation and Intensification of East Pacific Easterly Waves*. Ph.D Dissertation, Colorado State University, 151 pp.
- 26) Rydbeck, A. V., and E. D. Maloney, 2016: In Situ Initiation of East Pacific Easterly Waves in a Regional Model *J. Atmos. Sci.*, to be submitted 3/16.

PIs Contact Information

Eric D. Maloney (lead PI)
Department of Atmospheric Science
Cooperative Institute for Research in the Atmosphere (CIRA)
Colorado State University
1371 Campus Delivery
Fort Collins, CO 80523-1371
Phone: (970) 491-3368
Fax: (970) 491-8449
emaloney@atmos.colostate.edu

Shang-Ping Xie (co-PI)
Scripps Institution of Oceanography
UC San Diego
9500 Gilman Drive # 0206
La Jolla CA, 92093-0206
Phone: 858-822-0053
Fax: 858-822-0302

6. Budget for the Coming Year

The budget for the coming year is unchanged from that in the submitted proposal.

7. Future Work

The work for the remainder of the project is anticipated to be the same as in the submitted proposal, with the exception that we have expanded our focus to help develop process-oriented model diagnostics that will help us to determine why some models can simulate North American climate accurately, while others cannot. Diagnostics are also being developed that inform climate applications.

PROJECT TITLE: Multi-disciplinary Investigation of Concurrent Tornadoes and Flash Floods in the Southeastern US

PRINCIPAL INVESTIGATOR(S) (CIRA/CSU PI): Russ Schumacher, CSU ATS

RESEARCH TEAM: (CIRA/CSU Staff involved in the project listed in order of staffing time on project, contribution level, or other): Erik Nielsen, Samuel Childs, and Greg Herman (CSU ATS graduate students); Jennifer Henderson (graduate student at Virginia Tech; working as student hourly on this project)

NOAA TECHNICAL CONTACT: (Main NOAA PI on the project and specific office affiliation): n/a

NOAA RESEARCH TEAM (The equivalent of CIRA Research Team for NOAA Staff involved in the project and their affiliations): n/a

PROJECT OBJECTIVE(S):

--Investigate the detailed meteorological conditions in concurrent, co-located tornado and flash flood events (TORFF events) in the southeastern US, including how they evolve in time, and how they differ from cases where only the individual hazards occur. Using readily available radar, precipitation, and reanalysis datasets, we will quantitatively identify the meteorological factors that commonly lead to TORFF events in the southeast, along with one or two detailed case studies of particularly destructive events.

--Investigate the NWS warning process during multi-hazard events, and document the unique challenges in these events. By conducting observational analysis and interviews with NWS forecasters in the southeast, we will examine the challenges they encounter in preparing for, identifying, and issuing warnings with enough lead time for appropriate societal response.

PROJECT ACCOMPLISHMENTS:

Our research is underway on this project, both in terms of the analysis of historical data and in collection of data on the NWS warning process in the field. Jen Henderson has now made two visits to NWS offices in the southeast to observe the unique challenges associated with issuing warnings for multiple hazards, beyond those associated with single hazards. We have extended our research to focus on the southeast, including a case study of the event in late December 2015 and we are developing tools to monitor for TORFF events in real time.

Publications: None

Annual Progress Report

Observational constraints on the mechanisms that control size- and chemistry-resolved aerosol fluxes over a Colorado forest

Award Number: NA14OAR4310141
Principal Investigator: Dr. Delphine K. Farmer
Institution: Colorado State University, Fort Collins, CO 80523
Co-investigators: Dr. Chris Kummerow
Start Date: August 1, 2014
Period Covered: May 1, 2015 – March 15, 2016

I Project Statement

This project is focused on providing observational constraints on dry deposition of organic compounds in the gas and particle phase, and the extent to which forest-atmosphere exchange controls the fate of organic carbon in the atmosphere. The proposed work tackles the following questions:

1. Which chemical and physical components dominate the aerosol flux budget, and how do they vary seasonally?
2. How does dry deposition of accumulation mode aerosol over a temperate forest vary seasonally, and what is the impact of this sink on aerosol lifetime?
3. How important are the fluxes of semi-volatile organic compounds in controlling organic aerosol deposition?

II Accomplishments

Summary: Progress during the second year of research includes (i) field measurement of gas-phase oxidized and non-oxidized organic compounds and size-resolved particle fluxes at Manitou Experimental Forest in the summer and winter, (ii) demonstration of eddy covariance flux measurements of oxidized gas-phase VOCs, (iii) preliminary interpretation of flux measurements, and (iv) development of aerosol inlet.

(i) Field measurements of VOC, oVOC and aerosol.

Field measurements of volatile organic compounds (VOCs, by proton-transfer-reaction time-of-flight mass spectrometry, PTR-TOF-MS), oxidized VOCs (oVOCs_(g)) by acetate ionization time-of-flight mass

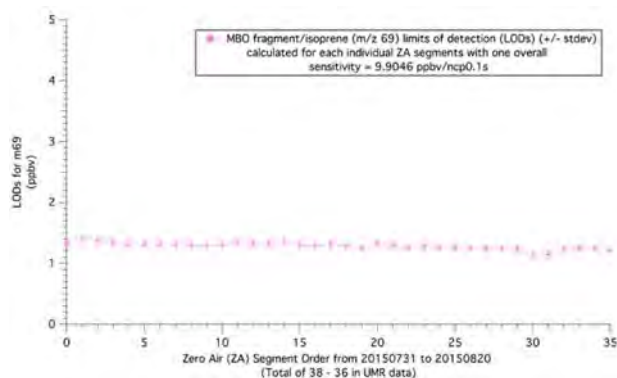

Figure 1. The detection limit (0.1 second averaging) of MBO remained stable throughout the entire campaign. This stability is typical of all calibrated VOCs from the PTR-TOF-MS.

spectrometry, acetate-CIMS) and size-resolved aerosol (ultra high sensitivity aerosol spectrometer, UHSAS) were made in the summer of 2015 (July 5- August 25 2015) and winter of 2016 (Feb.1 – 29 2016). All measurements were taken at 10 Hz, and are in the process of being analyzed for both concentration and eddy covariance concentrations.

As described in the original proposal, this involves software development. Simultaneous, supporting measurements included NO, NO₂, O₃, and CO concentrations from John Ortega at the National Center of Atmospheric Research, as well as NH_{3(g)} flux measurements from Jen Murphy’s group at the University of Toronto. In addition, wet deposition was collected throughout the summer and winter campaigns, and will be analyzed by an REU student this summer.

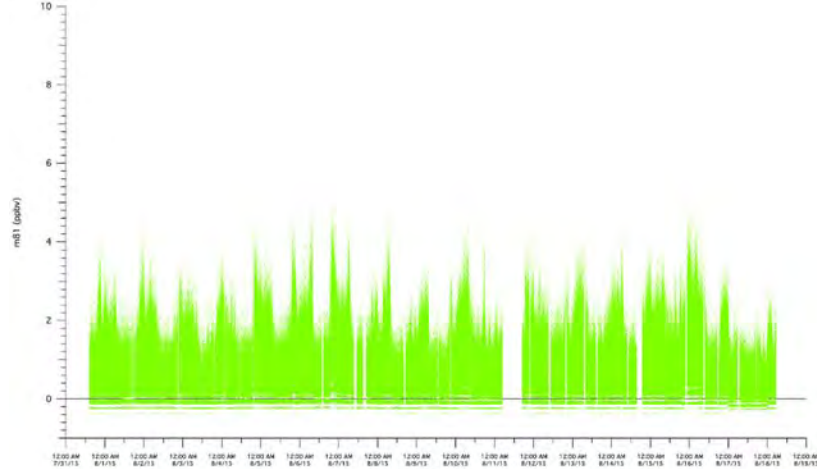
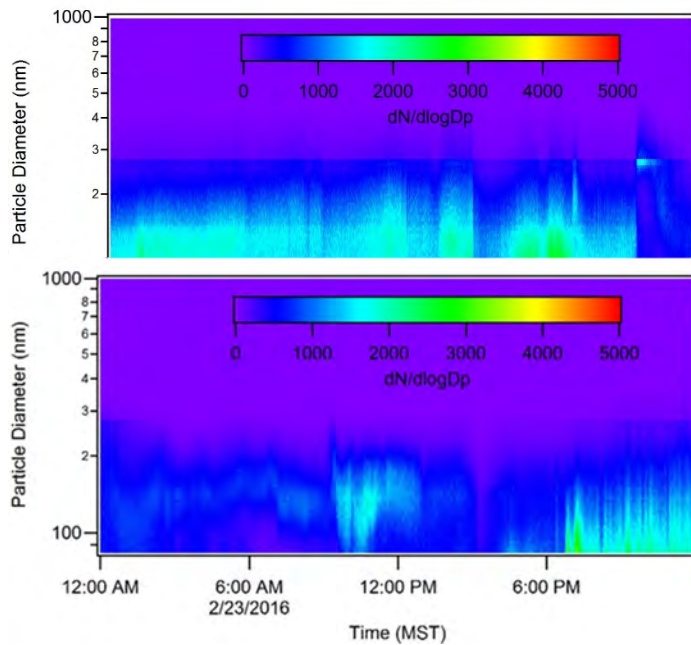

Figure 2. Sample 10 Hz concentration data for the monoterpene fragment (m/z 81) as observed by the PTR-TOF-MS.

Preliminary data analysis demonstrates adequate sensitivity of PTR-MS and acetate-CIMS measurements for concentration measurements of calibrated compounds (Figure 1,2). VOC concentrations are dominated by monoterpenes at night (Figure 1) and MBO during the day, consistent with previous measurements (Ortega et al. 2014). One intriguing observation is the measurement of hexenal, a green leafy volatile emitted by plants as a result of stress. We are currently investigating these concentrations to determine if the emissions are temperature related, and to consider the impact of this and other biogenic stress emissions in affecting atmospheric chemistry at the site.



The size-resolved aerosol measurements also have adequate sensitivity for flux measurements within the lower (<300nm) size bins, and work is ongoing to determine how much averaging is required to determine fluxes for the larger (300-1000 nm) size

Figure 3. Sample size distribution data from the summer (upper) and winter (lower) campaigns at Manitou Experimental Forest. Concentrations and calculated fluxes are much higher in the summer than the winter, but above the flux detection limit during the daytime during both seasons.

bins. In addition, we find obvious concentration differences between the summer and winter campaigns, confirming the hypothesis that different seasons would provide a large range in aerosol number concentrations and thus provide the necessary data for determining size-resolve deposition velocities across a range of aerosol concentrations and turbulence regimes.

(ii) *Demonstration of eddy covariance flux measurements*

Figure 4. Lag correlation diagram for individual half hour data points between formic acid (as observed by acetate-CIMS) and the vertical wind speed (sonic anemometer). The clear, distinguishable peak demonstrates that the flux measurements have adequate signal-to-noise ratios for calculation of eddy covariance flux measurements during the daytime.

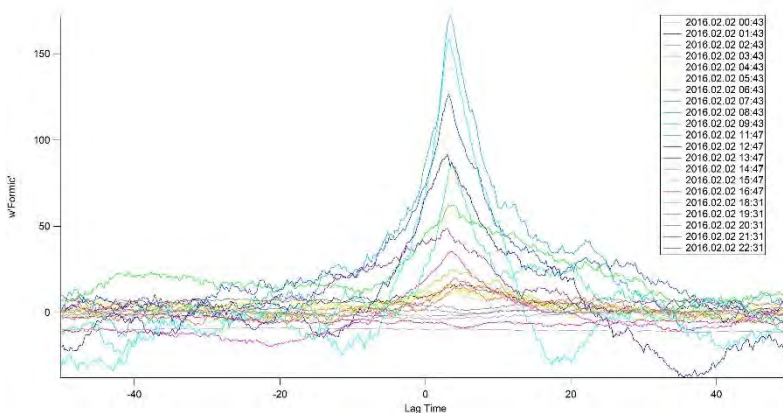

Initial analysis of acetate-CIMS data demonstrates adequate sensitivity of acetate-CIMS for eddy covariance measurement of multiple compounds. Data quality steps include: (1) calculation of time-lag between sonic anemometer data and CIMS measurements; (2) rotation of sonic anemometer data to account for discrepancies between orientation of sonic anemometer relative to ground; and (3) spectral analysis of cross-correlation between vertical wind speed and high resolution signals from the mass spectrometer.

All of these components have been successfully implemented and tested in the software.

(iii) *Preliminary interpretation of flux measurements.*

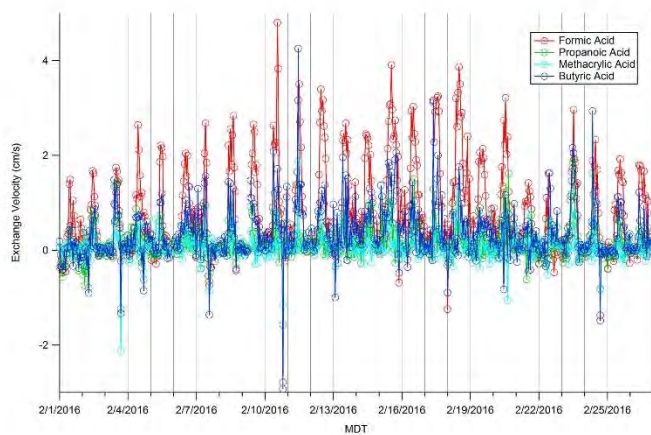

Figure 5. Exchange velocities (cm/s) for four small, volatile organic acids that were calibrated in the field throughout the project. All four organic acids show fluxes above the detection limit, and are dominated in the winter by upward fluxes.

We observe both upward and downward fluxes of oVOC (Figure 5). Demonstrates the calculated exchange velocities for four organic acids in the winter campaign. These exchange velocities peak at 4 cm/s – a surprisingly large emission, but one consistent with previous observations from the Wennberg group during SOAS (Nguyen et al. 2015). We note much larger exchange velocities for formic acid and butyric acid than for propanoic acid or

methacrylic acid.

The observed exchange velocities for oVOC vary with the size of the organic acid and extent of oxidation. We can investigate these trends using mass defect plots (Brophy et al. 2015), in which the mass spectral signals are plotted as the difference between the exact mass and the nominal mass for a given peak in the mass spectrum. More oxidized organic compounds with higher O:C ratios tend to have lower mass defects than less oxidized organic compounds. Looking at exchange velocities calculated for a given half hour (Figure 7) shows that both upward and downward fluxes are observed across the mass spectrum. For this particular half hour, upward fluxes are observed for many of the smaller oVOC, while downward fluxes are observed for larger oVOC. We intend to investigate these fluxes in Van Krevelen space and as a function of oxidation state and solubility and Henry's Law constants, as determined from known data or structure-activity relationships.

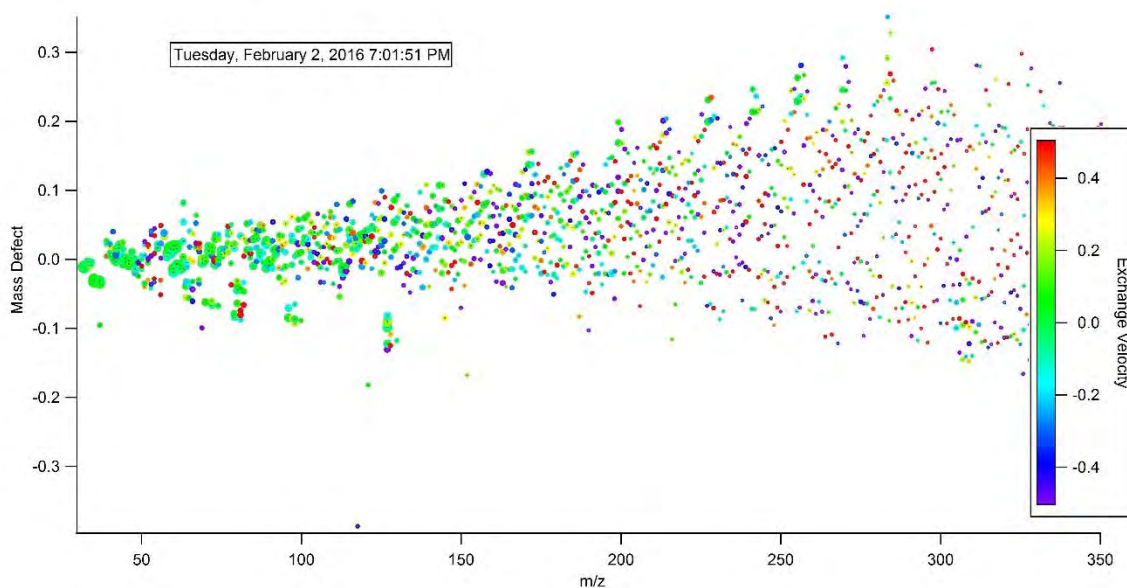

Figure 6. A sample mass defect plot colored by exchange velocity for a single half hour flux period at Manitowish Experimental Forest. The sign convention has positive exchange velocities for upward fluxes, and negative exchange velocities for downward fluxes. Both upward and downward fluxes were observed across the mass spectrum, with the largest absolute magnitudes in exchange velocities observed in the middle of the day when turbulence was largest.

(iv) *Characterization of aerosol inlet*

We have ongoing work characterizing and validating our design of an aerosol inlet (e.g. Figure 7). The aerosol inlet is based on designs presented in the literature from the McNeill and Abatt groups. However, preliminary investigation found that one widely-used material (silcosteel) actually produced particles when heated, and was thus an inappropriate material for an inlet. Further investigation prompted us to try quartz tubing, which does not produce any interferences when heated. The optimal temperature of the inlet depends on residence time and thus flow rate: current experiments are focused on testing the minimum temperature to completely volatilize non-refractory organic aerosol. This aerosol inlet should be ready for deployment and quantitative aerosol flux measurement during the upcoming 2016 campaigns.

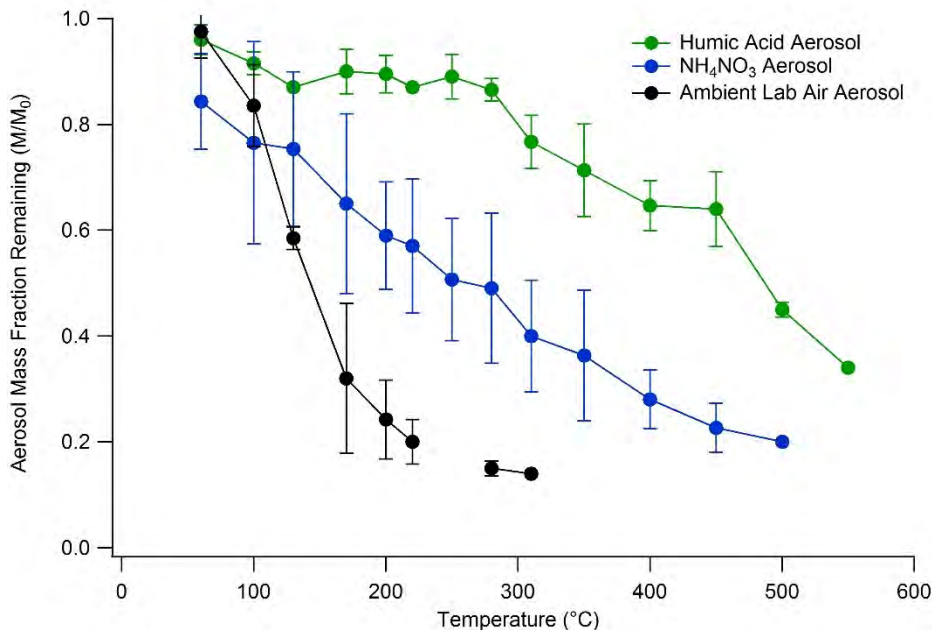

Figure 7. Sample thermogram from characterization experiments demonstrating that aerosol inlet demonstrates that a temperatures (>400C) are required to completely volatilize aerosol

III Work Plan for Year 3

As described in our Year 1 Annual Report, we will finish the seasonal field campaigns with Spring 2016 (April 15-May 15), Summer 2016 (July 15-August 15), and Fall 2016 (Sept.15-Oct.15). Data analysis is on-going, and will continue throughout the project. We are in the process of preparing a first publication (estimated submission May 2016), with at least two additional publications planned for submission by the end of 2016. Towards the end of the project, we intend to focus on development and testing of deposition parameterizations, and the implementation of such parameterizations into regional and global models through collaboration with modelers.

IV Presentations and Publications

Delphine Farmer. "What controls the fate of atmospheric carbon?" Invited seminar at University of California San Diego. Jan 12, 2016. San Diego, CA

References Cited

- Nguyen, T. B., J. D. Crouse, A. P. Teng, J. M. St. Clair, F. Paulot, G. M. Wolfe and P. O. Wennberg (2015). "Rapid deposition of oxidized biogenic compounds to a temperate forest." *Proceedings of the National Academy of Sciences* **112**(5): E392-E401.
- Ortega, J., A. Turnipseed, A. B. Guenther, T. G. Karl, D. A. Day, D. Gochis, J. A. Huffman, A. J. Prenni, E. J. T. Levin, S. M. Kreidenweis, P. J. DeMott, Y. Tobo, E. G. Patton, A. Hodzic, Y. Y. Cui, P. C. Harley, R. S. Hornbrook, E. C. Apel, R. K. Monson, A. S. D. Eller, J. P. Greenberg, M. C. Barth, P. Campuzano-Jost, B. B. Palm, J. L. Jimenez, A. C. Aiken, M. K. Dubey, C. Geron, J. Offenberg, M. G. Ryan, P. J. Fornwalt, S. C. Pryor, F. N. Keutsch, J. P. DiGangi, A. W. H. Chan, A. H. Goldstein, G. M. Wolfe, S. Kim, L. Kaser, R. Schnitzhofer, A. Hansel, C. A. Cantrell, R. L. Mauldin and J. N. Smith (2014). "Overview of the Manitou Experimental Forest Observatory:

site description and selected science results from 2008 to 2013." Atmospheric Chemistry and Physics **14**(12): 6345-6367.

A CPT for Improving Turbulence and Cloud Processes in the NCEP Global Models

Steven K. Krueger (Lead P.I.), Peter A. Bogenschutz (P.I.), Shrinivas Moorthi (P.I.),
Robert Pincus (P.I.), and David A. Randall (P.I.)

Year 2 Progress Report
Grant NA13OAR4310101

Results and Accomplishments

Our hypothesis is that the NCEP global models can be improved by installing an integrated, self-consistent description of turbulence, clouds, deep convection, and the interactions between clouds and radiative and microphysical processes. The goal of our CPT is to unify the representation of turbulence and SGS cloud processes and to unify the representation of subgrid-scale (SGS) deep convective precipitation and grid-scale precipitation as the horizontal resolution decreases.

We aim to improve the representation of small-scale phenomena by implementing a PDF-based SGS turbulence and cloudiness scheme that will replace the boundary layer turbulence scheme, the shallow convection scheme, and the cloud fraction schemes in the GFS and CFS. We intend to improve the treatment of deep convection by introducing a unified parameterization that scales continuously between the simulation of individual clouds when and where the grid spacing is sufficiently fine and the behavior of a conventional parameterization of deep convection when and where the grid spacing is coarse. We will endeavor to improve the representation of the interactions of clouds, radiation, and microphysics in the GFS/CFS by using the additional information provided by the PDF-based SGS cloud scheme. The team is evaluating the impacts of the model upgrades with metrics used by the NCEP short-range and seasonal forecast operations.

SGS Clouds and Turbulence

Incorporation into the NCEP global forecast model

A. Belochitski and S. Moorthi (both at NCEP) have nearly completed the installation of our PDF-based SGS turbulence and clouds scheme called SHOC (Simplified Higher-Order Closure). The entirety of the SHOC code was adopted for a global model environment from its origins in a cloud resolving model, and was incorporated into NCEP GFS. All GFS SHOC runs performed so far were medium range NWP forecasts at T62 rewith prescribed initial conditions for 0Z 1 June of 2011.

SHOC was first tested in a non-interactive mode, or, in other words, in a configuration in which SHOC receives inputs from the GFS host model, but its outputs are not returned to the GFS. Detailed evaluation of SHOC will be presented when it is fully coupled to NCEP GFS. However it is worth noting that:

- SGS turbulence kinetic energy (TKE) values produced by GFS SHOC are consistent with those produced by SHOC in a CRM.
- SGS TKE in GFS SHOC exhibits a well defined diurnal cycle over land (Figure 1).
- There is enhanced boundary-layer turbulence in the subtropical stratocumulus and tropical transition-to-cumulus areas (Figure 1).
- Buoyancy flux diagnosed from the assumed PDF is consistent with that independently calculated using the Brunt-Vaisala frequency in identifying stable and unstable regions.

Next, SHOC was coupled to the GFS. Specifically, the turbulent diffusion coefficients computed by SHOC are now used in place of those currently produced by the GFS boundary layer and shallow convection schemes. In addition, SGS condensation and cloud fraction

diagnosed from SHOCs sub-grid PDF replaced those calculated in the current large-scale cloudiness scheme. Ongoing activities consist of debugging the fully coupled SHOC.

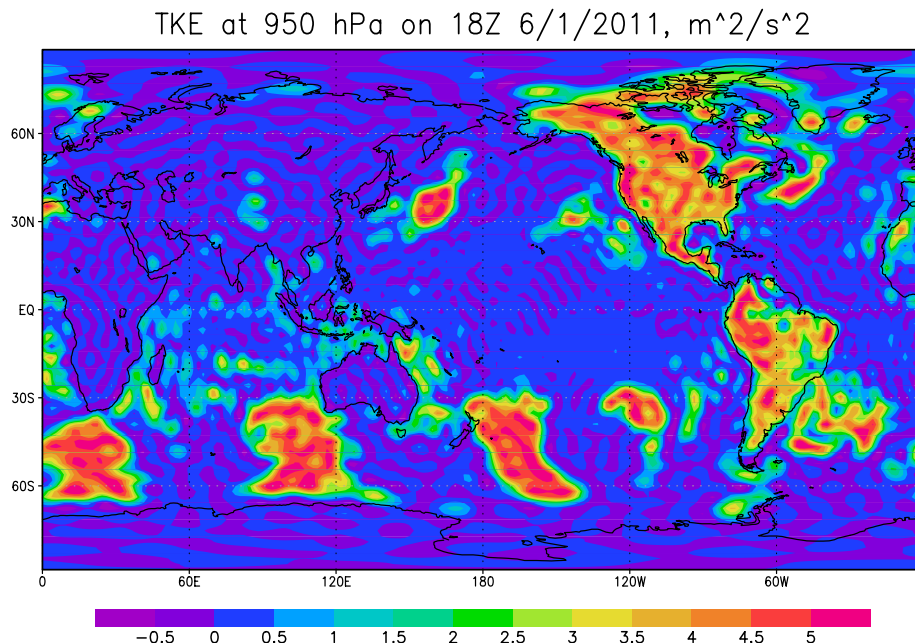

Figure 1: Turbulent kinetic energy (TKE, m²/s²) at 950 hPa on 18Z 6/1/2011 (daytime over North and South America) in NCEP GFS initialized on 0Z 6/1/2011 and run at T62 resolution.

Continued development and testing in cloud resolving models

Developments and testing of the SHOC parameterization by P. Bogenschutz (NCAR) are ongoing, partially with support from the CPT. While the majority of the SHOC testing and developments were performed within a cloud resolving model (CRM) and the Super-Parameterized Community Atmosphere Model (SP-CAM), the CPT benefits from these efforts as a greater understanding of SHOC performance and code upgrades can be gained. Bogenschutz performed experiments that examined the scale sensitivity of two different turbulence closures for a deep convection case. The results for both closures exhibit generally good scale insensitivity for horizontal grid sizes of 0.8 to 6.4 km, with slightly improved scale insensitivity for System for Atmosphere Modeling (SAM) CRM simulations when the SHOC parameterization is used versus when a low-order closure turbulence scheme is used for a deep convective regime. The reason is due to a more realistic partitioning of resolved and sub-grid scale turbulence as grid size changes.

S. Krueger (University of Utah) studied the sensitivity of CRM simulations to subgrid-scale (SGS) turbulence closure, microphysics, and resolution. His group performed two sets of simulations: One of an evolving mixed-phase cloud-topped boundary layer during a cold-air outbreak over the North Atlantic Ocean, and a second of radiative-convective equilibrium (RCE) at two different sea surface temperatures (in order to assess sensitivity to climate change).

For the cold-air outbreak case, the results are not sensitive to the SGS turbulence closure for horizontal grid sizes less than about 10 km because mesoscale cellular convection is present which is resolved by grid sizes of 10 km or less. However, for this mixed-phase cloud-topped boundary layer, the results are sensitive to the microphysical scheme used.

The RCE simulation results are sensitive to horizontal grid size (in the range of 0.5 km to 16 km), SGS cloud and turbulence closure, and microphysics. The dependence on grid size in these explicit convection simulations supports the need for a unified cumulus parameterization scheme in which the updraft area fraction can be any value from 0 to 1.

In contrast, the differences due to the SST change (between otherwise identical simulations) are mostly independent of horizontal grid size, SGS cloud and turbulence closure, and microphysics except for the shortwave cloud radiative effects.

Cumulus Parameterization

D. Dazlich and D. Randall (both at CSU) and S. Moorthi installed the Chikira-Sugiyama (CS) convection parameterization into the GFS. Moorthi tuned the CS scheme for the GFS by allowing the cloud base maximum vertical velocity to vary with resolution.

The scheme was initially tested with 30-day integrations of the control model and the new scheme. These were initialized to 0Z 1 June 2011 and run at both T62 and T126 resolutions. Comparison of several output fields between the default and CS runs showed CS to perform satisfactorily. A comparison of the probability distribution functions of the total precipitation rates between the two models and TRMM satellite data (see Figure 2) show the CS can better represent the frequency of heavy rain events compared to the control.

The two models were integrated for one year with climatological SST at T62 resolution. Monthly mean maps of CS fields compared well with the control model. Tropical intraseasonal variability was also compared and CS represented this well in the 850mb and 200mb zonal wind fields. CS reduced the top of atmosphere radiative imbalance in the annually-averaged global mean compared to the control (see Figure 3). These integrations are now being repeated at T126 resolution.

The CS scheme has been implemented as an option in NEMS and has been tested at T1534 resolution. A forecast made from October 24, 00z, 2012 produced a fairly good forecast for Hurricane Sandy.

Radiative Transfer and SGS Clouds

R. Pincus (University of Colorado) has made progress on the coupling of SHOC and the Arakawa-Wu unified convection to radiation within the GFS. Both parameterizations represent a significant departure from the existing coupling in which stratiform cloud properties are assumed to be uniform with each grid cell and the convective clouds don't interact with radiation because they have such small areal extent. We needed a structure that would let us draw samples of cloud properties (for use with the McICA treatment of sub-grid variability) that would use the PDF of cloud properties from SHOC and/or the properties of finite convective clouds from AW; this is made more difficult because we need a representation general enough to encompass any variation of current and new parameterizations. Pincus' solution is to use more modern features of Fortran, especially type-bound procedures and polymorphism, to hide the details from the underlying radiative transfer algorithm while providing the ability to draw samples consistent with whichever parameterizations are ac-

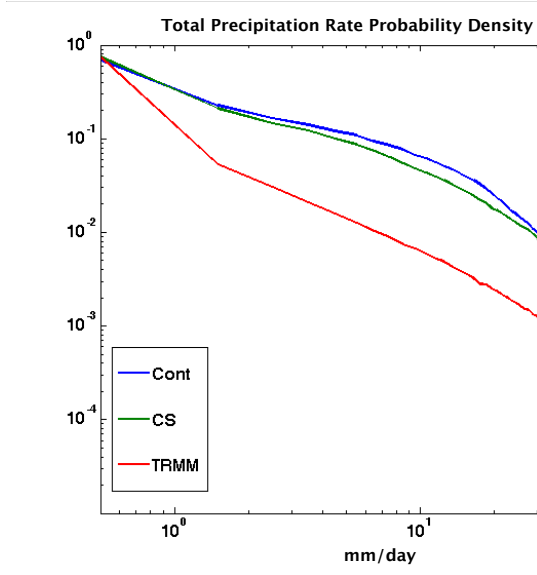

Figure 2: Total precipitation probability distribution function for June 2011, 50 N. Model outputs (30-day integrations on a 2.5-degree grid. T62: Control, default GFS, and CS, Chikira-Sugiyama convection) are compared against TRMM. TRMM has been time-averaged to 6 hours and spatially averaged to a 2.5-degree grid.

Annually-averaged global mean energy fluxes (W m⁻²)

	Control	C-S
OLR	239.66	238.61
TOA net down SW	254.40	248.90
TOA net down rad	14.75	10.29
SFC latent heat flux	88.52	88.10
SFC sensible heat flux	15.65	14.60
SFC net up LW	63.06	61.73
SFC net down SW	178.40	172.85
SFC net down energy flux	11.17	8.41

Figure 3: Annually-averaged, global mean energy fluxes at top of atmosphere and surface. All units W/m². From one year T62 integrations with climatological SST with Chikira-Sugiyama convection (C-S) and without (Control)

tive. We now have to do the hard work of writing the underlying code, but we are now able to do so incrementally as new physics is added.

Sampling treats cloud macrophysical variability. With respect to microphysics we are in ongoing discussions with Yu-Tai Hou, the EMC global model radiation developer, about how to structure microphysical assumptions that will blend smoothly with work being done by Sarah Lu's CPT.

Highlights of Accomplishments

- SHOC code was adapted for the global model environment. SHOC replaces the parameterizations of boundary layer turbulence, shallow convection, and large-scale condensation previously used in NCEP GFS.
- CRM simulations of deep convection at horizontal resolutions from 0.5 km to 16 km support the need for a unified cumulus parameterization scheme.
- Installed the Chikira-Sugiyama (CS) convection parameterization into the GFS.
- CS better represents the frequency of heavy rain events and reduces the top of atmosphere radiative imbalance in the annually-averaged global mean.
- Developed a general method for conveying arbitrarily complicated cloud information.

Publications from the Project

(None)

PI Contact Information

Lead P.I.:

Steven K. Krueger, Professor
Department of Atmospheric Sciences
University of Utah
135 South 1460 East, Room 819
Salt Lake City, UT 84112-0110

steven.krueger@utah.edu
phone: (801) 581-3903

P.I.:

Dr. Shrinivas Moorthi, Research Meteorologist
Global Climate and Weather Modeling Branch
Environmental Modeling Center / NCEP
5830 University Research Court - (W/NP23)
College Park MD 20740

Shrinivas.Moorthi@noaa.gov
phone: (301) 683-3718

P.I.:

David A. Randall, Professor
Department of Atmospheric Science
Colorado State University
1371 Campus Delivery
Fort Collins, Colorado 80523-1371

randall@atmos.colostate.edu
phone: (970) 491-8474

P.I.:

Dr. Robert Pincus, Research Scientist
CIRES
University of Colorado at Boulder
Box 216 UCB
Boulder, CO 80309-0216

robert.pincus@colorado.edu
phone: (917) 464-3569

P.I.:

Peter A. Bogenschutz, Project Scientist
Climate and Global Dynamics
National Center for Atmospheric Research
P.O. Box 3000
Boulder, CO 80307-3000

bogensch@ucar.edu
phone: (303) 497-1341

Budget for Coming Year

The budgets for the coming year are unchanged from those revised before the awards were made in accord with NOAA’s requests.

Investigator	Institution	Budget
Krueger	Univ of Utah	\$71,000
Moorthi	NCEP/NOAA	\$125,000
Pincus	ESRL/NOAA	\$85,000
Randall	CSU	\$65,000
Bogenschutz	NCAR	\$12,000

Future Work

The future work is unchanged from that in the submitted proposal, which is reproduced below. However, progress is anticipated to be significantly less rapid than originally planned due to the reduction of Moorthi’s (NCEP/NOAA) budget by more than \$130K, and the consequent reduction in postdocs at NCEP from two to one.

- **Year 3**

Belochitski and Moorthi will complete debugging of the fully coupled SHOC in the NCEP GFS. Bogenschutz will continue to test SHOC performance on the deep convective regime and scale sensitivity, continue developments and improvements of SHOC parameterization, and will collaborate on developing a single column version of SHOC. Krueger will assist with the installation and evaluation of SHOC in the GFS SCM, collaborate with Pincus on using information from SHOC in the radiative transfer model, and collaborate with Randall on using information from the unified cumulus parameterization in SHOC. Randall and Dazlich will implement a first version of the Unified Parameterization proposed by Arakawa and Wu, by building on the work we have already done with the Chikira-Sugiyama parameterization. They will also continue tests of the model, in both forecast mode and climate mode. Pincus will work with Yu-Tai Hou to choose microphysical options that work with SHOC and can easily be extended when 2-moment microphysics is available, implement McICA sampling for double-Gaussian PDFs as produced by SHOC, and depending on progress, help EMC integrate updated RRTMGP radiation code using our new cloud/aerosol/radiation interfaces into the GFS.

Continue to perform medium-range NWP forecasts with prescribed initial conditions (from the operational GDAS). Evaluate model performance and tune the physics if necessary. Continue to perform AMIP-type climate tests¹ with prescribed (observed) SSTs. Depending on the results tune the model or modify the parameterizations. Since the planned changes touch all aspects of the physics including SGS turbulence, cloud-radiation-microphysics interaction, and unified convection, we expect extensive testing and fine tuning.

¹An AMIP-type climate test is a year-long forecast with observed boundary conditions of SST, snow, and sea ice fields to help identify if the updated physics has some climate bias.

Carry out fully cycled GFS parallel experiments at lower resolution (such as T382), including both analysis and forecast steps. Using NCEP/EMC/GCWMB² standard verification package to assess performance of the updated model compared to the operational version at that resolution. Evaluation metrics include but are not limited to anomaly correlations, RMSE, precipitation skill scores, fits to surface and rawinsonde observations, hurricane track, etc. This procedure may need to be iterated to obtain optimal performance from the new physics.

If coupling to an ocean model is available,³ start testing with the coupled model to assess the impact of physics on long term coupled integration. If the results from any of the physics changes show promise for NWP, perform the cycled parallel test at the current (or future) operational resolution for possible operational implementation.

- **Year 4**

Continue coupled climate forecast experiments. Examine impact of new physics on ENSO, MJO, ISO, monsoon variability, etc. Perform coupled model runs in the seasonal forecast mode: i.e., several years (~ 5 years) of nine-month retrospective forecasts from operational initial states starting from different seasons to assess the impact of the new coupled model on seasonal forecasting. Depending on the results, EMC may select all or parts of the physics upgrade to be considered for future CFS implementation. Likewise, we will again parallel test all or parts of physics upgrade (incorporated in the NEMS-based global model) in fully cycled mode at the anticipated resolution for future global model and make it available for operational implementation.

²Global Climate and Weather Modeling Branch

³The current GFS is already coupled to MOM4 (GFDL's Modular Ocean Model, v. 4). However, the new GFS in the NEMS (NOAA Environmental Modeling System) infrastructure is yet to be coupled, but will be coupled to MOM5 (Modular Ocean Model, v. 5) and HYCOM (HYbrid Coordinate Ocean Model). CPC is already running the current GFS coupled to MOM4 as preliminary step toward future CFSV3.

Title of grant: Towards Assimilation of Satellite, Aircraft, and Other
Upper-Air CO₂ Data into CarbonTracker
Type of report: Year 2 progress report
Name of PI: David F. Baker
Period covered by the report: 05/01/14 to 04/30/15
Institution name and address: Cooperative Inst. for Research in the Atmosphere
Colorado State University
1371 Campus Delivery
Fort Collins CO 80523-1371
NOAA award number: NA13OAR4310077
NOAA technical contact: Pieter Tans, ESRL/Global Modeling Division
NOAA research personnel: Andrew Jacobson, CIRES/University of Colorado
CIRA/CSU research personnel: Michael Trudeau, Andrew Schuh, David Baker

Background:

CarbonTracker-CO₂ (CT) is a data assimilation system that estimates sources and sinks of CO₂ from atmospheric measurements, using an atmospheric transport model to link CO₂ concentrations to surface fluxes. It solves for fluxes across continental biome-sized regions over land, and basin-sized regions over the ocean, using data from NOAA/GMD's global network of *in situ* CO₂ measurement sites (flasks, tall towers, and continuous sensors). Over the past decade, it has been the most-used CO₂ flux product in the world. As currently configured, however, the link between surface fluxes and the down-stream effect on CO₂ concentrations is truncated after only five weeks: this is too short a time for these fluxes to mix well into the middle to upper part of the atmospheric column. As a result, CT cannot use data taken far away from the surface, such as aircraft profiles and column-averaged CO₂ measurements from satellite and ground-based spectrometers, to provide a reliable constraint on surface fluxes: signals in the upper part of the atmospheric column are mis-attributed to near-field fluxes (those emitted within 5 weeks) rather than to the far-field fluxes that actually caused them. Given the current explosion of such data from satellites (GOSAT, OCO-2, *etc.*) and from the Total Column Carbon Observing Network (TCCON), we would like to modify CT to be able to use these data. In this project, we will experiment with lengthening the 5-week assimilation window currently used in the CT ensemble Kalman smoother (enKS), as well as adding an "outer-loop" inversion to optimize the prior used in the enKS at coarser scales, to minimize truncation errors from shorter window lengths in the enKS. We will also enhance CT to solve for the surface CO₂ fluxes at higher spatial resolution when using the new high-density data. Simulation experiments will be used to accurately assess the impact of the modifications.

A secondary goal is to diversify CarbonTracker by allowing the use of a second transport model as the basis of the inversion scheme. It was discovered in the past couple years that the TM5 model around which CarbonTracker was based did not have enough vertical mixing over the continents, causing the fluxes retrieved by the inversion to be skewed, particularly in terms of the partition of flux between the northern and tropical continents. Having a second model "opinion" will help diagnose such errors in the future.

Adding GEOS-Chem as a second transport model in CT

In order to test CarbonTracker at window lengths longer than the current 5-week setting, we had planned to use the PCTM transport model, which PI Baker has used for other work in a fast-running, low-resolution configuration. Baker ported PCTM, along with its driving MERRA meteorology, to the zeus computer, to that end. However, in discussions with Andy Jacobson, it was decided that, given the effort involved in modifying PCTM for use in CarbonTracker, it would make more sense for the CarbonTracker project to use a different model with better user support: GEOS-Chem. GEOS-Chem and PCTM are very similar: they both use the Lin-Rood finite volume advection scheme, and they both use GEOS5 analysis and reanalysis products from NASA/Goddard for their driving meteorology and mixing fields. They differ in their vertical mixing schemes – GEOS-Chem’s are a bit more process-based (though it is not necessarily the case that they lead to better transport results). The main difference between the two models, at this point, is that GEOS-Chem is used by a large and growing team of collaborating researchers, with technical support from Daniel Jacob’s group at Harvard, while the PCTM model seems to be in more of a holding pattern, with few updates having been made to the model over the past decade (at least by the original developers at NASA/Goddard). A new MPI-parallelized version of GEOS-Chem is coming out soon, while PCTM has only shared-memory parallelization, with no plans for moving to MPI. Also, the vertical mixing schemes currently being used in PCTM could be added as options in GEOS-Chem, resulting in a PCTM-within-GEOS-Chem model that would give the best of both worlds. The same changes that PI Baker made to PCTM to allow it to run quickly at coarse resolution could be made to GEOS-Chem too, to allow it to be used for the long-window experiments.

Andrew Schuh was brought onto the project to add GEOS-Chem into CarbonTracker, instead of PI Baker adding PCTM. Andrew has had considerable experience over the past few years porting, compiling, and modifying GEOS-Chem for use in his own ensemble Kalman filter for estimating CO₂ fluxes.

Andrew has modified GEOS-Chem to accept the same prior flux fields and to solve for the same biome-based flux multiples as are being used in the TM5-based version of the current CarbonTracker. He also added code to accept *in situ* measurements in NOAA/GMD’s new ObsPack format, and to average the model output in the same manner as CarbonTracker now does. With these changes, GEOS-Chem now can be dropped into a driver program that performs the time-stepping and measurement updates that constitute the CarbonTracker ensemble Kalman filter. Andy Jacobson uses R scripts to do this. Andrew has a similar set of R scripts that execute his own ensemble Kalman filter, which he has been developing for a number of years. Using GEOS-Chem in his own enKF scripts, but with the measurement and flux parameter details set to those of the current CarbonTracker, Andrew has now done test cases to compare how closely his code compares to the existing TM5-based CarbonTracker. Two main factors could cause differences in the results: 1) the transport model (GEOS-Chem vs. TM5), and 2) the details of the enKF optimization code (Andy Jacobson’s R code, based on Whitaker & Hamill (2002), versus Andrew Schuh’s R code, based on Tippet et al (2003)).

Forward runs of identical flux priors show that GEOS-Chem gives similar CO₂ fields to those from TM5, when sampled at NOAA’s *in situ* sites (Fig. 1), with subtle differences in vertical trapping of CO₂ and in long-term trends. When GEOS-Chem is used in Andrew Schuh’s enKF inversion code, and compared to the results of Andy Jacobson’s Carbon Tracker code

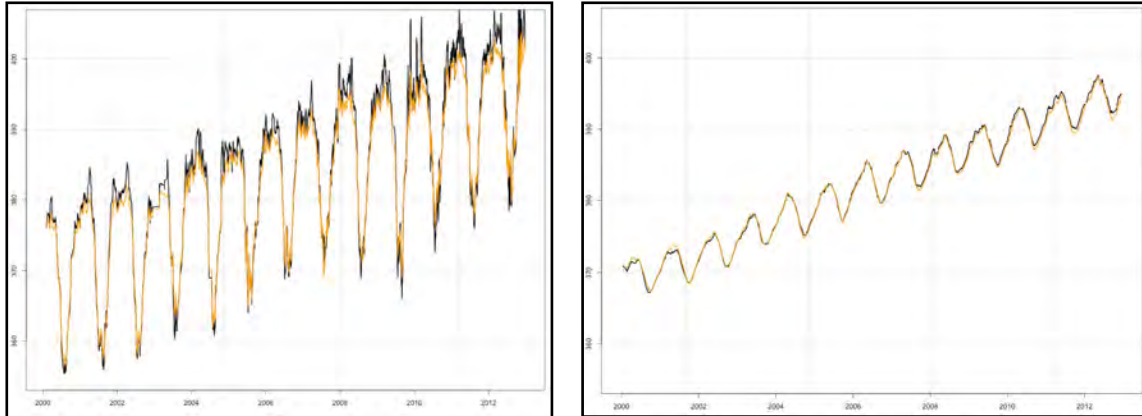

Figure 1: Comparison of CO₂ concentrations given by two transport models, TM5 (orange) and GEOS-Chem (black), at two NOAA *in situ* measurement sites (Park Falls, Wisconsin, left, and the South Pole, right) across a 12-year run using identical MERRA drivers and *a priori* flux priors.

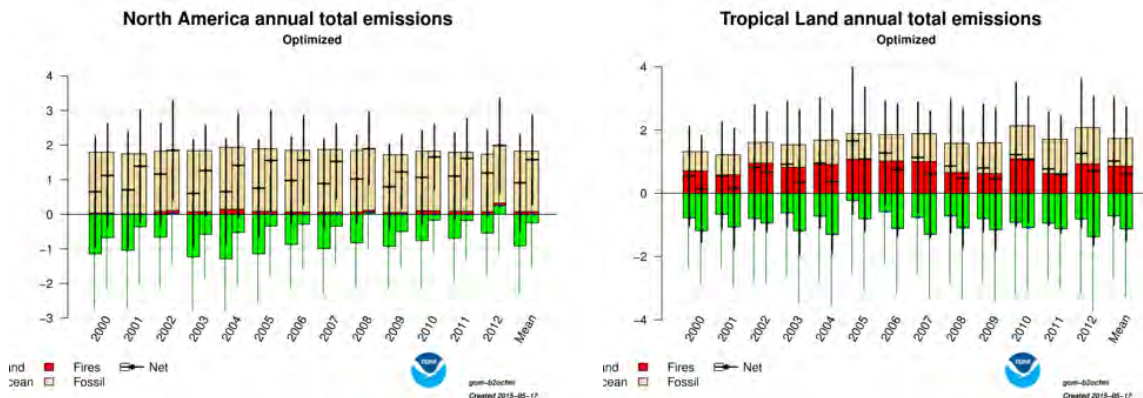

Figure 2: Comparison of regionally-integrated CO₂ flux for two different versions of CarbonTracker using the same prior fluxes and *in situ* measurement data: the current CarbonTracker-2013b, with TM5 transport and Andy Jacobson's driver code (left-hand bars); and that using GEOS-Chem and Andrew Schuh's driver code (right-hand bars). Flux results given for North America (left) and the total Tropical Land regions (right). Land biosphere NEE (green), fossil fuel burning (tan), and wildfire (red).

(again, testing both transport and inversion code differences), larger flux differences are found (Fig. 2). Since the difference due to transport from the forward runs (Fig. 1) seemed small, we think these larger inversion differences should be due to differences in the inversion code. This is most likely due to problems with the implementation of Andrew Schuh's driver code, but the possibility exists that some of it might also be due to issues with the current implementation of CarbonTracker (i.e., with Andy Jacobson's driver code). The next step is to do similar comparisons with GEOS-Chem using the Jacobson driver code, and TM5 with the Schuh drivers, to better understand the differences.

Impact of lengthening the enKF window length

On the TM5 side, Michael Trudeau also looked into the possibility of running CarbonTracker at a $4^\circ \times 6^\circ$ (lat/lon) resolution (coarser than the $2^\circ \times 3^\circ$ resolution currently being used in CT for the full globe). Going to this coarser resolution does speed up TM5's run time by a factor of 2 to 3, but we were hoping for a larger speed-up for doing the window tests efficiently. We were going to wait until GEOS-Chem was fully implemented to do the window-length tests, but Andy Jacobson went ahead and submitted a suite of such tests using TM5, some of the tests at the current $2^\circ \times 3^\circ$ resolution, some using the $4^\circ \times 6^\circ$ driver files that Michael put together. A couple of these experiments simply lengthened the current 5-week window to 3 and 6 months, keeping the 1 week flux time discretization and 1 week forward stepping length the same as in the current CT implementation. (Because the time it takes to do these runs is proportional to the number of time steps in the enKF state vector, which changed from 5 to 12 to 26, these took quite long to run – the 6-month run is still only 25% finished.) Other experiments lengthened the window to 3 or 6 months, kept the flux discretization length at 1 week, but changed the time-stepping length from 1 week to 2 weeks or 4 weeks. This innovation of Andy's may greatly speed up these longer-window runs – we are in the process of assessing what the cost is, in terms of accuracy, of taking longer steps like this. And finally, Andy submitted some runs at the coarser spatial resolution ($4^\circ \times 6^\circ$).

Lengthening the enKF window length from 5 weeks to 3 months generally seems to reduce the biases in the *a posteriori* measurement residuals seen in the current implementation of CarbonTracker. An example of this is seen in Figure 3, for NOAA Mauna Loa flask samples.

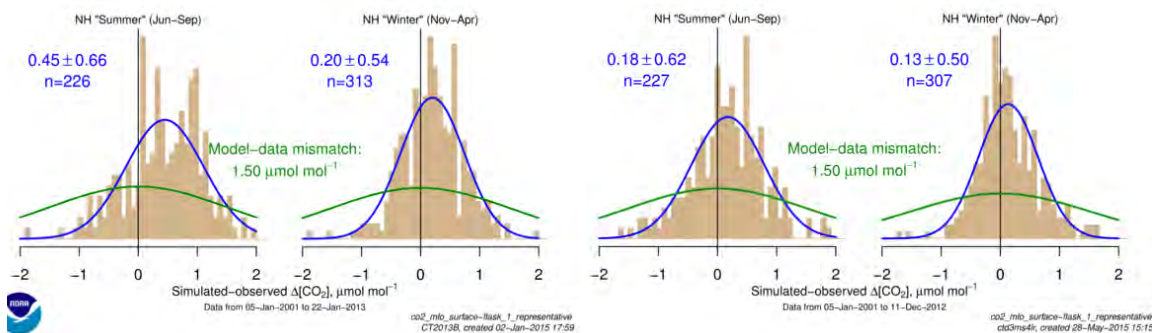

Figure 3: *A posteriori* measurement residuals for NOAA flask samples at Mauna Loa [ppm], for broad “summer” and “winter” seasons. The overall bias in the current CT-2013 fit (left) is improved when lengthening the enKF assimilation window from 5 weeks to 3 months (right), from 0.45 to 0.18 ppm in the summer, and from 0.18 to 0.13 ppm in the winter.

It also seems to reduce the spread in the *a posteriori* measurement residuals in the northern hemisphere. Figure 4 gives “summer” and “winter” histograms of the fit to all the NH data used in the inversions, for the standard (5-week window) CT-2013b product versus a coarse-resolution ($4^\circ \times 6^\circ$) CT run with a 3-month window: running with the longer window results in almost a two-fold reduction in the standard deviation in the summer months (from 6.31 to 3.24 ppm), though the improvement in the winter is less (from 4.01 to 3.17 ppm). Much of the reduction in the NH summer is due to an improvement in reducing large outliers (>5 ppm, say). Apparently the use of the longer window allows the “carbon weather” in the NH summer to be fit better – this points to the importance of following CO_2

plumes far downstream of their emission locations (farther than 5 weeks) when attempting to model CO₂ measurements.

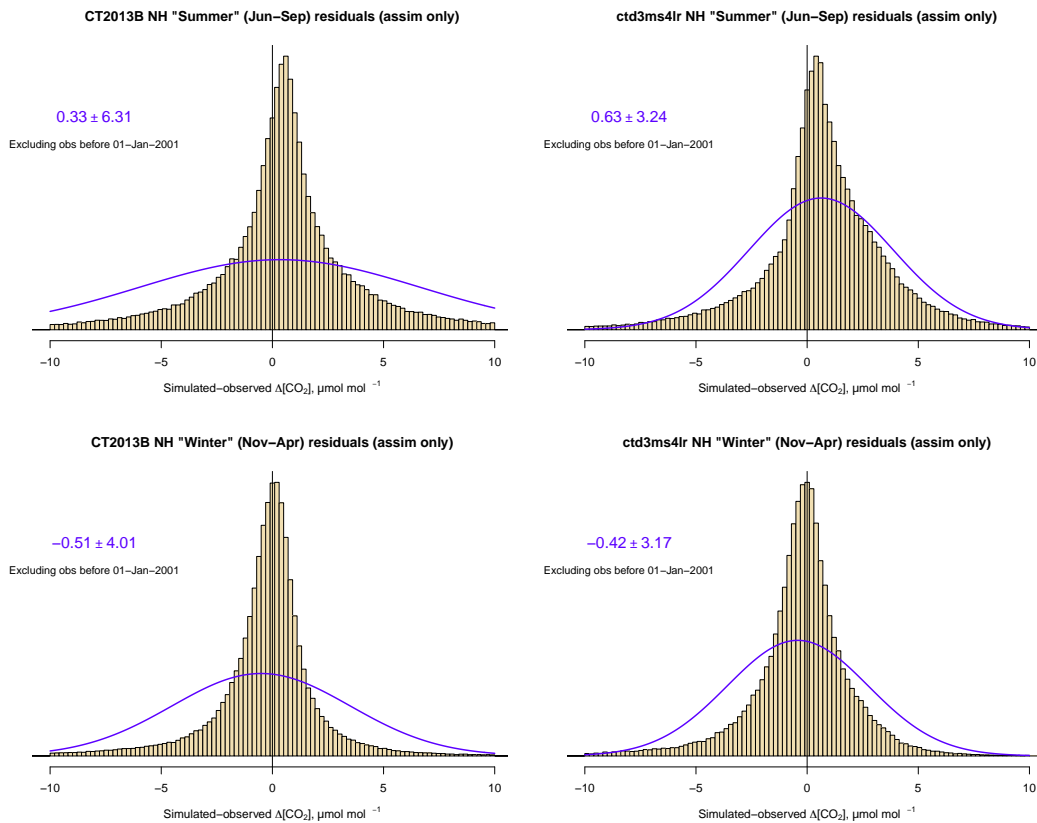

Figure 4: *A posteriori* measurement residuals for all northern hemisphere *in situ* measurements used in the CT-2013b inversion, for broad “summer” and “winter” seasons. CT-2013b results on left, results for a coarse-resolution 3-month window case on right.

We hope to have a more complete view of the impact of the longer window lengths when Andy’s tests have all finished running and the needed plots have been made. If we find that Andy’s time-saving trick of stepping forward multiple weeks at a time does not significantly degrade the performance of the inversion, then we may be able to use TM5 at 4°x6° resolution to perform even longer window runs (up to 12 months or longer). Otherwise we will work on putting together a coarser-resolution version of GEOS-Chem (coarser than the current coarsest resolution of 4°x5°) to do these runs.

CarbonTracker has already been modified to use column CO₂ measurements from satellite and TCCON in its inverse mode – we will next work on GOSAT flux inversions with CarbonTracker, and see how important the longer window lengths are to those results. Finally, we will investigate the benefits of using an outer-loop inversion, and experiment with different window lengths for the enKF, to give the best flux results (testing will be done using simulated data with a known truth).

References

Whitaker, J.S. and T. Hamill, 2002: Ensemble data assimilation without perturbed observations. *Mon. Wea. Rev.*, **130**, 1913-1924. [http://dx.doi.org/10.1175/1520-0493\(2002\)130<1913:EDAWPO>2.0.CO;2](http://dx.doi.org/10.1175/1520-0493(2002)130<1913:EDAWPO>2.0.CO;2)

Tippett, M.K., J.L. Anderson, C.H. Bishop, T.M. Hamill, and J.S. Whitaker, 2003: Ensemble Square Root Filters, *Mon. Wea. Rev.*, **131**, 1485-1490.

NOAA Joint Hurricane Testbed (JHT) Year 3 Mid-Year Report

Date: March 8th, 2016

Project Title: Upgrades to the Operational Monte Carlo Wind Speed Probability Program

Principal Investigators: Andrea Schumacher

Affiliation: CIRA / Colorado State University

Award Period: September 2013 - August 2015

Reporting Period: September 2013 - February 2016

1. PROJECT OVERVIEW AND OBJECTIVES

This project sought to complete a number of upgrades to the current Monte Carlo wind speed probability model (hereafter MC model), many of which are based on NHC feedback over the past few hurricane seasons. Three improvements to the MC model algorithm itself were made including replacing the linear forecast interpolation scheme with a more precise spline fit scheme, applying a bias correction to the model track error statistics to provide consistency between NHC's uncertainty products, and applying a bias correction to the radii-CLIPER used by the MC model to improve the accuracy of the wind speed probabilities for exceptionally small or large tropical cyclones. Three additions/enhancements were also developed, which included estimates of the arrival and departure times of 34/50/64-kt winds, an integrated GPCE parameter, and wind speed probabilities to 7 days. Finally, the error statistic generation code and scripts were consolidated to simplify annual product updates.

2. ACCOMPLISHMENTS

All upgrades were completed during the project period. A brief description and evaluation of each upgrade is given below. Additional time was given to us to continue real-time evaluation through the end of the 2015 Atlantic and N.E. Pacific hurricane seasons. Seasonal verification for 2015 can be found in Section 2f. A summary and developer recommendations can be found in Section 3, in addition to suggestions for future work in this area.

a. Potential improvements to the MC model algorithm

Three potential improvements were made to the MC model algorithm, each of which is meant to address a specific issue with MC model that was noted by either developers or users at NHC (often during special cases such as recurving landfall cases and extremely large storms like Hurricane Sandy). A brief overview of each potential improvement is given below in Sections (i)-(iii) and impacts on MC model performance are shown in Section (iv).

(i) Improved time interpolation scheme

The MC model currently uses linear interpolation to interpolate between forecast times. As result, errors have been found to be larger for the times between the NHC forecast points and an eastward bias is introduced for re-curving cyclones. Also, realization tracks have an unrealistic “jagged” appearance. To address these issues associated with linear interpolation, a spline fit interpolation approach was added as an option in the MC model. Figure 1 shows the wind speed probabilities using linear interpolation (top left) and the spline fit (top right) for Hurricane Earl when it was forecast to recurve along the U.S. east coast. The spline fit methodology appears to be correcting the eastward bias in this case, providing a more realistic interpolated track forecast after 48 hours. The corresponding 34-kt wind speed probabilities along the North Carolina coast increase from 5-10% (easiest to see in difference plot in Fig. 1 bottom left) where tropical storm force winds were indeed observed (Fig. 1 bottom right). Also, the spline fit makes realization tracks appear somewhat smoother and more realistic (Figure 2).

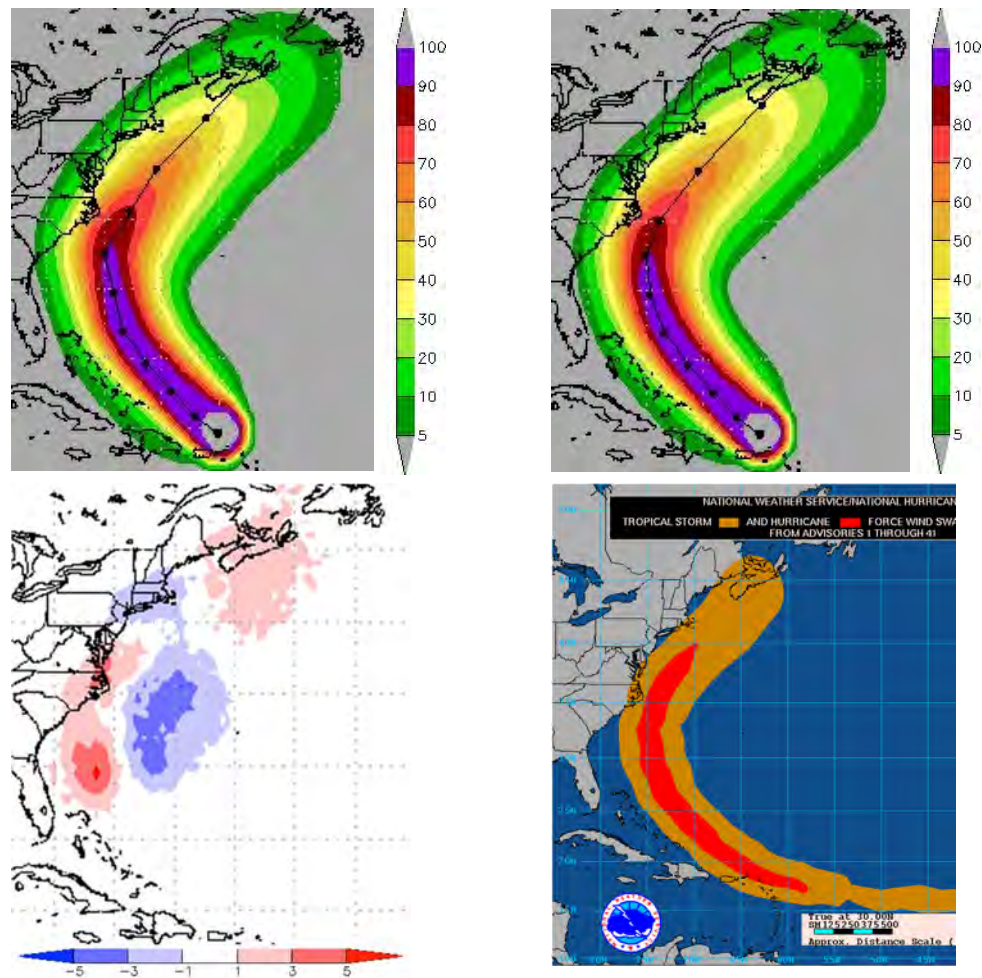

Figure 1. 34-kt wind speed probabilities using linear interpolation (top left), spline fit (top right), wind speed probability differences (spline - linear, bottom left), and NHC wind history (bottom right) for Hurricane Earl on 31 Aug 2010 0000 UTC.

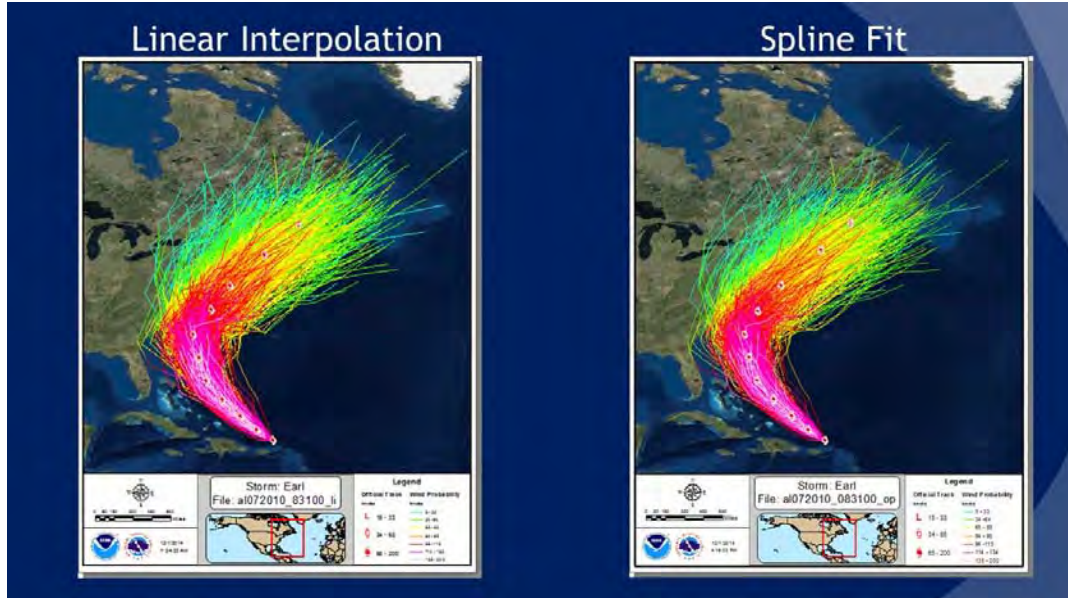

Figure 2. Realization tracks using linear interpolation (left) and spline fit (right) for Hurricane Early on 31 Aug 2010 0000 UTC (courtesy of C. Ogden).

(ii) Bias correction to track error statistics

NHC routinely provides the cone of uncertainty based on the 67th percentile of the previous 5-year average track errors as part of their advisory package. In principle, this same information could be determined from the MC model track realizations. Preliminary tests of this procedure showed that the cones did not exactly match, partially due to differing samples used to create the MC model error statistics, which include extra-tropical cases, and a small bias introduced by the serial correlation correction in the MC model. To fix this inconsistency new error statistics were derived using only cases NHC uses in their annual verification (i.e., excluding extra-tropical cases). Also, the MC model was adapted to compute the difference between the 67th percentile cone size derived from model-sample track errors that do not incorporate GPCE and the official cone size. This difference, or estimate of bias introduced by the serial correlation, is then used to correct the MC model-sampled track errors with GPCE information incorporated. The advantage to obtaining the cone from the MC model is that it would impose consistency between NHC's uncertainty products, and would increase or reduce the size of the cone based on the track forecast confidence that is obtained from the GPCE parameter, should this capability be desired.

(iii) Wind radii bias correction

The current MC model uses a climatology and persistence model to estimate the 34-kt, 50-kt, and 64-kt wind radii for its realizations, which has been found to greatly over

(under) estimate radii for exceptionally small (large) tropical cyclones. To address this issue, the MC model was adapted to use the official R34, R50, and R64 radii forecasts. Since official radii forecasts are only made out to 36-72 hours, radii at times after the last available radius forecast are relaxed back to the climatology-persistence method at an e-folding time of 32 hours. This radii bias correction was added as an option that can be turned on in the main MC model code.

Figure 3 shows an example of the 34-kt WSPs for Hurricane Sandy using the current method (left) and the bias-corrected method (center) in comparison to the actual observed 34-kt winds (right). As expected, this bias-correction method gives much more realistic-looking WSPs for this large storm out to 120 hours.

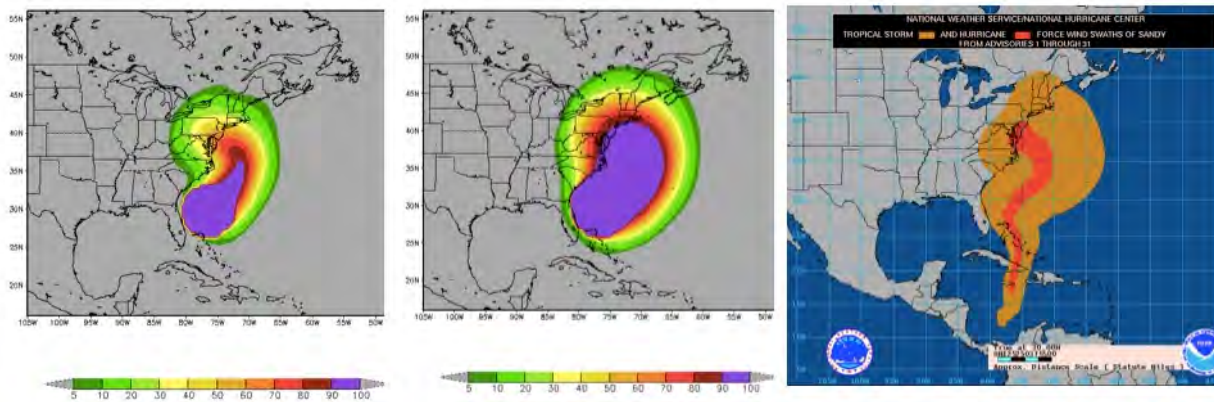

Figure 3. 34-kt wind speed probabilities for Hurricane Sandy before (left) and after (center) radii bias correction. Observed 34-kt winds are shown for comparison (right, in orange).

(iv) Impacts of potential improvements on basin-wide MC model performance

To assess the extent to which each algorithm change impacts the performance of the MC model, experimental versions of the MC model incorporating each potential improvement *individually* were developed and run over the Atlantic and N.E. Pacific basins from 2011-2014. Brier scores (Figure 4) and reliability (Figure 5) were calculated for each experimental MC model and a control version that is nearly identical to the 2015 operational MC model to provide a quantitative look at how each potential improvement actually improves (or degrades) MC model performance.

Summary of 2011-2014 verification (for cumulative probabilities):

- Spline interpolation: Impact on Brier scores and reliability is very small for all wind thresholds in both basins (as expected).
- Error statistics bias correction: Degrades Atlantic Brier scores by ~2% for 34-kt WSPs but improves 50-kt and 64-kt by a similar amount. Degrades all N.E. Pacific Brier scores by 3-4% for all wind thresholds. Worsens the slight tendency

towards overprediction in the Atlantic for 34 and 50-kt WSPs but has very small impact on reliability of Atlantic 64-kt and N.E. Pacific WSPs.

- Radii bias correction: Improves Atlantic 34-kt and 50-kt Brier scores up to 5%. Improves N.E. Pacific 34-kt Brier scores up to 8% and has very small impact on N.E. Pacific 50-kt Brier scores. Degrades 64-kt Brier scores up to 5% in both basins. Improves reliability of N.E. Pacific WSPs for all wind thresholds (reduces consistent overprediction in control WSPs to nearly perfect). Has very little impact on reliability in the Atlantic, except for 64-kt WSPs where it introduces an underprediction.

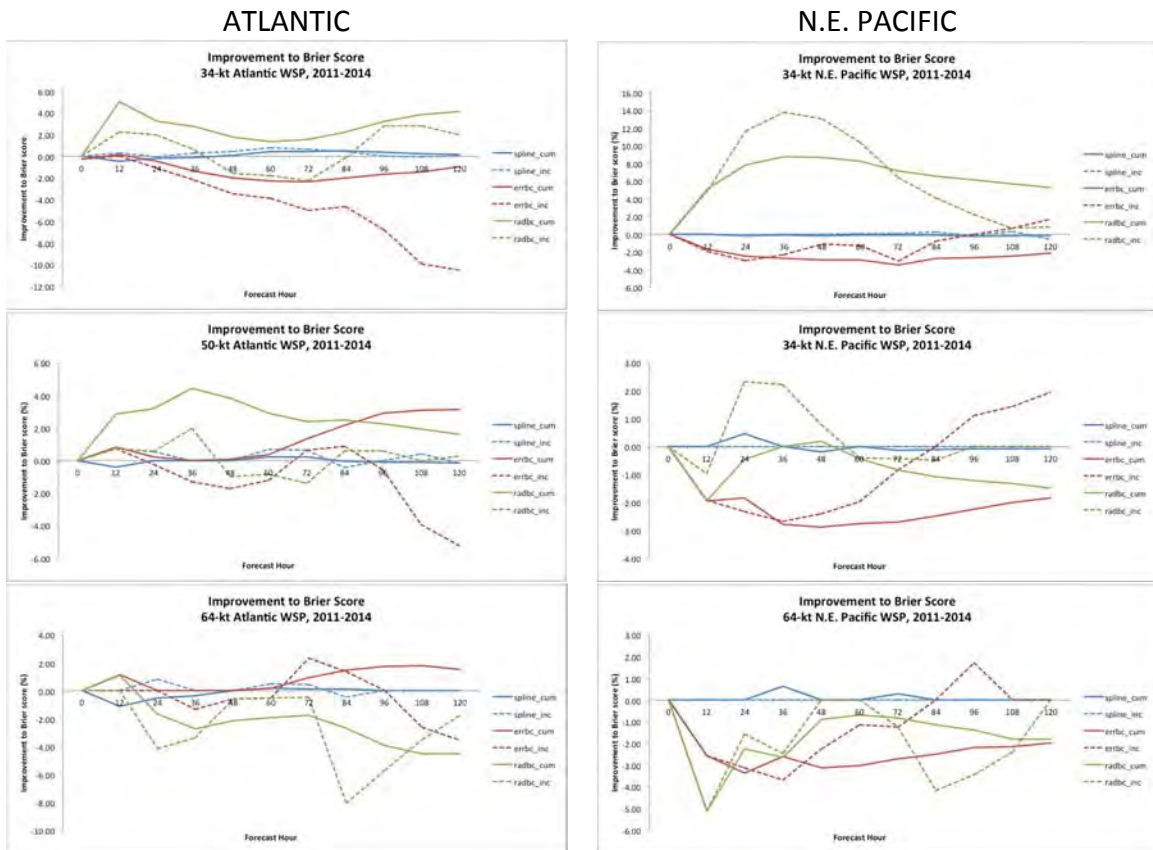

Figure 4. Percent improvement in Brier scores for 34-kt (top), 50-kt (center), and 64-kt (bottom) wind speed probabilities in the Atlantic (left) and N.E. Pacific from 2011-2014 for each potential improvement; spline interpolation (blue), error statistic bias correction (red), and radii bias correction (green) versions of the MC model. Improvement is defined as a reduction in Brier scores from the control MC model over the same sample. Brier score improvements for cumulative (incremental) wind speed probabilities are solid (dashed).

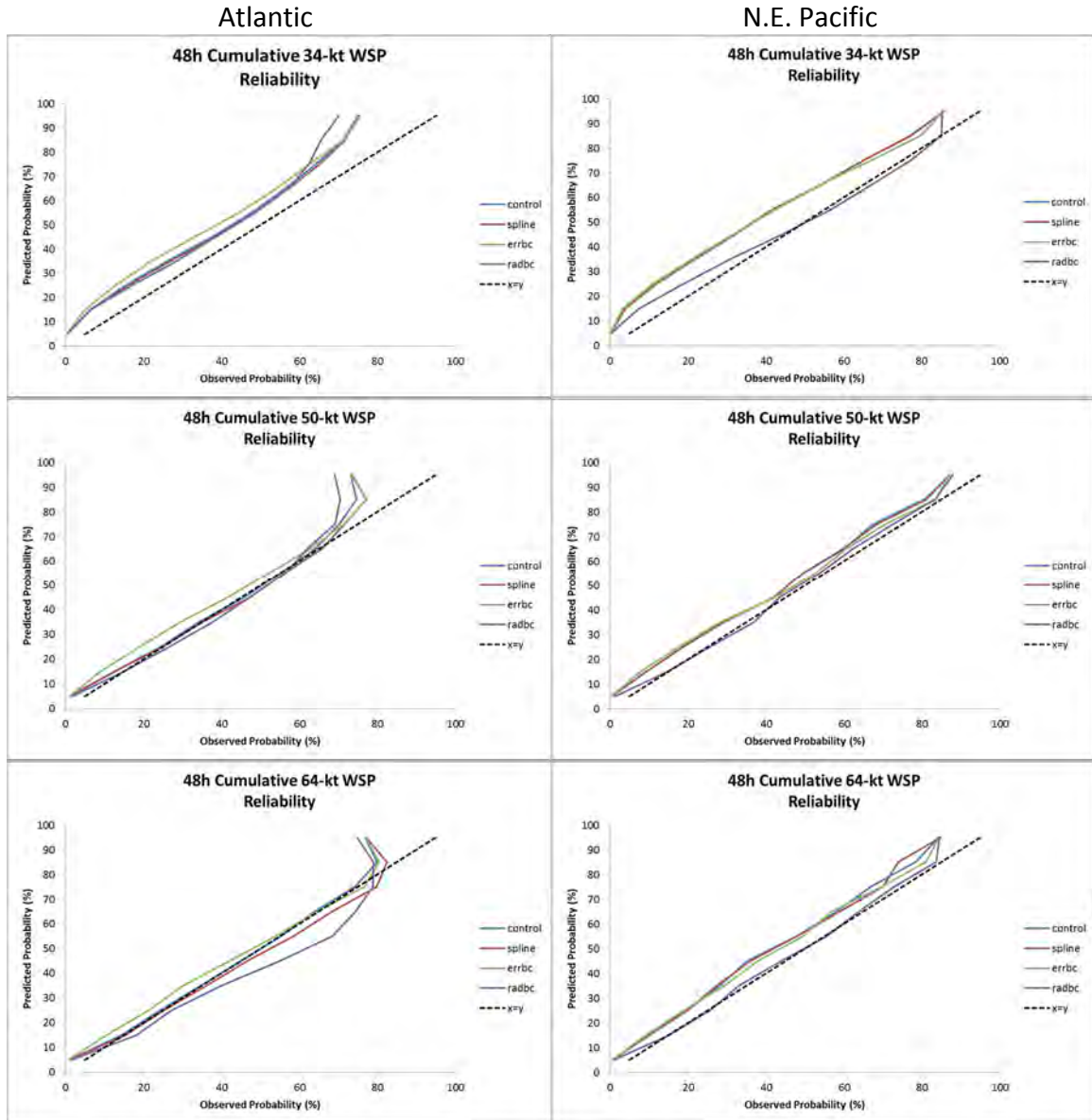

Figure 5. Reliability diagrams for 34-kt (top), 50-kt (center), and 64-kt (bottom) cumulative wind speed probabilities in the Atlantic (left) and N.E. Pacific from 2011-2014 for each potential improvement; spline interpolation (red), error statistic bias correction (green), and radii bias correction (purple). For reference, reliability for the control (blue) and the $x=y$ line (black dashed) are shown.

b. Time of arrival and departure estimates

One of the applications that can be generated with the Hurricane Landfall Probability Application (HuLPA) is the times of arrival and departure of 34, 50 and 64-kt winds at a user-specified point. NHC feedback has indicated that this information would be extremely useful for emergency managers, but generating these values for a wide range of coastal points using HuLPA's post-processing GUI would be very inefficient. This timing information has now been incorporated directly into the MC model. The MC model code was adapted by NHC focal points to estimate the time of arrival/departure of 34-, 50-, and 64-kt winds using various probability thresholds (e.g., Figure 6). The version of the MC model code that includes the arrival/departure estimates was given to CIRA in Year 2 and, with additional support from Hurricane Sandy Supplemental funds, was upgraded to Fortran 90 and prepared for operational implementation. The clean, modularized, F90-compliant code was delivered to Mark DeMaria in June 2015. The code was installed, compiled, and tested on WCOSS and the Automated Tropical Cyclone Forecast (ATCF) system by TSB staff. The test case provided ran successfully on both systems with approximate run times of 2 minutes.

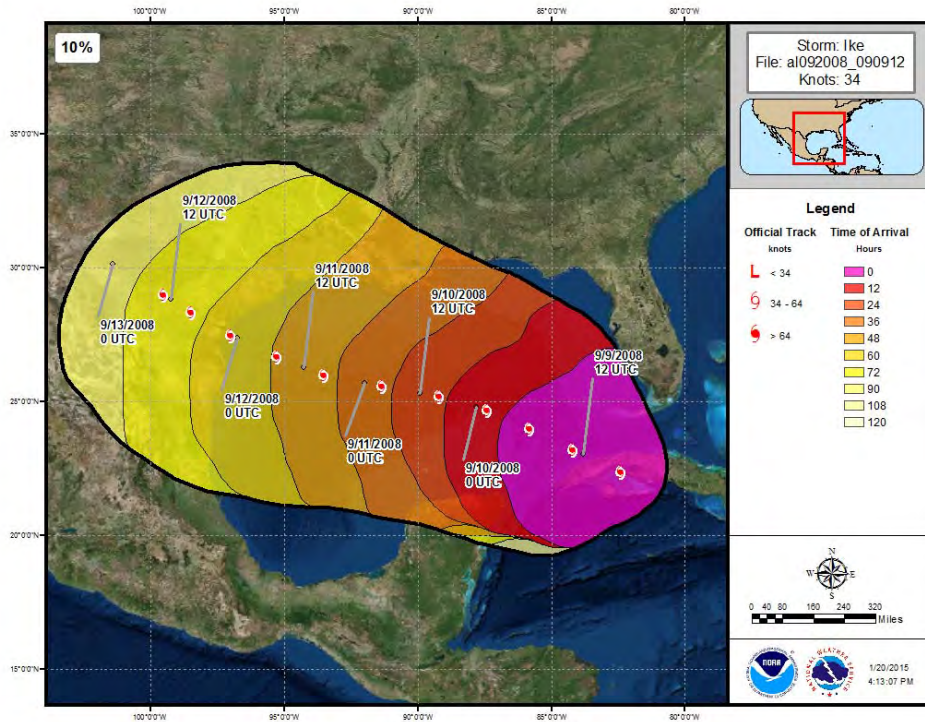

Figure 6. Time of arrival estimates (based on 10th percentile) for Hurricane Ike on 18 September 2008 at 18 UTC generated by the newly upgraded MC model. Image courtesy of Casey Ogden, NHC.

c. Integrated GPCE parameter

It has been shown that past NHC track forecast errors can be separated into terciles based on their corresponding GPCE value, and that track forecast errors in the low (high) terciles tend to correspond to less (more) spread in forecast errors (DeMaria et al. 2013). This finding motivated the use of a GPCE parameter in the MC model. At present, this GPCE parameter determines the track error statistics used by the MC model at each forecast time to estimate wind speed probabilities, but the GPCE categories (low, medium, high) are not output directly.

It is trivial to output the GPCE categories from the MC model, but it would be desirable to do so in a way that provides a single GPCE estimate valid for the entire forecast. As such, a time-integrated measure of the GPCE, called time-average normalized GPCE (TANG), was developed from GPCE information currently used in the MC model. This integrated uncertainty measure is obtained by normalizing GPCE at each forecast time by the mean and standard deviation of the last 5 years of GPCE values and then averaging over all forecast times. The same method was applied to track forecast errors to calculate time-average normalized track errors (TANTE).

After discussion with NHC POCs in late year 1, we decided to investigate several different methods of developing a categorical GPCE estimate. Two different thresholding schemes were tested; partitioning GPCE values into equally sized terciles (33%/33%/33%) and a scheme with smaller numbers of high and low values (10%/80%/10%) in order to emphasize extremes. NHC POCs expressed an interest in having integrated GPCE estimates for both the early part of the forecast (days 1 and 2) and the later part (days 3, 4, and 5). 2009-2013 Atlantic TANTE distributions for low (blue), medium (red), and high (green) GPCE values using the two different thresholding definitions are shown in Figure 7 for all 3 forecast times examined (entire forecast, early, and late). These distributions suggest that all TANG thresholds being tested provide a separation between low and high track forecast errors, with low (high) TANG corresponding to lower (higher) errors and less (more) spread. To further investigate the skill of the different thresholds, several cases were chosen from the development sample that have low GPCE values early in the forecast and high GPCE values later on (and vice versa, Figure 8). For this test, we found that the tercile thresholds did a better job of correctly classifying cases at all forecast intervals.

Terciles (33/33/33)

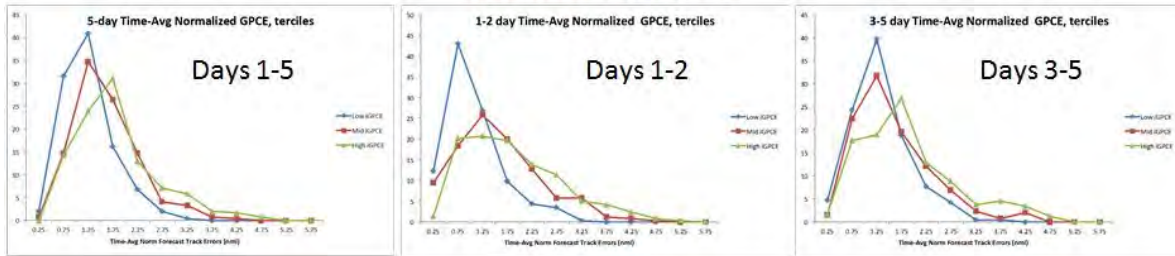

10/80/10

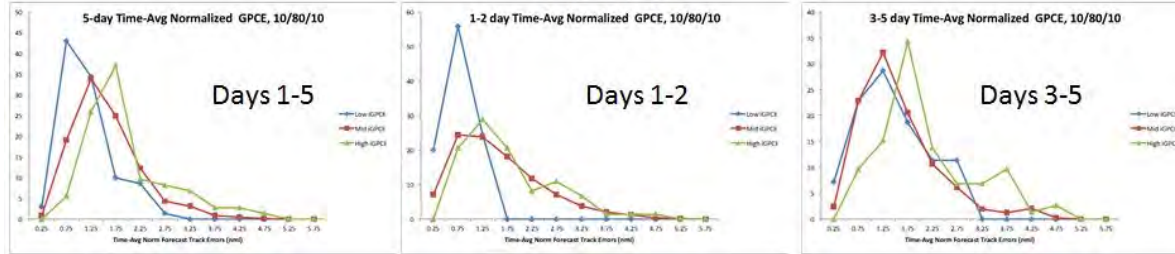

Figure 7. Distributions of 2009-2013 Atlantic time-average normalized track errors for low (blue), medium (red), and high (green) time-average normalized GPCE values, using terciles (top) and 10%/80%/10% (bottom) partitioning to define GPCE categories.

Low GPCE Days 1-2 / High GPCE Days 3-5										TANG 1-2day		TANG 3-5day		TANG 0-5day		
Fcst Hr	12	24	36	48	60	72	84	96	108	120	10/80/ 10	33/33/ 33	10/80/ 10	33/33/ 33	10/80/ 10	33/33/ 33
AL172012 101512	33	54	69	86	130	174	240	306	382	458	M	L	M	H	M	H
AL182011 102606	23	42	66	97	154	211	333	455	607	759	L	L	H	H	H	H
AL162011 093006	26	46	71	100	148.5	197	279	361	427.5	494	M	L	H	H	M	H
AL062010 082706	21	42	65	100	137.5	175	226	277	328	379	L	L	M	H	M	M

High GPCE Days 1-2 / Low GPCE Days 3-5										TANG 1-2day		TANG 3-5day		TANG 0-5day		
Fcst Hr	12	24	36	48	60	72	84	96	108	120	10/80/ 10	33/33/ 33	10/80/ 10	33/33/ 33	10/80/ 10	33/33/ 33
AL032012 062100	41	66	122	154	153	152	177.5	203	229.5	256	H	H	M	L	M	H
AL162011 092112	42	70	96	122	127.5	133	162.5	192	230.5	269	M	H	M	L	M	M
AL052011 080706	52	97	149	165	152.5	140	166.5	193	216	239	H	H	M	L	M	H
AL062010 082118	63	112	146	168	160	152	168	184	189	194	H	H	M	L	M	H

Figure 8. Categorization test results for 4 cases with low GPCE at early forecast times and high GPCE for late forecast times (top) and 4 cases with high GPCE at early forecast times and low GPCE at late forecast times (bottom).

d. Extend wind speed probabilities to 7 days

NHC began making in-house track and intensity forecasts beyond 5 days in 2011. Currently, 148h and 166h forecasts are available in the official a-decks available on the NHC ftp site. Using these extended forecasts, the 6-day and 7-day track and intensity forecast errors were calculated and a 7-day version of the MC model was developed. An example of the cumulative 34-kt wind speed probabilities for Hurricane Isaac out to 5 days (left) and out to 7 days (right) is shown in Figure 9. Brier skill scores were calculated over the 2011-2014 sample cases the Atlantic and N.E. Pacific through 7 days and are shown in Figure 10. The Brier skill scores for the incremental wind speed probabilities drop off quickly to zero after 120 hours, indicating the wind speed probabilities have little skill after 5 days.

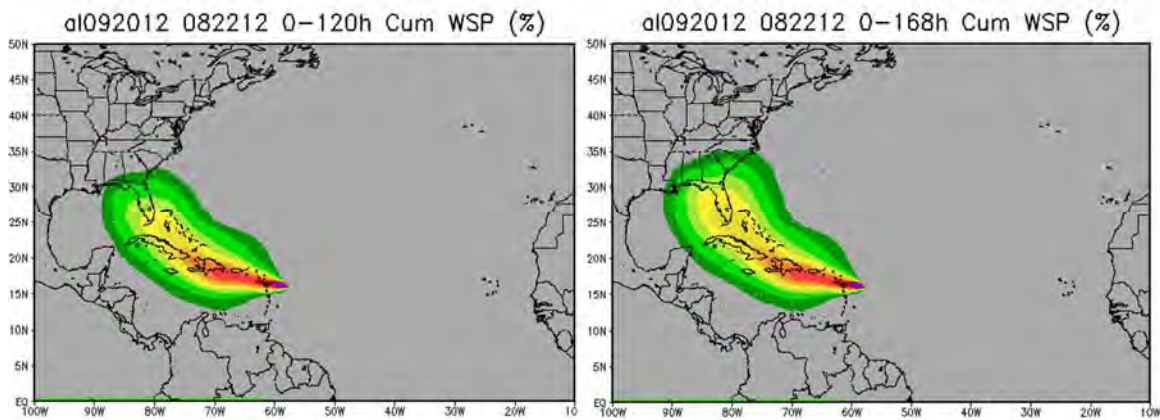

Figure 9. Example of cumulative 5-day (left) and 7-day (right) 34-kt wind speed probabilities for Hurricane Isaac on 22 August 2012 at 12Z.

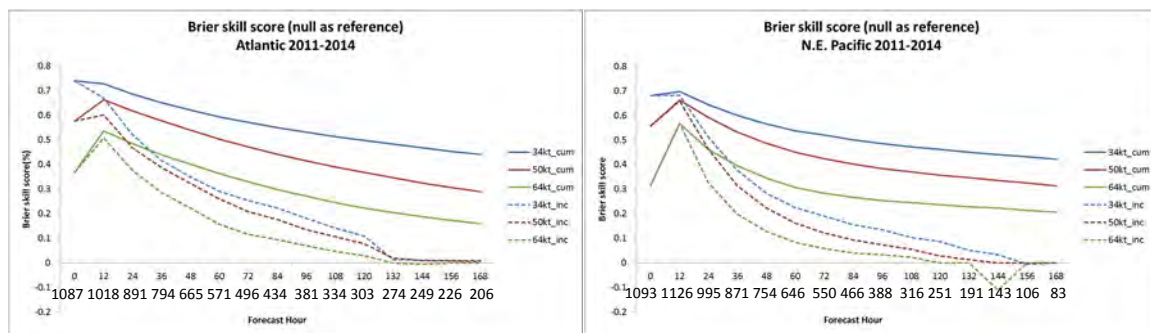

Figure 10. Brier skill scores (using null forecast as reference) for the Atlantic and N.E. Pacific 2011-2014 samples for 7-day wind speed probabilities.

e. Software improvements

Updating the MC model each year is a multi-step process requiring the execution of several scripts and Fortran programs. To streamline this process, the various pieces of

script and code have been consolidated and wrapped with a master update script. Annual updates to the MC model now only require the execution of the single script with a run time of approximately 1 minute per basin. This simplification makes it possible to turn over the task of annual updates to NHC, should that be desired.

f. Real-time product demonstration and 2015 verification

Experimental versions of the MC model were developed to incorporate each of the 3 improvements listed above. These 3 experimental versions were run in parallel at CIRA in near-real-time (available approximately 3 hours after synoptic time) during the 2014 and 2015 Atlantic and N.E. Pacific hurricane seasons.

In 2014, plots of the 34-, 50, and 64-kt 120-hr cumulative wind speed probabilities were generated at each synoptic time reflecting each potential improvement listed in 2a. A control version that is nearly identical to the operational wind speed probability product was also run for comparison purposes. These images were made available to NHC POCs for evaluation via an ftp site. Feedback from 2014 suggested that difference plots be added to the demonstration so forecasters could more easily see the effects each updates has on the wind speed probabilities. In 2015, difference plots were added to the parallel run demonstration and the output was moved to the CIRA/RAMMB TC Realtime webpage (http://rammb.cira.colostate.edu/products/tc_realtime/). Both the wind speed probability plots and difference plots are displayed (Figure 11).

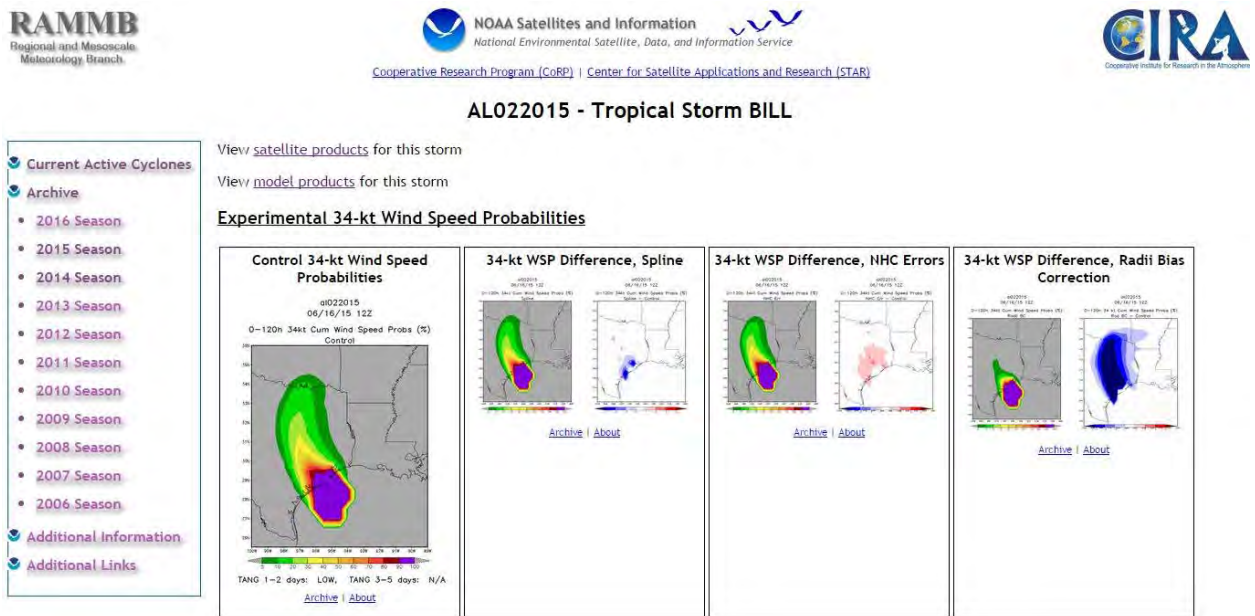

Figure 11. Example of experimental 34-kt wind speed probabilities for tropical storm Bill on the CIRA/RAMMB TC Realtime webpage.

Brier score improvements and reliability for 2015 are shown below in Figures 12 and 13, respectively. Overall, these verification values are quite similar to those for the 2011-2014 sample (Figures 4 and 5). The only notable difference is the negative impact the radii bias correction had on Atlantic 34-kt wind speed probability Brier scores. The impact of the radii bias correction was positive for the 2011-2014 sample. It is possible that the absence of cases much larger or smaller than climatology in 2015 in the Atlantic reduced the opportunities this change had to make a positive impact on Brier scores. More testing of the radii bias correction may be needed to ensure it does not degrade the MC model during average years.

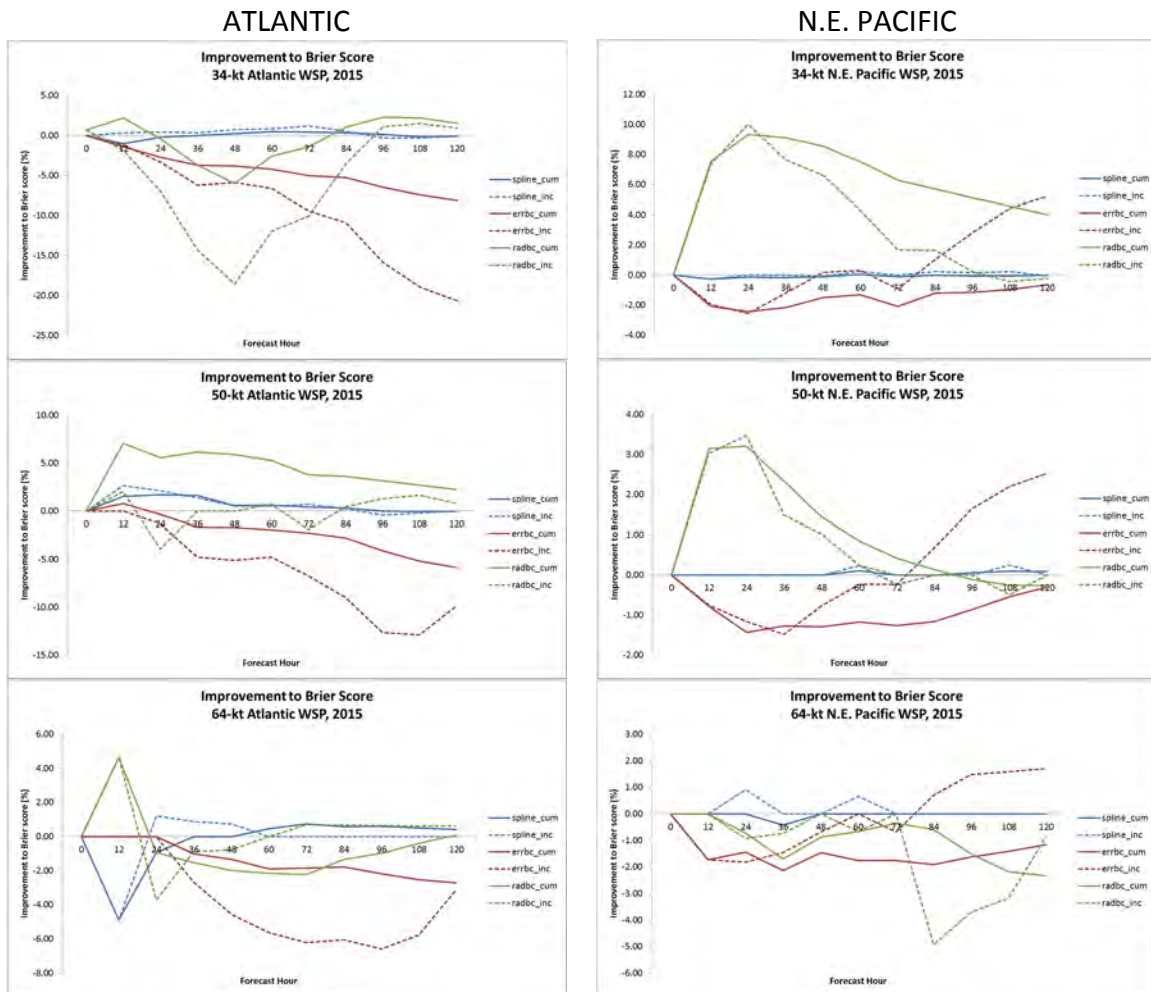

Figure 12. Percent improvement in Brier scores for 34-kt (top), 50-kt (center), and 64-kt (bottom) wind speed probabilities in the Atlantic (left) and N.E. Pacific in 2015 for each potential improvement; spline interpolation (blue), error statistic bias correction (red), and radii bias correction (green) versions of the MC model. Improvement is defined as a reduction in Brier scores from the control MC model over the same sample. Brier score improvements for cumulative (incremental) wind speed probabilities are solid (dashed).

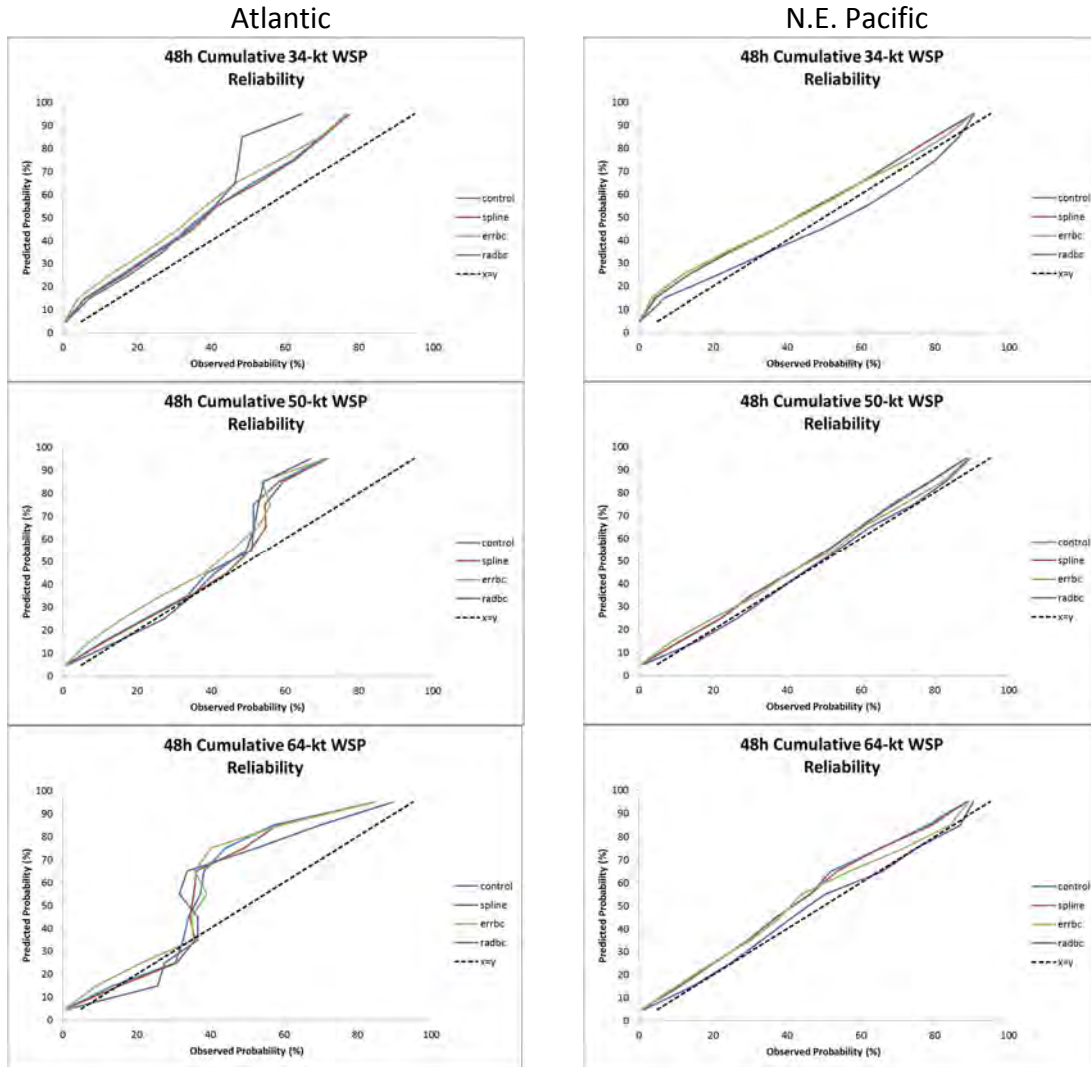

Figure 13. Reliability diagrams for 34-kt (top), 50-kt (center), and 64-kt (bottom) cumulative wind speed probabilities in the Atlantic (left) and N.E. Pacific in 2015 for each potential improvement; spline interpolation (red), error statistic bias correction (green), and radii bias correction (purple). For reference, reliability for the control (blue) and the $x=y$ line (black dashed) are shown.

3. SUMMARY, DEVELOPER RECOMMENDATIONS, AND FUTURE WORK

a. Spline interpolation

Using the spline interpolation scheme instead of linear interpolation for both the official track forecast and the realizations has a negligible impact on both Brier scores and reliability, yet generates more realistic-looking tracks and improves product performance for recurring tropical cyclones.

Developer recommendation: Implementation of this improvement presents little risk of product degradation and should be considered.

b. Error statistics bias correction

Error statistics were standardized and a bias correction was added to the MC model to allow it to exactly reproduce the NHC cone of uncertainty from its sampled track realization errors. The impact of this correction on 2011-2015 Brier scores was mixed but generally small ($\sim\pm 2-4\%$). While this correction improved reliability in the N.E. Pacific for all wind thresholds it degraded reliability and introduced underprediction for Atlantic 64-kt wind speed probabilities. One benefit of this bias correction is to provide consistency between NHC's uncertainty products. Another potential future benefit would be to enable the ability to obtain the cone of uncertainty directly from the MC model. The advantage to obtaining the cone in this manner is that its size would increase and decrease with forecast confidence obtained from the GPCE parameter.

Developer recommendation: Given the mixed impacts on Brier scores and reliability, more real-time testing of this bias correction may be necessary to verify that the bias correction is working as it should for all cases.

c. Radii bias correction

This bias correction essentially “nudges” the realization radii towards the official R34, R50, and R64 forecast when they are available. This correction made a significant improvement in the appearance of the wind speed probabilities for extremely large and small cases (e.g., Sandy) and improved Brier scores in both basins for 34-kt and 50-kt wind speed probabilities. However, the 64-kt wind speed probability Brier scores were degraded by $\sim 5\%$ in both the Atlantic and N.E. Pacific.

Developer recommendation: Consider a conditional implementation of this improvement to just the 34-kt and possibly 50-kt wind speed probabilities or wait and investigate other bias correction methods that work effectively for all wind thresholds.

d. Time of arrival / departure of 34, 50, and 64-kt winds

This product addition was completed primarily by NHC collaborator Mark DeMaria. The MC model now has a flag that, when set, will calculate the time of arrival of the 34, 50, and 64-kt winds at various probability thresholds and write them to an output text file. This addition of these calculations does increase the run time of the code, but it still runs in a short enough time (under 2 minutes) that should be adequate for operations.

Developer recommendation: The information provided by this addition will be very helpful to users such as emergency managers. Work should continue on determining the best way to display this information for users.

e. Integrated GPCE parameter

An integrated GPCE parameter has been developed and thresholds have been defined to provide integrated GPCE estimates of low, medium, or high for the early (days 1 and 2) and late (days 3, 4, and 5) official track forecasts. Partitioning time-average normalized GPCE values into terciles provided the best discrimination between low and high track errors and hence was chosen as our prototype GPCE categorization algorithm. GPCE categories are calculated as part of the regular MC model processing and can be easily added to the main output text file.

Developer recommendation: This is a no-cost implementation that will provide forecasters condensed GPCE information. Future work should be done to determine its utility in applications such as the generation of GPCE-based cone of uncertainty. As a start, we attempted some preliminary work - see section g below).

f. 7-day wind speed probabilities

The MC model was extended beyond 5 days using 144 hour and 168 hour official forecasts made available post-season in the a-decks. Only 4 years of 6-day and 7-day forecasts were available and there were a relatively small number of cases upon which to develop error statistics. Brier skill scores showed that wind speed probabilities beyond 120 hours had little to no forecast skill over a null forecast.

Developer recommendation: Given this very limited skill it is not recommended that the MC model be extended beyond 5 days at this time. Other methods, such as the incorporation of numerical model guidance and error statistics, could be explored to see if a skill can be improved at long range forecast times.

g. Implementation status and future work

Upgrades a, b, c, d, and e have all been added to the most current operational version of the MC model code as options with flags to turn them on and off. A new version of the code had to be developed to extend the MC model beyond 5 days (upgrade f). Since the beginning of this work, the MC model code has been updated and modularized through a Hurricane Sandy Supplemental project. As such, all upgrades that are accepted for implementation will have to be incorporated into the modernized model code. However, since A. Schumacher was involved with both projects this task should not take a significant amount of extra time or effort.

As a first effort to see how the integrated GPCE parameter developed in this study could be used to incorporate GPCE information into the size of the cone of uncertainty, prototype cone sizes for 2014 were created using the integrated GPCE thresholds derived for the entire forecast time (Table 1) and those created for the early and late forecast periods (Table 2). LOW and HIGH cone sizes are based on the 67th percentile of track errors for cases with the lowest and highest TANG values, respectively. The 2014 official cone sizes are shown for comparison. Using the TANG thresholds developed for the entire forecast period (Table 1) provides a cone that is smaller when TANG is smaller and larger when TANG is larger for all forecast times except 120 hours. The same is true when TANG thresholds developed for just the early (days 1 and 2) and late (days 3, 4, and 5) are used (Table 2), although LOW cone size < official cone size < high cone size is true at all forecast times using this method. This work is preliminary and just meant to demonstrate a single method that could be used for creating different cone sizes based on GPCE (i.e., track uncertainty). Future work could be done to test this method, as well as other methods such as the generation of a cone directly from the MC model, in the future.

Forecast Hr	2014 Cone (nmi)	LOW TANG (Lowest 33%)	HIGH TANG (Highest 33%)
12	32	28	42
24	54	46	68
36	71	70	93
48	91	82	113
72	124	102	139
96	169	157	186
120	223	215	219

Table 1. Cone sizes determined by integrated GPCE categories low and high for the entire forecast period.

Days 1 & 2			
Forecast Hr	2014 Cone	LOW TANG (Lowest 33%)	HIGH TANG (Highest 33%)
12	32	21	41
24	54	35	68
36	71	52	85
48	91	69	110
Days 3, 4, & 5			
72	124	109	139
96	169	159	196
120	223	215	235

Table 2. Cone sizes determined by integrated GPCE categories low and high for the early (days 1 and 2) and late (days 3, 4, and 5) forecast periods.

Project Title: Use of the Ocean-Land-Atmosphere Model (OLAM) with Cloud System-Resolving Refined Local Mesh to Study MJO Initiation

Project Number: NA13OAR4310163

PIs: Eric D. Maloney and William Cotton (Colorado State University) and Robert Walko (University of Miami)

Report Type: Year 3 Report

Results and Accomplishments

The following sections list the primary accomplishments for Year 3. All publications from this project are listed at the end of this report, although only the publications from this reporting period will be discussed in detail here.

Consequences of Systematic Model Drift in DYNAMO MJO Hindcasts with SP-CAM and CAM5 (Hannah et al. 2015).

Hindcast simulations of MJO events during the Dynamics of the MJO (DYNAMO) field campaign are conducted with two models, one with conventional parameterization (CAM5) and a comparable model that utilizes super-parameterization (SP-CAM). SP-CAM is shown to produce a qualitatively better reproduction of the fluctuations of precipitation and low-level zonal wind associated with the first two DYNAMO MJO events compared to CAM5 (**Figure 1**). Interestingly, skill metrics using the real-time multivariate MJO index (RMM) suggest the opposite conclusion, that CAM5 has more skill than SP-CAM. This inconsistency can be

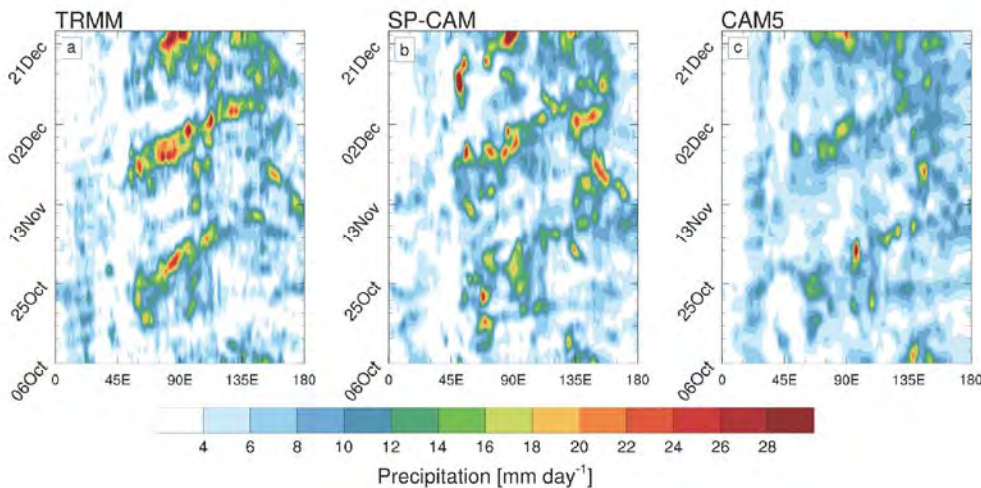

Figure 1. Hovmöller diagram of equatorial precipitation averaged from 5°S-5°N for 05-09 day lead times.

explained by a systematic increase of RMM amplitude with lead-time, which results from a drift of the large-scale wind field in SP-CAM that projects strongly onto the RMM index (**Figure 5**). CAM5 hindcasts exhibit a contraction of the moisture distribution, in which extreme wet and dry conditions become less frequent with lead-time. SP-CAM hindcasts better reproduce the observed moisture distribution, but also have stronger drift patterns of moisture budget terms, such as an increase in drying by meridional advection in SP-CAM. This advection tendency in

SP-CAM appears to be associated with enhanced off-equatorial synoptic eddy activity with lead-time. Systematic drift moisture tendencies in SP-CAM are of similar magnitude to intraseasonal moisture tendencies, and therefore are important for understanding MJO predictability.

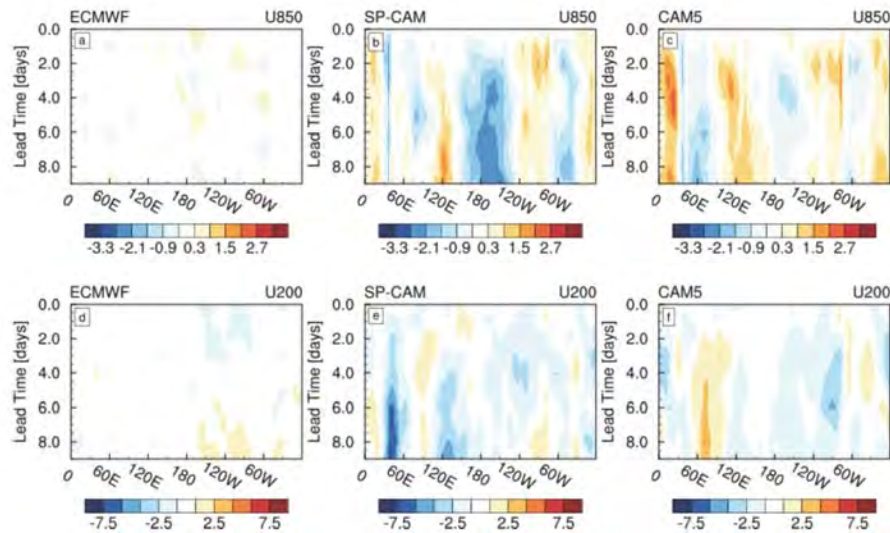

Figure 5. Hovmöller diagrams of the systematic drift over the DYNAMO period as a function of time since hindcast initialization (see text) in the wind fields used in the RMM index in ERAi, SP-CAM, and CAM5. Data was equatorial averaged from 15°S-15°N, consistent with the RMM index.

Objective Diagnostics and the Madden-Julian Oscillation. Part I: Methodology (Wolding and Maloney 2015a)

Graduate student Brandon Wolding developed advanced MJO diagnostics that provided substantial insight into the nature of MJO events during DYNAMO and the ability of conventional MJO indices such as those of Wheeler and Hendon to successfully characterize the nature of the MJO. Diagnostics obtained as an extension of empirical orthogonal function (EOF) analysis are shown to address many disadvantages of using EOF-based indices to assess the state of the Madden-Julian Oscillation (MJO). The Realtime Multivariate MJO (RMM) index and the Filtered MJO OLR (FMO) index are used to demonstrate these diagnostics. General

characteristics of the indices, such as the geographical regions that most heavily in each index,

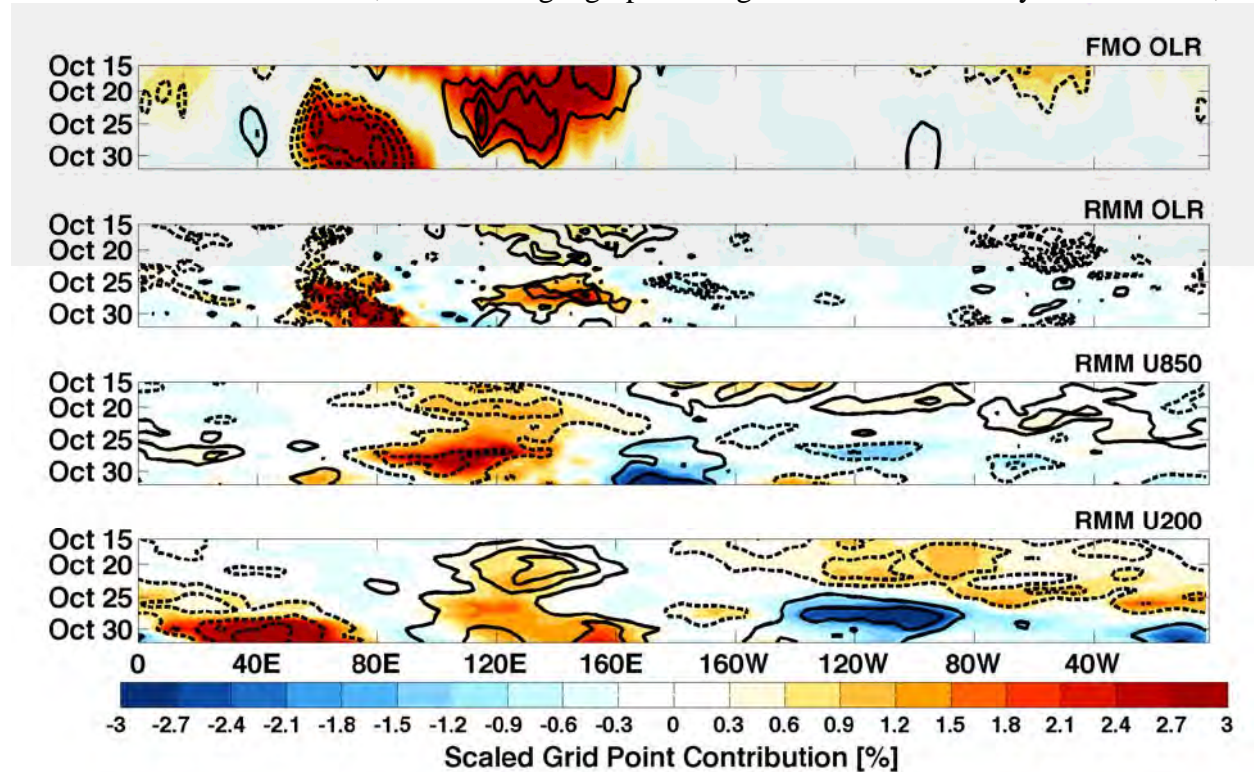

Figure 2. OLR, U850, and U200 anomalies (contours) averaged from 15N-15S and corresponding scaled grid point contribution (shading) for the RMM and FMO index from October 15-31. Positive (negative) anomalies are given by solid (dashed) contours. In the top panel, OLR has been bandpass filtered to 20-96 days. Contours for the filtered OLR, unfiltered OLR, U850, and U200 anomalies are, respectively, as follows: every 5 W/m^2 beginning at 10 W/m^2 , every 10 W/m^2 beginning at 20 W/m^2 , every 2 m/s beginning at 2 m/s, every 5 m/s beginning at 5 m/s.

are assessed using the diagnostics. The diagnostics also identify how a given field at various geographical locations, influences the index value at a given time. Termination (as defined by the RMM index) of the October 2011 MJO event that occurred during the Cooperative Indian Ocean Experiment on Intraseasonal Variability in the Year 2011(CINDY) Dynamics of the MJO (DYNAMO) field campaign is shown to have resulted from changes in zonal wind anomalies at 200 hPa over the eastern Pacific Ocean, despite the onset of enhanced convection in the Indian Ocean and the persistence of favorable lower and upper level zonal wind anomalies near this region (**Figure 2**). The diagnostics objectively identify, for each specific geographical location, the index phase where the largest MJO-related anomalies in a given field are likely to be observed. This allows for the geographical variability of anomalous conditions associated with the MJO to be easily assessed throughout its lifecycle. This paper is published in *Journal of Climate*. In Part II of this study (see below), unique physical insight into the moist static energy and moisture budgets of the MJO is obtained from the application of diagnostics introduced here.

Objective Diagnostics and the Madden-Julian Oscillation. Part II: Application to Moist Static Energy and Moisture Budgets (Wolding and Maloney 2015b)

Processes controlling moisture variations associated with the MJO are investigated using

budgets of moist static energy (MSE) and moisture. To first order, precipitation anomalies are maintained by anomalous large-scale vertical moisture advection, which can be understood through application of a weak temperature gradient balance framework to the MSE budget. Intraseasonal variations in longwave radiative cooling play a crucial role in destabilizing the MJO, allowing anomalous large-scale vertical advective moistening to meet or exceed the increase in moisture loss by net condensation during the enhanced phase, and anomalous large-scale vertical advective drying to meet or exceed the decrease in moisture loss by net condensation during the suppressed phase. The result is a positive feedback between the net effect of these processes and moisture anomalies. Intraseasonal variations in surface latent heat flux (SLHF) enhance this positive feedback, but appear to be insufficient to destabilize the MJO in the absence of radiative feedbacks.

Insight into the response of an ensemble cloud population to an anomalous moisture source (e.g. enhanced SLHF) is gained by examining fields where only high frequency variability (< 20 days) has been removed. During the enhanced phase, approximately 85% of the moisture removed by net condensation is re-supplied by the large-scale vertical moisture advection associated with apparent heating by microphysical processes and sub-grid scale vertical fluxes of dry static energy. This suggests that a relatively large increase in net condensation could be supported by a relatively small anomalous moisture source, even in the absence of radiative feedbacks. These results highlight the importance of process-oriented assessment of MJO-like variability within models, and suggest a WTG balance framework may be used to identify destabilization mechanisms, thereby distinguishing between MJO-like variability of fundamentally different character. We are currently exploring ways to incorporate these model diagnostics into the standard evaluation packages of climate modeling centers (including GFDL and NCAR) to improve evaluation of global climate models, and ensure they are getting realistic simulations of tropical variability for the correct reasons. This paper is published in *Journal of Climate*.

DYNAMO events in OLAM

We have continued to experiment with hindcast experiments during three events in the DYNAMO period using OLAM, including simulations with different nested mesh sizes, resolutions, and nudging strategies. Basic comparison of the fidelity of the OLAM performance relative to observations in humidity, temperature, winds, moist static energy, and precipitation has been conducted, and indicates a substantial sensitivity to the domain configuration that will help inform subsequent runs. **Figure 3** shows the results of nudged OLAM runs in the MSE anomaly field, demonstrating an ability to successfully simulate the first two DYNAMO MJO events. We are currently in the process of generating a moist static energy budget for OLAM that can be used as a diagnostic tool for understanding the physics of the MJO initiation process in the model. It has taken quite a bit more time than anticipated to get the output protocol optimized given the irregular grid topology, especially when running the model in a parallel framework. However, we have overcome these challenges and are in the process of demonstrating the power of this model for understanding MJO initiation. Gustavo Carrio here at CSU has been instrumental in helping to overcome these challenges, including reconfiguring OLAM to run on systems such as Yellowstone in Wyoming.

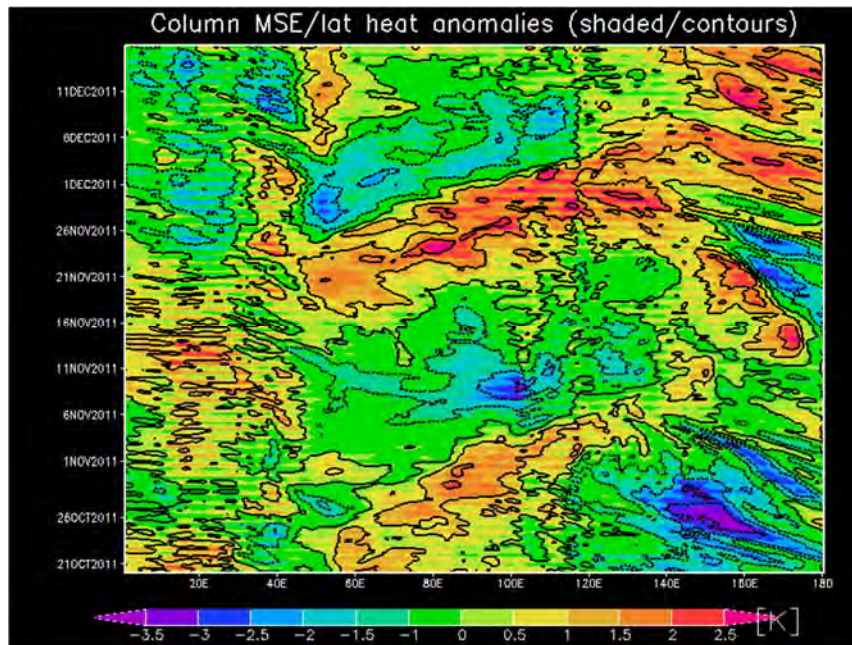

Figure 3. Column-integrated MSE anomalies (shaded) and latent heat anomalies (contour) in nudged OLAM experiments during the DYNAMO experiment.

The moistening diagnostics of Wolding and Maloney (2015b) have been applied to these runs, indicating a key role for radiative feedbacks in destabilizing the MJO through their impact on the moisture budget. A new manuscript is being generated detailing the OLAM runs and the moisture budget diagnostics.

Initiation of an Intraseasonal Oscillation in an Aquaplanet General Circulation Model (Maloney and Wolding 2015)

MJO initiation was studied in an aquaplanet general circulation model that has strong and highly regular MJO-like variability. About 80% of MJO events in the model are found to be successive events, immediately preceded by another strong MJO event. Rossby gyres associated with the previous cycle of suppressed MJO convection to the east are shown to help initiate the next cycle of MJO convection in the western warm pool, consistent with the recent study of Zhao et al. Meridional and vertical moisture advection associated with the anomalous Rossby gyres help to moisten the MJO initiation region in advance of convective onset.

An experiment is conducted in which circumnavigating Kelvin waves and their influence on the MJO initiation region are suppressed. While MJO activity in the model is just as regular with suppression of circumnavigation, MJO amplitude is reduced relative to the control simulation, especially in the western part of the warm pool. Possible physical mechanisms responsible for this change in MJO amplitude are discussed. This paper is published in *Journal of Advances in Modeling Earth Systems*.

Air-sea interaction and MJO Initiation in a coupled GCM (Maloney et al. 2016).

We have investigated the impact of SST-driven boundary layer convergence to MJO initiation in a coupled GCM. The impact of ocean coupling on MJO dynamics is investigated in

the superparameterized NCAR Community Climate System Model (SPCCSM), a model that produces realistic eastward propagating MJO variability in the tropics. The bulk boundary layer model of Back and Bretherton (2009) is first used to diagnose SST-driven convergence anomalies associated with composite SPCCSM MJO SST anomalies. **Figure 4** shows SST anomalies and associated surface convergence anomalies from two different phases of the SPCCSM MJO (these phases can be considered about 15 days apart in time). The SST anomalies

SST (Contour) and SST-Driven Conv. Moistening (Color)

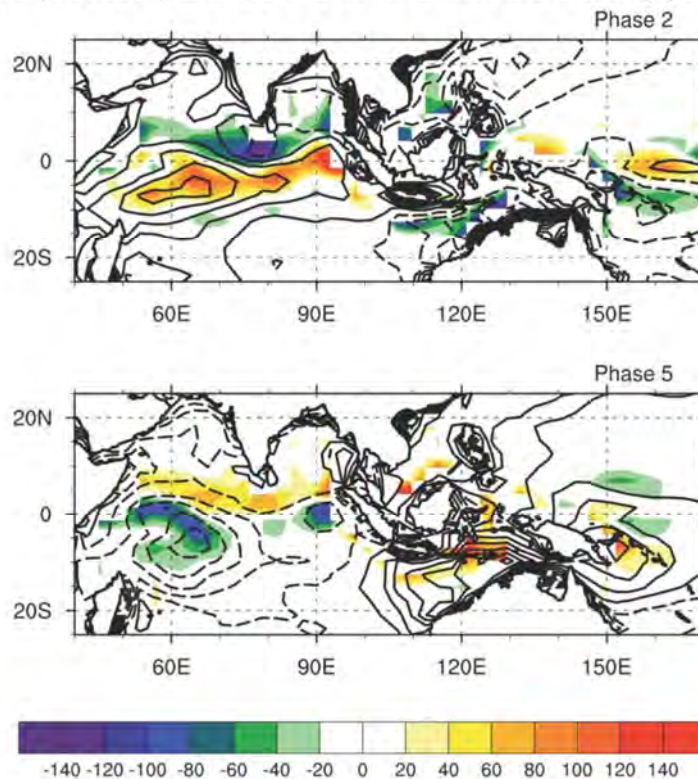

Figure 4. SST anomalies (contours) and SST-driven moisture convergence anomalies (colors) for Phases 2 and 5 of the MJO in the SPCCSM. The SST contour interval is $0.05^{\circ}C$, and the units of convergence anomalies are $W m^{-2}$. Note that the convergence anomalies have been converted to energy units to reflect latent heat convergence.

drive surface convergence anomalies through a similar hydrostatic surface pressure adjustment mechanism to that proposed by Lindzen and Nigam (1987). Then, the moisture convergence anomalies associated with the anomalous mass convergence field are determined by assuming a characteristic boundary layer specific humidity content. **Figure 5** shows that SST-driven anomalies may be just as important as horizontal moisture advection for driving a positive moisture tendency in advance of enhanced MJO precipitation in the Indian Ocean MJO initiation region for plausible boundary layer model parameter settings. Horizontal advection was previously hypothesized to be the leading terms in the intraseasonal moisture budget in the context of MJO propagation. These results suggest that SST-induced boundary layer moisture convergence may play an important role in MJO propagation and initiation, and may help explain why coupled models produce better simulations of the MJO than uncoupled atmospheric

models, and highlights the salient upper ocean and boundary layer processes that models need to get right to produce realistic MJO variability.

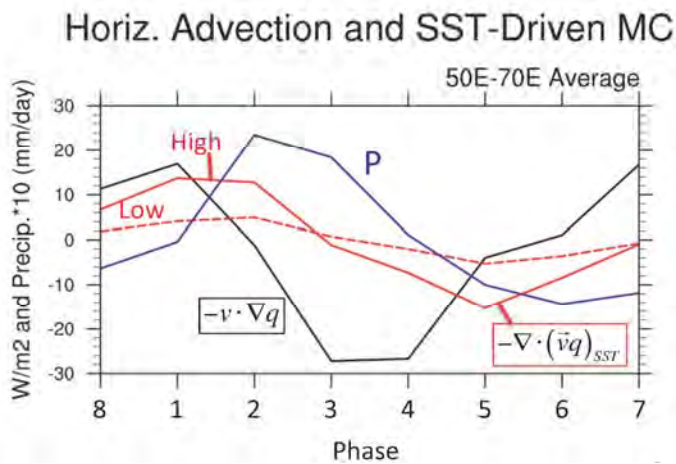

Figure 5. Composite 10°N-10°S averaged Indian Ocean precipitation, column-integrated horizontal moisture advection, and SST-driven moisture convergence anomalies in the SPCCSM as a function of MJO phase. High and low estimates for the SST-driven convergence anomalies are provided based on plausible parameter settings of the Back and Bretherton (2009) boundary layer model.

MJO Initiation in a High Resolution Regional Model (Riley Dellaripa and Maloney 2016).

A cloud system resolving version of the RAMS model (the predecessor regional version of OLAM) demonstrates realistic representation of MJO convective variability during the DYNAMO field program when integrated in the Northern Sounding Array (**Figure 6**). Horizontal model grid spacing in 1.5 km. The model demonstrates a realistic simulation of air-sea coupling via wind-induced surface flux variability as that represented by buoy sites in the Indian Ocean initiation region, and also produces a comparable representation of convective organization to that of DYNAMO observations. Latent heat flux variability is very strongly correlated with precipitation variability, both locally and in the domain average. The convective partitioning from the model is represented in this plot of stratiform-convective fraction as a function of time (**Figure 7**).

Detailed analysis of this run provides a mixed picture as to the support of convective organization in the model by surface fluxes. During the MJO suppressed phase, individual convective systems are supported by wind-driven flux feedbacks both before and during the mature phase of mesoscale convective systems. However, during the MJO onset and mature phases, while surface fluxes support individual mesoscale convective systems during their growth stage, mature MCSs are provided no support by wind-induced flux anomalies, similar to recent work in RCE frameworks used to examine self-aggregation. The WTG moistening diagnostics of Wolding and Maloney (2015b) are also applied in this run indicating substantial support for MJO convective variability by radiative feedbacks and their impact on the mid- and lower- tropospheric moisture budget.

Figure 6. Model 20 minute rain rate in the DYNAMO Northern Sounding array as a function of time for the November 2011 DYNAMO event. Units of rainrate are mm day⁻¹.

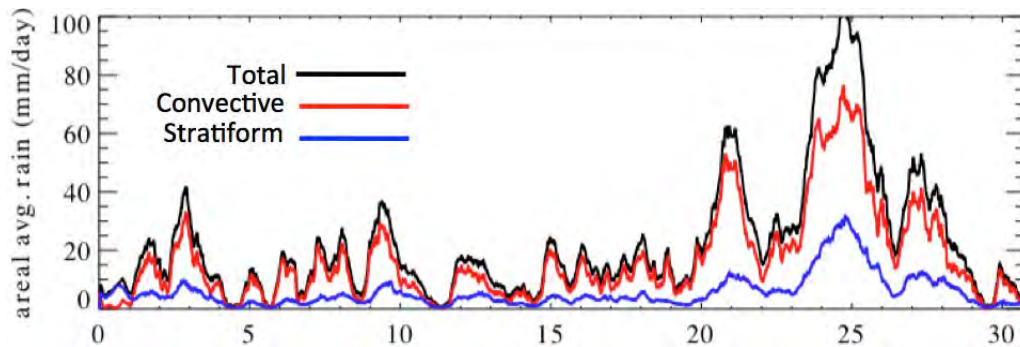
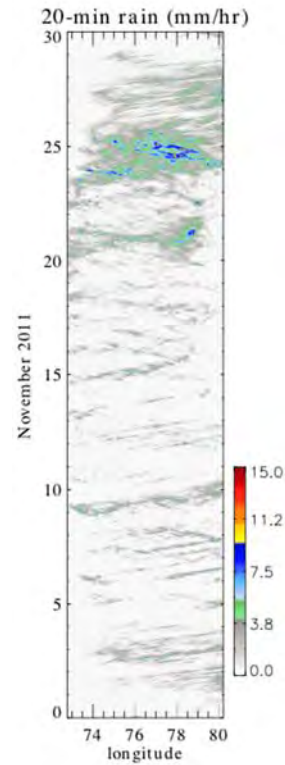

Figure 7. Northern Sounding Array stratiform-convective partitioning as simulated by the RAMS model. The x-axis represents day of the month November 2011.

Weak temperature gradient diagnostics of the MJO applied to SP-CESM (Wolding and Maloney 2016)

Multi-decade runs of the NCAR CESM are conducted to examine the initiation and maintenance mechanisms associated with the MJO. In particular, the moisture budget diagnostics of Wolding and Maloney (2015b) that take advantage of the weak temperature gradient nature of the tropical atmosphere are used to understand moistening processes. It is shown that the net effects of diabatic processes, including radiative feedbacks, are to destabilize the MJO through supporting

growth of moisture anomalies. The vertical profile of moistening by diabatic processes is shown in **Figure 8**. Horizontal advection provides a stabilizing influence on the growth of water vapor anomalies, which would grow without check without this negative feedback. A paper describing these results will be submitted to *Journal of Climate* by the end of March.

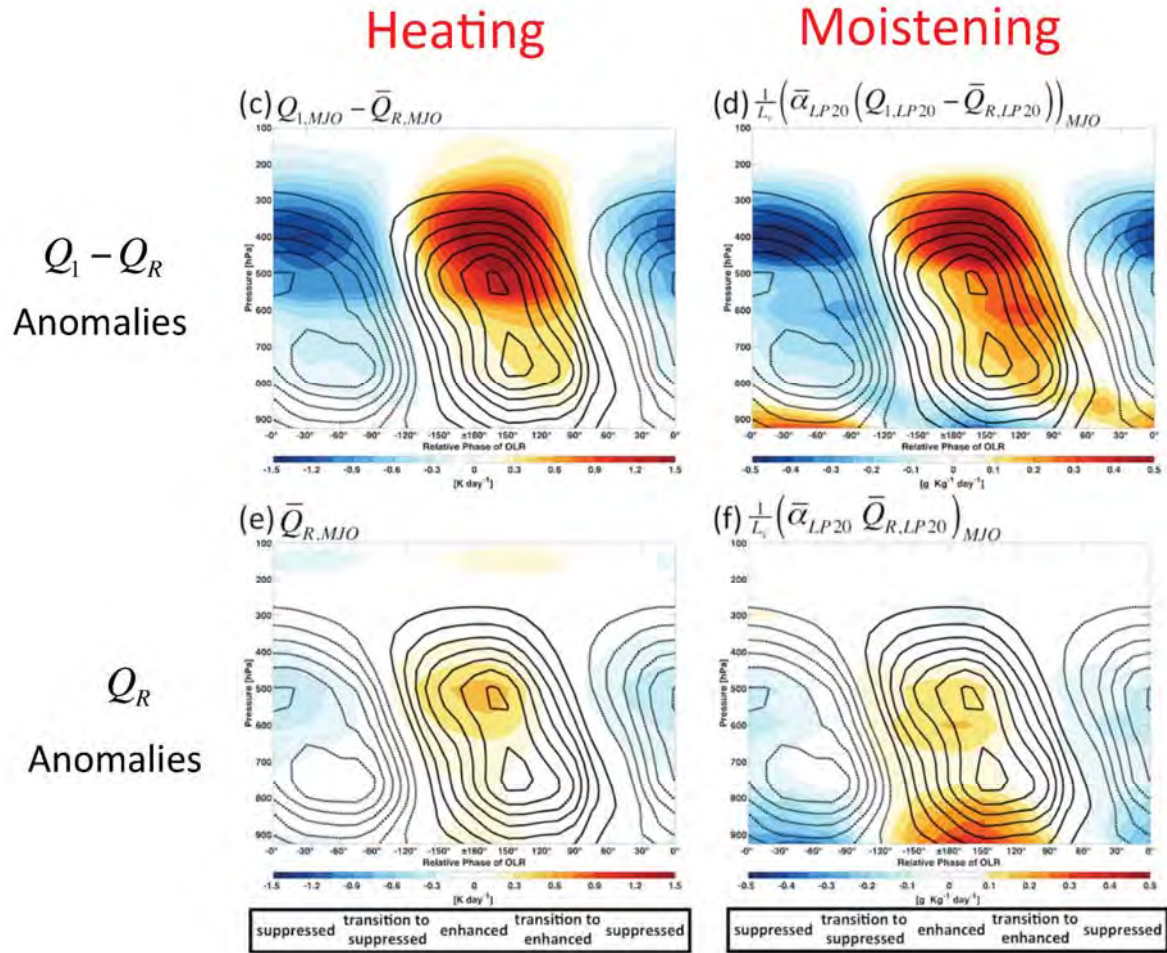

Figure 8. Composite vertical structure of condensational heating and radiative heating anomalies (left) and their moistening effect as determined through the assumption of WTG balance (right).

Highlights of Accomplishments

- Analysis of OLAM indicates the importance of radiative feedbacks to the initiation and maintenance of the November DYNAMO MJO events.
- Objective weak temperature gradient diagnostics of the DYNAMO and broader region applied to reanalysis and global and regional models indicate that the MJO is destabilized by radiative feedbacks, and propagated by horizontal advection. We are currently working to entrain these diagnostics into the evaluation packages for the GFDL AM and NCAR CAM.
- Aquaplanet model experiments indicate that Rossby gyres associated with the previous cycle of MJO convection help to initiate the MJO, and that Kelvin wave

circumnavigation plays a secondary role.

- We showed that MJO hindcasts during the DYNAMO period could be improved through increasing convective entrainment.
- We showed that with increased entrainment, the NCAR CAM5 appears to produce a good MJO for the wrong reasons, with a bottom-heavy heating profile compensating for too weak of cloud-radiative feedbacks. This highlights areas of improvement for climate models.
- The SP-CAM produces an improved representation of the MJO relative to the NCAR CAM during the DYNAMO period, although the SP-CAM exhibits a poorer MJO skill score based on RMSE since SP-CAM mean state drift projects strongly onto the MJO indices used to assess skill.
- The SP-CAM produces too strong of a simulation of vertical MSE advection relative to ERA-I that helps to destabilize the MJO, associated with too bottom-heavy of a diabatic heating profile.
- Advanced MJO diagnostics were developed that showed the RMM index to be dominated by east Pacific 200 hPa zonal wind variability during the October DYNAMO event that erroneously suggested a weakening of the event at the end of October.
- We showed that ocean coupling may help produce MJO initiation through SST-driven convergence that aids column moistening in advance of MJO convection, highlighting why uncoupled models have difficulty simulating the MJO

Publications From the Project

- Hannah, W. M., and E. D. Maloney, 2014: The Moist Static Energy Budget in NCAR CAM5 Hindcasts during DYNAMO. *J. Adv. Modeling Earth Sys.*, **6**, doi:10.1002/2013MS000272.
- Hannah, W. M., E. D. Maloney, and M. Pritchard, 2015: Consequences of Systematic Model Drift in DYNAMO MJO Hindcasts with SP-CAM and CAM5. *J. Adv. Modeling. Earth Sys.*, **7**, 1051–1074.
- Wolding, B. O., and E. D. Maloney, 2015: Objective Diagnostics and the Madden-Julian Oscillation. Part I: Methodology. *J. Climate*, **28**, 4127–4140.
- Wolding, B. O., and E. D. Maloney, 2015: Objective Diagnostics and the Madden-Julian Oscillation. Part II: Application to Moist Static Energy and Moisture Budgets. *J. Climate*, **28**, 7786–7808.
- Maloney, E. D., and B. O. Wolding, 2015: Initiation of an Intraseasonal Oscillation in an Aquaplanet General Circulation Model. *J. Adv. Model. Earth. Sys.*, **7**, 1956–1976.
- Maloney, E. D., DeMott, C., and S. deSzoeki, 2016: SST-driven boundary layer convergence moistening and the MJO in the SP-CESM. *J. Climate*, to be submitted.
- Wolding, B. O., and E. D. Maloney, 2016: Weak temperature gradient diagnostics of the MJO applied to SP-CESM. *J. Climate*, to be submitted.

PIs Contact Information

Eric D. Maloney (lead PI)
Department of Atmospheric Science
Cooperative Institute for Research in the Atmosphere (CIRA)
Colorado State University

1371 Campus Delivery
Fort Collins, CO 80523-1371
Phone: (970) 491-3368
Fax: (970) 491-8449
emaloney@atmos.colostate.edu

William Cotton (co-PI)
Department of Atmospheric Science
Cooperative Institute for Research in the Atmosphere (CIRA)
Colorado State University
1371 Campus Delivery
Fort Collins, CO 80523-1371
Phone: (970) 491-8593
Fax: (970) 491-8449

Robert Walko (co-PI)
Rosenstiel School of Marine and Atmospheric Science,
University of Miami,
4600 Rickenbacker Causeway,
Miami, FL 33149-1031.
Phone: (305) 421-4621