

Mechanical Vibration Trees

**Joseph Genin
John S. Maybee**

CU-CS-029-73

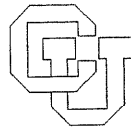

University of Colorado at Boulder

DEPARTMENT OF COMPUTER SCIENCE

MECHANICAL VIBRATION TREES +

by

Joseph Genin
School of Mechanical Engineering
Purdue University
Lafayette, Indiana

and

John S. Maybee
Depts of Mathematics and Computer Science
University of Colorado
Boulder, Colorado

Report #CU-CS-029-73

August, 1973

+ This work supported in part by National Science Foundation Grant # GJ-660

1. Introduction. The purpose of this paper is to develop a chapter in the theory of the small vibrations of mechanical systems which is the consequence of some recent work in matrix theory. The results which we shall obtain are based primarily upon papers of Parter [1] and Maybee [2], [3], [4]. And, while we shall expound our theory in the context of mechanics, the methods and results are applicable in other areas as well, in particular in electrical vibrations.

We shall be interested in the vibrations of a mechanical system for which the kinetic energy T has the form

$$T = \frac{1}{2} \sum_{j=1}^n m_j \dot{q}_j^2, \quad m_j > 0, \quad 1 \leq j \leq n, \quad (1.1)$$

and the potential energy V has the form

$$V = \sum_{ij=1}^n s_{ij} q_i q_j. \quad (1.2)$$

Here the variables q_1, \dots, q_n are the generalized coordinates of the system and the matrix $S = [s_{ij}]_1^n$ has properties which we will now specify.

To this end we require some preliminary ideas.

(i) If $A = [a_{ij}]_1^n$ satisfies the condition $a_{ij} \neq 0$ if and only if $a_{ji} \neq 0$ we say it is combinatorially symmetric.

(ii) If A is a combinatorially symmetric matrix the graph of A , $G(A)$, consists of n vertices v_1, \dots, v_n with an edge joining v_i and v_j , $i \neq j$, if $a_{ij} \neq 0$.

Observe that in this definition we have not made use of the elements a_{ii} , $1 \leq i \leq n$, hence $G(A)$ is loop free.

(iii) A graph T is called a tree if it is connected and has no circuits.

Definition 1. The square matrix $A = [a_{ij}]_1^n$ is said to be of class Q_2^+ if $G(A)$ is a tree and if

$$\left. \begin{aligned} a_{jj} &> 0, \quad 1 \leq j \leq n, \\ a_{ij}a_{ji} &\geq 0, \quad \text{for } i \neq j. \end{aligned} \right\} \quad (1.3)$$

Definition 2. A mechanical system will be called a vibration tree if the kinetic and potential energies are given by (1.1) and (1.2) where the matrix S is symmetric and positive definite and $G(S)$ is a tree.

We note that the hypotheses of symmetry and positive definiteness guarantee that conditions (1.3) are satisfied for S hence $S \in Q_2^+$.

In addition to the matrix S we have two other matrices associated with a vibration tree. First the matrix $M = \text{diag} [m_1, \dots, m_n]$, which is a diagonal matrix with positive diagonal entries, and also

$$U = M^{-1}S \quad (1.4)$$

which we shall call the matrix of the system. Let us derive the properties of U .

In the first place $U \in Q_2^+$, since $S \in Q_2^+$ and multiplication of the i -th row of S by the positive number $\frac{1}{m_i}$ does not affect the membership of S in Q_2^+ . Also U is not symmetric, but it is a well known fact that a positive definite non-singular matrix L exists such that $\bar{U} = L^{-1} U L$ is symmetric. In the present case L can be chosen to be a positive diagonal matrix (see [2]). In fact, it is easy to see that if

$$U = [v_{ij}]_1^n$$

and

$$\bar{U} = [u_{ij}]_1^n$$

then for $i \neq j$

$$u_{ij} = \operatorname{sgn} v_{ij} \sqrt{v_{ij} v_{ji}}$$

where

$$\operatorname{sgn} v_{ij} = \begin{cases} 1 & \text{if } v_{ij} > 0, \\ -1 & \text{if } v_{ij} < 0, \\ 0 & \text{if } v_{ij} = 0. \end{cases}$$

Now consider the free vibrations of a vibration tree. Using the Lagrange equations of motion we have

$$M\ddot{q} + Sq = 0$$

where $q = (q_1, \dots, q_n)$. We can also write this system in the form

$$\ddot{q} + Uq = 0. \quad (1.5)$$

Thus we can characterize a vibration tree as a system of the form (1.5)

where the matrix $U \in Q_2^+$.

2. Examples of Vibration Trees.

Example 1. A mechanical system is called a Sturm system if the kinetic energy is given by (1.1) and the potential energy has the form

$$V = \sum_{i=1}^n a_i q_i^2 - 2 \sum_{i=1}^{n-1} b_i q_i q_{i+1}, \quad a_i > 0, \quad 1 \leq i \leq n, \quad (2.1)$$

$$b_i > 0, \quad 1 \leq i \leq n-1.$$

Charles Sturm was the first to investigate the oscillations of such systems in detail. His work was discovered in manuscripts found after his death (see Bocher [5]). Moreover, his remarkable theorem of algebra was also discovered in the course of these investigations.

The matrix S for the Sturm system is a Jacobi or tridiagonal matrix. That is, we have $s_{ij} = 0$ if $|i-j| > 1$, $s_{ii} = a_i$, $1 \leq i \leq n$, and $s_{ii+1} = s_{i+1i} = -b_i$, $1 \leq i \leq n-1$. The graph of S is shown in figure 1. For convenience, we shall call such a graph a Sturm graph.

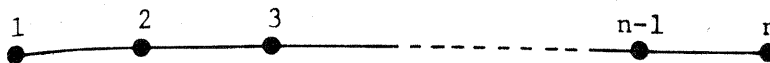

$G(S)$ for a Sturm system

figure 1.

Among the many physical problems which lead to Sturm systems we mention only one; namely the transverse oscillations of a weightless ideally flexible thread with n beads. This problem has an honorable place in the history of mechanics, having been studied by d'Alembert, Daniel Bernoulli, Euler, and Lagrange. With appropriate hypotheses on the motion the problem has the form

$$T = \frac{1}{2} \sum_{i=1}^n m_i \dot{y}_i^2, \quad v = \frac{\sigma}{2} \sum_{i=0}^n \frac{1}{\ell_i} (y_{i+1} - y_i)^2, \quad y_0 = y_{n+1} = 0. \quad (2.2)$$

where y_j is the displacement of the j -th bead, m_j is the mass of the j -th bead, ℓ_j the segment of the thread between the $(j-1)$ -th and j -th beads, and σ is the (constant) tension in the thread. The formulas (2.2) are correct if both ends of the thread are stationary.

Example 2.

Consider the system of springs and masses illustrated in figure 2. By use of a free body diagram and some simple manipulation the equations

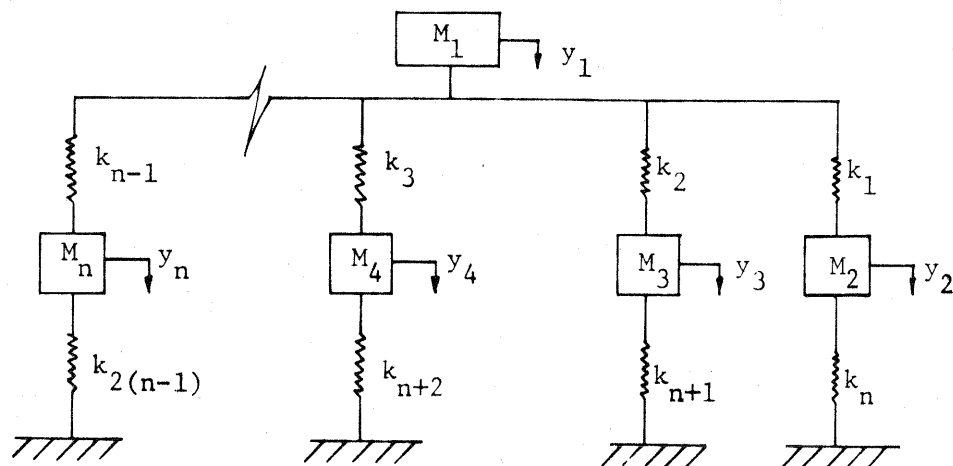

Figure 2.

for the free vibrations of this system can be put into the form (1.5).

Let us set

$$\alpha = \frac{1}{M_1} \sum_{j=1}^{n-1} k_j, \quad b_j = -\frac{k_j}{\sqrt{M_1 M_j}}, \quad 1 \leq j \leq n-1,$$

$$\gamma_j = \frac{1}{M_j} (k_j + k_{n+j-1}).$$

Then, corresponding to the matrix U in (1.5), we have the symmetric matrix

$$\bar{U} = \begin{bmatrix} \alpha & b_1 & b_2 & \dots & b_{n-1} \\ b_1 & \gamma_1 & 0 & \dots & 0 \\ b_2 & 0 & \gamma_2 & \dots & 0 \\ \dots & \dots & \dots & \dots & \dots \\ b_{n-1} & 0 & 0 & \dots & \gamma_{n-1} \end{bmatrix}. \quad (2.3)$$

A matrix having the form (2.3) is usually called a bordered diagonal matrix and, for this reason, we shall refer to any mechanical system with such a matrix, as a bordered diagonal vibration tree. The graph of \bar{U} is shown in figure 3.

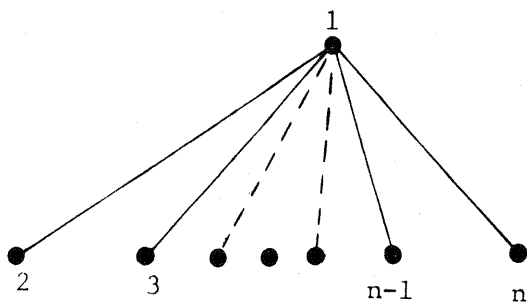

Graph of bordered diagonal matrix

Figure 3.

As one might conjecture the fundamental properties of the bordered diagonal vibration tree are quite different from those of the Sturm system.

3. Fundamental Spectral Properties of Vibration Trees.

We have seen in the introduction that the natural frequencies and modes of vibration of a vibration tree can be obtained from the study of the symmetric matrix \bar{U} . The matrix \bar{U} is also positive definite since S is positive definite, hence $U = M^{-1}S$ is also, and thus so is $\bar{U} = D^{-1}UD$ by two applications of the Binet-Cauchy formula. It follows that if $\lambda_1, \dots, \lambda_n$ are the eigenvalues of the matrix \bar{U} , we can assume that

$$0 < \lambda_1 \leq \lambda_2 \leq \dots \leq \lambda_n. \quad (3.1)$$

Our purpose in this section is to refine the sequence of inequalities (3.1) and to deduce some facts concerning certain of the eigenvectors of a vibration tree. To achieve this we must first introduce an additional concept.

Let us denote by C_{01} the closed qualitative cone in \mathcal{R}^n containing in its interior the vector $x = (1, 1, \dots, 1)$, i.e., the vector with n components all equal to 1, and by C_{02} the cone containing $-x$.

(Qualitative cones in \mathbb{R}^n are discussed in the paper [4].) In general, we denote by C_{kj} the various closed qualitative cones in \mathbb{R}^n containing in their interior at least one vector having exactly k changes of sign in its sequence of components. Thus, for example, we might denote by C_{11} the cone containing $x = (-1, 1, \dots, 1)$ (each component except the first equal to 1), by C_{12} the cone containing $s = (-1, -1, 1, 1, \dots, 1)$, etc. Each of these closed qualitative cones is a closed hyperoctant in \mathbb{R}^n and each closed hyperoctant is found somewhere in the sequence C_{kj} . Clearly $k \leq n-1$.

Now we formulate

Theorem 1. Let \bar{U} be the matrix of a vibration tree. Then:

- (i) \bar{U} has a unique positive eigenvalue $\bar{\lambda}$ such that for every other eigenvalue λ of \bar{U} , $\bar{\lambda} > \lambda > 0$.
- (ii) There exists a qualitative cone C_{pq} such that an eigenvector y of \bar{U} belonging to $\bar{\lambda}$ belongs to the interior of C_{pq} .
- (iii) No other eigenvector of \bar{U} not linearly dependent upon y belongs to C_{pq} .

Proof. We have already observed that the eigenvalues of \bar{U} are positive, hence the righthand half of the inequality in (i) is true. The remainder of theorem 1 results from the following construction. We shall first construct a vector $x = (x_1, \dots, x_n)$ with all components different from zero and having the property that the scalar product of the j -th row vector $\bar{u}_j = (u_{j1}, \dots, u_{jn})$ of \bar{U} with x has the same sign as x_j , i.e.,

$$\left(\sum_{k=1}^n u_{jk} x_k \right) x_j > 0, \quad 1 \leq j \leq n. \quad (3.2)$$

To this end set $x_1 = 1$ and suppose $u_{1i_1}, \dots, u_{1i_p}$, $1 < i_1 < i_2 < \dots < i_p \leq n$ are the nonzero elements in the first row of \bar{U} which are not on the principal diagonal of \bar{U} . We set $x_{k+1} = 1$ if $u_{1i_k} > 0$ and $x_{k+1} = -1$ if $u_{1i_k} < 0$. Next let $u_{2i_1}, \dots, u_{2i_p}$, $2 < i_1 < i_2 < \dots < i_p \leq n$ be the nonzero elements in the second row of \bar{U} which are above the principal diagonal of \bar{U} . We set $x_{p+1+k} = 1$ if $u_{2i_k} > 0$ and $x_{p+1+k} = -1$ if $u_{2i_k} < 0$. This process is continued until all of the nonzero elements above the principal diagonal of \bar{U} are used up. Since $G(\bar{U})$ is a tree there are exactly $n-1$ of these nonzero elements and the vector x will be completely and uniquely determined by this construction. It remains to establish (3.2). By construction $u_{jk} x_k x_j \geq 0$ for $k > j$ and it is obvious that $u_{jj} x_j^2 > 0$. Finally, for $k < j$ $u_{jk} x_k x_j = u_{kj} x_k x_j \geq 0$ again by construction.

Now the vector x which we have constructed belongs to a unique qualitative cone C_{pq} and the inequality (3.2) implies that \bar{U} maps C_{pq} into itself. Moreover, \bar{U} is irreducible so that no coordinate subspace of \mathbb{R}^n is left invariant by \bar{U} and hence \bar{U} is irreducible relative to the cone C_{pq} . The entire theorem now follows from the generalized Perron-Frobenius theorem of Birchoff and Vandergraft and its corollaries (see the paper [6]).

We remark that a different and perhaps simpler proof of most of theorem 1 was given in the paper [2]. But the present formulation of the theorem is more precise and the construction of the vector x is of particular interest in mechanics since the eigenvector y belonging to $\bar{\lambda}$ will have the same sign pattern as x . We further remark that the

We first require the following result from the paper [3].

Lemma 1. Let $\bar{U} \in Q_2^+$. Then every cycle of \bar{U}^{-1} is positive and every element of \bar{U}^{-1} is different from zero.

We shall point out some interesting facts related to lemma 1 below, but for the moment it furnishes a primary tool for the proof of

Theorem 2. Let \bar{U} be the matrix of a vibration tree. Then:

(i') \bar{U}^{-1} has a unique positive eigenvalue $\hat{\lambda}$ such that for every other eigenvalue λ of \bar{U}^{-1} , $\hat{\lambda} > \lambda > 0$.

(ii') There exists a qualitative cone $C_{\hat{p}, \hat{q}}$ such that an eigenvector \hat{y} of \bar{U}^{-1} belonging to $\hat{\lambda}$ belongs to the interior of $C_{\hat{p}, \hat{q}}$.

(iii') No other eigenvector of \bar{U}^{-1} belongs to $C_{\hat{p}, \hat{q}}$.

Proof. By lemma 1 \bar{U}^{-1} is irreducible and a Morishima matrix.* Hence there exists a permutation matrix P such that

$$B = P^t \bar{U}^{-1} P = \begin{bmatrix} B_{11} & B_{12} \\ B_{21} & B_{22} \end{bmatrix}$$

where B_{11} and B_{22} are square positive matrices and $-B_{12}$ and $-B_{21}$ are (in general) rectangular positive matrices. It follows that B and hence also \bar{U}^{-1} itself leaves invariant a qualitative cone $C_{\hat{p}, \hat{q}}$ in \mathbb{R}^n and is irreducible with respect to this cone. The remaining results of the theorem follow again from the generalized Perron-Frobenius theorem.

* Matrices having all nonzero cycles positive have been extensively studied and are called Morishima matrices (see [4]). Professor Michio Morishima of the London School of Economics is a distinguished mathematical economist. His original work on such matrices appeared in 1952 in the paper [7].

cone C_{pq} is determined uniquely up to compliments by \bar{U} . Two cones are complimentary if the elements of one are the negatives of the elements of the other.

By following through the construction of the theorem we obtain the followingsign patterns for aneigenvector belonging to the largest eigenvalue of \bar{U} when \bar{U} is a Jacobi matrix, the matrix of a Sturm system, and when \bar{U} is a bordered diagonal matrix.

1. Suppose \bar{U} is a Jacobi matrix with each element $u_{ii+1} < 0$, $1 \leq i \leq n-1$. Then

$$\text{sgn } y = (+, -, +, -, +, \dots, (-1)^{n+1})$$

where $\text{sgn } y$ is the vector defined in [4]. In this case \bar{U} is the matrix of a Sturm system.

2. Suppose \bar{U} is a Jacobi matrix with each element $u_{ii+1} > 0$, $1 \leq i \leq n-1$. Then

$$\text{sgn } y = (+, +, \dots, +) .$$

3. Suppose \bar{U} is a bordered diagonal matrix with $u_{1i} < 0$, $2 \leq i \leq n$. Then

$$\text{sgn } y = (+, -, -, \dots, -) .$$

4. Suppose \bar{U} is a bordered diagonal matrix with $\text{sgn } u_{1i} = (-1)^n$, $2 \leq i \leq n$. Then

$$\text{sgn } y = (+, +, -, +, \dots, (-1)^n) .$$

As a consequence of theorem 1 the sequence of inequalities (3.1) is sharpened so as to have the form

$$0 < \lambda_1 \leq \lambda_2 \leq \dots \leq \lambda_{n-1} < \lambda_n . \quad (3.1')$$

Our next results will, among other things, sharpen this sequence still further. For this purpose we shall examine the matrix \bar{U}^{-1} .

Several observations may be made. In the first place, observe that the sequence (3.1) is now refined to

$$0 < \lambda_1 < \lambda_2 \leq \dots \leq \lambda_{n-1} < \lambda_n, \quad (3.1'')$$

since the largest eigenvalue of \bar{U}^{-1} is the reciprocal of the smallest eigenvalue of \bar{U} .

Observe also that we have not given any rule in the proof of theorem 2 for computing the sign pattern of the eigenvector y_1 corresponding to λ_1 . We shall correct this omission shortly.

Finally observe that the matrix \bar{U}^{-1} is of considerable interest in mechanics. It is called the flexibility matrix or influence matrix of the system.

4. The eigenvector belonging to the smallest eigenvalue of a vibration tree.

We shall make use of the cofactor formula first published in [3] (see also [4]) in order to find the sign pattern of the eigenvector belonging to the smallest eigenvalue of \bar{U} . To save verbiage let us denote this eigenvector by y_1 to conform with the notation of (3.1'').

Let $u_{\alpha\beta}$ be an element of \bar{U} , $\alpha \neq \beta$, and consider the cofactor $U_{\alpha\beta}$. According to the above mentioned formula $U_{\alpha\beta}$ can be computed if we know the chains from β to α in \bar{U} and appropriate principal minors of \bar{U} . Since $G(\bar{U})$ is a tree, there is exactly one nonzero chain in \bar{U} from β to α . Also because of positive definiteness the principal minors of \bar{U} are positive and the sign of $U_{\alpha\beta}$ depends only upon the nonzero chain $\bar{u}(\beta \rightarrow \alpha)$. Such a chain enters the cofactor formula with sign $(-1)^r$ where r is the length of the chain. Finally \bar{U}^{-1} is a Morishima matrix, hence the sign patterns of any two rows are

either identical or the negative of one another. Thus y_1 has the sign pattern of, say, the first row of \bar{U}^{-1} . All of these facts enable us to state the following result.

Theorem 3. Let \bar{U} be the matrix of a vibration tree, let λ_1 be the smallest eigenvalue of \bar{U} , and let y_1 be a corresponding eigenvector. Then the first component of y_1 is positive and the j -th component for $1 < j \leq n$ has sign $(-1)^p \text{sign } \bar{u}(j \rightarrow 1)$ where $\bar{u}(j \rightarrow 1)$ is the (unique) nonzero chain in \bar{U} from j to 1 and p is the length of $\bar{u}(j \rightarrow 1)$.

Let us illustrate theorem 3 with an example. Suppose \bar{U} has the graph shown in figure 4 with the signs of the appropriate elements not on the principal diagonal as indicated. (For example, the + sign on the

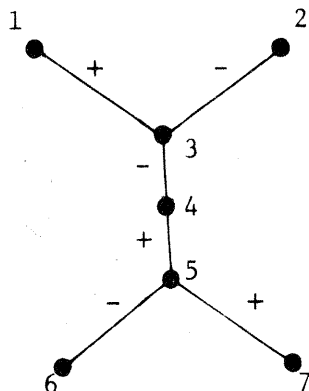

Figure 4.

edge joining vertices 1 and 3 indicates that u_{13} and u_{31} are positive, etc.) Then y_1 satisfies $\text{sgn } y_1 = (1, -1, -1, -1, 1, 1, -1)$. On the other hand the sign pattern of y_7 , the eigenvector belonging to the largest eigenvalue λ_7 of \bar{U} , is given by $\text{sgn } y_7 = (1, 1, -1, -1, 1, -1, 1)$. Thus we have $p = 4$, $\hat{p} = 3$ for the present example.

5. More on the examples.

The two examples of section 2 represent, in a sense which will become clear presently, the two extreme possibilities for the spectrum of a vibration tree. We can, indeed, use them to show that the results obtained in sections 3 and 4 cannot be improved upon in general.

The monograph [8] of Gantmacher and Krein gives a thorough account of the theory of Sturm systems. We summarize the principal results below in theorem 4 using the language of qualitative cones.

Theorem 4. Let \bar{U} be the matrix of a Sturm system. Then the eigenvalues of \bar{U} satisfy

$$0 < \lambda_1 < \lambda_2 < \dots < \lambda_n \quad (5.1)$$

and there exists a sequence of qualitative cones $C_{0j_1}, C_{1j_2}, \dots, C_{n-1, j_n}$ such that an eigenvector y_p of \bar{U} belonging to λ_p belongs to the interior of the cone C_{p-1, j_p} .

We remark that the sequence of cones C_{p-1, j_p} , $1 \leq p \leq n$, is determined uniquely up to complimentary cones by \bar{U} .

Now it is obvious that the sequence of inequalities (5.1) is much stronger than (3.1''), but the example of the bordered diagonal vibration tree shows that (3.1'') is the strongest sequence of inequalities obtainable in the general case.

Consider indeed the matrix \bar{U} given in (2.3). Setting $D(\lambda) =$ determinant $(\bar{U} - \lambda I)$ we have

$$D(\lambda) = (\alpha - \lambda) \prod_{i=1}^{n-1} (\gamma_i - \lambda) - \sum_{j=1}^{n-1} b_j^2 \prod_{\substack{i=1 \\ i \neq j}}^{n-1} (\gamma_i - \lambda). \quad (5.2)$$

Suppose there are m distinct values among the γ_i which we may take to be $\beta_1, \beta_2, \dots, \beta_m$ in increasing order and these occur with multiplicities n_1, n_2, \dots, n_m respectively. We have, of course,

$$n_1 + n_2 + \dots + n_m = n - 1 .$$

(We could have $m = n - 1$ so that there are no repetitions among the γ_i .)

From the righthand side of (5.2) we can factor out $\prod_{i=1}^m (\beta_i - \lambda)^{n_i - 1}$,

hence β_i is an eigenvalue of \bar{U} of multiplicity $n_i - 1$. Now divide

$D(\lambda)$ by $\prod_{i=1}^m (\beta_i - \lambda)^{n_i}$ to yield

$$\frac{D(\lambda)}{\prod_{i=1}^m (\beta_i - \lambda)^{n_i}} = \alpha - \lambda - \sum_{i=1}^m \frac{c_i^2}{\beta_i - \lambda} = \alpha - d(\lambda) ,$$

where $d(\lambda) = \lambda + \sum_{i=1}^m \frac{c_i^2}{\beta_i - \lambda}$ and c_i^2 is the sum of the n_i values of

b_j^2 associated with β_i , hence $c_i^2 > 0$. Clearly the eigenvalues of \bar{U} not found among the β_i are going to satisfy

$$d(\lambda) = \alpha . \tag{5.3}$$

Let us plot $d(\lambda)$ against λ . Obviously $d(\lambda)$ is asymptotic to each of the vertical lines $\lambda = \beta_i$, $1 \leq i \leq m$. Moreover, we have

$$d'(\lambda) = 1 + \sum_{i=1}^m \frac{c_i^2}{(\beta_i - \lambda)^2} > 0 ,$$

hence d is an increasing function of λ wherever it is defined.

Observe that $d(0) > 0$, $d \rightarrow -\infty$ as $\lambda \rightarrow -\infty$ and $d \rightarrow +\infty$ as $\lambda \rightarrow +\infty$.

Hence the graph is as shown in figure 5. We see that the $m+1$ roots

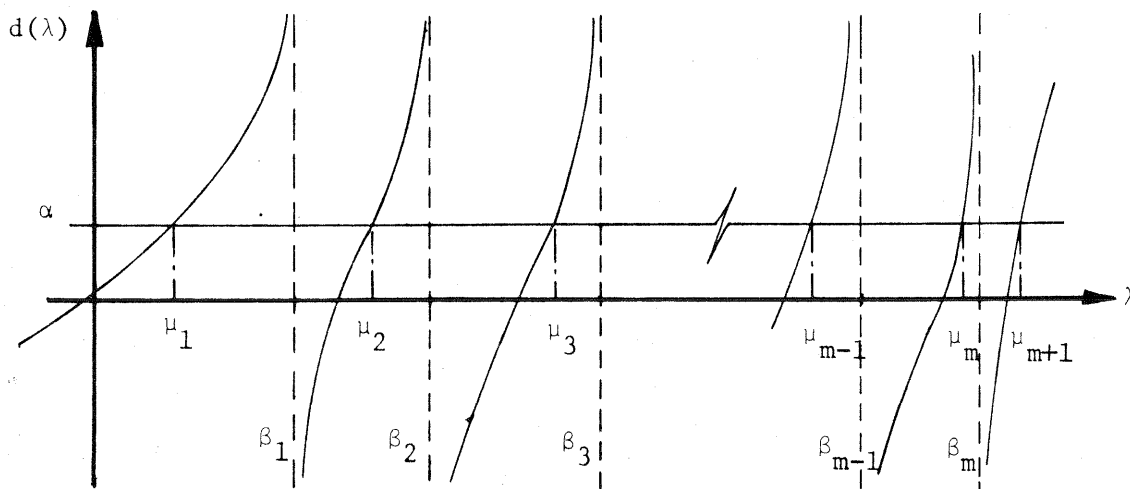

Figure 5.

of $d(\lambda) = \alpha$, denoted by μ_1, \dots, μ_{m+1} satisfy the relations

$$\mu_1 < \beta_1, \beta_{i-1} < \mu_i < \beta_i, 2 \leq i \leq m, \beta_m < \mu_{m+1}. \quad (5.4)$$

It follows that the n eigenvalues of \bar{U} are divided into two groups as follows:

- I. There are $n - (m + 1)$ eigenvalues consisting of $n_i - 1$ values equal to β_i , $1 \leq i \leq m$.
- II. There are $m + 1$ eigenvalues μ_j , $1 \leq j \leq m + 1$, which are simple and satisfy (5.4).

The first group can be empty (the case $m = n - 1$) but there are always at least two elements in the second group. In the case $m = 1$ where all γ_i are equal to β_1 there are two elements in group II and the sequence (3.1'') has the form

$$0 < \lambda_1 < \lambda_2 = \lambda_3 = \dots = \lambda_{n-1} < \lambda_n,$$

justifying our claim that the sequence (3.1'') cannot be sharpened in general.

Theorem 4 also contains a very strong statement about the eigenvectors of a Sturm system. For comparison, let us examine the eigenvectors of the bordered diagonal vibration tree.

It is convenient to suppose that the rows and columns of \bar{U} are so arranged that

$$\gamma_j = \beta_i \quad \text{for } 0 < j - n_1 - \dots - n_{i-1} \leq n_i$$

We must consider the equation $(\bar{U} - \lambda I)y = 0$ where $y = (y_1, \dots, y_n)$ and λ is an eigenvalue of \bar{U} . This system is

$$(\alpha - \lambda)y_1 + \sum_{j=1}^{n-1} b_j y_{j+1} = 0 \quad (5.5)$$

$$b_j y_1 + (\gamma_j - \lambda)y_{j+1} = 0, \quad 2 \leq j \leq n-1. \quad (5.6)$$

Suppose first $\lambda = \beta_i$. Then n_i equations of the form (5.6) reduce to $b_j y_1 = 0$, hence $y_1 = 0$. The remaining $n-1-n_i$ equations of the form (5.6) reduce to $(\gamma_j - \beta_i)y_{j+1} = 0$ hence the corresponding components of the eigenvector are all zero. Finally the n_i components which need not be zero must satisfy (5.5) which becomes

$$\sum_{j=1}^{n-1} b_j y_{j+1} = 0 \quad (5.7)$$

because $y_1 = 0$. There are n_i nonzero terms on the lefthand side of (5.5") and we can clearly obtain $n_i - 1$ linearly independent solutions, hence $n_i - 1$ linearly independent eigenvectors. Moreover, it is easy to see that these eigenvectors can be so chosen as to have exactly two nonzero components.

It remains to consider an eigenvector belonging to μ_k , $1 \leq k \leq m+1$. For such an eigenvector we have the $n-1$ equations

$$u_{j+1} = \frac{b_j}{\lambda - \gamma_j} u_1, \quad 1 \leq j \leq n-1,$$

since $\lambda - \gamma_j \neq 0$, $1 \leq j \leq n-1$. Evidently all of these eigenvectors have the property that each component is nonzero

Thus we can conclude that for the bordered diagonal vibration tree the presence of multiple eigenvalues implies the existence of eigenvectors with some zero components.

6. Spectral multiplicity.

The example of the bordered diagonal vibration tree represents more typically the behavior of vibration trees than does the classical example of the Sturm system. (Our discussion of this example is borrowed, in part, from that of Wilkinson [9], although this author does not examine the eigenvectors.) Indeed we shall see that every vibration tree which is not a Sturm system can have multiple eigenvalues.

It seems to be commonly supposed, if one may judge by statements available in the literature, that multiple eigenvalues can be ignored in vibration problems. This supposition amazes the present authors. Not only can multiple eigenvalues occur in nearly all vibration trees -- which represent the simplest large scale systems -- but nearly equal eigenvalues can occur even in Sturm systems. The use of the modern digital computer has taught us that nearby eigenvalues are extremely difficult to distinguish from actual multiple eigenvalues in the real world of computation. In any system in which multiple eigenvalues can occur, nearby eigenvalues can obviously also occur.

In order to study the possible spectral multiplicities of vibration trees we require some determinant formulas and some additional graph

theoretic ideas. The first person to point out the close connection between the graph $G(A)$ and the spectral properties of A when $G(A)$ is a tree was Parter in the paper [1]. Of course, the use of topological methods to derive determinant formulas for electrical networks goes back to Kirchhoff and J. C. Maxwell.

First a few graph theoretic concepts. If G is a graph and p a vertex of G we remind the reader that the degree of p is equal to the number of edges of G incident at p . An edge of a graph G is called a bridge (of G) if its removal causes G to become disconnected. If G is a tree with n vertices it has exactly $n-1$ edges and every edge is a bridge. Following Parter we shall let $G(p,q)$ denote the connected subtree of G containing p obtained by removing the edge $\{p,q\}$. If G is the graph of the matrix \bar{U} we denote by $D(p,q)$ the determinant of the (principal) submatrix $\bar{U}(p,q)$ corresponding to the subtree $G(p,q)$. We let $D(p,q,\lambda)$ be the characteristic polynomial of this submatrix. We set $D(\lambda) = \det(\bar{U} - \lambda I)$. Finally we denote by $D'(p,q,\lambda)$ the determinant obtained from $D(p,q,\lambda)$ by deleting the row and column containing $u_{pp} - \lambda$.

Our subsequent results are based upon two determinant formulas.

I. The edge formula:

$$D(\lambda) = D(p,q,\lambda)D(q,p,\lambda) - u_{pq}^2 D'(p,q,\lambda)D'(q,p,\lambda) \quad (6.1)$$

The edge formula holds for any edge $\{p,q\}$ in $G(\bar{U})$ (we set $D'(p,q,\lambda) = 1$ if $D(p,q,\lambda) = a_{pp} - \lambda$). It is the generalization to an arbitrary tree of a corresponding formula for Sturm systems upon which Sturm based his investigations. There is a second generalization which Parter called the neighbor formula.

II. The neighbor formula:

$$D(\lambda) = (u_{qq} - \lambda) \prod_{j=1}^k D(p_j, q, \lambda) - \sum_{j=1}^k u_{p_j q}^2 D'(p_j, q, \lambda) \prod_{\substack{m=1 \\ m \neq j}}^k D(p_m, q, \lambda) \quad (6.2)$$

where p_1, \dots, p_k are the neighbors of q in G . The neighbor formula holds for any vertex q in $G(\bar{U})$. (Observe the close similarity of formula (6.2) to (5.2) which is the neighbor formula applied to the vertex l of degree $n-1$ in that example.) The integer k is the degree of the vertex q .

Observe that if q is an endpoint of $G(\bar{U})$, i.e., a vertex of degree 1 both formulas reduce to

$$D(\lambda) = (u_{qq} - \lambda)D(p, q, \lambda) - u_{pq}^2 D'(p, q, \lambda). \quad (6.3)$$

Using formulas (6.1) and (6.2) and an ingenious graph theoretic argument Parter proved the following theorem which we paraphrase as it applies to vibration trees.

Theorem 5. Let \bar{U} be the matrix of a vibration tree. Then \bar{U} has an eigenvalue λ of multiplicity greater than 1 if and only if $G(\bar{U})$ contains a point q of degree ≥ 3 such that λ is an eigenvalue of $D(p_j, q, \lambda)$ for at least three neighbors p_j , $1 \leq j \leq 3$, of q .

Some remarks are in order.

Among vibration trees Sturm systems are characterized by the fact that $G(\bar{U})$ has no vertex of degree > 2 . All other vibration trees have at least one vertex of degree ≥ 3 . Consequently any vibration tree which is not a Sturm system will have a multiple eigenvalue if the physical parameters are properly chosen.

Let us give a simple mechanical interpretation of the theorem. Suppose, to be specific, $G(\bar{U})$ contains a point p of order 3 with neighbors p_1, p_2, p_3 . Consider the submatrix $\bar{U}(p_j, p)$. It is the matrix of a vibration tree obtained by imposing constraints upon the original system. The mechanical interpretation of the theorem is now clear. A vibration tree has a multiple eigenvalue λ if and only if there is a point at which at least three subsystems are joined together each of which has λ as an eigenvalue.

Next we remark that the if portion of theorem 5 is an immediate consequence of formula (6.2). Indeed, if the point q in the formula has 3 or more neighbors such that λ_0 is a zero of $D(p, q, \lambda)$, then each term on the righthand side has at least a double zero at λ_0 . Moreover, the following lemma is immediate.

Lemma 2. Let \bar{U} be the matrix of a vibration tree. Then \bar{U} has an eigenvalue λ_0 of multiplicity k if $G(\bar{U})$ contains a point q of degree $\geq k+1$ such that for $k+1$ neighbors p_1, \dots, p_{k+1} of q , λ_0 is an eigenvalue of $D(p_j, q, \lambda)$.

We shall show that the condition of the lemma is not necessary.

In fact, we have

Lemma 3. Given any positive integer $p \geq 2$ there exists a vibration tree having an eigenvalue of multiplicity p with matrix \bar{U} such that $G(\bar{U})$ has no vertex of degree > 3 .

Proof. The proof is by induction on p . For $p = 2$ consider the tree of figure 6.

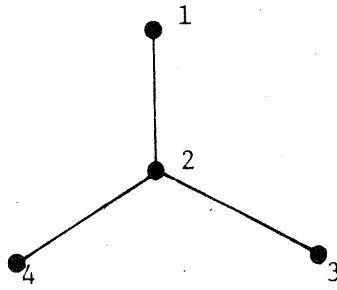

$G(\bar{U})$ for $p = 2$

Figure 6.

The corresponding matrix is

$$\bar{U} = \begin{bmatrix} a_1 & b_1 & b_2 & b_3 \\ b_1 & a_2 & 0 & 0 \\ b_2 & 0 & a_3 & 0 \\ b_3 & 0 & 0 & a_4 \end{bmatrix},$$

a bordered diagonal matrix with a double eigenvalue if $a_1 = a_3 = a_4$.

Thus the lemma is true for $p = 2$. Suppose, now it is true for the value $p-1$ and let G_{p-1} be the corresponding graph. Let q be a vertex of degree 1 of G_{p-1} and construct G_p as shown in Figure 7.

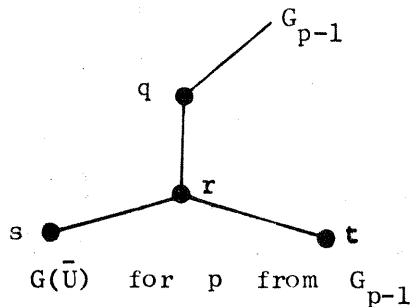

Figure 7.

We apply formula (6.2) at the point q . Denoting by $D_{p-1}(\lambda)$ the determinant of the matrix of \bar{U} corresponding to G_{p-1} we have for the matrix corresponding to the graph in figure 7

$$\begin{aligned}
D(\lambda) &= (u_{rr} - \lambda)D_{p-1}(\lambda)D(s,r,\lambda)D(t,r,\lambda) \\
&\quad - u_{rq}^2 D'_{p-1}(\lambda)D(s,r,\lambda)D(t,r,\lambda) \\
&\quad - u_{rs}^2 D_{p-1}(\lambda)D(t,r,\lambda) - u_{rt}^2 D_{p-1}(\lambda)D(s,r,\lambda) .
\end{aligned}$$

Since $D(s,r,\lambda) = u_{ss} - \lambda$, $D(t,r,\lambda) = u_{tt} - \lambda$, this reduces to

$$\begin{aligned}
D(\lambda) &= (u_{rr} - \lambda)(u_{ss} - \lambda)(u_{tt} - \lambda)D_{p-1}(\lambda) - u_{rq}^2 D'_{p-1}(\lambda)(u_{ss} - \lambda)(u_{tt} - \lambda) \\
&\quad - u_{rs}^2 D_{p-1}(\lambda)(u_{tt} - \lambda) - u_{rt}^2 D_{p-1}(\lambda)(u_{ss} - \lambda) .
\end{aligned}$$

Suppose λ_0 is a zero of $D_{p-1}(\lambda)$ of order $p-1$ then it is a zero of $D_{p-1}(\lambda)$ of order $p-2$. It follows that, if $u_{ss} = u_{tt} = \lambda_0$, λ_0 will be a zero of order p of $D(\lambda)$. This completes the inductive step and the lemma is proved.

We remark that the vibration tree we have constructed in the proof will have $p-1$ vertices of degree 3 in its graph. As an illustration, figure 8 shows the graph we have constructed for an eigenvalue of multiplicity 5. If the elements on the principal diagonal of \bar{U} corresponding to all vertices of degree ≤ 2 are all equal to λ_0 , then λ_0 will be an eigenvalue of multiplicity 5. It is easy to construct specific mechanical examples which have this form.

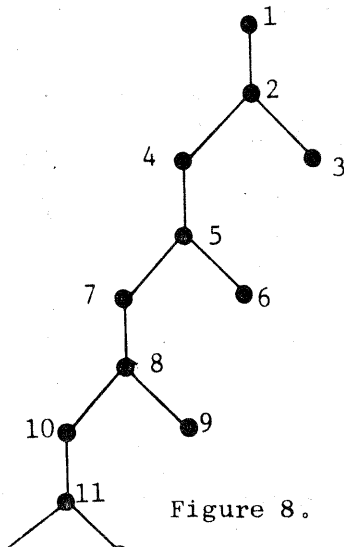

Figure 8.

Obviously there are now many special results on spectral multiplicities which can be obtained with the help of the ideas we have introduced. We shall not pursue this question further in the present paper. Instead we will conclude with a brief discussion of eigenvectors belonging to multiple eigenvalues.

Let us focus our attention upon a vertex q of degree ≥ 3 of $G(\bar{U})$. The matrix \bar{U} may be written in the form

$$\bar{U} = \begin{bmatrix} \bar{U}(p_1, q) & 0 & \dots & \bar{u}'_{p_1, q} & \dots & \dots \\ 0 & \bar{U}(p_2, q) & \dots & \bar{u}'_{p_2, q} & \dots & \dots \\ \dots & \dots & \dots & \dots & \dots & \dots \\ \bar{u}_{p_1, q} & \bar{u}_{p_2, q} & \dots & u_{qq} & \dots & \bar{u}_{p_k, q} \\ \dots & \dots & \dots & \dots & \dots & \dots \\ \dots & \dots & \dots & \bar{u}'_{p_k, q} & \dots & \bar{U}(p_k, q) \end{bmatrix}$$

when q has degree k . Here $\bar{u}_{p_1, q}$ is a row vector having exactly one nonzero element and $\bar{u}'_{p_1, q}$ is the corresponding column vector.

Suppose, to be specific, that the points p_1, p_2, p_3 are neighbors of q such that $D(p_j, q, \lambda_0) = 0$, $1 \leq j \leq 3$, hence λ_0 is a double eigenvalue of \bar{U} . Let $x = (x_1, \dots, x_{r_1})$, $y = (y_1, \dots, y_{r_2})$, $z = (z_1, \dots, z_{r_3})$ be the eigenvectors of $\bar{U}(p_1, q)$, $\bar{U}(p_2, q)$, and $\bar{U}(p_3, q)$ respectively belonging to λ_0 . We may assume that x_1, y_1, z_1 are the components associated with the points p_1, p_2 , and p_3 . (This is equivalent to supposing that $\bar{u}_{p_1, q} = (u_{p_1, q}, 0, \dots, 0)$, etc.)

If $x_1 y_1 z_1 \neq 0$ choose any a and b such that

$$au_{p_1 q} x_1 + bu_{p_2 q} y_1 = 0$$

and any c and d such that

$$cu_{p_1 q} x_1 + du_{p_3 q} z_1 = 0 .$$

Then the vectors

$$v_1 = (ax_1, \dots, ax_{r_1}, by_1, \dots, by_{r_2}, 0, 0, \dots, 0)$$

and

$$v_2 = (cx_1, \dots, cx_{r_1}, 0, \dots, 0, dz_1, \dots, dz_{r_3}, 0, \dots, 0)$$

are linearly independent eigenvectors of \bar{U} belonging to λ_0 .

If $x_1 = 0$, then

$$v_1 = (x_1, \dots, x_{r_1}, 0, 0, \dots, 0)$$

is an eigenvector of \bar{U} belonging to λ_0 .

If $x_1 = 0$ and $y_1 z_1 \neq 0$ choose a and b such that $au_{p_2 q} y_1 + bu_{p_3 q} z_1 = 0$

and

$$v_2 = (0, \dots, 0, ay_1, \dots, ay_{r_2}, bz_1, \dots, bz_{r_3}, 0, \dots, 0)$$

is a second eigenvector.

Finally if $x_1 = 0$ and, say $y_1 = 0$, then

$$v_2 = (0, \dots, 0, y_1, \dots, y_{r_2}, 0, \dots, 0)$$

is a second eigenvector.

Clearly the above considerations can be extended to the general case and we see that linearly independent eigenvectors belonging to multiple eigenvalues of \bar{U} can always be found easily from eigenvectors of proper

submatrices of \bar{U} . These eigenvectors will also always have some components equal to zero.

The result of this section clearly justify our remark in section 5 that the bordered diagonal vibration tree is more representative of vibration trees in general than the Sturm system is.

Bibliography

1. Parter, S., On the eigenvalues and eigenvectors of a class of matrices, J. SIAM, Vol. 8, 1960, 376-388.
2. Maybee, J., New generalizations of Jacobi matrices, J. SIAM, Vol. 14, 1966, 1032-1037.
3. Maybee, J., Matrices of class J_2 , J. Res. Natl. B. Stan., Vol. 71, 1967, 215-224.
4. Maybee, J. and Quirk, J., Qualitative problems in matrix theory, SIAM Review, Vol. 11, 30-51.
5. Bocher, M., The published and unpublished works of Charles Sturm on algebraic and differential equations, Bull. AMS, 18, 1911, 40-51.
6. Vandergraft, J., Spectral properties of matrices which have invariant cones, SIAM J. Appl. Math., Vol. 16, 1968, 1208-1222.
7. Morishima, M., On the laws of change of the price system in an economy which contains complimentary commodities, Osaka Economic Papers, Vol. 1, 1952, 101-113.
8. Gantmacher, F. and Krein M., Oscillation Matrices and Kernels and Small Vibrations of Mechanical Systems, Translated from the Russian by U.S. Atomic Energy Commission 1961, Originally published by State Publishing House for Technical-Theoretical Literature, Moscow, 1950.
9. Wilkinson, J., The Algebraic Eigenvalue Problem, Oxford Univ. Press, 1965.