



**COLORADO**

**Department of Transportation**



# **M-E Pavement Design Manual**

**2020**

## INTRODUCTION

### **Purpose of Manual**

The purpose of this Pavement Design Manual is to provide the Colorado Department of Transportation (CDOT) and consultant pavement designers with a uniform and detailed procedure for designing pavements on CDOT projects. This manual should be used after July 1, 2020.

### **Organization of the Manual**

The manual is organized in a manner that affords the users with simple and methodical steps in the design of pavements for the Colorado state highway system. The contents are arranged carefully to provide users with sufficient flexibility in selecting and focusing on the appropriate topics and chapters that will suit their specific pavement design needs. There are four major pavement design categories presented in this manual; new construction/reconstruction, rehabilitation with overlays, rehabilitation without overlays, and intersection designs. Each category contains CDOT's current procedures utilized in the design of flexible and rigid pavements. Also included are relevant and required input data including pavement design information, subgrade and base materials, pavement type selection, life cycle cost analysis, pavement justification report (PJR), and appendices. These chapters are provided to support and document the entire pavement design process. The Introduction Pavement Design Manual Organization Flow Chart depicts a general overview of how this manual is organized.

### **Importance of Pavement Design**

CDOT spends more than 30 percent of its annual construction and maintenance budget on pavements. Therefore, pavements need to be properly designed using an analytical process with accurate design inputs. A pavement design needs to be performed during the early phase of project development. This step ensures that pavement design is used to estimate and establish the project cost rather than the project cost dictating the pavement design.

### **Training**

This manual provides general and detailed information about pavement design processes and procedures applicable to various locations in the State of Colorado. Information on more comprehensive training courses entitled Pavement Design and Life Cycle Cost Analysis and other materials related training classes is available through the CDOT Materials and Geotechnical Branch, Pavement Management and Design Program.

### **Approved Pavement Design Methods**

The AASHTO Mechanistic-Empirical (M-E) design procedure using AASHTOWare Pavement M-E Design software (formerly DARWin-ME™) is the recommended method to determine pavement design thickness. The CDOT strongly recommends using the AASHTO Interim Mechanistic Empirical Pavement Design Guide (MEPDG) Manual of Practice along with the latest CDOT Pavement Design Manual.

### **Coordinating Designs with Other Agencies**

Other agencies should contact either the Region Materials Engineer (RME) or the Pavement Design Program Manager (PDMP) concerning CDOT and Region policies relating to pavement issues.

### **Data Collection**

The data collected for new construction and rehabilitation projects are somewhat different. The pavement rehabilitation project will take the largest data collection effort. In many instances, it may be necessary to design for both pavement reconstruction and pavement rehabilitation. The final selection between the two will involve a study of costs, traffic handling, and other related items.

### **Pavement Justification Report (PJR) and Other Documentation**

A PJR is a formal engineering document that presents all analysis, data, and other considerations used to design a pavement. Guidelines for the information that needs to be included in a pavement design report are contained in this manual. For the special cases identified below that do not require a pavement design report, the documentation should include a brief description of the criteria, engineering considerations, and or Region policy used in the decision process. For other reporting requirements, contact the RME for guidance. The PJR shall be sent to the CDOT Region Materials Engineer. A copy of the PJR on all surface treatment projects and all new or reconstruction projects with Hot Mix Asphalt (HMA or Portland Cement Concrete Pavement (PCCP) material costs greater than \$3,000,000 will be sent to the PDPM. Access and local agency project PJR's will not be required to be submitted to the PDPM.

### **Projects Needing a Pavement Justification Report**

HMA overlays less than 2 inches are considered a preventive maintenance treatment, and therefore a PJR may not be required. Nevertheless, considering the significant investment thin overlays represent, these treatments should be considered in an overall pavement preservation program. For design categories not covered above, contact the RME or the PDPM for guidance about recommended design procedures and documentation requirements.

### **Responsibility, Approval, and Signature Authority**

Pavement design and documentation is primarily the responsibility of the engineer of record and must be reviewed and approved by the RME. In the event that the RME position is vacant, the pavement designs shall be forwarded to the CDOT Materials and Geotechnical Branch Manager. For the pavement design work prepared by a consultant, the PJR shall be stamped, signed, and dated by the consultant and shall include his/her Professional Engineer's License number. The development of pavement design in CDOT is done in English units, which is the standard.

## SUMMARY OF MANUAL REVISIONS FROM 2019

SECTION	MAJOR REVISIONS
Introduction, Acronyms and Definitions	<ul style="list-style-type: none"> <li>▪ Updated contact list</li> </ul>
Chapter 1	<ul style="list-style-type: none"> <li>▪ New Section 1.5.3 Optimization Feature</li> </ul>
Chapter 2	<ul style="list-style-type: none"> <li>▪ Updated initial IRI smoothness values</li> </ul>
Chapter 3	<ul style="list-style-type: none"> <li>▪ Updated Table 3.15 Geographic Coordinates and Data Availability of Colorado Weather Stations</li> </ul>
Chapter 4	
Chapter 5	
Chapter 6	
Chapter 7	<ul style="list-style-type: none"> <li>▪ New Section 7.14 Widened Lanes</li> <li>▪ Table 7.6 updated to 7 inches of concrete thickness and 6 inches of ABC</li> </ul>
Chapter 8	<ul style="list-style-type: none"> <li>▪ New Section 8.17.1 Designs That Require Milling of Existing HMA</li> </ul>
Chapter 9	
Chapter 10	
Chapter 11	
Chapter 12	
Chapter 13	<ul style="list-style-type: none"> <li>▪ AC cost adjustment value</li> <li>▪ Updated discount rate</li> <li>▪ Revised Section 13.2.4 Hot Mix Asphalt, Bottom-Up Fatigue Cracking</li> </ul>
Chapter 14	
Appendix A	
Appendix B	
Appendix C	
Appendix D	
Appendix E	
Appendix F	
Appendix G	
Appendix H	
Appendix I	New Appendix, Geosynthetic Guidelines
Supplement	

## ACKNOWLEDGEMENTS

The Materials and Geotechnical Branch of the Colorado Department of Transportation thanks the following individuals who contributed their expertise, knowledge, and time in reviewing the CDOT Pavement Design Manual.

## PAVEMENT DESIGN CONTRIBUTORS

### Headquarters

Craig Wieden  
Materials and Geotechnical Branch Manager  
4670 Holly Street, Unit A  
Denver, CO 80216  
(303) 398-6501  
[Craig.Wieden@state.co.us](mailto:Craig.Wieden@state.co.us)

Michael Stanford  
Asphalt Program Manager  
4670 Holly Street, Unit A  
Denver, CO 80216  
(303) 398-6576  
[Michael.Stanford@state.co.us](mailto:Michael.Stanford@state.co.us)

Eric Prieve  
Concrete and Physical Properties  
Program Manager  
4670 Holly Street, Unit A  
Denver, CO 80216  
(303) 398-6542  
[Eric.Prieve@state.co.us](mailto:Eric.Prieve@state.co.us)

Ty Ortiz  
Geohazards Program Manager  
4670 Holly Street, Unit A  
Denver, CO 80216  
(303) 398-6601  
[Ty.Ortiz@state.co.us](mailto:Ty.Ortiz@state.co.us)

David Thomas  
Soils and Geotechnical Program Manager  
4670 Holly Street, Unit A  
Denver, CO 80216  
(303) 398-6604  
[David.Thomas@state.co.us](mailto:David.Thomas@state.co.us)

Melody Perkins  
Pavement Design Program Manager  
4670 Holly Street, Unit A  
Denver, CO 80216  
(303) 398-6561  
[Melody.Perkins@state.us.co](mailto:Melody.Perkins@state.us.co)

### Special Assistance

Dahir Egal  
FHWA Pavements/Operations Engineer  
12300 West Dakota Ave., Suite 180  
Lakewood CO 80228  
(720) 963-3021  
[Dahir.Egal@dot.gov](mailto:Dahir.Egal@dot.gov)

### Region 1

James Chang  
Region Materials Engineer  
4670 Holly Street, Unit B  
Denver, CO 80216  
(303) 398-6801  
[James.Chang@state.us.co](mailto:James.Chang@state.us.co)

Shamshad Hussain  
Assistant Region Materials Engineer  
4670 Holly Street, Unit B  
Denver, CO 80216  
(303) 398-6802  
[Shamshad.Hussain@state.co.us](mailto:Shamshad.Hussain@state.co.us)

Kevin Moore  
Assistant Region Materials Engineer  
4670 Holly Street, Unit B  
Denver, CO 80216  
(303) 398-6803  
[Kevin.Moore@state.co.us](mailto:Kevin.Moore@state.co.us)

**Region 1**

Stephen Henry  
Region Materials Engineer  
4670 Holly Street, Unit C  
Denver, CO 80216  
(303) 398-6703  
[Stephen.Henry@state.co.us](mailto:Stephen.Henry@state.co.us)

Laura Conroy  
Assistant Region Materials Engineer  
4670 Holly Street, Unit C  
Denver, CO 80216  
(303) 398-6801  
[Laura.Conroy@state.co.us](mailto:Laura.Conroy@state.co.us)

**Region 2**

Jody Pieper  
Region Materials Engineer  
905 Erie Ave.  
Pueblo, CO 81001  
(719) 562-5532  
[Jody.Pieper@state.co.us](mailto:Jody.Pieper@state.co.us)

Jeri Mero  
Assistant Region Materials Engineer  
905 Erie Ave.  
Pueblo, CO 81001  
(719) 546-5703  
[Jeri.Mero@state.co.us](mailto:Jeri.Mero@state.co.us)

**Region 3**

Coulter Golden  
Region Materials Engineer  
2328 G Road  
Grand Junction, CO 81505  
(970) 683-7561  
[Coulter.Golden@state.co.us](mailto:Coulter.Golden@state.co.us)

Babaft Moore  
Pavement Management  
2328 G Road  
Grand Junction, CO 81505  
(970) 683-7561  
[Babaft.Moore@state.co.us](mailto:Babaft.Moore@state.co.us)

**Region 4**

Gary DeWitt  
Region Materials Engineer  
3971 W. Service Road  
Evans, CO 80602  
(970) 350-2379  
[Gary.Dewitt@state.co.us](mailto:Gary.Dewitt@state.co.us)

Steven Heimmer  
Assistant Region Materials Engineer  
3971 W. Service Road  
Evans, CO 80602  
(970) 350-2380  
[Steven.Heimmer@state.co.us](mailto:Steven.Heimmer@state.co.us)

**Region 5**

Tim Webb  
Region Materials Engineer  
3803 N. Main Ave., Suite 200  
Durango, CO 81301  
(970) 385-1625  
[Tim.Webb@state.co.us](mailto:Tim.Webb@state.co.us)

Beaux Kemp  
Assistant Region Materials Engineer  
3803 N. Main Ave., Suite 200  
Durango, CO 81301  
(970) 385-1627  
[Beaux.Kemp@state.co.us](mailto:Beaux.Kemp@state.co.us)

## TABLE OF CONTENTS

<b>INTRODUCTION .....</b>	<b>1</b>
<b>SUMMARY OF MANUAL REVISIONS FROM 2018.....</b>	<b>3</b>
<b>ACKNOWLEDGEMENTS .....</b>	<b>5</b>
<b>PAVEMENT DESIGN CONTRIBUTORS .....</b>	<b>5</b>
<b>TABLE OF CONTENTS .....</b>	<b>6</b>
<b>LIST OF FIGURES .....</b>	<b>18</b>
<b>LIST OF TABLES .....</b>	<b>27</b>
<b>ACRONYMS COMMON TO CDOT .....</b>	<b>31</b>
<b>DESIGN OF PAVEMENT STRUCTURE DEFINITIONS .....</b>	<b>35</b>
<b>MECHANISTIC-EMPIRICAL (M-E) PAVEMENT DESIGN BASIC DEFINITIONS.....</b>	<b>52</b>
<b>ESTIMATING FORMULAS, CALCULATIONS, AND CONVERSION FACTORS.....</b>	<b>54</b>
<b>CHAPTER 1: INTRODUCTION .....</b>	<b>56</b>
1.1 Introduction .....	56
1.2 Scope and Limitations .....	56
1.2.1 Limitations .....	56
1.2.2 Scope .....	57
1.3 Overview of AASHTO Pavement Mechanistic-Empirical Design Procedure .....	57
1.4 Overview of AASHTOWare Pavement M-E Design Software .....	59
1.4.1 Installing M-E Design Software .....	59
1.4.2 Uninstalling M-E Design Software .....	59
1.4.3 Running M-E Design Software .....	61
1.5 Working with the M-E Design Database .....	65
1.5.1 Saving to the M-E Design Database .....	67
1.5.2 Retrieving or Importing from M-E Design Database .....	74
1.5.3 Optimization Function .....	78
<b>CHAPTER 2: PAVEMENT DESIGN INFORMATION .....</b>	<b>82</b>
2.1 Introduction .....	82
2.2 Site and Project Identification .....	82
2.3 Project Files/Records Collection and Review .....	82
2.3.1 Project Data Collection .....	82
2.3.2 Field Survey .....	82
2.3.3 Initial Selection .....	82
2.3.4 Physical Testing .....	82
2.3.5 Evaluation and Selection .....	83
2.3.6 Historic M-E Design Software Files .....	83
2.3.7 Records Review .....	83
2.4 Site Investigation .....	84
2.4.1 Abutting Land Usage .....	84
2.4.2 Existing/Proposed Project Geometrics .....	84
2.4.3 Conditions Survey .....	85
2.4.4 Drainage Characteristics .....	85
2.5 Construction and Maintenance Experience .....	86
2.6 Pavement Management System (PMS) Condition Data .....	86
2.7 Design Performance Criteria and Reliability (Risk) .....	88

2.8	Defining Input Hierarchy .....	95
2.9	Drainage .....	96
2.9.1	Subdrainage Design .....	97
<b>CHAPTER 3: TRAFFIC AND CLIMATE .....</b>		<b>99</b>
3.1	Traffic.....	99
3.1.1	CDOT Traffic Data .....	100
3.1.2	Traffic Inputs Hierarchy .....	101
3.1.3	Volume Counts .....	102
3.1.4	Lane and Directional Distributions .....	103
3.1.5	Growth Factors for Trucks .....	104
3.1.6	Vehicle Classification .....	106
3.1.6.1	Level 1 Vehicle Class Inputs .....	110
3.1.6.2	Level 2 Vehicle Class Inputs .....	110
3.1.6.3	Level 3 Vehicle Class Inputs .....	111
3.1.7	Number of Axles Per Truck .....	113
3.1.7.1	Level 1 Number of Axles Per Truck .....	113
3.1.7.2	Level 2 Number of Axles Per Truck .....	113
3.1.7.3	Level 3 Number of Axles Per Truck .....	113
3.1.8	Monthly Adjustment Factors (Trucks) .....	114
3.1.8.1	Level 1 Monthly Adjustment Factors .....	115
3.1.8.2	Level 2 Monthly Adjustment Factors .....	115
3.1.8.3	Level 3 Monthly Adjustment Factors .....	115
3.1.9	Hourly Distribution Factors (Trucks) .....	116
3.1.9.1	Level 1 Hourly Distribution Factors .....	116
3.1.9.2	Level 2 Hourly Distribution Factors .....	116
3.1.9.3	Level 3 Hourly Distribution Factors .....	117
3.1.10	Axle Load Distribution .....	118
3.1.10.1	Level 1 Axle Load Distribution Factors .....	118
3.1.10.2	Level 2 Axle Load Distribution Factors .....	118
3.1.10.3	Level 3 Axle Load Distribution Factors .....	118
3.1.11	Vehicle Operational Speed (Trucks) .....	125
3.1.11.1	Lateral Wander of Axle Loads .....	125
3.1.12	Axle Configuration and Wheelbase .....	126
3.1.13	Tire Pressure .....	128
3.1.14	Traffic Files in Electronic Format for M-E Design Software .....	128
3.2	Climate .....	128
3.2.1	Creating Project Specific Climate Input Files .....	129
3.2.1.1	Design Life Greater Than Climate Data.....	129
3.2.1.1	Design Life Less Than Climate Data.....	129
<b>CHAPTER 4: SUBGRADE .....</b>		<b>140</b>
4.1	Introduction .....	140
4.2	Soil Survey Investigation .....	140
4.2.1	Soil Surveys and Preliminary Soil Profile.....	141
4.2.2	Soil Survey Classification .....	142
4.2.2.1	Reconnaissance Soil Surveys.....	142
4.2.2.1	Preliminary Soil Surveys.....	142
4.2.3	Soil Surveys.....	143



4.2.3.1	Horizontal Distribution of Borings.....	143
4.2.3.2	Proposed Ne Line and/or Grade.....	144
4.2.3.3	Boring Depth.....	145
4.2.3.4	Sampling Methods.....	147
4.2.4	Hydraulic Conditions.....	147
4.2.5	Piping.....	148
4.2.6	Condition of Existing Pavements.....	148
4.2.7	Frost.....	148
4.2.8	Adjacent Terrain.....	148
4.2.9	Excavation Characteristics.....	148
4.2.10	Embankment Foundations.....	149
4.2.11	Swelling Soils.....	149
4.2.12	Soil Identification and Description.....	150
4.2.13	Rock Identification and Description.....	151
4.2.14	Determination of Need for Culvert Protection.....	152
4.2.14.1	Field Observations and Sampling.....	152
4.3	Subgrade and Embankment .....	164
4.4	Subgrade Characterization for the M-E Design .....	165
4.4.1	General Characterization .....	165
4.4.2	Modeling Subgrade Layers in M-E Design Software .....	170
4.4.3	Recommended Inputs for Subgrade/Embankment Materials .....	171
4.4.3.1	Inputs for New HMA and JPCP .....	171
4.4.3.2	Inputs for HMA Overlay of Existing Flexible Pavements .....	175
4.4.3.3	Inputs for Overlays of Existing Rigid Pavements .....	176
4.5	Rigid Layer .....	180
4.6	Rock Fill .....	181
4.7	Frost Susceptible Soils .....	181
4.8	Sulfate Subgrade Soils .....	185
4.9	Expansive Subgrade Soils .....	186
4.10	Stabilizing Agents .....	190
4.10.1	Lime Treated Subgrade .....	191
4.10.2	Cement Treated Subgrade .....	192
4.10.3	Fly ash and Lime/Fly Ash Treated Subgrade .....	193
4.11	Geosynthetic Fabrics and Mats .....	194
4.11.1	Introduction .....	194
4.11.2	Separator Layer .....	195
4.12	Material Sampling and Testing .....	196
<b>CHAPTER 5: GRANULAR AND TREATED BASE MATERIALS .....</b>		<b>200</b>
5.1	Bases .....	200
5.2	Sampling Base Materials During a Soil Survey Investigation .....	200
5.3	Aggregate Base Course (ABC) .....	200
5.3.1	Unbound Layer Characterization in M-E Design .....	202
5.3.2	Modeling Unbound Aggregate Base Layers in M-E Design Software.....	206
5.4	Treated Base Course .....	207
5.4.1	Characterization of Treated Base in M-E Design .....	208
5.4.2	Modeling Treated Base in M-E Design .....	211
5.5	Permeable Bases .....	212
5.6	Reclaimed Asphalt and Concrete Pavement .....	213

5.6.1 Reclaimed Asphalt Pavement Base .....	213
5.6.1.1 Reclaimed Asphalt Pavement (RAP) Base .....	214
5.6.1.2 Full Depth Asphalt Reclaimed Base (FDR) .....	215
5.6.2 Reclaimed Concrete Pavement Base (RCP) .....	216
5.7 Base Layer Made of Rubblized Rigid Pavement .....	216
5.8 Material Sampling and Testing .....	217
<b>CHAPTER 6: PRINCIPLES OF DESIGN FOR FLEXIBLE PAVEMENT .....</b>	<b>221</b>
6.1 Introduction .....	221
6.2 M-E Design Methodology for Flexible Pavement .....	221
6.3 Select a Trial Design Strategy .....	222
6.3.1 Flexible Pavement Design Types .....	222
6.3.2 Concept of Perpetual Pavements .....	224
6.3.3 Establish Trial Design Structure .....	225
6.4 Select the Appropriate Performance Indicator Criteria for the Project .....	227
6.5 Select the Appropriate Reliability Level for the Project .....	231
6.6 Assemble M-E Design Software Inputs. ....	231
6.6.1 General Information .....	231
6.6.1.1 Design Period .....	231
6.6.1.2 Construction Dates and Timeline.....	231
6.6.1.3 Identifiers .....	231
6.6.2 Traffic .....	232
6.6.3 Climate .....	232
6.6.4 Pavement Layer Characterization .....	232
6.6.4.1 Asphalt Concrete Characterization .....	232
6.6.4.2 Unbound Layers and Subgrade Characterization .....	234
6.7 Run M-E Design Software.....	235
6.8 Evaluate the Adequacy of the Trial Design.....	236
6.9 Modifying Trial Designs.....	237
6.10 HMA Thickness with ABC .....	250
6.11 Required Minimum Thickness of Pavement Layer.....	250
6.12 Asphalt Materials Selection .....	251
6.12.1 Aggregate Gradation.....	251
6.12.2 Selection of SuperPave™ Gyratory Design .....	253
6.12.3 Binder Selection .....	254
6.12.3.1 Example .....	258
6.12.4 Asphalt Binder Characterization for M-E Design .....	264
6.13 Asphalt Mix Design Criteria.....	265
6.13.1 Fractured Face Criteria.....	265
6.13.2 Air Void Criteria .....	266
6.13.3 Criteria for Stability .....	267
6.13.4 Moisture Damage Criteria .....	267
6.13.5 Warm Mix Asphalt (WMA).....	268
6.14 Effective Binder Content (By Volume) .....	269
6.15 Rumble Strips .....	269
<b>CHAPTER 7: PRINCIPLES OF DESIGN FOR RIGID PAVEMENT .....</b>	<b>271</b>
7.1 Introduction .....	271
7.2 M-E Design Methodology for Rigid Pavement .....	271

7.3	Select Trial Design Strategy .....	273
7.3.1	Rigid Pavement Layers .....	273
7.3.2	Establish Trial Design Structure .....	273
7.4	Select the Appropriate Performance Indicator Criteria for the Project .....	274
7.5	Select the Appropriate Reliability Level for the Project .....	275
7.6	Assemble the M-E Design Inputs .....	275
7.6.1	General Information .....	275
7.6.1.1	Design Period .....	275
7.6.1.2	Project Timeline .....	276
7.6.1.3	Identifiers .....	276
7.6.1.4	Traffic .....	276
7.6.1.5	Climate .....	276
7.6.1.6	Pavement Layer Characterization .....	276
7.6.1.7	Portland Cement Concrete .....	276
7.6.1.8	Asphalt Treated Base Characterization .....	278
7.6.1.9	Chemically Stabilized Base Characterization .....	279
7.6.1.10	Unbound Material Layers and Subgrade Characterization .....	279
7.6.2	JPCP Design Features .....	279
7.7	Run M-E Design .....	279
7.8	Evaluate the Adequacy of the Trial Design .....	281
7.9	Modifying Trial Designs .....	282
7.10	Joint Spacing (L) .....	290
7.11	Slab/Base Friction .....	290
7.12	Effective Temperature Differential (°F) .....	291
7.13	Dowel Bar (Load Transfer Devices) and Tie Bars .....	292
7.14	Widened Lanes .....	294
7.15	Lane Edge Support Condition (E) .....	295
7.16	Base Erodibility .....	295
7.17	Sealant Type .....	296
7.18	Concrete Pavement Minimum Thickness .....	297
7.19	Concrete Pavement Texturing, Stationing, and Rumble Strips .....	297
7.20	Concrete Pavement Materials Selection .....	297
7.20.1	Understanding pH in Concrete Mixes .....	298
7.20.2	Alkali Aggregate Reactivity .....	298
7.20.3	Sulfate Resistant Concrete Pavement .....	299

**CHAPTER 8: PRINCIPLES OF DESIGN FOR PAVEMENT REHABILITATION WITH FLEXIBLE OVERLAYS .....305**

8.1	Introduction .....	305
8.1.1	Structural Versus Functional Overlays .....	306
8.1.2	Guidelines .....	306
8.2	Determine Existing Pavement Condition .....	307
8.2.1	Records Review .....	307
8.2.2	Field Evaluation .....	308
8.2.3	Visual Distress .....	308
8.2.4	Drainage Survey .....	308
8.2.5	Non-Destructive Testing, Coring, and Material Testing Program .....	309
8.3	Determine Cause and Mechanism of Distress .....	309
8.4	Define Problems and Inadequacies of Existing Pavement .....	311

8.5	Identify Possible Constraints .....	312
8.6	Select Feasible Strategy for Flexible Pavement Rehabilitation Trial Designs .....	313
8.6.1	Feasible AC Overlay Alternatives .....	313
8.6.2	Structural HMA Overlays .....	315
8.7	Proper Pre-Overlay Treatments and Other Design Considerations .....	316
8.7.1	Distress Types that Require Pre-Overlay Treatments .....	316
8.7.2	Pre-Overlay Treatments and Additional Considerations .....	318
8.7.3	Recycling the Existing Pavement .....	319
8.7.3.1	Cold Planing or Milling .....	319
8.7.3.1.1	Cold In-Place Recycling (CIR) or Cold Central Plant Recycling (CCPR) .....	321
8.7.3.2	Types of Hot In-Place Recycling (HIR) .....	312
8.7.3.2.1	Surface Recycling (Heating and Scarifying Treatment) .....	324
8.7.3.2.2	Remixing (Heating and Remixing Treatment) .....	326
8.7.3.2.3	Repaving (Heating and Repaving Treatment) .....	329
8.7.3.3	Selecting the Appropriate Hot-In-Place Recycling Process .....	331
8.7.4	Reflection Crack Control .....	332
8.7.5	Pavement Widening .....	333
8.7.6	Preventive Maintenance .....	334
8.8	Conventional Overlay .....	335
8.9	Existing Portland Cement Concrete Slab .....	337
8.9.1	Flexible Overlay on Rigid Pavement .....	337
8.10	Overlay Using Micro-Surfacing .....	338
8.11	Full Depth Reclamation (FDR) .....	340
8.12	Rubblization and Flexible Pavement Overlay .....	341
8.13	Stone Matrix Asphalt Project and Material Selection Guidelines .....	343
8.13.1	Recommended Minimum Thickness Layers .....	344
8.14	Characterizing Existing Pavement Condition for AC Overlay Design .....	344
8.15	Low Volume Road Rehabilitation .....	346
8.15.1	General Information .....	346
8.15.2	Rehabilitation Techniques .....	346
8.16	Assemble M-E Design Software Inputs .....	358
8.16.1	General Information .....	358
8.16.1.1	Design Period .....	358
8.16.1.2	Construction Dates and Timeline .....	358
8.16.1.3	Identifiers .....	358
8.16.2	Traffic .....	358
8.16.3	Climate .....	358
8.16.4	Pavement Layer Characterization .....	358
8.16.4.1	Characterization of HMA Overlay Layer .....	359
8.16.4.2	Characterization of Existing HMA Layer .....	359
8.16.4.3	Characterization of Existing PCC Layer (Fractured) .....	361
8.16.4.4	Characterization of Unbound Base Layers and Subgrade.....	363
8.17	Run M-E Design Software .....	363
8.18	Evaluate the Adequacy of the Trial Design .....	366
8.19	Modifying Trial Designs .....	367

**CHAPTER 9: PRINCIPLES OF DESIGN FOR PAVEMENT REHABILITATION WITH RIGID OVERLAY .....369**

9.1	M-E Introduction .....	369
9.1.1	CDOT Required Procedure for Rigid Overlays .....	370
9.2	Determining Existing Pavement Condition .....	371
9.2.1	Records Review .....	371
9.2.2	Field Evolution .....	371
9.2.3	Visual Distress .....	371
9.2.4	Non-Destructive Testing .....	374
9.2.5	Coring and Material Testing Program .....	375
9.2.6	Lane Condition Uniformity .....	375
9.3	Determine Cause and Mechanism of Distress .....	376
9.4	Define Problems and Inadequacies of Existing Pavement .....	376
9.5	Identify Possible Constraints .....	378
9.6	Selecting a Feasible Strategy for Rigid Pavement Rehabilitation Trial Designs .....	378
9.6.1	Bonded Concrete Overlays .....	378
9.6.1.1	PCC Over PCC .....	378
9.6.1.2	PCC Over HMA .....	379
9.6.2	Feasibility of Alternatives for Bonded Concrete Overlays .....	381
9.6.3	The CDOT Thin Concrete Overlay Thickness Design .....	382
9.6.4	Development of Design Equation .....	384
9.6.4.1	Corner Loading (1998) .....	385
9.6.4.2	Mid-Joint Loading (1998) .....	385
9.6.4.3	Determination of Critical Load Location (1988) .....	385
9.6.4.4	Interface Bond on Load-Induced Concrete Stress .....	385
9.6.4.5	Interface Bond on Load-Induced Asphalt Strain .....	386
9.6.4.6	Temperature Restraint Stress .....	386
9.6.4.7	Development of Prediction Equations for Design Stresses and Strains .....	387
9.6.4.8	PCCP and HMA Pavement Fatigue .....	388
9.6.4.9	Converting Estimated ESALs to Concrete Overlay ESALs .....	389
9.6.5	Example Project CDOT Thin Concrete Overlay Design .....	390

**CHAPTER 10: REHABILITATION OF PORTLAND CEMENT CONCRETE  
PAVEMENT .....394**

10.1	Introduction .....	394
10.2	Scope and Limitations .....	394
10.3	Colorado Documented Design Methods .....	395
10.4	Project Information .....	399
10.5	Pavement Evaluation .....	400
10.5.1	Functional and Structural Condition .....	401
10.5.2	Structural Condition .....	401
10.5.2.1	Functional Condition .....	401
10.5.2.2	Problem Classifications Between Structural and Functional Condition .....	402
10.5.2.3	Material Condition and Properties .....	402
10.5.2.4	Non-Destructive Testing .....	402
10.5.2.5	Destructive Testing .....	404
10.5.3	Drainage Condition .....	406
10.5.4	Lane Condition Uniformity .....	407
10.6	Pavement Rehabilitation Techniques .....	407
10.6.1	Diamond Grinding .....	408
10.6.2	Concrete Crack Sealing .....	412

10.6.3	Concrete Joint Resealing .....	404
10.6.4	Partial Depth Repair .....	417
10.6.5	Full Depth Concrete Pavement Repair .....	419
10.6.6	Dowel Bar Retrofit .....	425
10.6.7	Cross Stitching .....	429
10.6.8	Slab Stabilization and Slabjacking .....	432
10.7	Selecting the Appropriate Pavement Rehabilitation Techniques .....	435

**CHAPTER 11: PRINCIPLES OF DESIGN FOR FLEXIBLE PAVEMENT**

<b>INTERSECTIONS .....</b>	<b>441</b>	
11.1	Introduction .....	441
11.2	Design Considerations .....	441
11.3	Design Period .....	442
11.4	Traffic Analysis .....	442
11.5	Design Methodology .....	442
11.6	Assessing Problems with Existing Intersection .....	443
11.7	Performance Characteristics of Existing Intersections .....	443
11.8	Utilities .....	445

**CHAPTER 12: PRINCIPLES OF DESIGN FOR RIGID PAVEMENT INTERSECTIONS**

<b>.....</b>	<b>446</b>	
12.1	Introduction .....	446
12.2	Design Consideration .....	446
12.3	Design Period .....	446
12.4	Traffic Analysis .....	447
12.5	Design Methodology .....	447
12.6	Rigid Pavement Joint Design for Intersections .....	447
12.7	Assessing Problems with Existing Intersections .....	454
12.8	Detail for Abutting Asphalt and Concrete .....	454
12.9	Roundabout Pavement Design .....	455
12.9.1	Roundabout Geometry .....	456
12.9.1.1	Minimum Radius .....	456
12.9.1.2	Inscribed Circle Diameter .....	457
12.9.1.3	Circulatory Roadway Width .....	457
12.9.1.4	Central Island .....	457
12.9.2	General Joint Layout .....	457
12.9.3	Details of PCCP Joints .....	460
12.9.4	Typical Section .....	461
12.10	Diverging Diamond Interstate Design.....	462
12.10.1	General Joint Layout .....	462

**CHAPTER 13: PAVEMENT TYPE SELECTION AND LIFE CYCLE COST ANALYSIS**

<b>.....</b>	<b>466</b>	
13.1	Introduction .....	466
13.2	Implementation of a LCCA .....	467
13.2.1	Analysis Period .....	467
13.2.2	Performance Life .....	467
13.2.3	Years to First Rehabilitation .....	468
13.2.4	Restoration, Rehabilitation, and Resurfacing Treatments.....	468

13.2.5	Rehabilitation Selection Process.....	469
13.2.6	Portland Cement Concrete Pavement .....	471
13.2.7	Widening Pavements.....	472
13.4	Discount Rate .....	472
13.5	Life Cycle Cost Factors .....	475
13.5.1	Initial Construction Costs .....	475
13.5.2	Asphalt Cement Adjustment .....	476
13.5.3	Maintenance Cost .....	476
13.5.4	Design Cost .....	476
13.5.5	Pavement Construction Engineering Costs .....	477
13.5.6	Traffic Control Costs .....	477
13.5.7	Serviceable Life .....	477
13.5.8	User Costs .....	477
13.5.8.1	Introduction .....	478
13.5.8.2	Using the User Cost Software .....	478
13.6	Probabilistic Life Cycle Cost Analysis.....	487
13.7	FHWA RealCost Software.....	487
13.7.1	Real Cost Switchboard .....	488
13.7.2	Real Word Example Using the RealCost Software .....	489
13.7.3	Project Details Options .....	489
13.7.4	Analysis Options .....	490
13.7.5	Traffic Data Options .....	492
13.7.6	Value of User Time .....	494
13.7.7	Traffic Hourly Distribution .....	495
13.7.8	Added Time and Vehicle Cost Options .....	497
13.7.9	Saving and Opening Project-Level Inputs .....	498
13.7.10	Alternative Level Data Input Forms .....	524
13.7.11	Executing the Simulation .....	528
13.7.12	Analyzing Probabilistic Agency Costs .....	529
13.7.13	Analyzing Probabilistic User Cost .....	530
13.8	Comparing Probabilistic Results .....	531
13.9	Pavement Type Selection Committee (PTSC) .....	532
13.9.1	Purpose .....	533
13.9.2	Scope .....	533
13.9.3	Membership .....	533
13.9.4	Roles of Membership .....	534
13.10	Alternate Bid.....	535
13.11	Redesign of Projects.....	536
<b>CHAPTER 14: PAVEMENT JUSTIFICATION REPORTS .....</b>		<b>538</b>
14.1	Introduction .....	538
14.2	Pavement Justification Report .....	538
14.2.1	General Information .....	538
14.2.2	Site Conditions .....	539
14.2.3	Subgrade Materials .....	539
14.2.4	Design Traffic .....	539
14.2.5	Pavement Materials Characteristics .....	539
14.2.6	Pavement Design and Selection Process .....	540
14.3	Guidelines for Data on Plan Sheets .....	540

<b>APPENDIX A: PROCEDURS FOR FORENSIC STUDY OF DISTRESS OF HOT MIX ASPHALT AND PORTLAND CEMENT CONCRETE .....</b>	<b>542</b>
A.1 Introduction .....	542
A.2 Formation of and Evaluation Team .....	542
A.3 Levels of Investigation .....	542
A.3.1 Level 1 (CDOT Region) .....	542
A.3.2 Level II (CDOT Statewide) .....	543
A.3.3 Level III (National Effort) .....	543
A.4 Site Investigation .....	543
A.4.1 Visual Analysis .....	543
A.4.2 Review of Construction Documents .....	547
A.4.3 Investigational Requirements .....	547
A.4.4 Required Core Samples and Testing .....	547
A.4.5 Core Samples from Hot Mix Asphalt and PCCP.....	547
A.4.6 Base and Subgrade Samples .....	547
A.5 Final Report .....	548
A.6 Funding Sources .....	549
<b>APPENDIX B: FORMS .....</b>	<b>551</b>
<b>APPENDIX C: DEFLECTION TESTING AND BACKCALCULATION .....</b>	<b>554</b>
C.1 Introduction.....	554
C.2 FWD Testing: Flexible Pavements .....	555
C.2.1 FWD Testing Pattern: Flexible Pavement .....	555
C.2.2 FWD Drop Sequence: Flexible Pavement .....	558
C.2.3 FWD Sensor Spacing: Flexible Pavement .....	558
C.2.4 Surface Temperature Measurement: Flexible Pavement .....	558
C.3 FWD Testing: Rigid Jointed Plain Concrete Pavements .....	559
C.3.1 FWD Testing Pattern: Rigid Pavement .....	559
C.3.2 FWD Sensor Spacing: Rigid Pavement .....	561
C.3.3 Surface Temperature Measurement: Rigid Pavement .....	562
C.3.4 Surface Temperature Measurement: Rigid Pavement .....	563
C.4 FWD Testing: Composite Pavement .....	564
C.4.1 FWD Drop Sequence: Composite Pavement .....	566
C.4.2 FWD Sensor Spacing: Composite Pavement .....	567
C.4.3 Pavement Temperature Readings: Composite Pavement .....	567
C.5 Field Test Report .....	568
C.6 FWD Data Processing .....	568
C.6.1 Pre-Analysis .....	570
C.6.2 Pavement Surface Condition Survey .....	570
C.6.3 Pavement Coring and Subgrade Boring .....	570
C.6.4 Full Data Processing .....	571
C.6.5 Data Analysis, Interpretation and Reporting .....	571
C.6.6 Results Reporting: Flexible Pavements .....	572
C.6.7 Results Reporting: Jointed and Composite Pavements .....	572
C.6.8 Data Analysis and Interpretation: Jointed and Composite Pavements .....	572



<b>APPENDIX D: LOW VOLUME ROAD PAVEMENT MAINTENANCE.....</b>	<b>574</b>
D.1 Introduction .....	574
D.2 White Paper: The New Economy .....	574
<b>APPENDIX E: PAVEMENT TREATMENT GUIDE FOR HIGHWAY CATEGORIES..</b>	<b>581</b>
E.1 Introduction .....	581
E.2 Definitions .....	581
E.2.1 Highway Categories .....	581
E.2.2 Treatment Categories .....	581
E.3 Policy and Process .....	582
<b>APPENDIX F: HMA MATERIALS INPUT LIBRARY .....</b>	<b>584</b>
F.1 Introduction .....	584
F.2 Mix Types and Properties .....	584
F.2.1 Dynamic Modulus .....	584
F.2.2 Asphalt Binder .....	584
F.2.3 Creep Compliance and Indirect Tensile Strength .....	584
<b>APPENDIX G: PCC MATERIALS INPUT LIBRARY .....</b>	<b>590</b>
G.1 Introduction .....	590
G.2 Mix Types .....	590
G.2.1 Compressive and Flexural Strength .....	590
G.2.2 Static Elastic Modulus and Poisson’s Ratio .....	590
G.2.3 Coefficient of Thermal Expansion .....	591
<b>APPENDIX H: HISTORICAL CDOT 18,000 POUND EQUIVALENT AXLE LOAD CALCULATIONS .....</b>	<b>593</b>
H.1 Introduction .....	593
H.2 Traffic Projections .....	593
H.2.1 Volume Counts .....	593
H.2.2 Lane and Directional Distributions .....	593
H.2.3 Vehicle Classification .....	594
H.2.4 Growth Factors .....	597
H.2.5 Vehicle or Truck Weights .....	597
H.2.6 Traffic Equivalence Load Factors .....	597
H.2.7 Discussion and Calculation of Traffic Load for Pavement Design .....	597
H.2.8 Traffic Projections .....	599
<b>APPENDIX I: GEOSYNTHETICS IN M-E DESIGN .....</b>	<b>602</b>
Definition .....	602
I.1 Purpose .....	603
I.2 Application.....	604
I.2.1 Appropriate Applications .....	604
I.2.2 Aggregate Base Course .....	604
I.3 Geotextile Properties .....	604
I.4 Soft Subgrade and Expansive Soils .....	606
I.5 Pavement Design .....	608
I.6 Pavement Mechanistic Emperical Design (PMED) .....	611
I.6.1 Side by Side Design Verification .....	613

I.7	Other Design Considerations .....	613
I.8	Certifications of Compliance .....	613
I.9	Delivery, Storage, and Handling .....	614
I.9.1	Delivery .....	614
I.9.2	Storage .....	614
I.9.3	Acceptance .....	615
I.10	Construction of Base Reinforcement .....	615
I.10.1	Securing Methods .....	615
I.10.2	Geosynthetic Placement .....	615
I.10.3	Overlaps .....	615
I.10.4	Curves .....	615
I.10.4	Surface Preparation.....	616
I.10.6	Repairing Damaged Areas .....	616

**SUPPLEMENT: MATERIAL PROPERTIES OF SUBGRADE, SUBBASE, BASE,  
FLEXIBLE AND RIGID LAYERS .....617**

S.1	Introduction .....	617
S.1.1	Soil Consistency .....	617
S.1.2	Sieve Analysis .....	618
S.1.3	Unit Weight, Water Content, and Specific Gravity .....	619
S.1.4	Pavement Materials Chemistry .....	621
S.1.5	Elastic Modulus .....	623
S.1.6	Binder Complex Shear Modulus .....	630
S.1.7	Poisson’s Ratio .....	631
S.1.8	Coefficient of Lateral Pressure .....	632
S.1.9	Unconfined Compressive Strength .....	633
S.1.10	Modulus of Rupture .....	633
S.1.11	Tensile Creep and Strength for Hot Mix Asphalt .....	634
S.2	Resilient Modulus of Conventional Unbound Aggregate Base, Subbase, Subgrade, and Rigid Layer .....	635
S.2.1	Laboratory $M_r$ Testing .....	637
S.2.2	Field $M_r$ Testing .....	640
S.3	Resistance Value (R-value) .....	641
S.4	Modulus of Subgrade Reaction (k-value) .....	643
S.4.1	Static Elastic k-value .....	645
S.4.2	Dynamic k-value .....	645
S.5	Bedrock .....	646
S.6	Unbound Subgrade, Granular, and Subbase Materials .....	647
S.7	Chemically Stabilized Subgrades and Bases .....	647
S.7.1	Top of Layer Properties for Stabilized Materials .....	650
S.7.2	Bottom of Layer Properties for Stabilized Materials .....	651
S.7.3	Other Properties of Stabilized Layers .....	652
S.7.3.1	Coefficient of Thermal Expansion of Aggregate.....	652
S.7.3.2	Saturated Hydraulic Conductivity.....	654
S.8	Reclaimed Asphalt and Recycled Concrete Base Layer.....	655
S.9	Fractured Rigid Pavement .....	656
S.10	Pavement Deicers .....	657
S.10.1	Magnesium Chloride .....	657

## LIST OF FIGURES

Figure 1.1 M-E Design Process .....	58
Figure 1.2 Location of M-E Design Software HELP Document.....	60
Figure 1.3 M-E Design Software Default Window .....	60
Figure 1.4 M-E Design Software HELP Document .....	61
Figure 1.5 M-E Design Software Splash Screen .....	62
Figure 1.6 Open M-E Design Projects.....	63
Figure 1.7 M-E Design Software Main Window.....	63
Figure 1.8 M-E Design Software Project Tab .....	64
Figure 1.9 M-E Design Software Color-Coded Inputs to Assist User Input Accuracy .....	64
Figure 1.10 M-E Design Software Splash Screen Showing Database Login Location.....	66
Figure 1.11 M-E Software Splash Screen Showing Database Login Information .....	66
Figure 1.12 Saving an Entire Project to the M-E Design Database (Option 1).....	67
Figure 1.13 Saving an Entire Project to the M-E Design Database (Option 2).....	68
Figure 1.14 Window Showing Successful Project Save.....	68
Figure 1.15 Changing the Project Display Name/Identifier .....	69
Figure 1.16 Saving Traffic Data .....	70
Figure 1.17 Saving Specific Traffic Elements.....	71
Figure 1.18 Saving Axle Load Distribution Elements.....	71
Figure 1.19 Window Showing Successful Axle Load Distribution Save.....	72
Figure 1.20 Error Saving Axle Load Distribution .....	72
Figure 1.21 Defining Identifiers for Axle Load Distribution .....	73
Figure 1.22 Editing Display Name/Identifiers for Axle Load Distribution.....	73
Figure 1.23 Importing an Entire Project from the M-E Design Database .....	74
Figure 1.24 Selecting a Project to Import from the M-E Design Database .....	75
Figure 1.25 Getting an Element from the M-E Design Database .....	75
Figure 1.26 Advanced Search Blank Window in the M-E Design Database .....	76
Figure 1.27 Advanced Search Window with Information .....	77
Figure 1.28 Selecting a Project Using Advanced Search Tool.....	77
Figure 1.29 The Optimization Function.....	78
Figure 1.30 Selecting the Layer for Optimization .....	79
Figure 1.31 Optimization Input Values .....	79
Figure 1.32 Optimize Thickness Button .....	80
Figure 1.33 Optimization Results Screenshot.....	80
Figure 2.1 Performance Criteria and Reliability in the M-E Design Software for a Sample Flexible Pavement Design .....	93
Figure 2.2 Performance Criteria and Reliability in the M-E Design Software for a Sample JPCP Design.....	93
Figure 2.3 Function Classification Map.....	94
Figure 3.1 Traffic Inputs in the M-E Design Software.....	100
Figure 3.2 OTIS Screenshot.....	103
Figure 3.3 M-E Design Software Screenshot of AADT .....	103
Figure 3.4 Diagram of Lanes for M-E Design and LCCA .....	104
Figure 3.5 M-E Design Software Screenshot of Growth Rate.....	105
Figure 3.6 CDOT Vehicle Classifications .....	109
Figure 3.7 M-E Design Software Screenshot of Vehicle Class Distribution.....	111
Figure 3.8 Vehicle Class Distribution Factors for CDOT Clusters .....	112
Figure 3.9 Truck Traffic Classification Groups.....	113

Figure 3.10	M-E Design Screenshot of Number of Axles Per Truck .....	114
Figure 3.11	M-E Design Screenshot of Monthly Adjustment Factors .....	116
Figure 3.12	Level 2 Hourly Distribution Factors.....	117
Figure 3.13	Single Axle Distribution in the M-E Design Software.....	119
Figure 3.14	CDOT Averages of Single Axle Load Distribution (Classes 5 and 9 only).....	124
Figure 3.15	CDOT Averages of Tandem Axle Load Distribution (Classes 5 and 9 only).....	124
Figure 3.16	M-E Design Software Screenshot of Traffic Lateral Wander .....	125
Figure 3.17	Schematic of Mean Wheel Location .....	126
Figure 3.18	Schematic of Design Lane Width.....	126
Figure 3.19	Axle Configuration and Wheelbase in the M-E Design Software .....	127
Figure 3.20	Schematic of Axle Configuration and Wheelbase.....	127
Figure 3.21	Climate Tab in the M-E Design Software .....	131
Figure 3.22	Location of Colorado Weather Stations .....	132
Figure 3.23	Region 1 Weather Stations and Highway Surface Type Map.....	134
Figure 3.24	Region 2 Weather Stations and Highway Surface Type Map.....	135
Figure 3.25	Region 3 Weather Stations and Highway Surface Type Map.....	136
Figure 3.26	Region 4 Weather Stations and Highway Surface Type Map.....	137
Figure 3.27	Region 5 Weather Stations and Highway Surface Type Map.....	138
Figure 4.1	Recommended Location of Borings in the Cut Section .....	144
Figure 4.2	Recommended Location of Borings in a Fill Section .....	145
Figure 4.3	Recommended Depth of Borings in Cut Sections.....	146
Figure 4.4	Recommended Depths of Borings in Fill .....	147
Figure 4.5	CDOT Form #554.....	160
Figure 4.6	CDOT Form #555, as Submitted by the Region .....	161
Figure 4.7	CDOT Form #555, as Completed by the Central Laboratory .....	162
Figure 4.8	CDOT Form #157.....	163
Figure 4.9	Subgrade Preparation.....	164
Figure 4.10	Special Cases of Embankment Fill.....	166
Figure 4.11	Subgrade Material Properties in the M-E Design.....	166
Figure 4.12	M-E Design Software Screenshot for Other Engineering/Physical Properties of Subgrade.....	167
Figure 4.13	M-E Design Software Screenshot for Level 2 Resilient Modulus Input.....	173
Figure 4.14	M-E Design Software Screenshot for Level 3 Resilient Modulus Input.....	174
Figure 4.15	k-value vs. Soil Classification .....	178
Figure 4.16	k-value vs. Degree of Saturation for A-4 Through A-7 Soils .....	179
Figure 4.17	Colorado Annual Freezing Index (Degrees-Fahrenheit Days).....	182
Figure 4.18	Frost Depth to Annual Freezing Index .....	183
Figure 4.19	Frost Susceptible Soil Classifications .....	184
Figure 4.20	Subexcavated Subgrade Layers .....	187
Figure 4.21	Effective Depth of Moisture Treatment .....	189
Figure 4.22	Recommended Depth of Moisture Treatment .....	189
Figure 4.23	Lime/Cement-Stabilization Flow Chart .....	190
Figure 4.24	Lime Treated Structural Subgrade Layer .....	192
Figure 4.25	Cross Section of Lime Treated Cut Section Subgrade .....	192
Figure 4.26	Cement Treated Structural Subgrade Layer .....	193
Figure 4.27	Fly Ash Treated Structural Subgrade Layer .....	194
Figure 5.1	Unbound Aggregate Base Course Layers.....	201
Figure 5.2	Limiting Modulus Criteria of Unbound Aggregate Base Layers .....	204
Figure 5.3	Limiting Modulus Criteria of Unbound Subbase Layers .....	205

Figure 5.4	Stabilized Treated Structural Base Layers .....	208
Figure 5.5	M-E Design Software Screenshot for Treated Base Inputs.....	209
Figure 5.6	Structural Permeable Aggregate Base Course Layers.....	213
Figure 5.7	Reclaimed Asphalt and Concrete Pavement Base Layers.....	214
Figure 5.8	Photos of Reclaimed Asphalt Pavement Base.....	214
Figure 5.9	Photos of Full Depth Asphalt Reclaimed Base .....	216
Figure 5.10	Rubblized Base Course.....	217
Figure 5.11	Photo of Rigid Pavement Being Rubblized.....	217
Figure 6.1	Asphalt Concrete Pavement Layer Systems.....	223
Figure 6.2	Structural Layers .....	224
Figure 6.3	Perpetual Pavement Design Concept.....	225
Figure 6.4	M-E Design Software Screenshot of Flexible Pavement Trial Design Structure ....	226
Figure 6.5	M-E Design Software Screenshot Showing General Information (left), Performance Criteria and Reliability (right).....	227
Figure 6.6	Performance Prediction Model Coefficients for Flexible Pavement Designs (Marshall Mix).....	228
Figure 6.7	Performance Prediction Model Coefficients for Flexible Pavement Designs.....	230
Figure 6.8	Asphalt Concrete Layer and Material Properties in M-E Design.....	233
Figure 6.9	Sample Flexible Pavement Trial Design PDF Output Report.....	235
Figure 6.10	Sensitivity of HMA Alligator Cracking to Truck Volume.....	239
Figure 6.11	Sensitivity of HMA Alligator Cracking to AC Thickness .....	240
Figure 6.12	Sensitivity of HMA Alligator Cracking to Asphalt Binder Content .....	240
Figure 6.13	Sensitivity of HMA Alligator Cracking to Air Voids .....	241
Figure 6.14	Sensitivity to HMA Alligator Cracking to Base Type .....	241
Figure 6.15	Sensitivity of HMA Alligator Cracking to Base Thickness .....	242
Figure 6.16	Sensitivity of HMA Alligator Cracking to Climate .....	242
Figure 6.17	Sensitivity of Total Rutting to Truck Volume.....	243
Figure 6.18	Sensitivity of Total Rutting to AC Thickness .....	243
Figure 6.19	Sensitivity of Total Rutting to Asphalt Binder Grade .....	244
Figure 6.20	Sensitivity of Total Rutting to Air Voids .....	244
Figure 6.21	Sensitivity of Total Rutting to Base Type .....	245
Figure 6.22	Sensitivity of Total Rutting to Climate .....	245
Figure 6.23	Sensitivity of HMA Transverse Cracking to Thickness.....	246
Figure 6.24	Sensitivity of HMA Transverse Cracking to Asphalt Binder Grade.....	246
Figure 6.25	Sensitivity of HMA Transverse Cracking to Asphalt Binder Content.....	247
Figure 6.26	Sensitivity of HMA Transverse Cracking to Base Type.....	247
Figure 6.27	Sensitivity of HMA Transverse Cracking to Climate .....	248
Figure 6.28	Sensitivity of HMA IRI to Truck Volume .....	248
Figure 6.29	Sensitivity of HMA IRI to AC Thickness .....	249
Figure 6.30	Sensitivity of HMA IRI to Asphalt Binder Grade.....	249
Figure 6.31	Sensitivity of HMA IRI to Base Thickness.....	250
Figure 6.32	PG Binder Grades.....	257
Figure 6.33	Colorado 98 Percent Reliability LTPP High Pavement Temperature Weather Station Models .....	260
Figure 6.34	Colorado 98 Percent Reliability LTPP Low Pavement Temperature Weather Station Models .....	261
Figure 6.35	LTPP Interface Form for Weather Station Selection (Version 3.1).....	262
Figure 6.36	LTPP Weather Station Output Data (Version 3.1).....	262
Figure 6.37	LTPP Binder Selection at 98 Percent Reliability .....	263

Figure 7.1 Rigid Pavement Layers.....	273
Figure 7.2 M-E Design Screenshot Showing General Information, Performance Criteria, and Reliability.....	274
Figure 7.3 M-E Design Screenshot of Rigid Pavement Trial Design Structure .....	274
Figure 7.4 Performance Prediction Model Coefficients for Rigid Pavement Designs .....	275
Figure 7.5 PCC Layer and Material Properties in M-E Design.....	277
Figure 7.6 M-E Design Screenshot of JPCP Design Features .....	280
Figure 7.7 Sample Rigid Pavement Design PDF Output Report.....	281
Figure 7.8 Sensitivity of JPCP Transverse Cracking to PCC Thickness.....	284
Figure 7.9 Sensitivity of JPCP Transverse Cracking to PCC Coefficient of Thermal Expansion.....	284
Figure 7.10 Sensitivity of JPCP Transverse Cracking to Traffic Volume.....	285
Figure 7.11 Sensitivity of JPCP Transverse Cracking to Design Reliability .....	285
Figure 7.12 Sensitivity of JPCP Faulting to PCC Thickness.....	286
Figure 7.13 Sensitivity of JPCP Faulting to PCC Coefficient of Thermal Expansion .....	286
Figure 7.14 Sensitivity of JPCP Faulting to Traffic Volume.....	287
Figure 7.15 Sensitivity of JPCP Faulting to Design Reliability .....	287
Figure 7.16 Sensitivity of JPCP IRI to PCC Thickness.....	288
Figure 7.17 Sensitivity of JPCP Faulting to PCC Coefficient of Thermal Expansion .....	288
Figure 7.18 Sensitivity of JPCP IRI to Traffic Volume.....	289
Figure 7.19 Sensitivity of JPCP IRI to Design Reliability .....	289
Figure 7.20 Curling and Warping .....	291
Figure 7.21 Details of Dowel Bar Placement .....	293
Figure 7.22 Diagram of a Widened Lane.....	295
Figure 7.23 Idealized Sketch of Cracking Pattern in Concrete Mass .....	299
Figure 7.24 Sulfate Attack .....	300
Figure 8.1 Rehabilitation Alternative Selection Process .....	305
Figure 8.2 Condition Evaluation Checklist (Flexible).....	310
Figure 8.3 Photos of Alligator (Fatigue) Cracking .....	316
Figure 8.4 Photos of Longitudinal and Transverse Cracking .....	317
Figure 8.5 Photos of Rutting.....	317
Figure 8.6 Photos of Irregularities .....	318
Figure 8.7 Photo of Milling of Old Asphalt.....	320
Figure 8.8 Photo of Asphalt After Milling.....	320
Figure 8.9 Cold Planing of Existing Flexible Pavement.....	323
Figure 8.10 Schematic of Cold Planing Equipment.....	323
Figure 8.11 Photo Showing Equipment Used for Cold Planing .....	323
Figure 8.12 Surface Recycling Layers.....	325
Figure 8.13 Schematic of Surface Recycling Equipment .....	325
Figure 8.14 Photo of Heating Scarifying Equipment (Initial Operation) .....	326
Figure 8.15 Photo of Heater Section of the Equipment Train .....	326
Figure 8.16 Remixing Layers .....	328
Figure 8.17 Schematic of Remixing Equipment.....	328
Figure 8.18 Photos of Heating and Remixing Equipment .....	329
Figure 8.19 Repaving Layers.....	330
Figure 8.20 Hot Mix Paving (Single Operation Continued).....	331
Figure 8.21 Photo of Hot Mix Paving (Single Operation) Equipment .....	331
Figure 8.22 Thin Wearing Course Treatment Layer.....	335
Figure 8.23 Schematic of Thin Wearing Course Equipment.....	335

Figure 8.24	Conventional Hot Mix Asphalt (HMA) Layer .....	336
Figure 8.25	Photo of a Conventional HMA Overlay .....	336
Figure 8.26	Schematic of Conventional HMA Paving Equipment.....	336
Figure 8.27	Photos of Typical HMA Overlay Equipment (Truck with Spreader and Roller)...	337
Figure 8.28	Photo Showing Micro-Surfacing .....	339
Figure 8.29	Photo Showing Micro-Surfacing Equipment .....	339
Figure 8.30	Full Depth Reclamation (FDR) Layers .....	340
Figure 8.31	Schematic of FDR Equipment.....	341
Figure 8.32	Photos of FDR Equipment.....	341
Figure 8.33	Rubbilization and Overlay Layers.....	342
Figure 8.34	Schematic of Rubbilization and Overlay Equipment .....	342
Figure 8.35	Photos of the Rubbilization Initial Operation.....	343
Figure 8.36	Photos Showing the Emulsion Spraying and Placing Chips .....	346
Figure 8.37	Photos Showing the Rolling and Sweeping After Chip Placement.....	348
Figure 8.38	Diagram of a Double Chip Seal.....	348
Figure 8.39	Photos Show a Cape Seal Where a Chip Seal is Applied, Cures, and After A Month a Slurry Seal is Applied.....	349
Figure 8.40	Photo Showing the Placing of a Slurry Seal.....	349
Figure 8.41	Photo Showing a Slurry Seal 1.5 Hours After Placement .....	350
Figure 8.42	Photos Showing Crack Sealing .....	350
Figure 8.43	Photos of Cold Mix Paving .....	351
Figure 8.44	Photos Showing the Placing of a Fog Coat and the Final Result .....	351
Figure 8.45	Photos Showing Various Stages of Full Depth Replacement Patching .....	352
Figure 8.46	Photo Showing A Cold In-Place Recycling Operation .....	353
Figure 8.47	Photos of Ultra-Thin Asphalt Overlays.....	353
Figure 8.48	Photo Showing a Stress Absorbing Membrane .....	354
Figure 8.49	Photo of Manual Skin Patching.....	354
Figure 8.50	Performance Prediction Model Coefficients for Flexible Pavement Rehabilitation Designs (AC over JPCP, AC over Semi-rigid, and AC over AC) ..	364
Figure 8.51	Milled Thickness Input Screen.....	365
Figure 8.52	Existing Layer Thickness if Milling is Planned .....	366
Figure 9.1	Rehabilitation Alternative Selection Process .....	369
Figure 9.2	Pavement Condition Evaluation Checklist (Rigid) .....	373
Figure 9.3	Bonded or Unbonded Overlay of Asphalt or Composite Pavement.....	380
Figure 9.4	Unbonded Overlay of Concrete, Asphalt, or Composite Pavement with a Full Concrete Lane Addition.....	380
Figure 9.5	Sample TWT Project Location Map.....	391
Figure 9.6	Input and Required Thickness Form for Thin Concrete Overlay Design .....	392
Figure 10.1	CPR Sequencing.....	408
Figure 10.2	Photos of Diamond Grinding and Grooving .....	409
Figure 10.3	Dimensions for Grinding and Grooving.....	411
Figure 10.4	Dimensional Grinding Texture for Hard and Soft Aggregate .....	412
Figure 10.5	Photos of Crack Sealing .....	414
Figure 10.6	Photos of Concrete Joint Resealing.....	415
Figure 10.7	Photos of Partial Depth Concrete Repair.....	417
Figure 10.8	Photos of Full Depth Concrete Repair.....	419
Figure 10.9	Photos of Concrete Slab Removal.....	422
Figure 10.10	Photos of Compaction of Subbase and Flowfill Placement .....	422
Figure 10.11	Grout Retention Disk.....	423

Figure 10.12	Photos of Tie Bar Installation During Concrete Repair .....	424
Figure 10.13	Photos of Precast Concrete Panel Repair .....	425
Figure 10.14	Typical Dowel Bar Retrofit Installation .....	427
Figure 10.15	Typical Dowel Bar Retrofit Sequencing of the Installation .....	428
Figure 10.16	Photos of Dowel Bar Retrofit Processes .....	429
Figure 10.17	Photos of Cross Stitching .....	430
Figure 10.18	Photos of Slot Stitching .....	431
Figure 10.19	Typical Slab Stabilization Hole Layout .....	433
Figure 10.20	Typical Slab Raising in Slabjacking.....	434
Figure 10.21	Typical Slabjacking Hole Layout.....	434
Figure 10.22	Photos of Slabjacking.....	435
Figure 11.1	Rutting in Subgrade or Base.....	443
Figure 11.2	Plastic Flow .....	444
Figure 11.3	Rutting in Asphalt Layer .....	444
Figure 12.1	Typical Joint Layout for a Rigid Pavement Intersection.....	450
Figure 12.2	Typical Joint Layout for a Rigid Pavement Intersection.....	451
Figure 12.3	Typical Joint Layout for a Rigid Pavement Intersection.....	451
Figure 12.4	Typical Joint Layout for a Rigid Pavement Intersection.....	452
Figure 12.5	Typical Joint Layout for a Rigid Pavement Intersection.....	452
Figure 12.6	Typical Joint Layout for a Rigid Pavement Intersection.....	453
Figure 12.7	Typical Joint Layout for a Rigid Pavement Intersection.....	453
Figure 12.8	Detail of Asphalt and Concrete Slab Joint .....	455
Figure 12.9	Basic Geometric Elements of a Roundabout.....	456
Figure 12.10	Isolating the Circle .....	458
Figure 12.11	Pave-Through Layout.....	458
Figure 12.12	Six Step Jointing Layout .....	459
Figure 12.13	Basic Joints and Zones of a Roundabout.....	460
Figure 12.14	Typical Section of an Urban Double-Lane Roundabout .....	461
Figure 12.15	Divergent Diamond Interchange 11-Step Quadrant Method.....	464
Figure 13.1	Pavement Selection Process Flow Chart .....	466
Figure 13.2	User Cost Website .....	477
Figure 13.3	Single Lane Closure Screenshot.....	478
Figure 13.4	Single Lane Closure Highlighting Pilot Car Operations .....	478
Figure 13.5	Example of Input for a Cross Over.....	479
Figure 13.6	Screenshot Showing Type of Work Menu .....	480
Figure 13.7	Screenshot of the Function Class Menu .....	481
Figure 13.8	Successfully Analyzed Menu Bar .....	481
Figure 13.9	Analysis Error Message.....	482
Figure 13.10	Editing Input Buttons .....	482
Figure 13.11	Hourly Distribution Edit Screen.....	483
Figure 13.12	Edit Parameters Screen.....	484
Figure 13.13	Edit Costs Screen.....	484
Figure 13.14	Saving a File .....	485
Figure 13.15	The Real Cost Switchboard .....	488
Figure 13.16	Project Details Input Screen .....	489
Figure 13.17	Analysis Option Screen .....	490
Figure 13.18	Traffic Data Option Screen .....	492
Figure 13.19	Value of User Option Screen.....	494
Figure 13.20	Traffic Hourly Distribution Screen .....	495



Figure 13.21	PCCP Normalized Dollar Amount per Year .....	506
Figure 13.22	PCCP Normalized Dollar Amount per Thickness.....	506
Figure 13.23	PCCP Normalized Dollar Amount per Thickness.....	507
Figure 13.24	PCCP Normalized Dollar Amount per Total Square Yards for Projects Less Than 10,000 Square Yards.....	507
Figure 13.25	PCCP Normalized Dollar Amount for Projects of 6 Inches or Less in Thickness and Less Than 10,000 Square Yards in Size.....	508
Figure 13.26	Normalized Dollar Amount for Projects of 8 to 9 Inches in Thickness and Less Than 10,000 Square Yards in Size.....	508
Figure 13.27	Normalized Dollar Amount for Projects of 9 to 10 Inches in Thickness and Less Than 10,000 Square Yards in Size .....	508
Figure 13.28	PCCP Normalized Dollar Amount for Projects of 10 to 11 Inches in Thickness and Less Than 10,000 Square Yards in Size.....	509
Figure 13.29	PCCP Normalized Dollar Amount for Projects of 11 to 12 Inches in Thickness and Less Than 10,000 Square Yards in Size.....	509
Figure 13.30	PCCP Normalized Dollar Amount for Projects of 12 Inches or Greater in Thickness and Less Than 10,000 Square Yards in Size .....	509
Figure 13.31	PCCP Normalized Dollar Amount per Total Square Yards for Projects Greater Than 10,000 Square Yards.....	510
Figure 13.32	PCCP Normalized Dollar Amount for Projects of 8 to 9 Inches in Thickness and Greater Than 10,000 Square Yards in Size.....	510
Figure 13.33	PCCP Normalized Dollar Amount for Projects of 9 to 10 Inches in Thickness and Greater Than 10,000 Square Yards in Size.....	510
Figure 13.34	Normalized Dollar Amount for Projects of 10 to 11 Inches in Thickness and Greater Than 10,000 Square Yards in Size.....	511
Figure 13.35	PCCP Normalized Dollar Amount for Projects of 11 to 12 Inches in Thickness and Greater Than 10,000 Square Yards in Size.....	511
Figure 13.36	PCCP Normalized Dollar Amount for Projects of 12 Inches or Greater in Thickness and Greater Than 10,000 Square Yards in Size.....	511
Figure 13.37	HMA Overlay Normalized Dollar per Year and Project Size .....	512
Figure 13.38	HMA Overlay Normalized Dollar per Product Type and Project Size .....	512
Figure 13.39	HMA Overlay Normalized Dollar per Product Type and Project Size .....	513
Figure 13.40	HMA Overlay Normalized Dollar Amount for Projects Less Than 10,000 Tons	513
Figure 13.41	HMA Overlay Normalized Unit Costs for SX(100) PG 64-28 on Projects Less Than 10,000 Tons .....	514
Figure 13.42	HMA Overlay Normalized Unit Costs for SX(100) PG 64-22 on Projects Less Than 10,000 Tons .....	514
Figure 13.43	HMA Overlay Normalized Unit Costs for SX(100) PG 58-28 on Projects Less Than 10,000 Tons .....	514
Figure 13.44	HMA Overlay Normalized Unit Costs for SX(100) PG 76-28 on Projects Less Than 10,000 Tons .....	515
Figure 13.45	HMA Overlay Normalized Unit Costs for Furnish HMA on Projects Less Than 10,000 Tons .....	515
Figure 13.46	HMA Overlay Normalized Unit Costs for Projects with Greater Than 10,000 Tons.....	515
Figure 13.47	HMA Overlay Normalized Unit Costs for SX(100) PG 64-22 on Projects Greater Than 10,000 Tons .....	516
Figure 13.48	HMA Overlay Normalized Unit Costs for SX(75) on Projects Greater Than 10,000 Tons.....	516

Figure 13.49 HMA Overlay Normalized Unit Costs for SX(100) PG 58-28 on Projects Greater Than 10,000 Tons .....	516
Figure 13.50 HMA Overlay Normalized Unit Costs for SX(100) PG 64-28 on Projects Greater Than 10,000 Tons .....	517
Figure 13.51 HMA Overlay Normalized Unit Costs for SX(100) PG 76-28 on Projects Greater Than 10,000 Tons .....	517
Figure 13.52 HMA Mill and Fill Normalized Dollar per Year and Project Size.....	518
Figure 13.53 HMA Mill and Fill Normalized Dollar per Product Type.....	518
Figure 13.54 HMA Mill and Fill Normalized Dollar per Product Type.....	519
Figure 13.55 HMA Mill and Fill Normalized Unit Costs for Projects Less Than 10,000 Tons	519
Figure 13.56 HMA Mill and Fill Normalized Unit Costs for SX(100) PG 64-22 on Projects Less Than 10,000 Tons .....	520
Figure 13.57 HMA Mill and Fill Normalized Unit Costs for SX(100) PG 76-28 on Projects Less Than 10,000 Tons .....	520
Figure 13.58 HMA Mill and Fill Normalized Unit Costs for SX(100) PG 58-28 on Projects Less Than 10,000 Tons .....	520
Figure 13.59 HMA Mill and Fill Normalized Unit Costs for Projects Greater Than 10,000 Tons.....	521
Figure 13.60 HMA Mill and Fill Normalized Unit Costs for SX(100) PG 76-28 on Projects Greater Than 10,000 Tons .....	521
Figure 13.61 HMA Mill and Fill Normalized Unit Costs for SX(100) PG 64-22 on Projects Greater Than 10,000 Tons .....	521
Figure 13.62 HMA Mill and Fill Normalized Unit Costs for SMA on Projects Greater Than 10,000 Tons.....	522
Figure 13.63 HMA Mill and Fill Normalized Unit Costs for SX(100) PG 64-22 on Projects Greater Than 10,000 Tons .....	522
Figure 13.64 HMA Mill and Fill Normalized Unit Costs for SX(100) PG 58-34 on Projects Greater Than 10,000 Tons .....	522
Figure 13.65 Alternative 1 (HMA) Screen .....	525
Figure 13.66 Alternative 2 (PCCP) Screen.....	526
Figure 13.67 Probabilistic Results Screen .....	527
Figure 13.68 Simulation Screen.....	528
Figure 13.69 Agency Cost Results Screen.....	529
Figure 13.70 User Cost Results Screen.....	530

## Appendices and Supplements

Figure A.1 Pavement Condition Evaluation Checklist (Rigid).....	536
Figure A.2 Pavement Condition Evaluation Checklist (Flexible).. ..	537
Figure B.1 Design Data (Page 1 of 2) (CDOT Form 463 12/03) .....	542
Figure B.2 Design Data (Page 2 of 2) (CDOT Form 463 12/03) .....	543
Figure B.3 Maintenance Project – Request Form (CDOT Form 463M Rev. 4/10) .....	544
Figure C.1 Depiction of FWD Load Distribution Through Pavement.....	547
Figure C.2 Flexible Pavement Staggered Testing Pattern.....	548
Figure C.3 JPCP Testing Pattern.....	552
Figure C.4 Joint Transfer Testing Sensor Spacing.....	554
Figure C.5 Corner Testing Sensor Location.....	554
Figure C.6 Staggered Testing Pattern.....	556
Figure C.7 Joint Load Transfer Testing Sensor Spacing.....	558
Figure C.8 Field Test Report.....	560

Figure C.9	Coring Log Example.....	562
Figure H.1	CDOT Vehicle Classifications.....	587
Figure S.1	Atterberg Limits.....	594
Figure S.2	Gradation Plot.....	594
Figure S.3	Soil Sample Constituents.....	595
Figure S.4	Plot of Maximum Dry Unit Weight and Optimum Water Content.....	597
Figure S.5	Periodic Table.....	598
Figure S.6	Dissociation of Water.....	599
Figure S.7	pH Scale.....	599
Figure S.8	Elastic Modulus.....	600
Figure S.9	Dynamic Modulus Stress-Strain Cycles.....	602
Figure S.10	Shifting of Various Mixture Plots .....	605
Figure S.11	Dynamic Modulus $ E^* $ Master Curve.....	605
Figure S.12	Shift Factor Plot.....	605
Figure S.13	Binder Complex Shear Modulus Specimen Loading.....	606
Figure S.14	Binder Complex Shear Modulus Shear-Strain Cycles.....	607
Figure S.15	Poisson's Ratio.....	608
Figure S.16	Unconfined Compressive Strength.....	609
Figure S.17	3-Point Beam Loading for Flexural Strength.....	610
Figure S.18	Indirect Tensile Strength.....	611
Figure S.19	Distribution of wheel Load of Subgrade Soil ( $M_r$ ) .....	612
Figure S.20	Critical Stress/Strain Locations for Bases, Subbases, Subgrade, and Rigid Layer...	613
Figure S.21	Subgrade Material Element at Critical Location.....	614
Figure S.22	Resilient Modulus Test Specimen Stress State.....	615
Figure S.23	Resilient Modulus Test Specimen Loading.....	615
Figure S.24	Resilient Modulus Seasonal Variation.....	616
Figure S.25	Resistance R-value Test Specimen Loading State.....	617
Figure S.26	Correlation Plot between Resilient Modulus and R-value.....	618
Figure S.27	Distribution of Wheel Load to Subgrade Reaction (k-value) .....	619
Figure S.28	Field Plate Load Test for k-value.....	621
Figure S.29	Critical Stress Locations for Stabilized Subgrade.....	624
Figure S.30	Critical Stress Locations for Recycled Pavement Bases.....	630
Figure S.31	Critical Stress Location for Rubblized Base.....	631

## LIST OF TABLES

Table 1.1	Recommended Pavement Design Procedures.....	57
Table 2.1	Moisture-Related Distress in Flexible Pavements .....	87
Table 2.2	Moisture-Related Distress in Rigid Pavements .....	88
Table 2.3	Reliability (Risk).....	89
Table 2.4	Recommended Threshold Values of Performance Criteria for New Construction of Flexible Pavement.....	90
Table 2.5	Recommended Threshold Values of Performance Criteria for Rehabilitation of Flexible Pavement Projects.....	91
Table 2.6	Recommended Threshold Values of Performance Criteria for New Construction of Rigid Pavement.....	92
Table 2.7	Recommended Threshold Values of Performance Criteria for Rehabilitation of Rigid Pavement Projects .....	92
Table 2.8	Selection of Input Hierarchical Level.....	96
Table 3.1	Hierarchy of Traffic Inputs .....	101
Table 3.2	Recommendations of Traffic Inputs at Each Hierarchical Level .....	102
Table 3.3	Design Lane Factor.....	104
Table 3.4	Growth Rate Determined Using OTIS 20-Year Growth Factor .....	106
Table 3.5	Class 5 and Class 9 Distribution Per Cluster Type.....	110
Table 3.6	Level 2 CDOT Vehicle Class Distribution Factors .....	112
Table 3.7	Level 2 Number of Axles Per Truck.....	114
Table 3.8	Level 2 Monthly Adjustment Factors .....	115
Table 3.9	Hourly Distribution Factors .....	117
Table 3.10	Level 2 Single Axle Load Distribution Factors (Percentages) .....	120
Table 3.11	Level 2 Tandem Axle Load Distribution Factors (Percentages) .....	121
Table 3.12	Level 2 Tridem Axle Load Distribution Factors (Percentages).....	122
Table 3.13	Level 2 Quad Axle Load Distribution Factors (Percentages).....	123
Table 3.14	Recommendations for Climatic Inputs .....	130
Table 3.15	Geographic Coordinates and Data Availability of Colorado Weather Stations .....	133
Table 4.1	M-E Design Major Subgrade Categories.....	140
Table 4.2	Rock Classification.....	153
Table 4.3	Recommended Subgrade Inputs for New Flexible and JPCP Designs.....	168
Table 4.4	Recommended Subgrade Inputs for HMA Overlays of Existing Flexible Pavement	169
Table 4.5	Recommended Subgrade Inputs for Overlays of Existing Rigid Pavement.....	170
Table 4.6	Level 3 Resilient Modulus For Embankments and Subgrade.....	174
Table 4.7	Average Backcalculated to Laboratory Determined Elastic Modulus Ratios .....	175
Table 4.8	k-value Ranges for Various Soil Types .....	180
Table 4.9	Treatment of Expansive Soils .....	187
Table 4.10	Probable Swell Damage Risk .....	188
Table 4.11	Application and Associated Functions of Geosynthetics in Roadway Systems .....	195
Table 5.1	CDOT Classification for Aggregate Base Course .....	202
Table 5.2	Characterization of Treated Bases in M-E Design .....	209
Table 5.3	Level 1 Input Requirement and Corresponding Testing Protocols for Characterization of Treated Bases in M-E Design .....	210
Table 5.4	Level 2 Correlations for Elastic Modulus of Treated Bases.....	210
Table 5.5	Level 2 Correlations for Flexural Strength of Treated Base.....	211
Table 5.6	Level 3 Default Elastic Modulus and Flexural Strength of Treated Bases.....	211
Table 5.7	DOT Classification for Reclaimed Asphalt Pavement .....	215

Table 6.1 Layered Rut Distribution .....	233
Table 6.2 Input Properties and Recommendations for HMA Material Characterization .....	234
Table 6.3 Modifying Flexible Pavement Trial Designs.....	238
Table 6.4 Minimum Thicknesses for Bicycle Paths .....	251
Table 6.5 Master Range Table for Stone Matrix Asphalt.....	252
Table 6.6 HMA Grading Size and Location Application .....	253
Table 6.7 HMA Grading Size and Layer Thickness.....	253
Table 6.8 Environmental Categories.....	254
Table 6.9 Recommended SuperPave™ Gyratory Design Revolution (N <sub>DES</sub> ) .....	255
Table 6.10 Available Asphalt Cement Grades in Colorado.....	255
Table 6.11 SuperPave™ Weather Data Summary.....	263
Table 6.12 Environmental Categories (restated) .....	264
Table 6.13 Recommended SuperPave™ Gyratory Design Revolution (N <sub>DES</sub> ) (restated) .....	264
Table 6.14 Recommended Sources of Inputs for Asphalt Binder Characterization .....	265
Table 6.15 Fractured Face Criteria .....	266
Table 6.16 Minimum VMA Requirements .....	267
Table 6.17 Criteria for Stability and Voids Filled with Asphalt (VFA) .....	267
Table 6.18 Moisture Damage Criteria .....	267
Table 7.1 PCC Material Inputs and Recommendations for New JPCP Design.....	278
Table 7.2 Modifying Rigid Pavement Trial Designs .....	283
Table 7.3 Reinforcing Size Table (20-Year or Greater Design Life) .....	293
Table 7.4 Dowel Bar Target Placement Tolerances .....	294
Table 7.5 Material Types and Erodibility Class .....	296
Table 7.6 Minimum Thicknesses for Highways, Roadways, and Bicycle Paths.....	297
Table 7.7 Concrete Classification .....	298
Table 7.8 Requirements to Protect Against Damage to Concrete by Sulfate Attack from External Sources of Sulfates .....	301
Table 8.1 Common Distress Causes of Flexible Pavements and Associated Problem Types...	312
Table 8.2 List of Recommended Overlay Solutions to Functional Problems.....	314
Table 8.3 Selection Guidelines for HIR Process Distress-Related Considerations .....	332
Table 8.4 SMA Functional and Structural Recommended Minimum Thickness Layers .....	344
Table 8.5 Characterization of Existing Flexible Pavement for M-E Design .....	345
Table 8.6 Characterization of Existing Rigid Pavement for M-E Design .....	345
Table 8.7 Rehabilitation Techniques Versus Observed Distresses.....	347
Table 8.8 Rehabilitation Techniques Benefits and Applications.....	355
Table 8.9 Characterization of Existing Flexible and Semi-Rigid Pavement for M-E Design...	360
Table 8.10 Characterization of Existing JPCP for M-E Design .....	361
Table 8.11 Characterization of Fractured Concrete Pavement for M-E Design.....	362
Table 8.12 Recommended Fractured Slab Design Modulus Values for Level 1 Characterization .....	362
Table 8.13 Recommended Fractured Slab Design Modulus Values for Level 3 Characterization .....	362
Table 8.14 Recommendations for Modifying Trial Design to Reduce Distress/ Smoothness for HMA Overlays of JPCP.....	367
Table 9.1 Required Concrete Overlay Procedure .....	371
Table 9.2 Distress Levels for Assessing Drainage Adequacy of JPCP .....	372
Table 9.3 Load Transfer Efficiency Quality .....	375
Table 9.4 Common Distress Causes of Rigid Pavements and Associated Problem Types .....	377
Table 9.5 Design Factors for Rigid Pavement.....	384

Table 10.1	Structural Adequacy for JPCP .....	401
Table 10.2	Functional Adequacy for JPCP.....	402
Table 10.3	Load Transfer Efficiency Quality .....	403
Table 10.4	Distress Levels for Durability of JPCP.....	405
Table 10.5	Strength Correlation Formulas.....	406
Table 10.6	Distress Levels for Assessing Drainage Adequacy of JPCP .....	407
Table 10.7	Trigger Values for Diamond Grinding .....	410
Table 10.8	Limit Values for Diamond Grinding .....	411
Table 10.9	Hot Poured Crack Sealant Estimated Quantities .....	414
Table 10.10	Sealant Severity Level .....	416
Table 10.11	Sealant Survey Sampling Frequency .....	416
Table 10.12	Minimum Cost Effective Distance Between Two Patches .....	421
Table 10.13	Guidelines for PCC Treatment Selection.....	436
Table 12.1	Recommended Inscribed Circle Diameters .....	457
Table 13.1	Default Input Values for Treatment Periods to be Used in a LCCA .....	470
Table 13.2	Default Rehabilitation Processes for PCCP.....	471
Table 13.3	Present Worth Factors for Discount Rates.....	473
Table 13.4	Discount Factors for Discrete Compounding .....	474
Table 13.5	Annual Maintenance Costs .....	475
Table 13.6	Range of Capacity Values per Type of Work.....	480
Table 13.7	Analysis Data Inputs and Analysis Options .....	490
Table 13.8	Traffic Data Options .....	491
Table 13.9	Value of User Time Data Options .....	494
Table 13.10	Traffic Hourly Distribution Data Options .....	495
Table 13.11	Added Time and Vehicle Costs Data Options .....	496
Table 13.12	Added Time and Vehicle Stopping Costs Screen.....	497
Table 13.13	Saving and Opening Project Level Inputs .....	498
Table 13.14	Number of Projects in the Study.....	499
Table 13.15	Results of Heater Remixing.....	500
Table 13.16	Results of Heater Scarifying.....	500
Table 13.17	Results of Full Depth Reclamation.....	500
Table 13.18	Cold In-Place Recycling .....	501
Table 13.19	PCCP Projects Less Than 10,000 Square Yards.....	501
Table 13.20	PCCP Projects Greater Than 10,000 Square Yards.....	502
Table 13.21	HMA Overlay Projects Less Than 10,000 Tons.....	503
Table 13.22	HMA Overlay Projects Less Than 10,000 Tons.....	503
Table 13.23	HMA Mill and Fill for Projects Greater Than 10,000 Tons .....	504
Table 13.24	HMA Mill and Fill for Projects Greater Than 10,000 Tons .....	505
Table 13.25	Alternative Level Data Options .....	524
Table 13.26	Simulation Data Options.....	528
Table 13.27	Possible Elements for Pavement Type Selection Process .....	534
Table 14.1	Pavement Data on Plan Sheets.....	540

## Appendices and Supplements

Table C.1	Flexible Pavement Test Spacing Guidelines.....	548
Table C.2	Jointed Plain Concrete Pavement Test Spacing Guidelines.....	552
Table C.3	Composite Pavement Test Spacing Guidelines.....	556
Table F.1	Asphalt Binder Complex Shear Modulus ( $G^*$ ) and Phase Angle ( $\delta$ ) Values of	

Typical CDOT HMA Mixtures.....	576
Table F.2 Properties of Typical CDOT HMA Mixtures.....	577
Table F.3 Dynamic Modulus Values of Typical CDOT HMA Mixtures.....	578
Table F.4 Creep Compliance Values of Typical CDOT HMA Mixtures.....	579
Table F.5 Indirect Tensile Strength Values of Typical CDOT HMA Mixtures.....	580
Table G.1 Properties of Typical CDOT PCC Mixtures.....	582
Table G.2 Materials and Sources Used in Typical CDOT PCC Mixtures.....	582
Table G.3 Compressive Strength of Typical CDOT PCC Mixtures.....	582
Table G.4 Flexural Strength of Typical CDOT PCC Mixtures.....	583
Table G.5 Static Elastic Modulus and Poisson’s Ratio of Typical CDOT PCC Mixtures.....	583
Table G.6 CTE Values of Typical CDOT PCC Mixtures.....	583
Table H.1 Design Lane Factor.....	585
Table H.2 Colorado Equivalency Factors.....	588
Table S.1 Nominal Dimensions of Common Sieves.....	595
Table S.2 Recommended Testing Temperatures and Loading Frequencies.....	601
Table S.3 Comparisons of $M_r$ Suggested NCHRP 1-40D and Colorado Soils with R-values.....	620
Table S.4 Poisson’s Ratio for Bedrock.....	622
Table S.5 Elastic Modulus for Bedrock.....	622
Table S.6 Poisson’s Ratios for Subgrade, Unbound Granular and Subbase Materials.....	623
Table S.7 Coefficient of Lateral Pressure.....	623
Table S.8 Poisson’s Ratios for Chemically Stabilized Materials.....	625
Table S.9 Poisson’s Ratios for Asphalt Treated Permeable Base.....	625
Table S.10 Poisson’s Ratios for Cold Mixed asphalt and Cold Mixed Recycled Asphalt Materials .....	625
Table S.11 Minimum Unconfined Compressive Strengths for Stabilized Layers.....	626
Table S.12 Typical E, E*, or $M_r$ Values for Stabilized Materials.....	627
Table S.13 Typical $M_r$ Values for Deteriorated Stabilized Materials.....	627
Table S.14 Typical Modulus of Rupture ( $M_r$ ) Values for Stabilized Materials.....	628
Table S.15 Recommended Values of PCC Coefficient of Thermal Expansion.....	628
Table S.16 Unbound Compacted Material Dry Thermal Conductivity and Heat Capacity.....	629
Table S.17 Chemically Stabilized Material Dry Thermal Conductivity and Heat Capacity.....	629
Table S.18 Asphalt Concrete and PCC Dry Thermal Conductivity and Heat Capacity.....	630
Table S.19 Cold Mixed Asphalt and Cold Mixed Recycled Asphalt Poisson’s Ratios.....	631
Table S.20 Typical E, E*, or $M_r$ Values for stabilized Materials.....	631
Table S.21 Poisson’s Ratio for PCC Materials.....	632
Table S.22 Typical $M_r$ Values for Fractured PCC Layers.....	633

## ACRONYMS COMMON TO CDOT

AADT	Annual Average Daily Traffic
AASHTO	American Association of State Highway and Transportation Officials
ASTM	American Society for Testing and Materials
ABC	Aggregate Base Course
ACI	American Concrete Institute
ACPA	American Concrete Pavement Association
ADT	Average Daily Traffic
AMC	Annual Maintenance Cost
ARA	Asphalt Rejuvenating Agent
ASR	Alkali Silica Reactivity
CAPA	Colorado Asphalt Pavement Association
CBR	California Bearing Ratio
CDOT	Colorado Department of Transportation
CFR	Code of Federal Regulations
CIR	Cold In-Place Recycling
CP	Colorado Procedure
CTB	Cement Treated Base
CPPP	Concrete and Physical Properties Program
DARWin™	Design Analysis and Rehabilitation Program for Windows
DTD	Division of Transportation Development
EATB	Emulsified Asphalt Treated Base
ESAL	Equivalent Single Axle Load
FASB	Foamed Asphalt Stabilized Base



FDR	Full Depth Reclamation
FHWA	Federal Highway Administration
FIR	Field Inspection Review
FOR	Final Office Review
FMM	Field Materials Manual
FWD	Falling Weight Deflectometer
HBP	Hot Bituminous Pavement
HIR	Hot In-Place Recycling
HMA	Hot Mix Asphalt
HMAP	Hot Mix Asphalt Pavement
IRI	International Roughness Index
JPCP	Jointed Plain Concrete Pavement
LCCA	Life Cycle Cost Analysis
LL	Liquid Limit
LS	Loss of Support
LTB	Lime Treated Base
LTPP	Long Term Pavement Performance
MMS	Maintenance Management System
MGPEC	Metropolitan Government Pavement Engineering Council
$M_r$	Resilient Modulus
MR	Modulus of Rupture
MUTCD	Manual on Uniform Traffic Control Devices
NMAS	Nominal Maximum Aggregate Size
$N_{DES}$	Recommended SuperPave™ Gyratory Design Revolution
NDT	Nondestructive Testing

NLPM	Network Level Pavement Manager
PCCP	Portland Cement Concrete Pavement
PDM	Pavement Design Manual
PG	Performance Grade
PI	Plasticity Index
PJR	Pavement Justification Report
PMA	Polymer Modified Asphalt
PMBB	Plant Mix Bituminous Base
PMBP	Plant Mix Bituminous Pavement
PDPM	Pavement Design Program Manager
PM	Pavement Manager
PMS	Pavement Management System
PMSC	Plant Mix Seal Coat
PTSC	Pavement Type Selection Committee
PSI	Present Serviceability Index
PWF	Present Worth Factor
RAP	Reclaimed Asphalt Pavement
RCP	Reclaimed Concrete Pavement
RCC	Roller Compacted Concrete
RIC	Research Implementation Council
RME	Region Materials Engineer
RSL	Remaining Service Life
SHRP	Strategic Highway Research Program
SMA	Stone Matrix Asphalt

SN	Structural Number
TCP	Traffic Control Plan
VFA	Voids Filled with Asphalt
VMA	Voids in the Mineral Aggregate
WIMS	Weigh-In-Motion Station
WSN	Weighted Structural Number
WWF	Welded Wire Fabric

## **DESIGN OF PAVEMENT STRUCTURES DEFINITIONS**

### **ADT (Current Year)**

The average two-way daily traffic (ADT), in the number of vehicles, for the current year. The average 24-hour volume, being the total number during a stated period, divided by the number of days in that period. Unless otherwise stated, the period is a year.

### **ADT (Design Year)**

The average two-way daily traffic for the future year used as a target in design.

### **AADT**

The annual average two-way daily traffic volume. It represents the total traffic on a section of roadway for the year, divided by 365. It includes both weekday and weekend traffic volumes.

### **Analysis Period**

The period of time for which the economic analysis is to be made. Ordinarily, the period will include at least one rehabilitation activity.

### **Approach Slab**

Section of pavement just prior to joint, crack, or other significant roadway feature relative to the direction of traffic.

### **Arterial Highway**

A highway primarily for through traffic, usually on a continuous route.

### **Asphalt Mix Design**

The process and documentation of proportions of asphalt, cement, and mineral aggregate with the percentages of each component and size of particle that will result in a homogeneous mix and can be compacted into asphaltic concrete.

### **Asphalt Rejuvenating Agent (ARA)**

A bituminous emulsion sprayed on new asphalt pavements to seal them from the adverse environmental effect of air and water. ARA is also used on dry, weathered asphalt pavement to give them new vitality and plasticity.

### **Asphalt Overlay**

One or more courses of asphalt construction on an existing pavement. The overlay may include a leveling course, to correct the contour of the old pavement, followed by uniform course or courses to provide needed thickness.

### **At-Grade Intersection**

An intersection where all roadways join or cross at the same level.

### **Axle Load**

The total load transmitted by all wheels on a single axle extending across the full width of the vehicle. Tandem axles 40 inches or less apart will be considered as a single axle.

**Base Course**

The layer or layers of specified or selected material of designed thickness placed on a subbase or subgrade to support a surface course.

**Bituminous**

A term used to designate materials that are derived from petroleum, coal, tar, etc.

**Bituminous Surface Treatment**

Alternate layers of bituminous binder material and stone chips.

**Binder**

Asphalt cement used to hold stones together for paving.

**Bleeding**

A type of asphalt pavement distress identified by a film of bituminous material on the pavement surface that creates a shiny, glass-like, reflective surface that may be tacky to the touch in warm weather.

**Block Cracking**

The occurrence of cracks that divide the asphalt surface into approximately rectangular pieces, typically one square foot or more in size.

**Blowup**

The result of localized upward movement or shattering of a slab along a transverse joint or crack.

**California Bearing Ratio (CBR) Test**

An empirical measure of bearing capacity used for evaluation of bases, subbases, and subgrades for pavement thickness design.

**Cement Treated Base**

A base consisting of a mixture of either mineral aggregate or granular soil and portland cement mixed, and spread on a prepared subgrade to support a surface course.

**Centerline**

The painted line separating opposing traffic lanes.

**Channels**

A ditch or canal adjacent to the roadway.

**Chipping**

Breaking or cutting off small pieces from the surface.

**Chip Seal**

A seal coat consisting of the application of asphalt followed by a cover aggregate.

**Cohesive Failure**

The loss of a material's ability to bond to itself resulting in the material splitting or tearing apart from itself (i.e. joint sealant splitting).

### **Cold In-Place Recycled Pavement**

A pavement structure composed of an asphalt concrete wearing surface and portland cement concrete slab. An asphalt concrete overlay on a Portland Cement Concrete (PCC) slab is also called a composite pavement.

### **Control of Access**

The condition where the right of owners or occupants of abutting land or other persons to access light, air, or view in connection with a highway is controlled by a public authority.

### **Collector**

A road of the intermediate functional category that collects traffic from the local roads to arterials or distributes traffic to local roads from arterials.

### **Concrete Overlay (Whitetopping)**

The procedure for placing Portland Cement Concrete (PCC) overlays over existing Hot Mix Asphalt (HMA) pavements. Concrete overlay may be either conventional, thin, or ultra-thin depending on the required thickness of the PCC overlay. In general, conventional Concrete overlay uses 8 inches or greater.

- Thin concrete overlay uses greater than 4 but less than 8 inches.
- Ultra-thin concrete overlay uses 4 inches or less thickness of PCC overlay.

### **Constant Dollars**

Un-inflated dollars that represent the prevailing prices for all elements at the base year for the analysis.

### **Corner Break**

A portion of a jointed concrete pavement separated from the slab by a diagonal crack intersecting the transverse and longitudinal joint, which extends down through the slab allowing the corner to move independently from the rest of the slab.

### **Corrective Maintenance**

Corrective maintenance could be a planned or unplanned strategy that restores the existing roadway to the intended design life. Typically, this process occurs within the first five years after construction.

### **Corridor**

A grouping of project segments that are on the same highway facility that have some or all of the following characteristics: logical termini (i.e. begin/end point), similar roadway cross section, geologic and materials conditions, and future traffic. The projects in a corridor are advanced through preconstruction project development together to approximately 30 percent design in an effort to identify ROW, Utility and other resource impacts.

### **Cross-Stitching**

A repair technique for longitudinal cracks and joints that are in reasonably good condition. The purpose of cross-stitching is to maintain aggregate interlock and provide added reinforcement and strength to the crack or joint. The technique uses deformed tie bars inserted into holes drilled across a crack at angles of 35 to 45 degrees depending on slab thickness.

### **DARWin™**

A software program that performs the complex calculations for design and analysis of pavement structures. DARWin™ is an acronym for Design, Analysis, and Rehabilitation for Windows.

### **Deflection Analysis**

The procedure used to establish pavement strength indices based on pavement deflections induced by a force.

### **Deformed Bar**

A reinforcing bar for rigid slabs. Most often used to tie slabs together in the longitudinal direction across lane lines including tying travel lanes and shoulders.

### **Design Period**

The number of years from initial construction or rehabilitation until terminal service life. This term should not be confused with pavement life or analysis period. By adding asphalt overlays as required, pavement life may be extended indefinitely or until geometric considerations or other factors make the pavement obsolete. The initial design period is the number of years for which the volume and type of traffic and the resultant wheel or axle load application are forecast, and on which pavement designs are calculated.

### **Design Traffic (18k ESAL)**

The design traffic is the total number of equivalent 18,000-lb single axle load (18k ESAL) applications expected during the design period. This can be calculated or obtained from CDOT personnel at the Traffic Analysis Unit of the Division of Transportation Development.

### **Deterministic Life Cycle Cost Analysis**

A traditional cost comparison process where each item of interest is assigned a fixed discrete value, usually a value most likely to occur based on historical data and user judgement. This value includes all costs over the life of the project, such as construction, maintenance, and rehabilitation adjusted to a present value.

### **Diamond Grinding**

A process of improving a pavement's ride by creating a smooth, uniform profile by removing faulting, slab warping, studded tire wear, and patching unevenness.

### **Discount Rate**

A value in percent used for comparing the alternative uses of funds over a period of time. The discount rate may be defined as the difference between the market interest rate and inflation rate using constant dollars over the analysis period.

### **Dowel**

A load transfer device in a rigid slab usually consisting of a plain, epoxy coated, round steel bar. Most often used to provide load transfer between slabs in the transverse direction that are within the same lane.

### **Drainage Coefficients**

Factors used to modify structural layer coefficients in flexible pavements, or stresses in rigid pavements as a function of how well the pavement structure can handle the adverse effect of water infiltration.

### **Durability Cracking**

The breakup of concrete due to freeze-thaw expansive pressures within certain aggregates. Also called D-Cracking.

### **Economic Analysis**

A justification of the expenditure required and the comparative worth of a proposed improvement as compared to other alternate plans.

### **Economic Life**

Economic life is the total useful life of a pavement structure including the extended service life gained when the initial pavement is supplemented by the addition of structural layers. It also defines the period of time beyond which further use is not economical.

### **Edge Cracking**

Fracture and material loss in pavements without paved shoulders which occurs along the pavement perimeter. Caused by soil movement beneath the pavement.

### **Embankment (Embankment Soil)**

The prepared or natural soil underlying the pavement structure.

### **Emulsified Asphalt Treated Base**

A base consisting of a mixture of mineral aggregate and emulsified asphalt spread on a subgrade to support a surface course.

### **Equivalence Factor**

A numerical factor that expresses the relationship of a given axle load in terms of their effect on the serviceability of a pavement structure. All axle loads are equated in terms of the equivalent number of repetitions of an 18,000-pound single axle.

### **Equivalent Single Axle Loads (ESALs)**

The effect on pavement performance of any combination of axle loads of varying magnitude expressed in terms of the number of 18,000-lb single-axle loads required to produce an equivalent effect. This is calculated by summing the equivalent 18,000-pound single axle loads (18k ESALs) used to combine mixed traffic to design traffic for the design period. The value of 18k ESALs is obtained as an accumulative total from the beginning of use until and including the design year. The 18k ESAL is calculated by multiplying the annual design traffic volume by the Traffic Equivalence Factor (e) at a given Terminal Serviceability Index ( $P_t$ ).

### **Expansion Factor**

A factor expressing the expected traffic growth trend on a particular section of highway.

### **Expressway**

A divided arterial highway for through traffic with full or partial control of access and generally with grade separations at major intersections.

### **Fatigue Cracking**

A series of small, jagged, interconnecting cracks caused by failure of the asphalt concrete surface under repeated traffic loading (also called alligator cracking).



**Fault**

Difference in elevation between opposing sides of a joint or crack.

**Flexible Pavement**

A pavement structure of which the surface course is made of asphaltic concrete, that maintains intimate contact with and distributes loads to the subbase or subgrade and depends upon aggregate interlock, particle friction, and cohesion for stability.

**Foamed Asphalt Stabilized Base**

A base consisting of mixed wet unheated aggregates and asphalt cement while the asphalt cement is in a foamed state.

**Fog Seal**

A seal coat consisting of an application of diluted asphalt emulsion without an aggregate cover.

**Free Edge**

Pavement border that is able to move freely.

**Freeway**

An expressway with full control of access and all at-grade intersections eliminated.

**Full Depth Asphalt**

A asphaltic concrete pavement structure consisting of one and only one layer. There is no base, subbase, or intermediary layer of gravel between the asphaltic concrete layer and subgrade.

**Full Depth Reclamation**

A rehabilitation technique in which the full thickness of asphalt pavement and a predetermined portion of the underlying materials (base, subbase and/or subgrade) is uniformly pulverized and blended to provide an upgraded, homogeneous base material. This new stabilized base course may be used for an asphalt or concrete wearing surface.

**Functional Deficiency**

Any condition that adversely affects the roadway user. These include poor surface friction and texture, hydroplaning and splash from wheel path rutting, and excess surface distortion.

**Functional Maintenance**

A planned strategy of low cost treatments that are meant to sustain the roadway and its appurtenances in a manner that delivers a condition in order to keep traffic moving.

**Grade Separation**

A crossing of two highways, or a highway and a railroad, at different levels.

**Granular Base**

A base consisting of mineral aggregate laid and compacted on a subbase or subgrade to support a surface course.

**Grooving**

Grooving restores skid resistance to concrete pavements. It increases the surface friction and surface drainage capabilities of a pavement by creating small longitudinal or transverse channels that drain water from underneath the tire, reducing the potential for hydroplaning.

**Hairline Crack**

A fracture that is very narrow in width, less than 0.125 inches (3 mm).

**Hinged Joint**

A joint between two rigid pavement slabs in which flexure is permitted but separation and vertical displacement of abutting rigid slabs are prevented by metal ties and mechanical or aggregate interlock.

**Hot Bituminous Pavement**

A combination of mineral aggregate and bituminous material, mixed in a central plant, laid and compacted while hot, to act as a surface course and carry traffic. Hot Bituminous Pavement is an older design usage. Also known as Plant Mixed Bituminous Pavement, see Hot Mix Asphalt for current designation.

**Hot In-Place Recycled Pavement: Heater Remixing**

A pavement rehabilitation process that consists of reworking the existing pavement with a heating device, reshaping, and compaction. This operation may be performed with or without the addition of a rejuvenating agent, aggregates, or new asphalt mix.

**Hot In-Place Recycled Pavement: Heater Repaving**

A pavement rehabilitation process that consists of reworking the existing pavement with a heating device. During the lay down process of the old rejuvenated material, a virgin lift will be added reshaped and compacted.

**Hot In-Place Recycled Pavement: Heater Scarifying**

A pavement rehabilitation process that consists of reworking the existing pavement with a heating device. A rejuvenating agent will be added to the old mix reshaped and compacted.

**Hveem Stabilometer**

A device for the measurement of the lateral pressure transmitted by a soil or aggregate being subjected to a vertical load. The pressure obtained is used to compute the R-value, which is the internal resistance or the internal friction property of a bituminous pavement or a base. The data obtained is used to compute the relative stability.

**Hydroplaning**

To skid on wet pavement because water on the pavement causes the tires to lose contact with it.

**Joint Seal Damage**

Any distress associated with the joint sealant, or lack of joint sealant.

**Keyway**

A groove on either vertical or horizontal face of a concrete slab. A keyway is often molded in concrete structures. A keyway molded on a vertical face of a concrete slab will provide interlock and load transfer to an adjacent slab. A keyway molded on a horizontal face of a concrete structure will provide interlock and resist horizontal movement of a concrete structure molded over the keyway.

**Lane Factor**

Factors used to convert total truck traffic to Design Lane Truck Traffic given the number of lanes.

**Lanes to Shoulder Drop-off**

The difference in elevation between the traffic lane and the shoulder.

**Lane to Shoulder Separation**

Widening of the joint between the traffic lane and the shoulder.

**Lime-Treated Base**

A base consisting of a mixture of soil, hydrated lime, and water usually mixed in place and placed to support a pavement structure, or the components thereof.

**Load Transfer Device**

A mechanical means designed to carry loads across a joint in a rigid slab.

**Local Street or Local Road**

A street or road primarily for access to residence, business, or other abutting property.

**Longitudinal**

Parallel to the pavement centerline.

**Low Volume Road**

A road with a two-directional Average Annual Daily Traffic (AADT) of less than 100 trucks per day and less than 1,000 cars per day.

**Maintenance**

The preservation of the entire roadway, including surface, shoulders, roadsides, structures, and such traffic control devices as are necessary for its safe and efficient utilization.

**Major Rehabilitation**

Pavement treatments that consist of structural enhancements that extend the serviceable life of an existing pavement and improve its load-carrying capability.

**Map Cracking**

A series of interconnected hairline cracks in portland cement concrete pavements that extend only into the upper surface of the concrete. It includes cracking typically associated with Alkali-Silica Reactivity (ASR).

**Mechanistic-Empirical Pavement Design Guide**

The guide and its accompanying software that provides a uniform basis for the design of flexible, rigid, and composite pavements, using mechanistic-empirical approaches which are more realistically characterize in-service pavements and improve the reliability of designs.

**Micro-Surfacing**

A seal coat consisting of the application of polymer modified emulsion followed by a cover of aggregates selected for properties of hardness and angularity.

### **Minor Rehabilitation**

Pavement treatments consisting of functional or structural enhancements made to the existing pavement sections to improve pavement performance or extend serviceable life.

### **Modulus of Elasticity (E)**

A measure of the rigidity of a material and its ability to distribute loads defined by the ratio of strain to stress in a portland cement concrete pavement slab.

### **Modulus of Subgrade Reaction (k-value)**

Westergard's modulus of subgrade reaction for use in rigid pavement design (the load in pounds per square inch on a loaded area of the roadbed soil or subbase divided by the deflection, in inches, of the roadbed soil or subbase), psi/in. The modulus of subgrade reaction is the supporting capability of a soil measured by its ability to resist penetration of a series of loaded stacked plates.

### **Modulus of Rupture (S<sub>c</sub>)**

An index of the flexural strength of the portland cement concrete pavement. It is a measure of the extreme fiber stress developing under slab bending, the mode in which most concrete pavements are loaded. The modulus of rupture required by the design procedure is the mean value determined after 28 days using third-point-loading (AASHTO T97).

### **Nominal Maximum Aggregate Size**

One sieve size larger than the first sieve to retain more than 10 percent of the material (Roberts et al., 1996).

### **Overlays**

- **Leveling Course:** The layer of material placed on an existing paved surface to eliminate irregularities prior to placing an overlay or a surface course. Milling procedures are to be considered the primary method to address rutting and are to be used instead of a leveling course to remove ruts whenever possible.
- **Overlay Course:** Surfacing course, either plant mixed or road mixed, placed over an existing pavement structure after placement of a leveling course, as appropriate.

### **Partial Depth Reclamation**

A rehabilitation technique in which a portion of the asphalt pavement is pulverized, mixed with a stabilizing agent, and placed back on the remaining pavement surface. Partial depth reclamation is limited to correcting only those distresses that are surface problems in the asphalt layer.

### **Patch**

An area where the pavement has been removed and replaced with a new material.

### **Patch Deterioration**

Distress occurring within a previously repaired area.

### **Pavement**

The part of roadway having a constructed surface for the facilitation of vehicular movement.

### **Pavement Design (Design, Structure Design)**

The specifications for materials and thickness of the pavement components.

## **Pavement Joints**

The designed vertical planes of separation or weakness. Complete details of concrete pavement joints are given a standard specifications in CDOT's *Standard Plans M & S Standards*.

### **Joints Used in Portland Cement Concrete Pavement**

- **Construction Joints:** Joints made necessary by a prolonged interruption in placing concrete. They are formed by placing concrete up to one side of a planned joint and allowing it to set before the concrete is placed on the other side of a joint. They may be either longitudinal or transverse.
- **Contraction Joints:** Joints placed either transversely at recurrent intervals or longitudinally between traffic lanes to control cracking.
- **Expansion Joints:** Transverse joints located to provide for expansion without damage to themselves, adjacent slabs, or structures.
- **Weakened Plane Joints (Longitudinal and Transverse):** Weakened plane joints are placed both longitudinally and transversely in PCCP. CDOT specifies using a saw to cut the weakened planes at  $\frac{1}{3}$  in PCCP.

## **Pavement Maintenance**

Typically, these treatments are preventive in nature and are intended to keep the pavement in serviceable condition. They may be classified as corrective, preventive, reactive, or functional.

## **Pavement Management**

Pavement management is the evaluation, documentation, and analysis of the amount, quality, and type of pavement under the responsibility of any given owner or agency. It is also the planning and budgeting for the upkeep and replacement of paved assets.

## **Pavement Performance**

The trend of serviceability with load applications.

## **Pavement Rehabilitation**

Work undertaken to extend the service life of an existing facility. This includes placement of additional surfacing material and/or completing any other work necessary to return an existing roadway, including shoulders, to a condition of structural or functional adequacy. This could include the complete removal and replacement of the pavement structure.

## **Pavement Structure**

The combination of subbase, base course, and surface course placed on a prepared subgrade to support the traffic load and distribute it to the roadbed.

## **Pavement Section**

A layered system designed to distribute concentrated traffic loads to the subgrade. Performance of the pavement structure is directly related to the physical properties of the subgrade soils and traffic loadings. Most soils can be adequately represented for pavement design purposes by means of the soil support value for flexible pavements and a modulus of subgrade reaction for rigid pavements

**Performance Period**

The period of time that the initially constructed or rehabilitated pavement structure will last (perform) before reaching its terminal serviceability. This is also called the design period.

**Permeability**

The property of soils which permits the passage of any fluid. Permeability depends on grain size, void ratio, shape, and arrangement of pores.

**Plant Mixed Bituminous Base**

A base consisting of mineral aggregate and bituminous materials mixed in a central plant, and laid and compacted while hot on a subbase or a subgrade to support a surface course.

**Plant Mixed Bituminous Pavement**

A combination of mineral aggregate and bituminous material mixed in a central plant, laid and compacted while hot to act as a surface course and carry traffic. Plant Mixed Bituminous Pavement is an older designation usage. Also known as Hot Bituminous Pavement, see Hot Mix Asphalt for current designation.

**Plant Mixed Seal Coat**

A seal coat consisting of a combination of mineral aggregate and bituminous material mixed in a central plant, laid, and compacted while hot.

**Polished Aggregate**

Surface mortar and texturing worn away to expose coarse aggregate in the concrete.

**Popouts**

Small pieces of pavement broken loose from the surface.

**Pothole**

A bowl-shaped depression in the pavement surface.

**Prepared Roadbed**

In place roadbed soils compacted or stabilized according to provisions of applicable specifications.

**Present Serviceability Index (PSI)**

A number derived by a formula for estimating the serviceability rating calculated from measurements of certain physical features of the pavement.

**Preventive Maintenance**

Preventive maintenance is a planned strategy of cost-effective treatments performed on an existing roadway system and its appurtenances that preserves the system, retards future deterioration, and maintains or improves the functional condition of the system without significantly increasing the structural capacity.

**Prime Coat**

Bituminous materials used on aggregate base courses to provide good adhesion to the hot mix asphalt layer placed above.

### **Probabilistic Life Cycle Cost Analysis**

A process where probabilistic LCCA inputs are described by probability functions that convey both the range of likely inputs and the likelihood of their occurrence. Probabilistic LCCA also allows for the simultaneous computation of differing assumptions for many different variables. Probabilistic LCCA allow the value of individual data inputs to be defined by a frequency (probability) distribution.

### **Pumping**

The ejection of foundation material, either wet or dry, through joints or cracks, or along edges of rigid slabs resulting from vertical movements of the slab.

### **Punchout**

A localized area of a continuously reinforced concrete pavement bounded by two transverse cracks and a longitudinal crack. Aggregate interlock decreases over time and is eventually lost which leads to steel rupture and allows the pieces to be punched down into the subbase and subgrade.

### **Raveling**

The wearing away of the pavement surface caused by the dislodging of aggregate particles.

### **Reactive Maintenance**

Reactive maintenance is an unplanned, therefore, unscheduled; sometimes immediate treatments performed on an existing roadway system and its appurtenances that is necessary to avoid serious consequences.

### **Reconstruction**

Treatments requiring full removal and replacement and or improvement of the existing pavement structure which includes subbase, base course, and surface course due to pavement condition and structural capabilities. A LCCA is required. Typical AASHTO criteria are addressed and designed to current standards.

### **Reflection Cracking**

The fracture of asphalt concrete above joints in the underlying pavement layer(s).

### **Reinforcement**

Steel embedded in a rigid slab to resist tensile stresses and detrimental opening of cracks.

### **Reliability**

The probability, expressed as a percentage that a pavement structure will carry the traffic for which it is designed over the design or analysis period.

### **Remaining Service Life (RSL)**

The number of years a pavement is expected to last until maintenance and rehabilitation treatments no longer improve or maintain the surface condition.

### **Resilient Modulus ( $M_r$ )**

A measure of the modulus of elasticity of roadbed soil or other pavement material. In M-E Design, the subgrade resilient modulus  $M_r$  is measured at optimum moisture content and density. This  $M_r$  is different than the AASHTO 1993 empirical design procedure which was basically a “wet of optimum”  $M_r$ . The input  $M_r$  is then internally adjusted to field conditions by the M-E Design

software on a month to month basis based on water table depth, precipitation, temperature, soil suction, and other factors.

### **Rigid Pavement**

A pavement structure of which the surface course is made of portland cement concrete.

### **Rigid Slab**

A section of portland cement concrete pavement bounded by joints and edges designed for continuity of flexural stress.

### **Roadbed**

The graded portion of a highway within top and side slopes prepared as a foundation for the pavement structure and shoulder.

### **Roadbed Material**

The material below the pavement structure in cuts and embankments and in embankment foundations, extending to such depth as affects the support of the pavement structure.

### **Roadway**

The portion of a highway including shoulders, for vehicular use.

### **Roundabout**

A circular intersection with yield control of all entering traffic, channelized approaches, counter-clockwise circulation, and appropriate geometric curvature to ensure travel speeds on the circulatory roadway are typically less than 30 miles per hour.

### **Rutting**

Longitudinal surface depressions in the wheel paths.

### **Sand Seal**

A seal coat consisting of the application of asphalt emulsion followed by a sand cover aggregate.

### **Scaling**

The deterioration of the upper 0.125 to 0.5 inches of the concrete surface, resulting in the loss of surface mortar.

### **Seal Coat**

A thin treatment consisting of bituminous material, usually with cover aggregate, applied to a surface as an armor coat or for delineation. The term includes but is not limited to sand seal, chip seal, slurry seal, and fog seal.

### **Service Life**

The service life is the number of years a pavement is expected to last from completion of construction until pavement failure.

### **Serviceability**

The ability, at the time of observation, of a pavement to serve traffic using the facility. Also, serviceability is a pavement's ability to provide adequate support and a satisfactory ride at any specific time.



**Serviceability Index**

A number that is indicative of the pavement's ability to serve traffic at any specific time in its life.

**Shelf Project**

A project that has been advanced through preconstruction process and completed the Pavement Type Selection and Life Cycle Cost Analysis. A final pavement type has been identified, is developed using Alternate Pavement Type Bidding methodology, or has gone through the Pavement Type Selection Committee and the Chief Engineer has recommended a preferred alternative.

**Shoving**

Permanent, longitudinal displacement of a localized area of the pavement surface caused by traffic pushing against the pavement.

**Single Axle Load**

The total load transmitted by all wheels whose centers may be included between two parallel transverse vertical planes 40 inches apart and extending across the full width of the vehicle.

**Skid Hazard**

Any condition that might contribute to making a pavement slippery when wet.

**Slot Stitching**

A technique for repairing longitudinal cracks or joints. It is an extension of dowel bar retrofit, which is used to add dowel bars to existing transverse joints. The purpose of slot-stitching is to provide positive mechanical interconnection between two slabs or segments. The deformed bars placed in the slots hold the segments together serving to maintain aggregate interlock and provide added reinforcement and strength to the crack or joint. The bars also prevent the crack or joint from vertical and horizontal movement or widening. Larger diameter bars (> 25mm, > 1 inch) also serve to provide long-term load transfer capabilities.

**Slurry Seal**

A seal coat consisting of a semi fluid mixture of asphaltic emulsion and fine aggregate. This type of seal is usually placed in a very thin course of  $\frac{1}{8}$  to  $\frac{1}{4}$  inches.

**Soil Support Value**

A number that expresses the relative ability of a soil or aggregate mixture to support traffic loads through the pavement structure.

**Spalling**

Cracking, breaking, chipping, or fraying of the concrete slab surface within 2 feet of a joint or crack.

**Squeegee Seal**

A seal coat similar to a sand seal, consisting of the application of asphalt emulsion and sand. The application of a squeegee seal differs from that of a sand seal in that a surface drag is used to spread the emulsion to seal cracks

### **Stabilometer R-Value**

A numerical value expressing the measure of a soil's or aggregate's ability to resist the transmission of vertical load in a lateral or horizontal direction. A test for evaluating bases, subbases, and subgrades for pavement thickness design. It is measured with a stabilometer.

### **Standard Normal Deviate ( $Z_R$ )**

The standard normal deviate is a statistical value identical to the Z-scale value used in the standard normal distribution. It is a measure of the deviation of any observations from the mean of all observations expressed in terms of the number of standard deviations. Each calculated Z value corresponds to a certain level of significance, confidence interval, certainty, or reliability value in a standard normal distribution curve. The standard normal deviate (Z) can be calculated from the equation:

$$Z = \frac{\text{Observed Value} - \text{Mean of all Observed Values}}{\text{Standard Deviation of all Observations}}$$

### **Stone Matrix Asphalt (SMA)**

A mixture of crushed coarse aggregate, crushed fine aggregate, mineral filler, asphalt cement, and stabilizing agent typically used as a wearing course. A stabilizing agent is used to prevent drain down of the asphalt cement and typically consists of fibers, polymers, or limestone dust (powder).

### **Structural Deficiency**

Any condition that adversely affects the load carrying capability of the pavement structure. These include inadequate thickness, cracking, distortion, and disintegration. Several types of distress (i.e., caused by poor construction techniques, low temperature cracking) are not initially caused by traffic loads, but do become more severe under traffic to the point that they also detract from the load carrying capability of the pavement.

### **Structural Layer Coefficient ( $a_1$ , $a_2$ , $a_3$ )**

The empirical relationship between structural number (SN) and layer thickness that expresses the relative ability of a material to function as a structural component of the pavement and express the relative strength of a layer in a pavement structure.

### **Structural Number (SN)**

An index derived from an analysis of traffic, roadbed soil conditions, and environment that may be converted to thickness of flexible pavement layers by using suitable structural layer coefficients related to the type of materials being used in each layer of the pavement structure.

### **Subbase**

The layer or layers of specified or selected material of designed thickness placed on a subgrade to support a base course. Subgrade treated with lime, fly ash, cement kiln dust, or combination of stabilization will be considered subbase.

### **Subgrade**

The top surface of a roadbed upon which the pavement structure and shoulders are constructed.

### **Surface Course**

The uppermost component of a pavement structure designed to accommodate the traffic load, the top layer of which resists skidding, traffic abrasion, and the disintegrating effects of climate. The top layer is also sometimes called the wearing course.

**Surface Life**

A period of time where treatments can be performed on a pavement that maintain or improve the surface condition.

**Tack Coat**

A light application of emulsified asphalt applied to an existing asphalt or portland cement concrete pavement surface. It is used to ensure a bond between the surface being paved and the overlaying course. Typically 0.10 gal/yd<sup>2</sup> of diluted CSS1h.

**Tandem Axle Load**

The total load transmitted to the road by two consecutive axles whose centers may be included between parallel vertical planes spaced more than 40 inches but not more than 96 inches apart, extending across the full width of the vehicle.

**Tie Bar**

A deformed steel bar or connector embedded across a longitudinal joint for a rigid slab to prevent separation of abutting slabs.

**Tining**

A process by which it is achieved by a mechanical device equipped with a tining head (metal rake) that moves laterally across the width of the paving surface.

**Treated Base**

A layer of base material stabilized with asphalt, portland cement, or other suitable stabilizers.

**Traffic Equivalence Factor (e)**

A numerical factor that expresses the relationship of a given axle load to another axle load in terms of their effect on the serviceability of a pavement structure.

**Transverse**

Perpendicular to the pavement centerline.

**Triple Axle Load**

The total load transmitted to the road by three consecutive axles whose centers may be included between parallel planes spaced more than 40 inches but no more than 96 inches apart, extending across the full width of the vehicle.

**Water Bleeding**

Seepage of water from joints or cracks.

**Weathering**

The wearing away of the pavement surface caused by the loss of asphalt binder.

**Weigh-In-Motion (WIM) Station**

The process of measuring the dynamic tire forces of a moving vehicle and estimating the corresponding tire loads of the static vehicle.

**Welded Wire Fabric (WWR)**

A two-way reinforcement system for rigid slabs, fabricated from cold-drawn steel wire and having parallel longitudinal wires welded at regular intervals to parallel transverse wires. The wires may be either smooth or deformed.

**Whitetopping (old definition)**

The procedure for placing portland cement concrete overlays over existing hot mix asphalt pavements. Whitetopping may be either conventional, thin, or ultra-thin depending on the required thickness of the PCC overlay. In general, conventional whitetopping uses 8 inches or greater:

- **Thin whitetopping** uses greater than 4 but less than 8 inches.
- **Ultra-thin whitetopping** uses 4 inches or less thickness of a PCC overlay.

## MECHANISTIC-EMPIRICAL (M-E) PAVEMENT DESIGN BASIC DEFINITIONS

These definitions may be slightly different from the definition in the previous section. These basic definition as are to agree with the usage as in the Mechanistic-Empirical (M-E) Pavement Design Guide. Some have been modified to clarify this manual's notation.

### Basic Definitions of the Roadway

#### Base

The layer or layers of specified or select material of designed thickness placed on a subbase or subgrade to support surface course. The layer directly beneath the PCC slab is called the base layer.

- **Aggregate Base:** A base course consisting of compacted aggregates which includes granular base and unbound granular base.
- **Asphalt Concrete Base:** Asphalt concrete used as a base course. This may include asphalt base course, hot-mixed asphalt base, asphalt-treated base, bituminous aggregate base, bituminous base, bituminous concrete base, and plant mix bituminous base.
- **Cold Mix Asphalt:** Asphalt concrete mixtures composed of aggregate and/or asphalt emulsions or cutback asphalts, which do not require heating during mixing. This may include emulsified asphalt treated base.
- **Permeable Aggregate Base:** A crushed mineral aggregate base, treated or untreated, having a particle size distribution such that when compacted the interstices will provide enhanced drainage properties. It may include a granular drainable layer, untreated permeable base, free-draining base, and stabilized treated permeable base.
- **Asphalt Treated Permeable Base:** A permeable base containing a small percentage of asphalt cement to enhance stability. This may include asphalt-treated open-graded base or asphalt treat base; permeable.
- **Cement Treated Base:** A base course consisting of mineral aggregates blended in place or through a pugmill with a small percentage of portland cement to provide cementitious properties and strengthening. This may also include aggregate cement, cement-stabilized graded aggregate, and cement-stabilized base.
- **Lean Concrete Base:** A base course constructed of plant mixed mineral aggregates with a sufficient quantity of portland cement to provide a strong platform for additional pavement layers and placed with a paver.
- **Lime-Fly Ash Base:** A blend of mineral aggregate, lime, fly ash, and water combined in proper proportions and producing a dense mass when compacted.
- **Cement Treated Permeable Base:** An open-graded aggregate base treated with portland cement to provide enhanced base strength and reduce erosion potential.

## Fabric Layers

- **Geosynthetics:** A planar material manufactured from a polymeric material used with soil, rock, earth, or other geotechnical-related materials. It serves six primary functions: filtration, drainage, separation, reinforcement, fluid blockage, and protection. Typical geosynthetics include geotextiles, geomembranes, and geogrids.
- **Geotextiles:** Permeable fabric made of textile materials used as filters to prevent soil migration, separators to prevent soil mixing, and reinforcement to add shear strength to a soil.
- **Geomembranes:** Impermeable polymer sheeting used as fluid barriers to prevent migration of liquid pollutants in the soil.
- **Geogrids:** Polymeric grid material having relatively high tensile strength and a uniformly distributed array of large apertures (openings). The apertures allow soil particles on either side to come in direct contact, thereby increasing the interaction between the geogrid and surrounding soils. Geogrids are used primarily for reinforcement.

## Roadbed

The graded portion of a highway between top and side slopes, prepared as a foundation for the pavement structure and shoulder.

## Subbase

The layer or layers of specified or selected materials of designed thickness placed on a subgrade to support a base course. This may include granular subbase and unbound granular subbase. **Note:** The layer directly below the PCC slab is now called a base layer, not a subbase layer.

## Subgrade

The top surface of a roadbed upon which the pavement structure and shoulders are constructed.

- **Select Material:** A suitable native material obtained from a specified source, such as a particular roadway cut or borrow area, having specified characteristics to be used for a specific purpose.
- **Soil Cement:** A mechanically compacted mixture of soil, portland cement, and water used as a layer in a pavement system to reinforce and protect the subgrade or subbase. It may also include cement-treated subgrade.
- **Lime Stabilized Subgrade:** A prepared and mechanically compacted mixture of hydrated lime, water, and soil supporting the pavement system that has been engineered to provide structural support.

## Surface Course

One or more layers of a pavement structure designed to accommodate the traffic load, the top layer of which resists skidding, traffic abrasion, and the disintegrating effects of climate. The top layer of flexible pavements is sometimes called the “wearing” course.

## ESTIMATING FORMULAS, CALCULATIONS, AND CONVERSION FACTORS

### Estimating Formulas

- **Diluted Emulsified Asphalt:** 0.10 gal./sq. yd. (diluted - slow setting)
- **Bituminous Pavement:** 110 lbs./sq. yd./1" thickness
- **Aggregate Base Course (Class 2 and 6):** 133 lbs./cu. ft.
- **Filter Material:** 110 lbs./cu. ft.
- **Hydrated Lime:** 26.4 lbs./sq. yd./ 8 in. depth at 4% lime
- 39.6 lbs./sq. yd./12 in. depth at 4% lime
- 59.4 lbs./sq. yd./12 in. depth at 6% lime
- **Asphalt Rejuvenating Agent:** 0.15 gal./sq. yd. (diluted)
- **Asphalt Rejuvenating Agent:** 0.15 gal./sq. yd. (non-diluted asphalt rejuvenating agent for use with Item 404 - Heater and Scarifying Treatment)
- **Micro-Surfacing Seal Coat:** 35 lbs./sq. yd. (based on an average rut depth of  $\frac{3}{4}$  inches)
- **Crack Sealant:** quantities of crack sealant were estimated based on the level of cracking and the following ratios. The quantities shown here are for information only.
  - Heavy: 2 tons per lane mile
  - Medium: 1 ton per lane mile
  - Light: 0.5 ton per lane mile
  - Very Light: 0.25 ton per lane mile

### Conversion Factors

- 1 ton = 0.90718 metric ton
- 1 lb/cu. ft = 16.018 kg/cu. meter
- 1 psi/in. = 0.271 kpa/mm
- 0.10 gal./sq. yd. = 0.453 L/sq. meter
- 0.15 gal./sq. yd. = 0.70 L/sq. meter
- 110 lbs/sq. yd./one inch = 2.34 kg/sq. meter/25.4 millimeter
- 110 lbs/cu. ft. = 1762 kg./cu. meter
- 133 lbs/cu. ft. = 2130 kg/cu. meter
- inches = 50.8 mm or 50 mm (rounded for pavement design)
- inches = 101.6 mm or 100 mm (rounded for pavement design)
- $\frac{1}{2}$  inch = 12.7 mm or 12.5 (rounded for pavement design)
- A U.S. gallon (determined by fluid volume at 72°F, at sea level) of fresh water weighs exactly 8.3452641 lbs.

## Incentive/Disincentive Calculations

$$I/DP = (PF - 1) \times (QR) \times (UP) \times (W \div 100)$$

Where: I/DP = Incentive/disincentive payment  
PF = Pay factor  
QR = Quantity in tons of HMA represented by the process  
UP = Unit bid price of asphalt mix  
W = Element factor from Table 105-2 of *CDOT's Standards and Specifications*

### **When AC is Paid for Separately UP Shall Be:**

$$UP = [(Ton_{HMA}) \times (UP_{HMA}) + (Ton_{AC}) \times (UP_{AC})] \div Ton_{HMA}$$

Where: Ton<sub>HMA</sub> = Tons of asphalt mix  
UP<sub>HMA</sub> = Unit bid price of asphalt mix  
Ton<sub>AC</sub> = Tons of asphalt cement  
UP<sub>AC</sub> = Unit bid price of asphalt cement

### **For the Joint Density Element:**

$$UP = UP_{HMA}$$

Where: UP<sub>HMA</sub> = Unit Bid Price of Asphalt Mix

### **When AC is Paid for Separately UP Shall Be:**

$$UP = [(BTON_{HMA}) \times (BUP_{HMA}) + (BTON_{AC}) \times (BUP_{AC})] \div BTON_{HMA}$$

Where: BTON<sub>HMA</sub> = Bid tons of asphalt mix  
BUP<sub>HMA</sub> = Unit bid price of asphalt mix  
BTON<sub>AC</sub> = Bid tons of asphalt cement  
BUP<sub>AC</sub> = Unit bid Price of asphalt cement



# CHAPTER 1 INTRODUCTION

## 1.1 Introduction

The Colorado Department of Transportation (CDOT) has adopted the *AASHTO Interim Mechanistic-Empirical Pavement Design Guide (MEPDG) Manual of Practice* for pavement design and analysis along with the AASHTOWare Pavement M-E Design software, otherwise called the M-E Design software. The M-E Design software uses the methodology and pavement design models described in the *AASHTO Interim MEPDG Manual of Practice*. The pavement design models in the M-E Design software were calibrated and validated using extensive Colorado pavement performance data.

This manual presents the following information to assist CDOT pavement design engineers to perform pavement designs using the *AASHTO Interim MEPDG Manual of Practice* and the M-E Design software. CDOT has updated to M-E Design Version 2.3.1 for 2020.

- An overview of the AASHTO Pavement M-E Design procedure
- An overview of the M-E Design software
- Guidelines for obtaining all needed inputs for design/analysis
- Guidance to perform pavement design/analysis using the software
- Examples of pavement design using the Design Guide software

This guidance will assure adequate strength and durability to carry the predicted traffic loads for the design life of each project. Alternative designs (flexible and rigid) should be considered for each project and specific project conditions. The final design should be based on a thorough investigation of projected traffic, specific project conditions, life-cycle economics, and the performance of comparable projects with similar structural sections and conditions.

## 1.2 Scope and Limitations

### 1.2.1 Limitations

Design of the pavement structure includes the termination of the thickness of subbases, bases, and surfacing to be placed over subgrade soils. An important aspect of this design is the selection of available materials that are most suited to the intended use. Their grouping in horizontal layers under the pavement, from poorer layers on the bottom to better layers on the top, should be such that the most benefit will be derived from the inherent qualities of each material. In establishing the depth of each layer, the objective is to provide a minimum thickness of overlying material that will reduce the unit stress on the next lower layer and commensurate with the load-carrying capacity of the material within that layer.

The design of the roadbed cross-section is not an exact science. With many variables to be correlated, reducing the problem to exact mathematical terms applied to structures is extremely difficult. Present practice, as discussed herein, stems from mechanistic procedures and empirical relationships developed from test tracks and other pavement experiments, as well as, the

observation of pavements under service throughout the state. Research continues on this subject and current design methods may be subject to frequent modification.

### 1.2.2 Scope

Pavement structure sections, except for experimental construction for research, are to be designed using methods or standards described in **Table 1.1 Recommended Pavement Design Procedures**. Although M-E Design allows pavement design and analysis of seventeen pavement types, not all of these pavement types have been calibrated for Colorado conditions. Furthermore, this design procedure does not include performance prediction models for thin and ultra-thin concrete overlay designs. Designers are advised as much as possible to follow recommendations presented in **Table 1.1 Recommended Pavement Design Procedures** for selecting appropriate pavement design/analysis methodology for a given pavement type.

**Table 1.1 Recommended Pavement Design Procedures**

Pavement Type	Design Methodology	
	CDOT 2018 Pavement M-E Design Manual	CDOT 2014 Pavement Design Manual (18k ESAL Design)
New HMA	✓	
Flexible Overlays of Existing HMA	✓	
Flexible Overlays of Existing Rigid	✓	
New Rigid	✓	
PCC Overlays of Existing Rigid	✓	
Thin and Ultrathin Concrete Overlay		✓
Concrete Pavement Restoration	✓	
Flexible Pavement for Intersections	✓	
Rigid Pavement for Intersections	✓	

### 1.3 Overview of AASHTO Pavement Mechanistic-Empirical Design Procedure

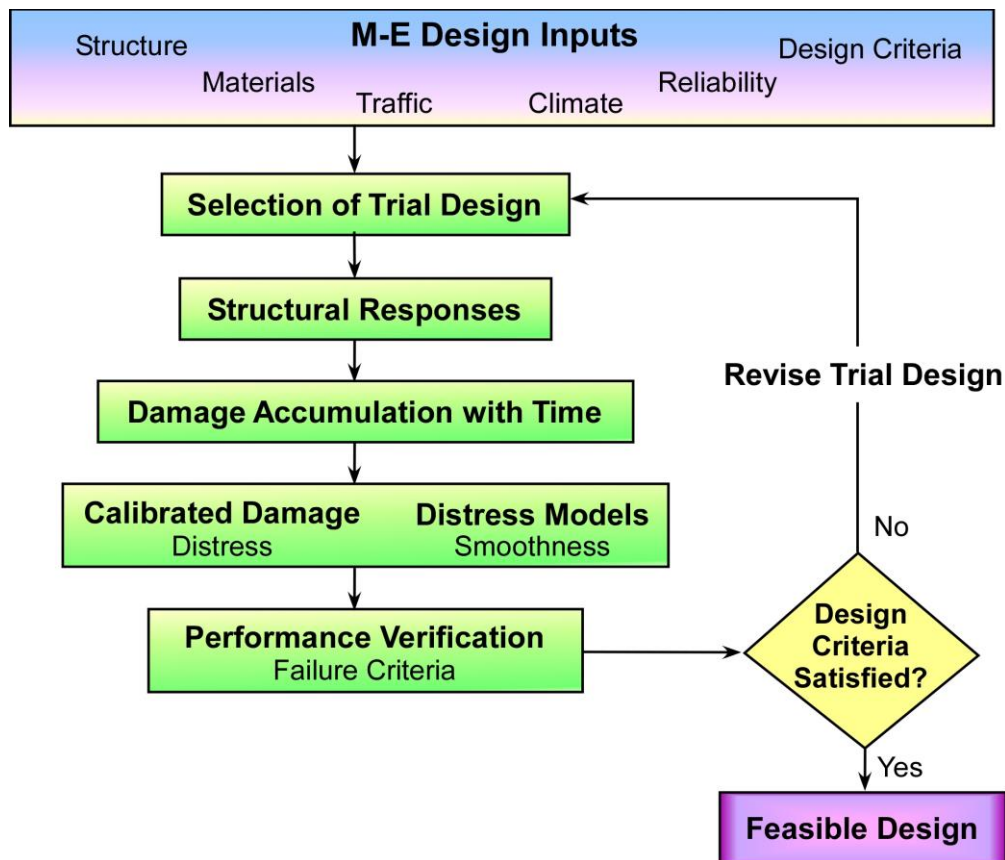
The AASHTO Pavement M-E Design Procedure is based on mechanistic-empirical design concepts. This means the design procedure calculates pavement responses such as stresses, strains, and deflections under axle loads and climatic conditions, and accumulates the damage over the design analysis period. The procedure empirically relates calculated damage over time to pavement distresses and smoothness based on performance of actual projects in Colorado. More details are found in the following documents.

- AASHTO, *Mechanistic-Empirical Pavement Design Guide: A Manual of Practice*, July 2008, Interim Edition, American Association of State Highway and Transportation Officials, Washington, DC, 2008.
- AASHTO, *Guide for the Local Calibration of the Mechanistic-Empirical Pavement Design Guide*, November 2010, American Association of State Highway and Transportation Officials, Washington, DC, 2010.

- NCHRP, 1-37A Project. *2002 Design Guide: Design of New and Rehabilitated Pavement Structures*, National Cooperative Highway Research Program, National Academy of Sciences, DC, 2004.

The pavement design computations using the M-E Design procedure and software are an iterative process as shown in the flowchart in **Figure 1.1 M-E Design Process**. The software provides:

- A user interface to input design variables
- Computational models for month by month analysis and performance prediction
- Results and outputs from the analysis for decision making
- Outputs in both pdf and Microsoft Excel formats suitable for use in design reports



**Figure 1.1 M-E Design Process**

The design iterative process with the M-E Design procedure involves the following key steps:

1. The designer develops a trial design and obtains all inputs.
2. The software computes the traffic, climate, damage, key distresses (fatigue cracking, rutting, joint faulting, etc.), and International Roughness Index (IRI) over the design life on a month by month basis for concrete and a two week basis for HMA pavement.

3. The predicted performance (distress and IRI) over the design life is compared to the design performance criteria at a desired level of design reliability. Does the design pass or fail to meet the design reliability for each distress and IRI?
4. The design may be modified as needed to meet performance and reliability requirements.

## 1.4 Overview of AASHTOWare Pavement M-E Design Software

The AASHTOWare Pavement M-E Design software is a production-ready software tool for performing pavement designs using the methodology described in the AASHTO *MEPDG Manual of Practice*. The M-E Design software performs a wide range of analysis and calculations in a rapid, easy to use format. With its many customized features, the M-E Design software will help simplify the pavement design process and result in improved, cost-effective designs. The following subsections provide a brief overview of the process involved in installing, uninstalling, and running the M-E Design software.

A very detailed and comprehensive user manual for the M-E Design software is available with the software. Since the details of this process are likely to change over time, they are not repeated here. The HELP document can be easily obtained in two ways:

- From the Windows Start menu, click ‘*All Programs*’ and then select the ‘*AASHTO DARWin-ME*’ folder, refer to **Figure 1.2 Location of M-E Design Software HELP Document**.
- Press the ‘*F1* key’ after opening the software, see **Figure 1.3 M-E Design Software Default Window** and **Figure 1.4 M-E Design Software HELP Document**.

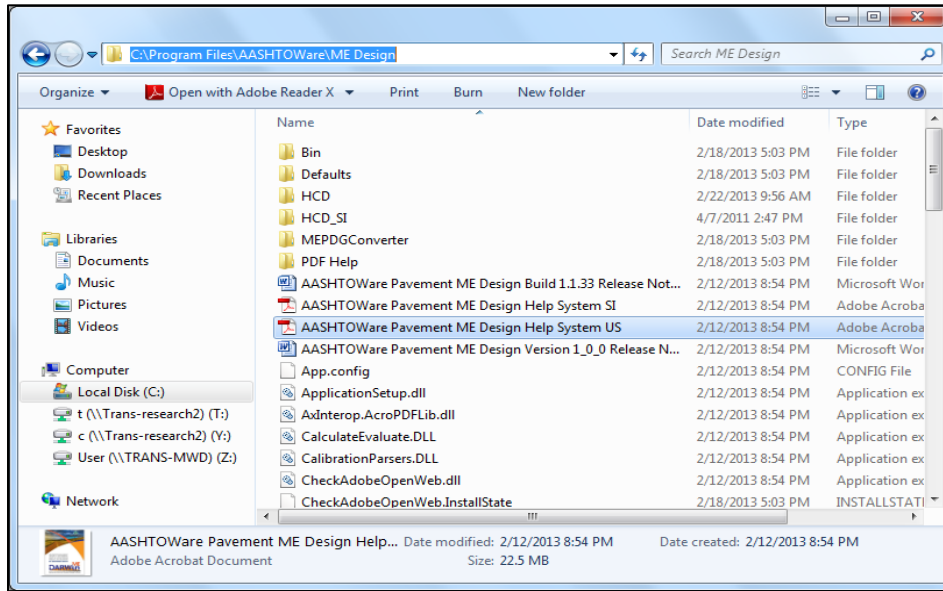
### 1.4.1 Installing M-E Design Software

For more information on installing the M-E Design software files, minimum software requirements, and licensing agreements, contact the CDOT IT System Administrator or refer to the M-E Design software HELP document.

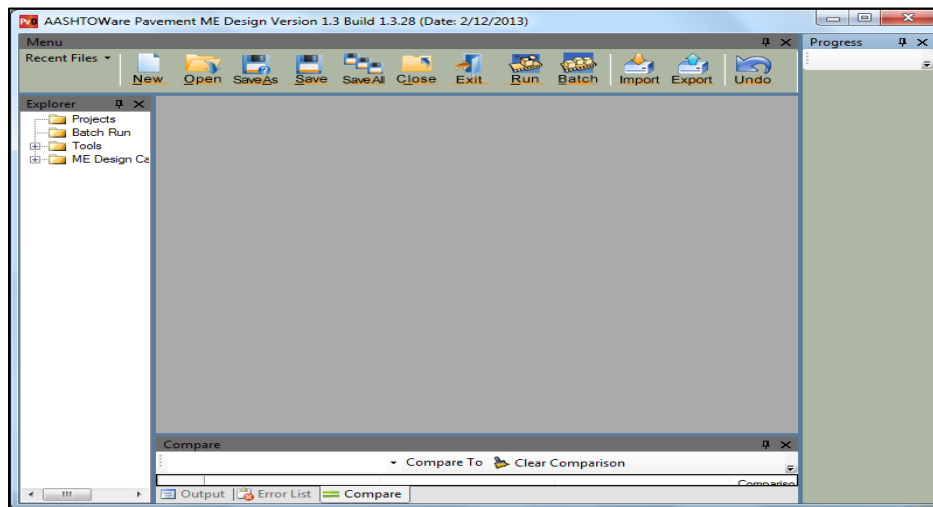
### 1.4.2 Uninstalling M-E Design Software

Never just delete the various files of the M-E design software. Always uninstall the software using the procedure outlined in the M-E Design software HELP document. For more information of uninstalling the M-E Design software files, contact the CDOT IT System Administrator or refer to the M-E Design software help document.

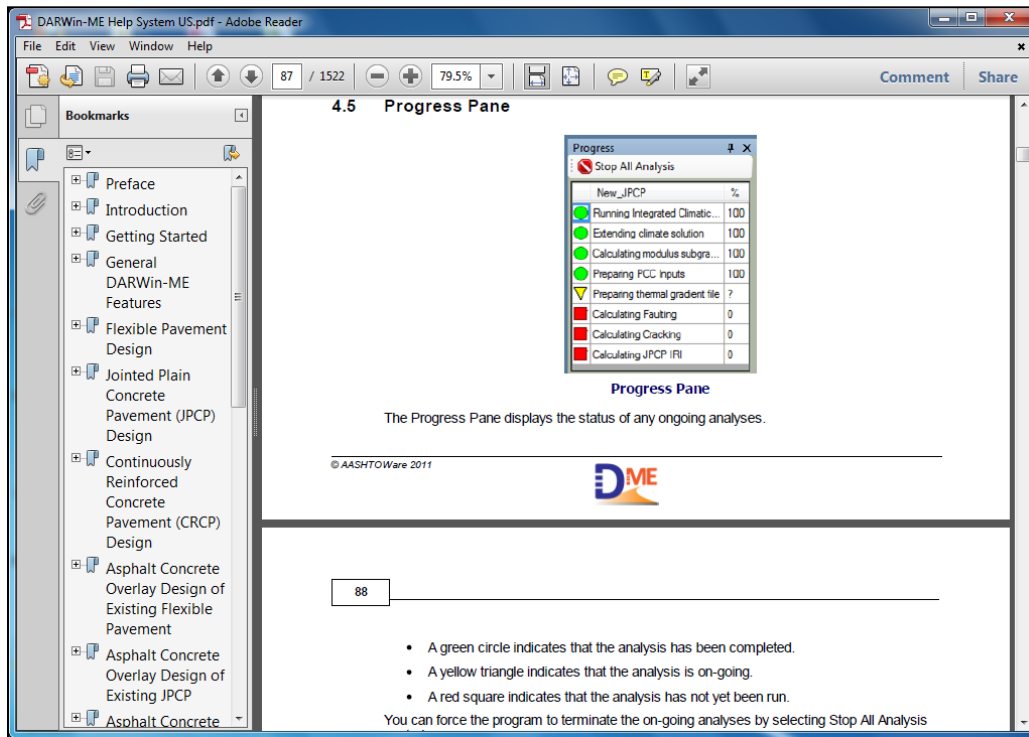
**Note:** This process does not remove the :hcd weather station files under the folder. This folder must be manually deleted if desired. If existing old MEPDG weather station files exist, it is recommended to remove all of the files and then download the new weather station files.



**Figure 1.2 Location of M-E Design Software HELP Document**



**Figure 1.3 M-E Design Software Default Window**



**Figure 1.4 M-E Design Software HELP Document**

### 1.4.3 Running M-E Design Software

The M-E Design program will be added to your Windows Start menu during installation and an icon will be added to the PC desktop.

Click the ‘*Start*’ button in the bottom left corner of your screen to find the M-E Design software.

1. Go to the ‘*Programs*’ option to see a list of folders and programs.
2. Select the ‘*DARWin-ME*’ folder and click on the design guide icon.

The program can also be run by double-clicking the ‘*M-E Design*’ icon on the desktop. The software opens with a splash screen shown in **Figure 1.5 M-E Design Software Splash Screen**. A new file must be opened for each new project, much like opening a new file for each document on a word processor or other standard Windows applications. A maximum of ten projects can be opened together by clicking the ‘*Open Menu*’ in M-E Design (see **Figure 1.6 Open M-E Design Projects**). Select ‘*New*’ from the menu on the tool bar to open a new project. A typical layout of the program is shown in **Figure 1.7 M-E Design Software Main Window** and **Figure 1.8 M-E Design Software Project Tab**.

The user first provides the general project information and the inputs for three main categories: traffic, climate, and structure. All inputs for the software program are color coded as shown in **Figure 1.9 M-E Design Software Color-Coded Inputs to Assist User Input Accuracy**.

Input screens that require user entry of data are coded red. Those that have default values but not yet verified and accepted by the user are coded yellow. Default inputs that have been verified and

accepted by the user or when the user enters design-specific inputs are coded green. The program will not run until all input screens are either yellow or green.

The user may choose to run the analysis by clicking on the 'Run' button after all inputs are provided for the trial design. The software will execute the damage analysis and the performance prediction engines for the trial design's input. The user can view input and output summaries created by the program when the execution of the run is complete. The program creates a summary of all inputs and provides an output summary of the distress and performance prediction in both tabular and graphical formats. All charts are plotted in both pdf and Microsoft Excel formats and may be incorporated into electronic documents and reports.



**Figure 1.5 M-E Design Software Splash Screen**

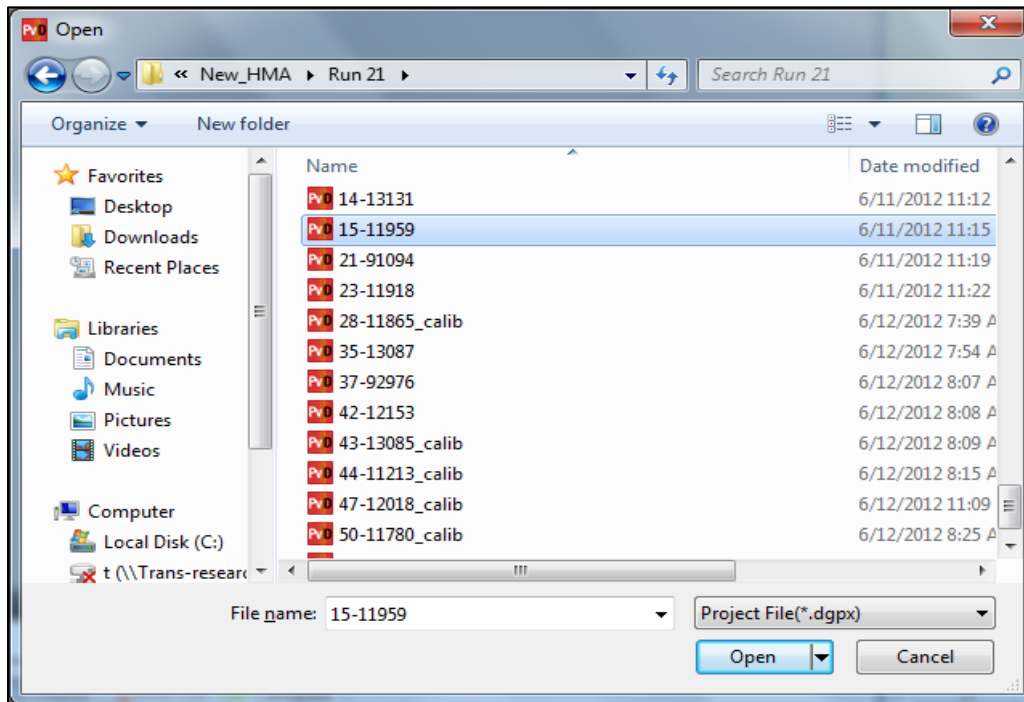


Figure 1.6 Open M-E Design Projects

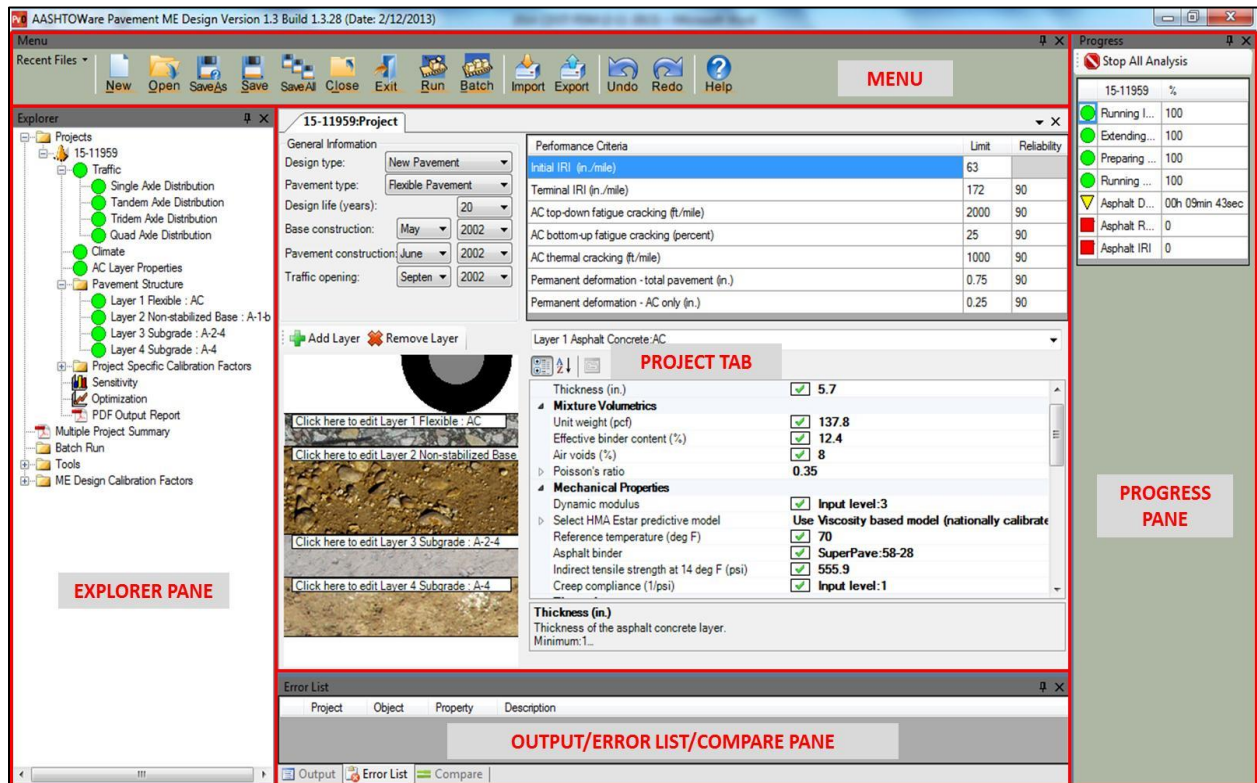


Figure 1.7 M-E Design Software Main Window



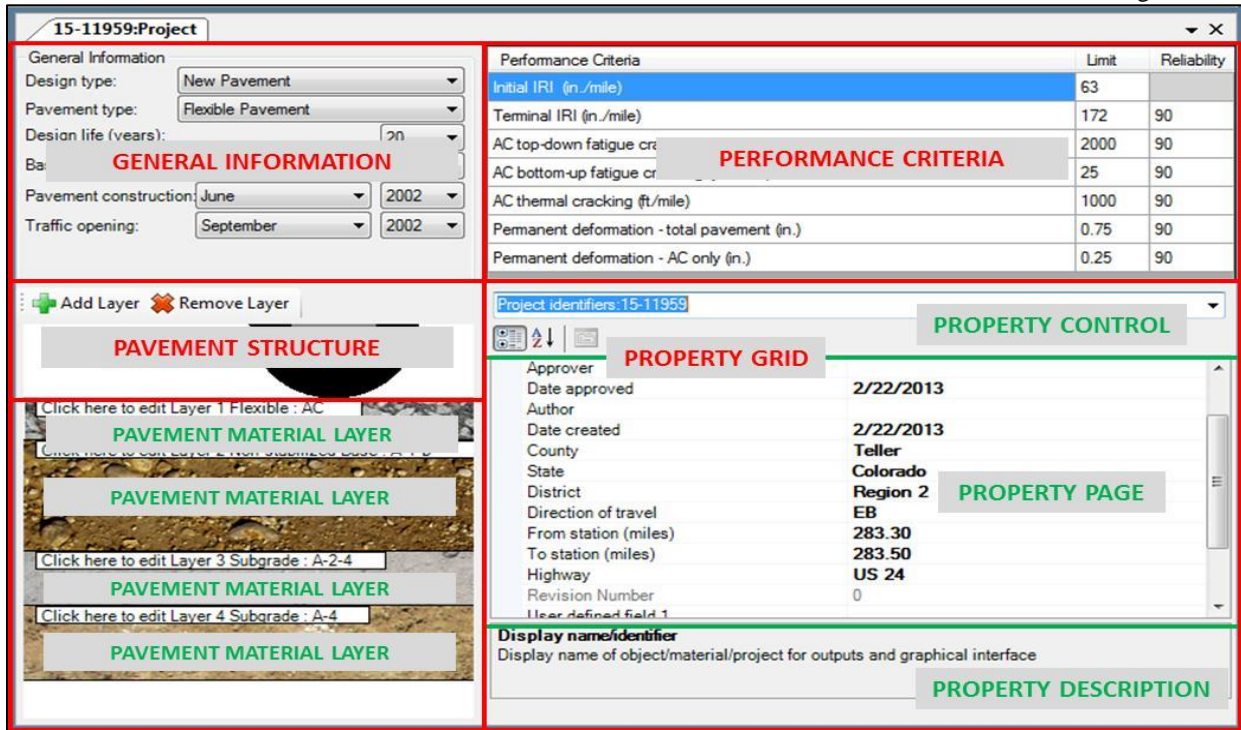


Figure 1.8 M-E Design Software Project Tab

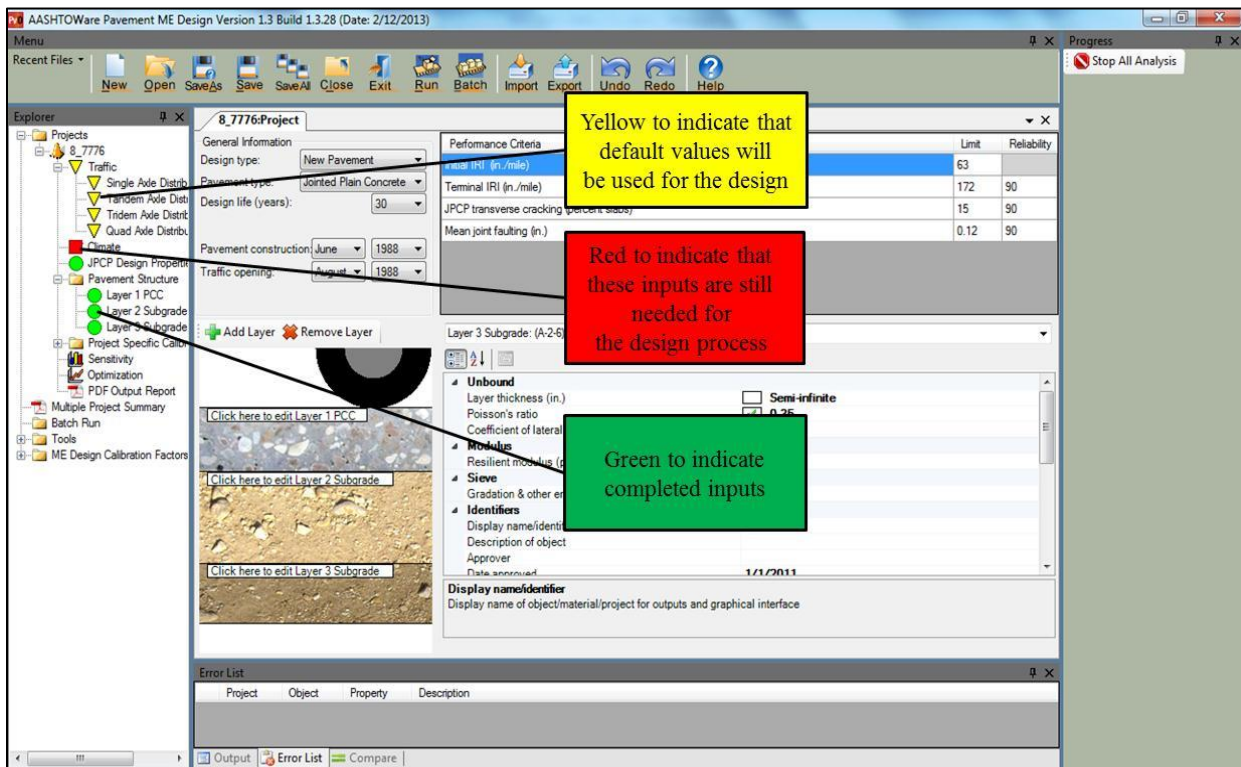


Figure 1.9 M-E Design Software Color-Coded Inputs to Assist User Input Accuracy

## 1.5 Working with the M-E Design Database

M-E Design now includes an enterprise option for saving, searching, and loading projects utilizing a relational database. This feature allows users to store and retrieve data at varying degrees of granularity, from entire projects to data from individual projects such as pavement layers, materials, traffic, climate, backcalculation, etc. This section briefly describes how to set-up a M-E Design database in both MS SQL and ORACLE environments.

### **Download and Access Instructions**

Blank M-E Design databases for MS SQL and ORACLE can be found in the Database Resource Documents section at <http://www.me-design.com/>. The user must have a valid user name and password to access the website. The login credentials will be supplied by AASHTO at the time of software purchase.

### **Database Installation**

The following sections describe the installation process for creating a blank M-E Design database.

### **Installation Requirements**

The requirements for installing and creating a blank M-E Design database are as follows:

- A user with administrative privileges on the target machine will be required to set up the M-E Design database.
- The maximum size of the M-E Design database shall be no greater than 10 GB.
- ORACLE 10g Release 2 or ORACLE Client 10g Release 2 or greater (contains the ORACLE Provider for OLEDB)
- Microsoft SQL Server 2005 or Express (and later versions)

Once the database is installed, the user can open the M-E Design software and select '*Open M-E Design*' with a data base connection check box (see **Figure 1.10 M-E Design Software Splash Screen Showing Database Login Location.**)

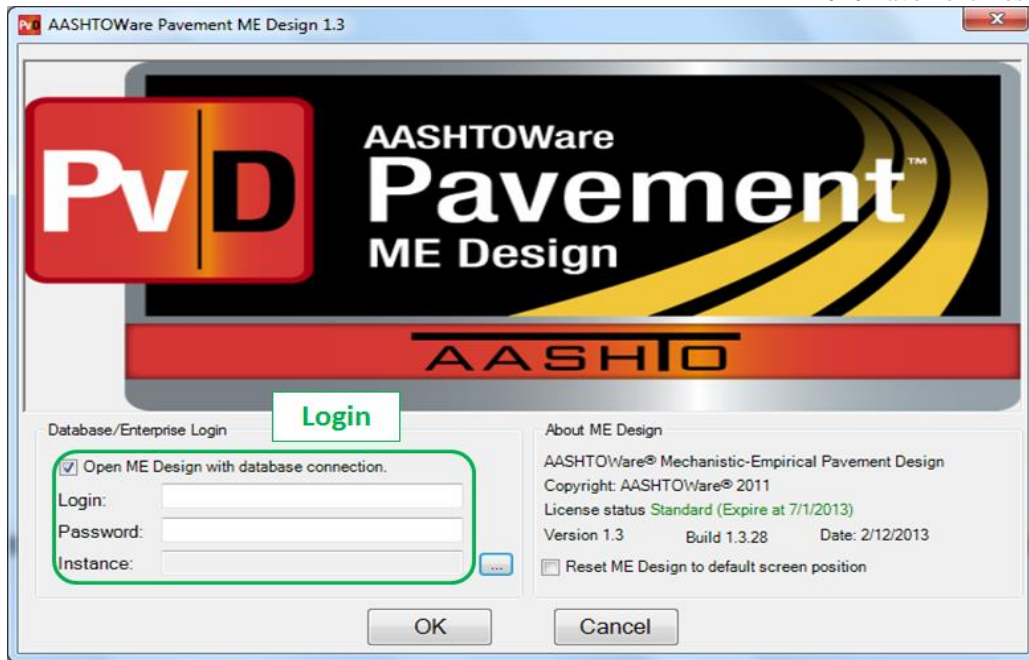


Figure 1.10 M-E Design Software Splash Screen Showing Database Login Location

Enter the Login name and Password supplied by the CDOT IT Department to access the M-E Design database, see **Figure 1.11 M-E Design Software Splash Screen Showing Database Login Information.**



Figure 1.11 M-E Software Splash Screen Showing Database Login Information

### 1.5.1 Saving to M-E Design Database

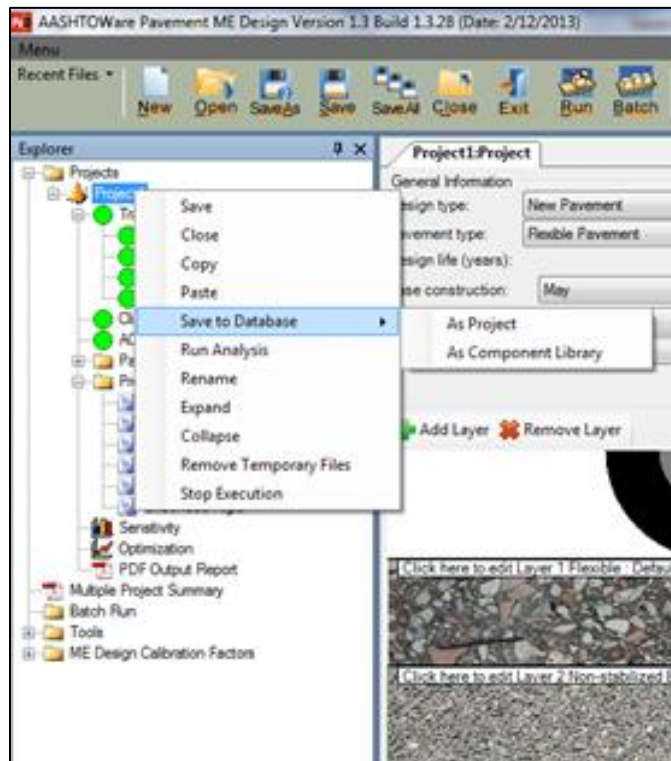
This section will discuss how to save M-E Design elements to the database. It will also highlight the differences in how the elements are saved on each screen and supply screenshots for each example. **Note:** In order for the ‘Save to Database’ option to be available, the user must connect to a M-E Design database during the login process.

#### Saving Projects

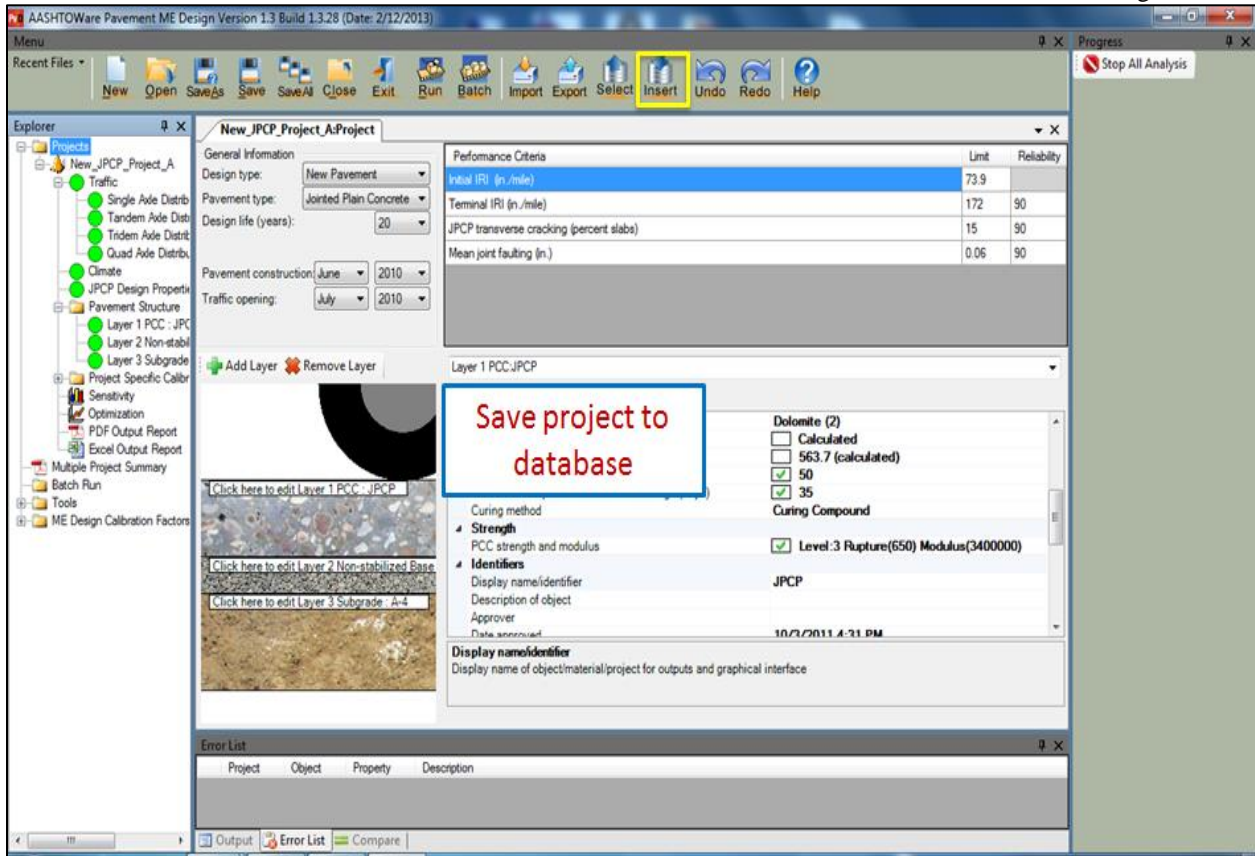
When a user saves a project, all elements of the project are saved in the database. If any of the project elements have an error, the user will be informed of the error with a message box and asked to correct the error before continuing. There are two ways to save a project to the database:

1. Right click on the project name under the ‘Projects’ node and select ‘Save to Database’ (see **Figure 1.12 Saving and Entire Project to M-E Design Database (Option 1)**).
2. Click to highlight the project name under the ‘Projects’ node and click the ‘Insert’ icon on the menu bar across the top of the application (see **Figure 1.13 Saving an Entire Project to the M-E Design (Option 2)**).

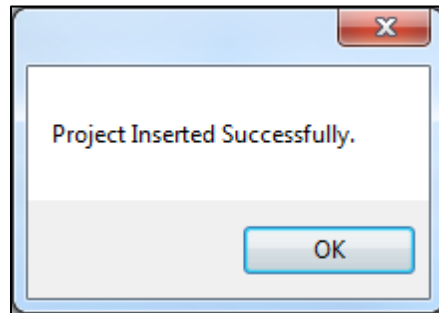
If the project contains no errors in the message, ‘Project Inserted Successfully’ will pop up (see **Figure 1.14 Window Showing Successful Project Save**). Click ‘OK’ to close the message box.



**Figure 1.12 Saving an Entire Project to the M-E Design Database (Option 1)**

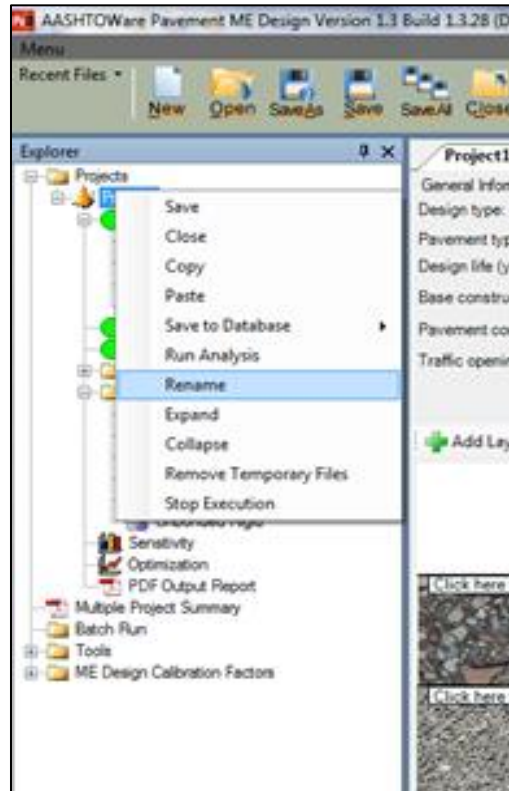


**Figure 1.13 Saving an Entire Project to the M-E Design Database (Option 2)**



**Figure 1.14 Window Showing Successful Project Save**

Once a project is saved to the database, the project cannot be saved again under the same name. Only project elements can be “saved over” or updated once they exist in the database. To change the ‘*Display name/Identifier*’ of your project, right click on the project title in the Explorer pane and select ‘*Rename*’ (see **Figure 1.15 Changing the Project Display Name/Identifier**). Choose a new name for your project and then right click on the project in the Explorer and select ‘*Save to Database*’. The project will now save with a new name.



**Figure 1.15 Changing the Project Display Name/Identifier**

### **Saving Project Elements**

Saving project elements is similar to the steps described in the section titled Saving Projects. Project elements include but are not limited to the following:

- Traffic
  - Single axle distribution
  - Tandem axle distribution
  - Tridem axle distribution
  - Quad axle distribution
- Climate
- Any layers added under “*Pavement Material Layers*” node
- Backcalculation

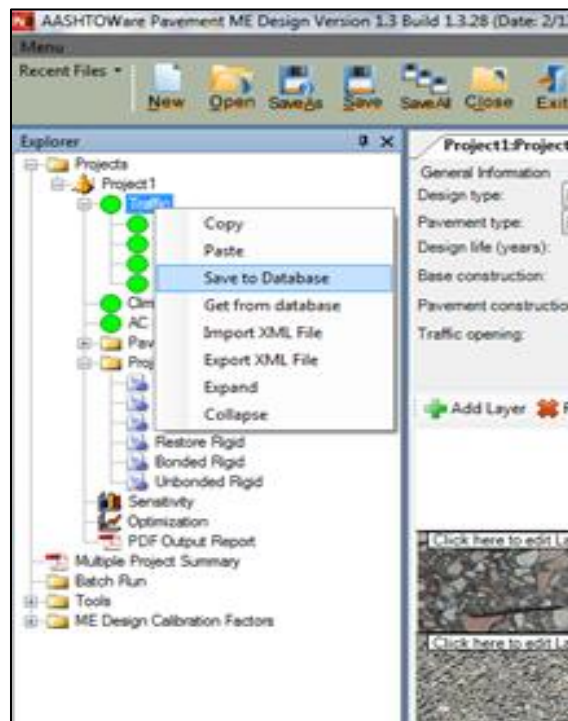
There is one primary difference between saving an entire project and saving elements within the project. Unlike projects, project elements can be saved over and over again without having to modify any element identifiers. This means if the user wants to save a project element such as ‘*Traffic*’, make changes to it, and save it again, the program will update the project with the new traffic information instead of creating a new one.

All the elements described above have a ‘*Save to Database*’ method associated with them, with a few special cases for traffic and its associated elements. The traffic element provides two unique saving methodologies.

1. Right clicking on the 'Traffic' node and selecting 'Save to Database' will save information under the 'Traffic' node only (see **Figure 1.16 Saving Traffic Data**).
2. The user may also elect to double click on the 'Traffic' node which will open the traffic interface. The user can then right click on any of the views within the interface including vehicle class distribution and growth, monthly adjustment, or axles per truck; and select 'Save to Database' to save the applicable traffic element to the database (see **Figure 1.17 Saving Specific Traffic Elements**).

**Note:** This is the only way to save these particular traffic elements independently as they do not appear in the Explorer tree.

In contrast, saving any one of the axle load elements automatically saves all the others as well. **Figure 1.18 Saving Axle Load Distribution Elements** shows how to save axle load distribution elements in the M-E Design database. If the axle load distribution contains no errors, the message 'Axle Load Inserted Successfully' will pop up (see **Figure 1.19 Window Showing Successful Axle Load Distribution Save**). Click 'OK' to close the message box.



**Figure 1.16 Saving Traffic Data**

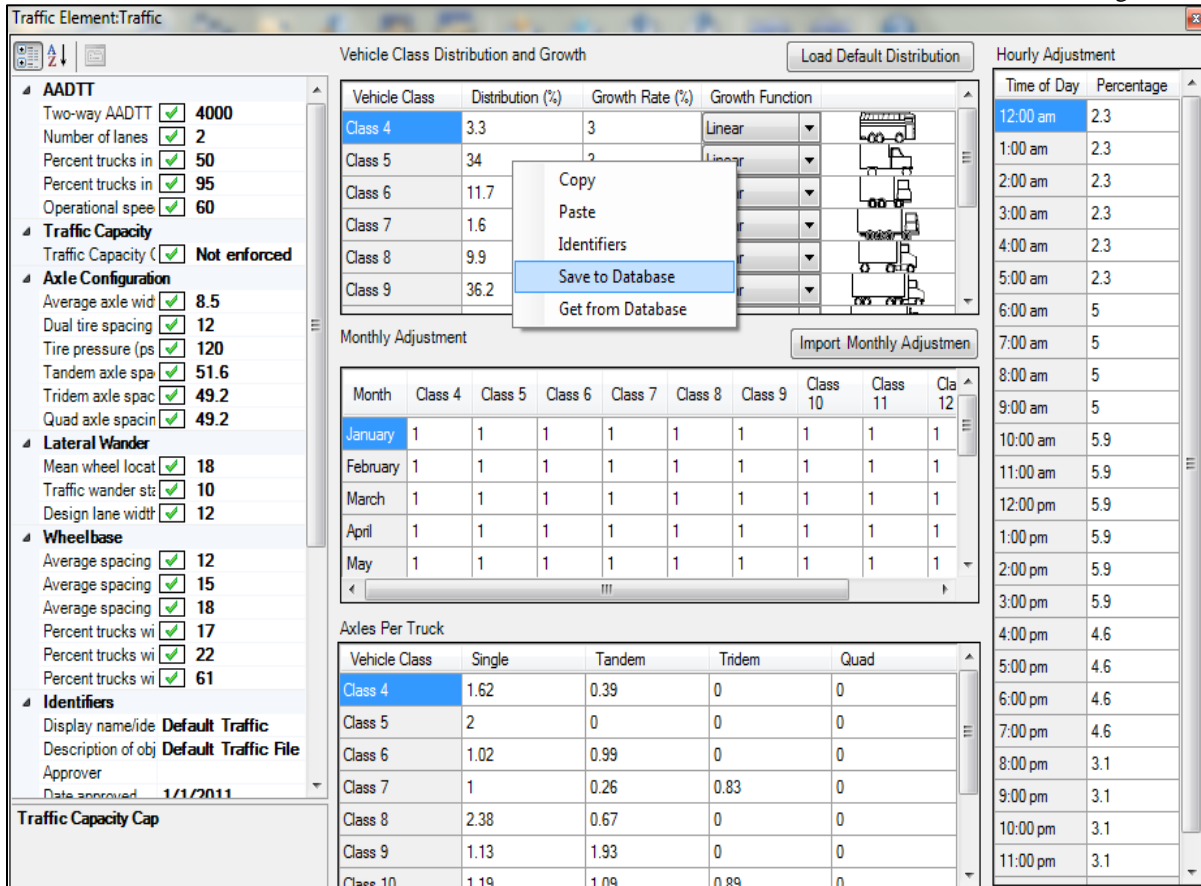


Figure 1.17 Saving Specific Traffic Elements

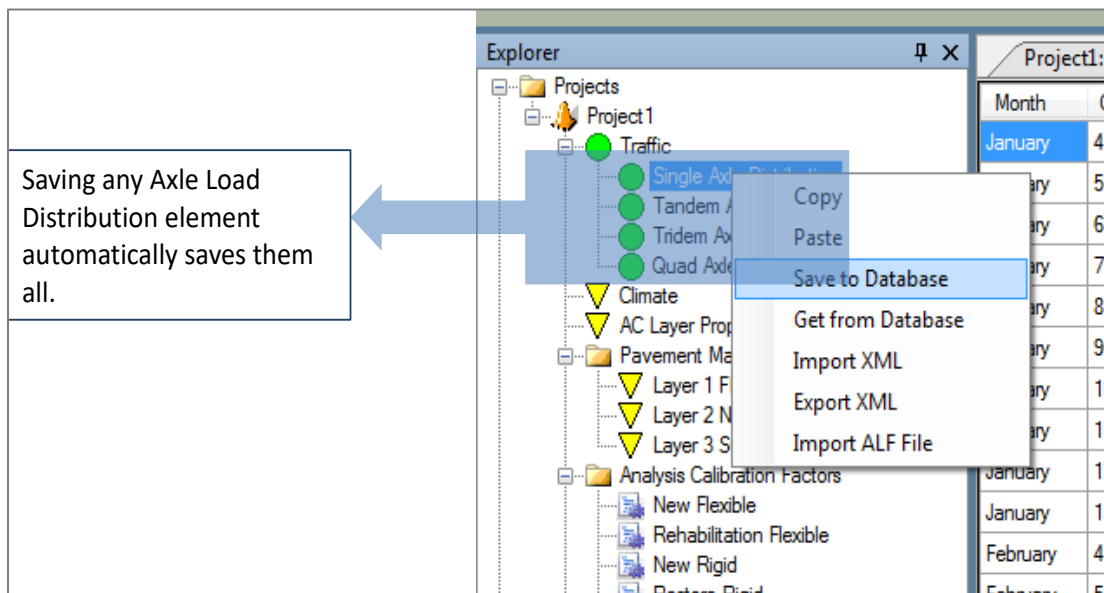
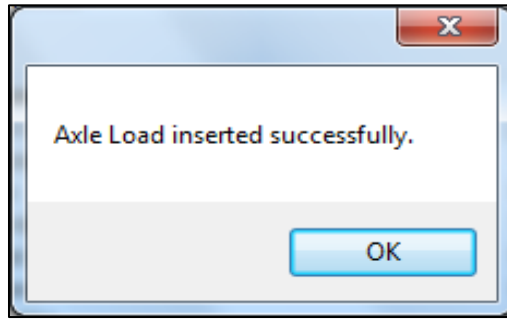


Figure 1.18 Saving Axle Load Distribution Elements

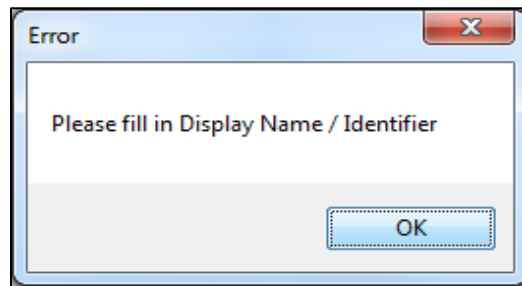




**Figure 1.19 Window Showing Successful Axle Load Distribution Save**

If the user receives the following error message shown in **Figure 1.20 Error Saving Axle Load Distribution** while saving the project element, then either the user needs to change the existing name of the element/project they are trying to save, or fill in the '*Display Name/Identifier*' field for the element.

This means the user needs to open the axle load distribution interface, right click, and select '*Identifiers*' (see **Figure 1.21 Defining Identifiers for Axle Load Distribution**). The user can fill in the '*Display Name/Identifier*' field shown in **Figure 1.22 Editing Display Name/Identifiers for Axle Load Distribution** and '*Close*' the window. Now the axle load distribution element is saved to the database.



**Figure 1.20 Error Saving Axle Load Distribution**

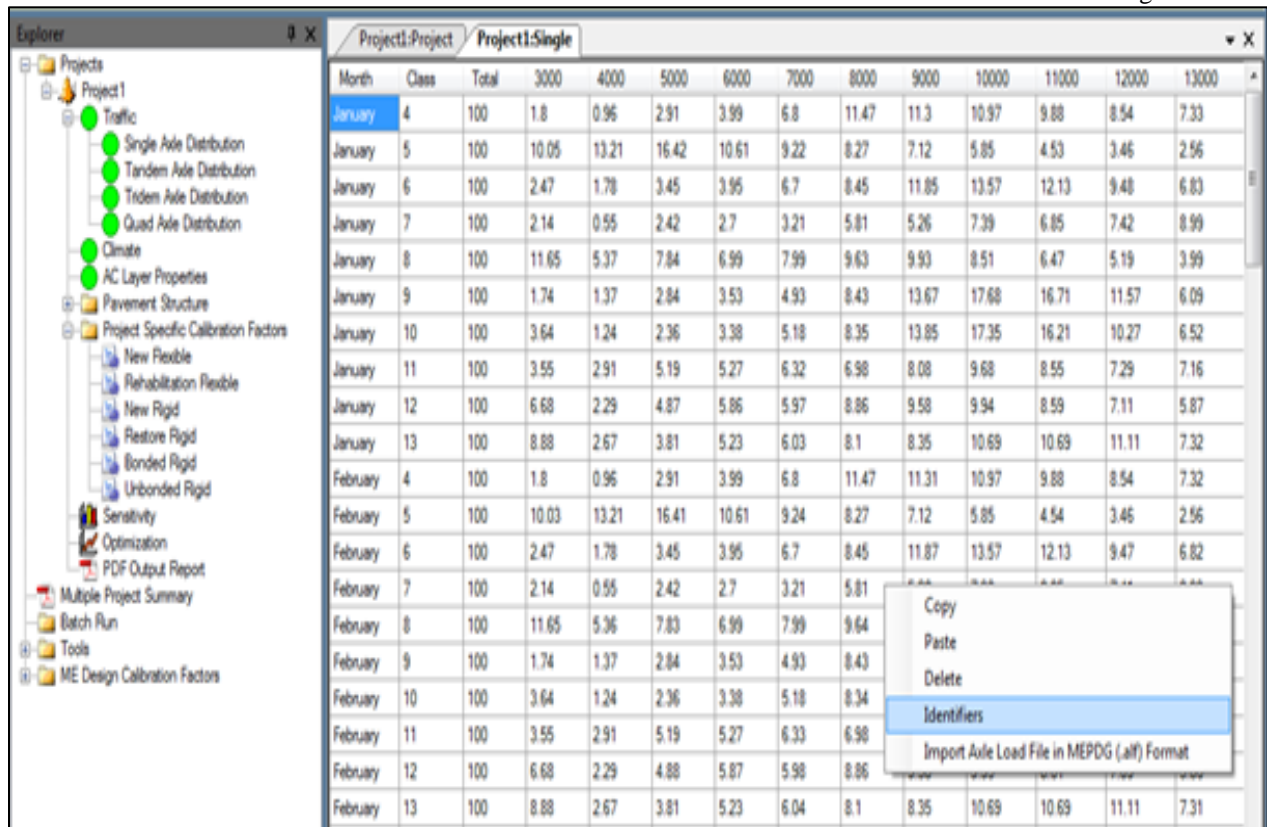


Figure 1.21 Defining Identifiers for Axle Load Distribution

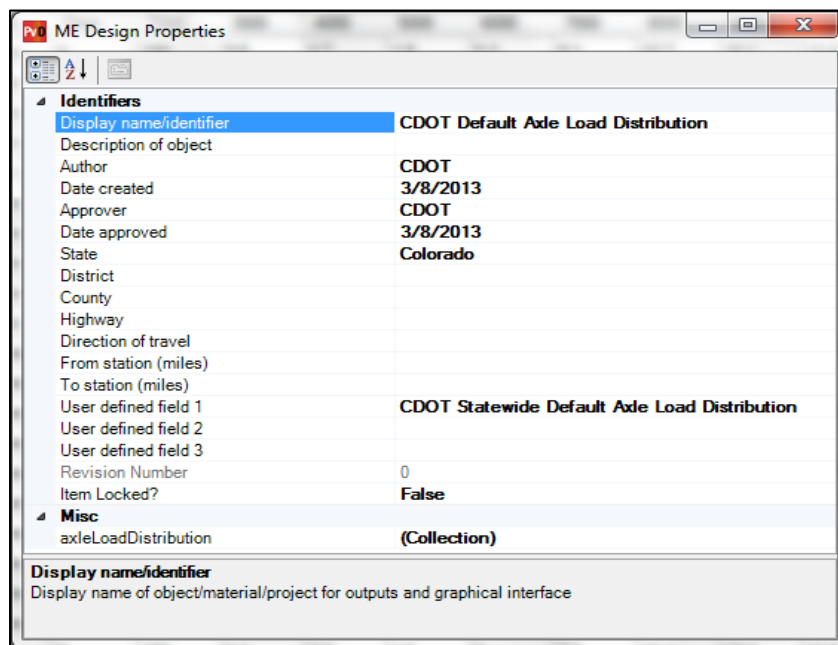


Figure 1.22 Editing Display Name/Identifiers for Axle Load Distribution

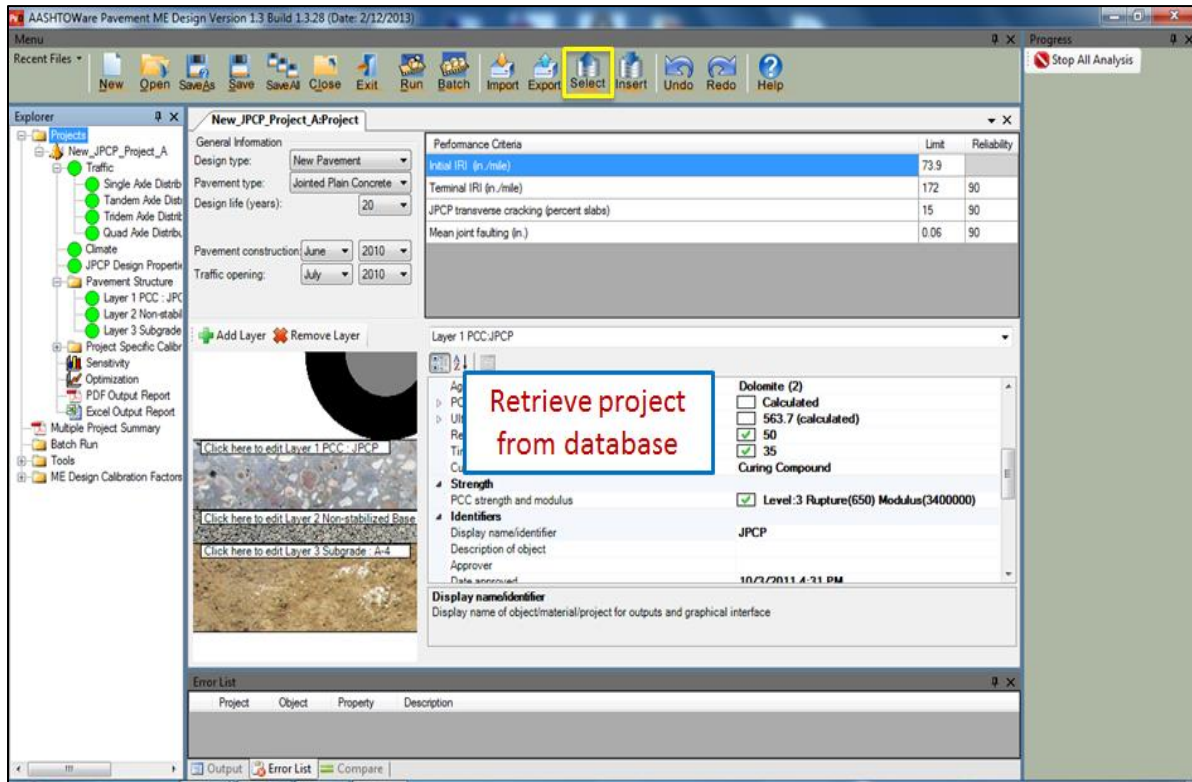
## 1.5.2 Retrieving or Importing from M-E Design Database

The data import process works similar to the save process in which the user should right click on the project or element they wish to import and select ‘*Get from Database*’. This will load the database information into the appropriate project.

### Importing a Project

There are two ways to import an entire project from the database:

1. Right click on the project name under the ‘*Projects*’ node and select ‘*Get from Database*’.
2. Click to highlight the project name under the ‘*Projects*’ node and click the ‘*Select*’ icon on the menu bar across the top of the application (see **Figure 1.23 Importing an Entire Project from M-E Design Database**).



**Figure 1.23 Importing an Entire Project from the M-E Design Database**

This will open the search tool in M-E Design and will allow users to search for the database objects they wish to pull into the current projects, or they may load an existing project from memory. **Note:** If a user selects an element, but has no active projects in the explorer, a new project will be created. One of the projects from the list can then be selected and loaded into the user interface. Click ‘*OK*’ to import a project or project element from the database. (see **Figure 1.24 Selecting a Project to Import from M-E Design Database**). Once the statement has been generated, the user clicks on the ‘*Search*’ button and is presented with the following screen.

### Importing Elements into a Project

To import project elements, right click on the element you wish to import, and click ‘Get from Database’. This will bring up a window asking the user to select the element they wish to retrieve from the database. For example, to load climate data from the database, the user should right click on ‘Climate’ and select ‘Get from Database’ (see **Figure 1.25 Getting an Element from the M-E Design Database**). The M-E Design element is then loaded into the current project.

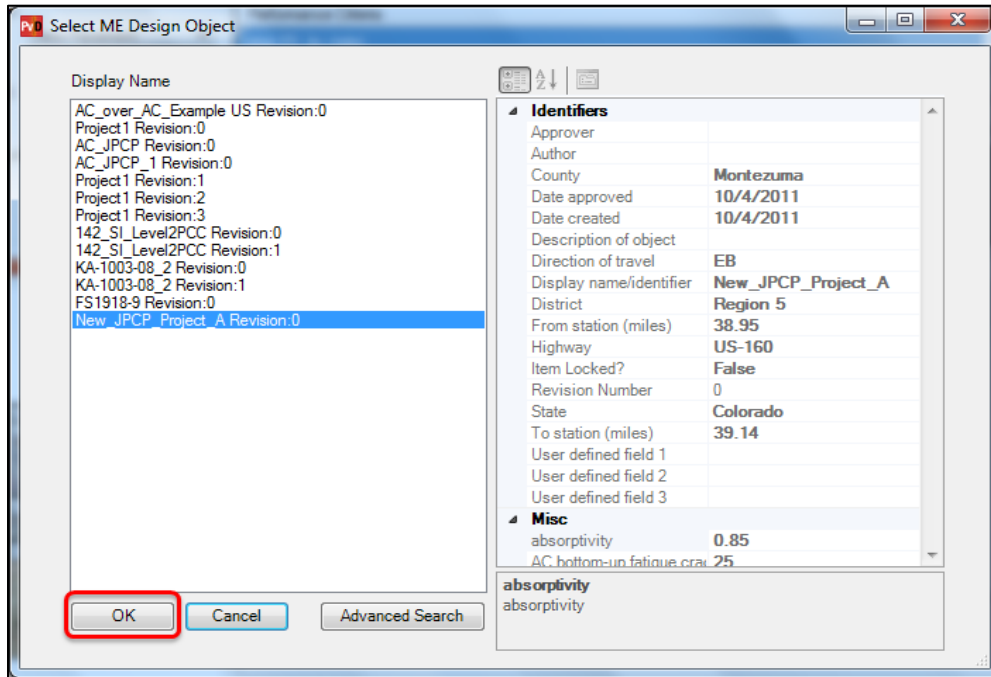


Figure 1.24 Selecting a Project to Import from the M-E Design Database

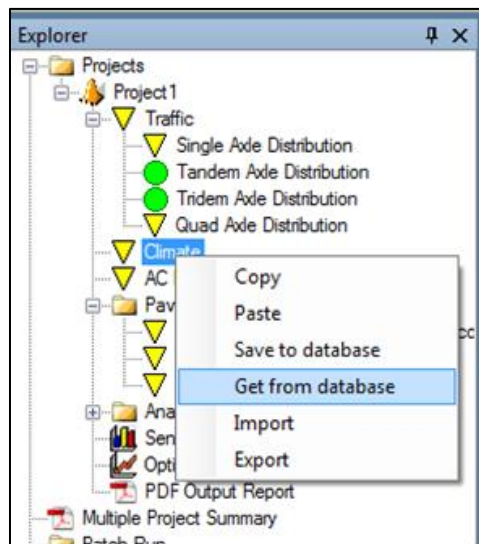
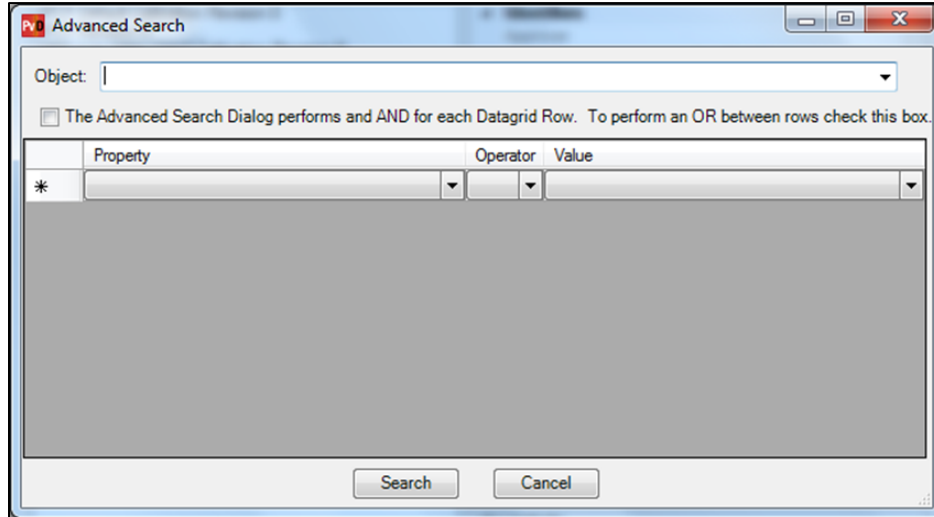


Figure 1.25 Getting an Element from the M-E Design Database

### Using Advanced Search Tool

After opening the search tool in M-E Design, click the ‘*Advanced Search*’ option. This will open an advanced search tool which allows a user to form queries to search for the database objects they wish to pull into the current project or to load an existing project from memory. **Note:** If a user selects an element, but has no active projects in the explorer, a new project will be created. Projects and project elements can be queried to find data which matches specific M-E Design criteria. In the example below, the user has selected the project and the variable(s) they wish to use a search. **Figure 1.26 Advanced Search Blank Window in the M-E Design Database** shows the advanced search window.



**Figure 1.26 Advanced Search Blank Window in the M-E Design Database**

First, the user selects the ‘*Object Type*’ (in this case ‘*Project*’) they wish to filter. Next, they select a property associated with the object type (in this case ‘*Display Name*’). Finally, the user selects a value to match with the property (in this case ‘*HMA over HMA*’). The user then selects which type of operator to apply to the statement (in this case ‘=’). Refer to **Figure 1.27 Advanced Search Window with Information**.

Pressing the search button runs the filter and produces a list of projects or project elements for users to select. In this case, the entire statement is generated and shown in **Figure 1.28 Selecting a Project Using Advanced Search Tool**, where ‘*Display Name = HMA*’ place the arrow over HMA, and press ‘*OK*’ to import the project or project element in the M-E Design interface.

### A Special Note on Traffic

As previously mentioned, the traffic element works slightly different from the other M-E Design elements. All of the traffic elements for retrieving data from the database mirror the functionality of the save operation (i.e. retrieving a single axle distribution element will import tandem, tridem, and quad axle distribution elements).

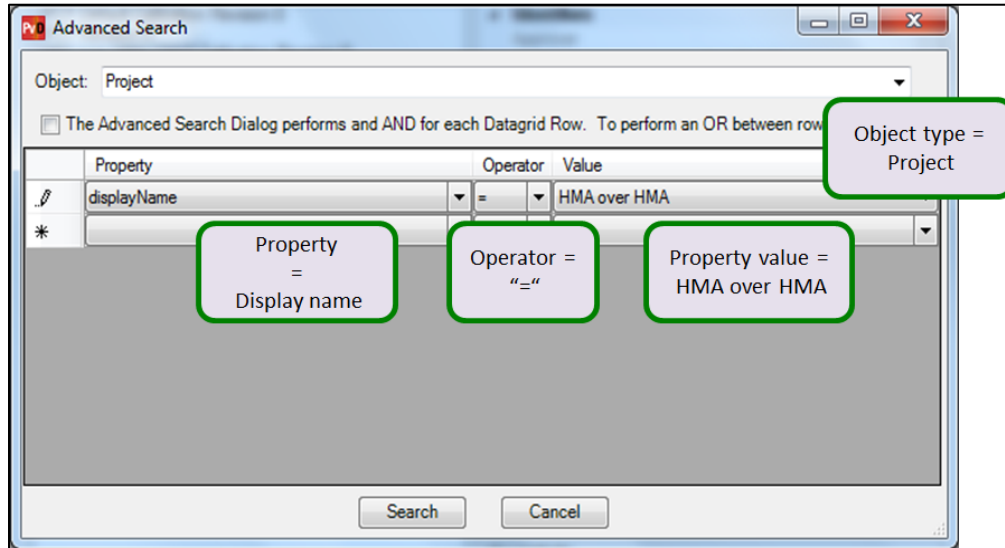


Figure 1.27 Advanced Search Window with Information

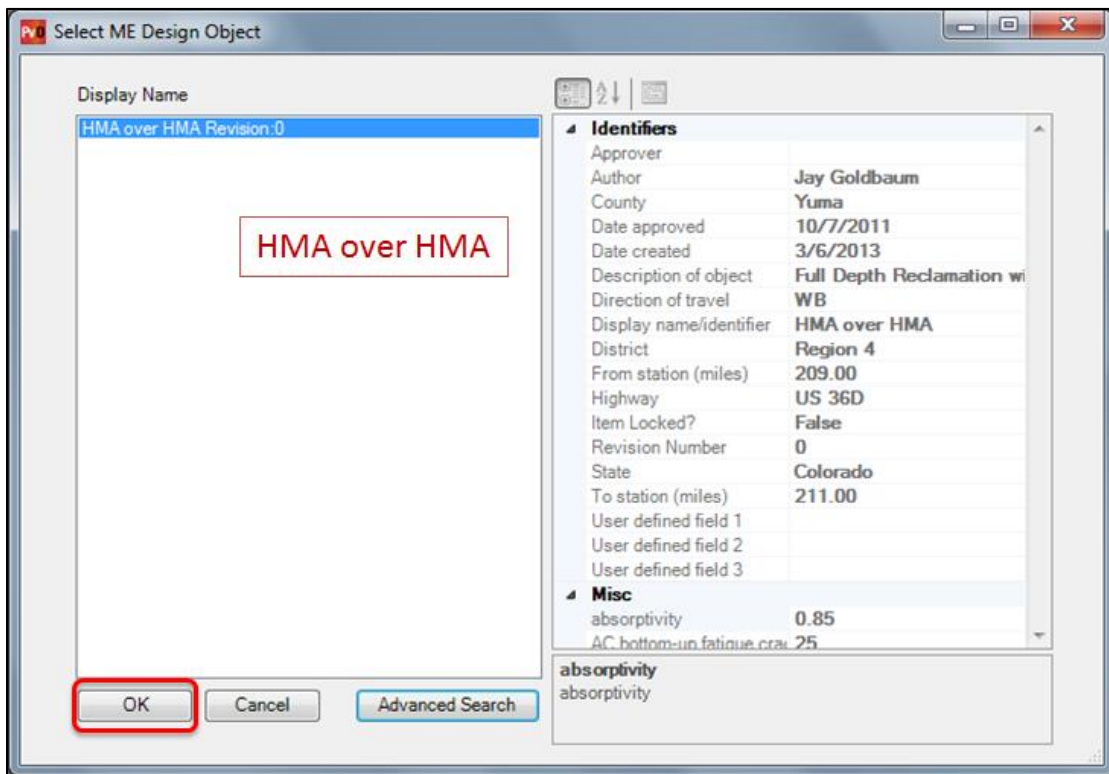
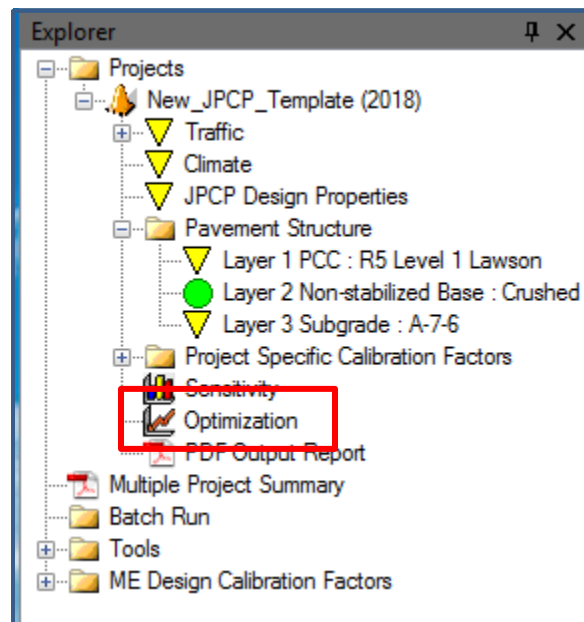


Figure 1.28 Selecting a Project Using Advanced Search Tool

### 1.5.3 Optimization Function

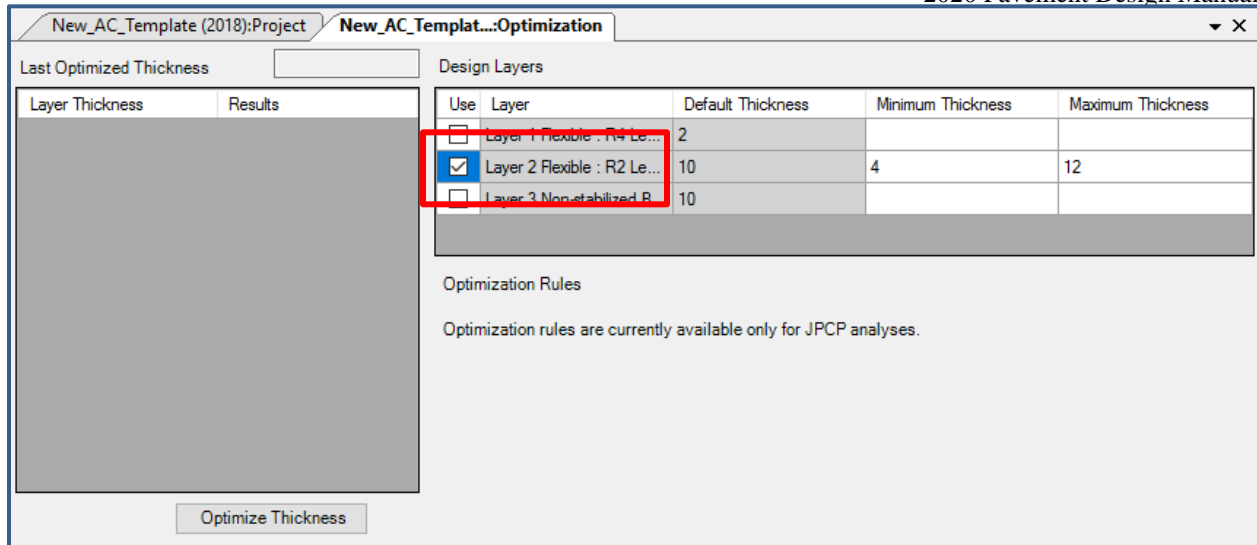
The M-E Design Program has a built in tool that allows the designer to find the minimal thickness of a strata layer while maintaining a constant thickness of all other pavement layers. The tool will be referred to as the ‘Optimization’ function, or optimization for short. The function allows a designer to input a maximum and minimum thickness value for a strata and the program will run the designs changing the thickness of that strata until the thinnest, passing thickness is determined. For example, if the design requires 6 inches of concrete, the designer may use the optimization feature for the aggregate base course layer and choose between 6 and 20 inches. The program will run a design using 6 inches; if it passes the program will produce the standard pdf report for 6 inches. If the design fails at 6 inches the program will run a design using 20 inches, if it passes then it will choose the middle value, in this scenario 13 inches and run a design. The program will incrementally change the aggregate base thickness until the thinnest layer thickness that passes is determined. Steps for using the optimization feature are shown below:

Step 1. Click on the Optimization Function, **Figure 1.29 The Optimization Function.**



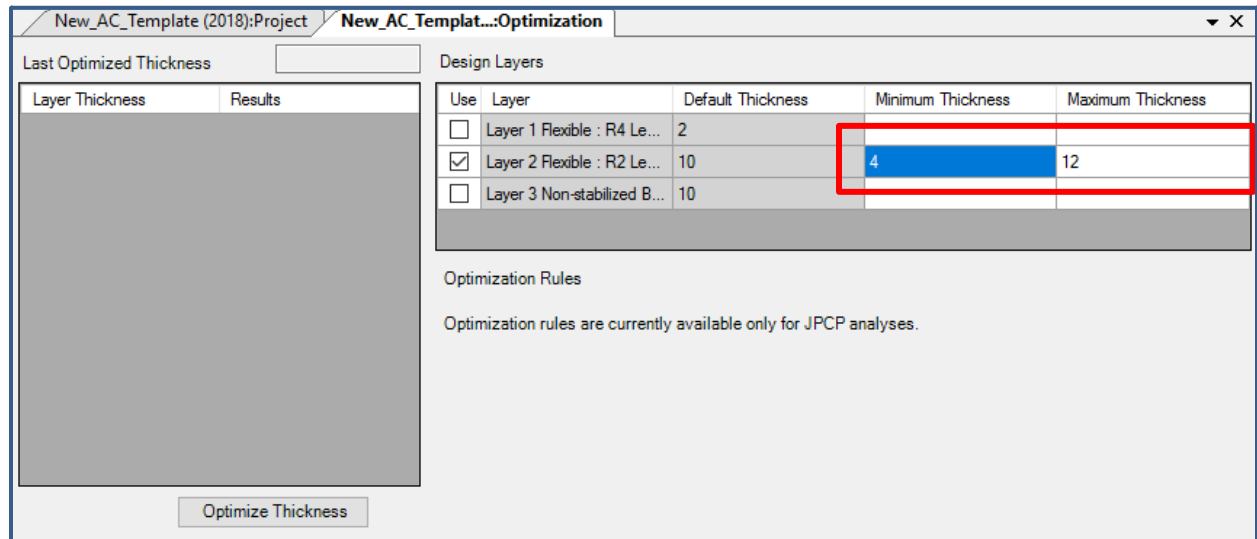
**Figure 1.29 The Optimization Function**

Step 2. Check the box of the layer you want to optimize, **Figure 1.30 Selecting the Layer for Optimization**



**Figure 1.30 Selecting the Layer for Optimization**

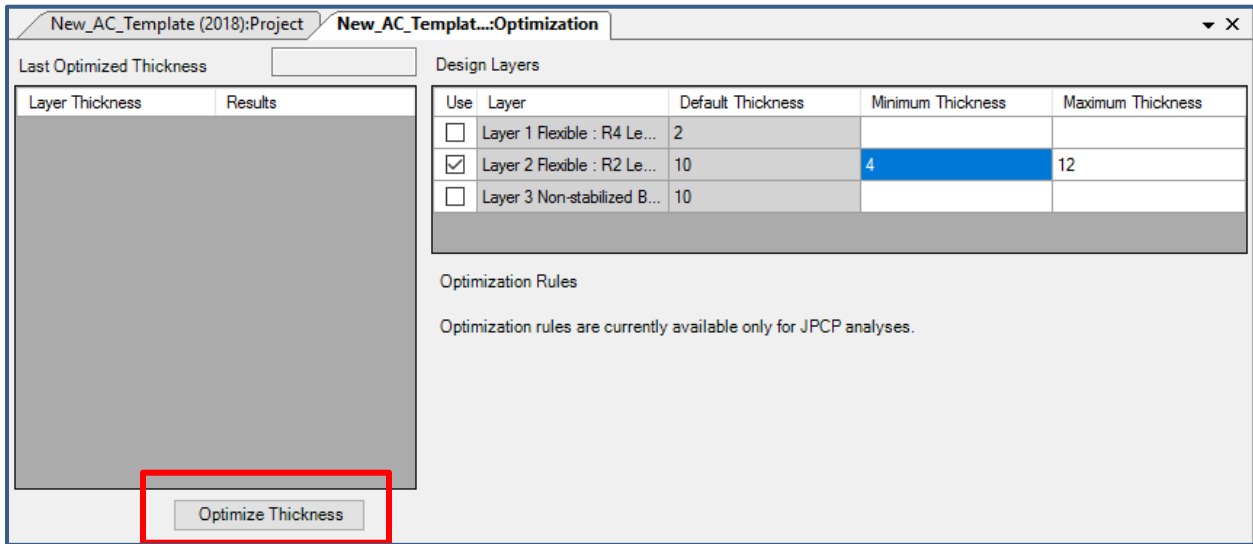
Step 3. Input the minimum and maximum thickness values for the strata, **Figure 1.31 Optimization Input Values.**



**Figure 1.31 Optimization Input Values**



Step 4. Click on the ‘*Optimize Thickness*’ button, **Figure 1.32 Optimize Thickness Button.**



**Figure 1.32 Optimize Thickness Button**

The program will run until the thinnest passing layer is determined, **Figure 1.33 Optimization Results Screenshot.** A pdf. for this design will be provided. The pdf. will show the word ‘*optimized*’ adjacent to the thickness of the strata used in the optimization.

Layer Thickness	Results
6	Failed
11.75	Passed
9	Failed
10.5	Passed
9.5	Failed
10	Failed

Last Optimized Thickness: 10.5

**Figure 1.33 Optimization Results Screenshot**

## References

1. *AASHTO Mechanistic-Empirical Pavement Design Guide, A Manual of Practice, Interim Edition, July 2008*, American Association of State Highway and Transportation Officials, Washington, DC, 2008.
2. *AASHTO Guide for the Local Calibration of the Mechanistic-Empirical Pavement Design Guide*, November 2010, American Association of State Highway and Transportation Officials, Washington, DC, 2010.
3. CDOT Final\_Calibration\_June\_12\_2012.

## CHAPTER 2 PAVEMENT DESIGN INFORMATION

### 2.1 Introduction

This chapter provides pavement designers the general information required for conducting pavement design and analysis using the M-E Design software. This section does not include traffic, climate, and material related inputs.

### 2.2 Site and Project Identification

Site/project location information is used to identify the project under design. This input has no bearing on design but is very helpful in documenting a design for review and record keeping. The M-E Design software provides the ability to enter site or project identification information such as the location of the project, jurisdiction, identification numbers, beginning and ending milepost, direction of traffic, date created, and date approved.

### 2.3 Project Files/Records Collection and Review

#### 2.3.1 Project Data Collection

Information gathered should include such items as “As Built” plans from previous projects, pavement design data, materials and soil properties, climate conditions, determination of traffic inputs, and any information relevant to major maintenance.

#### 2.3.2 Field Survey

A pavement evaluation should be conducted to determine the cause of the pavement deterioration. Information gathered in this survey includes review items such as distress, drainage conditions, roughness, traffic control options, safety considerations, any other overall project conditions, and assessments including an estimate of drivable life. For new alignments, the soil survey investigation records are reviewed.

#### 2.3.3 Initial Selection

Preliminary alternate designs are developed to repair the existing distress and prevent future problems. Based on an evaluation of various candidate alternatives, the first cuts are made at this time, as is a determination if additional data is needed.

#### 2.3.4 Physical Testing

Testing includes collection of additional information such as coring, deflection testing, resilient modulus, permeability, moisture content, etc.

### **2.3.5 Evaluation and Selection**

The selection of new construction and rehabilitation techniques includes identifying the various constraints associated with the project, such as:

- Funding (first cost consideration)
- Traffic control
- Design period
- Geometric problems
- Right of way
- Utilities
- Vertical clearance problems (i.e. overhead clearance)

### **2.3.6 Historic M-E Design Software Files**

Pavement design/analysis projects created in M-E Design software are saved as .dgp files. After a design/analysis run has been successfully completed, the application will generate a pdf file and Microsoft Excel spreadsheet containing input summary and output results of the trial design. There are several project or CDOT specific input files for traffic, climate, and material characterization associated with the pavement design/analysis projects.

The M-E Design software includes a database option that facilitate enterprise level data management for archiving and searching projects, comparing inputs of any two projects, and creating input data libraries. Each object (i.e. any discrete item such as pavement material layer data, axle load distribution factors, climate and design features, or the project itself) has a unique informational tag called identifiers. The designers can use identifiers to identify, search, filter, save, and retrieve information in a database environment.

The designer should review the data files available with the software system and the database. Project records including the project files, input files, calibration factors, and the output records should be stored in the appropriate data storage systems specified by CDOT. For reasons of software update and input changes, the designer should keep track of the software version, project time stamps, and input modifications using the identifiers of M-E Design software objects.

### **2.3.7 Records Review**

Review of historic and current project files and/or records is an important aspect of pavement design/analysis. A review of these records may reveal key details of interest and significance to the pavement designer. Reviewing the project files and/or records will be the most beneficial to the pavement designer who has not been with the project since its original construction. In reviewing the project files and/or records, the pavement designer should be on the alert for any information relating to pavement design and construction. The Regions should keep copies of the information in the original report for 5 to 8 years.

Records review typically comprises of the following activities:

- Review construction and maintenance files.
- Review previous distress surveys and pavement management records. If possible, establish performance trends and deterioration rates.
- Review previous Falling Weight Deflectometer (FWD) deflection test data.
- Review previous pavement borings and laboratory test results of pavement materials and subgrade soils.
- For existing pavements, perform a windshield survey or an initial surveillance of the roadway's surface, drainage features, and other related items.
- Identify roadway segments with similar or different surface and subsurface features. As much as possible, isolate each unique factor that will influence pavement performance.
- Identify the field testing/material sampling requirements for each segment and the associated traffic control requirements.
- Determine if the pavement performed better or worse than similar designs.

The information gathered in records review can be used to divide a new alignment or existing pavement into units with similar site conditions. Existing pavements may be further divided into units with similar design features and performance characteristics.

## **2.4 Site Investigation**

It may be advantageous to visit the proposed project site a few times during the development of a pavement or rehabilitation design. The pavement designer may find it desirable to make a brief visit to the project site as the first step in the scoping process. As the investigation proceeds, events may develop which will make it desirable to revisit the project site. The following are some of the items that should be determined during visits to the project site.

### **2.4.1 Abutting Land Usage**

The abutting land usage will have an effect on the selection of a pavement type or rehabilitation design procedure. If the abutting land is rural, then a note should be made of its use such as farming, ranching, or other with descriptive details as needed. If the property is urban, a record of usage in terms of residential or commercial is helpful. Additional details on type of residences or commercial usage are also helpful.

### **2.4.2 Existing/Proposed Project Geometrics**

Notes should be made as to the type and typical section including the vertical and horizontal alignment characteristics. Data concerning the typical section should indicate the average and maximum 'cut and fill' heights and extent over the project. Items such as the number of travel lanes, shoulders, type and extent of curb and gutter, and vertical clearances at structures should be recorded.

### 2.4.3 Pavement Condition Survey

Pavement condition is a key input required for the determination of feasible rehabilitation alternatives. The CDOT Pavement Management System (PMS) provides network-level pavement condition data for use in the preliminary evaluation of the project. If there is no PMS data for a roadway section of interest, one should conduct a manual distress survey of the project to assess the pavement condition and establish the causes of distresses/failure.

### 2.4.4 Drainage Characteristics

Drainage characteristics should be noted during the visit to the project. Items such as the general terrain drainage, existing pavement drainage, and bridge drainage structures need to be noted. The number of bridges, how the existing pavement terminates at the bridge ends, and if the bridges have bridge approach slabs is important to note. The condition of the bridge end/approach slab and the approach slab/pavement interface conditions are of special interest when concrete pavement exists.

Distresses can be related to particular moisture properties of the materials in the pavement. If the existence of these properties is not recognized and corrected where possible, the rehabilitation work will be wasted by allowing the same type of moisture-related distress to reoccur. The recognition of the amount, severity, and cause of moisture damage also plays an important role in the selection of the rehabilitation scheme to be utilized on the pavement. This information will help in the structural evaluation of the pavement.

Moisture-related distresses develop from external and internal factors that influence the moisture condition in a pavement. An example of external factors are the climatic factors in an area that regulate the supply of moisture to the pavement. Internal factors are pavement material properties whose interaction with moisture influences pavement performance.

The recognition of each distress and the mechanism causing that distress are necessary if the correct rehabilitation procedures are to be selected. Each distress type that develops within a pavement will be load, environment-related, or a combination of the two. Moisture will serve to accelerate this deterioration when it is environment-related. Moisture problems must be recognized and corrected to prevent future deterioration.

The fact that moisture problems may appear in any layer emphasizes the necessity of having a logical procedure for examining the pavement in order to determine the cause of the problem. Non-Destructive Testing (NDT) will indicate the overall structural level of the pavement. However, NDT alone cannot identify which component of the pavement is responsible for the strength loss. Distress analysis must be utilized in conjunction with the NDT analysis to identify potential moisture-related problems. If the subgrade has moisture problems that caused the distress, it may do no good to overlay, recycle, rework the pavement, or stabilize the base without also addressing the subgrade. If the base or subbase has moisture problems one may need to rework or stabilize the base and/or rework the drainage of the granular layer. **Table 2.1 Moisture-Related Distress in Flexible Pavements** and **Table 2.2 Moisture Related Distress in Rigid**

**Pavements** contains a breakdown of the more common moisture-related distresses for flexible and rigid pavements.

## 2.5 Construction and Maintenance Experience

On any given project, there are always construction and maintenance experiences with pavement structures that were never entered into the permanent records relating to the project. Usually, it was not realized that information such as this would be useful in the future. The Program Engineers, Resident Engineers, Project Engineers, Construction Inspectors, and other personnel involved with the project may have useful information if interviewed. The Region Maintenance Superintendent and other maintenance personnel may have pavement performance data that do not appear elsewhere in the records. Frequently, maintenance forces have repaired substantial sections of the project and this information is not always readily available in the records.

## 2.6 Pavement Management System (PMS) Condition Data

The PMS provides network-level pavement condition information for planning and programming purposes. PMS data are used to help select reconstruction, rehabilitation, preventive maintenance projects, and evaluate performance trends. It also provides pavement condition information useful for performing a preliminary evaluation of a project.

For M-E Design, site-specific or project-specific past performance data is used to characterize the existing pavement's condition for use in rehabilitation design. The specifics of how PMS condition data is used is presented in **Chapter 8 Principles of Design for Pavement Rehabilitation with Flexible Overlays** and **Chapter 9 Principles of Design for Pavement Rehabilitation with Rigid Overlays** for rehabilitation designs using flexible and rigid overlays.

CDOT collects and reports pavement performance data on a tenth mile basis, in only one direction of all two-lane highways. CDOT PMS data of relevance to the M-E Design are the following:

- International Roughness Index (IRI)
- Rutting
- Faulting
- Cracking distress

For more information about PMS data, contact the PMS unit or the Region Pavement Manager.

**Table 2.1 Moisture-Related Distress in Flexible Pavements**

Type	Distress Manifestation	Moisture Problem	Climatic Problem	Materials Problem	Load Associated	Structural Defect Begins In		
						Asphalt	Base	Subgrade
Surface Defect	Bleeding	No	Accentuated by high temp	Bitumen	No	Yes	No	No
	Raveling	No	No	Aggregate	Slightly	Yes	No	No
	Weathering	No	Humidity and light dried bitumen	Bitumen	No	Yes	No	No
Surface Deformation	Bump or Distortion	Excess moisture	Frost Heave	Strength moisture	Yes	No	Yes	Yes
	Corrugation or Rippling	Slight	Climatic and suction relations	Unstable mix	Yes	Yes	Yes	Yes
	Shoving	No	-	Unstable mix loss of bond	Yes	Yes	No	No
	Rutting	Excess in granular layers	Suction and materials	Compaction properties	Yes	Yes	Yes	Yes
	Depression	Excess	Suction and materials	Settlement fill material	Yes	No	No	Yes
	Potholes	Excess	Frost heave	Strength moisture	Yes	No	Yes	Yes
Cracking	Longitudinal	Yes	Spring thaw strength loss	-	Yes	Faulty construction	Yes	Yes
	Alligator	Yes drainage	-	Possible mix problems	Yes	Yes, Mix	Yes	Yes
	Transverse	Yes	Low-temp. freeze thaw cycles	Thermal properties	No	Yes temperature susceptible	Yes	Yes



**Table 2.2 Moisture-Related Distress in Rigid Pavements**

Type	Distress Manifestation	Moisture Problem	Climatic Problem	Materials Problem	Load Associated	Structural Defect Begins In		
						Asphalt	Base	Subgrade
Surface Defect	Spalling	Possible	No	-	No	Yes	No	No
	Crazing	No	No	Rich mortar	No	Yes weak surface	No	No
Surface Deformation	Blow-up	No	Temp.	Thermal properties	No	Yes	No	No
	Pumping	Yes	Moisture	Fines in base moisture sensitive	Yes	No	Yes	Yes
	Faulting	Yes	Moisture suction	Settlement deformation	Yes	No	Yes	Yes
	Curling	Possible	Moisture and temp.	-	No	Yes	No	No
Cracking	Corner	Yes	Yes	Follows pumping	Yes	No	Yes	Yes
	Diagonal Transverse Longitudinal	Yes	Possible	Cracking follows moisture build-up	Yes	No	Yes	Yes
	Punch-out	Yes	Yes	Deformation following cracking	Yes	No	Yes	Yes
	Joint	Produces damage later	Possible	Proper filler and clean joints	No	Joint	No	No

## 2.7 Design Performance Criteria and Reliability (Risk)

Performance verification is the basis of the acceptance or rejection of a trial design evaluated using the M-E Design software. A successful design is one where all the selected performance threshold limits are satisfied at their chosen levels of reliability at the end of the design life.

M-E Design requires the designer to specify the critical levels or threshold values of pavement distresses and smoothness to judge the adequacy of a design. The type of distresses used in performance verification is specific to the pavement type (flexible or rigid) and design (rehabilitation or new design). Additionally, design reliability levels are required to account for uncertainty and variability that is expected to exist in pavement design and construction, as well as, in the application of traffic loads and climatic factors over the design life. The threshold and reliability levels for distresses and smoothness significantly impact construction costs and performance. The designer must set realistic numerical limits or threshold values for each performance criterion and reasonable reliability levels for a given design life.

Limits on the various performance criteria should be considered along with design reliability and design period. Both performance criteria and reliability factors are determined based on the functional classification of the roadway and whether it is in an urban or a rural location. Once selected, the limits should be used consistently throughout the pavement type selection and design calculations. **Consultation of the mix design(s) with the RME shall occur.**

**Recommended Range for Reliability**

The reliability is a factor of safety to account for the inherent variations in construction, materials, traffic, climate, and other design inputs. **Table 2.3 Reliability (Risk)** provides the recommended values for the pavement structure to survive the design period traffic. Reliability values recommended for use in previous editions of the AASHTO Design Guide should not be used with M-E Design. Reliability is not dependent on either type of pavement or type of project.

**Table 2.3 Reliability (Risk)**

Functional Classification	Value for Reliability
Interstate	80-95
Principal Arterials (freeways and expressways)	75-95
Principal Arterials (other)	75-95
Minor Arterial	70-95
Major Collectors	70-90
Minor Collectors	50-90
Local	50-80

**Table 2.4 Recommended Threshold Values of Performance Criteria for New Construction or Reconstruction of Flexible Pavement Projects, Table 2.5 Recommended Threshold Values of Performance Criteria for New Construction or Reconstruction Projects of Rigid Pavement, Table 2.6 Recommended Threshold Values of Performance Criteria for Rehabilitation Projects of Flexible Pavements and Table 2.7 Recommended Threshold Values of Performance Criteria for Rehabilitation Projects of Rigid Pavements** provide the threshold values recommended in M-E Design for pavements. M-E Design also requires the designer to enter the expected initial smoothness (IRI) at the time of construction. **It is recommended to use an initial IRI value of 61 inches/mile for all HMA projects and 78 inches/mile for all PCC projects** as they reflect targets that are documented using smoothness data from flexible and rigid pavements constructed between 2011 and 2016. **It is recommended the same reliability value be used for all distresses; any changes should have Region Materials and Staff Materials approval.**

**Figure 2.1 Performance Criteria and Reliability in the M-E Design Software for a Sample Flexible Pavement Design** presents the M-E Design software screenshot showing performance criteria and the corresponding design reliability values selected for the design/analysis of a sample flexible pavement design.

**Figure 2.2 Performance Criteria and Reliability in the M-E Design Software for a Sample JCPC Design** presents the M-E Design software screenshot showing performance criteria and the corresponding design reliability values selected for the design/analysis of a sample rigid pavement design.

**Table 2.4 Recommended Threshold Values of Performance Criteria for New Construction of Flexible Pavement**

Flexible Pavement		
Performance Criteria	Maximum Value at End of the Design Life	Determines the Years to First Rehabilitation (Minimum Age Shall be 14 Years)
Terminal IRI (inches per mile)		Interstate – 160 Principal Arterial – 200 Minor Arterial – 200 Major Collector – 200 Minor Collector – 200* Local Roadway – 200*
AC Top-Down Fatigue Cracking (feet per mile)		Interstate – 2,000 Principal Arterial – 2,500 Minor Arterial – 3,000 Major Collector – 3,000 Minor Collector – 3,000* Local Roadway – 3,000*
AC Bottom-Up Fatigue Cracking (percent lane area)	Interstate – 10 Principal Arterial – 25 Minor Arterial – 25 Major Collector – 25 Minor Collector – 25* Local Roadway – 25*	
AC Thermal Cracking (feet per mile)	Interstate – 1,500 Principal Arterial – 1,500 Minor Arterial – 1,500 Major Collector – 1,500 Minor Collector – 1,500* Local Roadway – 1,500*	
Permanent Deformation (total inches)		Interstate – 0.55 Principal Arterial – 0.65 Minor Arterial – 0.80 Major Collector – 0.80 Minor Collector – 0.80* Local Roadway – 0.80*
Permanent Deformation AC Only (inches)		Interstate – 0.40 Principal Arterial – 0.50 Minor Arterial – 0.65 Major Collector – 0.65 Minor Collector – 0.65* Local Roadway – 0.65*
Additional Thresholds for Chemically Stabilized Layer		
Fatigue Fracture (percent lane area)  (For semi-rigid base layer)		Interstate – 10 Principal Arterial – 25 Minor Arterial – 25 Major Collector – 25 Minor Collector – 25* Local Roadway – 25*
AC Total Fatigue Cracking Bottom Up + Reflective (percent lane area) (For semi-rigid base layer)		Interstate – 10 Principal Arterial – 25 Minor Arterial – 25 Major Collector – 25 Minor Collector – 25* Local Roadway – 25*
AC Total Transverse Cracking Thermal + Reflective (feet per mile) (For semi-rigid base layer)		Interstate – 1,500 Principal Arterial – 1,500 Minor Arterial – 1,500 Major Collector – 1,500 Minor Collector – 1,500* Local Roadway – 1,500*
<b>Note:</b> * M-E Design has not been calibrated for minor collectors or local roadways. Exceptions to the threshold values may be approved by the RME.		

**Table 2.5 Recommended Threshold Values of Performance Criteria for Rehabilitation of Flexible Pavement Projects**

Flexible Pavement		
Performance Criteria	Maximum Value at End of the Design Life (Minimum Age Shall Be 10 Years)	
Terminal IRI (inches per mile)	Interstate – 160 Principal Arterial – 200 Minor Arterial – 200 Major Collector – 200 Minor Collector – 200* Local Roadway – 200*	
AC Top-Down Fatigue Cracking (feet per mile)	Interstate – 2,000 Principal Arterial – 2,500 Minor Arterial – 3,000 Major Collector – 3,000 Minor Collector – 3,000* Local Roadway – 3,000*	
AC Bottom-Up Fatigue Cracking (percent lane area)	Interstate – 10 Principal Arterial – 25 Minor Arterial – 25 Major Collector – 25 Minor Collector – 25* Local Roadway – 25*	
AC Thermal Cracking (feet per mile)	Interstate – 1,500 Principal Arterial – 1,500 Minor Arterial – 1,500 Major Collector – 1,500 Minor Collector – 1,500* Local Roadway – 1,500*	
Permanent Deformation (total inches)	Interstate – 0.55 Principal Arterial – 0.65 Minor Arterial – 0.80 Major Collector – 0.80 Minor Collector – 0.80* Local Roadway – 0.80*	
Permanent Deformation AC Only (inches)	Interstate – 0.40 Principal Arterial – 0.50 Minor Arterial – 0.65 Major Collector – 0.65 Minor Collector – 0.65* Local Roadway – 0.65*	
AC Total Fatigue Cracking Bottom-Up + Reflective (percent lane area)	Interstate – 20 Principal Arterial – 35 Minor Arterial – 35 Major Collector – 35 Minor Collector – 35* Local Roadway – 35*	Use 50% Reliability
AC Total Transverse Cracking Thermal + Reflective (feet per mile)	Interstate – 2,500 Principal Arterial – 2,500 Minor Arterial – 2,500 Major Collector – 2,500 Minor Collector – 2,500* Local Roadway – 2,500*	
Additional Thresholds for Chemically Stabilized Layer		
Fatigue Fracture (percent lane area)  (For semi-rigid base layer)	Interstate – 20 Principal Arterial – 35 Minor Arterial – 35 Major Collector – 35 Minor Collector – 35* Local Roadway – 35*	
<b>Note:</b> * M-E Design has not been calibrated for minor collectors or local roadways. Exceptions to the threshold values may be approved by the RME.		

**Table 2.6 Recommended Threshold Values of Performance Criteria for New Construction of Rigid Pavement**

Rigid Pavement (JPCP)		
Performance Criteria	Maximum Value at End of the Design Life	Determines the Year to First Rehabilitation (Minimum Age Shall Be 27 Years)
Terminal IRI (inches per mile)		Interstate – 160 Principal Arterial – 200 Minor Arterial – 200 Major Collector – 200 Minor Collector – 200* Local Roadway – 200*
Transverse Slab Cracking (percent)		Interstate – 7.0 Principal Arterial – 7.0 Minor Arterial – 7.0 Major Collector – 7.0 Minor Collector – 7.0* Local Roadway – 7.0*
Mean Joint Faulting (inches)	Interstate – 0.12 Principal Arterial – 0.14 Minor Arterial – 0.20 Major Collector – 0.20 Minor Collector – 0.20* Local Roadway – 0.20*	
<b>Note:</b> * M-E Design has not been calibrated for minor collectors or local roadways. Exceptions to the threshold values may be approved by the RME.		

**Table 2.7 Recommended Threshold Values of Performance Criteria for Rehabilitation of Rigid Pavement Projects**

Rigid Pavement (JPCP)	
Performance Criteria	Maximum Value at End of the Design Life (Minimum Age Shall Be 20 Years)
Terminal IRI (inches per mile)	Interstate – 160 Principal Arterial – 200 Minor Arterial – 200 Major Collector – 200 Minor Collector – 200* Local Roadway – 200*
Transverse Slab Cracking (percent)	Interstate – 7.0 Principal Arterial – 7.0 Minor Arterial – 7.0 Major Collector – 7.0 Minor Collector – 7.0* Local Roadway – 7.0*
Mean Joint Faulting (inches)	Interstate – 0.12 Principal Arterial – 0.14 Minor Arterial – 0.20 Major Collector – 0.20 Minor Collector – 0.20* Local Roadway – 0.20*
<b>Note:</b> * M-E Design has not been calibrated for minor collectors or local roadways. Exceptions to the threshold values may be approved by the RME.	

15-11959:Project

General Information

Design type: New Pavement

Pavement type: Flexible Pavement

Design life (years): 20

Base construction: May 2002

Pavement construction: June 2002

Traffic opening: Septen 2002

Performance Criteria	Limit	Reliability
Initial IRI (in./mile)	63	
Terminal IRI (in./mile)	172	90
AC top-down fatigue cracking (ft/mile)	2000	90
AC bottom-up fatigue cracking (percent)	25	90
AC thermal cracking (ft/mile)	1000	90
Permanent deformation - total pavement (in.)	0.75	90
Permanent deformation - AC only (in.)	0.25	90

**Figure 2.1 Performance Criteria and Reliability in the M-E Design Software for a Sample Flexible Pavement Design**

25-10326:Project

General Information

Design type: New Pavement

Pavement type: Jointed Plain Concrete

Design life (years): 20

Pavement construction: June 1996

Traffic opening: Septen 1996

Performance Criteria	Limit	Reliability
Initial IRI (in./mile)	63	
Terminal IRI (in./mile)	172	90
JPCP transverse cracking (percent slabs)	15	90
Mean joint faulting (in.)	0.12	90

**Figure 2.2 Performance Criteria and Reliability in the M-E Design Software for a Sample JPCP Design**

The appropriate functional classification for a certain roadway can be determined from the information on CDOT Form #463: Design Data, completed for the specific highway project being designed. A blank CDOT Form #463 is shown in the Appendix of the *CDOT Project Development Manual* and **APPENDIX B: FORMS** of this manual. As an example, CDOT Form #463 identifies a segment of State Highway 83 as a principal arterial; the reliability for this roadway can be obtained from **Table 2.3 Reliability (Risk)**. As the table shows, the reliability for this road may range from 75 to 95 percent. This is a high profile road, so the reliability is set at 95 percent.

CDOT has a map available designating highway functional classifications, see **Figure 2.3 Functional Classification Map**. The map may be downloaded from the following website: [http://alphainternal.dot.state.co.us/App\\_DTD\\_DataAccess/Downloads/StatewideMaps/func\\_clas\\_s\\_pdf.pdf](http://alphainternal.dot.state.co.us/App_DTD_DataAccess/Downloads/StatewideMaps/func_clas_s_pdf.pdf)

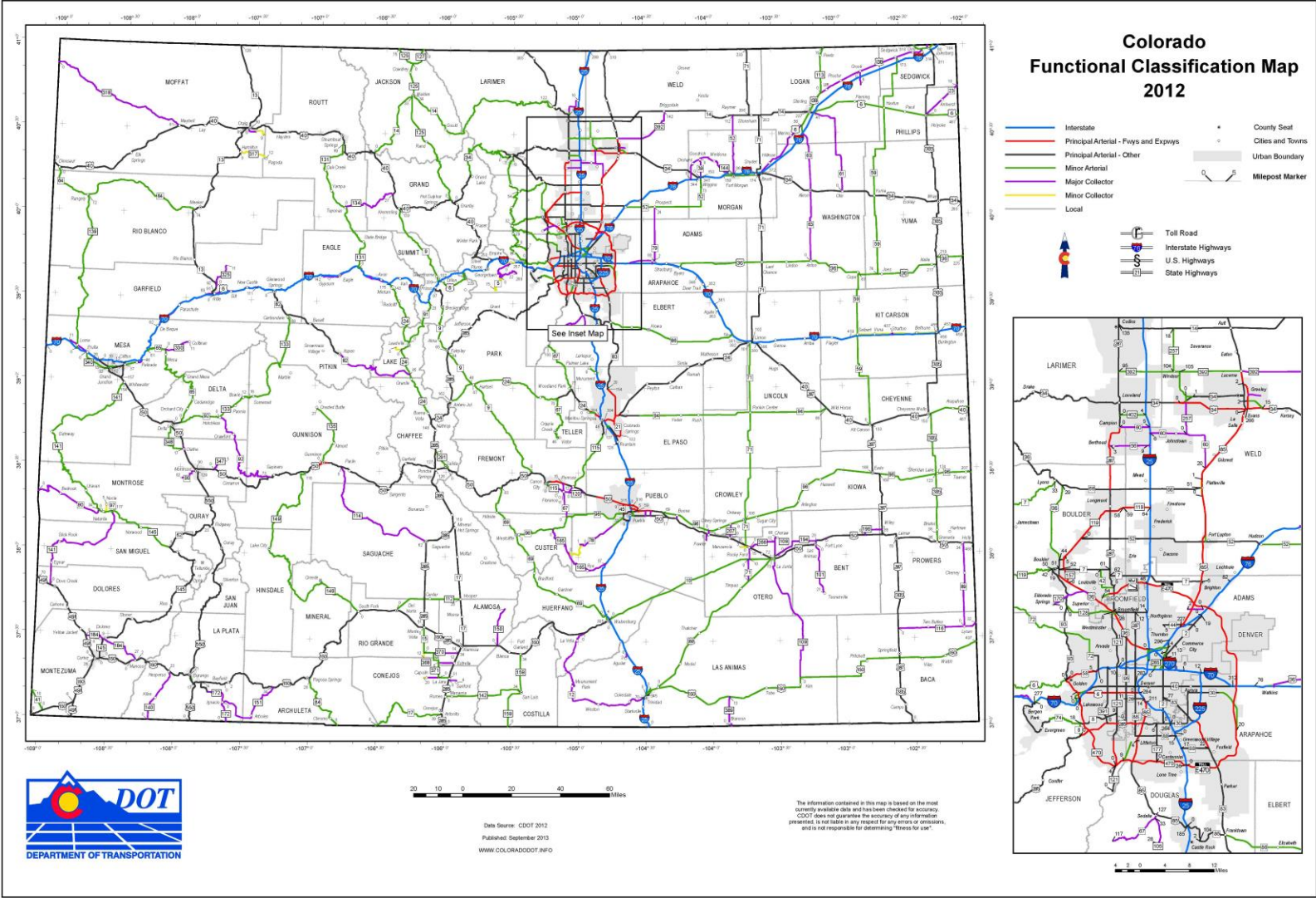


Figure 2.3 Function Classification Map

## 2.8 Defining Input Hierarchy

M-E Design employs a hierarchical approach to input parameters with regard to traffic, material, and condition of existing pavement. This approach provides the designer with a lot of flexibility in obtaining the design inputs for a project based on the criticality of the project and available resources.

For many of the design inputs, M-E Design allows the designer to select any of three levels of inputs:

- **Level 1:** Project-specific or site-specific inputs are obtained from direct testing or measurements. Obtaining Level 1 inputs requires more resources and time than other levels. Level 1 input would typically be used for designing heavily trafficked pavements or wherever there is dire safety or economic consequences of early failure. Examples include measuring dynamic modulus of hot mix asphalt (HMA) using laboratory testing, measuring PCC elastic moduli using laboratory testing, or using on-site measured traffic classification data.
- **Level 2:** Inputs are estimated from correlations or regression equations derived from a limited testing program or obtained from the agency database. This level could be used when resources or testing equipment are not available for tests required for Level 1. Examples include estimating resilient modulus of unbound materials and subgrade from R-values, estimating PCC elastic moduli from compressive strength tests, or using traffic classification data based on the functional class of the roadway.
- **Level 3:** Inputs are based on “best-estimated” or typical values for the local region. This level might be used for design where there are minimal consequences of early failure (i.e. lower volume roads). Examples include using default resilient modulus values for unbound materials, estimating PCC elastic moduli from 28-day compressive or flexural strength tests, or using default traffic classification data.

The designer can also select a mix of input levels for a given project. For instance, the designer can select the HMA creep compliance at Level 1, subgrade resilient modulus at Level 2, and traffic load spectra at Level 3 for analyzing a flexible pavement trial design. The computational algorithms, procedures, and performance models for predicting distress and smoothness are exactly the same irrespective of the input level used in the design; however, the accuracy of the inputs as defined by the input level may affect the accuracy of performance prediction results.

The input hierarchy provides a powerful tool to show the advantages of good engineering design (using Level 1 inputs) in improving the reliability of the design, and the possibility to reduce pavement construction and rehabilitation costs. It is recommended the designer obtain the inputs that are appropriate and practical for the magnitude of the project under design. Larger, more significant projects require more accurate design inputs.



The selection of the hierarchical level for a specific input depends on several factors, including:

- Sensitivity of the pavement performance to a given input
- The criticality of the project
- The information available at the time of design
- The resources and time available to the designer to obtain the inputs

The designer should consider the above mentioned factors and select a predominant level of input hierarchy based on the recommendations presented in **Table 2.8 Selection of Input Hierarchical Level**. **Note:** The term “Predominant Input Hierarchy” implies the designer should, as much as possible, provide inputs at the selected input level.

**Table 2.8 Selection of Input Hierarchical Level**

Criticality/Sensitivity of Design	Description	Predominant Input Hierarchy
Very Critical	High volume interstates, urban freeways, and expressways	Level 1
Critical	Principal arterials, rural interstates, heavy haul (i.e. mining, logging routes)	Level 1 or Level 2
Some What Critical	Minor arterial and collectors	Level 2 or Level 3
Not Critical	Local roads	Level 3

## 2.9 Drainage

Water is a fundamental variable in most problems associated with pavement performance and is directly or indirectly responsible for many of the distresses found in pavement systems. A well-drained pavement section is required to maintain the strength coefficients assigned to individual components of a hot mix asphalt pavement section. Edge drains, cross drains, and drainage layers all must tie into a collection system or some other means to carry collected water away from intersections and the pavement section. Installing drainage systems that collect and impound water rather than diverting it away from the pavement section should never be allowed.

The M-E Design procedure does not consider the effects of drainage directly in pavement design/analysis methodology. Drainage effects are considered indirectly through seasonal adjustments of unbound material, subgrade moisture, and related impacts on the strength/modulus.

As good drainage is a prerequisite to any good design, designers must always consider strategies for combating the effects of water in a pavement system such as:

- Preventing water from entering the pavement
- Providing drainage to remove excess water quickly
- Building the pavement strong enough to resist the combined effect of load and water

It is preferable to exclude water from the pavement and provide for rapid drainage. The cost of improving the drainage should be compared to the cost of building a stronger pavement. It is more likely drainage improvements will outperform a stronger pavement. To obtain adequate pavement drainage, the designer should consider providing three types of drainage systems that may include surface, groundwater, and structural drainage.

It is important to understand the roadway geometry, particularly the drainage gradients in the roadway prism, when selecting the type of base. As long as the base will be able to carry drainage away from the pavement structure, a gravel base will perform adequately. It is also important to note that these values apply only to the effects of drainage on untreated base and subbase layers.

### **2.9.1 Subdrainage Design**

Subdrainage is an important consideration in new construction or reconstruction and in the resurfacing, restoration, and rehabilitation of pavement systems. Detailed procedures for pavement subsurface design are provided in several publications, including:

- *CDOT Drainage Design Manual*
- *Guidelines for the Design of Highway Internal Drainage System, AASHTO 1986 Guide's Appendix AA*
- FHWA's DRIP software
- *MEPDG 2004 Design Documents Part 3, Chapter 1*

If necessary, the pavement designer should coordinate with the respective Region Hydraulics Engineer and/or Staff Hydraulics Engineer where a pavement drainage problem is anticipated. The pavement designer may consult the references provided above.

## References

1. *AASHTO Mechanistic-Empirical Pavement Design Guide, A Manual of Practice, Interim Edition, July 2008*, American Association of State Highway and Transportation Officials, Washington, DC, 2008.
2. DRIP 2.0 Software Program < <http://isddc.dot.gov/OLPFiles/FHWA/010942.pdf> >

## CHAPTER 3 TRAFFIC AND CLIMATE

Traffic and climate related inputs required for conducting pavement design and analysis using M-E Design software are discussed in this chapter.

### 3.1 Traffic

Prior to M-E Design, the number of 18,000-pound Equivalent Single Axle Loads (18-kip ESAL) represented the amount of traffic and its characteristics. However, M-E Design traffic input requirements are more detailed and can be categorized as follows, refer to **Figure 3.1 Traffic Inputs in the M-E Design Software**:

- Base year traffic information
  - Analysis period or pavement design life
  - Date newly constructed or rehabilitated pavement is opened to traffic
  - Two-way average annual daily truck traffic (AADTT)
  - Number of lanes in design direction
  - Truck direction distribution factor
  - Lane distribution factor
  - Operational speed
- Traffic adjustment factors
  - Monthly adjustment factors
  - Vehicle class distribution
  - Truck hourly distribution
  - Growth rate and type
  - Number of axles per truck
  - Axle load distribution factors
- General traffic inputs
  - Lateral wander of axle loads
  - Axle configuration
  - Wheelbase
  - Tire pressure

This section primarily deals with traffic input requirements for pavement designs using M-E Design software. The 18-kip ESALs are still required for asphalt binder selection, see **Section 6.12.3 Binder Selection** and pavement designs using the CDOT thin and ultra-thin Concrete Overlay design procedures. Refer to the *CDOT 2012 Pavement Design Manual* for information on traffic characterization using the ESAL methodology.

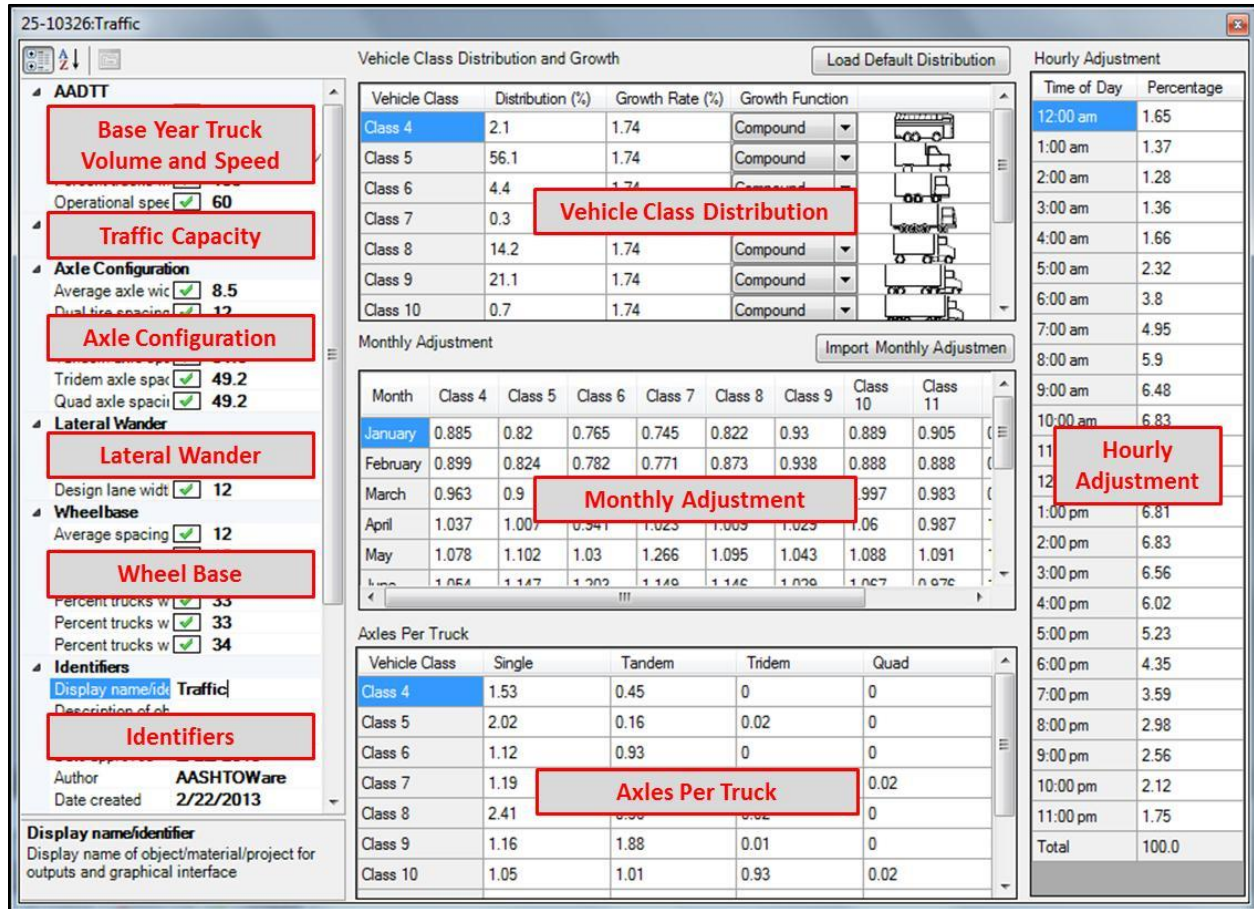


Figure 3.1 Traffic Inputs in the M-E Design Software

### 3.1.1 CDOT Traffic Data

The Department has various sites on the highway system where instruments have been placed in the roadway to measure axle loads as a vehicle passes over the site. These stations, called Weigh-in-Motion (WIM) sites, can provide accurate information of the existing traffic load. An estimate of growth over the design period will be needed to calculate the traffic load during the design period. The link <http://dtdapps.coloradodot.info/Otis/TrafficData> is used to access traffic load information.

The Division of Transportation Development (DTD) Traffic Analysis Unit supplies traffic analysis for pavement structure design. All vehicular traffic on the design roadway is projected for the design year in the categories of passenger cars, single unit trucks, and combination trucks with various axle configurations. The DTD Traffic Analysis Unit will make adjustments for directional distribution and lane distribution.

The DTD provides traffic projections of Average Annual Daily Traffic (AADT) and ESALs. The designer must request 10, 20, and 30-year traffic projections for flexible pavements and 20 and 30-year traffic projections for rigid pavements from the Traffic Section of DTD. Requests for traffic projections should be coordinated with the appropriate personnel of DTD. The pavement

designer can help ensure accurate traffic projections are provided by documenting local conditions and planned economic development that may affect future traffic loads and volumes. The DTD should be notified of special traffic situations when traffic data are requested. Some special situations may include:

- A street that is or will be a major arterial route for city buses.
- A roadway that will carry truck traffic to and from heavily used distribution or freight centers.
- A highway that will experience an increase in traffic from a connection to a major, high-traffic area.
- A highway that will be constructed in the near future.
- A roadway that will experience a decrease in traffic due to the future opening of a parallel roadway facility.

### 3.1.2 Traffic Inputs Hierarchy

The M-E Design methodology defines three levels of traffic data inputs based on how well the pavement designer can estimate future truck traffic for the roadway being designed. **Table 3.1 Hierarchy of Traffic Inputs** presents the hierarchy description of traffic inputs and common data sources. Refer to **Table 2.8 Selection of Input Hierarchical Level** for selection of an appropriate hierarchical level for traffic inputs. **Table 3.2 Recommendations of Traffic Inputs at Each Hierarchical Level** presents the traffic input requirements of the M-E Design method and the recommendations for obtaining these inputs at each hierarchical input level.

**Table 3.1 Hierarchy of Traffic Inputs**

Input Hierarchy	Description
Level 1	Site-specific traffic data determined from site-specific measurements of weigh-in-motion data <ul style="list-style-type: none"> <li>• Volume counts</li> <li>• Traffic adjustment factors</li> <li>• Axle load distribution</li> </ul>
Level 2	Site-specific traffic volume counts <ul style="list-style-type: none"> <li>• CDOT averages of traffic adjustment factors and axle load data</li> <li>• Derived averages from CDOT weigh-in-motion</li> <li>• Automatic vehicle classification historical data</li> </ul>
Level 3	Site-specific traffic volume counts and national averages of traffic adjustment factors and axle load data (M-E Design software defaults)

**Table 3.2 Recommendations of Traffic Inputs at Each Hierarchical Level**

<b>Input</b>	<b>Level 1</b>	<b>Level 2</b>	<b>Level 3</b>
AADT	Use project specific historical traffic volume data <b>Section 3.1.3 Volume Counts</b>		
Traffic Growth Rate Distribution Factor	Use project specific historical traffic volume data <b>Section 3.1.5 Growth Factors for Trucks</b>		
Lane and Directional Distribution Factor	Use project specific values	<b>Section 3.1.4 Lane and Directional Distributions</b>	
Vehicle Class Distribution	Use project specific values	Use CDOT averages <b>Table 3.5 Level 2 Vehicle Class Distribution Factors</b>	Use M-E Design software defaults
Monthly Adjustment Factor	Use project specific values	Use CDOT averages <b>Table 3.7 Level 2 Monthly Adjustment Factors</b>	
Hourly Distribution Factor	Use project specific values	Use CDOT averages <b>Table 3.8 Hourly Distribution Factors</b>	
Axle Load Distribution	Use project specific values	Use CDOT averages <b>Section 3.1.10 Axle Load Distribution</b>	
Operational Speed	Use posted or design speed (Levels 1 and 2 not available)		
Number of Axles Per Truck	Use project specific values	Use CDOT averages <b>Table 3.6 Level 2 Number of Axles Per Truck</b>	
Lateral Traffic Wander	Use M-E Design software defaults (Levels 1 and 2 not available) <b>Section 3.1.12 Lateral Wander of Axle Load</b>		
Axle Configuration	Use M-E Design software defaults (Levels 1 and 2 not available) <b>Section 3.1.13 Axle Configuration and Wheelbase</b>		
Wheelbase	Use project specific values	Use national defaults <b>Section 3.1.13 Axle Configuration and Wheelbase</b>	
Tire Pressure	Use M-E Design software defaults (Levels 1 and 2 not available) <b>Section 3.1.14 Tire Pressure</b>		

### 3.1.3 Volume Counts

M-E Design characterizes traffic volume as the Annual Average Daily Truck Traffic (AADTT) (see **Figure 3.2 M-E Design Software Screenshot of AADTT**). AADTT is a product of Annual Average Daily Traffic (AADT) and percent trucks (FHWA vehicle Classes 4 through 13). Project specific AADTT for the base year is required for pavement design/analysis of all hierarchical input levels. CDOT reports both AADT and AADTT, thus historical AADT and/or AADTT estimates for a specific project segment can be accessed from the link:

<http://dtdapps.coloradodot.info/Otis/TrafficData>.

Station ID	Route	Start	End	AADT	Year	Single Trucks	Combined Trucks	% Trucks	DHV	Projected AADT	Projected Single Trucks	Projected Combined Trucks
100994	025A	199.397	200.132	239,000	2016	5,500	6,500	5	8	323,128	7,436	8,788
100995	025A	200.132	201.592	253,000	2016	6,600	6,100	5	8	339,273	8,851	8,180
100996	025A	201.592	202.688	232,000	2016	6,300	5,600	5.1	8	321,320	8,726	7,756
100997	025A	202.688	203.537	224,000	2016	6,000	5,600	5.2	8	305,312	8,178	7,633
100998	025A	203.537	204.037	217,000	2016	6,700	6,500	6.1	8	286,223	8,837	8,574
100999	025A	204.037	205.057	221,000	2016	7,100	6,900	6.3	8	291,499	9,365	9,101
101000	025A	205.057	205.919	213,000	2016	6,800	6,600	6.3	8	285,633	9,119	8,851
101001	025A	205.919	206.149	211,000	2016	6,800	6,800	6.4	8	282,951	9,119	9,119
101002	025A	206.149	206.335	206,000	2016	6,600	6,600	6.4	8	280,778	8,996	8,996
101003	025A	206.335	206.991	203,000	2016	6,300	6,300	6.2	8	263,291	8,171	8,171
101004	025A	206.991	207.581	195,000	2016	6,200	6,200	6.4	8	255,060	8,110	8,110
101005	025A	207.581	207.99	227,000	2016	6,100	6,800	5.7	8	276,940	7,442	8,296

Figure 3.2 OTIS Screenshot

### 3.1.4 Lane and Directional Distributions

The most heavily used lane is referred to as the design lane. Generally, the outside lanes are the design lanes. Traffic analysis determines a percent of all trucks traveling on the facility for the design lanes. This is also referred to as a lane distribution factor.

The percent of trucks in the design direction is applied to the two directional AADT to account for any differences to truck volumes by the direction. The percent trucks in the design direction is referred to as the directional distribution factor. Generally, the directional distribution factor is a 50/50 percent split. If the number of lanes and volumes are not the same for each direction, it may be appropriate to design a different pavement structure for each direction of travel.

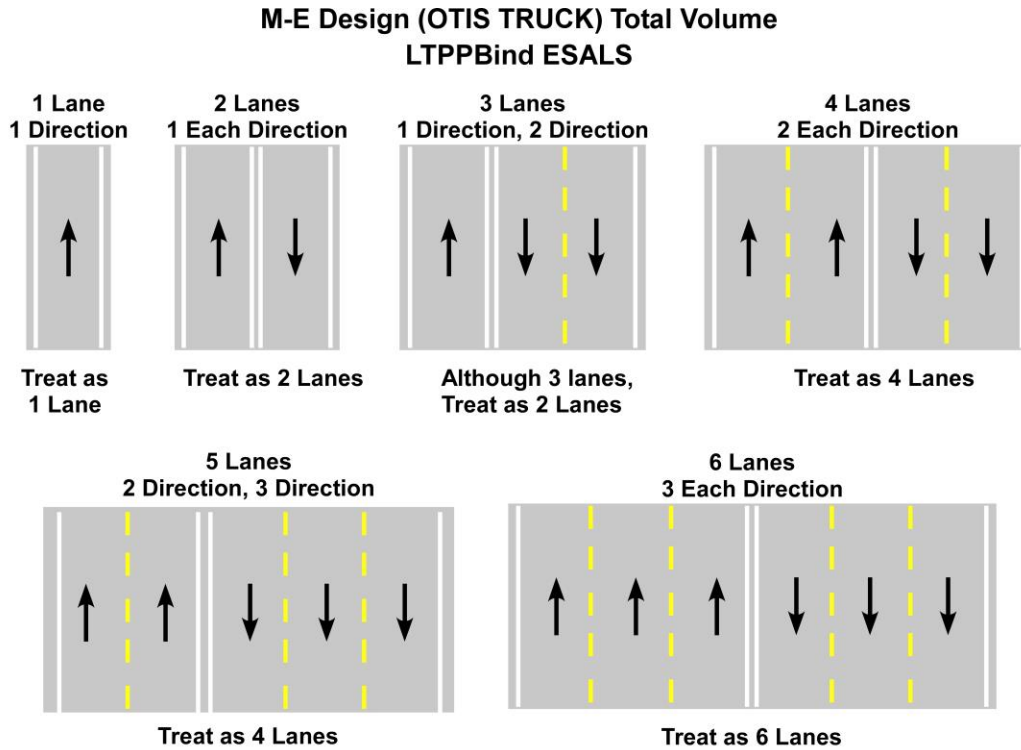
CDOT uses a design lane factor to account for the lane and directional distribution which are combined into one factor, the design lane factor. **Table 3.3 Design Lane Factor** shows the relationship of the design lane factor versus the lane and directional distributions. **Figure 3.2 M-E Design Software Screenshot of AADTT** presents the M-E Design software screenshot of lane and directional distribution factors.

AADTT		
Two-way AADTT	<input checked="" type="checkbox"/>	745
Number of lanes	<input checked="" type="checkbox"/>	2
Percent trucks in design direction	<input checked="" type="checkbox"/>	50
Percent trucks in design lane	<input checked="" type="checkbox"/>	90
Operational speed (mph)	<input checked="" type="checkbox"/>	60

Figure 3.3 M-E Design Software Screenshot of AADTT



**Figure 3.4 Diagram of Lanes for M-E Design and LCCA**



Note: 1) If an odd number of lanes, treat as one lane lower than maximum number of directional lanes (i.e. 3 lanes treated as 2 lanes)  
2) Acceleration, deceleration, and turning lanes are not to be considered as a lane

**Table 3.3 Design Lane Factor**

Type of Facility	Number of Lanes in Design Direction	Design Lane Factor	Percent of Total Trucks in the Design Lane (Outside Lane)	Directional Split (Design Direction/ Non-design Direction)
One Way	1	1.00	100	NA
2-Lanes	1	0.60	100	60/40
4-Lanes	2	0.45	90	50/50
6-Lanes	3	0.309	60	50/50
8-Lanes	4	0.25	50	50/50

**Note:** The *Highway Capacity Manual*, 2000 (Exhibit 12-13) recommends using a default value for directional split of 60/40 on a two-lane highway may it be rural or urban (3).

### 3.1.5 Growth Factors for Trucks

The number of vehicles using a pavement tends to increase with time. A simple growth rate assumes the AADT is increased by the same amount each year. A compound growth rate assumes the AADT percent growth rate for any given year is applied to the volume during the preceding











year. CDOT a **compound** growth rate. Use equation **Eq. 3-1** or **Table 3.4 Growth Rate Determined Using OTIS 20-Year Growth Factor**.

$$T_f = (1+r)^n \quad \text{Eq. 3-1}$$

Where:

- $T_f$  = growth factor
- $r$  = rate if growth expressed as a fraction
- $n$  = number of years

The CDOT traffic analysis unit may be consulted to estimate the increase in truck traffic over time (using the M-E Design approach). The M-E Design software has the capability to use different growth rates for different truck classes, but assumes the growth rate remains the same throughout the analysis period, see **Figure 3.3 M-E Design Software Screenshot of Growth Rate**. Additionally, the estimated traffic volumes to be used in the pavement design can be subjected to roadway capacity limits. Project specific growth rates are required for pavement design/analysis for all hierarchical input levels. An estimate of truck volume growth over the design period can be accessed from the link <http://dtdapps.coloradodot.info/Otis/TrafficData>.

Vehicle Class	Distribution (%)	Growth Rate (%)	Growth Function	
Class 4	2.1	1.74	Compound	
Class 5	56.1	1.74	Compound	
Class 6	4.4	1.74	Compound	
Class 7	0.3	1.74	Compound	
Class 8	14.2	1.74	Compound	
Class 9	21.1	1.74	Compound	
Class 10	0.7	1.74	Compound	
Class 11	0.7	1.74	Compound	
Class 12	0.2	1.74	Compound	
Class 13	0.2	1.74	Compound	
Total	100			

**Figure 3.5 M-E Design Software Screenshot of Growth Rate**

**Table 3.4 Growth Rate Determined Using OTIS 20-Year Growth Factor**

20 Year Growth Factor (OTIS)	r (%)	20 Year Growth Factor (OTIS)	r (%)
1.00	0.000	2.30	4.256
1.05	0.245	2.35	4.364
1.10	0.478	2.40	4.475
1.15	0.703	2.45	4.584
1.20	0.916	2.50	4.690
1.25	1.122	2.55	4.793
1.30	1.320	2.60	4.894
1.35	1.512	2.65	4.995
1.40	1.697	2.70	5.092
1.45	1.877	2.75	5.179
1.50	2.048	2.80	5.283
1.55	2.196	2.85	5.377
1.60	2.378	2.90	5.464
1.65	2.535	2.95	5.559
1.70	2.689	3.00	5.647
1.75	2.840	3.05	5.834
1.80	2.983	3.10	5.820
1.85	3.123	3.15	5.905
1.90	3.261	3.20	5.988
1.95	3.393	3.25	6.070
2.00	3.526	3.30	6.149
2.05	3.655	3.35	6.232
2.10	3.784	3.40	6.310
2.15	3.902	3.45	6.386
2.20	4.021	3.50	6.465
2.25	4.139		

### 3.1.6 Vehicle Classification

M-E Design requires a vehicle class distribution which represents the percentage of each truck class (Classes 4 through 13) within the truck traffic distribution as part of the AADTT for the base year. The sum of the percent AADTT of all truck classes should equal 100. This normalized distribution is determined from an analysis of AVC data and represents data collected over multiple years. CDOT uses a classification scheme of categorizing vehicles into three bins. These vehicle classifications types are (1):

- Passenger vehicles: Classes 1-3 are 0-20 feet
- Single unit trucks: Classes 4-7 are 20-40 feet
- Combination trucks: Classes 8-13 and greater than 40 feet long

These bins are further broken down into 13 classes. The 13 classification scheme follows FHWA vehicle type classification. For some situations, a fourth bin containing all unclassified vehicles is used. Additional classes, Class 14 and 15, may also be included in the fourth bin. CDOT vehicle classes are presented in **Figure 2.3 Functional Classification Map**. FHWA vehicle classes with definitions are presented as follows (2). **Note:** The M-E Design method does not include vehicle Classes 1 to 3 (i.e. light weight vehicles) and Classes 14 and 15 (i.e. unclassified vehicles).

- Class 1: Motorcycles:** All two or three-wheeled motorized vehicles. Typical vehicles in this category have saddle type seats and are steered by handlebars rather than steering wheels. This category includes motorcycles, motor scooters, mopeds, motor-powered bicycles, and three-wheel motorcycles. This vehicle type may be reported at the option of the State.
- Class 2: Passenger Cars:** All sedans, coupes, and station wagons manufactured primarily for the purpose of carrying passengers, including passenger cars pulling recreational or other light trailers.
- Class 3: Other Two-Axle, Four-Tire Single Unit Vehicles:** All two-axle, four-tire, vehicles other than passenger cars. Included in this classification are pickups, panels, vans, and other vehicles such as campers, motor homes, ambulances, hearses, carryalls, and minibuses. Other two-axle, four-tire single-unit vehicles pulling recreational or other light trailers are included in this classification. Because automatic vehicle classifiers have difficulty distinguishing Class 3 from Class 2, these two classes may be combined into Class 2.
- Class 4: Buses:** All vehicles manufactured as traditional passenger-carrying buses with two axles and six tires, or three or more axles. This category includes only traditional buses (including school buses) functioning as passenger-carrying vehicles. Modified buses should be considered a truck and should be appropriately classified.
- Class 5: Two-Axle, Six-Tire, Single-Unit Trucks:** All vehicles on a single frame including trucks, camping and recreational vehicles, motor homes, etc., with two axles and dual rear wheels.
- Class 6: Three-Axle Single-Unit Trucks:** All vehicles on a single frame including trucks, camping and recreational vehicles, motor homes, etc., with three axles.
- Class 7: Four or More Axle Single-Unit Trucks:** All trucks on a single frame with four or more axles.
- Class 8: Four or Fewer Axle Single-Trailer Trucks:** All vehicles with four or fewer axles consisting of two units, one of which is a tractor or straight truck power unit.
- Class 9: Five-Axle Single-Trailer Trucks:** All five-axle vehicles consisting of two units, one of which is a tractor or straight truck power unit.
- Class 10: Six or More Axle Single-Trailer Trucks:** All vehicles with six or more axles consisting of two units, one of which is a tractor or straight truck power unit.
- Class 11: Five or fewer Axle Multi-Trailer Trucks:** All vehicles with five or fewer axles consisting of three or more units, one of which is a tractor or straight truck power unit.
- Class 12: Six-Axle Multi-Trailer Trucks:** All six-axle vehicles consisting of three or more units, one of which is a tractor or straight truck power unit.
- Class 13: Seven or More Axle Multi-Trailer Trucks:** All vehicles with seven or more axles consisting of three or more units, one of which is a tractor or straight truck power unit.

**Note:** In reporting information on trucks the following criteria should be used:

- Truck tractor units traveling without a trailer will be considered single-unit trucks.
- A truck tractor unit pulling other such units in a "saddle mount" configuration will be considered one single-unit truck and defined only by the axles on the pulling unit.
- Vehicles are defined by the number of axles in contact with the road, therefore, "floating" axles are counted only when in the down position.
- The term "trailer" includes both semi and full trailers.


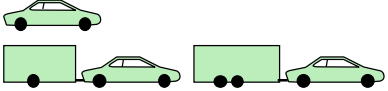
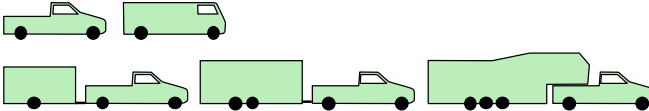

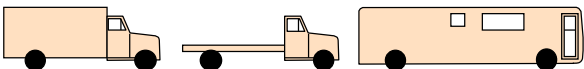
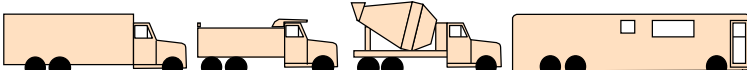

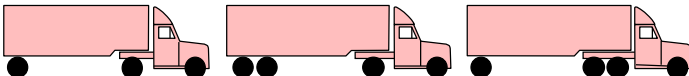
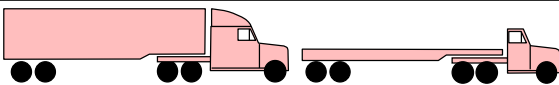
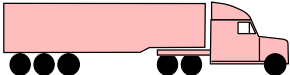
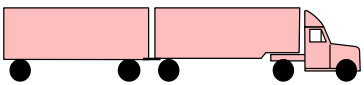
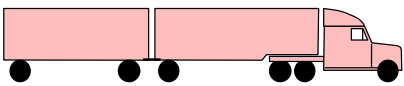
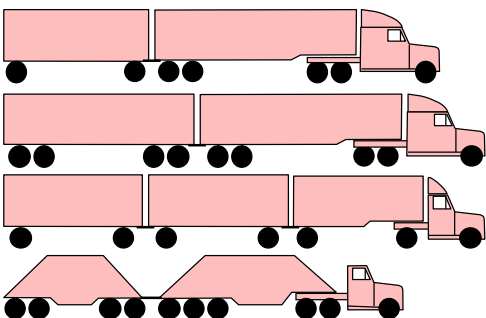
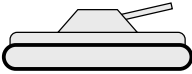
	Class	Schema	Description
Light-weight Vehicles	1		all motorcycles plus two wheel axles
	2		all cars plus one/two axle trailers
	3		all pickups and vans single/dual wheels plus one/two/three axle trailers
Single Unit Vehicles	4		buses single/dual wheels
	5		two axle, single unit single/dual wheels
	6		three axle, single unit
	7		four axle, single unit
Combination Unit Vehicles	8		four or less axles, single trailers
	9		five axles, single trailers
	10		six or more axles, single trailers
	11		five or less axles, multi-trailers
	12		six axles, multi-trailers
	13		seven or more axles, multi-trailers
	14		Unclassifiable vehicle
Unclassified Vehicles	15		Not used

Figure 3.6 CDOT Vehicle Classifications

For M-E Design, the vehicle class distribution inputs can be defined at three hierarchical input levels. See **Figure 3.5 M-E Design Software Screenshot of Vehicle Class Distribution**. The three input levels are described in the following sections.

### 3.1.6.1 Level 1 Vehicle Class Inputs

Level 1 inputs are the actual measured site data (over 24-hours) and must be used for highways with heavy seasonal and atypical traffic. This data can be obtained from the CDOT DTD.

### 3.1.6.2 Level 2 Vehicle Class Inputs

Level 2 inputs are the regional average values determined from traffic analyses of data from various WIM and AVC sites in Colorado. The traffic data analyses indicated three vehicle class distribution clusters defined according to location and highway functional class. The descriptions of vehicle class clusters are presented as follows, refer to **Table 3.5 Class 5 and Class 9 Distribution per Cluster Type**:

- **Cluster 1:** This distribution had one large primary peak for Class 5 vehicles with percentage ranging from 40 to 75. There was a secondary peak for Class 8 and 9 trucks with percentage ranging from 10 to 30 percent. The main highway functional class was 4-lane rural principal arterials (non-interstate, US highways and state routes), and a few sections of urban freeways.
- **Cluster 2:** This distribution had two distinct peaks for Class 5 and 9 vehicles. The percentage of Class 5 ranged from 5 to 35 and the percentage of Class 9 ranged from 40 to 80. The main highway functional class was 4-lane rural principal arterial, interstate, and highways.
- **Cluster 3:** This distribution had two distinct peaks for Class 5 and 9 vehicles with percentages of each class ranging from 15 to 50, with Class 9 trucks having a slightly higher percentage than other truck types. The main highway functional classes were 2-lane rural principal arterials (other), 2-lane rural major collectors, and 4-lane urban principal arterials.

**Table 3.5 Class 5 and Class 9 Distribution Per Cluster Type**

Cluster	Class 5 Distribution (%)	Class 9 Distribution (%)	Most Common Highway Functional Class
Cluster 1	40-75	10-30	<ul style="list-style-type: none"> <li>• 4-lane rural principal arterial (non-interstate)</li> <li>• A few urban freeways</li> </ul>
Cluster 2	5-35	40-80	<ul style="list-style-type: none"> <li>• 4-lane rural principal arterial (other)</li> <li>• Interstate highways</li> </ul>
Cluster 3	15-50	15-50	<ul style="list-style-type: none"> <li>• 2-lane rural principal arterial (other)</li> <li>• 2-lane rural major collector</li> <li>• 4-lane urban principal arterial</li> </ul>

As a minimum, selection of the appropriate cluster type must be based on project location as shown in **Table 3.6 Level 2 Vehicle Class Distribution Factors** and **Figure 3.6 Vehicle Class Distribution Factors for CDOT Clusters**. Designers must choose the default vehicle class distribution for the cluster that most closely describes the design traffic stream for the roadway under design.

### 3.1.6.3 Level 3 Vehicle Class Inputs

For situations, where CDOT clusters are not suitable and Level 1 data is not available, designers may use an appropriate default Truck Traffic Class (TTC) group in the M-E Design software. TTC factors were developed using traffic data from over a 100 WIM and AVC sites located nationwide. The data was obtained from FHWA LTPP program data.

Designers may select the most appropriate from seventeen TTC groups that best describe the truck traffic mix of a given project. **Figure 3.7 Truck Traffic Classification Groups** presents a screenshot of the seventeen TTC groups and their descriptions in the M-E Design software.











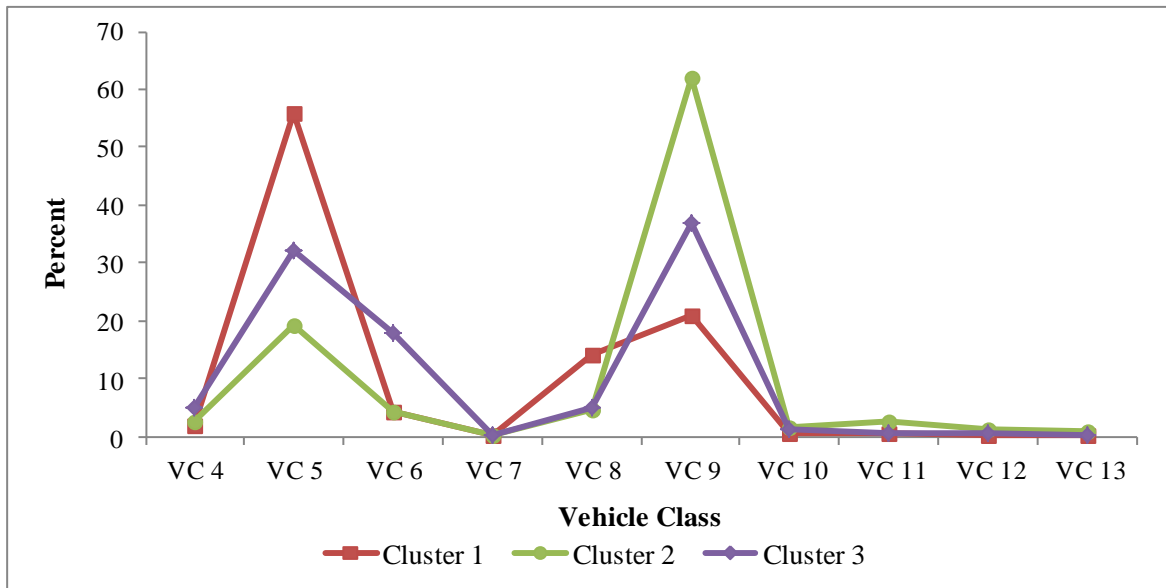
Vehicle Class Distribution and Growth				Load Default Distribution
Vehicle Class	Distribution (%)	Growth Rate (%)	Growth Function	
Class 4	2.1	1.74	Compound	
Class 5	56.1	1.74	Compound	
Class 6	4.4	1.74	Compound	
Class 7	0.3	1.74	Compound	
Class 8	14.2	1.74	Compound	
Class 9	21.1	1.74	Compound	
Class 10	0.7	1.74	Compound	
Class 11	0.7	1.74	Compound	
Class 12	0.2	1.74	Compound	
Class 13	0.2	1.74	Compound	
Total	100			

Figure 3.7 M-E Design Software Screenshot of Vehicle Class Distribution



**Table 3.6 Level 2 CDOT Vehicle Class Distribution Factors**

Vehicle Class	Cluster 1 (Predominately Class 5)	Cluster 2 (Predominately Class 9)	Cluster 3 (Predominately Class 5 and 9)
	4-Lane Rural Principal Arterial (Non-Interstate)	4-Lane Rural Principal Arterial (Interstates and Highways)	2-Lane Rural Principal Arterial (other) 2-Lane Rural Major Collector 4-Lane Urban Principal Arterial
4	2.1	2.7	5.1
5	56.1	19.3	32.3
6	4.4	4.5	18
7	0.3	0.3	0.3
8	14.2	4.6	4.9
9	21.1	61.9	36.8
10	0.7	1.6	1.2
11	0.7	2.7	0.7
12	0.2	1.3	0.5
13	0.2	1.1	0.2



**Figure 3.8 Vehicle Class Distribution Factors for CDOT Clusters**

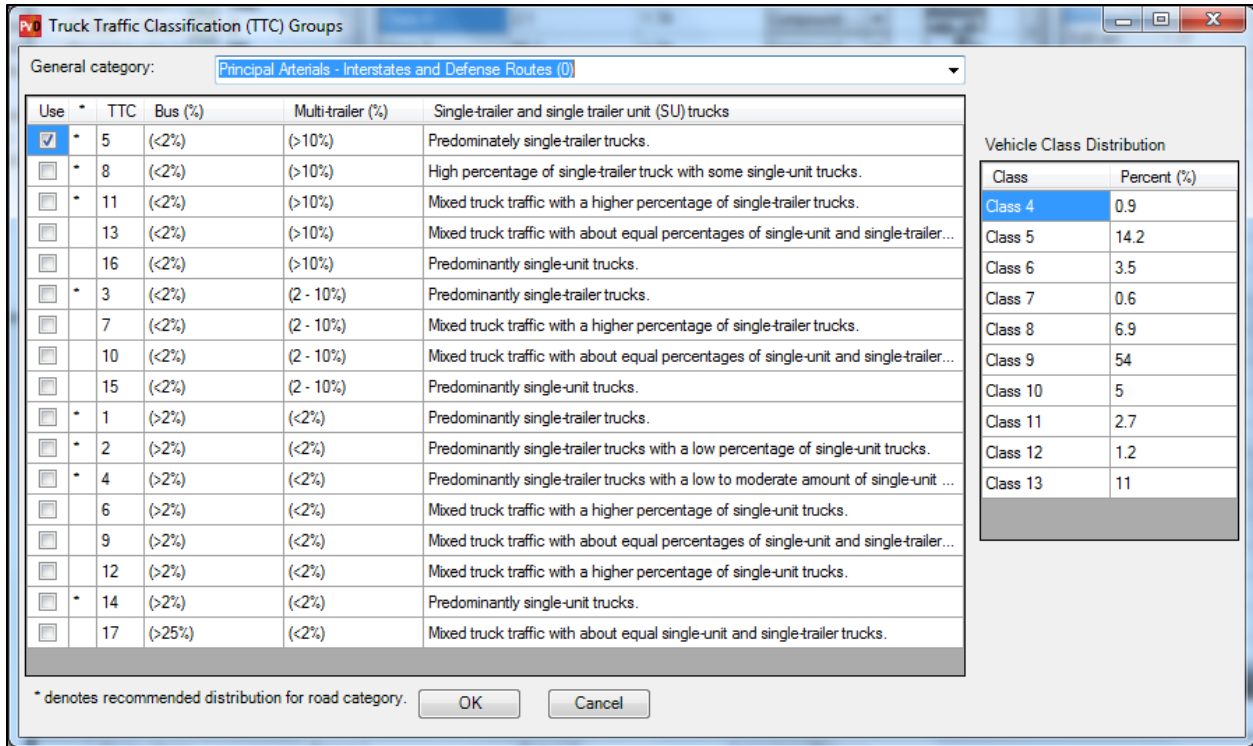


Figure 3.9 Truck Traffic Classification Groups

### 3.1.7 Number of Axles per Truck

This input represents the average number of axles for each truck class (FHWA vehicle Class 4 to 13) and each axle type (single, tandem, tridem, and quad). For the M-E Design, the number of axles per truck can be defined at three hierarchical input levels. **Figure 3.8 M-E Design Screenshot of Number of Axles Per Truck** presents the M-E Design software screenshot for the number of axles per truck. Three input levels are described in the following sections.

#### 3.1.7.1 Level 1 Number of Axles Per Truck

Level 1 inputs are the actual measured site data and must be used for highways with heavy seasonal and atypical traffic. This data can be obtained from the CDOT DTD.

#### 3.1.7.2 Level 2 Number of Axles Per Truck

Level 2 inputs are the statewide average values determined from traffic analyses of data from various WIM and AVC sites in Colorado. Refer to **Table 3.7 Level 2 Number of Axles Per Truck** for CDOT statewide averages.

#### 3.1.7.3 Level 3 Number of Axles Per Truck

Level 3 inputs are the M-E Design software defaults. This level is not recommended.

Axles Per Truck				
Vehicle Class	Single	Tandem	Tridem	Quad
Class 4	1.53	0.45	0	0
Class 5	2.02	0.16	0.02	0
Class 6	1.12	0.93	0	0
Class 7	1.19	0.07	0.45	0.02
Class 8	2.41	0.56	0.02	0
Class 9	1.16	1.88	0.01	0
Class 10	1.05	1.01	0.93	0.02
Class 11	4.35	0.13	0	0
Class 12	3.15	1.22	0.09	0
Class 13	2.77	1.4	0.51	0.04

**Figure 3.10 M-E Design Screenshot of Number of Axles Per Truck**

**Table 3.7 Level 2 Number of Axles Per Truck**

Vehicle Class	Single Axle	Tandem Axle	Tridem Axle	Quad Axle
4	1.53	0.45	0.00	0.00
5	2.02	0.16	0.02	0.00
6	1.12	0.94	0.00	0.00
7	1.19	0.07	0.45	0.02
8	2.41	0.56	0.02	0.00
9	1.16	1.90	0.01	0.00
10	1.15	1.01	0.93	0.02
11	4.35	0.29	0.02	0.00
12	3.27	1.22	0.09	0.00
13	2.77	1.40	0.51	0.04

### 3.1.8 Monthly Adjustment Factors (Trucks)

Truck traffic monthly adjustment factors represent the proportion of the annual truck traffic for a given truck class that occurs in a specific month. The sum of monthly factors for all months for each vehicle class must equal 12. These monthly distribution factors may be determined from WIM, AVC, or manual truck traffic counts. Axle data shall come from CDOT’s data base.

For the M-E Design, the monthly adjustment factors can be defined at three hierarchical input levels, see **Figure 3.9 M-E Design Screenshot of Monthly Adjustment Factors**. The input levels are described in the following sections.

### 3.1.8.1 Level 1 Monthly Adjustment Factors

Level 1 inputs are the actual measured site data and must be used for highways with heavy seasonal and atypical traffic. This data can be obtained from the CDOT DTD.

### 3.1.8.2 Level 2 Monthly Adjustment Factors

Level 2 inputs are the statewide average values determined from traffic analyses of data from various WIM and AVC sites in Colorado. Refer to **Table 3.8 Level 2 Monthly Adjustment Factors** for Level 2 averages. The axle data and clusters shall come from CDOT’s data base.

### 3.1.8.3 Level 3 Monthly Adjustment Factors

Level 3 inputs are the M-E Design software defaults. This level is not recommended for use on CDOT projects

**Table 3.8 Level 2 Monthly Adjustment Factors**

Month	Vehicle/Truck Class									
	4	5	6	7	8	9	10	11	12	13
<b>Jan</b>	0.885	0.820	0.765	0.745	0.822	0.930	0.889	0.905	0.918	0.862
<b>Feb</b>	0.899	0.824	0.782	0.771	0.873	0.938	0.888	0.888	0.976	0.830
<b>Mar</b>	0.963	0.900	0.843	1.066	0.993	0.990	0.997	0.983	0.919	0.925
<b>Apr</b>	1.037	1.007	0.941	1.023	1.009	1.029	1.060	0.987	1.031	1.050
<b>May</b>	1.078	1.102	1.030	1.266	1.095	1.043	1.088	1.091	1.123	0.999
<b>Jun</b>	1.054	1.147	1.203	1.149	1.146	1.029	1.067	0.976	1.083	1.035
<b>Jul</b>	1.103	1.209	1.467	1.279	1.175	0.995	1.090	1.057	1.082	1.255
<b>Aug</b>	1.117	1.158	1.275	1.034	1.148	1.049	1.089	1.101	1.055	0.968
<b>Sep</b>	1.064	1.114	1.116	1.032	1.050	1.041	1.066	1.070	0.976	1.081
<b>Oct</b>	1.029	1.011	0.966	0.979	0.985	1.043	1.017	1.031	0.944	1.103
<b>Nov</b>	0.912	0.906	0.857	0.862	0.879	1.004	0.951	0.998	1.001	1.031
<b>Dec</b>	0.859	0.802	0.755	0.794	0.825	0.909	0.798	0.913	0.892	0.861

Monthly Adjustment										
Month	Class 4	Class 5	Class 6	Class 7	Class 8	Class 9	Class 10	Class 11	Class 12	Class 13
January	0.885	0.82	0.765	0.745	0.822	0.93	0.889	0.905	0.918	0.862
February	0.899	0.824	0.782	0.771	0.873	0.938	0.888	0.888	0.976	0.83
March	0.963	0.9	0.843	1.066	0.993	0.99	0.997	0.983	0.919	0.925
April	1.037	1.007	0.941	1.023	1.009	1.029	1.06	0.987	1.031	1.05
May	1.078	1.102	1.03	1.266	1.095	1.043	1.088	1.091	1.123	0.999
June	1.054	1.147	1.203	1.149	1.146	1.029	1.067	0.976	1.083	1.035
July	1.103	1.209	1.467	1.279	1.175	0.995	1.09	1.057	1.082	1.255
August	1.117	1.158	1.275	1.034	1.148	1.049	1.089	1.101	1.055	0.968
Septem...	1.064	1.114	1.116	1.032	1.05	1.041	1.066	1.07	0.976	1.081
October	1.029	1.011	0.966	0.979	0.985	1.043	1.017	1.031	0.944	1.103
Novem...	0.912	0.906	0.857	0.862	0.879	1.004	0.951	0.998	1.001	1.031
Decem...	0.859	0.802	0.755	0.794	0.825	0.909	0.798	0.913	0.892	0.861

**Figure 3.11 M-E Design Screenshot of Monthly Adjustment Factors**

### 3.1.9 Hourly Distribution Factors (Trucks)

The hourly distribution factors represent the percentage of the total truck traffic within each hour of the day and are required for the analysis of only rigid pavements. Site-specific hourly distribution factors may be estimated from WIM, AVC, or manual truck traffic counts.

For the M-E Design, the hourly distribution factors can be defined at three hierarchical input levels. The three input levels are described in the following sections.

#### 3.1.9.1 Level 1 Hourly Distribution Factors

Level 1 inputs are the actual measured site data and must be used for highways with heavy seasonal and atypical traffic. This data can be obtained from the CDOT DTD.

#### 3.1.9.2 Level 2 Hourly Distribution Factors

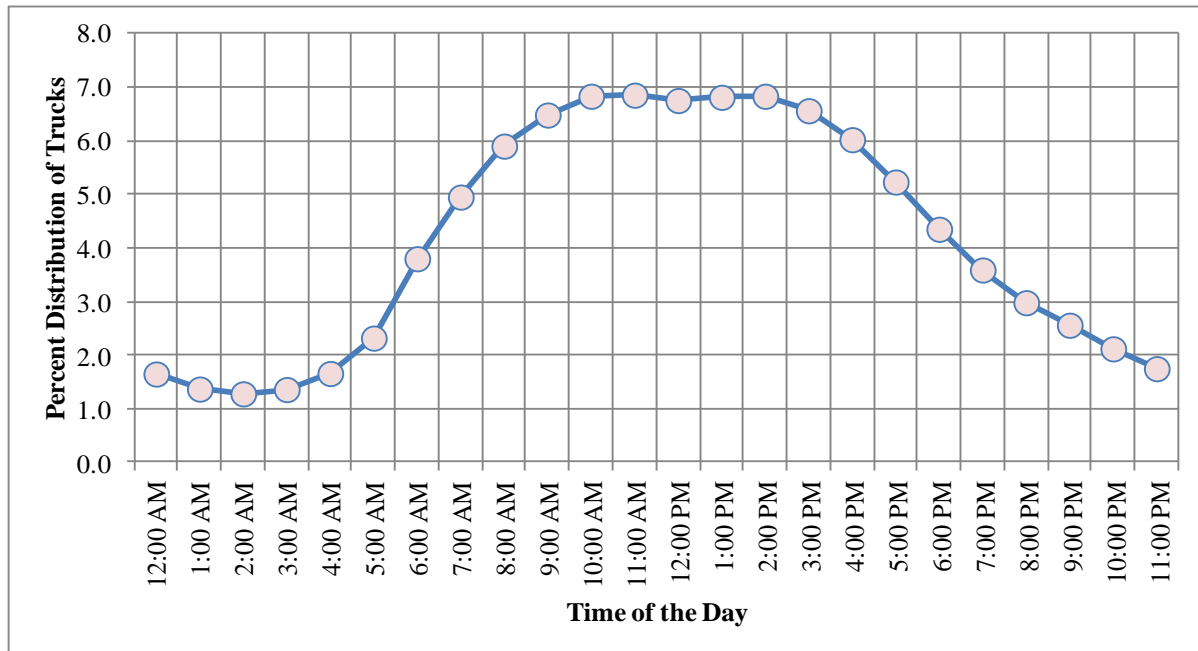
Level 2 inputs are the statewide average values determined from traffic analyses of data from various WIM and AVC sites in Colorado. Refer to **Table 3.9 Hourly Distribution Factors** and **Figure 3.10 Level 2 hourly Distribution Factors for Level 2 Averages**. The axle data and clusters shall come from CDOT’s database.

### 3.1.9.3 Level 3 Hourly Distribution Factors

Level 3 inputs are the M-E Design software defaults. This level is not recommended.

**Table 3.9 Hourly Distribution Factors**

Time Period	Distribution, percent	Time Period	Distribution, percent
12:00 a.m. - 1:00 a.m.	1.65	12:00 p.m. - 1:00 p.m.	6.75
1:00 a.m. - 2:00 a.m.	1.37	1:00 p.m. - 2:00 p.m.	6.81
2:00 a.m. - 3:00 a.m.	1.28	2:00 p.m. - 3:00 p.m.	6.83
3:00 a.m. - 4:00 a.m.	1.36	3:00 p.m. - 4:00 p.m.	6.56
4:00 a.m. - 5:00 a.m.	1.66	4:00 p.m. - 5:00 p.m.	6.02
5:00 a.m. - 6:00 a.m.	2.32	5:00 p.m. - 6:00 p.m.	5.23
6:00 a.m. - 7:00 a.m.	3.80	6:00 p.m. - 7:00 p.m.	4.35
7:00 a.m. - 8:00 a.m.	4.95	7:00 p.m. - 8:00 p.m.	3.59
8:00 a.m. - 9:00 a.m.	5.90	8:00 p.m. - 9:00 p.m.	2.98
9:00 a.m. - 10:00 a.m.	6.48	9:00 p.m. - 10:00 p.m.	2.56
10:00 a.m. - 11:00 a.m.	6.83	10:00 p.m. - 11:00 p.m.	2.12
11:00 a.m. - 12:00 p.m.	6.85	11:00 p.m. - 12:00 a.m.	1.75



**Figure 3.12 Level 2 Hourly Distribution Factors**

### 3.1.10 Axle Load Distribution

The axle load distribution factors represent the percentage of the total axle applications within each load interval for a specific axle type (single, tandem, tridem, and quad) and vehicle class (Classes 4 through 13). A definition of load intervals for each axle type is provided below:

- **Single Axles:** 3,000 lb. to 40,000 lb. at 1,000-lb. intervals
- **Tandem Axles:** 6,000 lb. to 80,000 lb. at 2,000-lb. intervals
- **Tridem and Quad Axles:** 12,000 lb. to 102,000 lb. at 3,000-lb. intervals. Developing site-specific axle load distribution factors involves the processing of a massive amount of WIM data. The processing should be completed external to the M-E Design software using traffic loading analysis software.

For M-E Design, the axle load distribution factors can be defined at three hierarchical input levels. See **Figure 3.11 Single Axle Distribution in the M-E Design Software** for a screenshot of axle load distribution factors in the M-E Design software. The input levels are described in the following sections.

#### 3.1.10.1 Level 1 Axle Load Distribution Factors

Level 1 inputs are the actual measured site data and must be used for highways with unique traffic characteristics and heavy haul routes (i.e. mining, lumber, and agricultural routes). This data can be obtained from the CDOT DTD.

#### 3.1.10.2 Level 2 Axle Load Distribution Factors

Level 2 inputs are the statewide average values determined from traffic analyses of data from various WIM and AVC sites in Colorado. **Table 3.10 Level 2 Axle Load Distribution Factors (Percentages)** through **Table 3.13 Level 2 Quad Axle Load Distribution Factors (Percentages)**, presents the CDOT averages of axle load distribution factors for single, tandem, tridem and quad axles for each truck class, respectively. The axle data and clusters shall come from CDOT's data base.

**Figure 3.12 CDOT Averages of Single Axle Load Distribution (Classes 5 and 9 only)** presents the load distributions of single axles for vehicle Classes 5 and 9. **Figure 3.13 CDOT Averages of Tandem Axle Load Distribution (Classes 5 and 9 only)** presents the load distributions of tandem axles for vehicle Classes 5 and 9. Electronic versions of the Level 2 axle load distributions factors can be obtained from the CDOT Pavement Design office.

#### 3.1.10.3 Level 3 Axle Load Distribution Factors

Level 3 inputs are the M-E Design software defaults. This level is not recommended for use on CDOT projects.

Month	Class	Total	3000	4000	5000	6000	7000	8000	9000	10000	11000	12000	13000	14000
January	4	99.97	0.28	0.73	1.77	5.18	8.12	12.73	10.08	11.45	9.11	9.81	6.59	7.11
January	5	100.01	3.69	9.71	14.2	17.72	12.56	11.97	7.19	6.2	3.63	3.19	1.71	1.93
January	6	100.02	2.73	2.86	3.85	4.77	4.61	7.48	9.46	14.63	11.36	10.35	5.42	5.76
January	7	100.01	3.78	3.45	2.25	2.75	3.07	3.85	3.32	6.38	7.33	8.54	6.63	6.61
January	8	100.01	7.61	6.63	7.1	8.63	8.44	11.24	9.57	10.41	6.57	5.67	3.15	3.56
January	9	100.02	1.42	2.5	2.93	3.43	3.39	5.89	9.34	18.41	17.14	14.29	5.72	4.45
January	10	99.99	0.92	1.23	1.93	3.3	3.66	6.43	9.17	16.61	15.03	13.75	6.74	6.86
January	11	100.02	1.69	2.17	3.87	6.46	6.14	7.89	8.72	12.31	9.15	8.6	5.12	6.85
January	12	99.98	2.2	3.48	5.08	7.98	7.27	10.22	11.02	14	9.32	8.24	4.47	5
January	13	100.01	3.13	3.18	3.4	6.19	5.25	7.45	7.88	9.91	7.39	8.07	5.02	7.52
February	4	99.99	0.23	0.81	1.74	5.33	8.49	12.67	10.35	11.55	9.15	9.72	6.51	7.1
February	5	100.02	3.98	10.45	15.97	19.7	13.19	11.09	6.08	5.2	2.96	2.58	1.39	1.6
February	6	100.01	2.73	2.85	3.84	4.81	5.06	7.94	9.89	14.79	11.42	10.11	5.22	5.35
February	7	100.03	4.9	1.93	2.27	1.32	4.43	3.99	2.65	4.74	8.66	9.29	7.32	8.44
February	8	99.97	7.33	6.45	7.07	8.51	8.59	11.42	9.48	10.35	6.54	5.62	3.22	3.55
February	9	100	1.47	2.53	2.94	3.44	3.43	6.13	9.36	18.27	16.86	14.31	5.79	4.65
February	10	100	0.97	1.18	1.98	3.36	3.84	6.83	9.38	16.42	14.83	14.36	7.49	6.52
February	11	100.01	0.95	2.18	3.59	6.29	5.7	7.97	8.71	12.13	8.99	8.68	5.57	7.37
February	12	99.99	1.56	2.55	4.06	9.1	7.09	9.61	11.67	12.98	9.67	8.91	4.65	6.85
February	13	99.97	3	3.05	3.24	5.78	4.5	8.1	9.66	9.37	7.94	7.68	5.86	8.8
March	4	100	0.27	0.74	1.61	5.05	7.8	12.35	10.28	11.6	9.29	9.89	6.47	7.27
March	5	100	4.73	10.98	15.79	19.04	12.61	10.96	6.15	5.26	3.02	2.66	1.44	1.63

Figure 3.13 Single Axle Distribution in the M-E Design Software



**Table 3.10 Level 2 Single Axle Load Distribution Factors (Percentages)**

Mean Axle Load (lbs.)	Vehicle/Truck Class									
	4	5	6	7	8	9	10	11	12	13
3,000	0.24	4.71	2.19	3.49	8.44	1.39	0.76	1.85	1.51	2.59
4,000	0.78	11.26	2.75	3.13	7.28	2.51	1.41	2.11	2.97	3.03
5,000	1.77	16.33	3.98	2.56	7.40	3.00	2.30	3.59	4.66	3.27
6,000	5.24	18.85	5.03	2.64	8.36	3.54	3.49	6.44	8.65	5.20
7,000	8.19	12.49	4.79	2.86	8.10	3.41	3.73	6.09	7.66	4.89
8,000	12.87	10.93	7.67	3.92	10.75	5.87	6.41	8.41	10.14	7.37
9,000	10.32	6.13	9.77	3.87	9.17	9.19	9.18	9.19	11.54	8.06
10,000	11.46	5.22	15.52	5.65	10.06	18.64	17.04	12.53	14.27	10.20
11,000	9.21	2.97	12.24	6.04	6.37	17.62	15.60	9.05	9.77	8.25
12,000	9.87	2.56	10.78	7.46	5.59	14.63	14.47	8.87	8.93	8.60
13,000	6.45	1.39	5.47	6.33	3.07	5.65	7.00	5.49	4.75	5.97
14,000	7.05	1.62	5.52	8.39	3.56	4.26	6.33	6.88	5.34	8.08
15,000	4.78	1.15	3.54	7.22	2.55	2.32	3.63	5.22	3.41	6.20
16,000	2.68	0.69	2.06	5.82	1.55	1.50	1.92	3.20	1.74	3.64
17,000	2.53	0.79	2.15	7.44	1.76	1.64	1.80	3.50	1.70	3.88
18,000	1.56	0.52	1.42	4.57	1.18	1.23	1.05	2.15	0.76	2.19
19,000	1.35	0.51	1.28	4.82	1.15	1.11	0.80	1.84	0.63	1.96
20,000	0.83	0.33	0.79	3.63	0.73	0.68	0.54	1.01	0.35	1.20
21,000	0.76	0.32	0.67	2.78	0.65	0.51	0.51	0.82	0.26	0.94
22,000	0.47	0.21	0.42	1.79	0.38	0.30	0.31	0.40	0.20	0.58
23,000	0.41	0.22	0.36	1.46	0.34	0.23	0.26	0.29	0.18	0.51
24,000	0.23	0.15	0.23	0.76	0.20	0.16	0.22	0.26	0.09	0.42
25,000	0.20	0.16	0.21	0.62	0.19	0.14	0.20	0.14	0.08	0.45
26,000	0.13	0.12	0.15	0.53	0.13	0.09	0.14	0.08	0.05	0.47
27,000	0.11	0.08	0.13	0.60	0.12	0.08	0.13	0.08	0.07	0.29
28,000	0.06	0.03	0.08	0.33	0.07	0.05	0.08	0.06	0.04	0.12
29,000	0.07	0.03	0.08	0.31	0.07	0.04	0.08	0.06	0.04	0.17
30,000	0.06	0.02	0.06	0.30	0.05	0.03	0.06	0.05	0.03	0.10
31,000	0.03	0.02	0.04	0.09	0.04	0.02	0.04	0.03	0.01	0.07
32,000	0.03	0.02	0.04	0.16	0.04	0.02	0.04	0.03	0.01	0.08
33,000	0.02	0.01	0.03	0.11	0.03	0.01	0.03	0.02	0.01	0.06
34,000	0.02	0.01	0.03	0.05	0.03	0.01	0.05	0.02	0.00	0.09
35,000	0.01	0.01	0.02	0.02	0.02	0.01	0.01	0.01	0.00	0.03
36,000	0.01	0.01	0.02	0.01	0.02	0.01	0.03	0.01	0.01	0.05
37,000	0.01	0.00	0.02	0.04	0.02	0.00	0.01	0.01	0.00	0.03
38,000	0.01	0.01	0.02	0.02	0.02	0.00	0.01	0.02	0.00	0.05
39,000	0.00	0.00	0.01	0.01	0.01	0.00	0.02	0.00	0.00	0.03
40,000	0.00	0.00	0.01	0.03	0.02	0.00	0.01	0.00	0.00	0.02
41,000	0.14	0.14	0.42	0.16	0.45	0.09	0.31	0.18	0.11	0.89

**Table 3.11 Level 2 Tandem Axle Load Distribution Factors (Percentages)**

Mean Axle Load, lbs.	Vehicle/Truck Class									
	4	5	6	7	8	9	10	11	12	13
6,000	0.41	38.29	2.94	12.80	18.36	3.21	0.90	4.34	2.19	3.22
8,000	1.51	24.51	7.75	2.15	9.01	5.20	1.57	1.62	3.19	3.76
10,000	2.68	16.41	12.42	3.45	9.79	7.57	3.08	3.78	4.89	5.06
12,000	4.17	8.75	12.11	3.65	10.51	8.61	5.30	6.50	9.15	7.11
14,000	4.46	4.66	9.72	3.15	10.15	8.29	7.08	13.11	10.75	8.50
16,000	4.82	2.61	7.83	0.70	8.39	7.24	8.17	8.03	11.61	8.73
18,000	6.53	1.60	6.30	2.20	6.65	6.08	8.73	8.03	12.58	8.04
20,000	8.19	1.03	5.26	0.65	5.50	5.21	8.66	8.31	12.86	7.51
22,000	9.39	0.71	4.49	3.40	4.33	4.74	8.02	9.39	10.78	7.33
24,000	10.04	0.49	3.86	4.00	3.33	4.50	7.08	9.00	8.14	6.27
26,000	9.41	0.31	3.47	6.15	2.41	4.53	6.35	8.10	5.33	5.05
28,000	8.81	0.21	3.20	2.10	1.83	4.77	6.00	6.46	3.37	4.19
30,000	8.53	0.14	3.32	4.35	1.60	5.41	5.67	4.88	2.06	4.46
32,000	6.48	0.08	2.94	3.15	1.19	5.40	4.73	2.95	0.97	3.34
34,000	4.95	0.05	2.71	5.85	1.08	5.48	4.21	2.16	0.55	2.91
36,000	3.51	0.03	2.48	5.85	0.97	4.66	3.51	1.02	0.33	2.83
38,000	2.10	0.02	2.15	7.55	0.88	3.28	2.54	0.61	0.34	2.16
40,000	1.29	0.02	1.74	6.05	0.74	2.01	1.99	0.44	0.27	2.17
42,000	0.78	0.01	1.39	4.00	0.60	1.20	1.64	0.32	0.15	1.34
44,000	0.52	0.01	1.05	2.50	0.50	0.77	1.10	0.19	0.09	0.83
46,000	0.37	0.01	0.75	3.85	0.39	0.52	0.81	0.09	0.04	0.84
48,000	0.26	0.00	0.52	1.20	0.30	0.36	0.70	0.09	0.12	0.93
50,000	0.19	0.00	0.37	1.60	0.23	0.26	0.53	0.08	0.03	0.62
52,000	0.13	0.02	0.34	4.15	0.19	0.19	0.37	0.05	0.02	0.87
54,000	0.11	0.01	0.24	1.15	0.15	0.14	0.26	0.04	0.02	0.31
56,000	0.08	0.01	0.18	1.40	0.13	0.10	0.20	0.05	0.04	0.28
58,000	0.05	0.00	0.12	0.15	0.11	0.07	0.16	0.03	0.01	0.23
60,000	0.04	0.00	0.08	1.00	0.08	0.05	0.15	0.03	0.02	0.15
62,000	0.03	0.00	0.06	0.75	0.07	0.04	0.11	0.07	0.01	0.12
64,000	0.02	0.00	0.05	0.60	0.05	0.03	0.07	0.02	0.00	0.22
66,000	0.01	0.00	0.03	0.00	0.05	0.02	0.05	0.01	0.00	0.09
68,000	0.01	0.00	0.03	0.00	0.03	0.02	0.10	0.01	0.00	0.11
70,000	0.01	0.00	0.01	0.00	0.03	0.01	0.03	0.01	0.00	0.04
72,000	0.00	0.00	0.02	0.40	0.02	0.01	0.03	0.01	0.00	0.05
74,000	0.01	0.00	0.01	0.00	0.03	0.01	0.01	0.01	0.00	0.05
76,000	0.00	0.00	0.01	0.00	0.02	0.00	0.02	0.01	0.00	0.03
78,000	0.00	0.00	0.00	0.00	0.02	0.00	0.01	0.01	0.00	0.02
80,000	0.00	0.00	0.00	0.00	0.02	0.00	0.01	0.01	0.00	0.02
82,000	0.05	0.00	0.05	0.00	0.23	0.04	0.06	0.16	0.05	0.25

**Table 3.12 Level 2 Tridem Axle Load Distribution Factors (Percentages)**

Mean Axle Load, lbs.	Vehicle/Truck Class									
	4	5	6	7	8	9	10	11	12	13
12,000	0.00	65.36	0.00	4.82	11.33	38.87	15.53	0.00	19.21	3.20
15,000	0.00	17.43	0.00	3.96	7.69	11.93	10.88	0.00	6.55	4.21
18,000	0.00	8.73	0.00	3.78	9.59	8.99	9.05	0.00	6.99	4.87
21,000	0.00	4.26	0.00	6.28	9.32	5.50	7.23	0.00	14.85	3.31
24,000	0.00	1.65	0.00	3.79	7.83	3.82	6.03	0.00	3.22	2.59
27,000	0.00	0.98	0.00	5.04	7.42	3.24	6.05	0.00	0.63	3.11
30,000	0.00	0.48	0.00	4.84	7.77	2.90	5.79	0.00	3.41	3.75
33,000	0.00	0.24	0.00	5.82	5.88	2.90	5.78	0.00	6.59	4.29
36,000	0.00	0.34	0.00	8.30	5.45	2.93	6.49	0.00	6.02	5.24
39,000	0.00	0.12	0.00	8.19	4.74	2.65	5.87	0.00	5.54	6.88
42,000	0.00	0.11	0.00	9.17	4.17	2.76	5.58	0.00	6.16	7.31
45,000	0.00	0.06	0.00	8.36	3.60	2.52	4.06	0.00	2.33	6.91
48,000	0.00	0.06	0.00	7.35	3.02	2.14	2.71	0.00	5.15	6.34
51,000	0.00	0.06	0.00	4.93	2.75	2.12	2.23	0.00	4.50	6.75
54,000	0.00	0.03	0.00	3.28	1.49	1.67	1.68	0.00	2.97	7.60
57,000	0.00	0.04	0.00	3.77	1.64	1.46	1.36	0.00	2.37	5.84
60,000	0.00	0.01	0.00	1.22	1.32	0.98	1.05	0.00	0.00	5.41
63,000	0.00	0.01	0.00	2.88	0.62	0.60	0.69	0.00	3.23	4.18
66,000	0.00	0.00	0.00	0.86	0.47	0.46	0.53	0.00	0.10	2.55
69,000	0.00	0.00	0.00	0.55	0.49	0.35	0.40	0.00	0.16	1.56
72,000	0.00	0.00	0.00	0.50	0.36	0.25	0.26	0.00	0.00	1.08
75,000	0.00	0.00	0.00	0.46	0.38	0.21	0.22	0.00	0.00	0.78
78,000	0.00	0.00	0.00	0.43	0.57	0.15	0.13	0.00	0.00	0.57
81,000	0.00	0.00	0.00	0.25	0.36	0.13	0.10	0.00	0.00	0.43
84,000	0.00	0.01	0.00	0.42	0.24	0.08	0.08	0.00	0.00	0.34
87,000	0.00	0.00	0.00	0.09	0.12	0.07	0.05	0.00	0.00	0.33
90,000	0.00	0.00	0.00	0.53	0.24	0.06	0.03	0.00	0.00	0.22
93,000	0.00	0.00	0.00	0.01	0.09	0.04	0.02	0.00	0.00	0.11
96,000	0.00	0.00	0.00	0.02	0.09	0.03	0.02	0.00	0.00	0.03
99,000	0.00	0.00	0.00	0.01	0.03	0.01	0.01	0.00	0.00	0.04
102,000	0.00	0.01	0.00	0.10	0.90	0.17	0.06	0.00	0.00	0.18

**Table 3.13 Level 2 Quad Axle Load Distribution Factors (Percentages)**

Mean Axle Load, lbs.	Vehicle/Truck Class									
	4	5	6	7	8	9	10	11	12	13
12,000	0.00	0.00	0.00	0.00	0.00	41.50	39.41	0.00	0.00	13.63
15,000	0.00	0.00	0.00	3.73	0.00	0.00	6.08	0.00	0.00	3.04
18,000	0.00	0.00	0.00	0.00	0.00	0.00	5.50	0.00	0.00	4.15
21,000	0.00	0.00	0.00	16.67	0.00	0.15	16.55	0.00	0.00	4.46
24,000	0.00	0.00	0.00	0.17	0.00	0.00	0.60	0.00	0.00	19.83
27,000	0.00	0.00	0.00	0.00	0.00	0.00	1.10	0.00	0.00	1.99
30,000	0.00	0.00	0.00	0.00	0.00	0.00	0.78	0.00	47.75	1.84
33,000	0.00	0.00	0.00	0.00	0.00	8.35	1.16	0.00	14.70	5.11
36,000	0.00	0.00	0.00	0.00	0.00	50.00	2.23	0.00	19.35	1.89
39,000	0.00	0.00	0.00	0.00	0.00	0.00	1.60	0.00	13.80	4.63
42,000	0.00	0.00	0.00	0.00	0.00	0.00	0.96	0.00	0.00	5.71
45,000	0.00	0.00	0.00	0.00	0.00	0.00	3.04	0.00	0.00	1.21
48,000	0.00	0.00	0.00	15.00	0.00	0.00	2.14	0.00	1.90	3.81
51,000	0.00	0.00	0.00	0.00	0.00	0.00	1.34	0.00	0.00	3.76
54,000	0.00	0.00	0.00	0.00	0.00	0.00	1.39	0.00	0.00	4.01
57,000	0.00	0.00	0.00	0.00	0.00	0.00	1.95	0.00	2.45	1.80
60,000	0.00	0.00	0.00	33.33	0.00	0.00	5.33	0.00	0.00	3.31
63,000	0.00	0.00	0.00	0.00	0.00	0.00	2.20	0.00	0.00	2.49
66,000	0.00	0.00	0.00	14.47	0.00	0.00	3.08	0.00	0.00	3.46
69,000	0.00	0.00	0.00	16.67	0.00	0.00	0.88	0.00	0.00	2.80
72,000	0.00	0.00	0.00	0.00	0.00	0.00	0.46	0.00	0.00	1.38
75,000	0.00	0.00	0.00	0.00	0.00	0.00	0.14	0.00	0.00	2.04
78,000	0.00	0.00	0.00	0.00	0.00	0.00	0.08	0.00	0.00	0.45
81,000	0.00	0.00	0.00	0.00	0.00	0.00	0.25	0.00	0.00	0.28
84,000	0.00	0.00	0.00	0.00	0.00	0.00	0.19	0.00	0.00	1.60
87,000	0.00	0.00	0.00	0.00	0.00	0.00	0.01	0.00	0.00	0.03
90,000	0.00	0.00	0.00	0.00	0.00	0.00	0.00	0.00	0.00	0.71
93,000	0.00	0.00	0.00	0.00	0.00	0.00	0.00	0.00	0.00	0.00
96,000	0.00	0.00	0.00	0.00	0.00	0.00	0.00	0.00	0.00	0.00
99,000	0.00	0.00	0.00	0.00	0.00	0.00	1.61	0.00	0.00	0.00
102,000	0.00	0.00	0.00	0.00	0.00	0.00	0.00	0.00	0.00	0.56

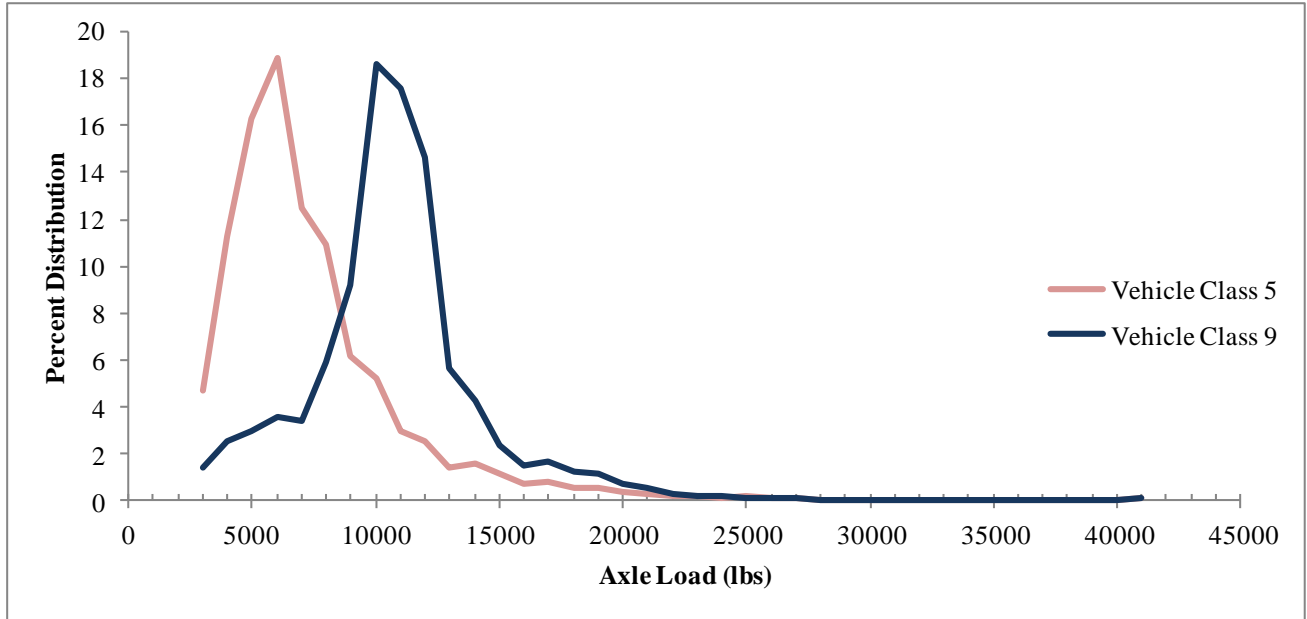


Figure 3.14 CDOT Averages of Single Axle Load Distribution (Classes 5 and 9 only)

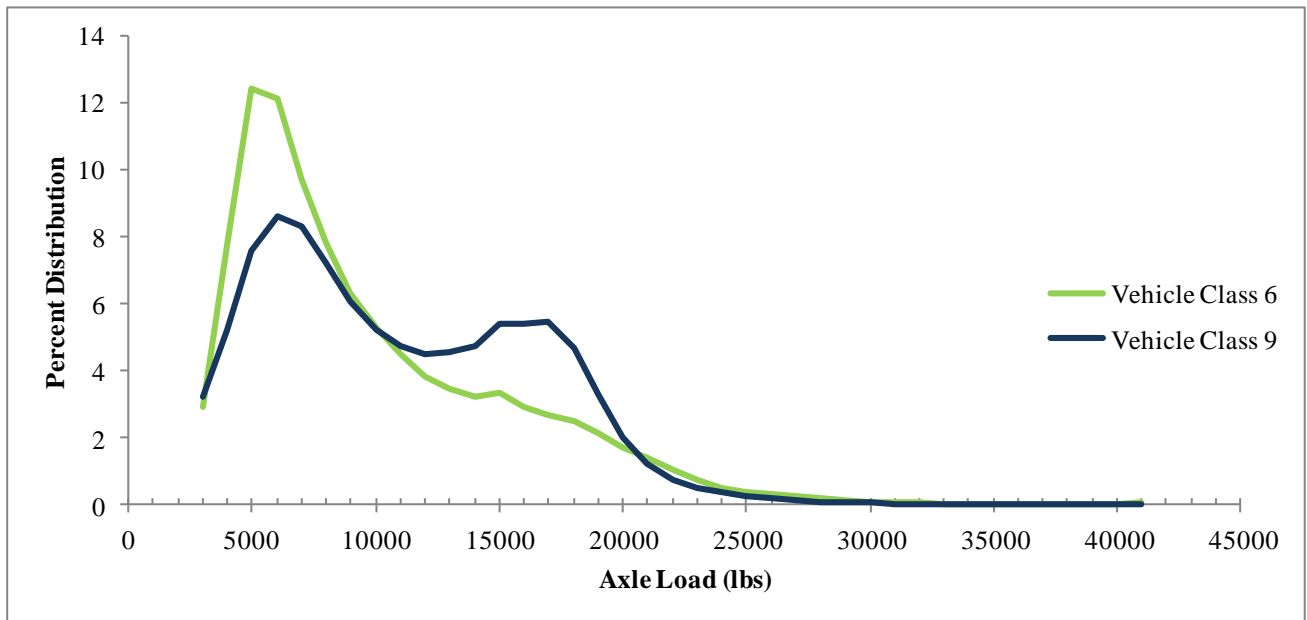


Figure 3.15 CDOT Averages of Tandem Axle Load Distribution (Classes 5 and 9 only)

### 3.1.11 Vehicle Operational Speed (Trucks)

The vehicle operational speed of trucks or the average travel speed generally depends on many factors, including the roadway facility type (interstate or otherwise), terrain, percentage of trucks in the traffic stream, and so on. Truck speed has a significant impact on the HMA dynamic modulus ( $E^*$ ) and the predicted performance. Lower speeds resulting higher incremental damage, i.e. more fatigue cracking or deeper ruts or faulting. The posted truck speed limit is suggested unless local site conditions, such as a steep upgrade or bus stop, require a lower speed.

#### 3.1.11.1 Lateral Wander of Axle Loads

The inputs required for characterizing lateral wander (see **Figure 3.14 M-E Design Software Screenshot of Traffic Lateral Wander**) include the following:

- **Mean Wheel Location:** This is the distance from the outer edge of the wheel to the pavement marking (see **Figure 3.15 Schematic of Mean Wheel Location**). The M-E Design software provides a default value of 18 inches which is recommended unless a measure value is available.
- **Traffic Wander Standard Deviation:** This is the standard deviation of the lateral traffic wander. The wander is used to predict distress and performance by determining the number of axle load applications over a specified point. For standard lane widths, a standard deviation value of 10 inches is suggested unless a measured value is available. A lower or higher lateral wander value is suggested for narrower or wider lanes, respectively.
- **Design Lane Width:** This is the distance between the lane markings on either side of the design lane (see **Figure 3.16 Schematic of Design Lane Width**).

▾ Lateral Wander		
Mean wheel location (in.)	<input checked="" type="checkbox"/>	18
Traffic wander standard deviation (in.)	<input checked="" type="checkbox"/>	10
Design lane width (ft)	<input checked="" type="checkbox"/>	12
▾ Wheelbase		

**Figure 3.16 M-E Design Software Screenshot of Traffic Lateral Wander**



Figure 3.17 Schematic of Mean Wheel Location

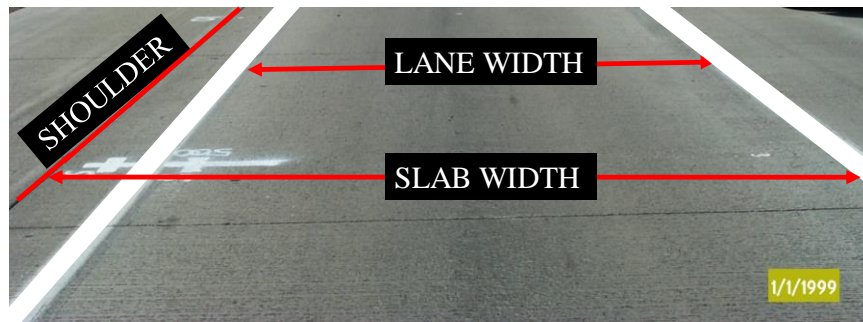


Figure 3.18 Schematic of Design Lane Width

### 3.1.12 Axle Configuration and Wheelbase

The inputs needed to describe the configurations of the typical tire and axle loads (see **Figure 3.17 Axle Configuration and Wheelbase in the M-E Design Software** and **Figure 3.18 Schematic of Axle Configuration and Wheel Base**) include:

- **Average Axle Width:** This input is the distance between two outside edges of an axle. The recommended value of axle width for trucks is 8.5 feet.
- **Dual Tire Spacing:** This input is the distance between centers of a dual tire. The recommended value of dual tire spacing for trucks is 12 inches.

<b>Wheelbase</b>		
Average spacing of short axles (ft)	✓	12
Average spacing of medium axles (ft)	✓	15
Average spacing of long axles (ft)	✓	18
Percent trucks with short axles	✓	33
Percent trucks with medium axles	✓	33
Percent trucks with long axles	✓	34
<b>Identifiers</b>		
<b>Axle Configuration</b>		
Average axle width (ft)	✓	8.5
Dual tire spacing (in.)	✓	12
Tire pressure (psi)	✓	120
Tandem axle spacing (in.)	✓	51.6
Tridem axle spacing (in.)	✓	49.2
Quad axle spacing (in.)	✓	49.2
<b>Lateral Wander</b>		

Figure 3.19 Axle Configuration and Wheelbase in the M-E Design Software

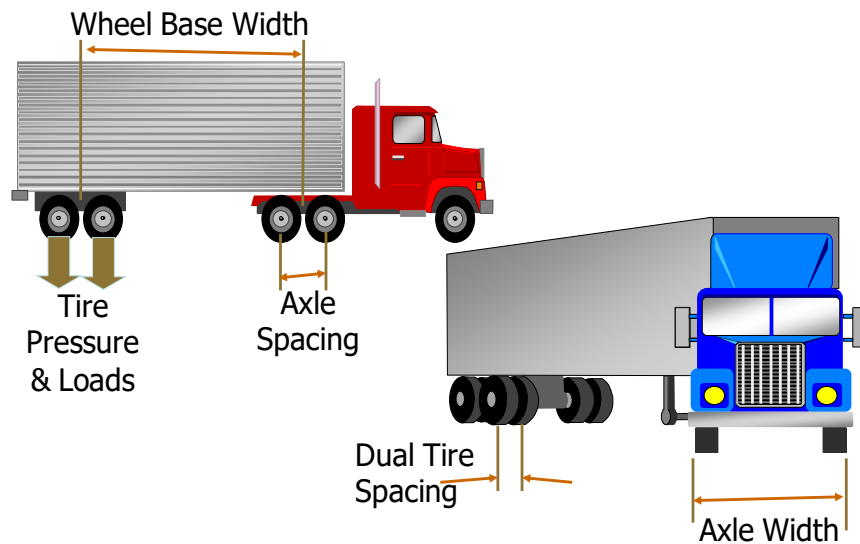


Figure 3.20 Schematic of Axle Configuration and Wheelbase

- Axle Spacing:** This input is the distance between the two consecutive axles of a tandem, tridem, or quad truck. It is used in determining the number of load applications for JPCP top-down cracking. The spacing of the axles is recorded in the WIM database. These values have been found to be relatively constant for the standard truck classes. The following values are suggested for use unless the predominant truck class has different axle spacing.
  - Tandem axle spacing: 51.6 inches
  - Tridem axle spacing: 49.2 inches
  - Quad axle spacing: 49.2 inches



- **Wheelbase:** This input is the distance between the centers of the front and rear axles. It is used in determining the number of load applications for JPCP top-down cracking. The wheelbase is recorded in the WIM database. The following national averages are suggested for use, unless site-specific wheelbase values are available.
  - Trucks with short spacing (10-13.5 feet): 17.5%
  - Trucks with medium spacing (13.5 to 16.5 feet): 21.6%
  - Trucks with long spacing (16.5 to 20.0 feet): 60.9%

### 3.1.13 Tire Pressure

Tire pressure may vary with the tire type. A constant value of hot inflation tire pressure representing the average operating conditions should be used. The hot inflation pressure is typically about 10 to 15 percent greater than the cold inflation pressure. A hot inflation tire pressure value of 120 psi is suggested for use unless a special loading condition is simulated.

### 3.1.14 Traffic Files in Electronic Format for the M-E Design Software

Designers can create their own traffic input files in electronic formats by directly inputting the data using the traffic input interface of the M-E Design software. This is not recommended for most of the required inputs with exceptions for simple inputs such as AADTT, growth rate, etc.

For more complex input types such as the axle load distribution or axles per truck, the designers can add Level 1 and 2 inputs in electronic format from the CDOT DTD. Level 3 input data can be retrieved directly from the M-E Design software.

## 3.2 Climate

Climate data for the M-E Design software is obtained from weather stations located throughout the state. Information from these stations (temperature, precipitation, wind speed, percent sunshine, and relative humidity) are used to predict the temperature and moisture profiles within the pavement structure during the design life. In addition, the M-E Design software requires the depth to groundwater table (GWT) as an input. The GWT is an important input in the program. Based on calculations from the climate data, the water level may change with seasonal precipitation creating thicker pavement structures. The closer to the surface the GWT is the more likely a thicker pavement structure will be needed. If the designer does not know the GWT then 10 feet, should be used. However, if the designer suspects the GWT is less than 10 feet but does not have boring data to confirm, a boring or other method should be used to determine the GWT. **Note:** The GWT depth value entered in the M-E Design software is the depth below the final pavement surface.

For critical designs, the GWT data can be obtained from Colorado Division of Water Resources database, United States Department of Agriculture (USDA) Natural Resources Conservation Service (NRCS) Soil Survey Geographic (SSURGO) database, or project-specific soil borings. For non-critical designs, one should guesstimate the GWT depth based on designer's experience.

### 3.2.1 Creating Project Specific Climate Input Files

The M-E Design software will identify the six closest weather stations for a given project location based on its geographic coordinates. Designers can select one or more weather stations based on the proximity to the project location. A single weather station can be selected when the project is within reasonable proximity. It is recommended that a virtual station may be made by selecting at least three surrounding weather stations. Proximity is defined in terms of longitude, latitude, and elevation. The designer should select the stations that are closest to the project in elevation and distance. Given Colorado's mountainous terrain, caution should be used if the elevations are significantly different even if the stations are relatively close to the project. The recommendations for selecting climatic inputs are presented in **Table 3.14 Recommendations for Climatic Inputs**. A screenshot of the climate tab from the M-E Design software is presented in **Figure 3.19 Climate Tab in the M-E Design Software**.

Climate data is currently available for 42 weather stations in Colorado, see **Figure 3.20 Location of Colorado Weather Stations**. Weather stations located near the border of neighboring states (Utah, Wyoming, Nebraska, New Mexico, Oklahoma, Kansas and Arizona) may also be used. **Table 3.14 Geographic Coordinates and Data Availability of Colorado Weather Stations** presents the geographic coordinates of Colorado weather stations, including start and end dates of available hourly weather records.

Climate data shown in **Table 3.15 Geographic Coordinates and Data Availability of Colorado Weather Stations** range from 3.9 to 55.9 years. M-E Design calculates the effects of the climate data using the following analysis.

#### 3.2.1.1 Design Life Greater Than Climate Data

If a project has a design life that exceeds the climate data, the program will repeat the climate data until the design life is met.

- **Example:** If a project has a 30 year design life and the station used is (23036) Buckley (also known as Aurora) which only has 10.3 years of data, the program will repeat the 10.3 years until it reaches 30 years. Thus, the data will be repeated 2.91 times.
- **Note:** If an anomaly year of significant freezing or heating exists within the data set, the effect of that year may be exaggerated since it may be used multiple times during a calculation. If this occurs, it is suggested that the designer use a virtual weather station if another station is in reasonable distance and elevation. Using two or more weather stations may help balance the data from the anomaly.

#### 3.2.1.2 Design Life Less Than the Climate Data

Some weather stations have an exceptional amount of climate data. The M-E Design Program uses the first years of data until the design life is met. This means the most current climate data is not used, rather the oldest which may be as indicative of current weather patterns. As such the designer should manually select the most current weather data from the 'Hourly Climate Data' tab

shown on **Figure 3.19 Climate Tab in the M-E Design Software**. This is done by scrolling down month and year bars and clicking on the ‘*Verify Weather*’ button.

- **Example:** A project has a 20 year design life and is using the (03065) Broomfield weather station, 25.6 years of climate data is available from September 1984 to March 2010. The designer needs to click on the ‘Hourly Climate Data’ tab and customize the weather data the program will use to be from 1990 to 2010.
- **Note:** During the mid and late 1970’s the United States experienced unusually cold, arctic periods for extended times. During this time areas became frozen and remained frozen, thus resulting in an increase in the freezing index and decrease in freeze/thaw cycles. Also, it appears that most locations in Colorado has had increased precipitation since the 1970’s, thus caution should be taken if data from the 1970 is used.

**Table 3.14 Recommendations for Climatic Inputs**

Climate Inputs	Recommendations
Weather Station $\leq$ 50 Miles and Elevation Difference $\leq$ 500 feet	Import specific weather station
Weather Station $>$ 50 Miles Elevation Difference $>$ 500 feet	Create a virtual weather station that includes two or more surrounding weather stations
Depth of Water Table (feet)	<p>Actual depth may be found in County Soil Reports<sup>1</sup>, project geotechnical reports, or an estimate based on the area. The depth of the water table typically ranges from 3 to 100 feet.</p> <p>If the water table is encountered within the upper 10 feet the designer should investigate dewatering methods and/or drains to lower the water table’s elevation. Separate designs should be made for areas that do not have a high water table versus those that do. If dewatering is not an option, the design will likely result in a thick pavement.</p>
<p><b>Note:</b> <sup>1</sup> The United States Department of Agriculture (USDA) Natural Resources Conservation Service (NRCS) Soil Survey Geographic (SSURGO) database. Another available resource for estimating depth of water table for a project site is the Colorado Division of Water Resources database and geologic well logs available online at <a href="http://www.nrcs.usda.gov/wps/portal/nrcs/main/soils/survey/geo/">http://www.nrcs.usda.gov/wps/portal/nrcs/main/soils/survey/geo/</a>.</p>	

25-10326:Climate

Summary | Hourly climate data

**Climate Station**

- Longitude (decimal degrees)  -105.09005
- Latitude (decimals degrees)  39.9653
- Elevation (ft)  5218
- Depth of water table (ft)  Annual(10)
- Climate station  DENVER,CO (03017)

**Identifiers**

- Display name/identifier
- Description of object
- Approver
- Date approved 10/3/2011 4:31 PM
- Author
- Date created 10/3/2011 4:31 PM
- County
- State
- District
- Direction of travel
- From station (miles)
- To station (miles)
- Highway
- Revision Number 0
- User defined field 1
- User defined field 2
- User defined field 3
- Item Locked? False

**Climate Summary**

- Mean annual air temperature (deg F) 50.4
- Mean annual precipitation (in.) 13.5
- Number of wet days 9.5
- Freezing index (deg F - days) 984
- Average annual number of freeze/thaw cycl 71.4

**Monthly Temperatures**

- Average temperature in January (deg F) 30.9
- Average temperature in February (deg F) 32.4
- Average temperature in March (deg F) 39.7
- Average temperature in April (deg F) 47.5
- Average temperature in May (deg F) 57.7
- Average temperature in June (deg F) 66.8
- Average temperature in July (deg F) 74.7
- Average temperature in August (deg F) 71.5
- Average temperature in September (deg F) 62.9
- Average temperature in October (deg F) 50.5
- Average temperature in November (deg F) 38.6
- Average temperature in December (deg F) 30.6

**Climate station**  
Climate station selected from hourly climatic database (optional)

**Mean annual air temperature (deg F)**

New\_AC\_Template (2018):Project | New\_AC\_Template (2018):Climate

Summary | Hourly climate data

March /1990 to March /2010 Weather

Date/Hour	Temperature (deg F)	Wind Speed (mph)	Sunshine (%)	Precipitation (in.)	Humidity (%)	Water Table (ft)
3/1/1990	29.9	6.9	2.4	0	82.1	10
3/1/1990 ...	29.9	6.5	1.9	0	82.5	10
3/1/1990 ...	30	6.1	1.6	0	82.8	10
3/1/1990 ...	30	4.9	1.2	0	83	10
3/1/1990 ...	30.1	3.9	1	0	83.2	10
3/1/1990 ...	30.1	3.8	0.8	0	85	10
3/1/1990 ...	30.1	4	0.6	0	86.4	10
3/1/1990 ...	29.8	3.2	0.5	0	87.5	10
3/1/1990 ...	29.9	2.6	0.4	0	88.4	10
3/1/1990 ...	29.9	2	0.3	0	89.1	10
3/1/1990 ...	30	1.6	0.3	0	89.7	10
3/1/1990 ...	30	2.2	0.2	0	90.2	10
3/1/1990 ...	29.8	1.8	0.2	0	88.3	10
3/1/1990 ...	29.7	2.4	0.1	0	86.9	10
3/1/1990 ...	29.6	3.1	15.1	0	86.3	10

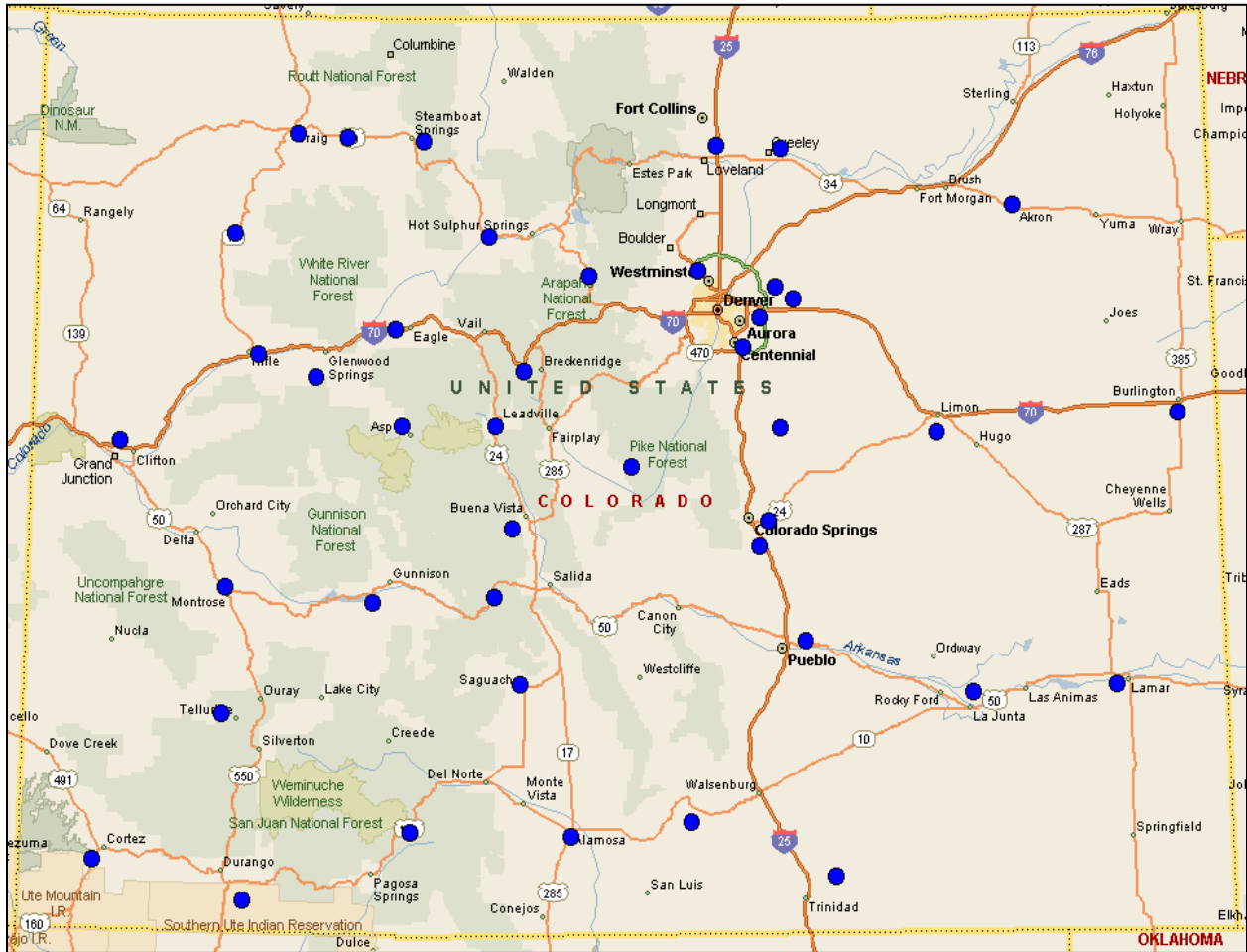
**Climate Station**

- Longitude (decimal degrees)  -105.117
- Latitude (decimals degrees)  39.909
- Elevation (ft)  5669.9
- Depth of water table (ft)  Annual(10)
- Climate station  BROOMFIELD,CO (03065)

**Identifiers**

- Display name/identifier
- Description of object
- Approver
- Date approved 8/26/2015
- Author
- Date created 8/26/2015
- County
- State
- District
- Direction of travel
- From station (miles)
- To station (miles)
- Highway
- Revision Number 0
- User defined field 1
- User defined field 2
- User defined field 3
- Item Locked? False

Figure 3.21 Climate Tab in the M-E Design Software



**Figure 3.22 Location of Colorado Weather Stations**

**Table 3.15 Geographic Coordinates and Data Availability of Colorado Weather Stations**

Station Number	Station	Latitude	Longitude	Elevation	Start Date	End Date	Years of Data
24015	Akron/Washington County	40.172	-103.232	4621	6/1/1973	3/31/2010	36.9
23061	Alamosa Muni(AWOS)	37.436	-105.866	7540.9	1/1/1973	3/31/2010	37.3
93073	Aspen Pitkin County SAR	39.223	-106.868	7742	1/1/1973	3/31/2010	37.3
23036	Aurora (Buckley AFB)	39.702	-104.752	5662	1/1/2000	3/31/2010	10.3
03065	Broomfield/Jefferson County	39.909	-105.117	5669.9	9/1/1984	3/31/2010	25.6
03026	Burlington	39.245	-102.284	4216.8	2/1/1999	3/31/2010	11.2
93067	Centennial	39.57	-104.849	5828	10/1/1983	3/31/2010	26.5
93037	Colorado Springs Municipal AP	38.812	-104.711	6169.9	1/1/1973	3/31/2010	37.3
03038	Copper Mountain Resort	39.467	-106.15	12074	8/1/2004	3/31/2010	5.7
93069	Cortez/Montezuma County	37.303	-108.628	5914	1/1/1973	3/31/2010	37.3
12341	Cottonwood Pass	38.783	-106.217	9826	7/1/2005	3/31/2010	4.8
24046	Craig-Moffat	40.495	-107.521	6192.8	9/1/1996	3/31/2010	13.6
03017	Denver (DIA) 03017	39.833	-104.658	5431	1/1/1995	3/31/2010	15.3
12342	Denver Nexrad 12342	39.783	-104.55	5606.9	5/1/2006	3/31/2010	3.9
93005	Durango/La Plata Airport	37.143	-107.76	6685	1/1/1973	3/31/2010	37.3
23063	Eagle County Airport	39.643	-106.918	6535	1/1/1973	3/31/2010	37.3
03040	Elbert County Airport	39.217	-104.633	7060	6/1/2004	3/31/2010	5.8
94015	Fort Carson/Butts	38.7	-104.767	5869.4	1/1/1969	3/31/2010	41.3
94062	Fort Collins Airport	40.452	-105.001	5016	5/1/1986	3/31/2010	23.9
12344	Glenwood Springs	39.433	-107.383	10603.5	7/1/2005	3/31/2010	4.7
23066	Grand Junction Airport	39.134	-108.538	4838.8	1/1/1973	3/31/2010	37.3
24051	Greeley/Weld County Airport	40.436	-104.618	4648.9	8/1/1991	3/31/2010	18.7
93007	Gunnison County Airport	38.452	-107.034	7673.8	4/1/1976	3/31/2010	34.0
94025	Hayden/Yampa (AWOS)	40.481	-107.217	6602	1/1/1973	5/31/2010	37.4
94076	Kremmling Airport	40.054	-106.368	7411	6/1/2004	3/31/2010	5.8
23067	La Junta Muni Airport	38.051	-103.527	4214.8	1/1/1961	3/31/2010	49.3
03042	La Veta Pass	37.5	-105.167	10216.7	7/1/2004	3/31/2010	5.8
03013	Lamar Muni Airport	38.07	-102.688	3070	1/1/1980	3/31/2010	30.3
93009	Leadville/Lake County Airport	39.228	-106.316	9926.7	7/1/1987	3/31/2010	22.8
93010	Limon Muni Airport	39.189	-103.716	5365.1	1/1/2004	3/31/2010	6.2
94050	Meeker	40.049	-107.885	6390	12/1/1978	3/31/2010	31.4
93013	Montrose Regional Airport	38.505	-107.898	5758.8	1/1/1973	3/31/2010	37.3
03039	Pagosa Springs	37.45	-106.8	11790.9	6/1/2004	3/31/2010	5.8
93058	Pueblo Airport	38.29	-104.498	4720.1	6/1/1954	3/31/2010	55.9
03016	Rifle/Garfield Airport	39.526	-107.726	5543.9	7/1/1987	3/31/2010	22.8
03069	Saguache Muni Airport	38.097	-106.169	7826	10/1/2004	3/31/2010	5.5
03041	Salida/Monarch Pass	38.483	-106.317	12030.7	6/1/2004	3/31/2010	5.8
12343	Steamboat Springs	40.467	-106.767	10633.1	4/1/2005	5/31/2010	5.2
03011	Telluride Regional Airport	37.954	-107.901	9078	12/1/2000	3/31/2010	9.3
23070	Trinidad/Animas County AP	37.259	-104.341	5743	1/1/1973	3/31/2010	37.3

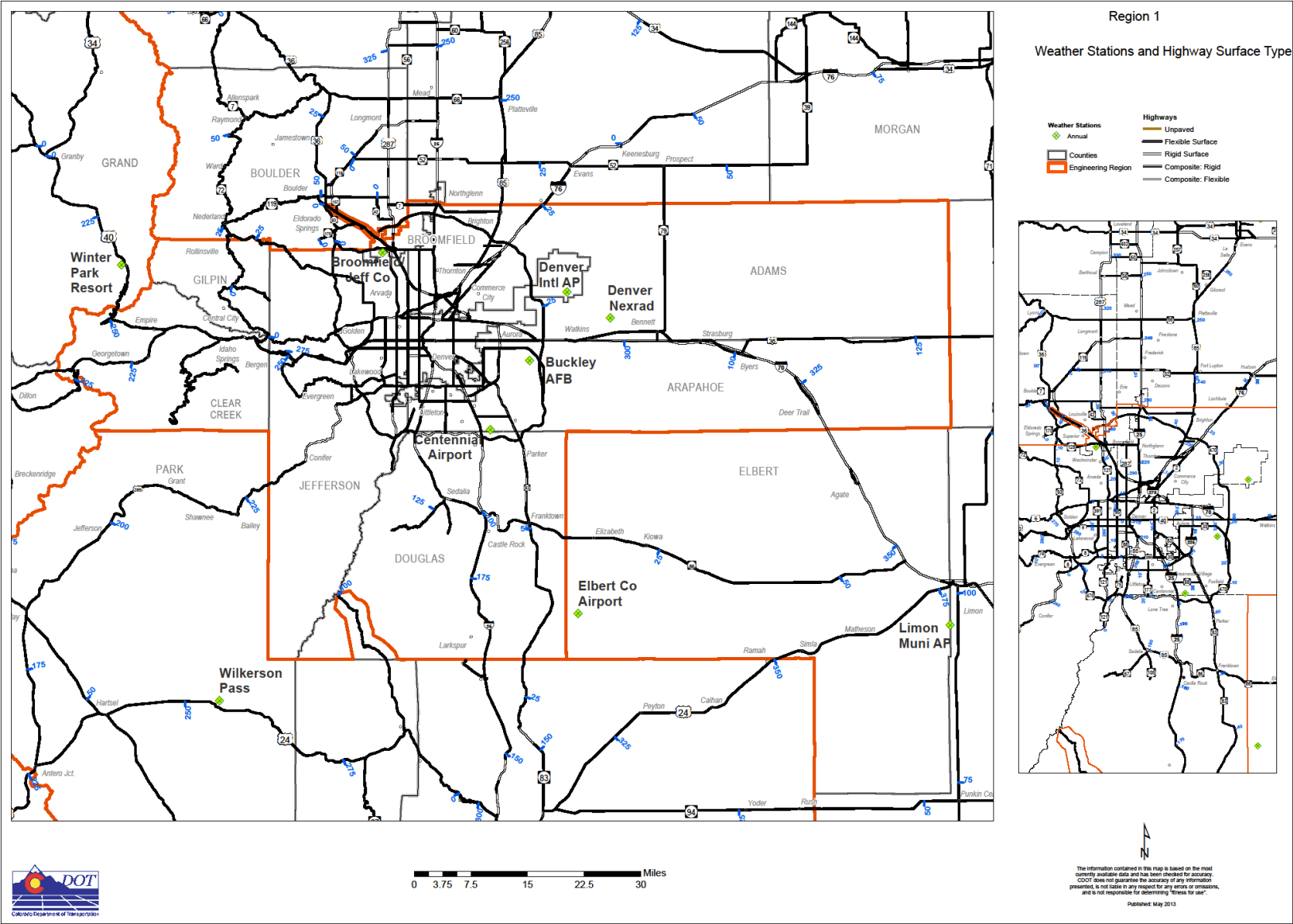


Figure 3.23 Region 1 Weather Stations and Highway Surface Type Map

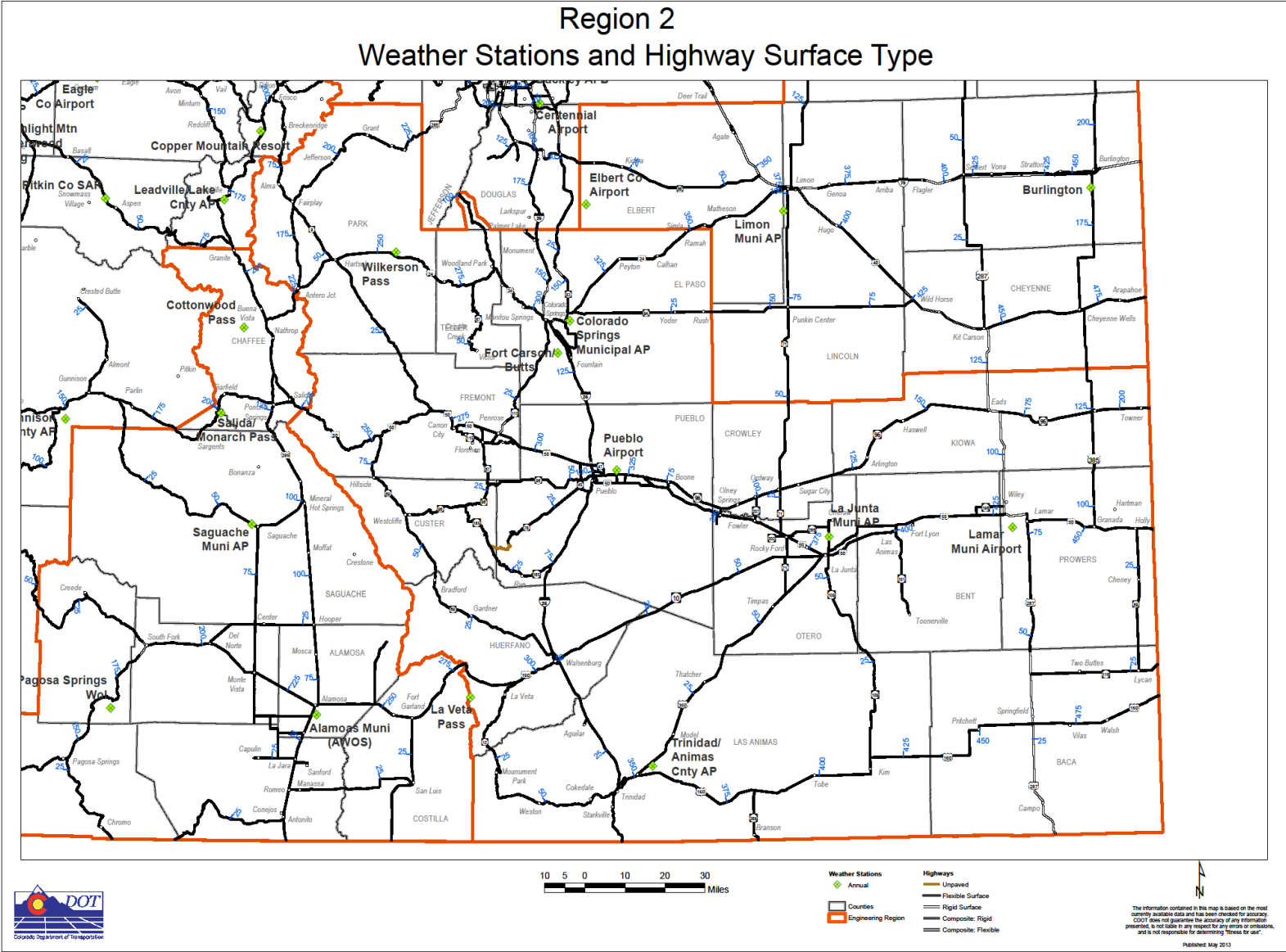
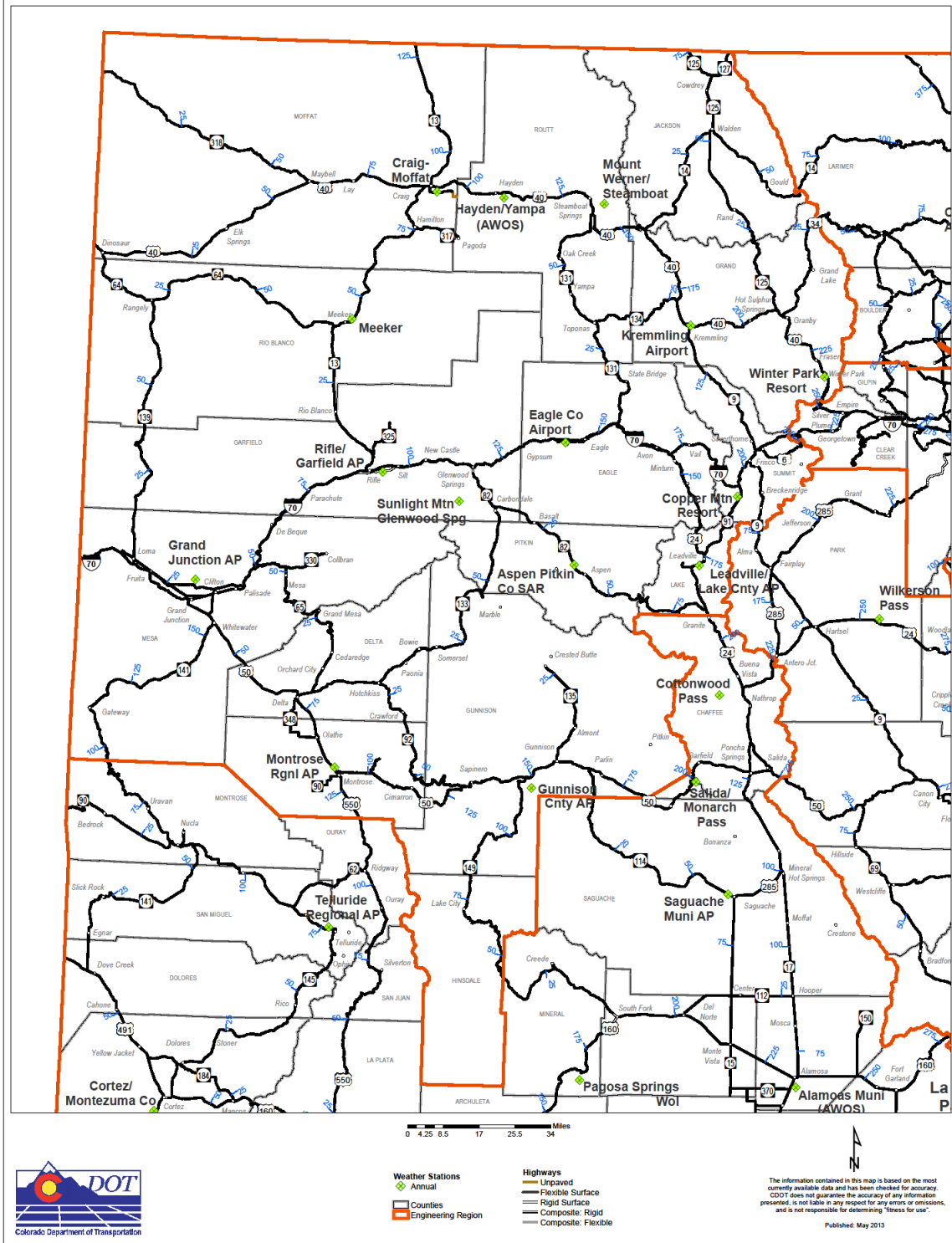


Figure 3.24 Region 2 Weather Stations and Highway Surface Type Map



### Region 3 Weather Stations and Highway Surface Type



**Figure 3.25 Region 3 Weather Stations and Highway Surface Type Map**

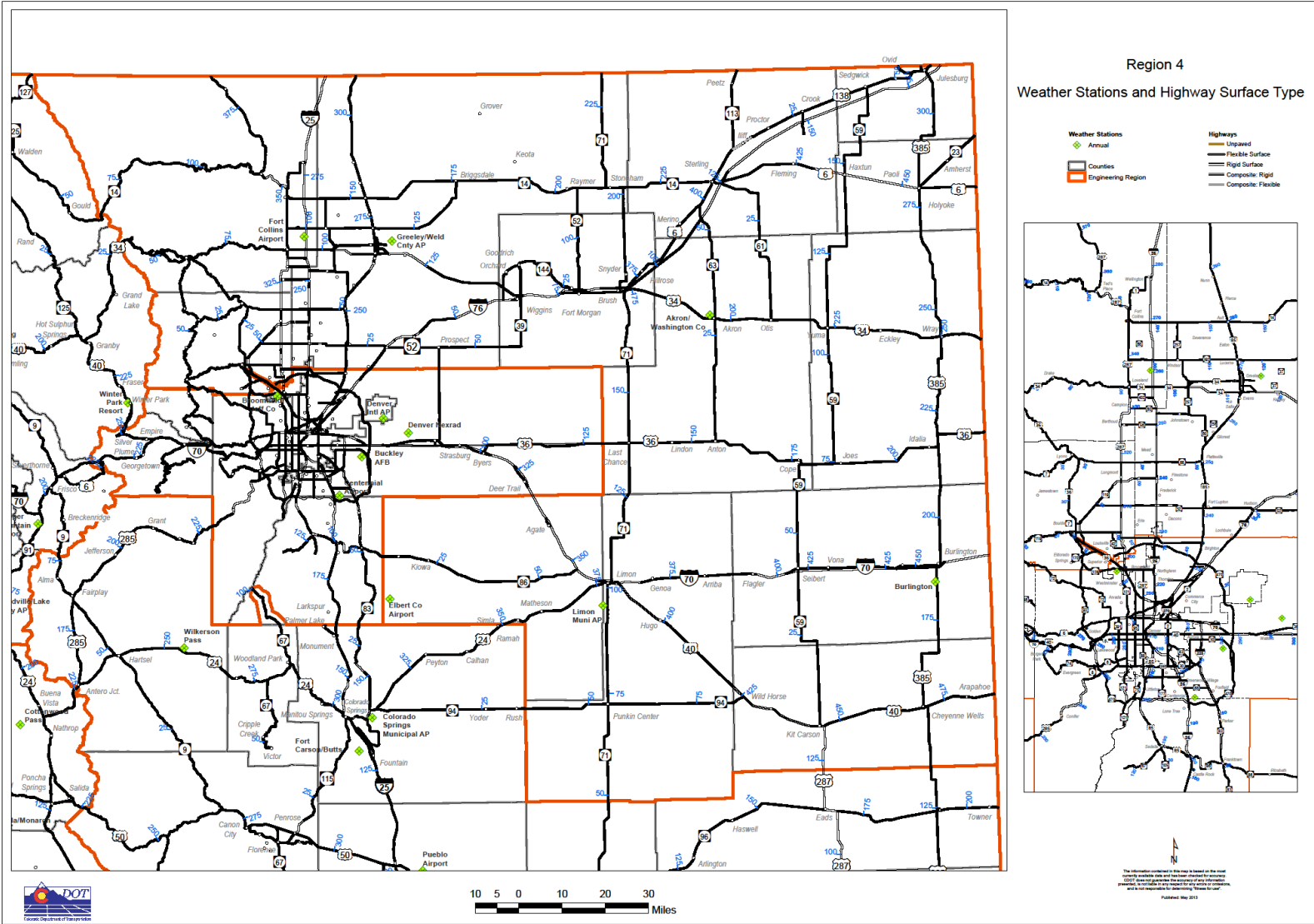


Figure 3.26 Region 4 Weather Stations and Highway Surface Type Map

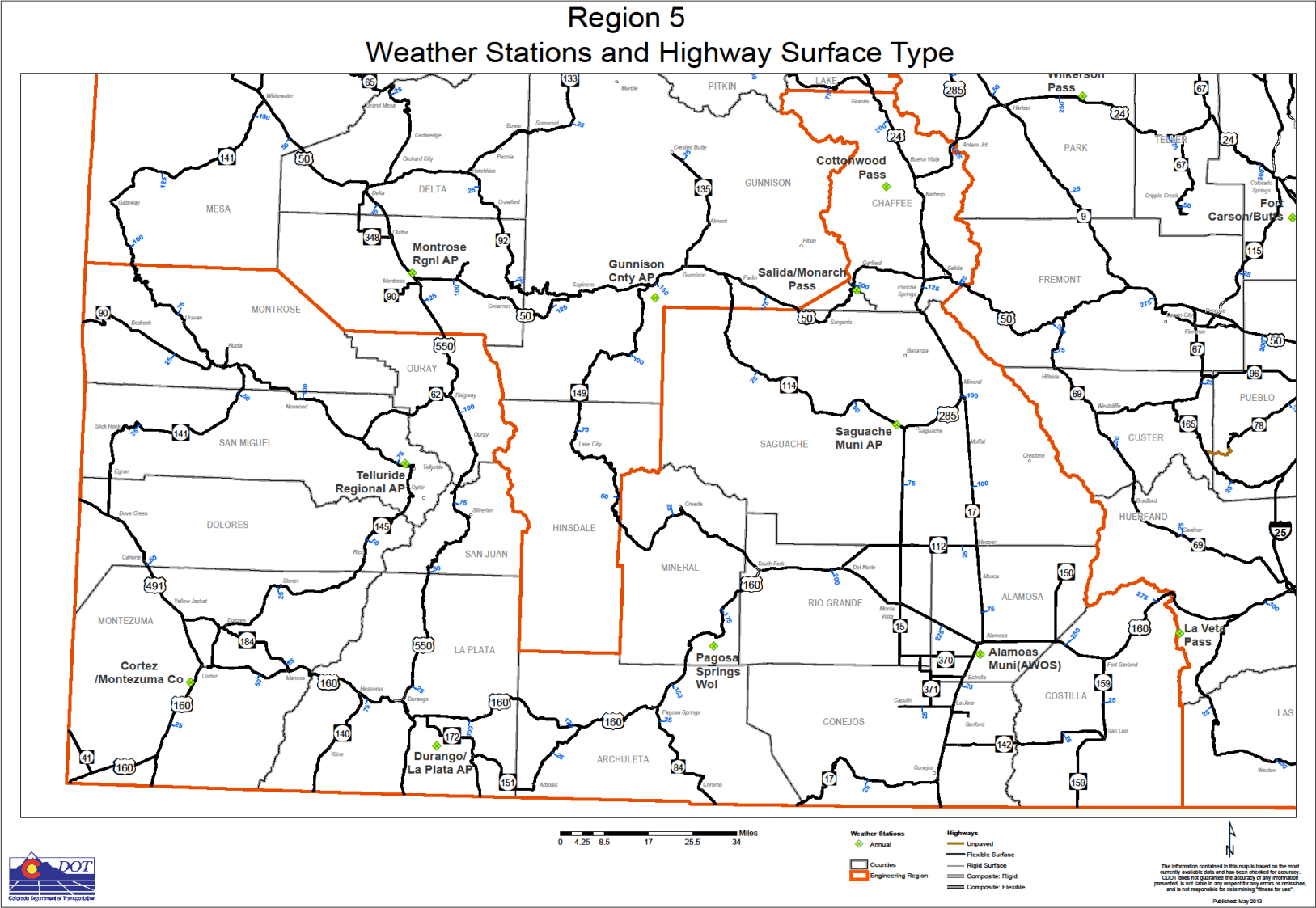


Figure 3.27 Region 5 Weather Stations and Highway Surface Type Map

## References

1. *Heavy Vehicle Travel Information System*, Field Manual, FHWA publication PDF version, May 2001 (revised), obtained at website, <http://www.fhwa.dot.gov/ohim/tvtw/hvtis.htm>
2. *Highway Capacity Manual*, Transportation Research Board, National Research Council, Washington, D.C., 2000.
3. *AASHTO Mechanistic-Empirical Pavement Design Guide, A Manual of Practice, Interim Edition, July 2008*, American Association of State Highway and Transportation Officials, Washington, DC, 2008.

## CHAPTER 4 SUBGRADE

### 4.1 Introduction

Subgrade is the top surface of a roadbed upon which the pavement structure and shoulders are constructed. The subgrade can be further subdivided and described as imported soil or a man-made compacted layer of the same soil as beneath it (natural subgrade). This chapter provides procedures and recommended guidelines for determining the design parameters of the subgrade soils or foundation for use in new and rehabilitated pavement designs. The subgrade support is a key fundamental input in pavement design as the selection of overlying layer types, thicknesses, and properties. Regardless of the pavement type, the subgrade is characterized in a similar manner. The M-E Design procedure categorizes major subgrade types as shown in **Table 4.1 M-E Design Major Subgrade Categories**.

**Table 4.1 M-E Design Major Subgrade Categories**

Material Category	Sub-Category
Rigid Foundation	Solid, Massive and Continuous Highly Fractured, Weathered
Subgrade Soils	Gravelly Soils (A-1; A-2) Sandy Soils <ul style="list-style-type: none"> <li>• Loose Sands (A-3)</li> <li>• Dense Sands (A-3)</li> <li>• Silty Sands (A-2-4; A-2-5)</li> <li>• Clayey Sands (A-2-6; A-2-7)</li> </ul> Silty Soils (A-4; A-5) Clayey Soils <ul style="list-style-type: none"> <li>• Low Plasticity Clays (A-6)               <ul style="list-style-type: none"> <li>♦ Dry-Hard</li> <li>♦ Moist Stiff</li> <li>♦ Wet/Saturated-Soft</li> </ul> </li> <li>• High Plasticity Clays (A-7)               <ul style="list-style-type: none"> <li>♦ Dry-Hard</li> <li>♦ Moist Stiff</li> <li>♦ Wet/Saturated-Soft</li> </ul> </li> </ul>

### 4.2 Soil Survey Investigation

The M-E Design process begins with a preliminary soil survey. Geotechnical investigations are typically required for new construction and reconstruction projects. Contact the Regional Materials Engineer or CDOT Materials and Geotechnical Branch to request a geotechnical investigation, and refer to Chapter 200 of the Field Material Manual for further information.

## 4.2.1 Soil Surveys and Preliminary Soil Profile

### Procedure Overview

This set of guidelines generally follows the current practices CDOT personnel use for obtaining soil profiles. It is intended to establish standardized procedures for use by Region Materials personnel in the performance of uniform and adequate soils investigations. Soil surveys are conducted prior to new alignments and most road widening projects as part of the pavement design process. The purpose of soil surveys are to locate the various soil types within the existing and proposed roadway at elevations above and below the profile grade. The extent of each soil type is noted and each type is identified by the AASHTO classification method. The condition of sub-soils upon which embankments will be constructed is evaluated to avoid problems such as:

- Pavement design
- Slope design
- Slope appearance
- Cost
- Landslides
- Embankment subsidence and settlement
- Excavation characteristics
- Expansive materials
- Drainage
- Compaction characteristics

All of these problems are directly related to:

- The character and distribution of soil and rock bodies, both inside and outside of the right-of-way.
- The influence of surface and sub-surface water on these materials.

With the proper amount and type of samples and field information, the designers are provided with data denoting the types of materials to be encountered, the vertical and horizontal boundaries of the changes in these materials, and their strength and deformation characteristics. Adequate preliminary investigation will help prevent uneconomical over-design and unforeseen failure resulting from under-design.

Proper investigations to achieve these goals cannot be dictated by a rigidly prescribed set of procedures, although certain basic requirements must be satisfied in each investigation. Both the detail and extent of the investigation will vary depending on the individual problem, the nature of the project under consideration, and the allowable risk of failure.

Investigations may sometimes need to go beyond the minimum soil profile recommendation presented within this document. Projects in special problem areas or in areas of rough terrain are the most likely to require more extensive investigations. Such studies are especially recommended for high-speed, multi-lane facilities in rough terrain. The Soils & Geotechnical Program (S&GP) of the Central Laboratory or outside consultants will conduct these studies.

## 4.2.2 Soil Survey Classification

Soil surveys may be classified as reconnaissance or preliminary, depending upon the type of information developed and the stage of project development during which each is performed.

### 4.2.2.1 Reconnaissance Soil Surveys

Reconnaissance surveys are general in nature and are performed during Phase II (Corridor Location study) of project development under the CDOT Action Plan. The survey, including sample locations and methods, may be performed either by Region Materials Personnel, Soils & Geotechnical Program (S&GP), or outside consultants as determined by mutual agreement. The information developed during these surveys is used in preparation of Environmental Impact Statements for proposed projects. These surveys are performed only if the necessary information cannot be obtained from existing data, such as soil maps, test reports from previous projects in the area, etc. Information required from reconnaissance surveys:

- a) AASHTO classification of all major soil types present in the corridor.
- b) Identification of landforms or geologic formations with which each is associated.
- c) Description of specific engineering problems associated with each.

This information will be included in the soils and geology reconnaissance report prepared for each project and should be developed through joint effort of Region Materials Personnel and the Engineering Geologist or Geotechnical Engineer assigned to the project. The field survey, if required, will consist only of identifying the major soils present and obtaining representative bulk samples of each. Usually, no line will have been established at this point in the project development and sample locations may be selected without regard for line and grade. Samples may be taken by the most convenient method available that insures the samples are representative of the major soil types and large enough to permit accurate laboratory classification. Sampling methods are discussed in more detail in **Section 4.2.3.4 Sampling Methods**.

### 4.2.2.2 Preliminary Soil Surveys

Preliminary soil surveys are performed during Phase III (Preliminary Design) of project development under the CDOT Action Plan. The information developed during these surveys is used in project design and preparation of cost estimates and must therefore be as accurate as possible. These surveys are performed on all new alignments and most widening projects. Two checklists; **Region Preliminary Soil Survey Sampling Checklist** and **Region Soil Survey Drilling Checklist** are provided in **Section 4.2.14.1 Field Observations and Sampling**. This is not meant to be all inclusive, rather a reference guide that may be used.

One of the most important items to be determined during the survey is the relationship between soil boundaries and the line and grade of the proposed project. If soil survey personnel do not know the location of line and grade at the time of the investigation, they cannot be certain the soil conditions encountered in the borings represent conditions to be encountered during construction. In particular, they cannot be sure the soil conditions have been sampled to proper depth below finished grade if they do not know where finished grade will be located.

It is important to identify the presence of sulfates in soils at project locations. This can be determined by visiting the following website: <http://websoilsurvey.nrcs.usda.gov/app/>

This website can provide soil engineering properties as well as approximate location, depth, and concentrations of sulfates. If the presence of sulfates on project locations is suspected, the preliminary soils survey needs to sample and test the soil layers. During the preliminary soil survey, one sample, per soil type, will be tested approximately 1 per 1,000 linear feet of two-lane roadway or fraction thereof. Frequency may be reduced or increased per the RME's recommendation. The boring depth for the preliminary soils survey will be a minimum of 3 feet below the proposed finished grade. The sample size will be a minimum of 5 lbs. per soil type. Where water is present at drainages, a minimum of 1 pint sample will be taken of the water. CP-L 2103 will be used in the testing of sulfates in water or soil and can be performed in the field or by the Region Lab if adequate facilities and equipment are available.

### **4.2.3 Soil Surveys**

Soil and rock materials encountered in borings or surface outcrops should be identified and described per Sections 12 and 13 of this guidance. Accurate descriptions of soil or rock encountered in the field are important to the economic planning of the project design. Avoid complicated descriptions (not relevant to design or construction problems). Consultation with the Regional Materials Engineer and Project Team in order to collaboratively determine actual sample locations, frequencies, and depths is highly recommended prior to sampling and testing.

Approved traffic control shall be use as required based on the boring locations specified for the project. Borings can be drilled or dug by hand, power auger, power rotary drill, backhoe, or any other practical method. In any case, it is of the utmost importance to use the method that will insure the attainment of representative, uncontaminated samples whether bulk samples, undisturbed samples, core samples, drill cutting samples, or split-spoon samples. Care should be taken to make sure that loose, sloughed soil or rock in the bottom of the borings is not mixed in with samples representing the given depth. Where uncertainty exists as to the reliability of a sample, the sample shall be discarded and a new sample shall be collected. In the following paragraphs, the term "drilled" is used to mean any appropriate method for advancing a boring.

#### **4.2.3.1 Horizontal Distribution of Borings**

Borings will be spaced no farther apart than 500 feet in continuous cut and fill sections, and no farther apart than one mile under any circumstance. In addition, borings should be drilled wherever there is any variation in soil or geological conditions, base gravels, and/or pavement thicknesses. Time should be taken to obtain a sufficient number of borings to outline current pavement conditions and sub-surface complexities. During the design phase of the project, if it is determined that additional data or samples are needed, such will be obtained and a supplemental report submitted.

Since there is, at times, considerable lag between the time of the preliminary soil profile and actual construction, borings drilled through the existing pavement should be held to a minimum as directed by the Regional Materials Engineer. Such borings present maintenance problems, and excessive drilling in the traffic flow presents needless hazards.

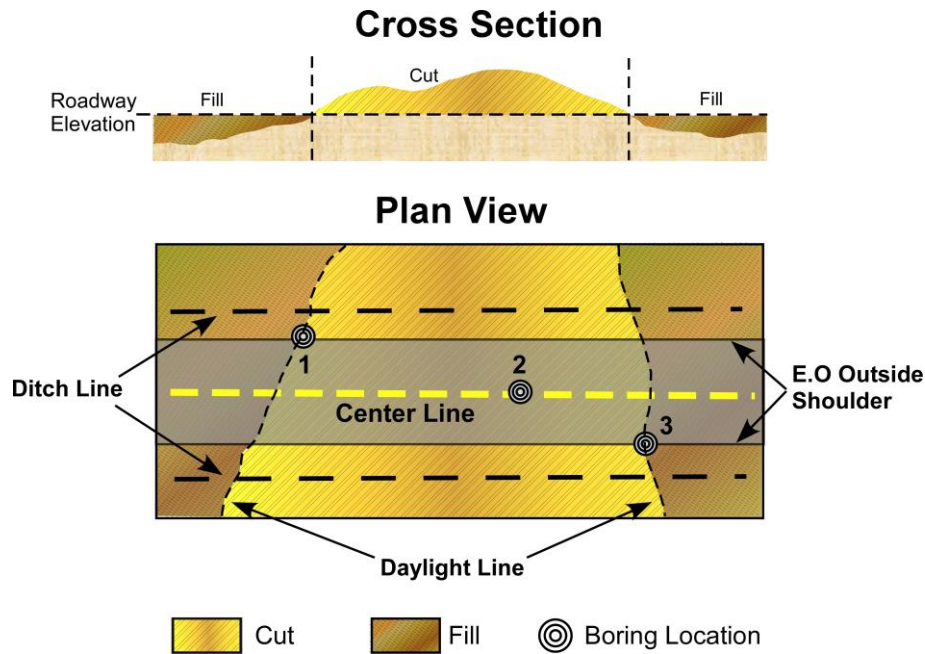
When taking soil surveys on proposed widening jobs, attention should be given to areas where CMP, RCP, or box culverts may be extended, replaced, or added. Quite often these areas will require excavation of unsuitable materials such as organic rich material or unsuitable material.



Such requirement for excavation should be reported with respect to stationing, distance from survey line, and approximate depth. If it is not practical to drill borings in the unsuitable material, it may be possible to get a rough estimate of depth by probing with a bar or rod.

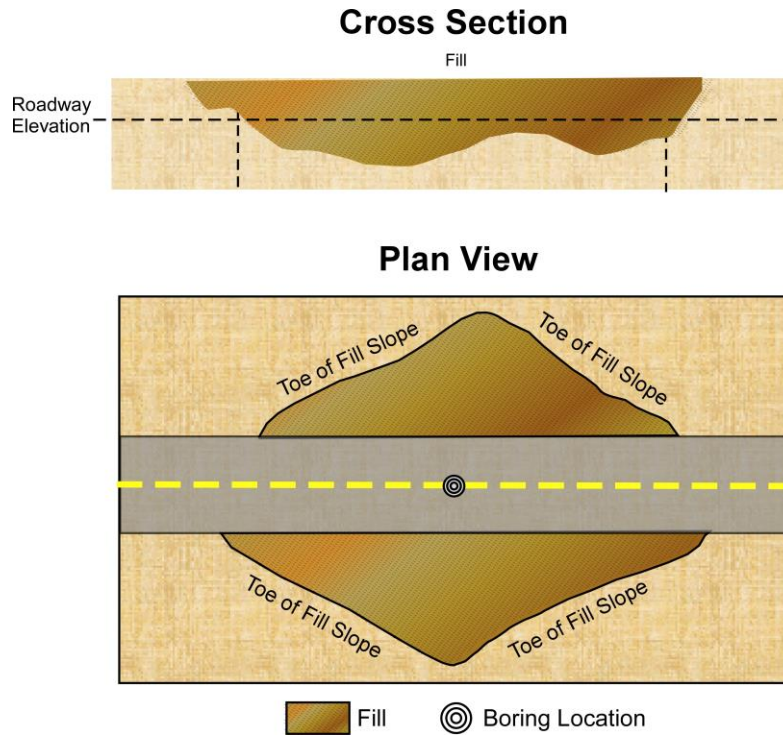
#### 4.2.3.2 Proposed Ne Line and/or Grade

For cut sections or where differing soil conditions are anticipated, borings should be spaced as shown in **Figure 4.1 Recommended Location of Borings in the Cut Section**. At locations 1 and 3, borings should be drilled on proposed outside shoulder line (edge of pavement) at the daylight line between cut and fill. An additional boring should be drilled at location 2 (highest elevation of terrain on center line).



**Figure 4.1 Recommended Location of Borings in the Cut Section**

For fills/embankments, boring(s) should be drilled on centerline as shown in **Figure 4.2 Recommended Location of Borings in a Fill Section**. One of the borings shall be located at the point of the thickest proposed fill. Additional borings may be required for global stability analysis.



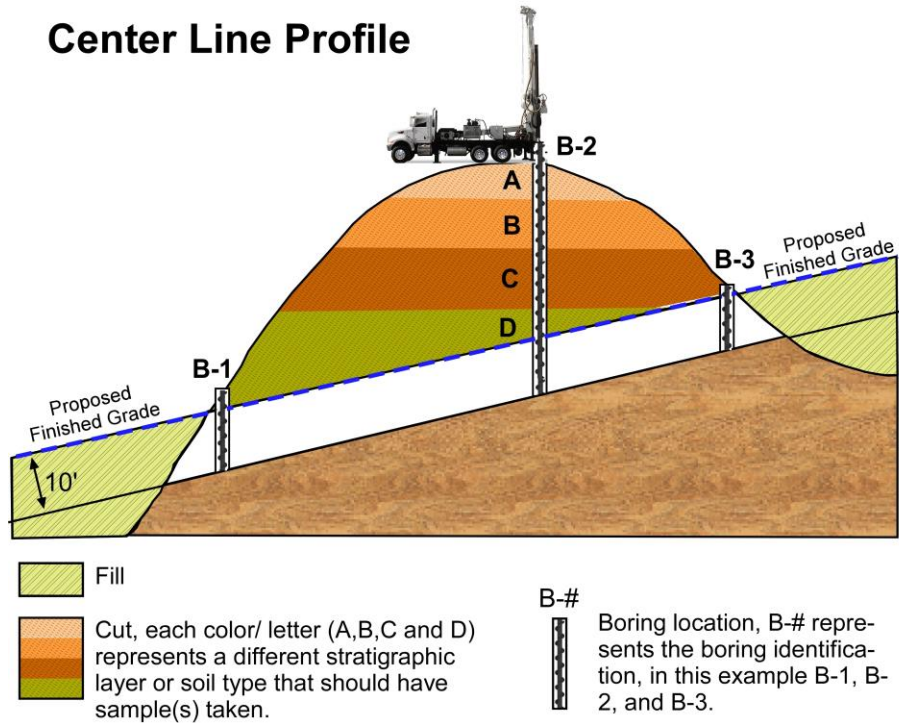
**Figure 4.2 Recommended Location of Borings in a Fill Section**

### 4.2.3.3 Boring Depth

For existing grades or cuts, borings shall extend at least 10 feet below finished grade. For new grades requiring embankments greater than 5 feet, borings shall extend at least 2 times the total height of the proposed fill below the base elevation or 5 feet into hard substratum ( $N > 30$ ). If that depth is greater than the depth capability of the equipment available to Region personnel, the S&GP or commercial drilling contractors will be requested to provide drilling services. Such services would be performed under supervision of Region personnel, assisted by S&GP if desired.

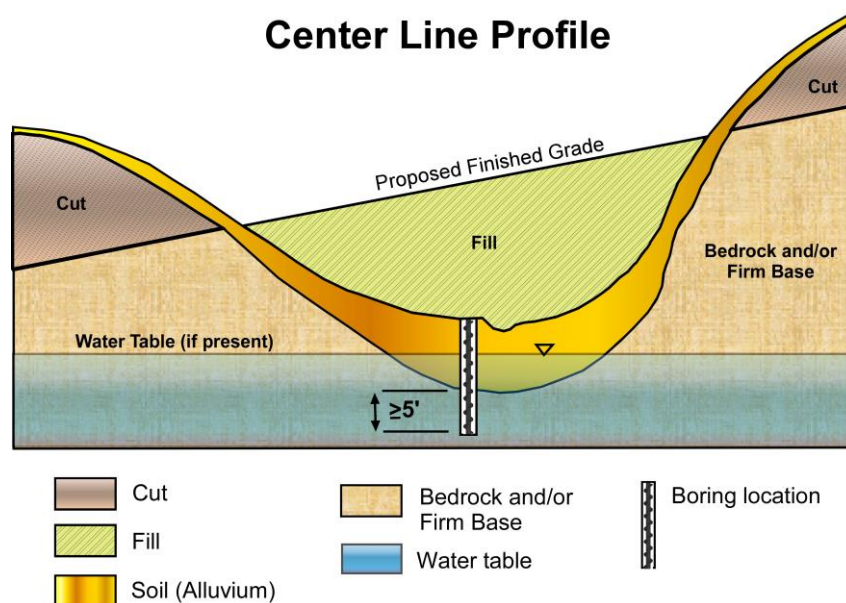
For proposed cut sections the depths of borings and sampling requirements should be as shown in **Figure 4.3 Recommended Depth of Borings in Cut Sections**. As per boring location 2, **Figure 4.3 Recommended Depth of Borings in Cut Sections**, soil and/or rock layers A, B, C, and D should be separately sampled or similarized.

## Center Line Profile



**Figure 4.3 Recommended Depth of Borings in Cut Sections**

For fills whose proposed maximum height is more than 5 feet, the depths of borings and the sampling recommendations should be as shown in **Figure 4.4 Recommended Depths of Borings in Fill**. Unless the bedrock or firm substratum as shown in **Figure 4.4 Recommended Depths of Borings in Fill** is too hard for the drilling method being employed, all borings (such as Location #1, **Figure 4.4 Recommended Depths of Borings in Fill** should penetrate at least 5 feet into the hard substratum. However, in such cases the desirability of drilling to hard bedrock should be considered in at least one boring.



### **Figure 4.4 Recommended Depths of Borings in Fill**

Where alluvial soils as shown in **Figure 4.4 Recommended Depths of Borings in Fill** are composed of soft, compressible, fine grained materials, samples should be collected for consolidation testing. For at-grade sections all borings shall extend at least 10 feet below existing ground. All soils shall be sampled in bulk or similarized.

#### **4.2.3.4 Sampling Methods**

A sample should be taken for each soil encountered except for the material which might be used as topsoil. If topsoil is going to be required on the project, the lateral extent and depth of material, which could be utilized for topsoil, should be noted on CDOT Form #554. If the same soil is found in more than one boring, it may be similarized to a soil already sampled. Similarization is the process of combining or eliminating samples from nearby locations that exhibit similar physical properties such as color, grain size, gradation, plasticity, roundness, etc. This increases productivity and efficiency while reducing cost for sample shipment and laboratory analysis. Care should be exercised in similarizing soils and additional samples should be taken where doubt exists. Similarization will be limited to one mile. Soil samples taken in each boring will be visually classified and similarized in the Region by certified inspectors and testers prior to submittal for laboratory analysis.

Borings should be numbered consecutively from Boring #1, starting from project station 0+00. Mile posts can be substituted for stationing if project stationing has not been developed at the time of the soil survey. Each soil layer encountered in the boring shall be identified by the boring number followed by letter A, B, C, etc. In Boring #1, the first layer would be 1 A, the second 1 B, etc. Each layer shall be sampled in bulk or similarized. A bulk sample should be composed of at least one full sack and weigh at least 33 lbs. Pavement cores shall be collected and photograph (2MB file size) of the asphalt or concrete pavement. Core sample diameters will be 4 inch minimum for HMA and the size necessary to drill the boring for PCCP. Alternate sampling methods may be requested by the Regional Materials Engineer or the Designers. These may include, but are not limited to:

- Standard Penetration Tests per ASTM D1586 - Standard Test Method for Standard Penetration Test (SPT) and Split-Barrel Sampling of Soils.
- Colorado Procedure – Laboratory 3201-10, Standard Method of Test for Continuous Penetration Test.
- Geophysical Survey per FHWA-HRT-05-028, Geophysical Methods for Transportation Applications.

#### **4.2.4 Hydraulic Conditions**

The distribution and mode of occurrence of surface and sub-surface water should be noted and included as part of all reports. Where free water is encountered in any boring, the water level is to be checked and noted on CDOT Form #555 along with the date and hour of the observation. In cases where a high water table is suspected, it is recommended that the boring be drilled or dug at least to two feet below the elevation of the water table. Where possible, the boring is to be left open for a period of at least 24 hours and the water level, date, and hour recorded.

The location of all springs should be determined both horizontally and vertically with respect to centerline and grade line. The location of lakes, ponds, swampy areas, and reservoirs should be noted. Notes should especially be taken if the water is expected to influence the stability of pavements, cut slopes, or embankments. The normal annual precipitation at the project site should be determined from the most recent isohyetal map.

#### **4.2.5 Piping**

Piping is the mechanical movement of particles due to seepage. Areas requiring culverts, foundations, and ditch linings should be investigated to determine whether the soil is subject to piping. Piping often occurs in silts, fine sands, and loosely compacted material. Concentration of seepage into a few channels may cause piping. If the preliminary investigation indicates conditions and soils that could cause piping, the Staff Hydraulics Unit should be requested to make a thorough investigation.

#### **4.2.6 Condition of Existing Pavements**

The condition of existing concrete or asphalt pavements should be taken into account for stabilization and may be noted on a station-to-station basis on CDOT Form #903. This information is used for assignment of strength coefficients. Report the type and thickness of existing pavement and any previous pavement stabilization.

#### **4.2.7 Frost**

In areas of severe frost action, the soil should be checked for frost susceptibility. If necessary, recommendation should be made for the removal and replacement of frost susceptible soil with non-frost heaving material. Non-frost heaving material should be replaced to a depth of  $\frac{1}{3}$  to  $\frac{1}{2}$  the estimated frost penetration. The ground water table (perched tables or aquifers included) should be checked on all projects and in areas of severe frost action. The bottom of ditch linings should be kept at least three feet above the water table (unless the foundation materials are free draining sands or gravels).

#### **4.2.8 Adjacent Terrain**

This information is used primarily by the CDOT Staff Hydraulics Unit in determining rainfall runoff factors in the design of drainage structures. Rather than noting conditions on a station-to-station basis, a general statement relative to the project as a boring should be made. If there are distinct breaks over the length of the project, each type of terrain should be noted. Such designations as rolling grassland, steep timbered slopes, paved commercial, etc. are appropriate.

#### **4.2.9 Excavation Characteristics**

During the investigation, notes should be kept concerning the estimated excavation characteristics of all soil or rock materials encountered. Materials should be classified as:

- Common excavation,
- Ripping required, or
- Pre-blasting required.

It is often necessary to construct shallow embankments from cuts or borrow pits containing boulders too large to be buried in the fills. The disposal of such boulders can be a problem on each project where this condition occurs. If such oversized material is encountered during the investigation, it should be noted on CDOT Form #555 so the Project Manager can include a NOTE in the plans that this material will usually become the property of the Prime Contractor, and is required that they dispose of material per local laws and applicable State regulations.

#### 4.2.10 Embankment Foundations

The construction of highways over weak, compressible soils presents some of the more difficult problems in soil mechanics. If embankments are constructed over foundation soils having insufficient strength to support the added load, shear failure or slip-outs may occur, or the underlying soft material may displace by outward plastic flow.

If the foundation soil is highly compressible, excessive settlement of the embankment may occur, resulting in damage or destruction of the pavement, damage to structures, or hazards to traffic due to distortion of the profile and cross section of the roadbed. Such settlement may occur even if the strength of the foundation is high enough to preclude shear failure.

For the above reasons, it is recommended that Region personnel request a foundation investigation be performed by the S&GP where embankments more than 5 feet in height will be constructed on soft foundation soils.

#### 4.2.11 Swelling Soils

Swelling soils are common in Colorado and are frequently encountered during highway construction. To minimize damage to roadways from swelling action, it is necessary that these soils be recognized when encountered in the field and the soil boundaries along the project be determined during the preliminary soil survey.

A detailed map showing boundaries of swelling soil areas classified by the amount of swell potential has been published by the Colorado Land Use Commission and has been distributed to all CDOT Regions. This map should be consulted prior to commencing any soils survey, whether reconnaissance or preliminary.

It is sometimes difficult to identify swelling soils visually, but the following criteria are often helpful:

- **Texture** - When dry, the natural surface exposures of swelling soils usually exhibit an irregular or pebbly texture resembling popcorn.
- **Plasticity** - All swelling soils are plastic and most are highly plastic. The presence of plasticity can be determined in the field by moistening a sample and attempting to roll a thread in the palm of the hand.
- **Bentonite Clay** - A common clay causing swell in soils is bentonite, which usually occurs in shales, either as fine particles invisible to the naked eye or as thin, light colored bands which contrast with the darker color of the shale and are oriented parallel to the bedding. The bands range in color from light tan to light greenish gray and may range in thickness from a fraction of an inch to as much as two or three inches. Pieces of this material will adhere to a moistened finger and will break down in a matter of

minutes if dropped into water.

If any of these characteristics are noted during the soil survey (particularly in those areas indicated on the map) or if the possibility of swell is suspected for any other reason, notation to this effect should be made on CDOT Form #554.

Even though a soil contains expansive clays, it may not swell if the in-place moisture is high enough. It is therefore important to know the actual moisture content of the soil in order to assess the possibility of problems due to swell. For this reason, if swelling soils are identified or suspected during the soil survey, moisture samples should be taken at or slightly below the elevation of the proposed grade line in those areas where the soils are present.

Problems due to expansive soils usually occur in cut areas and in transitions from cut to fill areas. They could also occur in fill areas where moderate to high swelling soils are used for fill. These soils are usually identified by:

- Liquid limit
- Plasticity index
- Expansion pressure
- Swell-consolidation

The liquid limit and plasticity index usually correlate with swell potential in the laboratory. However, they may not be related to the swell potential in the field because of moisture content, density, and chemicals in the in-situ soil.

Many potential high swelling soils in areas of high ground water have taken on enough moisture that additional swelling is unlikely to occur. But certain dry, dense and often un-weathered soils must be treated to lesson swell potential. If a treatment is determined to be necessary, then the type of treatment shall be determined by the Region Materials Engineer or it may be advisable to request additional analysis by the CDOT Soils & Geotechnical Program.

#### **4.2.12 Soil Identification and Description**

For engineering purposes, soil is defined as any naturally occurring unconsolidated material composed of mineral grains with gases or liquids occupying the inter-granular spaces. A complete soil identification for engineering purposes shall follow *ASTM D2488 – Standard Practice for Description of Soils* and include:

**Angularity** - Describe the angularity of the sand (coarse sizes only), gravel, cobbles, and boulders, as angular, subangular, subrounded, or rounded. A range of angularity may be stated, such as: subrounded to rounded.

**Shape** - Describe the shape of the gravel, cobbles, and boulders as flat, elongated, or flat and elongated if applicable; otherwise, do not mention the shape. Indicate the fraction of the particles that have the shape.

**Color** - Describe the color. Color is an important property in identifying organic soils, and within a given locality it may also be useful in identifying materials of similar geologic origin. If the sample contains layers or patches of varying colors, this shall be noted and all representative colors

shall be described. The color shall be described for moist samples. If the color represents a dry condition, this shall be stated in the description.

**Odor** - Describe the odor if organic or unusual. Soils containing a significant amount of organic material usually have a distinctive odor of decaying vegetation. This is especially apparent in fresh samples. If the samples are dried, the odor may often be revived by moistening the sample and slightly heating it. Odors from petroleum products, chemicals or other substances shall be described. Some fumes emitting from soil samples, especially of a chemical nature, may pose a health risk. Proper safety protocols which may include the use of personal protective equipment must be followed in these instances. It is the responsibility of the user to determine the extent of the health risk and the correct protocols to follow.

**Moisture Condition** - Describe the moisture condition as dry, moist, or wet.

**HCl Reaction** (if available) - Describe the reaction with HCl as none, weak, or strong. Since calcium carbonate is a common cementing agent, a comment of its presence on the basis of the reaction with dilute hydrochloric acid is important.

**Consistency** - For intact fine-grained soil, describe the consistency as very soft, soft, firm, hard, or very hard. This observation is inappropriate for soils with significant amounts of gravel.

**Cementation** - Describe the cementation of intact coarse-grained soils as weak, moderate, or strong.

**Structure** - Describe the structure of intact soils as stratified, laminated, fissured, slickensided, blocky, lensed, or homogeneous.

**Range of Particle Sizes** - For gravel and sand components, describe the range of particle sizes that are retained on the No. 4 sieve (gravel) and No. 200 sieve (sand). For example, about 20 % fine to coarse gravel, about 40 % fine to coarse sand.

**Maximum Particle Size** - Describe the maximum particle size found in the sample. For example, gravel up to 2 inches in diameter.

**Additional Comments** – Any additional information shall be noted, such as the presence of roots or root borings, difficulty in drilling or augering the boring, caving of the trench or boring, presence of mica, trash or other man made materials, etc.

#### **4.2.13 Rock Identification and Description**

For engineering purposes rock is defined as a naturally occurring mineralogical aggregate, which in an intact, unfractured sample will yield a laboratory unconfined compressive strength greater than or equal to 200 psi. A complete rock description for engineering purposes includes:

**Classification** - Reference is made to **Table 2.1 Rock Classification**. This is a relatively simple but practical system which can be used by the field person, whether geologist, engineer, or technician.

**Color** - As for soils (See Section 4.2.12 Soil Identification and Description)



**Hardness and Degree of Cementation:**

- Soft - Can be scratched with a fingernail.
- Moderately Hard - Can be scratched easily with a knife but cannot be scratched with a fingernail.
- Hard - Difficult to scratch with a knife.
- Very Hard - Cannot be scratched with a knife

**Partings in the Rock** - Including fractures, faults, and joints:

- Intact - No partings.
- Widely Fractured - Partings more than 10 feet apart.
- Closely Fractured - Partings less than 10 feet apart but more than 6 inches apart.
- Brecciated Partings - Less than 6 inches apart.

**Moisture Content** - Moisture content in rock cannot be determined by simple tests such as those used for soil, but should be estimated visually. As with soils, the terms dry, moist, and wet are adequate for field description.

**4.2.14 Determination of Need for Culvert Protection**

The best time to observe, sample, or report conditions indicating the need for corrosion protection of culverts is on the preliminary soil survey as shown on CDOT Form #554, see **Figure 2.5 CDOT Form #554**. However, completed soil surveys should be reviewed where it seems necessary. If additional samples are required, submit on a CDOT Form #157, see **Figure 2.8 CDOT Form #157**. The class of pipe required to resist abrasion and corrosion shall be determined using the *CDOT Pipe Material Selection Policy*.

**4.2.14.1 Field Observations and Sampling**

Past performance of culvert material is the best source of information. The local Maintenance Foreman can provide a history of culvert performance in the area. Observation of culverts on projects in adjacent areas of similar soil conditions will also provide useful information. Uncoated galvanized pipe, which shows no corrosion after at least two years of service, does not require soil or water sampling. However, a coated pipe, which shows no corrosion, may be in an environment that would attack an uncoated pipe. Samples of both the soil in contact with the pipe and the water going through the pipe would provide this information.

The condition of the interior of a culvert tells only part of the story. In most cases, the corrosive substances are in the soil in contact with the pipe, rather than in the water. Therefore, to truly appraise the amount of corrosive attack, it is necessary to expose and examine some of the pipe exterior. The presence of extensive rust spots would indicate a serious condition. A soil sample should be taken near any observed corrosion to determine if it is due to a high or low pH, or corrosive salts. The extent and location of the corrosion would be noted on CDOT Form #554, see **Figure 2.5 CDOT Form #554**.

Crystals, encrustations and alkali deposits in the streambed near the waterline, are signs of a possible corrosive water. Stains on the rocks are usually associated with minerals, therefore a

tailings dump or mine drainage should be looked for upstream. If found, it should be noted on CDOT Form #554.

**Table 4.2 Rock Classification**

<b>Sedimentary Rocks</b>	Coarse-grained <sup>1</sup>	Conglomerate	Dominant grain size is boulders or gravel.
		Sandstone	Dominant grain size is sand.
	Fine-grained <sup>2</sup>	Shale	Thin-bedded. Dominant grain size is clay and silt.
		Limestone	Usually light-colored, composed of calcite and/or dolomite (will usually effervesce with dilute HCl).
<b>Igneous and Metamorphic Rocks</b>	Coarse-grained <sup>1</sup>	Gneiss	Composed of alternating bands of different colored minerals.
		Schist	Major component is mica layered structure.
		Marble	Coarse grained limestone.
		Granite	Granular, ranging in color from light to medium gray to salmon pink.
		Diorite	Contains approximately equal proportions of dark and light colored minerals.
		Gabbro	Granular dark gray to black.
	Fine-grained <sup>2</sup>	Rhyolite	Nearly white to light gray.
		Quartzite	Composed entirely of quartz.
		Andesite	Medium gray.
		Basalt	Dark gray to black (sometimes porous or vesicular).
<b>Notes:</b> <sup>1</sup> - Individual crystals or fragments, which compose the rock, <i>can</i> be seen with the unaided eye. <sup>2</sup> - Individual crystals or fragments, which compose the rock, <i>cannot</i> be seen with the unaided eye.			

Water that seeps out of the ground or from some layer in an embankment will probably have variations in the amount of dissolved salts from season to season, depending on the volume of water moving through the soil and the amount and availability of soluble mineral matter. It may be necessary to sample water seeps in spring, summer, and fall verify the water's chemistry.

Alkali deposits on the soil (such as from Mancos and Pierre Shales) and fine silty soils should be tested.

The Central Laboratory recommends all suspected soils and water be sampled. The accompanying CDOT Form #554 or #157, see **Figure 2.5 CDOT Form #554** and see **Figure 2.8 CDOT Form #157**, should mention the conditions that prompted the sampling, and the exact location in reference to the proposed or existing culvert.

Soil and water samples will be run in the laboratory to determine pH, hardness, alkali content, etc. Recommendations from the laboratory concerning required protective action may be based on evaluation of one or several of these test results and their interactions.

Unusual stains, encrustations of salt, alkali, or unpleasant odors should be mentioned on CDOT Form #554 or #157, as these are indicative of conditions which may cause culvert corrosion. The possible existence of an abrasive condition should also be noted. A serious problem should be discussed with the Hydraulics Unit for a possible solution.

A water sample shall be a minimum of 1 pint in volume. The water sample shall be collected and stored in a clean, unreactive and leak proof container. The soil sample should weigh at least a pound and be sent in a plastic bag.

On the basis of field observations and laboratory tests (where deemed necessary) the Region shall recommend to the Staff Design Engineer the types of culvert to be used and their location.

## Region Preliminary Soil Survey Sampling Checklist – 2018

This checklist is provided as support for field personnel in conducting the soil survey. It is not intended to be a guidance document nor is it a sign of work fulfillment if completed. Communication with the Region Materials Engineer is required to insure all required sampling is conducted to meet the project specifications.

### Sampling of Boring Materials

1. Take one sample per soil type containing at least 33 lbs. (15 kg) of minus No. 4 screen materials for **Classification**.
2. A minimum of one boring per 1,000 linear feet of roadway will be done.
3. Minimum depth of 3 feet below proposed finished subgrade is required.
4. At least one boring shall be drilled to a depth of at least 10 feet in order to determine the presence of water and bedrock.
5. Soil samples taken in each boring will be **visually classified and similarized** in the Region.
6. Soil samples will be logged on Form #555 by Region personnel.
7. Borings will be logged individually in numerical order following the convention noted in the Soil Survey / Preliminary Soil Profile, Subsection 6.4.
8. Samples that are similar will be logged and similarize (as applicable) after the initially encountered soil type(s).
9. There will not be more than 1 mile between similarized soil samples.
10. Soil samples for **Sulfate** tests will be collected for **each** soil type in **each** boring.
11. Soil and water (if available) samples for Corrosion tests for pipe selection will be collected at inlet or outlet locations where water or soil contact water transport structure (pipe, culvert, etc.)
12. A minimum of 5 lbs. of soil will be sampled for **Sulfate** and **Corrosion** tests.
13. A minimum of 1/2 quart (500 ml) of water will be sampled for **Corrosion** tests.
14. **Sulfate** and **Corrosion** samples will be sealed in a container or bag, marked with the Test No. and logged on Form #555 by placing an “S” for sulfate testing only and a “C” for corrosion tests in the **Sulfate/Corrosion** column. A copy of Form #157 and Form #555 will be included in the **Sulfate/Corrosion** submittal to be sent to the Central Laboratory **Chemical Unit**.
15. Corrosion tests include Sulfate, Chloride, pH, and Soil Resistivity for pipe material type selection.

### Materials Ownership and Forms

1. The soil samples will be logged on the most current Preliminary Soil Survey Form #555.
2. Form #157 will be completed with specified soil tests by Region personnel.
3. Form #157 and Form #555 will be included in the sample bag with the tag (Form #633) marked appropriately.
4. Electronic Form #555 shall be e-mailed to the Central Lab Soils Program lab manager.
5. Soil samples will be sent to the Region Materials Lab for analysis. The Central Lab Soil Program lab manager can be contacted if assistance it required for sample analysis..
6. Samples for **Sulfate** and **Corrosion** tests will be tagged (Form #633) and sent to the Region Materials Lab or Central Lab’s Chemical Unit and submitted through Site Manager Materials.

### **Materials Ownership and Documentation**

1. **Field** or **Region Lab** will use CP 20, CP 21, and the Form #564 to complete the soil classification.
2. **Field** or **Region** will follow CP 24 and mathematically scalp the gradation on the appropriate sieve and determine if there are significant variations in the material from the preliminary soil survey.
3. **If there are significant variations from the preliminary soil survey**, all +3/8, +#4, and - #4 materials will be separated and retained in separate bags.
4. The sample material with a Form #157 requesting an R-value will be sent to the Region Lab (\*) or Central Lab.
5. The soil classification on Form #564 will also be sent to the Region Lab or Central Lab.
6. If **no** significant variations are found, record on the Form #219 for project documentation.

### **Borrow Pits** (refer to Standard Specifications for Road & Bridge Construction for details)

**Contractor Source:** The cost of complying with Section 106.02, (b) *Contractor Source* requirements, including sampling, testing, and corrective action by the Contractor, shall be included in the work.

CDOT reserves the right to verify the contractor's source.

### **Materials Ownership, Sampling, and Forms (FMM QA Schedule)**

1. If embankment will support concrete pavement or be chemically stabilized, during production one soil sample per 2,000 yds<sup>3</sup> or fraction thereof will be tested for sulfate from the designated source by CDOT project or Region personnel.
2. Results will be documented on Forms #157 and #323.
3. During qualification of a borrow source, one 5 lb. sample of soil, per soil type, will be submitted to the Chemical Unit of the Central Laboratory for sulfate content.

### **Notes:**

1. Region Lab/Soils Program will perform classification of soils.
2. Chemical Unit will perform chemical analysis of soil samples for sulfates.
3. Chemical Unit will provide the Project with the chemical analysis on qualification of borrow sources.
4. For the preliminary soil survey, the Chemical Unit will provide the Region Materials Program with the chemical analysis reports and forward the results to the Soils Program.
5. The Soils Program will input the chemical results onto the electronic Form #555, and forward the completed preliminary soil survey to the Region Materials Program.
6. Chemical Unit will perform chemical analysis of soil samples for corrosion tests and will provide test results to the Region for pipe material type selection.
7. \* If the Region Lab has the ability to perform CP-L 3101 then no sample needs to be sent to the Central Lab.

## Region Soil Survey Drilling Checklist

### Reconnaissance of Drill Site

	<u>Yes</u>	<u>No</u>	<u>N/A</u>
1. Was a reconnaissance survey of the area to be drilled performed?	<input type="checkbox"/>	<input type="checkbox"/>	<input type="checkbox"/>
2. Have landowner clearances and locates been obtained?	<input type="checkbox"/>	<input type="checkbox"/>	<input type="checkbox"/>
3. Have temporary easements been obtained?	<input type="checkbox"/>	<input type="checkbox"/>	<input type="checkbox"/>
4. Have drilling methods been determined?	<input type="checkbox"/>	<input type="checkbox"/>	<input type="checkbox"/>
5. Have roadway condition and type of pavement been noted?	<input type="checkbox"/>	<input type="checkbox"/>	<input type="checkbox"/>
6. Have rock outcrops been noted?	<input type="checkbox"/>	<input type="checkbox"/>	<input type="checkbox"/>
7. Have survey cross sections or profiles been performed?	<input type="checkbox"/>	<input type="checkbox"/>	<input type="checkbox"/>
8. Is there drilling for existing roadway?	<input type="checkbox"/>	<input type="checkbox"/>	<input type="checkbox"/>
9. Is there drilling for new or extension of roadway surface?	<input type="checkbox"/>	<input type="checkbox"/>	<input type="checkbox"/>
10. Have structures and culverts been identified?	<input type="checkbox"/>	<input type="checkbox"/>	<input type="checkbox"/>
11. Has the Soil Survey Field Report, Form # 554 been completed?	<input type="checkbox"/>	<input type="checkbox"/>	<input type="checkbox"/>
12. Have sulfate/corrosion resistance samples been taken?	<input type="checkbox"/>	<input type="checkbox"/>	<input type="checkbox"/>

### Preliminary Soil Survey

#### General

1. Preliminary Soil Survey, Form #555 worksheet available and used?	<input type="checkbox"/>	<input type="checkbox"/>	<input type="checkbox"/>
2. Borings drilled in roadway?	<input type="checkbox"/>	<input type="checkbox"/>	<input type="checkbox"/>
3. Borings drilling in shoulder?	<input type="checkbox"/>	<input type="checkbox"/>	<input type="checkbox"/>
4. Boring drilled in R.O.W.?	<input type="checkbox"/>	<input type="checkbox"/>	<input type="checkbox"/>
5. 1 boring per 1,000 linear feet of 2-lane roadway minimum?	<input type="checkbox"/>	<input type="checkbox"/>	<input type="checkbox"/>
6. 1 boring per 500 linear feet of 2-lane roadway in cut/fill areas minimum?	<input type="checkbox"/>	<input type="checkbox"/>	<input type="checkbox"/>
7. 1 boring to a depth of at least 10 feet?	<input type="checkbox"/>	<input type="checkbox"/>	<input type="checkbox"/>
8. Is the finished grade known?	<input type="checkbox"/>	<input type="checkbox"/>	<input type="checkbox"/>
9. Depth of boring minimum of 3-10 feet below finished roadway grade?	<input type="checkbox"/>	<input type="checkbox"/>	<input type="checkbox"/>
10. Is the finished grade unknown?	<input type="checkbox"/>	<input type="checkbox"/>	<input type="checkbox"/>
11. Depth of boring minimum of 3-10 feet into subgrade material?	<input type="checkbox"/>	<input type="checkbox"/>	<input type="checkbox"/>
12. Pavement cores collected, labeled, and photographed?	<input type="checkbox"/>	<input type="checkbox"/>	<input type="checkbox"/>
13. Additional drilling performed after the finished grade is known?	<input type="checkbox"/>	<input type="checkbox"/>	<input type="checkbox"/>
14. Water table encountered and depth noted?	<input type="checkbox"/>	<input type="checkbox"/>	<input type="checkbox"/>
15. Drilling adjacent to Wetlands?	<input type="checkbox"/>	<input type="checkbox"/>	<input type="checkbox"/>
16. Ground water wells established?	<input type="checkbox"/>	<input type="checkbox"/>	<input type="checkbox"/>
17. In-situ samples taken?	<input type="checkbox"/>	<input type="checkbox"/>	<input type="checkbox"/>
18. Have sulfate/corrosion resistance samples been taken?	<input type="checkbox"/>	<input type="checkbox"/>	<input type="checkbox"/>

#### Cut Areas

1. Boring location similar to <b>Figure SS-1</b> ?	<input type="checkbox"/>	<input type="checkbox"/>	<input type="checkbox"/>
2. Boring depth similar to <b>Figure SS-3</b> ?	<input type="checkbox"/>	<input type="checkbox"/>	<input type="checkbox"/>
3. Depth of boring minimum of 3 feet below finished roadway grade?	<input type="checkbox"/>	<input type="checkbox"/>	<input type="checkbox"/>
4. Additional drilling performed in cut sections needed?	<input type="checkbox"/>	<input type="checkbox"/>	<input type="checkbox"/>

#### Fill Areas

1. If proposed fill is greater than 5 feet, were borings 2 x H?	<input type="checkbox"/>	<input type="checkbox"/>	<input type="checkbox"/>
2. Boring location similar to <b>Figure SS-2</b> ?	<input type="checkbox"/>	<input type="checkbox"/>	<input type="checkbox"/>
3. Boring depth 5 feet into hard substratum?	<input type="checkbox"/>	<input type="checkbox"/>	<input type="checkbox"/>
4. Boring depth similar to <b>Figure SS-4</b> ?	<input type="checkbox"/>	<input type="checkbox"/>	<input type="checkbox"/>

\* If suspicious material is encountered during drilling

- Stop Drilling
- Do not move the drill rig
- Secure area and provide traffic control if necessary
- Contact Region Environmental and/or Region Safety Coordinator

## Mathematically Scalping a Gradation (Instructions for when a Preliminary Soil Survey has been performed.)

When less than 75 percent is passing the 3/4 inch sieve, divide the 3/8 inch sieve percent by the 1 inch sieve percent and multiply the quotient by 100. The result will yield the “as run” gradation reported on CDOT Form #555. Perform this calculation on each successive sieve. When more than 75 percent is passing the 3/4 inch sieve, use the 3/4 inch sieve percent as a divisor and then perform the same calculation on each successive sieve.

			< 75%					
Sieve	3	1	3/4	3/8	#4	#10	#40	#200
% Passing	100	66	61	50	45	41	28	16
As Run		100	100	76	68	62	42	24

Scalp  
 $(50 / 66) * 100 = 76$

			> 75%					
Sieve	3	1	3/4	3/8	#4	#10	#40	#200
% Passing	100	99	98	95	90	80	57	21
As Run		100	100	97	92	82	58	21

Scalp  
 $(95 / 98) * 100 = 97$

### Cumulative Setup for a R-Value

			< 75%					
Sieve	3	1	3/4	3/8	#4	#10	#40	#200
% Passing	100	66	61	50	45	41	28	16
As Run		100	100	76	68	62	42	24

Scalp  
 $(50 / 66) * 100 = 76$

			100	R-value Setup	76	68		
				X	X			
				12	12			
			+ 3/8	288			$(100-76) * 12 = 288$	
			+ #4	384			$(100-68) * 12 = 384$	
			- #4	1200				

			> 75%					
Sieve	3	1	3/4	3/8	#4	#10	#40	#200
% Passing	100	99	98	95	90	80	57	21
As Run		100	100	97	92	82	58	21

Scalp  
 $(95 / 98) * 100 = 97$

			100	R-value Setup	97	92		
				X	X			
				11	11			
			+ 3/8	33			$(100-97) * 11 = 33$	
			+ #4	88			$(100-92) * 11 = 88$	
			- #4	1100				

## **CDOT Forms #554, #555, and #157; Examples and Instructions**

CDOT Form #554, see **Figure 2.5 CDOT Form #554** shall be used as the first sheet on each Soil Survey.

Full distribution, as indicated on the form, will be made at the time samples are transmitted to the Central Laboratory.

The report number from CDOT Form #554 (**Figure 2.5 CDOT Form #554**) shall be placed on all of CDOT Form #555 sheets included in the Soil Survey.

CDOT Form #555, see **Figure 4.6 CDOT Form #555, as Submitted by the Region** and **Figure 4.7 CDOT Form #555, as Completed by the Central Laboratory**, may be used in place of the field notebook. However, the electronic Form #555 shall be e-mailed to the Soils Program Laboratory Manager when samples have been submitted to the Central laboratory.

The Region office may elect to type the information from the field notebook or original CDOT Form #555 onto another Form #555. A hard copy of CDOT Form #554 and #555 shall accompany samples submitted to the Central Laboratory.

A copy of CDOT Form #555 may be made for Region Materials Laboratory files. No other distribution of the partially completed Form #555 is necessary.

When samples have been processed in the Central Laboratory, CDOT Form #555 will be completed and distributed.

Distribution of photocopies will be made as indicated on CDOT Form #554.



Serial #1267						
<b>COLORADO DEPARTMENT OF TRANSPORTATION SOIL SURVEY FIELD REPORT</b>			Report	000023		
			Project #	IM 0253-151		
			Location	I-25, SH 7 to WCR 16		
Function	Part.	Project code (SA#)	Region	Date		
3200	P	11925	4	5/5/02		
Begin station	189+00	End station	569+00	Length	5.3	KM. → MI.
Equations (stations)	212+00 Bk =212+10 Ah					
Structures (stations)	240+00, E-12-B, Crow Creek;					
	312+00, E-17-A, Deer Creek; 640+00, E-18-F, Dry Wash					
Type of construction	New Alignment			Compaction type:	T99	
No. of test holes	25	No. of samples	17	Proposed pavement type	Flexible	
Adjacent terrain data	Rolling Hills					
Perform tests for swelling soil	Yes			Water sample	1	
Are old uncoated culverts corroding?	Yes			If yes, or area does not contain uncoated pipe, either descriptive documentation, samples or both are required per "Soil Survey Procedure" in the Design Manual.		
Record number and type of samples submitted for corrosion analysis. If submitted on separate CDOT Form #157, give report No.	1		Water			
	2		Soil			
Type of drilling equipment used	4" Auger			Resident Engineer	Dave Forsyth	
Comments	<i>Swampy area between Sta. 345+50 - 348+25.</i>					
	<i>Existing landslide on hillside @ Sta. 350+00 30' Lt.</i>					
	<i>Centerline located adjacent to pond between</i>					
	<i>Sta. 410+25 - 410+00.</i>					
	<i>All excavation will be common except rock outcrop between</i>					
	<i>Sta. 470+20 &amp; 472+50 which will require blasting.</i>					
	<i>Large boulders (2'-3') embedded in grade @ Sta. 514+00</i>					
Sampled by	Fidel Gonzales		Title	E/PS Tech III		
			Supervisor (Proj./Res./Mats.) signature	Corey Stewart / P.E. I		
White - Staff Materials & Geotechnical Yellow - Resident Engineer's Office (Project file) Pink - Region Materials office			Address	1050 Lee Hill Rd. Boulder, Co. 80302		

CDOT Form #554 1/01

Figure 4.5 CDOT Form #554

COLORADO DEPARTMENT OF TRANSPORTATION <b>PRELIMINARY SOIL SURVEY</b>															
User ID: MAYHEWT		Note 1: If samples are submitted leave sieve analysis section blank Note 2: Comments should be placed in the description column of the form Note 3: Sulfate content expressed as a percent (Dry soil), or ppm in water.										Form #554 No. 25687	Date Submitted: 04/17/2015		
												Form #557 No. 351633			
												Region: 1	Contract ID: C18180		
												Project No: FBR 0404-050			
												Project Location: US 40 Over Sand Creek			
Sample ID/ Station & Log	Test No.	Description	Sulfate Content (SO <sub>4</sub> )	Percent passing						Liquid limit	Plastic Index	Classification & Group Index	Mois- ture %	R-Val	M <sub>p</sub> P.S.I.
				3"	1"	3/4"	3/8"	#4	#10	#40	#200				
MP 97 to 103.3															
MP 97+20 8' LT															
0" to 5"	1A	HMA													
5" to 18"	1B	ABC-sample										0.7			
18" to 40"(refusal)	1C	Red, Gravelly, silt-sm	0.02									0.8			
MP 98+00 6' RT															
0" to 5"	2A	HMA													
5" to 16"	2B	ABC, similar to 1B													
16" to 30"(refusal)	2C	Brown, gravelly silt-sm	0.00									1.1			
MP 99+00 8' RT															
0" to 8"	3A	HMA													
8" to 12"	3B	ABC, similar to 1B													
12" to 28"(refusal)	3C	Similar to 2C	0.00												

CDOT Central Lab  
 Region Materials Engineer  
 Resident Engineer

Previous editions are obsolete and may not be used. CDOT Form #555 5/14

Figure 4.6 CDOT Form #555, as Submitted by the Region

COLORADO DEPARTMENT OF TRANSPORTATION PRELIMINARY SOIL SURVEY														
User ID: MAYHEWT			Form #157/No. 3571633			Form #554 No. 25687			Date Submitted: 04/17/2015					
Region: 1			Contract ID: C18180			Project No. FBR 0404-050			Project Location: US 40 Over Sand Creek					
Sample ID/ Station & Log	Test No.	Description	Sulfate Content (SO <sub>4</sub> )	Percent passing					Liquid Plastic Index	Classification & Group Index	Mois- ture %	R-Val	M <sub>R</sub> P.S.I.	
				3"	1"	3/4"	#4	#10						#40
MP 97 to 103.3														
MP 97+20 8' LT														
0" to 5"	1A	HMA												
5" to 18"	1B	ABC-sample		100	87	64	49	29	19.5	8	A-2-4(0)	0.7	73	28853
18" to 40"(refusal)	1C	Red, Gravelly, silt-sm	0.02	100	86	74	62	48	33.1	26	A-2-6(0)	0.8	50	25317
MP 98+00 6' RT														
0" to 5"	2A	HMA												
5" to 16"	2B	ABC, similar to 1B									A-2-4(0)		73	28853
16" to 30"(refusal)	2C	Brown, gravelly, silt-sm	0.00	100	76	59	50	36	22.8	28	A-2-6(0)	1.1	55	19492
MP 99+00 8' RT														
0" to 8"	3A	HMA												
8" to 12"	3B	ABC, similar to 1B									A-2-4(0)			28853
12" to 28"(refusal)	3C	Similar to 2C	0.00								A-2-6(0)			19492

CDOT Central Lab  
 Region Materials Engineer  
 Resident Engineer

Previous editions are obsolete and may not be used.

CDOT Form #555 5/14

Figure 4.7 CDOT Form #555, as Completed by the Central Laboratory

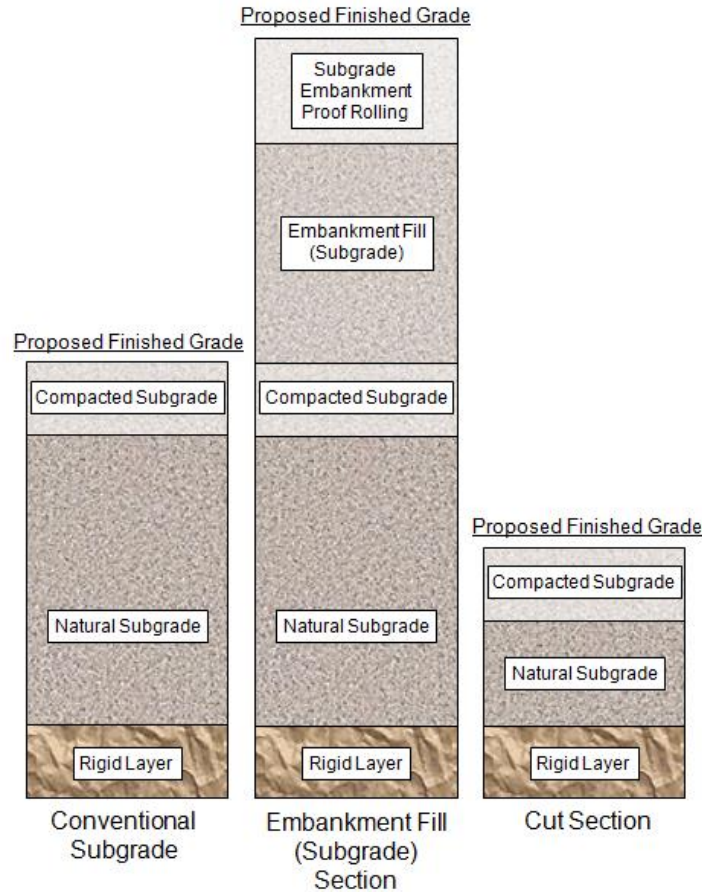
<b>COLORADO DEPARTMENT OF TRANSPORTATION FIELD REPORT FOR SAMPLE IDENTIFICATION OR MATERIALS DOCUMENTATION</b>  Metric units <input type="checkbox"/> yes <input checked="" type="checkbox"/> no			Region 1	Field sheet # 120227
			Contract ID C18180	Date Submitted 03/16/2015
			Project No. FBR 0404-050	
			Project Location US 40 Over Sand Creek	
Material Type Embankment, Soil		Field Lab phone 719-555-2525	Cell Phone 719-555-5353	
Material Code (LIMS) 203.03.01.01	Item 203	Class	Grading	Special Provisions <input checked="" type="checkbox"/> yes
Previously used on Project No.:		Previous CDOT Form #157 F/S No.(s):		<input checked="" type="checkbox"/> CDOT Form #633 (sack) <input type="checkbox"/> CDOT Form #634 (can)
● Sample Identification: Quantity & Unit of material submitted, describe tests required, precise location sample removed from ( stationing), etc. ● Materials Documentation: Field inspected (describe appearance, weight/dimensions, model/serial number), COC &/or CTR provided , etc. Submitting (6) canvas bags of soil for preliminary soil survey.				
Please complete the following tests: T89, T90, and M145 CP-L3101 (Min 50)				
Soil Survey enclosed in bag #1				
User ID KOCHISL				
Sample ID (#1) 153G113625	Sample ID (#2) 153G3738		Sample ID (#3) 153G114101	
Sample ID (#4) 153G114523	Sample ID (#5) 153G115236		Sample ID (#6) 153G120559	
APL/QML Acceptance: APL Ref. No.	Product name:		Date checked:	
APL/QML Acceptance: APL Ref. No.	Product name:		Date checked:	
Preliminary <input checked="" type="checkbox"/> Construction <input type="checkbox"/> Maintenance <input type="checkbox"/> Emergency <input type="checkbox"/>			Date needed 04/01/2015	
Contractor		Supplier		
Sampled from (Pit, roadway, windrow, stock, etc.)		Pit name or owner		
Quantity represented 1/LANE MILE, MIN	Previous quantity		Total quantity to date	
Sample submitted: <input checked="" type="checkbox"/> Yes <input type="checkbox"/> No	Shipped specified quantity to: 6 <input checked="" type="checkbox"/> Central lab <input type="checkbox"/> Region lab		Via CDOT	Date 03/17/2015
Sampled or inspected by (print name) LESLIE KOCHIS	Title EPST III		E-mail leslie.kochis@dot.state.co.us	
Supervisor (Pro./Res./Mats. Engr./Maint. Supt.) (print name) KARL LARSON	Title CEPM I		Residency LIMON	
Distribution: White copy - CDOT Central Laboratory (submit white copy only if sample or information is directed to Staff Materials) Canary copy - Region Materials Engineer Pink copy - Resident Engineer			CDOT Form #157 4/14  Previous editions are obsolete and may not be used.	

Figure 4.8 CDOT Form #157

### 4.3 Subgrade and Embankment

Subgrade can be categorized as shown in **Figure 4.1 Subgrade Preparation**.

- Conventional:** Man-made compacted layer (typically 12 inches) of the subgrade soil over the uncompacted natural soil material. Conventional subgrade involves the pre-conditioning of the natural subgrade material into a compacted layer. Pre-conditioning typically involves proof rolling usually before placement of other engineered layers.



**Figure 4.9 Subgrade Preparation**

- Embankment Fill:** Placement of a thick layer of imported soil or rock material over the uncompacted natural soil, typically located in a fill section. The typical soil or rock embankment material has a maximum dry density of not less than 90 pounds per cubic foot. Other properties such as resilient modulus ( $M_r$ ) must be as specified in the contract plans, specifications, and as presented below:
  - Soil Embankment:** Shall consist predominantly of materials smaller than 4.75mm (No. 4) sieve in diameter. Soil embankment is constructed with moisture density control in accordance with the requirements of Subsection 203.07 - Construction of Embankment and Treatment of Cut Areas with

Moisture and Density Control of *CDOT Standard Specification for Road and Bridge Construction*.

- **Rock Embankment:** Shall consist of materials with 50 percent or more by weight, at field moisture content, of particles with least dimension diameters larger than 4.75 mm (No. 4) sieve and smaller than 6 inches. Rock embankment is constructed without moisture density control in accordance with the requirements of Subsection 203.08 - Construction of Embankments without Moisture and Density Control of *CDOT Standard Specification for Road and Bridge Construction*.
- **Cut Section:** The finished subgrade cut section scarified to a depth of 6 inches with moisture applied or removed as necessary and compacted to a specified relative compaction.

The designer needs to be aware of a few fill embankment requirements. Claystone or soil-like nondurable shale, as defined by Colorado Procedure CP 26, shall not be treated as sound rock and shall be pulverized, placed, and compacted as soil embankment. Claystone or soil-like nondurable shale particles greater than 12 inches in diameter shall not be placed in the embankment (17).

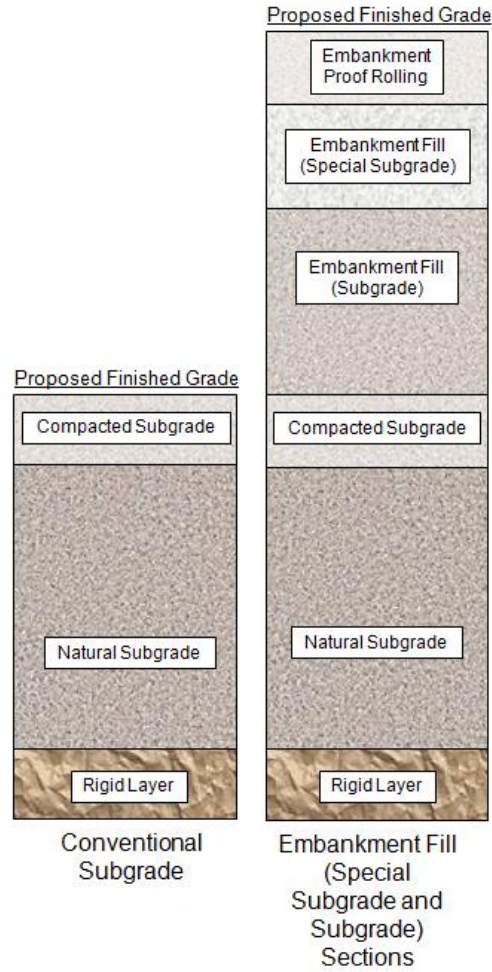
A special case of compacted subgrade is a fill section where the fill is comprised of two layers of subgrades with different engineering properties. The lower fill may comprise of a lesser resilient modulus than the upper layer. For illustration purposes, the upper embankment fill layer is shown here as special subgrade. The upper layer may require engineered material with a higher resilient modulus than the lower layer such as a  $M_r$  value of 25,000 psi in the top 2 feet of subgrade, and the lower layer may have a  $M_r$  value of 10,000 psi (see **Figure 4.2 Special Cases of Embankment Fill**).

## 4.4 Subgrade Characterization for the M-E Design

### 4.4.1 General Characterization

The subgrade characterization procedure for M-E Design is dependent on pavement type and design (new or rehabilitation). The inputs required are the resilient modulus, soil classification, moisture content, dry density, saturated conductivity, and other physical/engineering properties (see **Figure 4.3 Subgrade Material Properties in M-E Design** and **Figure 4.4 M-E Design Software Screenshot for Other Engineering/Physical Properties of Subgrade**).

**Note:** In M-E Design, the subgrade resilient modulus  $M_r$  is measured at optimum moisture content and density. This  $M_r$  is different than the AASHTO 1993 empirical design procedure which was basically a “wet of optimum”  $M_r$ . The input  $M_r$  is then internally adjusted to field conditions by the M-E Design software on a month to month basis based on water table depth, precipitation, temperature, soil suction, and other factors. Select the software option *Modify Input Values by Temperature/Moisture* to allow the software to seasonally adjust the input  $M_r$  to field conditions.



**Figure 4.10 Special Cases of Embankment Fill**

Layer 4 Subgrade: A-4

**Semi-infinite**  
 **0.35**  
 **0.5**

**9764**

**A-4**

**Identifiers**  
 Display name/identifier **A-4**

**Layer thickness (in.)**  
 Thickness of the unbound layer.  
 Minimum: 1  
 Maximum: 360

**Figure 4.11 Subgrade Material Properties in the M-E Design**

Sieve Size	Percent Passing										
0.001mm		Liquid Limit	21								
0.002mm		Plasticity Index	5								
0.020mm		<input type="checkbox"/> Is layer compacted?									
#200	60.6	<input type="checkbox"/> Maximum dry unit weight (pcf)	118.4								
#100		<input type="checkbox"/> Saturated hydraulic conductivity (ft/hr)	8.325e-06								
#80	73.9	<input type="checkbox"/> Specific gravity of solids	2.7								
#60		<input type="checkbox"/> Optimum gravimetric water content (%)	11.8								
#50		<input type="checkbox"/> User-defined Soil Water Characteristic Curve (SWCC)									
#40	82.7	<table border="1"> <tbody> <tr> <td>af</td> <td>68.8376536119812</td> </tr> <tr> <td>bf</td> <td>0.998285126875545</td> </tr> <tr> <td>cf</td> <td>0.475715611755117</td> </tr> <tr> <td>hr</td> <td>500</td> </tr> </tbody> </table>		af	68.8376536119812	bf	0.998285126875545	cf	0.475715611755117	hr	500
af	68.8376536119812										
bf	0.998285126875545										
cf	0.475715611755117										
hr	500										
#30											
#20											
#16											
#10	89.9										
#8											
#4	93										
3/8-in.	95.6										
1/2-in.	96.7										
3/4-in.	98										
1-in.	98.7										
1 1/2-in.	99.4										
2-in.	99.6										
2 1/2-in.											
3-in.											
3 1/2-in.	99.8										

**Figure 4.12 M-E Design Software Screenshot for Other Engineering/Physical Properties of Subgrade**

The input requirements for subgrade characterization are presented by pavement type and design:

- New Flexible and New JPCP: **Table 4.2 Recommended Subgrade Inputs in New Flexible and JPCJ Designs.**
- HMA Overlays of Existing Flexible Pavement: **Table 4.3 Recommended Subgrade Inputs for HMA Overlays of Existing Flexible Pavement.**
- Overlays of Existing Rigid Pavement: **Table 4.4 Recommended Subgrade Inputs for Overlays of Existing Rigid Pavement.**



**Table 4.3 Recommended Subgrade Inputs for New Flexible and JPCP Designs**

Pavement and Design Type	Material Property	Input Hierarchy		
		Level 1	Level 2	Level 3
New Flexible and JPCP	Resilient modulus	Not available	CDOT lab testing	AASHTO Soil Classification
	Gradation	Not available	Colorado Procedure 21-08	Use CDOT defaults
	Atterberg limit <sup>1</sup>	Not available	AASHTO T 195	Use CDOT defaults
	Poisson's ratio	Not available	Use M-E Design software defaults	Use M-E Design software default of 0.4
	Coefficient of lateral pressure	Not available	Use M-E Design software defaults	Use M-E Design software default of 0.5
	Maximum dry density	Not available	AASHTO T 180	Estimate internally using gradation, plasticity index, and liquid limit. <sup>2</sup>
	Optimum moisture content	Not available	AASHTO T 180	
	Specific gravity	Not available	AASHTO T 100	
	Saturated hydraulic conductivity	Not available	AASHTO T 215	
	Soil water characteristic curve parameters	Not available	Not applicable	

**Note:**  
<sup>1</sup> For drainage reasons if non-plastic use PI = 1  
<sup>2</sup> The M-E Design software internally computes the values of the following properties based on the inputs for gradation, liquid limit, plasticity index, and if the layer is compacted. If the designer chooses, they may modify the internally computed default values. The software updates the default values to user-defined values once the user clicks outside the software's input screen.

**Table 4.4 Recommended Subgrade Inputs for HMA Overlays of Existing Flexible Pavement**

Pavement and Design Type	Material Property	Input Hierarchy		
		Level 1	Level 2	Level 3
HMA Overlays of Existing Flexible Pavement	Resilient modulus	FWD deflection testing and backcalculated resilient modulus	CDOT lab testing	AASHTO soil classification
	Gradation	Colorado Procedure 21-08		Use CDOT defaults
	Atterberg limit <sup>1</sup>	AASHTO T 195		Use CDOT defaults
	Poisson's ratio	Use software defaults		Use M-E Design software default of 0.4
	Coefficient of lateral pressure	Use software defaults		Use M-E Design software default of 0.5
	Maximum dry density	AASHTO T 180		Estimate internally using gradation, plasticity index, and liquid limit. <sup>2</sup>
	Optimum moisture content	AASHTO T 180		
	Specific gravity	AASHTO T 100		
	Saturated hydraulic conductivity	AASHTO T 215		
	Soil water characteristic curve parameters	Not applicable		
<b>Note:</b>				
<sup>1</sup> For drainage reasons if non-plastic use PI = 1				
<sup>2</sup> The M-E Design software internally computes the values of the following properties based on the inputs for gradation, liquid limit, plasticity index, and if the layer is compacted. If the designer chooses, they may modify the internally computed default values. The software updates the default values to user-defined values once the user clicks outside the software's input screen.				

**Table 4.5 Recommended Subgrade Inputs for Overlays of Existing Rigid Pavement**

Pavement and Design Type	Material Property	Input Hierarchy		
		Level 1	Level 2	Level 3
Overlays of Rigid Pavement	Resilient Modulus	FWD deflection testing and backcalculated dynamic k-value <sup>3</sup>	CDOT lab testing	AASHTO soil classification
	Gradation	Colorado Procedure 21-08		Use CDOT defaults
	Atterberg Limit <sup>1</sup>	AASHTO T 195		Use CDOT defaults
	Poisson's ratio	Use software defaults		Use M-E Design software default of 0.4
	Coefficient of lateral pressure	Use software defaults		Use M-E Design software default of 0.5
	Maximum dry density	AASHTO T 180		Estimate internally using gradation, plasticity index, and liquid limit. <sup>2</sup>
	Optimum moisture content	AASHTO T 180		
	Specific gravity	AASHTO T 100		
	Saturated hydraulic conductivity	AASHTO T 215		
	Soil water characteristic curve parameters	Not applicable		
<b>Note:</b>				
<sup>1</sup> For drainage reasons if non-plastic use PI = 1				
<sup>2</sup> The M-E Design software internally computes the values of the following properties based on the inputs for gradation, liquid limit, plasticity index, and if the layer is compacted. If the designer chooses, they may modify the internally computed default values. The software updates the default values to user-defined values once the user clicks outside the software's input screen.				
<sup>3</sup> The k-value represents the subgrade layer, as well as, unbound layers including granular aggregate base and subbase layers.				

#### 4.4.2 Modeling Subgrade Layers in M-E Design Software

The M-E Design software divides the pavement structure, including subgrade, into sublayers for analysis purposes. The software divides the top 8 feet of a pavement structure and subgrade into a maximum of 19 sublayers. The remaining subgrade is treated as a semi-infinite layer. The designer should consider the following to properly characterize subgrade in M-E Design:

- **Modeling Embankments**
  - When a full-depth flexible or semi-rigid pavement is placed directly on a thick embankment fill, the top 10 inches is modeled as an Aggregate Base Layer, while the remaining embankment is modeled as the Subgrade Layer 1. The  $M_r$  and other physical/engineering properties remain the same for both layers. The natural subgrade below the embankment fill is modeled as Subgrade Layer 2.

- **Modeling Thick Aggregate Bases**
  - When a thick granular aggregate base (more than 10 inches) is used, the top 10 inches is modeled as an aggregate base layer, while the remaining aggregate is modeled as the Subgrade Layer 1. The  $M_r$  and other physical/engineering properties remain the same for both layers. The compacted or natural subgrade below the thick aggregate base is modeled as lower subgrade layers.
- **Modeling Compacted Subgrade**
  - The compacted and natural subgrade are modeled as separate subgrade layers.
- **Need for Improvement**
  - The designer should establish the need for improving or strengthening the existing subgrade based on subsurface investigation results. Typically, if the subgrade has a  $M_r$  less than 10,000 psi, subgrade improvement could be considered.
- **Effects of Frost Susceptible/Active Soils**
  - The M-E Design software does not directly predict the increase in distresses caused by expansive, frost susceptible, and collapsible soils. Treatments to such problematic soils could be considered (outside the M-E Design analysis) as a part of the design strategy.
- **Modeling Bedrock**
  - Bedrock or any hard layer encountered more than about 20 feet below the pavement will have an insignificant effect on the calculated pavement responses and predicted distresses/IRI. Inclusion of bedrock in the pavement structure below 20 feet is **not** recommended.
- **Modeling Geosynthetics**
  - Filter fabrics, geotextiles, and geogrids cannot be directly included in the pavement structure.

#### 4.4.3 Recommended Inputs for Subgrade/Embankment Materials

##### 4.4.3.1 Inputs for New HMA and JPCP

###### Level 1 Inputs

Level 1 inputs are not available for new HMA and JPCP designs in this manual since they are project specific values.

## **Level 2 Inputs**

The designer must input a single value of design  $M_r$ . Two approaches are available for Level 2 design subgrade  $M_r$ :

- **Laboratory Resilient Modulus:** The design  $M_r$  may be obtained through laboratory resilient modulus tests conducted in accordance with AASHTO T 307, Determining the Resilient Modulus of Soils and Aggregate Materials. Subgrade design  $M_r$  should reflect the range of stress states likely to be developed beneath flexible or rigid pavements subjected to moving wheel loads. Therefore, the laboratory measured  $M_r$  should be adjusted for the expected in-place stress state for use in M-E Design software. Stress state is determined based on the depth at which the material will be located within the pavement system (i.e., the stress states for specimens to be used as base or subbase or subgrade may differ considerably).
- **CDOT Resilient Modulus, R-value Correlation:** The design  $M_r$  may be obtained through correlations with other laboratory tested soil properties such as the R-value. Equation **Eq. 4-1** gives an approximate correlation of resistance value (R-value) to  $M_r$ . This equation is valid only for AASHTO T 190 procedure. If the R-value of the existing subgrade or embankment material is estimated to be greater than 50, a FWD analysis or resilient modulus by AASHTO T 307 should be performed. CDOT uses Hveem stabilometer equipment to measure strength properties of soils and bases. This equipment yields an index value called the R-value. The R-value is considered a static value and the  $M_r$  value is considered a dynamic value.

$$M_r = 3438.6 * R^{0.2753} \qquad \text{Eq. 4-1}$$

Where:

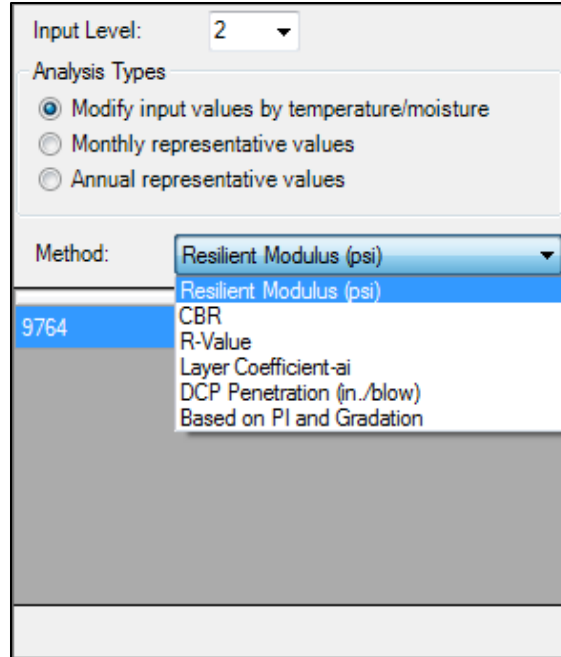
$M_r$  = resilient modulus (psi)

R = R-value obtained from the Hveem stabilometer

This equation **should be** used for R-values of 50 or less. Research is currently being done for soils with R-values greater than 50. The Hveem equipment does not directly provide resilient modulus values, rather, it provides the R-value which is then used to obtain an approximation of resilient modulus from correlation formulas.

The M-E Design software allows the designer to estimate  $M_r$  using other soil properties (see **Figure 4.5 M-E Design Software Screenshot for Level 2 Resilient Modulus Input**).

- California Bearing Ration (CBR)
- R-value
- Layer coefficient ( $a_i$ )
- Dynamic Cone Penetrometer (DCP) Penetration
- Plasticity Index (PI) and gradation (i.e., percent passing No. 200 sieve)



**Figure 4.13 M-E Design Software Screenshot for Level 2 Resilient Modulus Input**

The mathematical relationship between the  $M_r$  value and the above mentioned soil properties are hard coded in the M-E Design software, and the estimation is done internally. The  $M_r$  to R-value correlation in the software follows the relationship provided in the *AASHTO 1993 Pavement Design Guide*. Other engineering properties may be obtained as recommended in **Table 4.2 Recommended Subgrade Inputs in New Flexible and JPCP Designs**.

### **Level 3 Inputs**

Typical  $M_r$  values for Level 3 inputs are presented in **Table 4.5 Level 3 Resilient Modulus For Embankments and Subgrade**. **Note:** The  $M_r$  values presented in this table are at optimum moisture content and maximum dry density. **Table 4.5 should only be used for a preliminary pavement design when a resilient modulus or R-value is unavailable. The final pavement design shall use Level 1 or 2 resilient modulus value(s) specific to the project that is/are obtained either in a laboratory or via Equation 4-1.** Figure 4.6 M-E Design Software Screenshot for Level 3 Resilient Modulus Input presents the screenshot showing the Level  $M_r$  input in the M-E Design software which uses predictive equations based on soil class, gradation, plasticity index, liquid limit, and internally calculates other engineering properties.

**Table 4.6 Level 3 Resilient Modulus For Embankments and Subgrade  
(Only Use For A Preliminary Design)**

AASHTO Soil Classification	Resilient Modulus ( $M_R$ ) at Optimum Moisture (psi)	
	Flexible Pavements	Rigid Pavements
A-1-a	19,700	14,900
A-1-b	16,500	14,900
A-2-4	15,200	13,800
A-2-5	15,200	13,800
A-2-6	15,200	13,800
A-2-7	15,200	13,800
A-3	15,000	13,000
A-4	14,400	18,200
A-5	14,000	11,000
A-6	17,400	12,900
A-7-5	13,000	10,000
A-7-6	12,800	12,000

**Note:** This table is only to be used during a preliminary design when there is minimum knowledge of the subgrade properties. Levels 1 and 2 values **must** be used for all final designs.

Input Level: 3

Analysis Types

- Modify input values by temperature/moisture
- Monthly representative values
- Annual representative values

Method: Resilient modulus (psi)

9764

**Figure 4.14 M-E Design Software Screenshot for Level 3 Resilient Modulus Input**

#### 4.4.3.2 Inputs for HMA Overlay of Existing Flexible Pavements

##### Level 1 Inputs

Level 1 design subgrade  $M_r$  (at in-situ moisture content) for overlays of existing pavement designs, is obtained through FWD testing and backcalculation of pavement deflection data. **APPENDIX C: Deflection Testing and Backcalculation Method** contains detailed information on how to perform FWD testing and process pavement deflection data to obtain backcalculated elastic moduli.

The subgrade elastic modulus ( $E_R$ ) values obtained from backcalculation of FWD deflection data do not match with the resilient modulus values measured in the laboratory. The FWD backcalculated elastic modulus values represent field conditions under dynamic loading and require an adjustment to laboratory test conditions. The adjustment factors to convert FWD backcalculated elastic modulus to laboratory resilient modulus values are presented in **Table 4.6 Average Backcalculated to Laboratory Determined Elastic Modulus Ratios**. In the M-E Design software, the backcalculated in-situ subgrade  $M_r$  should be entered in conjunction with the in-situ subgrade moisture content. Average moisture content measured at the time of FWD testing is recommended for use. Other engineering properties may be obtained as recommended in **Table 4.2 Recommended Subgrade Inputs in New Flexible and JPCP Designs**.

**Table 4.7 Average Backcalculated to Laboratory Determined Elastic Modulus Ratios**

Layer Type	Location	Mean $E_R/M_r$ Ratio
Unbound Granular Base and Subbase Layers	Granular base/subbase between two stabilized layers (cementitious or asphalt stabilized materials)	1.43
	Granular base/subbase under a PCC layer	1.32
	Granular base/subbase under an HMA surface or base layer	0.62
Embankment and Subgrade Soils	Embankment or subgrade soil below a stabilized subbase layer or stabilized soil	0.75
	Embankment or subgrade soil below a flexible or rigid pavement without a granular base/subbase layer	0.52
	Embankment or subgrade soil below a flexible or rigid pavement with a granular base or subbase layer	0.35
<b>Note:</b> $E_R$ = Elastic modulus backcalculated from deflection basin measurements. $M_r$ = Elastic modulus of the in-place materials determined from laboratory repeated load resilient modulus test.		

##### Level 2 Inputs

Follow the guidelines presented in **Level 2 Inputs for New HMA and JPCP**.

##### Level 3 Inputs

Follow the guidelines presented in **Level 3 Inputs for New HMA and JPCP**.



### 4.4.3.3 Inputs for Overlays of Existing Rigid Pavements

#### Level 1 Inputs

The modulus of subgrade reaction (k-value) is a required input for rigid rehabilitation designs, unbonded concrete overlays, HMA over existing JPCP, and JPCP over AC designs. M-E Design also requires the month FWD testing was performed for seasonal adjustments.

The “effective” dynamic k-value represents the compressibility of underlying layers (i.e. unbound base, subbase, and subgrade layers) upon which the upper bound layers and existing HMA or PCC layer is constructed. The dynamic k-value is obtained through FWD testing and backcalculation of pavement deflection data. **APPENDIX C – Deflection Testing and Backcalculation Method** contains detailed information on how to perform FES testing and process pavement deflection data to obtain the dynamic modulus of subgrade reaction. The designer should only use Level 1 inputs because this level will show the pavement’s response. **Note:** The k-value used in the *1998 AASHTO Supplement* is a static elastic k-value, while M-E Design uses the dynamic k-value. Other engineering properties may be obtained as recommended in **Table 4.2 Recommended Subgrade Inputs in New Flexible and JPCP Designs**.

#### Level 2 Inputs

Level 2 subgrade  $M_r$  is obtained from field testing such as R-value tests. Follow the guidelines presented in **Level 2 Inputs for New HMA and JPCP**.

M-E Design software will internally convert the  $M_r$  input to an effective, single dynamic k-value as a part of input processing. This conversion is performed internally for each month of the design analysis period and utilized directly to compute critical stresses and deflections in the incremental damage accumulation over the analysis period. Other engineering properties may be obtained as recommended in **Table 4.2 Recommended Subgrade Inputs in New Flexible and JPCP Designs**.

#### Level 3 Inputs

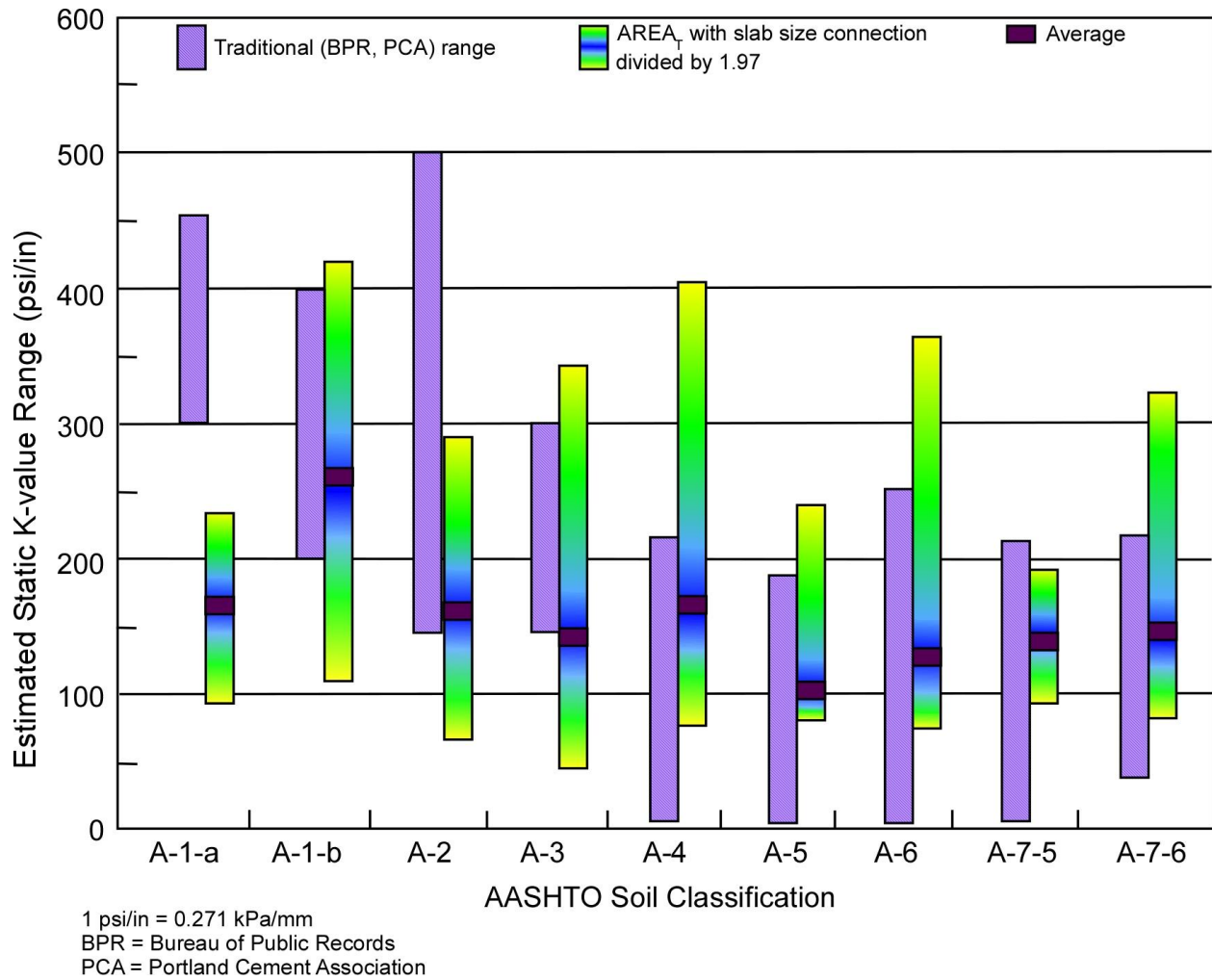
Follow the guidelines presented for **Level 3 Inputs for New HMA and JPCP**.

- **Estimating or Measuring the k-value:** The *1998 AASHTO Supplement* outlines three procedures to estimate or measure the k-value. There is no direct laboratory procedure for determining the initial k-value, however, there are three procedures for estimating the initial k-value. One of the procedures has three methods of correlations to determine the initial k-value. The procedures and methods are:
  - Correlations with soil type and other soil properties or tests
  - Correlation using soil classification
  - Correlation to California Bearing Ratio
  - Correlation by Dynamic Cone Penetrometer Plate bearing tests
  - Deflection testing and backcalculation (recommended)

A procedure not described in the 1998 AASHTO Supplement is using an R-value correlated to the dynamic  $M_r$  and a simplified, older AASHTO relationship equation to obtain a k-value.

After selecting which procedure to use, the designer continues to adjust the initial k-value. Two adjustment steps follow. The first step is to adjust the initial k-value to a seasonal effective k-value for the effects of a shallow rigid layer and/or an embankment above the natural subgrade.

- **Correlations of Initial k-value Using Soil Classifications:** Initial k-values may be correlated to the soil type and basic physical properties. In general, the static k-value can be determined using a simplified graphical depiction of soil classification in **Figure 4.8 k-value vs. Soil Classification**. Greater detail can be found using **Table 4.7 k-value Ranges for Various Soil Types**.
- **Cohesionless Soils (A-1 and A-3):** Recommended k-value ranges for insensitive to moisture variation A-1 and A-3 soils are summarized in Table 11 of the *1998 AASHTO Supplement* as shown in **Table 4.7 k-value Ranges for Various Soil Types** which has typical ranges of dry density and CBR for each soil type.
- **Granular Materials (A-2):** Recommended k-values for granular materials that fall between A-1 and A-3 soils are summarized in Table 11 of the *1998 AASHTO Supplement* as shown in **Table 4.7 k-value Ranges for Various Soil Types** which has typical ranges of dry density and CBR for each soil type.
- **Cohesive Soils (A-4 through A-7):** Recommended k-values for AASHTO classification of fine-grained A-4 through A-7 soils as a function of saturation are shown in the *1998 AASHTO Supplement* and in **Figure 4.9 k-values Versus Degree of Saturation for A-4 through A-7 Soils**. Each line represents the middle range of reasonable values  $\pm 40$  psi/in.



**Figure 4.15 k-value vs. Soil Classification**

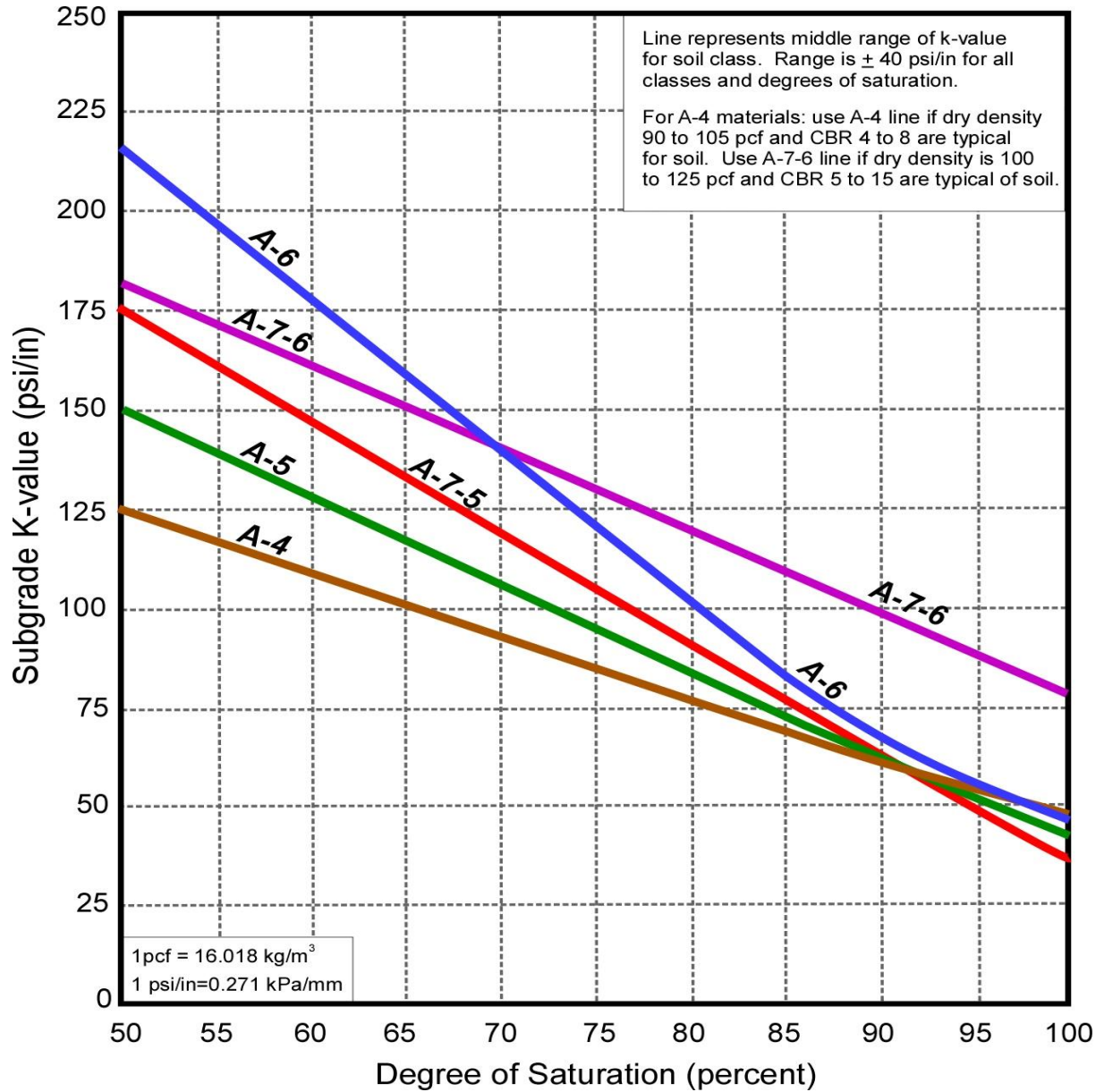


Figure 4.16 k-value vs. Degree of Saturation for A-4 Through A-7 Soils

**Table 4.8 k-value Ranges for Various Soil Types**

AASHTO Classification	Description	Unified Class	Dry Density (lb/ft <sup>3</sup> )	CBR (percent)	k-value (psi/in)
<b>Coarse-grained soils</b>					
A-1-a, well graded	Gravel	GW, GP	125 - 140	60 - 80	300 - 450
A-1-a, poorly graded			120 - 130	35 - 60	300 - 400
A-1-b	Coarse sand	SW	110 - 130	20 - 40	200 - 400
A-3	Fine sand	SP	105 - 120	15 - 25	150 - 300
<b>A-2 soils (granular materials with high fines)</b>					
A-2-4, gravelly	Silty gravel	GM	130 - 145	40 - 80	300 - 500
A-2-5, gravelly	Silty sandy gravel				
A-2-4, sandy	Silty sand	SM	120 - 135	20 - 40	300 - 400
A-2-4, sandy	Silty gravelly sand				
A-2-6, gravelly	Clayey gravel	GC	120 - 140	20 - 40	200 - 450
A-2-7, gravelly	Clayey sandy gravel				
A-2-6, sandy	Clayey sand	SC	105 - 130	10 - 20	150 - 350
A-2-7, sandy	Clayey gravelly sand				
<b>Fine-grained soils</b>					
A-4	Silt	ML, OL	90 - 105	4 - 8	25 - 165*
	Silt/sand/gravel mixture		100 - 125	5 - 15	40 - 220 *
A-5	Poorly graded silt	MH	80 - 100	4 - 8	25 - 190*
A-6	Plastic clay	CL	100 - 125	5 - 15	25 - 255*
A-7-5	Moderately plastic elastic clay	CL, OL	90 - 125	4 - 15	25 - 215*
A-7-6	Highly plastic elastic clay	CH, OH	80 - 110	3 - 5	40 - 220*
<p><b>Note:</b> * k-value of fine grained soil is highly dependent on the degree of saturation. See Figure 40. These recommended k-value ranges apply to a homogeneous soil layer at least 10 ft. (3 m) thick. If an embankment layer less than 10 ft. (3 m) thick exists over a softer subgrade, the k-value for the underlying soil should be estimated from this table and adjusted for the type and thickness of embankment material using Figure 43. If a layer of bedrock exists within 10 ft. (3 m) of the top of the soil, the k should be adjusted using Figure 43. (These notes refer to figures in the <i>1998 AASHTO Supplement</i>).</p>					

## 4.5 Rigid Layer

A rigid layer is defined as the lower soil stratum with a high resilient or elastic modulus (greater than 100,000 psi). A rock layer may consist of bedrock, severely weathered bedrock, igneous, metamorphic, sedimentary material, or combinations of each, which cannot be excavated without blasting or the use of large mechanical equipment used for ripping bedrock, or over-consolidated clays. For example, a thick shale or claystone layer would be considered a rigid layer.

In M-E Design, the presence of a rigid layer within 10 feet of the pavement surface may have an influence on the structural responses of pavement layers. The designer may need to use multiple subgrade layers especially when the depth to the rigid layer exceeds 100 inches. **Note: The thickness of the last subgrade layer is limited to 100 inches when a rigid layer is added to the pavement structure in M-E Design. The rigid layer can be ignored for pavement design when the depth exceeds 20 feet.**

The M-E Design software recommended default elastic modulus values are 750,000 psi for solid, massive and continuous bedrock and 500,000 psi for highly fractured and weathered bedrock. The suggested default value for Poisson's ratio is 0.15.

## 4.6 Rock Fill

In pavement design, a rock fill would be a rigid layer and is defined in Subsection 203.03 - Embankment of *CDOT Standard Specification for Road and Bridge Construction*, 2011 (34). Rock fill shall consist of sound, durable stones, boulders, or broken rock not less than six inches in the smallest dimension. At least 50 percent of the rock used shall have a volume of 2 cubic feet or more, as determined by physical or visual measurement.

## 4.7 Frost Susceptible Soils

In areas subject to frost, soils may be removed and replaced with selected, nonsusceptible material. Where such soils are too extensive for economical removal, they may be covered with a sufficient depth of suitable material to overcome the detrimental effects of freezing and thawing. The need for such measures and the type and thickness of material required must be determined on the basis of local experience and types of materials (20). Frost heaving may be caused by crystallization of ice lenses in voids of soils containing fine particles. Bearing capacity may be reduced substantially during thawing periods. Frost heaving can be more severe during freeze-thaw periods because water is more readily available. Several cycles of freeze and thaw may occur during a winter season and cause more damage than one long period of freezing in more northerly areas of the state.

To compute the monthly or annual freezing index and estimate frost heave depth, the following equation is used:

$$FI = \sum_{i=1}^n (0 - T_i)$$

**Eq. 4-2**

Where:

FI = freezing index, degrees Celsius (°C) degree-days

T<sub>i</sub> = average daily air temperature on day i, °C

n = days in the specified period when average daily temperature is below freezing

i = number of days below freezing

When using this equation, only the days where the average daily temperature is below freezing are used. Therefore, the freezing index is the negative of the sum of all average daily temperatures below 0 °C within the given period (29).

See **Figure 4.9 Colorado Annual Freezing Index (Degrees-Fahrenheit Days)** for a map of Colorado showing isopieth lines for the annual freezing index. The isopieth lines are in units of degree-Fahrenheit days. The highest Freezing Index values are in the mountains, Berthoud Pass, Taylor Park, and Climax. The lowest values are on the western side of the state, Gateway, Uravan, and Palisade. **Note:** The Freezing Index values do not necessarily follow elevations.

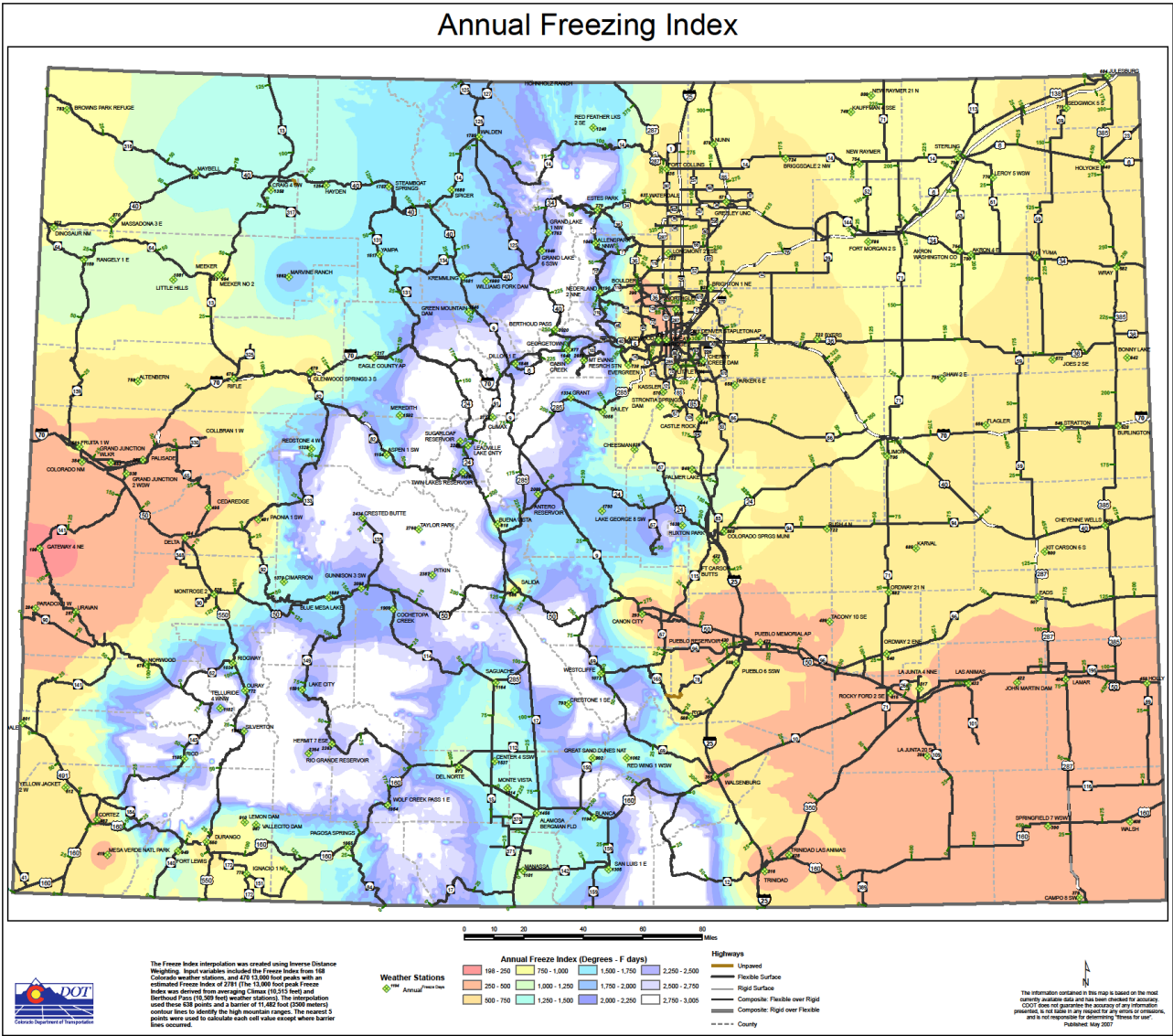
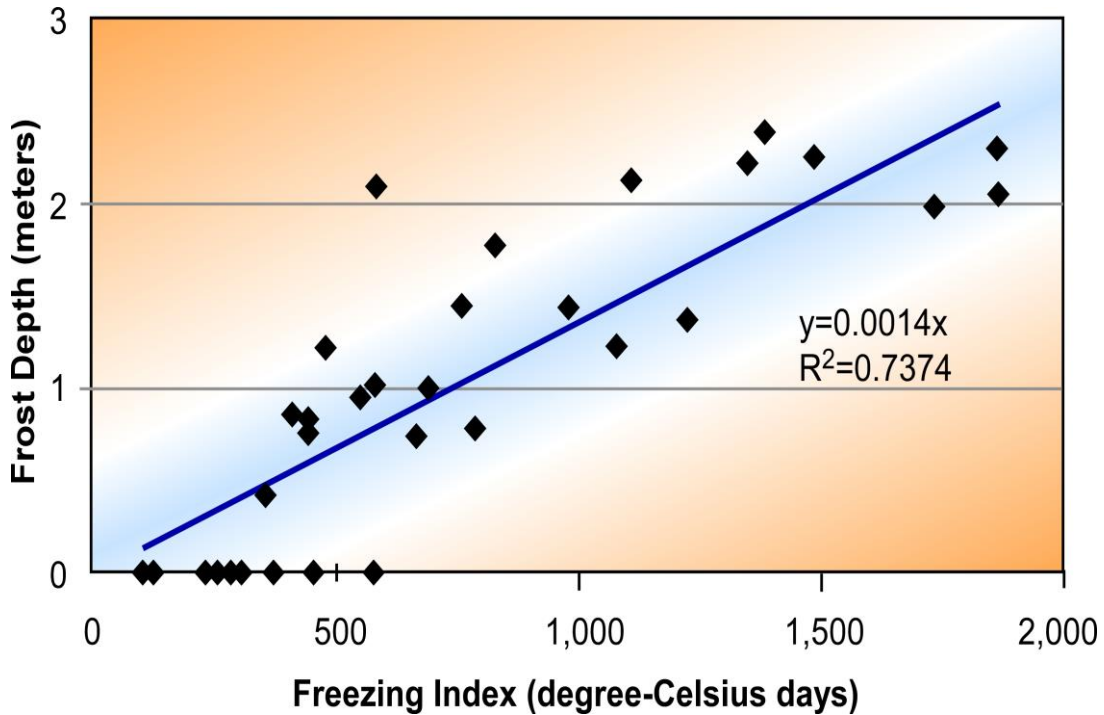


Figure 4.17 Colorado Annual Freezing Index (Degrees-Fahrenheit Days)



**Figure 4.18 Frost Depth to Annual Freezing Index**

To convert the Annual Freezing Index (degrees-Fahrenheit days) to (degrees-Celsius days) use equation **Eq. 4-3**. The conventional conversion formula has the term 32 °F and is accounted for in the number of days below freezing.

$$\begin{aligned} \text{FI} &= \text{Annual Freezing Index (}^\circ\text{C days)} \\ &= \left(\frac{5}{9}\right) \text{Annual Freezing Index (}^\circ\text{F days)} \end{aligned} \qquad \text{Eq. 4-3}$$

There is a relationship between the Annual Freezing Index (FI) and frost depth. The seasonal monitoring program with FHWA Long-Term Pavement Performance sites analyzed this relationship (see equation **Eq. 4-4**) (30).

$$\text{Frost Depth} = 0.0014 \times \text{FI} \qquad \text{Eq. 4-4}$$

Where:

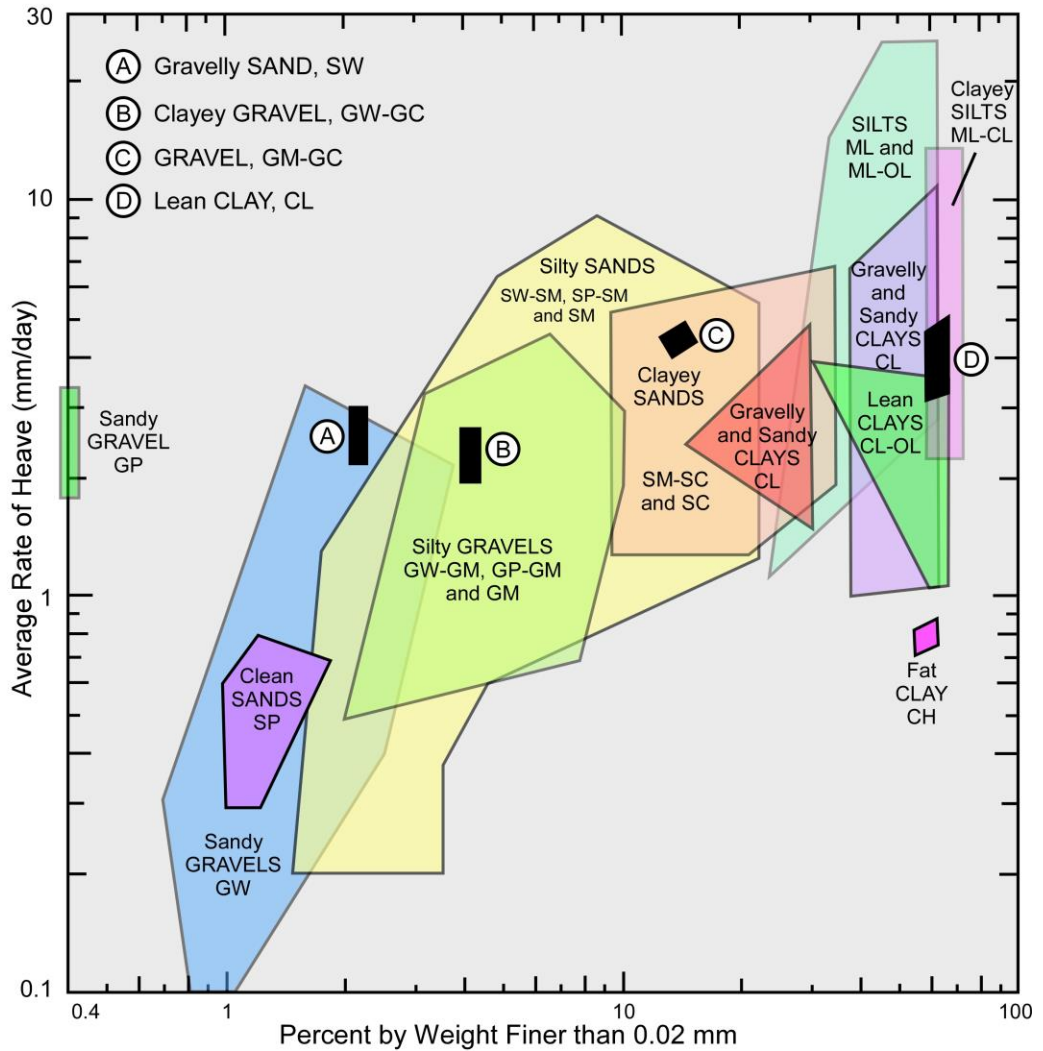
Frost depth is in meters

FI is the annual freezing index (°Celsius days)

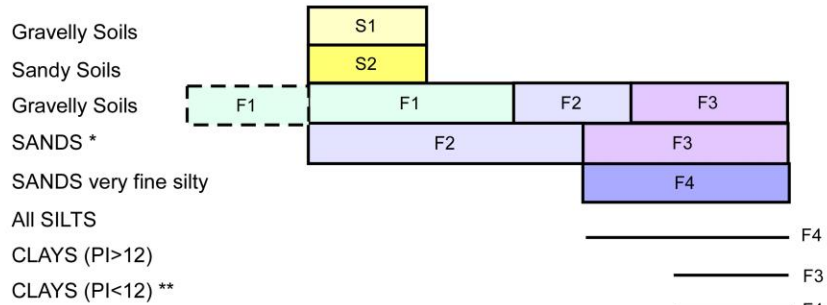
A graph was developed to show the relationship of frost depth versus freezing index, (see **Figure 4.10 Frost Depth to Annual Freezing Index**). The data scatter is influenced by local site conditions. Refer to **Figure 4.11 Frost Susceptible Soil Classifications** for possible scatter.



Frost Susceptibility Classifications



Summary Envelopes



Modified from the U.S Army Corps of Engineers

\* Except very fine silty SANDS  
\*\* Varved CLAYS and other fine-grained banded sediments

Figure 4.19 Frost Susceptible Soil Classifications

**Figure 4.11 Frost Susceptible Soil Classifications** shows frost susceptibility for various soil classifications (31). The figure shows rates of heave in laboratory freezing tests on remolded soils. Because of the severity of the remolded laboratory test, the rates of heave shown in the figure are generally greater than may be expected under normal field conditions.

Frost susceptible soils have been classified into general groups (16):

- Gravels, crushed rock, sands, and similar materials exhibit little or no frost action when clean and free draining under normal freezing conditions.
- Silts are highly frost susceptible. The relatively small voids, high capillary potential/action, and relatively good permeability accounts for this characteristic.
- Clays are cohesive and, although their potential capillary action is high, their capillary rate is low. Although frost heaving can occur in clay soils, it is not as severe as for silts since the impervious nature of clays makes passage of water slow. The supporting capacity of clays must be reduced greatly during thaws, although significant heave has not occurred.
- Muck is an unsuitable material with a minimum of 15 percent organic material, in either natural subgrade, fill embankment, or cut sections and should be removed. Muck may be soil formed from decaying plant materials. Problems with highly organic soils are related to their extremely compressible nature. Those of relatively shallow depth, are often most economically excavated and replaced with suitable select material. Deeper deposits have been alleviated by placing surcharge embankments for preconsolidation with provisions on removal of water (20).

In using the pavement design procedures, it is understood to use the final material properties of the soils in construction as inputs for the design analysis. Therefore, the calculation of depth of frost penetration and suitable low frost susceptible soils must be performed prior to pavement design.

## 4.8 Sulfate Subgrade Soils

Sulfate induced problems in soils stabilized using calcium-based stabilizing agents such as lime and portland cement has been documented since the late 1950's in the United States. A number of highly qualified cement chemists have studied the mechanism in an effort to understand and control sulfate attack on portland cement concrete structures. It is very important for the designers to understand the fundamentals of sulfate-induced distress and the risk levels when sulfate soils are stabilized with lime or with other calcium-based stabilizing agents.

Sulfates typically are concentrated closer to the surface in the drier, western regions. Moving eastward into wetter and more humid climates, the general rule is that if sulfates are present they tend to concentrate at deeper depths. For preliminary soil information, two valuable tools can be used to assess the presence and significance of sulfates within an area. These are the *United States*

*Department of Agriculture's County Soils Report*, and the “Web Soil Survey” developed by the Natural Resources Conservation Service (NRCS) of the United States Department of Agriculture. The “Web Soil Survey” is located at <http://websoilsurvey.nrcs.usda.gov/app/> and allows the user to locate the construction job site, identify where sulfates typically occur, and determine the depth to expect significant concentrations.

The *County Soils Report* provides agricultural and engineering data for each soil. It is conveniently tabulated and generally shows the presence of gypsum and other sulfate salts, as well as, the depth of significant concentrations if any exist. This is an extremely valuable reconnaissance tool. It is very important not only to identify the presence of sulfates but also the depth of occurrence. For example, a soil may be essentially sulfate free in the upper 2 or 3 feet but have sulfate concentrations at a depth of 6 feet. In this case, sulfates would not be of concern during normal surface stabilization operations but could be of concern in cut and fill areas.

If sulfates are present and identified in the soils report, a field testing plan should be established with the Geotechnical Engineer. The frequency of testing depends on the level of sulfates present and the geological information for the region. If initial testing confirms the presence of sulfates in concentrations that may present problems, additional testing for the concentration of water-soluble sulfates may be warranted prior to recommending lime stabilization of the subgrade. Refer to *Chapter 200 of CDOT Field Materials Manual* for more information on sulfates.

## 4.9 Expansive Subgrade Soils

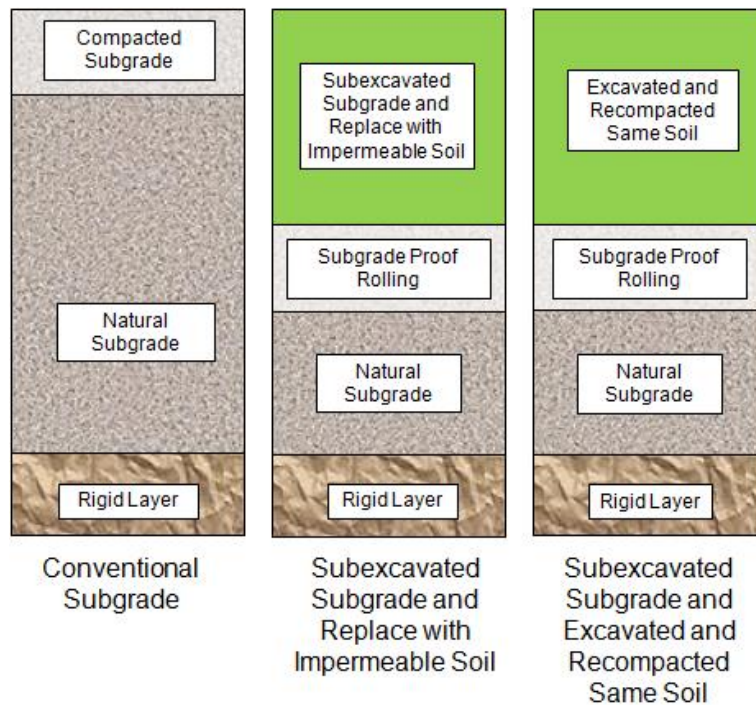
Soils that are excessively expansive should receive special consideration. One solution is to cover these soils with a sufficient depth of select material to overcome the detrimental effects of expansion. Expansive soils may often be improved by compaction at water contents over the optimum. In other cases, it may be more economical to treat expansive soils by stabilizing with a suitable stabilizing agent, such as lime (20).

One treatment of expansive soils is by performing the following subexcavation method. Subexcavate the expansive soil (dry dense unweathered shales and dry dense clays) and backfill with impermeable soil at 95 percent of maximum dry density at or above optimum moisture, in accordance with AASHTO Designation T 99. This treatment should carry through the cut area and transition from cut to fill until the depth of fill is approximately equal to the depth of treatment.

**Table 4.8 Treatment of Expansive Soils** is to be used as a guide to determine the depth of treatment as revised from Colorado Department of Highways Memo #323 (Construction) Swelling Soils, 1/5/1966. Projects on the interstate and National Highway System will require treatment of expansive soils. Treatment may take the form of subexcavation and replacing with impermeable soil, or subexcavate and recompact with moisture control of the same soil, see **Figure 4.12 Subexcavated Subgrade Layers**. Granular soils should not be used as backfill for subexcavation or replacement of expansive subgrade soils without a filter separator layer and edge drains to collect and divert the water from the pavement structure (26).

**Table 4.9 Treatment of Expansive Soils**

Plasticity Index	Depth of Treatment Below Normal Subgrade Elevation
10 – 20	2 feet
20 – 30	3 feet
30 – 40	4 feet
40 – 50	5 feet
More than 50	Placed in the bottom of the fills of less than 50 feet, or greater than 6 feet in height, or wasted.



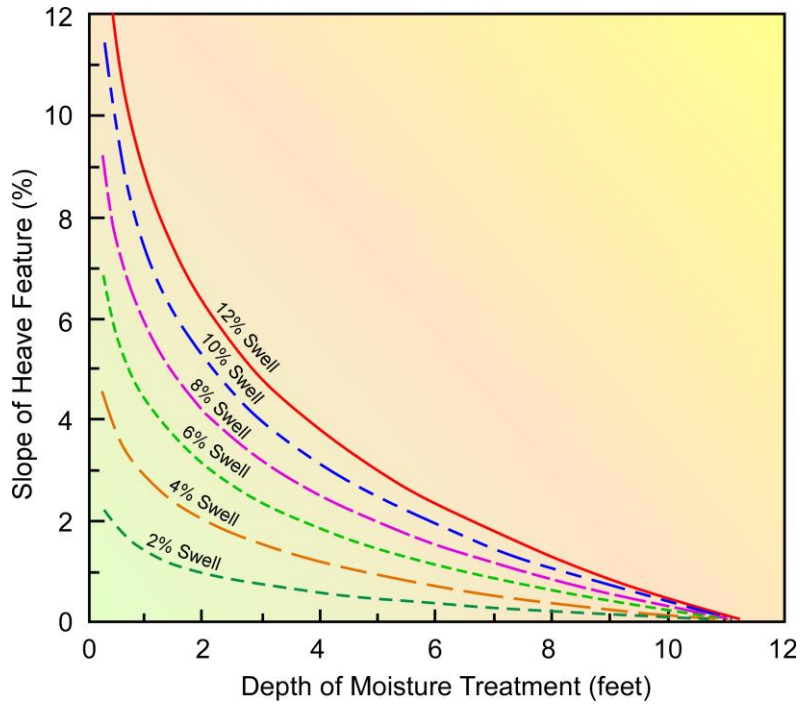
**Figure 4.20 Subexcavated Subgrade Layers**

The risk of swell potential is always a concern to the designer. The categories of the “swell damage risk” is shown in **Table 4.9 Probable Swell Damage Risk**. The designer should use **Table 4.9 Probable Swell Damage Risk** and **Table 4.8 Treatment of Expansive Soils** to decide the risk.

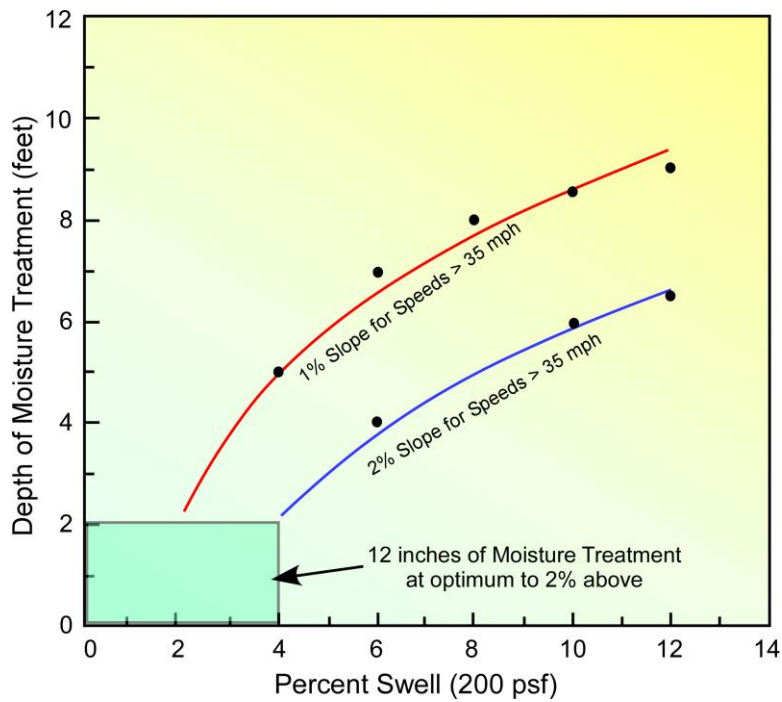
**Table 4.10 Probable Swell Damage Risk**

<b>Swell (%)</b>	<b>Swell Pressure (psf, at 200 psf surcharge)</b>	<b>Probable Swell Damage Risk</b>
0	0	None
0 - 1	0 - 1,000	Low
1 - 5	1,000 - 5,000	Medium
5 - 20	5,000 - 10,000	High
Over 20	Over 10,000	Very High

The Metropolitan Government Pavement Engineers Council (MGPEC) has published potential swell risk characterized by the driver's perception. Under the Section - Swelling Soils of the publication *Development of Pavement Design Concepts*, April 1998 (24) it documents the driver's perception concept. A driver's perception of a bump is directly related to the slope of the bump and perception of pavement roughness is related to the vehicle speed. A design criteria separation of below and above 35 mph was found to be an appropriate separation. Slopes representing the maximum allowable movement before causing discomfort to the driving public have been analyzed relating to vehicle speed. Streets with speeds less than 35 mph have a discomfort level of a 2 percent change. Higher speed streets and highways have a discomfort level of a 1 percent change. The slope of the heave is also related to the depth of the moisture treatment (subexcavation by means of excavate and recompact). **Figure 4.12 Effective Depth of Moisture Treatment** and **Figure 4.23 Recommended Depth of Moisture Treatment** graph the concept of slope of the bump and depth of recommended moisture treatment. **Table 4.9, Figure 4.13 Effective Depth of Moisture Treatment** and **Figure 4.14 Recommended Depth of Moisture Treatment** use the percent swell to determine the depth of subgrade treatment. **Table 4.8 Treatment of Expansive Soils** uses the plasticity index to determine the depth of subgrade treatment. The designer should consider each method and know the field conditions to make a reasonable decision.



**Figure 4.21 Effective Depth of Moisture Treatment**



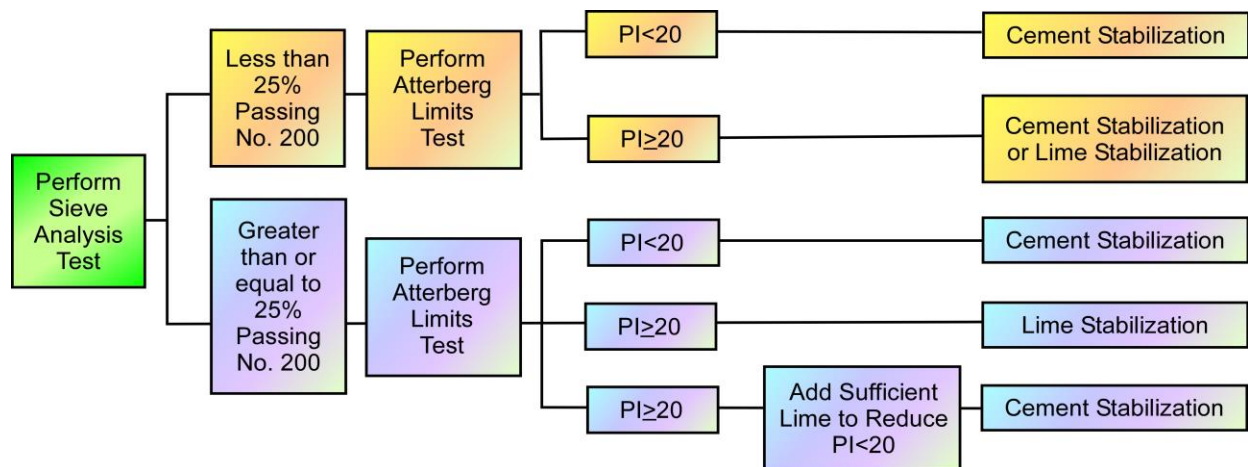
**Figure 4.22 Recommended Depth of Moisture Treatment**

## 4.10 Stabilizing Agents

The strength and stability of all subgrade soils improve with compaction. For certain subgrade soils, the strength gained even after compaction may not be adequate. Similarly, silty and clayey subgrade soils may be collapsible or expansive in nature, and thus not suitable for pavement construction. Stabilization of soils is an effective method for improving the properties of soil and pavement system performance. Mechanical stabilization is the process in which the properties of subgrade soils are improved by blending and compacting the soils without the use of admixtures or stabilizing agents. Unstable and expansive subgrade soils may be stabilized through chemical stabilization; many stabilizing agents may be effective by improving the in-lace soil properties rather than removing and replacing material or increasing base thickness. The objective of stabilizing agents is to increase the strength and stiffness, improve workability and constructability, and reduce the plasticity index (PI) and swell potential for expansive clays. Availability or financial considerations may be the determining factor in which a stabilizing agent is used.

Approved stabilizing agents are asphalt, lime, lime/fly ash, fly ash, portland cement, and approved chemical stabilizers. Other agents may be used with prior approval of CDOT. The approved stabilizing agents are combined with selected aggregate or soils, or with native materials to improve their stability and strength as load carrying elements of structural sections. The type and amount of stabilizing agent should be developed from tests of available materials, followed by cost comparisons against untreated materials.

Lime generally performs better on fine-grained materials, cement on coarse-grained soils, and fly ash performs well mostly on silty sands. Cement also provides highly effective clay stabilization, usually with the added benefit of higher strength gain, but quality control may be difficult. The following chart, **Figure 4.15 Lime/Cement Stabilization Flow Chart**, provides a good estimate of the lime and cement for a certain soil type dependent upon gradation and plasticity index.



**Figure 4.23 Lime/Cement-Stabilization Flow Chart**

#### 4.10.1 Lime Treated Subgrade

When swell potential as determined by ASTM D 4546 is found to be greater than 0.5 percent using a 200 psf surcharge, stabilization should be used per *CDOT Standard Specification for Road and Bridge Construction, 2011* specification book, Table 307-1. If the R-value of the subgrade soil is greater than 40, the use of a base layer is not recommended in the structural layering of a potential swelling soil. Soil with a plasticity index of more than 50 should be placed in the bottom of the fills of less than 50 feet in height, or wasted. The backfill soil should be uniform and all lenses or pockets of very high swelling soil should be removed and replaced with the predominant type of soil that has a plasticity index less than 50. If removal is not practical or subgrade soils were determined to have a plasticity index greater than 10, in-place treatment such as a lime-treated subgrade is recommended. A subgrade proposed for lime treatment should be investigated for sulfates. In some cases, such as construction over a rocky subgrade or when having to maintain traffic over a widened section, an aggregate base may be desirable.

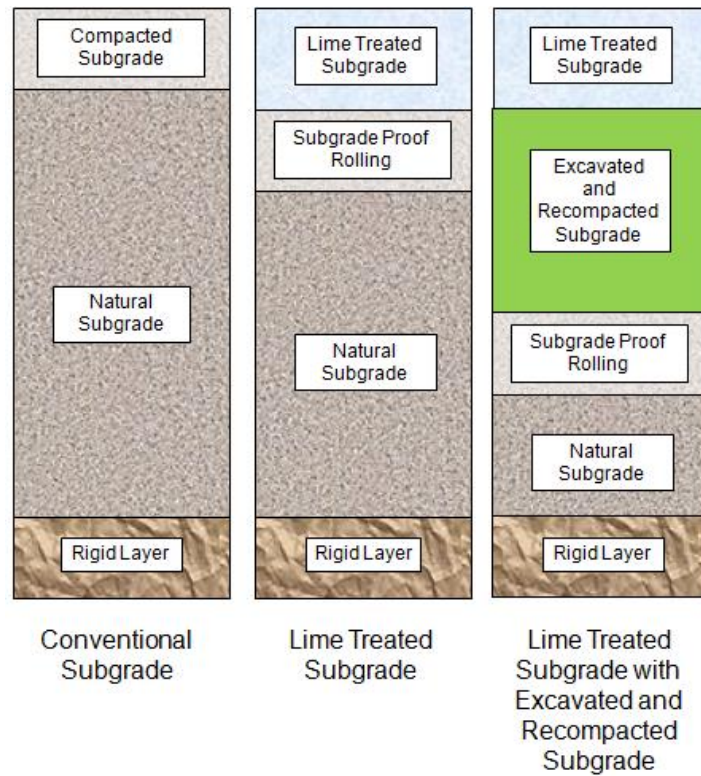
Lime treated subgrade consists of blending the existing subgrade material with a minimum of 3 percent lime by weight per design, to the specified depth and compaction (see **Figure 4.16 Lime Treated Structural Subgrade Layer**). Lime may be either quicklime or hydrated lime, shall conform to the requirements of ASTM C 977 along with a rate of slaking test for quicklime in accordance with ASTM C 110, and shall be the product of a high-calcium limestone as defined by ASTM C 51. The use of dolomitic or magnesia quicklime with magnesium oxide contents in excess of 4 percent, carbonated hydrated lime, and lime kiln dust or cement kiln dust shall not be allowed unless approved by the RME.

Some soils, when treated with lime, will form cementitious compounds resulting in a relatively high strength material. Lime reduces the ability of clays to absorb water, thus increasing internal friction and shear strength. Lime provides greater workability by changing the clays into friable sand-like material and reduces the plasticity index and swell potential.

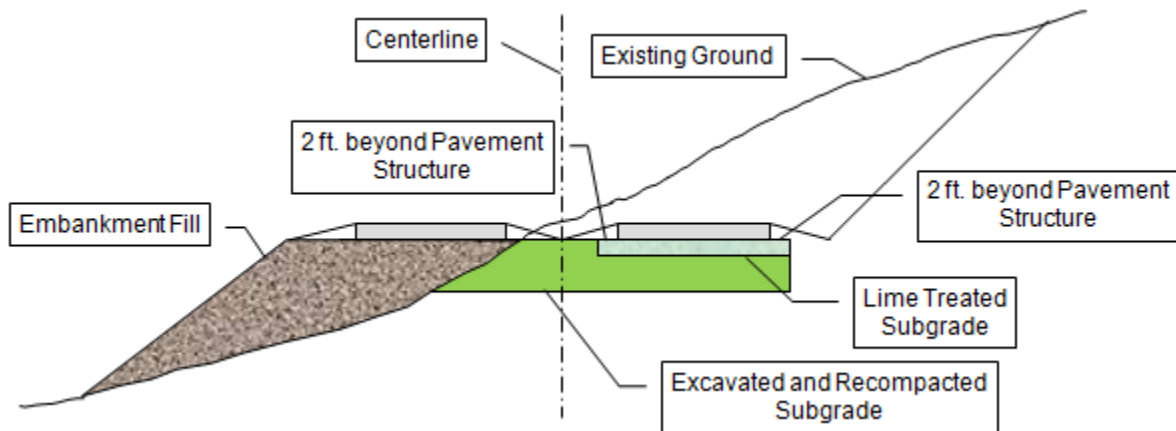
The designer should test the soil for the concentration of water-soluble sulfates prior to recommending lime stabilization of the subgrade. Water-soluble sulfate content should be less than 0.2 percent by mass. Sulfate content greater than 0.2 percent can cause an adverse reaction among the lime, soil, sulfate ions, and water. This can lead to loss of stability and cause swelling or heave. Additionally, excessive lime in the subgrade can create leaching of calcium into the ground water. For more information, see *Chapter 200 of the CDOT Field Materials Manual*.

Additional treatment of the natural subgrade may be needed. If lime treatment depth seems to be too thick to be practical, the swell potential subgrade may need to be excavated and recompacted to a depth as shown in **Table 4.8 Treatment of Expansive Soils**. The recompaction shall be at  $2 \pm 1$  percent above optimum moisture control, see **Figure 4.16 Lime Treated Structural Subgrade Layer**. **Figure 4.17 Cross Section of Lime Treated Cut Section Subgrade** shows the extent of the subexcavation excavated and recompacted treatment, or moisture treatment in cross sectional view.





**Figure 4.24 Lime Treated Structural Subgrade Layer**

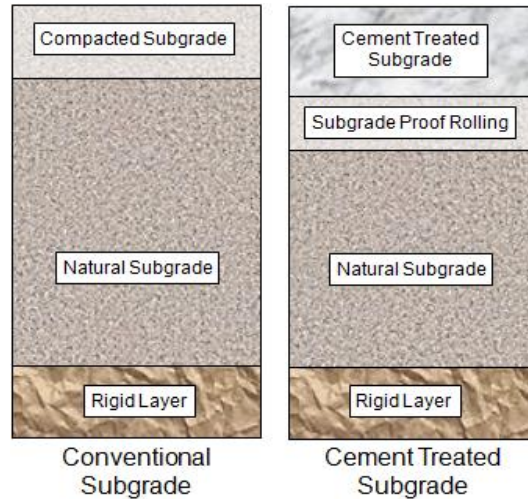


**Figure 4.25 Cross Section of Lime Treated Cut Section Subgrade**

#### 4.10.2 Cement Treated Subgrade

Cement is typically used to stabilize fine and coarse grained sands and low plastic index clays where the plasticity index is less than 20, see **Figure 4.18 Cement Treated Structural Subgrade Layer**. Cement treated subgrade will have higher unconfined strength, reduced permeability will

inhibit leaching, and can rapid set within two hours of the subgrade being treated. Normal percentages used in cement treated subgrade are from 2 to 15 percent by weight.

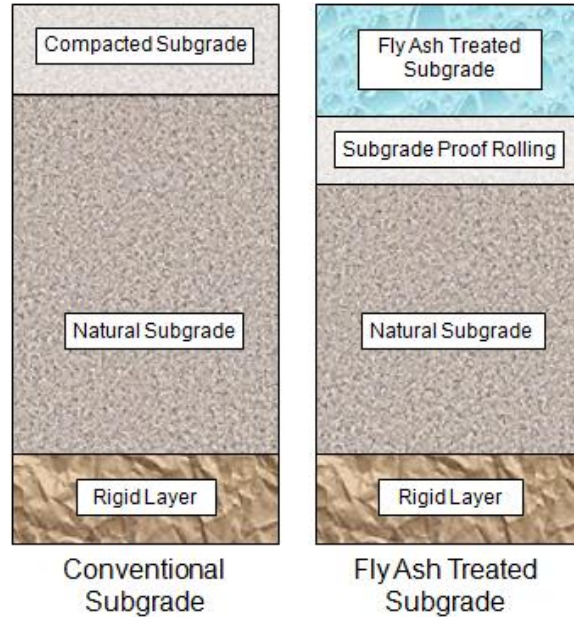


**Figure 4.26 Cement Treated Structural Subgrade Layer**

### 4.10.3 Fly Ash and Lime/Fly Ash Treated Subgrade

CDOT recommends the use of Class C fly ash as a stabilizing agent due to its calcium content. It can be used in sands and clays with low plasticity indices and at percentages of up to 25 percent. Fly ash percentages in the subgrade of greater than 25 percent can lead to a decrease in density and durability issues. Fly ash treated subgrade will typically experience increased unconfined compressive strengths similar to lime, as well as, increased sand maximum densities (see **Figure 4.19 Fly Ash Treated Structural Subgrade Layer**).

When used, the typical lime/fly ash content of a mixture ranges from 12 to 30 percent with lime to fly ash ratios of 1:3 to 1:4 being common. Class C fly ash is recommended for these mixtures, however, the designer may use high carbon Class C fly ash for soil stabilization.



**Figure 4.27 Fly Ash Treated Structural Subgrade Layer**

## 4.11 Geosynthetic Fabrics and Mats

### 4.11.1 Introduction

Geosynthetic fabrics and mats can be used as reinforcement in a variety of ways within and below the pavement section. Anytime poor or marginally acceptable in-situ soils are encountered, geosynthetic fabrics and mats should be considered. CDOT Soils and Rockfall Program personnel are available to help in the selection of the most appropriate product. Technical representatives for individual brand materials are also available.

Listed below are conditions for an in-situ subgrade where a geosynthetic may be used as a viable alternative. The listing and **Table 4.10 Application and Associated Functions of Geosynthetics in Roadway Systems** are from the publication *FHWA-NHI-07-092, Geosynthetic Design & Construction Guidelines Reference Manual, August 2008, Chapter 5.0 (33)*.

- Poor soils
  - USCS: SC, CL, CH, ML, MH, OL, OH and PT
  - AASHTO: A-5, A-6, A-7-5 and A-7-6
- Low undrained shear strength
  - Shear strength =  $\tau_f = c_u < 2,000$  psf (90 kPa),  $c_u$  is the undrained strength
  - CBR < 3 (**Note:** soaked saturated CBR as determined with ASTM D 4429)
  - R-value (California)  $\approx < 20$
  - $M_r \approx < 4,500$  psi (30 MPa)

- High water table
- High sensitivity: dynamic disturbance results in viscous flow.

**Table 4.10 Application and Associated Functions of Geosynthetics in Roadway Systems** shows additional guidance of when and how geosynthetics can be used as a separator, stabilizer, base reinforcement, or drainage material. For additional information on material use and approved products, the CDOT Materials Bulletin dated January 25, 2008, clarifies the terminology and application of geosynthetics (32).

**Table 4.11 Application and Associated Functions of Geosynthetics in Roadway Systems**  
(Table 5.1 FHWA-NHI-07-092, *Geosynthetic Design & Construction Guidelines Reference Manual*, August 2008)

Application	Function(s)	Subgrade Strength	Qualifier
Separator	Separation Secondary: filtration <sup>1</sup>	2,000 psf ≤ c <sub>u</sub> ≤ 5,000 psf (90 kPa ≤ c <sub>u</sub> ≤ 240 kPa) 3 ≤ CBR ≤ 8 4,500 psi ≤ M <sub>r</sub> ≥ 11,600 psi (30 MPa ≤ M <sub>r</sub> ≥ 80 MPa)	Soils containing high fines A-1-b, A-2-4, A-2-5, A-2-6, A-4, A-5, A-6, A-7-5, A-7-6
Stabilization	Separation, filtration and some reinforcement (especially CBR < 1) Secondary: separation	c <sub>u</sub> < 2,000 psf (90) kPa CBR < 3 M <sub>r</sub> < 4,500 psi (30 MPa)	Wet, saturated fine grained soils (i.e. silt, clay, and organic soils)
Base Reinforcement	Reinforcement Secondary: separation	600 psf ≤ c <sub>u</sub> ≤ 5,000 psf (30 kPa ≤ c <sub>u</sub> ≤ 240 kPa) 3 ≤ CBR ≤ 8 1,500 psi ≤ M <sub>r</sub> ≥ 11,600 psi (10 MPa ≤ M <sub>r</sub> ≥ 80 MPa)	All subgrade conditions, reinforcement located within 6 to 12 inches of pavement
Drainage	Transmission and filtration Secondary: separation	Not applicable	Poorly drained subgrade

**Note:** <sup>1</sup> Always evaluate filtration requirements.

#### 4.11.2 Separator Layer

If coarse, open-graded base or subbase courses are used, it may be necessary to provide a means for preventing the intrusion of the underlying fine-grained roadbed soils. Historically preventive measures usually consist of providing a layer of suitable material to act as a barrier between the roadbed soils and the susceptible subbase or base. An engineered aggregate layer serves this purpose. To ensure the gradation of the separator layer will prevent subgrade fines from migrating up, the following criteria are imposed (20, 22). Equation **Eq. 4.5** may be referred to as the piping ratio.

$$D_{15B} \leq 5 \times D_{85S} \qquad \text{Eq. 4-5}$$

$$D_{50B} \leq 25 \times D_{50S} \qquad \text{Eq. 4-6}$$

Where:

$D_{15B}$  = particle size wherein 15 percent of the base or subbase course particles are smaller than this size

$D_{85S}$  = particle size wherein 85 percent of the roadbed soil particles are smaller than this size

$D_{50B}$  = particle size wherein 50 percent of the base or subbase course particles are smaller than this size

$D_{50S}$  = particle size wherein 85 percent of the roadbed soil particles are smaller than this size

Separation fabrics used to separate fine grain silts and clays from open-graded drainage mats and subbase/base materials are an especially valuable and cost-effective application. Without them, a soft subgrade could inundate the open void spaces of drainage mats and base courses, thereby decreasing their strength and ability to drain.

## 4.12 Material Sampling and Testing

Sampling involves coring the existing pavement to determine layer thicknesses, permit visual inspection of the subsurface condition, and obtain material samples of unbound layers for further testing. For an existing pavement, the types of tests performed on the extracted materials should depend on the type of distress(s) observed. Contact the Region Materials Engineer and see Chapter 200 of the *Field Materials Manual* for information on recommended sampling intervals and further guidance on available material test methods.

## References

1. *Guidelines for Stabilization of Soils Containing Sulfates*, Technical Memorandum, by Austin White Lime, Chemical Lime, Texas Lime, distributed by National Lime Association, Arlington, VA, August 2000.
2. Hunter, D., *Lime-Induced Heave in Sulfate-Bearing Clay Soil*, ASCE Journal of Geotechnical Engineering Vol. 114 Issue 2, 1988 pp. 150-167.
3. Little, D. N., *Handbook for Stabilization of Pavement Subgrades and Base Courses with Lime*, National Lime Association, Kendall/Hunt Publishing Company, Dubuque, Iowa, 1995.
4. Hopkins, T. C., T. L. Beckham, L. Sun, B. Ni and B. Butcher, *Long-Term Benefits of Stabilizing Soil Subgrades*, Kentucky Transportation Center, College of Engineering, University of Kentucky, Lexington, Kentucky, 2002.
5. Copas, T. L. and H. A. Pennock, *Lime- Fly Ash-Stabilized Bases and Subbases*, NCHRP Synthesis of Highway Practice 37, TRB, National Research Council, Washington, D.C., 1976.
6. McManis, K. L. and A. Arman, *Class C Fly Ash as a Full or Partial Replacement for Portland Cement or Lime*, Transportation Research Record 1219, TRB, National Research Council, Washington, D.C., 1989, pp. 68-81.
7. Nicholson, P. G., V. Kashyap, and C.F. Fujii, *Lime and Fly Ash Admixture Improvement of Tropical Hawaiian Soils*, Transportation Research Record 1440, TRB, National Research Council, Washington, D.C., 1994, pp. 71-78.
8. Petry, T. M., *Performance-Based Testing of Chemical Stabilizers*, Transportation Research Record 1589, TRB, National Research Council, Washington, D.C., 1997, pp. 36-41.
9. Prusinski, J. R., and S. Bhattacharja, *Effectiveness of Portland Cement and Lime in Stabilizing Clay Soils*, Transportation Research Record 1652, TRB, National Research Council, Washington, D.C., 1999, pp. 215-227.
10. Parsons, R. L., and J. P. Milburn, *Engineering Behavior of Stabilized Soils*, Transportation Research Record 1837, TRB, National Research Council, Washington, D.C., 2003, pp. 20-29.
11. *1972 Roadway Design Manual*, Colorado Department of Transportation.
12. *1980 Roadway Design Manual*, Colorado Department of Transportation.
13. *Standard Specifications for Road and Bridge Construction*, Colorado Department of Transportation, Denver, Co, 2005.

14. Yeh, Shan-Tai, and Su, Cheng-Kuang, *Resilient Properties of Colorado Soils*, Final Report CDOH-DH-SM-89-9, Colorado Department of Highways, December 1989.
15. Chang, Nien-Yin, Chiang, Hsien-Hsiang, and Jiang, Lieu-Ching, *Resilient Modulus of Granular Soils with Fines Contents*, Final Research Report CDOT 91-379, Colorado Department of Transportation, May 1994.
16. *Guide for Mechanistic-Empirical Design*, Final Report, NCHRP Project 1-37A, National Cooperative Highway Research Program, Transportation Research Board, National Research Council, Submitted by ARA, INC., ERES Consultants Division, Champaign, IL, March 2004.
17. *CDOT Field Materials Manual*, Colorado Department of Transportation, 2004.
18. *AASHTO Guide for Design of Pavement Structures*, American Association of State Highway and Transportation Officials, Washington, DC, 1993.
19. Supplement to the AASHTO Guide for Design of Pavement Structures, Part II, - Rigid Pavement Design & Rigid Pavement Joint Design, American Association of State Highway and Transportation Officials, Washington, DC, 1998.
20. *AASHTO Interim Guide for Design of Pavement Structures 1972*, published by American Association of State Highway and Transportation Officials, Washington, DC, 1972.
21. DRIP 2.0 Software Program <<http://www.fhwa.dot.gov/pavement/software.cfm>>
22. Mallela, Jagannath, Larson, Gregg, Wyatt, Tim, Hall, Jim, and Barker, Walter, *User's Guide for Drainage Requirement In Pavements- Drip 2.0 Microcomputer Program*, ERES Consultants, Division of Applied Research Associates, Inc., 505 W. University Avenue, Champaign, IL 61820 and prepared for Federal Highway Administration, 400 Seventh Street, SW, Washington, DC 20590, July 2002.
23. *LTPP Data Analysis Phase I: Validation of Guidelines for k-Value Selection and Concrete Pavement Performance Prediction*, Publication FHWA-RD-96-198, Federal Highway Administration, Research and Development, Turner-Fairbank Highway Research Center, 6300 Georgetown Pike, McLean, VA 22101-2296, January 1997.
24. *Development of Pavement Design Concepts*, prepared by CTL/Thompson, Inc., Consulting Engineers, 1971 West 12<sup>th</sup> Ave, Denver, CO 80204 and prepared for the Metropolitan Government Pavement Engineers Council, April 1998.
25. *FHWA Reclaimed Asphalt Concrete - User Guideline - Granular Base*, <<http://www.fhwa.dot.gov/research>> (1/25/2006).

26. Ardani, Ahmad, *Expansive Soil Treatment Methods in Colorado*, Final Report CDOT-DTD-R-92-2, Colorado Department of Transportation, March 1992.
27. Colorado Department of Highways Memo #323, (Construction) Swelling Soils, 1/5/1966.
28. *Basic Asphalt Recycling Manual*, Federal Highway Administration, 400 Seventh Street, SW, Washington, DC 20590 and Asphalt Recycling and Reclaiming Association, #3 Church Circle, PMB 250, Annapolis, MD 21401, 2001.
29. *Long-Term Pavement Performance Information Management System: Pavement Performance Database User Reference Guide*, Publication No. FHWA-RD-03-088 (Interim Update), Federal Highway Administration, Research, Development and Technology, Turner-Fairbank Highway Research Center, 6300 Georgetown Pike, McLean, VA 22101-2296, September 2005.
30. Long-Term Pavement Performance (LTPP) Data Analysis Support: National Pooled Fund Study TPF-5(013), Effects of Multiple Freeze Cycles and Deep Frost Penetration on Pavement Performance and Cost, Publication No. FHWA-HRT-06-121, Federal Highway Administration, Research and Development, Turner-Fairbank Highway Research Center, 6300 Georgetown Pike, McLean, VA 22101-2296, November 2006.
31. *Engineering and Design Pavement Criteria for Seasonal Frost Conditions, Mobilization Construction*, Engineering Manual EM1110-3-138, Department of the Army, Corps of Engineers, Office of the Chief of Engineers, Washington, D.C. 20314, April 9, 1984.
32. CDOT Materials Bulletin, 2008 Number 1, Geosynthetics and Geotextiles, Project Development Branch (for Materials and Geotechnical Branch), January 25, 2008.
33. *FHWA-NHI-07-092, Geosynthetic Design & Construction Guidelines Reference Manual*, NHI Course No. 132013, National Highway Institute, Federal Highway Administration, U.S. Department of Transportation, Washington, D.C., August 2008.
34. *Standard Specifications for Road and Bridge Construction*, Colorado Department of Transportation, Denver, Co, 2011.  
<http://www.coloradodot.info/business/designsupport/construction-specifications/2011-Specs>
35. *AASHTO Mechanistic-Empirical Pavement Design Guide, A Manual of Practice, Interim Edition, July 2008*, American Association of State Highway and Transportation Officials, Washington, DC, 2008.



## CHAPTER 5

# GRANULAR AND TREATED BASE MATERIALS

### 5.1 Bases

A base course is a layer of material beneath the pavement's surface course. The design and construction of a pavement structure may include one or more base courses and is constructed on the subbase course, or, if no subbase is used, directly on the natural subgrade. It may be used in various combinations to design the most economical structural section for a specific project. Bases should be non-erodible, especially under rigid pavements, and may be constructed of gravels, mixtures of soil and aggregate, mixtures of asphalt and aggregate, mixtures of cement and aggregate or soil, or other innovative materials. Bases may be made of unbound materials, such as gravel, or bound materials, such as lime treated subgrade (17).

### 5.2 Sampling Base Materials During a Soil Survey Investigation

Base and subbase material samples are collected for information and testing during the soil survey investigation. The purpose of material sampling is to gather information for the design of pavement rehabilitation and/or new pavement structure. Follow the steps described in **Section 4.2 Soil Survey Investigation** for conducting soil survey investigations.

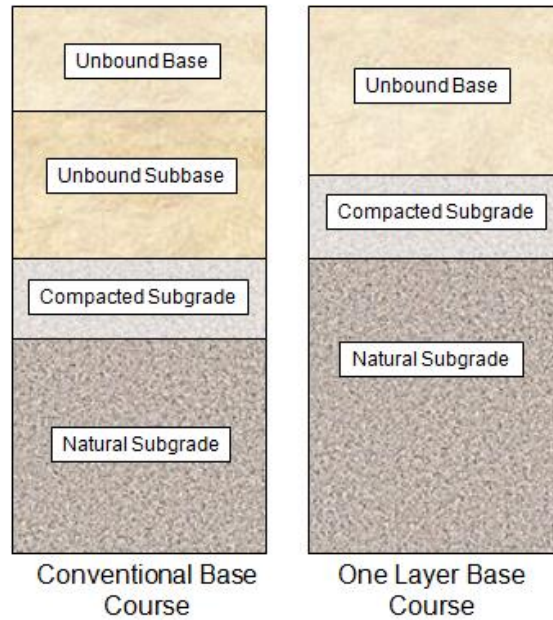
During the investigation, collect base and subbase samples for the following information and testing:

- **Thickness**
- **Gradation:** CP 21, PI and LL (AASHTO T 89 and T 90)
- **Resistance Value:** CP L 3101 and L 3102
- **Fill All Sample Holes:** provide and place patching material similar to the existing surface.
- **Combine:** similar soil and aggregate types encountered; note locations and depths.

### 5.3 Aggregate Base Course (ABC)

Aggregate base is normally specified as the lowest element of any structural section because it generally results in the most economical design. It may consist of more than one layer, see **Figure 5.1 Unbound Aggregate Base Course Layers**.

Aggregate base courses under flexible pavements provide a significant increase in structural capacity. Pavement design of flexible pavement depends on the wheel loads being distributed over a greater area as the depth of the pavement structure increases. Thick granular layers aim to improve the natural soil subgrade foundation of weak, fine-grained subgrades and are generally greater than 18 inches thick (16). Added benefits include improved drainage by preventing the accumulation of free water, protection against frost damage, preventing intrusion of fine-grained roadbed soils in base layers, providing a uniform underlying surface course support, and providing a construction platform.



**Figure 5.1 Unbound Aggregate Base Course Layers**

Subbase layers are usually distinguished from the base course layers by less stringent specification requirements for strength, plasticity, and gradation. Because the subbase course must be of significantly better quality than the roadbed soil, the subbase is often omitted if roadbed soils are of high quality. When the roadbed soils are of relatively poor quality and the design procedure indicates the requirement for substantial thickness of pavement, alternate designs should be prepared for structural sections with and without a subbase. A selection may be made based on availability and relative costs for a base and subbase (20). Unbound subbase layers may be pit-run gravels comprised of rounded rock, sand, and soil mixture. Typically, sand or granular materials, or course grained materials with limited fines, corresponding to AASHTO A-1 and A-2 soils may be used. California Bearing Ratio (CBR) and/or resilient modulus testing may measure strength and stiffness of the subbase. Subbases having strengths and stiffness of CBR values 6 percent or greater, corresponding resilient moduli ( $M_r$ ) of approximately 8,000 psi, R-value of 50, or structural coefficient ( $a_3$ ) of 0.06 would be designated as an aggregate subbase material.

A CDOT base's  $M_r$  may range from 20,000 to 48,675 psi. Slight differences of the suggested values can be found in charts, graphs, and correlation tables of other publications. CDOT Aggregate Base Course Class 1, 2 or 3 would be classified as a subbase. Class 1 and 2 are more restrictive because of the sieve sizing than Class 3 (pit-run). Aggregate base courses Class 4 and Class 6 limit the fines from 3 to 12 percent passing the No. 200 sieve. When the gradation approaches the 12 percent passing, the base becomes impermeable, and as such, when the gradation approaches the 3 percent limit they tend to be more permeable.

Aggregate base courses under rigid pavements provide a drainage layer, protection against frost damage, uniform, stable, permanent support, and support for the heavy equipment used during rigid pavement placement, and reduce pumping. There is some increase in structural capacity when a base is placed under a rigid pavement, but typically not a significant amount (17). Bases provide uniform support of rigid pavements across the joints and under the entire slab. A non-

erodable base is most desirable. To limit pumping of fines through the joints, a good base course gradation such as an Aggregate Base Course (Class 6) limits the fines from 3 to 12 percent passing the No. 200 sieve. The base course is considered a structural layer of the pavement along with the concrete slab, thus its thickness and modulus are important design values (19).

Aggregates for bases should be crushed stone, crushed slag, crushed gravel, natural gravel, or crushed reclaimed concrete or asphalt material and shall conform to the requirements of Section 703.03 of *CDOT Standard Specifications for Road and Bridge Construction* and **Table 5.1 CDOT Classification for Aggregate Base Course** and **Table 5.7 CDOT Classification** for reclaimed asphalt pavement and quality requirements of AASHTO M 147. Placement and compaction of each lift layer shall continue until a density of not less than 95 percent of the maximum density determined in accordance with AASHTO T 180 has been achieved (13). FHWA also recommends using only crushed aggregates in the unbound base layer to maintain good mechanical interlock. The design thickness should be rounded up to the next 1.0 inch increment.

**Table 5.1 CDOT Classification for Aggregate Base Course**

Sieve Size	Mass Percent Passing Square Mesh Sieves						
	LL Not Greater Than 35			LL Not Greater Than 30			
	Class 1	Class 2	Class 3	Class 4	Class 5	Class 6	Class 7
6"			100				
4" (100 mm)		100					
3" (75 mm)		95-100					
2 1/2" (60 mm)	100						
2" (50 mm)	95-100			100			
1 1/2" (37.5 mm)				90-100	100		
1" (25 mm)					95-100		100
3/4" (19 mm)				50-90		100	
#4 (4.75 mm)	30-65			30-50	30-70	30-65	
#8 (2.36 mm)						25-55	20-85
#200 (75 μm)	3-15	3-15	20 max.	3-12	3-15	3-12	5-15

**NOTE:** Class 3 material shall consist of bank or pit-run material.

### 5.3.1 Unbound Layer Characterization in M-E Design

The unbound layer characterization in M-E Design is similar to that of subgrade characterization. The inputs required for unbound layer characterization are the resilient modulus and other physical/engineering properties such as soil classification, moisture content, dry density, saturated hydraulic conductivity, etc., and follows the same guidelines used in subgrade material

characterization. **Note:** M-E Design prefers to have a minimum of three unbound layers for a successful design.

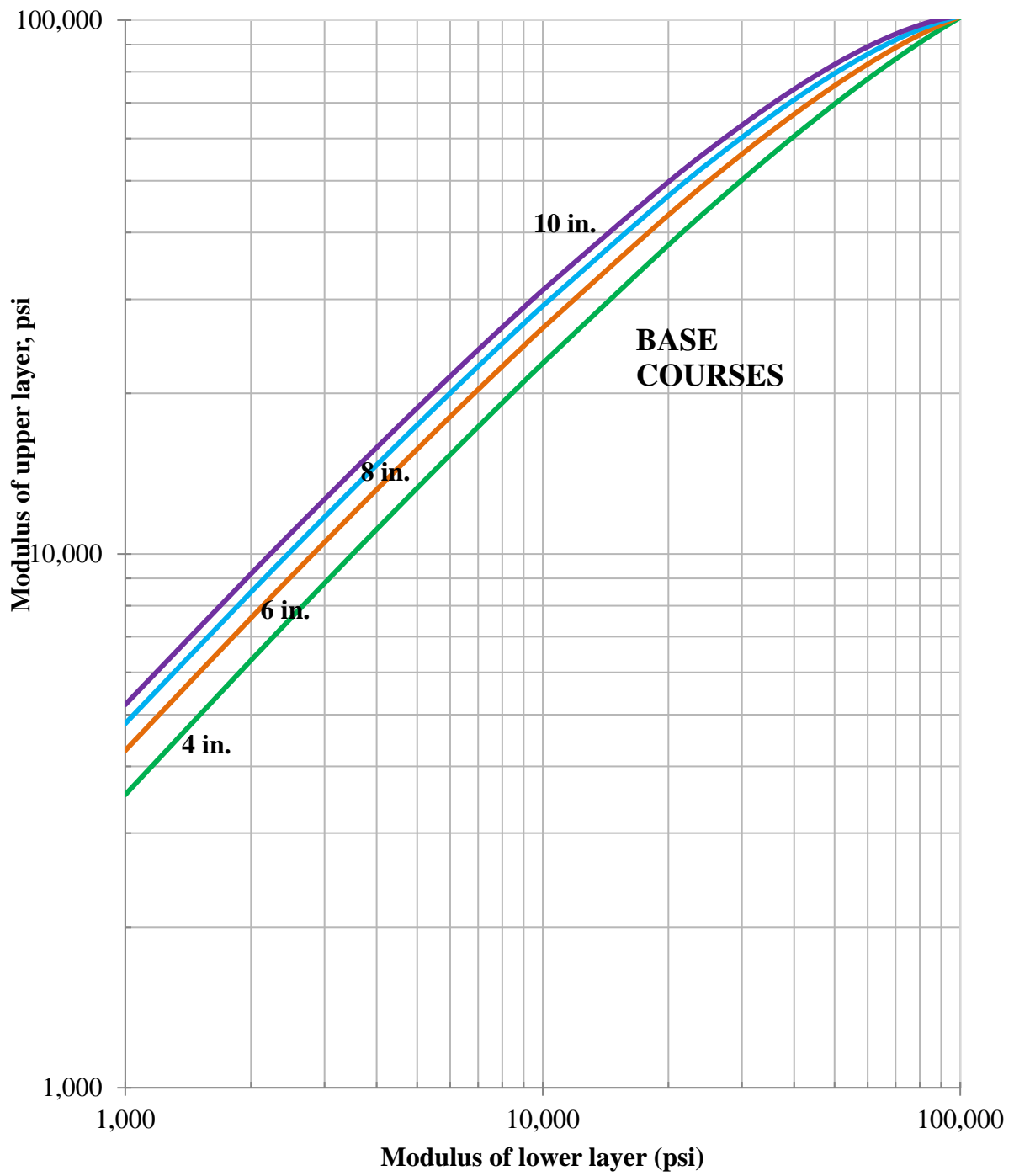
- New Flexible and JPCP: **Table 4.2 Recommended Subgrade Inputs in New Flexible and JPCP Designs.**
- HMA Overlays of Existing Flexible Pavement: **Table 4.3 Recommended Subgrade Inputs for HMA Overlays of Existing Flexible Pavement.**
- Overlays of Existing Rigid Pavement: **Table 4.4 Recommended Subgrade Inputs for Overlays of Existing Rigid Pavement.**

The design  $M_r$  of the aggregate base and subbase layers must be adjusted for limiting modulus criteria and modified accordingly. This check is necessary to avoid decompaction and build-up of tensile stresses in the unbound layers.

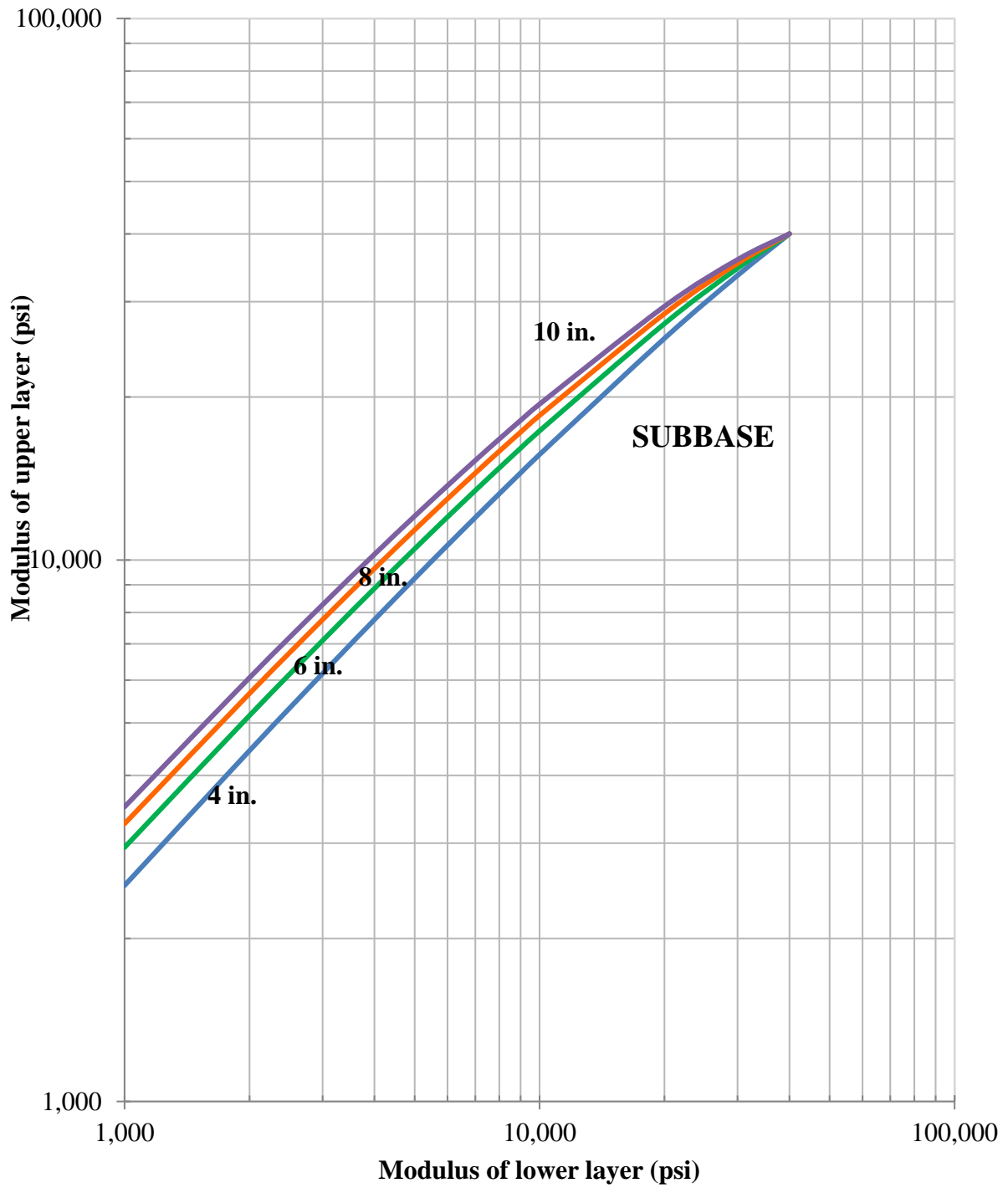
The  $M_r$  of the unbound material in each layer is a function of the layer thickness and the modulus of the next underlying layer (including subgrade layers). **Note:** The unbound materials are stress-dependent; the  $M_r$  value decreases with increasing depth as the induced stresses attenuate. Therefore, to avoid decompaction, the  $M_r$  of the aggregate base and subbase layers should not exceed the limiting modulus criteria determined using **Figure 5.2 Limiting Modulus Criteria of Unbound Aggregate Base Layers** and **Figure 5.3 Limiting Modulus Criteria of Unbound Subbase Layers**. The *AASHTO Interim MEPDG Manual of Practice* recommends the design  $M_r$  value of the unbound material be capped at the corresponding limiting modulus.

Using **Figure 5.2 Limiting Modulus Criteria of Unbound Aggregate Base Layers** and **Figure 5.3 Limiting Modulus Criteria of Unbound Subbase Layers** involves entering the graph with a known value of the modulus of the lower layer and the thickness of the next overlying layer. The figures limit the maximum values of 100,000 psi and 40,000 psi for base and subbase course materials, respectively.

**Example:** If the  $M_r$  of the underlying subgrade layer is 10,000 psi and the thickness of the overlying subbase layer is 8 inches, the  $M_r$  of the overlying layer is limited to approximately 28,500 psi.



**Figure 5.2 Limiting Modulus Criteria of Unbound Aggregate Base Layers**



**Figure 5.3 Limiting Modulus Criteria of Unbound Subbase Layers**

### 5.3.2 Modeling Unbound Aggregate Base Layers in M-E Design Software

To properly characterize unbound layers for M-E Design, the designer should consider the following:

- **Modeling Thick Aggregate Bases**
  - When a thick granular aggregate base (more than 12 inches) is used, the top 8 or 10 inches is modeled as an aggregate base layer, while the remaining aggregate is modeled as Subgrade Layer 1. The  $M_r$  and other physical/engineering properties remain the same for both layers. The compacted or natural subgrade below the thick aggregate base is modeled as lower subgrade layers as appropriate.
  
- **Modeling Thin Aggregate Bases**
  - If a thin aggregate base layer is used between two thick unbound materials, the thin layer should be combined with the weaker or lower layer.
  - When similar aggregate base and subbase materials are combined, the material properties of the combined layer should be those from the thicker layer.
    - ♦ Averaging the material properties is not recommended.
    - ♦ When similar materials have about the same thickness, the material with the lower modulus value should be used.
  
- **Limiting Modulus Criteria**
  - The designer must make sure the  $M_r$  of the unbound layer does not exceed the limiting modulus determined using **Figure 5.2 Limiting Modulus Criteria of Unbound Aggregate Base Layers** and **Figure 5.3 Limiting Modulus Criteria of Unbound Subbase Layers**.
  
- **Stabilized Layer**
  - Granular base materials treated with a small amount of stabilizers, such as asphalt, emulsion, cement, lime, or other pozzolanic materials for constructability reasons should be defined as an unbound layer or combined with other unbound layers, as necessary.
  - Per Applied Research Associates, Inc., since Colorado has no calibration coefficient, one **should not** use a stabilized layer. Rather the designer should treat the layer as a high quality subbase or base course with a constant modulus.

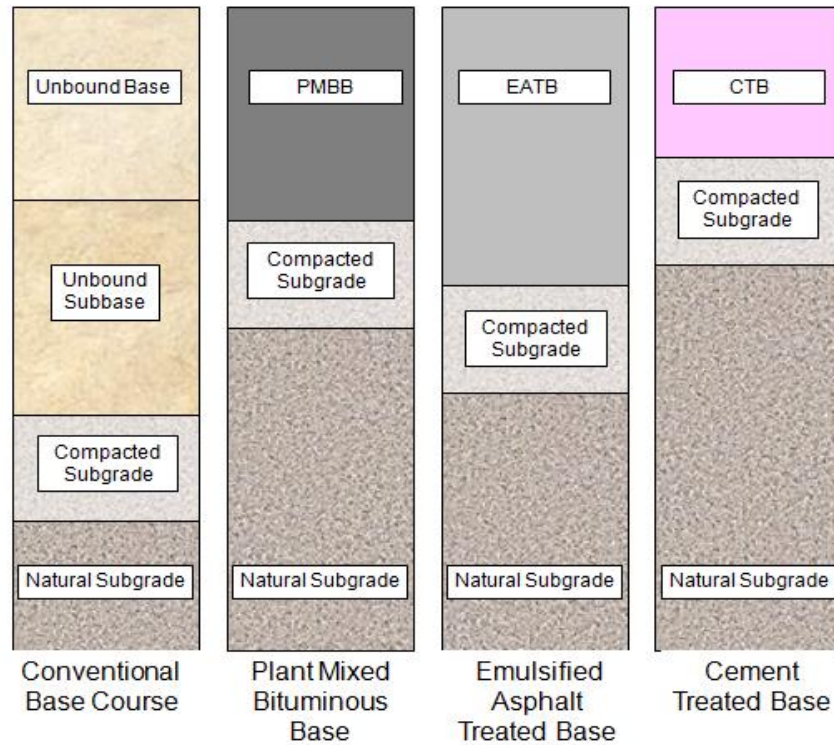
- **Soil Aggregate Materials**
  - Sand and other soil-aggregate materials should be defined separately from crushed stone or crushed aggregate base materials.

## 5.4 Treated Base Course

The use of bases in the design of rigid pavements is a function of the pavement material's structural quality characterized by the modulus of rupture and elastic modulus. In comparison to the strength of the concrete slab, the structural contributions of the underlying layers are relatively small. Treated or untreated bases can be used under rigid pavements, but is not mandatory. **Figure 5.4 Stabilized Treated Structural Base Layers** shows several materials historically used by CDOT as bases.

- **Treated Bases** under flexible pavements are similar to rigid pavements, as such the structural capacity is increased while decreasing the flexible pavement's thickness. These bases are used to strengthen a weak subgrade and are another design tool in the layering system where lower quality materials are in the bottom courses.
- **Plant Mix Bituminous Base (PMBB)** is composed of a mixture of aggregate, filler (if required), hydrated lime, and bituminous material. The aggregate and bituminous materials are mixed at a central batch plant. Several aggregate fractions are sized, uniformly graded, and combined in such proportions that the resulting composite blend meets the job-mix formula. PMBB is a very good non-erodible base.
- **Emulsified Asphalt Treated Base (EATB)** is composed of a mixture of aggregate, water (if required), and emulsified asphalt. The aggregate and emulsified asphalt is mixed at a central batch plant and the aggregates are specified per the classification of an aggregate base course. In certain instances subgrades may be used if they are sandy and do not have an excessive amount of material finer than the No. 200 sieve. Placement and spreading is by approved spreading devices capable of achieving specified surface tolerances and a compaction not less than 95 percent of AASHTO T 180.
- **Cement Treated Base (CTB)** is a mixture of aggregate and portland cement. The aggregate is obtained from scarifying the existing roadway and shall meet specified gradation. Mixing is accomplished by means of a mixer that will thoroughly blend the aggregate with the cement. The mixer is equipped with a metering device that will introduce the required quantity of water during the mixing cycle. Another option is to have the aggregate proportioned and mixed with cement and water at a central batch plant. Compaction is not less than 95 percent of AASHTO T 134.





**Figure 5.4 Stabilized Treated Structural Base Layers**

#### 5.4.1 Characterization of Treated Base in M-E Design

Treated base materials include lean concrete, cement stabilized, open-graded cement stabilized, soil cement, lime-cement-fly ash, and lime treated materials should be considered as a bound layer. Materials with chemical stabilizers engineered to provide long-term strength and durability should be considered a chemically stabilized layer (i.e. cement treated, lean concrete, pozzolonic treated). Lime and/or lime-fly ash stabilized soils engineered to provide structural support can also be considered a chemically stabilized layer. These mixtures have a sufficient amount of stabilizer mixed in with the soil, as such these types of layers are placed directly under the PCC or lowest asphalt layer. **Figure 5.5 M-E Software Screenshot for Treated Base Inputs** presents a screenshot of treated base materials. **Note:** M-E Design has a stratigraphic layer called Sandwich Granular. This layer should only be used when the designer has a layer of untreated base placed ‘sandwiched’ between a chemically stabilized subgrade HMA layer.

Aggregate or granular base materials lightly treated with small amounts of chemical stabilizers to enhance constructability or expedite construction (i.e. lower the plasticity index, improve the strength) **should not** be considered a chemically stabilized layer. Typically, lightly stabilized materials are placed deeper in the pavement structure. **Note:** Currently Colorado does not have a calibration coefficient for a stabilized layer, therefore one should treat the layer as a high quality subbase or base course with a constant modulus. The material inputs required for characterizing treated base layers in M-E Design are presented in **Table 5.2 Characterization of Treated Base in M-E Design**.

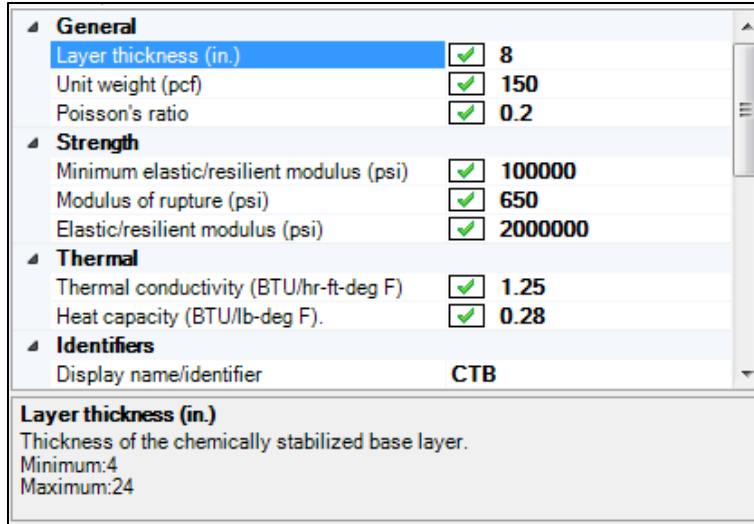


Figure 5.5 M-E Design Software Screenshot for Treated Base Inputs

Table 5.2 Characterization of Treated Bases in M-E Design

Input Property	Level 1	Level 2	Level 3
Elastic/Resilient Modulus	<b>Table 5.3 Level 1 Input Requirement and Corresponding Testing Protocols for Characterization of Treated Bases in M-E Design</b>	<b>Table 5.4 Level 2 Correlations for Elastic Modulus of Treated Bases</b>	<b>Table 5.6 Level 3 Default Elastic Modulus and Flexural Strength of Treated Bases</b>
Modulus of Rupture (flexible pavements)		<b>Table 5.4 Level 2 Correlations for Flexural Strength of Treated Bases</b>	
Minimum Elastic / Resilient Modulus (flexible pavements)	Use the following values: <ul style="list-style-type: none"> <li>Lean concrete: 300,000 psi</li> <li>Cement stabilized aggregate: 100,000 psi</li> <li>Open graded cement stabilized: 50,000 psi</li> <li>Soil cement: 25,000 psi</li> <li>Lime-cement-fly ash: 40,000 psi</li> <li>Lime stabilized soils: 15,000 psi</li> </ul>		
Poisson's Ratio	Use typical values: <ul style="list-style-type: none"> <li>Lean concrete &amp; cement stabilized aggregate: 0.10 to 0.20</li> <li>Soil cement: 0.15 to 0.35</li> <li>Lime-fly ash materials: 0.10 to 0.15</li> <li>Lime stabilized soil: 0.15 to 0.20</li> </ul>		
Thermal Conductivity	Use the M-E Design software default value of 1.25 BTU/hr-ft-°F		
Heat Capacity	Use the M-E Design software default value of 0.28 BTU/lb-°F		
Total Unit Weight	Use the M-E Design software default value of 150 lb/ft <sup>3</sup>		

**Table 5.3 Level 1 Input Requirement and Corresponding Testing Protocols for Characterization of Treated Bases in M-E Design**

Design Type	Material Type	Measured Property	Source of Data		Recommended Test Protocol and Data Source
			Test	Estimate	
New	Lean Concrete & Cement-Treated Aggregate	Elastic modulus	✓		ASTM C 469
		Flexural strength	✓		AASHTO T 97
	Lime-cement-fly Ash	Resilient modulus		✓	No test protocols available. Estimate using Levels 2 and 3
	Soil Cement	Resilient modulus	✓		Mixture Design and Testing Protocol (MDTP) in conjunction with AASHTO T 307
	Lime Stabilized Soil	Resilient modulus		✓	No test protocols available. Estimate using Levels 2 and 3
Existing	Lean Concrete & Cement-Treated Aggregate	FWD backcalculated modulus	✓		ASTM D4694
	Lime-Cement-Fly Ash				
	Soil Cement				
	Lime Stabilized Soil				

**Table 5.4 Level 2 Correlations for Elastic Modulus of Treated Bases**

Material Type	Recommended Correlations
Lean Concrete <sup>1</sup>	$E = 57,000 \times \sqrt{f'_c}$
Cement Treated Aggregate <sup>1</sup>	$f'_c = \text{compressive strength, psi (AASHTO T 22) (18)}$
Open Graded Cement Stabilized	No correlations are available
Soil Cement <sup>2</sup>	$E = 1200 \times q_u$ $q_u = \text{unconfined compressive strength, psi (ASTM D 1633) (18)}$
Lime-Cement-Fly Ash <sup>2</sup>	$E = 500 + q_u$ $q_u = \text{unconfined compressive strength, psi (ASTM C 593) (19)}$
Lime Stabilized Soils <sup>2</sup>	$M_r = 0.124 \times q_u + 9.98$ $q_u = \text{unconfined compressive strength, psi. (ASTM D 5102) (17)}$
<p><b>Note:</b> E is the modulus of elasticity in psi and <math>M_r</math> = resilient modulus in ksi.  <sup>1</sup> Compressive strength <math>f'_c</math> can be determined using AASHTO T22.  <sup>2</sup> Unconfined compressive strength <math>q_u</math> can be determined using the MDTP.</p>	

**Table 5.5 Level 2 Correlations for Flexural Strength of Treated Base**

Material Type	Test Protocol	Typical $M_r$ (psi)
Lean Concrete	AASHTO T 22	$M_r \approx 20\%$ of $q_u$ (conservative estimate)
Cement Treated Aggregate		
Soil Cement	ASTM D 1633	
Lime-Cement-Fly Ash	ASTM C 593	
Lime Stabilized Soils	ASTM D 5102	
Open Graded Cement Stabilized Aggregate	Not available	Not available

**Note:**  $q_u$  = unconfined compressive strength

**Table 5.6 Level 3 Default Elastic Modulus and Flexural Strength of Treated Bases**

Material Type	E or $M_r$ Range (psi)	E or $M_r$ Typical (psi)	Flexural Strength (psi)
Lean Concrete	1,500,000 to 2,500,000	2,000,000	450
Cement Stabilized Aggregate	700,000 to 1,500,000	1,000,000	200
Soil Cement	50,000 to 1,000,000	500,000	100
Lime-Cement-Fly Ash	500,000 to 2,000,000	1,500,000	150
Lime Stabilized Soils <sup>1</sup>	30,000 to 60,000	45,000	25
Open Graded Cement Stabilized Aggregate	—	750,000	200

**Note:** <sup>1</sup> For reactive soils within 25 percent passing No. 200 sieve and plasticity index of at least 10.

#### 5.4.2 Modeling Treated Base in M-E Design

To properly model a treated base or a stabilized subgrade in M-E Design, the designer should consider the following:

- **Plant Mix Bituminous Base:** This layer is produced at a central batch plant in a similar manner conventional asphalt mixtures are produced and should be considered either as or combined with a HMA base layer.
- **Emulsified Asphalt Treated Base:** This layer is composed of crushed stone base materials and emulsified asphalt. It should be combined with the crushed stone base materials or considered as an unbound aggregate mixture.

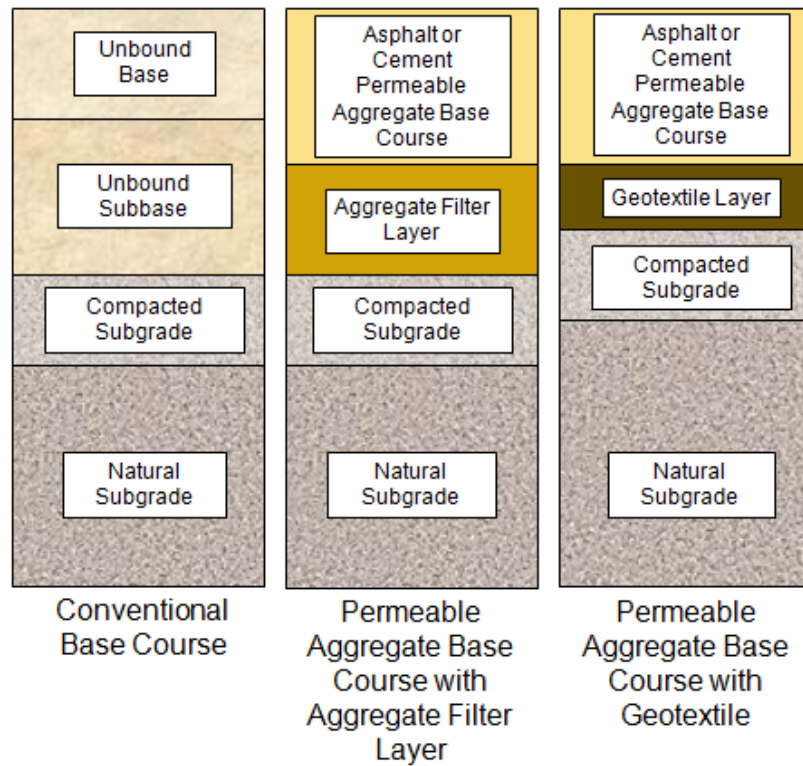
- **Cement Treated Base:** Cement treated and other pozzolanic stabilized materials that are engineered to provide structural support should be treated as a separate layer. Where a small portion of cement and/or other pozzolanic materials are added to granular base materials for constructability issues, such layers should be considered as an unbound material and combined with those unbound layers if necessary.
- **Lime and/or Lime-Fly Ash Stabilized Soils:** These soils may be considered a stabilized material if the layer is engineered to provide structural support; otherwise, they could be considered an unbound layer that is insensitive to moisture and the resilient modulus (stiffness) of the layer can be held constant over time.

## 5.5 Permeable Bases

Open-graded aggregate bases are becoming popular. Permeable bases may be unstabilized or stabilized and should be placed in a layer at least 4 inches thick. Care must be taken when designing with permeable bases as they are subject to freeze-thaw cycles.

- **Unstabilized** permeable bases contain smaller size aggregates to provide interlock, however this creates a lower permeability. Typically, the coefficient of permeability is 1,000 to 3,000 feet/day. Unstabilized bases are difficult to compact and density is difficult to measure. CDOT does not recommend using an unstabilized permeable base.
- **Stabilized** permeable bases are open-graded aggregates that have been stabilized with asphalt or portland cement. Stabilization of the base does not appreciably affect the permeability of the material and provides a very stable base during the construction phase. The coefficient of permeability is greater than 3,000 feet/day. Stabilized bases provide a stable working platform for construction equipment.
- **Asphalt** stabilized permeable bases contain 2 to 2.5 percent asphalt by weight. Care must be used in construction to prevent over rolling which can lead to degradation of the aggregate and loss of permeability. The base should be laid at a temperature of 200°F to 250°F and compacted between 100°F and 150°F.
- **Cement** stabilized bases have 2 to 3 bags of portland cement/cubic yard. This provides a very strong base that is easily compacted with a vibratory screed and plate. Curing can occur by covering the base with polyethylene sheeting for 3 to 5 days or with a fine water mist sprayed several times the day after the base is placed.

The designer is suggested to use FHWA's DRIP 2.0 software. The software has capabilities to perform roadway geometry calculations for the drainage path, sieve analysis calculations, inflow calculations, permeable base design, separator design (geotextile or aggregate layer), and edgedrain design (see **Figure 5.6 Structural Permeable aggregate Base Course Layers**). The software may be obtained from the website: <http://www.fhwa.dot.gov/pavement/desi.cfm>.



**Figure 5.6 Structural Permeable Aggregate Base Course Layers**

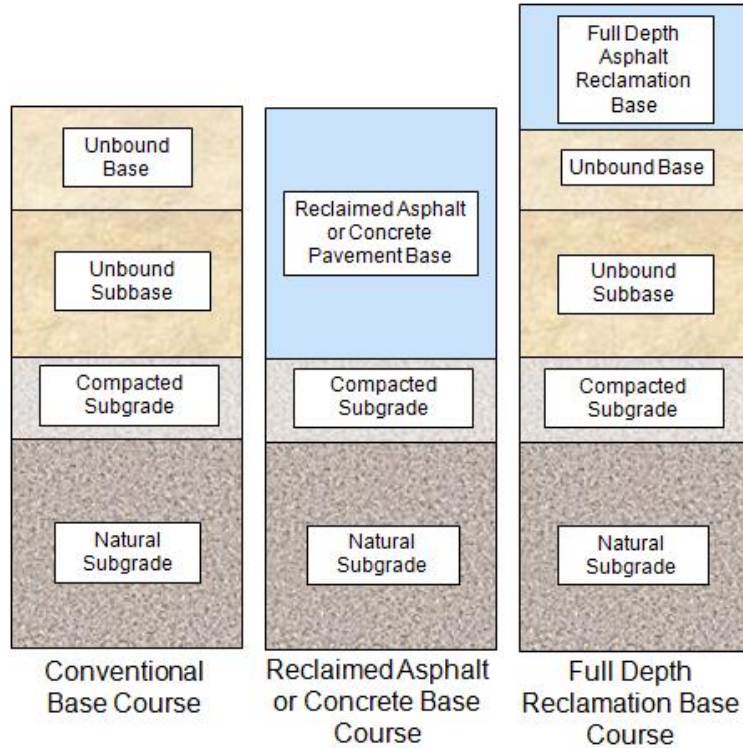
Drainage is particularly important where heavy flows of water are encountered (i.e., springs or seeps), where detrimental frost conditions are present, or where soils are particularly susceptible to expansion with increase in water content. Special subsurface drainage may include provisions of a permeable material beneath the pavement for interception and collection of water, and/or pipe drains for collection and transmission of water. Special surface drainage may require facilities like dikes, paved ditches, and catch basins (20).

## 5.6 Reclaimed Asphalt and Concrete Pavement

Refer to **Figure 5.7 Reclaimed Asphalt and Concrete Pavement Base Layers** for using reclaimed asphalt or concrete for a base layer.

### 5.6.1 Reclaimed Asphalt Pavement Base

Recycled asphalt pavement may be used as a granular base or subbase provided it meets gradation and minimum R-values specified in contract documents. Recycled asphalt used as an aggregate base is discussed in this section as a cold recycling process compared to a hot process. The cold recycling process of asphalt consists of recovered, crushed, screened, and blended material with conventional aggregates, and is placed as a conventional granular material.



**Figure 5.7 Reclaimed Asphalt and Concrete Pavement Base Layers**

### 5.6.1.1 Reclaimed Asphalt Pavement (RAP) Base

Aggregate for Reclaimed Asphalt Pavement (RAP) base shall meet the grading requirements of **Table 5.7 CDOT Classification for Reclaimed Asphalt Program**. The aggregate shall have a liquid limit of non-viscous (NV), plasticity index of non-plastic (NP), and a Los Angeles percentage of wear of 45 or less. Placement and compaction of each lift layer shall continue until a density of at least 100 percent on the maximum wet density as determined in accordance with Colorado Procedure CP-53 has been achieved (13), see **Figure 5.8 Photos of Reclaimed Asphalt Pavement Base**.



Source: <http://www.pavementinteractive.org> and <http://www.wjgraves.com>

**Figure 5.8 Photos of Reclaimed Asphalt Pavement Base**

### 5.6.1.2 Full Depth Asphalt Reclaimed Base (FDR)

A full depth asphalt reclaimed base is an in-place process that pulverizes the existing pavement and thoroughly mixes the individual surface and granular base course layers into a relatively homogeneous mixture. It is then recompact as a granular base (25), see **Figure 5.9 Photos of Full Depth Asphalt Reclaimed Base**. Stabilizing agents may be added with a laboratory mix design to optimize the quantity of stabilizing agent and other properties of the reclaim mix. Pavement distresses that can be treated by full depth asphalt reclamation are as follows (28):

- Cracking from age, fatigue, slippage, edge, block, longitudinal, reflection, and discontinuity.
- Reduced ride quality due to swell, bumps, sags, and depressions, which are not contributed to swelling soils.
- Permanent deformations in the form of rutting, corrugation, and shoving
- Loss of bonding between layers and stripping
- Loss of surface integrity due to raveling, potholes, and bleeding
- Inadequate structural capacity

**Table 5.7 DOT Classification for Reclaimed Asphalt Pavement Aggregate Base Course**

Sieve Size	Mass Percent Passing Square Mesh Sieves	
	ABC (RAP)	
	Lower Limit	Upper Limit
2" (50 mm)	100	-
1 1/2" (37.5 mm)	-	-
1" (25 mm)	85	100
3/4" (19 mm)	75	100
1/2" (12.5 mm)	55	90
3/8" (9.5 mm)	45	80
#4 (4.75 mm)	25	55
#8 (2.36 mm)	-	-
#16 (1.18 mm)	5	25
#30 (600 µm)	-	-
#50 (300 µm)	-	-
#100 (150 µm)	-	-
#200 (75 µm)	0	5





Source: <http://west-cansealcoating.com> and <http://www.rocksolidstabilization.com>

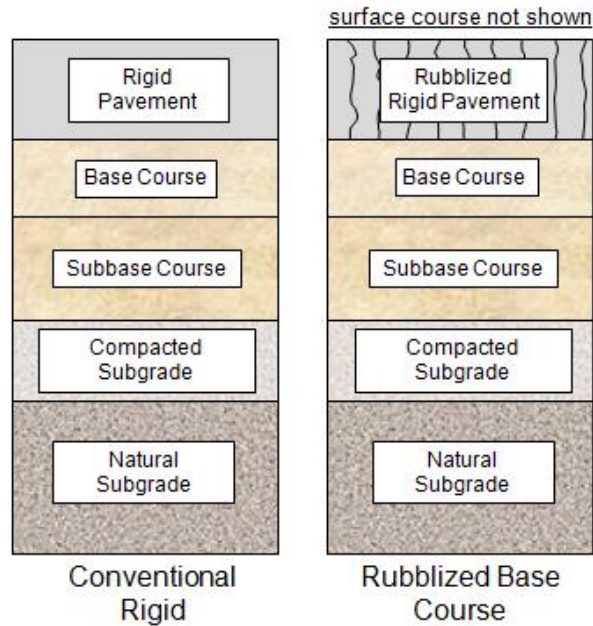
**Figure 5.9 Photos of Full Depth Asphalt Reclaimed Base**

### **5.6.2 Reclaimed Concrete Pavement Base (RCP)**

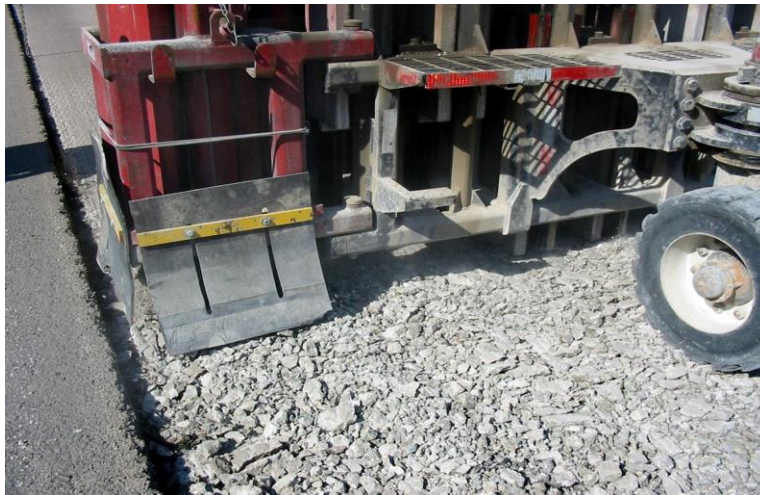
Reclaimed Concrete Pavement (RCP) may be used as a granular base or subbase, similar to recycled asphalt. RCP is the recycling of recovered, crushed, and screened concrete pavement that is placed as a conventional granular material. RCP shall meet all conventional granular material requirements and have all steel removed in the recovering process.

### **5.7 Base Layer Made of Rubblized Rigid Pavement**

Rubblization is a fracturing of existing rigid pavement creating a high-density granular material. The rough, hard particles provide an internal friction to resist rutting while the lack of tension prevents cracking in the surface layer. The reasoning for this is the more concrete available for expansion and contraction during temperature changes, the greater the movement of the slab, thus, the greater the opening of joints and cracks. Rubblization reduces the size of concrete pieces so the expansion and contraction has minimum movement. The space between the fractured pieces moves less so cracks are not reflected through the surface course. An edge drain system needs to be installed to remove water captured between the fractured concrete slabs. The fractured concrete pavement has been found to be more permeable than a dense graded compacted base layer (see **Figure 5.10 Rubblized Base Course** and **Figure 5.11 Photo of Rigid Pavement Being Rubblized**).



**Figure 5.10 Rubblized Base Course**



Source: <http://www.antigoconstruction.com>

**Figure 5.11 Photo of Rigid Pavement Being Rubblized**

## 5.8 Material Sampling and Testing

Sampling involves coring the existing pavement to determine layer thicknesses, make a visual inspection of the subsurface condition, and obtain material samples of unbound layers for further testing. For an existing pavement, the types of tests performed on the extracted materials should depend on the type of distress observed. Contact the Region Materials Engineer and see Chapter 200 of the *Field Materials Manual* for information on recommended sampling intervals and further guidance on available material test methods.

## References

1. *Guidelines for Stabilization of Soils Containing Sulfates*, Technical Memorandum, by Austin White Lime, Chemical Lime, Texas Lime, distributed by National Lime Association, Arlington, VA, August 2000.
2. Hunter, D., *Lime-Induced Heave in Sulfate-Bearing Clay Soil*, ASCE Journal of Geotechnical Engineering Vol. 114 Issue 2, 1988 pp. 150-167.
3. Little, D. N., *Handbook for Stabilization of Pavement Subgrades and Base Courses with Lime*, National Lime Association, Kendall/Hunt Publishing Company, Dubuque, Iowa, 1995.
4. Hopkins, T. C., T. L. Beckham, L. Sun, B. Ni and B. Butcher, *Long-Term Benefits of Stabilizing Soil Subgrades*, Kentucky Transportation Center, College of Engineering, University of Kentucky, Lexington, Kentucky, 2002.
5. Copas, T. L. and H. A. Pennock, *Lime- Fly Ash-Stabilized Bases and Subbases*, NCHRP Synthesis of Highway Practice 37, TRB, National Research Council, Washington, D.C., 1976.
6. McManis, K. L. and A. Arman, *Class C Fly Ash as a Full or Partial Replacement for Portland Cement or Lime*, Transportation Research Record 1219, TRB, National Research Council, Washington, D.C., 1989, pp. 68-81.
7. Nicholson, P. G., V. Kashyap, and C.F. Fujii, *Lime and Fly Ash Admixture Improvement of Tropical Hawaiian Soils*, Transportation Research Record 1440, TRB, National Research Council, Washington, D.C., 1994, pp. 71-78.
8. Petry, T. M., *Performance-Based Testing of Chemical Stabilizers*, Transportation Research Record 1589, TRB, National Research Council, Washington, D.C., 1997, pp. 36-41.
9. Prusinski, J. R., and S. Bhattacharja, *Effectiveness of Portland Cement and Lime in Stabilizing Clay Soils*, Transportation Research Record 1652, TRB, National Research Council, Washington, D.C., 1999, pp. 215-227.
10. Parsons, R. L., and J. P. Milburn, *Engineering Behavior of Stabilized Soils*, Transportation Research Record 1837, TRB, National Research Council, Washington, D.C., 2003, pp. 20-29.
11. *1972 Roadway Design Manual*, Colorado Department of Transportation.
12. *1980 Roadway Design Manual*, Colorado Department of Transportation.

13. *Standard Specifications for Road and Bridge Construction*, Colorado Department of Transportation, Denver, Co, 2005.
14. Yeh, Shan-Tai, and Su, Cheng-Kuang, *Resilient Properties of Colorado Soils*, Final Report CDOH-DH-SM-89-9, Colorado Department of Highways, December 1989.
15. Chang, Nien-Yin, Chiang, Hsien-Hsiang, and Jiang, Lieu-Ching, *Resilient Modulus of Granular Soils with Fines Contents*, Final Research Report CDOT 91-379, Colorado Department of Transportation, May 1994.
16. *Guide for Mechanistic-Empirical Design*, Final Report, NCHRP Project 1-37A, National Cooperative Highway Research Program, Transportation Research Board, National Research Council, Submitted by ARA, INC., ERES Consultants Division, Champaign, IL, March 2004.
17. *CDOT Field Materials Manual*, Colorado Department of Transportation, 2004.
18. *AASHTO Guide for Design of Pavement Structures*, American Association of State Highway and Transportation Officials, Washington, DC, 1993.
19. Supplement to the AASHTO Guide for Design of Pavement Structures, Part II, - Rigid Pavement Design & Rigid Pavement Joint Design, American Association of State Highway and Transportation Officials, Washington, DC, 1998.
20. *AASHTO Interim Guide for Design of Pavement Structures 1972*, published by American Association of State Highway and Transportation Officials, Washington, DC, 1972.
21. DRIP 2.0 Software Program < <http://www.fhwa.dot.gov/pavement/desi.cfm>>
22. Mallela, Jagannath, Larson, Gregg, Wyatt, Tim, Hall, Jim, and Barker, Walter, *User's Guide for Drainage Requirement In Pavements- Drip 2.0 Microcomputer Program*, ERES Consultants, Division of Applied Research Associates, Inc., 505 W. University Avenue, Champaign, IL 61820 and prepared for Federal Highway Administration, 400 Seventh Street, SW, Washington, DC 20590, July 2002.
23. *LTPP Data Analysis Phase I: Validation of Guidelines for k-Value Selection and Concrete Pavement Performance Prediction*, Publication FHWA-RD-96-198, Federal Highway Administration, Research and Development, Turner-Fairbank Highway Research Center, 6300 Georgetown Pike, McLean, VA 22101-2296, January 1997.
24. *Development of Pavement Design Concepts*, prepared by CTL/Thompson, Inc., Consulting Engineers, 1971 West 12<sup>th</sup> Ave, Denver, CO 80204 and prepared for the Metropolitan Government Pavement Engineers Council, April 1998.
25. *FHWA Reclaimed Asphalt Concrete - User Guideline - Granular Base*, <<http://www.fhwa.dot.gov/research>> (1/25/2006).

26. Ardani, Ahmad, *Expansive Soil Treatment Methods in Colorado*, Final Report CDOT-DTD-R-92-2, Colorado Department of Transportation, March 1992.
27. Colorado Department of Highways Memo #323, (Construction) Swelling Soils, 1/5/1966.
28. *Basic Asphalt Recycling Manual*, Federal Highway Administration, 400 Seventh Street, SW, Washington, DC 20590 and Asphalt Recycling and Reclaiming Association, #3 Church Circle, PMB 250, Annapolis, MD 21401, 2001.
29. *Long-Term Pavement Performance Information Management System: Pavement Performance Database User Reference Guide*, Publication No. FHWA-RD-03-088 (Interim Update), Federal Highway Administration, Research, Development and Technology, Turner-Fairbank Highway Research Center, 6300 Georgetown Pike, McLean, VA 22101-2296, September 2005.
30. Long-Term Pavement Performance (LTPP) Data Analysis Support: National Pooled Fund Study TPF-5(013), Effects of Multiple Freeze Cycles and Deep Frost Penetration on Pavement Performance and Cost, Publication No. FHWA-HRT-06-121, Federal Highway Administration, Research and Development, Turner-Fairbank Highway Research Center, 6300 Georgetown Pike, McLean, VA 22101-2296, November 2006.
31. *Engineering and Design Pavement Criteria for Seasonal Frost Conditions, Mobilization Construction*, Engineering Manual EM1110-3-138, Department of the Army, Corps of Engineers, Office of the Chief of Engineers, Washington, D.C. 20314, April 9, 1984.
32. CDOT Materials Bulletin, 2008 Number 1, Geosynthetics and Geotextiles, Project Development Branch (for Materials and Geotechnical Branch), January 25, 2008.
33. *FHWA-NHI-07-092, Geosynthetic Design & Construction Guidelines Reference Manual*, NHI Course No. 132013, National Highway Institute, Federal Highway Administration, U.S. Department of Transportation, Washington, D.C., August 2008.
34. *Standard Specifications for Road and Bridge Construction*, Colorado Department of Transportation, Denver, Co, 2011.  
<http://www.coloradodot.info/business/designsupport/construction-specifications/2011-Specs>
35. *AASHTO Mechanistic-Empirical Pavement Design Guide, A Manual of Practice, Interim Edition, July 2008*, American Association of State Highway and Transportation Officials, Washington, DC, 2008.

## CHAPTER 6

# PRINCIPLES OF DESIGN FOR FLEXIBLE PAVEMENT

### 6.1 Introduction

Design of flexible pavement structures involves the consideration of numerous factors, the most important are truck volume, weight and distribution of axle loads, HMA, underlying material properties, and the supporting capacity of the subgrade soils. **Typical reconstruction projects should have a design life of 20 years for reconstructions and 10 years for rehabilitations unless mitigating circumstances exist.**

Methods are presented in this section for the design of the flexible pavement structure with respect to thickness of the subbase, base, surface courses, and the quality and strength of the materials in place. Interaction between pavement materials and climate is evaluated as part of the M-E Design process.

### 6.2 M-E Design Methodology for Flexible Pavement

M-E Design uses an iterative process. The key steps in the design process include the following:

1. **Select a Trial Design Strategy**
2. **Select Appropriate Performance Indicator Criteria for the Project:** Establish criteria for acceptable pavement performance (i.e. distress/IRI) at the end of the design period. Performance criteria were established to reflect different magnitudes of key pavement distresses which trigger major rehabilitation or reconstruction. CDOT criteria for acceptable performance is based on highway functional class and location.
3. **Select Appropriate Reliability Level for the Project:** The reliability is in essence a factor of safety that accounts for inherent variations in construction, materials, traffic, climate, and other design inputs. The level of reliability selected should be based on the criticality of the design and selected for each individual performance indicator. CDOT criteria for a desired reliability is based on highway functional class and location.
4. **Assemble All Inputs for the Pavement Trial Design Under Consideration:** Define subgrade support, asphalt concrete and other paving material properties, traffic loads, climate, pavement type and design, and construction features. The inputs required to run the M-E Design program may be obtained using one of three hierarchical levels and need not be consistent for all inputs in a given design. The hierarchical level for a given input is selected based on the importance of the project, input, and resources at the disposal of the user.
5. **Run the M-E Design Software:** The software calculates changes in layer properties, damage, key distresses, and IRI over the design life. The key steps include:

- a) Processing input to obtain monthly values of traffic, seasonal variations of material, and climatic inputs needed in design evaluations for the entire design period.
  - b) Computing structural responses (stresses and strains) using multilayer elastic theory or finite element based pavement response models for each axle type and load and each damage-calculation increment throughout the design period.
  - c) Calculating accumulated distress at the end of each analysis period for the entire design period.
  - d) Predicting key distresses (rutting, bottom-up/top-down fatigue cracking, and thermal cracking) at the end of each analysis period throughout the design life using calibrated mechanistic-empirical performance models.
  - e) Predicting IRI as a function of initial IRI, distresses accumulating over time, and site factors at the end of each analysis increment.
6. **Evaluate Adequacy of the Trial Design:** The trial design is considered “adequate” if none of the predicted distresses/IRI exceed the performance indicator criteria at the design reliability level chosen for the project. If any criteria has been exceeded, one must determine how the deficiency can be remedied by altering material types, properties, layer thicknesses, or other design features.
7. **Revise the Trial Design, as Needed:** If the trial design is deemed “inadequate”, one must revise the inputs and re-run the program until all performance criteria have been met. Once met, the trial design becomes a feasible design alternative.

Design alternatives that satisfy all performance criteria are considered feasible from a structural and functional viewpoint and may be considered for other evaluations, such as life cycle cost analysis. Consultation of the mix design(s) with the RME shall occur. A detailed description of the design process is presented in the interim edition of the *AASHTO Mechanistic-Empirical Pavement Design Guide Manual of Practice*, AASHTO 2008.

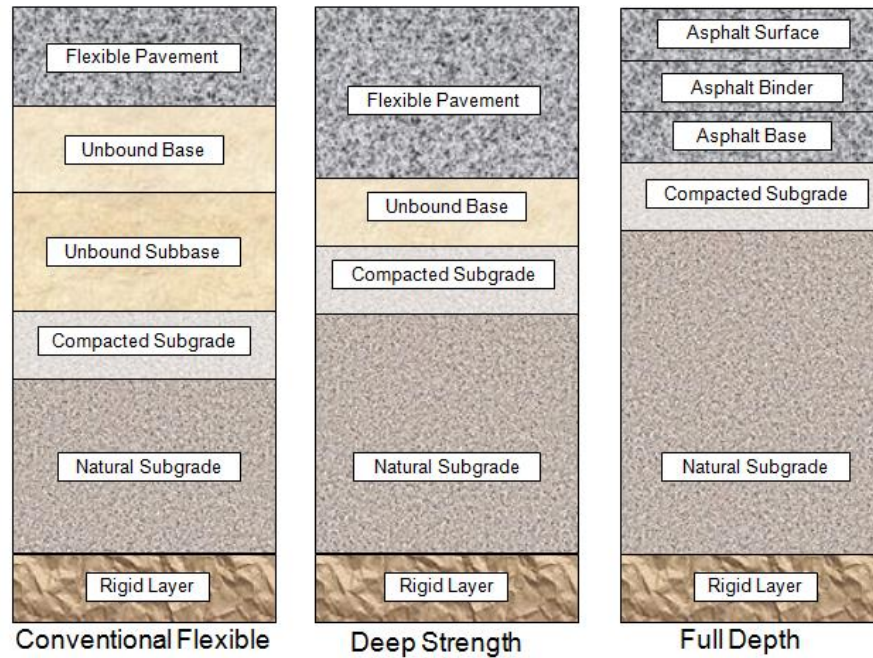
## 6.3 Select a Trial Design Strategy

### 6.3.1 Flexible Pavement Design Types

**Figure 6.1 Asphalt Concrete Pavement Layer Systems** illustrates well known CDOT combinations of asphalt concrete structural pavement layers. Designers can select from among several flexible pavement options as shown below:

- **Conventional Flexible Pavements:** Flexible pavements consisting of a relatively thin asphalt concrete layer placed over an unbound aggregate base layer and subgrade.
- **Deep-Strength AC Pavements:** Flexible pavements consisting of a relatively thick asphalt concrete layer placed over an unbound aggregate base layer and subgrade.

- **Full-Depth AC Pavements:** Asphalt concrete layers placed directly over the subgrade.

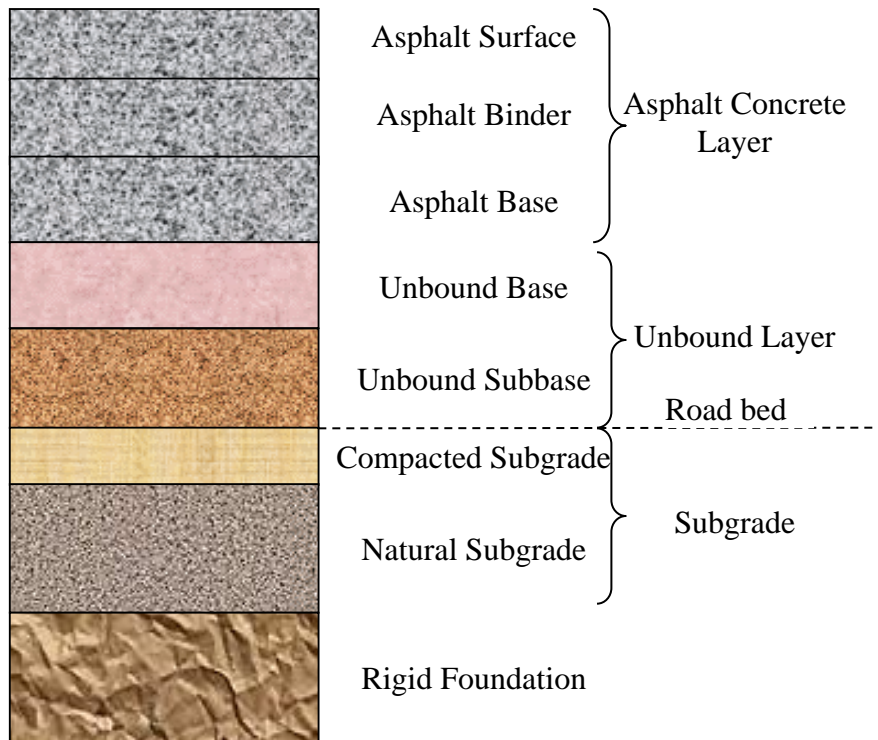


**Figure 6.1 Asphalt Concrete Pavement Layer Systems**

The asphalt concrete layer in **Figure 6.1 Asphalt Concrete Pavement Layer Systems** may be comprised of several layers of asphalt concrete courses to include a surface course, intermediate or binder course, and a base course (see **Figure 6.2 Structural Layers**). The surface, binder, and base courses are typically different in composition and are placed in separate construction operations (3).

- **Surface Course:** The surface course normally contains the highest quality materials. It provides characteristics such as friction, smoothness, noise control, rut and shoving resistance, and drainage. It also serves to prevent the entrance of excessive quantities of surface water into the underlying HMA courses, bases, and subgrade.
- **Intermediate/Binder Course:** The intermediate course, sometimes called binder course, consists of one or more lifts of structural HMA placed below the surface course. Its purpose is to distribute traffic loads so stresses transmitted to the pavement foundation will not result in permanent deformation to the course. It also facilitates the construction of the surface course.
- **Base Course:** The base course consists of one or more HMA lifts located at the bottom of the structural HMA course. Its major function is to provide the principal support of the pavement structure. The base course should contain durable aggregates that will not be damaged by moisture or frost action.

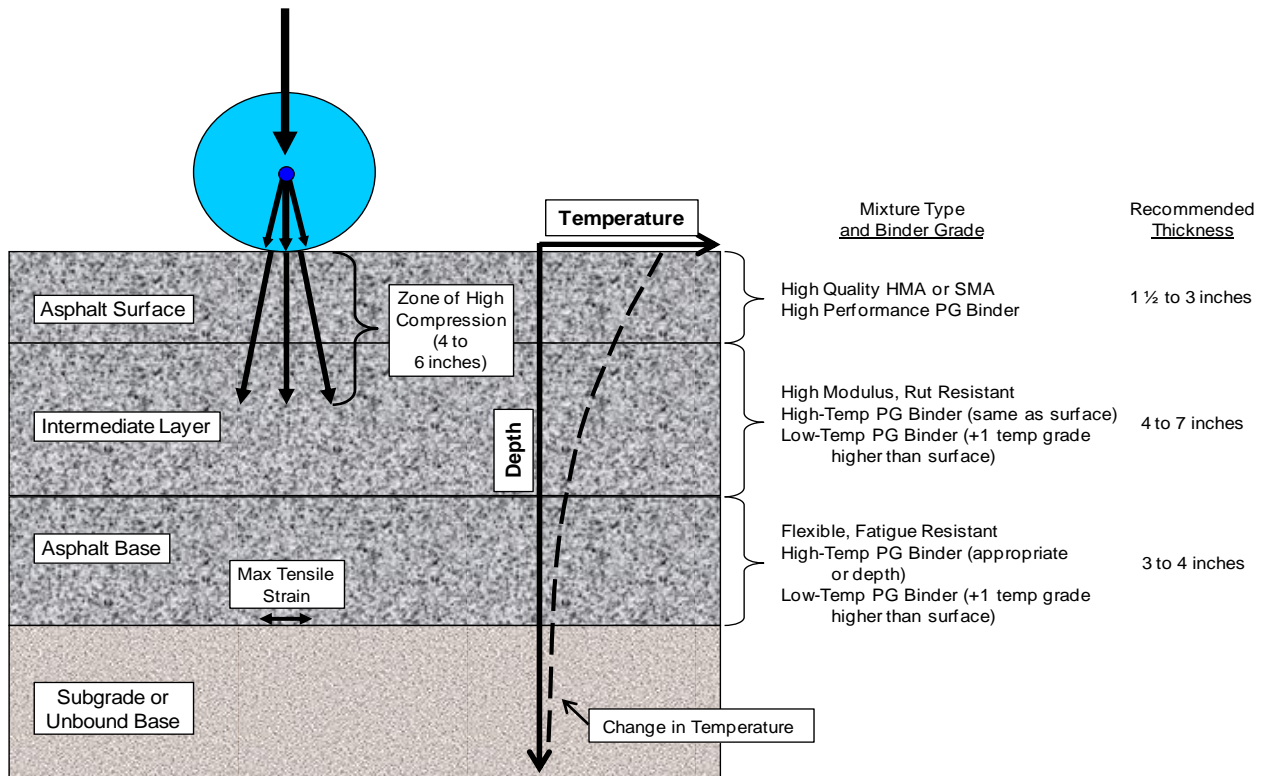




**Figure 6.2 Structural Layers**

### 6.3.2 Concept of Perpetual Pavements

A perpetual pavement is defined as an asphalt pavement designed and built to last longer than 50 years without requiring major structural rehabilitation or reconstruction, and needing only periodic surface renewal in response to distresses confined to the top of the pavement (6). Full depth and deep-strength asphalt pavement structures have been constructed since the 1960s. Full-depth pavements are constructed directly on subgrade soils and deep-strength sections are placed on relatively thin (4 to 6 inches) granular base courses. A 20-year traffic design period is to be used for the traffic loading. One of the chief advantages of these pavements is that the overall section of the pavement is thinner than those employing thick granular base courses. Such pavements have the added advantage of significantly reducing the potential for fatigue cracking by minimizing the tensile strains at the bottom of the asphalt layer (7) (see **Figure 6.1 Asphalt Concrete Pavement Layer Systems**). An asphalt perpetual pavement structure is designed with a durable, rut and wear resistant top layer with a rut resistant intermediate layer and a fatigue resistant base layer (see **Figure 6.3 Perpetual Pavement Design Concept**).



**Figure 6.3 Perpetual Pavement Design Concept**

This concept may be used in conventional, deep strength, or full depth asphalt structural layering. In mechanistic design, the principles of physics are used to determine a pavement's reaction to loading. Knowing the critical points in the pavement structure, one can design against certain types of failure or distress by choosing the right materials and layer thicknesses (7). Therefore, the uppermost structural layer resists rutting, weathering, thermal cracking, and wear. SMAs or dense-graded SuperPave mixtures provide these qualities. The intermediate layer provides rutting resistance through stone-on-stone contact and durability is imparted by the proper selection of materials. Resistance to bottom-up fatigue cracking is provided by the lowest asphalt layer having a higher binder content or by the total thickness of pavement reducing the tensile strains in this layer to an insignificant level (6).

### 6.3.3 Establish Trial Design Structure

The designer must establish a trial design structure (combination of material types and thicknesses). This is done by first selecting the pavement type of interest (see **Figure 6.5 M-E Design Software Screenshot Showing General Information (left), Performance Criteria and Reliability (right)**). M-E Design automatically provides the top layers of the selected pavement type. The designer may add or remove pavement structural layers and/or modify the layer material type and thickness as appropriate. **Figure 6.4 M-E Design Software Screenshot of Flexible Pavement Trial Design Structure** shows an example of flexible pavement trial design with pavement layer configuration on the left and layer properties of the AC surface course on the right.

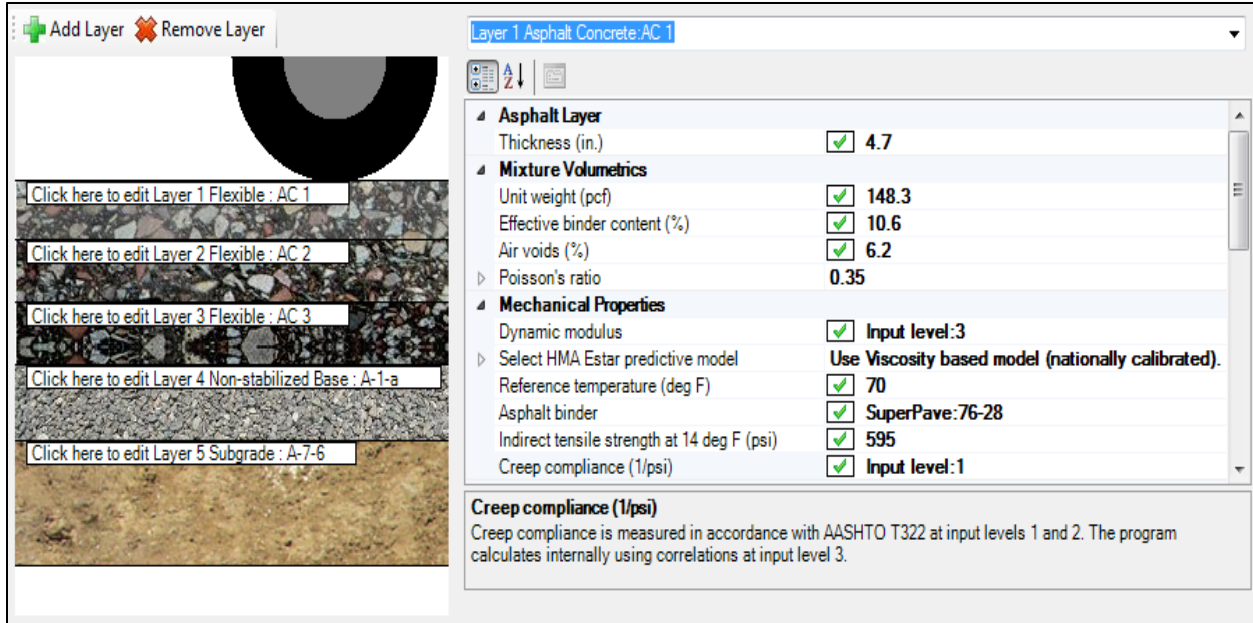


Figure 6.4 M-E Design Software Screenshot of Flexible Pavement Trial Design Structure

## 6.4 Select the Appropriate Performance Indicator Criteria for the Project

**Table 2.4 Recommended Threshold Values of Performance Criteria for New Construction or Reconstruction Projects** presents recommended performance criteria for flexible pavement design. The designer should enter the appropriate performance criteria based on functional class. An appropriate initial smoothness (IRI) is also required, **For new flexible pavements, the recommended initial IRI is 61 inches/mile.**

**Figure 6.5 M-E Design Software Screenshot Showing General Information (left) Performance Criteria and Reliability (right)** shows performance criteria for a sample flexible pavement trial design. The coefficients of performance prediction models considered in the design of a new flexible pavement are shown in **Figure 6.6 Performance Prediction Model Coefficients for Flexible Pavement Designs (Marshall Mix)** through **Figure 6.8 Performance Prediction Model Coefficients for Flexible Pavement Designs (PMA Mix)**. The value of AC rutting coefficient (BR1) is based on the type of HMA

**23-11918:Project** ▼ ×

General Information		Performance Criteria	Limit	Reliability
Design type:	New Pavement ▼	Initial IRI (in./mile)	80	
Pavement type:	Flexible Pavement ▼	Terminal IRI (in./mile)	172	90
Design life (years):	20 ▼	AC top-down fatigue cracking (ft./mile)	2000	90
Base construction:	May ▼ 2001 ▼	AC bottom-up fatigue cracking (percent)	25	90
Pavement construction:	June ▼ 2001 ▼	AC thermal cracking (ft./mile)	250	90
Traffic opening:	Septen ▼ 2001 ▼	Permanent deformation - total pavement (in.)	0.75	90
		Permanent deformation - AC only (in.)	0.25	90

**Figure 6.5 M-E Design Software Screenshot Showing General Information (left), Performance Criteria and Reliability (right)**

New Flexible Pavement-Calibration Settings	
<b>AC Cracking</b>	
AC Cracking C1 Top	<input checked="" type="checkbox"/> 7
AC Cracking C2 Top	<input checked="" type="checkbox"/> 3.5
AC Cracking C3 Top	<input checked="" type="checkbox"/> 0
AC Cracking C4 Top	<input checked="" type="checkbox"/> 1000
AC Cracking Top Standard Deviation	$200 + 2300/(1+\exp(1.072-2.1654*\text{LOG}10(\text{TOP}+0.0001)))$
AC Cracking C1 Bottom	<input checked="" type="checkbox"/> 0.021
AC Cracking C2 Bottom	<input checked="" type="checkbox"/> 2.35
AC Cracking C3 Bottom	<input checked="" type="checkbox"/> 6000
AC Cracking Bottom Standard Deviation	$1+15/(1+\exp(-3.1472-4.1349*\text{LOG}10(\text{BOTTOM}+0.0001)))$
<b>AC Fatigue</b>	
AC Fatigue K1	<input checked="" type="checkbox"/> 0.007566
AC Fatigue K2	<input checked="" type="checkbox"/> 3.9492
AC Fatigue k3	<input checked="" type="checkbox"/> 1.281
AC Fatigue BF1	<input checked="" type="checkbox"/> 130.3674
AC Fatigue BF2	<input checked="" type="checkbox"/> 1
AC Fatigue BF3	<input checked="" type="checkbox"/> 1.217799
<b>AC Rutting</b>	
AC Rutting K1	<input checked="" type="checkbox"/> -3.35412
AC Rutting K2	<input checked="" type="checkbox"/> 1.5606
AC Rutting K3	<input checked="" type="checkbox"/> 0.3791
AC Rutting BR1	<input checked="" type="checkbox"/> 7.6742
AC Rutting BR2	<input checked="" type="checkbox"/> 1
AC Rutting BR3	<input checked="" type="checkbox"/> 1
AC Rutting Standard Deviation	$0.1414*\text{Pow}(\text{RUT},0.25)+0.001$
<b>CSM Cracking</b>	
<b>CSM Fatigue</b>	
<b>IRI</b>	
IRI Flexible C1	<input checked="" type="checkbox"/> 50
IRI Flexible C2	<input checked="" type="checkbox"/> 0.55
IRI Flexible C3	<input checked="" type="checkbox"/> 0.0111
IRI Flexible C4	<input checked="" type="checkbox"/> 0.02
IRI Flexible Over PCCC1	<input checked="" type="checkbox"/> 40.8
IRI Flexible Over PCCC2	<input checked="" type="checkbox"/> 0.575
IRI Flexible Over PCCC3	<input checked="" type="checkbox"/> 0.0014
IRI Flexible Over PCCC4	<input checked="" type="checkbox"/> 0.00825
<b>Subgrade Rutting</b>	
Granular Subgrade Rutting K1	<input checked="" type="checkbox"/> 2.03
Granular Subgrade Rutting BS1	<input checked="" type="checkbox"/> 0.22
Granular Subgrade Rutting Standard Deviation	$0.0104*\text{Pow}(\text{BASERUT},0.67)+0.001$
Fine Subgrade Rutting K1	<input checked="" type="checkbox"/> 1.35
Fine Subgrade Rutting BS1	<input checked="" type="checkbox"/> 0.37
Fine Subgrade Rutting Standard Deviation	$0.0663*\text{Pow}(\text{SUBRUT},0.5)+0.001$
<b>Thermal Fracture</b>	
AC thermal cracking Level 1K	<input checked="" type="checkbox"/> 6.3
AC thermal cracking Level 1 Standard Deviation	$0.1468 * \text{THERMAL} + 65.027$
AC thermal cracking Level 2K	<input checked="" type="checkbox"/> 0.5
AC thermal cracking Level 2 Standard Deviation	$0.2841 * \text{THERMAL} + 55.462$
AC thermal cracking Level 3K	<input checked="" type="checkbox"/> 6.3
AC thermal cracking Level 3 Standard Deviation	$0.3972 * \text{THERMAL} + 20.422$
<b>Identifiers</b>	

Figure 6.6 Performance Prediction Model Coefficients for Flexible Pavement Designs (Marshall Mix)

New Flexible Pavement-Calibration Settings	
<b>AC Cracking</b>	
AC Cracking C1 Top	<input checked="" type="checkbox"/> 7
AC Cracking C2 Top	<input checked="" type="checkbox"/> 3.5
AC Cracking C3 Top	<input checked="" type="checkbox"/> 0
AC Cracking C4 Top	<input checked="" type="checkbox"/> 1000
AC Cracking Top Standard Deviation	$200 + 2300/(1+\exp(1.072-2.1654*\text{LOG}10(\text{TOP}+0.0001)))$
AC Cracking C1 Bottom	<input checked="" type="checkbox"/> 0.021
AC Cracking C2 Bottom	<input checked="" type="checkbox"/> 2.35
AC Cracking C3 Bottom	<input checked="" type="checkbox"/> 6000
AC Cracking Bottom Standard Deviation	$1+15/(1+\exp(-3.1472-4.1349*\text{LOG}10(\text{BOTTOM}+0.0001)))$
<b>AC Fatigue</b>	
AC Fatigue K1	<input checked="" type="checkbox"/> 0.007566
AC Fatigue K2	<input checked="" type="checkbox"/> 3.9492
AC Fatigue k3	<input checked="" type="checkbox"/> 1.281
AC Fatigue BF1	<input checked="" type="checkbox"/> 130.3674
AC Fatigue BF2	<input checked="" type="checkbox"/> 1
AC Fatigue BF3	<input checked="" type="checkbox"/> 1.217799
<b>AC Rutting</b>	
AC Rutting K1	<input checked="" type="checkbox"/> -3.35412
AC Rutting K2	<input checked="" type="checkbox"/> 1.5606
AC Rutting K3	<input checked="" type="checkbox"/> 0.3791
AC Rutting BR1	<input checked="" type="checkbox"/> 6.7
AC Rutting BR2	<input checked="" type="checkbox"/> 1
AC Rutting BR3	<input checked="" type="checkbox"/> 1
AC Rutting Standard Deviation	$0.1414*\text{Pow}(\text{RUT},0.25)+0.001$
<b>CSM Cracking</b>	
<b>CSM Fatigue</b>	
<b>IRI</b>	
IRI Flexible C1	<input checked="" type="checkbox"/> 50
IRI Flexible C2	<input checked="" type="checkbox"/> 0.55
IRI Flexible C3	<input checked="" type="checkbox"/> 0.0111
IRI Flexible C4	<input checked="" type="checkbox"/> 0.02
IRI Flexible Over PCCC1	<input checked="" type="checkbox"/> 40.8
IRI Flexible Over PCCC2	<input checked="" type="checkbox"/> 0.575
IRI Flexible Over PCCC3	<input checked="" type="checkbox"/> 0.0014
IRI Flexible Over PCCC4	<input checked="" type="checkbox"/> 0.00825
<b>Subgrade Rutting</b>	
Granular Subgrade Rutting K1	<input checked="" type="checkbox"/> 2.03
Granular Subgrade Rutting BS1	<input checked="" type="checkbox"/> 0.22
Granular Subgrade Rutting Standard Deviation	$0.0104*\text{Pow}(\text{BASERUT},0.67)+0.001$
Fine Subgrade Rutting K1	<input checked="" type="checkbox"/> 1.35
Fine Subgrade Rutting BS1	<input checked="" type="checkbox"/> 0.37
Fine Subgrade Rutting Standard Deviation	$0.0663*\text{Pow}(\text{SUBRUT},0.5)+0.001$
<b>Thermal Fracture</b>	
AC thermal cracking Level 1K	<input checked="" type="checkbox"/> 6.3
AC thermal cracking Level 1 Standard Deviation	$0.1468 * \text{THERMAL} + 65.027$
AC thermal cracking Level 2K	<input checked="" type="checkbox"/> 0.5
AC thermal cracking Level 2 Standard Deviation	$0.2841 * \text{THERMAL} + 55.462$
AC thermal cracking Level 3K	<input checked="" type="checkbox"/> 6.3
AC thermal cracking Level 3 Standard Deviation	$0.3972 * \text{THERMAL} + 20.422$
<b>Identifiers</b>	

New Flexible Pavement-Calibration Settings	
<b>AC Cracking</b>	
AC Cracking C1 Top	<input checked="" type="checkbox"/> 7
AC Cracking C2 Top	<input checked="" type="checkbox"/> 3.5
AC Cracking C3 Top	<input checked="" type="checkbox"/> 0
AC Cracking C4 Top	<input checked="" type="checkbox"/> 1000
AC Cracking Top Standard Deviation	$200 + 2300/(1+\exp(1.072-2.1654*\text{LOG}10(\text{TOP}+0.0001)))$
AC Cracking C1 Bottom	<input checked="" type="checkbox"/> 0.021
AC Cracking C2 Bottom	<input checked="" type="checkbox"/> 2.35
AC Cracking C3 Bottom	<input checked="" type="checkbox"/> 6000
AC Cracking Bottom Standard Deviation	$1+15/(1+\exp(-3.1472-4.1349*\text{LOG}10(\text{BOTTOM}+0.0001)))$
<b>AC Fatigue</b>	
AC Fatigue K1	<input checked="" type="checkbox"/> 0.007566
AC Fatigue K2	<input checked="" type="checkbox"/> 3.9492
AC Fatigue k3	<input checked="" type="checkbox"/> 1.281
AC Fatigue BF1	<input checked="" type="checkbox"/> 130.3674
AC Fatigue BF2	<input checked="" type="checkbox"/> 1
AC Fatigue BF3	<input checked="" type="checkbox"/> 1.217799
<b>AC Rutting</b>	
AC Rutting K1	<input checked="" type="checkbox"/> -3.35412
AC Rutting K2	<input checked="" type="checkbox"/> 1.5606
AC Rutting K3	<input checked="" type="checkbox"/> 0.3791
AC Rutting BR1	<input checked="" type="checkbox"/> 4.3
AC Rutting BR2	<input checked="" type="checkbox"/> 1
AC Rutting BR3	<input checked="" type="checkbox"/> 1
AC Rutting Standard Deviation	$0.1414*\text{Pow}(\text{RUT},0.25)+0.001$
<b>CSM Cracking</b>	
<b>CSM Fatigue</b>	
<b>IRI</b>	
IRI Flexible C1	<input checked="" type="checkbox"/> 50
IRI Flexible C2	<input checked="" type="checkbox"/> 0.55
IRI Flexible C3	<input checked="" type="checkbox"/> 0.0111
IRI Flexible C4	<input checked="" type="checkbox"/> 0.02
IRI Flexible Over PCCC1	<input checked="" type="checkbox"/> 40.8
IRI Flexible Over PCCC2	<input checked="" type="checkbox"/> 0.575
IRI Flexible Over PCCC3	<input checked="" type="checkbox"/> 0.0014
IRI Flexible Over PCCC4	<input checked="" type="checkbox"/> 0.00825
<b>Subgrade Rutting</b>	
Granular Subgrade Rutting K1	<input checked="" type="checkbox"/> 2.03
Granular Subgrade Rutting BS1	<input checked="" type="checkbox"/> 0.22
Granular Subgrade Rutting Standard Deviation	$0.0104*\text{Pow}(\text{BASERUT},0.67)+0.001$
Fine Subgrade Rutting K1	<input checked="" type="checkbox"/> 1.35
Fine Subgrade Rutting BS1	<input checked="" type="checkbox"/> 0.37
Fine Subgrade Rutting Standard Deviation	$0.0663*\text{Pow}(\text{SUBRUT},0.5)+0.001$
<b>Thermal Fracture</b>	
AC thermal cracking Level 1K	<input checked="" type="checkbox"/> 6.3
AC thermal cracking Level 1 Standard Deviation	$0.1468 * \text{THERMAL} + 65.027$
AC thermal cracking Level 2K	<input checked="" type="checkbox"/> 0.5
AC thermal cracking Level 2 Standard Deviation	$0.2841 * \text{THERMAL} + 55.462$
AC thermal cracking Level 3K	<input checked="" type="checkbox"/> 6.3
AC thermal cracking Level 3 Standard Deviation	$0.3972 * \text{THERMAL} + 20.422$
<b>Identifiers</b>	

**Figure 6.7 Performance Prediction Model Coefficients for Flexible Pavement Designs (Polymer Modified Superpave Mix)**

## 6.5 Select the Appropriate Reliability Level for the Project

Recommended reliability levels for flexible pavement designs are located in **Table 2.3 Reliability (Risk)**. The designer should select an appropriate reliability level based on highway functional class and location. **Figure 6.5 M-E Design Software Screenshot Showing General Information (left), Performance Criteria and Reliability (right)** shows design reliability values for a sample flexible pavement trial design.

## 6.6 Assemble M-E Design Software Inputs

### 6.6.1 General Information

#### 6.6.1.1 Design Period

The design period for new flexible pavement construction and reconstruction is at least 20 years. For special designs, the designer may use a different design period as appropriate.

#### 6.6.1.2 Construction Dates and Timeline

The following inputs are required to specify the construction dates and timeline (see **Figure 6.5 M-E Design Software Screenshot Showing General Information (left), Performance Criteria and Reliability (right)**):

- Base/subbase construction month and year
- Pavement construction month and year
- Traffic open month and year

The designer may select the most likely month and year for construction completion of the key activities listed above. Selection is based on the designer's experience, agency practices, or estimated from the planned construction schedule. For large projects that extend into different paving seasons, it is suggested each paving season be evaluated separately and the designer judge the acceptability of the trial design based on the more conservative situation. The M-E Design software does not consider staged construction events, nor does it consider the impact of construction traffic on damage computations.

**Note:** The pavement performance predictions begin from the month the pavement is open to traffic. The changes to pavement material properties due to time and environmental conditions are calculated beginning from the month and year the material was placed.

#### 6.6.1.3 Identifiers

Identifiers are helpful in documenting the project location and recordkeeping. M-E Design allows designers to enter site or project identification information such as the location of the project (route signage, jurisdiction, etc.), identification numbers, beginning and ending milepost, direction of traffic, and date.



## 6.6.2 Traffic

Several inputs are required for characterizing traffic for the M-E Design software and are described in detail in **Section 3.1 Traffic**.

## 6.6.3 Climate

The climate input requirements for the M-E Design software are described in detail in **Section 3.2 Climate**.

## 6.6.4 Pavement Layer Characterization

As shown in **Figure 6.2 Structural Layers**, a typical flexible pavement design comprises of the following pavement layers: asphalt concrete, unbound aggregate base layers, and subgrade. The inputs required by M-E Design for characterizing these layers are described in the following sections.

### 6.6.4.1 Asphalt Concrete Characterization

Asphalt concrete types used in Colorado include:

- **Hot Mix Asphalt (HMA):** Composed of aggregates with an asphalt binder and certain anti-stripping additives.
- **Stone Matrix Asphalt (SMA):** Gap-graded HMA that maximizes rutting resistance and durability with a stable stone-on-stone skeleton held together by a rich mixture of AC, filler, and stabilizing agents.

The designers should apply the following guidelines when defining an asphalt concrete layer:

- As much as possible and as appropriate, the asphalt concrete layers must be combined into three layers: surface, intermediate and base. Asphalt layers with similar HMA mixtures may be combined into a single layer.
- When multiple layers are combined, the properties of the combined layer should be the weighted average of the individual layers.
- The M-E Design software does not consider very thin layers (thickness less than 1.5 inches).
- Weakly stabilized asphalt materials (i.e. sand-asphalt) should not be considered an asphalt concrete layer.
- M-E Design models layer by layer rutting. **Table 6.1 Layered Rut Distribution** shows the percentages used for calculating the final rutting in Colorado.

**Table 6.1 Layered Rut Distribution**

Layer	Colorado Percent Distribution	Global Percent Distribution
Hot Mix Asphalt	60	80
Aggregate Base Course	10	5
Subgrade	30	15

Designers are required to input volumetric properties such as air voids, effective asphalt content by volume, aggregate gradation, mix density, and asphalt binder grade (see **Figure 6.9 Asphalt Concrete Layer and Material Properties in M-E Design**). The designers are also required to input the engineering properties such as the dynamic modulus, creep compliance, indirect tensile strength of HMA materials, and the viscosity versus temperature properties of rolling thin film oven (RTFO) aged asphalt binders. These inputs can be obtained following the input hierarchy levels depending on the criticality of the project. The volumetric properties entered into the program need to be representative of the in-place asphalt concrete mixture. The project-specific in-place mix properties will not be available at the design stage. The designer should use typical values available from previous construction records or target values from the project specifications.

Layer 1 Asphalt Concrete:AC 1

Asphalt Layer  
 Thickness (in.)  4.7

Mixture Volumetrics  
 Unit weight (pcf)  148.3  
 Effective binder content (%)  10.6  
 Air voids (%)  6.2  
 Poisson's ratio 0.35

Mechanical Properties  
 Dynamic modulus  Input level:3  
 Select HMA Estar predictive model Use Viscosity based model (nationally calibrated).  
 Reference temperature (deg F)  70  
 Asphalt binder  SuperPave:76-28  
 Indirect tensile strength at 14 deg F (psi)  595  
 Creep compliance (1/psi)  Input level:1

Thermal  
 Thermal conductivity (BTU/hr-ft-deg F)  0.67  
 Heat capacity (BTU/lb-deg F)  0.23  
 Thermal contraction 1.191E-05 (calculated)

Identifiers  
 Display name/identifier AC 1

---

**Thickness (in.)**  
 Thickness of the asphalt concrete layer.  
 Minimum:1  
 Maximum:20

**Figure 6.8 Asphalt Concrete Layer and Material Properties in M-E Design**

**Table 6.2 Input Properties and Recommendations for HMA Material Characterization** presents the HMA input requirements of the M-E Design Method and recommendations for obtaining inputs at each hierarchical input level. The designer may use Level 1 inputs of typical CDOT HMA mixtures for Level 2 and 3 inputs. See **APPENDIX F** and **Table 2.6 Selection of Input Hierarchical Level** for selection of an appropriate hierarchical level for HMA characterization. For new construction (i.e. new HMA) the designer **should always click “True” for the Poisson’s Ratio** (currently the default value is “False”).

**Table 6.2 Input Properties and Recommendations for HMA Material Characterization**

Input Property	Level 1	Level 2	Level 3
Dynamic Modulus (E*)	Mix specific E* and/or AASHTO TP62 test results	Gradation ( <b>APPENDIX E</b> )	
Asphalt Binder Properties	Binder properties from laboratory testing of HMA using AASHTO T315		Binder grade ( <b>APPENDIX E</b> )
Tensile Strength <sup>1</sup> at 14 °F	AASHTO T322 test results	Use tensile strength and creep compliance ( <b>APPENDIX E</b> )	
Creep Compliance			
Poisson’s Ratio	M-E Design software option ( <i>Is Poisson's ratio calculated?</i> )		Use 0.35
Air Voids	Use air voids ( <b>APPENDIX E</b> )		
Volumetric Asphalt Content	Use volumetric asphalt content ( <b>APPENDIX E</b> )		
Total Unit Weight	Use total unit weight ( <b>APPENDIX E</b> )		
Surface Shortwave Absorptivity	Use 0.85		
Coefficient of Thermal Contraction of the Mix	1.3E-05 in./in./°F (mix CTE) and 5.0 E-06 in./in./°F (aggregate CTE)		
Thermal Conductivity	0.67 Btu/(ft)(hr)(°F)		
Heat Capacity	0.23 BTU/lb.- °F		
Reference Temperature	70 °F		
<b>Note:</b> <sup>1</sup> The designer should use Level 1 Inputs. The Level 3 Inputs for tensile strength are much smaller which will cause more thermal cracking and greater creep compliance.			

#### 6.6.4.2 Unbound Layers and Subgrade Characterization

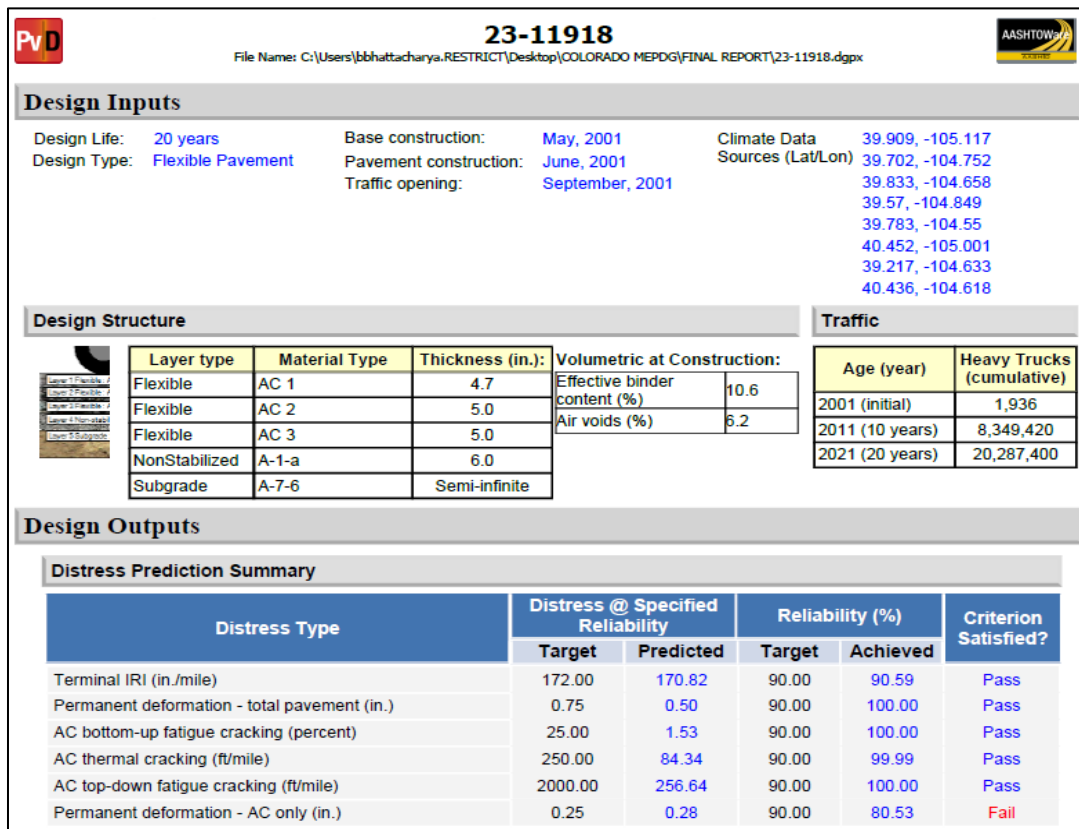
Refer to **Section 5.3.1 Unbound Layer Characterization in M-E Design** for unbound aggregate base layer characterization. Refer to **Section 4.4 Subgrade Characterization for M-E Design** for subgrade characterization.

## 6.7 Run M-E Design Software

Designers should examine all inputs for accuracy and reasonableness prior to running the M-E Design software. Next, one should run the software to obtain outputs required to determine if the trial design is adequate. After a trial run has been successfully completed, M-E Design will generate a report in form of a PDF and/or Microsoft Excel file, refer to **Figure 6.10 Sample Flexible Pavement Trial Design PDF Output Report**. The output report has input information, reliability of design, material properties, and predicted performance. It also includes the month to month estimates of material properties over the entire design period in either tabular or graphical form. For a flexible pavement trial design, the report provides the following:

- Monthly estimates of HMA dynamic modulus for each sublayer
- Monthly estimates of resilient modulus of unbound layers and subgrade
- Monthly estimates of AADTT
- Monthly estimates of climate parameters
- Cumulative trucks (FHWA Class 4 through 13) over the design period
- Cumulative ESALs over the design period (an intermediate file in the project folder)

After the trial run is complete, the designer should re-examine all inputs and outputs for accuracy and reasonableness before accepting a trial design as complete.



**Figure 6.9 Sample Flexible Pavement Trial Design PDF Output Report**

## 6.8 Evaluate the Adequacy of the Trial Design

The output report of a flexible pavement trial design includes the monthly accumulation of the following key distress types at their mean values and chosen reliability for the entire design period:

- **Alligator Fatigue Cracking:** Traditional wheel path cracking that initiates at the bottom of the HMA layer and propagates to the surface under repeated load applications. Beyond a critical threshold, the rate of cracking accelerates and may require significant repairs and lane closures. Fatigue cracking is highly dependent on the effective asphalt content by volume and air voids.
- **Transverse Cracking:** Thermal cracks typically appear as transverse cracks on the pavement surface due to low temperatures, hardening of the asphalt, and/or daily temperature cycles. Excessive transverse cracking may adversely affect ride quality.

The designer should examine the results to evaluate if the performance criteria for each of the above-mentioned indicators are met at the desired reliability. **If alligator fatigue cracking or transverse cracking criteria have not been met, the trial design is deemed unacceptable and revised accordingly to produce a satisfactory design.**

The output report also includes the monthly accumulation of the following secondary distress types and smoothness indicators at their mean values and chosen reliability for the entire design period:

- **Permanent Deformation:** The report includes HMA rutting and total permanent deformation (includes rutting on unbound layers and subgrade). Excessive rutting may cause safety concerns.
- **Surface-Initiated Fatigue Cracking or Longitudinal Cracking:** These load-related cracks appear at the HMA surface and propagate downwards. Beyond a critical threshold, the rate of cracking accelerates and may require significant repairs and lane closures.
- **IRI:** The roughness index represents the profile of the pavement in the wheel paths. Higher IRI indicates unacceptable ride quality.

**The designer should examine the results to evaluate if the performance criteria for permanent deformation, surface-initiated fatigue cracking or longitudinal cracking, and IRI meet the minimum of 14 years at the desired reliability.** If any of the criteria have not been met, the trial design is deemed unacceptable and revised accordingly to produce a satisfactory design.

Another important output is the reliability level of each performance indicator at the end of the design period. If the reliability value predicted for the given performance indicator is greater than the target/desired value, the trial design passes for that indicator. If the reverse is true, then the trial design fails to provide the desired confidence and the performance indicator will not reach the

critical value during the pavement's design life. In such an event, the designer needs to alter the trial design to correct the problem.

The strategies for modifying a trial design are discussed in **Section 6.9 Modifying Trial Designs**. The designer can use a range of thicknesses to optimize the thickness of the trial design to make it more acceptable. In addition, the software allows the designer to perform a sensitivity analysis on the key inputs. The results of the sensitivity analysis can be used to further optimize the trial design if modifying AC thickness alone does not produce a feasible design alternative. A detail description of thickness optimization procedure and sensitivity analysis is provided in the *Software HELP Manual*.

## 6.9 Modifying Trial Designs

An unsuccessful trial design may require revisions to ensure all performance criteria are satisfied. The trial design is modified by systematically revising the design inputs. In addition to layer thickness, many other design factors influence performance predictions. The design acceptance is distress-specific; in other words, the designer needs to first identify the performance indicator that failed to meet the performance target and modify one or more design inputs that has a significant impact on the given performance indicator. The impact of design inputs on performance indicators is typically obtained by performing a sensitivity analysis. Strategies used to produce a satisfactory design by modifying design inputs can be broadly categorized into to following:

- Pavement layer considerations
- Increasing layer thickness
- Modifying layer type and layer arrangement
- Foundation improvements (i.e. stabilize the upper subgrade soils)
- Pavement material improvements:
  - Use of higher quality materials (i.e. use of polymer modified asphalt, crushed stones)
  - Material design modifications (i.e. increase asphalt content, reduce amount of fines, modify gradations etc.)
  - Construction quality (i.e. reduce HMA air voids, increase compaction density, decrease as-constructed pavement smoothness)

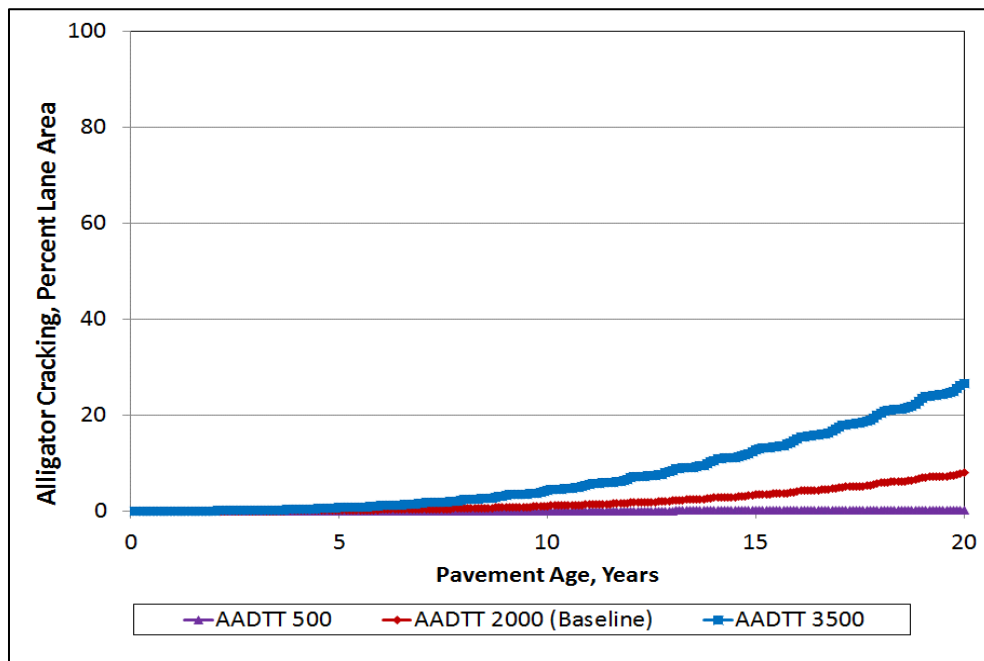
Once again, when modifying the design inputs, the designer needs to be aware of the sensitivity of these inputs to various distress types. Changing a single input to reduce one distress may result in an increase in another distress. For example, the designer may consider using a harder asphalt to reduce HMA rutting, but that will likely increase the predicted transverse cracking. **Table 6.3 Modifying Flexible Pavement Trial Designs** presents a summary of inputs that may be modified to optimize trial designs and produce a feasible design alternative.

**Table 6.3 Modifying Flexible Pavement Trial Designs**

<b>Distress/IRI</b>	<b>Design Inputs that Impact</b>
<b>AC Rutting</b>	<ul style="list-style-type: none"> <li>• Use a polymer modified asphalt for the HMA surface layer</li> <li>• Increase the dynamic modulus of the HMA mixture(s)</li> <li>• Reduce the asphalt content in the HMA mixture(s)</li> <li>• Increase the amount of crushed aggregate</li> <li>• Increase the amount of manufactured fines in the HMA mixture</li> </ul>
<b>Transverse Cracking</b>	<ul style="list-style-type: none"> <li>• Decrease the stiffness of the AC surface mix               <ul style="list-style-type: none"> <li>▪ Use a softer asphalt</li> <li>▪ Increase asphalt binder</li> <li>▪ Increase indirect tensile strength</li> <li>▪ Reduce creep compliance</li> </ul> </li> <li>• Increase AC layer thickness</li> </ul>
<b>Alligator Cracking</b>	<ul style="list-style-type: none"> <li>• Increase HMA layer thickness</li> <li>• Increase HMA dynamic modulus for HMA layers thicker than 5 inches and decrease HMA dynamic modulus for HMA layers thinner than 3 inches</li> <li>• Revise the mixture design of the HMA base layer               <ul style="list-style-type: none"> <li>▪ Increase asphalt binder content</li> <li>▪ Achieve higher density and lower air voids during compaction</li> <li>▪ Use harder asphalt/polymer modified asphalt but ensure good compaction is achieved</li> <li>▪ Increase percent manufactured fines, and/or percent crushed aggregates</li> </ul> </li> <li>• Reduce stiffness gradients between upper and lower layers               <ul style="list-style-type: none"> <li>▪ Using a higher quality/stiffer HMA layer on top of poor quality/low resilient modulus granular base or foundation tends to increase fatigue cracking</li> </ul> </li> <li>• Increase the thickness or stiffness of a high quality unbound base layer and/or use a stabilized layer</li> </ul>
<b>Unbound Base Rutting</b>	<ul style="list-style-type: none"> <li>• Increase the resilient modulus of the aggregate base</li> <li>• Increase the density of the aggregate base</li> <li>• Stabilize the upper foundation layer for weak, frost susceptible, or swelling soils</li> <li>• Place a layer of select embankment material with adequate compaction</li> <li>• Increase the HMA or granular layer thickness</li> <li>• Address drainage related issues to protect from the detrimental effects of moisture</li> </ul>
<b>Subgrade Rutting</b>	<ul style="list-style-type: none"> <li>• Increase the layer stiffness and layer thickness of any layers above the subgrade layers:               <ul style="list-style-type: none"> <li>▪ Increase HMA and/or unbound layer thickness or stiffness</li> <li>▪ Include a stabilized drainable base</li> </ul> </li> </ul>

Distress/IRI	Design Inputs that Impact
	<ul style="list-style-type: none"> <li>• Improve the engineering properties of the subgrade material:               <ul style="list-style-type: none"> <li>▪ Increase the stiffness (modulus) of the subgrade layer(s) itself through the use of lime stabilized subgrade</li> <li>▪ Effective use of subsurface drainage systems, geotextile fabrics, and impenetrable moisture barrier wraps to protect from the detrimental effects of moisture</li> <li>▪ Increase the grade elevation to increase the distance between the subgrade surface and ground water table</li> </ul> </li> </ul>
IRI	<ul style="list-style-type: none"> <li>• Reduce initial IRI (achieving smoother as-constructed pavement surface through more stringent smoothness criteria)</li> <li>• Improve roadbed foundation (replace frost susceptible or expansive subgrade with non-frost susceptible or stabilized subgrade materials)</li> <li>• Place subsurface drainage system to remove ground water</li> </ul>

**Figure 6.11 Sensitivity of HMA Alligator Cracking to Truck Volume through Figure 6.32 Sensitivity of HMA IRI to Base Thickness. Figure 6.30 Sensitivity of HMA IRA to AC Thickness** presents sensitivity plots of a sample flexible pavement trial design showing the effects of key inputs, such as traffic volume, asphalt binder content, asphalt binder grade, air voids, base type, base thickness, and climate on key distresses/IRI. **Note:** The plots do not exhaustively cover the effects of all key factors on flexible pavement performance; other significant factors are not shown herein.



**Figure 6.10 Sensitivity of HMA Alligator Cracking to Truck Volume**



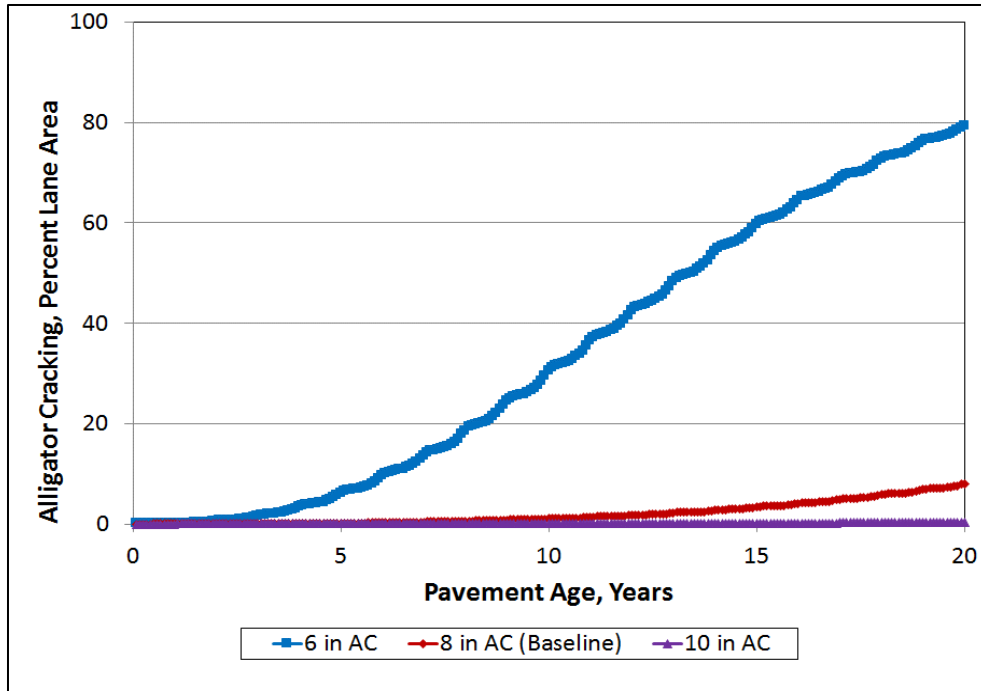


Figure 6.11 Sensitivity of HMA Alligator Cracking to AC Thickness

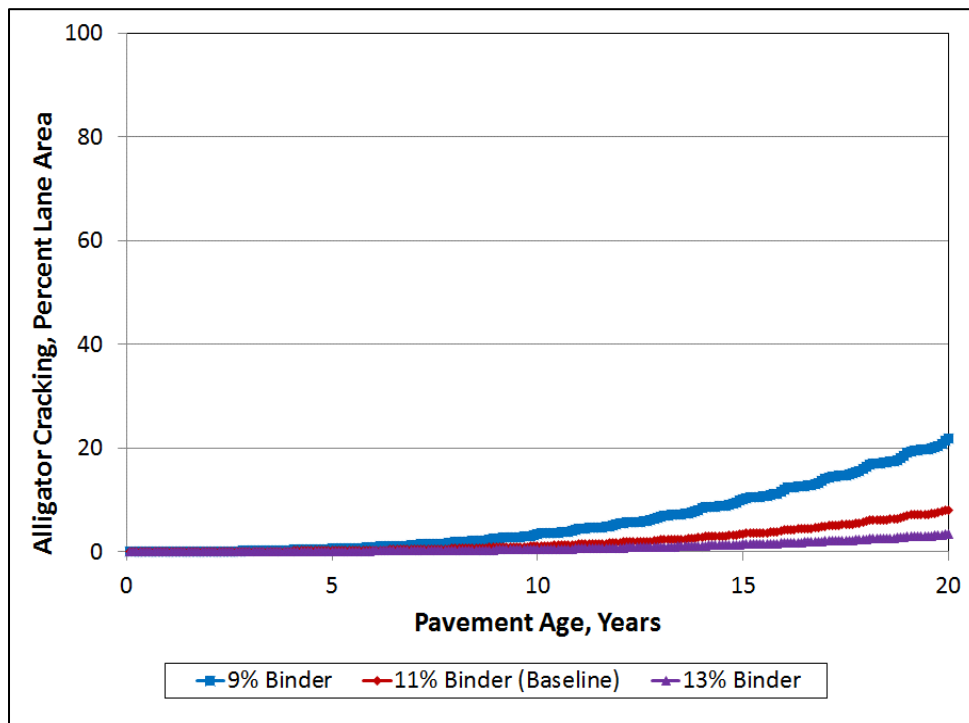


Figure 6.12 Sensitivity of HMA Alligator Cracking to Asphalt Binder Content

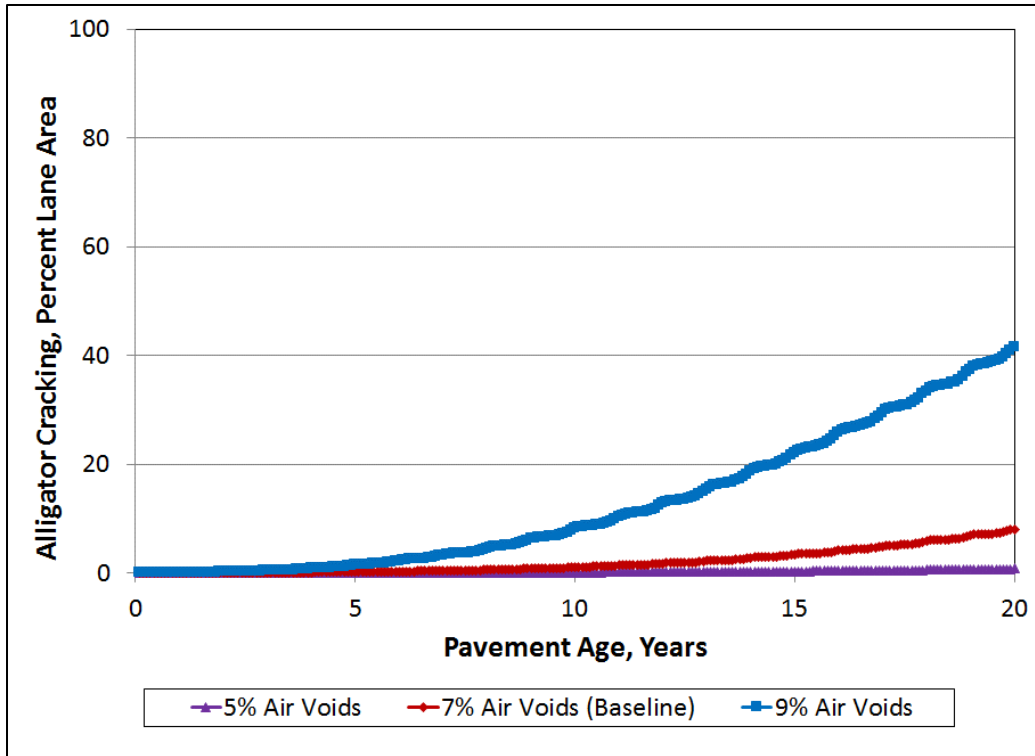


Figure 6.13 Sensitivity of HMA Alligator Cracking to Air Voids

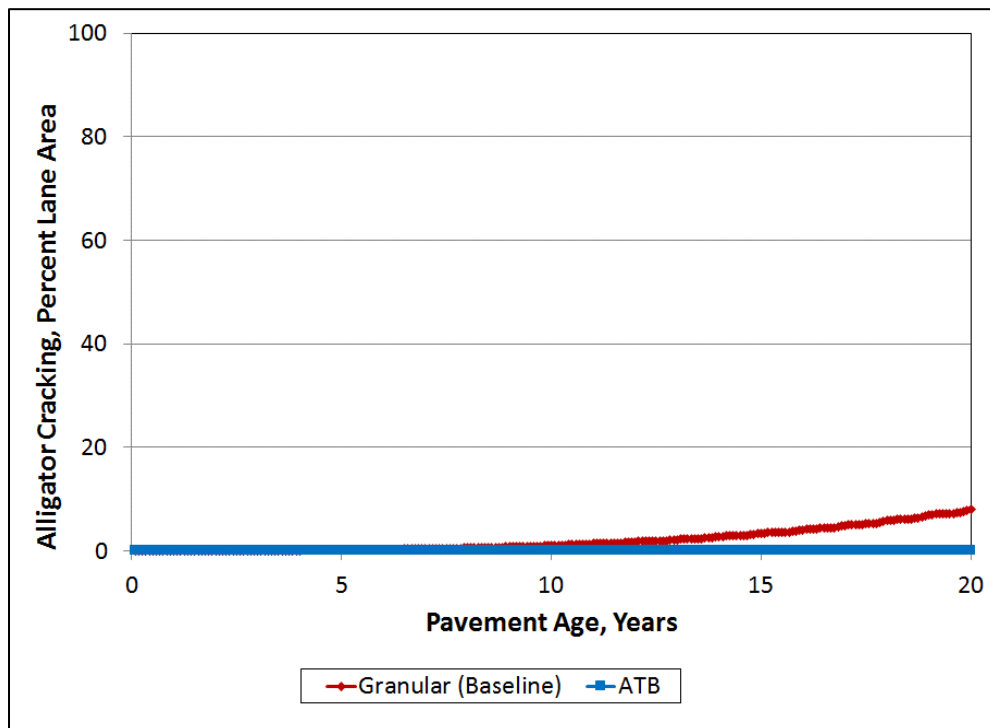


Figure 6.14 Sensitivity to HMA Alligator Cracking to Base Type

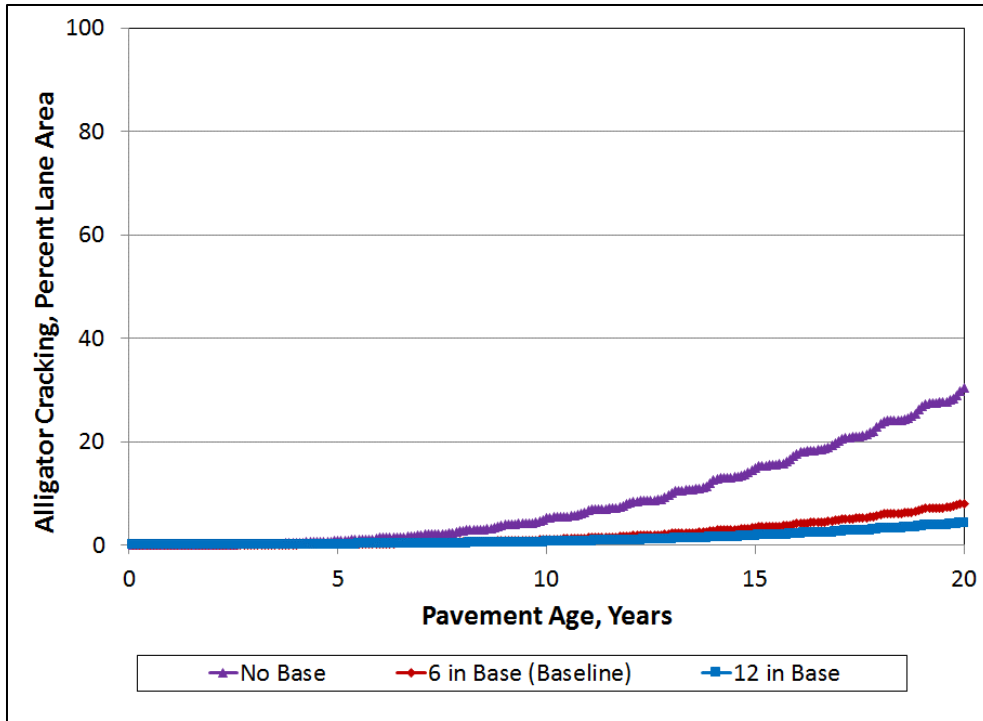


Figure 6.15 Sensitivity of HMA Alligator Cracking to Base Thickness

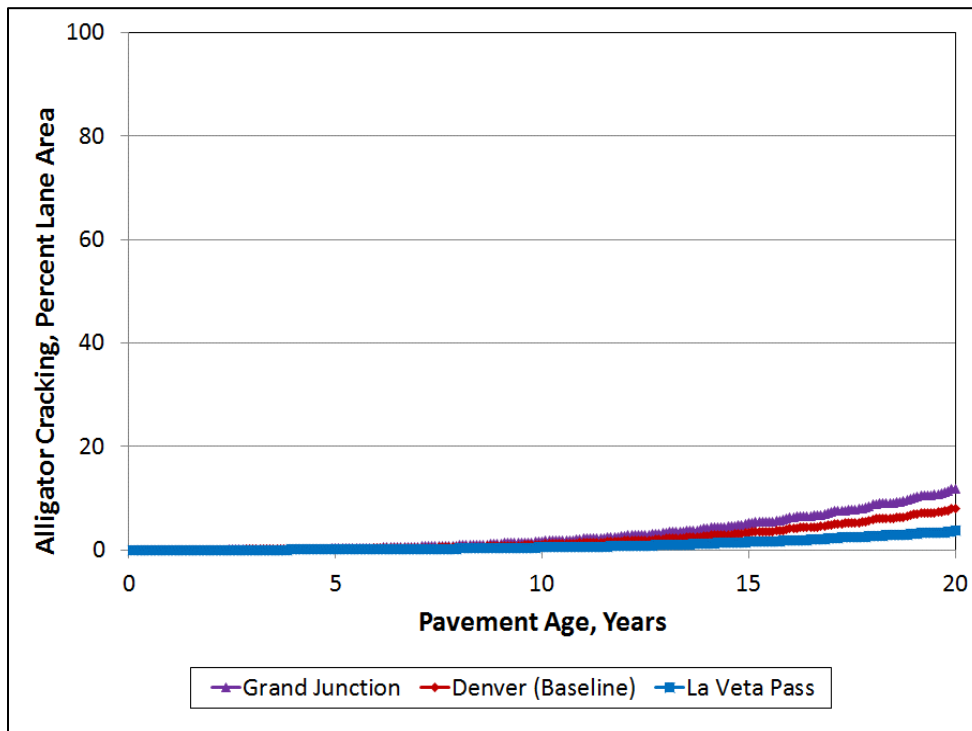
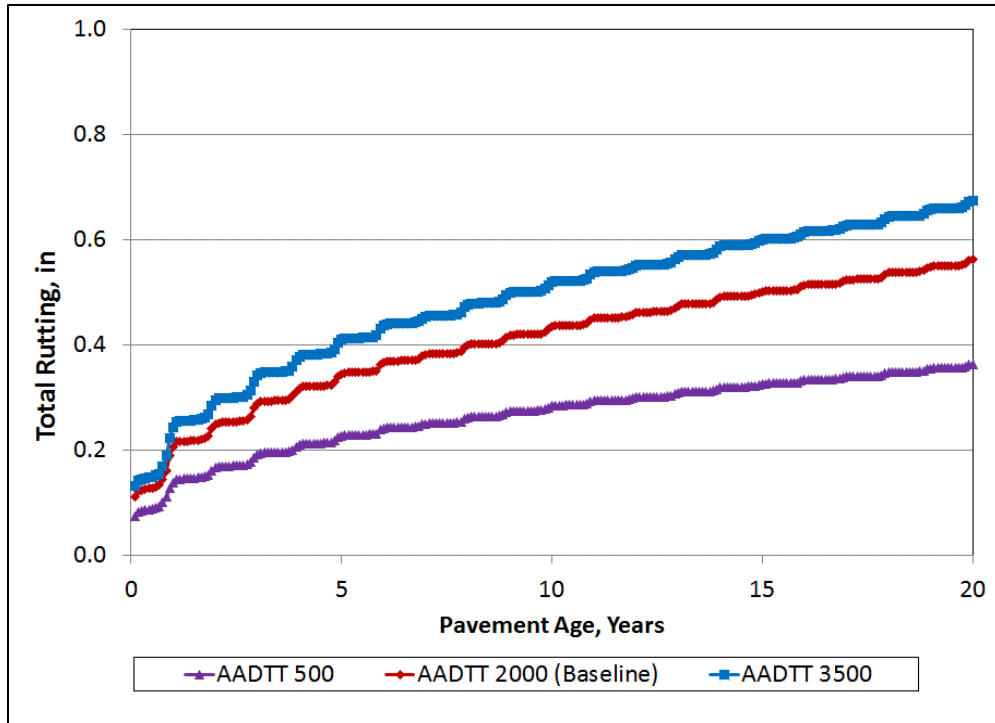
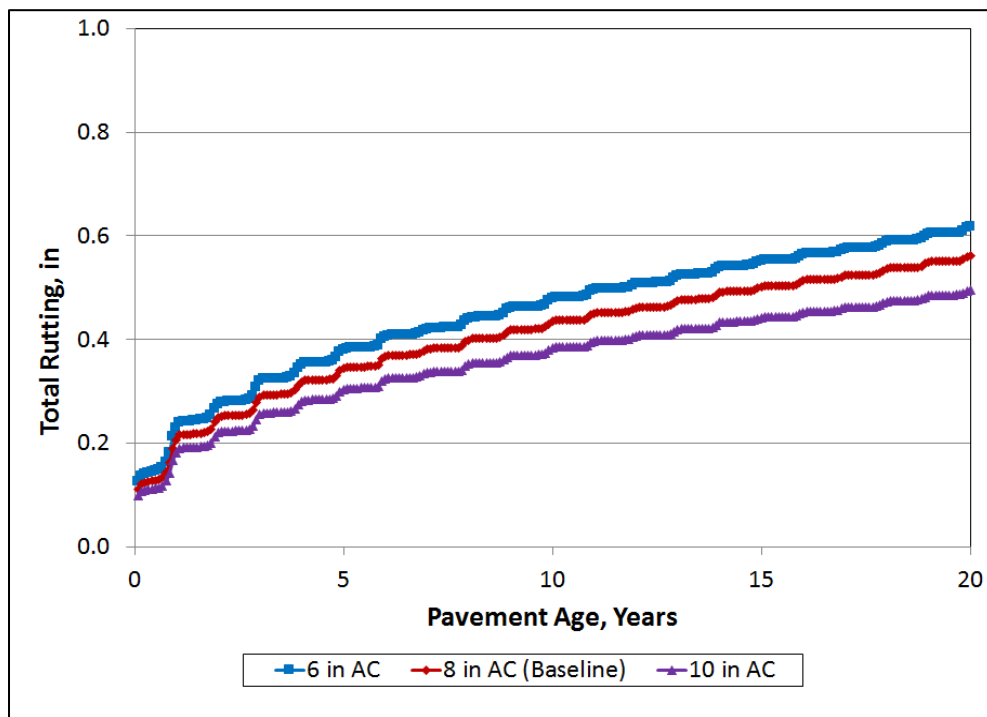


Figure 6.16 Sensitivity of HMA Alligator Cracking to Climate



**Figure 6.17 Sensitivity of Total Rutting to Truck Volume**



**Figure 6.18 Sensitivity of Total Rutting to AC Thickness**

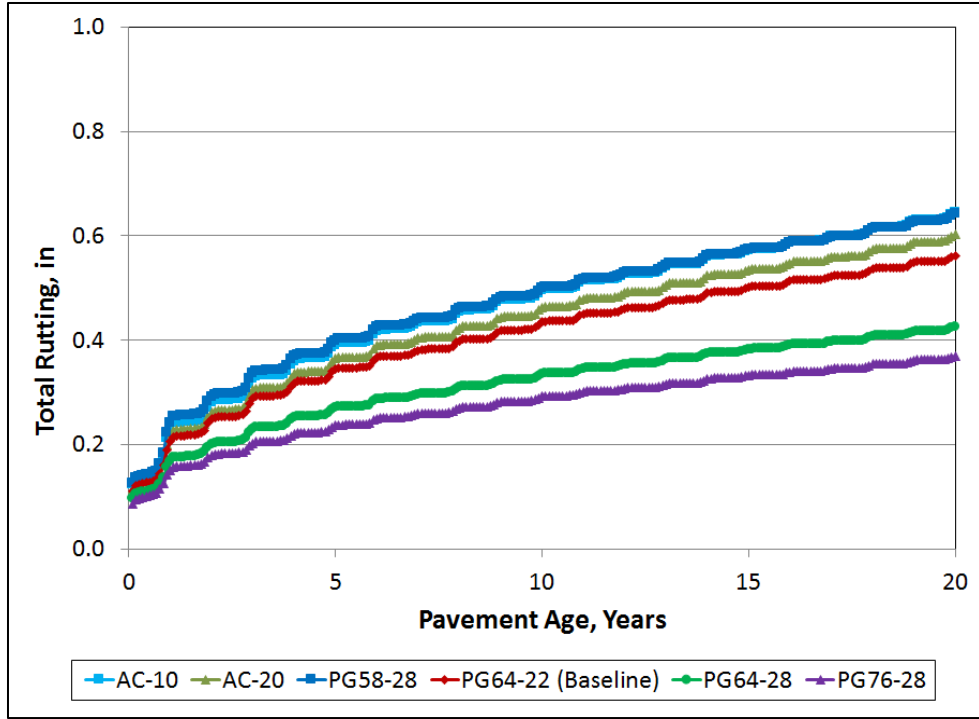


Figure 6.19 Sensitivity of Total Rutting to Asphalt Binder Grade

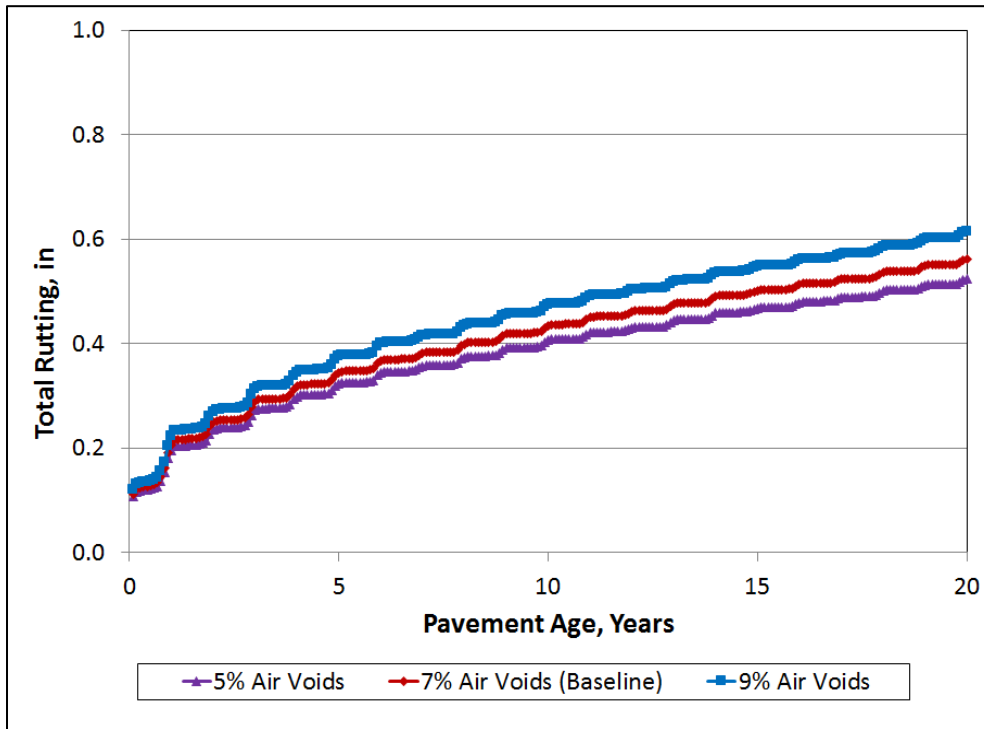


Figure 6.20 Sensitivity of Total Rutting to Air Voids

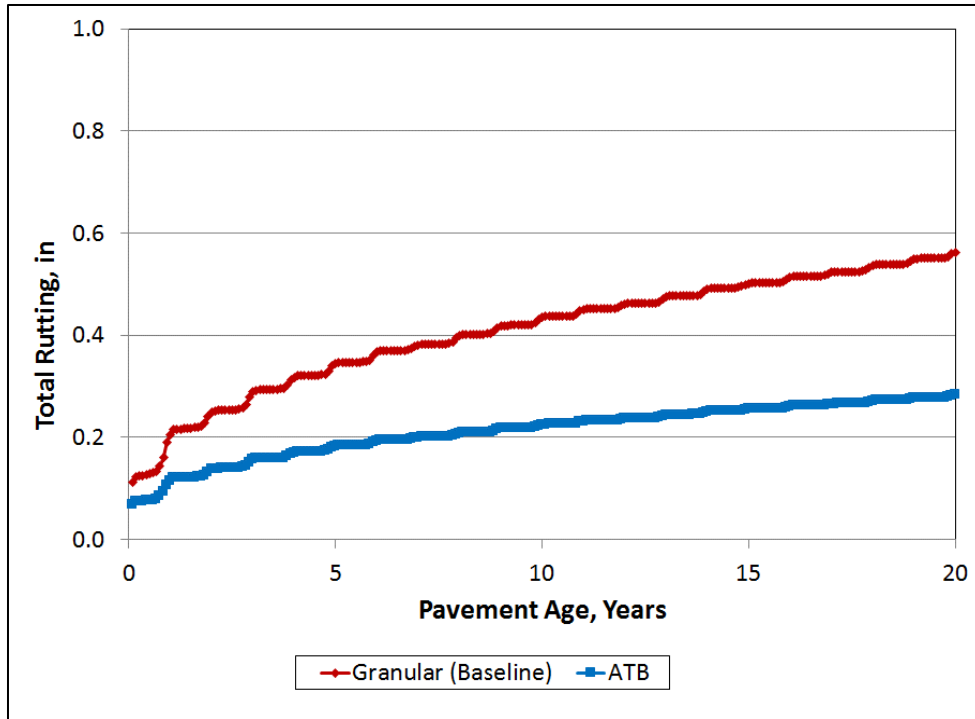


Figure 6.21 Sensitivity of Total Rutting to Base Type

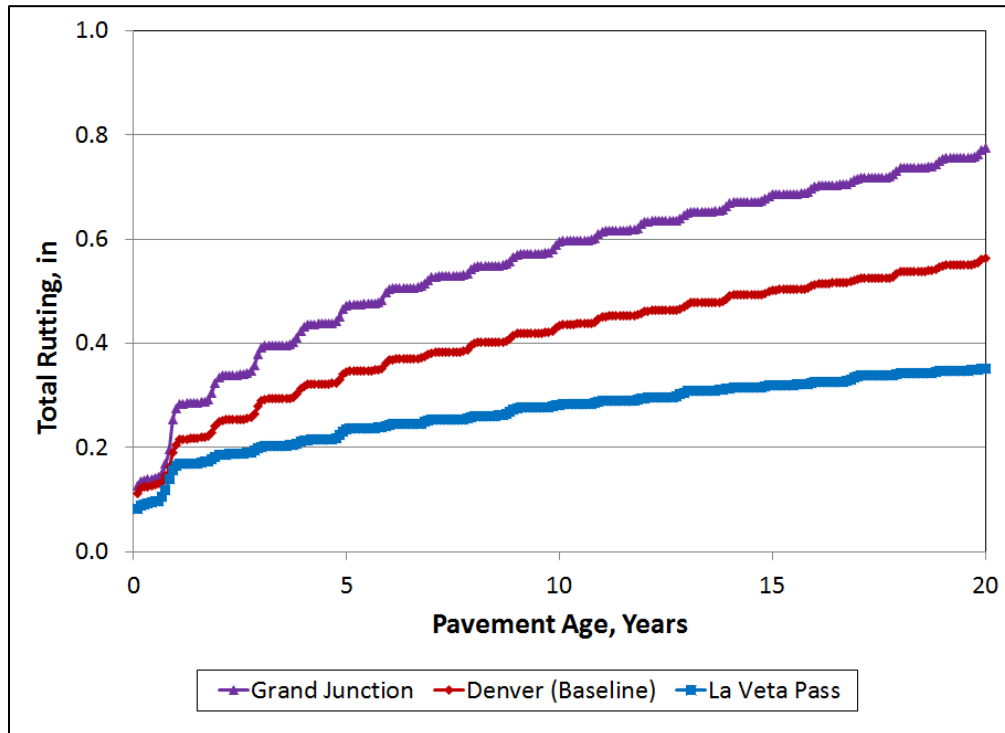


Figure 6.22 Sensitivity of Total Rutting to Climate

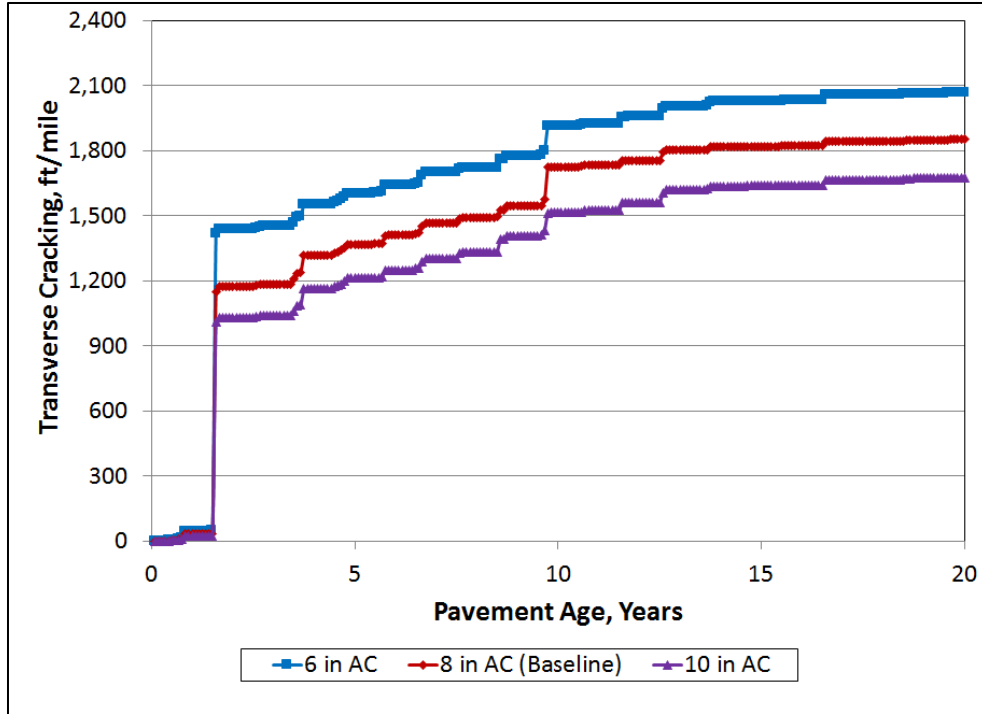


Figure 6.23 Sensitivity of HMA Transverse Cracking to Thickness

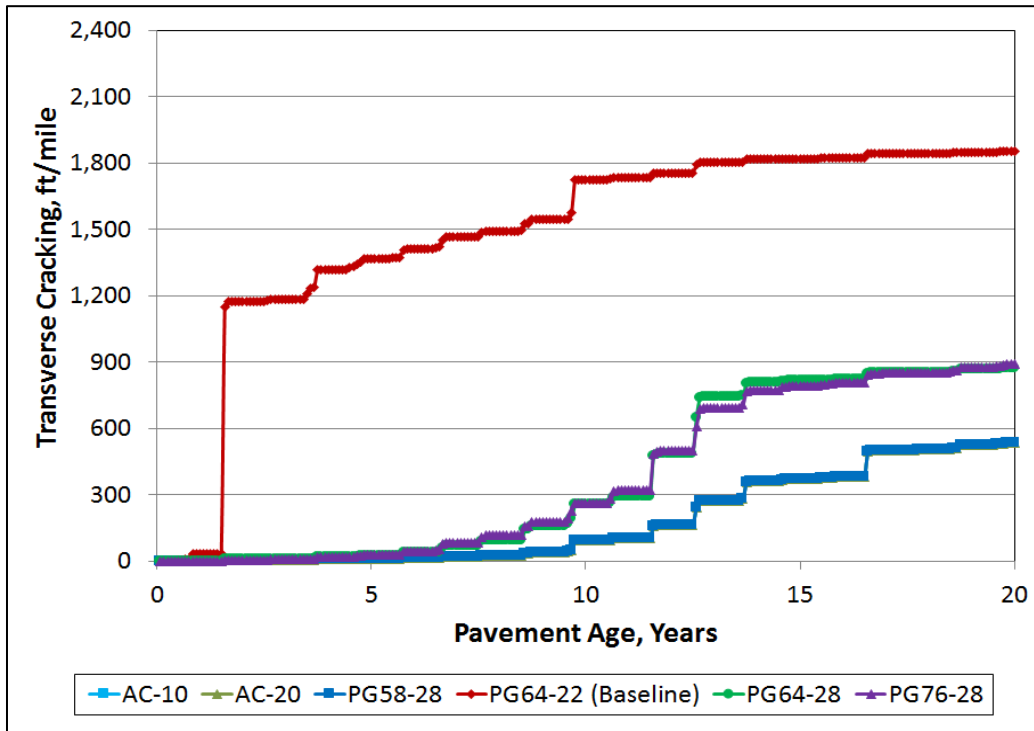


Figure 6.24 Sensitivity of HMA Transverse Cracking to Asphalt Binder Grade

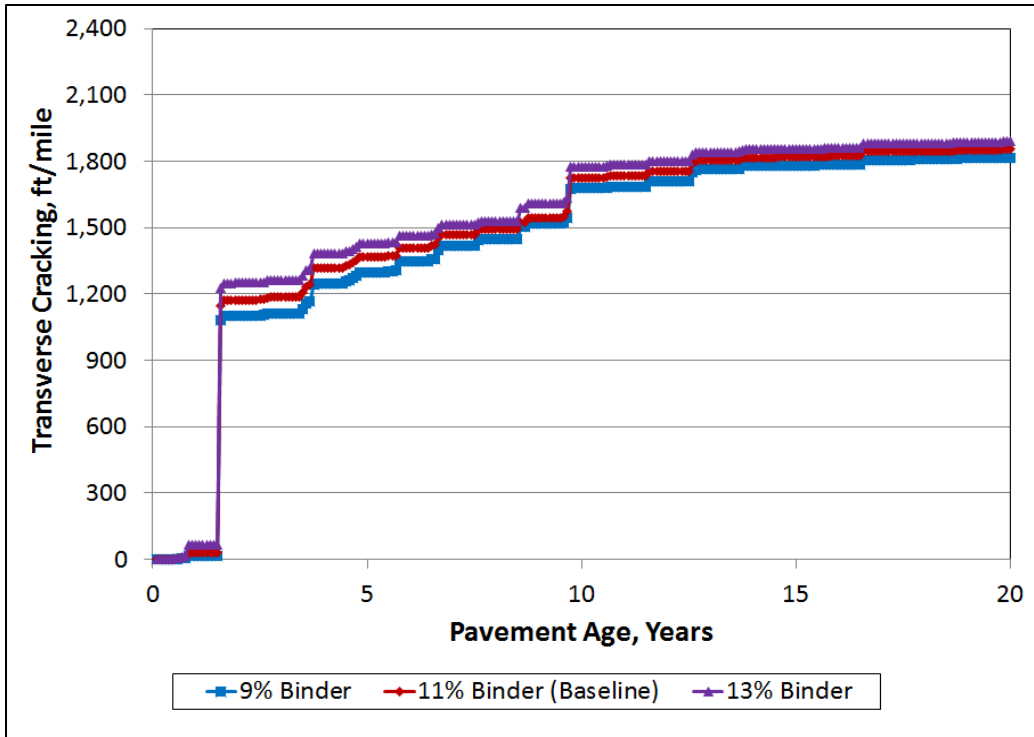


Figure 6.25 Sensitivity of HMA Transverse Cracking to Asphalt Binder Content

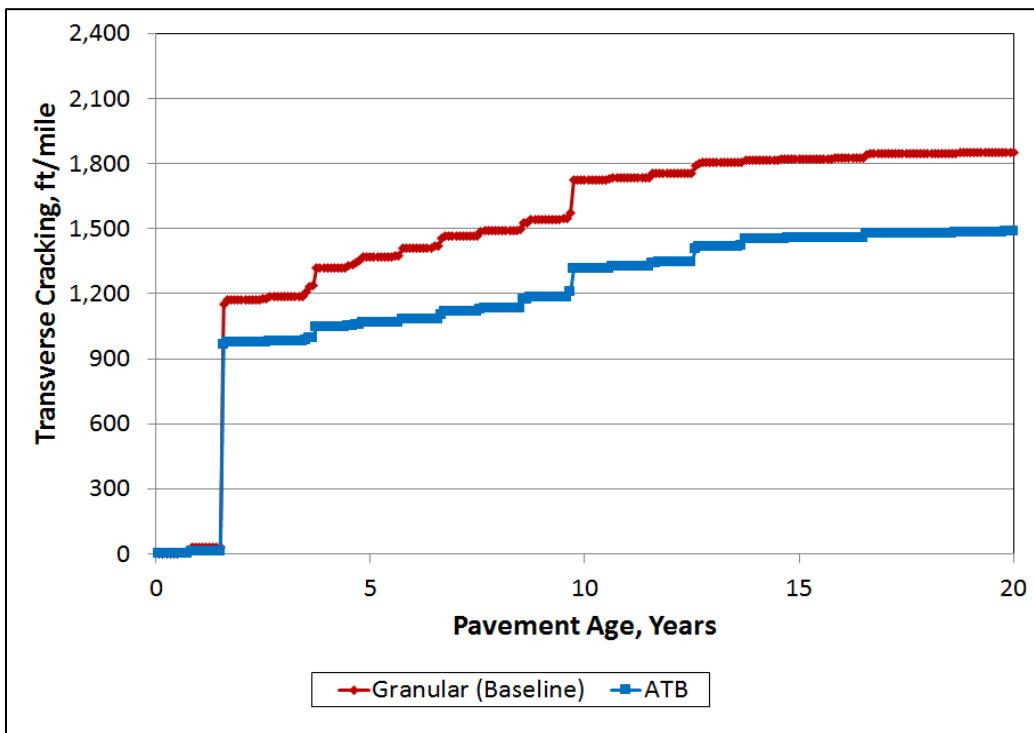


Figure 6.26 Sensitivity of HMA Transverse Cracking to Base Type



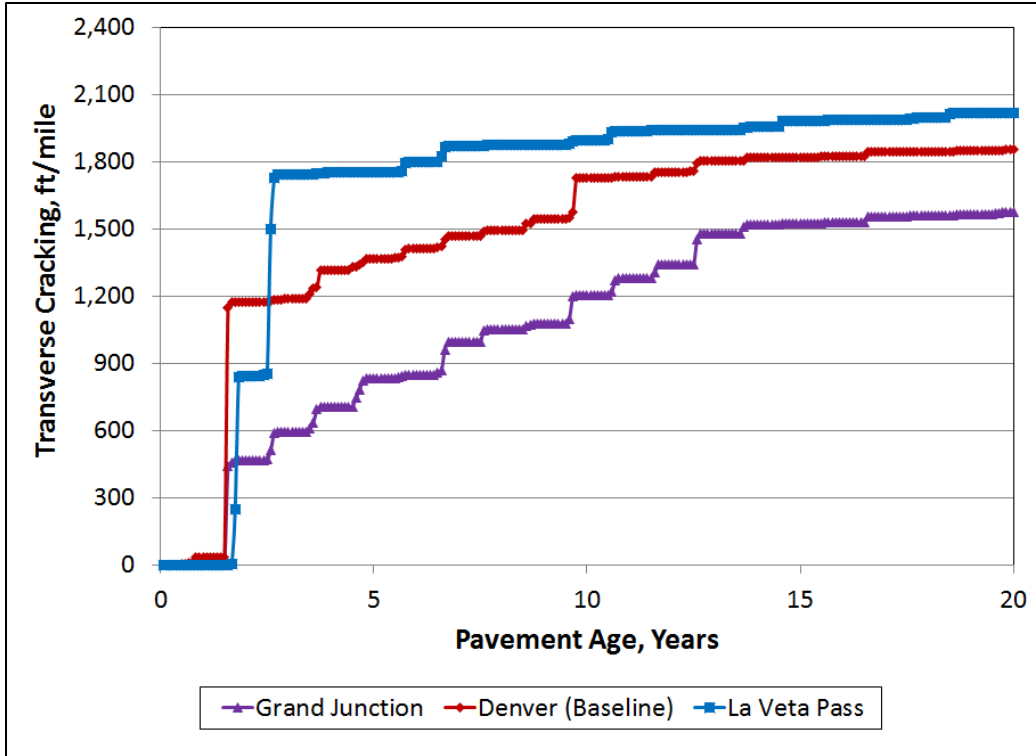


Figure 6.27 Sensitivity of HMA Transverse Cracking to Climate

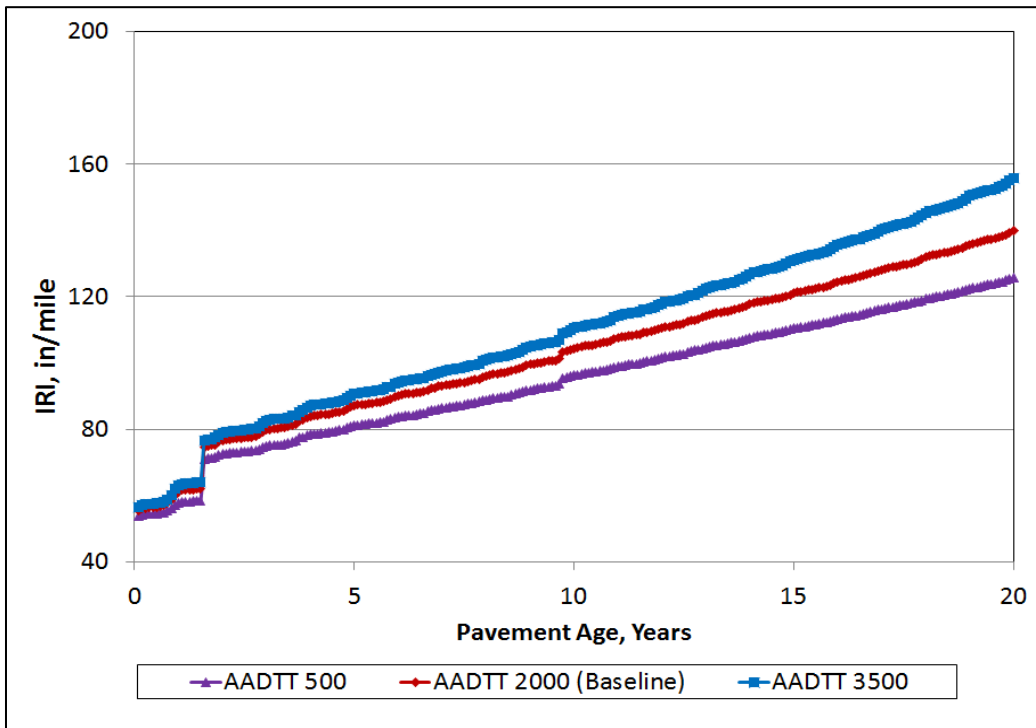


Figure 6.28 Sensitivity of HMA IRI to Truck Volume

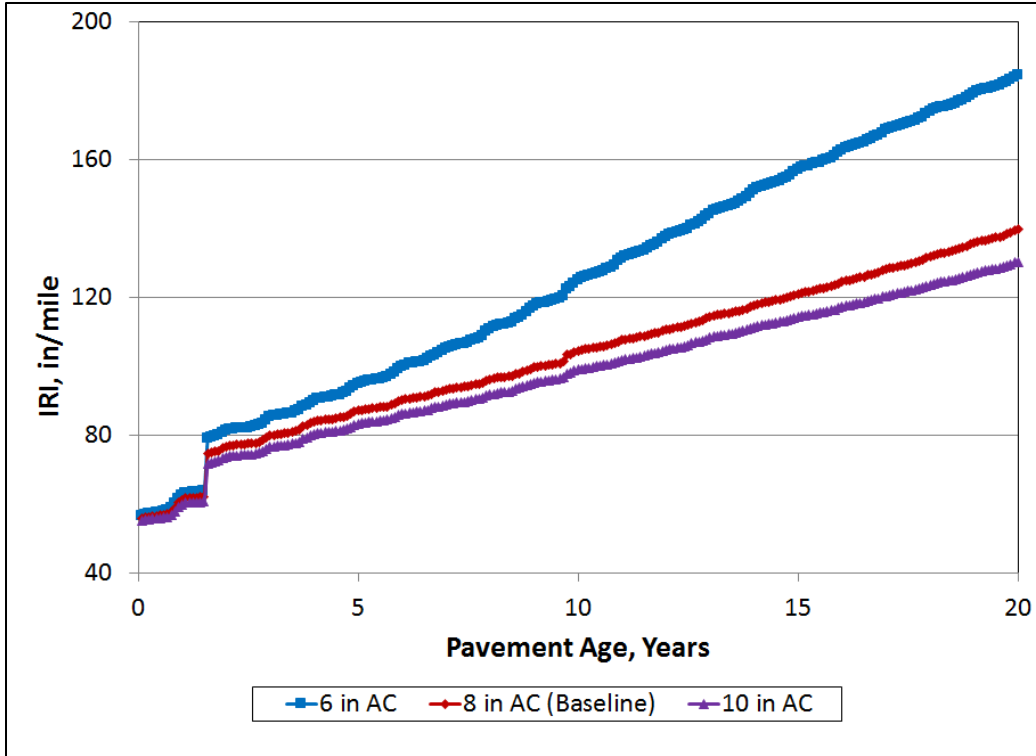


Figure 6.29 Sensitivity of HMA IRI to AC Thickness

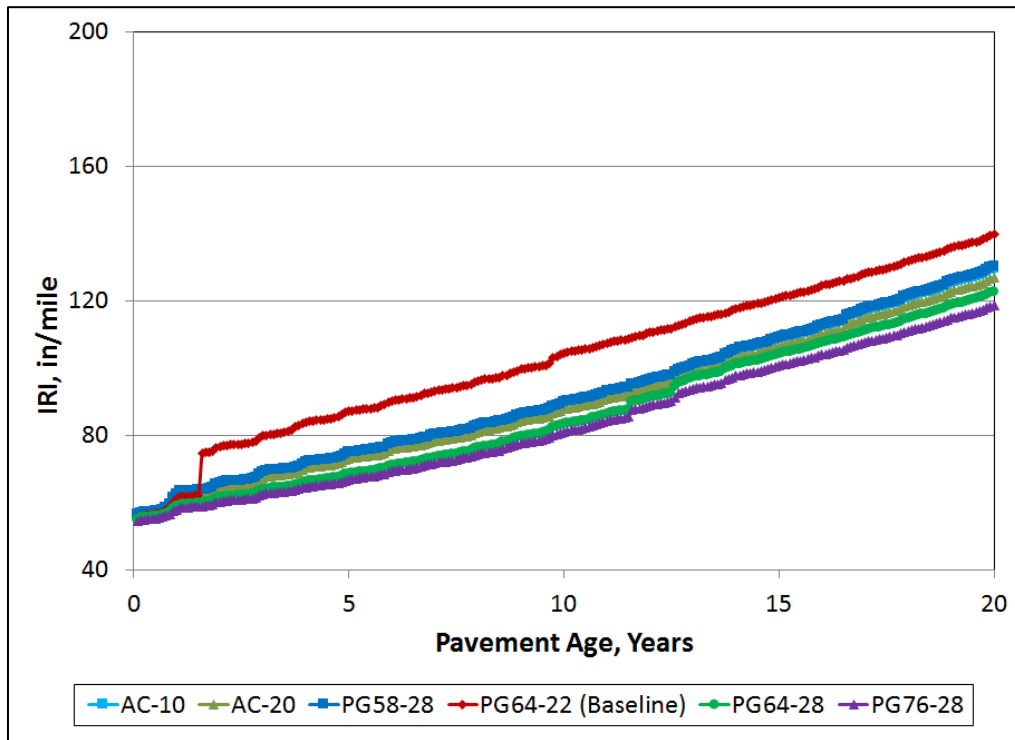


Figure 6.30 Sensitivity of HMA IRI to Asphalt Binder Grade

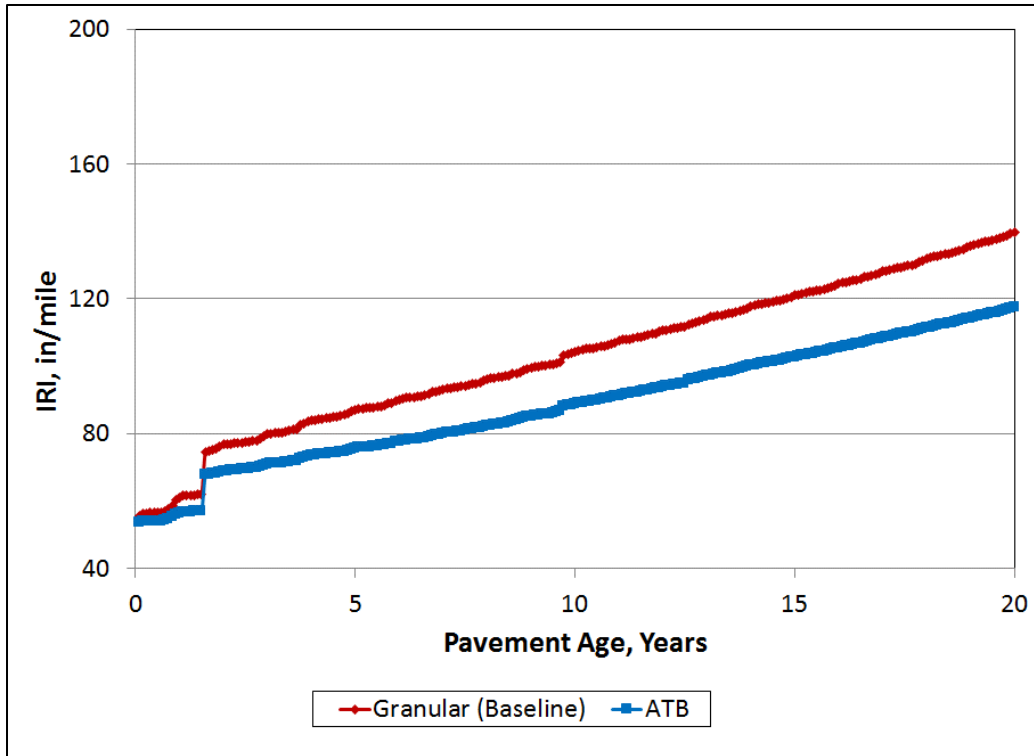


Figure 6.31 Sensitivity of HMA IRI to Base Thickness

## 6.10 HMA Thickness with ABC

**As a minimum, the designer should include 4 inches of ABC for any thickness of HMA when the design truck traffic is less than 500 trucks per day. Six inches of ABC should be used for any thickness of HMA when the design truck traffic is greater than 500 trucks per day.**

## 6.11 Required Minimum Thickness of Pavement Layer

Compaction of a hot mix asphalt pavement during its construction is the single most important factor affecting the ultimate performance of the pavement. Achieving adequate compaction increases pavement performance by decreasing rutting, reducing damage due to moisture and oxidation, and increasing the stability of the mix. Factors affecting the cooling rate of the mat include the layer thickness, the temperature of the mix when placed, ambient temperature, temperature of the base, and wind conditions. Layer thickness is the single most important variable in the cooling rate of an asphalt mat, especially for thin layers. This is especially true in cool weather because thin layers of an asphalt mat have less capacity to retain heat than thicker lifts of pavement. The thicker layers of an asphalt mat help to maintain the temperature at a workable level, thus increasing the time available for compaction. Because of the increased difficulty in achieving density and the importance of achieving compaction, a minimum layer thickness for construction of HMA pavement is two inches. A designer of special mixes, such as stone matrix

The suggested thicknesses for bicycle paths is shown on **Table 6.3 Minimum Thickness for Bicycle Paths**.

**Table 6.4 Minimum Thicknesses for Bicycle Paths**

Design Truck Traffic	Hot Mix Asphalt Pavement (inches)	Aggregate Base Course (inches)
Multi-use sidewalks <sup>1</sup>	4.0	6.0
Sidewalks <sup>2</sup>	3.0	6.0 <sup>3</sup>
<b>Notes:</b> <sup>1</sup> Maintenance vehicles may include light duty trucks. <sup>2</sup> Pedestrian and bicycle only, typical snow removal equipment would be a snow blower. <sup>3</sup> May be reduced to 3.0 inches in thickness if suitable subgrade exists and approved by the RME.		

asphalt or thin lift HMA should look at minimum thickness requirements of the particular product. The minimum thickness of these special mixes is likely to be a dimension other than two inches.

## 6.12 Asphalt Materials Selection

### 6.12.1 Aggregate Gradation

Definitions of Aggregate Size:

- **Nominal Maximum Aggregate Size (NMAS):** The size of aggregate of the smallest sieve opening through which the entire amount of aggregate is permitted to pass.
  - **Note:** For Item 403 - HMA and SMA, the Nominal Maximum Size is defined as one sieve size larger than the first sieve to retain more than ten percent of the aggregate.
- **Maximum Aggregate Size** is defined as one size larger than nominal maximum size. The flexible pavement usually consists of ¾ inch nominal maximum aggregate size (NMAS) in the lower layers, with a hot mix asphalt (HMA) Grading S. The top surface layer, should be either stone matrix asphalt (SMA) or a Grading SX. SMA mixes are often used in areas expected to experience extreme traffic loading. When low to high traffic loads are expected, a ½ inch NMAS, Grading SX should be used.

CDOT uses the No. 30 sieve as one of the job-mix formula tolerance sieves. **Table 6.4 Master Range Table for Stone Mix Asphalt**. is based (with some exceptions) on NCHRP No. 4 and ¾ inch and AASHTO ½ inch and ¾ inch SMA gradations ranges, where the No. 30 sieve range is included in the ½ inch and ¾ inch gradations.

**SMA Gradation Nomenclature Example:**

The ¾ inch (19.0 mm) gradation is named the ¾ inch Nominal Maximum Aggregate Size gradation because the first sieve that retains more than 10 percent is the ½ inch sieve, and the next sieve larger is the ¾ inch sieve, refer to **Table 6.5 Master Range Table for Stone Mix Asphalt**.

A CDOT study (1) found less thermal segregation in the top lift when Grading SX mixes were used. HMA Grading SX can also be used where layers are very thin or where the pavement must taper into an existing pavement. A study from Auburn University (2) found little difference in the stability or rutting of ¾ inch and ½ inch NMA mixes. CDOT cost data for 2005 showed a slight increase in the cost per ton of Grading SX mixes as compared to Grading S mixes with the same bid quantities.

HMA with a 1-inch NMA, Grading SG, should not be used in the surface layer. Although Grading SG mixes have been used in specialized situations, they are not currently used or accepted on a regular basis for pavement mixes. CDOT has found that the production and placement of Grading SG mixes are prone to segregation and the use should be discouraged.

**Table 6.5 Master Range Table for Stone Matrix Asphalt**

Sieve Size	Percent by Weight Passing Square Mesh Sieves			
	#4 (4.75 mm) Nominal Maximum	¾" (9.5 mm) Nominal Maximum	½" (12.5 mm) Nominal Maximum	¾" (19.0 mm) Nominal Maximum
1 " (25 mm)	-	-	-	100
¾" (19.0 mm)	-	-	100	90-100
½" (12.5 mm)	100	100	90-100	50-88
¾" (9.5 mm)	100	90-100	50-80	25-60
#4 (4.75 mm)	90-100	26-60	20-35	20-28
#8 (2.36 mm)	28-65	20-28	16-24	16-24
#16 (1.18mm)	22-36	-	-	-
#30 (600 µm)	18-28	12-18	12-18	12-18
#50 (300 µm)	15-22	10-15	-	-
#100 (150 µm)	-	-	-	-
#200 (75 µm)	12-15	8-12	8-11	8-11

**For structural overlays, the minimum allowed layer thickness will be 2 inches.** For functional overlays used in preventive maintenance or other treatments, thinner lifts are allowed.

**Table 6.6 HMA Grading Size and Location Application** and **Table 6.7 HMA Grading Size and Layer Thickness** gives guidance for mix selection and recommended layer thicknesses for various layers and nominal maximum aggregate sizes.

**Table 6.6 HMA Grading Size and Location Application**

CDOT HMA Grade	Nominal Maximum Aggregate Size (NMAS)	Application
SF	No. 4 sieve	Leveling course, rut filling, scratch course, etc.
ST	$\frac{3}{8}$ inch	Thin lifts and patching
SX	$\frac{1}{2}$ inch	Top layer (preferred)
S	$\frac{3}{4}$ inch	Top layer, layers below the surface, patching
SG	1 inch	Layers below the surface, deep patching

**Table 6.7 HMA Grading Size and Layer Thickness**

CDOT HMA Grade	Nominal Maximum Aggregate Size (NMAS)	Overlay Layer Thickness (inches)	
		Minimum	Maximum
SX	$\frac{1}{2}$ inch	1.50	3.00
S	$\frac{3}{4}$ inch	2.25	3.50
SG	1 inch	3.00	4.00
SF	No. 4 sieve	0.75 <sup>1</sup>	1.50
ST	$\frac{3}{8}$ inch	1.125	2.50

**Note:** <sup>1</sup> Layers of SF mixes may go below 1 inch as needed to taper thin lift to site conditioning (i.e. rut filling).

### 6.12.2 Selection of SuperPave™ Gyratory Design

To choose the appropriate number of revolutions of a SuperPave™ gyratory asphalt mix design on a particular project, determining the design 18k ESALs and the high temperature environment for the project is necessary. The following steps should be followed to determine the proper SuperPave™ gyratory design revolutions for a given project:

**Step 1. Determine 18k ESALs:** In order to obtain the correct SuperPave™ gyratory compaction effort (revolutions), the 18k ESALs **must** be a 20-year cumulative 18k ESAL of the

design lane in one direction. The compaction effort simulates the construction compaction roller to obtain the correct voids properties to resist the intended traffic in the design lane. The department’s traffic analysis unit of the Division of Transportation Development (DTD) automatically provides an ESAL calculator. One must use a 20-year design, appropriate number of lanes, and a specified flexible pavement. Even a 10-year asphalt overlay must use a 20-year cumulative 18k ESAL number for the design lane.

**Step 2. Reliability for the 7-Day Average Maximum Air Temperature:** The next decision is to determine the type of project being designed. For new construction or reconstruction, asphalt cement with 98 percent reliability for low and high temperature properties is recommended. For overlays, asphalt cement with 98 percent reliability for high temperature properties (rutting resistance) and 50 percent reliability for low temperature properties (cracking resistance) is recommended. Asphalt cements with lower than 98 percent reliability against rut resistance should not be specified. In the SuperPave™ system, anything between 50 percent and 98 percent reliability is considered 50 percent reliability for the purpose of binder selection. The low temperatures are specified at a lower reliability for overlays because of reflection cracking.

**Step 3. Determine Weather Data for the Project:** Obtain the highest 7-day average maximum air temperature, based on weather data in the project area from the computer program LTPPBind 3.1 (beta). Refer to **Section 6.12.3 Binder Selection** for a further explanation of LTPPBind 3.1 (beta). From the appropriate high temperature, find the environmental category for the project from **Table 6.8 Environmental Categories**. The Environmental Categories are from CDOT Pavement Management Program’s Environmental Zones. The Environmental Zones (Categories) are one of four pavement groupings used to group pavements into families that have similar characteristics.

**Table 6.8 Environmental Categories**

Highest 7-Day Average Air Temperature	High Temperature Category
> 97°F (> 36°C)	Hot (southeast and west)
> 88° to 97°F (> 31° to 36°C)	Moderate (Denver, plains and west)
81° to 88°F (27° to 31°C)	Cool (mountains)
< 81°F (< 27°C)	Very Cool (high mountains)

**Step 4. Selection of the Number of Design Gyration (N<sub>DES</sub>):** Select the N<sub>DES</sub> from **Table 6.9 Recommended SuperPave™ Gyrotory Design Revolution (N<sub>DES</sub>)**. For example, Table 6.7 shows that for 5,000,000 18k ESALs and a high temperature category of “Cool”, the design revolutions should be 75.

**Table 6.9 Recommended SuperPave™ Gyratory Design Revolution (N<sub>DES</sub>)**

CDOT Pavement Management System Traffic Classification (20 Year Design ESAL)	20 Year Total 18k ESAL in the Design Lane	High Temperature Category			
		Very Cool	Cool	Moderate	Hot
Low	< 100,000	50	50	50	50
	100,000 to < 300,000	50	75	75	75
Medium	300,000 to < 1,000,000	75	75	75	75
	1,000,000 to < 3,000,000	75	75	75	100
High	3,000,000 to < 10,000,000	75	75	100	100
Very High	10,000,000 to < 30,000,000	---	---	100	---
Very Very High	≥ 30,000,000	---	---	125	---

**Note:** Based on *Standard Practice for SuperPave™ Volumetric Design for Hot-Mix Asphalt (HMA)*, AASHTO Designation R 35-04.

### 6.12.3 Binder Selection

Performance graded (PG) binders have two numbers in their designation, such as PG 58-34. Both numbers describe the pavement temperatures in degrees Celsius at which the pavement must perform. The first number (58 in the example) is the high temperature standard grade for the pavement, and the second number (minus 34 in the example) is the low temperature standard grade. PG 64-28 (rubberized) or PG 76-28 (polymerized) or bituminous mixtures should only be placed directly on an existing pavement or milled surface that does not show signs of stripping or severe raveling. Cores should be taken to determine if stripping is present. Because of a limited number of tanks, Colorado local suppliers only have the capacity to supply a limited number of asphalt cement grades. **Table 6.10 Available Asphalt Cement Grades in Colorado** shows available grades that may be used and/or available on CDOT projects.

**Table 6.10 Available Asphalt Cement Grades in Colorado**

Polymer Modified	Unmodified
PG 76-28	
PG 70-28	PG 64-22
PG 64-28	PG 58-28
PG 58-34	

**Note:** The Region Materials Engineer may select a different gyratory design revolution for the lower HMA lifts.



LTPPBind 3.1 (beta) is a working version, dated September 15, 2005. Beta only means it is going through the 508-compliance process for the visually disabled users as required by the Federal Government. The computer program may be obtained from the following web address:

<http://www.fhwa.dot.gov/pavement/ltpb/ltpbind.cfm>

The program allows the user to select the asphalt binder grade for the appropriate project site conditions. In the *Preferences* under the *File* menu, use 12.5mm ( $\frac{1}{2}$  inch) for the CDOT target rut depth default value. The computer program has a help menu to assist the user and supporting technical information regarding the computation of design temperatures required for the selection of the asphalt binder grade as provided in the *Climatic Data* and *Algorithms* sections. The algorithms are broken down under four subsections. Each algorithm equation is shown and briefly explained for high temperature, low temperature, PG with depth, and PG grade bumping.

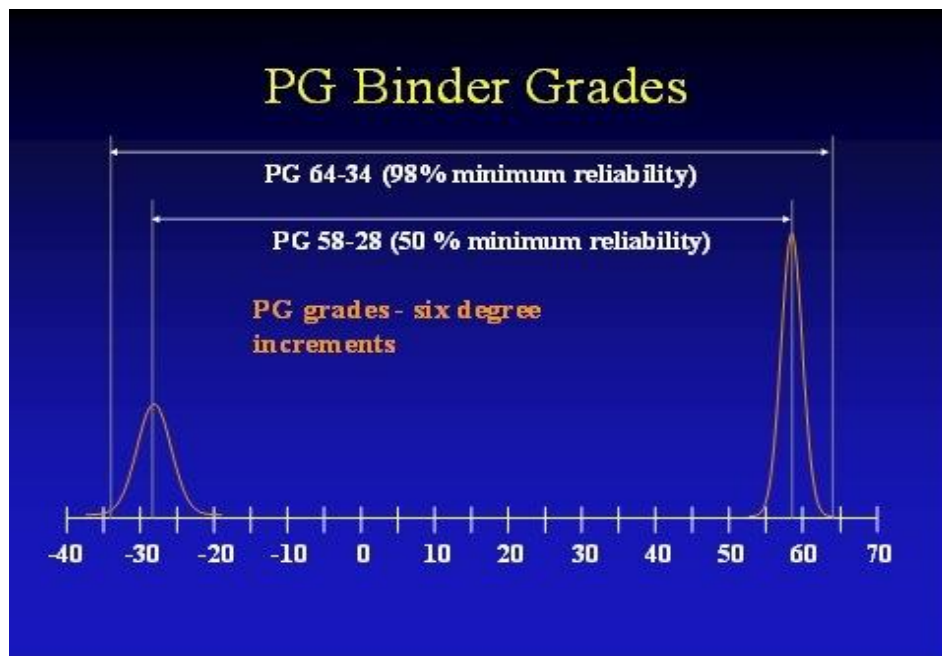
- **High Temperature:** The high temperature is based on a rutting damage model. The LTPP high temperature model was not used in this version since it provided very similar results to the SHRP Model at 98 percent reliability. Initially, the user must select a preference for a target rut depth, but they have the option to change the target rut depth. The default is 12.5 mm ( $\frac{1}{2}$  inches).
- **Low Temperature:** The low temperature is based on LTPP climatic data using air temperature, latitude, and depth to surface.
- **PG with Depth:** LTPP pavement temperature algorithms were used to adjust the PG for a depth into the pavement. The LTPP algorithms are empirical models developed from seasonal monitoring data.
- **PG Grade Bumping:** PG grade bumping was based on the rutting damage concept for high temperature adjustments. Adjustments were developed as the difference between PG for standard traffic conditions (ESAL of 3 million and high speed) and site conditions. 187 sites throughout the U.S. for five target rut depths were analyzed. The PG adjustments were then averaged by various ESAL ranges, traffic speeds, and Base PG.

The following steps should be followed to determine the proper SuperPave™ asphalt cement grade for a given project:

**Step 1. Determine Proper Reliability to Satisfy Pavement Temperature Property Requirements:** The first step is to determine what type of project is being designed.

- For new construction or reconstruction, asphalt cement with 98 percent reliability for both low and high pavement temperature properties is recommended.
- For overlays, asphalt cement with 98 percent reliability for high pavement temperature properties (rutting resistance) and 50 percent reliability for low pavement temperature properties (cracking resistance) are recommended.

- Asphalt cements with lower than 98 percent reliability against rut resistance should not be specified.
- In the SuperPave™ system, anything between 50 and 98 percent reliability is considered 50 percent reliability for the purpose of binder selection.
- The low pavement temperatures are specified at a lower reliability for overlays because of reflection cracking.
- Refer to **Figure 6.33 PG Binder Grades** for a graphical representation of reliability.



**Figure 6.32 PG Binder Grades**

**Step 2. Determine Weather Data for the Project:** Obtain the SuperPave™ recommended asphalt cement grade, based on weather data and traffic in the project area. Recommendations on 98 percent reliability high and low pavement temperature weather stations are found in **Figure 6.33 Colorado 98 Percent Reliability LTPP High Pavement Temperature Weather Station Models** and **Figure 6.34 Colorado 98 Percent Reliability LTPP Low Pavement Temperature Weather Station Models**, neither of which accounts for grade bumping. The program also calculates the reliability of various asphalt cements for a given location. This source will yield the 98 and 50 percent reliability asphalt cement for a project area with a free flowing traffic condition, which is described in Step 3. For example, when the recommendations call for a PG 58-22 for a given project, due to the available binder grades in Colorado, a PG 64-22 would be specified. This selection provides for rut resistance while preserving the same level of resistance to cracking. Because of the danger of rutting, in no case should the

recommended high temperature requirements be lowered based on availability. Each RME has a copy of this program.

**Step 3. Select Location of Roadway:** Place the cross hair on the location of area of interest in the weather data program LTPP Bind. The program selects five weather stations surrounding the area of interest. The designer has the option to use any number of weather stations representative of the climate at the area of interest.

**Step 4. Adjust HMA Performance Grade Binder to Meet Layer Depth, Traffic Flow and Loading Requirements:** SuperPave™ high temperature reliability factors are based on historical weather data and algorithms to predict pavement temperature. At a depth layer of 1 inch or more below the surface, high temperature recommendations are changed because of the depth and temperatures at that depth.

For pavements with multiple layers a lesser grade may be specified for lower layers based on the amount of material needed and other economical design decisions. In many cases, the requirements for lower layers might be obtained with an unmodified or more economical grade of asphalt cement. It is recommended that at least 10,000 tons of mix in the lower layer is needed before a separate asphalt cement is specified for the lower layer.

Adjustments can be made to the base high temperature binder through the '*PG Binder Selection*' screen. Adjustments to reliability, depth of layer, traffic loading, and traffic speed (fast and slow) will be required. These adjustments are called grade bumping. Additional grade bumping may be performed for stop and go traffic characteristics such as intersections. This extra grade bump may be applied, but is suggested the designer have prior regional experience on doing such.

### 6.12.3.1 Example

**Example:** A new roadway project will be constructed near Sugarloaf Reservoir. It will have two lanes per direction and a traffic characteristic of slow moving because it is a winding mountain road. Find the appropriate binder grade.  $N_{DES}$  for the surface layer is obtained in the same manner as the previous example and has a design revolution of 75.

**Step 1. Determine 18k ESAL:** Design Lane ESALs = 4,504,504 from DTD web site (20 year 18k ESAL in the design lane).

**Step 2. Use LTPP Software Database:** Use LTPPBind software database to obtain the data from the nearest weather station, Sugarloaf Reservoir. Appropriate weather stations can be determined from information on state, county, coordinates, location, and/or station ID. **Figure 6.35 LTPP Interface Form for Weather Station Selection (Version 3.1)** is where the cross hair is placed for the new roadway project. **Figure 6.36 LTPP Weather Station Output Data (Version 3.1)** shows the data at the weather station Sugarloaf Reservoir.

- Step 3. Select the Desired Weather Stations:** The LTPPBind software gives the option to select the weather stations that provide the best weather data at the project location (see the upper table in **Figure 6.37 LTPP PG Binder Selection at 98 Percent Reliability**). Check the first three weather stations. Uncheck the two weather stations furthest from the project, these stations are too far from the site and not representative of site conditions.
- Step 4. Select the Temperature Adjustments:** Because this is a principal arterial and a new construction project, 98 percent reliability is chosen with a layer depth of zero (0) for the surface layer (see **Figure 6.37 LTPP PG Binder Selection at 98 Percent Reliability**).
- Step 5. Select the Traffic Adjustments for High Temperature:** Select the appropriate traffic loading and traffic speed. The design lane ESALs are 4,504,504 and the traffic speed is slow. Grade bumping is automatic and is demonstrated by toggling in appropriate cells. The following data summarized in **Table 6.11 SuperPave™ Weather Data Summary** are obtained from Steps 1 through 5.
- Step 6. Select Final Binder:** **Table 6.9 Available Asphalt Cement Grades in Colorado** lists the binder grades available in Colorado. A PG 58-28 (unmodified) is available, but it does not meet the low temperature requirement. The lowest temperature binders available in Colorado can meet is -34° C. This is available in PG 58-34 (polymer modified). Therefore, at 98 percent reliability use PG 58-34.
- Step 7. Find the Temperature that Falls into the Environmental Category:** Use **Table 6.11 Environmental Categories (restated)** to obtain the highest 7-day average air temperature, 24.3°C. **Table 6.12 Environmental Categories (restated)** shows the temperature falls into the category ‘Very Cool’ (high mountains).
- Step 8 Select the Gyratory Design Revolution (N<sub>DES</sub>):** **Table 6.13 Recommended SuperPave™ Gyratory Design Revolution (N<sub>DES</sub>)** shows at 4,504,504 18k ESAL and a high temperature category of “Very Cool” the design revolutions should be 75.

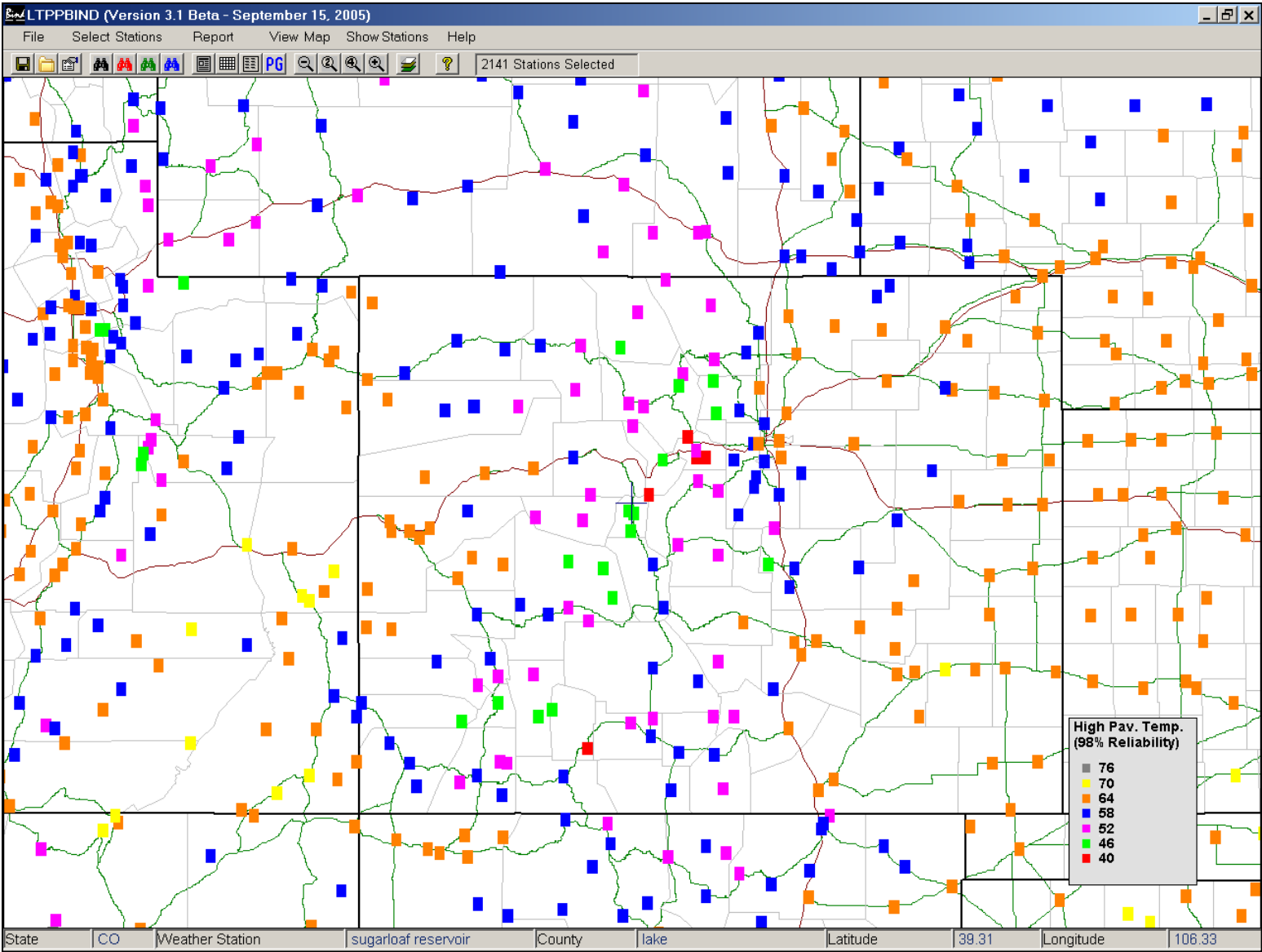


Figure 6.33 Colorado 98 Percent Reliability LTPP High Pavement Temperature Weather Station Models

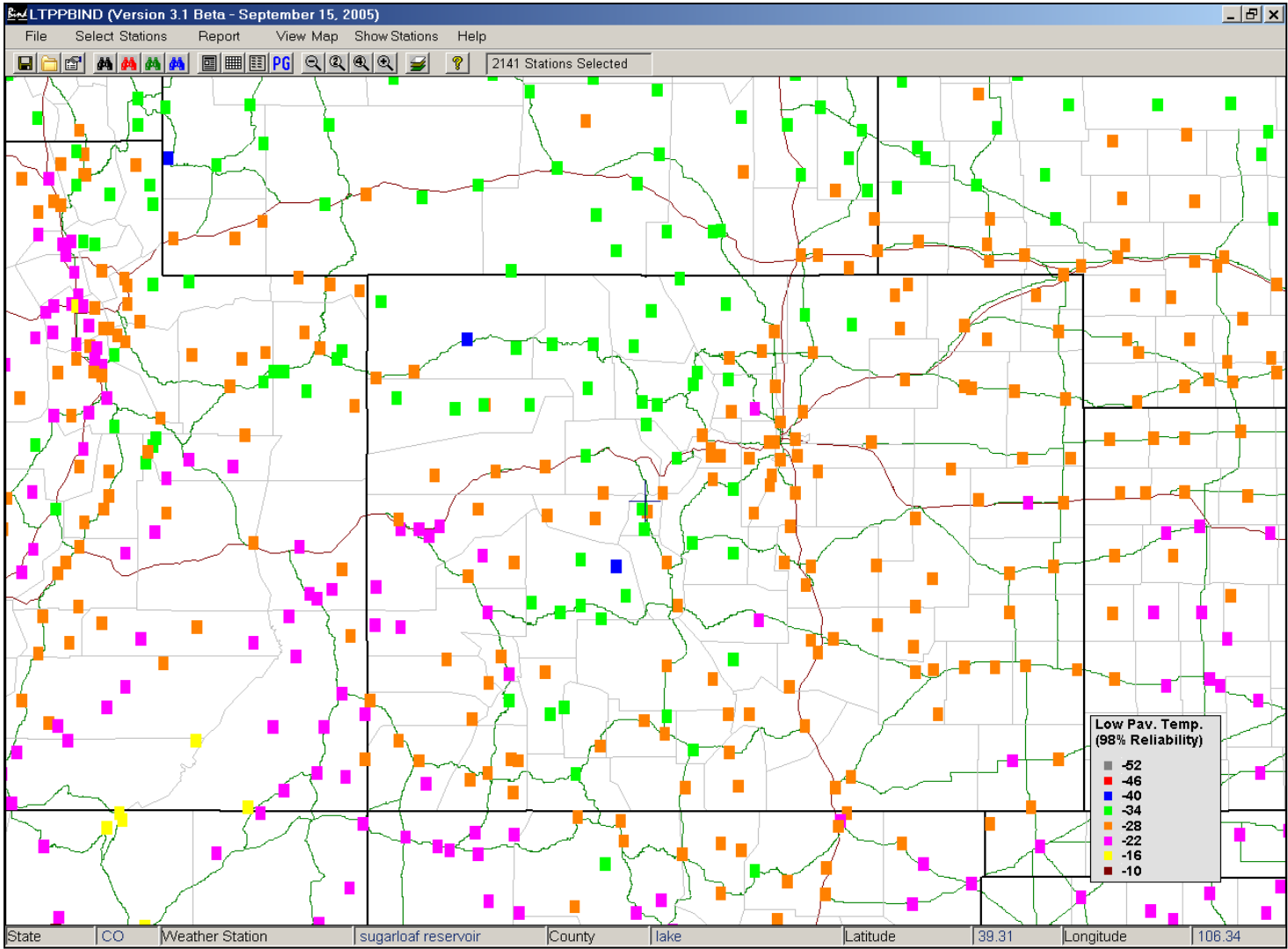


Figure 6.34 Colorado 98 Percent Reliability LTPP Low Pavement Temperature Weather Station Models

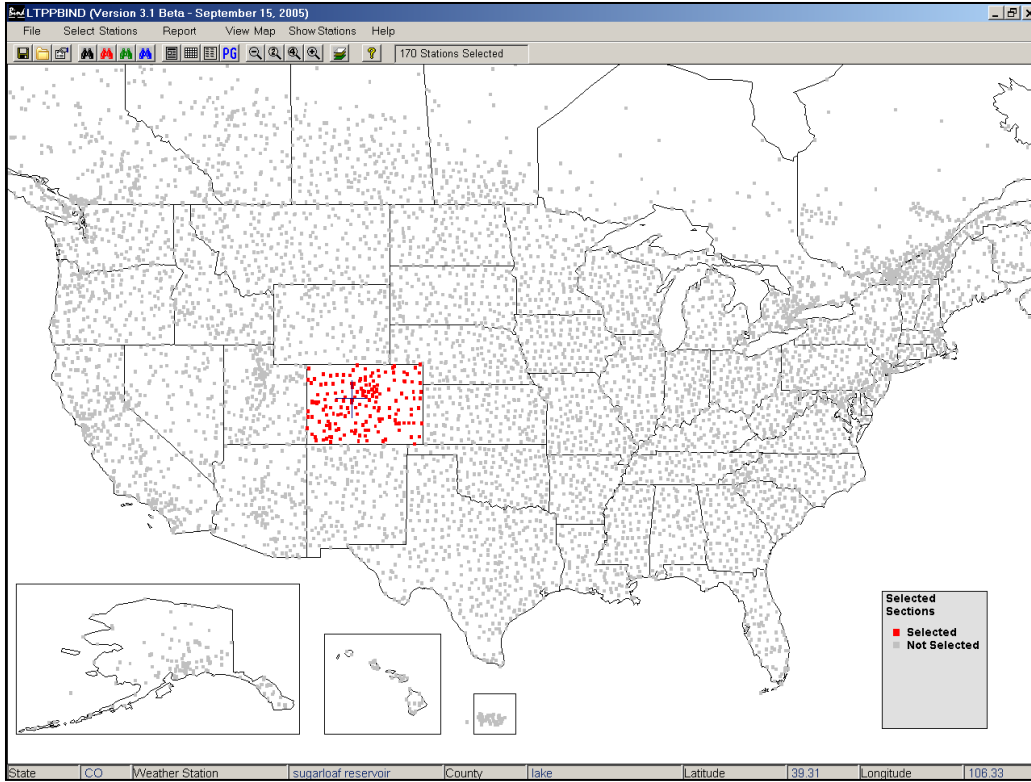


Figure 6.35 LTTP Interface Form for Weather Station Selection (Version 3.1)

**Report - 170 Selected Weather Stations**

State/Province: **CO**  
Weather Station: **SUGARLOAF RESERVOIR**

Station ID	<b>CO8064</b>	Latitude	<b>39.25</b>
County / District	<b>LAKE</b>	Longitude	<b>106.37</b>
Last Year Data Avail.	<b>1997</b>	Elevation, m	<b>2757</b>

Air Temperature	Mean	Std Dev	Min	Max	Years
High Air Temperature, Deg. C	<b>24.3</b>	<b>1.5</b>	<b>20.4</b>	<b>27.9</b>	<b>30</b>
Low Air Temperature, Deg. C	<b>-31.2</b>	<b>5.3</b>	<b>-43</b>	<b>-23.5</b>	<b>29</b>
Low Air Temp. Drop, Deg. C	<b>30.1</b>	<b>3.7</b>	<b>25.5</b>	<b>38</b>	<b>29</b>
Degree Days over 10 Deg. C	<b>1274</b>	<b>159</b>	<b>822</b>	<b>1539</b>	<b>30</b>

Pavement Temperature and PG	HIGH	LOW	High Rel	Low Rel
Pavement Temperature, C	<b>39.5</b>	<b>-21.4</b>	<b>50</b>	<b>50</b>
50% Reliability PG	<b>40</b>	<b>-22</b>	<b>76</b>	<b>55</b>
>50% Reliability PG	<b>40</b>	<b>-28</b>	<b>76</b>	<b>93</b>
=	<b>46</b>	<b>-28</b>	<b>98</b>	<b>93</b>
=	<b>46</b>	<b>-34</b>	<b>98</b>	<b>98</b>
=				
=				

? PG Chart PG Distribution Save Cancel

Figure 6.36 LTTP Weather Station Output Data (Version 3.1)

**PG Binder Selection**

Parameter	A=8 km	B=10 km	C=16 km	D=25 km	E=35 km
Station ID	✓ CO8064	✓ CO4885	✓ CO1660	✗ CO8501	✗ CO5507
Elevation, m	9046	9229	10516	8542	7269
Degree-Days >10 C	1274	1328	761	1442	2083
Low Air Temperature, C	-31.2	-30.5	-30.4	-31.4	-29.9
Low Air Temp. Std Dev	5.3	3.5	2.9	4.3	3.4

**Input Data**

Latitude, Degree:       Lowest Yearly Air Temperature, C:

Yearly Degree-Days >10 Deg.C:       Low Air Temp. Standard Dev., Deg:

**Temperature Adjustments**

Base HT PG:

Desired Reliability, %:

Depth of Layer, mm:

**Traffic Adjustments for HT**

Traffic Loading	Traffic Speed	
	Fast	Slow
Up to 3 M. ESAL	0.0	2.8
3 to 10 M. ESAL	7.8	10.3
10 to 30 M. ESAL	13.2	15.5
Above 30 M. ESAL	15.5	17.7

PG Temperature	HIGH	LOW
PG Temp. at 50% Reliability	37.7	-21.1
PG Temp. at Desired Reliability	39.2	-28.3
Adjustments for Traffic	10.3	
Adjustments for Depth	0.0	0.0
Adjusted PG Temperature	49.5	-28.3
Selected PG Binder Grade	52	-34

?      Recalculate PG      Save      Cancel

**Figure 6.37 LTPP Binder Selection at 98 Percent Reliability**

**Table 6.11 SuperPave™ Weather Data Summary**

98 Percent Reliability	
Depth of Layer	0 mm
Traffic Loading and Speed Adjustment	10.3°C (slow)
PG Binder Grade	52      -34



**Table 6.12 Environmental Categories (restated)**

Highest 7-Day Average Air Temperature	High Temperature Category
> 97°F (> 36°C)	Hot (southeast and west)
> 88° to 97°F (> 31° to 36°C)	Moderate (Denver, plains and west)
81° to 88°F (27° to 31°C)	Cool (mountains)
< 81°F (< 27°C)	Very Cool (high mountains)

**Table 6.13 Recommended SuperPave™ Gyrotory Design Revolution (N<sub>DES</sub>) (restated)**

CDOT Pavement Management System Traffic Classification (20 Year Design ESAL)	20 Year Total 18k ESAL in the Design Lane	High Temperature Category			
		Very Cool	Cool	Moderate	Hot
Low	< 100,000	50	50	50	50
	100,000 to < 300,000	50	75	75	75
Medium	300,000 to < 1,000,000	75	75	75	75
	1,000,000 to < 3,000,000	75	75	75	100
High	3,000,000 to < 10,000,000	75	75	100	100
Very High	10,000,000 to < 30,000,000	---	---	100	---
Very Very High	≥ 30,000,000	---	---	125	---

**Note:** Based on *Standard Practice for SuperPave™ Volumetric Design for Hot-Mix Asphalt (HMA)*, AASHTO Designation R 35-04.

#### 6.12.4 Asphalt Binder Characterization for M-E Design

For flexible pavement design using M-E Design, the viscosity of the asphalt binder is a critical input parameter to incorporate the viscoelastic response (i.e. time-temperature dependency) of asphalt concrete mixtures. The asphalt binder viscosity is used in the calculations of dynamic modulus values of asphalt mixtures for aged and unaged conditions. The key input parameters that define the viscosity temperature relationship are the slope (A) and intercept (VTS) resulting from a regression of the asphalt binder viscosity values measured or estimated at different temperatures.

Laboratory testing of asphalt binders is required to develop viscosity temperature relationships at the Level 1 input hierarchy. For performance grade binders, the asphalt binder viscosity values

can be estimated from the dynamic shear rheometer test data conducted in accordance with AASHTO T 315, Determining the Rheological of Asphalt Binder Using a Dynamic Shear Rheometer (DSR). Alternatively, for conventional grade binders (i.e. penetration grade or viscosity grade), the asphalt binder viscosity values can be obtained from a series of conventional tests, including absolute and kinematic viscosities, specific gravity, softening point, and penetrations. At the hierarchical input Level 3, the default values of A-VTS parameters included in M-E Design are based on the asphalt binder grade selection.

For flexible pavement rehabilitation designs, the age-hardened binder properties can be determined using asphalt binder extracted from field cores of asphalt pavement layers that will remain in place after rehabilitation. For projects where asphalt is not extracted, historical information and data may be used. **Table 6.14 Recommended Sources of Inputs for Asphalt Binder Characterization** presents recommended sources for asphalt binder characterization at different hierarchical input levels. Refer to the *AASHTO Intrim MEPDG Manual of Practice* and MEPDG Documentation for more information.

**Table 6.14 Recommended Sources of Inputs for Asphalt Binder Characterization**

Materials Category	Measured Property	Recommended Test Protocol	Hierarchical Input Level		
			3	2	1
Asphalt Binder	Asphalt binder complex shear modulus ( $G^*$ ) and phase angle ( $\delta$ ); at 3 test temperatures, <b>or</b>	AASHTO T 315			
	Conventional binder test data: Penetration, <b>or</b>	AASHTO T 49			
	Ring and ball softening point	AASHTO T 53		✓	✓
	Absolute viscosity	AASHTO T 202			
	Kinematic viscosity	AASHTO T 201			
	Specific gravity, <b>or</b>	AASHTO T 228			
	Brookfield viscosity	AASHTO T 316			
	Asphalt binder grade: PG grade, <b>or</b>	AASHTO M 320			
	Viscosity grade, <b>or</b>	AASHTO M 226	✓		
Penetration grade	AASHTO M 20				
Rolling thin film oven aging	AASHTO T 315		✓	✓	

## 6.13 Asphalt Mix Design Criteria

### 6.13.1 Fractured Face Criteria

CDOT's aggregate fractured face criteria requires the aggregate retained on the No. 4 sieve must have at least two mechanically induced fractured faces (2) (see **Table 6.15 Fracture Face Criteria**).

**Table 6.15 Fractured Face Criteria**

<b>Percent Fractured Faces of 20 Year 18k ESAL in Design Lane</b>	<b>SF</b>	<b>ST</b>	<b>SX</b>	<b>S</b>	<b>SG</b>	<b>SMA</b>
Non-Interstate Highways or Pavements with < 10,000,000 Total 18K ESALs	60%	60%	60%	60%	90%	90%
Interstate Highways or Pavements with > 10,000,000 Total 18K ESALs	70%	70%	70%	70%	90%	90%

**6.13.2 Air Void Criteria**

A design air void range of 3.5 to 4.5 percent with a target of 4.0 percent will be used on all SX, S, SG, and ST mixes. A design air void range of 4.0 to 5.0 percent with a target of 4.5 percent will be used on all SF Mixes. Refer to **Table 6.16 Minimum VMA Requirements** for design air voids and minimum VMA requirements and criteria for voids at  $N_{DES}$ . The air void criteria will be applied to the approved design mix. The nominal maximum size is defined as one size larger than the first sieve to retain more than 10 percent. The designer should interpolate specified VMA values for design air voids between those listed in the table. All mix designs shall be run with a gyratory compactor angle of 1.25 degrees. CDOT Form #43 will establish construction targets for asphalt cement and all mix properties at air voids up to 1.0 percent below the mix design optimum. The designer should extrapolate VMA values for production (CDOT Form 43) air voids beyond those listed in **Table 6.16 Minimum VMA Requirements**.

**Table 6.16 Minimum VMA Requirements**

Nominal Maximum Size <sup>1</sup> mm (in)	Design Air Voids <sup>2,3</sup>			
	3.5%	4.0%	4.5%	5.0%
37.5 (1½")	11.6	11.7	11.8	N/A
25.0 (1")	12.6	12.7	12.8	
19.0 (¾")	13.6	13.7	13.8	
12.5 (½")	14.6	14.7	14.8	
9.5 (⅜")	15.6	15.7	15.8	16.9

**Note:**  
<sup>1</sup> The nominal maximum size defined as one size larger than the first sieve to retain more than 10%.  
<sup>2</sup> Interpolate specified VMA values for design air voids between those listed.  
<sup>3</sup> Extrapolate specified VMA values for production air voids between those listed.

### 6.13.3 Criteria for Stability

Criteria for stability and voids filled with asphalt (VFA) are shown in **Table 6.17 Criteria for Stability and Voids Filled with Asphalt (VFA)**.

**Table 6.17 Criteria for Stability and Voids Filled with Asphalt (VFA)**

SuperPave™ Gyrotory Revolutions (N <sub>DES</sub> )	Hveem Minimum Stability*	VFA (%)
125	30	65-75
100	30	65-75
75	28	65-80
50	**	70-80

**Note:** 1-inch mix (CDOT Grade SG) has no stability requirements.  
\* Hveem Stability criteria for mix design approval and for field verification.  
\*\* Hveem Stability is not a criterion for mixes with a N<sub>DES</sub> of 50.

### 6.13.4 Moisture Damage Criteria

Moisture damage criteria are shown in **Table 6.18 Moisture Damage Criteria**.

**Table 6.18 Moisture Damage Criteria**

Characteristic	Value
Minimum dry split tensile strength, (psi)	30
Minimum tensile strength ratio, CP-L 5109, (%)	80
Minimum tensile strength ratio, CP-L 5109, SMA, (%)	70

### 6.13.5 Warm Mix Asphalt (WMA)

Warm mix asphalt provides a means to reduce the carbon footprint of both highway agencies and the asphalt industry. Warm Mix Asphalt (WMA) refers to a group of technologies that allows asphalt mixtures to be produced and placed at lower temperatures. Through the application of chemical and/or mechanical means, liquid asphalt is made more workable at reduced temperatures. This reduces the amount of fuel used to produce the mixtures as well as the emissions originating from production and placement. The different process and products to manufacture WMA are broken into three categories: chemical additives, plant foaming devices, and material foaming processes.

**Chemical Additives:** Chemical additives can be divided into two classes: organic (long-chain waxes) and surfactants. Long-chain waxes lower the viscosity of the asphalt binder at working temperatures and then harden at service temperatures. Surfactants lower the surface tension of the liquid binder, improving its ability to coat and compact at lower temperatures.

**Plant Foaming:** Plant foaming devices are systems that can be mounted on batch and continuous plants. These devices inject a small amount of water (1-3 percent by weight) into the asphalt binder before it is introduced to the aggregate. As water comes into contact with the hot asphalt binder in an expansion chamber, it vaporizes and expands to about 1,700 times its liquid binder and allows more thorough coating of the aggregate particles. Production temperatures for mechanical foaming systems range from 250-275 °F.

**Material Foaming:** Material foaming processes use either moist sand or zeolite (a water bearing material) to foam the asphalt binder as it is mixed. In this process, hot asphalt and coarse aggregate are combined before a sand fraction containing a carefully controlled amount of moisture is added, causing expansion of the binder. A coating additive is employed in the wet sand method. For zeolite, the mineral contains a small amount of water in its crystalline structure that is released at high temperatures. The wet sand method requires plant modifications as well as the use of an additive, while the zeolite method requires plant modifications to introduce the material and zeolite (9).

Benefits of using WMA include the following:

- **Low Temperature Paving:** WMA may be placed at lower temperatures than traditional HMA. The additives used allow for better aggregate coating and workability. Reduction in cure time has been observed, thus cooler pavement temperatures allows traffic onto the new mat sooner.
- **Energy and Fuel Savings:** Reduction in production temperature results in reduction in energy consumption. Traditional HMA requires temperatures in excess of 300°F at the production plant, while WMA production may require temperatures in the low 200's°F.
- **Environmental Benefits:** Decreased production temperature allows for better air quality and reduced emissions at the plant and paver. Thus, worker exposure to fumes and odors and general atmospheric emissions are reduced. (10)

- **Paving Time:** WMA has an extended paving window by allowing the contractor to work at night, extending the paving season, and paving during sudden weather changes.
- **Haul Distance Improvements:** The lower temperatures associated with WMA allows the contractor to haul materials over a longer distance with less heat loss to the mix.

## 6.14 Effective Binder Content (By Volume)

Effective binder content ( $P_{be}$ ) is the amount of binder not absorbed by the aggregate, i.e. the amount of binder that effectively forms a bonding film on the aggregate surfaces. Effective binder content is what the service performance is based on and is calculated based on the aggregate bulk specific gravity ( $G_{sb}$ ) and the aggregate effective specific gravity ( $G_{se}$ ). The higher the aggregate absorption, the greater the difference between  $G_{se}$  and  $G_{sb}$ . The effective binder content by volume is the effective binder content ( $P_{be}$ ) times the ratio of the bulk specific gravity of the mix ( $G_{mm}$ ) and the specific gravity of the binder ( $G_b$ ). The formula is:

$$P_{be} \text{ (by volume)} = P_{be} * (G_{mm} / G_b)$$

Where

$P_{be}$  = effective asphalt content, percent by total weight of mixture

$G_{mm}$  = bulk specific gravity of the mix

$G_b$  = specific gravity of asphalt (usually 1.010)

$P_{be}$  is determined as follows:

$$P_{be} = P_b - (P_{ba}/100) * P_s$$

Where

$P_b$  = asphalt, percent by total weight of mixture

$P_{ba}$  = absorbed asphalt, percent by total weight of aggregate

$P_s$  = aggregate, percent by total weight of mixture

$P_{ba}$  is determined as follows:

$$P_{ba} = 100 ((G_{se} - G_{sb}) / (G_{sb} * G_{se})) * G_b$$

Where

$P_{ba}$  = absorbed asphalt, percent by total weight of aggregate

$G_{se}$  = effective specific gravity of aggregate

$G_{sb}$  = bulk specific gravity of aggregate

## 6.15 Rumble Strips

When Rumble Strips are installed, they shall be of the style and location as shown on CDOT's *Standard Plans, M & S Standards*, July 2012 Plan Sheet No. M-614-1, Rumble Strips.

## References

1. Gilbert, K., *Thermal Segregation*, 2005, CDOT Report No. CDOT-DTD-R-2005-16. <http://www.coloradodot.info/programs/research/pdfs/2005/thermalsegregation.pdf>.
2. Brown, E.R. and Bassett, C.E. *Effects of Maximum Aggregate Size on Rutting Potential and Other Properties of Asphalt-Aggregate Mixtures 1990*. Transportation Research Record 1259, TRB, National Research Council, Washington, D.C., 1990, pp. 107-119.
3. *HMA Pavement Mix Type Selection Guide*, FHWA Information Series 128, Federal Highway Administration, 400 7th Street S.W., Washington, DC 20590 and National Asphalt Pavement Association (NAPA), 5100 Forbes Blvd, Lanham, MD 20706, January 2001.
4. *Guide for Mechanistic-Empirical Design, Final Report*, NCHRP Project 1-37A, National Cooperative Highway Research Program, Transportation Research Board, National Research Council, Submitted by ARA, INC., ERES Consultants Division, Champaign, IL, March 2004.
5. Locander, Robert, *Analysis of Using Reclaimed Asphalt Pavement (RAP) as a Base Material*, Final Report, CDOT Report No. CDOT-2009-5, Colorado Department of Transportation, February 2009.
6. *Perpetual Pavements - A Synthesis*. Asphalt Pavement Alliance, 5100 Forbes Boulevard, Lanham, MD 20706 : Asphalt Pavement Alliance, 1/2002. Synthesis.
7. *Perpetual Bituminous Pavements*. Transportation Research Board (TRB). 2101 Constitution Avenue, NW, Washington, DC 20418 : Transportation Research Board, National Research Center, December 2001. Research Circular. TRB Committee on General Issues in Asphalt Technology (A2D05). Number 503, ISSN 0097-8515.
8. *AASHTO Mechanistic-Empirical Pavement Design Guide, A Manual of Practice, Interim Edition, July 2008*, American Association of State Highway and Transportation Officials, Washington, DC, 2008.
9. *Warm Mix Asphalt – We All Win!*, David E Newcomb, P.E., Ph.D., article on [www.co-asphalt.com](http://www.co-asphalt.com), March 2013.
10. *Warm Mix Asphalt: The Product and Its Availability*, Colorado Asphalt Pavement Association, Colorado asphalt Pavement Association, Denver, Colorado December 14, 2007.

## CHAPTER 7 PRINCIPLES OF DESIGN FOR RIGID PAVEMENT

### 7.1 Introduction

Rigid pavement design is based on the mechanistic-empirical (M-E) design concepts. The design procedure utilizes distress and smoothness prediction models developed and calibrated locally. The *MEPDG Design Guide* and the *AASHTO Interim MEPDG Manual of Practice* documents provide a detailed description of the M-E concepts for rigid pavement designs.

The design procedures described in this chapter can be used for design of new or reconstructed rigid pavements. There are no fundamental differences in the pavement design procedure for new alignment and reconstruction, however, the potential reuse of the materials from the existing pavement structure can be an important issue. Refer to **CHAPTER 9: Principles of Design for Pavement Rehabilitation with Rigid Overlay** when rehabilitation designs are necessary with rigid overlays or restoration projects.

**The design life for typical thin white topping should be 10 to 20 years for rehabilitations and 30 years for reconstruction.** An overview of the proven concrete pavement practices the Colorado Department of Transportation (CDOT) has implemented over the last several years is documented in the Final Research Report CDOT-DTD-R-2006-9, *Implementation of Proven PCCP Practices in Colorado*, dated April 2006 (8).

### 7.2 M-E Design Methodology for Rigid Pavement

The M-E Design of rigid pavements is an iterative process. The key steps in the design process include the following:

- **Select a Trial Design Strategy**
- **Select the Appropriate Performance Indicator Criteria for the Project:** Establish criteria for acceptable pavement performance (i.e. distress/IRI) at the end of the design period. CDOT criteria for acceptable performance is based on highway functional class and location. The performance criteria is established to reflect magnitudes of key pavement distresses and smoothness that trigger major rehabilitation or reconstruction.
- **Select the Appropriate Reliability Level for the Project:** The reliability is a factor of safety to account for inherent variations in construction, materials, traffic, climate, and other design inputs. The level of reliability selected should be based on the criticality of the design. CDOT criteria for desired reliability is based on highway functional class and location. The desired level of reliability is selected for each individual performance indicator.



- **Assemble All Inputs for the Pavement Trial Design Under Consideration:** Define subgrade support, PCC and other paving material properties, traffic loads, climate, pavement type, and design/construction features. The inputs required to run M-E Design may be obtained using one of three hierarchical levels of effort and need not be consistent for all of the inputs in a given design. A hierarchical level for a given input is selected based on the importance of the project and input, and the resources at the disposal of the designer.
- **Run the M-E Design Software:** The software calculates changes in layer properties, damage, key distresses, and IRI over the design life. The key steps include:
  - **Processing Input** to obtain monthly values of traffic inputs and seasonal variations of material and climatic inputs needed in the design evaluations for the entire design period.
  - **Computing Structural Responses** (stresses and strains) using finite element based pavement response models for each axle type and load and damage-calculation increment throughout the design period.
  - **Calculating Accumulated Distress** and/or damage at the end of each analysis period for the entire design period.
  - **Predicting Key Distresses** (JPCP transverse cracking and joint faulting) at the end of each analysis period throughout the design life using the calibrated mechanistic-empirical performance models.
  - **Predicting Smoothness** as a function of initial IRI, distresses that accumulate over time, and site factors at the end of each analysis increment.
- **Evaluate the Adequacy of the Trial Design:** The trial design is considered “adequate” if none of the predicted distresses/IRI exceed the performance indicator criteria at the design reliability level chosen for the project. If any of the criteria has been exceeded, determine how this deficiency can be remedied by altering material types and properties, layer thicknesses, or other design features.
- **Revise the Trial Design, as Needed:** If the trial design is deemed “inadequate”, revise the inputs/trial design and re-run the program. Iterate until all the performance criteria have been met. Once they have been met, the trial design becomes a feasible design alternative.

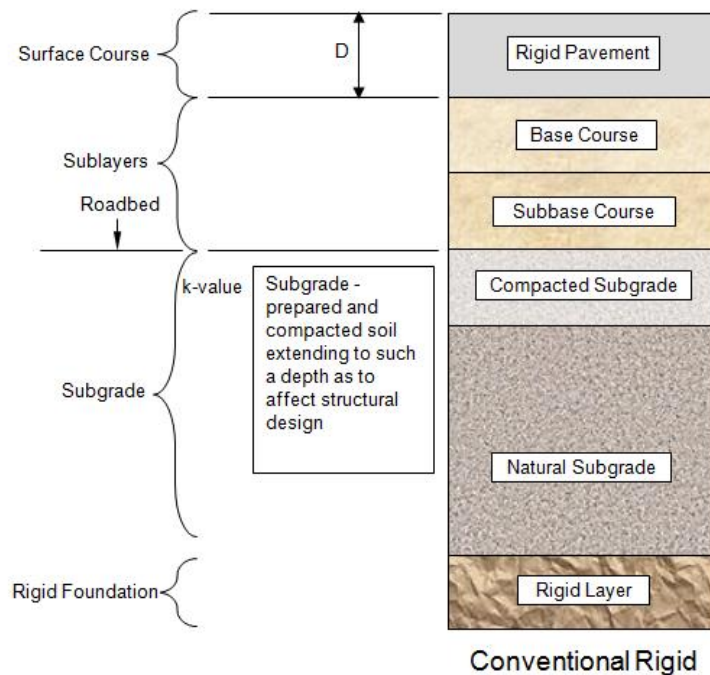
The design alternatives that satisfy all performance criteria are considered feasible from a structural and functional viewpoint and can be further considered for other evaluations, such as life cycle cost analysis. A detailed description of the design process is presented in the interim edition of the AASHTO *Mechanistic-Empirical Pavement Design Guide Manual of Practice*, AASHTO, 2008.

## 7.3 Select Trial Design Strategy

### 7.3.1 Rigid Pavement Layers

**Figure 7.1 Rigid Pavement Layers** shows a conventional rigid layered system. The PCC slab may be placed over base, subbase, or directly on a prepared subgrade. The base (layer directly beneath the PCC slab) and subbase layers (layer placed below the base layer) may include unbound aggregates, asphalt stabilized granular, cement stabilized, lean concrete, crushed concrete, lime stabilized, recycled asphalt pavement (RAP), and other materials. Base/subbase layers may be dense graded or permeable drainage layers.

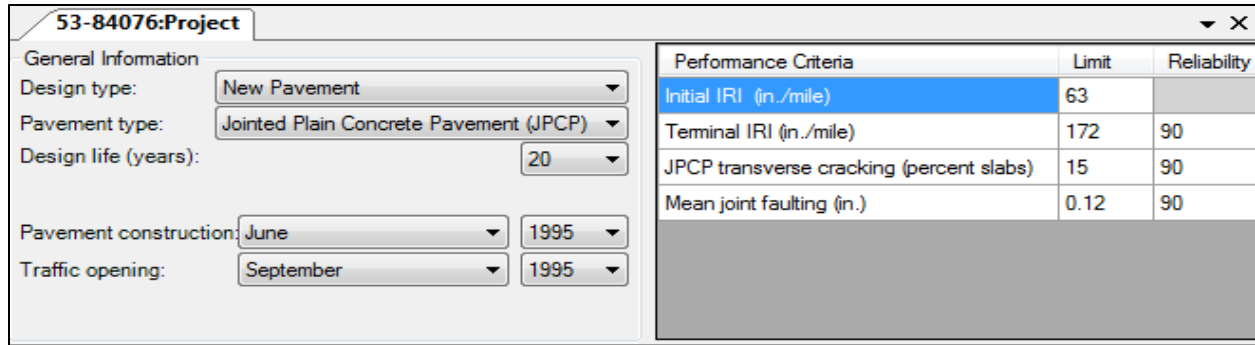
Transverse joints are closely spaced in JPCP, typically between 10 and 20 feet, to minimize transverse cracking from temperature and moisture gradients. JPCP may have tied or untied longitudinal joints.



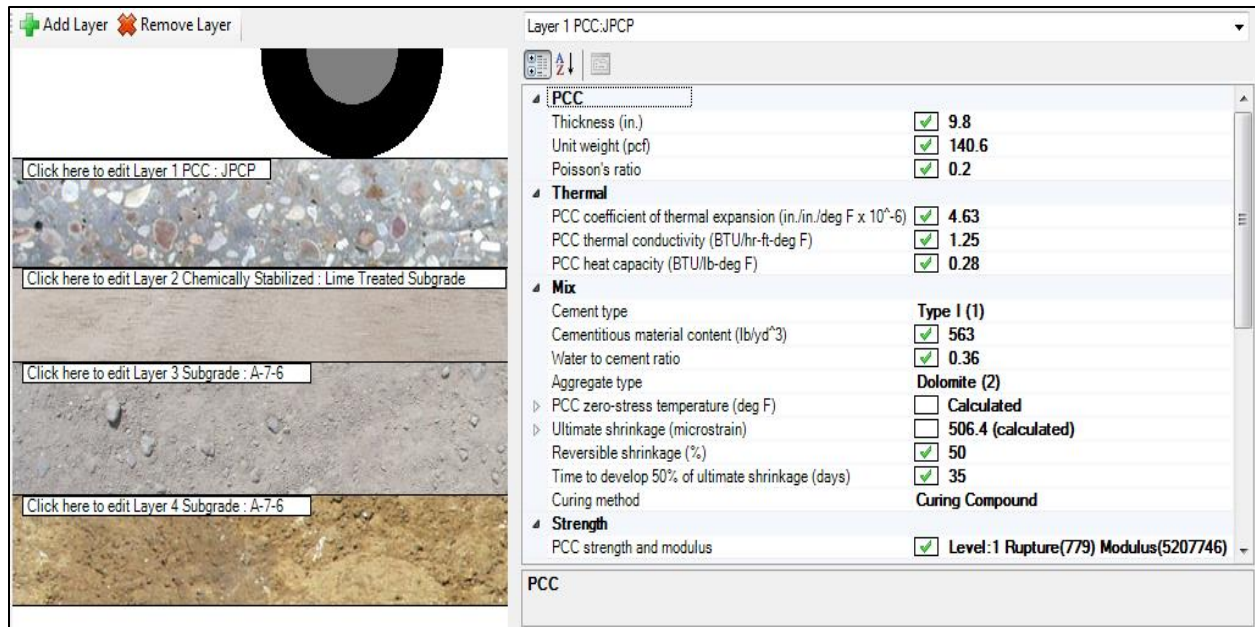
**Figure 7.1 Rigid Pavement Layers**

### 7.3.2 Establish Trial Design Structure

The designer must establish a trial design structure (combination of material types and thicknesses). This is done by first selecting the pavement type (see **Figure 7.2 M-E Design Screenshot Showing General Information Performance Criteria and Reliability**). M-E Design automatically provides the top layers of the selected pavement type. The designer may add or remove pavement structural layers and modify layer material type and thickness as appropriate. **Figure 7.3 M-E Design Screenshot of Rigid Pavement Trial Design Structure** shows the pavement layer configuration of a sample rigid pavement and trial design on the left and layer properties of the PCC slab on the right.



**Figure 7.2 M-E Design Screenshot Showing General Information, Performance Criteria, and Reliability**



**Figure 7.3 M-E Design Screenshot of Rigid Pavement Trial Design Structure**

## 7.4 Select the Appropriate Performance Indicator Criteria for the Project

**Table 2.4 Recommended Threshold Values of Performance Criteria for New Construction or Reconstruction Projects** presents recommended performance criteria for a rigid pavement design. The designer should enter the appropriate performance criteria based on functional class. An appropriate initial smoothness (IRI) is also required. **For new rigid pavements, the recommended initial IRI is 78 inches/mile.** This recommendation is for regular paving projects and projects with incentive-based smoothness acceptance; the designer may modify this value as needed. **Figure 7.3 M-E Design Screenshot Showing General Information, Performance Criteria, and Reliability** shows performance criteria for a sample rigid pavement trial design. The coefficients of performance prediction models considered in the design of a rigid pavement

are shown in **Figure 7.4 Performance Prediction Model Coefficients for Rigid Pavement Designs**.

Parameter	Value
<b>PCC Cracking</b>	
PCC Cracking C1	2
PCC Cracking C2	1.22
PCC Cracking C4	0.6
PCC Cracking C5	-2.05
PCC Reliability Cracking Standard Deviation	$\text{Pow}(57.08 * \text{CRACK}, 0.33) + 1.5$
<b>PCC Faulting</b>	
PCC Faulting C1	0.5104
PCC Faulting C2	0.00838
PCC Faulting C3	0.00147
PCC Faulting C4	0.008345
PCC Faulting C5	5999
PCC Faulting C6	0.8404
PCC Faulting C7	5.9293
PCC Faulting C8	400
PCC Reliability Faulting Standard Deviation	$0.0831 * \text{Pow}(\text{FAULT}, 0.3426) + 0.00521$
<b>PCC IRI-CRCP</b>	
<b>PCC IRI-JPCP</b>	
PCC IRI J1	0.8203
PCC IRI J2	0.4417
PCC IRI J3	1.4929
PCC IRI J4	25.24
PCC IRI JPCP Std.Dev.	5.4

**Figure 7.4 Performance Prediction Model Coefficients for Rigid Pavement Designs**

## 7.5 Select the Appropriate Reliability Level for the Project

**Table 2.3 Reliability (Risk)** presents recommended reliability levels for rigid pavement designs. The designer should select an appropriate reliability level based on highway functional class and location (see **Figure 7.3 M-E Design Screenshot Showing General Information, Performance Criteria, and Reliability**).

## 7.6 Assemble the M-E Design Inputs

### 7.6.1 General Information

#### 7.6.1.1 Design Period

**The design period for new rigid pavement construction and reconstruction is 20 or 30 years. It is recommended a 30-year design period be used for rigid pavements.** Selection of a design period other than 10, 20, or 30 years needs to be supported by a LCCA or other overriding considerations.

### 7.6.1.2 Project Timeline

The following inputs are required to specify the project timeline in the design (see **Figure 7.3 M-E Design Screenshot Showing General Information, Performance Criteria and Reliability**).

- Pavement construction month and year
- Traffic open month and year

The designer may select the most likely month and year when the PCC surface layer is scheduled to be placed, and when the pavement section is scheduled to be opened to traffic. Changes to the surface layer material properties due to time and environmental conditions are considered beginning from the construction date. **Due to warping, curling and other factors, if the actual month(s) of construction is unknown then the month of May should be used.**

### 7.6.1.3 Identifiers

Identifiers are helpful in documenting the project location and recordkeeping. M-E Design allows designers to enter site or project identification information, such as the location of the project (route signage, jurisdiction, etc.), identification numbers, beginning and ending milepost, direction of traffic, and date.

### 7.6.1.4 Traffic

Several inputs are required for characterizing traffic for M-E Design and are described in detail in **Section 3.1 Traffic**.

### 7.6.1.5 Climate

The climate input requirements for M-E design are described in detail in **Section 3.2 Climate**.

### 7.6.1.6 Pavement Layer Characterization

As shown in **Figure 7.1 Rigid Pavement Layers**, a typical rigid pavement design comprises of the following pavement layers: PCC, treated and/or unbound aggregate base, and subgrade. The inputs required by the M-E Design software for characterizing these layers are described in the following sections.

### 7.6.1.7 Portland Cement Concrete

The inputs required for PCC layer characterization are divided into three categories (see **Figure 7.5 PCC Layer and Material Properties in M-E Design**).

- **General and Thermal Properties:** This category includes layer thickness, Poisson's ratio, Coefficient of Thermal Expansion (CTE), thermal conductivity, and heat capacity.

- **PCC Mix-Related Properties:** This category includes cement type (Types I, II, or III), cement content, water/cement (or w/c) ratio, aggregate type, PCC zero-stress temperature, ultimate shrinkage at 40 percent relative humidity, reversible shrinkage, and curing method.
- **Strength and Stiffness Properties:** This category includes modulus of rupture (flexural strength), static modulus of elasticity, and/or compressive strength.

These inputs are required for predicting pavement responses to applied loads, long-term strength and elastic modulus, and effect of climate (temperature, moisture, and humidity) on PCC expansion and contraction. **Table 7.1 PCC Material Inputs and Recommendations for New JPCP Designs** presents recommendations for inputs used in PCC material characterization for a new JPCP design. Level 1 inputs of typical CDOT PCC mixtures may be used for Levels 2 and 3 (see **APPENDIX G**). Refer to **Table 2.6 Selection of Input Hierarchical Level** for selection of an appropriate hierarchical level for material inputs.

Layer 1 PCC:JPCP		
<b>PCC</b>		
Thickness (in.)	<input checked="" type="checkbox"/>	9.8
Unit weight (pcf)	<input checked="" type="checkbox"/>	140.6
Poisson's ratio	<input checked="" type="checkbox"/>	0.2
<b>Thermal</b>		
PCC coefficient of thermal expansion (in./in./deg F x 10 <sup>-6</sup> )	<input checked="" type="checkbox"/>	4.63
PCC thermal conductivity (BTU/hr-ft-deg F)	<input checked="" type="checkbox"/>	1.25
PCC heat capacity (BTU/lb-deg F)	<input checked="" type="checkbox"/>	0.28
<b>Mix</b>		
Cement type		Type I (1)
Cementitious material content (lb/yd <sup>3</sup> )	<input checked="" type="checkbox"/>	563
Water to cement ratio	<input checked="" type="checkbox"/>	0.36
Aggregate type		Dolomite (2)
PCC zero-stress temperature (deg F)	<input type="checkbox"/>	Calculated
Calculated internally?		True
User-specified PCC set temperature	<input type="checkbox"/>	
Ultimate shrinkage (microstrain)	<input type="checkbox"/>	506.4 (calculated)
Calculated internally?		True
User-specified PCC ultimate shrinkage	<input type="checkbox"/>	
Reversible shrinkage (%)	<input checked="" type="checkbox"/>	50
Time to develop 50% of ultimate shrinkage (days)	<input checked="" type="checkbox"/>	35
Curing method		Curing Compound
<b>Strength</b>		
PCC strength and modulus	<input checked="" type="checkbox"/>	Level:1 Rupture(779) Modulus(5207746)
<b>Identifiers</b>		
Display name/identifier		JPCP

Figure 7.5 PCC Layer and Material Properties in M-E Design

**Table 7.1 PCC Material Inputs and Recommendations for New JPCP Design**

Input Property (Strength)	Input Hierarchy		
	Level 1	Level 2	Level 3
<b>Elastic Modulus</b>	Mix specific values (ASTM C 469)		Use typical values from <b>APPENDIX G</b> . Select a mix that is closest to the project. Use a default ratio of 1.20 for 20-year / 28-day strength gain of elastic modulus and flexural strength.
<b>Flexural Strength</b>	Mix specific values (AASHTO T 97)		
<b>Compressive Strength</b>		Mix specific values (AASHTO T 22)	
<b>Unit Weight</b>	Mix specific values (AASHTO T 121)	<b>APPENDIX G</b>	
<b>Poisson's Ratio</b>	Mix specific values (ASTM C 469)	<b>APPENDIX G</b>	
<b>Coefficient of Thermal Expansion</b>	Mix specific values (AASHTO TP 60)	<b>APPENDIX G</b>	
<b>Surface Shortwave Absorptivity</b>	0.85		
<b>Thermal Conductivity</b>	1.25		
<b>Heat Capacity</b>	0.28		
<b>Cement Type</b>	Mix specific values	Typical values from the CDOT PCC input library. Select a mix that is closest to the project.	
<b>Cementitious Material Content</b>	Mix specific values	Typical values from the CDOT PCC input library. Select a mix that is closest to the project.	
<b>Water to Cement Ratio</b>	Mix specific values	Typical values from the CDOT PCC input library. Select a mix that is closest to the project.	
<b>Curing Method</b>	Select an appropriate method based on Section 412.14 of <i>CDOT Standard Specifications for Road and Bridge Construction</i>		
<b>PCC Zero-stress Temperature</b>	Internally calculated		
<b>Ultimate Shrinkage</b>	Internally calculated		
<b>Reversible Shrinkage</b>	50 percent		
<b>Time to Develop 50 Percent of Ultimate Shrinkage</b>	35 days		

**7.6.1.8 Asphalt Treated Base Characterization**

The asphalt treated base layer is modeled as a HMA layer. The material input requirements are identical to those of a conventional HMA layer as described in **Section 6.6.4.1 Asphalt Concrete**

**Characterization**, with an exception to indirect tensile strength and creep compliance values. For JPCP designs, no sub-layering is done within the asphalt treated base layer.

#### 7.6.1.9 Chemically Stabilized Base Characterization

Refer to **Section 5.4.1 Characterization of Treated Base in M-E Design** for treated base characterization.

#### 7.6.1.10 Unbound Material Layers and Subgrade Characterization

Refer to **Section 5.3.1 Unbound Layer Characterization in M-E Design** for unbound aggregate base layer characterization; and refer to **Section 4.4 Subgrade Characterization for M-E Design** for subgrade characterization.

### 7.6.2 JPCP Design Features

JPCP design features and construction practices influence long-term performance. The common design features considered in M-E Design (see **Figure 7.6 M-E Design Screenshot of JPCP Design Features**) include the following:

- Surface shortwave absorptivity: Refer to **Table 7.1 PCC Material Inputs and Recommendations for New JPCP Design**
- Joint spacing: Refer to **Section 7.10 Joint Spacing (L)**
- PCC-base contact friction: Refer to **Section 7.11 Slab/Base Friction**
- Permanent curl/warp effective temperature difference: Refer to **Section 7.12 Effective Temperature Differential (°F)**
- Widened slab: Refer to **Section 7.14 Lane Edge Support Condition**
- Dowel bars: Refer to **Section 7.13 Dowel Bars (Load Transfer Devices) and Tie Bars**
- Tied shoulders: Refer to **Section 7.13 Dowel Bars (Load Transfer Devices) and Tie Bars** and **Section 7.14 Lane Edge Support Condition**
- Base type and erodibility index: Refer to **Section 7.15 Base Erodibility**
- Sealant type: Refer to **Section 7.16 Sealant Type**

## 7.7 Run M-E Design

Designers should examine all inputs for accuracy and reasonableness prior to running M-E Design. The designer will run the software to obtain outputs required for evaluating whether the trial design is adequate. After a trial run has been successfully completed, M-E Design will generate a report in form of a PDF and/or Microsoft Excel file, see **Figure 7.7 Sample Rigid Pavement Design PDF Output Report**. The report contains the following information: inputs, reliability of design, materials and other properties, and predicted performance.

After the trial run is complete, the designer should examine all inputs and outputs for accuracy and reasonableness. The output report also includes the estimates of material properties and other



properties on a month-by-month basis over the entire design period in either tabular or graphical form. For a JPCP pavement trial design, the report provides the following:

- PCC flexural strength/modulus of rupture
- PCC elastic modulus
- Unbound material resilient modulus
- Subgrade k-value
- Cumulative trucks (FHWA Class 4 through 13) over the design period

Once again, the designer should examine the above mentioned parameters to assess their reasonableness before accepting a trial design as complete.

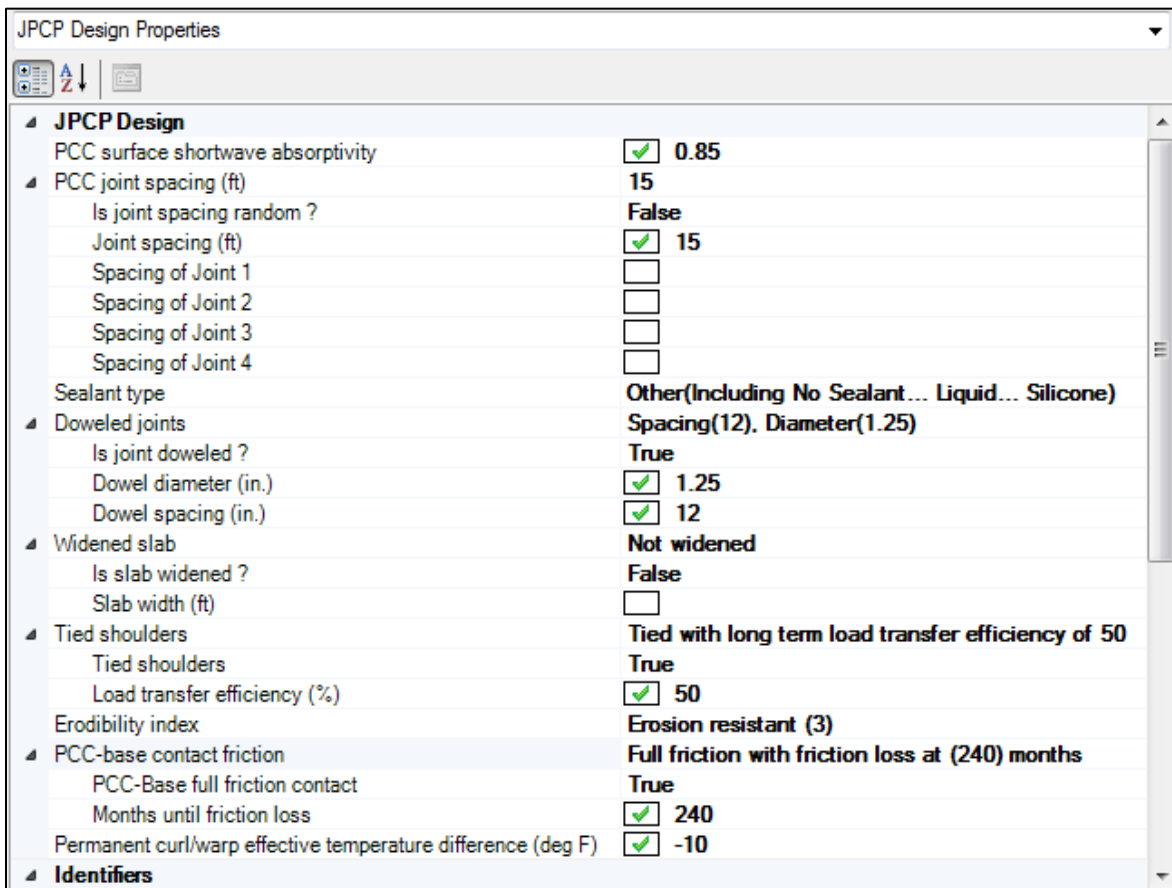


Figure 7.6 M-E Design Screenshot of JPCP Design Features

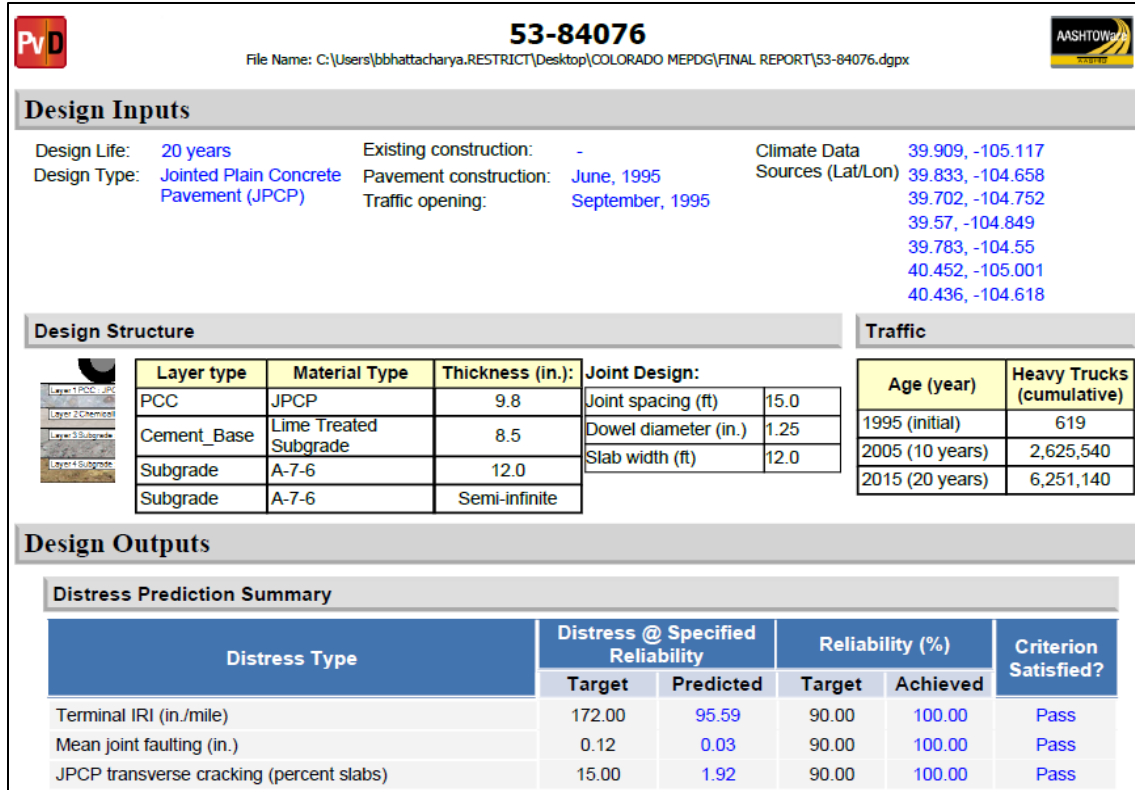


Figure 7.7 Sample Rigid Pavement Design PDF Output Report

## 7.8 Evaluate the Adequacy of the Trial Design

The output report of a rigid pavement trial design includes the monthly accumulation of the following key distress types at their mean values and chosen reliability for the entire design period:

- Joint Faulting:** This is an indicator of erosion of sublayers and the effectiveness of joint LTE. A critical value is reached when joint faulting results in excess roughness, which is unacceptable to drivers and difficult to remove by re-texturing.
  - The designer should examine the results to evaluate if the performance criteria for joint faulting are met at the desired reliability. If joint faulting has not been met, the trial design is deemed unacceptable and revised accordingly to produce a satisfactory design.
  - The output report also includes the monthly accumulation of the following secondary distress types and smoothness indicators at their mean values and chosen reliability values for the entire design period.
- Percent Slabs Cracked:** This is the mean predicted transverse cracks that form from fatigue damage at the top and bottom of the slab. Beyond a critical threshold, the rate of cracking accelerates and may require significant repairs and lane closures.

- **IRI:** This is a function of joint faulting and slab cracking along with climate and subgrade factors. A high IRI indicates unacceptable ride quality.
  - The designer should examine the results to evaluate if the performance criteria for percent slabs cracked and IRI meet the **minimum of 27 years** at the desired reliability.
  - If any of the criteria have not been met, the trial design is deemed unacceptable and revised accordingly to produce a satisfactory design.

Another important output is the reliability levels of each performance indicator at the end of the design period. If the reliability value predicted for the given performance indicator is greater than the target/desired value, the trial design passes for that indicator. If the reverse is true, then the trial design fails to provide the desired confidence and performance indicator will not reach the critical value during the pavement's design life. In such an event, the designer needs to alter the trial design to correct the problem.

The strategies for modifying a trial design are discussed in **Section 7.9 Modifying Trial Designs**. The designer can use a range of thicknesses to optimize the trial design and make it more acceptable. Additionally, the software allows the designer to perform a sensitivity analysis for key inputs. The results of the sensitivity analysis can be used to further optimize the trial design if modifying PCC thickness alone does not produce a feasible design alternative. A detail description of the thickness optimization procedure and sensitivity analysis is provided in the *Software HELP Manual*.

## 7.9 Modifying Trial Designs

An unsuccessful trial design may require revisions to ensure all performance criteria are satisfied. The trial design is revised by systematically modifying the design inputs. The design acceptance in M-E Design is distress-specific; in other words, the designer needs to first identify the performance indicator that failed to meet the performance targets and modify one or more design inputs that has a significant impact on a given performance indicator accordingly. The impact of design inputs on performance indicators is typically obtained by performing a sensitivity analysis.

The strategies to produce a satisfactory design by modifying design inputs can be broadly categorized into:

- Pavement layer considerations:
  - Increasing layer thickness
  - Modifying layer type and layer arrangement
  - Foundation improvements
- Pavement material improvements:
  - Use of higher quality materials
  - Material design modifications
  - Construction quality

Remember, when modifying the design inputs, the designer needs to be aware of input sensitivity to various distress types. Changing a single input to reduce one distress may result in an increase in another distress. **Table 7.2 Modifying Rigid Pavement Trial Designs** presents a summary of inputs that may be modified to optimize trial designs and produce a feasible design alternative.

**Table 7.2 Modifying Rigid Pavement Trial Designs**

Distress/IRI	Design Inputs that Impact
<b>Transverse Cracking</b>	<ul style="list-style-type: none"> <li>• Increase slab thickness</li> <li>• Increase PCC strength</li> <li>• Minimize permanent curl/warp through curing procedures that eliminate built-in temperature gradient</li> <li>• PCC tied shoulder (separate placement or monolithic placement).</li> <li>• Widened slab (1 to 2 feet)</li> <li>• Use PCC with a lower coefficient of thermal expansion</li> </ul>
<b>Joint Faulting</b>	<ul style="list-style-type: none"> <li>• Increase slab thickness</li> <li>• Reduce joint width over analysis period</li> <li>• Increase erosion resistance of base (specific recommendations for each type of base)</li> <li>• Minimize permanent curl/warp through curing procedures that eliminate built-in temperature gradient</li> <li>• PCC tied shoulder</li> <li>• Widened slab (1 to 2 feet)</li> </ul>
<b>IRI</b>	<ul style="list-style-type: none"> <li>• Require more stringent smoothness criteria and greater incentives</li> <li>• Increase slab thickness</li> <li>• Ensure PCC has proper entrained air content</li> <li>• Decrease joint spacing</li> <li>• Widen the traffic lane slab by 2 feet</li> <li>• Use a treated base (if nonstabilized dense graded aggregate was specified)</li> <li>• Increase diameter of dowels</li> </ul>

**Figure 7.8 Sensitivity of JPCP Transverse Cracking to PCC Thickness** through **Figure 7.19 Sensitivity of JPCP IRI to Design Reliability** presents sensitivity plots of a sample rigid pavement trial design showing the effects of key inputs, such as traffic volume, PCC thickness, PCC coefficient of thermal expansion, and design reliability on key distresses. **Note:** The plots do not cover the effects of all key factors on rigid pavement performance; other significant factors are not shown herein.

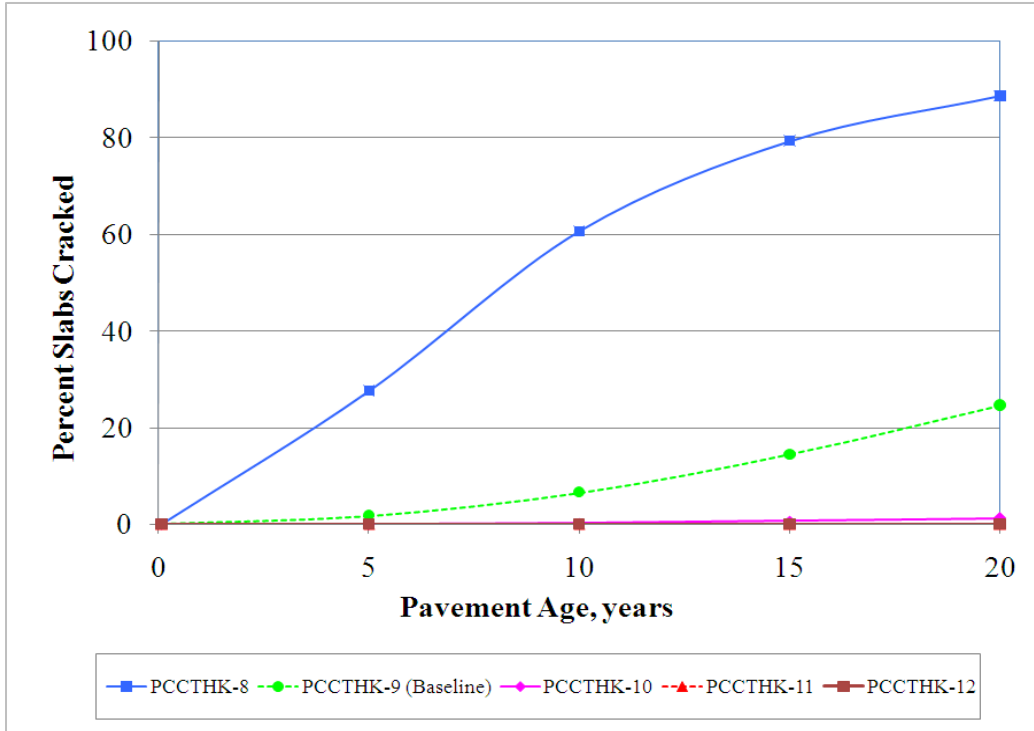


Figure 7.8 Sensitivity of JPCP Transverse Cracking to PCC Thickness

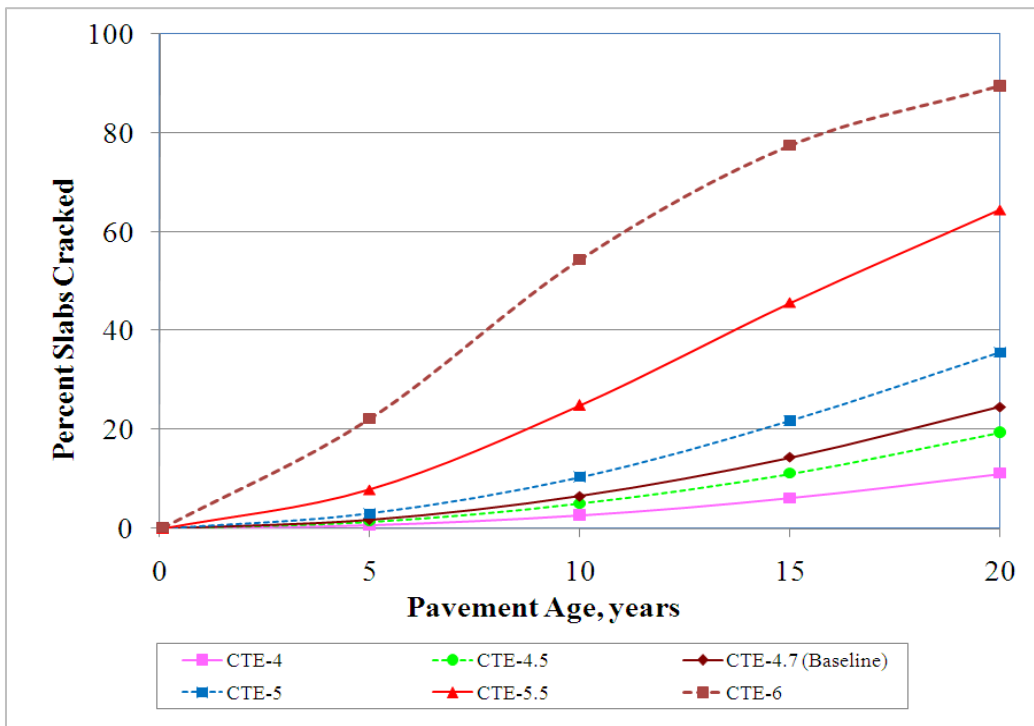


Figure 7.9 Sensitivity of JPCP Transverse Cracking to PCC Coefficient of Thermal Expansion

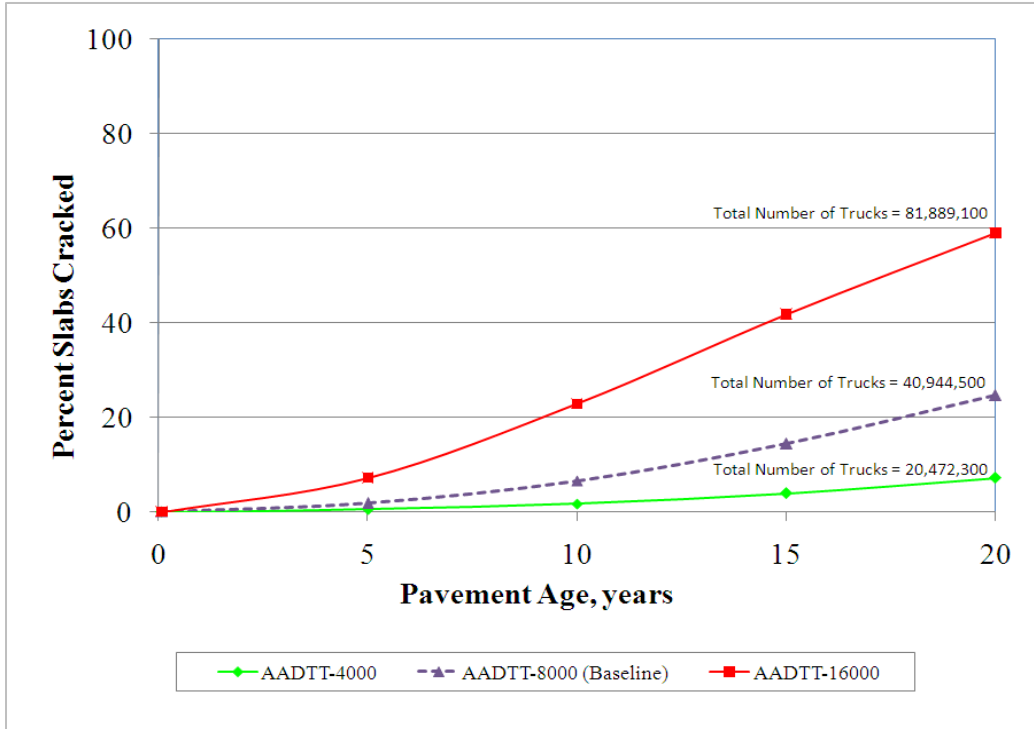


Figure 7.10 Sensitivity of JPCP Transverse Cracking to Traffic Volume

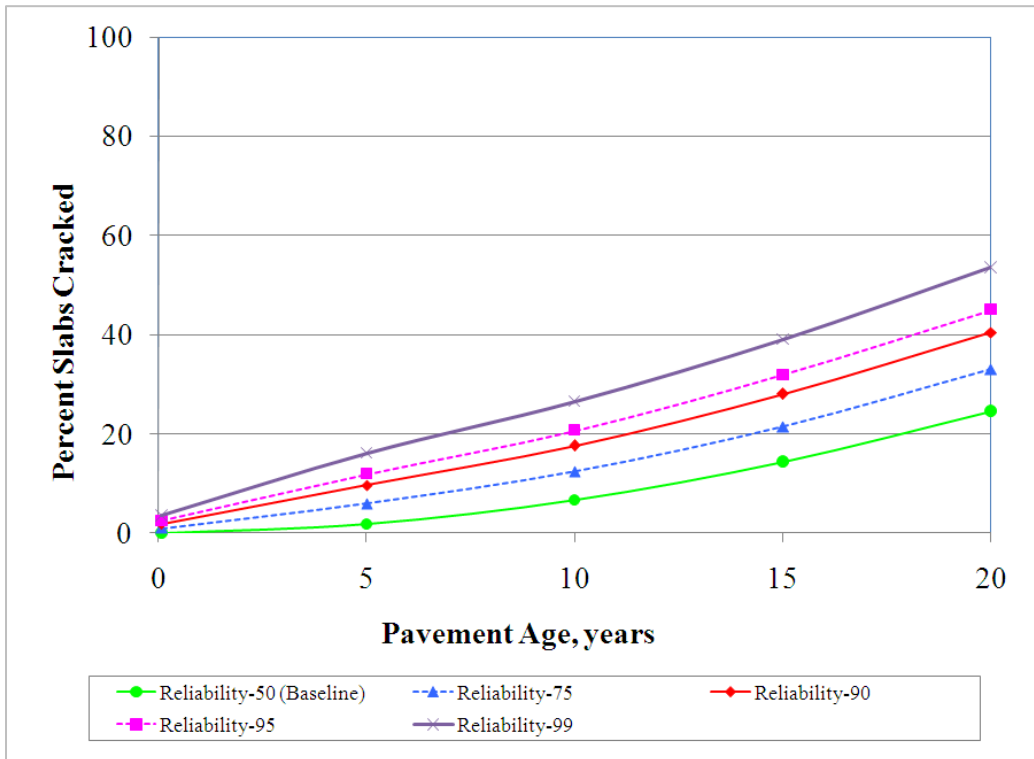


Figure 7.11 Sensitivity of JPCP Transverse Cracking to Design Reliability

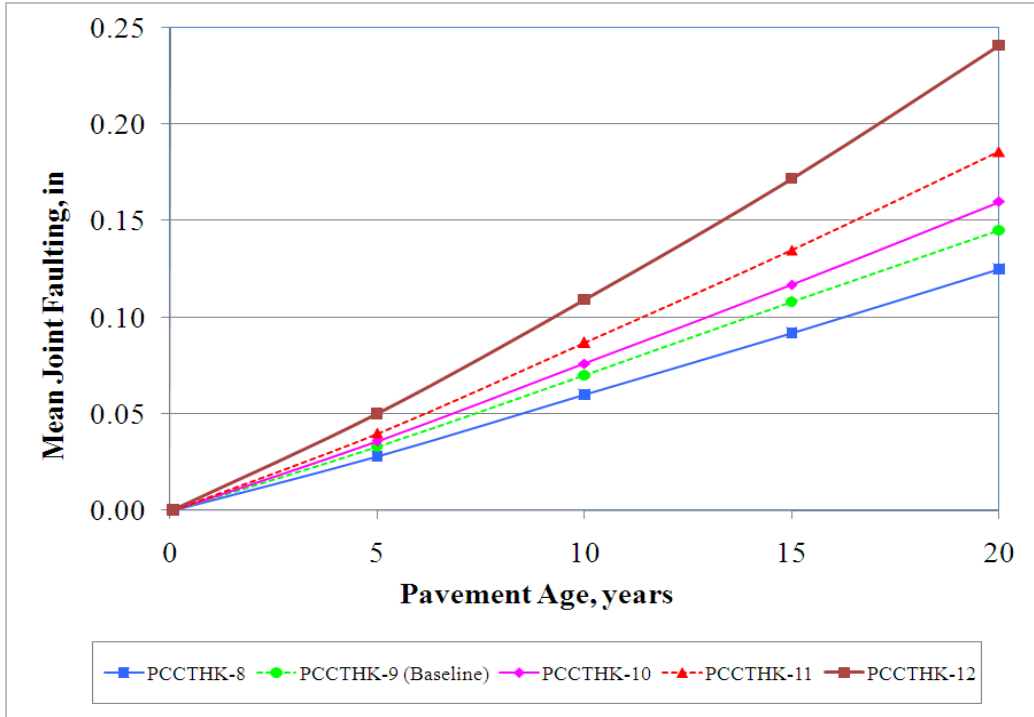


Figure 7.12 Sensitivity of JPCP Faulting to PCC Thickness

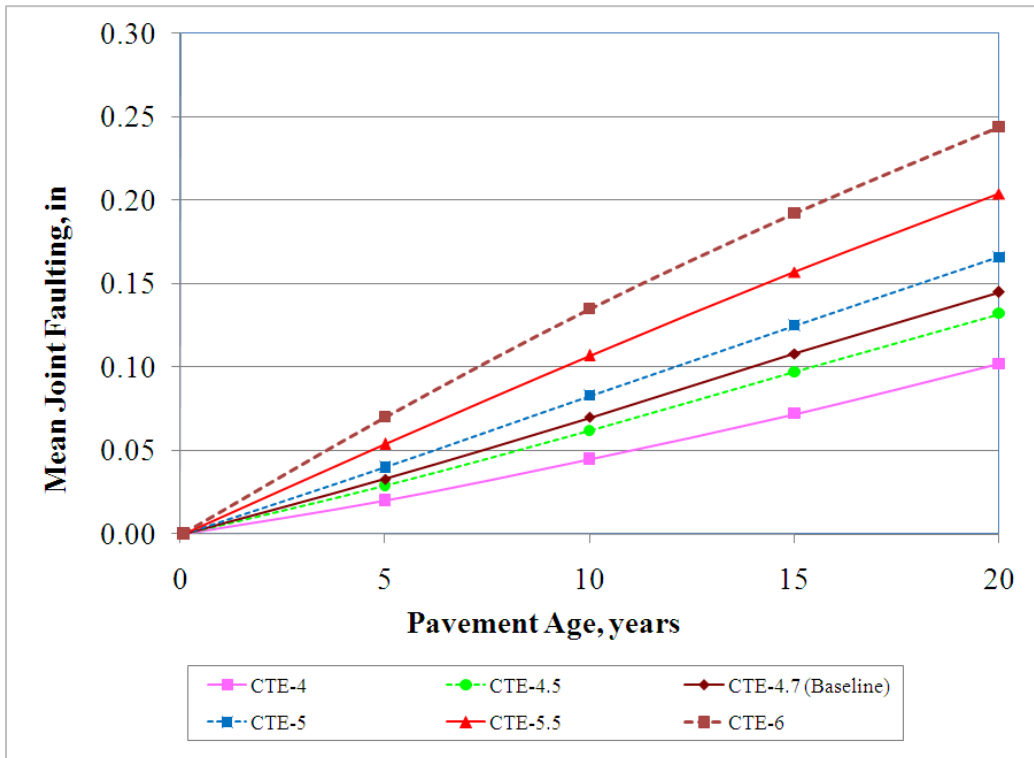


Figure 7.13 Sensitivity of JPCP Faulting to PCC Coefficient of Thermal Expansion

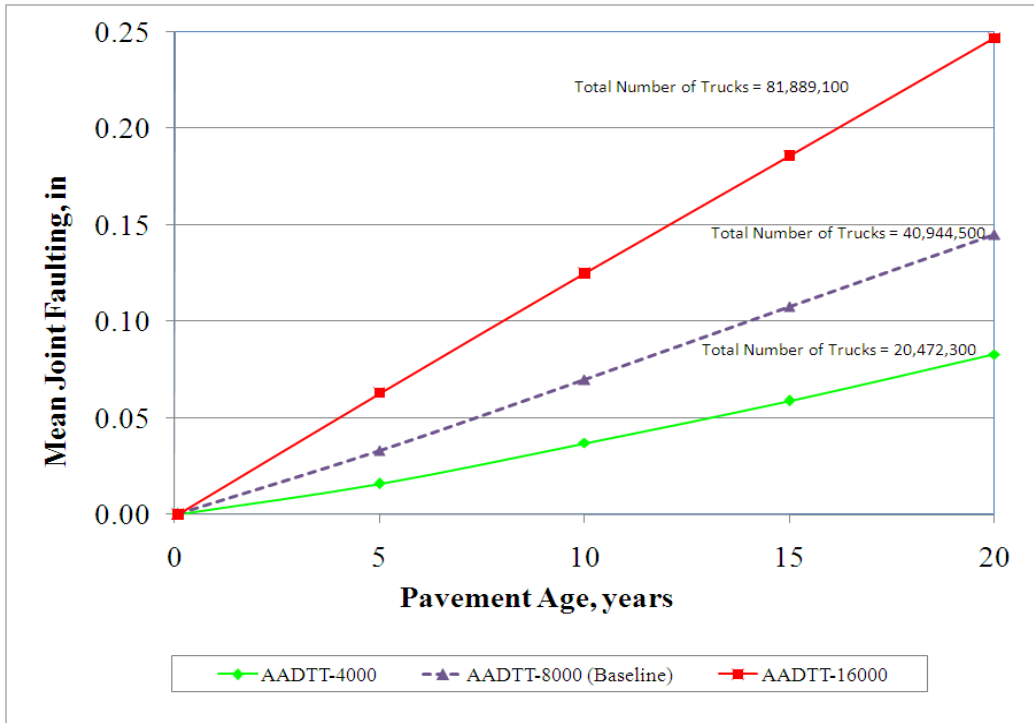


Figure 7.14 Sensitivity of JPCP Faulting to Traffic Volume

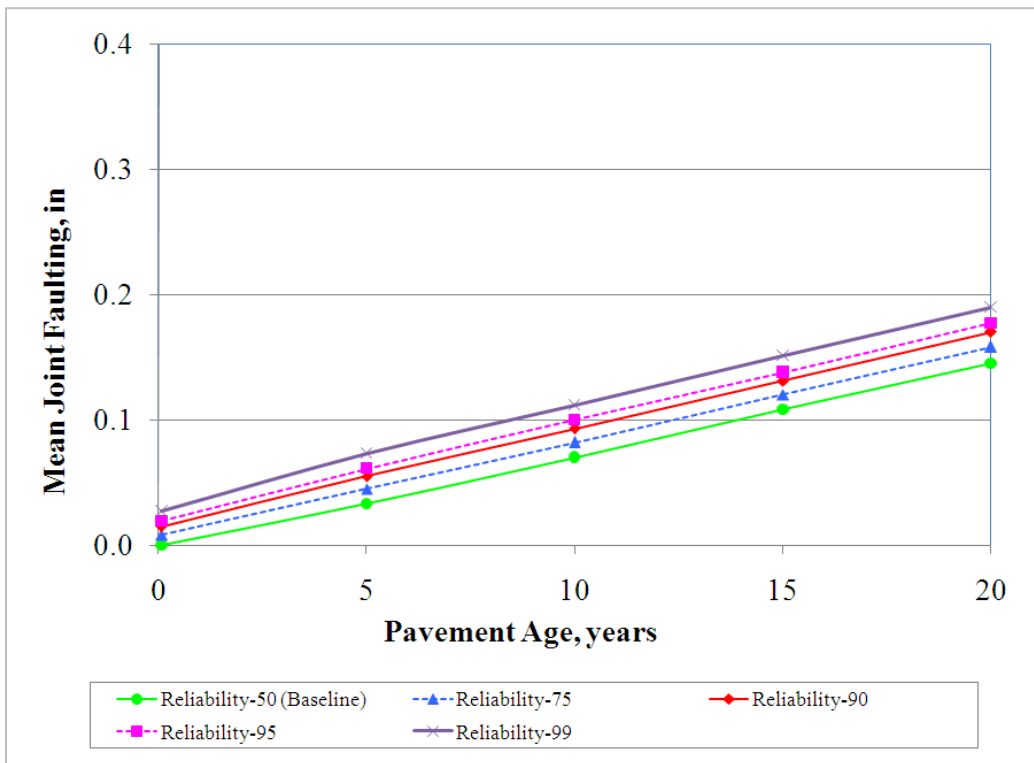


Figure 7.15 Sensitivity of JPCP Faulting to Design Reliability



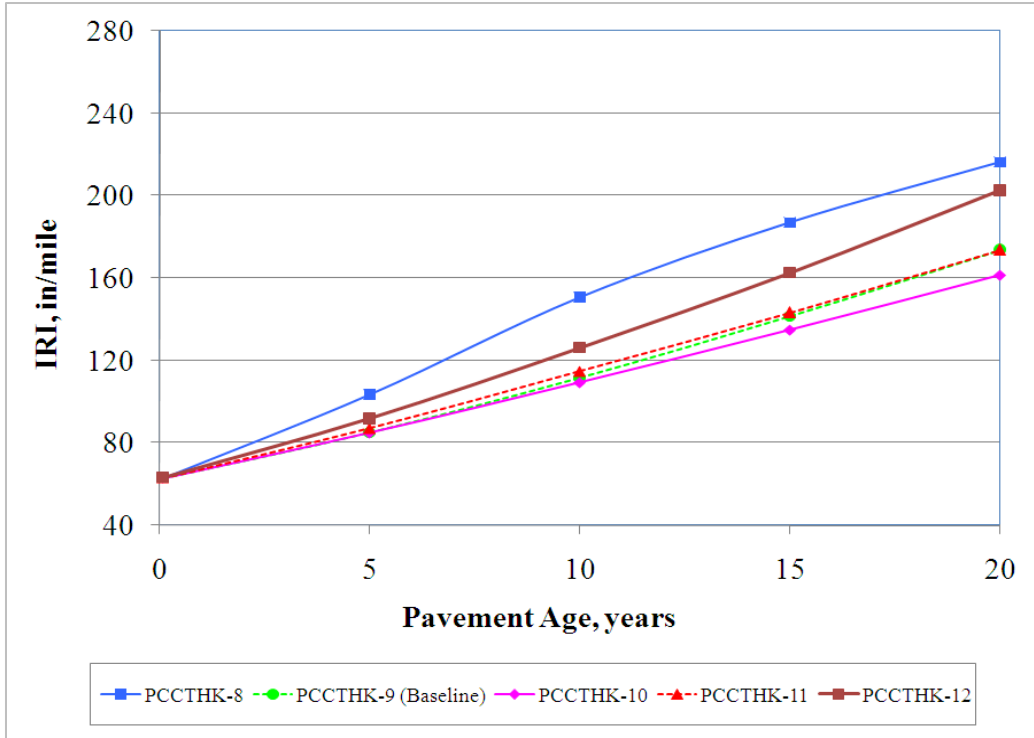


Figure 7.16 Sensitivity of JPCP IRI to PCC Thickness

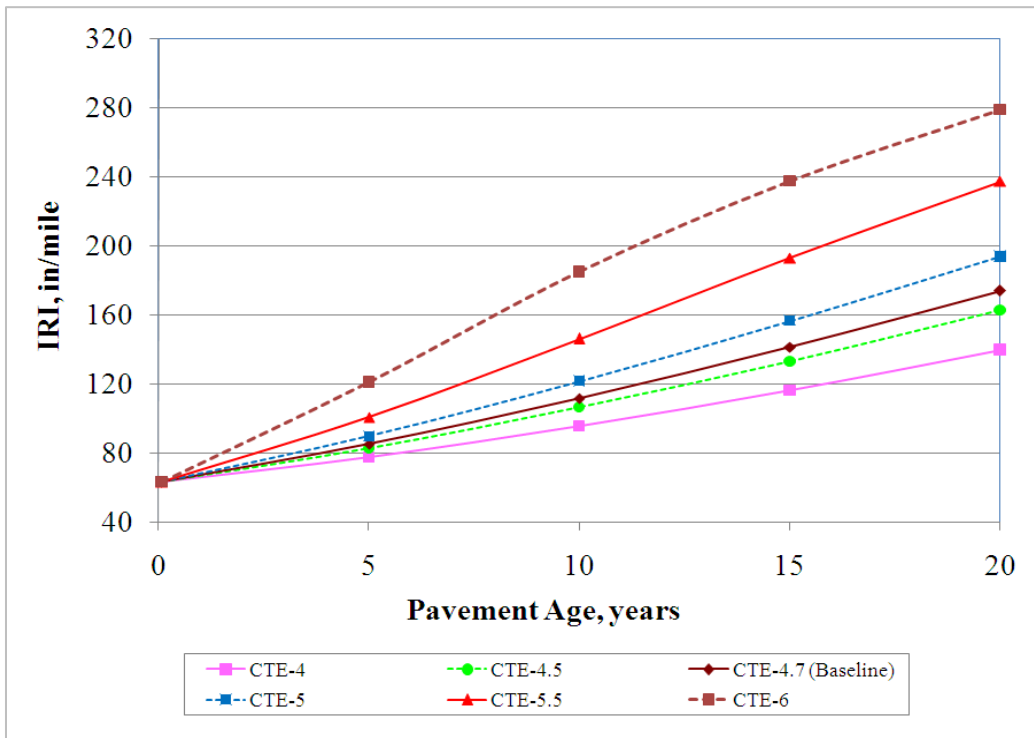


Figure 7.17 Sensitivity of JPCP Faulting to PCC Coefficient of Thermal Expansion

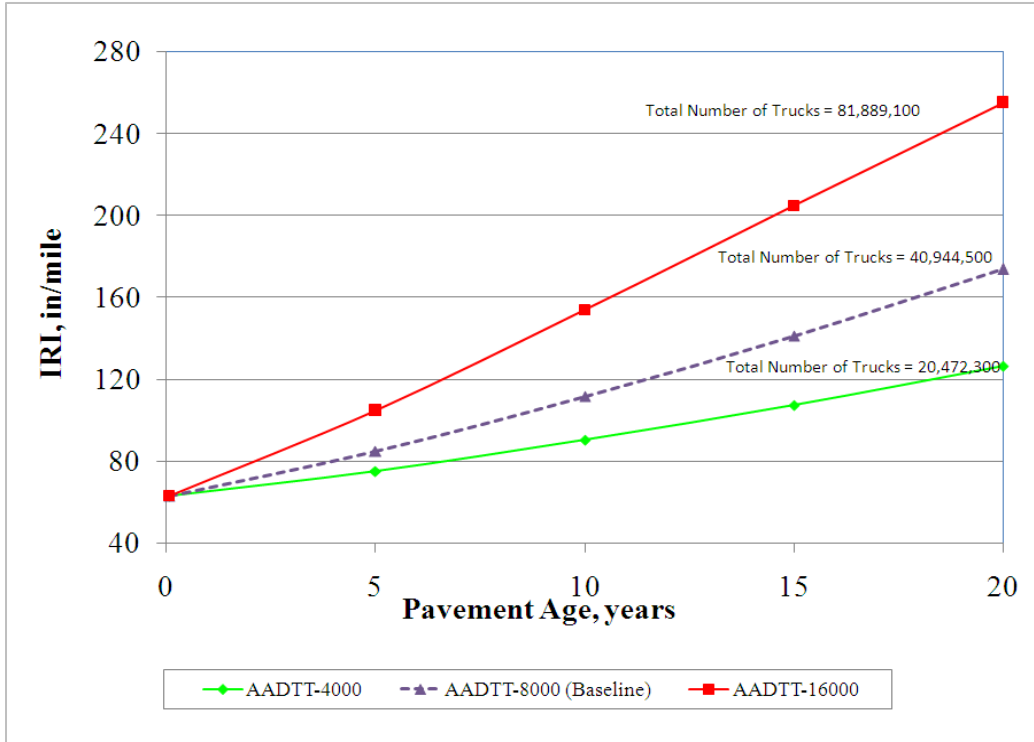


Figure 7.18 Sensitivity of JPCP IRI to Traffic Volume

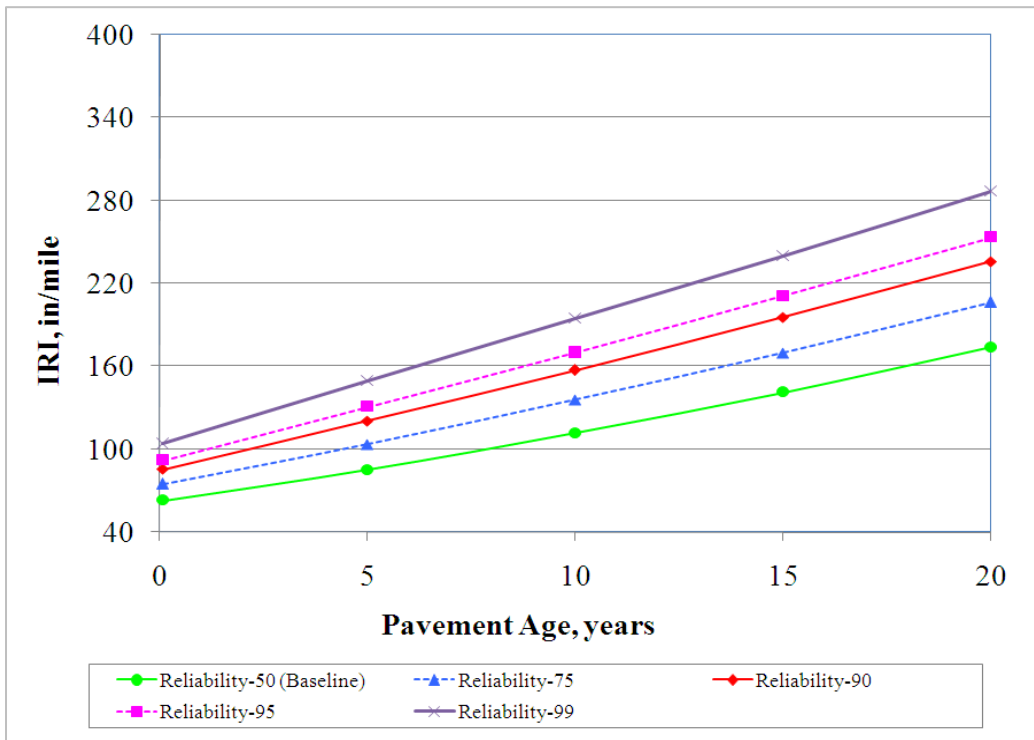


Figure 7.19 Sensitivity of JPCP IRI to Design Reliability

## 7.10 Joint Spacing (L)

In general, the spacing of both transverse and longitudinal contraction joints depends on local conditions of materials and environment, whereas expansion and contraction joints are primarily dependent on layout and construction capabilities. For contraction joints, when a positive temperature gradient, or base frictional resistance increases; the spacing increases as the concrete tensile strength increases. Spacing is also related to the slab thickness and joint sealant capabilities.

Determination of the required slab thickness includes an input for joint spacing. As joint spacing increases, stresses due to thermal curling and moisture warping increase. CDOT designs their PCCP using the Jointed Plain Concrete Pavement (JPCP) method. For a detailed illustration, see CDOT's current Standard Plan Sheet M-412-1. **CDOT uses a joint spacing of 15 feet maximum for concrete pavement thicknesses over 6 inches, 12 feet maximum for concrete thicknesses of 6 inches or less, and a minimum of 8 feet for any full depth pavement.**

## 7.11 Slab/Base Friction

The time over which full contact friction exists between the PCC slab and the underlying layer (usually the base course) is an input in M-E Design. This factor indicates (1) whether or not the PCC slab/base interface has full friction at construction, and (2) how long full friction will be available at the interface if present after construction. This factor is a significant input in JPCP cracking predictions since a monolithic slab/base structure is obtained when full friction exists at the interface.

Global calibration of JPCP performance prediction models show full contact friction exists over the life of the pavements for all base types, with the exception of cement treated or lean concrete base. Therefore, it is recommended the designer set the “months to full contact friction” between the JPCP and the base course equal to the design life of the pavement for unbound aggregate, asphalt stabilized, and cementitious stabilized base courses.

For cement treated or lean concrete base, the months of full contact friction may be reduced if attempts are made to debond the base from the PCC slab. The age at which debonding occurs can be confirmed through construction specifications and/or historical records. If no efforts are made to debond the interface, the designer is recommended to use 10 years of full interface friction.

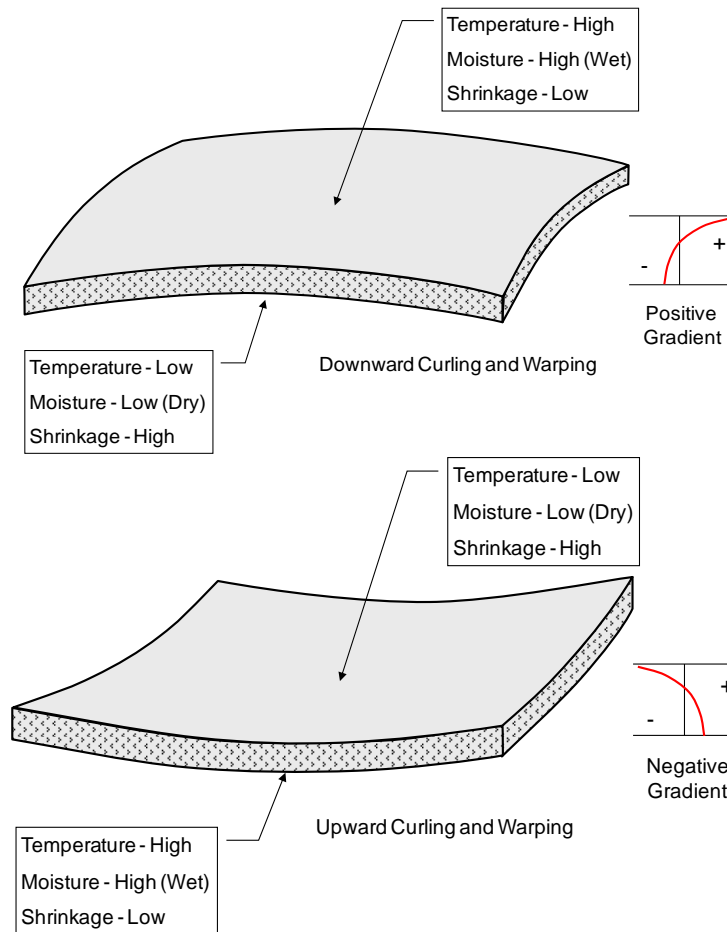
The inputs required for M-E Design software are as follows:

- Presence or absence of PCC-Base full-friction contact
- Months until friction loss
  - Use the design life (in months) for asphalt treated and aggregate base types
  - Use 120 months for lean concrete and cement treated base

## 7.12 Effective Temperature Differential (°F)

An effective temperature differential includes the effects of temperature, precipitation, and wind. Wind is considered because if moist, it has an influence on the surface. Wind may be drier at the surface of the slab creating a larger differential. The same concept may be applied to temperature differences.

Curling is slab curvature produced by a temperature gradient throughout the depth of the slab. Warping is moisture-induced slab curvature. As shown in **Figure 7.20 Curling and Warping**, a positive gradient occurs when temperature and/or moisture levels at the top of a PCC slab are higher than at the bottom of the PCC slab, resulting in downward curvature. In contrast, negative gradients occur when the temperature and moisture in the slab are greater at the bottom, resulting in upward slab curvature. Curling and warping actions may offset or augment each other. During summer days, curling may be counteracted by warping. During summer nights, the curling and warping actions may compound each other. Gradients, as shown in **Figure 7.20 Curling and Warping** are primarily non-linear in nature (5).



**Figure 7.20 Curling and Warping**

The magnitude of thermal and moisture gradients within a pavement are influenced by factors of daily temperature and relative humidity conditions, base layer type, slab geometry with constraints, shrinkage characteristics, and concrete mixture characteristics. The key characteristics of concrete mixtures that influence pavement response to thermal gradients are the coefficient of thermal expansion, thermal conductivity, and specific heat (5).

Paving operations are often performed during the morning and daytime of hot sunny days, a condition that tends to expose the newly paved slabs to a high temperature differential from the intense solar radiation and heat of hydration. Depending on the exposure conditions, a significant amount of positive temperature gradient may be present at the time of hardening. On the other hand, shrinkage occurs when the surface dries and bottom moisture wicks into the base/subbase. This resultant condition has been termed the "zero-stress temperature gradient" and is permanently locked into the slab at the time of construction. The permanent components of curling and warping are considered together and are indistinguishable. Creep occurs over time and negates the effects of the permanent curvature, but only a portion of the permanent curling and warping actually affects the long term pavement response (7). Refer to CDOT Final Research Report CDOT-DTD-R-2006-9, *Implementation of Proven PCCP Practices in Colorado*, dated April 2006 (8) for additional discussion on curling.

M-E Design's recommended value for permanent curl/warp is -10°F (obtained through optimization) for all new and reconstructed rigid pavements in all climatic regions. This is an equivalent linear temperature difference from top to bottom of the slab.

### **7.13 Dowel Bars (Load Transfer Devices) and Tie Bars**

Load transfer is used to account for the ability of a concrete pavement structure to transfer (distribute) load across discontinuities, such as joints or cracks. Load transfer devices, aggregate interlock, and the presence of tied longitudinal joints along with tied shoulders all have an effect.

All new rigid pavements, new construction and reconstruction, including ramps, auxiliary lanes, acceleration/deceleration lanes, and urban streets will require epoxy coated smooth dowel bars in the transverse joints for load transfer. Smooth dowel bars aid the transfer of load across joints and allow thermal contraction in the PCCP. Since these transverse joints must be allowed to expand and contract, deformed tie bars should never be used as load transfer devices in the transverse direction. Most pavements should be dowelled.

If the pavement has shoulders, the shoulders must be portland cement concrete and tied to the travel lanes. Two major advantages of using tied portland cement concrete shoulders is the reduction of slab stress and increased service life. Concrete shoulders of three feet or greater may be considered a tied shoulder. Pavements with monolithic or tied curb and gutter that provide additional stiffness and keep traffic away from the edge may be treated as a tied shoulder. Studies have shown that on interstate projects, increasing the outside slab an additional two feet is equivalent to a tied shoulder. In a typical situation with 12-foot lane widths, the paint stripe is placed at 12 feet and the longitudinal joint is sawed and tied at 14 feet. Requiring the longitudinal joint to coincide with the lane line is recommended in urban locations. 14-foot longitudinal joints

may not be appropriate for ramps, since ramps are usually much thinner in comparison to the main line pavement.

Dowel bar diameter and tie bar size versus thickness of concrete pavement and type of base is tabulated and noted in *CDOT Standard Plans, M & S Standard Drawing*, July 2012, M-412-1, Sheet 5, Reinforcing Size Table (9). The table is reproduced in **Table 7.3 Reinforcing Size Table**.

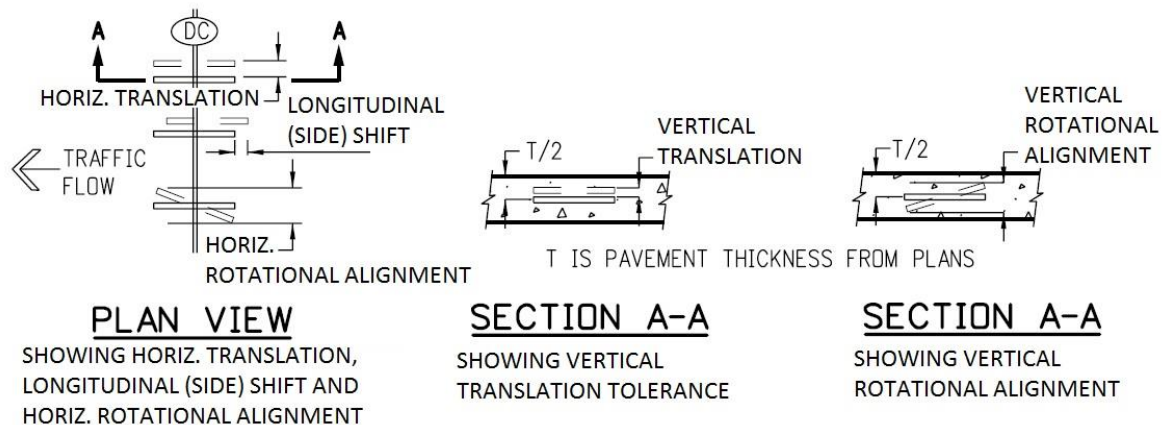
**Table 7.3 Reinforcing Size Table (20-Year or Greater Design Life)**

Pavement Thickness (T) (inches)	Dowel Bar Diameter (inches)	Minimum Concrete Cover (inches)
$7 < T < 8$	1	2.5
$8 \leq T \leq 10$	1.25	3
$10 < T \leq 15$	1.50	3

- Tie bars for longitudinal joints shall conform to AASHTO M 284 and shall be Grade 60, epoxy-coated, and deformed.
- Tie bar length is to be 30 inches and spaced at 36 inches on center.
- Tie bar size is No. 5 when pavement is placed on unbound bases.
- Tie bar size is No. 6 when pavement is placed on lime treated soil, asphalt treated, cement treated, milled asphalt, or recycled asphalt pavement bases.

Dowel bars for transverse joints shall conform to AASHTO M 254 for the coating and to ASTM A 615, Grade 60 for the core material and shall be epoxy-coated, smooth, and lightly greased, pre-coated with wax or asphalt emulsion, or sprayed with an approved material for their full length.

Details illustrating dowel placement tolerances are shown on *CDOT Standard Plans, M & S Standard Drawing*, July 2012, M-412-1, Sheet 1. Dowel bar placement is at  $T/2$  depth and saw cuts of  $T/4$  (see **Figure 7.21 Details of Dowel Bar Placement**) for roadways 8 inches or greater in thickness.



**Figure 7.21 Details of Dowel Bar Placement**

The tolerances are referenced in Subsection 412.13 of the CDOT *Standard Specification for Road and Bridge Construction*, 2011 (23) and as revised. The tolerance table is reproduced in **Table 7.4 Dowel Bar Target Placement Tolerances**. Tolerances are based on *NCHRP Report 637, Guidelines for Dowel Alignment in Concrete Pavements* (22).

**Table 7.4 Dowel Bar Target Placement Tolerances**

Position	Tolerance (inches)
Horizontal and Vertical Translation	1
Longitudinal (Side) Shift Translation	3
Horizontal and Vertical Rotational Alignment	1.5

For tied concrete shoulders, M-E Design requires the input of the long-term or terminal deflection load transfer efficiency (LTE) between the lane (PCC outer lane slab) and shoulder's longitudinal joint. The LTE is defined as the ratio of deflections of the unloaded and loaded slabs. The higher the LTE, the greater the support provided by the shoulder to reduce critical responses of the mainline slabs. Typical long-term deflection LTE are:

- 50 to 70 percent for a monolithically constructed and tied PCC shoulder
- 30 to 50 percent for a separately constructed tied PCC shoulder
- Untied concrete shoulders or other shoulder types that do not provide significant support, therefore a low LTE value should be used.

## 7.14 Widened Lanes

Widened lanes may be used for some PCC designs, however the roadway's geometry and curb and gutter may dictate whether widened lanes are practical. Widened lanes should only be used in the design lane, **Figure 7.22 Diagram of a Widened Lane**. The following guidelines should also be used.

- If the thin concrete overlay is equal to or greater than 7 inches, the designer may use widened lanes if determined feasible.
- Widened lanes are good for two types of roadways, the first is rural roads with one lane in each direction; the second are the outside lane of interstates.

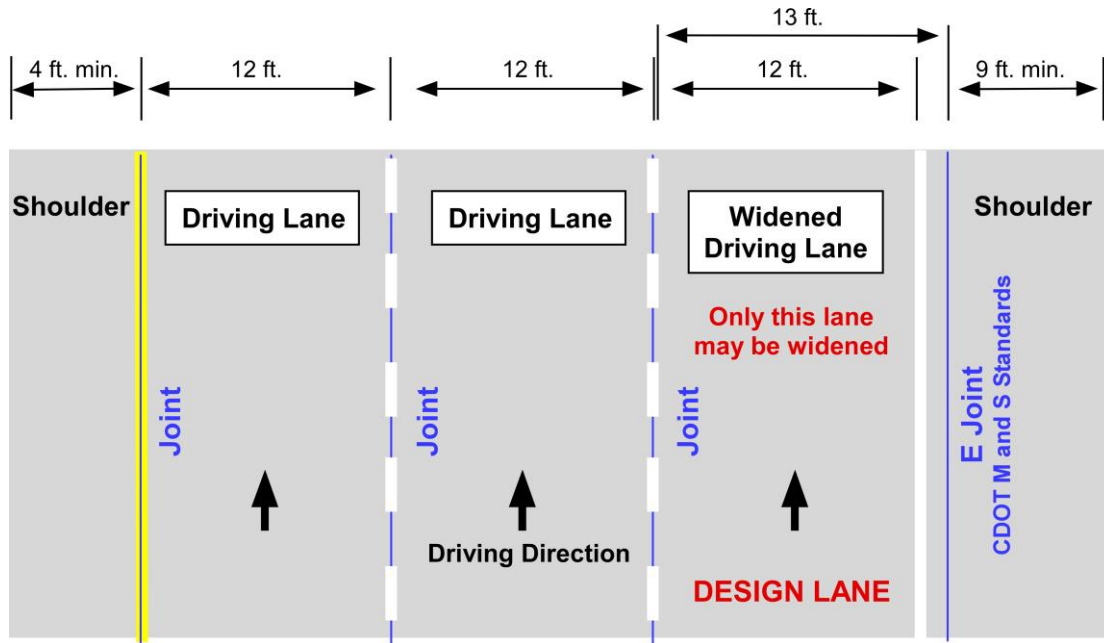


Figure 7.22 Diagram of a Widened Lane

## 7.15 Lane Edge Support Condition (E)

- Conventional lane width (12 feet) with free edge
- Conventional lane width (12 feet) with tied concrete shoulder
- Wide slab (i.e. 13 feet) with conventional traffic lane width (12 feet)

Refer to CDOT Final Research Report CDOT-DTD-R-2006-9, *Implementation of Proven PCCP Practices in Colorado*, dated April 2006 (8), and *Evaluation of Premature PCCP Longitudinal Cracking in Colorado*, Final Research Report CDOT-DTD-R-2003-1, dated January 2003 (11) for additional discussion on widen slabs.

## 7.16 Base Erodibility

The erodibility index allows the designer to select the base's resistance to erosion. The potential for base or subbase erosion (layer directly beneath the PCC layer) has a significant impact on the initiation and propagation of pavement distress. Different base types are classified based on long-term erodibility behavior as follows:

- Class 1: Extremely erosion resistant materials
- Class 2: Very erosion resistant materials
- Class 3: Erosion resistant materials
- Class 4: Fairly erodible materials
- Class 5: Very erodible materials



Rigorous definitions of the material types that qualify under these various categories are presented in **Table 7.5 Material Types and Erodibility Class**.

**Table 7.5 Material Types and Erodibility Class**

Erodibility Class	Material Description and Testing
1	<ul style="list-style-type: none"> <li>(a) Lean concrete with approximately 8 percent cement; or with long-term compressive strength &gt; 2,500 psi. (&gt; 2,000 psi. at 28-days), and a granular subbase layer or a stabilized soil layer, or a geotextile fabric placed between the treated base and subgrade, otherwise Class 2.</li> <li>(b) Hot mixed asphalt concrete with 6 percent asphalt cement that passes appropriate stripping tests (see <b>Figure 2.2.8</b>) and aggregate tests; and a granular subbase layer or a stabilized soil layer, otherwise Class 2.</li> <li>(c) Permeable drainage layer; asphalt treated aggregate (see <b>Figure 2.2.8</b> and <b>Table 2.2.57</b> for guidance) or cement treated aggregate (see <b>Table 2.2.58</b> for guidance) and an appropriate granular or geotextile separation layer placed between the treated permeable base and subgrade.</li> </ul>
2	<ul style="list-style-type: none"> <li>(a) Cement treated granular material with 5 percent cement manufactured in plant, or long-term compressive strength 2,000 to 2,500 psi (1,500 to 2,000 psi at 28-days) and a granular subbase layer or a stabilized soil layer, or a geotextile fabric placed between the treated base and subgrade; otherwise Class 3.</li> <li>(b) Asphalt treated granular material with 4 percent asphalt cement that passes the appropriate stripping test and a granular subbase layer or a treated soil layer, or a geotextile fabric placed between the treated base and subgrade; otherwise Class 3.</li> </ul>
3	<ul style="list-style-type: none"> <li>(a) Cement-treated granular material with 3.5 percent cement manufactured in plant, or long-term compressive strength 1,000 to 2,000 psi (750 psi to 1,500 at 28-days).</li> <li>(b) Asphalt treated granular material with 3 percent asphalt cement that passes appropriate stripping test.</li> </ul>
4	Unbound crushed granular material having dense gradation and high quality aggregates.
5	Untreated soils (PCC slab placed on prepared/compacted subgrade)

### 7.17 Sealant Type

Sealant type applied for transverse joints is a key input used in a joint spalling model which is used for predicting JPCP smoothness. The sealant options are liquid, silicone, and preformed, however, for M-E Design the designer should use a silicone sealant.

### 7.18 Concrete Pavement Minimum Thickness

The minimum thickness requirement may be changed on a project to project bases depending on traffic, soil conditions, bases, etc. (see **Table 7.6 Minimum Thickness for Highways, Roadways and Bicycle Paths**).

**Table 7.6 Minimum Thicknesses for Highways, Roadways, and Bicycle Paths**

Design Truck Traffic	Portland Cement Concrete Pavement (inches)	Aggregate Base Course (inches)
Greater than 1,000,000 ESALs (equivalent to 250 AADTT <sup>5</sup> for 30 year designs)	7.0	6.0
Less than or equal to 1,000,000 ESALs for driveways	6.0	6.0
Multi-use sidewalks <sup>1</sup>	6.0	6.0 <sup>2</sup>
Sidewalks <sup>3,4</sup>	4.0	6.0 <sup>2</sup>
<b>Notes:</b> <sup>1</sup> Maintenance vehicles may include light duty trucks. <sup>2</sup> May be reduced to 4.0 inches in thickness if approved by the RME. <sup>3</sup> Pedestrian and bicycle only, typical snow removal equipment would be a snow blower. <sup>4</sup> Per Standard Plan No. M-609-1, Curb, Gutters and Sidewalks of CDOT's <i>M&amp;S Standards</i> , July 2012. <sup>5</sup> AADTT is the average annual daily truck traffic.		

## 7.19 Concrete Pavement Texturing, Stationing, and Rumble Strips

- Texture:** Final surface of the pavement shall be uniformly textured with a broom, burlap drag, artificial turf, or diamond ground to obtain a specified average texture depth of the panel being greater than 0.05 inches. Refer to CDOT Final Research Report CDOT-2012-10, *Assessment of Concrete Pavement Texturing Methodologies in Colorado*, dated October 2012 (25), and CDOT Final Research Report CDOT-DTD-R-2005-22, *PCCP Texturing Methods*, dated January 2005 (12).
- Stationing:** Stationing shall be stamped into the outside edge of the pavement at 500-foot intervals on each outside mainline shoulder as shown on *CDOT Standard Plans, M & S Standard Drawing*, July 2012, Standard Plan No. M-412-1, Concrete Pavement Joints.
- Rumble Strips:** When rumble strips are installed, they shall be of the style and location as shown on *CDOT Standard Plans, M & S Standard Drawing*, July 2012, Standard Plan Sheet No. M-614-1, Rumble Strips.

## 7.20 Concrete Pavement Materials Selection

Concrete pavement is a construction paving material that consists of cement (commonly portland cement), other cementitious materials (fly ash), aggregate (gravel and sand), water, and chemical

admixtures. The concrete solidifies and hardens after mixing and placement due to a chemical process known as hydration. The water reacts with cement, which bonds the other components together, eventually creating a hard stone-like material.

CDOT designates a concrete pavement mix as a Class P. **Table 7.7 Concrete Classification** shows the specified mix properties. Class E is a fast track mix that may be substituted for Class P. Class P and E are defined in Section 601 Structural Concrete and 701 Hydraulic Cement of *CDOT Standard Specification for Road and Bridge Construction*, 2011 (23) and as revised.

**Table 7.7 Concrete Classification**

Concrete Class	Required Field Compressive Strength (psi)	Minimum Cementitious Content (lbs/yd <sup>3</sup> )	Air Content Percent Range (Total)	Maximum Water Cement Ratio
P	4,500 at 28 days	520	4-8	0.44
E	4,500 at 28 days	520	4-8	0.44

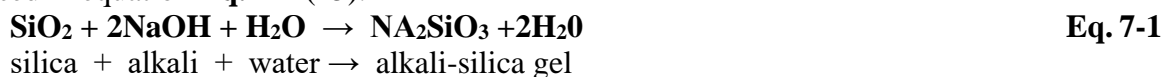
**Note:** Table taken from Standard Special Provision: *Revision of Sections 105, 106, 412, 601 and 709 Conformity to the Contract of Portland Cement Concrete Pavement and Dowel Bars and Tie Bars for Joints*, dated April 30, 2015

### 7.20.1 Understanding pH in Concrete Mixes

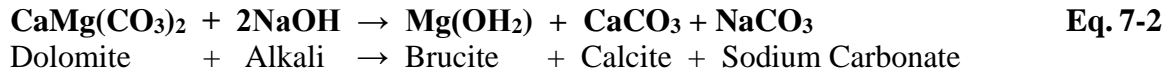
A brief explanation of pH is presented in **Section S.1.4.2 pH Scale** in the **SUPPLEMENT** chapter. When applied to pavement design, freshly poured concrete can have a pH of 11 to 13 making it very alkaline. This high initial alkalinity helps resist corrosion, but as concrete ages, the pH can drop to around 8 increasing the degradation of steel reinforcement and load transfer devices. The high alkalinity of concrete can also affect the performance of fresh and hardened concrete when admixtures are used.

### 7.20.2 Alkali Aggregate Reactivity

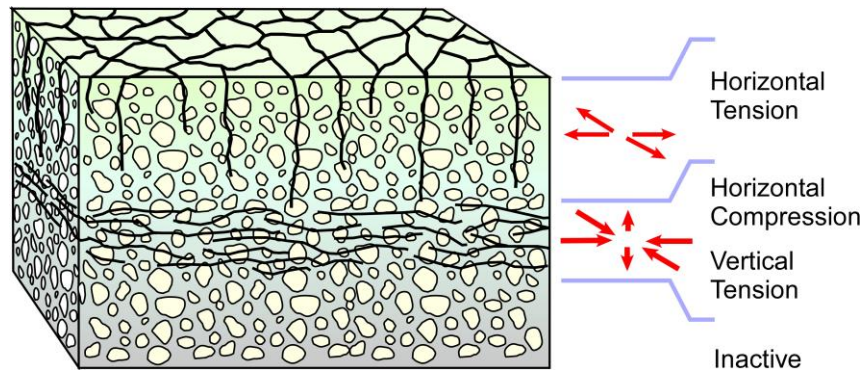
The high alkalinity of concrete can cause serious problems when interacting with different parts of the mix, namely alkali-silica and alkali-carbonate reactions. Alkali-silica reactivity (ASR) is the process in which certain minerals in the aggregate along with the presence of moisture are broken down by the highly alkaline environment of concrete. This process produces a gel-like substance that expands adding tensile forces to the concrete matrix, which then leads to external cracking of the concrete slab (13). The cracking allows more water to infiltrate creating more gel and more expansion. Ultimately, the concrete destroys itself. The ASR chemical reaction is expressed in equation **Eq. 7-1** (15).



Alkali-carbonate reactivity (ACR) is much less common than ASR, but it does have similar expansive properties that occur within the aggregate and deteriorate concrete pavement. The ACR reaction is dependent on certain types of clay rich, or impure, dolomitic limestones rarely used in concrete because of their inherently weak structure (14). The ACR chemical reaction known as dedolomitization is represented in equation Eq. 7-2 (15). The cracking pattern is shown in **Figure 7.22 Idealized Sketch of Cracking Pattern in Concrete Mass Caused By Internal Expansion.**



"Sandgravel" aggregates in parts of Kansas, Nebraska, Colorado, and Wyoming, especially those from the Platte, Republican, and Laramie Rivers, have been involved in the deterioration of concrete (17). In 1983 a team was formed to evaluate the concrete pavement condition in Colorado and to recommend rehabilitation methods for these pavements. This team identified that one-third of the pavements inspected suffered from ASR (19). A follow up study conducted in 1987 focused on the cause of ASR in Colorado. The study concluded that aggregates in the Denver Metro area showed no signs of ASR reaction, but aggregate from the Three Bells pit near Windsor demonstrated rapid signs of expansion. This study led CDOT to modify its specifications and require low alkali cement for all concrete pavement, it also identified the need for Class F fly ash in areas where reactive aggregates have been a problem (20).



**Figure 7.23 Idealized Sketch of Cracking Pattern in Concrete Mass Caused by Internal Expansion**

(Figure 93, *Petrographic Methods of Examining Hardened Concrete: A Petrographic Manual*, July 2006)

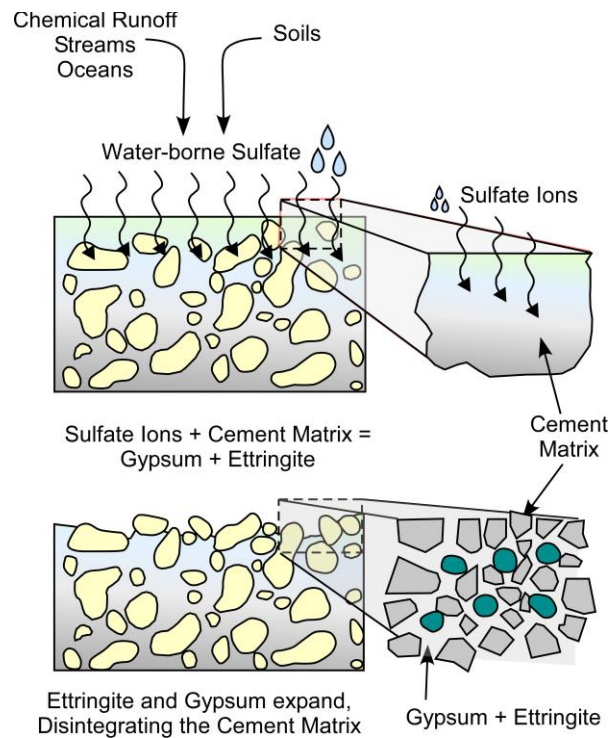
### 7.20.3 Sulfate Resistant Concrete Pavement

Sulfates may be found in soil and water and are referred to as "alkali". The sulfates in soils and water are the main source of external sulfate attack on concrete pavement. Although the mechanism of sulfate attack is complex, it is primarily thought to be caused by two chemical reactions: 1) the formation of gypsum through the combination of sulfate and calcium ions, and/or 2) the formation of ettringite through the combination of sulfate ions and hydrated calcium aluminate (18). Ettringite ( $\text{Ca}_6[\text{Al}(\text{OH})_6]_2(\text{SO}_4)_3 \cdot 26\text{H}_2\text{O}$ ) is a high-sulfate, calcium sulfo-aluminate mineral which naturally occurs in curing concrete. The problem appears when ettringite forms after the concrete has set, this is known as Delayed Ettringite Formation (DEF). This process

is extremely harmful, because as ettringite crystals form they expand and create internal tensile stresses in the cement matrix (21). These stresses will cause the concrete to crack, but may not be apparent for 3-10 years (18).

Sulfate attack is a chemical reaction between sulfates and the calcium aluminate ( $C_3A$ ) in cement, resulting in surface softening (22) (see **Figure 7.23 Sulfate Attack**). Steps taken to prevent the development of distress due to external sulfate attack include minimizing the tri-calcium aluminate content in the cement or reducing the quantity of calcium hydroxide in the hydrated cement paste through the use of pozzolanic materials. It is also recommended that a w/c ratio less than 0.45 be used to help mitigate external sulfate attack (18).

Severity levels of potential exposure to sulfate attack have been developed. **Table 7.8 Requirements to Protect Against Damage to Concrete by Sulfate Attack from External Sources of Sulfates** shows the classification levels of potential exposure. Concrete pavement mix designs must provide protection against sulfate attack, thus cementitious material requirements are modified. As the severity of potential exposure increases, the cementitious material requirements become more stringent and the water cement ratio becomes less stringent. Refer to Section 601 Structural Concrete of CDOT *Standard Specification for Road and Bridge Construction*, 2011 (23) and as revised for additional cementitious material requirements.



**Figure 7.24 Sulfate Attack**

(Figure 5-18, *Integrated Materials and Construction Practices for Concrete Pavement: State-of-the-33 Practice Manual*)

**Table 7.8 Requirements to Protect Against Damage to Concrete by Sulfate Attack from External Sources of Sulfates**

<b>Severity of Potential Exposure</b>	<b>Water-soluble Sulfate (SO<sub>4</sub>), Percent Dry Soil</b>	<b>Sulfate (SO<sub>4</sub>) in Water (ppm)</b>	<b>Maximum Water Cement Ratio</b>	<b>Cementitious Material Requirements</b>
Class 0	0.00 to 0.10	0 to 150	0.50	Class 0
Class 1	0.11 to 0.20	150 to 1,500	0.50	Class 1
Class 2	0.21 to 2.00	1,501 to 10,000	0.45	Class 2
Class 3	2.01 or greater	10,001 or greater	0.40	Class 3

## References

1. *AASHTO Guide for Design of Pavement Structures*, American Association of State Highway and Transportation Officials, Washington, DC, 1993.
2. *Supplement AASHTO Guide for Design of Pavement Structures, Part II, - Rigid Pavement Design & Rigid Pavement Joint Design*, American Association of State Highway and Transportation Officials, Washington, DC, 1998.
3. *Techniques for Pavement Rehabilitation*, Nichols Consulting Engineers, Chtd., U.S. Department of Transportation, Federal Highway Administration and National Highway Institute, Arlington, Virginia, Sixth Edition, January 1998.  
[http://www.fhwa.dot.gov/pavement/pub\\_details.cfm?id=375](http://www.fhwa.dot.gov/pavement/pub_details.cfm?id=375)
4. *LTPP Data Analysis Phase I: Validation of Guidelines for k-Value Selection and Concrete Pavement Performance Prediction*, Publication FHWA-RD-96-198, Federal Highway Administration, Research and Development, Turner-Fairbank Highway Research Center, 6300 Georgetown Pike, McLean, VA 22101-2296, January 1997.
5. Wells, Steven A., *Early Age Response of Jointed Plain Concrete Pavements to Environmental Loads*, thesis was presented and defended on July 27, 2005, University of Pittsburgh, School of Engineering, 2005.
6. *Computer-Based Guidelines for Concrete Pavements, Volume II: Design and Construction Guidelines and HIPERPAV® II User's Manual*, Publication No. FHWA-HRT-04-122, U.S. Department of Transportation, Federal Highway Administration, Research and Development, Turner-Fairbank Highway Research Center, 6300 Georgetown Pike, Mclean VA 22101-2296, February 2005.
7. *Guide for Mechanistic-Empirical Design*, Final Report, NCHRP Project 1-37A, National Cooperative Highway Research Program, Transportation Research Board, National Research Council, Submitted by ARA, INC., ERES Consultants Division, Champaign, IL, March 2004.
8. Ardani, Ahmad, *Implementation of Proven PCCP Practices in Colorado*, Final Report, Report No. CDOT-DTD-R-2006-9, Colorado Department of Transportation, Research Branch, April 2006.
9. CDOT Standard Plans, Concrete Pavement Joints M-412-1, July 2006.
10. *Standard Specifications for Road and Bridge Construction*, Colorado Department of Transportation, Denver, Co, 2005.

11. Ardani, Ahmad, Hussain, Shamsad, and LaForce, Robert, *Evaluation of Premature PCCP Longitudinal Cracking in Colorado*, Final Report, Report No. CDOT-DTD-R-2003-1, Colorado Department of Transportation, Research Branch, January 2003.
12. Ardani, Ahmad and Outcalt, William (Skip), *PCCP Texturing Methods*, Final Report, Report No. CDOT-DTD-R-2005-22, Colorado Department of Transportation, Research Branch, January 2005.
13. *Alkali Silica Reactivity*, Canadian Strategic Highway Research Program, Transportation Association of Canada, Technical Brief #13, April 1996, 1 October 2007. <http://www.cshrp.org/products/csbf-e13.pdf>
14. *Alkali Aggregate Reaction*, Concrete Technology, Portland Cement Association, 2007, 2 October 2007. [http://www.cement.org/tech/cct\\_dur\\_AAR.asp](http://www.cement.org/tech/cct_dur_AAR.asp)
15. *Alkali-Aggregate Reaction in Roads & Bridges*, West, Graham, London: Thomas Telford Ltd. 1996 pp. 10-12.
16. *Petrographic Methods of Examining Hardened Concrete: A Petrographic Manual*, Publication No. FHWA-HRT-04-150, 1401 East Broad Street, Richmond, VA 23219 and Federal Highway Administration, Office of Infrastructure R&D, 6300 Georgetown Pike, McLean, VA 22101, July 2006.
17. *Standard Practice for Concrete for Civil Works Structures*, Publication No. EM 1110-2-2000, Department of the Army, US Army Corps of Engineers, Washington, DC 20314-1000, 1 February 1994.
18. *Guidelines for Detection, Analysis, and Treatment of Materials-Related Distress in Concrete Pavements - Volume 1: Final Report*, Report No. FHWA-RD-01-163, U.S. Department of Transportation, Federal Highway Administration, Research, Development and Technology, Turner-Fairbank Highway Research Center, 6300 Georgetown Pike, Mclean VA 22101-2296, August 2002.
19. *Rehabilitation of Concrete Pavements*, Report No. CDOH-83-1, Colorado Department of Highways, U.S. Department of Transportation, Federal Highway Administration, January 1983.
20. *Colorado Reactive Aggregate*, Report No. CDOH-DH-DML-87-5, Colorado Department of Highways, U.S. Department of Transportation, Federal Highway Administration, June 1987.
21. *Integrated Materials and Construction Practices for Concrete Pavement: State-of-the-Practice Manual*, FHWA Publication No. HIF-07-004, U.S. Department of Transportation, Federal Highway Administration, October 2007.



22. *Guidelines for Dowel Alignment in Concrete Pavements*, NCHRP Report 637, National Cooperative highway Research Program, Transportation Research Board, Washington, D.C., 2009.
23. *Standard Specifications for Road and Bridge Construction*, Colorado Department of Transportation, Denver, Co, 2011.  
<http://www.coloradodot.info/business/designsupport/construction-specifications/2011-Specs>
24. *AASHTO Mechanistic-Empirical Pavement Design Guide, A Manual of Practice, Interim Edition, July 2008*, American Association of State Highway and Transportation Officials, Washington, DC, 2008.
25. Rasmussen, Robert Otto and Sohaney, Richard C., *Assessment of Concrete Pavement Texturing Methodologies in Colorado*, CDOT Final Research Report CDOT-2012-10, dated October 2012 (24).

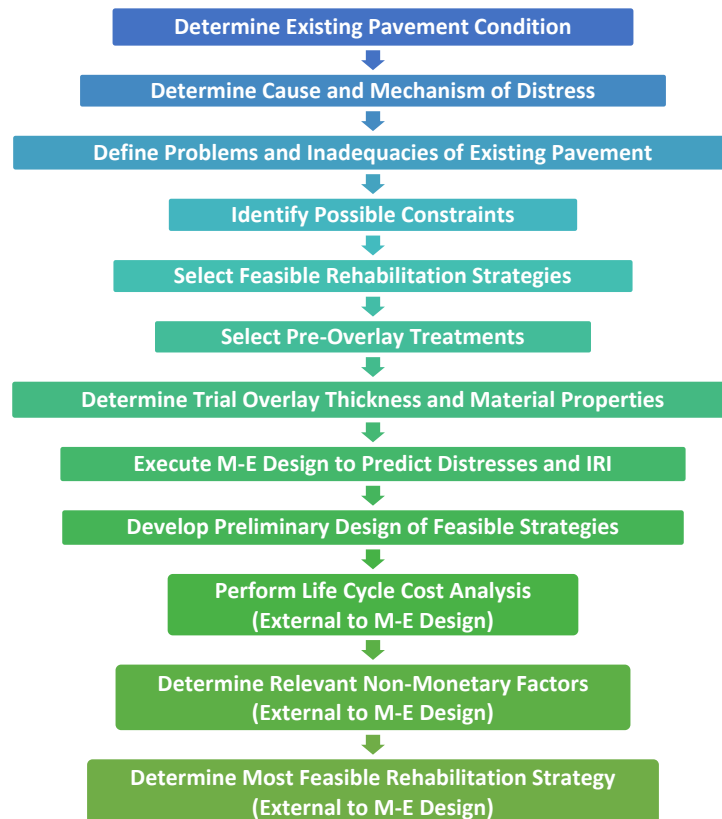
## CHAPTER 8

# PRINCIPLES OF DESIGN FOR PAVEMENT REHABILITATION WITH FLEXIBLE OVERLAYS

### 8.1 Introduction

This chapter describes the information needed to create cost effective rehabilitation strategies using M-E Design. Policy decision making that advocates applying the same standard fixes to every pavement does not produce successful pavement rehabilitation. Instead, successful rehabilitation depends on decisions based on the specific condition and design of the individual pavement. The rehabilitation design process begins with collection and detailed evaluation of project information in order to determine the cause of the pavement distress. Finally, a choice needs to be made to select an engineered rehabilitation technique(s) that will correct the distresses.

Overlays are used to remedy structural or functional deficiencies of existing flexible pavements and extend their useful service life. It is important the designer consider the type of deterioration present when determining whether the pavement has a structural or functional deficiency, so an appropriate overlay type and design can be developed (see **Figure 8.1 Rehabilitation Alternative Selection Process**). Designers must consider all of the following:



**Figure 8.1 Rehabilitation Alternative Selection Process**

### 8.1.1 Structural Versus Functional Overlays

The overlay design procedures in this section provide an overlay thickness to correct a structural deficiency. If no structural deficiency exists, an overlay thickness equal to zero will be obtained. Structural deficiency arises from any condition that adversely affects the load carrying capability of the pavement structure. Conditions include inadequate thickness, cracking, distortion, and disintegration. **Note:** Several types of distress (i.e. distresses caused by poor construction techniques) are not initially caused by traffic loads, but become more severe under traffic to the point that they detract from the load carrying capability of the pavement. **An overlay lift thickness should be about two inches when correcting structural deficiencies.**

Functional deterioration is defined as any condition adversely affecting the highway user. These include poor surface friction and texture, hydroplaning and splash from wheel path rutting, and excess surface deterioration. Overlay designs, including thickness, preoverlay repairs and reflection crack treatments must address the causes of functional problems and prevent their recurrence. This can only be done through sound engineering and requires experience in solving the specific problems involved. The overlay design required to correct functional problems should be coordinated with that required to correct any structural deficiencies. If a pavement has only a functional deficiency, it would not be appropriate to develop an overlay design using a structural deficiency design procedure.

Leveling courses could be part of a functional rehabilitation strategy; since the thickness varies throughout, they do not improve the structural value. This does not mean the pavement does not need an overlay to correct a functional deficiency. If the deficiency is primarily functional, then a minimal overlay should remedy the functional problem. If the pavement has a structural deficiency a structural overlay thickness adequate to carry future traffic over the design period is needed.

### 8.1.2 Guidelines

The following guidelines may help determine what type of rehabilitation is needed. Additional information concerning mix designs and properties may be found in **APPENDIX E**.

- **Major Rehabilitation:** Pavement treatments that consist of structural enhancements that extend the serviceable life of an existing pavement and improve its load-carrying capability.
  - **Minimum design life of 10 years for asphalt or concrete.** Pavement design criteria and LCCA shall be performed as required.
  - Thin bonded concrete overlays of asphalt
  - Typical treatments include resurfacing with full depth reclamation, slab replacement and rubblization, and those found with Minor Rehabilitation.
- **Minor Rehabilitation:** Pavement treatments consisting of functional or structural enhancements made to the existing pavement sections to improve pavement performance or extend serviceable life.

- Functional enhancements will be documented to address issues of concern to ensure proper treatment selection. No design life criteria will be required for functional treatments. LCCA is optional for functional treatments as the intent is to replace existing pavement structure and correct functional and or age-related issues with the existing pavement structure.
  - **Structural enhancements will have a minimum design life of 10 years for asphalt or concrete.** Pavement design criteria and LCCA shall be performed as required.
  - Typical treatments in addition to resurfacing may include milling, leveling course, cold-in-place recycling or hot in-place recycling, diamond grinding, a small amount of full-depth or partial depth panel replacement, dowel and tie bar repairs, stitching cracks, and routing and sealing the joints and cracks.
- **Pavement Maintenance:** Typically, these treatments are preventive in nature and are intended to keep the pavement in serviceable condition. They may be classified as corrective, preventive, reactive, or functional.
    - A LCCA is not required for pavement maintenance treatments as the intent is to replace or maintain the existing pavement structure and correct construction related issues, functional and or age-related issues with the existing pavement structure, and to perform corrective maintenance treatments as needed.
    - Preventive maintenance projects will be performed on pavements in good or fair condition.
    - Functional maintenance projects, when applicable, will be used to correct functional and or age-related issues with the existing pavement structure and to perform corrective maintenance treatments as needed. These projects will primarily be performed on low volume roadways.
    - Typical treatments include thin functional treatments 1 ½ inches in thickness or less or other treatments only intended to maintain the existing pavement. Examples include thin HMA/SMA overlays, chip seals, crack sealing, panel replacement, dowel and tie bar repairs, diamond grinding, and crack stitching.

## 8.2 Determine Existing Pavement Condition

### 8.2.1 Records Review

Obtaining specific project information is the first step in the process of rehabilitation. Five basic types of detailed project information are necessary; design, construction, traffic, environmental, and pavement condition. One should conduct a detailed records review before an evaluation of the project can be made. Refer to **Section 2.3 Project Files/Records Collection and Review** for more information.

### 8.2.2 Field Evaluation

A detailed field evaluation of the existing pavement condition and distresses is necessary for rehabilitation design. As a minimum, designers must consider the following as part of pavement evaluation:

- Existing pavement design, condition of pavement materials, especially durability problems, and subgrade soil
- Distress types present, severities, and quantities
- Future traffic loadings
- Climate
- Existing subdrainage facilities condition

It is important the existing pavement condition evaluation be conducted to identify functional and structural deficiencies to enable designers to select an appropriate combination of pre-overlay repair treatments, reflection crack treatments, and flexible overlay designs to correct the deficiencies present.

### 8.2.3 Visual Distress

Prior to the selection of corrective measures, the types of distress have to be identified and documented. A field inspection is mandatory in order to determine the pavement distress and condition. Isolating areas of distress can pinpoint different solutions for different sections along a project. The cause of distresses is not always easily identified and may consist of a combination of problems. **Figure 8.2 Pavement Condition Evaluation Checklist (Flexible)** provides guidance for existing pavement evaluation (a similar checklist is available in **Figure 9.2 Pavement Condition Evaluation Checklist (Rigid)** for rigid pavement). For information on how to conduct a distress survey refer to **APPENDIX A.4 Site Investigation**.

CDOT has a distress manual documenting pavement distress, description, severity levels and additional notes. The distress manual is presented in Appendix B - Colorado DOT Distress Manual for HMA and PCC Pavements in the publication *Development of a Pavement Maintenance Program for the Colorado Department of Transportation*, Final Report, CDOT-DTD-R-2004-17, August 2004. The report is in pdf format and can be downloaded from the web page <http://www.coloradodot.info/programs/research/pdfs/2004/preventivemaintenance.pdf>.

### 8.2.4 Drainage Survey

Condition of drainage structures and systems such as ditches, longitudinal edge drains, transverse drains, joint and crack sealant, culverts, storm drains, inlets, and curb and gutters are all important to convene water away from the pavement structure. Visual distress will reveal the types and extents of distresses present in the pavement that are either caused by or accelerated by moisture. Drainage assessment can also be benefitted by data obtained from coring and material testing.

### 8.2.5 Non-Destructive Testing, Coring, and Material Testing Program

In addition to a survey of the surface distress, a coring and testing program is recommended to verify or identify the cause of the observed surface distress. The locations for coring should be selected following the distress survey to assure all significant pavement conditions are represented. If NDT is used, the test data should be used to help select appropriate sites for additional coring.

The objective of coring is to determine material thicknesses and conditions. A great deal of information will be gained by a visual inspection of the cored material, however, it should be noted that the coring operation causes a disturbance of the material, especially along the cut face of asphaltic concrete material. For example, in some cases coring has been known to disguise the presence of stripping. Consequently, at least some of the asphalt cores should be split apart to check for stripping. The appropriate core diameter will be determined by the RME.

The testing program should be directed toward determining how the existing materials compare with similar materials that would be used in a new pavement, how the materials may have changed since the pavement was constructed, and whether or not the materials are functioning as expected. The types of tests to be performed will depend on the material types and the types of distress observed. A typical testing program may include strength tests for asphaltic concrete and portland cement concrete cores, gradation tests to look for evidence of degradation and/or contamination of granular materials, and extraction tests to determine binder contents and gradations of asphaltic concrete mixes. Portland cement concrete cores exhibiting durability problems may be examined by a petrographer to identify the cause of the problem. For flexible pavement evaluation, NDT testing is used to determine the elastic modulus of each of the structural layers, including subgrade, at non-distressed locations (see **APPENDIX C**).

## 8.3 Determine Cause and Mechanism of Distress

Knowing the exact cause of distress is a key input required by designers for assessing the feasibility of rehabilitation design alternatives and a critical element in M-E Design. An assessment of existing pavement conditions is performed using outputs from distress and drainage surveys, coring, and material testing. The observation should begin with a review of all information available regarding the design, construction, and maintenance history of the pavement, followed by a detailed survey to identify the type, amount, severity, and location of surface distresses. Some key distress types that are indicators of structural deficiencies are as follows:

- **Fatigue or Alligator Cracking** in the wheel paths. Patching and a structural overlay are required to prevent this distress from re-occurring.
- **Rutting** in the wheel paths
- **Transverse or Longitudinal Cracks** that develop into potholes

## PAVEMENT EVALUATION CHECKLIST (FLEXIBLE)

PROJECT NO.: \_\_\_\_\_ LOCATION: \_\_\_\_\_  
 PROJECT CODE (SA #): \_\_\_\_\_ DIRECTION: \_\_\_\_\_ MP \_\_\_\_\_ to MP \_\_\_\_\_  
 DATE: \_\_\_\_\_ BY: \_\_\_\_\_  
 TITLE: \_\_\_\_\_

### TRAFFIC

- Existing 18k ESAL/YR  
 - Design 18k ESAL

### EXISTING PAVEMENT DATA

- Subgrade (AASHTO) - Roadway Drainage Condition: (good, fair, poor)  
 - Base (type/thickness) - Shoulder Condition (good, fair, poor)  
 - Soil Strength (R/M<sub>R</sub>) -

### DISTRESS EVALUATION SURVEY

Type	Distress Severity*	Distress Amount*
Alligator (Fatigue) Cracking		
Bleeding		
Block Cracking		
Corrugation		
Depression		
Joint Reflection Cracking (from PCC Slab)		
Lane/Shoulder Joint Separation		
Longitudinal Cracking		
Transverse Cracking		
Patch Deterioration		
Polished Aggregate		
Potholes		
Raveling/Weathering		
Rutting		
Slippage Cracking		
OTHER		

\* *Distress Identification Manual for the Long-Term Pavement Performance Program*, U.S. Department of Transportation, Federal Highway Administration, Publication No. FHWA-RD-03-031, June 2003.

**Figure 8.2 Condition Evaluation Checklist (Flexible)**  
(A Restatement of Figure A.2)

- **Localized Failing Areas** where the underlying layers are disintegrating and causing a collapse of the asphaltic concrete surface, i.e. major shear failure of base course or subgrade, or stripping of the bituminous base course. This is a very difficult problem to repair and an investigation should be carried out to determine its extent. If the failure is not extensive, full depth patching and a structural overlay should remedy the problem. If the failure is too extensive for full depth patching, reconstruction or a structural overlay designed for the weakest area is required.
- **Other Types of Distress** that, in the opinion of the engineer, would detract from the performance of an overlay.

Depending on the types and amounts of deterioration present, rehabilitation options with or without pre-overlay treatments are to be considered. **Table 8.1 Common Distress Causes of Flexible Pavements and Associated Problem Types** presents a summary of distress causes on existing flexible pavements.

## 8.4 Define Problems and Inadequacies of Existing Pavement

Accurately identifying existing problems is a key factor when selecting appropriate rehabilitation design alternatives for the trial design. Information gathered and presented using the pavement condition evaluation checklist must be reviewed by the designer using guidance presented in **Table 8.1 Common Distress Causes of Flexible Pavements and Associated Problem Types** to define possible problems with the existing pavement. A review of the extent and severity of distresses present will allow the designer to determine if the existing pavement deficiencies are primarily structural, functional, or materials durability related. It also allows the designer to determine if there is a fundamental drainage problem causing the pavement to deteriorate prematurely.

Once an existing pavement deficiency is characterized (functional, structural, durability, or combination of these), the next step is to select feasible design alternatives and perform a trial design. A description of common pavement problem types are presented as follows:

- **Functional Deterioration:** Functional deficiency arises from any condition(s) that adversely affect the highway user, including poor surface friction and texture, hydroplaning and splash from wheel path rutting, and excess surface distortion. If a pavement has only a functional deficiency, it would not be appropriate to develop an overlay design using a structural deficiency design procedure. Overlay designs, including thickness, pre-overlay repairs, and reflection crack treatments, must address the causes of functional problems and prevent their recurrence. This can only be done through sound engineering, and requires experience in solving the specific problems involved. The overlay design required to correct functional problems should be coordinated with that required to correct any structural deficiencies.
- **Structural Deterioration:** This is defined as any condition that adversely affects the load carrying capability of the pavement structure. These include inadequate thickness, as well as cracking, distortion, and disintegration. It should be noted that several types



of distress (i.e. distresses caused by poor construction techniques), are not initially caused by traffic loads, but do become more severe under traffic to the point that they also detract from the load carrying capability of the pavement.

- **Material Durability Deterioration:** Any condition that negatively impacts the integrity of paving materials leading to disintegration and eventual failure of the materials. Research indicates that poor durability performance can be attributed to the existing pavement material constituents, mix proportions, and climatic factors (i.e. excessive moisture and intense freeze-thaw cycles). Examples of durability problems include AC stripping, aggregate damage from repeated freeze thaw cycles, secondary mineralization, embedded shale deposits, and alkali-aggregate.

**Table 8.1 Common Distress Causes of Flexible Pavements and Associated Problem Types**

Distress Types	Load	Environment			Materials	Construction
		Moisture	Temperature	Subgrade		
Alligator Cracking	P	C	C	C	C	C
Bleeding	C	N	C	N	P	C
Block Cracking and Contraction / Shrinkage Fracture	N	C	P	N	P	C
Corrugation	P	C	C	N	C	N
Depression	C	C	N	C	P	P
Edge Cracking	P	C	N	C	N	P
Transverse “Thermal” Cracks	N	N	P	N	P	C
Longitudinal Cracks in the Wheelpath	P	N	C	C	C	P
Longitudinal Cracks Outside the Wheelpath	N	N	P	C	P	P
Potholes	P	C	C	N	C	C
Pumping	P	P	C	C	N	N
Raveling and Weathering	N	C	C	N	P	C
Rutting	P	C	C	C	P	C
Shoving	P	C	C	C	P	N
Swelling and Bumps	N	P	C	C	P	N

**Notes:** P= Primary Factor; C= Contributing Factor; N= Negligible Factor.

## 8.5 Identify Possible Constraints

The feasibility of any type of overlay design depends on the following major considerations:

- Construction feasibility of the overlay
- Traffic control
- Materials and equipment availability

- Climatic conditions
- Construction problems such as noise, air and/water pollution, hazardous materials/waste, subsurface utilities, overhead bridge clearance, shoulder thickness and side slope extensions in the case of limited right-of-way, etc.
- Traffic disruptions

Designers must consider all of the factors listed above along with others not mentioned to determine whether a flexible overlay or reconstruction is the best rehabilitation solution for a given situation.

## 8.6 Select Feasible Strategy for Flexible Pavement Rehabilitation Trial Designs

### 8.6.1 Feasible AC Overlay Alternatives

AC overlays are a cost effective rehabilitation technique used to correct an existing pavement's functional and structural deficiencies. The type and thickness of the required overlay is based on an evaluation of present pavement conditions and estimates of future traffic. In general, the designer must apply the following rules when considering rehabilitation alternatives involving AC overlays:

- **When a pavement surface evaluation indicates adequate structural strength but the condition of the surface needs correction, a functional overlay may be used.** Surface conditions that may require correction include excessive permeability, surface raveling, surface roughness, rutting, and low skid resistance. **Table 8.2 List of Recommended Overlay Solutions to Function Problems** provides a list of recommended overlay solutions to functional problems. Thus, for an existing pavement deemed as primarily functional deficient, a minimal AC overlay (i.e. 1 to 2 inches) is recommended to remedy the problem.
  - **Note:** Leveling courses included as part of a rehabilitation strategy can be deemed as a functional overlay since their thickness varies along a project and does not improve the pavement's structural capacity. The thickness of the leveling course must, however, be sufficient to correct the functional deficiency.
  - **Note:** If an existing pavement has low to moderate distress, less than ½ inch rut depth, and good drainage and physical characteristics, then other cost effective treatments may be appropriate (i.e. heater scarification).
  - **Note:** If the existing pavement has low to moderate distress, rut depth between ½ inch and 1 inch, and good drainage and physical characteristics, a hot mix asphalt leveling course consisting of Grading SX, ST, or SF with smaller nominal aggregate size prior to the overlay may be a cost effective alternative.

For PCC pavements with minor functional or durability issues, thin asphalt overlays can be placed to correct surface distress. These overlays can range in thickness from the minimum 2 inch HMA overlay to a 3 inch overlay. Thin asphalt overlays are not to be placed over severely cracked, step faulted, shattered, or broken pavements.

**Table 8.2 List of Recommended Overlay Solutions to Functional Problems**

Functional Problem	Cause	Possible Overlay Solution
Surface Friction	Polishing or bleeding of surface	Thin overlay or micro-surfacing, milling maybe required
Hydroplaning	Wheel path rutting	Thin overlay or micro-surfacing, milling may be required
Surface Roughness	Distortion due to swells and heaves	Leveling overlay with varying thickness
Transverse and Longitudinal Cracking	Traffic load, climate and materials	Conventional overlay and full depth repair may remedy this problem
Potholes	Traffic load	Conventional overlay and full depth repair may remedy this problem
Raveling of the Surface	Climate and materials	Thin overlay or micro-surfacing or HIR
Raveling from Stripping	Inadequate freeze thaw resistance	Removal of entire layer affected by stripping

- **When a pavement surface evaluation indicates possible structural deficiencies.**

A more detailed analysis should be undertaken to determine the following:

- Do structural deficiencies exist?
- If so can the deficiency be corrected by an HMA overlay?
- Would the typical HMA overlay thickness be sufficient to accommodate predicted future traffic for the selected design period?

If the answer to all of the above questions is yes, then a thick HMA overlay to correct structural deficiencies is warranted. **Note:** a thick HMA overlay may be used to correct base or subgrade deficiencies, thus for pavements deemed as structurally deficient, a structural overlay thickness adequate to carry future traffic over the design period is needed. The HMA overlay lift thickness should be at least 2 inches when correcting structural deficiencies.

**Note:** Although structural HMA overlays can generally be used for all structurally deficient existing pavements, conditions where an HMA overlay is not considered feasible for existing flexible or semi-rigid pavements are listed as follows:

- The use of thick flexible pavement overlays that do not satisfy the structural requirements of the pavement structure.

- Existing stabilized base show signs of serious deterioration and requires a large amount of repair to provide a uniform support for the HMA overlay.
- Existing granular base must be removed and replaced due to infiltration and contamination of clay fines or soils, or saturation of the granular base with water due to inadequate drainage.

Thicker HMA overlays may be used to provide additional structural capacity for the existing PCC pavement. Minor slab repairs are required to mitigate the continuation of PCC slab deterioration before an HMA overlay is placed.

- **When the existing pavement shows severe rutting or distortion or is severely cracked**, total reconstruction may be warranted. Reflective cracking potential should be considered in making a determination whether to reconstruct or overlay the roadway. For example, excessive structural rutting indicates the existing materials lack sufficient stability to prevent rutting from re-occurring, or the amount of high-severity alligator cracking is so great that complete removal and replacement of the existing pavement surface layer is dictated.

Existing, worn-out PCC pavements are prone to reflection cracking when an HMA overlay is placed. Horizontal and vertical movements occurring within the underlying PCC layer cause reflection cracking. Reflection cracking can occur at any PCC joint or crack. Reflection cracking can be mitigated if the existing PCC slab is rubblized into fragments.

- **When the existing pavement has significant durability problems**, total reconstruction may also be warranted. For example, stripping in existing HMA layers may warrant those layers to be removed and replaced. Existing PCC pavements with reactive aggregates are expected to deteriorate even after an overlay is placed. In such situations, total reconstruction may be warranted.

### 8.6.2 Structural HMA Overlays

The AC overlay design in this Chapter provides an HMA overlay thickness to correct a structural deficiency. Conventional HMA or Stone Matrix Asphalt (SMA) overlays are similar to thin wearing course overlays. SMA overlays are a single operation of placing flexible pavement over existing flexible or rigid pavements. Generally, they are a thicker overlay than the thin wearing courses.

Thin preventive maintenance overlays or surface treatments can sometimes be placed to slow the rate of deterioration of pavements showing initial cracking, but do not exhibit any immediate structural or functional deficiency. Generally, preventive maintenance overlays should be done only on pavements with no obvious signs of major distress and have a Drivable Life (DL) of 6 years or more. This type of overlay includes thin flexible pavement and various surface treatments

that help keep out moisture. The overlays may be a thin wearing course over existing flexible or rigid pavements. Preventive maintenance overlays are generally single operations.

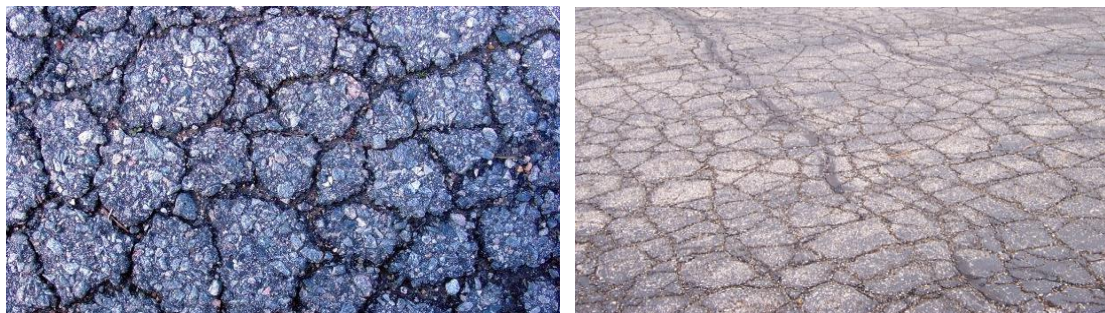
## 8.7 Proper Pre-Overlay Treatments and Other Design Considerations

Rehabilitation with conventional HMA overlays will only be effective if all significant deterioration in the existing HMA or PCC pavement is repaired prior to overlay placement. Although existing pavement deterioration is mostly manifested by visible distress at the surface, significant amounts of damage can exist in the subsurface which may not be visible at the surface. Subsurface pavement damage may be detected through destructive and nondestructive forensic evaluations. Non-Destructive Testing (NDT) using the deflection method is detailed in **APPENDIX C**. The designer should use a single or combination of corrective techniques that will provide the best overall solution to extend the pavement life. M-E Design does not consider pre-overlay treatments as part of the overlay design process; however, the designer will need to consider the effect of some applied treatments when characterizing the existing pavement.

### 8.7.1 Distress Types that Require Pre-Overlay Treatments

Regardless of the nature of existing damage and distress, all significant distresses and damage should be repaired before an overlay is placed. The following types of distress should be repaired prior to the overlay of flexible pavements. If they are not repaired, the service life of the overlay will be greatly reduced.

- **Alligator (Fatigue) Cracking:** All areas of high severity alligator cracking must be patched. Localized areas of medium severity alligator cracking should be patched unless a paving fabric or other means of reflective crack control is used. The patching must include removal of any soft subsurface material, refer to **Figure 8.4 Photos of Alligator (Fatigue) Cracking**.



Source: <http://www.driverknowledgetests.com> and <http://asphaltmanagementinc.com>

**Figure 8.3 Photos of Alligator (Fatigue) Cracking**

- **Longitudinal and Transverse Cracks:** High severity longitudinal and transverse cracks should be patched. Longitudinal and transverse cracks that are open greater than 0.25 inches should be filled with a sand asphalt mixture or other suitable crack filler. A method of reflective crack control is recommended for transverse cracks that experience significant opening and closing. Crack filling should be performed independently and at least one year in advance of an overlay operation to allow

sufficient curing time for the sealant. This is particularly important on overlays with thicknesses of 2 inches or less where tearing, shoving, and wash boarding can occur during the rolling operation due to crack filler material expanding into the fresh hot bituminous pavement, refer to **Figure 8.4 Photos of Longitudinal and Transverse Cracking**.



Source: <http://www.surface-engineering.net> and <http://asphaltmagazine.com>

**Figure 8.4 Photos of Longitudinal and Transverse Cracking**

- **Rutting:** Remove ruts by milling or placement of a leveling course. If rutting is severe, an investigation to determine which layer is causing the rutting should be conducted to determine whether an overlay is feasible, refer to **Figure 8.5 Photos of Rutting**.



Source: <http://i1.wp.com> and <http://www.pavementinteractive.org>

**Figure 8.5 Photos of Rutting**

- **Surface Irregularities:** Depressions, humps, and corrugations require investigation and treatment of their cause. In most cases, removal and replacement will be required, see **Figure 8.6 Photos of Irregularities**.



Source: <http://www.stmuench.com>, <http://www.roadscience.net>, and [http://1.bp.blogspot.com/s1600/IMG\\_0257.jpg](http://1.bp.blogspot.com/s1600/IMG_0257.jpg)

**Figure 8.6 Photos of Irregularities**

**Note:** Distress in the existing pavement is likely to adversely affect the performance of the overlay. Much of the deterioration that occurs is a result of not repairing the existing pavement. In such situations, an overlay would not contribute much to extending the drivable life of the existing pavement, thus, existing distress/damage should be repaired prior to overlay placement. The designer should also consider the cost tradeoffs of pre-overlay repair and overlay type. For example, if the existing pavement is severely deteriorated, selecting an overlay type less sensitive to the existing pavement condition may be more cost effective than an extensive pre-overlay repair (i.e. unbonded PCC overlays over an existing PCC pavement rather than a thick HMA overlay).

### 8.7.2 Pre-Overlay Treatments and Additional Considerations

Several pre-overlay repair types are routinely deployed to correct structural deficiencies prior to overlay placement. Selection of an appropriate pre-overlay treatment must be done only after a thorough evaluation of the existing pavement has been conducted. The evaluation process should include:

- A review of the historical construction data
- Inspecting the surface for severe distresses
- Checking the crown or cross slope for any drainage problems
- Taking cores at an approximate frequency of 2 cores per lane mile across the full width of the driving lanes to determine the following:
  - Rut depth prior to coring
  - Total thickness of HMA
  - In-place air voids
  - Moisture susceptibility
  - Depth to any paving fabric
  - Depth to next layer

Asphalt pavement rehabilitation includes the removal and replacement of a portion of the existing pavement. An example would be removing (by milling) the driving lane's wheel rutting and

recycling the removed material. Rehabilitation techniques may also include rejuvenation of the existing pavement prior to overlay (i.e. heater-scarify or cold recycle of the existing pavement to remove irregularities) rejuvenate an oxidized pavement, full depth patching, base removal and replacement, and the use of fabric should all be analyzed.

Corrective action for rutted pavements should consist of removal by milling. This process should be used instead of a leveling course whenever possible. The use of a leveling course should be restricted to applications where rut depths are minimal (less than ½ inch), or rutting is not a result of low stability. In-place recycling can be an acceptable alternative as part of a comprehensive rehabilitation action when addressing rutting.

### 8.7.3 Recycling the Existing Pavement

Recycling a portion of an existing flexible pavement layer may be considered an option in the design of an overlay. Complete recycling of the flexible pavement layer may sometimes be done in conjunction with the removal of a deteriorated base course. M-E Design considers recycled asphalt concrete materials as part of flexible overlay design. The options for recycling existing flexible pavements include:

- Cold In-Place Recycling (CIP)
- Hot In-Place Recycling (HIR)
- Full Depth Reclamation (FDR)

Details on characterizing recycled materials for M-E Design are presented in **Section 8.16.4.2 Characterization of Existing HMA Layer** and brief descriptions of pre-overlay treatments are presented in the following sections.

#### 8.7.3.1 Cold Planing or Milling

Cold planing or milling has been widely used for removing existing hot mix asphalt pavement in order to restore the surface to a specified grade and cross-slope free of imperfections. A decision to remove a portion of the present HMA should be based on sound economic and engineering principles. The need to remove all or part of the existing pavement should be evaluated for every project. The planing depth should be uniform throughout the project and go at least ½ inch into the underlying pavement layer. Planing should be used for the following reasons:

- Correct severe rutting in asphalt pavement due to low air voids
- Avoid areas where the existing pavement grade cannot be raised
- Remove moisture or rut susceptible mixes
- Eliminate a pavement mix problem, such as severe raveling, that should be removed rather than overlaid
- Create a butt joint to match the existing grade



The reasons for milling a rutted pavement before placing an overlay include the following:

- Milling removes low void materials from the wheel path. The minimum depth for milling should be  $\frac{1}{2}$  inch below the bottom of the wheel path. When the existing ruts are greater than  $\frac{1}{2}$  inch it is recommended that cores be taken during the design phase to establish the required removal depth. Milling should extend to a depth where the existing material has air voids in the range of 3 to 5 percent.
- Milling leaves a roughened surface that provides an excellent bond with the overlay. Milling machines with automatic grade control restore both longitudinal and transverse grade, thus improving the smoothness of the final overlay.
- Milling eliminates the need for leveling courses and problems associated with compacting material of varying width and thickness.

As a result of the grooves produced during milling, the pavement will have an increased surface area and additional tack coat is required to assure adequate bond.



Source: <http://www.phaltless.com>

**Figure 8.7 Photo of Milling of Old Asphalt**



Source: <http://www.phaltless.com>

**Figure 8.8 Photo of Asphalt After Milling**

It is important to remember that when milling, the designer must take into account the loss of structural value when material is removed. A structural replacement depth must be included to account for the removed material. This is in addition to the design depth required to satisfy traffic loadings. When preparing pavement rehabilitation that includes milling, the designer must determine the appropriate depth for milling, show the appropriate depth on the plans, and allow enough quantity for the structural replacement of the milled material in the surfacing requirements. The depth of milling is a critical input in M-E Design to account for the continuation of fatigue damage and rutting in the existing pavement structure. Refer to **Figure 8.7 Photo of Milling of Old Asphalt** and **Figure 8.8 Photo of Asphalt After Milling**.

Widths of the cold planers vary and a number of passes may be needed for a full width planed surface. The milled material may be hauled away and/or stockpiled for use in the HMA overlay. Traffic may be run on the exposed surface, however it is recommended to keep the surface exposed only for a short period. The duration of exposed surface depends on the traffic, location, and type of project. **Figure 8.9 Cold Planing of Existing Flexible Pavement**, **Figure 8.10 Schematic of Cold Planing Equipment** and **Figure 8.11 Photo Showing Equipment Used for Cold Planing** shows the layers and equipment used.

If the existing pavement has low to moderate distress, less than ½ inch rut depth, and good drainage, then other cost effective treatments may be appropriate such as heater scarification. If the existing pavement has low to moderate distress, rut depth between ½ inch and 1 inch, and good drainage, then a hot mix asphalt leveling course consisting of Grading SX, ST, or SF with smaller nominal aggregate size placed prior to the overlay may be a cost effective alternative.

Under some conditions, variable depth planing may be appropriate. An example is when planing is used to correct a crown or cross-slope problem. Circumstances have occurred when a layer was not completely removed by planing which leads to delamination under traffic and a rough ride quality prior to the overlay. The rut depth and HMA thickness information should be included on the plan and profile sheets or in tabular form to ensure proper planing depth throughout the project. Planing adjacent to vertical obstructions such as a guardrail and barrier wall is difficult with most equipment, therefore, it is recommended the designer specify a maximum clearance for the planing equipment. During the planing process, irregularities may occur before the area is overlaid with HMA, thus, it is recommended the designer include a separate HMA patching pay item for about 5 percent of the planing square yards. This HMA patching item should be paid by the ton. The designer should work closely with the Region Materials Engineer to ensure the crown or cross-slope is addressed in the design and to specify the proper HMA patching material.

#### **8.7.3.1.1 Cold In-Place Recycling (CIR) or Cold Central Plant Recycling (CCPR)**

Cold In-Place Recycling (CIR) allows one to recycle the asphalt pavement without the application of heat during the recycling process to produce a rehabilitated pavement. CIR treatment depth is typically within the 2 to 4 inch range using an emulsion. If lime is added to the recycled mix, they can be added in dry form or as slurry. The slurry method eliminates potential dust problems and permits greater control of the amount of recycling modifier being added. Input parameters for M-E Design are listed in Appendix F.

CIR uses a number of pieces of equipment including tanker trucks, milling machines, crushing and screening units, mixers, pavers, and rollers. There are different types of CIR trains with different equipment configurations. The trains differ from one another in how the RAP is removed and sized, how the recycling additives and modifiers are added, how they are mixed and controlled, and how the resultant mix is placed.

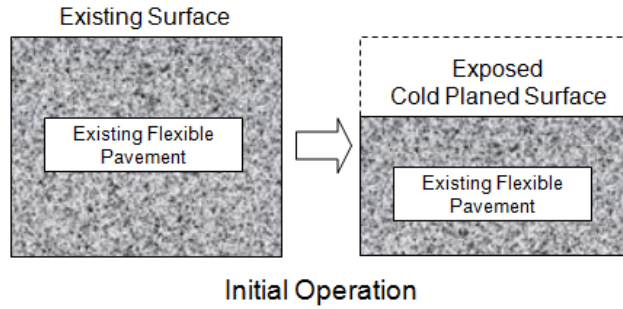
In a single unit CIR train, removal of the RAP is usually performed by a milling machine using a down cutting rotor. The maximum size of RAP can be kept less than 2 inches by controlling the forward speed. Additional sand mixing of the recycling additive is performed in the milling machine's cutting chamber. The placement of the recycled mix is performed with a screed attached to the back of the unit. A predetermined amount of recycling additive is added based on the treatment volume which is determined by the treatment width, depth, and the anticipated forward speed of the unit. This approach provides the lowest degree of process control, since the treatment volume and recycling additive application rate are not directly linked.

Two-unit CIR trains usually consist of a large full lane milling machine and a mix paver. The milling machine removes and sizes the RAP and deposits it into the mix paver. The mix paver has an infeed belt with belt scale and a processing computer to accurately control the amount of recycling additive and modifier being added. The mix pavers are equipped with scalping screens to remove oversized material. The mix paver contains a pugmill that mixes the materials and has an automatically controlled screed for mix placement and initial compaction. The liquid recycling additives are added based on the weight of RAP being processed, independent of the treatment width, depth, and forward speed of the train. The two-unit train provides an intermediate to high degree of process control since the treatment volume and the recycling additive application rates are directly linked. (2)

Densification of CIR mixes requires more compactive energy than conventional HMA. This is due to the high internal friction developed between the mix particles, the higher viscosity of the binder due to aging, and colder compaction temperatures. Compaction is usually achieved with a large sized pneumatic-tire roller and vibrating steel drum rollers. The mixes are compacted as the mixture begins the "break" turning from brown to black. When asphalt emulsions or emulsified recycling additives are used, this could take from 30 minutes to 2 hours, depending on the characteristics of the asphalt emulsion, thickness of the CIR mix, and environmental conditions. The compacted CIR mixture must be adequately cured before a wearing surface is placed. The rate of curing is quite variable and depends on several factors, including environmental conditions drainage, and moisture characteristics of the mix. Typical curing periods are several days to 2 weeks, depending on the aforementioned factors, the recycling additive and any modifiers used.

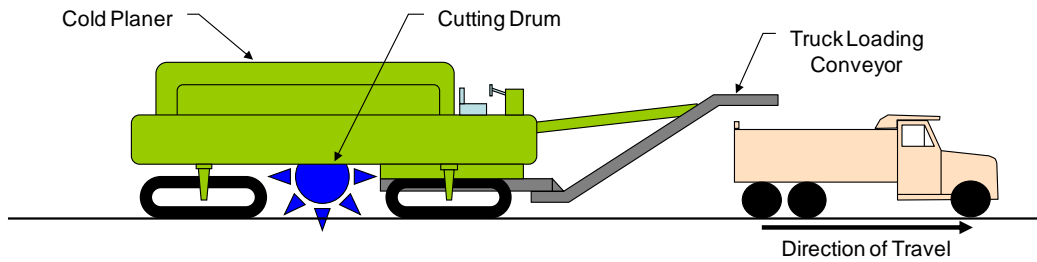
### **8.7.3.2 Types of Hot In-Place Recycling (HIR)**

CDOT uses three HIR processes to correct surface distresses of structurally adequate flexible pavements. These HIR processes include heating and scarifying, heating and remixing, and heating and repaving. To date, heating and scarifying is a standard specification and the other two processes are project special provisions.

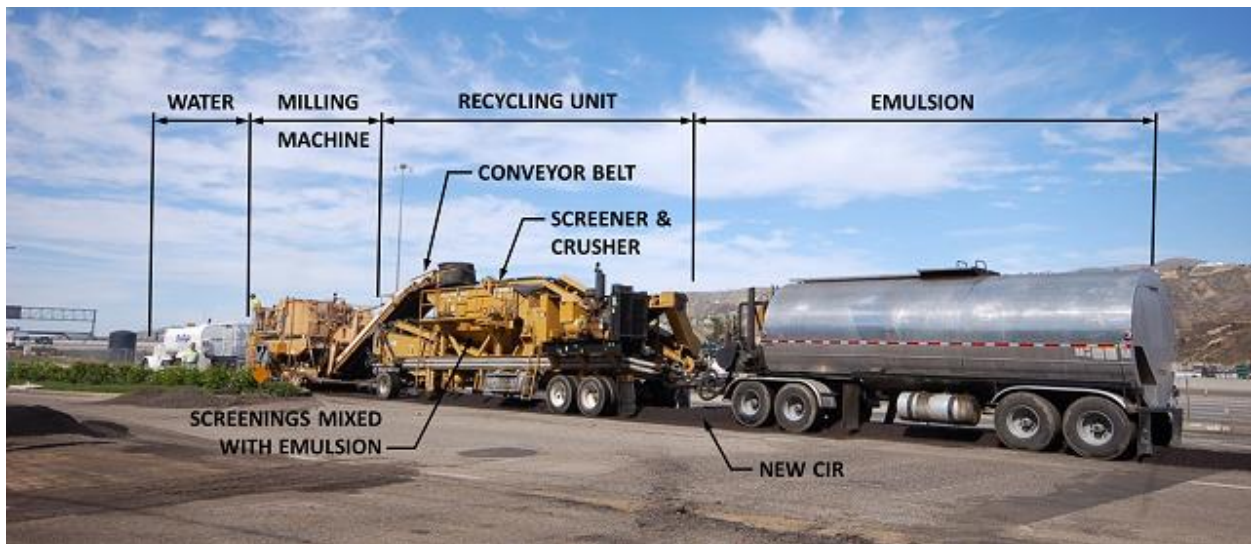


Cold planing is the removal of the top portion of existing flexible pavement. The material is removed and stockpiled.

**Figure 8.9 Cold Planing of Existing Flexible Pavement**



**Figure 8.10 Schematic of Cold Planing Equipment**



Source: <http://dpw.lacounty.gov>

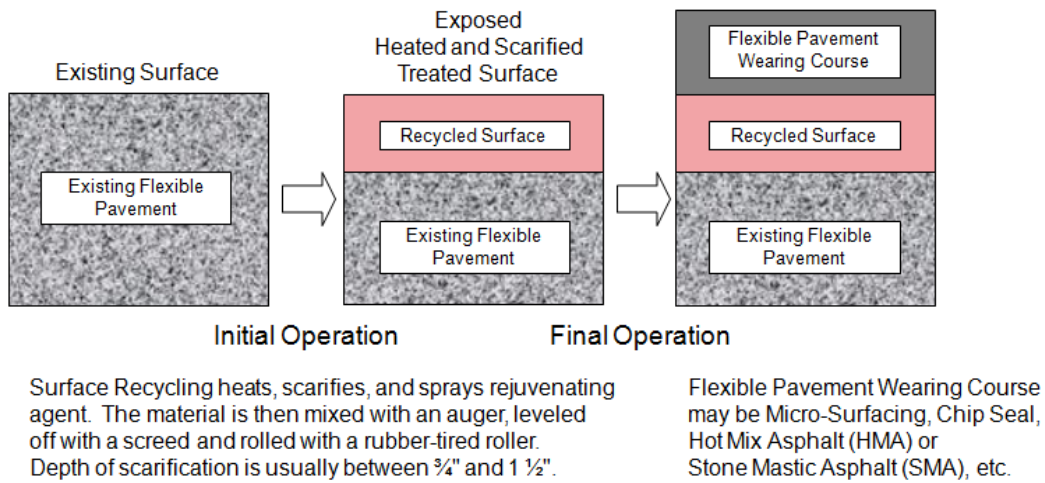
**Figure 8.11 Photo Showing Equipment Used for Cold Planing**

### 8.7.3.2.1 Surface Recycling (Heating and Scarifying Treatment)

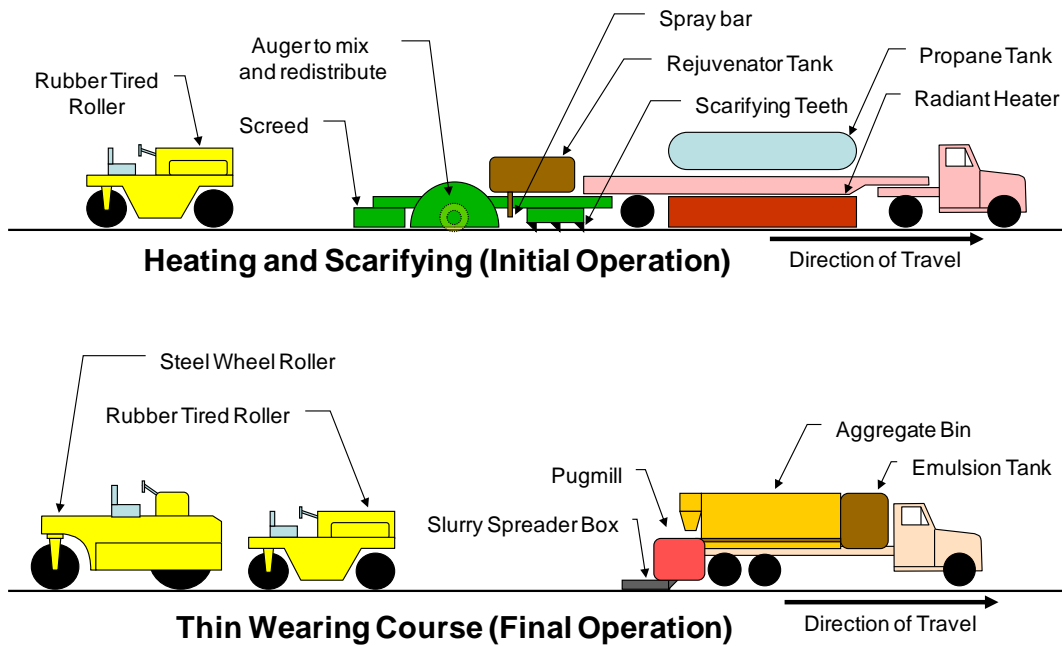
The existing pavement is heated, scarified, sprayed with a rejuvenating agent, mixed with an auger, leveled off with a screed, and rolled with a rubber-tired roller. The depth of scarification usually specified for the surfacing recycling process is between  $\frac{3}{4}$  and  $1\frac{1}{2}$  inches with 1 inch being most common. A tack coat may be required if another layer of HMA will be added after surface recycling. This process normally requires a wearing course which must be calculated separately from the surface recycling process. Normally, the wearing course is placed by a paving supplier/contractor. Grinding may be required since the surface smoothness is not controlled and the heating and scarifying may make the surface rough and/or a varied the cross-slope. Projects with tight curves may require grinding. See **Figure 8.12 Surface Recycling Layers** and **Figure 8.13 Schematic of Surface Recycling Equipment**, **Figure 8.14 Photo of Heating Scarifying Equipment (Initial Operation)** and **Figure 8.15 Photo of Heater Section of the Equipment Train**.

- **Preliminary Engineering Job-Mix Formula:** CDOT will perform a preliminary engineering job-mix formula for estimating purposes. Cores will be obtained to verify the mat thickness and materials to be surface recycled. Cores can be categorized into like pavement materials, and a design should be performed on each set of similar samples. It is necessary to obtain 50 pounds of sample material per mix design. The mix design will be performed as per Colorado Procedure CP-L 5140.
- **Contractor Job-Mix Formula:** The contractor must submit a job-mix formula as per Colorado Procedure CP 52, a list of materials, and target values to be used on the project to the Region Materials Engineer at least one week prior to the start of construction. A duplicate copy of the job-mix formula, list of materials, and target values to be used should be sent to the Materials and Geotechnical Branch.
- **Structural Design:** Design structural requirements will be met for engineering applications, and a minimum 2 inch overlay thickness will be used in conjunction with the surface recycling. For maintenance applications, a minimum of 55 pounds per square yard of additional HMA is recommended, or a chip seal coat may be used as a wearing surface.
- **Construction Considerations:** The surface recycling is generally not performed through more than one lift of the existing mat. Geotextile fabrics should not be present within the top 2 inches of the existing pavement structure prior to the remixing process. In addition, geotextile fabrics should not be installed within the top 2 inches of the new pavement structure. Surface recycling can be performed either full width or in the driving lanes only. Traffic control for the paving trains must be taken into consideration. Surface recycling usually requires two separate paving operations, one for the recycling and the other for the wearing course. It is recommended the wearing course be placed within 7 days after surface recycling. For engineering applications, the type and the amount of rejuvenating agent will be determined as per Colorado Procedure CP-L 5140. Controlling the application rate

is very important to the success of this treatment, so education of project personnel on the use of the data is very important.



**Figure 8.12 Surface Recycling Layers**



**Figure 8.13 Schematic of Surface Recycling Equipment**



Source: <http://www.pavementinteractive.org>

**Figure 8.14 Photo of Heating Scarifying Equipment (Initial Operation)**



Source: <http://www.cutlerrepaving.com>

**Figure 8.15 Photo of Heater Section of the Equipment Train**

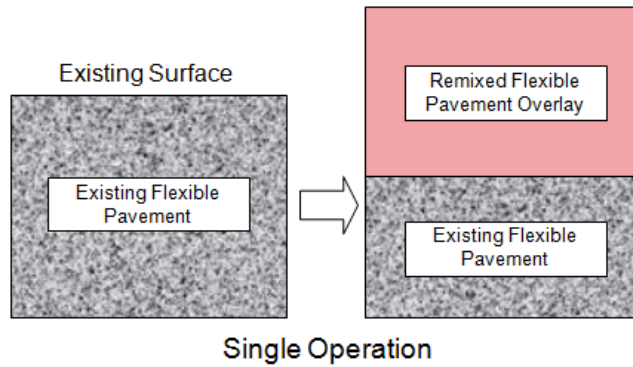
#### **8.7.3.2.2 Remixing (Heating and Remixing Treatment)**

The remixing process heats, mills, and removes 1½ to 2 inches of the existing pavement, and adds a rejuvenating agent, virgin aggregate or new HMA. All materials are mixed in a pug mill to form a single, homogenous mix. A remixing process sometimes occurs when additional aggregates are needed for strength and stability. Treatment depths for the single stage method are generally between 1 and 2 inches with 1½ inches being most common. No tack coat is required for the single

operation. Treatment depths for the multiple stage method are between 1½ and 3 inches with 2 inches being the most common. Each succeeding multiple stage operation remixes the layer below the previously worked layer that has been stockpiled into a windrow. This process requires grade control on the laydown machine. See **Figure 8.16 Remixing Layers**, **Figure 8.17 Schematic of Remixing Equipment**, and **Figure 8.18 Photo of Remixing Equipment**.

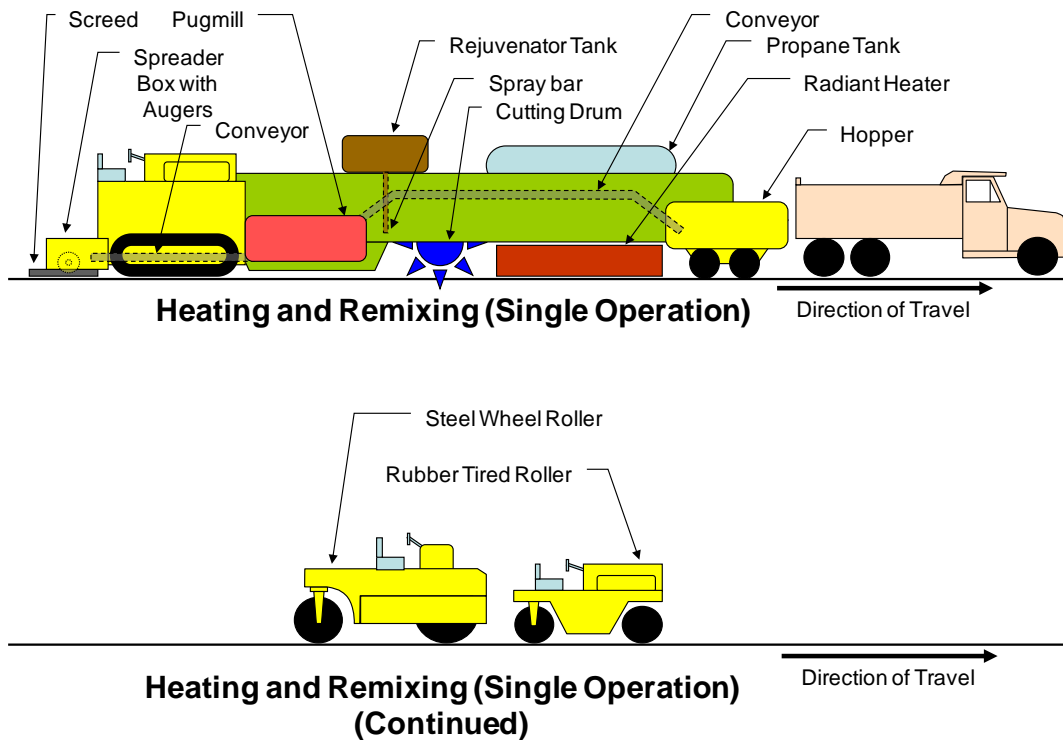
- **Preliminary Engineering Job-Mix Formula:** CDOT will perform a preliminary engineering job-mix formula for estimating purposes. Cores will be obtained to verify the mat thickness and materials to be recycled. Cores can be categorized into like pavement materials and a design should be performed on each set of similar samples. It is necessary to obtain 50 pounds of sample material per mix design. The mix design will be performed as per Colorado Procedure CP-L 5140.
- **Contractor Job-Mix Formula:** CDOT Form #43, per Colorado Procedure CP 52, reviewed and approved by the Region Materials Engineer will be executed between the Engineer and the Contractor to establish the job-mix formula one week prior to construction. The Contractor must send a duplicate copy of the executed Form #43 to the Materials and Geotechnical Branch.
- **Structural Design:** For engineering and maintenance applications, the design structural requirements will be met. The remixing process is generally followed by a 2 inch overlay or other surfacing materials.
- **Construction Considerations:** Geotextile fabrics should not be present within the top 2 inches of the existing pavement structure prior to the remixing process, or within the top 2 inches of the new pavement structure. The remixing process can be performed either full width or in the driving lanes only. If only the driving lanes are remixed and the resulting lane/shoulder drop off is 1 inch or less, the drop off may be tapered for safety consideration. Traffic control for a long paving train must also be taken into consideration, as such the process of remixing requires only one paving operation. The remixing process may be performed through multiple layers by using multiple stages. For engineering applications, the type and amount of virgin aggregate, asphalt cement, and rejuvenating agent will be determined as per Colorado Procedure CP-L 5140. The typical additional mix rates are 30 to 70 pounds per square yard of HMA, with 50 pounds per square yard being the most common. Controlling the application rate and grade is very important to the success of this treatment, so education of project personnel on the use of the data is very important. The job-mix formula for the complete mix will be as per the Contractor Mix Design Approval Procedures (Colorado Procedure CP 52). The amount of virgin aggregate, and/or HMA added should only be that amount required to offset longitudinal and transverse surface irregularities and surface inundations to provide a rideable surface. A chip seal may be supplied as a wearing surface for maintenance applications, and an overlay for structural applications.





Remixing is a process that heats, plans (mills) and removes 1 ½" to 2" of the existing pavement, then adds in rejuvenating agent, virgin aggregate or new hot mix asphalt (HMA). All materials are mixed in a small mobile pug mill to form a single, homogenous mixture. The operation is simultaneously performed in a paving train operation. The overlay mixture is compacted with a roller.

**Figure 8.16 Remixing Layers**



**Figure 8.17 Schematic of Remixing Equipment**



Source: <http://blogsdir.cms.rrcdn.com> and <http://media.wirtgen-group.com>

**Figure 8.18 Photos of Heating and Remixing Equipment**

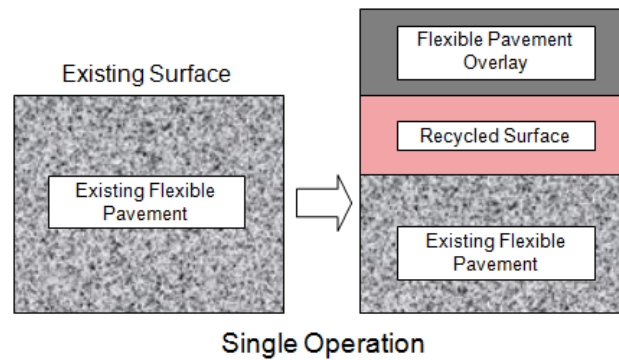
### **8.7.3.2.3 Repaving (Heating and Repaving Treatment)**

This process combines surface recycling with a simultaneous thin overlay of new hot mix asphalt. When placed simultaneously, a strong thermal bond is formed between the two layers. The depth of scarification usually specified for the surfacing recycling process is between  $\frac{3}{4}$  and  $1\frac{1}{2}$  inches with 1 inch being most common and a 1 to 2 inch integral overlay thickness is used. No tack coat is required for this single operation. This process requires grade control on the laydown machine. See **Figure 8.19 Repaving Layers**, **Figure 8.20 Schematic of Repaving Formula**, and **Figure 8.21 Photo of Hot Mix Paving (Single Operation) Equipment**.

- **Preliminary Engineering Job-Mix Formula:** CDOT will perform a preliminary engineering job-mix formula for estimating purposes. Cores will be obtained to verify the mat thickness and materials to be surface recycled. Cores can be categorized into like pavement materials, and a design should be performed on each set of similar samples. It is necessary to obtain 50 pounds of sample material per mix design. The mix design will be performed as per Colorado Procedure CP-L 5140.
- **Contractor Job-Mix Formula:** CDOT Form #43, per Colorado Procedure CP 52, reviewed and approved by the Region Materials Engineer will be executed between the Engineer and the Contractor to establish the job-mix formula one week prior to construction. The Contractor must send a duplicate copy of the executed Form #43 to the Materials and Geotechnical Branch.
- **Structural Design:** The design structural requirements will be met for structural and maintenance applications so as to take advantage of the thermal bond this process creates. For maintenance applications, a minimum of 110 pounds per square yard of additional HMA is recommended. For structural applications, a minimum of 165 pounds per square yard of additional HMA is recommended.

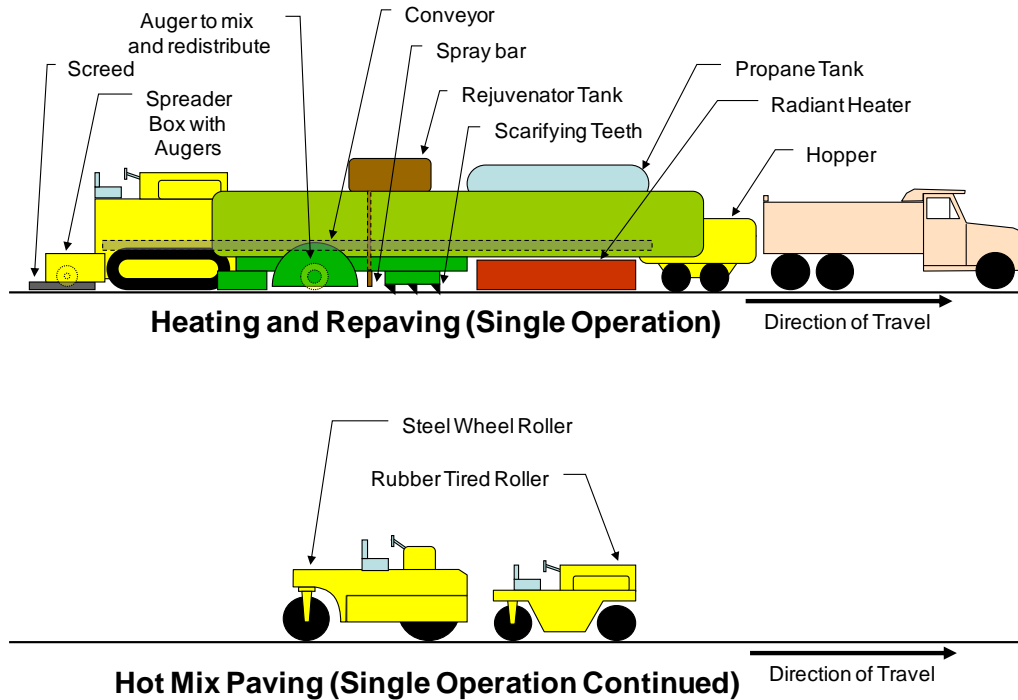
- **Construction Considerations:** The repaving method is generally not performed through more than one lift of the existing mat. Geotextile fabrics should not be present within the top 2 inches of the existing pavement structure prior to the repaving process, or within the top 2 inches of the new pavement structure. Repaving can be performed either full width or in the driving lanes only. If only the driving lanes are repaved and the resulting lane/shoulder drop off is 1 inch or less, the drop off may be tapered for safety consideration. Traffic control for a long paving train must be taken into consideration. Since the recycling and paving operation are done simultaneously, the process requires only one paving operation. The maximum repaving and overlay thickness should not exceed a total of 3 inches. For engineering applications, the type and the amount of rejuvenating agent will be determined as per Colorado Procedure CP-L 5140. Controlling the application rate and grade is very important to the success of this treatment, so education of project personnel is very important.

Job-mix formula for the virgin mix will be as per the Contractor Mix Design Approval Procedures (Colorado Procedure CP 52). It should be noted that when 220 pounds per square yard are added to the recycled mix, the driving lane would be approximately two inches higher than the shoulder. For safety consideration, the grade of the shoulder should be raised to match the repaved areas.



Repaving is the process of heating, scarifying, adding rejuvenating agent and mixing of the surface. A new hot mix asphalt overlay is placed over the heated recycled surface. These two operations are done simultaneously in a paving train operation. A strong thermal bond is formed between the two layers. The overlay is compacted with a roller. Depth of scarification is usually between  $\frac{3}{4}$ " and  $1\frac{1}{2}$ ".

**Figure 8.19 Repaving Layers**



**Figure 8.20 Hot Mix Paving (Single Operation Continued)**



Source: <http://www.fhwa.dot.gov>

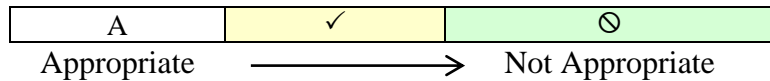
**Figure 8.21 Photo of Hot Mix Paving (Single Operation) Equipment**

### 8.7.3.3 Selecting the Appropriate Hot In-Place Recycling Process

**Table 8.3 Selection Guidelines for HIR Process Distress-Related Considerations** provides a general guideline for the preliminary selection of candidate recycling or reclamation methods for the rehabilitation of asphalt pavements.

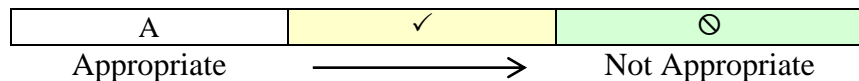
**Table 8.3 Selection Guidelines for HIR Process Distress-Related Considerations**

Pavement Distress Mode	Candidate HIR Process		
	Remixing	Repaving	Surface Recycling
Raveling	A	A	A
Potholes	A	A	✓
Bleeding	A	✓	✓
Skid Resistance	✓	A	⊘
Rutting	A	✓	✓
Corrugations	A	✓	✓
Shoveling	A	✓	✓
Fatigue Cracking	A	A	⊘
Edge Cracking	A	A	⊘
Slippage Cracking Block Cracking Long./Trans./Reflect. Cracking	A	A	✓
Swells, Bumps, Sags, Depressions	A	✓	✓
Marginal Existing Pavement Strength	✓	✓	⊘



**Non-Distress Related Considerations**

Initial Cost <sup>1</sup>	Remixing <sup>2</sup> \$3.75 - \$4.75 SY	Repaving <sup>3</sup> \$1.80 SY	Surface Recycling <sup>4</sup> \$1.43 SY
User Costs	See Section 13.5.6	See Section 13.5.6	See Section 13.5.6
Minimum Turning Radius Greater than 500 Feet	A	A	A
Minimum Turning Radius Less than 500 Feet.	⊘	⊘	A



<sup>1</sup> The initial cost does not include the cost of any succeeding pavement layer that will be required to complete the work. The cost of any additional pavement overlay to be installed after each hot in-place recycling process should be considered in the cost evaluation step.

<sup>2</sup> Price is only for the process mat

<sup>3</sup> Price is for full depth reclamation patching

<sup>4</sup> Price is for cold in-place recycling, process mat

**8.7.4 Reflection Crack Control**

The basic mechanism of reflection cracking is strain concentration in the overlay due to movement in the vicinity of existing surface cracks. This movement may be bending or shear induced by loads, or may be horizontal contraction induced by temperature changes. Load induced

movements are influenced by the thickness of the overlay, and/or the thickness and stiffness of the existing pavement. Temperature induced movements are influenced by daily and seasonal temperature variations, the coefficient of thermal expansion of the existing pavement, and the spacing of cracks.

Reflection cracks are a frequent cause of overlay deterioration. Some overlays are less susceptible to reflection cracking than others because of their materials and design. Similarly, some reflection crack control measures are more effective with some pavement and overlay types than others. Additional steps must be taken to reduce the occurrence and severity of reflection cracking.

Pre-overlay repair (i.e., patching and crack filling, and heater scarifying) may help delay the occurrence and deterioration of reflection cracks. Additional reflection crack control measures that have been beneficial in some cases include the following:

- Removal of the pavement by milling or planing. Specific distresses are reduced or eliminated by removal of the pavement.
- Crack relief layers greater than 3 inches thick have been effective in controlling reflection of cracks subject to large movements. These crack relief layers can be achieved with cold recycling techniques.
- Crack filling at least one year prior to the overlay
- Stress absorbing membrane interlayer

The long term benefits of non-woven synthetic fabrics have been shown to be none beneficial as a crack resistance interlayer between the old pavement and new overlay. They generally retard the cracks from propagating into the new overlay; however, the cracks will usually reappear within a few years. Encountering the non-woven synthetic fabric interlayer has caused production problems in most subsequent rehabilitation strategies (i.e. cold planing, hot-in-place recycling processes, etc.). Due to these adverse effects, it is not recommended to use non-woven synthetic fabrics as a pre-overlay repair method.

### **8.7.5 Pavement Widening**

Many overlays are placed in conjunction with pavement widening when either adding lanes or adding width to a narrow lane. This situation requires coordination between the design of the widened pavement section and the overlay so the surface of both sections will be structurally and functionally adequate. Many lane-widening projects have developed serious deterioration along the longitudinal joint due to improper design.

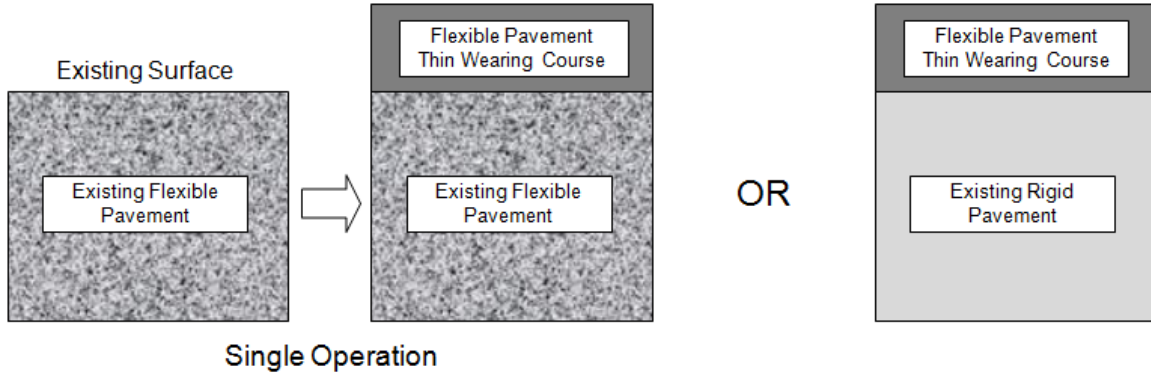
Key design recommendations are as follows:

- The design lives of both the overlay and the new widening construction should be the same to avoid the need for future rehabilitation at significantly different ages.
- The widened cross section should generally closely match the existing pavement or cross section in material type and thickness. Widening which will carry traffic, will be fully stabilized in accordance with standard procedures for new construction.

- The overlay should generally be the same thickness over the widening section and the traffic lane.
- Longitudinal subdrainage may be placed along the outer edge of the widened section if needed.
- When a pavement is widened to the outside, the designer must be careful when placing a deeper pavement section outside the existing pavement section. By placing a deeper pavement section outside of the existing section, drainage under the pavement may be impeded and a bathtub effect where excess water is retained may result.
- Many times in an urban setting, a widened outside lane becomes a future through lane. The designer must balance the immediate traffic needs with the possibility that in the future the lane will become a through lane. The through lane may extend for a couple of blocks to a full corridor length. In either case, it is likely it will need to handle heavy loads such as trucks and buses.
- The design subgrade resilient modulus value should be reviewed; specifically verify the resilient modulus is consistent with that incorporated into the flexible pavement design equation.

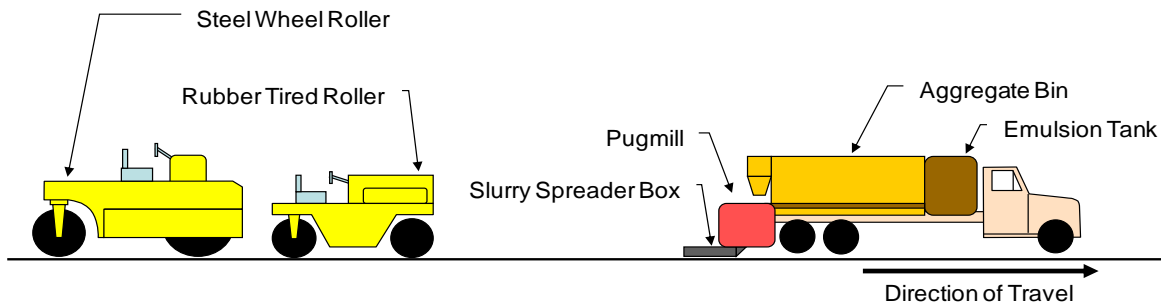
### 8.7.6 Preventive Maintenance

Preventive maintenance overlays and surface treatments are sometimes placed to slow the rate of pavement deterioration showing initial cracking but do not exhibit any immediate structural or functional deficiency. Generally, **preventive maintenance overlays should be done only on pavements with no obvious signs of major distress and have a Drivable Life (DL) of 6 years or more.** This type of overlay includes thin flexible pavement and various surface treatments that help keep out moisture. Preventive maintenance overlays are generally single operations. The overlays may be a thin wearing course over existing flexible or rigid pavements as shown in **Figure 8.22 Thin Wearing Course Treatment Layer**. Equipment of a slurry type operation is shown in **Figure 8.23 Schematic of Thin Wearing Course**. The types of rollers depend on the surface course being laid.



Flexible Pavement Thin Wearing Course  
may be Micro-Surfacing, Chip Seal,  
thin Stone Mastic Asphalt (SMA), etc.

**Figure 8.22 Thin Wearing Course Treatment Layer**

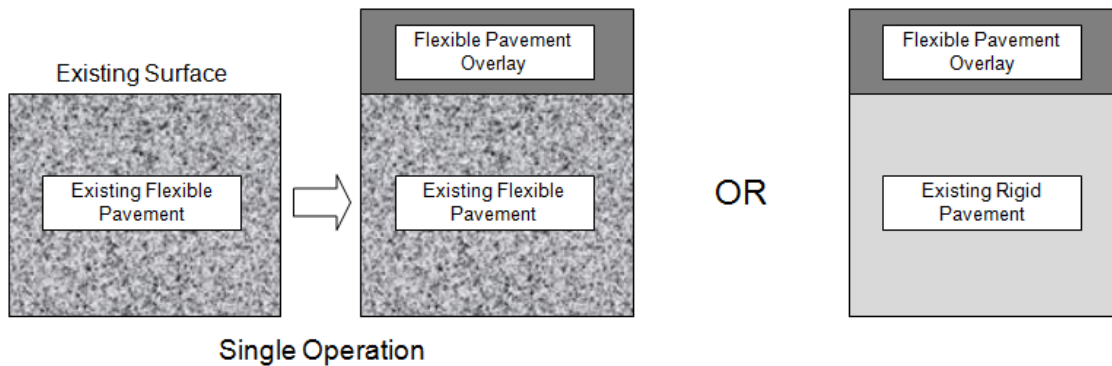


**Figure 8.23 Schematic of Thin Wearing Course Equipment**

## 8.8 Conventional Overlay

Conventional Hot Mix Asphalt (HMA) or Stone Matrix Asphalt (SMA) overlays are similar to the thin wearing course overlays. These overlays consist of a single operation of placing flexible pavement over existing flexible or rigid pavements. Generally, they are a thicker overlay than the thin wearing courses. **Figure 8.24 Conventional Hot Mix Asphalt (HMA) Layer, Figure 8.25 Photo of a Conventional HMA Overlay, Figure 8.26 Schematic of Conventional HMA Paving Equipment and Figure 8.27 Photos of Typical HMA Overlay Equipment (Truck with Spreader and Roller)** show the layers and equipment used. The type and number of rollers are dependent on the type of mix being placed.





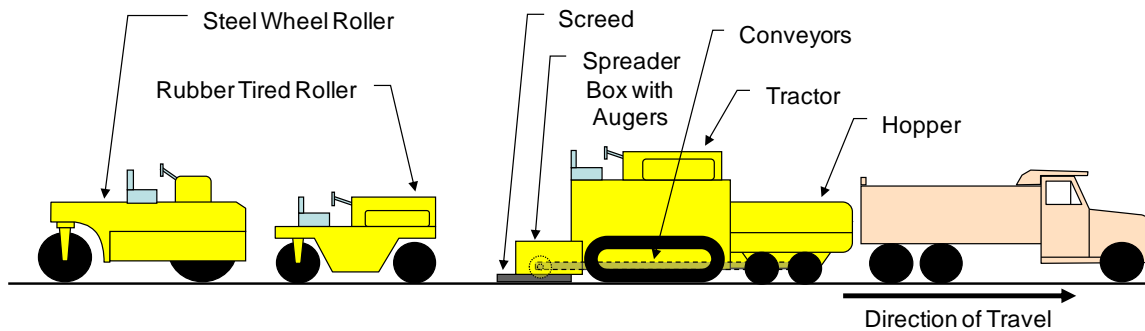
Flexible Pavement Overlay  
may be either Hot Mix Asphalt (HMA)  
or Stone Matrix Asphalt (SMA).

**Figure 8.24 Conventional Hot Mix Asphalt (HMA) Layer**



Source: <http://tti.tamu.edu>

**Figure 8.25 Photo of a Conventional HMA Overlay**



**Figure 8.26 Schematic of Conventional HMA Paving Equipment**



Source: <http://blackdiamondpaving.com> and <http://www.pavementinteractive.org>

**Figure 8.27 Photos of Typical HMA Overlay Equipment (Truck with Spreader and Roller)**

## 8.9 Existing Portland Cement Concrete Slab

The durability of an existing PCC slab greatly influences the performance of asphaltic concrete overlays. If reactive aggregate exists, the deterioration of the existing slab can be expected to continue after an overlay. The overlay must be designed with progressive deterioration of the underlying slab in mind.

### 8.9.1 Flexible Overlay on Rigid Pavement

A flexible overlay over an existing rigid pavement (also known as "blacktopping") is a significant and often used rehabilitation strategy. This type of rehabilitation represents the category in which overlay requirements is least known. Since the existing PCC pavement is usually cracked when an asphalt overlay is considered, the pavement structure is neither "rigid" nor "flexible" but in a "semi-rigid" condition. Even after the overlay is placed, cracking of the PCC pavement layer may increase, causing the rigidity of the overall pavement to approach a more flexible condition with time and traffic. When a designer places a HMA overlay on top of an existing concrete layer, fatigue cracking is nearly eliminated; however, the thermal cracking is greatly increased.

Thin asphalt overlays are used primarily to correct surface distress such as rutting, reactive aggregate, etc. These overlays can range in thickness from 2 to 3 inches. In some cases, a leveling course may be required. Thin asphalt overlays are not to be placed over severely cracked, step faulted, shattered, or broken pavements. An advantage of thin (less than 2 inches) overlays is that the clearance and roadside improvements associated with thick overlays are usually not necessary.

Thicker asphalt overlays are used to provide additional structural capacity for the existing pavement. Since the principal causes of cracking in an overlay are thermal contractions and expansions and vertical differential deflections of the underlying slabs, some effort must be made to mitigate these stresses. Differential deflections at cracks or joints are considered to be more

critical due to the quicker loading rate. The designer must consider the reflective cracking potential of the asphalt overlay over the existing rigid pavement.

At present, there are several techniques which minimize or eliminate reflective cracking distress, they are:

- Use of thick ( $\geq 2$  inches) asphalt overlays
- Crack and seal the existing pavement followed by an overlay
- Saw cutting matching transverse joints in overlay
- Use of crack relief layers
- Stress-absorbing membrane interlayer with an overlay
- Fabric/membrane interlayers with an overlay
- Rubblization

Additional design and cost considerations such as vertical clearance at structures, drainage modifications, and increasing the height of railings and barriers need to be considered when evaluating thick asphalt overlays. Design thickness will be rounded up to the next  $\frac{1}{4}$  inch increment.

## 8.10 Overlay Using Micro-Surfacing

Micro-surfacing is a thin surface pavement system composed of polymer modified asphalt emulsion, 100 percent crushed aggregate, mineral filler, water, and field control additives. It is applied at a thickness of 0.4 to 0.5 inches as a thin surface treatment primarily to improve the surface friction characteristics while producing a smooth wearing surface. Its other major use is to level wheel ruts on moderate and high volume roads. The treatment has also been used to address pavement distresses such as flushing, raveling, and oxidation. Micro-surfacing is used to improve the functional condition, not the structural condition (load carrying capacity) of a roadway, and has shown promising results in protecting the existing pavement. It is estimated to extend the service life 4 to 7 years which is particularly useful where a significant increase in thickness is not desired, such as curb and gutter sections. Micro-surfacing can be feathered out to the maximum mix aggregate size without edge raveling and can generally be opened to traffic within one hour of placement. Refer to **Figure 8.28 Photo Showing Micro-Surfacing** and **Figure 8.29 Photo Showing Micro-Surfacing Equipment**. It is particularly suitable for high volume roads and urban areas. See *Revision of Section 409 and 702 - Micro-Surfacing of the Sample Project Special Provision* for complete specifications related to micro-surfacing. <http://www.coloradodot.info/business/designsupport/construction-specifications/2011-Specs/sample-construction-project-special-provisions>

Micro-surfacing can be used to address the following types of conditions as described in the *Distress Identification Manual for the Long Term Pavement Performance Project* (SHRP-P-38) published by the Strategic Highway Research Program (SHRP), National Research Council:

- **Cracking:** Low severity cracking of any form including longitudinal, transverse or alligator. Micro-Surfacing will not stop reflective cracking.

- **Raveling/Abrasion:** Low to moderate severity levels (check existing pavement moisture resistance before specifying micro-surfacing).
- **Bleeding/Flushing:** Low to moderate severity levels (check existing pavement moisture resistance before specifying micro-surfacing).

Use a rut box followed by a wearing course when rutting is less than 1 inch in depth, where no plastic flow is occurring, and for rutting caused by compaction of the existing mat, inadequate subgrade up to 3 inches deep, or an unstable asphalt mat.

Fill ruts with multiple passes using a rut box with maximum  $\frac{3}{4}$  inch layers on asphalt or concrete pavements prior to an overlay. A  $\frac{1}{8}$  to  $\frac{1}{4}$  inch crown is recommended for ruts over 1 inch to compensate for initial compaction.



Source: <http://dpw.lacounty.gov>

**Figure 8.28 Photo Showing Micro-Surfacing**



Source: <http://dpw.lacounty.gov>

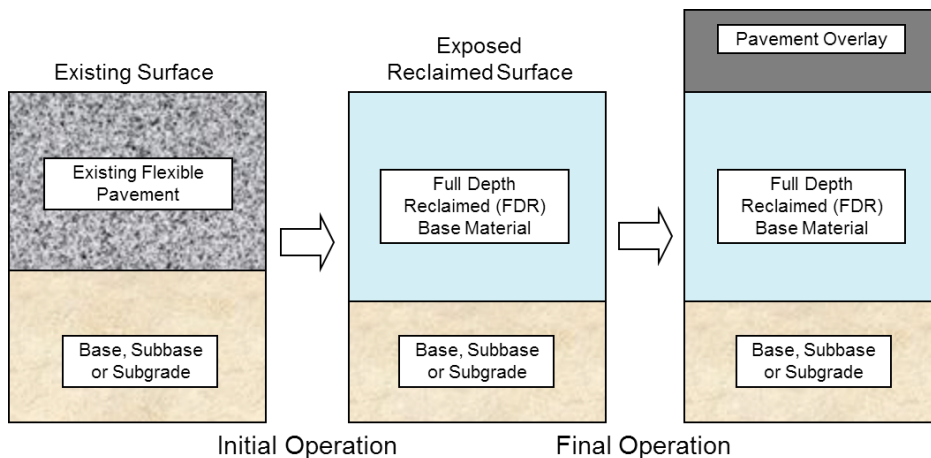
**Figure 8.29 Photo Showing Micro-Surfacing Equipment**

## 8.11 Full Depth Reclamation (FDR)

Full Depth Reclamation (FDR) is a rehabilitation or a reconstruction technique in which the full thickness of asphalt pavement and a pre-determined portion of the underlying materials (base, subbase, and/or subgrade) are uniformly pulverized and blended to provide a homogeneous material without the use of heat (2). FDR is a two-phase operation. The first operation is to create the base material. Temporary traffic maybe placed on the roadway after this operation. The final operation is to place an overlay on top of the base material. For pavement design, the full depth reclaimed material is considered a base material. See **Figure 8.30 Full Depth Reclamation (FDR) Layers**, **Figure 8.31 Schematic of FDR Equipment**, and **Figure 8.32 Photo Showing FDR Equipment**.

Designers using M-E Design should use the following recommendations:

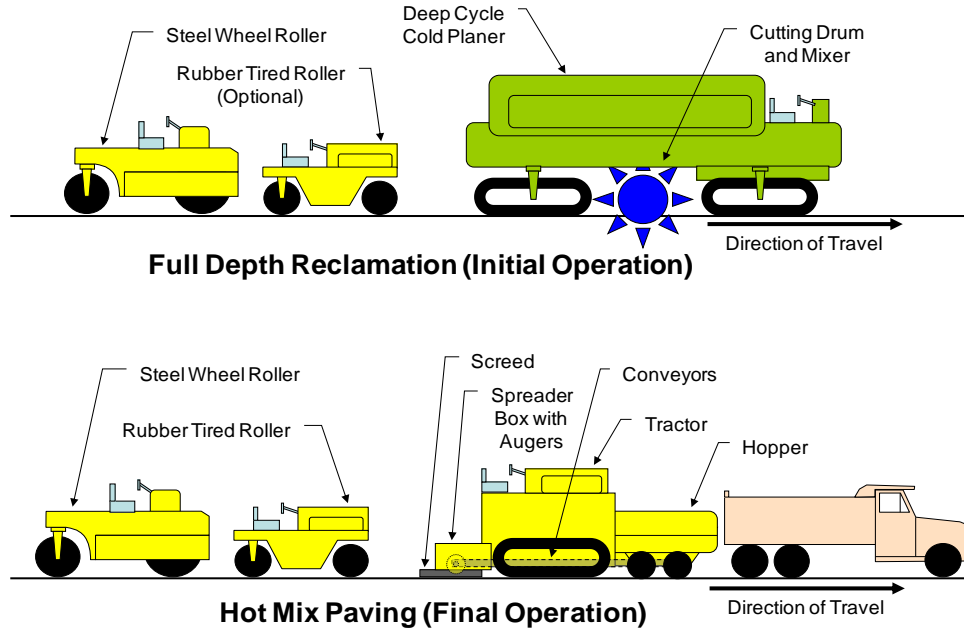
- If an emulsion is not used with FDR, treat the layer as an unbound base.
- If there is evidence of stripping in the lower layer, the designer should consider using a hydrated lime with the emulsion to counteract the stripping and treat the layer as a stabilized layer.
- If the site has good material and an emulsion will be added, treat the layer as a stabilized base.



FDR is the pulverizing, without heat, of existing flexible pavement to produce an aggregate base material by mixing of some or all of the underlying granular base, subbase or subgrade material.

Pavement Overlay may be either Hot Mix Asphalt (HMA) or Stone Matrix Asphalt (SMA) or Portland Cement Concrete (PCC).

**Figure 8.30 Full Depth Reclamation (FDR) Layers**



**Figure 8.31 Schematic of FDR Equipment**  
(sheeps foot not shown)



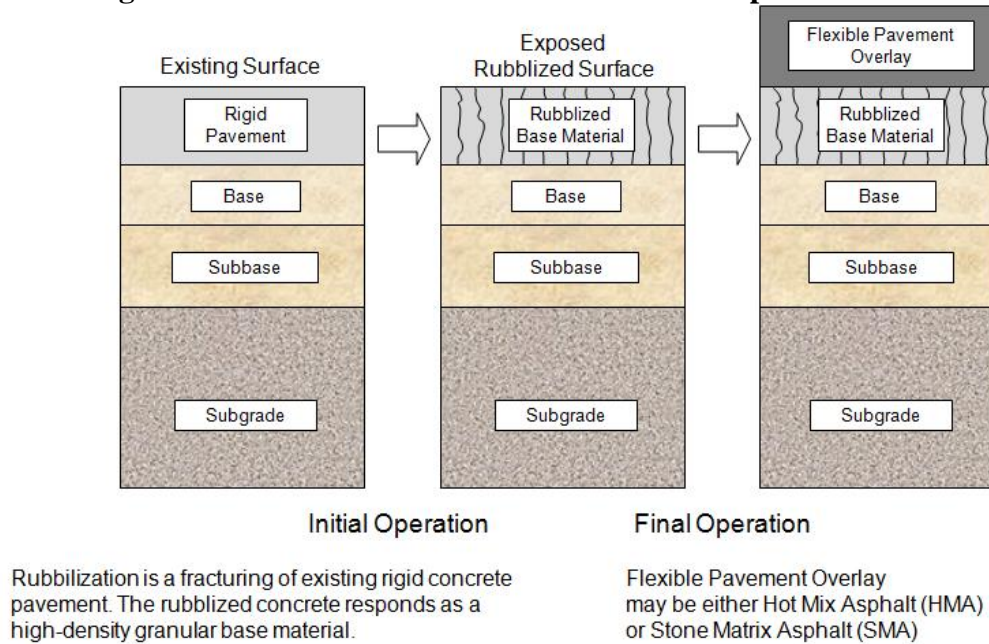
Source: <http://cncement.org> and <http://www.kelchner.com>

**Figure 8.32 Photos of FDR Equipment**

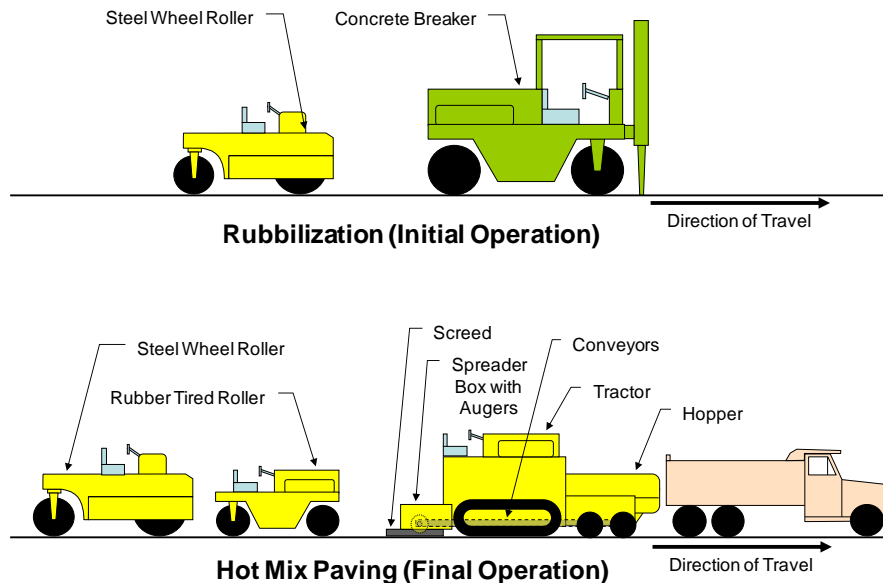
## 8.12 Rubblization and Flexible Pavement Overlay

Existing, worn-out PCC pavements present a particular problem for rehabilitation due to the likelihood of reflection cracking when a HMA overlay is placed. Horizontal and vertical movements occurring within the underlying PCC layer cause reflection cracking. Reflection cracking can occur at any PCC joint or crack. The reflection cracking problem must be addressed in the HMA overlay design phase if long-term performance of the overlay is to be achieved (3).

The objective of rubblization is to eliminate reflection cracking in the HMA overlay by the total destruction of the existing PCC pavement. This process is normally achieved by rubblizing the slab into fragments (4). Rubblization and overlay is a two-phase operation. The first operation is to create the rubblized base material. No traffic is placed on the roadway after this operation. The final operation is to place a flexible overlay on top of the rubblized base material. For pavement design, the rubblized material is considered a base material. See **Figure 8.33 Rubblization and Overlay Layers**, **Figure 8.34 Schematic of Rubblization and Overlay Equipment** and **Figure 8.35 Photos of the Rubblization Initial Operation**.



**Figure 8.33 Rubblization and Overlay Layers**



**Figure 8.34 Schematic of Rubblization and Overlay Equipment**



Source: <http://www.antigoconstruction.com> and <http://www.pavementinteractive.org>

**Figure 8.35 Photos of the Rubbilization Initial Operation**

### **8.13 Stone Matrix Asphalt Project and Material Selection Guidelines**

Stone Matrix Asphalt (SMA) is a gap-graded Hot Mix Asphalt (HMA) that maximizes rutting resistance and durability with a stable stone-on-stone skeleton held together by a rich mixture of asphalt binder, filler, and stabilizing agents. SMA is often considered a premium mix because of higher initial costs due to increased asphalt contents and the use of more durable aggregates. These mixes are almost exclusively used for surface courses on high volume interstates and highways. For a national perspective on designing SMA mixtures, refer to the National Cooperative Highway Research Program (NCHRP) Report 425, *Designing Stone Matrix Asphalt Mixtures for Rut-Resistant Pavements* (5).

The selection of a SMA mix on CDOT projects should be discussed with your Region Materials Engineer. The following conditions need to be present prior to considering the selection of a SMA mix for the wearing surface on the project.

- **Total Average Annual Daily Traffic** is greater than 20,000 in the design year.
- **Functional Class** of the roadway should be either a principal arterial, freeway, or interstate.
- **Underlying Pavement** should have a Lottman greater than 50 percent (Lottman to be tracked) with air voids greater than 3 percent.

Once the appropriate SMA project has been selected, in order to reduce the possibility of asphalt cement drain down or bleed spots, the SMA should contain cellulose fibers. For ease of construction, it is recommended the SMA extend full width of the pavement.



### 8.13.1 Recommended Minimum Thickness Layers

If no structural deficiency exists and a preventative maintenance treatment is desired, the structural number will be less than or equal to zero. This does not mean, however, that the pavement does not need an overlay to correct a functional deficiency. If the deficiency is primarily functional, the minimum SMA thickness will be 3 times the nominal maximum aggregate size. In this case, a fine-grained ( $\frac{3}{8}$  inch or No. 4 sieve) aggregate size is suggested (see **Table 8.4 SMA Functional and Structural Recommended Minimum Thickness Layers**).

**Table 8.4 SMA Functional and Structural Recommended Minimum Thickness Layers**

Nominal Maximum Aggregate Size (inches)	Layer Thickness (inches)
$\frac{3}{4}$	2.25
$\frac{1}{2}$	1.50
$\frac{3}{8}$	1.125
No. 4 sieve	0.75

### 8.14 Characterizing Existing Pavement Condition for AC Overlay Design

Characterization of the existing pavement is a critical element for determining the HMA overlay design features and thickness. Recommendations for characterization of existing pavements are presented in **Table 8.5 Characterization of Existing Flexible Pavement for M-E Design** and **Table 8.6 Characterization of Existing Rigid Pavement for M-E Design**.

**Table 8.5 Characterization of Existing Flexible Pavement for M-E Design**

Surface Condition <sup>1</sup>	Pavement Condition
Little or no alligator cracking and low severity transverse cracking	Excellent
Low severity alligator cracking < 10 percent <b>and/or</b> Medium and high severity transverse cracking < 5 percent Mean wheel path rutting < 0.25 inch No evidence of pumping, degradation or contamination by fines <sup>2</sup>	Good
Low severity alligator cracking > 10 percent <b>and/or</b> Medium severity alligator cracking < 10 percent <b>and/or</b> 5 percent < medium and high severity transverse cracking < 10 percent Mean wheel path rutting < 0.5 inch	Fair
Medium severity alligator cracking > 10 percent <b>and/or</b> High severity alligator cracking < 10 percent <b>and/or</b> Medium and high severity transverse cracking > 10 percent Mean wheel path rutting > 0.5 inch Some evidence of pumping, degradation or contamination by fines <sup>2,3</sup>	Poor
High severity alligator cracking <sup>4</sup> > 10 percent <b>and/or</b> High severity transverse cracking > 10 percent	Very Poor
<b>Notes:</b> <sup>1</sup> All of the distress observed is at the pavement surface. <sup>2</sup> Applicable for flexible pavement with granular base only. <sup>3</sup> In addition to any evidence of pumping noted during the condition survey, samples of base material should be obtained and examined for evidence of erosion, degradation and contamination by fines, drainage ability, and the reduction in structural layer coefficients. <sup>4</sup> Patching all high severity alligator cracking is recommended. The asphaltic concrete surface and stabilized base structural layer coefficients should reflect the amount of high severity cracking remaining after patching.	

**Table 8.6 Characterization of Existing Rigid Pavement for M-E Design**

Surface Condition	Pavement Condition
Little or no JPCP transverse cracking No signs of PCC durability problems (D-cracking, ASR, spalling, etc.)	Excellent
JPCP deteriorated cracked slabs (medium and high severity transverse and longitudinal cracks and corner breaks) < 5 percent Low severity durability problems Mean joint faulting < 0.1 inch	Good
JPCP deteriorated cracked slabs (medium and high severity transverse and longitudinal cracks and corner breaks) < 10 percent Low-medium severity durability problems Mean joint faulting < 0.15 inch	Fair
JPCP deteriorated cracked slabs (medium and high severity transverse and longitudinal cracks and corner breaks) > 10 percent Medium-high severity durability problems Mean joint faulting < 0.25 inch	Poor
High severity durability problems Mean joint faulting > 0.25 inch	Very Poor

## 8.15 Low Volume Road Rehabilitation

### 8.15.1 General Information

A low volume road is defined as a road with a two-directional average annual daily traffic (AADT) of less than 100 trucks per day and less than 1,000 cars per day. Approximately 810 centerline miles of the paved roads in Colorado are classified as low volume. Due to limited funding, CDOT needs to find additional, innovative rehabilitation strategies for these types of roadways. Prior to rehabilitation, the pavements are usually brittle, age hardened, and show a variety of transverse, longitudinal, and fatigue cracking. They may also exhibit signs of aggregate loss, reduced skid resistance, and rutting. Resurfacing thickness may depend on the condition of the existing pavement, and increases or decreases of anticipated AADT. The following are lists of rehabilitation techniques that could be used on low volume roads, **Tables 8.7 Rehabilitation Techniques Versus Observed Distresses** and **Table 8.8 Rehabilitation Techniques Benefits and Applications**.

### 8.15.2 Rehabilitation Techniques

**Single Chip Seal** is a cost effective surface application used to maintain, protect, and prolong the life of an asphalt pavement. The basic chip seal is composed of a binder, aggregate, and a flush coat or fog seal, and works best when used to preserve roads already in good condition. The process generally consists of a soft, flexible, polymer modified asphalt emulsion applied directly to the pavement followed by an application of No. 8 or ¼ inch aggregate before the emulsion sets up. A crushed and graded RAP may also be used as a chip aggregate. The thick asphalt membrane water proofs and bonds the new aggregate to the surface, providing a new skid resistant wearing course. Chip seals are usually applied on a 5 to 7 year cycle. See **Figure 8.36 Photos Showing the Emulsion Spraying and Placing Chips** and **Figure 8.37 Photos Showing the Rolling and Sweeping After Chip Placement**



Source: <http://dpw.lacounty.gov>

**Figure 8.36 Photos Showing the Emulsion Spraying and Placing Chips**

**Table 8.7 Rehabilitation Techniques Versus Observed Distresses**

	Transverse Cracks (minor*)	Transvers Cracks (major)	Longitudinal Cracks (minor*)	Longitudinal Cracks (major)	Fatigue Cracks (minor*)	Fatigue Cracks (major)	Rutting (minor)	Rutting (major)	Reflection Cracks (minor*)	Reflection Cracks (major)	Raveling	Potholes	Polished Surface	Preserves Curb Reveal	Increases Structural Strength	Quick Application
Single Chip Seal (conventional)	◆	◆	◆	◆	◆	◆	△	◆	◆	◆	◆	◆	◆	△	◆	◆
Single Chip Seal (polymer-modified emulsion)	◆	◆	◆	◆	◆	◆	△	◆	◆	◆	◆	◆	◆	△	◆	◆
Single Chip Seal (rubberized)	◆	◆	◆	◆	◆	◆	△	◆	◆	◆	◆	◆	◆	△	◆	◆
Multiple Chip Seal or Armor Coat	◆	◆	◆	◆	◆	◆	◆	△	◆	△	◆	△	◆	△	◆	◆
Stress Absorbing Membrane Seal	◆	◆	◆	◆	◆	◆	◆	△	◆	△	◆	△	◆	△	◆	◆
Stress Absorbing Membrane Interlayer	◆	◆	◆	◆	◆	◆	◆	△	◆	△	◆	△	◆	△	◆	◆
Crack Seal or Polymer Modified Crack Seal	◆	◆	◆	◆	◆	◆	◆	◆	◆	◆	◆	◆	◆	◆	◆	◆
Crack Filling	◆	◆	◆	◆	◆	◆	◆	◆	◆	◆	◆	◆	◆	◆	◆	◆
Slurry Seal	◆	◆	◆	◆	◆	◆	◆	◆	△	◆	◆	◆	◆	◆	◆	◆
Crack Seal and Micro-Slurry	◆	◆	◆	◆	◆	◆	◆	△	◆	△	◆	△	◆	◆	◆	◆
Cape Seal	◆	◆	◆	◆	◆	◆	△	◆	◆	◆	◆	◆	◆	◆	◆	◆
Fog Coat	◆	◆	◆	◆	◆	◆	◆	◆	◆	◆	◆	◆	◆	◆	◆	◆
Thin Overlay (1.0-1.5 inches)	◆	◆	◆	◆	◆	◆	◆	◆	◆	◆	◆	◆	◆	◆	△	◆
Ultra-Thin Overlay (<1 inch) (conventional asphalt)	◆	△	◆	△	◆	△	◆	△	◆	△	◆	◆	◆	◆	◆	◆
Ultra-Thin Overlay (<1 inch) (ST and SF mixes)	◆	◆	◆	◆	◆	◆	◆	◆	◆	◆	◆	◆	◆	△	◆	◆
Ultra-Thin Overlay (<1 inch) (micro-surfacing)	◆	△	◆	△	◆	△	◆	△	◆	△	◆	△	◆	◆	◆	◆
Cold-In-Place Recycling	◆	◆	◆	◆	◆	◆	◆	◆	◆	◆	◆	◆	◆	△	△	△
Cold-In-Place and Chip Seal	◆	◆	◆	◆	◆	◆	◆	◆	◆	◆	◆	◆	◆	△	△	△
Cold Mix Paving	◆	◆	◆	◆	◆	◆	◆	◆	◆	◆	◆	△	◆	△	△	△
Hot In-Place Recycling	◆	◆	◆	◆	◆	◆	◆	◆	◆	◆	◆	◆	◆	△	△	△
Hot Chip Seal	◆	◆	◆	◆	◆	◆	◆	△	◆	△	◆	△	◆	△	◆	◆
Full Depth Replacement (patching)	◆	◆	◆	◆	◆	◆	◆	◆	◆	◆	◆	◆	◆	◆	◆	◆

\* Minor cracks are up to 1/4 inches in width.

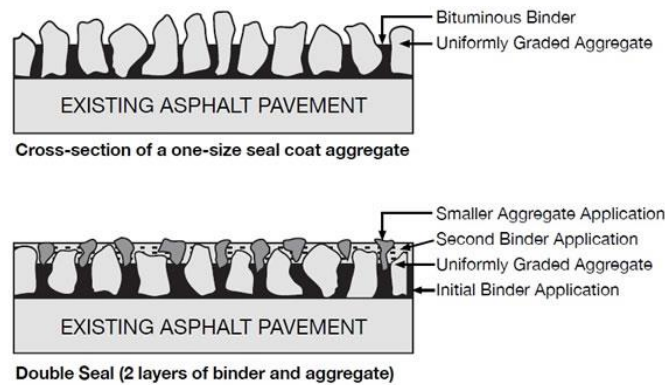
- ◆ Rehabilitation technique likely to fix the observed distress
- △ Rehabilitation technique has mixed results in fixing observed distress
- ◆ Rehabilitation technique unlikely to fix the observed distress



Source: <http://dpw.lacounty.gov>

**Figure 8.37 Photos Showing the Rolling and Sweeping After Chip Placement**

**Double Chip Seal** is a two layer chip seal where one layer is applied immediately after the other. Double chip seals are used on roads with moderate to severe cracking, open textured roads where surface fines have been lost, and on freshly leveled or milled roads where the surface is too open for a single chip seal. Sometimes a fabric is placed between the two layers to reduce the formation of reflective cracks. See **Figure 8.38 Diagram of a Double Chip Seal**.



Source: <http://www.general-liquids.ca>

**Figure 8.38 Diagram of a Double Chip Seal**

**Cape Seal** is a two step process where a chip seal is overlain with a slurry seal. During the first step, the binder is applied to the existing road surface sealing cracks up to ¼ inches wide (cracks greater than ¼ inch wide should be crack sealed prior to binder application). The aggregate is then placed and pressed with pneumatic rollers. The second step involves applying a slurry seal usually within 48 hours after the initial binder application to help hold loose chip material in place and to provide a smoother texture. See **Figure 8.39 Photos Show a Cape Seal Where a Chip Seal is Applied, Cures, and After A Month a Slurry Seal is Applied**.



Source: <http://www.cityofsalem.net>

**Figure 8.39 Photos Show a Cape Seal Where a Chip Seal is Applied, Cures, and After A Month a Slurry Seal is Applied**

**Hot Chip Seal** is a two-step surface treatment process that combines a regular chip seal with a thin lift of open-graded hot mix overlay. The hot mix overlay is usually a  $\frac{3}{4}$  inch mix.

**Slurry Seal** is one of the most common, cost effective forms of asphalt pavement preservation. Generally, it is composed of a graded aggregate, emulsified asphalt (unmodified or polymer-modified), water, fines and other additives which are mixed until a mortar-like compound is achieved. A slurry seal is designed for easy and efficient spreading and forms a hard wearing surface by filling voids, cracks and eroded areas. Usually slurry seals are  $\frac{1}{8}$  to  $\frac{3}{8}$  inches thick. Depending on weather conditions, a slurry seal will set up quickly allowing a quick release to traffic. See **Figure 8.40 Photo Showing the Placing of a Slurry Seal** and **Figure 8.41 Photo Showing a Slurry Seal 1.5 Hours After Placement**



Source: <http://dpw.lacounty.gov>

**Figure 8.40 Photo Showing the Placing of a Slurry Seal**



Source: <http://dpw.lacounty.gov>

**Figure 8.41 Photo Showing a Slurry Seal 1.5 Hours After Placement**

**Micro-Surfacing** Refer to **Section 8.10 Overlay Using Micro Surfacing**.

**Crack Seal** is a long-term, cost effective way to maintain pavement life by preventing water intrusion and other damaging factors from entering transverse and longitudinal cracks. Crack sealing materials can be either unmodified or polymer-modified and are most effective when used on pavements that are 3 to 5 years old or when cracks are first starting to appear. Crack sealing can be combined with many other rehabilitation techniques. See **Figure 8.41 Photos Showing Crack Sealing**.



Source: <http://www.all-ritesealcoating.com> and <http://huizengaenterprises.com>

**Figure 8.42 Photos Showing Crack Sealing**

**Cold Mix Paving** is a blend of coarse and fine aggregate and/or a crushed and graded RAP, combined with an emulsified asphalt. Usually, a mix design is customized for project-specific conditions and may be designed to provide flexible or rigid pavements. Cold mix paving provides early strength so traffic impedance is minimized. The paving may be designed to perform over existing pavements with deteriorated bases. See **Figure 8.43 Photos of Cold Mix Paving**.



Source: <http://www.cantat-associates.com> and <http://www.reevescc.com>

**Figure 8.43 Photos of Cold Mix Paving**

**ST and SF Mixes** are fine aggregate asphalt mixes where the largest aggregate particle is either  $\frac{3}{8}$  inches or from the No. 4 sieve. Further details of these mix designs can be found in Sections 403 and 703 of the *Colorado Department of Transportation Standard Specifications for Road and Bridge Construction, 2012*.

**Fog Coat** is a light spray application of dilute asphalt emulsion used to seal the existing asphalt surface, reduce raveling, and enrich dry and weathered surfaces (5). Road surfaces to be treated with fog seal must have an open texture to allow the material to penetrate. Tight surfaces normally cannot be treated with this method. For areas requiring the newly sealed pavement be opened to traffic shortly after the application, a blotter coat of sand may be placed to prevent tires from ‘picking up’ the recently layered emulsion. The sand will generally be removed by traffic over time. A fog seal should be used within the first two years of HMA placement. See **Figure 8.44 Photos Showing the Placing of a Fog Coat and the Final Result**.



Source: <http://dpw.lacounty.gov>

**Figure 8.44 Photos Showing the Placing of a Fog Coat and the Final Result**



**Thin Asphalt Overlays** are surface mixes typically  $\frac{3}{4}$  to  $1\frac{1}{2}$  inches thick placed on a prepared pavement surface showing no signs of structural distress. The surface may be milled or un-milled although milling is recommended because it provides a uniform, level surface and removes surface distresses. It is important a thin overlay not be used to correct widespread structural distresses such as alligator or longitudinal cracking in the wheel path. This type of overlay may be applied to correct functional problems such as skid resistance, ride quality, and noise generation.

**Full Depth Replacement Patching** is a rehabilitation or a reconstruction technique in which the full thickness of asphalt pavement and a pre-determined portion of the underlying materials (base, subbase, and/or subgrade) are removed and replaced. See **Figure 8.45 Photos Showing Various Stages of Full Depth Replacement Patching**.



Source: <http://www.pavementinteractive.org> and <http://rolarinc.com>

**Figure 8.45 Photos Showing Various Stages of Full Depth Replacement Patching**

**Cold-In-Place Recycling** is the recycling and reusing of the existing pavement layer, thus eliminating the costs of purchasing and transporting fresh aggregate. Usually, core samples are taken from the existing road and tested to determine the material constituents available so a proper mix design may be determined. Generally, 2 to 5 inches of the surface are pulverized to a pre-determined aggregate size, mixed with a rejuvenating asphalt emulsion and water, re-applied to the road, and compacted. Because no heat is applied to the asphalt, noxious fumes are reduced, creating a safer environment for construction workers and the public. See **Figure 8.46 Photo Showing A Cold In-Place Recycling Operation**



Source: <http://www.coughlincompany.com>

**Figure 8.46 Photo Showing A Cold In-Place Recycling Operation**

**Ultra-Thin Asphalt Overlays** consist of a heavy application of a polymer modified emulsion followed immediately by a thin layer of gap-graded hot mixed asphalt. The emulsion is used to bond the new and old pavements. The asphalt mix usually incorporates a combination of trap rock and limestone creating a durable surface. Ultra-thin overlays may be installed in lifts of  $\frac{1}{2}$  to  $\frac{7}{8}$  inches, requiring minimal milling. Once it has been rolled, the road can be immediately opened to traffic, refer to **Figure 8.47 Photos of Ultra-Thin Overlays**.



Source: <http://www.fp2.org> and <https://nbwest.com>

**Figure 8.47 Photos of Ultra-Thin Asphalt Overlays**

**Stress Absorbing Membranes** are composed of a polymer modified asphalt emulsion, fiberglass strands and aggregate, which when placed, act as a waterproof membrane and delays reflective cracking. Generally, fiber glass is sandwiched between two layers of asphalt emulsion prior to the application of the aggregate, and then either rolled into the surface or sprayed into place. The fiberglass increases the tensile strength and flexibility and reduces the resulting strain of the resurfacing product. The process is fairly quick, allowing an area to be opened to traffic within 15 minutes of placement and is rarely affected by temperature or humidity. See **Figure 8.48 Photo Showing a Stress Absorbing Membrane**.



Source: <http://www.gormanroads.com/fibermat.php>

**Figure 8.48 Photo Showing a Stress Absorbing Membrane**

**Manual Skin Patching** is when a small surface area showing distress is manually repaired and sealed. See **Figure 8.49 Photo of Manual Skin Patching**.



Source: <https://www.youtube.com/watch?v=bmRARbSmhCo>

**Figure 8.49 Photo of Manual Skin Patching**

**Table 8.8 Rehabilitation Techniques Benefits and Applications**

Treatment	When Applicable	Benefits
<b>Single Chip Seal</b>	<ul style="list-style-type: none"> <li>▪ Roadways with slight to moderate cracking</li> </ul>	<ul style="list-style-type: none"> <li>▪ Protects from oxidation and deterioration</li> <li>▪ Seals and resists reflection of small surface cracks</li> <li>▪ Reduces future cracking, distress and potholes</li> <li>▪ Improves skid resistance and safety</li> <li>▪ Easy and quick application causing minimum disruption to the public</li> <li>▪ Reduces moisture infiltration</li> <li>▪ Improves overall appearance</li> <li>▪ Crushed and graded RAP may be used as a chip aggregate</li> </ul>
<b>Double Chip Seal</b>	<ul style="list-style-type: none"> <li>▪ Roadways with moderate to severe cracking</li> <li>▪ open textured roads where surface fines have been lost</li> <li>▪ Freshly leveled or scratched roads where the surface is too open and porous for a single chip</li> </ul>	<ul style="list-style-type: none"> <li>▪ Protects from oxidation and deterioration</li> <li>▪ Seals and resists reflection of small surface cracks</li> <li>▪ Reduces future cracking, distress and potholes</li> <li>▪ Improves skid resistance and safety</li> <li>▪ Easy and quick application causing minimum disruption to the public</li> <li>▪ Reduces moisture infiltration</li> </ul>
<b>Cape Seal</b>	<ul style="list-style-type: none"> <li>▪ Roadways with slight to moderate cracking</li> </ul>	<ul style="list-style-type: none"> <li>▪ Protects from oxidation and deterioration</li> <li>▪ More durable than a standard slurry seal</li> <li>▪ No milling or utility adjustments are required</li> <li>▪ Significantly reduces appearance of cracks</li> <li>▪ Reduces moisture infiltration</li> <li>▪ Improves overall appearance</li> <li>▪ Eliminates the need to seal alligator cracking up to 1/4 inch, larger cracks still need to be sealed.</li> <li>▪ Weather dependent, requires ambient temperatures of 65° F and no rain for 24 hours.</li> </ul>
<b>Hot Chip Seal</b>	<ul style="list-style-type: none"> <li>▪ Used to seal and level roadways with moderate to heavy cracking and in need of re-profiling</li> <li>▪ Roadways must be structurally sound; any areas exhibiting structural failure should be repaired prior to sealing</li> </ul>	<ul style="list-style-type: none"> <li>▪ Protects from oxidation and deterioration</li> <li>▪ Reduces moisture infiltration</li> <li>▪ Provides a strong wearing surface that will improve the profile of the existing asphalt</li> <li>▪ Improves skid resistance and safety</li> <li>▪ Quiet surface treatment</li> <li>▪ Long life expectancy</li> <li>▪ Improves overall appearance</li> </ul>
<b>Slurry Seal</b>	<ul style="list-style-type: none"> <li>▪ Roadways with slight to moderate cracking</li> </ul>	<ul style="list-style-type: none"> <li>▪ Protects from oxidation and deterioration</li> <li>▪ Reduces moisture infiltration</li> <li>▪ Thin restorative surface treatment</li> <li>▪ Does not require milling or utility adjustment</li> <li>▪ Improves skid resistance and safety</li> <li>▪ Improves overall appearance</li> </ul>

<b>Micro-Surfacing</b>	<ul style="list-style-type: none"> <li>▪ Roadways with slight to severe cracking and rutting</li> </ul>	<ul style="list-style-type: none"> <li>▪ May be placed in multiple layers for greater thicknesses Protects from oxidation and deterioration</li> <li>▪ Improves skid resistance and safety</li> <li>▪ Easy and quick application causing minimum disruption to the public</li> <li>▪ Reduces moisture infiltration</li> <li>▪ Improves overall appearance</li> <li>▪ An environmentally safe product emitting no pollutants</li> <li>▪ May be used to fill wheel ruts where pavements are structurally sound</li> </ul>
<b>Crack Seal</b>	<ul style="list-style-type: none"> <li>▪ Sealing slight to severe longitudinal and transverse cracking</li> </ul>	<ul style="list-style-type: none"> <li>▪ Cost effective process to maintain existing pavement</li> <li>▪ Reduces moisture infiltration</li> <li>▪ Reduces the damage from freeze-thaw cycle</li> <li>▪ Prevents sand, stones and dirt from entering open cracks and causing compressive stresses</li> <li>▪ Prevents/delays pothole formation</li> </ul>
<b>Cold Mix Paving</b>	<ul style="list-style-type: none"> <li>▪ May be used to correct transverse, longitudinal, and fatigue cracking</li> <li>▪ Will not correct base failures</li> </ul>	<ul style="list-style-type: none"> <li>▪ Conventional paving equipment used to place material</li> <li>▪ Flexibility to perform well over deficient or severely deteriorated base.</li> <li>▪ Limited disruption to the public</li> </ul>
<b>ST or SF Mix Overlay</b>	<ul style="list-style-type: none"> <li>▪ May be used to correct slight to moderate longitudinal, transverse, and fatigue cracking</li> <li>▪ Will not correct base failures</li> </ul>	<ul style="list-style-type: none"> <li>▪ Protects from oxidation and deterioration</li> <li>▪ Seals and resists reflection of small surface cracks</li> <li>▪ Improves skid resistance and safety</li> <li>▪ Reduces moisture infiltration</li> <li>▪ Improves overall appearance</li> <li>▪ Conventional paving equipment used to place material</li> </ul>
<b>Fog Coat</b>	<ul style="list-style-type: none"> <li>▪ Product must have low viscosity</li> <li>▪ Will not correct cracks, base failures, or excessive stone loss</li> <li>▪ Open surface textured pavements</li> <li>▪ Should not be used on rubberized asphalt concrete or polymer modified mixes unless the pavement is over 5 years old</li> <li>▪ Limited by weather, usually cannot be applied in winter</li> </ul>	<ul style="list-style-type: none"> <li>▪ Protects from oxidation and deterioration</li> <li>▪ Reduces moisture infiltration</li> <li>▪ Rejuvenates existing asphalt binder, increases flexibility</li> <li>▪ Seals surface voids</li> <li>▪ Improves overall appearance</li> </ul>

<p><b>Thin Overlay (1 to 1.5 inches)</b> <b>Dense Graded Hot Mix Asphalt, Ultra-thin Bonded Wearing Coarse, and Stone Matrix Asphalt</b></p>	<ul style="list-style-type: none"> <li>▪ Must be on generally structurally sound pavements</li> <li>▪ Product cools very quickly and may be difficult to compact at times</li> </ul>	<ul style="list-style-type: none"> <li>▪ Protects from oxidation and deterioration</li> <li>▪ Reduces moisture infiltration and tire/pvmnt. noise</li> <li>▪ Increased skid resistance</li> <li>▪ Decreases backspray; increases visibility in wet weather</li> <li>▪ Strong bond to existing pavement</li> <li>▪ No displacement of tack coat from trucks delivering material to the paver</li> <li>▪ Anti-hydroplaning/anti-splash from tires</li> <li>▪ Preserves the curb reveal</li> <li>▪ Helps level the existing pavement</li> <li>▪ Quick application, minimum disruption to the public</li> </ul>
<p><b>Full Depth Replacement Patching</b></p>	<ul style="list-style-type: none"> <li>▪ Poorly structurally sound pavements</li> </ul>	<ul style="list-style-type: none"> <li>▪ Brand new interlaying layer utilizing the old surface</li> <li>▪ Removes existing crack patterns</li> <li>▪ Previous pavement is rejuvenated</li> <li>▪ Bridge clearances and curb heights remain the same</li> <li>▪ Protects from oxidation and deterioration</li> <li>▪ Reduces moisture infiltration and tire/pvmnt. noise</li> <li>▪ Increased skid resistance</li> </ul>
<p><b>Cold-In-Place Recycling</b></p>	<ul style="list-style-type: none"> <li>▪ Total pavement resurfacing and rehabilitation</li> <li>▪ Removes existing crack patterns</li> </ul>	<ul style="list-style-type: none"> <li>▪ Brand new interlaying layer utilizing the old surface</li> <li>▪ Removes existing crack patterns</li> <li>▪ Previous pavement is rejuvenated</li> <li>▪ Bridge clearances and curb heights remain the same</li> <li>▪ Hauling off excess/milled materials is minimized</li> </ul>
<p><b>Ultra-Thin Overlays</b></p>	<ul style="list-style-type: none"> <li>▪ Suitable for correcting raveling, longitudinal cracking that is not in the wheel path, and transverse cracking</li> </ul>	<ul style="list-style-type: none"> <li>▪ Protects from oxidation and deterioration</li> <li>▪ Reduces moisture infiltration and tire/pvmnt. noise</li> <li>▪ Increased skid resistance</li> <li>▪ Decreases back spray; increases visibility in wet weather</li> <li>▪ Strong bond to existing pavement</li> <li>▪ No displacement of tack coat from trucks delivering material to the paver</li> <li>▪ Anti-hydroplaning/anti-splash from tires</li> <li>▪ Preserves the curb reveal</li> <li>▪ Service life of 10-15 years</li> <li>▪ Helps level the existing pavement</li> <li>▪ Quick application, minimum disruption to the public</li> </ul>
<p><b>Hot In-Place Recycling</b></p>	<ul style="list-style-type: none"> <li>▪ Corrects surface distresses of structurally adequate flexible pavements</li> </ul>	<ul style="list-style-type: none"> <li>▪ New interlaying layer utilizing the old surface</li> <li>▪ Removes existing crack problems</li> <li>▪ Bridge clearances and curb heights remain the same</li> <li>▪ Reduces moisture infiltration</li> <li>▪ Increased skid resistance</li> </ul>
<p><b>Stress Absorbing Membrane</b></p>	<ul style="list-style-type: none"> <li>▪ For delaying reflective cracking</li> </ul>	<ul style="list-style-type: none"> <li>▪ Increases the tensile strength and flexibility of the surfacing product; reduces the resulting strain</li> <li>▪ Removes existing crack patterns</li> <li>▪ Quick process, minimal traffic delay</li> </ul>

## 8.16 Assemble M-E Design Software Inputs

### 8.16.1 General Information

#### 8.16.1.1 Design Period

**The design period for restoration, rehabilitation and resurfacing is 10 years.** Selection of less than 10-year design periods needs to be documented and supported by a LCCA or other over riding considerations. For special designs, the designer may use a different design period as appropriate.

#### 8.16.1.2 Construction Dates and Timeline

The following inputs are required to specify the project timeline in the design:

- Original pavement construction month and year
- Overlay construction month and year
- Traffic open month and year

#### 8.16.1.3 Identifiers

Identifiers are helpful in documenting the project location and record keeping.

### 8.16.2 Traffic

Several inputs are required for characterizing traffic for the M-E Design program and have been described in detail in **Section 3.1 Traffic**.

### 8.16.3 Climate

The climate input requirements for M-E Design are described in detail in **Section 3.2 Climate**.

### 8.16.4 Pavement Layer Characterization

Asphalt overlay design process described herein includes:

- HMA overlay of existing flexible pavement
- HMA overlay of existing intact JPCP pavement, including composite and second generation overlays
- HMA overlay of fractured PCC pavement

In M-E Design, the pavement layer characterization includes the characterization of the HMA overlay layer, existing pavement (i.e. flexible, intact or fractured PCC), treated and/or unbound base layer, and subgrade.

#### 8.16.4.1 Characterization of HMA Overlay Layer

Asphalt concrete overlay types used in Colorado may include HMA and SMA mixtures. The inputs required for the HMA overlay layer are the same as those of the new HMA layer. Refer to **Section 6.6.4.1 Asphalt Concrete Characterization**.

#### 8.16.4.2 Characterization of Existing HMA Layer

Asphalt layer thickness can be determined from plans or the soil survey of the completed roadbed; however, this information should be verified by field samples. If this information is not available, the thickness will be checked in the field at the time soil and aggregate base course are sampled.

The existing HMA layer is characterized by a damaged modulus representative of the conditions at the time of overlay placement in accordance with **Table 8.9 Characterization of Existing Flexible and Semi-Rigid Pavement for M-E Design**.

In M-E Design, the pavement layers with recycled asphalt concrete materials, such as the hot in-place recycling or cold in-place recycling, could be treated as a new flexible pavement design strategy. The recycled materials can be modeled either as a new HMA layer or an unbound layer depending on the amount of asphalt binder or emulsion added to the recycled material. When modeling the recycled material layer as a new HMA layer, it is recommended to use Level 1 or Level 2 inputs to accurately model the properties of the recycled layer. When modeling the recycled material layer as an unbound aggregate layer, the designer may use a fixed  $M_r$  value representative of the in-place material. **Note:** Use the ‘*annual representative values*’ option in the M-E Design software for a single value of  $M_r$  that is fixed for an entire year.

Full depth reclamation was not included in the global calibration of the M-E Design performance prediction models.

If milling the existing HMA layer is planned, one needs to subtract the milled thickness from the existing pavement structure. For example, if the existing HMA layer is 5 inches and 1.5 inches of milling is planned, then the thickness entered should be 3.5 inches. The mill thickness should also be placed in the ‘*AC Layer Properties*’ under the ‘*Rehabilitation*’ section.

For the existing JPCP slab, use the modulus of elasticity existing at the time of rehabilitation. This value will be higher than the 28-day modulus and either determined using the backcalculation of FWD data or estimated from the historical 28-day values in accordance with recommendations provided in **Table 8.10 Characterization of existing JPCP for M-E Design**. If the modulus of elasticity is determined from the FWD data, multiply the backcalculated PCC modulus by 0.8 to convert from dynamic to static modulus.



**Table 8.9 Characterization of Existing Flexible and Semi-Rigid Pavement for M-E Design**

Layer Material	Input	Rehabilitation Input Level 1	Rehabilitation Input Level 2	Rehabilitation Input Level 3
Asphalt Concrete	Damaged modulus	FWD back calculated modulus	Estimated from undamaged modulus (reduction factor from measured alligator cracking)	Estimated from undamaged modulus (reduction factor from pavement rating)
		Test frequency		
		AC mix temperature		
	Undamaged modulus	HMA dynamic modulus model	HMA dynamic modulus model with project specific inputs	HMA dynamic modulus model with agency historical inputs
		Project specific inputs/agency		
		Historical inputs		
	Fatigue damage	Damaged modulus is measured by NDT	Percent alligator cracking from visual condition survey	Pavement rating
Rut depth	Trench data (each layer)	User input (by layer)	Total rutting at surface	
Treated	Damaged modulus	FWD back calculated modulus	Estimated from undamaged modulus	Estimated from undamaged modulus
	Undamaged modulus	Compressive strength of field cores	Estimated from compressive strength of field cores	Estimated from typical compressive strength
	Fatigue damage	Percent alligator cracking from visual condition survey	Percent alligator cracking from visual condition survey	Pavement rating
Unbound Base or Subbase	Modulus	FWD back calculated modulus	Simple test correlations	Soil classification
	Rut depth	Trench data (each layer)	User input (by layer)	User input
Subgrade	Modulus	FWD back calculated modulus	Simple test correlations	Soil classification
	Rut depth	Trench data (each layer)	User input (by layer)	User input

For existing JPCP, the past damage is estimated from the total percent of slabs containing transverse cracking (all severities) plus the percentage of slabs replaced on the project. Required inputs for determining past fatigue damage are as follows:

- **Before Pre-Overlay Repair:** The percent of slabs with transverse cracks plus percent of previously repaired/replaced slabs. This represents the total percent of slabs that have cracked transversely prior to any restoration work.

- **After Pre-Overlay Repair:** The total percent repaired/replaced slabs. **Note:** The difference between before and after is the percent of slabs that are still cracked just prior to HMA overlay.

Repairs and replacement refers to full-depth repair and slab replacement of slabs with transverse cracks. The percentage of previously repaired and replaced slabs is added to the existing percent of transverse cracked slabs to establish past fatigue damage caused since opening to traffic.

**Table 8.10 Characterization of Existing JPCP for M-E Design**

Layer Material	Input	Rehabilitation Input Level 1	Rehabilitation Input Level 2	Rehabilitation Input Level 3
Jointed Plane Concrete Pavement (JPCP)	Elastic modulus for PCC	Field core (lab tests) or FWD backcalculated modulus (adjusted)	Estimated from compressive strength of field cores	Estimated from historical compressive strength data
	Modulus of rupture	Field beam (lab testing)	Estimated from compressive strength of field cores	Estimated from historical compressive strength data
	Past fatigue damage	Percent slabs cracked	Percent slabs cracked	Pavement rating
Existing Asphalt Base or Subbase	Dynamic modulus	FWD backcalculated modulus	HMA dynamic modulus model with project specific inputs	HMA dynamic modulus model with agency historical inputs
Existing Unbound Base or Subbase	Modulus	FWD backcalculated modulus	Simple test correlations	Soil classification
Subgrade	Modulus	FWD backcalculated modulus	Simple test correlations	Soil classification

#### 8.16.4.3 Characterization of Existing PCC Layer (Fractured)

Two input levels, Level 1 and Level 3, are provided for characterization of the fractured slab's modulus. Level 1 modulus values are functions of the anticipated variability of the slab fracturing process. When using these design values, the user must perform FWD testing of the fractured slab to ensure that not more than 5 percent of the in-situ fractured slab modulus values exceed 1,000 ksi. Level 3 modulus values are functions of the fracture method used and the nominal fragment size. The recommended Level 1 and Level 3 design values for the modulus of fractured slab are presented in **Table 8.12 Recommended Fractured Slab Design Modulus Values for Level 1 Characterization** and **Table 8.13 Recommended Fractured Slab Design Modulus Values for Level 3 Characterization**.

**Table 8.11 Characterization of Fractured Concrete Pavement for M-E Design**

Layer Material	Input	Input Level 1	Input Level 2	Input Level 3
Fractured Slab	Modulus	Tabulated with NDT quality assurance	None	Tabulated base on process and crack spacing
Existing Asphalt Base or Subbase	Dynamic Modulus	FWD backcalculated modulus	HMA dynamic modulus model with project specific inputs	HMA dynamic modulus model with agency historical inputs
	Rut Depth	Trench data	User input	User input
Existing Unbound Base or Subbase	Modulus	FWD backcalculated modulus	Simple test correlations	Soil classification
	Initial $\epsilon_p$	Trench data	User input	User input
Subgrade	Modulus	FWD backcalculated modulus	Simple test correlations	Soil classification
	Rut Depth	Trench data	User input	User input

**Table 8.12 Recommended Fractured Slab Design Modulus Values for Level 1 Characterization**

Expected Control on Slab Fracture Process	Anticipated Coefficient of Variation for the Fractured Slab Modulus (%)	Design Modulus (psi)
Good to Excellent	25	600,000
Fair to Good	40	450,000
Poor to Fair	60	300,000

**Table 8.13 Recommended Fractured Slab Design Modulus Values for Level 3 Characterization**

Type Fracture	Design Modulus (psi)
Rubbilization	150,000
Crack and Seat	—
12 inch crack spacing	200,000
24 inch crack spacing	250,000
36 inch crack spacing	300,000

#### 8.16.4.4 Characterization of Unbound Base Layers and Subgrade

The thickness of the base and subbase can be determined from plans or the soil survey of the completed roadbed, and should be verified by field samples. When this information is not available, samples will be taken at the same locations where the soil samples were taken (a minimum frequency of one sample per mile). For subgrades, obtain samples to determine the actual moisture content.

For HMA overlays of existing HMA, and semi-rigid/fractured PCC pavements, refer to **Table 4.3 Recommended Subgrade Inputs for HMA Overlays of Existing Flexible Pavement**, and for HMA overlays of existing rigid pavements, refer to **Table 4.4 Recommended Subgrade Inputs for Overlays of Existing Rigid Pavement**.

### 8.17 Run M-E Design Software

The coefficients of performance prediction models considered in the design of a flexible pavement rehabilitation are shown in **Figure 8.50 Prediction Model Coefficients for Flexible Rehabilitation Designs**.

Designers should examine all inputs for accuracy and reasonableness prior to running the M-E Design software. After the inputs have been examined, run the software to obtain outputs required and evaluate if the trial design is adequate. After a trial run has been successfully completed, the M-E Design software will generate a report in the form of a PDF and/or Microsoft Excel file. The report contains the following information: inputs, reliability of design, materials and other properties, and predicted performance.

After the trial run is complete, the designer should again examine all inputs and outputs for accuracy and reasonableness. The output report also includes the estimates of material properties and other properties on a month-by-month basis over the entire design period in either tabular or graphical form. The designer should at least examine the key parameters to assess their reasonableness before accepting a trial design as complete.

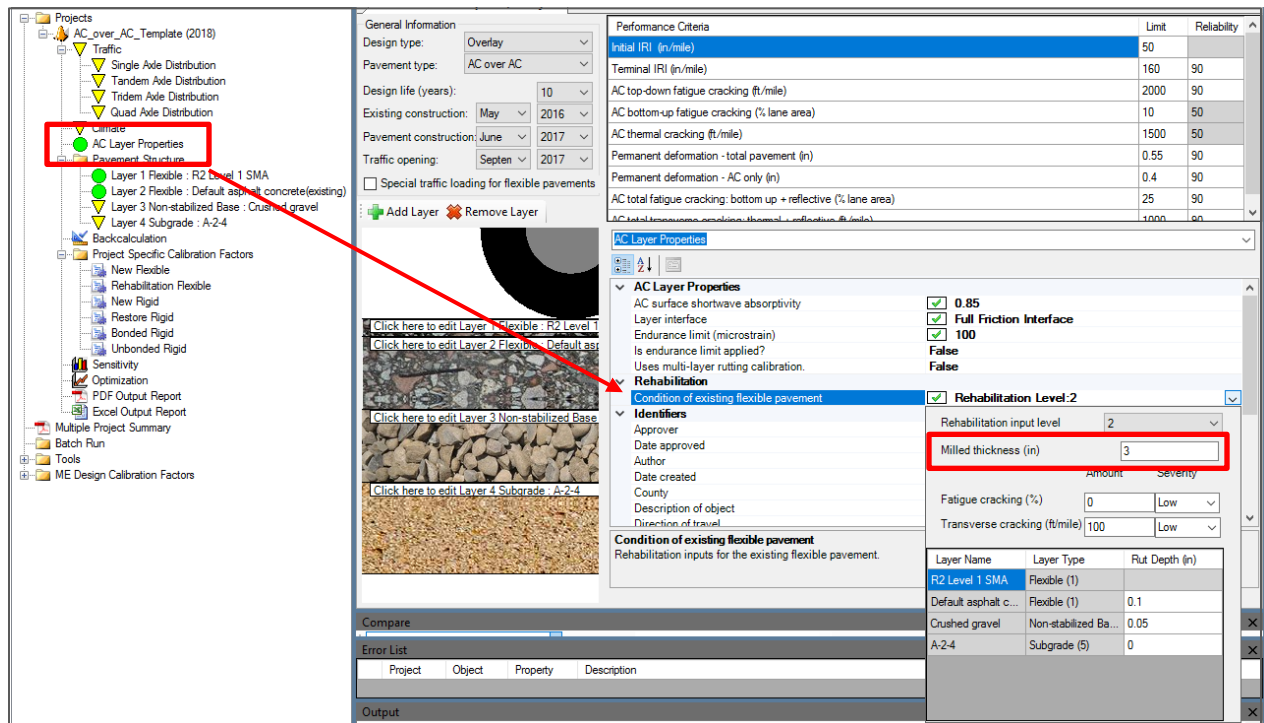
<b>AC Cracking</b>	
AC Cracking C1 Top	7
AC Cracking C2 Top	3.5
AC Cracking C3 Top	0
AC Cracking C4 Top	1000
AC Cracking Top Standard Deviation	$200+2300/(1+\exp(1.072-2.1654*\text{LOG}_{10}(\text{TOP}+0.0001)))$
AC Cracking C1 Bottom	0.021
AC Cracking C2 Bottom	2.35
AC Cracking C3 Bottom	6000
AC Cracking Bottom Standard Deviation	$1+15/(1+\exp(-3.1472-4.1349*\text{LOG}_{10}(\text{BOTTOM}+0.0001)))$
<b>AC Fatigue</b>	
AC Fatigue K1	0.007566
AC Fatigue K2	3.9492
AC Fatigue K3	1.281
AC Fatigue BF1	130.3674
AC Fatigue BF2	1
AC Fatigue BF3	1.217799
<b>AC Rutting</b>	
AC Rutting K1 (1)	-3.35412
AC Rutting K2 (1)	1.5606
AC Rutting K3 (1)	0.3791
AC Rutting BR1 (1)	4.3
AC Rutting BR2 (1)	1
AC Rutting BR3 (1)	1
AC Rutting Standard Deviation	$0.1414*\text{Pow}(\text{RUT } 0.25)+0.001$
<b>IRI</b>	
IRI Flexible C1	50
IRI Flexible C2	0.55
IRI Flexible C3	0.0111
IRI Flexible C4	0.02
IRI Flexible Over PCCC1	40.8
IRI Flexible Over PCCC2	0.575
IRI Flexible Over PCCC3	0.0014
IRI Flexible Over PCCC4	0.00825
<b>Reflective Fatigue Cracking AC</b>	
Reflective Fatigue Cracking AC K1	0.012
Reflective Fatigue Cracking AC K2	0.005
Reflective Fatigue Cracking AC K3	1
Reflective Fatigue Cracking AC C1	0.38
Reflective Fatigue Cracking AC C2	1.66
Reflective Fatigue Cracking AC C3	2.72
Reflective Fatigue Cracking AC C4	105.4
Reflective Fatigue Cracking AC C5	-7.02
Reflective Fatigue Cracking AC Standard Deviation	$1.1097*\text{Pow}(\text{FATIGUE } 0.6804)+1.23$
<b>Reflective Transverse Cracking AC</b>	
Reflective Transverse Cracking AC K1	0.012
Reflective Transverse Cracking AC K2	0.005
Reflective Transverse Cracking AC K3	1
Reflective Transverse Cracking AC C1	3.22
Reflective Transverse Cracking AC C2	25.7
Reflective Transverse Cracking AC C3	0.1
Reflective Transverse Cracking AC C4	133.4
Reflective Transverse Cracking AC C5	-72.4
Reflective Transverse Cracking AC Standard Deviation	$70.98*\text{Pow}(\text{TRANSVERSE } 0.2994)+30.12$
<b>Subgrade Rutting</b>	
Granular Subgrade Rutting K1	2.03
Granular Subgrade Rutting BS1	0.22
Granular Subgrade Rutting Standard Deviation	$0.0104*\text{Pow}(\text{BASERUT } 0.67)+0.001$
Fine Subgrade Rutting K1	1.35
Fine Subgrade Rutting BS1	0.37
Fine Subgrade Rutting Standard Deviation	$0.0663*\text{Pow}(\text{SUBRUT } 0.5)+0.001$
<b>Thermal Fracture</b>	
AC Thermal Cracking Level 1K	6.3
AC Thermal Cracking Level 2K	0.5
AC Thermal Cracking Level 3K	6.3

**Figure 8.50 Performance Prediction Model Coefficients for Flexible Pavement Rehabilitation Designs (AC over JPCP, AC over Semi-rigid, and AC over AC)**

### 8.17.1 Designs That Require Milling of Existing HMA

M-E Design allow the designer to adjust various parameters per project requirements, this includes milling an existing asphalt layer prior to an HMA overlay. Designing for a milled overlay, the designer must go to the AC Layer Properties and select the pull down menu under Rehabilitation Level, see **Figure 50 Milled Thickness Input Screen**. Fill in the box for Milled Thickness (in) with the proposed milling thickness, NOT the thickness of the pavement after milling. Additionally, the designer would used the final, after milling thickness as the existing HMA layer.

Example: An existing 8 inch thick asphalt roadway going to be rehabilitated. One of the proposed designs requires 3 inches of the existing roadway to be milled and removed prior to an HMA overlay. The designer would input 3 inches in the Milled Thickness (in) box in the AC Layer Properties Screen, and 5 inches as the Layer 2 Flexible Default Asphalt thickness. See **Figures 8.51, Milled Thickness Input Screen** and **8.52 Existing Thickness if Milling is Planned**.



**Figure 8.51 Milled Thickness Input Screen**

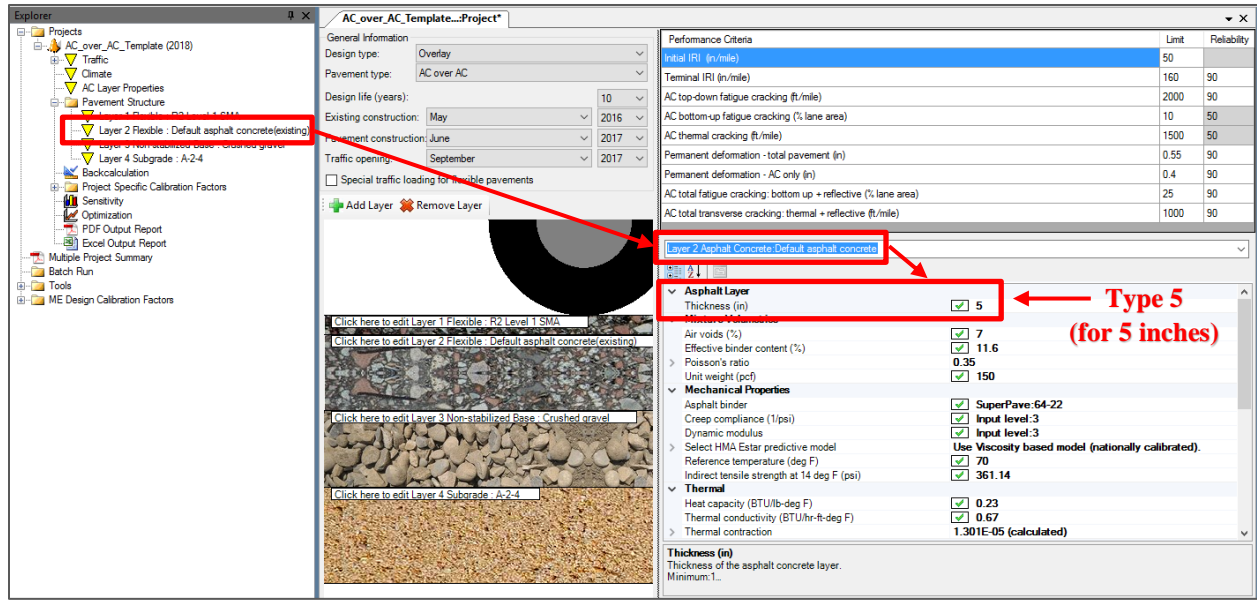


Figure 8.52 Existing Layer Thickness if Milling is Planned

## 8.18 Evaluate the Adequacy of the Trial Design

The output report of a AC overlay pavement trial design includes the monthly accumulation of the following key distress types and smoothness indicators for both overlay and existing pavement at their mean values and chosen reliability values:

- Terminal IRI
- AC top down fatigue cracking
- AC bottom up fatigue cracking
- AC thermal cracking
- Permanent deformation (total pavement)
- Permanent deformation (AC only)
- AC total fatigue cracking: bottom up + reflective
- AC total transverse cracking: thermal + reflective

The designer should examine the results to evaluate if the performance criteria for each of the above mentioned indicators have met the desired reliability. If any criteria have not been met, the trial design is deemed unacceptable and needs to be revised accordingly to produce a satisfactory design. The strategies for modifying a trial design are discussed in **Section 8.19 Modifying Trial Designs**. The software allows the designer to use a range of thicknesses to optimize the trial design's thickness and perform a sensitivity analysis for key inputs. The results of the sensitivity analysis can be used to further optimize the trial design if modifying AC thickness alone does not produce a feasible design alternative. A detail description of the thickness optimization procedure and sensitivity analysis is provided in the Software HELP Manual.

## 8.19 Modifying Trial Designs

Guidance on how to alter the trial design to meet performance criteria are based on an individual distress basis. Refer to **Section 6.9 Modifying Trial Designs** for more information.

For HMA overlays of intact grid pavements refer to **Table 8.14 Recommendations for Modifying trial Design to Reduce Distress/Smoothness for HMA Overlays of JPCP**.

**Table 8.14 Recommendations for Modifying Trial Design to Reduce Distress/Smoothness for HMA Overlays of JPCP**

Distress Type	Recommended Modifications to Design
Rutting in HMA	Refer to <b>Table 6.2 Modifying Flexible Pavement Trial Design</b>
Transverse Cracking in JPCP Existing Slab	<ul style="list-style-type: none"> <li>• Repair more of the existing slabs that were cracked prior to overlay placement</li> <li>• Increase HMA overlay thickness</li> </ul>
Reflection Cracking from Existing JPCP	<ul style="list-style-type: none"> <li>• Apply an effective reflection crack control treatment such as saw and seal the HMA overlay over transverse joints</li> <li>• Increase HMA overlay thickness</li> </ul>
Smoothness (IRI)	<ul style="list-style-type: none"> <li>• Build smoother pavements initially through more stringent specifications</li> <li>• Reduce predicted slab cracking and punchouts</li> </ul>



## References

1. AASHTO Standing Committee on Highway, 1997.
2. *Basic Asphalt Recycling Manual*, Federal Highway Administration, 400 Seventh Street, SW, Washington, DC 20590 and Asphalt Recycling and Reclaiming Association, #3 Church Circle, PMB 250, Annapolis, MD 21401, 2001.
3. *Rubblization of Portland Cement Concrete Pavements*, Transportation Research Circular Number E-C087, Transportation Research Board, 500 Fifth Street, NW, Washington, DC 20001, January 2006.
4. *Distress Identification Manual for the Long-Term Pavement Performance Program*, U.S. Department of Transportation, Federal Highway Administration, Publication No. FHWA-RD-03-031, June 2003.
5. *Designing Stone Matrix Asphalt Mixtures for Rut-Resistant Pavements, Report 425*, Transportation Research Board, National Research Council, National Academy Press, Washington, D.C., 1999.
6. *Dynamic Modulus of Cold-In-Place Recycling (CIR) Material*, Md. Rashadul Islam, Sylvester A. Kalevela, and Jill A. Rivera, Colorado Department of Transportation applied Research and Innovation Branch, Denver, Colorado 2018.

## CHAPTER 9

# PRINCIPLES OF DESIGN FOR PAVEMENT REHABILITATION WITH RIGID OVERLAYS

### 9.1 M-E Introduction

Overlays are used to remedy structural or functional deficiencies of existing flexible or rigid pavements and extend their useful service life. It is important the designer consider the type of deterioration present when determining whether the pavement has a structural or functional deficiency, so an appropriate overlay type and design can be developed. **Figure 9.1 Rehabilitation Alternative Selection Process** shows the flowchart for the rehabilitation alternative selection process. **Note:** Not all of the steps presented in this figure are performed directly by M-E Design, however designers must consider all of the steps to produce a feasible rehabilitation with rigid overlay design alternatives.

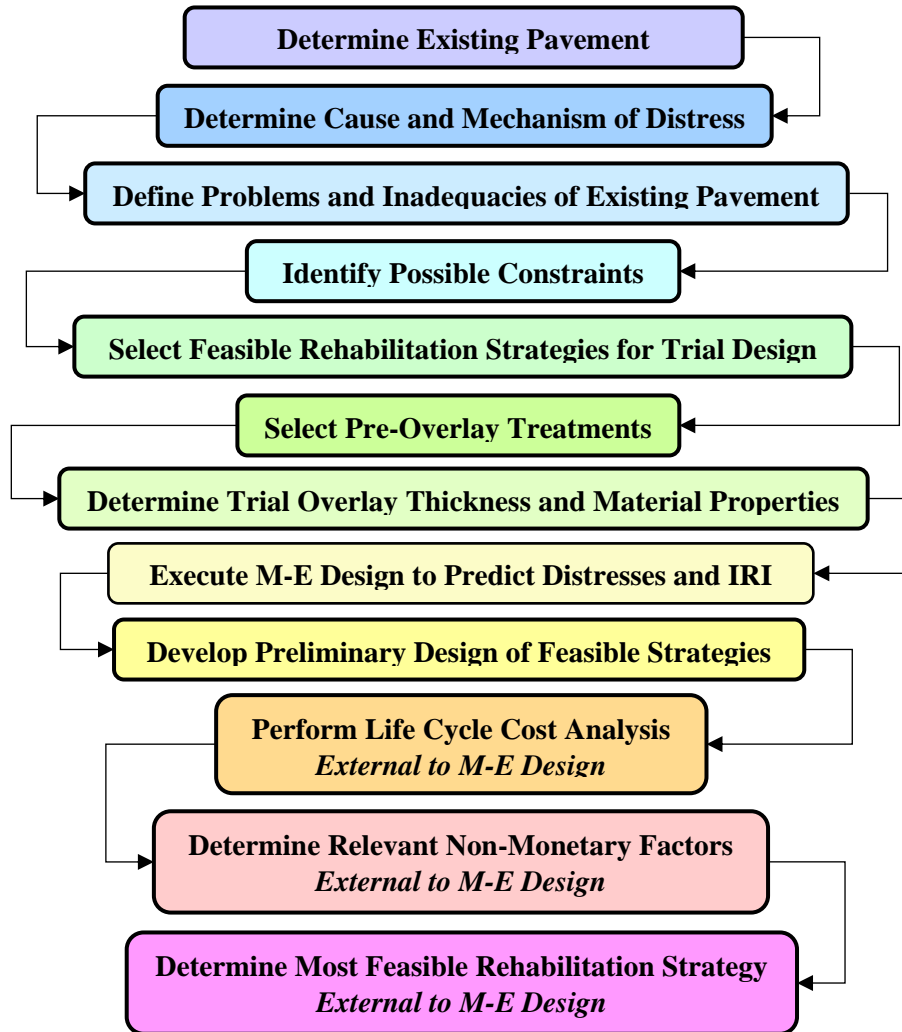


Figure 9.1 Rehabilitation Alternative Selection Process

This chapter describes the information needed to create cost effective rehabilitation strategies with PCC overlays using M-E Design and CDOT Thin Concrete Overlay design. Policy decision making that advocates applying the same standard fixes to every pavement does not always produce a successful pavement rehabilitation. Successful rehabilitation depends on decisions that are based on the specific condition and design of the individual pavement. The rehabilitation design process begins with the collection and detailed evaluation of project information. Once the data is gathered, an evaluation is in order to determine the cause of the pavement distress. Finally, a choice needs to be made to select an engineered rehabilitation technique(s) that will correct the distresses.

### 9.1.1 CDOT Required Procedure for Rigid Overlays

Concrete overlays are quickly becoming a popular method used nationwide to rehabilitate deteriorated asphalt pavements. Since the flexible asphalt surface is replaced by rigid concrete, the technique offers superior service, long life, low maintenance, low life-cycle cost, improved safety, and environmental benefits. The critical stress and strain prediction equations developed in an initial research report are part of a first generation design procedure and were issued in December 1998 in a document titled *Guidelines for the Thickness Design of Bonded Whitetopping Pavement in the State of Colorado*, CDOT-DTD-R-98-10. An initial MS Excel worksheet was developed along with the report. The equations were verified and/or modified with the collection of additional data and was reported under the August 2004, *Instrumentation and Field Testing of Thin Whitetopping Pavement in Colorado and Revision of the Existing Colorado Thin Whitetopping Procedure*, CDOT-DTD-R-2004-12. A revised MS Excel worksheet accompanies the report.

A concrete overlay is the construction of a new PCCP over an existing HMA pavement. It is considered an advantageous rehabilitation alternative for badly deteriorated HMA pavements, especially those that exhibit such distress as rutting, shoving, and alligator cracking (ACPA 1998). The primary concerns with concrete overlays are as follows:

- The thickness design procedure
- Joint spacing
- The use and spacing of dowels and tie bars

In general, CDOT **does not recommend a thin concrete overlay thickness of less than 5 inches. Conventional concrete overlays use a thickness of 8 inches or greater. Ultra-thin concrete overlay, which uses 4 inches or less of PCCP, should not be used on Colorado's state highways** (see **Table 9.1 Required Concrete Overlay Procedure**).

**Table 9.1 Required Concrete Overlay Procedure**

Required Thickness	
< 5 inches	Do not use
≥ 5 to < 8 inches	CDOT Thin concrete overlay procedure
≥ 8 inches	AASHTO Overlay design (M-E Design)

## 9.2 Determining Existing Pavement Condition

### 9.2.1 Records Review

Obtaining specific project information is the first step in the rehabilitation process. Five basic types of detailed project information are necessary: design, construction, traffic, environmental, and pavement condition. A detailed records review should be conducted before a project evaluation can be made. Refer to **Section 2.3 Project/Files Records Collection and Review** for information concerning a detailed records review.

### 9.2.2 Field Evaluation

A detailed field evaluation of the existing pavement condition and distresses is necessary for a rehabilitation design. It is important an existing pavement condition evaluation be conducted to identify functional and structural deficiencies so designers may select appropriate combinations of preoverlay repair treatments, reflection crack treatments, and PCC overlay designs to correct the deficiencies present. Designers must, as a minimum, consider the following as part of the pavement evaluation:

- Existing pavement design
- Condition of pavement materials, especially durability problems and subgrade soil
- Distress types present, severities, and quantities
- Future traffic loadings
- Climate
- Existing subdrainage facilities condition

### 9.2.3 Visual Distress

The types of distress have to be identified and documented prior to the selection of corrective measures. The cause of a distress is not always easily identified and may consist of a combination of problems. **Figure 9.2 Pavement Condition Evaluation Checklist (Rigid)** provides guidance for existing pavement evaluation for rigid pavements. A similar checklist is available in **Figure 8.2 Pavement Condition Evaluation Checklist (Flexible)** for flexible pavement. Refer to **Section A.4 Site Investigation** for information on how to conduct the distress survey.

CDOT has a distress manual documenting pavement distress, description, severity levels, and additional notes. The distress manual is presented in Appendix B - Colorado DOT Distress Manual for HMA and PCC Pavements in the publication *Development of a Pavement Maintenance Program for the Colorado Department of Transportation*, Final Report, CDOT-DTD-R-2004-17, August 2004. The report is in pdf format and may be downloaded from the web page <http://www.coloradodot.info/programs/research/pdfs/2004/preventivemaintenance.pdf>. A field inspection is mandatory in order to determine the pavement distress and condition. Isolating areas of distress can pinpoint different solutions for various sections along a project.

The condition of drainage structures and systems such as ditches, longitudinal edge drains, transverse drains, joint and crack sealant, culverts, storm drains, inlets, and curb and gutters are all important for diverting water away from the pavement structure. Visual observation will reveal the types and extents of distresses present in the pavement that are either caused by or accelerated by moisture. Drainage assessment can also be benefited by data obtained from coring and material testing. The permeability and effective porosity of base/subbase materials, as determined through laboratory tests or calculated from gradations, can be used to quantify drainability (see **Table 9.2 Distress Levels for Assessing Drainage Adequacy of JPCP**).

**Table 9.2 Distress Levels for Assessing Drainage Adequacy of JPCP**

Load-Related Distress	Highway Classification	Current Distress Level		
		Inadequate	Marginal	Adequate
<b>Pumping</b> All Severities (percent joints)	Interstate/freeway	> 25	10 to 25	< 10
	Primary	> 30	15 to 30	< 15
	Secondary	> 40	20 to 40	< 20
<b>Mean Transverse Joint/Crack Faulting</b> (inches)	Interstate/freeway	> 0.15	0.10 to 0.15	< 0.10
	Primary	> 0.20	0.125 to 0.20	< 0.125
	Secondary	> 0.30	0.15 to 0.30	< 0.15
<b>Durability</b> All Severity Levels of D- Cracking and Reactive Aggregate	All	Predominantly medium and high severity	Predominantly low and medium severity	None or predominantly low severity
<b>Corner Breaks</b> All Severities (number/mile)	Interstate/freeway	> 25	10 to 25	< 10
	Primary	> 30	15 to 30	< 15
	Secondary	> 40	20 to 40	< 20

## PAVEMENT EVALUATION CHECKLIST (RIGID)

PROJECT NO.: \_\_\_\_\_ LOCATION: \_\_\_\_\_  
 PROJECT CODE (SA #): \_\_\_\_\_ DIRECTION: \_\_\_\_\_ MP \_\_\_\_\_ TO MP \_\_\_\_\_  
 DATE: \_\_\_\_\_ BY: \_\_\_\_\_  
 TITLE: \_\_\_\_\_

### TRAFFIC

Existing \_\_\_\_\_ NUMBER OF TRUCKS  
 Design \_\_\_\_\_ NUMBER OF TRUCKS

### EXISTING PAVEMENT DATA

Subgrade (AASHTO) _____	Roadway Drainage Condition
Base (type/thickness) _____	(good, fair, poor)
Pavement Thickness _____	Shoulder Condition (good, fair, poor)
Soil Strength (R/M <sub>R</sub> ) _____	Joint Sealant Condition (good, fair, poor)
Swelling Soil (yes/no) _____	Lane Shoulder Separation (good, fair, poor)

### DISTRESS EVALUATION SURVEY

Type	Distress Severity*	Distress Amount*
Blowup		
Corner Break		
Depression		
Faulting		
Longitudinal Cracking		
Pumping		
Reactive Aggregate		
Rutting		
Spalling		
Transverse and Diagonal Cracks		
OTHER		

\* Distress Identification Manual for the Long-Term Pavement Performance Program, U.S. Department of Transportation, Federal Highway Administration, Publication No. FHWA-RD-03-031, June 2003.

**Figure 9.2 Pavement Condition Evaluation Checklist (Rigid)**  
 (A Restatement of Figure A.1) Drainage Survey

### 9.2.4 Non-Destructive Testing

Non-destructive testing may use three methods of testing to determine structural adequacy.

- **Deflection Testing:** Determine high deflections, layer moduli, and joint load transfer efficiencies
- **Profile Testing:** Determine joint/crack faulting
- **Ground Penetrating Radar:** Determine layer thickness

The data obtained from these methods would be project site-specific (i.e. Level 1 inputs). Deflection testing results are used to determine the following:

- Concrete elastic modulus and subgrade modulus of reaction (center of slab)
- Load transfer across joints/cracks (across transverse joints/cracks in wheelpath)
- Void detection (at corners)
- Structural adequacy (at non-distressed locations)

In addition to backcalculation of the pavement layer and subgrade properties, void detection, and deflection testing can also be used to evaluate the load transfer efficiency (LTE) of joints and cracks in rigid pavements. *Evaluation of Joint and Crack Load Transfer*, Final Report, FHWA-RD-02-088 is a study presenting the first systematic analysis of the deflection data under the LTPP program related to LTE.

$$\text{LTE} = (\delta_u / \delta_l) \times 100 \qquad \text{Eq. 9-1}$$

Where:

LTE = load transfer efficiency, percent

$\delta_u$  = deflection on unloaded side of joint or crack measured 6 inches from the joint/crack

$\delta_l$  = deflection on loaded side of joint or crack measured beneath the load plate the center of which is placed 6 inches from the joint/crack

Visual distresses present at the joint or crack should be recorded and quantified. Joint and crack distress information is useful in analyzing and filtering the results obtained from the LTE calculation. The load transfer rating as related to the load transfer efficiency is shown in **Table 9.3 Load Transfer Efficiency Quality**.

Crack LTE is a critical measure of pavement condition because it is an indicator of whether the existing cracks will deteriorate further. LTE tests are usually performed in the outer wheelpath of the outside lane. For JPCP, cracks are held together by aggregate interlock; joints designed with load transfer devices have steel and aggregate interlock. In general, cracks with a good load transfer (LTE greater than 75 percent) hold together quite well and do not significantly contribute to pavement deterioration. Cracks with poor load transfer (LTE less than 50 percent) are working cracks and can be expected to deteriorate to medium and high severity levels and will exhibit faulting over time. These cracks are candidates for rehabilitation.

**Table 9.3 Load Transfer Efficiency Quality**

<b>Load Transfer Rating</b>	<b>Load Transfer Efficiency (percent)</b>
Excellent	90 to 100
Good	75 to 89
Fair	50 to 74
Poor	25 to 49
Very Poor	0 to 24

### 9.2.5 Coring and Material Testing Program

Experience has shown that non-destructive testing techniques alone may not always provide a reasonable or accurate characterization of the in-situ properties, particularly for those of the top pavement layer. The determination of pavement layer type cannot be made through non-destructive testing. While historic information may be available, the extreme importance and sensitivity calls for a limited amount of coring at randomly selected locations to be used to verify the historic information. Pavement coring, base and subbase thicknesses, and samples are recommended to be collected at an approximate frequency of one sample per one-half mile of roadway. Several major parameters are needed in the data collection process. They are as follows:

- Layer thickness
- Layer material type
- Examination of cores to observe general condition and material durability
- In-situ material properties (i.e. modulus and strength)

Concrete slab durability may have a possible condition of severe D-Cracking and reactive aggregate. Petrographic analysis helps identify the severity of the concrete distresses when the cause is not obvious. Material durability problems are the result of adverse chemical or physical interactions between a paving material and the environment. The field condition survey and examination of cores for material durability reinforce each other.

### 9.2.6 Lane Condition Uniformity

On many four lane roadways, the outer truck lane deteriorates at a more rapid pace than the inner lane. The actual distribution of truck traffic across lanes varies with the roadway type, roadway location (urban or rural), the number of lanes in each direction, and the traffic volume. Because of these factors, it is suggested the lane distribution be measured for the project under consideration. Obtaining the actual truck lane distributions will determine the actual remaining life of the lane under consideration. Significant savings may result by repairing only the pavement lane that requires treatment.



### 9.3 Determine Cause and Mechanism of Distress

Knowing the exact cause of a distress is a key input required by designers for assessing the feasibility of rehabilitation design alternatives. Assessment of existing pavement conditions is done using outputs from distress and drainage surveys, usually some coring, and testing of materials. The evaluation of existing pavement conditions is a critical element in M-E Design's rehabilitation design. The observation should begin with a review of all information available regarding the design, construction, and maintenance history of the pavement. This should be followed by a detailed survey to identify the type, amount, severity, and location of surface distresses. Some of the key distress types are indicators of structural deficiencies:

- Deteriorated cracked slabs
- Corner breaks
- Mean transverse joint/crack faulting
- Pumping
- Spalling
- D-Cracking
- Other localized failing areas
- There may be other types of distress that, in the opinion of the engineer, would detract from the performance of an overlay

Depending on the types and amounts of deterioration present, rehabilitation options with or without pre-overlay treatments are considered. **Table 9.4 Common Distress Causes of Rigid Pavements and Associated Problem Types** presents a summary of causes for distresses present on existing rigid pavements.

### 9.4 Define Problems and Inadequacies of Existing Pavement

Information gathered and presented using the pavement condition evaluation checklist must be reviewed by the designer using guidance presented in **Table 9.4 Common Distress Causes of Rigid Pavements and Associated Problem Types** and **Table 8.1 Common Distress Causes of Flexible Pavement and Associated Problem Types** to define possible problems identified with the existing pavement. Accurately identifying existing problems is a key factor to be considered when selecting appropriate rehabilitation design alternatives for the trial design. A review of the extent and severity of distresses present will allow the designer to determine when the existing pavement deficiencies are primarily structural, functional, or materials durability related. It also allows the designer to determine if there is a fundamental drainage problem causing the pavement to deteriorate prematurely.

Once an existing pavement deficiency is characterized, the next step is to select among feasible design alternatives and perform a trial design. A description of common pavement problem types is presented as follows:

**Table 9.4 Common Distress Causes of Rigid Pavements and Associated Problem Types**

Distress Types	Load	Environment			Materials	Construction
		Moisture	Temperature	Subgrade		
Alkali-Aggregate Reactivity	N	P	C	N	P	N
Blow-Up	N	C	P	N	C	N
Corner Breaks	P	C	C	N	N	N
Depression	N	C	N	P	N	C
“D” Cracking	N	P	P	N	P	N
Transverse Joint Faulting	P	P	C	C	C	N
Joint Failure	N	C	C	N	P	C
Lane/Shoulder Dropoff	C	P	P	C	C	N
Longitudinal Slab Cracking	P	C	P	C	C	P
Spalling (Longitudinal and Transverse Joints)	C	C	P	N	P	C
Polish Aggregate	C	N	N	N	P	N
Popouts	N	C	C	N	P	C
Pumping	P	P	N	C	C	N
Random (map) Cracking, Scaling, and Cracking	N	N	C	N	C	P
Shattered Slab	P	C	N	C	C	N
Swell	N	P	P	C	C	N
Transverse Slab Cracking	P	N	C	C	C	P

**Notes:** P = Primary Factor; C = Contributing Factor; N = Negligible Factor

- Functional Deterioration:** Functional deficiency arises from any condition(s) that adversely affect the highway user. These include poor surface friction and texture, faulting, hydroplaning and splash from wheel path rutting, and excess surface distortion. Cracking and faulting affect ride quality but are not classified under functional distress. These conditions reduce load carrying capacity as stated above. The integrity of the base, concrete slab, and joint system is compromised under cracking and faulting. If a pavement has only a functional deficiency, it would not be appropriate to develop an overlay design using a structural deficiency design procedure. Overlay designs, including thickness, preoverlay repairs, and reflection crack treatments must address the causes of functional problems and prevent their reoccurrence. This can only be done through sound engineering, and requires experience in solving the specific problems involved. The overlay design required to correct functional problems should be coordinated with that required to correct any structural deficiencies.
- Structural Deterioration:** This is defined as any condition that adversely affects the load carrying capability of the pavement structure. Corner breaks, pumping, faulted joints and shattered slabs are some examples of structural related distresses. Evaluating

the level of structural capacity requires thorough visual survey and materials testing. Non-destructive testing is important to characterize both pavement stiffness and subgrade support. Restoration is applicable only for pavements with substantial remaining structural capacity. Pavements that have lost much of their structural capacity require either a thick overlay or reconstruction. It should also be noted that several types of distress, (i.e. distresses caused by poor construction techniques) are not initially caused by traffic loads, but do become more severe under traffic to the point they also detract from the load carrying capability of the pavement.

- **Material Durability Deterioration:** This is defined as any condition that negatively impacts the integrity of paving materials leading to disintegration and eventual failure of the materials. Research indicates poor durability performance can often be attributed to the existing pavement material constituents, mix proportions, and climatic factors such as excessive moisture and intense freeze-thaw cycles. Examples of durability problems include spalling, scaling and disintegration of cement-treated materials due to freeze thaw damage, map cracking and joint deterioration resulting from alkali-silica reactivity, stripping in the HMA base, and contamination of unbound aggregate layers with fines from subgrade.

## 9.5 Identify Possible Constraints

The feasibility of any type of overlay design depends on the following major considerations:

- Construction feasibility of the overlay
- Traffic control and disruptions
- Materials and equipment availability
- Climatic conditions
- Construction problems such as noise, air/water pollution, hazardous materials, waste, subsurface utilities, overhead bridge clearance, shoulder thickness and side slope extensions in the case of limited right-of-way, etc.

Designers must consider all of the factors listed above along with others not mentioned as they determine whether a flexible overlay or reconstruction is the best rehabilitation solution for the given situation.

## 9.6 Selecting a Feasible Strategy for Rigid Pavement Rehabilitation Trial Designs

### 9.6.1 Bonded Concrete Overlays

#### 9.6.1.1 PCC Over PCC

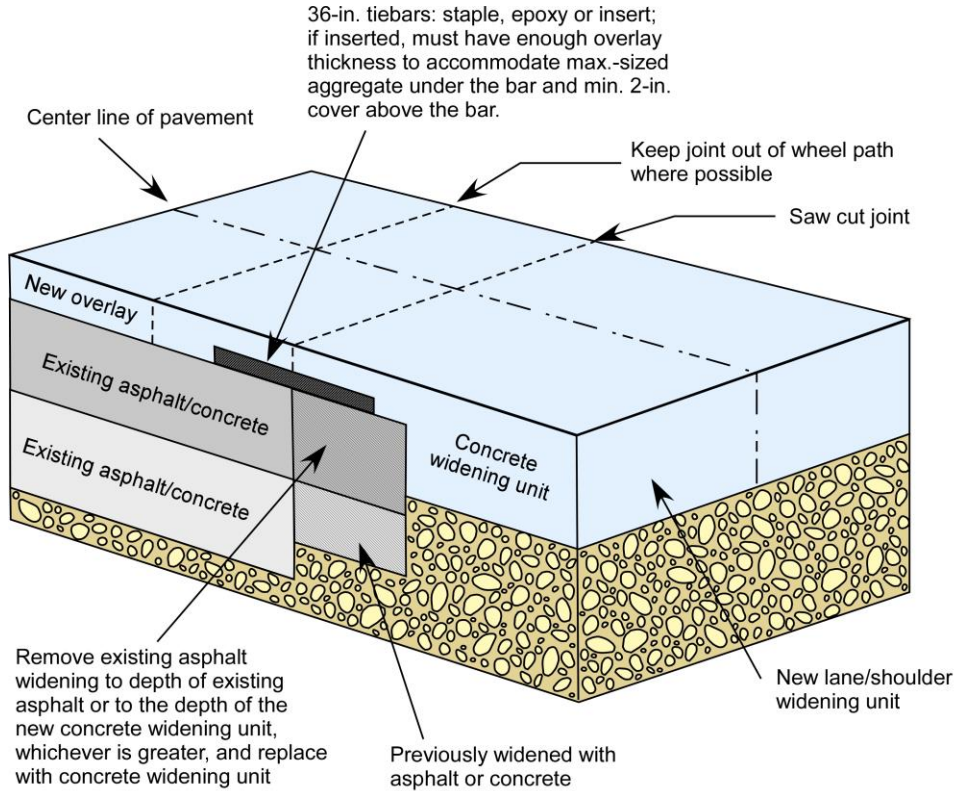
Bonded PCC overlays over existing jointed plain concrete pavement (JPCP) involve the placement of a thin concrete layer (typically 3 to 7 inches) atop the prepared existing PCC surface to form a permanent monolithic PCC section. The monolithic section improves load carrying capacity by reducing the critical structural responses which are top and bottom tensile stress in the longitudinal

direction for JPCP cracking and slab edge corner deflections at the joint for JPCP faulting. One should consult the Region Materials Engineer for additional information.

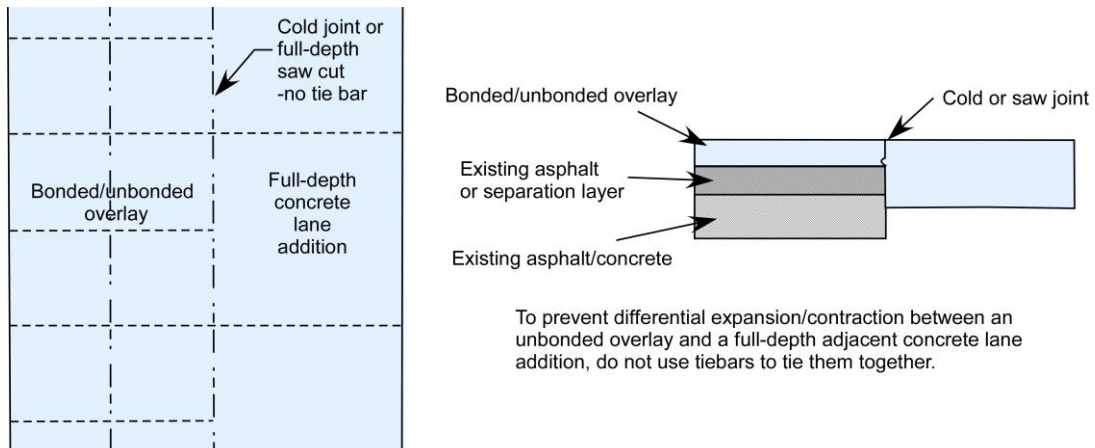
For bonded PCC overlays over existing JPCP, achieving long-term bonding is essential. To ensure an adequate bond, the existing surface should be cleaned of all surface contaminants including oil, paint, and unsound concrete. Milling, sand blasting, water blasting, or a combination of the above can accomplish this. Since all cracks in the old surface will reflect through the overlay, all joints and cracks in the original pavement must be reproduced in the overlay. For this reason, thin concrete overlays are restricted to pavements that are not heavily cracked. Thin concrete overlays should be used only when the existing concrete is in good condition or rehabilitated into a good condition.

#### 9.6.1.2 PCC Over HMA

Bonded PCC overlays over existing HMA involve the placement of a thin concrete layer, typically 3 to less than 8 inches, atop the existing HMA surface. These are used to restore the structural capacity and/or correct surface distresses of the existing HMA. The bond between the overlay and underlying HMA assists the horizontal shear transfer at the bond plane between the two types of pavement. Because of this bond, the shear stresses are transferred into the underlying HMA material, thereby reducing the tensile stresses in the PCC. To ensure an adequate bond, the existing HMA surface should be cleaned of surface contaminants such as oil and unsound HMA. Pavement marking material should be removed if more than two layers of marking material have been applied to the pavement. HMA with more than one layer of chip seals or slurry seals should be evaluated for its bond to the existing HMA. Power sweeping, cold milling, water blasting or a combination of the above can accomplish this. It has been determined that older HMA (over a few years old) will provide an adequate macrotexture for bonding without the need to cold plane the existing aged pavement. The Concrete Overlay Task Force has recommended an adequate platform for the PCC to be at least 3 inches of HMA in good condition and have a good bond to one another in the remaining 3 inches. FWD data should be obtained on every project. The typical overlay section is designed for a 10 or 20 year design while the typical widening portion is a 30 year design. An example of a bonded or unbonded overlay of asphalt or composite pavement is shown on **Figure 9.3 Bonded or Unbonded Overlay of Asphalt or Composite Pavement**. The figure illustrates a pavement that has been previously widened with asphalt or concrete that is to be widened again with a new concrete overlay. The intent of the tiebars is to tie the widening unit to the existing pavement. **Figure 9.4 Unbonded Overlay of Concrete, Asphalt or Composite Pavement with a Full Concrete Lane Addition** illustrates lane design details for an unbonded overlay of concrete, asphalt, or composite pavement with a full concrete lane addition. To prevent contraction between a concrete overlay and a full-depth adjacent concrete lane addition, use a butt joint with no tiebars.



**Figure 9.3 Bonded or Unbonded Overlay of Asphalt or Composite Pavement**  
(Previously widened with asphalt or concrete and to be widened again with new concrete overlay)



Note: The figure illustrates lane addition details. To prevent cracking related to differential expansion and contraction between a concrete overlay and a full-depth adjacent concrete lane addition, use a butt joint with no tiebars.

**Figure 9.4 Unbonded Overlay of Concrete, Asphalt, or Composite Pavement with a Full Concrete Lane Addition**

## 9.6.2 Feasibility of Alternatives for Bonded Concrete Overlays

The type of rehabilitation/restoration technique and thickness of the required overlay are based on an evaluation of present pavement conditions and estimates of future traffic. In general, the designer must apply the following rules when considering rehabilitation alternatives involving bonded concrete overlays:

- **An existing JPCP pavement surface evaluation indicates adequate structural strength but the surface needs correction.** Concrete Pavement Restoration (CPR) may be used to remedy the functional problem. CPR is a non-overlay option used to repair isolated areas of distress or to prevent or slow overall deterioration, as well as, to reduce the impact loadings on the concrete pavement without changing its grade. CPR includes diamond grinding, load transfer restoration, partial depth repairs, and full depth repairs.
- **An existing JPCP pavement surface evaluation indicates inadequate structural strength to carry future traffic, but the condition of the surface needs minor correction.** Bonded PCC overlays, in conjunction with surface restoration, may be used. Bonded overlays should be used only when the PCC slab is in good, sound condition to help ensure good bonding and little reflection cracking. Pre-overlay repairs including milling, load transfer restoration, and joint spalling repair may be undertaken as necessary to perform surface corrections of the existing PCC slab.
- **An existing HMA pavement surface evaluation indicates inadequate structural strength to carry future traffic, but the condition of the surface needs minor correction.** Bonded PCC overlays, in conjunction with surface restoration, may be used. The HMA should be evaluated by a combination of visual inspections, non-destructive tests such as FWD testing, and cores. Cores should be taken to determine damage not visible at the surface. Pre-overlay full-depth patching may be undertaken as necessary to repair severe load associated cracking and potholes. Bonded overlays should be used only when at least 3 inches of HMA remains and the HMA layers have good adhesion to each other. Rutting or shoving in the existing HMA exceeding 2 inches will require milling. The milling operation should reduce the affected area to a maximum of 2 inches in depth. When severe load associated cracking and/or severe stripping is found in the underlying layers, it is recommended that FWD testing be used to determine the structural strength of the HMA. Cracks greater than  $\frac{3}{4}$  inch prior to the PCC overlay should be filled with milling material or fine aggregate.
- **When the existing pavement has significant durability problems.** Unbonded PCC or conventional AC overlays over fractured concrete should be used. Unbonded overlays do not require much pre-overlay repair unless there is a spot of significant deterioration. A separator layer using a thin AC layer or paving fabric placed between the overlay and existing pavement should be used. Separating the existing and overlay PCC layers prevents distresses in the existing pavement from reflecting through the overlay. Slabs that move under traffic loads, isolated soft spots, pumping, or faulted

areas should be stabilized prior to overlaying. Total reconstruction may also be warranted. CPR is not recommended for rigid pavements that have significant material durability problems or other severe deterioration.

### 9.6.3 The CDOT Thin Concrete Overlay Thickness Design

The purpose of bonded concrete overlays of asphalt is to add structural capacity and eliminate surface distresses on the existing asphalt pavement. Severe surface defects are corrected to provide an acceptable and relatively smooth surface on which to place the concrete. Cold milling is only required when an asphalt mix has been placed within the last couple of years. The surface needs to be roughened to create a good interlocking bond. Also, by the use of cold milling, grade control can be accomplished at this time. The final operation is to pave the concrete with a conventional concrete paving machine.

Based on the field and theoretical analyses conducted during the research study, the following construction practices should be used:

- A good bond within the concrete/asphalt interface is essential for successful performance.
- For existing asphalt pavement being rehabilitated, the strain (and corresponding stress) in the concrete overlay is reduced by approximately 25 percent when the asphalt is milled prior to concrete placement. The strain (and corresponding stress) in concrete on new asphalt is increased by approximately 50 percent when the asphalt has not aged prior to concrete placement.

A minimum asphalt thickness of 3 inches (after cold planning or other remedial work) is recommended. **Table 9.5 Design Factors for Rigid Pavement** contains the various factors to be used in the concrete overlay design.

For more information, refer to CDOT Research Report No. CDOT-DTD-R-98-10, *Guidelines for the Thickness Design of Bonded Whitetopping Pavement in the State of Colorado, December 1998*, CDOT-DTD-R-2002-3, *Instrumentation and Field Testing of Whitetopping Pavements in Colorado and Revision of the TWT Design Procedure*, March 2002 and CDOT-DTD-R-2004-12, *Instrumentation and Field Testing of Thin Whitetopping Pavement in Colorado and Revision of the Existing Colorado Thin Whitetopping Procedure, August 2004*. The last two research reports can be found on web page <http://www.dot.state.co.us/publications/researchreports.htm#White>. A revised MS Excel worksheet was developed in conjunction with report CDOT-DTD-R-2004-12. The worksheet may be obtained from CDOT Materials and Geotechnical Branch, Pavement Design Unit 303-398-6561 or CDOT Research Branch 303-757-9506.

The proper selection of candidate projects for CDOT Thin Concrete Overlay is of paramount importance to its continued use as a viable rehabilitation alternative. Listed are guidelines for the pavement designer when considering if a thin concrete overlay will work on the project. The list was compiled from characteristics of good performing concrete overlay projects.

- Determine the modulus of existing asphalt by an analysis using FWD data.
- Cold mill when the rut depth exceeds 2 inches or when new HMA is placed to improve mechanical bond.
- The condition of the asphalt pavement must be in relatively good condition for an overlay.
- An existing roadway having a good aggregate base is preferred.
- Concrete overlays work well with a divided roadway. The median serves as a non-tied longitudinal joint.
- The cross traffic must be added to the mainline traffic at intersection locations for proper pavement design.



**Table 9.5 Design Factors for Rigid Pavement**

Factor	Source
Primary or Secondary	User input (select primary or secondary)
Joint Spacing	24 to 72 inches (dependent on thickness)
Trial Concrete Thickness	User input
Concrete Modulus of Rupture	650 psi (CDOT default value)
Concrete Elastic Modulus	<b>Table 7.1 PCC Material Inputs and Recommendations for New JPCP Design</b> or FWD data
Concrete Poisson's Ratio	0.15 (CDOT default value)
Asphalt Thickness	Soil profile report from laboratory
Asphalt Modulus of Elasticity (When Existing HMA was New)	User input (from FWD data))
Asphalt Poisson's Ratio	0.35 (CDOT default value)
Asphalt Fatigue Life Consumed	$\left[ 1 - \frac{\text{existing asphalt modulus}}{\text{asphalt modulus when new}} \right] * 100$ or Estimated by designer
k-value of the Subgrade	Soil profile report from laboratory and correlation equations
Temperature Differential	$\Delta T = 3^\circ \text{ F/in.}$ throughout the day (CDOT default value)
Design Truck Traffic	DTD Traffic Analysis Unit

A Project Special Provision has been developed and is to be used on thin concrete overlay projects. The Project Special Provision is located on the following web page:

<http://www.coloradodot.info/business/designsupport/construction-specifications/2011-Specs/sample-construction-project-special-provisions/section-300-500-revisions>

The specification is titled *Revision of Section 412, Portland Cement Concrete Pavement Thin Concrete Overlay*. Additionally, a thin concrete overlay typical joint layout plan sheet has been developed for the project special provision. It is titled *D-412-2, Thin Concrete Overlay Typical Joint Layout* and is found on web page:

[http://www.coloradodot.info/business/designsupport/standard-plans/2006-m-standards/2006-project-special-details/2006\\_m\\_standards\\_project\\_special\\_details\\_index](http://www.coloradodot.info/business/designsupport/standard-plans/2006-m-standards/2006-project-special-details/2006_m_standards_project_special_details_index)

#### 9.6.4 Development of Design Equations

Two different modes of distress may exist in pavements overlaid by concrete; corner cracking caused by corner loading and mid-slab cracking caused by joint loading. Both types of failure were considered in developing the original design equations (1998).

#### 9.6.4.1 Corner Loading (1998)

Both a 20-kip Single Axle Load (SAL) and a 40-kip Tandem Axle Load (TAL) were applied to the slab corners of the concrete overlay. The corner loading case was found to produce the maximum concrete stress for relatively few conditions. In general, the corner loading case governed at higher values of the effective radius of relative stiffness. As the stiffness increases, the load-induced stress decreases. All instances when the corner load case governed, relatively lower stresses resulted. The maximum stress, whether edge or corner, was used in the derivation of the concrete stress prediction equations.

#### 9.6.4.2 Mid-Joint Loading (1998)

Load-induced longitudinal joint stresses for a 20-kip single axle load (SAL) and a 40-kip tandem axle load (TAL) were computed. Maximum tensile stresses at the bottom of each layer were calculated for the concrete and asphalt. Maximum asphalt strains used in generating the design equations occurred for the joint loading condition. In most cases, the joint loading condition produced the maximum stress at the bottom of the concrete layer.

#### 9.6.4.3 Determination of Critical Load Location (1998)

The critical load location for the design of concrete pavement was determined during the original 1998 study by comparing the stress and strain data collected for each load position. The critical load location inducing the highest tensile stress in the concrete layer occurred when the load was centered along a longitudinal free edge joint. For concrete pavement, a free edge joint occurs when the asphalt and concrete are formed against a smooth vertical surface such as a formed concrete curb and gutter. It is reasonable that free edge loading produces the highest stress, but it is more likely the joints loaded by traffic will not be free edges. The equation for original data is shown and used in the 2004 procedure but could not be verified.

#### Original Critical Joint Stresses:

$$\sigma_{FE} = 1.87 \times \sigma_{TE} \quad \text{Eq. 9-2}$$

Where:

$\sigma_{FE}$  = load induced stress at a longitudinal free joint, psi

$\sigma_{TE}$  = load induced stress at a longitudinal tied joint, psi

#### 9.6.4.4 Interface Bond on Load-Induced Concrete Stress

The effect of interface bonding was evaluated by comparing measured stresses for zero temperature gradient conditions to the computed stresses for fully bonded pavement systems. Stresses caused by loads at mid-joint and slab corners were computed using the finite element computer program ILLISLAB (ILSL2), assuming a fully bonded concrete-asphalt interface. The program is based on plate bending theory for a medium-thick plate placed on a Winkler or spring foundation. Based on the previous study (1998), all the test sections where existing asphalt was

milled prior to concrete placement was determined to be the best approach for promoting bond for existing asphalt substrate conditions.

#### 2004 Interface Bond on Load-Induced Concrete Stresses:

$$\sigma_{EX} = 1.51 \times \sigma_{TH} \quad \text{Eq. 9-2}$$

Where:

$\sigma_{EX}$  = measured experimental partially bonded stress, psi

$\sigma_{TH}$  = calculated fully bonded stress, psi

#### 9.6.4.5 Interface Bond on Load-Induced Asphalt Strain

The effect of interface bond on the load-induced asphalt surface strain was also studied using field-collected data. If slabs were fully bonded, the concrete bottom strain would equal the asphalt surface strain. Due to slippage between the layers, asphalt strains are generally less than the concrete strains. There is approximately a 10 percent loss of strain transfer from the concrete to the asphalt due to the partial bond between the layers.

#### 2004 Interface Bond on Load-Induced Asphalt Strain:

$$\epsilon_{ac} = 0.897 \times \epsilon_{pcc} - 0.776 \quad \text{Eq. 9-4}$$

Where:

$\epsilon_{ac}$  = measured asphalt surface strain, microstrain

$\epsilon_{pc}$  = measured concrete bottom strain, microstrain

Stresses and strains at the bottom of the asphalt layer decrease with loss of bond. The design procedure assumes the average strain reductions reflecting partial bond at the interface are equally reflected at the bottom of the asphalt layer.

#### 9.6.4.6 Temperature Restraint Stress

Temperature gradients throughout load testing ranged from -2°F/in. to 6°F/in. Measurable stress changes occurred with changing temperature gradient, which indicates the restraint stresses are present and raises concern that there could be loss of support conditions. However, minimizing effects of curling and warping restraint stresses and possible loss of support may be done by minimizing the concrete overlay joint spacing (typically using 6 feet by 6 feet panels).

#### 2004 Temperature Effects on Load-Induced Stresses:

$$\sigma_{\%} = 3.85 \times \Delta T \quad \text{Eq. 9-5}$$

Where:

$\sigma_{\%}$  = percent change in stress from zero gradient

$\Delta T$  = temperature gradient, °F/in.

This relationship is applied to the partial bond stresses to account for the effect of temperature induced slab curling and loss of support effects on the load induced concrete stresses. For CDOT projects, a default temperature gradient of 3°F/in. will be used.

#### 9.6.4.7 Development of Prediction Equations for Design Stresses and Strains

Prediction equations were derived for computing design concrete flexural stresses and asphalt flexural strains. The 2004 equations include calibration factors for modeled thin whitetopping concrete stresses and asphalt strains; 151 percent for stresses and approximately 89 percent for stresses and strains would be required to account for the loss of bonding at the 95 percent confidence level. Asphalt strains are decreased by approximately 10 percent to account for the partial bonding condition at the 95 percent confidence level. Effects of temperature-induced slab curling on load-induced stresses were also included in the thickness design procedure, and all of the original 1998 adjustments for these stresses and strains were revised. The revised four equations are as follows:

2004 Concrete Stress for 30-kip SAL

$$(\sigma_{pcc})^{1/2} = 18.879 + 2.918t_{pcc}/t_{ac} + 425.44/l_e - 6.95 \times 10^{-6}E_{ac} - 9.0366 \log k + 0.0133L \quad \text{Eq. 9-6}$$

$R^2 \text{ adj} = 0.92$

2004 Concrete Stress for 40-kip TAL

$$(\sigma_{pcc})^{1/2} = 17.669 + 2.668t_{pcc}/t_{ac} + 408.52/l_e - 6.455 \times 10^{-6}E_{ac} - 8.3576 \log k + 0.00622L \quad \text{Eq. 9-7}$$

$R^2 \text{ adj} = 0.92$

2004 Asphalt Strain for 20-kip SAL

$$(\epsilon_{ac})^{1/4} = 8.224 + 0.2590t_{pcc}/t_{ac} + 0.044191l_e - 6.898 \times 10^{-7}E_{ac} - 1.1027 \log k \quad \text{Eq. 9-8}$$

$R^2 \text{ adj} = 0.92$

2004 Asphalt Strain for 40-kip TAL

$$(\epsilon_{ac})^{1/4} = 8.224 + 0.2590t_{pcc}/t_{ac} + 0.044191l_e - 6.898 \times 10^{-7}E_{ac} - 1.1027 \log k \quad \text{Eq. 9-8}$$

$R^2 \text{ adj} = 0.92$

Where:

$\sigma_{pcc}$  = maximum stress in the concrete slab, psi

$\epsilon_{ac}$  = maximum strains at bottom of asphalt layer, microstrain

$E_{pcc}$  = concrete modulus of elasticity, assumed 4 million psi

$E_{as}$  = asphalt modulus of elasticity, psi

$t_{pcc}$  = thickness of the concrete layer, in.

$t_{ac}$  = thickness of the asphalt layer, in.

$\mu_{pcc}$  = Poisson's ratio for the concrete, assumed 0.15

$\mu_{ac}$  = Poisson's ratio for the asphalt, assumed 0.35

$k$  = modulus of subgrade reaction, pci

$$\begin{aligned}
 L &= \text{joint spacing, in.} \\
 L_e &= \text{effective radius of relative stiffness for fully bonded slabs, in} \\
 &= \{E_{pcc} \times [t_{pcc}^3 / 12 + t_{pcc} \times (NA - t_{pcc} / 2)^2] / [k \times (1 - \mu_{pcc}^2)] + E_{ac} \times [t_{ac}^3 / 12 + t_{ac} \times \\
 &\quad (t_{pcc} - NA + t_{ac} / 2)^2] / [k \times (1 - \mu_{ac}^2)]\}^{1/4} \\
 NA &= \text{neutral axis from top of concrete slab, in.} \\
 &= [E_{pcc} \times t_{pcc}^2 / 2 + E_{ac} \times t_{ac} \times (t_{pcc} + t_{ac} / 2)] / [E_{pcc} \times t_{pcc} + E_{ac} \times t_{ac}]
 \end{aligned}$$

Each of the equations developed to calculate the critical stresses and strains in a concrete overlay are dependent on the effective radius of relative stiffness of the layered system. The radius of relative stiffness appears in many of the equations dealing with stresses and deflections of concrete pavements. Concrete overlays include an additional structural layer of asphalt concrete. The stiffness contribution of the asphalt layer is incorporated into the effective radius of the relative stiffness equation shown above.

Transverse joint spacing directly affects the magnitude of critical stresses in thin concrete overlays. Depending on the pavement design, climate, season, and time of the day, curling stresses in a concrete overlay can equal or exceed the load stresses. Thus, joint spacing is directly considered as an input in the CDOT design.

CDOT does not use dowels for transverse joints in thin concrete overlay designs; however, it recommends the use of tie bars in longitudinal joints. The 2004 equations are based on using tie bars in the longitudinal joints. The analysis used all wheel loadings next to tied longitudinal joints. CDOT project design drawing D-412-2, Thin Concrete Overlay Typical Joint Layout provides for this requirement.

#### 9.6.4.8 PCCP and HMA Pavement Fatigue

The Portland Cement Association (PCA) developed a fatigue criterion based on Miner's hypothesis stating fatigue resistance not consumed by repetitions of one load is available for repetitions of other loads. In a design, the total fatigue should not exceed 100 percent. The concrete fatigue criterion was incorporated as follows:

$$\begin{aligned}
 &\text{For } SR > 0.55 \\
 &\quad \mathbf{Log_{10}(N) = (0.97187 - SR) / 0.0828} \qquad \mathbf{Eq. 9-10}
 \end{aligned}$$

$$\begin{aligned}
 &\text{For } 0.45 \leq SR \leq 0.55 \\
 &\quad \mathbf{N = [4.2577 / (SR - 0.43248)] \times 3.268} \qquad \mathbf{Eq. 9-11}
 \end{aligned}$$

$$\begin{aligned}
 &\text{For } SR < 0.45 \\
 &\quad \mathbf{N = Unlimited} \qquad \mathbf{Eq. 9-12}
 \end{aligned}$$

Where:

SR = flexural stress to strength ratio  
N = number of allowable load repetitions

Asphalt pavements are generally designed based on two criteria, asphalt concrete fatigue and subgrade compressive strain. Subgrade compressive strain criterion was intended to control pavement rutting for conventional asphalt pavements. For concrete overlay pavements, when the asphalt layer is covered by concrete slabs, pavement rutting will not be the governing distress. The asphalt concrete fatigue equation developed by the Asphalt Institute was employed in the development of the concrete overlay design procedure. The asphalt concrete fatigue equation is as follows:

$$N = C \times 18.4 \times (4.32 \times 10^{-3}) \times [(1 / \epsilon_{ac}) \times 3.29] \times [(1/E_{ac}) \times 0.854] \quad \text{Eq. 9-13}$$

Where:

N = number of load repetitions for 20% or greater AC fatigue cracking

$\epsilon_{ac}$  = maximum tensile strain in the asphalt layer

$E_{ac}$  = asphalt modulus of elasticity, psi

C = correction factor, 10M

$M = 4.84 \times [(V_b/V_v + V_b) - 0.69]$

$V_b$  = volume of asphalt, percent

$V_v$  = volume of air voids, percent

For typical asphalt concrete mixtures, M would be equal to zero. The correction factor C, would become one, thus omitted from the equation. However, since a concrete overlay is designed to rehabilitate deteriorated asphalt pavement, the allowable number of load repetitions (N) needs to be modified to account for fatigue life consumed prior to concrete overlay construction. Therefore, the calculated repetitions must be multiplied by the fractional percentage representing the amount of fatigue life remaining in the asphalt concrete. For example, if it is determined that 25 percent of the asphalt fatigue life has been consumed prior to concrete overlay; the calculated allowable repetitions remaining must be multiplied by 0.75.

The concrete overlay pavement thickness design involves the selection of the proper concrete slab dimensions and thickness. Two criteria were used in governing the pavement design asphalt and concrete fatigue under joint or corner loading. Temperature and loss of support effects were also considered in the design procedure. A design example is presented in the next section to illustrate how to use the developed procedure to calculate the required concrete overlay concrete thickness.

#### 9.6.4.9 Converting Estimated ESALs to Concrete Overlay ESALs

CDOT currently designs pavements using the procedure developed by the American Association of State Highway and Transportation Officials (AASHTO). This empirical procedure is based on pavement performance data collected during the AASHO Road Test in Ottawa, in the late 1950's and early 1960's. Traffic (frequency of axle loadings) is represented by the concept of the 18-kip Equivalent Single Axle Load (ESAL). Factors are used to convert the damage caused by repetitions of all axles in the traffic mix (single and tandem) to an equivalent damage due to 18-kip ESALs alone. Because the relative damage caused by ESALs is a function of the pavement thickness, a series of ESAL conversion factors have been developed for a range of concrete thicknesses. However, the minimum concrete thickness included in the AASHTO design manual is 6 inches. Since concrete overlay thicknesses below 6 inches are anticipated, it was necessary to

develop correction factors to convert ESAL estimations based on thicker concrete sections. In addition, because the ESAL method of design appears to overestimate the required PCC thickness, it was necessary to develop a conversion factor, which would make the empirical and mechanistic procedures more compatible.

CDOT provided axle distributions for two highway categories (primary and secondary) anticipated as typical concrete overlay traffic loading. The ESAL conversion factors were designed for an 8 inch thick concrete pavement and a terminal serviceability of 2.5. The conversion factors were extrapolated for pavement thicknesses as low as 4 inches and the total ESALs were computed for a range of possible concrete overlay thicknesses. For each highway category, ESAL conversions were developed as a percentage of the total ESALs computed for an 8 inch thick concrete pavement. With these conversions, the designer only needs to obtain the design ESALs based on an assumed concrete thickness of 8 inches. For each trial concrete overlay thickness, the total ESAL estimation is adjusted based on the following conversion equations:

Primary Highway

$$F_{ESAL} = 0.985 + 10.057 \times (t_{pcc}) - 3.456 \quad \text{Eq. 9-14}$$

Secondary Highway

$$F_{ESAL} = (1.286 - 2.138 / t_{pcc}) - 1 \quad \text{Eq. 9-15}$$

Where:

$F_{ESAL}$  = conversion factor from ESAL estimation based on assumed, 8 inch thick concrete pavement

$T_{pcc}$  = thickness of concrete layer, inches

For example, in the design of a 4.5 inch thick concrete overlay on a secondary highway, the estimated ESALs based on an assumed 8 inch thick pavement, say 750,000, should be converted to 925,000 using the secondary highway conversion equation.

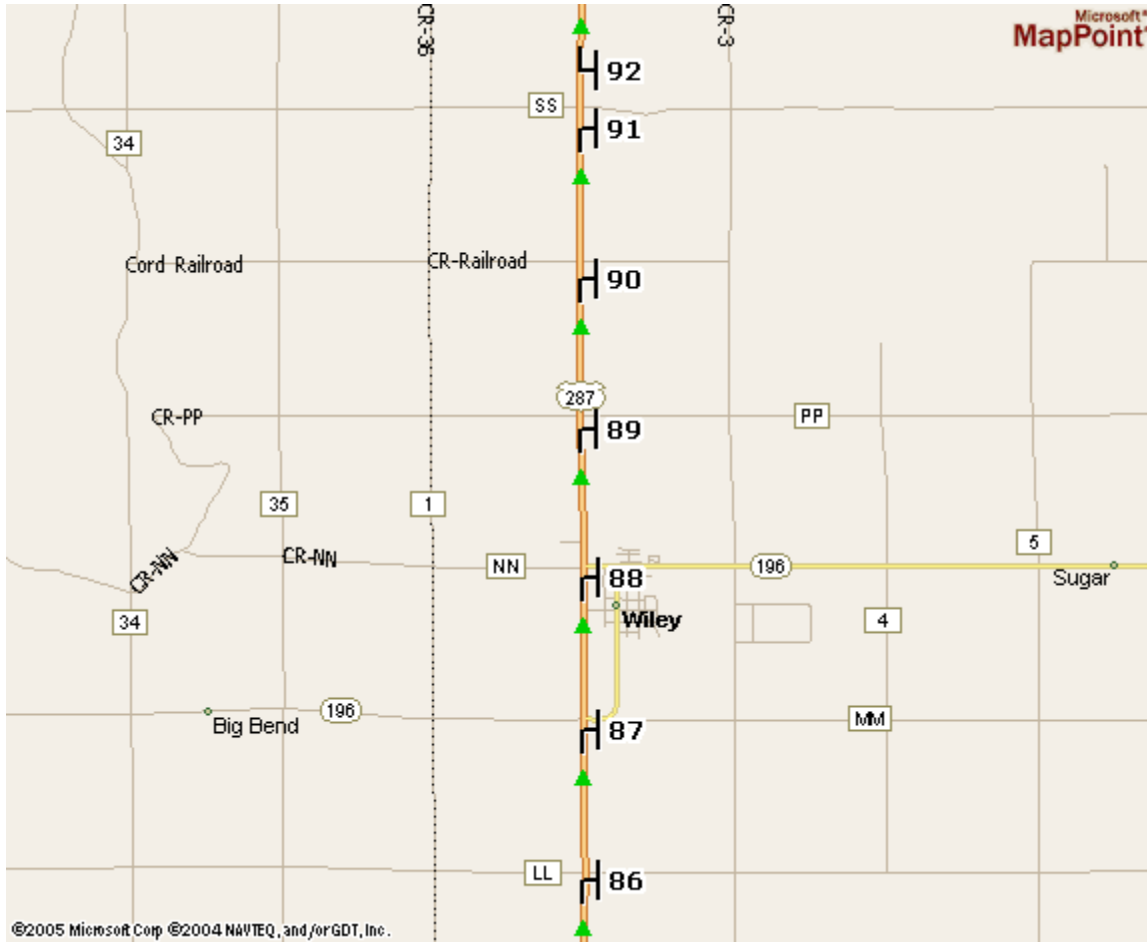
### 9.6.5 Example Project CDOT Thin Concrete Overlay Design

**Example:** A two-lane highway, Colorado State Highway 287 (SH 287) will need the cost for a typical 6 mile project. The cross section has 2 lanes, each 12 feet wide and a 10 foot shoulder on each side. Thus, the pavement is 44 feet wide and the total pavement area is 154,880 square yards. The existing pavement structure is 5.5 inches HMA after cold milling over a 12 inch gravel base from the outside of one shoulder to the other shoulder.

- Highway category (primary or secondary) = secondary
- Joint spacing,  $L = 72$  in.
- Trial concrete thickness = 4.1 in.
- Concrete modulus of rupture,  $M_R = 650$  psi
- Concrete modulus of elasticity,  $E_{pcc} = 4,000,000$  psi
- Concrete Poisson's ratio,  $\mu_{pcc} = 0.15$
- Asphalt thickness,  $t_{ac} = 5.5$  in.
- Asphalt modulus of elasticity,  $E_{ac} = 350,000$  psi

- Asphalt Poisson's ratio,  $\mu_{ac} = 0.35$
- Existing asphalt fatigue = 25 percent
- Existing modulus of subgrade reaction,  $k = 200$  pci
- Temperature differential,  $\Delta T = 3^\circ$  F/in. throughout the day
- Design ESALs = 245,544

The 2004 revised MS Excel worksheet is shown in **Figure 9.6 Input and Required Thickness Form for Thin Concrete Overlay Design** with the required concrete overlay thickness.



**Figure 9.5 Sample TWT Project Location Map**



**CDOT 2004 Thin Whitetopping Design Procedure**

**Whitetopping Input Parameters**

Highway Category (Primary or Secondary)*	Secondary
Joint Spacing, in.	72
Trial Concrete Thickness, in.	4.1
Concrete Flexural Strength, psi	650
Concrete Elastic Modulus, psi	4,000,000
Concrete Poisson's Ratio	0.15
Asphalt Thickness, in.	5.5
Asphalt Elastic Modulus, psi	350,000
Asphalt Poisson's Ratio	0.35
Asphalt Fatigue Life Previously Consumed, %	25
Subgrade Modulus, pci	200
Temperature Gradient, °F/in.	3
Design ESALs	245,544
Converted Concrete Thickness, in. =	5.24
ESAL Conversion Factor =	1.3072
Neutral Axis =	3.07
le =	27.36
L/le =	2.63

Critical Concrete Stresses and Asphalt Strains					
Load Induced		Bond Adjustment		Support Adjustment	
Stress, psi	μstrain	Stress, psi	μstrain	Stress, psi	μstrain
1	2	3	4	5	6
<b>201</b>	<b>228</b>	<b>303</b>	<b>204</b>	<b>338</b>	<b>204</b>

ESAL Fatigue Analysis						
No. of 18-kip ESALs	Concrete Fatigue Analysis			Asphalt Fatigue Analysis		
	Stress Ratio	Allowable ESALs	Fatigue, %	Asphalt μstrain	Allowable ESALs	Fatigue, %
7	8	9	10	11	12	13
<b>3.2E+05</b>	<b>0.520</b>	<b>3.2E+05</b>	<b>99.9</b>	<b>204</b>	<b>1.5E+06</b>	<b>21.0</b>

Concrete Fatigue, % = **99.9**      Asphalt Fatigue, % = **46.0**

Required Whitetopping Thickness = 4.25 in.

**Figure 9.6 Input and Required Thickness Form for Thin Concrete Overlay Design**

## References

1. *AASHTO Guide for Design of Pavement Structures*, American Association of State Highway and Transportation Officials, Washington, DC, 1993.
2. *Supplement AASHTO Guide for Design of Pavement Structures, Part II, - Rigid Pavement Design & Rigid Pavement Joint Design*, American Association of State Highway and Transportation Officials, Washington, DC, 1998.
3. *Whitetopping - State of the Practice*, Publication EB210.02P, American Concrete Pavement Association, 5420 Old Orchard Road, Suite A100, Skokie, IL, 1998.
4. *Guidelines for the Thickness Design of Bonded Whitetopping Pavement in the State of Colorado*, CDOT-DTD-R-98-10, Final Report, Scott M. Tarr, Mathew J. Sheehan, and Paul A. Okamoto, Colorado Department of Transportation, 4201 E. Arkansas Ave., Denver, CO, 80222, December 1998.
5. *Instrumentation and Field Testing of Thin Whitetopping Pavement in Colorado and Revision of the Existing Colorado Thin Whitetopping Procedure*, CDOT-DTD-R-2004-12, Final Report, Matthew J. Sheehan, Scott M. Tarr, and Shiraz Tayabji, Colorado Department of Transportation, 4201 E. Arkansas Ave., Denver, CO, 80222, August 2004.
6. *Distress Identification Manual for the Long-Term Pavement Performance Program*, U.S. Department of Transportation, Federal Highway Administration, Publication No. FHWA-RD-03-031, June 2003.
7. *AASHTO Mechanistic-Empirical Pavement Design Guide, A Manual of Practice, Interim Edition, July 2008*, American Association of State Highway and Transportation Officials, Washington, DC, 2008.

## CHAPTER 10

# REHABILITATION OF PORTLAND CEMENT CONCRETE PAVEMENT

### 10.1 Introduction

Prior to 1976, Federal-Aid Interstate funds could be used only for the initial construction of the system. All other non-maintenance work on the Interstate System was funded with Federal-Aid Primary or State funds. The Federal-Aid Highway Act of 1976 established the Interstate 3R program, which placed emphasis on the use of Federal funds for resurfacing, rehabilitation, and restoration. The Federal-Aid Highway Act of 1978 required 20 percent of each State's primary, secondary, and urban Federal-Aid funds be spent on 3R projects. The Federal-Aid Highway Act of 1981 added the fourth R, reconstruction, so existing facilities could be eligible for Federal funding. The Intermodal Surface Transportation Efficiency Act of 1991 (ISTEA) reclassifies the four Federal-Aid systems (interstate, primary, secondary and urban) into two Federal-Aid systems: the National Highway System (NHS) and the Non-NHS. Although the Interstate System is a part of the NHS, it retains its own identity and will receive separate funding. Due to the passage of 1998 TEA-21, funding is not available for surface transportation improvements but, federal funds are available for matching state and local funds to construct 4R projects (6). The above legislation and funding is the driving force behind the restoration of pavements and specifically this chapter.

This chapter provides a framework and describes the information needed to create cost effective rehabilitation strategies for Portland Cement Concrete Pavement (PCCP). Policy decision making that advocates applying the same standard fixes to every pavement does not produce successful pavement rehabilitation. Successful rehabilitation depends on decisions that are based on the specific condition and design of the individual pavement. Five basic types of detailed project information are necessary: design, construction, traffic, environmental, and pavement condition (1). Once the data is gathered, an evaluation is in order to determine the cause of the pavement distress. Finally, a choice needs to be made to select an engineered rehabilitation technique(s) that will correct the distresses.

### 10.2 Scope and Limitations

Pavement rehabilitation projects should substantially increase the service life of a significant length of roadway. The guidelines presented in this chapter will focus on restoration. The restoration presented refers to the pavement rehabilitation before an overlay or not needing one after the restoration. In this chapter, the words rehabilitation and restoration are interchangeable; one needs to understand the contents as presented. Resurfacing with an overlay is covered in **CHAPTER 8** and **CHAPTER 9** of this manual. **CHAPTER 8** is the design of flexible overlays. Most of the chapter deals with flexible overlays over flexible pavement, but, the same principles apply to flexible overlays over rigid pavements. **CHAPTER 9** mostly deals with rigid overlays over rigid pavement and the design of concrete overlays. Reconstruction involves complete removal of the pavement structure and would use the same design procedures as in **CHAPTER 7**. Reconstruction techniques offer the choice of selecting virgin or recycled materials. The use of recycled material can often lower project costs (1, 3).

The pavement designer will encounter other definitions relating to rehabilitation. Both definitions will refer to functional and structural conditions. The intent is to show how encompassing rehabilitation is:

- AASHTO defines Preventive Maintenance (PM) as a "planned strategy of cost-effective treatments to an existing roadway system and its appurtenances that preserves the system, retards future deterioration, and maintains or improves the functional condition of the system (without substantially increasing structural capacity)" (8).
- The publication *Development of a Pavement Maintenance Program for the Colorado Department of Transportation, Final Report*, CDOT-DTD-R-2004-17, August 2004 suggests this definition for Preventive Maintenance (22).

*“Preventive Maintenance: Work undertaken that preserves the existing pavement, retards future deterioration, and improves the functional life without substantially increasing the structural capacity.”*

- An AASHTO sponsored working group defined pavement preservation as "the planned strategy of cost-effective pavement treatments to an existing roadway to extend the life or improve the serviceability of the pavement. It is a program strategy intended to maintain the functional or structural condition of the pavement. It is the strategy for individual pavements and for optimizing the performance of a pavement network" (8).

The above definitions stress the point that pavement maintenance and preservation is planned and associated cost effective strategies. The gathering of information, evaluation, and selections of treatments as outlined below are the same if the strategies were or were not planned.

### 10.3 Colorado Documented Design Methods

By June 1952, 8 inches of concrete pavement over 6 inches of granular subbase was placed on the now northbound lanes of Interstate 25 from Evans Avenue southward through a rural area to the Town of Castle Rock. In 1951 the grading project in preparation for the concrete pavement had a requirement of 90 percent AASHTO T 180 Modified Compaction on A-6 and A-7 soils with a swell ranging from 4.3 to 9.9 percent. Shortly after the PCCP was placed, the Colorado Department of Highways (CDOH) noticed cracking and warping of the slabs in certain areas. By the following summer, the cracking and rising of the slabs had become severe in these areas. The cracking increased throughout the project from October 1952 of 1,802 linear feet to 13,959 linear feet by September 1958. What followed in 1956/1957 was not a restoration of the existing concrete pavement, but constructing experiential sections to investigate alternatives to mitigate the swell potential on the new future southbound lanes. A number of design philosophies in place now are a result of these experiential sections. The final report was published in 1966 titled, *Pavement Study - Project I 092-2(4)* in cooperation with U.S. Bureau of Public Roads (16). The grading project for the experiential sections required 95 percent AASHTO T 99 Standard Compaction as much on the wet side as feasible. Laboratory tests showed the A-7-5(20) soils that swelled 9.9 percent at 90 percent modified compaction swelled to only 2.8 percent at 95 percent standard

compaction. At this time, the Department felt that if the swell of the subgrade soils was less than 3 percent, 4 inches of subbase material plus 8 inches of PCCP would provide sufficient surcharge to nullify the detrimental effect of this small amount of swell. Five test sections were constructed from late 1957 to spring of 1958.

- **Section A:** ½ mile of 8 inch concrete pavement encasing a light welded wire reinforcing fabric placed 2 inches below the concrete surface with a joint spacing of 61.5 feet, concrete pavement was placed over 4 inches of sand subbase treated with 2 percent cement.
- **Section B:** ½ mile of 8 inch concrete pavement encasing a heavy welded wire reinforcing fabric with a joint spacing of 106.5 feet, concrete pavement placed over 4 inches of sand subbase treated with 2 percent cement.
- **Section C:** "Control Section" 1 mile of 8 inch non-reinforced concrete pavement with a joint spacing of 20 feet, placed on 4 inches cement-treated base.
- **Section D:** ½ mile of 10 inch non-reinforced concrete pavement with a joint spacing of 20 feet, placed on 4 inches cement treated base.
- **Section E:** ½ mile of 8 inch concrete pavement with a joint spacing of 20 feet, placed on 20 inches of cement treated base

1966 results showed the Section C "Control Section" had less cracking per mile than any other section; Section B had 718 feet/mile, Section D had 502 ft/mi, Section A had 396 feet/mile, Section E had 384 feet/mile, and Section C had 85 feet/mile. The tests sections would never be classified as severe when compared to the cracking of 1952-1957.

A number of important conclusions were presented. The 1966 report concluded remedial measures are necessary for high swelling soils. High swelling soils could be mitigated by applying moisture contents at or near optimum using standard 95 percent of AASHO T 99 standard compaction. If the subgrade soils had a swell less than 3 percent then no mitigation was necessary. DOH Memo #323, 1/5/66, (Construction) Swelling Soils was issued to address the depth of treatments in cuts sections. Refer to Chapter 2 of this Manual and *Chapter 200 of the Field Materials Manual* for additional information; both manuals basically follow Memo #323. Current thinking is to use a moisture content of optimum plus 2 percent and not to use continuously reinforced concrete pavement. Two reasons were presented, first being that for joint maintenance as a whole, cost was about the same for all sections. Second, the extra cost of wire mesh reinforcement was not justified considering rideability. The difference between a present service index of 4.0 and one of 3.4 were both considered acceptable. The maintenance forces provided a practical remedial rehabilitation by placing a thin overlay to improve the appearance and ride. Currently, this is a viable option and the most often used treatment.

In 1983 the Colorado Department of Highways (now referred to as the Colorado Department of Transportation, CDOT) prepared a research report titled *Rehabilitation of Concrete Pavements*, Report No. CDOH-83-1 (9). In 1983, the Colorado Department of Highways conducted an in-

depth evaluation of concrete pavements on the interstate system. The purpose of the evaluation was to determine the condition of the pavements and develop rehabilitation strategies for these concrete pavements in anticipation of increased 4R funds from the Federal Government. The rehabilitation philosophy used in 1983 was to restore all of the concrete pavements to "Like New" condition with a 20-year design life. Design procedures presented at the end of the study were developed utilizing thick concrete and asphalt as a means of achieving the 20-year design life. Nine types of distress were identified and thought to be the most frequently observed on interstate roadways in Colorado. The pavements ages ranged from 4 to 24 years with the average being 18 years. The nine distresses were:

- Reactive aggregate
- Longitudinal cracking
- Transverse cracking
- Rutting
- Depression
- Pumping
- Spalling
- Faulting
- Corner breaks

Reactive aggregates were found to be the most devastating in terms of cost and effective corrective methods. The study recommended fly ash to be used on a routine basis where reactive aggregate problems are known to exist. Currently fly ash is used in CDOT Class P concrete. Rutting was found to be the most prominent in the areas where studded tire traffic volume was higher. Currently the use of studded snow tires is waning; chemical de-icing products such as magnesium chloride and potassium acetate, are taking their place. Pumping was observed only in areas with relatively poor drainage and untreated granular base materials. In these areas the first stage of distress was found to be pumping followed by corner breaks, faulting, and ultimately slab block cracking. Currently pumping and faulting have been reduced by the use of load transfer devices. Dowel bar diameter significantly affects faulting per Long-Term Pavement Performance (LTPP) Tech Brief *LTPP Data Analysis: Frequently Asked Questions About Joint Faulting With Answers From LTPP*, FHWA-RD-97-101 (11). Presently, untreated granular bases are still being used and bases are not being specified with concrete pavement being placed on natural soils. As a reference, refer to AASHTO M155-87(2000) - *Standard Specification for Granular Material to Control Pumping Under Concrete Pavement* for aggregate base requirements. In other instances treated soils such as lime treated subgrade are being specified in swelling soil conditions. Spalling at the joints was observed under two types of conditions. Spalling occurred at plastic parting strip ribbons and where joint filler material was not replaced. Currently, plastic parting strips have been eliminated and the standard for joint saw cutting has been revised using only a narrow single cut instead of two saw cuts with a wider top cut. Longitudinal cracking is still prominent. Two apparent reasons is the slab widths are too wide for the design thickness, and serious construction problems, *Structural Factors of Jointed Plain Concrete Pavements: SPS-2 -- Initial Evaluation and Analysis*, FHWA-RD-01-167. CDOT published a research report *Evaluation of Premature PCCP Longitudinal Cracking in Colorado*, Final Report, Report No. CDOT-DTD-R-2003-1, concluding swelling soils, shallow saw cut depth, and malfunctioning or improperly adjusted paver vibrators creating vibrator trails produces longitudinal cracking (13). The 14 foot wide slabs on

rural interstates did not contribute to the cracking. A regional investigation is looking at the ends of the tie bars where voids occur at the location of longitudinal cracking. Other possible reasons may be wheel loadings applied before the concrete cures or thermal flashing.

Other conclusions were presented in the Report No. CDOH-83-1, 1983. First, rutting of low severity accounted for most of the distressed mileage. Second, reactive aggregates and faulting were most frequently occurring as high severity. Thirdly, medium severity of longitudinal cracking was observed.

The standard concrete pavement joint detail before 1983 required skewed and variable 13-19-18-12 transverse joint spacing and older standards of skewed or non-skewed equal 15 or 20 foot spacing depending on aggregate size. The transverse joints were not doweled except for the first 3 joints after the expansion joint. The saw depth was  $\frac{1}{4}$  or older standards of 2 inches minimum. The longitudinal joints had tie-bars at 30 inch centers and size No. 4 for 8 inch thick pavement and No. 5 for thickness greater than 8 inches or older standards of No. 4 at 36 inch spacing. Most of the interstate pavement at that time was 8 inches thick. The design procedure was to obtain design traffic, soil support, concrete strength, and an applied load safety factor. The load safety factor was directly related to high predicted truck traffic.

In 1988, the report titled *Rehabilitation of Concrete Pavements Follow-Up Study*, Report No. CDOH-88-8 was released (10). The Colorado Department of Highways had been working under the guidelines of the previous study for 5 years. The intent was to review the effectiveness and suitability of the concepts developed in 1983. In 1983, approximately 81 miles of concrete were rated in the poor category. Over the period from 1983 to 1988 nearly 64 miles of concrete roadway were rehabilitated; however, the 1988 survey determined that approximately 98 miles of pavement were in the poor category. The rehabilitation philosophy used in 1983 to restore all of the concrete pavements to "Like New" condition with a 20 year design life was modified under this study. With the issuance of the *1986 AASHTO Design Guide*, FHWA allowed the states to use a design life as low as 8 years for rehabilitation. A section of roadway can now be analyzed using both an 8 year and 20 year design life to optimize the expenditure of resources to achieve acceptable levels of service. Examples of the new design procedures were included in the report. A rehabilitation plan was provided for a 10 year effort. Highlights were to start rehabilitating the worst sections first, use the 8 year design concept wherever it was possible, and concentrating on sections having the highest levels of traffic. The focus of the study was to bring forth the rehabilitation by overlay design and not repair the nine distresses individually by restoration techniques.

Following the first report above, the need to showcase the latest state-of-the-art Concrete Pavement Restoration (CPR), a seminar and demonstration project was organized (Demonstration Project No. 69). The seminar was a cooperative effort between CDOH, ACPA and FHWA and was held a day after the AASHTO meeting on October 5, 1983 with approximately 200 state and highway officials and engineers along with industry representatives in attendance. The results of the seminar and notes in the construction of the demonstration were reported in *Evaluation of Concrete Pavement Restoration Procedures and Techniques*, Initial Report, Report No. CDOH-DTP-R-84-5 (14). The demonstration showcased the techniques of full depth repair, partial depth repair, undersealing, grinding, installing load transfer devices, joint sealing, and crack sealing. The site was on eastbound I-70 between Chambers Road and Tower Road. The pavement was 19 years

old, 8 inches of concrete pavement over 6 inches of base course surfacing, 20 foot joint spacing, skewed, with tie bars in the centerline longitudinal joint, no load transfer devices or steel in the transverse joints and with asphalt shoulders. *Concrete Pavement Restoration Demonstration*, Final Report, Report No. CDOH-DTD-R-88-6 (15) reports the subsequent evaluations for a period of three years after construction repair. Generally, most of the restoration techniques did not perform well in this demonstration project.

- **Full-Depth Repair:** 8 out of 13 replacement slabs cracked.
- **Partial-Depth Repair:** All 6 patches showed distress or failed.
- **Undersealing:** Inconsistent data in slab deflections of grouted and non-grouted slabs and how well uniform support was obtained.
- **Faulting and Grinding:** Typically slabs faulted in a third of the unground sections.
- **Load Transfer Device:** The obsolete device worked well especially in conjunction with undersealing.
- **Joint Sealing:** 12 different types of joint sealer were applied, some worked some failed.
- **Crack Sealing:** Routed and sealed with the same sealants used above, overall was not very successful, continued to crack and spall.

The pre-overlay design methods and techniques suggested in this Chapter are based on these reports as well as *Factors for Pavement Rehabilitation Strategy Selection* by the American Concrete Pavement Association (1). The following sections are based on the ACPA publication.

## 10.4 Project Information

Obtaining specific project information is the first step in the process of rehabilitation. Five basic types of detailed project information are necessary before an evaluation can be made:

- **Design Data:** Includes the pavement type and thickness. The components of the pavement are layer materials, strengths, joint design, shoulder design, drainage system and previous repair or maintenance.
- **Construction Data:** If possible obtain original construction conditions. Field books, daily logs and weather conditions are helpful. Concrete mix designs would show aggregate size and additives that may influence the existing concrete conditions.
- **Traffic Data:** Strategy selection requires past, current, and expected traffic growth. This helps determine the remaining effective structural capacity of the existing pavement. **Section 1.5 Traffic Projections** outlines the methods and procedures to calculate traffic loads.



- **Environmental Data:** Important factors are temperature, precipitation, and freeze-thaw conditions. These factors influence material integrity, structural capacity, and rideability.
- **Distress and/or Condition Data:** A distress survey should report the type, severity and quantity of each distress. A detailed concrete pavement distress/condition survey is required before a rehabilitation project can be evaluated and designed. The types of distress in concrete pavements have to be identified and documented prior to the selection of corrective measures. The cause of distresses is not always easily identified and may consist of a combination of problems. The following types of distress are common to deteriorating concrete pavements: excessive deflection, differential deflection at joints, moisture related distress at cracks and joints, cracking due to reactive aggregate, longitudinal and transverse cracking, spalling, faulting, pumping, rutting, and movement of slabs due to swelling soils. The condition survey should identify and document the types, location, and amount of distress encountered in the design selected for rehabilitation. Photographs are a good way to document many of the distresses mentioned above. **Figure 9.2 Pavement Condition Evaluation Checklist (Rigid)** should be used and placed in the pavement design report. To help determine the type of distress the pavement is exhibiting refer to FHWA *Distress Identification Manual* (4). This manual may be downloaded from the web page: <http://www.fhwa.dot.gov/publications/infrastructure/pavements/ltpa/reports/03031/> CDOT has a distress manual documenting pavement distress, description, severity levels, and additional notes (22). The distress manual is presented in Appendix B - Colorado DOT Distress Manual for HMA and PCC Pavements in the publication *Development of a Pavement Maintenance Program for the Colorado Department of Transportation*, Final Report, CDOT-DTD-R-2004-17, August 2004. The report is in pdf format and can be downloaded from the web page <http://www.coloradodot.info/programs/research/2004/preventivemaintenance.pdf>. In order to determine the pavement distress and condition, a field inspection is mandatory. Isolating areas of distress can pinpoint different solutions for different sections along a project. Non-Destructive Testing (NDT) and destructive testing (i.e. coring and boring) can determine the structural condition and material properties below the surface.

## 10.5 Pavement Evaluation

The second step is to analyze and evaluate the gathered project information. Pavement evaluation requires a systematic approach to quantify adequately and analyze the many variables that influence the selection of the appropriate rehabilitation technique. More engineering effort may be required for pavement rehabilitation than for new construction because of the additional elements of evaluating the existing pavement. An engineering evaluation must address several key issues such as functional and structural condition, materials condition, drainage conditions, and lane condition uniformity (1, 5, 6).

### 10.5.1 Functional and Structural Condition

The CDOT Pavement Management System triggers the need for rehabilitation work on automated visual surface distresses in a single lane. The distresses are rated and weighted in an index equation. The equation is weighted heavily to ride, then rut, and then cracking. The index equation is then converted into Remaining Service Life (RSL). Lost in the RSL values is the distinction between functional and structural distress. Be careful on just relying on the rating obtained from pavement management. As of this date, the observed surface distresses are limited to a few of the major pavement distresses. Pavement management will not pick up on Alkali Silica Reactivity (ASR) until the severe stage, showing up as surface cracking. Knowing ASR exists may influence the restoration technique the designer selects. Each distress condition will have its own set of repair techniques. The project pavement design engineer must determine if the pavement condition is in a functional or structural distress.

### 10.5.2 Structural Condition

Structural deterioration is any condition that reduces the load carrying capacity of a pavement (6, 7). Corner breaks, pumping, faulted joints, and shattered slabs are some examples of structural related distresses. Evaluating the level of structural capacity requires thorough visual survey and materials testing (7). Non-destructive testing is important to characterize both pavement stiffness and subgrade support. Restoration is applicable only for pavements with substantial remaining structural capacity. Pavements that have lost much of their structural capacity require either a thick overlay or reconstruction. To help assess the current structural adequacy of Jointed Plain Concrete Pavement (JPCP), the extent and severity of the distresses can be compared with value ranges provided in **Table 10.1 Structural Adequacy for JPCP**.

**Table 10.1 Structural Adequacy for JPCP**  
(Extracted from March 2004, *Guide for Mechanistic-Empirical Design*,  
Part 2 Design Inputs, Table 2.5.15 pg. 2.5.61 (17))

Load-Related Distress	Highway Classification	Current Distress Level		
		Inadequate	Marginal	Adequate
<b>Deteriorated Cracked Slabs</b> medium and high severity transverse and longitudinal cracks and corner breaks (percent slabs)	Interstate/freeway	> 10	5 to 10	< 5
	Primary	> 15	8 to 15	< 8
	Secondary	> 20	10 to 20	< 10
<b>Mean Transverse Joint/Crack Faulting</b> (inches)	Interstate/freeway	> 0.15	0.10 to 0.15	< 0.10
	Primary	> 0.20	0.125 to 0.20	< 0.125
	Secondary	> 0.30	0.15 to 0.30	< 0.15

#### 10.5.2.1 Functional Condition

Functional deterioration is defined as a condition that adversely affects the highway user. Functional distresses include problems which influence the ride quality, but are not necessarily signs of reduced structural capacity. These may include poor surface friction and texture,

hydroplaning and splash from wheel path rutting, and excess surface distortion. Cracking and faulting affect ride quality but are not classified as functional distress. These conditions reduce load carrying capacity as stated above. The integrity of the base, concrete slab, and joint system is compromised under cracking and faulting. To help assess the current functional adequacy of Jointed Plain Concrete Pavement (JPCP), International Roughness Index (IRI) is compared with value ranges provided in **Table 10.2 Functional Adequacy for JPCP**.

**Table 10.2 Functional Adequacy for JPCP**  
(Extracted from March 2004, *Guide for Mechanistic-Empirical Design, Part 2 Design Inputs*, Table 2.5.19, pg. 2.5.65 (17))

Pavement Type	Highway Classification	IRI (inch/mile) Level		
		Inadequate (Not Smooth)	Marginal (Moderately Smooth)	Adequate (Smooth)
Rigid (JPCP) and Flexible	Interstate/freeway	> 175	100 to 175	< 100
	Primary	> 200	110 to 200	< 110
	Secondary	> 250	125 to 250	< 125

### 10.5.2.2 Problem Classifications Between Structural and Functional Condition

How would the pavement designer classify lane separation? It could be classified as a functional condition if the lane separation (longitudinal joint width) becomes too excessive where the handling of a motorcycle becomes dangerous or adversely affects the highway user. It becomes a structural condition when the lane separation starts to manifest itself during rain storms when water infiltrates the base by cross slope sheet flow. Also, edge wheel loading next to the lane separation will eventually accumulate stress damage until finally over-stressing to the allowable limit. Even though no cracked slabs are present at the time of the investigation, lane separation will eventually be classified as a structural condition. The pavement designer could then say the integrity of the base, slab, and joint system is compromised.

### 10.5.2.3 Material Condition and Properties

An evaluation of material condition should not be done using assumed conditions or unknown material strengths. These factors are measurable from actual response to non-destructive and destructive testing methods.

### 10.5.2.4 Non-Destructive Testing

Non-destructive testing may use three methods of testing to determine structural adequacy (17).

- **Deflection Testing:** Determines high deflections, layer moduli, and joint load transfer efficiencies
- **Profile Testing:** Determines joint/crack faulting
- **Ground Penetrating Radar:** Determines layer thickness

This site specific data obtained from these methods would be a Level 1 input. Deflection testing results are used to determine the following:

- Concrete elastic modulus and subgrade modulus of reaction at center of slab
- Load transfer across joints/cracks (across transverse joints/cracks in wheelpath)
- Void detection at corners
- Structural adequacy at non-distressed locations

In addition to backcalculation of the pavement layer, subgrade properties, and void detection, deflection testing can also be used to evaluate the Load Transfer Efficiency (LTE) of joints and cracks in rigid pavements (18). *Evaluation of Joint and Crack Load Transfer*, Final Report, FHWA-RD-02-088 (19) is a study presenting the first systematic analysis of the deflection data under the LTPP program related to LTE.

$$\text{LTE} = (\delta_u / \delta_l) \times 100 \qquad \text{Eq. 10-1}$$

Where:

LTE = load transfer efficiency, percent

$\delta_u$  = deflection on unloaded side of joint or crack measured 6 inches from the joint/crack

$\delta_l$  = deflection on loaded side of joint or crack measured beneath the load plate and center of which is placed 6 inches from the joint/crack

Visual distresses present at the joint or crack should be recorded and quantified. Joint (and crack) distress information is useful in analyzing and filtering the results obtained from the LTE calculation. The load transfer rating as related to the load transfer efficiency is shown in **Table 10.3 Load Transfer Efficiency Quality**.

**Table 10.3 Load Transfer Efficiency Quality**  
(From March 2004, *Guide for Mechanistic-Empirical Design, Part 2 Design Inputs*, Table 2.5.9, pg. 2.5.49 (17))

Load Transfer Rating	Load Transfer Efficiency (percent)
Excellent	90 to 100
Good	75 to 89
Fair	50 to 74
Poor	25 to 49
Very Poor	0 to 24

Crack LTE is a critical measure of pavement condition because it is an indicator of whether the existing cracks will deteriorate further. LTE tests are usually performed in the outer wheelpath of the outside lane. For JPCP, cracks are held together by aggregate interlock; joints designed with load transfer devices have steel and aggregate interlock. In general, cracks with a good load transfer (LTE greater than 75 percent) hold together quite well and do not significantly contribute to pavement deterioration. Cracks with poor load transfer (LTE less than 50 percent) are working

cracks and can be expected to deteriorate to medium and high severity levels, will exhibit faulting over time, and are candidates for rehabilitation.

### 10.5.2.5 Destructive Testing

Experience has shown non-destructive testing techniques alone may not always provide a reasonable or accurate characterization of the in-situ properties, particularly for those of the top pavement layer (17). The determination of pavement layer type cannot be made through non-destructive testing. While historic information may be available, the extreme importance and sensitivity calls for a limited amount of coring at randomly selected locations to be used to verify the historic information. Pavement coring, base and subbase thicknesses, and samples are recommended to be collected at an approximate frequency of one sample per one-half mile of roadway. Several major parameters are needed in the data collection process. They are as follows:

- Layer thickness
- Layer material type
- Examination of cores to observe general condition and material durability
- In-situ material properties (i.e. modulus and strength)

Concrete slab durability may have a possible condition of severe D-Cracking and reactive aggregate. Petrographic analysis helps identify the severity of the concrete distresses when the cause is not obvious. Material durability problems are the result of adverse chemical or physical interactions between a paving material and the environment (17). The field condition survey and examination of cores for material durability reinforce each other (see **Table 10.4 Distress Levels for Durability of JPCP**). Listed are durability problems and causes.

- **D-Cracking:** The fracture of layer aggregate particles, and subsequently the PCC mortar, as a result of water freezing and expanding in the pores of moisture-susceptible course aggregate.
- **Freeze-Thaw Damage:** Spalling and scaling in freeze-thaw climates due to inadequate entrained air voids. The lack of entrained air restricts the internal expansion of water in concrete during periods of freezing and thawing.
- **Alkali-Silica Reactivity:** Map cracking and joint deterioration resulting from the reaction of high silica or carbonate aggregates and alkalies (sodium and potassium) in portland cement. The reaction produces a gel that absorbs water and swells, thus fracturing the cement matrix.
- **Steel Corrosion:** Pavements located in regions where de-icing salts are used.
- **Treated Base/Subbase Disintegration:** Stripping of asphalt cement by water in asphalt-treated materials, or the disintegration of cement-treated materials due to freeze-thaw cycles.
- **Unbound Base/Subbase Contamination** by fines from subgrade.

**Table 10.4 Distress Levels for Durability of JPCP**  
From March 2004, *Guide for Mechanistic-Empirical Design*,  
Part 2 Design Inputs, Table 2.5.22, pg. 2.5.70 (17)

Load-Related Distress	Highway Classification	Current Distress Level		
		Inadequate	Marginal	Adequate
<b>Patch Deterioration</b> Medium and High Severity (percent surface area)	Interstate/Freeway	> 10	5 to 10	< 5
	Primary	> 15	8 to 15	< 8
	Secondary	> 20	10 to 20	< 10
<b>D-cracking and ASR</b>	All	Predominantly medium and high severity	Predominantly low and medium severity	None or predominantly low severity
<b>Longitudinal Joint Spall</b> Medium and High Severity (percent length)	Interstate/Freeway	> 50	20 to 50	< 20
	Primary	> 60	25 to 60	< 25
	Secondary	> 75	30 to 75	< 30
<b>Transverse Joint Spalling</b> Medium and High Severity (joints /mile)	Interstate/Freeway	> 50	20 to 50	< 20
	Primary	> 60	25 to 60	< 25
	Secondary	> 75	30 to 75	< 30
<b>Stripping</b> (treated base/subbase)	All	Unable to recover majority of cores due to disintegration or stripping	Unable to recover some cores due to disintegration or stripping	Cores are predominantly intact
<b>Unbound Granular Base Contamination</b>	All	Contamination of unbound granular base/subbase with fines from subgrade		

For rigid pavements, one of the more significant properties influencing performance is the flexural strength (modulus of rupture) of the concrete. General correlations between splitting tensile strength and flexural strength may be used as a source of input since cores can be obtained from the pavement. Three correlation formulas may be used. The reports cannot be found but the formulas were kept. All are straight line relationships.

1971, Deville

$$\text{Flexural Strength} = 190 + 0.097 \times \text{compressive strength} \quad \text{Eq. 10-2}$$

1979, Mirza

$$\text{Flexural Strength} = 247 + 0.068 \times \text{compressive strength} \quad \text{Eq. 10-3}$$

1996, Lollar – using CDOT Region 1 (prior to 7/1/2013) data for master’s degree

$$\text{Flexural Strength} = 217 + 0.75 \times \text{compressive strength} \quad \text{Eq. 10-4}$$

There are many papers, articles, and opinions on the correlation between the different strength test types. ACPA does not recommend any one particular test. The listed national correlations are from ACPA website (see **Table 10.5 Strength Correlation Formulas**) (20): [http://www.pavement.com/Concrete\\_Pavement/Technical/FATQ/Construction/StrengthTests.asp](http://www.pavement.com/Concrete_Pavement/Technical/FATQ/Construction/StrengthTests.asp)

**Table 10.5 Strength Correlation Formulas**

Source/Author	Equation (psi)
ACI Journal / Raphael, J.M.	$M_r = 2.3 \times [F_c \wedge (2/3)]$
	$F_{st} = 1.7 \times [F_c \wedge (2/3)]$
ACI Code	$M_r = 7.5 \times [F_c \wedge (1/2)]$
	$F_{st} = 6.7 \times [F_c \wedge (1/2)]$
Center for Transportation Research / Fowler, D.W.	$F_{st} = 0.72 \times M_r$
Center for Transportation Research / Carrasquillo, R.	$M_r$ (3 <sup>rd</sup> point) = 0.86 x $M_r$ (center point)
Greer	$M_r = 21 + 1.254 F_{st}$
	$M_r = 1.296 F_{st}$
	$M_r = F_{st} + 150$
Hammit	$M_r = 1.02 F_{st} + 210.5$
Narrow & Ulbrig	$M_r = F_{st} + 250$
Grieb & Werner	$F_{st} = 5/8 M_r$ (river gravel)
	$F_{st} = 2/3 M_r$ (crushed limestone)
<p><b>Note:</b> When High-Performance Concrete (HPC) is used, the above relationships will not necessarily hold true. The HPC mixes with very low water/cement ratios tend to be more brittle and show different behaviors.  <math>F_{st}</math> = Splitting tensile strength  <math>F_c</math> = Compressive strength  <math>M_r</math> = Modulus of rupture = flexural strength, third-point loading (unless otherwise noted)</p>	

In-situ material properties of bases, subbases and soils including soil strength, may be obtained using the Dynamic Cone Penetrometer (DCP). The proposed mechanistic-empirical design guide software allows users to input DCP test results directly or indirectly depending on the models of choice. The pavement design engineer uses the above material properties to obtain a resilient modulus of each layer. The field and laboratory testing would have a hierarchical Level 2 for inputs in the mechanistic empirical design method. Level 3 would use similar values obtained through regional or typical default values.

### 10.5.3 Drainage Condition

Condition of drainage structures and systems such as ditches, longitudinal edge drains, transverse drains, joint and crack sealant, culverts, storm drains, inlets, and curb and gutters are all important to convene water away from the pavement structure. Visual distress may reveal the types and extents of distresses present in the pavement that are either caused by or accelerated by moisture. Drainage assessment can also be benefited by data obtained from coring and material testing. The permeability and effective porosity of base/subbase materials, as determined through laboratory tests or calculated from gradations, can be used to quantify drainability (17) (see **Table 10.6 Distress Levels for Assessing Drainage Adequacy of JPCP**).

**Table 10.6 Distress Levels for Assessing Drainage Adequacy of JPCP**  
From March 2004, *Guide for Mechanistic-Empirical Design*,  
Part 2 Design Inputs, Table 2.5.20, pg. 2.5.67 (17)

Load-Related Distress	Highway Classification	Current Distress Level		
		Inadequate	Marginal	Adequate
<b>Pumping</b> All Severities (percent joints)	Interstate/freeway	> 25	10 to 25	< 10
	Primary	> 30	15 to 30	< 15
	Secondary	> 40	20 to 40	< 20
<b>Mean Transverse Joint/Crack Faulting</b> (inches)	Interstate/freeway	> 0.15	0.10 to 0.15	< 0.10
	Primary	> 0.20	0.125 to 0.20	< 0.125
	Secondary	> 0.30	0.15 to 0.30	< 0.15
<b>Durability</b> All Severity Levels of D-Cracking and Reactive Aggregate	All	Predominantly medium and high severity	Predominantly low and medium severity	None or predominantly low severity
<b>Corner Breaks</b> All Severities (number/mile)	Interstate/freeway	> 25	10 to 25	< 10
	Primary	> 30	15 to 30	< 15
	Secondary	> 40	20 to 40	< 20

#### 10.5.4 Lane Condition Uniformity

On many four lane roadways, the outer truck lane deteriorates at a more rapid pace than the inner lane of shoulders. The actual distribution of truck traffic across lanes varies with the roadway type, location (urban or rural), the number of lanes in each direction, and the traffic volume. Because of these many factors, it is suggested the lane distribution be measured for the project under consideration (6). Obtaining the actual truck lane distributions will determine the actual remaining life of the lane under consideration. Significant savings may result by repairing only the pavement lane that requires treatment.

#### 10.6 Pavement Rehabilitation Techniques

Rehabilitation or restoration techniques are methods to preserve the integrity of the concrete pavement system or to bring the pavement system to an acceptable level for future performance. Concrete Pavement Restoration (CPR) is a series of engineered techniques designed to manage the rate of pavement deterioration in concrete roadways. Ideally, CPR is the first rehabilitation procedure applied to the concrete pavement. CPR is a non-overlay option used to repair isolated areas of distress, or to prevent or slow overall deterioration, as well as, to reduce the impact loadings on the concrete pavement without changing its grade (21). If the pavement needs more load carrying capacity or has deteriorated to poorer conditions, other procedures, such as bonded concrete overlay, unbonded concrete overlay, or asphalt overlay may be applied in conjunction with restoration. Pavement rehabilitation work shall not include normal periodic maintenance activities (2). Cleaning of cross culverts, inlets, and underdrain outlets would be considered normal periodic maintenance activities. CPR may be a maintenance activity, contract work by



maintenance purchase order, or contract low bid. Either way, the work performed is identical. A report was published in August 2004 to assist staff maintenance in developing a pavement maintenance program. Refer to Appendix A - Preventive Maintenance Program Guidelines in the publication *Development of a Pavement Maintenance Program for the Colorado Department of Transportation*, Final Report, CDOT-DTD-R-2004-17, August 2004 (22). The report is in pdf format and can be downloaded from the web page

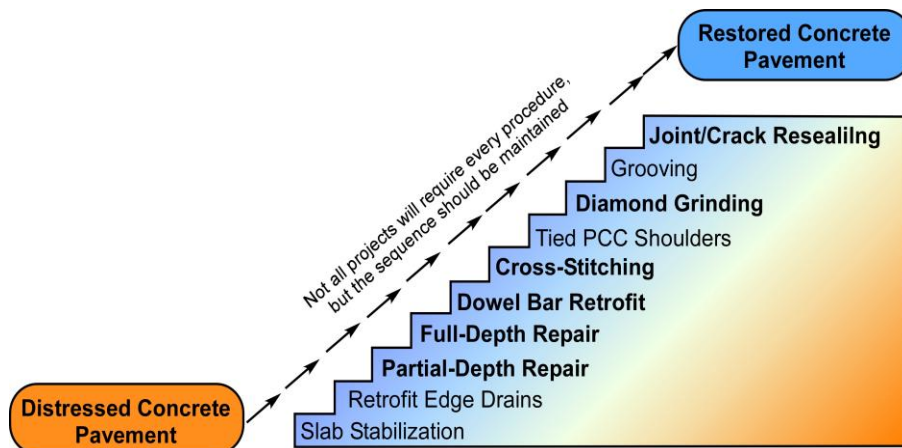
<http://www.coloradodot.info/programs/research/pdfs/2004/preventivemaintenance.pdf>

Specific maintenance treatments were documented. These same concrete pavement treatments are described in this chapter (see **Figure 10.1 CPR Sequencing**).

- Diamond grinding
- Concrete crack sealing
- Concrete joint resealing
- Partial depth repair
- Full depth concrete pavement repair
- Dowel bar retrofit

Two additional treatments will also be described.

- Cross stitching
- Slab stabilization



**Figure 10.1 CPR Sequencing**

*Recommended Sequence of Restoration Activities, ACPA, 2006*

### 10.6.1 Diamond Grinding

Diamond grinding and grooving are used to restore the surface of the PCCP. Diamond grinding is the removal of a thin layer of concrete generally about 0.25 inches (6 mm) from the surface of the pavement (36), refer to **Figure 10.2 Photos of Diamond Grinding and Grooving**. Grinding utilizes closely spaced diamond saw blades and corrects surface irregularities, such as cracking, rutting, warping, polishing, and joint faulting. Diamond grooving is the establishment of discrete grooves in the concrete pavement using diamond saw blades. The grooving is placed to break up

the flow of water across the surface. Grooving may be performed longitudinally or transversely however, CDOT's standard is to groove longitudinally (36). Grooving places the diamond blades  $\frac{3}{4}$  inch apart and is used to prevent hydroplaning on wet pavements. Grinding and grooving operations produce a slurry consisting of ground concrete and water. Local environmental regulations should be consulted to determine acceptable disposal solutions. After diamond grinding or grooving, all concrete joints and major cracks must be resealed.



Source: <https://www.penhall.com> and <http://www.wsdot.wa.gov>

**Figure 10.2 Photos of Diamond Grinding and Grooving**

Field studies of diamond ground pavement have indicated that diamond grinding can be an effective long-term treatment. CDOT uses a triangular distribution with a minimum value of 11, the most likely value of 15 years and the maximum value of 17. Additional information may be found in **Section 7.18 Concrete Pavement Texturing, Stationing, and Rumble Strips**.

Cold milling may be done on PCCP, although it is more commonly used on asphalt pavements. Cold milling uses carbide tips to chip off the distressed surface. Cold milling can cause damage to transverse and longitudinal joints. Figure 3 in the publication *Diamond Grinding and Concrete Pavement Restoration* by ACPA (23) shows photographs of the difference between a diamond ground surface and a milled surface. Unless surface unevenness, aggregate fracturing, and joint spalling are tolerable, cold milling should not be allowed as a final surface. One should consider using diamond grinding for the following:

- **Faulting at Joints and Cracks:** Removal of roughness caused by excessive faulting has been the most common need for surface restoration. Trigger values indicate when a highway agency should consider diamond grinding and CPR to restore rideability, see **Table 10.7 Trigger Values for Diamond Grinding**. Limit values for diamond grinding define the point when the pavement has deteriorated so much that it is no longer cost effective to grind, refer to **Table 10.8 Limit Values for Diamond Grinding**. The two tables below show when it is appropriate and how much to diamond grind, and are presented in FHWA technical report titled *Concrete Pavement Rehabilitation Guide for Diamond Grinding*, dated June 2001 (29). The report can be found on the website <http://www.fhwa.dot.gov/pavement/concrete/diamond.cfm>.

- **Smoothing Out Rehabilitation Roughness:** When partial-depth and full-depth repairs create differences in elevation between the repair and existing pavement, diamond grinding smooths out the repair.
- **Wheelpath Rutting:** Diamond grinding removes wheelpath ruts caused by studded tires, improves drainage in wet weather by eliminating pooling of water, and reduces the possibility of hydroplaning.
- **Re-establish Macrotexture:** Restores a polished surface to provide increased skid resistance, improves cornering friction numbers, and provides directional stability by tire tread-pavement-groove interlock.
- **Reduce Noise Level:** Re-textures worn and tined surfaces with a longitudinal texture and provides a quieter ride. Also removes the faults by leveling the surface, thus eliminating the thumping and slapping sound created by the faulted joints.
- **Removes Slab Warping and Curling:** Long joint spacing and stiff base support may result in curled slabs that are higher at joints than at mid-panel, while warped slabs are higher at the mid-panel. Diamond grinding smooths out the curled and warped slabs.
- **Minor Cross Slope Changes:** Minor cross slope changes helps transverse drainage and reduces the potential for hydroplaning.
- **Pre-overlay Treatment:** Creates a smooth base surface for thin micro-surfacing overlays.

**Table 10.7 Trigger Values for Diamond Grinding**

From Table 1, *Trigger Values for Diamond Grinding, Concrete Pavement Rehabilitation – Guide for Diamond Grinding, June 2001 (29)*

Traffic Volumes <sup>1</sup>	JPCP			JRCP			CRCP		
	High	Med	Low	High	Med	Low	High	Med	Low
<b>Faulting</b> mm-average (inches average)	2.0 (0.08)	2.0 (0.08)	2.0 (0.08)	4.0 (0.16)	4.0 (0.16)	4.0 (0.16)	N.A.		
<b>PSR</b>	3.8	3.6	3.4	3.8	3.6	3.4	3.8	3.6	3.4
<b>IRI</b> m/km (in/mi)	1.0 (63)	1.2 (76)	1.4 (90)	1.0 (63)	1.2 (76)	1.4 (90)	1.0 (63)	1.2 (76)	1.4 (90)
<b>Skid Resistance</b>	Minimum Local Acceptable Levels								
<b>Note:</b> <sup>1</sup> Volumes: High ADT > 10,000; Medium 3,000 < ADT < 10,000; Low ADT < 3,000									

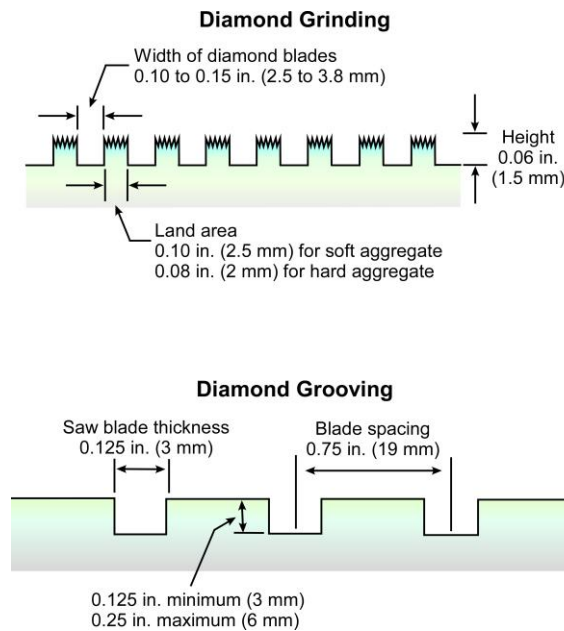
**Table 10.8 Limit Values for Diamond Grinding**

From Table 2, *Limit Values for Diamond Grinding, Concrete Pavement Rehabilitation – Guide for Diamond Grinding*, June 2001 (29)

Traffic Volumes <sup>1</sup>	JPCP			JRCP			CRCP		
	High	Med	Low	High	Med	Low	High	Med	Low
<b>Faulting</b> mm-average (inches average)	9.0 (0.35)	12.0 (0.50)	15.0 (0.60)	9.0 (0.35)	12.0 (0.50)	15.0 (0.60)	N.A.		
<b>PSR</b>	3.0	2.5	2.0	3.0	2.5	2.0	3.0	2.5	2.0
<b>IRI</b> m/km (in/mi)	2.5 (160)	3.0 (190)	3.5 (222)	2.5 (160)	3.0 (190)	3.5 (222)	2.5 (160)	3.0 (190)	3.5 (222)
<b>Skid Resistance</b>	Minimum Local Acceptable Levels								

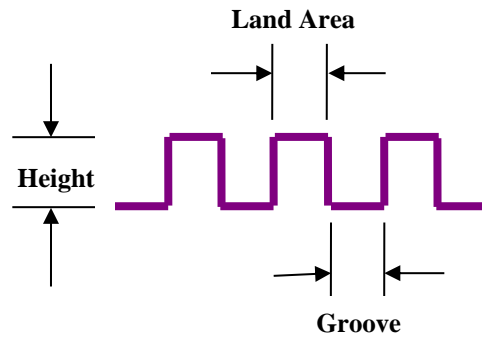
**Note:** <sup>1</sup> Volumes: High ADT > 10,000; Medium 3,000 < ADT < 10,000; Low ADT < 3,000

For both diamond grinding and grooving, the most important design element is the spacing of the blades on the grinding head. Grinding is made by using 50 to 60 circular saw blades per foot on a shaft to produce the desired texture. Grooving has a different cutting pattern, it has a uniform spacing of 0.75 inches (19 mm) between grooves (see **Figure 10.3 Dimensions for Grinding and Grooving**). **Figure 10.4 Dimensional Grinding Texture for Hard and Soft Aggregate** shows the suggested dimensions for hard and soft aggregates from an earlier publication.



**Figure 10.3 Dimensions for Grinding and Grooving**  
From Figure 7, *Concrete Pavement Rehabilitation and*

Preservation Treatment, November 2005 (36)



	<i>Range of Values mm (in)</i>	<i>Hard Aggregate mm (in)</i>	<i>Soft Aggregate mm (in)</i>
<b>Grooves</b>	1.0 – 4.0 (0.08-0.16)	2.5 – 4.0 (0.1 – 0.16)	2.5 – 4.0 (0.1 – 0.16)
<b>Land Area</b>	1.5 – 3.5 (0.06-0.14)	2.0 (0.08)	2.5 (0.1)
<b>Height</b>	1.5 (0.06)	1.5 (0.06)	1.5 (0.06)
<b>No. Grooves per meter</b>	164 – 194 (50-60)	174 – 194 (53-60)	164 – 177 (50-54)

**Figure 10.4 Dimensional Grinding Texture for Hard and Soft Aggregate**

From Figure 7, *Concrete Pavement Rehabilitation -Guide for Diamond Grinding*, June 2001 (29)

CDOT has published research reports on textures of new pavements. Refer to CDOT Final Report CDOT-DTD-R-2005-22 *PCCP Texturing Methods*, dated January 2005 (37) and Final Report CDOT-DTD-R-2006-9, *Implementation of Proven PCCP Practices in Colorado*, dated April 2006 (38).

### 10.6.2 Concrete Crack Sealing

Crack sealing is a commonly performed pavement maintenance activity that serves two primary purposes. One objective is to reduce the amount of moisture that can infiltrate a pavement structure, thereby reducing moisture-related distresses such as pumping. The second objective is to prevent the intrusion of incompressible materials into cracks so pressure-related distresses (such as spalling) are prevented (6).

Sealants may become ineffective anywhere from 1 to 4 years after placement. However, improvements in sealant materials, an increased recognition of the importance of a proper reservoir design, and an emphasis on effective crack/joint preparation procedures are expected to increase the expected life of sealant installations. At the same time, there is a persistent controversy over whether joint/crack sealing is needed at all (6). CDOT policy is to seal the cracks and not take the position that joint/crack sealing is not necessary.

What to crack seal:

- **Plastic Shrinkage and Working Cracks:** Cracks that remain tight usually do not require sealing. These cracks are typically very narrow (hairline), plastic shrinkage cracks and only penetrate to a partial depth. Once started, any crack may develop full depth through a slab. The crack may begin moving and functioning as a joint. Cracks which function as a joint are "working" cracks and are subject to nearly the same range of movement as transverse and longitudinal joints, therefore require sealing (24). If significant pavement integrity is being lost, then other remedial repairs are needed in conjunction with crack sealing.
- **Number of Cracks in a Slab:** Section 412.16 of CDOT's *Standard Specification for Road and Bridge Construction*, 2011 (40) book specifies when cracks penetrate partial depth they may be epoxy injected with the written approval of the Engineer. New construction and reconstruction that have full depth cracks which separate the slab into two or more parts will not be sealed, rather the slab will be removed and replaced. Rehabilitation treatments are generally designed with a shorter design life than new construction. Thus, when cracks are full depth and the slab is separated into three or more parts the slab should be removed and replaced or repaired. Slabs remaining in place that are cracked will require sealing, as well as, the repaired slabs if appropriate.
- **Crack Load Transfer Rating:** Refer to **Section 10.5.2.1 Non-destructive Testing** for guidance on LTE and when to remove and replace or repair the slab parts, or when to crack seal a good LTE crack.

Cracks are not straight and are therefore more difficult to shape and seal. Special crack saws are now available to help the operator follow crack wander. The saws have special blades with 7 to 8 inch diameters and are more flexible. The saws are supported by three wheels, the pivot wheel allows the saw to follow the crack. The desire is to obtain the same shape factor at the working cracks that is developed at the joints. Routers were used extensively in the past to create the seal reservoir. The trend now is to use special crack saws. It is believed better reservoir results and increased productivity are obtained with these special crack saws. **Figure 10.5 Photos of Crack Sealing.** Crack sealing requires all of the cleaning steps used in joint resealing, which includes the use of a backer rod and uniform sealant installation (24). This treatment procedure follows the concept of the joint details and sealants as specified in CDOT Standard Plan M-412-1 Concrete Pavement Joints, sheet 5 of 5. CDOT publication *Development of a Pavement Preventive Maintenance Program for the Colorado Department of Transportation* (22) follows the Standard Plan M-412-1 concept. This treatment using silicone sealant is recommended when the existing concrete surface is the new riding surface. A project special provision is required to outline the method of construction and payment. Section 408, Joint and Crack Sealant in the *Standard Specification for Road and Bridge Construction*, 2011 (40) book consists of work with hot poured joint and crack sealant. Section 408 does not require routing or sawing to develop a seal reservoir. This treatment is recommended when an overlay is required. When routed or sawed cracks with a backer rod is required, use Colorado Procedure CP 67-02 *Standard Method of Test for*

*Determining Adhesion of Joint Sealant to Concrete Pavement* as the test method for crack sealing adequacy.



Source: <http://cimlinepng.com> and <http://2.bp.blogspot.com>

**Figure 10.5 Photos of Crack Sealing**

Estimating crack sealant is based on the severity level of cracking. These are estimated quantities only and were used in HMA crack sealing projects. The quantities shown are for information only and are only listed as an aid to the pavement designer for comparison purposes (see **Table 10.9 Hot Poured Crack Sealant Estimated Quantities**).

**Table 10.9 Hot Poured Crack Sealant Estimated Quantities**

Cracking Severity Level	Crack Sealant (tons) per lane mile
Heavy	2
Medium	1
Light	0.50
Very Light	0.25

### 10.6.3 Concrete Joint Resealing

Joint resealing is a commonly performed pavement maintenance activity that serves two primary purposes. One objective is to reduce the amount of moisture that can infiltrate a pavement structure, thereby reducing moisture-related distresses such as pumping. A second objective is to prevent the intrusion of incompressible materials into joints so pressure-related distresses (such as spalling) are prevented (6), refer to **Figure 10.6 Photos of Concrete Joint Resealing**.



Source: <https://www.fhwa.dot.gov> and <http://www.pavementinteractive.org>

**Figure 10.6 Photos of Concrete Joint Resealing**

Sealants may become ineffective anywhere from 1 to 4 years after placement. However, improvements in sealant materials, an increased recognition of the importance of a proper reservoir design, and an emphasis on effective crack/joint preparation procedures are expected to increase the expected life of sealant installations. At the same time, there is a persistent controversy over whether joint/crack sealing is needed at all (6). CDOT policy is to seal the joints/cracks and not take the position that joint/crack sealing is not necessary. The above objectives and effectiveness are the same as stated in the section of concrete crack sealing and are reiterated here for emphases.

What to joint seal:

- **Joint Load Transfer Rating:** Refer to **Section 10.5.2.1 Non-destructive Testing** for guidance on LTE and when to improve the LTE or when to reseal the joint.
- **Joint Spalling:** Studies show joint sealing and resealing reduces joint spalling by keeping out incompressibles even on short-panel pavements (24). Joint resealing is still recommended, even on pavements supported by permeable base layers.
- **Type of Joints:** Joint resealing is to be done on transverse and longitudinal joints. If the shoulder is of HMA, the interface joint should also be resealed.

Existing sealant distresses (24):

- **Adhesion Loss:** The loss of bond between the sealant material and the concrete joint face.
- **Cohesion Loss:** The loss of internal bond within the sealant material.



- **Oxidation/Hardening:** The degradation of the sealant as a result of natural aging, long-term exposure to oxygen, ozone, ultra-violet radiation, and/or the embedment of incompressibles into the sealant material.

Resealing is necessary when sealant distress affects the average sealant condition and results in significant water and incompressible infiltration. The basis of this determination is typically engineering judgment. ACPA has suggested guidelines to assist in the engineering judgment (see **Table 10.10 Sealant Severity Level**). The length of the deterioration defines the severity level of deterioration along each surveyed joint.

**Table 10.10 Sealant Severity Level**

Severity Level	Length in Percent
Low	< 25
Moderate	≥ 25 to < 50
High	≥ 50

Every joint need not be surveyed to determine the average sealant condition, rather a statistical sampling can be performed. Random and area sampling frequencies are provided for a statistical significant survey. The area of sampling represents the average condition of the joints, therefore the selected area should be representative of the total length of the roadway in question. Longitudinal joints should be sampled at the same time the transverse joints are surveyed (see **Table 10.11 Sealant Survey Sampling Frequency**).

**Table 10.11 Sealant Survey Sampling Frequency**

Joint Spacing (feet)	Measurement Interval	Number of Joints (per mile)	Area (percent)
< 12	Every 9th joint	+85	20
12 - 15	Every 7th joint	85 - 70	20
15 - 20	Every 5th joint	70 - 50	20
20 - 30	Every 4th joint	50 - 35	20
30 +	Every 4th joint	35	20

Joint resealing requires removing the old sealant, reshaping the reservoir, and cleaning the reservoir. Removal of the old sealant may be done manually, use of a small plow, cutting with a knife, or sawing method. Shaping the reservoir may be done using saw blades. Cleaning must remove dust, dirt, or visible traces of the old sealant. A backer rod is required, followed by a uniform sealant installation process (24). The joint resealing procedure follows the concept of the joint details and sealants as specified in CDOT's Standard Plan M-412-1 Concrete Pavement Joints, sheet 5 of 5. CDOT publication *Development of a Pavement Preventive Maintenance Program for the Colorado Department of Transportation* (22) follows the Standard Plan M-412-1 concept as well. The joint resealing treatment using silicone sealant is recommended when the

existing concrete surface is the new riding surface. A project special provision is required to outline the method of construction and payment for joint resealing. Section 408, Joint and Crack Sealant in CDOT's *Standard Specification for Road and Bridge Construction*, 2011 (40) book consists of work with hot poured joint and crack sealant. This treatment is recommended when an overlay is required. Use Colorado Procedure (CP) 67-02 Standard Method of Test for Determining Adhesion of Joint Sealant to Concrete Pavement as the test method for joint resealing adequacy. The frequency of the test is documented in the Frequency Guide Schedule for Minimum Material Sampling, Testing, and Inspection chapter of the current *CDOT Field Materials Manual*.

#### 10.6.4 Partial Depth Repair

Partial-depth repair restores localized surface distress, such as spalling at joints and/or cracks in the upper one third to one half of a concrete pavement. Spalling is the breaking, cracking, chipping, or fraying of the slab edges that occurs within 2 inches of joints and cracks or their corners. Spalls that are smaller than 2 inches by 6 inches do not affect ride quality and do not need partial depth repair. Another localized surface distress may be severe scaling. A partial depth repair patch is usually very small (26) and should be done after slab stabilization, refer to **Figure 10.7 Photos of Partial Depth Concrete Repair**.



Source: <http://www.roadbridges.com> and <https://www.wbdg.org>

**Figure 10.7 Photos of Partial Depth Concrete Repair**

When not to use partial depth repairs (26):

- When spalls extend more than 6 to 10 inches from the joint and are moderately severe. These types indicate more deterioration is likely taking place below the surface and full depth repair is more appropriate.
- A partial depth repair cannot correct a crack through the full thickness of the slab. Partial depth repair is not recommended when the deterioration is greater than  $\frac{1}{3}$  to  $\frac{1}{2}$  the slab depth.

- A partial depth repair is not appropriate for distresses such as D-Cracking. These distresses are not confined to the surface.
- Partial depth repairs should not be used when spalls are caused by corrosion of metal.
- Pavements with little remaining structural life are not good candidates for partial depth repairs.

Guidelines on repair sizes (26):

- A patch typically covers an area less than 1¼ square yards and is only 2 to 3 inches deep.
- Patch boundaries should be square or rectangular and are easily shaped by saw cutting.
- Use a minimum length of 12 inches
- Use a minimum width of 4 inches
- Extend the patch limits beyond the distress by 3 to 4 inches
- Do not patch if the spall is less than 6 inches long and 1½ inches wide
- If two patches will be less than 2 feet apart, combine them into one large patch.
- Repair the entire joint length if there are more than two spalls along a transverse joint.
- During removal of the concrete, the patch depth is determined.

The recommended concrete removal method is by sawing and chipping. First, saw cuts are made around the perimeter of the repair area. The vertical faces provide a sufficient depth to prevent spalling of the repair material. Saw cuts should be at least 1½ inches deep, preferably more. Then chipping can be done with light (less than 30 pounds) pneumatic hammers until sound and clean concrete is exposed. For best results, use 15 pound hammers or lighter. Spade bits are preferred, light hammers with gouge bits can damage sound concrete. However, if the depth of the patch exceeds about ½ of the slab thickness or exposes any dowel bars, switch to a full depth repair. Chipping without sawing the perimeter has shown that when a thin or feathered concrete edge is along the perimeter it is prone to spalling and debonding. All loose particles, oil (from pneumatic tools), dust, and joint sealant materials must be thoroughly removed to create a good bond. Patches that cross or abut a working joint/crack require a compressible insert. The primary function is to keep the adjacent concrete from bearing against the new patch. The compressible insert provides space for when the slabs thermally expand. This is the primary reason for failure of partial depth repairs. The compressible insert should extend about one inch below and three inches beyond each patch area. At no time should the patch material be permitted to flow into or across the joint or crack. Curing is very important because the partial depth repair's large surface-area-to-volume ratio makes them susceptible to rapid heat and moisture loss. After the patch material has hardened, the reservoir may need to be reformed by saw cutting and then resealed. Patch material may be found in CDOT's Approved Products List website under Concrete; Repair/Patching; Rapid Set, Horizontal. It is best to use the patch material manufacturer's recommended bonding agent and follow their instructions. Depending on the specified patch material, opening to traffic may be specified by minimum strength or time after completing the patch repair. Care should be taken to ensure manufacturers water/cement ratios are achieved, as additional water will result in dramatically reduced strength and durability.

### 10.6.5 Full Depth Concrete Pavement Repair

Full depth repair or patching entails removing and replacing slab portions (full depth patching) or the complete slab to the bottom of the concrete (27). Sometimes the repair must go into the base and subbase layers. Full depth repairs improve pavement rideability and structural integrity. The most common distress for using full depth repair is joint deterioration, this includes any cracking, breaking or spalling of the slab edges. Below surface cracking and spalling requires full depth repairs. Any crack may develop full depth through a slab and may begin moving and functioning as a joint. Cracks which function as joints are "working" cracks. Working cracks are subject to nearly the same range of movement as transverse and longitudinal joints and therefore require sealing (24). However, once the cracks develop severe spalling, pumping or faulting it would be necessary to restore the pavement's structural integrity. Corner breaks and intersecting cracks in slabs are also candidates for full depth repairs. Refer to **Figure 10.1 CPR Sequencing** when other techniques are applied in conjunction with full depth repairs. The other techniques are cross stitching, retrofit dowel bars, and tied PCC shoulders or curb and gutter. Full depth repair should be done after partial depth repair and slab stabilization, refer to **Figure 10.8 Photos of Full Depth Concrete Repair**. If during a partial depth repair the distress is more extensive than originally thought then a full depth repair may be substituted.



Source: [www.dhctexas.com](http://www.dhctexas.com) and [www.infrastructures.com](http://www.infrastructures.com)

**Figure 10.8 Photos of Full Depth Concrete Repair**

When to use full depth repair (27):

- When spalls extend more than 6 to 10 inches from the joint and are moderately severe, they indicate more deterioration is likely taking place below the surface. Full depth repair is more appropriate for these types of distresses.

- When transverse joints or transverse cracks deteriorate with a moderate severity level of faulting equal to or greater than  $\frac{1}{4}$  inches, other techniques and full depth repair is appropriate.
- When longitudinal joints or cracks deteriorate with a high severity level of faulting of  $\frac{1}{2}$  inches, or are wider than  $\frac{1}{4}$  inches, then full depth repair and other techniques are to be used.
- New construction and reconstruction with full depth cracks that separate the slab into two or more parts will not be sealed, and the slab will be removed and replaced. Rehabilitation treatments are generally designed with a shorter design life than new construction, thus, when cracks are full depth and the slab is separated into three or more parts, the slab should be removed and replaced or repaired.

To size the repair, the pavement designer must know the mechanisms of the observed distresses. Generally the visible surface distresses show the minimum amount of repair area affected.

Guidelines on patch repair sizes (27):

- When the erosion action of pumping is present then the repair size should go beyond the limits of any base/subbase voids.
- The below slab deterioration may have to extend 3 feet beyond the visible distress in freeze-thaw climates.
- Parallel full lane width patching has been found to perform better than having interior corners of a partial width patch.
- If dowels (load transfer devices) are present, a minimum longitudinal patch length of 6 feet from the joint is acceptable to prevent the slab patch rocking and to provide room for equipment such as dowel hole drill rigs. If the other side of the transverse joint does not need repair with a minimum patch width, extend the patch beyond the joint about 12 to 15 inches to remove the existing dowels and install new dowels.
- If no dowels are present, a minimum longitudinal patch length of 8 to 10 feet may be used. The extra length will provide more load distributing stability on the base/subgrade. If the minimum width patch falls within 6 feet of a joint that does not need repair, extend the patch to the transverse joint.

Combining two smaller patches into one large patch can often reduce repair costs. When costs of the additional removal and patch material of a large patch is equivalent to the increased costs for additional sawing, sealing, drilling and grouting dowels, and/or chipping the patch thickness face of two smaller patches, a minimum cost effective distance has been calculated. When two patches will be closer than the distances as shown in **Table 10.12 Minimum Cost Effective Distance Between Two Patches**, it is probably more effective to combine them. Longitudinal patches

should be wide enough to remove the crack and any accompanying distress. One should locate the longitudinal joint beyond the wheel paths to avoid edge loading.

**Table 10.12 Minimum Cost Effective Distance Between Two Patches**

(Extracted from Table 2, Minimum Cost-Effective Distance Between Two Patches, *Guidelines for Full-Depth Repair*, Publication TB002.02P, American Concrete Pavement Association, 1995)

Slab Thickness (inches)	Patch Lane Width (feet)			
	9	10	11	12
8	15	13	12	11
9	13	12	11	10
10	12	11	10	9
11	11	10	9	8
12	10	9	8	8
15	8	8	7	6

**Note:** Table does not apply to longitudinal patches.

**Slab Removal:** Full depth saw cuts are to be made on all four sides to create a smooth, straight, vertical face. The saw cuts may require a full depth cut through the existing joint reservoir. These cuts may have to sever the existing tie bars for longitudinal cuts and dowel bars in the transverse cuts. The smooth faces improve the accuracy of new tie and dowel bar placement. Carbide tooth wheel saws can cause micro cracks in the surrounding concrete. It is recommended to use diamond bladed wheel saws. The preferred method to remove the existing deteriorated slab is to lift it out. A number of means to lift the slab out by the contractor are available, refer to **Figure 10.9 Photos of Concrete Slab Removal**. It may be necessary to provide additional saw cuts to facilitate the slab removal. Another method to remove the slabs after saw cutting is to break the deteriorated concrete into small fragments by drop hammers, hydraulic rams or jackhammers. The drawback to the break up method is it often damages the base/subbase and requires more patch preparation. Generally buffer cuts minimize the potential of damaging the surrounding concrete. These buffer cuts help absorb the energy and reduce spalling from the pavement breakers.



Source: <http://epg.modot.org> and <http://kenco.com>

**Figure 10.9 Photos of Concrete Slab Removal**

**Patch Preparation:** Sometimes it is necessary to remove and replace soft areas in the base/subbase. Good compaction is often difficult to achieve in the patch areas. It may be advantageous to fill the disturbed base/subbase areas with patching concrete. Flow-fill is ideal for utility excavations, Refer to **Figure 10.10 Photos of Compaction of Subbase and Flowfill Placement**. Flow-fill mix design properties are documented in Section 206.02 of CDOT's *Standard Specifications for Road and Bridge Construction* specifications (40).

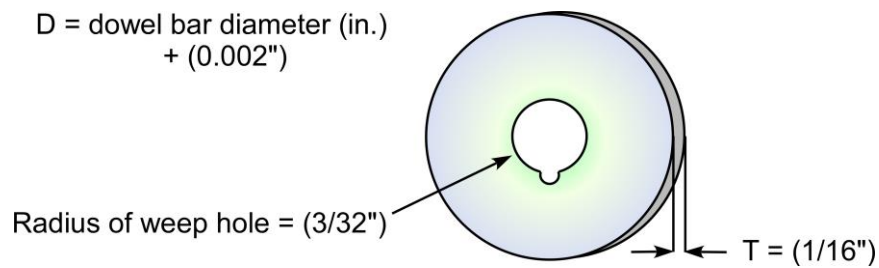


Source: <http://wikipave.org>

**Figure 10.10 Photos of Compaction of Subbase and Flowfill Placement**

**Install Load Transfer:** Load transfer devices (dowel bars) should conform to the size and placement as specified on CDOT *Standard Plans, M & S Standards*, July 2012, M-412-1 Concrete Pavement Joints. Dowel bars slip into holes drilled into the transverse edge of the existing slabs. Dowel drill rigs with gangs of drills are preferred to control drill alignment and wandering. Either standard pneumatic or hydraulic percussion drills are acceptable. Both can drill a typical dowel

hole in about 30 seconds. Standard pneumatic drills may cause slightly more spalling on the existing slab face. Hole diameter is dependent on the type of anchoring material used. Cement type grouts require about  $\frac{1}{4}$  inch larger hole and epoxy materials should be  $\frac{1}{16}$  inch larger than the nominal dowel diameter. A grout retention disk made of nylon or plastic shall be used for all dowel bars placed in the existing pavement (see **Figure 10.4 Grout Retention Disk**). An anchoring material should be used and not a compression fit. Adhesive anchoring materials are listed on CDOT's website for approved products conforming to AASHTO M 235. After drilling the dowel holes, the holes should be cleaned with compressed air and anchoring material applied as per the manufacturer's directions. Do not use any method that pours or pushes the material into the hole. To provide a good bearing surface and bond, insert the dowel with a twisting motion of about one revolution to evenly distribute the material around the dowels circumference. Apply a bond breaker coating onto the other half of the dowel bar that is to be imbedded in the fresh concrete.



**Figure 10.11 Grout Retention Disk**

**Install Tie Bars:** Tie bar installation is similar to the load transfer devices. The size and placement is specified on CDOT's *Standard Plans, M & S Standards*, July 2012, M-412-1 Concrete Pavement Joints. Tie bars are placed in the longitudinal joint face of existing slabs, refer to **Figure 10.12 Photos of Tie Bar Installation During Concrete Repair**. Full slab replacements and repairs greater than 15 feet require tie bars where previous tie bars existed. Hand held drills are acceptable because alignment is not critical. Tie bar requirements and pull out testing is specified in Section 412.13 of CDOT's *Standard Specifications for Road and Bridge Construction* (40). For repairs less than 15 feet long a bond breaker board ( $\frac{1}{4}$  inch fiberboard) may be placed along the longitudinal face. For urban area repairs around maintenance access units (manholes) do not install tie bars, instead place a bond breaker board around the perimeter. Tie bars are used to tie the curb and gutter to the travel lanes. The curb and gutter acts as lateral support similar to widened and tied shoulders.





Source: <http://www.minnich-mfg.com> and <http://www.dot.state.oh.us>

**Figure 10.12 Photos of Tie Bar Installation During Concrete Repair**

**Concrete Material:** All concrete pavement full depth patch repairs should use a concrete material and not asphaltic materials (HMA). Asphalt patches heave and compress during warm weather when the existing concrete slabs expand. Generally, full depth repairs are done under traffic conditions and time is of the essence. Class E concrete is used for fast track pavements and is specified in Section 601.02 of CDOT's *Standard Specifications for Road and Bridge Construction* (40) or as revised.

**Finishing:** Strike-off, consolidation, floating, and final surface finish is specified in Section 412.12 of CDOT's *Standard Specifications for Road and Bridge Construction* (40). The surface texture should be similar to the surrounding pavement.

**Curing:** The type and placement method of membrane curing compounds and/or curing blankets for Class P and Class E concretes are specified in Section 412.14 of CDOT's *Standard Specifications for Road and Bridge Construction* (40).

**Smoothness:** If many closely spaced patches are required, consider specifying the pavement smoothness specification. The requirements are specified in Section 105.07 of CDOT's *Standard Specifications for Road and Bridge Construction* (40). If diamond grinding is required, the grinding should precede joint sealing.

**Joint Sealing:** The final step is to saw the joint sealant reservoirs of the transverse and longitudinal joints, clean, and apply the joint sealant, refer to **Section 10.6.3 Concrete Joint Resealing**).

**Strength or Time Method on Opening to Traffic:** CDOT utilizes strength requirements or maturity relationships to determine when to open the roadway repair to traffic. Both methods are

specified in Section 412.12 of CDOT's *Standard Specifications for Road and Bridge Construction* (40).

**Precast Panels:** CDOT has been utilizing precast panels for full depth repairs. Each panel is custom cast to fit the patch repair dimensions. The removal of the existing slab(s) is the same as above. The advantage of this method is being able to open the roadway to traffic in a shorter length of time than the above conventional method. This operation is well suited for nighttime work on busy daytime highways, see **Figure 10.13 Photos of Precast Concrete Panel Repair**. Refer to CDOT Final Report CDOT-DTD-R-2006-8 *Precast Concrete Paving Panels: The Colorado Department of Transportation Region 4 Experience*, 2000 to 2006, dated August 2006 (39). An example of a project's complete plans and specifications utilizing precast panels is available in Region 4, Project Number MTCE 04-061R, Region 4 FY06 I-25 MP 244 to MP 270 Concrete Slab Replacement, Subaccount Number M4061R.



Source: [www.fhwa.dot.gov](http://www.fhwa.dot.gov)

**Figure 10.13 Photos of Precast Concrete Panel Repair**

### 10.6.6 Dowel Bar Retrofit

Dowel bar (load transfer devices) retrofit is a technique that increases the load transfer capability from one slab to the next through shear action (28). Slots are cut into the existing pavement at the transverse joints/cracks with slot cutting diamond saw (preferred method). Generally, three slots per wheel path are cut to a depth that allows the dowel bar to sit half way down in the slab with a half-inch of clearance to the bottom of the slot. Epoxy coated dowels must be a minimum of 14 inches long so at least six inches will extend on each side of the joint or crack. A non-metallic expansion cap is placed on one end of the dowel and the dowel is placed on non-metallic chairs for clearance. Horizontal and vertical alignments are critical. Refer to the Details Illustrating Dowel Placement Tolerances in CDOT's *Standard Plans, M & S Standards*, July 2012, M-412-1 Concrete Pavement Joints drawings. The slots are then backfilled using the same materials that would be used for partial depth repairs. The retrofit should last the remaining life of the pavement. Refer to **Figure 10.1 CPR Sequencing** when other techniques are applied in conjunction with dowel bar retrofit. The other techniques are cross stitching and tied PCC shoulders or curb and

gutter. Dowel bar retrofit should be done after full or partial depth repair, slab stabilization, and before diamond grinding.

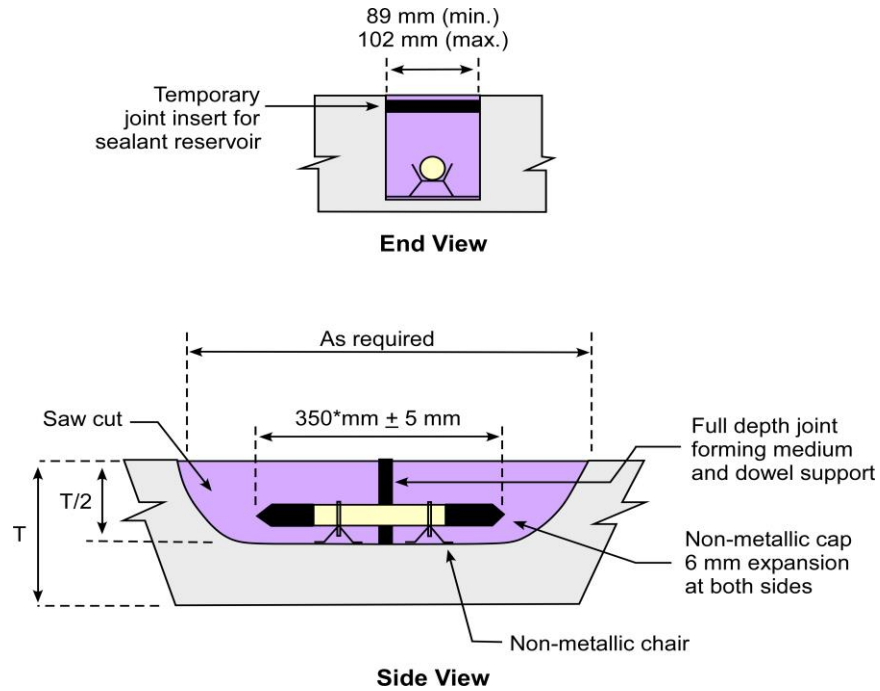
When to use dowel bar retrofit (28):

- Generally load transfer devices should be installed at transverse joints and transverse working cracks with poor load transfer but otherwise little or no deterioration.
- Pavements exhibiting D-Cracking are not good candidates for load transfer restoration because the concrete in the vicinity of the joints and cracks is likely to be weakened, thus retrofit load transfer devices would not have sound concrete on which to bear. For D-Cracked pavements with concrete deterioration only in the vicinity of joints and cracks, full depth repair is more appropriate.
- Pavements with distress caused by Alkali-Silica Reaction (ASR) or Alkali-Carbonate Reaction (ACR) are not good candidates for load transfer restoration either.

The load transfer rating as related to the load transfer efficiency is shown in **Table 10.3 Load Transfer Efficiency Quality**.

Dowel bars are between 1 and 1½ inches in diameter. The larger diameter dowel bars are used in thicker pavements (>10 inches). Dowel bars are spaced 12 inches on center in sets of three or four per wheel path. Edge spacing from the longitudinal joint to the first dowel bar varies. The edge distance is dependent on whether tie bars are located at the longitudinal joint. Use 12 inches if tie bars are not present and 18 inches if they are.

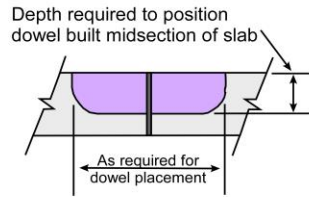
Refer to **Figure 10.14 Typical Dowel Bar Retrofit Installation** for a conceptual drawing of the retrofit installation. See **Figure 10.15 Typical Dowel Bar Retrofit Sequencing of the Installation** for the installation procedure and **Figure 10.16 Photos of Dowel Bar Retrofit Processes**. Apply a bond breaker coating (i.e. a light coating of grease or oil) to the dowel bars along their full length to facilitate joint movement. Bond breaker application is specified in Section 709.03 of CDOT's *Standard Specifications for Road and Bridge Construction* specifications (40).



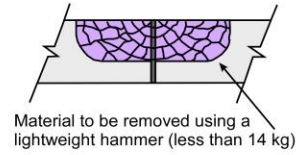
**Note:** For pavements with poor support conditions slightly longer bars should be considered.

**Figure 10.14 Typical Dowel Bar Retrofit Installation**  
Modified from Figure 4-9.3, *Dowel Bar Load Transfer Device*  
*Techniques for Pavement Rehabilitation*, 1998 (6)

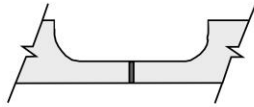
STEP 1 - SAW SLOT FOR EACH  
DOWEL BAR



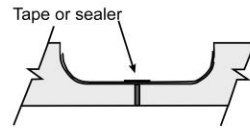
STEP 2 - REMOVE CONCRETE  
TO FORM KERF AND RINSE  
WITH WATER



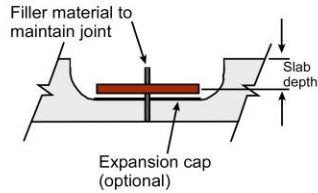
STEP 3 - SANDBLAST AND VACUUM  
CLEAN SLOT



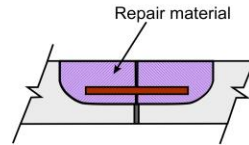
STEP 4 - SEAL OR PRIME ALL THREE  
SIDES OF SLOT. TAPE OR  
SEAL CRACKS AND JOINTS



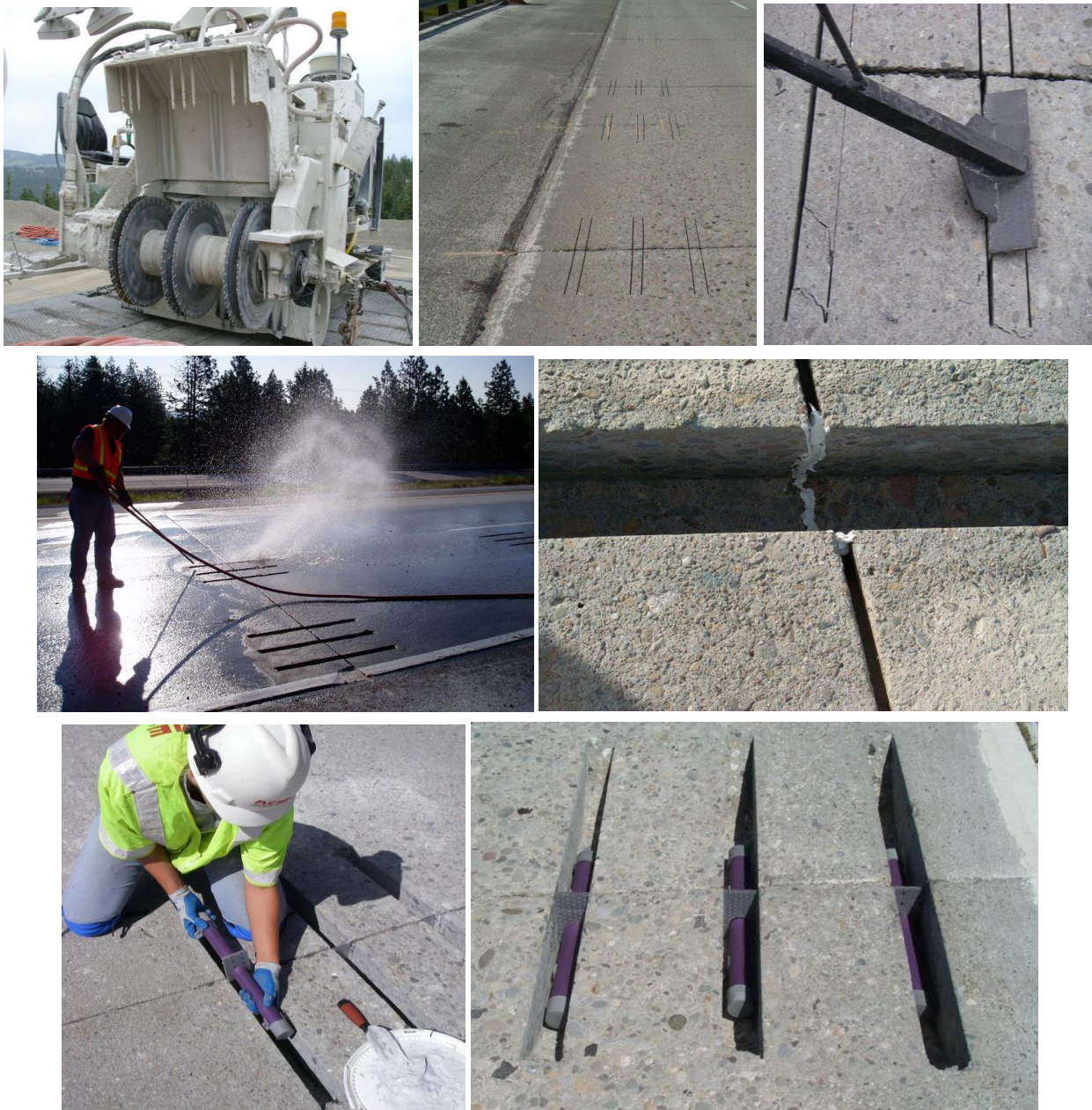
STEP 5 - PLACE AND ALIGN DOWEL  
BARS AND JOINT FILLER  
MATERIAL



STEP 6 - PLACE REPAIR MATERIAL



**Figure 10.15 Typical Dowel Bar Retrofit Sequencing of the Installation**  
From Figure 4-9.7, *Construction Procedures for Retrofitted Dowel Bar Installation*  
*Techniques for Pavement Rehabilitation* 1998 (6)



Source: <http://www.pavementinteractive.org>

**Figure 10.16 Photos of Dowel Bar Retrofit Processes**

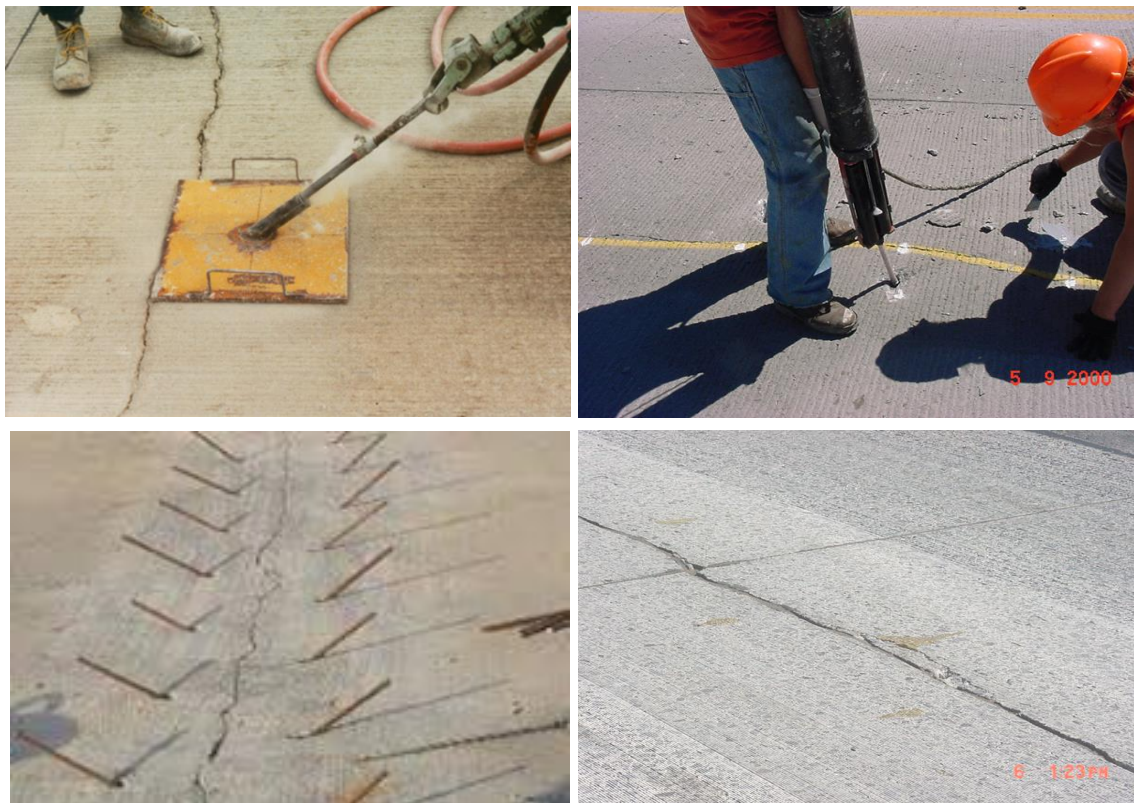
*Photos of cutting equipment for dowel slots, three cut slots, breaker bar used to remove concrete from the slots, cleaning slots with water, caulking dowel bar slot, inserting dowel assemblies, and dowel bar assembly, respectively*

**10.6.7 Cross Stitching**

Cross stitching longitudinal discontinuities, such as joints and cracks, is a repair technique to facilitate lateral load transfer of an otherwise unsupported free edge. The free edge is where the most critical loadings occur in the slab. This free edge condition may exist at a lane-to-lane or lane-to-shoulder joint. Working longitudinal cracks may also develop and create an unsupported

free edge condition. The cross stitching will help maintain the aggregate interlock in this situation if the crack doesn't widen too much. Cross stitching uses deformed tie bars inserted into holes drilled across a joint/crack at an angle. As observed on a CDOT project, if the angle is less than 35° from the horizontal the contractor has problems drilling the holes. The tie bars are placed and staggered with each other on each side of the joint/crack for the length of the discontinuity. The tie bars prevent joints and cracks from vertical and especially horizontal movement or widening. In new construction, tie bars are placed in plastic concrete to keep the joints tight in the hardened state and incompressibles and sheet flow of water into the base. The cross stitching repair technique for joints is to prevent further lane or shoulder separation and minimize the settlement of the slabs. Generally, this technique is used where the overall pavement condition, joints, and cracks are in good condition. If the joints and cracks are spalled too much, other rehabilitation repair methods may be appropriate.

Another similar technique is slot stitching which uses a modified dowel bar retrofit method. Slots are cut across the joints/cracks, deformed bars are placed in the slots, and the slots are backfill similar to dowel bar retrofit. If an overlay is not being placed after the repair, then cross stitching has a more pleasing appearance than slot stitching. If an overlay will be placed, either method is acceptable, see **Figure 10.17 Photos of Cross Stitching** and **Figure 10.18 Photos of Slot Stitching**.



Source: <http://waterproofing-world.blogspot.com> and <http://www.concreteisbetter.com>

**Figure 10.17 Photos of Cross Stitching**

*Photos show drilling the hole, drilling and measuring a hole, inserting bars into holes (not fully inserted in photo), and finished cross stitching, respectively*



Source: <http://www.rekma.net>

**Figure 10.18 Photos of Slot Stitching**

Both rehabilitation techniques are discussed in *Stitching Concrete Pavement Cracks and Joints*, Publication Special Report SR903P, ACPA and IGGA, 2001 (30). The publication illustrates the cross stitching bar dimensions, locations of drilled holes, and slot layouts. Be aware that if diamond grinding is performed after cross stitching, then the placement of the bars should be deep enough so they are not impacted by the grinding machining. The amount of anchor adhesive cover over the bars should be sufficient to protect the bars from the elements. Project plans should detail the appropriate stitching method.

Refer to **Figure 10.1 CPR Sequencing** when other techniques are applied in conjunction with the cross/slot stitching. Cross/slot stitching should be done after full/partial depth repair and slab stabilization and before diamond grinding and crack/joint sealing. Cross/slot stitching should last the remaining life of the pavement.

A special note is in order to understand the significance of tying the longitudinal joints and cracks. In the Section 3.4.3.8 Pavement Design Features, subheading Edge Support of the *Guide for Mechanistic-Empirical Design*, Final Report, NCHRP Project 1-37A (17) explains the structural effects of the edge support features are directly considered in the design process. The Design Guide evaluates the adequacy of the trial design through the prediction of key distresses and smoothness. The design process uses the Load Transfer Efficiency (LTE) equation for transverse joints related to shoulder type (HMA vs. PCC), tied PCC shoulders, or widen slabs. The distresses are percent slabs cracked and faulted joints versus time and are compared to the user defined allowable reliability limits. It appears that the Design Guide assumes all lane-to-lane joints are tied, but the designer has a choice on lane-to-shoulder jointing. LTE design input features are as follows:

- **Tied PCC Shoulder:** For tied concrete shoulders, the long-term LTE between the lane and shoulder must to be provided. The LTE is defined as the ratio of deflections of the unloaded versus loaded slabs. The higher the LTE, the greater the support provided by the shoulder to reduce critical responses of the mainline slabs. Typical long-term deflection LTE are:



- 50 to 70 percent for monolithically constructed and tied PCC shoulder
- 30 to 50 percent for separately constructed tied PCC shoulder
- **Untied Concrete Shoulders:** or other shoulder types do not provide significant support, therefore, a low LTE value should be used (i.e. 10 percent due to the support from extended base course).
- **Widened Slabs:** Improve JPCP performance by effectively moving the mean wheel path well away from the pavement edges where critical loadings occur. The design input for widened slab is the slab width which can range from 12 to 14 feet.

### 10.6.8 Slab Stabilization and Slabjacking

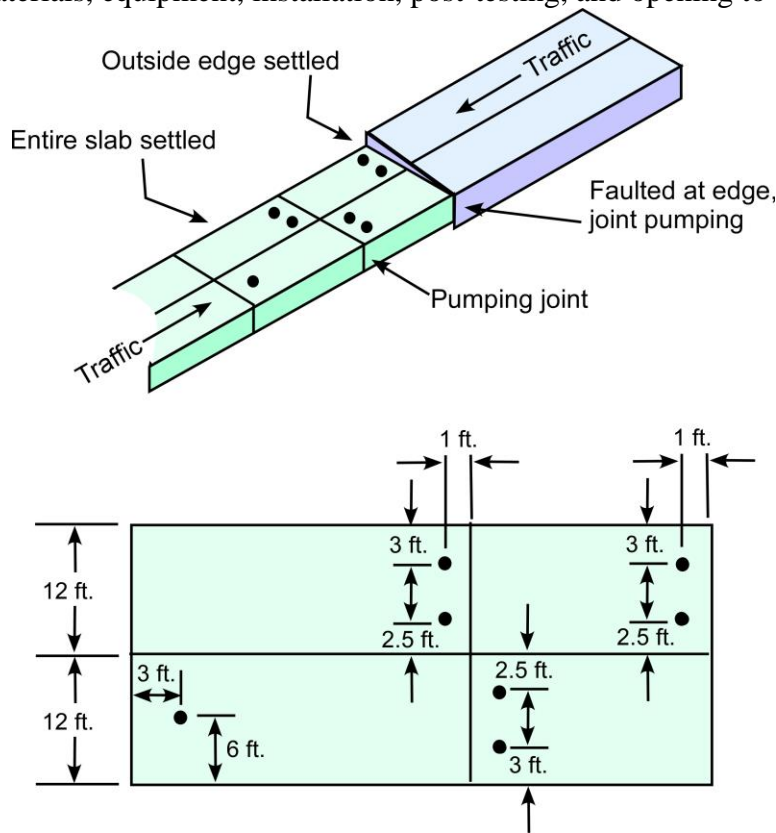
The purpose of slab stabilization (also called subsealing, undersealing, or pavement grouting) is to stabilize the pavement slab by the pressurized injection of a cement grout, pozzolan-cement grout, bituminous materials, or polyurethane mixture through holes drilled in the slab. The cement grout will, without raising the slab, fill the voids under it, displace water from the voids, and reduce the damaging pumping action caused by excessive pavement deflections. Slab stabilization should be accomplished as soon as significant loss of support is detected at slab corners. Symptoms of loss of support include increased deflections, transverse joint faulting, corner breaks, and the accumulation of fines in or near joints or cracks on traffic lanes or shoulders (31, 32).

When to use slab stabilization (33):

- Slab stabilization should be performed only at joints and working cracks where loss of support is known to exist. Symptoms of support loss include:
  - Increased deflections
  - Transverse joint faulting
  - Corner breaks
  - Accumulation of underlying fine materials in or near joints or cracks on the traffic lane or shoulder
- Slab stabilization should be performed before the voids become so large in area that they cause pavement failure. The only exception is when the pavement is to be overlaid with asphalt or concrete. In this case, slab stabilization is necessary, regardless of pavement condition. Slab stabilization is particularly important for asphalt overlays which have little resistance to shearing forces and reflect the underlying foundation problems.

Refer to **Figure 10.19 Typical Slab Stabilization Hole Layout** for a typical application and hole layout. Refer to **Figure 10.1 CPR Sequencing** when other techniques are applied in conjunction with slab stabilization. Slab stabilization should occur before partial depth repair and other repairs. The slab stabilization technique is detailed and discussed in *Slab Stabilization Guidelines for*

*Concrete Pavements*, Publication TB018P, ACPA, 1994 (32). The 20 page publication discusses void detection, materials, equipment, installation, post-testing, and opening to traffic.



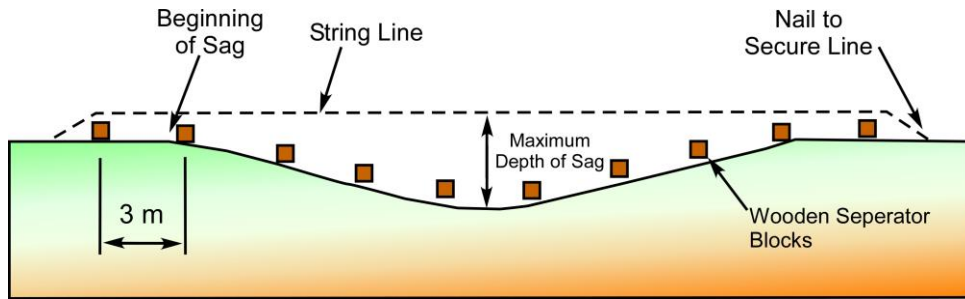
**Figure 10.19 Typical Slab Stabilization Hole Layout**

From Figure 4-7.6, *Location of Holes Depending on Defect to be Corrected*  
*Techniques for Pavement Rehabilitation*, 1998 (6)

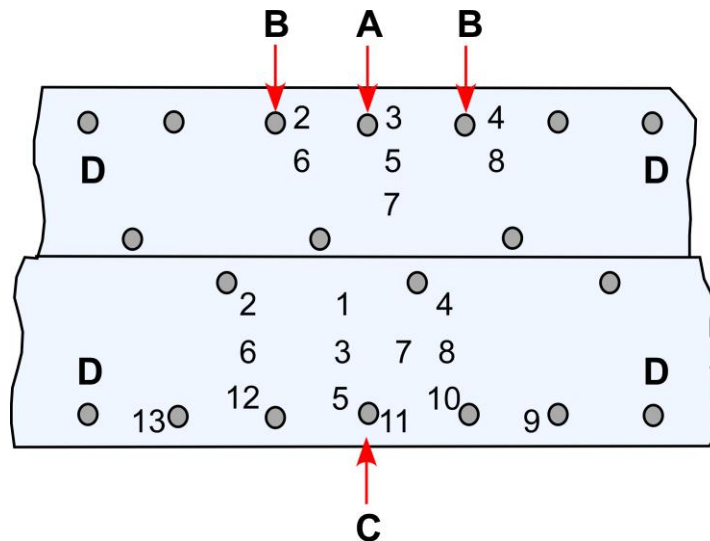
The purpose of slabjacking is to raise a slab in place permanently, prevent impact loading, correct faulty drainage, and prevent pumping at transverse joints by injection of a grout, pozzolan-cement grout or polyurethane mixture under the slab. The grout fills voids under the slab, thereby restoring uniform support. Slabjacking should be considered for any condition that causes nonuniform slab support, such as embankment settlement, settlement of approach slabs, settlement over culverts or utility cuts, voids under the pavements, differences in elevation of adjacent pavements, joints in concrete pavements that are moving or expelling water or soil fines, and pavement slabs that rock or teeter under traffic (31, 32). The performance of pavements subjected to slabjacking is somewhat dependent upon the origin of the corrected defect. For example, an embankment that slowly continues to settle will require periodic slabjacking. Periodic slabjacking may also be required on bridge approach slabs due to poor drainage design and improper embankment compaction (34). An example of a suggested slab jacking pumping sequence that provides a general guideline for obtaining satisfactory results is presented in manual *Techniques for Pavement Rehabilitation 1998* (6). It must be remembered that the sequence must be modified to meet the specific needs of a given project. Refer to **Figure 10.20 Typical Slab Raising in Slabjacking** and **Figure 10.21 Typical Slabjacking Hole Layout** for a typical application using a stringline

and hole layout. **Figure 10.22 Photos of Slab Jacking** shows examples of slabjacking on a roadway project(s).

An example of a project's complete plans and specifications utilizing slab jacking is available. The project was in Region 4, Project Number MTCE 04-061R, Region 4 FY06 I-25 MP 244 to MP 270 Concrete Slab Replacement, Subaccount Number M4061R. It used water blown formulation of high density polyurethane.



**Figure 10.20 Typical Slab Raising in Slabjacking**  
From Figure 4-7.9, *String Line Method of Slab Jacking*  
*Techniques for Pavement Rehabilitation*, 1998 (6)



**Figure 10.21 Typical Slabjacking Hole Layout**  
From Figure 4-7.7, *Location of Holes and the Order of Grout Pumping to Correct*  
*Settlement Techniques for Pavement Rehabilitation*, 1998 (6)



Source: <http://www.roadsurgeons.com.au> and <http://www.tluckey.com>

**Figure 10.22 Photos of Slabjacking**

*Photos show drill pattern and injection, final patching of injection holes, close-up of injection, and close-up of injection material oozing from the pavement seams and reduced vertical differential of the slabs.*

## 10.7 Selecting the Appropriate Pavement Rehabilitation Techniques

**Table 10.13 Guidelines for PCC Treatment Selection** is from a complete bound report titled *Development of a Pavement Preventive Maintenance Program for the Colorado Department of Transportation*, October 2004, by Larry Galehouse (35). **Note:** The Final Report CDOT-DTD-R-2004-17, August 2004 (22) is not as complete as the October 2004 bound report. The tabular guidelines only include CDOT's treatments as reported in the bound report. Refer also to **Table 10.13 Guidelines for PCC Treatment Selection** for additional treatments and repairs.

**Table 10.13 Guidelines for PCC Treatment Selection**

From Table Guidelines for Pavement Treatment Selection, *CDOT Preventive Maintenance Program Guidelines*, October 2004 (35)

Pavement Distresses	Parameter	Rigid Treatments					
		Diamond Grinding	Concrete Crack Resealing	Concrete Joint Resealing	Partial Depth Repair	Dowel Bar Retrofit	Full Depth Concrete Pavement Repair
Corner Breaks	Low	⊙	P	⊙	✓	⊙	✓
	Moderate	⊙	P	⊙	✓	⊙	✓
	High	✓	✓	⊙	✓	⊙	
Durability Cracking (“D” Cracking)	Low	⊙	✓	⊙	✓	⊙	✓
	Moderate	⊙	✓	⊙	✓	⊙	✓
	High	⊙	⊙	⊙	⊙	⊙	P
Longitudinal Cracking	Low	⊙	P	⊙	⊙	⊙	✓
	Moderate	✓	P	⊙	P	⊙	✓
	High	P	P	⊙	P	⊙	✓
Transverse Cracking	Low	⊙	P	⊙	✓	✓	✓
	Moderate	✓	P	⊙	P	✓	✓
	High	P	P	⊙	P	✓	✓
Joint Seal Damage	Low	⊙	⊙	✓	⊙	⊙	⊙
	Moderate	⊙	⊙	P	⊙	⊙	⊙
	High	⊙	⊙	P	⊙	⊙	⊙
Longitudinal Joint Spalling	Low	⊙	⊙	P	⊙	⊙	⊙
	Moderate	⊙	⊙	P	P	⊙	✓
	High	⊙	⊙	P	P	⊙	✓
Transverse Joint Spalling	Low	⊙	⊙	P	P	⊙	✓
	Moderate	⊙	⊙	P	P	⊙	✓
	High	⊙	⊙	P	P	⊙	P
Map Cracking and Scaling	Low	⊙	⊙	⊙	✓	⊙	✓
	Moderate	⊙	⊙	⊙	P	⊙	✓
	High	⊙	⊙	⊙	⊙	⊙	⊙
Polished Aggregate	Significant	P	⊙	⊙	⊙	⊙	⊙
<b>Condition Factors</b>							
Traffic AADT-T	< 400	✓	✓	✓	✓	✓	✓
	400 - 6,000	✓	✓	✓	✓	✓	✓
	> 6,000	✓	✓	✓	✓	✓	✓
Ride	Poor	P	⊙	⊙	✓	⊙	✓
Rural	Minimum Turning	✓	✓	✓	✓	✓	✓
Urban	Maximum Turning	✓	✓	✓	✓	✓	✓
Drainage	Poor	⊙	⊙	⊙	⊙	⊙	⊙

P – Preferred Treatment Option  
✓ – Acceptable Treatment Option  
⊙ – Not Recommended

## References

1. *Factors for Pavement Rehabilitation Strategy Selection*, Number 3.02, R & T Update, Concrete Pavement Research & Technology, American Concrete Pavement Association, Skokie, IL, February 2002.
2. *AASHTO Guide for Design of Pavement Structures*, American Association of State Highway and Transportation Officials, Washington, DC, 1993.
3. *Recycling Concrete Pavements*, TB014P, American Concrete Pavement Association, Skokie, IL, 1993.
4. *Distress Identification Manual for the Long-Term Pavement Performance Program*, Publication Number FHWA-RD-03-031, U.S. Department of Transportation, Federal Highway Administration, Washington, DC, March 2003.  
<<http://www.fhwa.dot.gov/research/>>
5. *Techniques for Pavement Rehabilitation*, ERES Consultants, Inc., U.S. Department of Transportation, Federal Highway Administration, Washington, DC, 1992.
6. *Techniques for Pavement Rehabilitation*, Nichols Consulting Engineers, Chtd., U.S. Department of Transportation, Federal Highway Administration and National Highway Institute, Arlington, Virginia, Sixth Edition, January 1998.  
< [http://www.asce.org/uploadedFiles/Continuing\\_Education\\_-\\_New/techpave.pdf](http://www.asce.org/uploadedFiles/Continuing_Education_-_New/techpave.pdf) >
7. *Revision of AASHTO Pavement Overlay Design Procedures*, Final Report, Darter, M., Elliott, R., Hall, K., National Cooperative Highway Research Program, Transportation Research Board, Washington, DC, April 1992.
8. *Public Benefits of Highway System Preservation and Maintenance*, A Synthesis of Highway Practice, NCHRP Synthesis 330, National Cooperative Highway Research Program, Transportation Research Board, Washington, DC, 2004.
9. *Rehabilitation of Concrete Pavements*, Final Report, Report No. CDOH-83-1, Colorado Department of Highways, January, 1983.
10. *Rehabilitation of Concrete Pavements Follow-Up Study*, Follow-Up Report, Report No. CDOH-88-8, Colorado Department of Highways, April 1988.
11. *LTPP Data Analysis: Frequently Asked Questions About Joint Faulting With Answers From LTPP*, Publication No. FHWA-RD-97-101, U.S. Department of Transportation, Federal Highway Administration, Research and Development Turner-Fairbank Highway Research Center, McLean, VA, August 1997.
12. *Structural Factors of Jointed Plain Concrete Pavements: SPS-2 -- Initial Evaluation and Analysis*, Publication No. FHWA-RD-01-167, U.S. Department of Transportation, Federal

- Highway Administration, Research and Development Turner-Fairbank Highway Research Center, McLean, VA, April 2005.
13. Ardani, Ahmad, Hussain, Shamshad, and LaForce, Robert, *Evaluation of Premature PCCP Longitudinal Cracking in Colorado*, Final Report, Report No. CDOT-DTD-R-2003-1, Colorado Department of Transportation, Research Branch, January 2003.
  14. Wood, K. L., *Evaluation of Concrete Pavement Restoration Procedures and Techniques*, Initial Report, Report No. CDOH-DTP-R-84-5, Colorado Department of Highways, March 1984.
  15. Killian, John, *Concrete Pavement Restoration Demonstration*, Final Report, Report No. CDOH-DTD-R-88-6, Colorado Department of Highways, February 1988.
  16. *Pavement Study - Project I 092-2(4)*, Final Report, Colorado Department of Highways, Planning & Research Division, Research and Special Studies Section, 1966.
  17. *Guide for Mechanistic-Empirical Design*, Final Report, NCHRP Project 1-37A, National Cooperative Highway Research Program, Transportation Research Board, National Research Council, Submitted by ARA, INC., ERES Consultants Division, Champaign, IL, March 2004.
  18. *Supplement to the AASHTO Guide for Design of Pavement Structures, Part II, - Rigid Pavement Design & Rigid Pavement Joint Design*, American Association of State Highway and Transportation Officials, Washington, DC, 1998.
  19. *Evaluation of Joint and Crack Load Transfer*, Final Report, FHWA-RD-02-088, U.S. Department of Transportation, Federal Highway Administration, Research and Development Turner-Fairbank Highway Research Center, McLean, VA, October 2003.
  20. *ACPA Pavement Technology Construction-Related FATQ*, (23, June 2005).  
< <http://resources.acpa.org/> >
  21. *The Concrete Pavement Restoration Guide*, Publication TB020.02P, American Concrete Pavement Association, Concrete Paving Technology, Skokie, IL, 1998.
  22. *Development of a Pavement Preventive Maintenance Program for the Colorado Department of Transportation*, Final Report, CDOT-DTD-R-2004-17, Colorado Department of Transportation, Research Branch, prepared by National Center for Pavement Preservation, Okemos, MI, August 2004.
  23. *Diamond Grinding and Concrete Pavement Restoration*, Publication TB008.01P, American Concrete Pavement Association, Concrete Paving Technology, Skokie, IL, 2000.

24. *Joint and Crack Sealing and Repair for Concrete Pavements*, Publication TB012P, American Concrete Pavement Association, Concrete Paving Technology, Skokie, IL, 1995.
25. *Standard Specifications for Road and Bridge Construction*, Colorado Department of Transportation, Denver, Co, 2005.
26. *Guidelines for Partial-Depth Spall Repair*, Publication TB003.02P, American Concrete Pavement Association, Concrete Paving Technology, Skokie, IL, 1998.
27. *Guidelines for Full-Depth Repair*, Publication TB002.02P, American Concrete Pavement Association, Concrete Paving Technology, Skokie, IL, 1995.
28. *Concrete Pavement Rehabilitation: Guide for Load Transfer Restoration*, Publication FHWA-SA-97-103, Federal Highway Administration, Washington, D.C., and Publication ACPA JP001P, American Concrete Pavement Association, Skokie, IL, 1997.
29. *Concrete Pavement Rehabilitation - Guide for Diamond Grinding*, FHWA Technical Report, Correa, Angel L. and Wong, Bing, Federal Highway Administration, 400 7<sup>th</sup> Street S.W., Washington, DC 20590, June 2001.  
<<http://www.fhwa.dot.gov/pavement/concrete/diamond.cfm>>
30. *Stitching Concrete Pavement Cracks and Joints*, Publication Special Report SR903P, American Concrete Pavement Association, Concrete Paving Technology and Research, Skokie, IL and International Grooving & Grinding Association, Coxsackie, NY, 2001.
31. *O&M: Concrete Repair*, Publication UFC 3-270-04, Unified Facilities Criteria, U.S. Army Corps of Engineers, March 15, 2001.
32. *Slab Stabilization Guidelines for Concrete Pavements*, Publication TB018P, American Concrete Pavement Association, Concrete Paving Technology, Skokie, IL, 1994.
33. *Slab Stabilization*, Factsheet from Military Tri-Service Transportation Website, (03, January 2006).  
< <https://transportation.ercd.dren.mil/tsmcx/index.htm> >
34. *Slabjacking*, Factsheet from Military Tri-Service Transportation Website, (03, January 2006).
35. < <https://transportation.ercd.dren.mil/tsmcx/index.htm> >
36. *CDOT Preventive Maintenance Program Guidelines*, prepared by National Center for Pavement Preservation, Okemos, MI, October 2004.
37. *Concrete Pavement Rehabilitation and Preservation Treatment*, Report FHWA-IF-06-005, CPTP TechBrief, November 2005.



38. Ardani Ahmad and Outcalt William (Skip), *PCCP Texturing Methods*, Final Report, Report No. CDOT-DTD-R-2005-22, Colorado Department of Transportation, Research Branch, January 2005.
39. Ardani Ahmad, *Implementation of Proven PCCP Practices in Colorado*, Final Report, Report No. CDOT-DTD-R-2006-9, Colorado Department of Transportation, Research Branch, April 2006.
40. DeWitt, Gary L., P.E., *Precast Concrete Paving Panels: The Colorado Department of Transportation Region 4 Experience, 2000 to 2006*, Final Report, Report No. CDOT-DTD-R-2006-8, Colorado Department of Transportation, Research Branch, August 2006.
41. *Standard Specifications for Road and Bridge Construction*, Colorado Department of Transportation, Denver, Co, 2011.  
<http://www.coloradodot.info/business/designsupport/construction-specifications/2011-Specs>
42. Daniel P. Frentress and Dale S. Harrington, *Guide for Partial-Depth Repair of Concrete Pavements*, Iowa State University, Institute for Transportation, National Concrete Pavement Technology Center, April 2012.

## CHAPTER 11

# PRINCIPLES OF DESIGN FOR FLEXIBLE PAVEMENT INTERSECTIONS

### 11.1 Introduction

A standard pavement design is based on fast-moving traffic traveling one direction on long stretches of roadway where drainage is usually easy to handle. This is not the situation with intersections. Traffic loadings are greater at intersections because of compounding traffic directions. Also, it's necessary to design for slower stop-and-go traffic, which induces much heavier stresses on the pavement section. In addition, drainage is often compromised within intersections, leading to saturation of the pavement section and the underlying subgrade. Some mixes with a history of good performance may not perform well in intersections, climbing lanes, truck weigh stations, and other slow-speed areas. Special attention should be focused on high traffic volume intersections to ensure the same outstanding performance.

The key to achieving this desired performance is recognizing that these pavements may need to be treated differently than conventional roadways. Specifically, the pavement must be designed and constructed to withstand the more severe conditions. Well-designed, properly constructed HMA intersections provide an economical and long-lasting pavement.

### 11.2 Design Considerations

Determining whether to use a high performance HMA intersection design versus a conventional HMA design should be assessed on a project-by-project basis. Some general rules to consider are as follows:

- **Intersections with Heavy Truck Traffic and High Traffic Volumes:** If the traffic loading for a 20-year design is a historic designation of one to three million ESALs or greater, a high performance asphalt intersection should be considered. When 20-year traffic loading of the two traffic streams have a historic designation of one million ESALs or greater within an intersection, a high performance intersection design should be considered. If high traffic volume intersections are within  $\frac{1}{4}$  mile of each other, the entire roadway should be designed using a high performance intersection design. Acceleration and deceleration lanes should be included as part of the intersection design.
- **Sharp Turns with Slow-Moving Traffic:** Should be included as part of the intersection design. If there are not enough high performance intersections within a project to warrant a high traffic volume intersection design throughout, but if the intersections within the project are potentially subject to moderate to heavy traffic (historic designation of one million ESALs or greater), they should be blocked out and a high traffic volume intersection design used. When there is two-way traffic, the transition should extend at least 300 linear feet on either side of the intersection. When there is one-way traffic, the transition should be at least 300 linear feet on the

deceleration side and 100 linear feet on the acceleration side of the intersection. The definitions and design factors necessary for flexible pavement design were introduced in previous sections.

- It is suggested a PG 76-28 binder be selected for asphalt intersections, providing it is available. In general, it is suggested the Superpave™ procedure be followed to select appropriate binder grade for asphalt intersection design.

### 11.3 Design Period

The destructive effect of repeated wheel loads is the major factor that contributes to the failure of highway pavement. Since both the magnitude of the load and the number of its repetitions are important, a provision is made in the design procedure to allow for the effects of the number and weight of all axle loads expected during the design period. **The design period for new flexible pavement construction and reconstruction is at least 20 years. The design period for restoration, rehabilitation and resurfacing is 10 years.** The selection of a design period less than 10-years needs to be supported by a LCCA or other overriding considerations.

### 11.4 Traffic Analysis

The destructive effect of repeated wheel loads is the major factor that contributes to the failure of highway pavement. Design traffic will be the historic 18,000-pound equivalent single axle load (18k ESAL) obtained from the CDOT's Traffic Analysis Unit of the Division of Transportation Development. The following website may assist the user in calculating an ESAL value <http://dtdapps.coloradodot.info/otis>. The actual projected traffic volumes for each category are weighted by the appropriate load equivalence factors and converted to a cumulative total historic 18k ESAL number to be entered into the flexible pavement design equation. The designer must inform the DTD Traffic Analysis Section that the intended use of the historic 18k ESAL is for flexible pavement design since different load equivalence factors apply to different pavement types. Cross traffic at intersections needs to be accounted for as part of the traffic count projection. Use only high quality aggregates. Select the SuperPave™ Gyratory design compaction effort one level higher than would be selected for normal roadway design. If a comparison of flexible and rigid pavements is being made, historic 18k ESALs for each pavement type must be requested. Another source of traffic load data can be weigh-in-motion data. Although these devices are not as plentiful, they are usually more accurate for measurements of traffic load in the present year. Projections for future traffic loads can be calculated similarly using growth factors provided by the DTD Traffic Analysis Unit.

### 11.5 Design Methodology

Design methodology for flexible intersections are similar to those found in **CHAPTER 6, Principles of Design for Flexible Pavement.**

## 11.6 Assessing Problems with Existing Intersection

A successful intersection rehabilitation project is dependent on proper project scoping. The keys to proper scoping are the following:

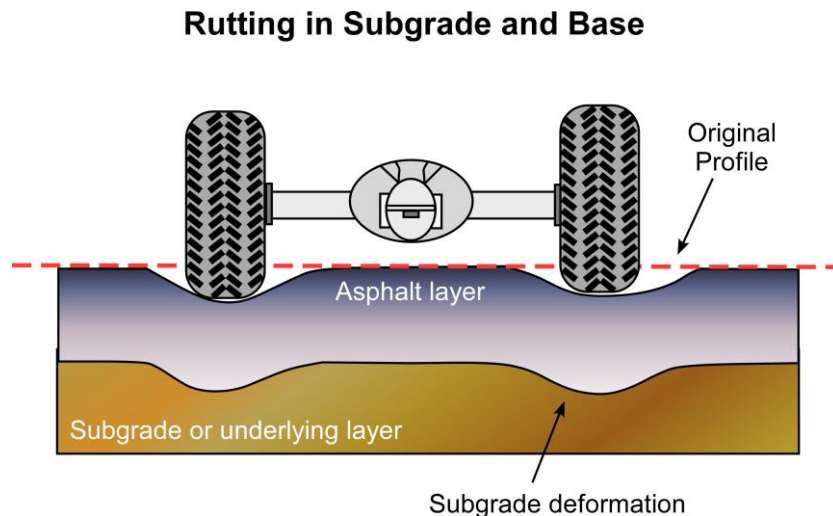
- Identifying the problem with the existing intersection
- Removing enough of the pavement section to encompass the entire problem
- Designing and reconstructing with a high performance hot mix asphalt mix design especially formulated for high traffic volume intersections.

## 11.7 Performance Characteristics of Existing Intersections

The AASHTO Joint Task Force on Rutting (1987) identified three types of rutting.

- Rutting in base (see **Figure 11.1 Rutting in Subgrade or Base**)
- Plastic flow rutting (see **Figure 11.2 Plastic Flow**)
- Rutting in asphalt layer (see **Figure 11.3 Rutting in Asphalt Layer**)

**Figure 11.1 Rutting in Subgrade or Base** shows how a weak subgrade or base will expedite damage in all pavements.



**Figure 11.1 Rutting in Subgrade or Base**

**Figure 11.2 Plastic Flow** shows how plastic flow can result for various reasons that include the following:

- High pavement temperatures
- Improper materials and mixture design
- Rounded aggregate
- Too much binder and/or filler
- Insufficient or too high of VMA

Plastic flow or deformation in the asphalt layer occurs during warm summer months when pavement temperatures are high. At intersections, stopped and slow moving traffic allow exhaust to elevate asphalt surface temperatures even higher. Dripping engine oil and other vehicle fluids are also concentrated at intersections and tend to soften the asphalt. A properly designed mixture with a stiffer asphalt binder and strong aggregate structure will resist plastic deformation of the hot mix asphalt pavement.

### Plastic Flow

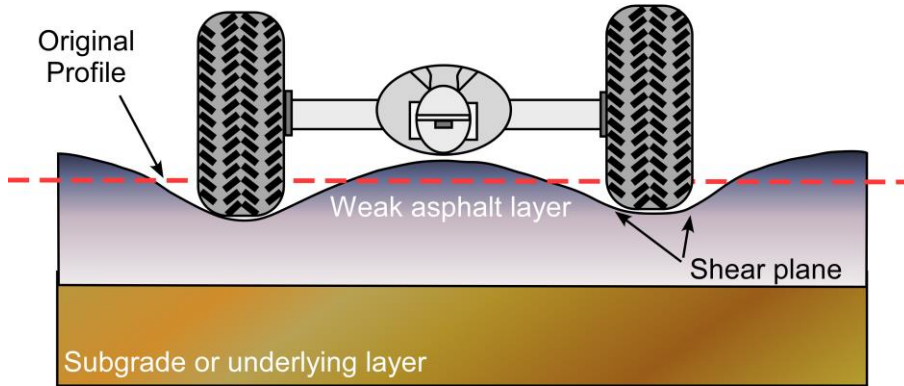


Figure 11.2 Plastic Flow

**Figure 11.3 Rutting in Asphalt Layer** shows HMA consolidation in the wheel paths. Proper compaction procedures and techniques will ensure the target density is achieved. Good quality control in the design and production of asphalt mixtures is crucial to prevent rutting in the asphalt layer. Consolidation occurs in the wheel paths due to insufficient compaction of the pavement section.

### Rutting in Asphalt Layer

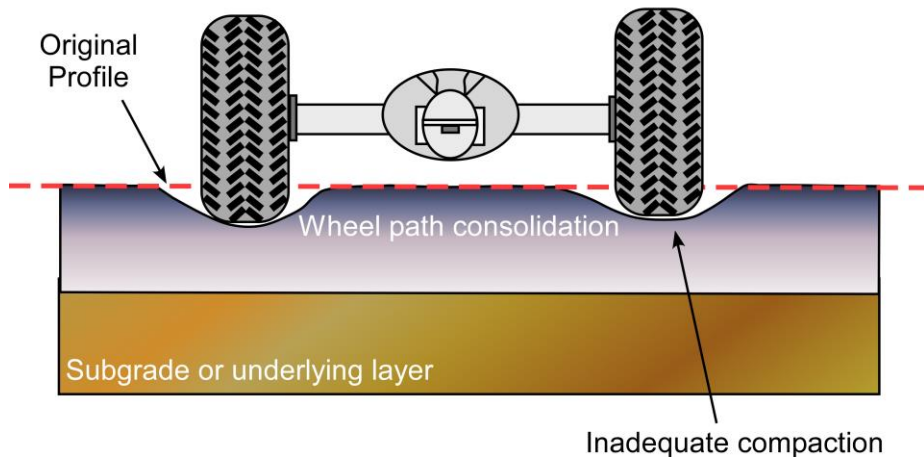


Figure 11.3 Rutting in Asphalt Layer

The following factors can contribute to lack of compaction:

- Insufficient compaction effort within the lower base layers of the pavement section
- Too few roller passes during paving
- Hot mix asphalt material cooling prior to achieving target density
- High fluid content (asphalt moisture, dust)
- Too low of an asphalt content
- Lack of cohesion in the mix, tender mix, and gradation problem with the mix can make it hard to compact

Surface wear is the result of chains and studded tires wearing away the road surface in winter.

## **11.8 Utilities**

Whether it be intersection rehabilitation or new construction, a utility study should be performed to determine if utilities being proposed, or those that are already installed, are adequate in size to handle the projected growth within their service area. It should be verified that existing utilities have been installed properly and utility trenches have been backfilled and compacted properly.

## CHAPTER 12

# PRICIPLES OF DESIGN FOR RIGID PAVEMENT INTERSECTIONS

### 12.1 Introduction

The construction and reconstruction of urban intersections utilizing Portland Cement Concrete Pavement (PCCP) needs to be given serious consideration by the designer. PCCP in an intersection offers many advantages, such as long life, reduction in maintenance costs, and elimination of wash boarding and rutting caused by the braking action of all types of traffic, especially heavy buses and trucks. PCCP in an intersection will eliminate the distress caused in asphalt pavements due to rolling traffic loads and the deceleration/acceleration forces.

### 12.2 Design Considerations

The distance from the intersection where deformation such as rutting and shoving occurs varies depending on the traffic situation, types of traffic, speed and stopping distance, and the number of vehicles per lane stopped at the intersection. Several approaches can be used. In some applications, PCCP can extend the full width for several hundred feet on each side of the intersection. In other situations, the concrete lanes approaching the intersection extend 250 feet (deceleration lane), while those going away terminate about 60 feet (acceleration lane) beyond the curb return. These approaches can be used for both high volume streets and bus stops. For more moderate traffic, 50 to 100 feet on each side of the intersection is likely to be adequate. This distance can be based on an evaluation of the existing traffic and pavement conditions.

Dowels should be placed in the transverse joints of the dominant traffic stream, as well as, the cross street transverse joints. Tie bars should be placed in the longitudinal joints of the dominant traffic stream and cross street sections past the intersection.

Class P concrete is recommended for rigid pavements. If it is desirable to fast track an intersection reconstruction, Class E concrete can be used. Class E concrete is designed to achieve a minimum of 2,500 psi in 12 hours or as required. It is possible to remove existing pavement, recondition the base materials, place Class E concrete, and have the roadway open for traffic within 24 hours.

### 12.3 Design Period

The destructive effect of repeated wheel loads and the impacts of braking action are the major factors that contribute to the failure of highway pavement at the intersections. Since the magnitude of the load, the number of its repetitions, and the braking actions are important, provisions are made in the design procedure to allow for the effects of braking actions and the number and weight of all axle loads expected during the design period. **The design period for new rigid pavement construction and reconstruction is 30 years.**

## 12.4 Traffic Analysis

When two roadways intersect there are two streams of traffic that exert loads on the pavement. The total of the historic design 18,000-pound equivalent single axle loads (18k ESAL) for each stream of traffic should be used in the calculation for the intersection's pavement thickness. In any pavement, the destructive effect of repeated wheel loads is the major factor that contributes to the pavement failure. Design traffic will be the 18k ESAL obtained from the Traffic Analysis Unit of the Division of Transportation Development, <http://dtdapps.coloradodot.info/Otis/TrafficData>. The actual projected traffic volumes for each category are weighted by the appropriate load equivalence factors and converted to a historic cumulative total 18k ESAL number to be entered into the rigid pavement design equation. Since different load equivalence factors apply to different pavement types, the designer must inform the Traffic Analysis Section that the intended use of the historic 18k ESAL is for a rigid pavement design.

Another source of traffic load data can be Weigh-In-Motion (WIM) data. Although these devices are not as plentiful, they are usually more accurate for measurements of traffic load in the present year. Projections for future traffic loads can be calculated similarly using growth factors provided by the DTD Traffic Analysis Unit.

## 12.5 Design Methodology

Design methodologies for rigid intersections are similar to those found in **CHAPTER 7, Principles of Design for Rigid Pavement**.

## 12.6 Rigid Pavement Joint Design for Intersections

Joints are used in PCCP to aid construction and eliminate random cracking. There are two types of longitudinal joints. The first are longitudinal weakened plane joints that relieve stresses and control longitudinal cracking. They are spaced to coincide with lane markings, and are formed by sawing the hardened concrete to a depth of  $\frac{1}{3}$  the pavement thickness. Longitudinal construction joints perform the same functions and also divide the pavement into suitable paving lanes. These construction joints should be tied with deformed reinforcing steel bars to hold the slabs in vertical alignment. Stresses in a slab are reduced when the slab is tied to adjacent slabs. Keyed joints may be used in a longitudinal construction joint, but tying the slabs is preferable.

- **The Key** may be formed by attaching a keyway at the mid-depth of a side form. With a slip form paver, the keyway can be formed as the paver advances. For detailed layout refer to the CDOT's *Standard Plans, M & S Standards*, July 2012.
- **Transverse Joints** are spaced at short intervals in the slab. A maximum of 12 feet is recommended to insure crack control and ease of construction. The joint should be sawed to a depth of at least  $\frac{1}{3}$  the pavement thickness.



- **Dowel Bars** in the first three transverse joints where PCCP abuts an asphalt pavement can prevent progressive slab movement.
- **Expansion Joints** are not required except at intersections.

The following summarizes the general design guides and information for constructing rigid pavement joints:

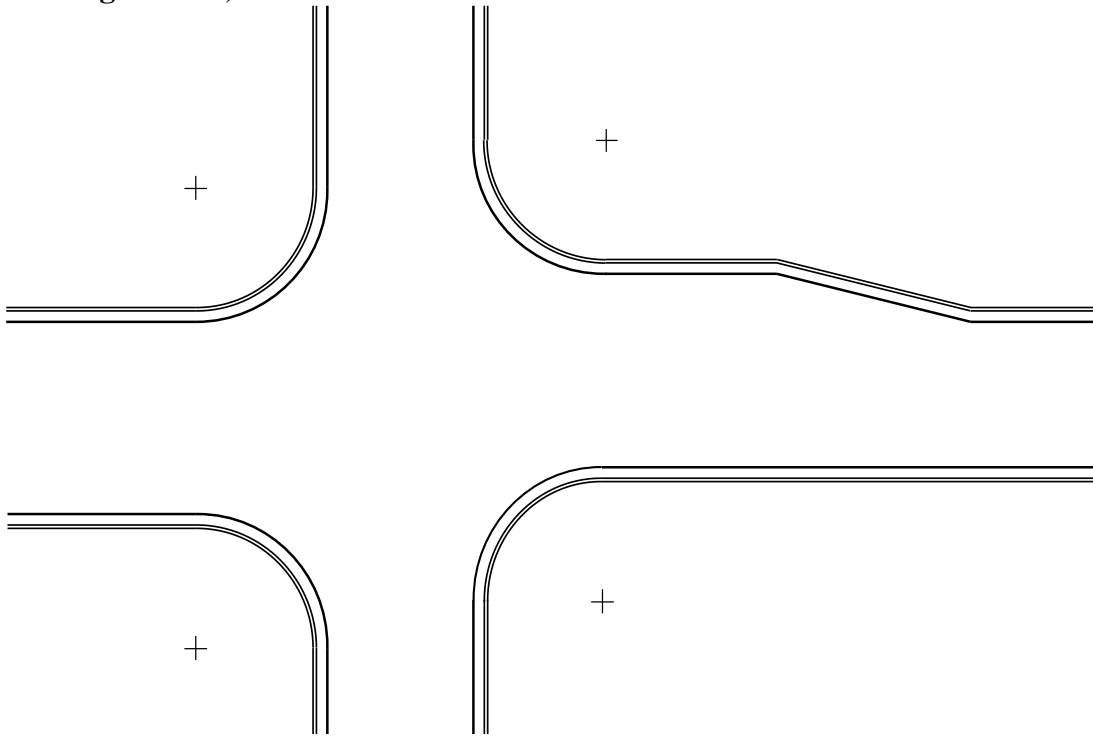
- Joints are used in PCCP to aid construction and minimize random cracking.
  - Odd shaped slabs and acute angles of less than 60 degrees should be avoided.
  - Longitudinal joint spacing should be approximately 12 feet. Longitudinal joints should be tied to hold adjacent slabs in vertical alignment, as well as, curb and gutter.
  - Transverse joint spacing should be at regular 12 foot intervals with no more than a 15 foot spacing. Transverse joints should be carried through the curb.
  - Thinner slabs tend to crack at closer intervals than thicker slabs. Long narrow slabs tend to crack more than square slabs.
  - All contraction joints must be continuous through the curb and have a depth equal to  $\frac{1}{3}$  of the pavement thickness.
  - Expansion joint filler must be full-depth and extend through the curb.
- The normal backfill behind the curb constrains the slabs and holds them together.
  - Offsets at radius points should be at least 18 inches wide.
  - Minor adjustments in joint location made by skewing or shifting to meet inlets and manholes will improve pavement performance.
  - When pavement areas have many drainage structures (particularly at intersections) place joints to meet the structures whenever possible.
  - Depending on the type of castings, manhole and inlet frames may be boxed out and isolated using expansion joint filler. The frames may be wrapped with expansion joint filler or the frames may be cast rigidly into the concrete.
- CDOT designs their PCCP using the JPCP (Jointed Plain Concrete Pavement) method. For a detailed illustration, see CDOT's *CDOT Standard Plans, M & S Standards*, July 2012, M-412-1 Concrete Pavement Joints and as revised.

Following the previous design of a new intersection near Sugarloaf Reservoir, the following steps and points should be followed to design slabs and location of joints:

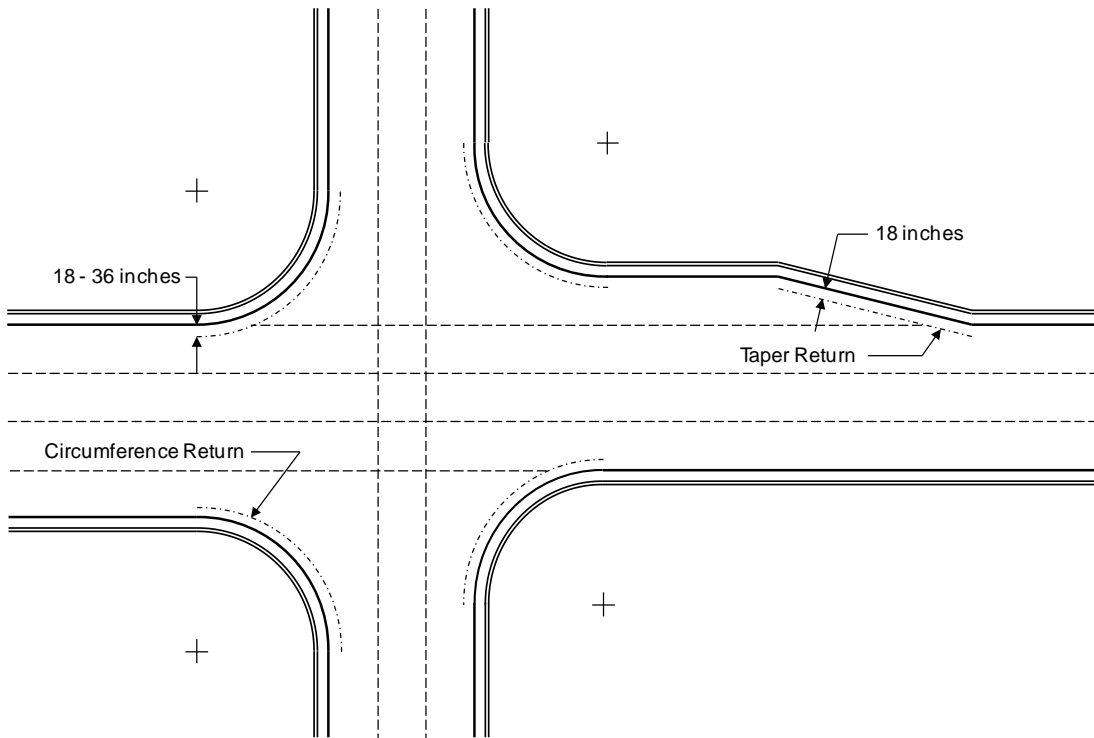
- **Step 1.** Draw all edge of pavement lines on a plan view. Plot all utility manholes, catch basins, water valve, etc. on the plan view (see **Figure 12.1**).
- **Step 2.** Draw lines, which define the median, travel lanes, and turning lanes. These lines define the longitudinal joints (See **Figure 12.2**).

- **Step 3.** Determine locations in which the pavement changes width (i.e. channelization tapers, turning lane tapers and intersection radius returns). Joints at these locations are necessary to isolate irregular shapes. Triangles or circles, which are left intact with a rectangular portion of a slab, will create a plane of weakness that will break during temperature movements of the slab. Concrete simply likes to be square (see **Figure 12.3**).
- **Step 4.** Draw transverse lines through each manhole or other utility. Joints need to be placed through utility structures in the pavement, or movement of the pavement will be restricted and cracking will result. When structures are located near a joint placed according to the steps above, isolation can be provided by adjusting the joint to meet the structure. By doing this, numerous short joints will be avoided. Add transverse joints at all locations where the pavement changes width, extending the joints through the curb and gutter. Create an "intersection box". Do not extend joints that intercept a circumference-return-return line, except at the tangent points. The joints at the tangent point farthest from the mainline becomes an isolation joint in the cross road for T and unsymmetrical intersections (see **Figure 12.4**).
- **Step 5.** The intermediate areas between the transverse joints placed in Steps 3 and 4 may also require transverse joints. These joints are placed using a standard joint spacing. There is an old rule of thumb for joint placement in plain concrete pavements that says, the joint spacing, in feet, should be no greater than two to two and a half times the slab thickness, in inches. However, in no case should the joint spacing exceed 15 feet (see **Figure 12.5**).
- **Step 6.** Where an intersection is encountered, intermediate joints must be placed. This is done by extending the radius line of each turning radius three feet beyond the back of curb. The extension is made at approximately the 45 degree line for small radii, and at approximately the 30 and 60 degree lines for larger radii. Joints are then connected to each of these points.
- **Step 7.** Expansion joints are needed adjacent to any structure, i.e., bridges, buildings, etc., and at T intersections. T intersections are isolated at the radius return to the intersecting street. The same layout discussed in Step 6 is used at that location.
- **Step 8.** If there are manholes or other structures, which cannot be intersected by a joint, they must be isolated. These structures can be isolated by boxing out the structure during paving. Manholes can also be isolated by using a telescoping manhole, which can be poured integral with the pavement. The area around the structure should be reinforced to control cracking. The joints that form a box out should be expansion joints to allow some movement.
- **Step 9.** Check the distances between the "intersection box" and the surrounding joints (see **Figure 12.6**).

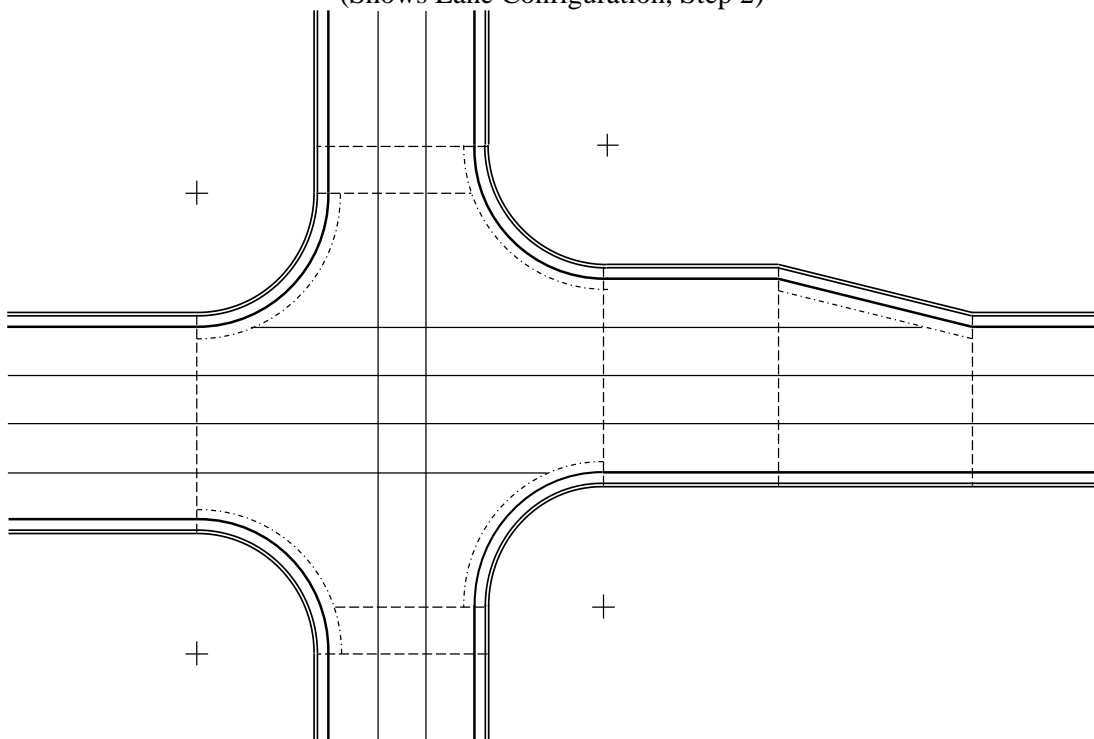
- **Step 10.** Lightly extend lines from the center of the curve(s) to the points defined by the “intersection box” and point(s) along any island. Add joints along these radius lines. Finally, make slight adjustments to eliminate dog legs in mainline edges (see **Figure 12.7**).



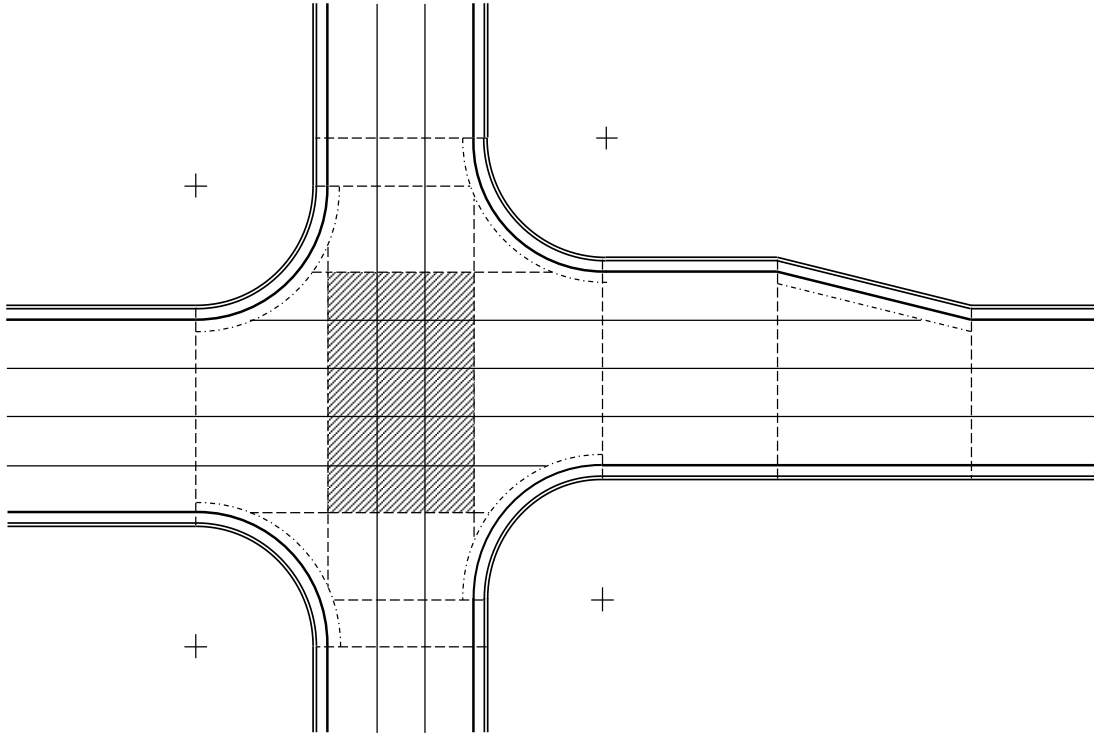
**Figure 12.1 Typical Joint Layout for a Rigid Pavement Intersection**  
(Shows Lane Configuration, Step 1)



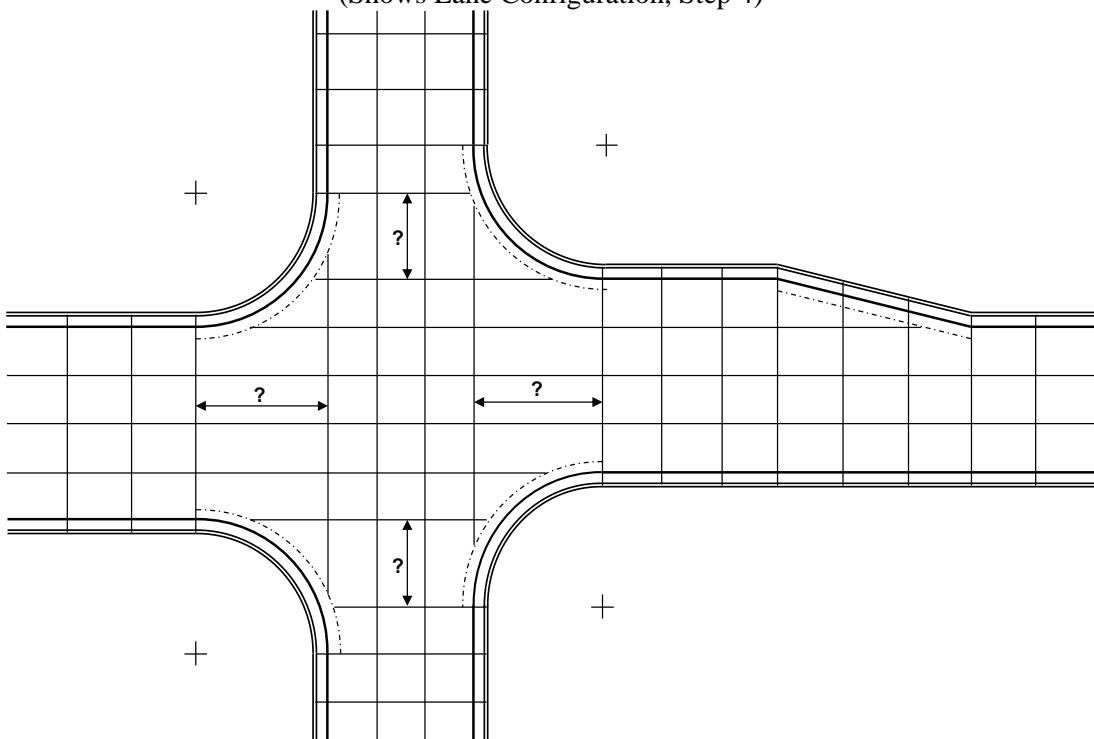
**Figure 12.2 Typical Joint Layout for a Rigid Pavement Intersection**  
(Shows Lane Configuration, Step 2)



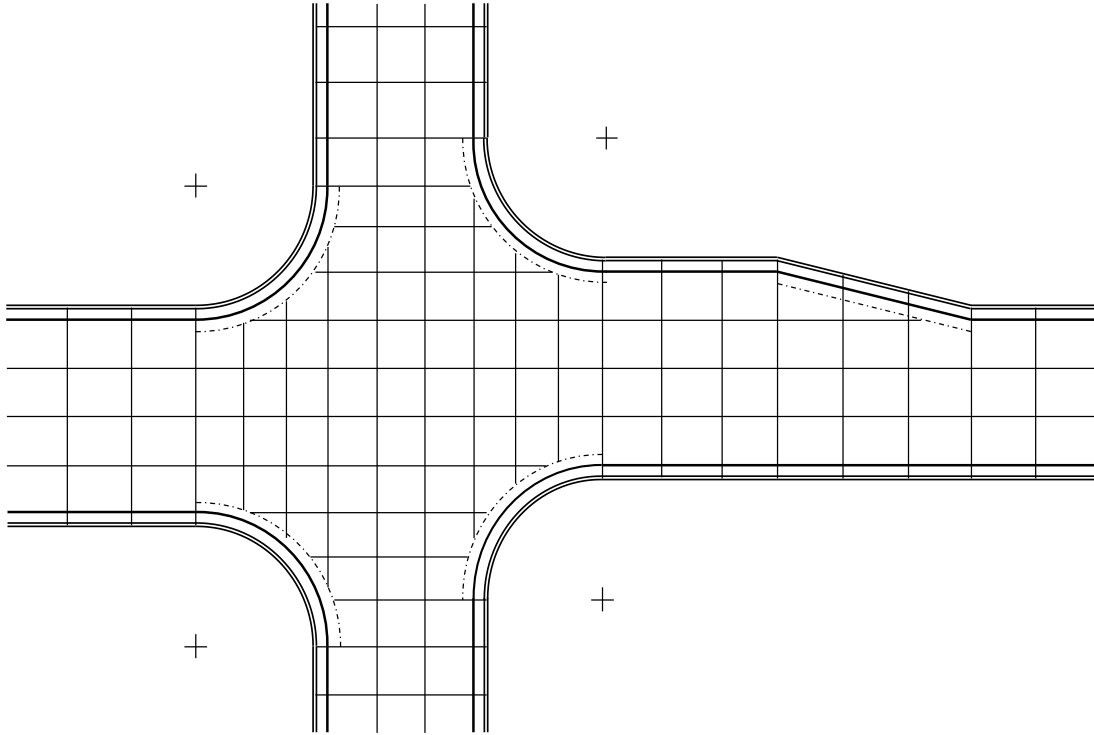
**Figure 12.3 Typical Joint Layout for a Rigid Pavement Intersection**  
(Shows Lane Configuration, Step 3)



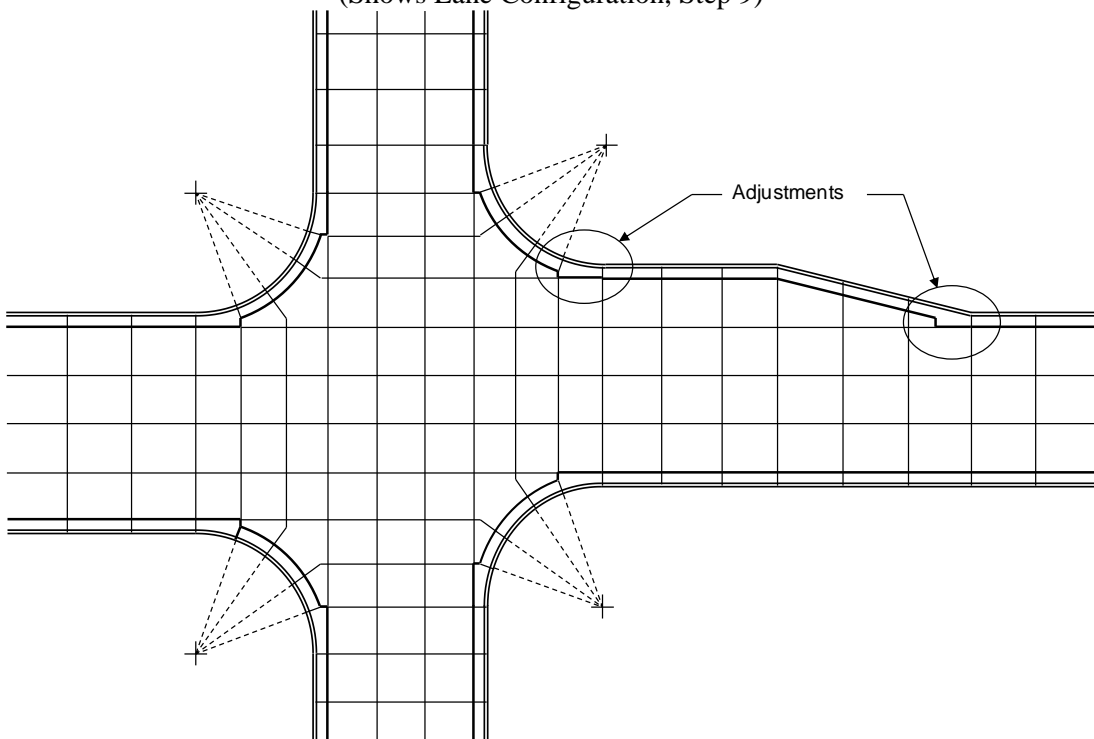
**Figure 12.4 Typical Joint Layout for a Rigid Pavement Intersection**  
(Shows Lane Configuration, Step 4)



**Figure 12.5 Typical Joint Layout for a Rigid Pavement Intersection**  
(Shows Lane Configuration, Steps 5 thru 8)



**Figure 12.6 Typical Joint Layout for a Rigid Pavement Intersection**  
(Shows Lane Configuration, Step 9)



**Figure 12.7 Typical Joint Layout for a Rigid Pavement Intersection**  
(Shows Lane Configuration, Step 10)

## 12.7 Assessing Problems with Existing Intersections

A successful rigid pavement intersection rehabilitation project is dependent on proper project scoping. The keys to proper scoping include the following:

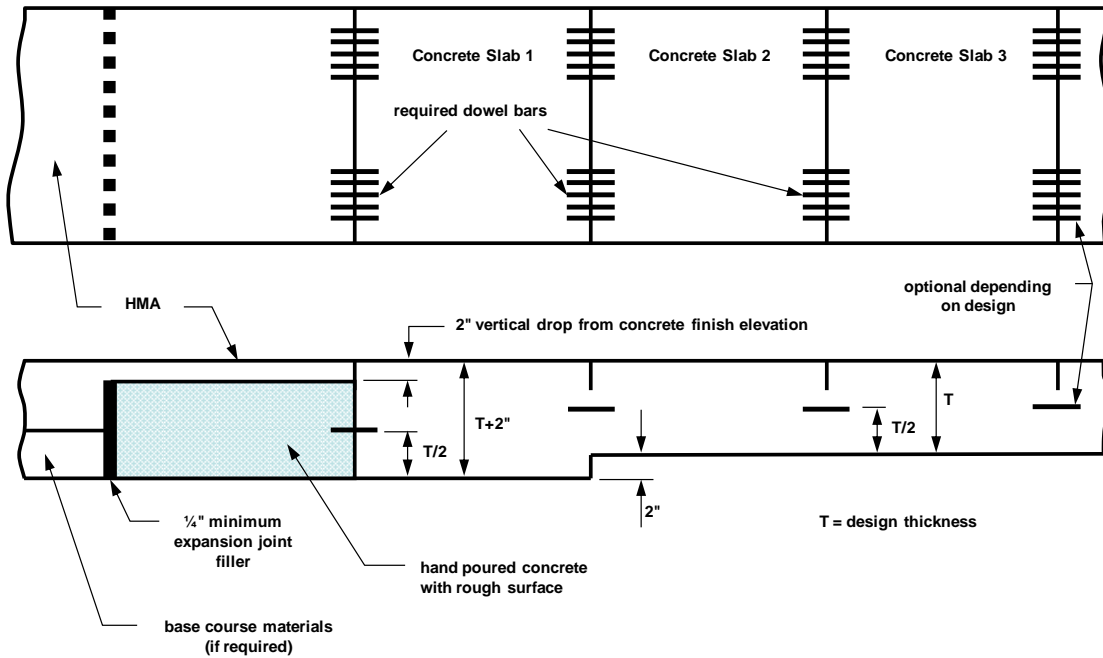
- Identifying the problem with the existing intersection
- Removing enough of the pavement section to encompass the entire problem
- Designing and reconstructing with a full depth PCCP especially formulated for high traffic volume intersections. Special caution should be exercised in concrete overlay intersections (using PCCP overlay and not a full depth PCCP design).

## 12.8 Detail for Abutting Asphalt and Concrete

When joining asphalt and concrete slabs refer to the schematic layout given in **Figure 12.8 Detail of Asphalt and Concrete Slab Joint**. The figure shows how at least three consecutive machine-laid concrete slabs will be constructed and doweled at the transverse construction joints to prevent creeping or curling. The size of the dowels will conform to \* Assumes 90 degree angles between entries and roundabouts with four or fewer legs.

CDOT's *Standard Plans, M & S Standards*, M-412-1 Concrete Pavement Joints and as revised (use the larger required dowel diameter in joining 2 different pavement thicknesses), will be 18 inches long, and spaced under the wheel paths as shown on CDOT's *Standard Plans, M & S Standards*, July 2012, M-412-1 Concrete Pavement Joints. A hand-poured concrete slab with a rough surface finish and a depth equal to the design thickness will be constructed and joined to the first of three machine-laid concrete slabs numbered 1, 2 and 3. Concrete Slab Number 1 will have a depth of design thickness plus 2 inches. Concrete slabs 2 and 3 will be constructed with a depth equal to the design thickness.

The bottom of the hand-poured concrete slab will be flush with the bottom elevation of concrete Slab 1 leaving a 2-inch vertical drop from the adjacent concrete slab's finish elevation. The HMA paving operation will terminate in the area of the hand-poured concrete slab that will be overlaid with a HMA overlay to fill the 2-inch vertical drop.



**Figure 12.8 Detail of Asphalt and Concrete Slab Joint**

## 12.9 Roundabout Pavement Design

Roundabouts are circular intersections with specific design and traffic control features. These features include yield control to entering traffic, channelized approaches, and appropriate geometric curvature to ensure travel speeds on the circulatory roadway are typically less than 30 mph. Thus, roundabouts are a subset of a wide range of circular intersection forms. Circular intersections that do not conform to the characteristics of modern roundabouts are called “traffic circles” (1).

Roundabouts have been categorized according to size and environment to facilitate discussion of specific performance or design issues. There are six basic categories based on environment, number of lanes, and size:

- Mini-roundabouts
- Urban compact roundabouts
- Urban single-lane roundabouts
- Urban double-lane roundabouts
- Rural single-lane roundabouts
- Rural double-lane roundabouts

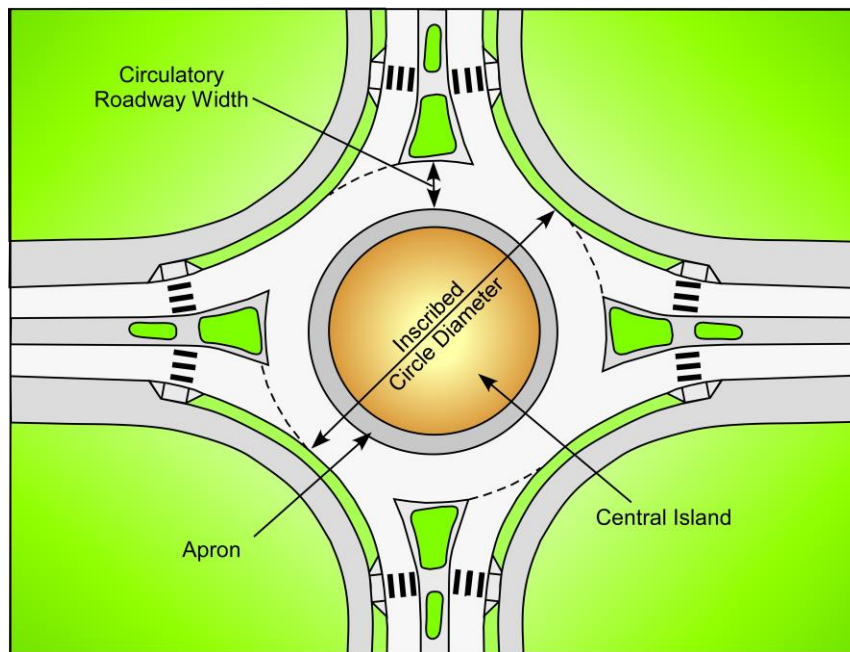
The most likely categories CDOT will use are the urban and rural double-lane roundabouts. The double-lane roundabouts can be expected to handle the increased traffic volumes of a state highway. The following chapter sections will address the double-lane categories.



## 12.9.1 Roundabout Geometry

### 12.9.1.1 Minimum Radius

The minimum radius geometry of a roundabout is dependent on several variables including vehicle path radii, alignment of approaches and entries, entry width, circulatory roadway width, size of the central island, entry and exit curves, size of the design vehicle, and land constraints. The designer must incorporate the needs of all the aforementioned items for proper design (see **Figure 12.9 Basic Geometric Elements of a Roundabout**). The AASHTO publication, *A Policy on Geometric Design of Highways and Streets* (2) provides the dimensions and turning path requirements for a variety of common highway vehicles. FHWA's *Roundabouts: An Informational Guide*, Publication No. FHWA-RD-00-067, June 2010 (3) provides guidelines in choosing an appropriate minimum radius.



**Figure 12.9 Basic Geometric Elements of a Roundabout**

(Modified from Exhibit 6-2, *Basic Geometric Elements of a Roundabout*, *Roundabouts: An Informational Guide*, Federal Highway Administration, Publication No. FHWA-RD-00-067, June 2000 (3))

### 12.9.1.2 Inscribed Circle Diameter

**Figure 12.9 Basic Geometric Elements of a Roundabout** shows the inscribed circle diameter, which is the distance across the circle inscribed by the outer curb of the circulatory roadway. In general, smaller inscribed diameters are better for overall safety because they help maintain lower speeds. Larger inscribed diameters allow for a better approach geometry, decreased vehicle approach speeds, and a reduced angle between entering and circulating vehicle paths. Thus, roundabouts in high-speed environments may require diameters that are somewhat larger than those recommended for low-speed environments. Very large diameters (greater than 200 feet)

should not be used because they will have high circulating speeds resulting in greater severity crashes.

**Table 12.1 Recommended Inscribed Circle Diameters**

(From Exhibit 6-19, *Recommended Inscribed Circle Diameter Ranges, Roundabouts: An Informational Guide, Federal Highway Administration, Publication No. FHWA-RD-00-067, June 2010 (3)*)

Site Category	Inscribed Circle Diameter Range* (feet)
Mini-Roundabout	45-80
Urban Compact	80-100
Urban Single Lane	100-130
Urban Double Lane	150-180
Rural Single Lane	115-130
Rural Double Lane	180-200
<b>Note:</b> * Assumes 90 degree angles between entries and roundabouts with four or fewer legs.	

### 12.9.1.3 Circulatory Roadway Width

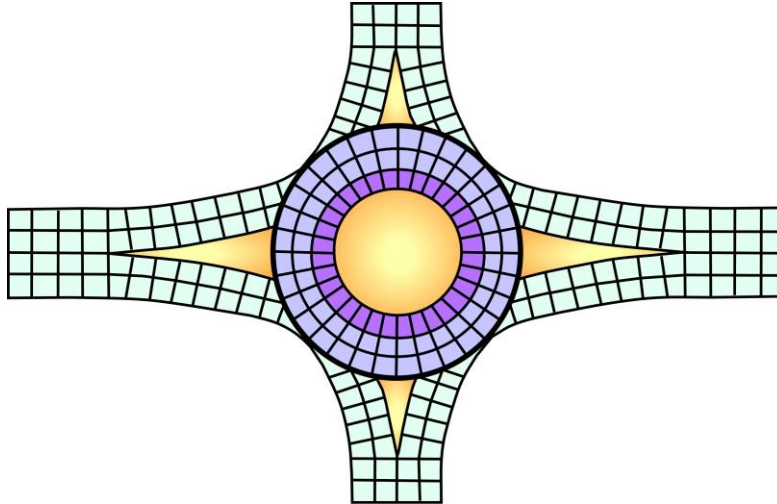
The required width of the circulatory roadway is determined from the width of the entries and turning requirements of the design vehicle. In general, it should always be at least as wide as the maximum entry width. Suggested lane widths and roundabout geometries are found on Exhibit 6-22 of FHWA's *Roundabouts: An Informational Guide*, Federal Highway Administration, Publication No. FHWA-RD-00-067, dated June 2010 (3).

### 12.9.1.4 Central Island

The central island of a roundabout is the center area encompassed by the circulatory roadway. Central islands should be circular in shape with a constant radius so drivers can maintain a constant speed. Islands should be raised, not depressed, as depressed islands are difficult for approaching drivers to recognize. An apron may be added to the outer edge of the central island when right-of-way, topography, or other constraints do not allow enlargement of the roundabout. An apron provides an additional paved area for larger vehicles, such as trucks, to negotiate the roundabout. An expansion joint should be used between the truck apron and the circular roadway.

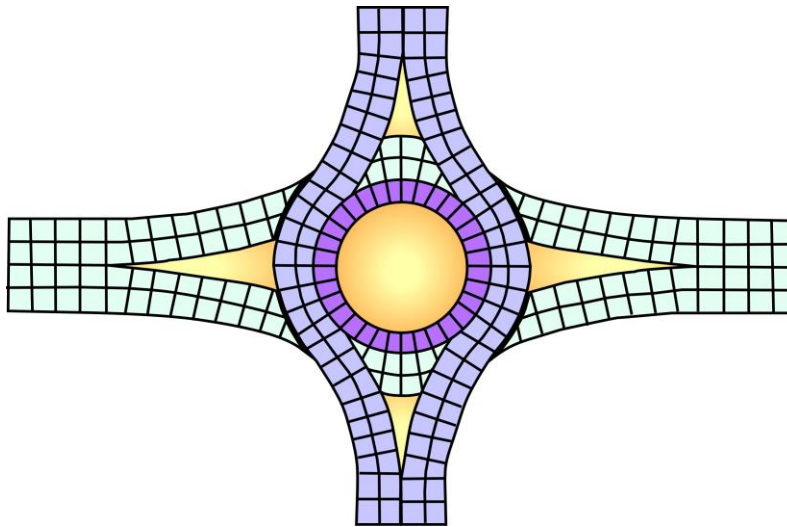
## 12.9.2 General Joint Layout

The pavement designer may choose from two layout approaches. One is to isolate the circle from the legs and the other is to use a pave through layout, **Figure 12.10 Isolating the Circle** and **Figure 12.11 Pave-Through Layout**. Once the approach layout is decided, a sequenced step-by-step procedure is utilized.



**Figure 12.10 Isolating the Circle**

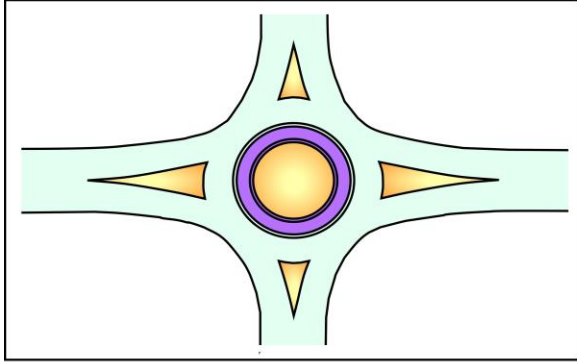
(From Figure 1, Joint Layout for Roundabout, Isolating Circle from Legs,  
*Concrete Roundabouts: Rigid Pavement Well-Suited for Increasing Popular Intersection Type*,  
ACPA, June 2005(4))



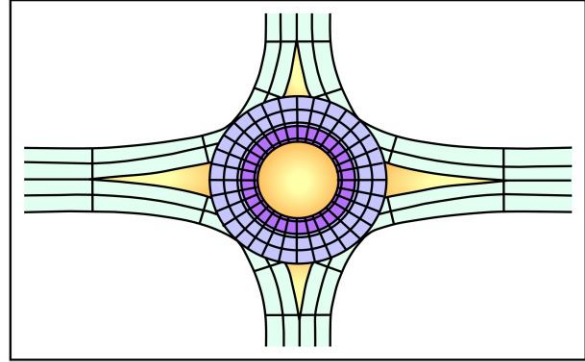
**Figure 12.11 Pave-Through Layout**

(From Figure 2, Joint Layout for Roundabout, Isolating Circle from Legs,  
*Concrete Roundabouts: Rigid Pavement Well-Suited for Increasing Popular Intersection Type*,  
ACPA, June 2005(4))

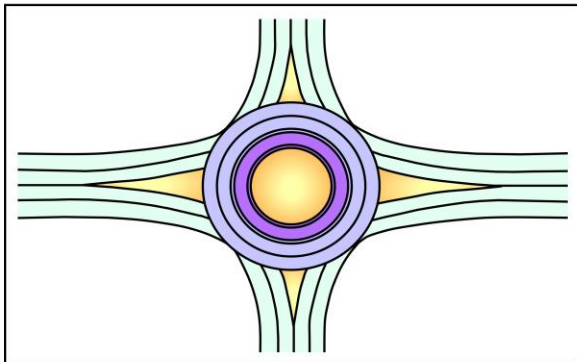
ACPA recommends a six step process on constructing joint layouts. **Figure 12.12 Six Step Jointing Layout** is an example illustrating and isolating circle for the general layout.



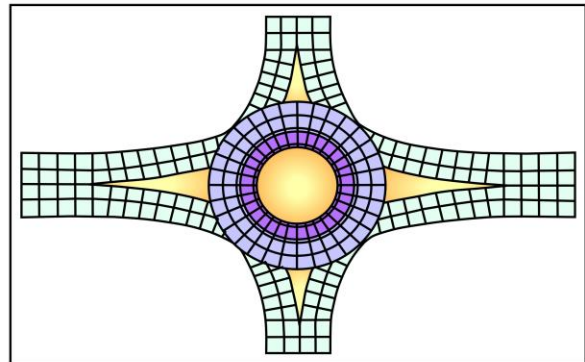
Step 1. Draw all pavement edge and back-of curb lines in the plan view. Draw location of all manholes, drainage inlets, and valve covers so that joints can intersect these.



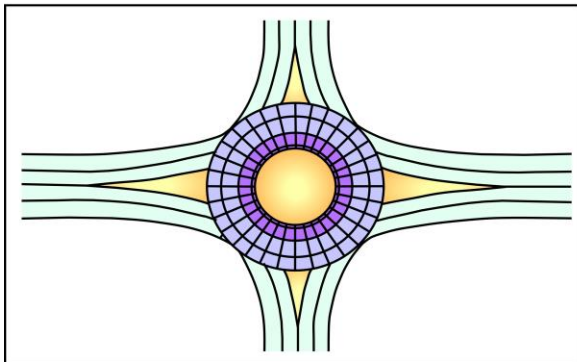
Step 4. On the legs, add transverse joints at all locations where a width change occurs in the pavement (at bullnose of median islands, begin and end of curves, tapers, tangents, curb returns, etc.). Extend these joints through the back of the curb and gutter.



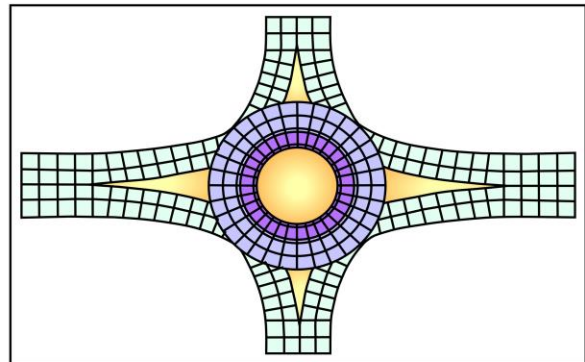
Step 2. Draw all lane lines on the legs and in the circular portion. If isolating circle from legs, do not extend these through the circle. If using "pave-through" method, determine which roadway will be paved through. Make sure no distance is greater than the maximum recommended width.



Step 5. Add transverse joints beyond and between those added in Step 4. Space joints out evenly between other joints, making sure not to violate maximum joint spacing.



Step 3. In the circle, add "transverse" joints radiating out from the center of the circle. Make sure that the largest dimension of the pie-shaped slab is smaller than the maximum recommended. Extend these joints through the back of the curb and gutter.



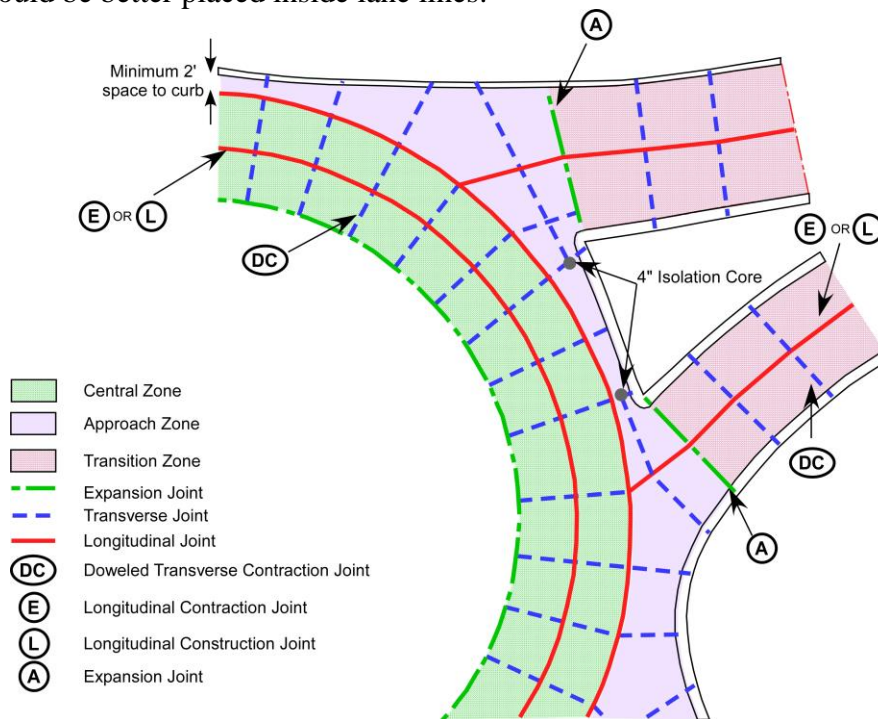
Step 6. Make adjustments for in-pavement objects, fixtures and to eliminate L-shapes, small triangular slabs, etc.

### Figure 12.12 Six Step Jointing Layout

(From Page 3, Six Steps, *Concrete Roundabouts: Rigid Pavement Well-Suited for Increasing Popular Intersection Type*, ACPA, June 2005 (4))

### 12.9.3 Details of PCCP Joints

Additional detailing of the joints is necessary to achieve long lasting, crack free pavements. **Figure 12.13 Basic Joints and Zones of a Roundabout**, shows a roundabout broken into three zones based on joint layout; the central, approach, and transition zones. The central zone consists of concentric circles (longitudinal joints) intersected by radial, transverse joints. The longitudinal joints are tied to minimize outward migration of the slabs. Slabs should be square or pie shaped with a maximum width of 14 feet and a maximum length of 15 feet. If possible, establish uniform lane widths to accommodate a slip-form paver. The transition zone generally consists of irregular shaped slabs and is usually tied to the central zone. Joint angles should be greater than 60 degrees. In cases where odd shapes occur, dog legs through curve radius points may be needed to achieve an angle greater than 60 degrees. An expansion joint should be used to properly box out fixtures such as manholes and inlets. An expansion joint is usually placed between the transition and approach zones to act as a buffer from the radial outward movement of the roundabout and the inward movement of the approach roads. All transverse or horizontally moving joints should extend through the curb and gutter sections to ensure their movement remains unrestricted and does not induce cracking in the adjoining slab. Generally, transverse joints are placed at 10 foot intervals in curb and gutter, however, since roundabout curb and gutter sections are tied or poured monolithically and the thickness is the same as the pavement thickness, the jointing may be increased to match the slab joint spacing. Longitudinal joints should be located close to, but offset from lane lines or pavement markings. Vehicles tend to track towards the center of the roundabout, thus, joints would be better placed inside lane lines.



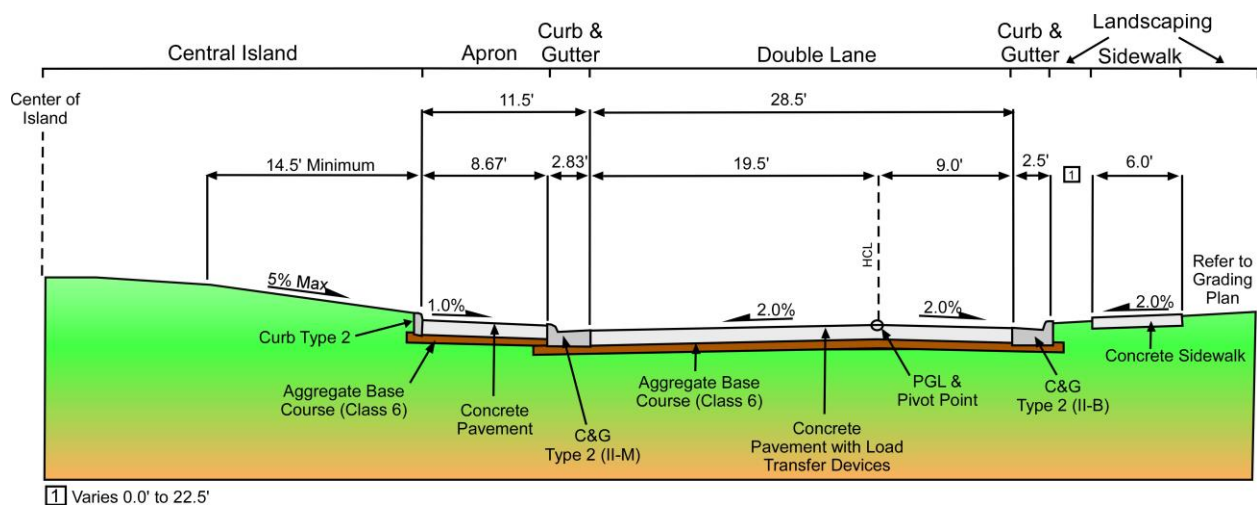
**Figure 12.13 Basic Joints and Zones of a Roundabout**

(Modified from Figure 4, Roundabout Zones, *Concrete Roundabout Pavements: A Guide to their Design and Construction*, Doc. No. TP-GDL-012, March 2004 (5))

Typically, state highway projects use load transfer devices (dowel bars) and tie-bars. These reinforcements must be detailed throughout the roundabout intersection. The dowel bars should be evenly distributed across the lane width and are generally spaced every 12 inches. The tie-bars are located in the longitudinal joints and are usually spaced every 36 inches. Tie bar requirements and pull out testing are specified in Section 412.13 of CDOT's *Standard Specifications for Road and Bridge Construction* (6). Dowel bar and tie-bar joints for roundabout pavement and truck ramp/apron are detailed in CDOT's *Standard Plans, M & S Standards*, July 2012, M-412-1, Concrete Pavement Joints and as revised. A MIT (Magnetic Imaging Technology) scan to verify dowel bar placement and alignment is not needed.

### 12.9.4 Typical Section

The concrete pavement thickness is calculated by adding the truck traffic for each stream of traffic going through the roundabout intersection, refer to **Table 7.6 Minimum Thicknesses for Highways, Roadways, and Bicycle Paths**. Structural components include the curb and gutter sections as detailed in CDOT's *Standard Plans, M & S Standards*, July 2012, 2012 M-609-1, Curb, Gutters, and Sidewalks and as revised. It is recommended to use Curb Type 2 (6 inch barrier) (Section B) for the inner most ring curb barrier adjacent to the in-field, Curb and Gutter Type 2 (Section IIM) (6 inch mountable – 2 foot gutter) for the middle ring curb barrier, and Curb and Gutter Type 2 (Section IIB) (6 inch barrier – 2 foot gutter) for the outer ring barrier. The gutter thickness has been increased to the thickness of the pavement and tie-bars are used to tie the gutters to the pavement. This mimics a monolith pour. Refer to **Figure 12.14 Typical Section of an Urban Double-Lane Roundabout** and **Section 7.14 Lane Edge Support Condition (E)** for more information.



**Figure 12.14 Typical Section of an Urban Double-Lane Roundabout**

## 12.10 Diverging Diamond Interstate Design

Diverging diamond interchanges become increasingly popular in the 2010's, with the first being installed in Springfield Missouri in 2009. These interchanges are primarily used to help improve traffic flow while improving safety relative to conventional diamond interchanges. This is achieved through eliminating conflict points and left turns across opposing traffic (6).

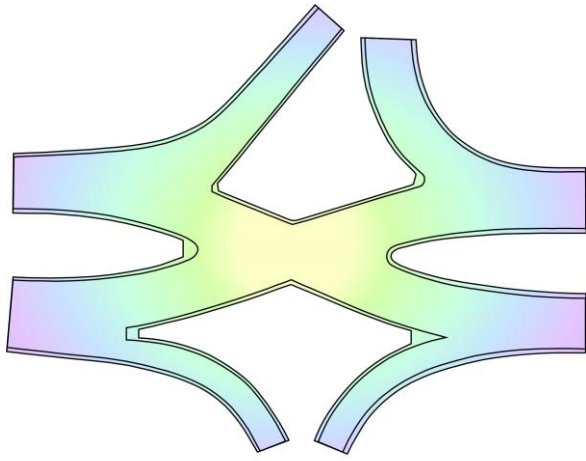
### 12.10.1 General Joint Layout

The joint layout for diverging diamond interchanges can be challenging due to cross-overs and sharp angles. An 11-step quadrant method has been developed for step-by-step joint layout plans, see Figure 13.21 Diverging Diamond Interchanges Joint Plan. Additional information may be found at the following web site:

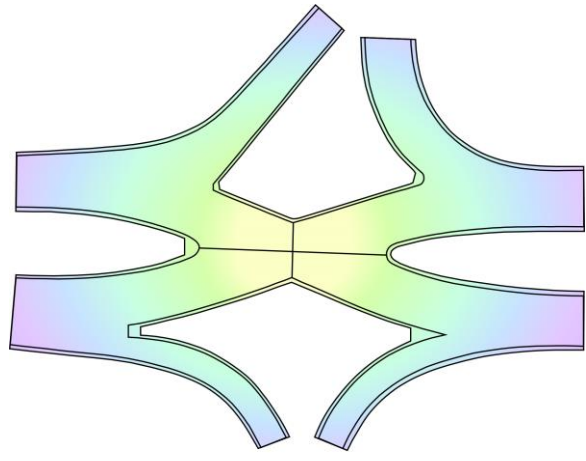
[http://wikipave.org/index.php?title=Joint\\_Layout#Diverging\\_Diamond\\_Interchanges\\_.28DDI.29](http://wikipave.org/index.php?title=Joint_Layout#Diverging_Diamond_Interchanges_.28DDI.29)

Quadrant Method's 11-steps:

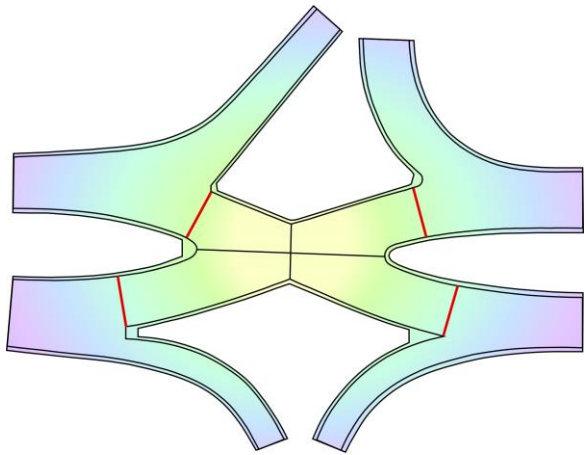
1. Draw all pavement edges and back-of-curb lines in plan view.
2. Divide the interchange into four quadrants.
3. Place a joint in each quadrant when the pavement width changes as you work your way out from the center. Make sure the joint is perpendicular to the direction of travel.
4. Lightly draw the circumference-return and taper-return line(s) outside of the central portion defined in Step 3.
5. Lightly draw cross road return lines on each side of the central bisecting joint.
6. Define paving lanes on the mainline approaches. Do not cross the cross road return lines defined in Step 5.
7. Place transverse joints on the mainline approaches.
8. Lightly draw cross road return lines for each of the on/off ramps.
9. Add longitudinal joints to the on/off ramps.
10. Add transverse joints to the on/off ramps.
11. Address doglegs and odd shaped panels as possible.



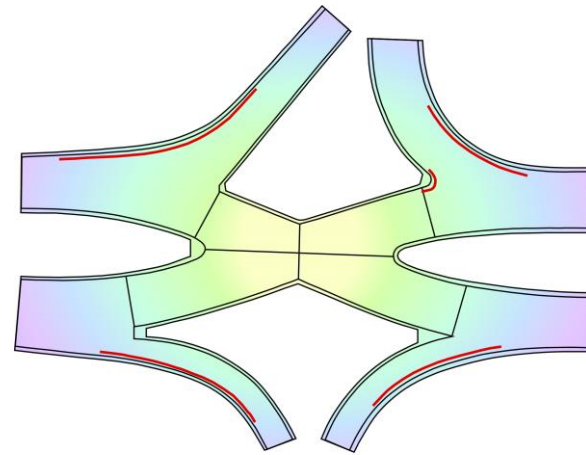
**STEP 1**



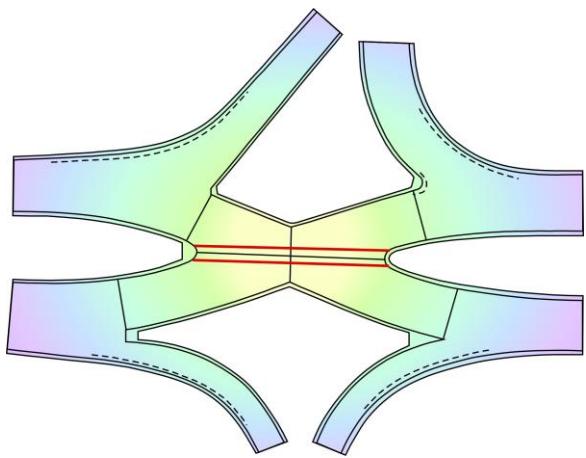
**STEP 2**



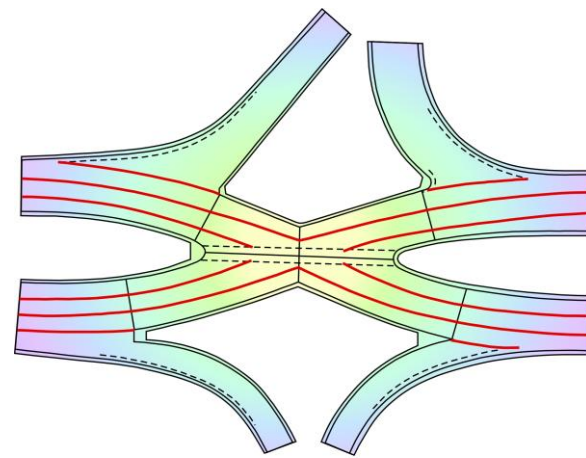
**STEP 3**



**STEP 4**

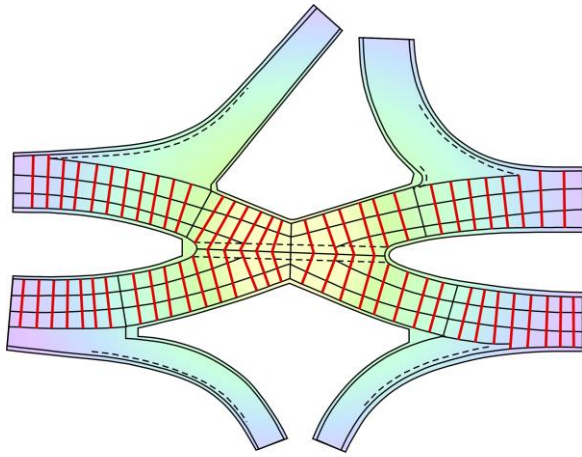


**STEP 5**

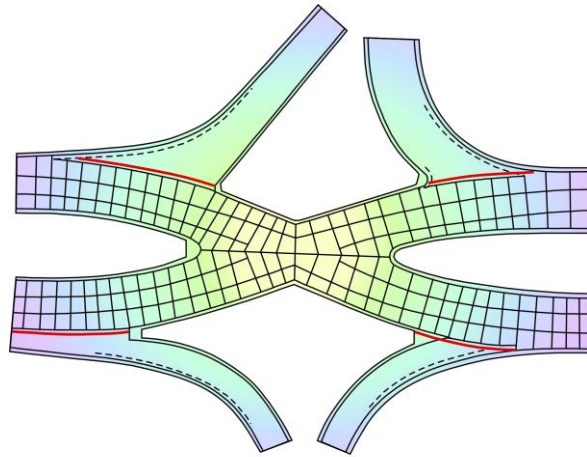


**STEP 6**

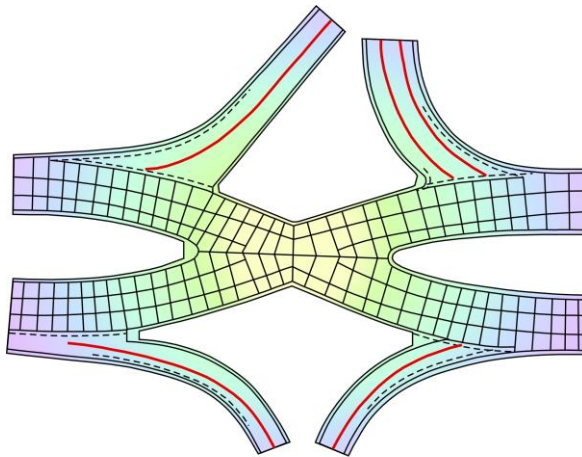




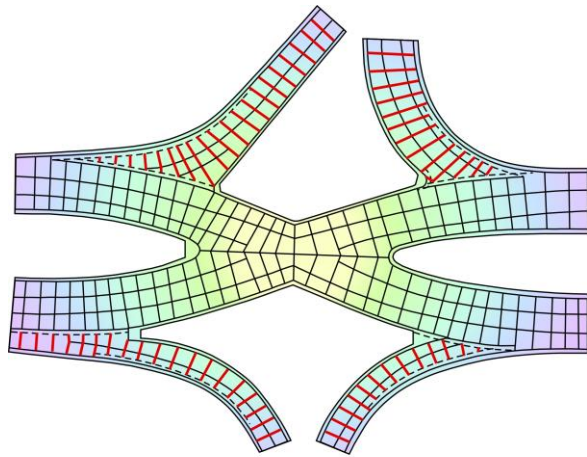
STEP 7



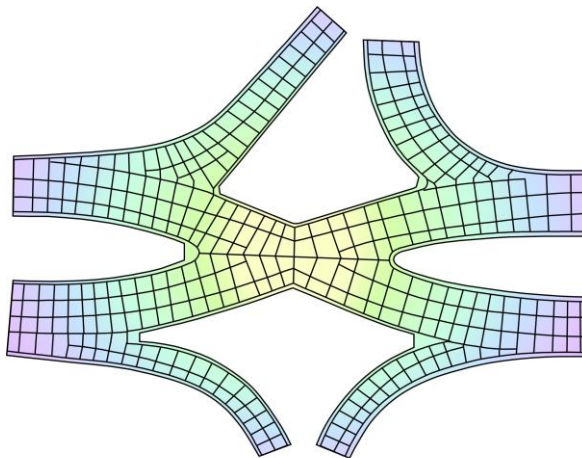
STEP 8



STEP 9



STEP 10



STEP 11

**Figure 12.15 Divergent Diamond Interchange 11-Step Quadrant Method**

## References

1. *Roundabouts: An Informal Guide*, FHWA-RD-00-067, Federal Highway Administration, Turner-Fairbanks Highway Research Center, June 2000.
2. *A Policy on Geometric Design of Highways and Streets*, Washington, D.C, AASHTO, 1994.
3. *Roundabouts: An Informational Guide*, Publication No. FHWA-RD-00-67, U.S. Department of Transportation, Federal Highway Administration, Robinson, June 2010.  
<http://www.fhwa.dot.gov/publications/research/safety/00067/000676.pdf>
4. *Concrete Roundabouts: Rigid Pavement Well-Suited for Increasing Popular Intersection Type*, Number 6.03, R & T Update, Concrete Pavement Research & Technology, American Concrete Pavement Association, Skokie, IL, June 2005.
5. *Concrete Roundabout Pavements, A Guide to their Design and Construction*, Document No. TP-GDL-012, Pavements Branch of the Road Network Infrastructure, TechMedia Publishing Pty Ltd., 2005.
6. Divergent Diamond Interchanges (DDI), American Concrete Pavement Association's Website, January 2017.  
[http://wikipave.org/index.php?title=Joint\\_Layout#Diverging\\_Diamond\\_Interchanges\\_.28DDI.29](http://wikipave.org/index.php?title=Joint_Layout#Diverging_Diamond_Interchanges_.28DDI.29)

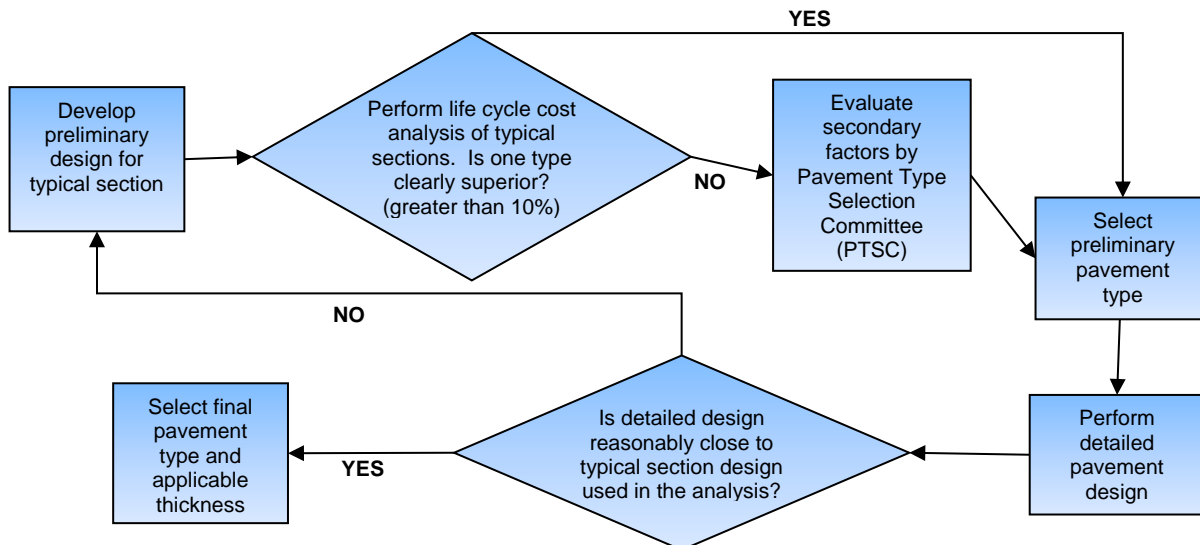
## CHAPTER 13 PAVEMENT TYPE SELECTION AND LIFE CYCLE COST ANALYSIS

### 13.1 Introduction

Some of the principal factors to be considered in choosing a pavement type are soil characteristics, traffic volume and types, climate, life cycle costs, and construction considerations. All of the above factors should be considered in any pavement design, whether it is for new construction or rehabilitation.

Life cycle cost comparisons must be made between properly designed structural sections that would be approved for construction. The various costs of the design alternatives over a selected analysis period are the major consideration in selecting the preferred alternative. A Life Cycle Cost Analysis (LCCA) includes costs of initial design and construction, future maintenance, rehabilitation, and user costs. The Colorado Department of Transportation (CDOT) uses the AASHTOWare™ DARWin™ M-E software program for designing flexible and rigid pavements. Federal Highway Administration (FHWA) RealCost software is to be used for probabilistic LCCA. It is imperative that careful attention be given to the calculations involved and the data used in the calculations to ensure the most realistic and factual comparison between pavement types and rehabilitation strategies. One should select the rehabilitation alternative that best satisfies the needs of a particular project considering economics, budget constraints, traffic service, climate, and engineering judgement.

Several design variations are possible within each rehabilitation strategy. A suggested flowchart illustrating the selection process for new pavement construction is shown in **Figure 13.1 Pavement Selection Process Flow Chart**.



**Figure 13.1 Pavement Selection Process Flow Chart**

## 13.2 Implementation of a LCCA

A LCCA comparing concrete to asphalt pavements will be prepared for all new or reconstruction projects with more than \$3,000,000 initial pavement material cost. This includes pavement and may include other pavement section elements such as base course material, geotextiles and geogrids, embankment, alternative base/subgrade treatments, etc. Pavement section elements other than pavement type should be included in the initial pavement material cost threshold if they differ by either type, quantity, etc. between the pavement types being compared. A LCCA comparing asphalt and concrete should also be prepared for all surface treatment projects with more than \$3,000,000 initial pavement cost where both pavement types are considered feasible alternatives as determined by the RME. If the RME determines one pavement type is not a feasible alternative for a surface treatment project, they will include information supporting their decision in the Pavement Justification Report (PJR). Some examples of why alternatives may not be considered feasible are constructability, lane closure limitations set by regional traffic policies, geometric constraints, and minimum required pavement thicknesses. It may be helpful to discuss constructability concerns with industry to ensure that CDOT does not overlook recent innovations within the paving industry(s). For CDOT projects, the net present value economic analysis will be used. Refer to the references at the end of this chapter for documents published that explain a LCCA.

Examples of projects where a LCCA may not be necessary are:

- A concrete pavement, which is structurally sound and requires only resealing and/or minor rehabilitation work.
- A concrete or asphalt pavement, which is structurally sound but may need skid properties restored or ride improved .
- Minor safety improvements such as channelization, shoulder work, etc.
- Bridge replacement projects with minimal pavement work
- Locations where curb and gutter or barrier prohibit the use of alternative thicker treatments.

### 13.2.1 Analysis Period

The analysis period to be used is the period of time selected for making an LCCA of pavement costs. **CDOT will be using a 40-year period for their LCCAs.** All alternatives being considered should be evaluated over this same period. For example, If the service life of an alternative were 15 years, another rehabilitation project would have to be applied at year 30, and into the future, until the analysis period is covered.

### 13.2.2 Performance Life

Besides initial costs and discount rate, the performance life of the rehabilitation strategy is a major component of the LCCA. The total economic life of the alternative is used to compare initial designs along with the performance lives gained from the future rehabilitation of the pavement.

CDOT uses an assortment of rehabilitation strategies for pavements. Potential pavement alternatives include, but are not limited to mill and fill, hot or cold in-place recycling, overlay, rubblization, and concrete overlays. Every approach to rehabilitation will include a type of treatment and the life of that treatment. Planned rehabilitation is used in the pavement analysis to make engineering comparisons of candidate strategies and is not used for future funding eligibility determinations.

To select a future strategy, the pavement designer will review the data from the Pavement Management System to determine what was done in the past. Each section of pavement could have its own unique rate of deterioration and performance life. The decision of using the same tactic or modifying the treatment will be determined by analyzing past treatments and the lives of those methods.

The RealCost program takes into account the entire range of probable pavement service lives for both the initial design and future rehabilitation designs. Therefore, the designer should use the worst case scenario(s) of performance life when determining the number of rehabilitation strategies to be included in the software program to ensure the 40 year analysis period is satisfied.

### 13.2.3 Years to First Rehabilitation

The M-E Design program is designed for a variety of uses, one of which is determining the projected life of a pavement structure which may be used to determine when the pavement will be rehabilitated. The following order of precedence is recommended for selecting the first year to rehabilitation to be used in the LCCA

The designer should use the life of the pavement determined by M-E Design in accordance to the terminal threshold requirements (refer to **Section 2.7 Design Performance Criteria and Reliability (Risk)**). In order to get a triangular distribution one should re-run the design using  $\pm 3\%$  of the designed reliability to determine the pavement life. No other variables shall be changed. **Pavement management data may be included in the Years to First Rehabilitation analysis.**

- **Example:** An interstate project has a 20-year design with various terminal thresholds reaching either 14 or 20 years per requirements in this manual. A reliability of 95% was used in the originally design, thus the designer should re-run the design (without changing any variables except reliability) at a reliability of 92% and 98%. In this example, the design passed at 20 years with 95% reliability, 24 years at 92% reliability, and 17 years at 98% reliability. Therefore the design life's range is 17 to 24 years.

### 13.2.4 Hot Mix Asphalt, Bottom-Up Fatigue Cracking

The M-E Design Program has the ability to predict various types of distresses that conform to the terminal threshold value at either the 14 or 20 years of life. Per **Table 2.4 Recommended Threshold Values of Performance Criteria for new construction of Flexible Pavement**, bottom-up fatigue cracking must have a minimum of 20 years prior to reaching the terminal threshold. If bottom-up fatigue cracking reaches its terminal threshold at year 20 and is the

triggering distress to the designing, the design indicates structural failure has occurred and cannot be corrected without major rehabilitation. When possible (geometry or other project considerations may limit the use of some methods) the designer should use the most economical method. Some methods may not be possible due to roadway geometry, access, etc. The following options should be considered for the design and LCCA.:

1. A reconstruction rather than a rehabilitation at year 20. Full depth reclamation may be used in this situation.
2. The designer may add additional thickness to the design so bottom-up fatigue cracking does not meet the terminal threshold at year 20.
3. To minimize fatigue cracking, the designer keeps the original 20 year design, however a rehabilitation is scheduled prior to year 20 but no sooner than year 14.
4. Bonded PCC overlay over the existing HMA per **Section 9.6.1.2 PCC Over HMA**

### 13.2.5 Rehabilitation Selection Process

CDOT has developed a selection process that takes full advantage of available pavement management performance data. It is believed the following guide will provide recommendations that are more representative of actual pavement performance on Colorado highways. The selection of the appropriate treatment should be based on an engineering analysis for the project. One should select the rehabilitation alternative that best satisfies the needs of a particular project considering economics, budget constraints, traffic service, climate, and engineering judgement.

- The pavement designer should use the historical treatments on the same roadway with the associated service life. Past strategies could be determined by coring the pavement, as well as, historical plan investigations. The coring program is outlined in **APPENDIX C**. Typically, discrepancies arise in the pavement management data and the thickness of cores.
- The pavement designer may have to categorize a lift thickness as being a structural or a functional (preventive maintenance) overlay.
  - The service life of a structural overlay is determined as the number of years between two structural overlays.
  - If a functional overlay was performed, a service life is not established and no adjustment is done on the expected service life. The cost of the functional treatment should be included as part of the maintenance cost and the cost shown in **Table 13.4 Annual Maintenance Costs** will need to be reevaluated.

If the core and historical information is unknown, then refer to **Table 13.1 Default Input Values for Treatment Periods to be Used in a LCCA**. The performance lives shown in **Table 13.1 Default Input Values for Treatment Periods to be Used in a LCCA** are based on statewide average data. This information does not distinguish between traffic and environmental conditions.

It only considers the historical timing of the rehabilitation treatments. Based on the current budgetary constraints, the optimal timing for these treatments may be different. Therefore, regional or local adjustments should be made using information from similar facilities with similar traffic levels if the data is available.

**Table 13.1 Default Input Values for Treatment Periods to be Used in a LCCA**

Type of Treatment <sup>(1)</sup>	Performance in Years		
	Minimum	Most Likely	Maximum
Cold Planing and Overlay	6	12	21
2 to 4 Inch Overlay	5	11	39
Stone Matrix Asphalt Overlay	5	9	17
Full Depth Reclamation and Overlay	10	12	15
Heating and Remixing and Overlay	4	7	14
Heating and Scarifying and Overlay	6	9	23
<b>Overall Weighted Statewide Average</b>	<b>5</b>	<b>10</b>	<b>26</b>
<b>Note:</b> <sup>(1)</sup> This table will not be used to select project-specific rehabilitation strategies. The performance years are not intended to be a comparative tool between different treatment types, they are default values to be entered into the probabilistic LCCA after the appropriate treatment has been selected based on project specific design criteria.			

### 13.2.6 Portland Cement Concrete Pavement

The LCCA of a PCCP may be analyzed with either a 20 or 30-year initial design period and a 40 year analysis period.

**Rehabilitation:** When available, the designer should use regional or local performance data of similar facilities and traffic levels. If no local data is available, the default **years to the first rehabilitation cycle for PCCP is a triangular distribution with a minimum value of 16 years the most likely value of 27 years and the maximum value of 39 years.** This information is based on statewide average data. It does not distinguish between traffic levels or environmental conditions, it only considers the historical timing. Due to budgetary constraint, the optimal timing may be different. Therefore, these values should only be used in the absence of any other information. **Table 13.2 Default Rehabilitation Processes for PCCP** lists the percentages of various rehabilitations for PCCP that are to be included in the LCCA.

**Table 13.2 Default Rehabilitation Processes for PCCP**

Rehabilitation Process	Percentage (%)
Full-Depth Removal in the Driving Lanes	1.5
Partial Depth Repair in the Driving Lanes	0.1
Stitching in the Driving Lanes	190
Retexturing in the Driving Lanes	50
Saw and Seal All Transverse and Longitudinal Joints	100

### 13.2.7 Widening Pavements

Widening existing pavements to accommodate the onslaught of increased traffic throughout the state is becoming more popular every year. Thus, we suggest the following:

- It is recommended that minor widening should be the same pavement type as the existing lane(s).
- **Hot Mix Asphalt:** Preventative procedures to reduce distresses of the existing roadway should be taken. This may be accomplished using a variety of methods ranging from crack sealing to full depth pavement removal.
  - The new widened lane(s) should be designed using a 20 year life and meeting the terminal threshold requirements shown on **Table 2.4 Recommended Threshold Values of Performance Criteria of new Construction of Flexible Pavement.**
  - Existing lanes should be designed with an overlay using a minimum 10 year life and meeting the terminal threshold requirements shown on **Table 2.5 Recommended Threshold Values of Performance Criteria for new Construction of Flexible Pavements** or **Table 2.5 Recommended Threshold Values of Performance Criteria for Rehabilitation of Flexible Pavement Projects.**
- **Portland Cement Concrete Pavement:** Preventative procedures to reduce distresses of the existing roadway should be taken. This may be accomplished using a variety of methods ranging from crack sealing to slab removal.
  - The new widened lane(s) should be designed using a minimum 30 year life and meeting the terminal threshold requirements shown on **Table 2.6 Recommended Threshold Values of Performance Criteria for New Construction of Rigid Pavement.**



### 13.2.8 Detour Pavements

Temporary pavements designed and used as detour pavements during the project's construction may be either HMA or concrete. Since these pavements are temporary, they do not need to match final project design, (i.e. a HMA roadway may use a concrete detour and vice versa). The contractor shall design and maintain the detour for the life of the project per specifications. The roadbase thickness (if roadbase is used) for the detour shall match the project's pavement structure. At a minimum, the pavement's thickness shall be half the designed pavement thickness. M-E Design may be used to determine the required design thickness.

## 13.4 Discount Rate

All future costs are adjusted according to a discount rate prorated to a present worth. Costs incurred at any time into the future can be combined with initial construction costs to give a total cost over the life cycle. See **Table 13.2 Present Worth Factors for Discount Rates** for a uniform series of deposits,  $S_n$ . **The current discount rate is 1.61 percent with a standard deviation 0.57 percent** (6).

The discount rate and standard deviation will be calculated annually. If the new 10-year average discount rate varies by more than two standard deviations from the original discount rate used at the time of the design, in this case 1.61 percent resulting in a discount rate range of 0.69 to 2.89 percent, a new LCCA should be performed. Thus, all projects that have been shelved prior to 2013 and/or not been awarded should rerun the analysis with the new discount rate. The designer is responsible for checking previous pavement designs to ensure an appropriate discount rate was used and the pavement choice is still valid.

The discounting factors are listed in **Table 13.3 Discount Factors for Discrete Compounding** in symbolic and formula form and a brief interpretation of the notation. Normally, it will not be necessary to calculate factors from these formulas. For intermediate values, computing the factors from the formulas may be necessary, or linear interpolation can be used as an approximation.

The single payment present worth  $P = F(P/F, i \%, n)$  notation is interpreted as, "Find P, given F, using an interest rate of  $i \%$  over  $n$  years". Thus, an annuity is a series of equal payments, A, made over a period of time. In the case of an annuity that starts at the end of the first year and continues for  $n$  years, the purchase price, P, would be  $P = A \times (P/A, i \%, n)$ . See **Table 13.2 Present Worth Factors for Discount Rates**.

**Table 13.3 Present Worth Factors for Discount Rates**

<i>n</i> (years)	Discount Rate	
	1.61%	
	$PWF_n$	$S_n$
5	0.9232	4.7673
6	0.9086	5.6759
7	0.8942	6.5701
8	0.8801	7.4502
9	0.8661	8.3163
10	0.8524	9.1687
11	0.8389	10.0076
12	0.8256	10.8331
13	0.8125	11.6456
14	0.7996	12.4453
15	0.7870	13.2322
16	0.7745	14.0067
17	0.7622	14.7689
18	0.7501	15.5191
19	0.7383	16.2573
20	0.7266	16.9839
21	0.7150	17.6990
22	0.7037	18.4027
23	0.6926	19.0952
24	0.6816	19.7768
25	0.6708	20.4476
30	0.6193	23.6455
35	0.5718	26.5979
40	0.5279	29.3237

**Note:**  $PWF_n$  = present worth factor  
 $S_n$  = uniform series of deposits

**Table 13.4 Discount Factors for Discrete Compounding**

Factor Name	Converts	Symbol	Formula	Interpretation of Notation
Single Payment Present Worth	F to P (future single payment to present worth)	$(P/F, i\%, n)$	$(1 + i)^{-n}$	Find P, given F, using an interest rate of $i\%$ over $n$ years
Uniform Series Present Worth	A to P (annual payment to present worth)	$(P/A, i\%, n)$	$\frac{(1 + i)^n - 1}{i(1 + i)^n}$	Find P, given A, using an interest rate of $i\%$ over $n$ years
<b>Note:</b> P = the single payment present worth; F = future single payment; $i\%$ = the interest rate percent, and $n$ = number of years.				

## 13.5 Life Cycle Cost Factors

Cost factors are values associated with the LCCA which cover the full cycle from initial design to the end of the analysis period. Any item that impacts the initial cost should be analyzed, as well as, a determination made as to whether it should be included in the cost analysis. Such items would include shoulder construction, major utility considerations, mobilization, temporary access, traffic crossovers, etc. Some of the factors the designer should consider are described in the following sections.

### 13.5.1 Initial Construction Costs

Pavement construction costs are the expenses incurred to build a section of pavement in accordance with plans and specifications. The pavement construction cost is one of the most important factors in the LCCA and should be as accurate as possible. Initial cost of PCCP and HMA should be based on the best available information. The current version of CDOT's *Cost Data Manual* should be used unless up-to-date bid prices are available for similar work in the same general area. The designer should take into consideration project specific information, such as special mixes, fast track mixes, pavement constructability, special binders, construction phasing, project location, and other pertinent information. These project details may alter the unit costs shown in the figures. The designer should exercise good judgment in the application of the PCCP and HMA unit costs. If there is a wide range of prices for a certain item, it is best to run a sensitivity analysis to determine the effect of cost variation on the end result. Computing the initial cost of a design alternative involves not only the material quantity calculations, but also the other direct costs associated with the pavement alternative being considered. Difference in grading quantities required by different pavement alternatives should be considered where appropriate. For example, the comparison of a thick overlay alternative versus a removal and replacement alternative should include the required shoulder quantity for the overlay. If traffic control costs vary from one alternative to another, the cost should be estimated and included as an initial cost. The different construction techniques, curing time, and duration of lane closures associated with PCCP or HMA have a significant impact on the user costs. For example, a HMA overlay could involve the closure of one lane of traffic at a time, while a concrete pavement overlay might necessitate complete roadway closure and construction detours. This will impact traffic control and user costs. The designer should utilize

the resources of the Engineering Estimates Unit as necessary to supplement information used in the calculation of the unit cost. The supporting information and any worksheets for the unit cost should be included in the Pavement Justification Report.

### 13.5.2 Asphalt Cement Adjustment

Included in the unit cost of HMA should be an adjustment for the Force Account Item. This item revises the Contactor's bid price of HMA found in the Cost Data book based on the price of crude oil at the time of construction. The data varies from year to year, Region to Region, and by the various binders used by CDOT. In 2012, the Contractors paid CDOT an average of \$2.56 per ton of HMA. In 2013, CDOT paid the Contractors an average of \$4.24 per ton of HMA. In 2017, the total weighted average of about 11 million tons of HMA is that CDOT paid the Contractors an average of \$0.77 per ton. Therefore, we recommend a triangular distribution with the minimum value of -\$2.56, a most likely value of \$0.77 and a maximum value of \$4.24 per ton of mix. The unit cost modification is based on data from projects that were awarded from 01/01/2008 through 12/31/2017.

### 13.5.3 Maintenance Cost

The designer should exercise good judgment in the application of maintenance costs. Inappropriate selection can adversely influence the selection of alternatives to be constructed. Maintenance costs should be based on the best available information. The CDOT Maintenance Management System compiled data on state highway maintenance costs. The annual maintenance cost per lane mile is shown in **Table 13.4 Annual Maintenance Costs**. This data was collected from January 1, 2000 to December 31, 2014 and normalized to 2015 dollars. If actual cost cannot be provided, use the following default values:

**Table 13.5 Annual Maintenance Costs**

Type of Pavement	Average Annual Cost Per Lane Mile	Lane Miles Surveyed
HMA	\$1,027	392
PCCP	\$640	416

### 13.5.4 Design Cost

The expected Preliminary Engineering (PE) costs for designing a new or rehabilitated pavement including materials, site investigation, traffic analysis, pavement design, and preparing plans with specifications vary from Region to Region and are in the **range of 8 to 12 percent with the average being 10 percent of the total pavement construction cost**.

### 13.5.5 Pavement Construction Engineering Costs

Included in the pavement construction cost should be the Cost of Engineering (CE). The CE and indirect costs can be found at the Site Manager Construction website.

### 13.5.6 Traffic Control Costs

Traffic control costs is the cost to place and maintain signs, signals, and markings and devices placed on the roadway to regulate, warn, or guide traffic. Traffic control costs vary from Region to Region and from day to night. **The range is from 10 to 18 percent with the average being 15 percent of the total pavement construction cost.** In some designs, the construction traffic control costs may be the same for both alternatives and excluded from the LCCA.

### 13.5.7 Serviceable Life

The serviceable life represents the value of an investment alternative at the end of the analysis period. The method CDOT uses to account for serviceable life is prorated based on the cost of the final rehabilitation activity, design life of the rehabilitation strategy, and the time since the last rehabilitation. For example, over a 40-year analysis, Alternative A requires a 10-year design life rehabilitation to be placed at year 31. In this case, Alternative A will have 1 year of serviceable life remaining at the end of the analysis (40-31=9 years of design life consumed and 10-9=1 year of serviceable life). The serviceable life is 1/10 of the rehabilitation cost, as shown in equation Eq. 13.1.

$$SL = (1 - (L_A/L_E)) * C \quad \text{Eq. 13.1}$$

Where:

- SL = serviceable life
- L<sub>A</sub> = the portion of the design life consumed
- L<sub>E</sub> = the design life of the rehabilitation
- C = the cost of the rehabilitation

### 13.5.8 User Costs

These costs are considered to be indirect “soft” costs accumulated by the facility user in the work zone as they relate to roadway condition, maintenance activity, and rehabilitation work over the analysis period. These costs include user travel time, increased vehicle operating costs (VOC), and crashes. Though these “soft” costs are not part of the actual spending for CDOT, they are costs borne by the road user and should be included in the LCCA. Due to the lack of crash cost data for certain types of work zone activities, CDOT will not consider the costs due to crashes.

## User Cost Program

### 13.5.8.1 Introduction

The User Cost website is a tool used to calculate the user cost associated with work zones for a LCCA. The program allows the engineer to start a new file or import a file from a previous edition of the program. Updates from the previous version include new cost data, pilot car operations, a larger number of types of work, cross over alternative, and printing capabilities.

### 13.5.8.2 Using the User Cost Software

#### Project Data

When entering the website, the designer will be looking at a fresh project page (see **Figure 13.5 User Cost Website**). Accessing the data cells may be done by pointing and clicking, or by using the tab key on the keyboard. The first step is to enter project specific data in the following fields (optional fields are not required for calculations):

- Project code: CDOT's 5 digit code
- Name of project
- Project start and end date (optional)
- Author and comments (optional)
- Length of closure
- Design speed
- Speed limit
- Work zone speed
- Percent grade

According to the Highway Capacity Manual, grades less than 2 percent will not need adjustments to the highway capacity (User Cost has a default value of 2 percent). Any grade less than 3% and longer than 1 mile, or any grade greater than 3% and longer than ½ mile should be analyzed separately. The average grade of the project may be used for analysis.

The screenshot shows the 'User Cost Website' interface. At the top left is the CDOT logo and 'COLORADO Department of Transportation'. The title 'User Cost Website' is on the top right. Below the header is a navigation bar with buttons: 'Edit Hourly Distribution', 'Edit Parameters', 'Edit Costs', 'Reset', 'Guide', 'Analyze', 'Save', 'Summary Report', 'Hourly Report', 'Q Graph', and 'User Cost Graph'. The main area contains a 'Select File to Open:' section with a 'Browse...' button. Below this are two columns of input fields: Project Code, Name of the Project, Project Start Date, Author & Comments, Length of Closure (with a 'miles' label), and Percent Grade (with a '2' in the input field). The second column includes Freeway Name, Region (with a dropdown menu showing 'R1'), Project End Date, Design Speed (with a '65 mph' label), Speed Limit (with a '55 mph' label), and Work Zone Speed Limit (with a '45 mph' label).

**Figure 13.2 User Cost Website**

Lane Closures

- Single Lane Closure (SLC):** For a single lane closure, enter the total number of lanes in each direction, the number of open lanes, and the number of temporary lanes (see **Figure 13.6 Single Lane Closure Screenshot**). Temporary lanes are temporary detours in the work zone at the time of construction. If the project requires using the shoulder, the shoulder is considered a temporary lane. **Note: The sum of open and temporary lanes must be less than or equal to the total number of lanes in each direction.**

<b>Type of Closure:</b>		<input checked="" type="radio"/> Single Lane	<input type="radio"/> Cross Over
<b>Enter The Following Data Per Direction</b>			
Total Number of Lanes:	<input type="text"/>	Number of Open Lanes:	<input type="text"/>
Single Unit Trucks [%]:	<input type="text"/>	Number of Temporary Lanes:	<input type="text"/>
Combination Trucks [%]:	<input type="text"/>	Average Annual Daily Traffic:	<input type="text"/>
<input type="checkbox"/> Work on Both Directions		<input type="checkbox"/> Pilot Car Operation	Please select stop time: <input type="text" value="15 Minutes"/>

**Figure 13.3 Single Lane Closure Screenshot**

- Traffic:** Next, enter the percent single and combination trucks along with the Average Annual Daily Traffic (AADT) for the direction you are working. Refer to **Section 3.1 CDOT Traffic** for obtaining traffic data. If the project requires working in both directions, check the ‘*Work on Both Directions*’ box.
- Pilot Car:** If a pilot car option is used, the program will calculate the pilot car as a separate ‘*Type of Work*’ line item in the final report. The user can select a vehicle stop time of either 15 or 30 minutes. The program will calculate the pilot car cost based on the number of vehicles and trucks, 80% of the AADT, and stop time selected (see **Figure 13.7 Single Lane Closure Highlighting Pilot Car Operations**).
- Cross Over:** In a cross over, the traffic volumes are the same as described in the single lane closure scenario.

<b>Type of Closure:</b>		<input checked="" type="radio"/> Single Lane	<input type="radio"/> Cross Over
<b>Enter The Following Data Per Direction</b>			
Total Number of Lanes:	<input type="text"/>	Number of Open Lanes:	<input type="text"/>
Single Unit Trucks [%]:	<input type="text"/>	Number of Temporary Lanes:	<input type="text"/>
Combination Trucks [%]:	<input type="text"/>	Average Annual Daily Traffic:	<input type="text"/>
<input type="checkbox"/> Work on Both Directions		<input checked="" type="checkbox"/> Pilot Car Operation	Please select stop time: <input type="text" value="15 Minutes"/>

**Figure 13.4 Single Lane Closure Highlighting Pilot Car Operations**

- **Example:** I-70, a divided 4-lane interstate (2 primary lanes and 2 secondary lanes) will be reconstructed using a cross over. The phasing is such that the secondary direction is closed first (see **Figure 13.8 Example of Input for a Cross Over**). The input is as follows:
  - Secondary Direction Total Number of Lanes = 2
    - ♦ Number of Open Lanes = 1
    - ♦ Number of Temporary Lanes = 0
  - Primary Direction Total Number of Lanes = 2
    - ♦ Number of Open Lanes = 1
    - ♦ Number of Temporary Lanes = 0

Type of Closure:		<input type="radio"/> Single Lane		<input checked="" type="radio"/> Cross Over	
Primary Direction			Secondary Direction		
Total Number of Lanes:	<input type="text" value="2"/>			Total Number of Lanes:	<input type="text" value="2"/>
Number of Open Lanes:	<input type="text" value="1"/> <input type="text" value="0"/>	Number of Temporary Lanes		Number of Open Lanes:	<input type="text" value="1"/> <input type="text" value="0"/>
Single Unit Trucks [%]:	<input type="text"/>	Combination Trucks [%]		Single Unit Trucks [%]:	<input type="text"/> <input type="text"/>
AADT:	<input type="text"/>		AADT: <input type="text"/>		

**Figure 13.5 Example of Input for a Cross Over**

### Type of Work

The program has a list of 52 different types of work that may be selected for a project (see **Figure 13.9 Screenshot Showing Type of Work Menu**). To select a ‘Type of Work’ from the list, point and single click on the item. To view additional items, use the arrows located on the right side of the menu to scroll down the list. Once you point and click on an item, the type of work moves into the ‘Type of Selected Work’ area. To remove an item after it has been selected, single click on the red ‘X’ to the right of the line item. It is suggested to pick the major item of the work to be constructed followed by minor work items and not to have more than five items selected. The program will allow one to select up to 25 types of work.

Once a ‘Type of Work’ is selected, default values assigned to each item for calculating the duration of the work and the lane capacity will be used for calculations. If project specifics require a different duration or capacity, click the box for ‘Duration, Depth, or Capacity’ and type a new value.

**Note:** The capacity adjustment factor has a set default value based on data from the *Highway Capacity Manual*, thus, if you have equipment in close proximity to the travelling public, you should input a value lower than the default value. **Table 13.5 Range of Capacity Values per Type of Work** shows the range in capacity that one may use to modify a particular type of construction or activity.



Type of Work	Function Class:	Rural Interstate (Weekday)		
203-Dozing	Total Duration (days):	0		
210-Adjust Guardrail	Normal Capacity per Lane:	0.0	Vehicles per hour per lane	
210-Replace Concrete Pavement				
304-Aggregate Base Course				
306-Reconditioning				
307-Lime Treated Subgrade <= 8.0 inches				
307-Lime Treated Subgrade <= 12.0 inches				
310-Full-Depth Reclamation <= 6 inches				
310-Full-Depth Reclamation <= 10 inches				

Type of Selected Work	Duration	Depth	Primary Capacity per Lane	Secondary Capacity per Lane	
202-Removal of Asphalt	0	N/A	1545	1545	✘
307-Lime Treated Subgrade <= 8.0 inches	0	4.00	1625	1625	✘

Figure 13.6 Screenshot Showing Type of Work Menu

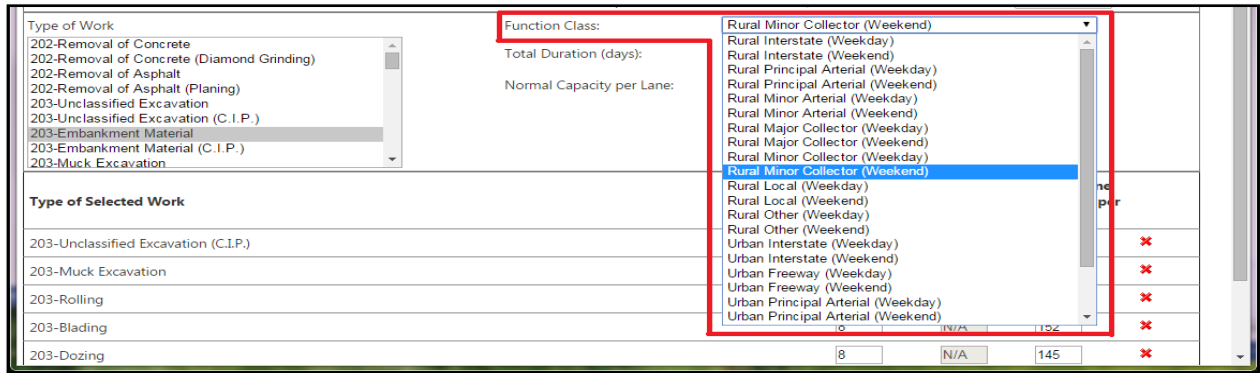
Table 13.6 Range of Capacity Values per Type of Work

Item	Description	Int. Adj. Factor
202	Removal of concrete	-160 to +50
202	Removal of concrete (planing)	+120 to +160
202	Removal of asphalt	-160 to + 50
202	Removal of asphalt (planing)	+120 to +160
203	Unclassified excavation	-100 to +100
203	Unclassified excavation (C.I.P.)	-50 to + 100
203	Embankment material	-100 to +100
203	Embankment material (C.I.P.)	-50 to +100
203	Muck excavation	-50 to +50
203	Rolling	+100 to +160
203	Blading	+50 to +160
203	Dozing	-50 to +100
210	Adjust guardrail	-50 to +50
210	Replace concrete pavement	0 to +50
304	Aggregate base course	-50 to +50
306	Reconditioning	-50 to +160
310	Process asphalt material for base	-50 to +100

Item	Description	Int. Adj. Factor
403	HMA stone matrix asphalt	-100 to +160
403	HMA (patching)	0 to +160
403	HMA ≤ 1.0"	-100 to +160
403	HMA ≤ 2.0"	-100 to +160
403	HMA ≤ 3.0"	-100 to +160
405	Heating and scarifying	-50 to +100
406	Cold-in-place recycle	-50 to +100
408	Hot poured joint and crack sealant	-100 to +160
409	Microsurfacing	-100 to +160
412	Concrete pavement system	-160 to +160
412	Concrete pavement ≤ 6.0"	-160 to +160
412	Concrete pavement ≤ 10.0"	-160 to +160
412	Concrete pavement ≤ 14.0"	-160 to +160
412	Routing and sealing PCCP cracks	-100 to +160
412	Cross stitching	-100 to +100
412	Rubbilization of PCCP	-120 to -160
***	Miscellaneous Other roadway construction	-160 to +160

## Function Class

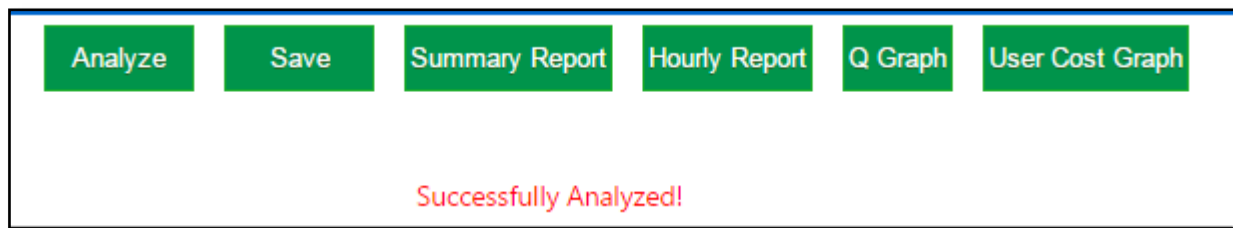
The ‘*Function Class*’ is a scroll down menu listing the different types of roadways (see **Figure 13.10 Screenshot of the Function Class Menu**). Items may be selected by pointing and single clicking on the item. Weekend and weekday options are provided for each functional class. In the case where lane closures span weekdays and weekends, both scenarios should be run and a weighted average user cost calculated.



**Figure 13.7 Screenshot of the Function Class Menu**

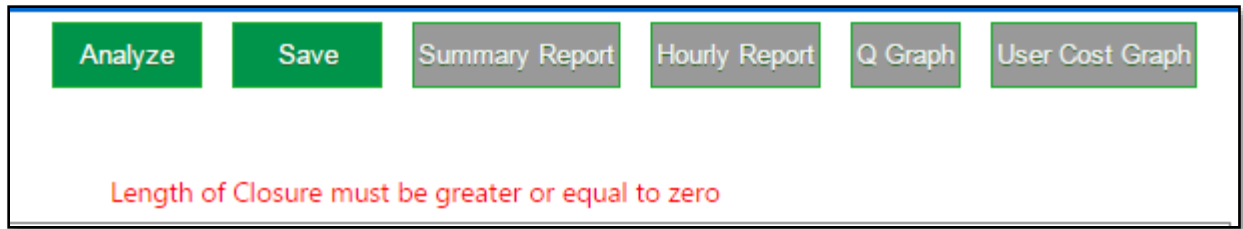
## Run the Program

When you click the ‘*Analyze*’ button you will either get a successfully analyzed, or an error message. If the data entered is appropriate and within the advised set range, the ‘*Report*’ button located at the top of the page will turn green (see **Figure 13.11 Successfully Analyzed Menu Bar**). At this point, all of the reports may be viewed by clicking the associated button. By clicking on a report button, a new page with the report will open in your browser. The reports may be printed by a right clicking and selecting ‘*Print*’.



**Figure 13.8 Successfully Analyzed Menu Bar**

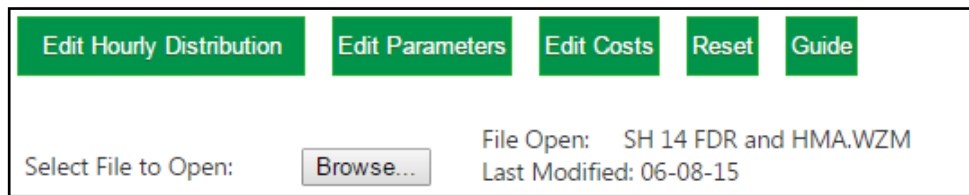
If an entry(s) is invalid, an error message will notify the user where the problem exists (see **Figure 13.12 Analysis Error Message**). The user may go back to any portion of the program, fix the error, and re-analyze the data until all error messages are corrected and a successful run is made.



**Figure 13.9 Analysis Error Message**

### Editing Default Inputs

Buttons that will allow you to customize construction information and parameters are available on the left side of the top row (see **Figure 13.13 Editing Input Buttons**). **Note:** If any information or parameters are changed, one must save them by selecting 'OK' to close the edit; if you click on 'Cancel' to close the box, it will not save any changes.



**Figure 13.10 Editing Input Buttons**

### Edit Hourly Distribution

This screen allows you to change the hourly traffic distribution values for your project. Staff traffic has an internal web site ([http://internal/App\\_DTD\\_DataAccess/index.cfm](http://internal/App_DTD_DataAccess/index.cfm) with a tab for traffic counts), however not all traffic data is available in all areas of the state at this time. The total sum of distribution factors cannot exceed 1.0 (see **Figure 13.14 Hourly Distribution Edit Screen**). **Note:** A queue greater than 5 miles or a delay greater than ½ hour should not be allowed to form. If the queue length exceeds 5 miles or a delay greater than ½ hour per the Regional traffic control guidelines, the project may require working at night. Past projects have shown that the travelling public may find alternative routes once a project begins, thus reducing the queue's length. If this is a likely scenario, discussions concerning the impact to traffic and other options may be discussed with the Region traffic engineer. The program calculates the user cost when a work zone is in place. For example, if the contractor only works from 9:00 a.m. to 5:00 p.m. on a single lane closure, then all the hourly traffic distribution values outside the working time should be changed to zero (0).

Edit Hourly Traffic Distribution Factors			
Current Functional Class: Rural Principal Arterial (Weekday)			
Hour 1:	<input type="text" value="0.0000"/>	Hour 13:	<input type="text" value="0.0560"/>
Hour 2:	<input type="text" value="0.0000"/>	Hour 14:	<input type="text" value="0.0580"/>
Hour 3:	<input type="text" value="0.0000"/>	Hour 15:	<input type="text" value="0.0660"/>
Hour 4:	<input type="text" value="0.0000"/>	Hour 16:	<input type="text" value="0.0800"/>
Hour 5:	<input type="text" value="0.0000"/>	Hour 17:	<input type="text" value="0.0000"/>
Hour 6:	<input type="text" value="0.0000"/>	Hour 18:	<input type="text" value="0.0000"/>
Hour 7:	<input type="text" value="0.0000"/>	Hour 19:	<input type="text" value="0.0000"/>
Hour 8:	<input type="text" value="0.0610"/>	Hour 20:	<input type="text" value="0.0000"/>
Hour 9:	<input type="text" value="0.0500"/>	Hour 21:	<input type="text" value="0.0000"/>
Hour 10:	<input type="text" value="0.0500"/>	Hour 22:	<input type="text" value="0.0000"/>
Hour 11:	<input type="text" value="0.0520"/>	Hour 23:	<input type="text" value="0.0000"/>
Hour 12:	<input type="text" value="0.0540"/>	Hour 24:	<input type="text" value="0.0000"/>
Sum of Hourly Distribution:		0.5270	
<input type="button" value="OK"/>		<input type="button" value="Cancel"/>	

**Figure 13.11 Hourly Distribution Edit Screen**

### Edit Parameters

Changing or editing a parameter in the User Cost software will effect one or more other variables. Below is a list of parameters and the effect they have on other variables (see **Figure 13.15 Edit Parameters Screen**).

- The intensity value (how close the contractor is working to the travelling public) is linked to lane capacity.
- Productivity changes the duration.
- The Present Serviceability Index (road quality) is linked to user cost due to wear and tear on the vehicles.
- The lane width factor affects the capacity.
- The width factor is affected by lane width, obstruction distance, freeway size, and whether an obstruction is on both sides.
- Ramps that are not metered will cause traffic to accelerate and slow down which affects the capacity in the work zone.
- CPI: Consumer Price Index may be found at the following website:  
<http://www.bls.gov/news.release/cpi.t01.htm>

**Edit Costs**

The ‘*Edit Costs*’ button near the top left corner allows the user to change the ‘*Value of Time*’ for cars, single unit trucks, and combine trucks. Once the costs are changed click on the ‘*OK*’ button (see **Figure 13.16 Edit Costs Screen**).

**Intensity Factors and Productivity**

Type of Work	Intensity	Productivity	
202-Removal of Concrete	-55	400	sy
202-Removal of Concrete (Diamond Grinding)	140	2500	sy
202-Removal of Asphalt	-55	1500	sy
202-Removal of Asphalt (Planing)	140	9000	sy
203-Unclassified Excavation	100	2500	cy
203-Unclassified Excavation (C.I.P.)	25	2500	cy
203-Embankment Material	100	2000	cy
203-Embankment Material (C.I.P.)	25	2000	cy
203-Muck Excavation	100	1000	cy
203-Rolling	130	39000	sy
203-Blading	105	1	la

sy - square yards/day    cy - cubic yards/day    la - lanes/day    ft - feet per day

Present Serviceably Index:       Ramp Volume:

CPI:

Calculate the Width Factor based on inputs:

Lane Width (ft):     Obstruction Distance:    

Obstruction Both Sides      Width Factor:

**Figure 13.12 Edit Parameters Screen**

**Costs**

Car Value of Time:

Single Unit Truck Value of Time:

Combined Value of Time:

**Figure 13.13 Edit Costs Screen**

## Saving Projects

The 'Save' button is located near the center of the row of buttons. This button will save all inputs, including any changes to the hourly distribution, parameters, and costs, as well as, time stamp the file so the user will know when the file was last modified. After clicking 'Save', the file will appear in the bottom left of the web window (see **Figure 13.17 Saving a File**).

If the file does not appear at the bottom, it may be because your computer is blocking pop-ups. The user can allow the pop-ups only for this site by clicking the red 'X' on the top navigation bar of the web browser when the program tries to download the file. Next, click on the file and select 'Open'. A text file will open. From the notebook text editor, select 'File', then 'Save', to save the file onto your computer. Next time the user opens the program, the file can be opened from the 'Browse' button at the top of the screen.

## Reset

The 'Reset' button will clear the page and reset all the default values.

The screenshot shows the 'User Cost Website' interface for the Colorado Department of Transportation. The top navigation bar includes buttons for 'Edit Hourly Distribution', 'Edit Parameters', 'Edit Costs', 'Reset', 'Guide', 'Analyze', 'Save', 'Summary Report', 'Hourly Report', 'Q Graph', and 'User Cost Graph'. The main form contains the following fields and sections:

- File Information:** File Open: SH 14 FDR and HMA.WZM, Last Modified: 06-08-15
- Project Details:** Project Code: 12345, Name of the Project: SH 14 FDR and HMA, Project Start Date: november, Author & Comments: testing by moss, Length of Closure: 7.82 miles, Percent Grade: 2, Freeway Name: SH 14, Region: R1, Project End Date: may, Design Speed: 65 mph, Speed Limit: 65 mph, Work Zone Speed Limit: 30 mph.
- Type of Closure:** Radio buttons for Single Lane (selected) and Cross Over.
- Enter The Following Data Per Direction:**
  - Total Number of Lanes: 1
  - Single Unit Trucks (%): 6.70
  - Combination Trucks (%): 8.00
  - Work on Both Directions:
  - Number of Open Lanes: 1
  - Number of Temporary Lanes: 0
  - Average Annual Daily Traffic: 9879
  - Pilot Car Operation:  Please select stop time: 15 Minutes
- Type of Work:** A list box with '307-Lime Treated Subgrade <= 8.0 inches' selected.
- Function Class:** Rural Principal Arterial (Weekday)
- Total Duration (days):** 70
- Normal Capacity per Lane:** 1515.8 Vehicles per hour per lane
- Table of Selected Work:**

Type of Selected Work	Duration	Depth	Work Zone Capacity per Lane
307-Lime Treated Subgrade <= 8.0 inches	6	N/A	1302

A red circle highlights the selected work item in the table. The bottom status bar shows the file name 'SH 14 FDR and H...WZM' and a 'Show all downloads...' link.

**Figure 13.14 Saving a File**

## 13.6 Probabilistic Life Cycle Cost Analysis

Two different computational approaches can be used in a LCCA; deterministic and probabilistic. The methods differ in the way they address the variability associated with the LCCA input values.

- **Deterministic:** In the deterministic approach, the analyst assigns each LCCA input variable a fixed, discrete value. The analyst determines the value most likely to occur for each parameter, usually basing the determination on historical evidence or professional judgment. Collectively, the input values are used to compute a single life-cycle cost estimate for the alternative under consideration. Traditionally, applications of a LCCA have been deterministic. A deterministic life-cycle cost computation is straightforward and can be conducted manually with a calculator or automatically with a spreadsheet. Sensitivity analyses may be conducted to test input assumptions by varying one input, holding other inputs constant, and determining the effect of the variation on the outputs. The deterministic approach, however, fails to address simultaneous variation in multiple inputs, and it fails to convey the degree of uncertainty associated with the life-cycle cost estimates.
- **Probabilistic:** Probabilistic LCCA inputs are described by probability functions that convey both the range of likely inputs and the likelihood of their occurrence. Probabilistic LCCA also allows for the simultaneous computation of differing assumptions for many different variables. Outputs and inputs express the likelihood a particular life-cycle cost will actually occur. Because of the dramatic increases in computer processing capabilities of the last two decades, the process of probabilistic analysis has become more practical. Simulating and accounting for simultaneous changes in LCCA input parameters can now be accomplished easily and quickly.

## 13.7 FHWA RealCost Software

The RealCost software was created with two distinct purposes. The first is to provide an instructional tool for pavement design decision-makers who want to learn about the LCCA. The software allows the student of LCCA to investigate the effects of cost, service life, and economic inputs on life-cycle cost. For this purpose, a Graphical User Interface (GUI) was designed to make the software easy to use. The second purpose is to provide an actual tool for pavement designers which they can use to incorporate life-cycle costs into their pavement investment decisions.

The RealCost software automates FHWA's LCCA methodology as it applies to pavements by calculating life-cycle values for both agency and user costs associated with construction and rehabilitation. The software can perform both deterministic sensitivity analyses and probabilistic risk analysis of pavement LCCA problems. Additionally, RealCost supports deterministic sensitivity and probabilistic risk analyses. RealCost compares two alternatives at a time and has been designed to give the pavement engineer the ability to compare an unlimited number of alternatives. By saving the input files of all alternatives being considered, the analyst can compare any number of alternatives. Furthermore, the software has been designed so an understanding of

the LCCA process is sufficient to operate the software. Outputs are provided in tabular and graphic format.

The software automates FHWA's work zone user cost calculation method. This method for calculating user costs compares traffic demand to roadway capacity on an hour-by-hour basis, revealing the resulting traffic conditions. The method is computation intensive and ideally suited to a spreadsheet application. The software does not calculate agency costs or service lives for individual construction or rehabilitation activities. These values must be input by the analyst and should reflect the construction and rehabilitation practices of the agency. While RealCost compares the agency and user life-cycle costs of alternatives, its analysis outputs alone do not identify which alternative is the best choice for implementing a project. The lowest life-cycle cost option may not be implemented when other considerations such as risk, available budgets, and political and environmental concerns are taken into account. As with any economic tool, LCCA provides critical information to the overall decision-making process, but not the answer itself. FHWA's RealCost software may be obtained at:

<http://www.fhwa.dot.gov/infrastructure/asstmgmt/lcca.cfm>

### 13.7.1 Real Cost Switchboard

RealCost opens to the main menu form, called the "*Switchboard*," a form superimposed on Microsoft Excel worksheet. The switchboard buttons, shown in **Figure 13.18 The RealCost Switchboard**, provide access to almost all of the functionality of the software including: data entry, analysis, reports, and utilities. The switchboard has five sections:

- **Project-Level Inputs:** Data that will be used for all alternatives. This data documents the project characteristics, define the common benefits that all alternatives will provide, and specifies the common values (i.e., discount rate) that will be applied with each alternative.
- **Alternative-Level Inputs:** Data that will be used for a specific design alternative. This data differentiate and alternatives from each other.
- **Input Warnings:** A list of missing or potentially erroneous data. The software identifies and displays the list.
- **Simulation and Output:** Forms used to view deterministic results, run Monte Carlo simulation of probabilistic inputs, view probabilistic results, and print reports.
- **Administrative Functions:** Forms used to save, clear, and retrieve data and to close the Switchboard or RealCost.



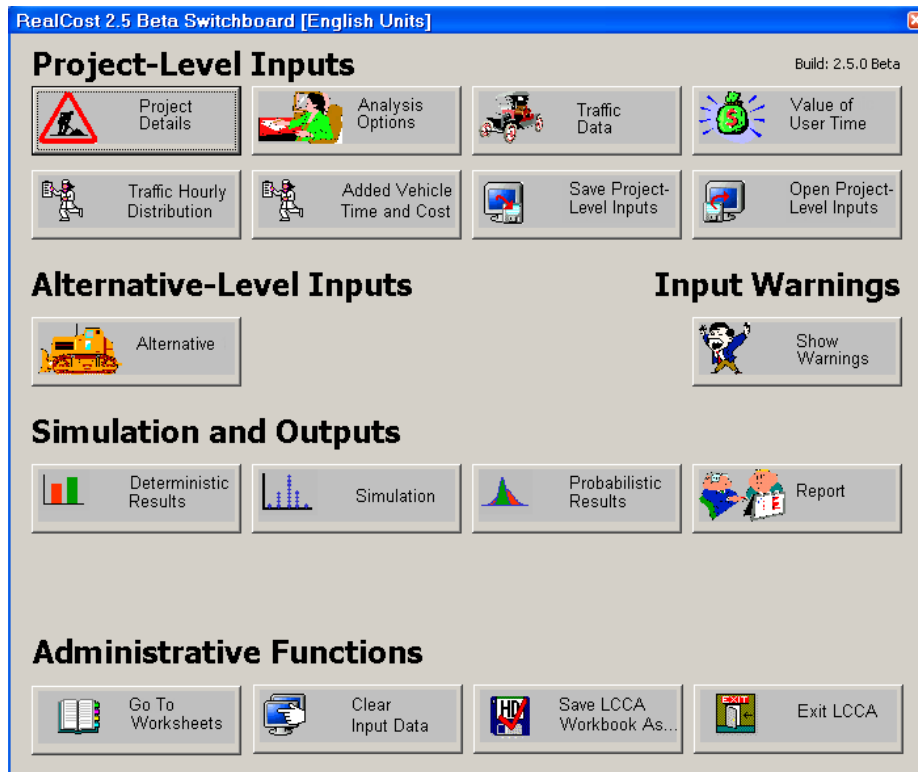


Figure 13.15 The Real Cost Switchboard

### 13.7.2 Real Word Example Using the RealCost Software

Compare 9 inches of HMA to 12 inches PCCP on a 4-lane section of I-70 (2-lanes per direction) near Bethune Colorado from MP 417 to MP 427, which is located in Region 1 (prior to 7/1/2013).

- **HMA (9 inches):** It is estimated the HMA alternative will take 54 construction days working from 8:00 a.m. to 5:00 p.m. with a single lane closure per direction. Each of HMA rehabilitation cycle will take approximately 20 construction days.
- **PCCP (12 inches):** The alternative will take 100 construction days per direction using a cross over. PCCP rehabilitation will take approximately 30 construction days (8:00 a.m. to 5:00 p.m.).

### 13.7.3 Project Details Options

The project details screen is used to identify and document the project, see **Figure 13.19 Project Details Input Screen**. The designer may enter project documentation details according to the field names (data entered into this form are not used in the analysis).

The screenshot shows a software window titled "Project Details" with a blue header bar. The window contains the following fields and controls:

- State Route:
- Project Name:
- Region:
- County:
- Analyzed By:
- Mileposts: Begin:  End:
- Comments:
- Buttons:

**Figure 13.16 Project Details Input Screen**

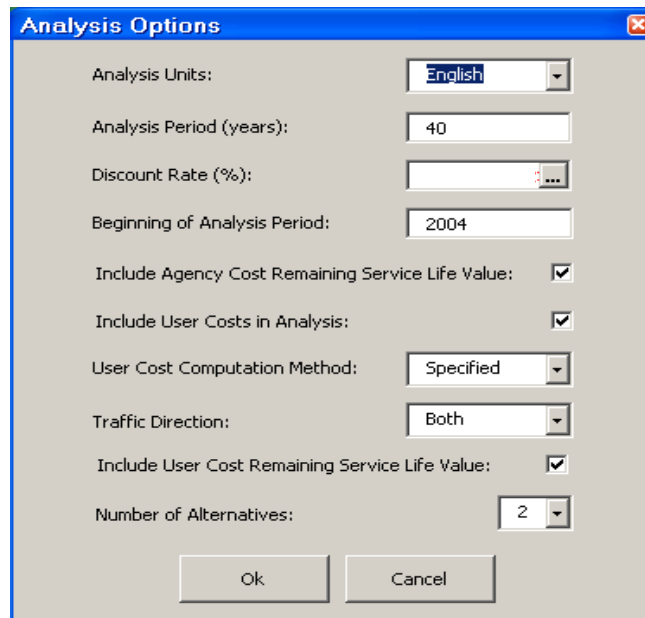
### 13.7.4 Analysis Options

Generally, analysis options are decided by agency policy rather than the pavement designer. Options defined in the Analysis Options form include the analysis period, discount rate, beginning year, inclusion of residual service life, and the treatment of user costs in the LCCA, see **Figure 13.20 Analysis Option Screen**. The data inputs and analysis options available on this form are discussed in **Table 13.6 Analysis Data Inputs and Analysis Options**, with CDOT and FHWA’s recommendations. A checked box equals “Yes,” and unchecked box equals “No”.

**Table 13.7 Analysis Data Inputs and Analysis Options**

Variable Name	Probability Distribution (CDOT Default)	Value (CDOT Default)	Source
Analysis Units	Select option	English	CDOT
Analysis Period (Years)	User specified	40	<b>Sections 13.3.1, 13.3.2, and 13.3.3</b>
Discount Rate (%)	Log normal	Mean and standard deviation	<b>Section 13.4</b> T-bill, inflation rate, and 10-year moving average
Beginning of Analysis Period	User specified	Date (year)	Project start date
Included Agency Cost Remaining Service Life Value	Select option	Yes	<b>Section 13.5</b> (serviceable life)
Include User Costs in Analysis	Select option	Yes	<b>Section 13.5.7</b>
User Cost Computation Method	Select option (specified/calculated)	Specified	<b>Section 13.5.7</b> Use user costs from CDOT WorkZone software*
Traffic Direction	Select option (both/inbound/outbound)	Both	Site specific
Include User Cost RSL	Select option	Yes	<b>Section 13.5.7</b>

**Note:** \* When "Specified" is selected the manual calculated user cost from the WorkZone program will be used in the RealCost program.



**Figure 13.17 Analysis Option Screen**

### 13.7.5 Traffic Data Options

Pavement engineers use traffic data to determine their design parameters. In RealCost traffic (see **Figure 13.21 Traffic Data Option Screen**) traffic data is used exclusively to calculate WorkZone.

**Table 13.8 Traffic Data Options**

Variable Name	Probability Distribution (CDOT Default)	Value (CDOT Default)	Source
AADT Construction Year (total for both directions)	Deterministic	User input	<b>Section 3.1.3</b>
Single Unit Trucks as Percentage of AADT (%)	Deterministic	User input	<b>Section 3.1.3</b>
Combination Trucks as Percentage of AADT (%)	Deterministic	User input	<b>Section 3.1.3</b>
Annual Growth Rate of Traffic (%)	Triangular	Minimum = 0.34 Most likely = 1.34 Maximum = 2.34	<b>Section 3.1.3</b>
Speed Limit Under Normal Operating Conditions (mph)	Deterministic	User input	Site specific
Lanes Open in Each Direction Under Normal Conditions	Deterministic	User input	Site specific
Free Flow Capacity (vphpl)	Deterministic	User input	CDOT WorkZone software (normal capacity per lane)
Queue Dissipation Capacity (vphpl)	Deterministic	User input	CDOT WorkZone software (work zone capacity per lane)
Maximum AADT (total for both directions)	Deterministic	User input	Site specific
Maximum Queue Length (miles)	Deterministic	5 miles	CDOT
Rural or Urban Hourly Traffic Distribution	Select option (urban/rural)	User input	CDOT WorkZone software (functional class)

**Traffic Data**

AADT Construction Year (total for both directions): 10372

Single Unit Trucks as Percentage of AADT (%): 6.3

Combination Trucks as Percentage of AADT (%): 22.9

Annual Growth Rate of Traffic (%): 1.34000003 ...

Speed Limit Under Normal Operating Conditions (mph): 75

Lanes Open in Each Direction Under Normal Conditions: 2

Free Flow Capacity (vphpl): 1942 ...

Free Flow Capacity Calculator

Queue Dissipation Capacity (vphpl): 1140 ...

Maximum AADT (total for both directions): 150000

Maximum Queue Length (miles): 5

Rural or Urban Hourly Traffic Distribution: Rural

Ok Cancel

**Figure 13.18 Traffic Data Option Screen**

- **The Free Flow Capacity (FFC or vphpl):** Obtained from CDOT WorkZone software and is labeled *'Normal Capacity Per Lane'* on the input screen.
- **Queue Dissipation Capacity (QDC or vphpl):** Must be equal to or greater than the largest value of work zone capacity per lane under the alternatives input screen(s); otherwise an error is detected under the input error warnings check. The QDC is on a roadway when there is no work zone. The traffic comes to a either a complete or near complete stop and then starts and dissipates; similar vehicles at a traffic light or if an object is in the roadway. Thus, the QDC is how much traffic the roadway will carry under these conditions. This is different than free flow capacity and during a work zone's normal traffic flow where normal traffic slows down but does not come to a complete stop or near stop. Therefore, the QDC must be larger for the same roadway to be able to disperse more volume of traffic than a work zone condition.

Only a deterministic value is needed for the maximum AADT (both direction). The *Highway Capacity Manual* (2000) lists various volumes of freeways with 4, 6, and 8 lanes and a 4 lane arterial. It is fortunate that Denver, Colorado is listed in the tables and exhibits.

**Exhibit 8-13** – Reported maximum directional volumes on selected urban streets in the *Highway Capacity Manual* (2000) is shown as:

Colorado State Highway 2

6 Lanes: 3,435 vehicles/hour

Therefore:  $3,435 \text{ vehicles/hour} * 2 \text{ directions} = 6,870 \text{ vehicles/hour both directions}$

$6,870 \text{ vehicles/hour both directions} * 24 \text{ hours} = 164,880 \text{ maximum AADT}$   
both directions

**Exhibit 8-19** – Reported maximum hourly one-way volumes on selected freeways in the *Highway Capacity Manual* (2000) lists various volumes of freeways with 4, 6, and 8 lanes.

Colorado State Highway I-225

4-lane: 4,672 vehicles/hour

Therefore:  $4,672 \text{ vehicles/hour} * 2 \text{ directions} = 9,344 \text{ vehicles/hour both directions}$

$9,344 \text{ vehicles/hour both directions} * 24 \text{ hours} = 224,256 \text{ maximum AADT}$   
both directions

Colorado State Highway 6

6-lane: 7,378 vehicles/hour

Therefore:  $7,378 \text{ vehicles/hour} * 2 \text{ directions} = 14,756 \text{ vehicles/hour both directions}$

$14,756 \text{ vehicles/hour both directions} * 24 \text{ hours} = 354,144 \text{ maximum AADT}$   
both directions

Interstate Highway I-25

8-lane: 8,702 vehicles/hour

Therefore:  $8,702 \text{ vehicles/hour} * 2 \text{ directions} = 17,404 \text{ vehicles/hour both directions}$

$17,404 \text{ vehicles/hour both directions} * 24 \text{ hours} = 417,696 \text{ maximum AADT}$   
both directions

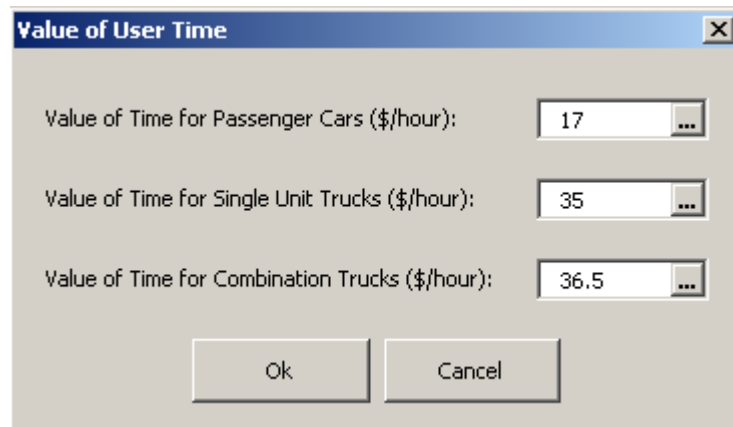
The pavement designer may select a reasonable maximum AADT. If need be, an interpolation may be in order to fit the project specifics. An alternate method is to use the Free Flow Capacity (vphpl) multiplied by the number of lanes, multiplied by the 2 directions, and multiplied by 24 hours.

### 13.7.6 Value of User Time

The 'Value of User Time' form, shown in **Figure 13.22 Value of User Option Screen**, allows editing of the values applied to an hour of user time. The dollar value of user time is different for each vehicle type and used to calculate user costs associated with delay during work zone operations.

**Table 13.9 Value of User Time Data Options**

Variable Name	Probability Distribution (CDOT Default)	Value (CDOT Default)	Source
Value of Time for Passenger Cars (\$/hour)	Deterministic	18.50	CDOT Work Zone software <b>Section 13.5.7</b>
Value of Time for Single Unit Trucks (\$/hours)	Deterministic	43.50	CDOT Work Zone software <b>Section 13.5.7</b>
Value of Time for Combination Trucks (\$/hour)	Deterministic	49.50	CDOT Work Zone software <b>Section 13.5.7</b>



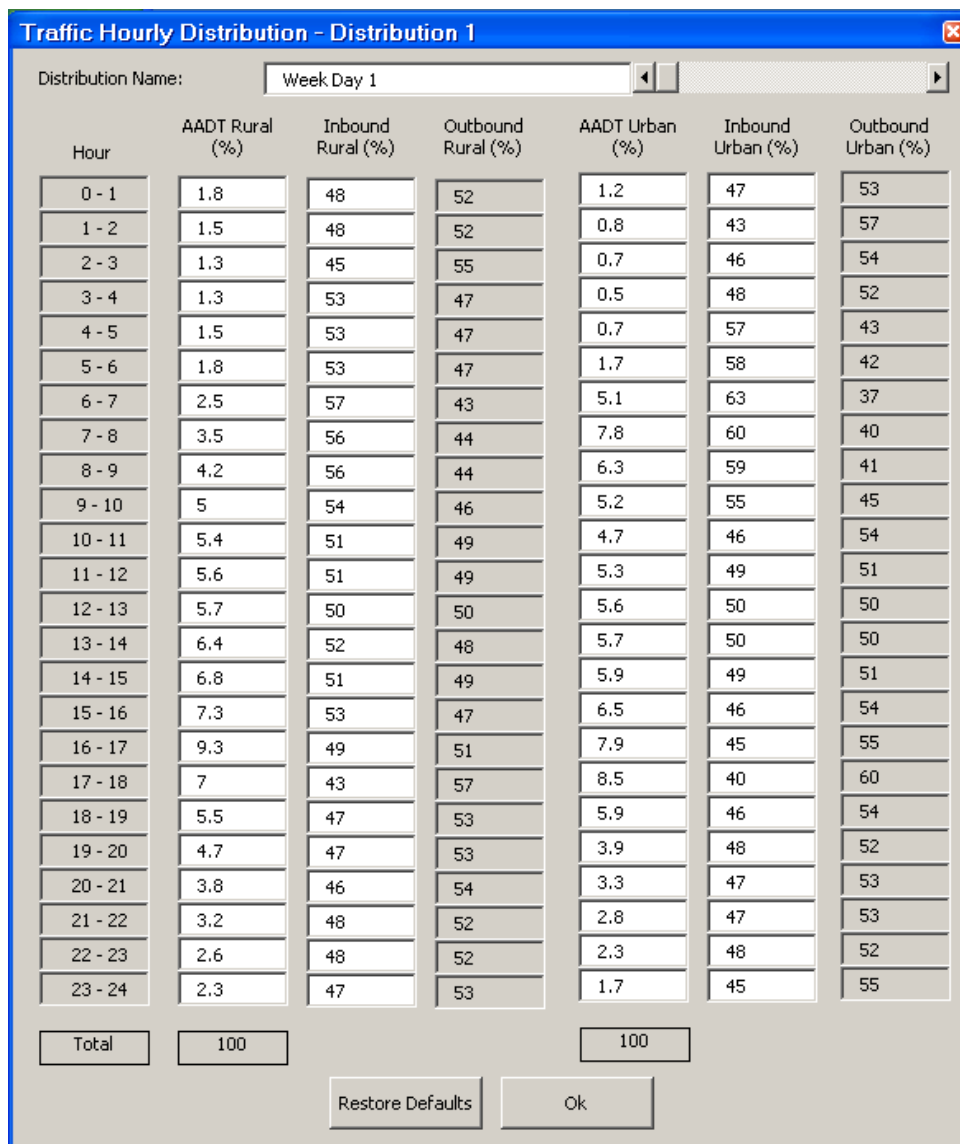
**Figure 13.19 Value of User Option Screen**

### 13.7.7 Traffic Hourly Distribution

To transform Annual Average Daily Traffic (AADT) to an hourly traffic distribution use the default Rural and Urban Traffic hourly distributions from MicroBENCOST provided with the RealCost software. The *'Traffic Hourly Distribution'* (see **Figure 13.23 Traffic Hourly Distribution Screen**) form is used to adjust (or restore) these settings. Distributions are required to sum to 100 percent.

**Table 13.10 Traffic Hourly Distribution Data Options**

Variable Name (percent)	Probability Distribution (CDOT Default)	Value (CDOT Default)	Source
AADT Rural	Real Cost default	Real Cost default	Real Cost software
Inbound Rural	Real Cost default	Real Cost default	Real Cost software
AADT Urban	Real Cost default	Real Cost default	Real Cost software
Inbound Urban	Real Cost default	Real Cost default	Real Cost software



**Figure 13.20 Traffic Hourly Distribution Screen**



### 13.7.8 Added Time and Vehicle Cost Options

- **Added Time per 1,000 Stops (Hours) and Added Cost per 1,000 Stops (\$):** These values are used to calculate user delay and vehicle costs due to speed changes that occur during work zone operations. This form (see **Figure 13.24 Added Time and Vehicle Stopping Costs Screen**) is used to adjust the default values for added time and added cost per 1,000 stops.
- **Idling Cost per Veh-Hr (\$):** This value is used to calculate the additional vehicle operating costs resulting from traversing a traffic queue under stop and go conditions. The costs and times are different for each vehicle type.
- **Restore Defaults:** This button functions much the same as it does on the ‘*Traffic Hourly Distribution*’ form. The default values are drawn from NCHRP Study 133, *Procedures for Estimating Highway User Costs, Air Pollution, and Noise Effects*.
- **Colorado Construction Cost Index:** May be obtained from the Agreements and Market Analysis Branch, Engineering Estimates and Market Analysis Unit. The unit publishes a quarterly report and is in Acrobat file format.

**Table 13.11 Added Time and Vehicle Costs Data Options**

Variable Name	Probability Distribution (CDOT Default)	Value (CDOT Default)	Source
Added Time Passenger Cars	Real Cost default	Real Cost default	Real Cost software
Added Time Single Unit Trucks	Real Cost default	Real Cost default	Real Cost software
Added Time Combination Trucks	Real Cost default	Real Cost default	Real Cost software
Added Cost Passenger Cars	Real Cost default	Real Cost default	Real Cost software
Added Cost Single Unit Trucks	Real Cost default	Real Cost default	Real Cost software
Added Cost Combination Trucks	Real Cost default	Real Cost default	Real Cost software
Base Transportation Component CPI	Deterministic	142.8	Real Cost software
Base Year	Deterministic	1996	Real Cost software
Current Transportation Component CPI	Deterministic	User input	CDOT
Current Year	Deterministic	User input	CDOT
Idling Cost Per Vehicle HR (\$) Passenger Cars	Real Cost default	Real Cost default	Real Cost software
Idling Cost Per Vehicle HR (\$) Single Unit Trucks	Real Cost default	Real Cost default	Real Cost software
Idling Cost Per Vehicle HR (\$) Combination Trucks	Real Cost default	Real Cost default	Real Cost software

**Added Time and Vehicle Stopping Costs**

Initial Speed (mph)	Added Time per 1,000 Stops (Hours)			Added Cost per 1,000 Stops (\$)		
	Passenger Cars	Single Unit Trucks	Combination Trucks	Passenger Cars	Single Unit Trucks	Combination Trucks
0	0	0	0	0	0	0
5	1.02	0.73	1.1	2.7	9.25	33.62
10	1.51	1.47	2.27	8.83	20.72	77.49
15	2	2.2	3.48	15.16	33.89	129.97
20	2.49	2.93	4.76	21.74	48.4	190.06
25	2.98	3.67	6.1	28.67	63.97	256.54
30	3.46	4.4	7.56	36.1	80.23	328.21
35	3.94	5.13	9.19	44.06	96.88	403.84
40	4.42	5.87	11.09	52.7	113.97	482.21
45	4.9	6.6	13.39	62.07	130.08	562.14
50	5.37	7.33	16.37	72.31	145.96	642.41
55	5.84	8.07	20.72	83.47	160.89	721.77
60	6.31	8.8	27.94	95.7	178.98	798.99
65	6.78	9.53	31.605	109.02	195.84	849.64
70	7.25	10.27	39.48	123.61	209.06	921.03
75	7.71	11	47.9	139.53	224.87	992.42
80	8.17	11.73	57.68	156.85	240.68	1063.82

Cost Escalation

Base Transp. Component CPI: 142.8

Base Year: 1996

Current Transp. Component CPI: 142.8

Current Year: 1996

Escalation Factor: 1.00

Escalate

Idling Cost per Veh-Hr (\$): 0.6927 0.7681 0.8248

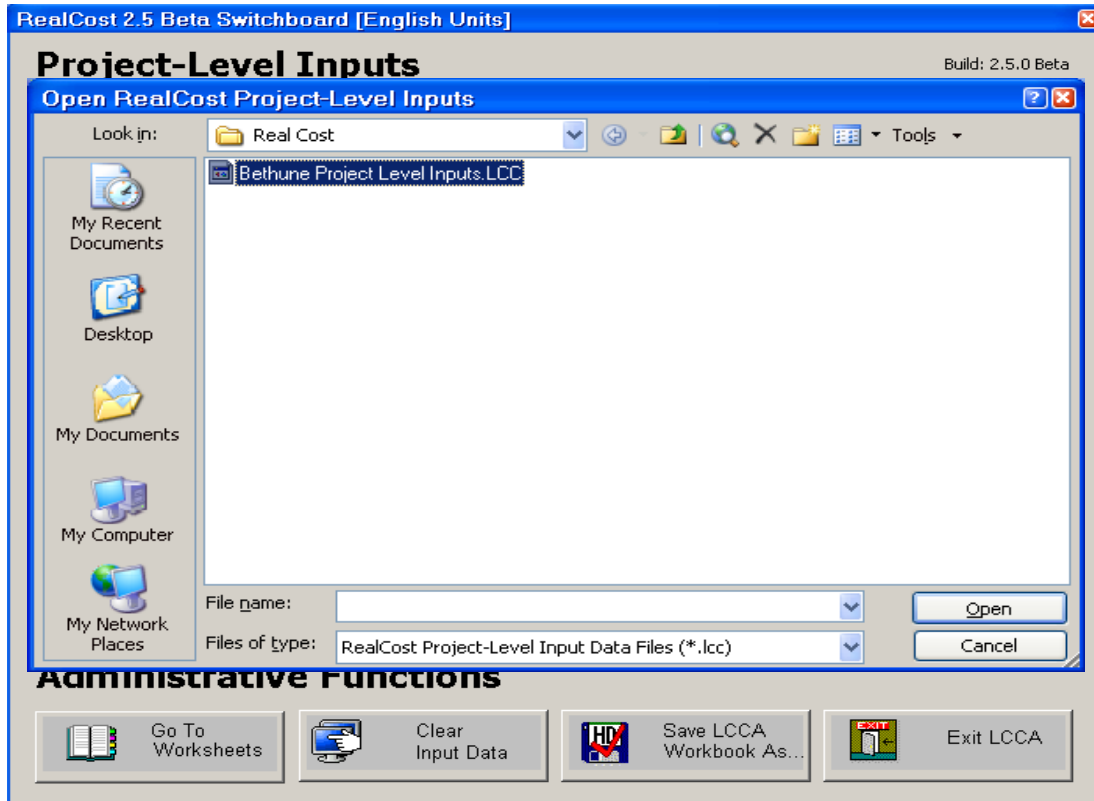
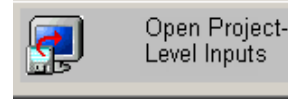
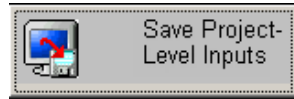
Restore Defaults Ok

**Table 13.12 Added Time and Vehicle Stopping Costs Screen**

### 13.7.9 Saving and Opening Project-Level Inputs

The last two buttons in the project level input section of the Switchboard (see **Figure 13.25 Saving and Opening Project Level Inputs**) are used to save and to retrieve (load) project-level inputs. Project-level inputs are saved in a small, comma-delimited file. This file may be named via ordinary Windows conventions and is automatically saved with the \*.LCC extension. Changing the file extension will prevent RealCost from recognizing the file. **Note:** Alternative level inputs are saved separately from project-level inputs. The mechanism to save and open alternative level inputs is found on the ‘Alternative 1’ and ‘Alternative 2’ forms.

**Warning:** Opening an \*.LCC file will overwrite data in the ‘Project-Level Inputs’ section.



**Table 13.13 Saving and Opening Project Level Inputs**

**Table 13.14 Number of Projects in the Study**

<b>Rehabilitation Technique</b>	<b>Components</b>	<b>Number of Projects</b>
Heater Remixing	Process Mat	49
	Rejuvenating Agent	45
	Hydrating Lime	30
Heater Scarifying	Process Mat	19
	Rejuvenating Agent	17
Full Depth Reclamation (FDR)	-	54
Hot Mix Asphalt Overlay < 10,000 tons	All projects	84
	SX(100) PG 64-28	22
	SX(100) PG 64-22	34
	SX(100) PG 58-28	7
	SX(100) PG 76-28	7
	Furnish HMA	7
Hot Mix Asphalt Overlay > 10,000 tons	All projects	121
	SX(100) PG 64-22	36
	SX(100) PG 76-28	11
	SX(100) PG 58-28	11
	SX(100) PG 64-28	8
	SX(75)	21
Hot Mix Asphalt Mill and Fill < 10,000 tons	All projects	51
	SX(100) PG 64-22	15
	SX(100) PG 76-28	17
	SX(75) PG 58-28	7
Hot Mix Asphalt Mill and Fill > 10,000 tons	All projects	63
	SX(100) PG 64-22	10
	SX(75) PG 58-28	20
	SX(100) PG 64-28	5
	SX(100) PG 58-34	4
	SMA	13
Portland Cement Concrete Pavement < 10,000 square yards	All projects	184
Portland Cement Concrete Pavement > 10,000 square yards	All projects	67
<b>Total</b>		<b>692</b>

**Table 13.15 Results of Heater Remixing**

	<b>Item</b>	<b>Amount</b>
Process Mat	Number of Projects	49
	Total Square Yards	10,448,936
	Total Normalized Dollar Amount	\$35,675,622
	Normalized Average per Square Yard	\$3.41
Rejuvenating Agent	Number of Projects	45
	Total Gallons	698,230
	Total Normalized Dollar Amount	\$1,243,166
	Normalized Average per Gallon	\$45.45
Furnish HMA	Number of Projects	30
	Total Tons	115,302
	Total Normalized Dollar Amount	\$5,330,720
	Normalized Average per Ton	\$1.78

**Table 13.16 Results of Heater Scarifying**

	<b>Item</b>	<b>Amount</b>
Process Mat	Number of Projects	19
	Total Square Yards	3,676,832
	Total Normalized Dollar Amount	\$3,785,756
	Normalized Average per Square Yard	\$1.03
Rejuvenating Agent	Number of Projects	17
	Total Gallons	288,676
	Total Normalized Dollar Amount	\$388,644
	Normalized Average per Gallon	\$1.35

**Table 13.17 Results of Full Depth Reclamation**

<b>Item</b>	<b>Amount</b>
Number of Projects	22
Total Square Yards	2,033,398
Total Normalized Dollar Amount	\$3,992,506
Normalized Average per Square Yard	\$1.80

**Table 13.18 Cold In-Place Recycling**

	<b>Item</b>	<b>Amount</b>
All projects	Number of Projects	25
	Total Square Yards	4,809,986
	Total Normalized Dollar Amount	\$3,785,756
	Normalized Average per Square Yard	\$1.43
Rejuvenating Agent	Number of Projects	20
	Total Gallons	5,159,599
	Total Normalized Dollar Amount	\$10,037,689
	Normalized Average per Gallon	\$1.64
Hydrated Lime	Number of Projects	23
	Total Tons	15,876
	Total Normalized Dollar Amount	\$1,594,706
	Normalized Average per Ton	\$100.45

**Table 13.19 PCCP Projects Less Than 10,000 Square Yards**

	<b>Item</b>	<b>Amount</b>
All projects	Number of Projects	184
	Total Square Yards	383,088
	Total Normalized Dollar Amount	\$24,650,614
	Normalized Average per Square Yard	\$64.35
6 to 7 inches	Number of Projects	42
	Total Square Yards	31,569
	Total Normalized Dollar Amount	\$1,161,058
	Normalized Average per Square Yard	\$36.78
7 to 8 inches	Number of Projects	1
	Total Square Yards	5,917
	Total Normalized Dollar Amount	\$172,757
	Normalized Average per Square Yard	\$29.20
8 to 9 inches	Number of Projects	29
	Total Square Yards	55,627
	Total Normalized Dollar Amount	\$3,206,541
	Normalized Average per Square Yard	\$57.64
9 to 10 inches	Number of Projects	30
	Total Square Yards	81,124
	Total Normalized Dollar Amount	\$5,771,991
	Normalized Average per Square Yard	\$71.15
10 to 11 inches	Number of Projects	33
	Total Square Yards	84,032
	Total Normalized Dollar Amount	\$6,172,580
	Normalized Average per Square Yard	\$73.46

11 to 12 inches	Number of Projects	24
	Total Square Yards	58,018
	Total Normalized Dollar Amount	\$4,330,870
	Normalized Average per Square Yard	\$74.65
12 or greater inches	Number of Projects	19
	Total Square Yards	55,623
	Total Normalized Dollar Amount	2,895,314
	Normalized Average per Square Yard	\$52.04

**Table 13.20 PCCP Projects Greater Than 10,000 Square Yards**

	Item	Amount
All projects	Number of Projects	67
	Total Square Yards	3,599,664
	Total Normalized Dollar Amount	\$131,056,876
	Normalized Average per Square Yard	\$36.41
4 to 7 inches	Number of Projects	3
	Total Square Yards	300,164
	Total Normalized Dollar Amount	\$6,576,434
	Normalized Average per Square Yard	\$21.91
8 to 9 inches	Number of Projects	10
	Total Square Yards	253,232
	Total Normalized Dollar Amount	\$11,911,473
	Normalized Average per Square Yard	\$47.04
9 to 10 inches	Number of Projects	17
	Total Square Yards	487,941
	Total Normalized Dollar Amount	\$22,002,017
	Normalized Average per Square Yard	\$45.09
10 to 11 inches	Number of Projects	10
	Total Square Yards	359,992
	Total Normalized Dollar Amount	\$12,380,592
	Normalized Average per Square Yard	\$34.39
11 to 12 inches	Number of Projects	7
	Total Square Yards	482,129
	Total Normalized Dollar Amount	\$18,558,033
	Normalized Average per Square Yard	\$38.49
12 or greater inches	Number of Projects	13
	Total Square Yards	978,159
	Total Normalized Dollar Amount	\$37,517,776
	Normalized Average per Square Yard	\$38.36

**Table 13.21 HMA Overlay Projects Less Than 10,000 Tons**

	<b>Item</b>	<b>Amount</b>
All projects	Number of Projects	84
	Total Tons	328,045
	Total Normalized Dollar Amount	\$26,368,555
	Normalized Average per Ton	\$79.79
SX(100) PG 64-28	Number of Projects	22
	Total Tons	65,638
	Total Normalized Dollar Amount	\$5,736,291
	Normalized Average per Ton	\$87.39
SX(100) PG 64-22	Number of Projects	34
	Total Tons	169,785
	Total Normalized Dollar Amount	\$12,741,234
	Normalized Average per Ton	\$82.66
SX(100) PG 58-28	Number of Projects	7
	Total Tons	37,083
	Total Normalized Dollar Amount	\$2,477,618
	Normalized Average per Ton	\$66.81
SX(100) PG 76-28	Number of Projects	7
	Total Tons	32,173
	Total Normalized Dollar Amount	\$2,330,107
	Normalized Average per Ton	\$72.42
Furnish HMA	Number of Projects	7
	Total Tons	23,435
	Total Normalized Dollar Amount	\$1,496,769
	Normalized Average per Ton	\$63.87

**Table 13.22 HMA Overlay Projects Less Than 10,000 Tons**

	<b>Item</b>	<b>Amount</b>
All projects	Number of Projects	121
	Total Tons	4,282,222
	Total Normalized Dollar Amount	\$248,255,441
	Normalized Average per Ton	\$57.97
SX(100) PG 64-28	Number of Projects	9
	Total Tons	196,537
	Total Normalized Dollar Amount	\$10,871,686
	Normalized Average per Ton	\$55.32
SX(100) PG 64-22	Number of Projects	36
	Total Tons	1,210,798
	Total Normalized Dollar Amount	\$68,523,424
	Normalized Average per Ton	\$56.59



SX(100) PG 58-28	Number of Projects	11
	Total Tons	416,493
	Total Normalized Dollar Amount	\$30,887,680
	Normalized Average per Ton	\$74.16
SX(100) PG 76-28	Number of Projects	11
	Total Tons	416,493
	Total Normalized Dollar Amount	\$30,887,680
	Normalized Average per Ton	\$79.73
SX (75)	Number of Projects	21
	Total Tons	719,034
	Total Normalized Dollar Amount	\$23,675,171
	Normalized Average per Ton	\$32.93

**Table 13.23 HMA Mill and Fill for Projects Greater Than 10,000 Tons**

	<b>Item</b>	<b>Amount</b>
All projects	Number of Projects	51
	Total Tons	212,732
	Total Normalized Dollar Amount	\$16,296,645
	Normalized Average per Ton	\$76.61
SX(100) PG 64-22	Number of Projects	15
	Total Tons	28,333
	Total Normalized Dollar Amount	\$2,418,438
	Normalized Average per Ton	\$85.36
SX(100) PG 58-28	Number of Projects	7
	Total Tons	21,216
	Total Normalized Dollar Amount	2,730,082
	Normalized Average per Ton	\$128.68
SX(100) PG 76-28	Number of Projects	17
	Total Tons	110,791
	Total Normalized Dollar Amount	\$7,000,071
	Normalized Average per Ton	\$63.18

**Table 13.24 HMA Mill and Fill for Projects Greater Than 10,000 Tons**

	<b>Item</b>	<b>Amount</b>
All projects	Number of Projects	63
	Total Tons	1,751,060
	Total Normalized Dollar Amount	\$127,667,932
	Normalized Average per Ton	\$72.56
SX(100) PG 58-34	Number of Projects	4
	Total Tons	95,697
	Total Normalized Dollar Amount	\$8,251,056
	Normalized Average per Ton	\$86.22
SX(100) PG 64-22	Number of Projects	5
	Total Tons	136,753
	Total Normalized Dollar Amount	\$9,562,261
	Normalized Average per Ton	\$69.92
SX(100) PG 58-28	Number of Projects	21
	Total Tons	688,657
	Total Normalized Dollar Amount	\$48,738,394
	Normalized Average per Ton	\$70.77
SX(100) PG 76-28	Number of Projects	10
	Total Tons	207,138
	Total Normalized Dollar Amount	\$12,558,276
	Normalized Average per Ton	\$60.63
SMA	Number of Projects	13
	Total Tons	345,467
	Total Normalized Dollar Amount	\$30,229,383
	Normalized Average per Ton	\$87.50

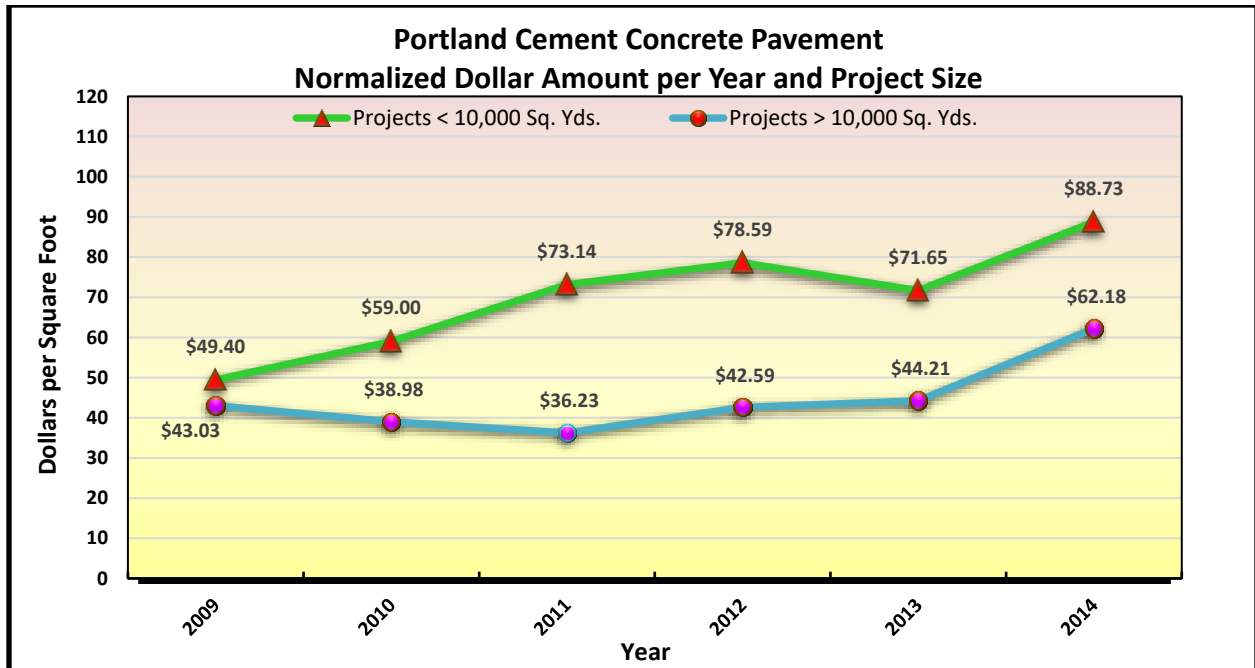


Figure 13.21 PCCP Normalized Dollar Amount per Year

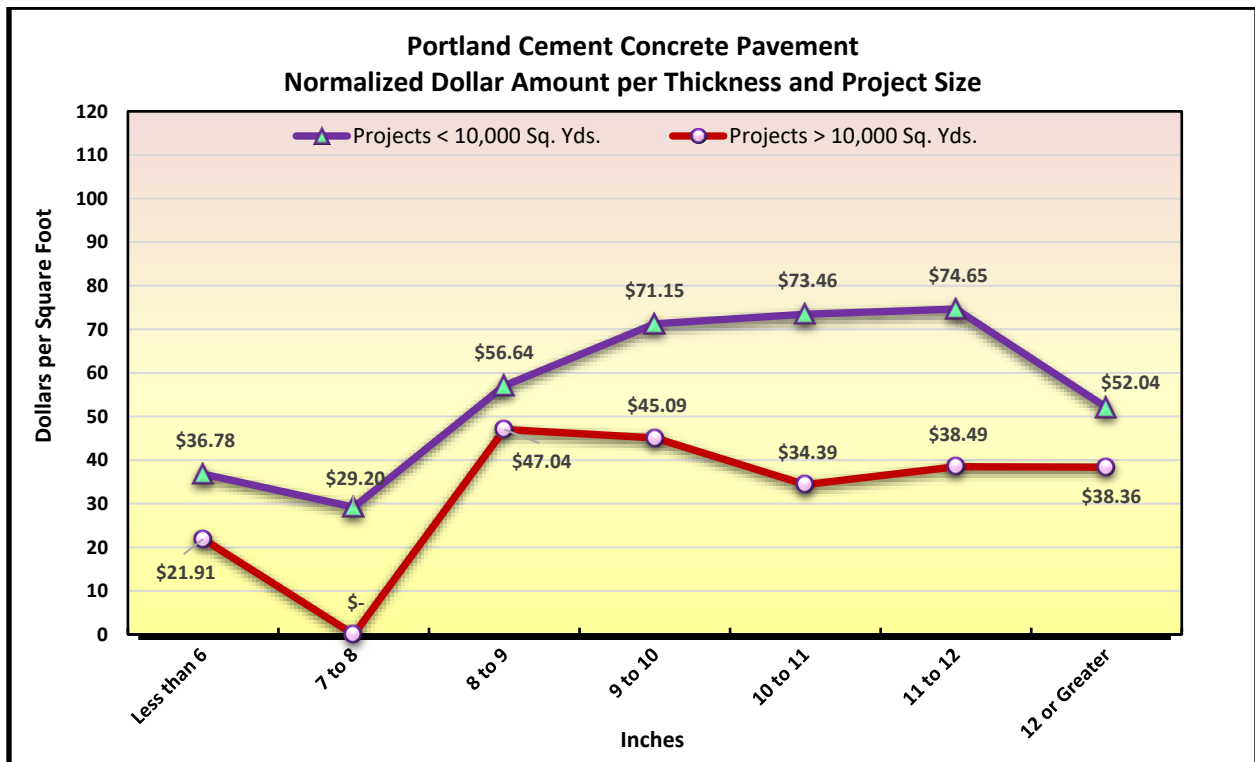


Figure 13.22 PCCP Normalized Dollar Amount per Thickness

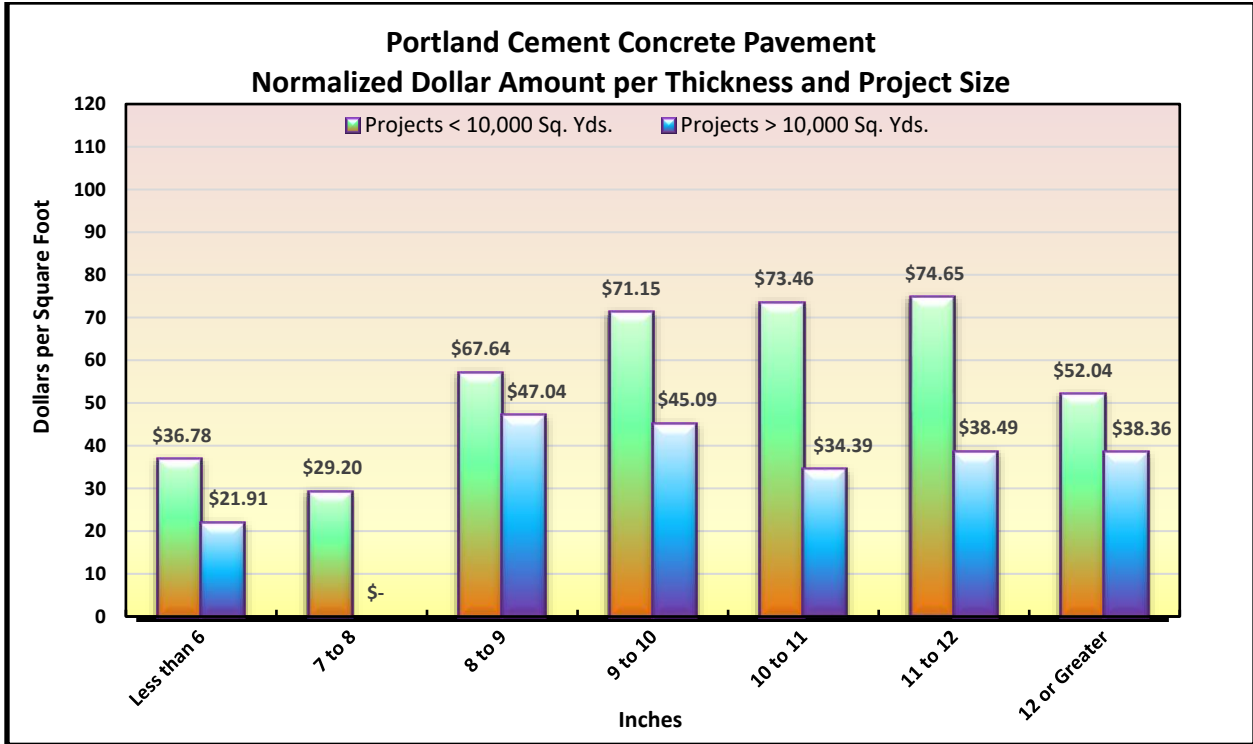


Figure 13.23 PCCP Normalized Dollar Amount per Thickness

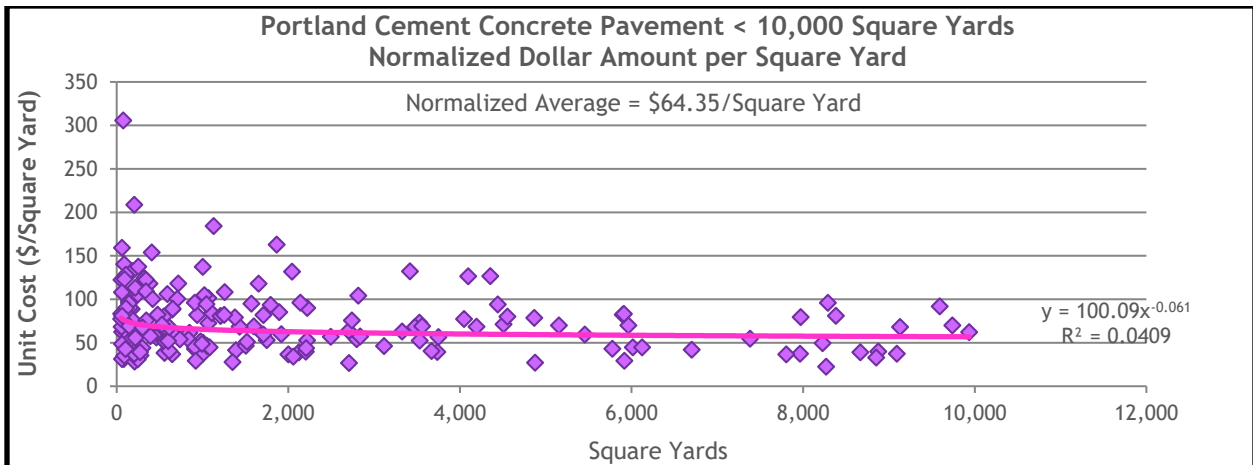
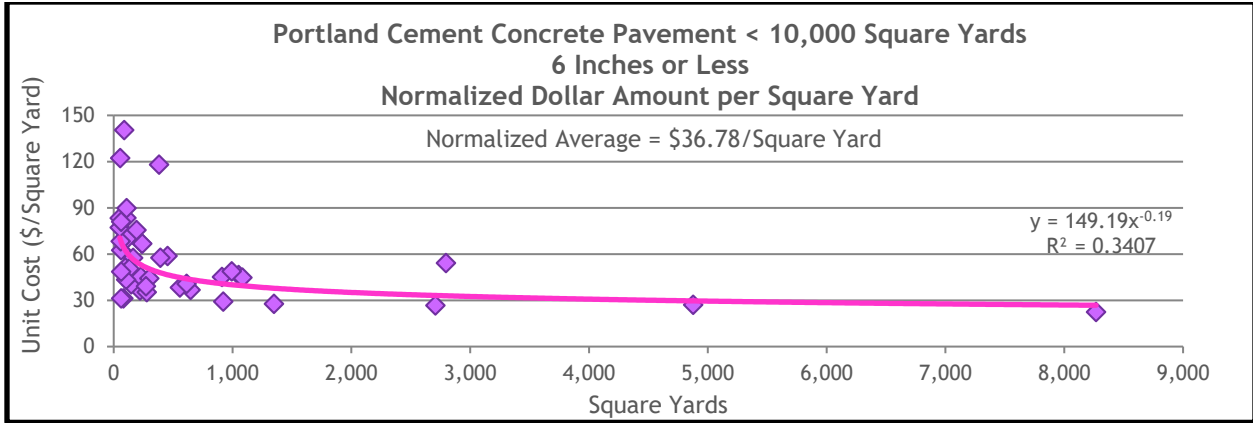
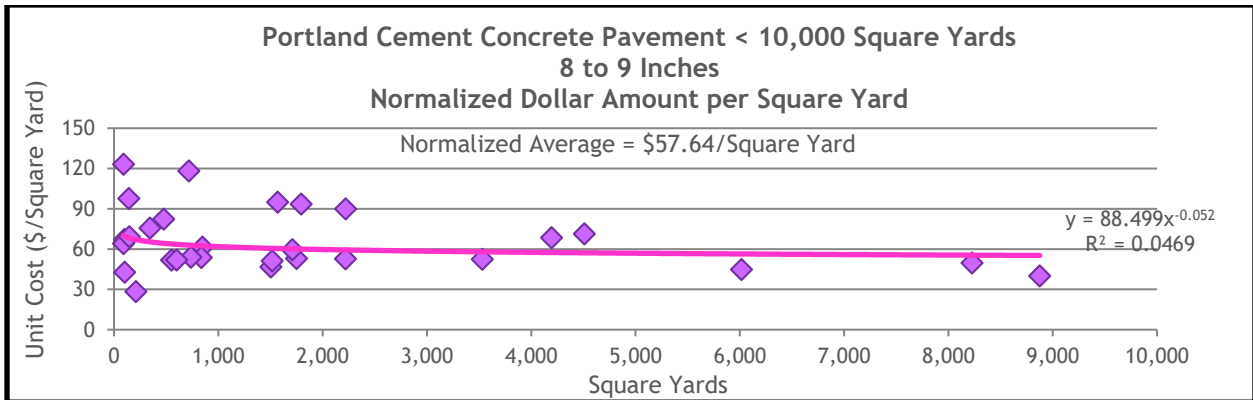


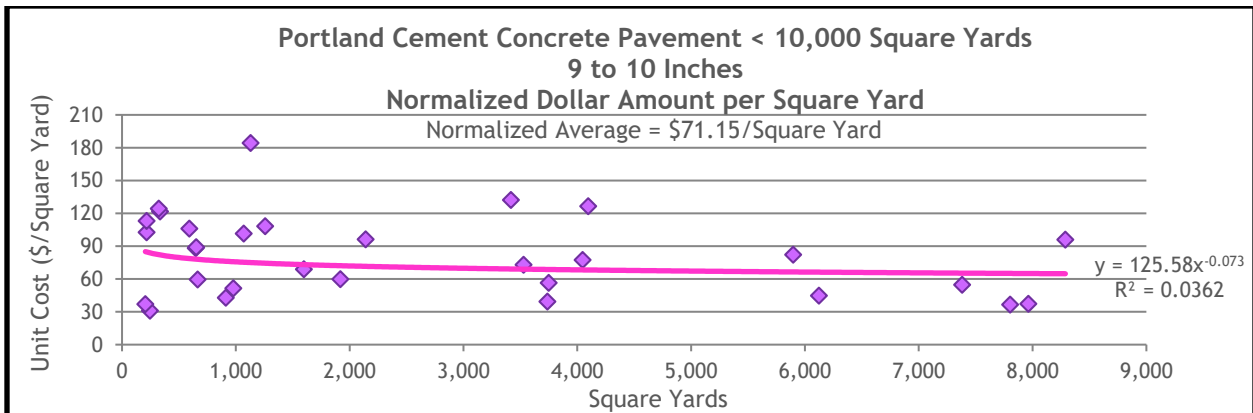
Figure 13.24 PCCP Normalized Dollar Amount per Total Square Yards for Projects Less Than 10,000 Square Yards



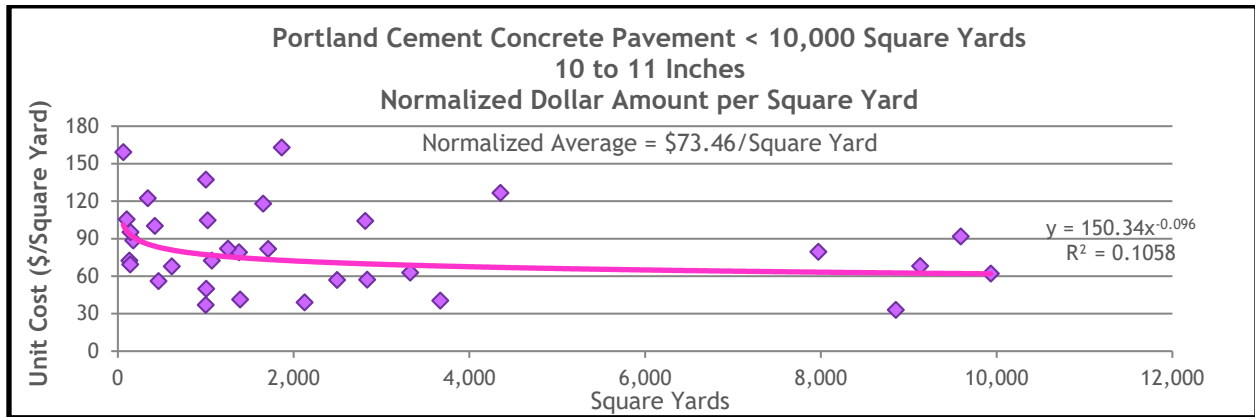
**Figure 13.25 PCCP Normalized Dollar Amount for Projects of 6 Inches or Less in Thickness and Less Than 10,000 Square Yards in Size**



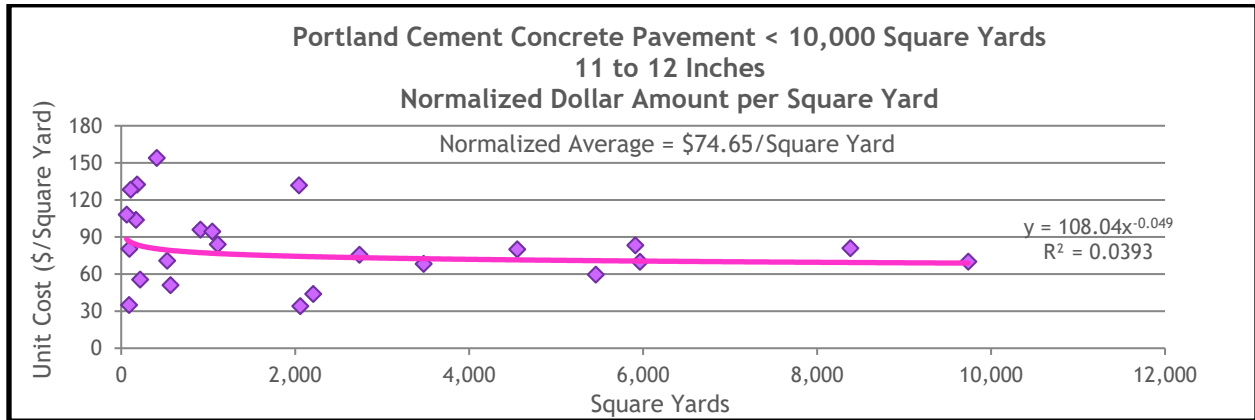
**Figure 13.26 Normalized Dollar Amount for Projects of 8 to 9 Inches in Thickness and Less Than 10,000 Square Yards in Size**



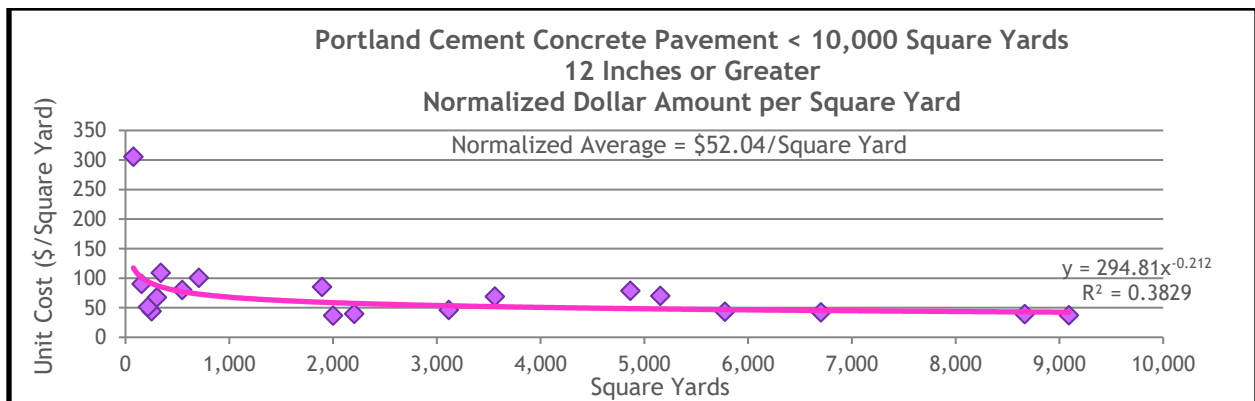
**Figure 13.27 Normalized Dollar Amount for Projects of 9 to 10 Inches in Thickness and Less Than 10,000 Square Yards in Size**



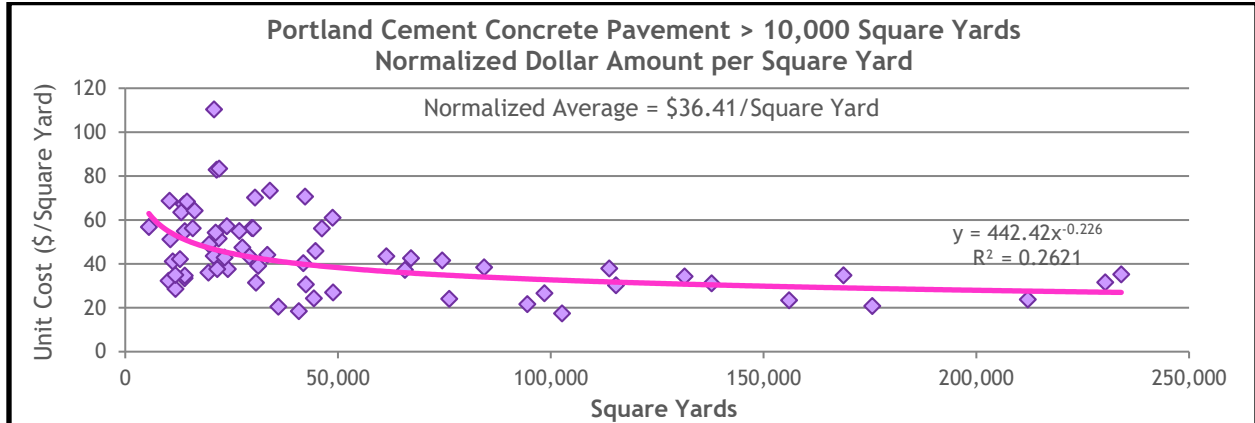
**Figure 13.28 PCCP Normalized Dollar Amount for Projects of 10 to 11 Inches in Thickness and Less Than 10,000 Square Yards in Size**



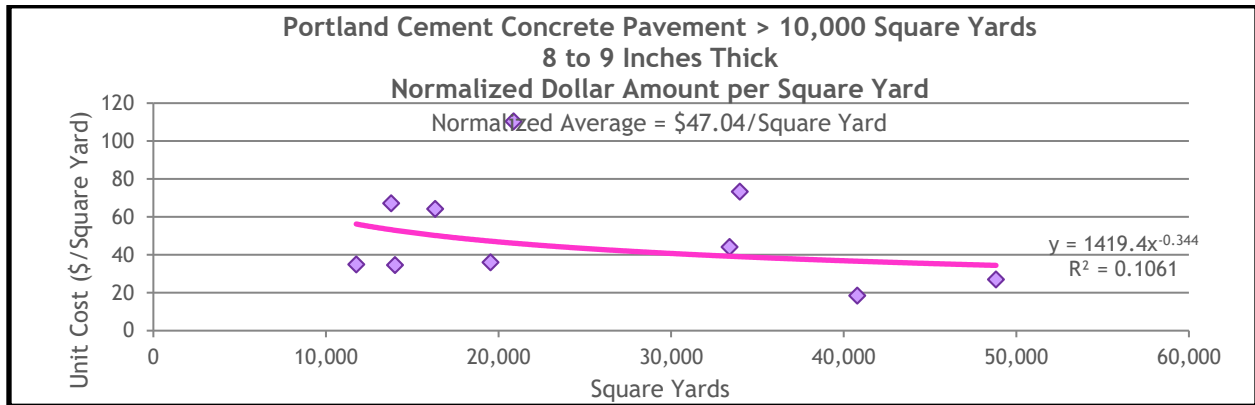
**Figure 13.29 PCCP Normalized Dollar Amount for Projects of 11 to 12 Inches in Thickness and Less Than 10,000 Square Yards in Size**



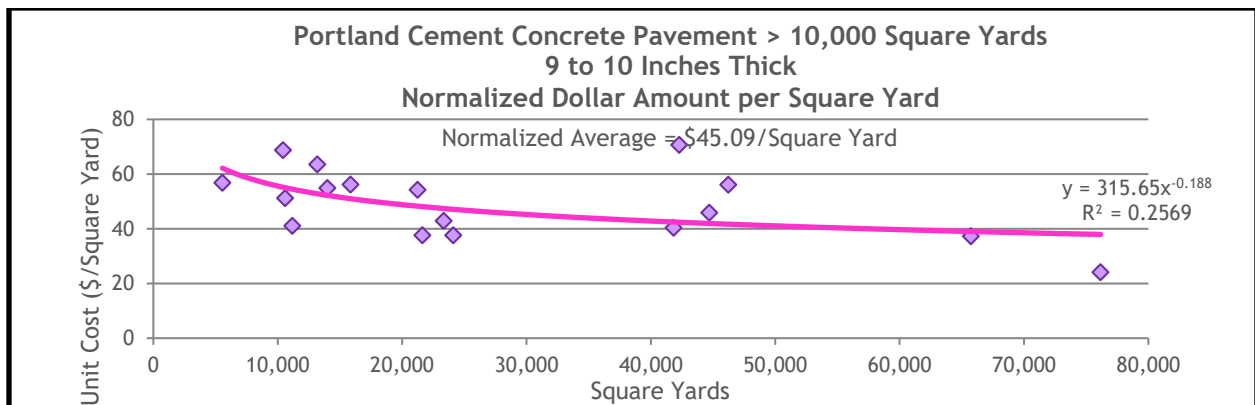
**Figure 13.30 PCCP Normalized Dollar Amount for Projects of 12 Inches or Greater in Thickness and Less Than 10,000 Square Yards in Size**



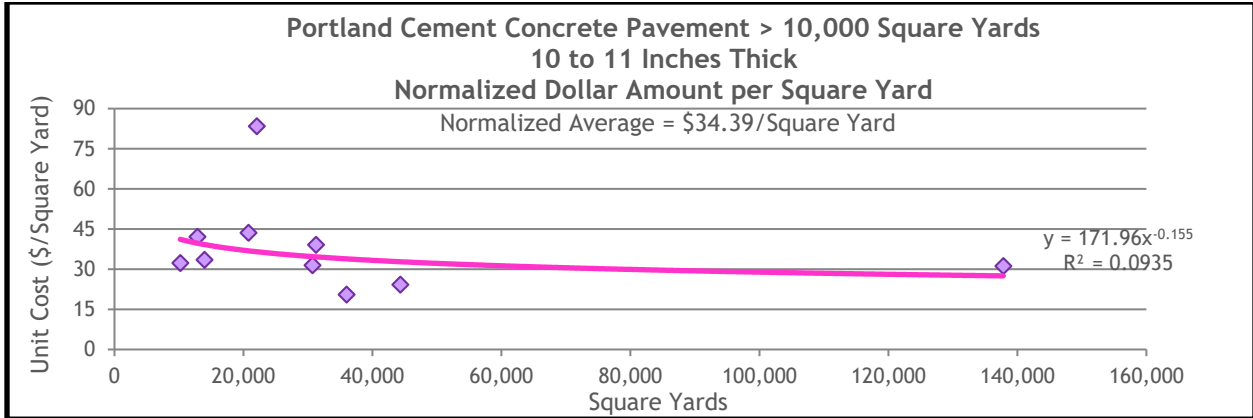
**Figure 13.31 PCCP Normalized Dollar Amount per Total Square Yards for Projects Greater Than 10,000 Square Yards**



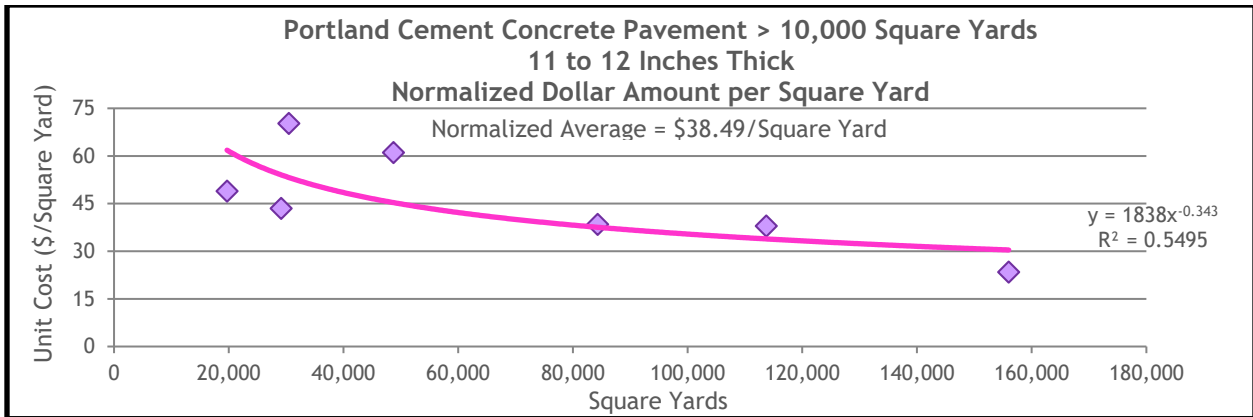
**Figure 13.32 PCCP Normalized Dollar Amount for Projects of 8 to 9 Inches in Thickness and Greater Than 10,000 Square Yards in Size**



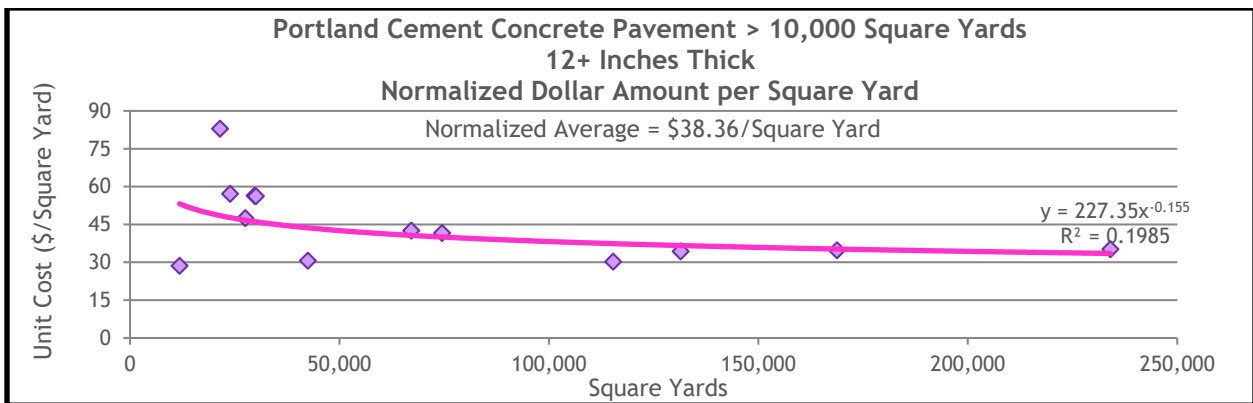
**Figure 13.33 PCCP Normalized Dollar Amount for Projects of 9 to 10 Inches in Thickness and Greater Than 10,000 Square Yards in Size**



**Figure 13.34 Normalized Dollar Amount for Projects of 10 to 11 Inches in Thickness and Greater Than 10,000 Square Yards in Size**

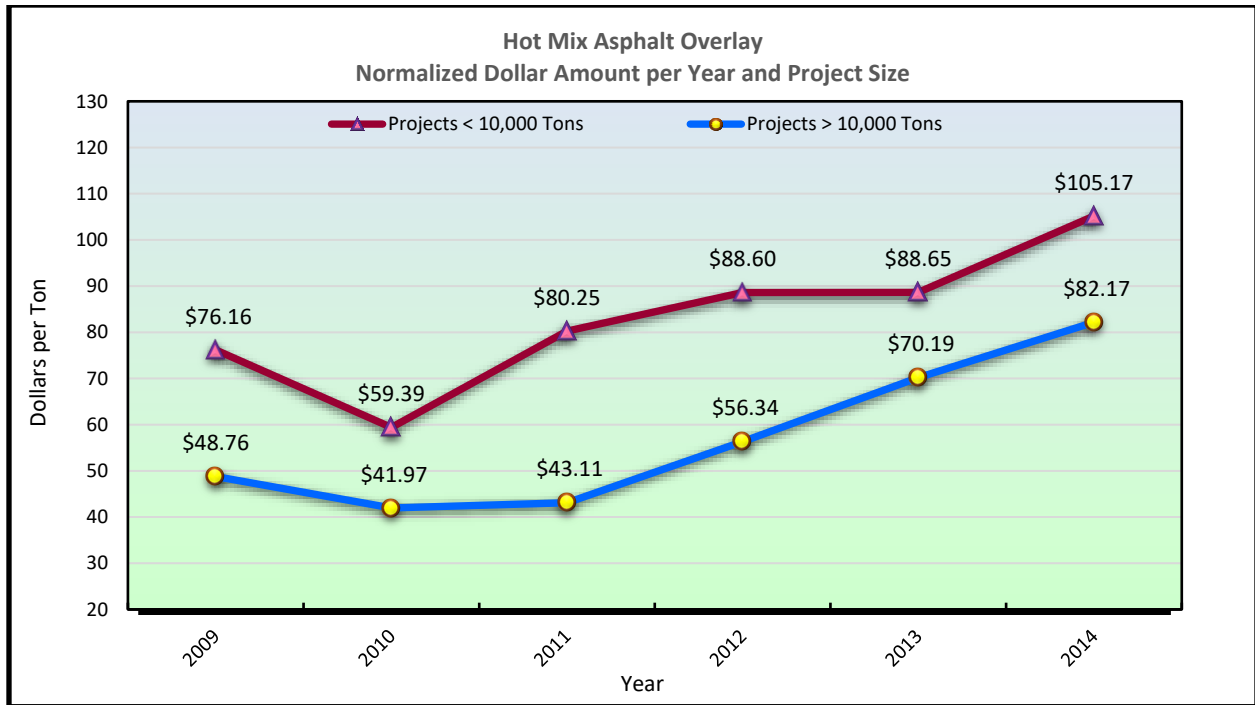


**Figure 13.35 PCCP Normalized Dollar Amount for Projects of 11 to 12 Inches in Thickness and Greater Than 10,000 Square Yards in Size**

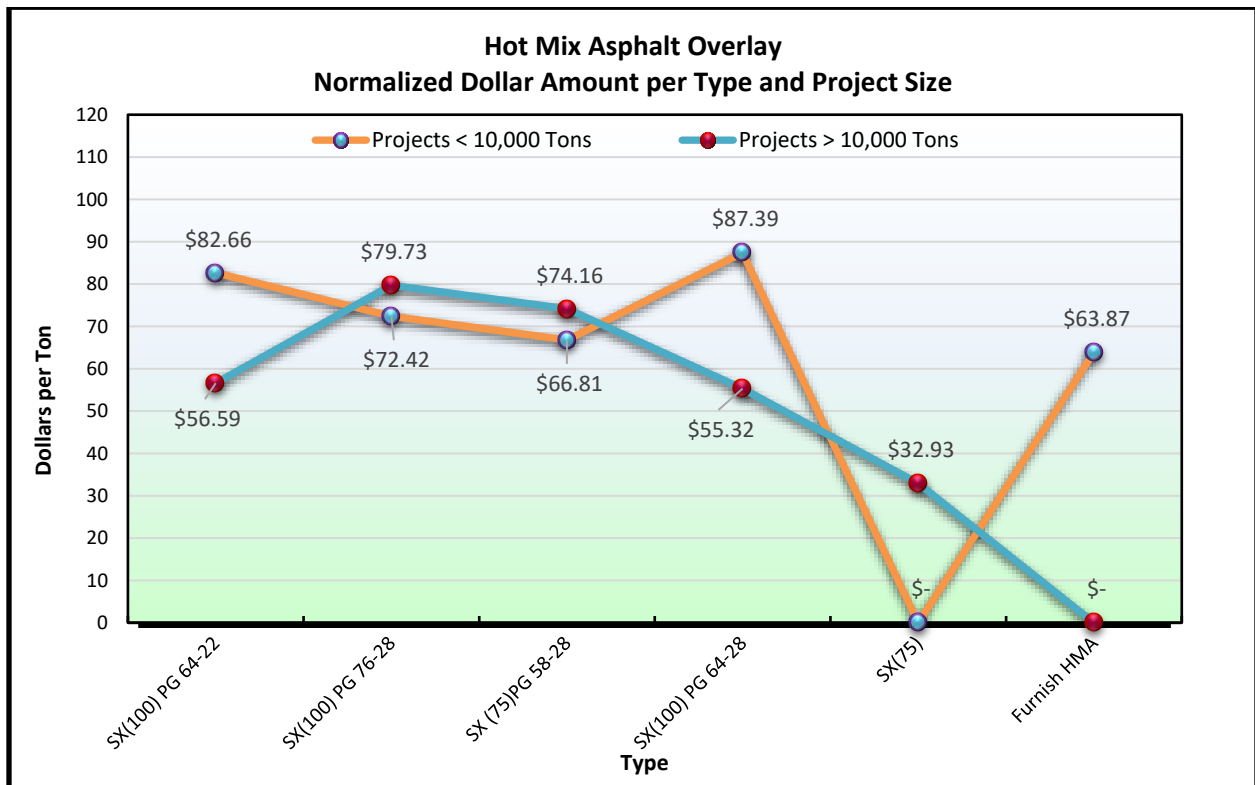


**Figure 13.36 PCCP Normalized Dollar Amount for Projects of 12 Inches or Greater in Thickness and Greater Than 10,000 Square Yards in Size**





**Figure 13.37 HMA Overlay Normalized Dollar per Year and Project Size**



**Figure 13.38 HMA Overlay Normalized Dollar per Product Type and Project Size**

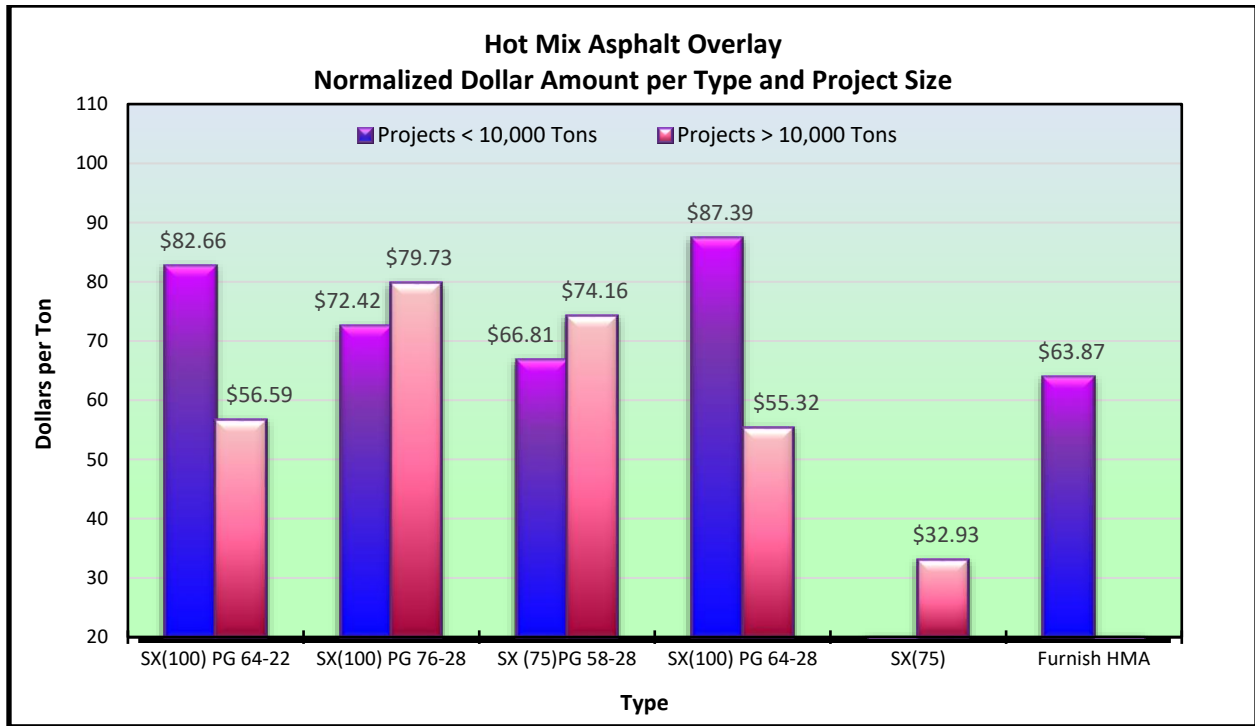


Figure 13.39 HMA Overlay Normalized Dollar per Product Type and Project Size

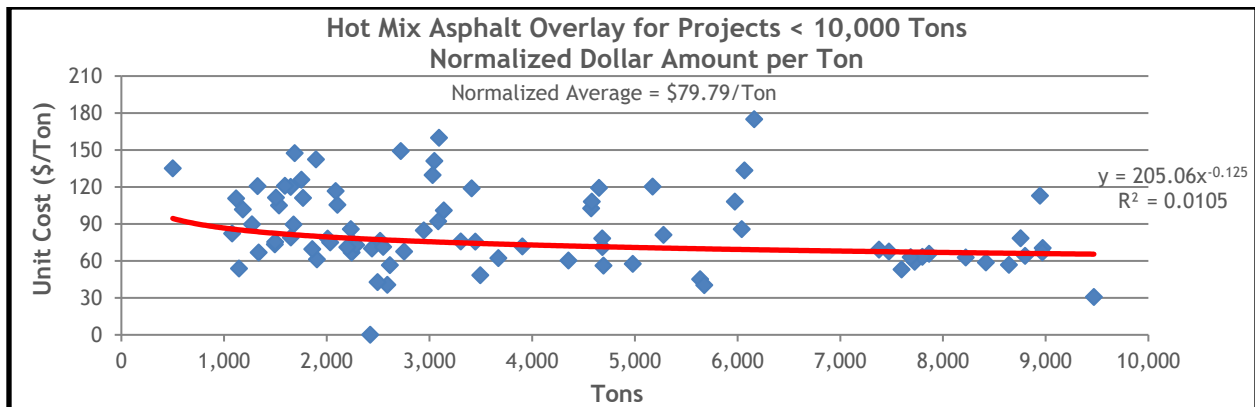
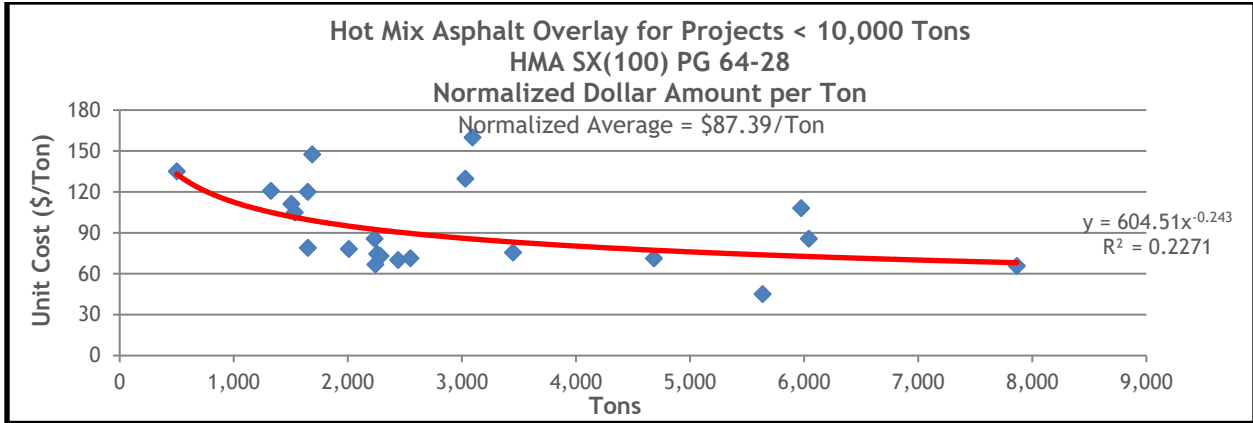
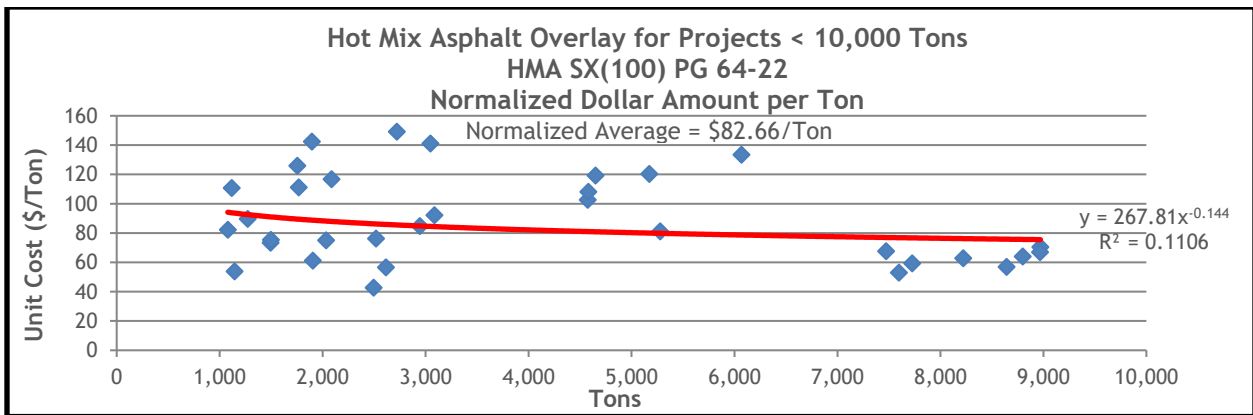


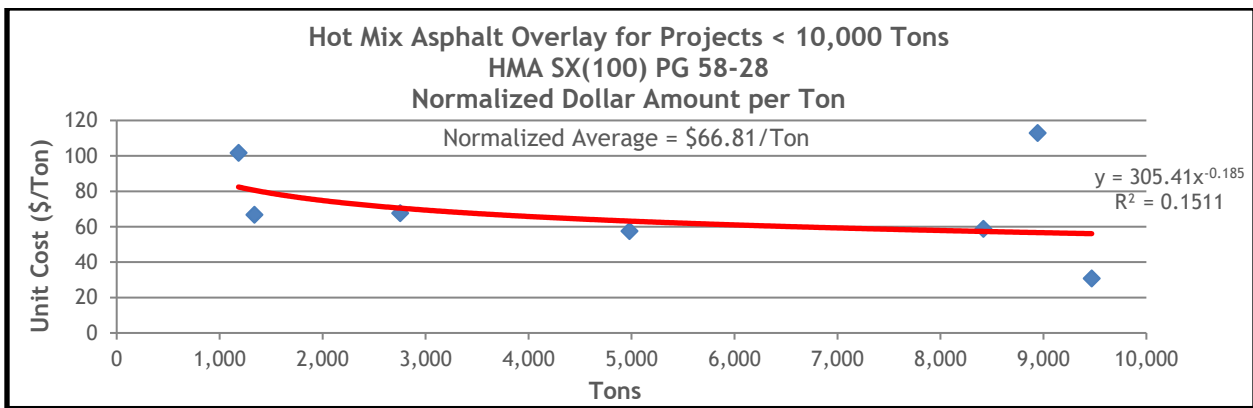
Figure 13.40 HMA Overlay Normalized Dollar Amount for Projects Less Than 10,000 Tons



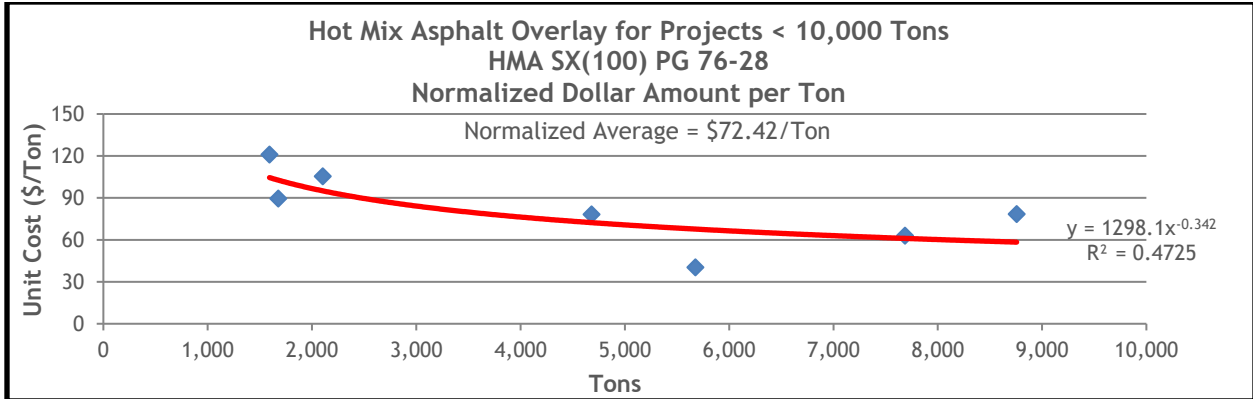
**Figure 13.41 HMA Overlay Normalized Unit Costs for SX(100) PG 64-28 on Projects Less Than 10,000 Tons**



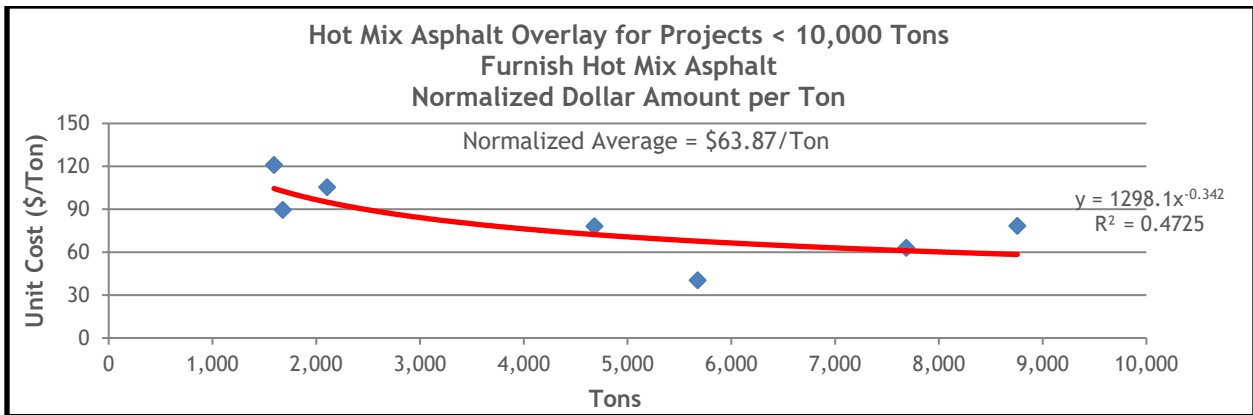
**Figure 13.42 HMA Overlay Normalized Unit Costs for SX(100) PG 64-22 on Projects Less Than 10,000 Tons**



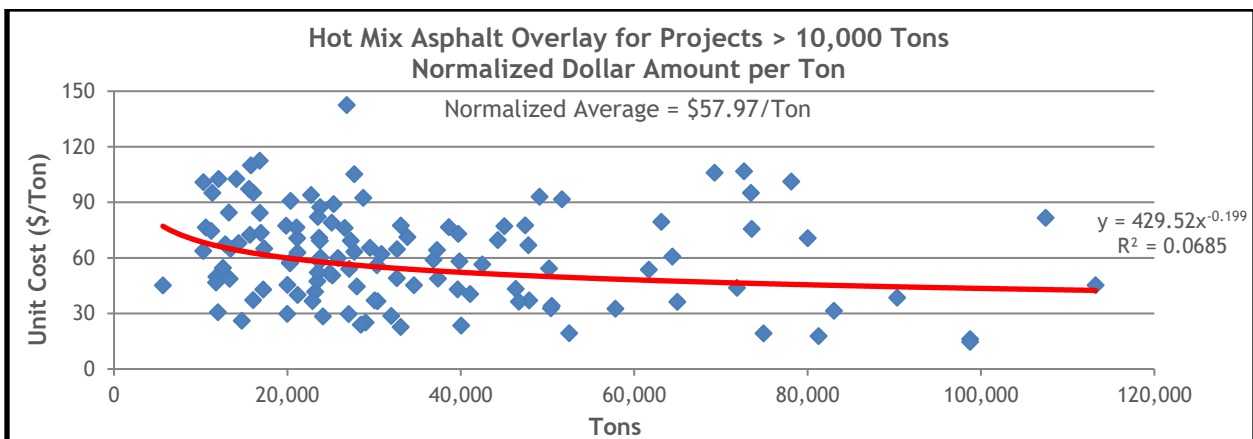
**Figure 13.43 HMA Overlay Normalized Unit Costs for SX(100) PG 58-28 on Projects Less Than 10,000 Tons**



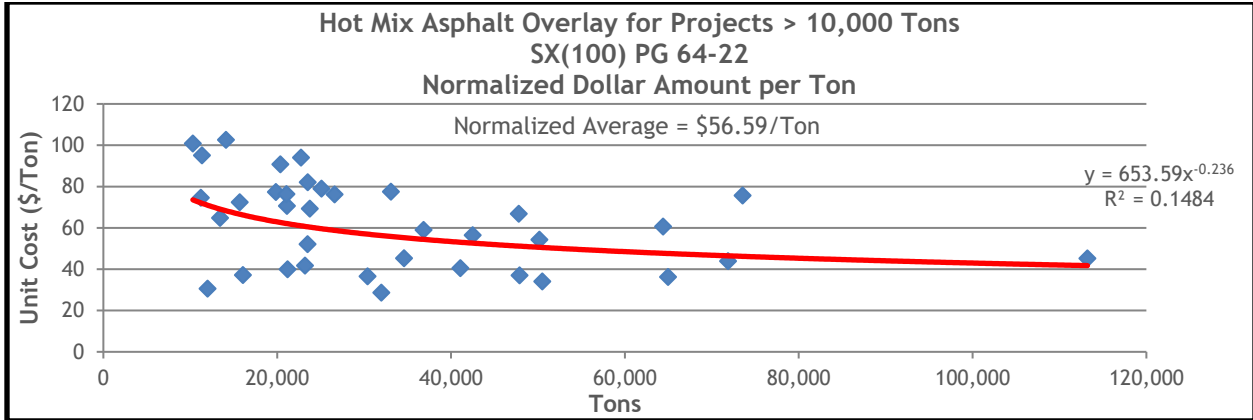
**Figure 13.44 HMA Overlay Normalized Unit Costs for SX(100) PG 76-28 on Projects Less Than 10,000 Tons**



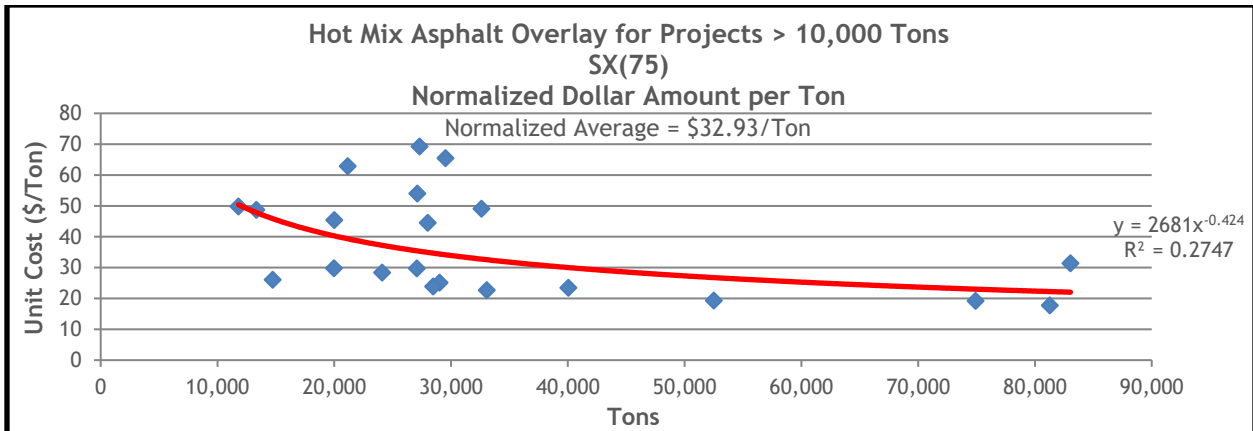
**Figure 13.45 HMA Overlay Normalized Unit Costs for Furnish HMA on Projects Less Than 10,000 Tons**



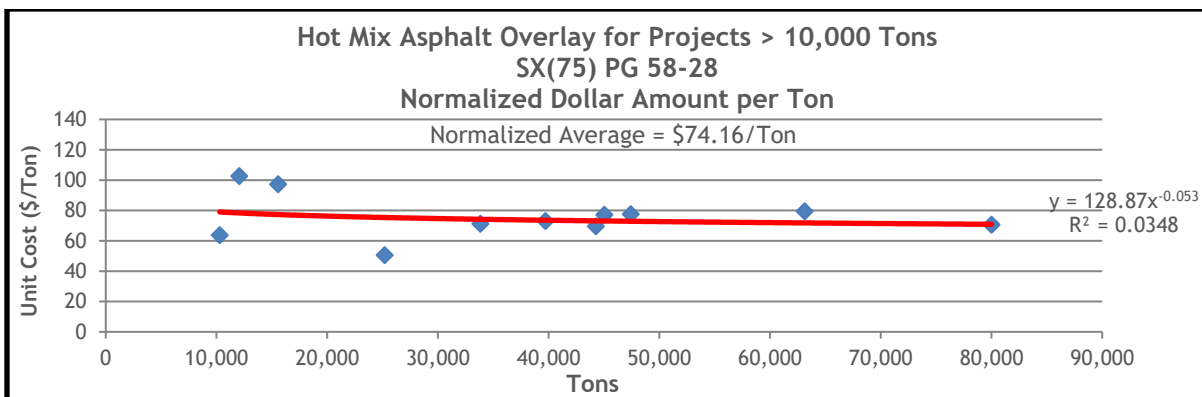
**Figure 13.46 HMA Overlay Normalized Unit Costs for Projects with Greater Than 10,000 Tons**



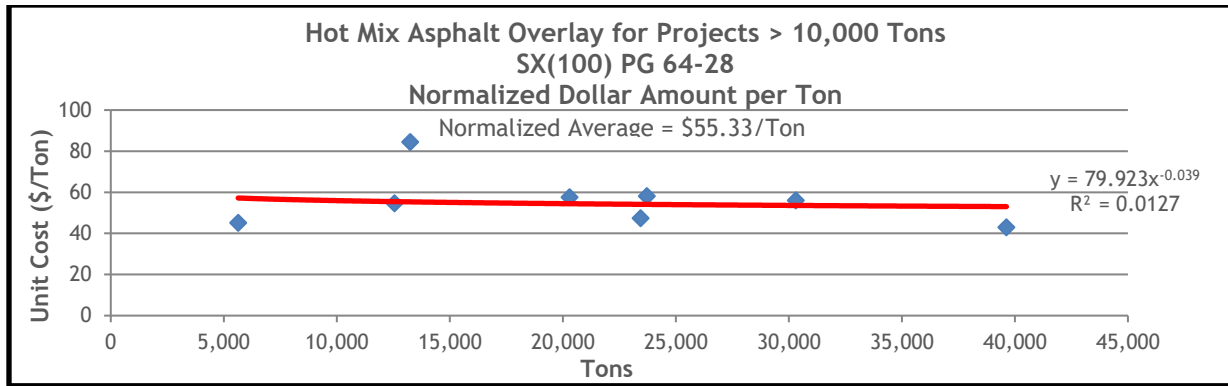
**Figure 13.47 HMA Overlay Normalized Unit Costs for SX(100) PG 64-22 on Projects Greater Than 10,000 Tons**



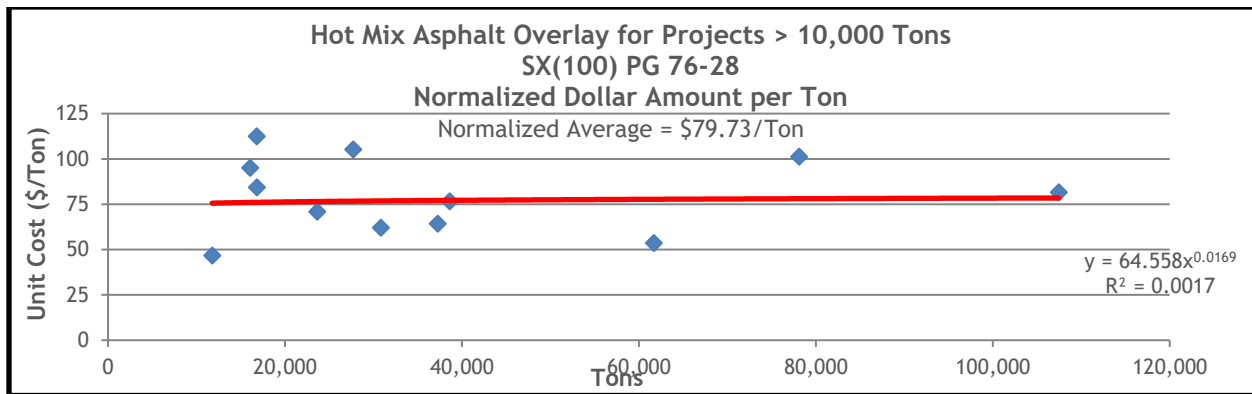
**Figure 13.48 HMA Overlay Normalized Unit Costs for SX(75) on Projects Greater Than 10,000 Tons**



**Figure 13.49 HMA Overlay Normalized Unit Costs for SX(100) PG 58-28 on Projects Greater Than 10,000 Tons**



**Figure 13.50 HMA Overlay Normalized Unit Costs for SX(100) PG 64-28 on Projects Greater Than 10,000 Tons**



**Figure 13.51 HMA Overlay Normalized Unit Costs for SX(100) PG 76-28 on Projects Greater Than 10,000 Tons**

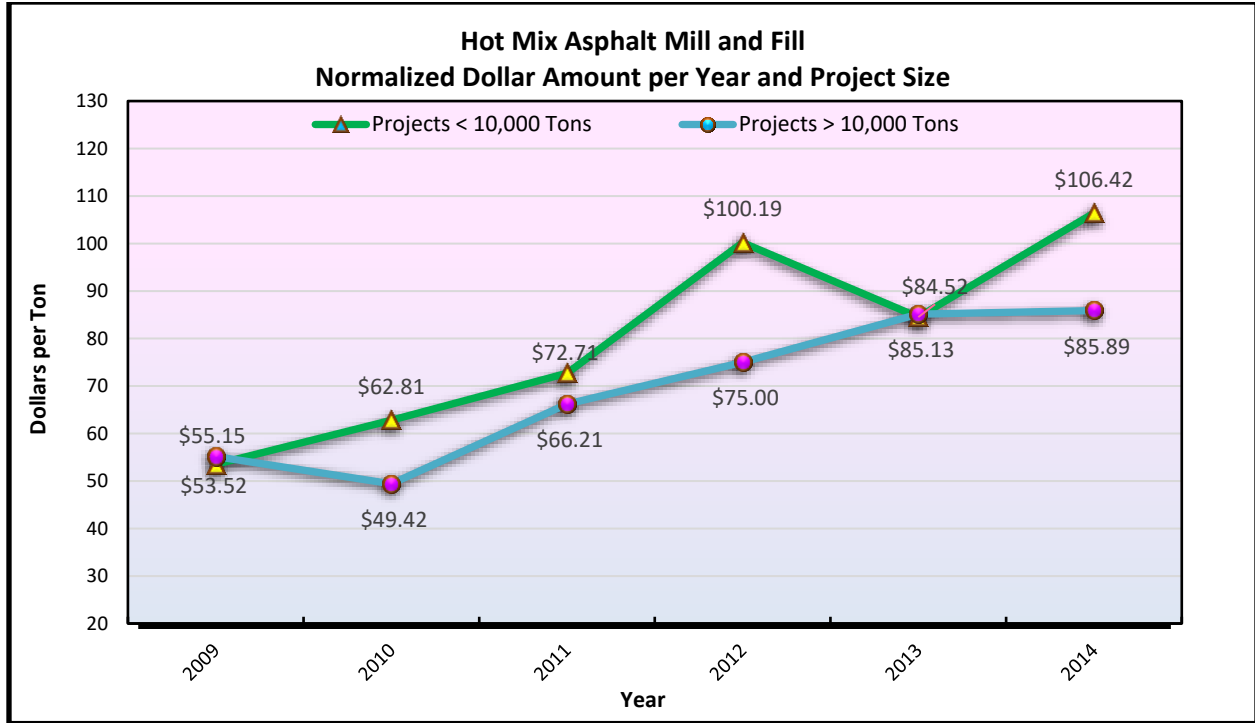


Figure 13.52 HMA Mill and Fill Normalized Dollar per Year and Project Size

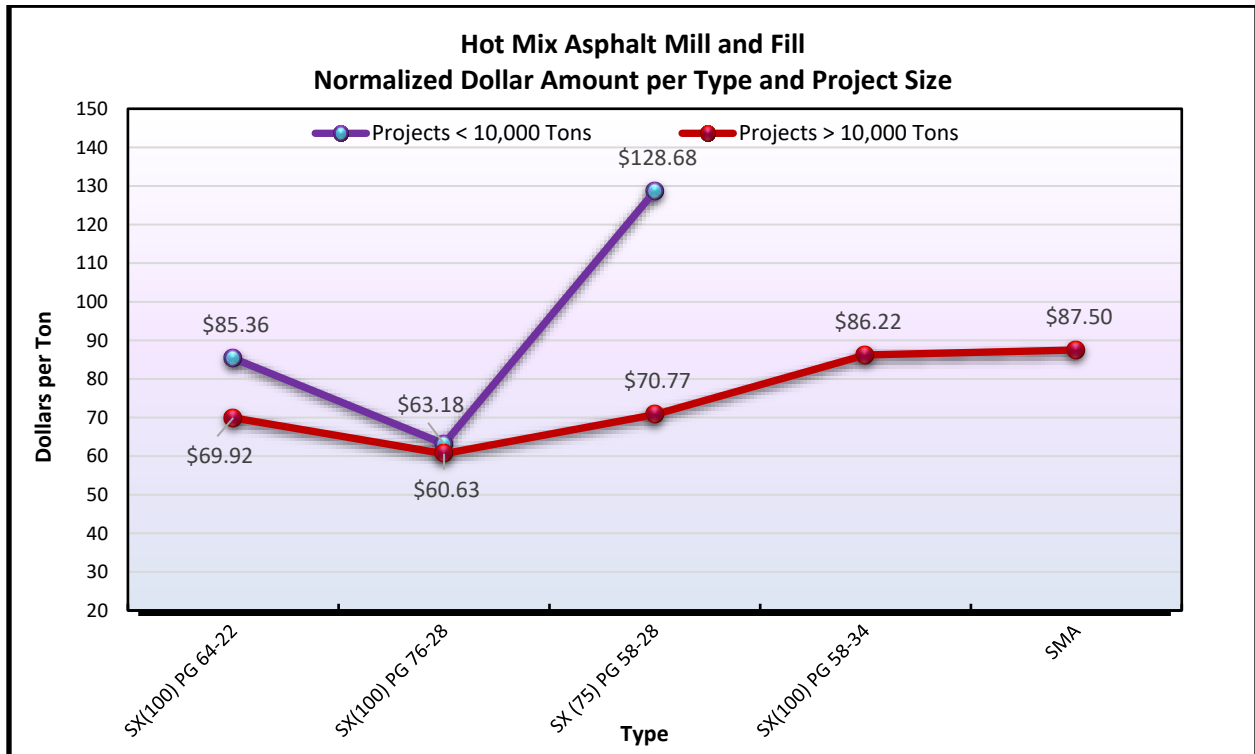


Figure 13.53 HMA Mill and Fill Normalized Dollar per Product Type

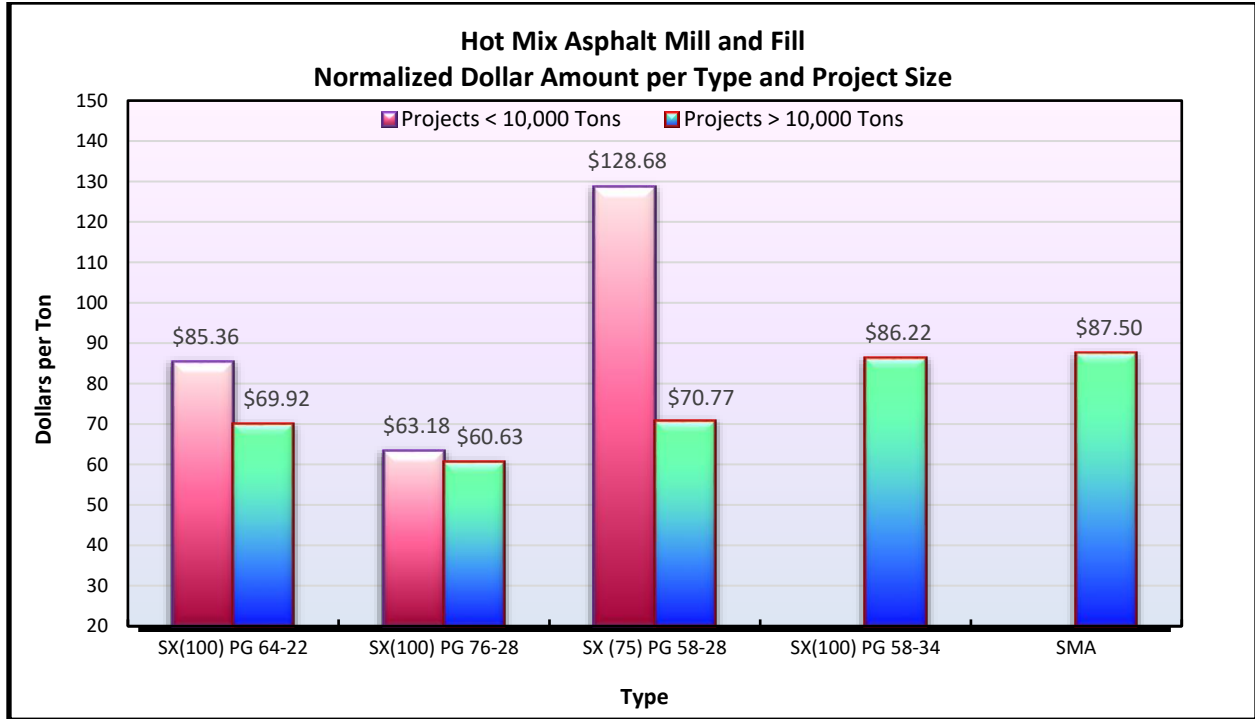


Figure 13.54 HMA Mill and Fill Normalized Dollar per Product Type

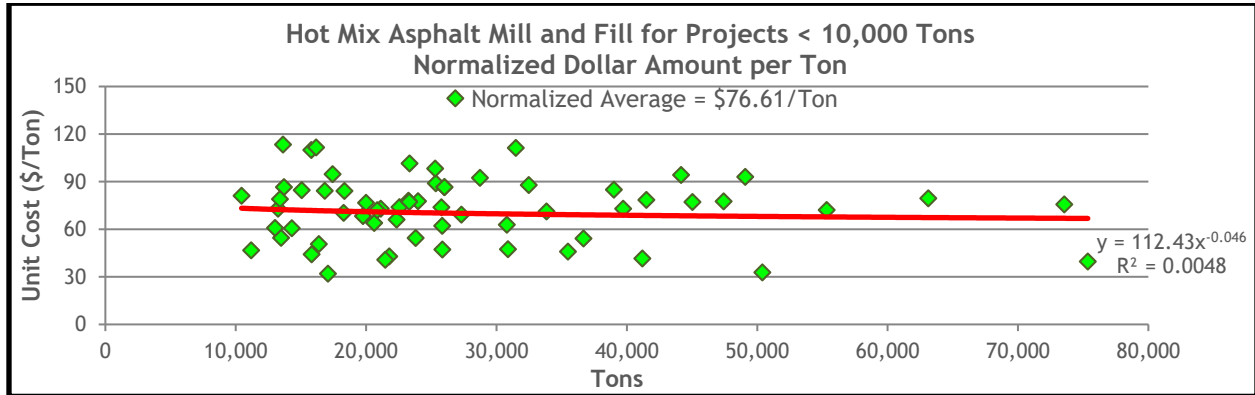
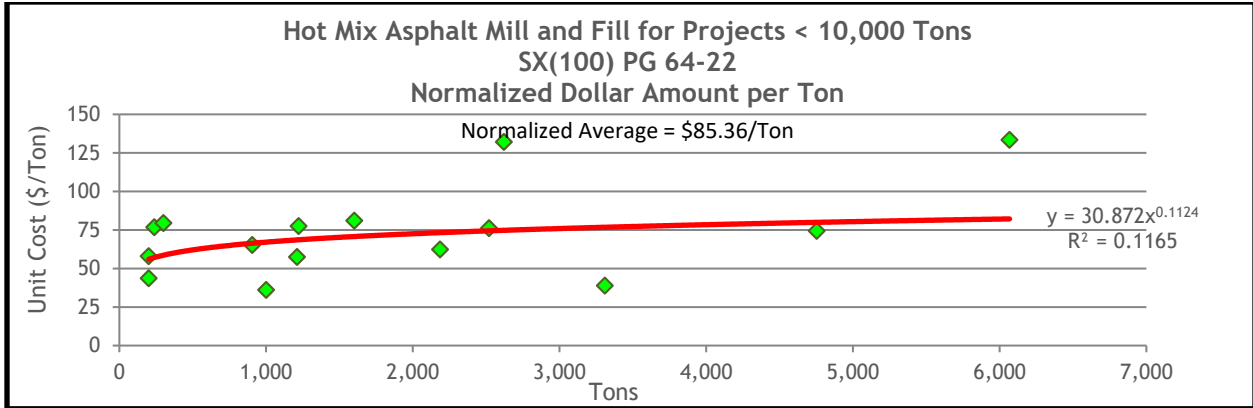
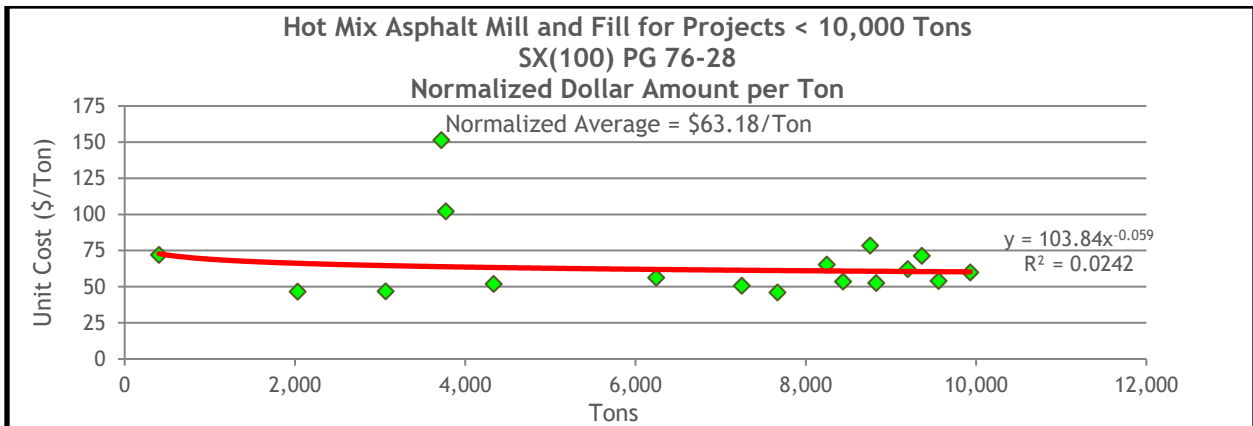


Figure 13.55 HMA Mill and Fill Normalized Unit Costs for Projects Less Than 10,000 Tons

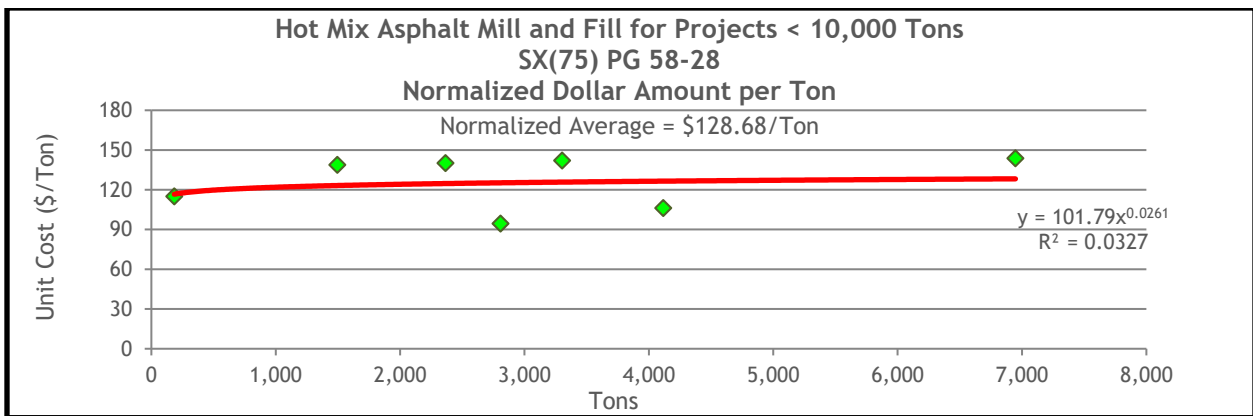




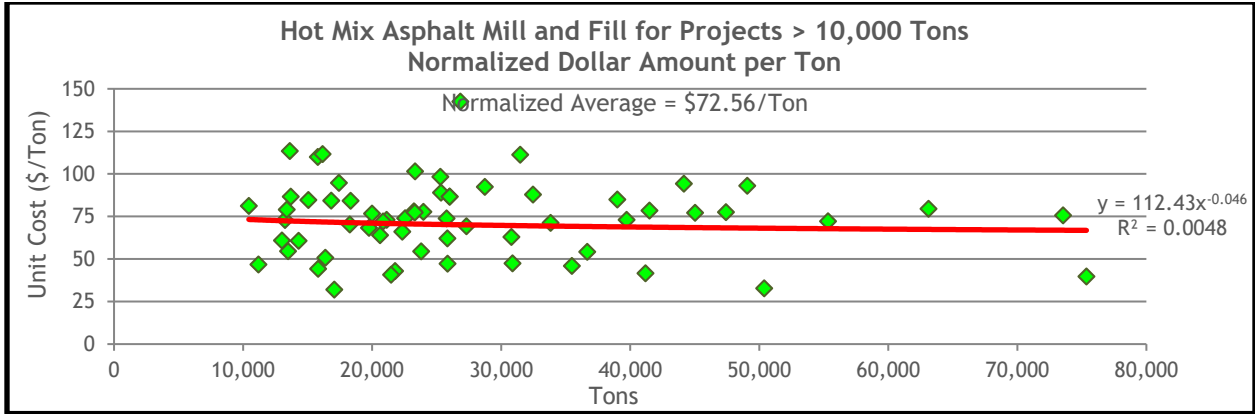
**Figure 13.56 HMA Mill and Fill Normalized Unit Costs for SX(100) PG 64-22 on Projects Less Than 10,000 Tons**



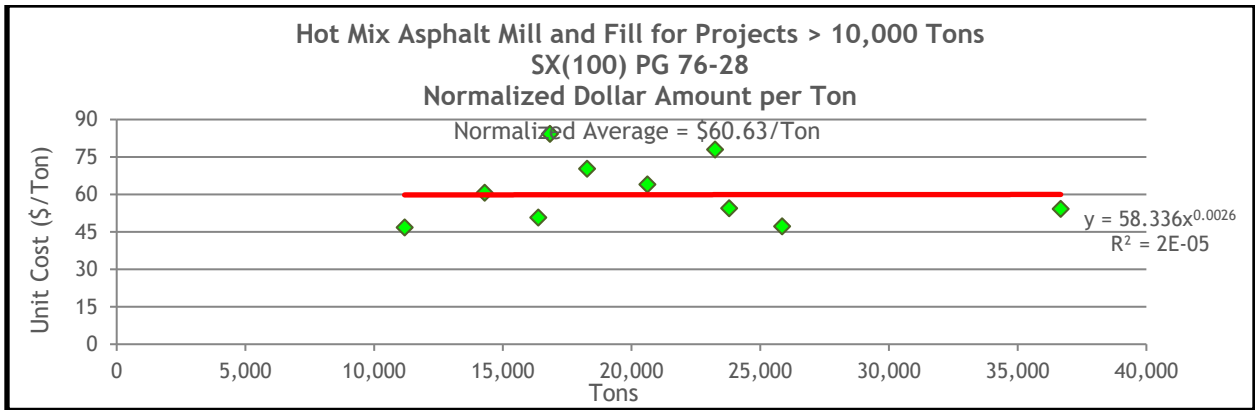
**Figure 13.57 HMA Mill and Fill Normalized Unit Costs for SX(100) PG 76-28 on Projects Less Than 10,000 Tons**



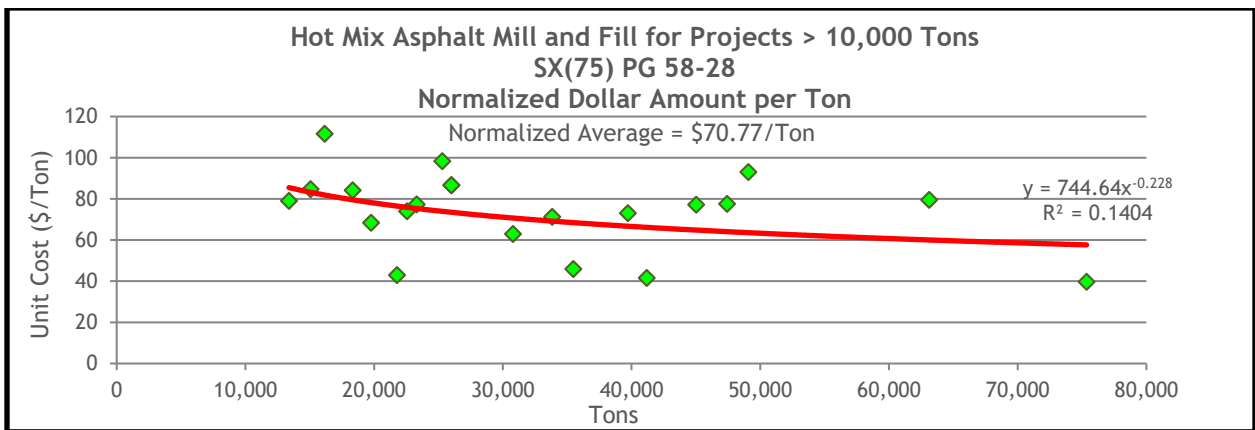
**Figure 13.58 HMA Mill and Fill Normalized Unit Costs for SX(100) PG 58-28 on Projects Less Than 10,000 Tons**



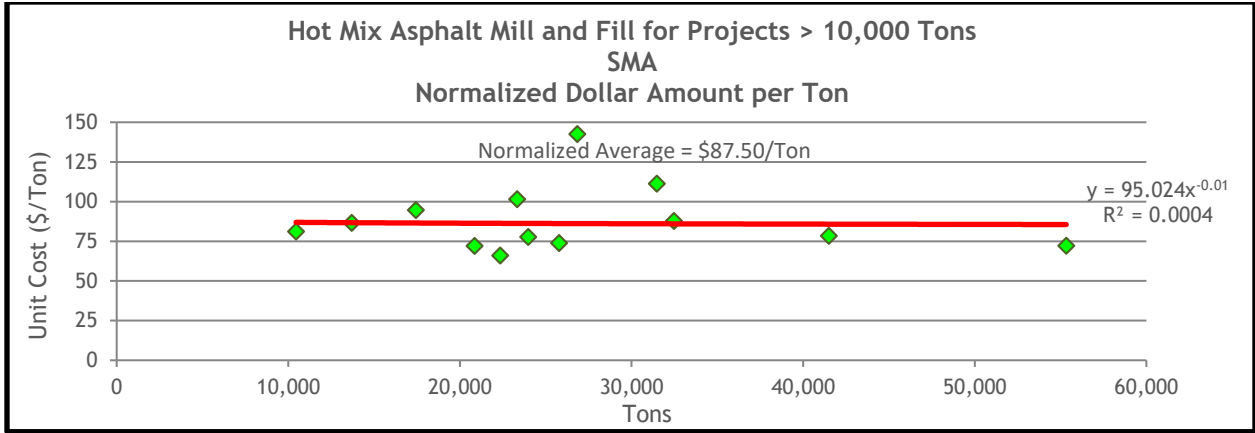
**Figure 13.59 HMA Mill and Fill Normalized Unit Costs for Projects Greater Than 10,000 Tons**



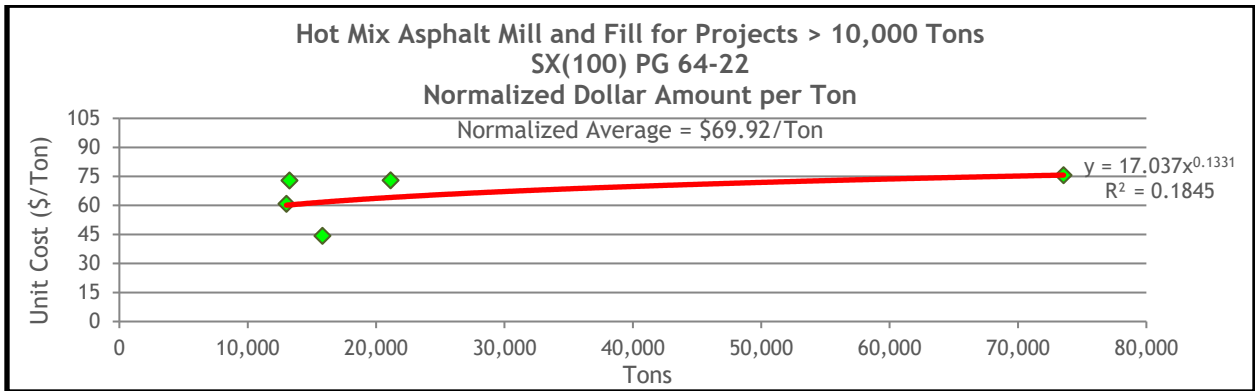
**Figure 13.60 HMA Mill and Fill Normalized Unit Costs for SX(100) PG 76-28 on Projects Greater Than 10,000 Tons**



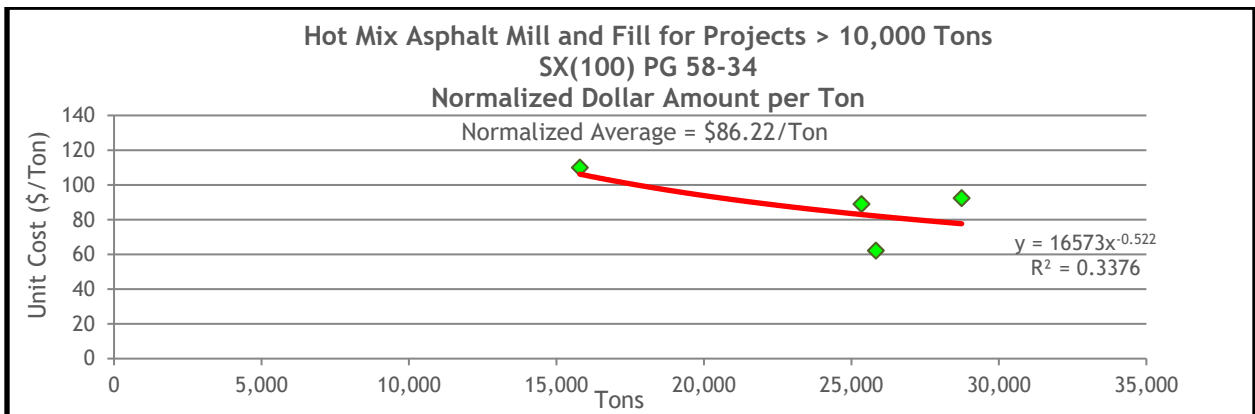
**Figure 13.61 HMA Mill and Fill Normalized Unit Costs for SX(100) PG 64-22 on Projects Greater Than 10,000 Tons**



**Figure 13.62 HMA Mill and Fill Normalized Unit Costs for SMA on Projects Greater Than 10,000 Tons**



**Figure 13.63 HMA Mill and Fill Normalized Unit Costs for SX(100) PG 64-22 on Projects Greater Than 10,000 Tons**



**Figure 13.64 HMA Mill and Fill Normalized Unit Costs for SX(100) PG 58-34 on Projects Greater Than 10,000 Tons**

### 13.7.10 Alternative Level Data Input Forms

- **Data that Define the Differences Between Alternatives:** These are specifics for component activities of each project alternative (the agency costs and work zone) and are considered alternative level inputs. Each project alternative is composed of up to seven activities and are performed in sequence. For example, Initial Construction precedes Rehabilitation 1, and Rehabilitation 3 precedes Rehabilitation 4. Data describing these activities are entered for each of the two project alternatives being compared. Refer to **Figure 13.70 Alternative 1 (HMA) Screen** and **Figure 13.71 Alternative 2 (PCCP) Screen** for a graphical representation.
- **ALTERNATIVE 1 and ALTERNATIVE 2 Inputs:** CDOT has created a Microsoft Excel worksheet for both pavement types to assist the designer in selecting the appropriate costs for initial and rehabilitation costs and a graphical representation. The user can select the cost of the pavement given the quantity. The forms for Alternative 1 and Alternative 2 are identical; at the top is a series of tabs which access different project alternative activities (see **Figure 13.72 Probabilistic Results Screen** and **Figure 13.73 Agency Cost Results Screen**). Data in this form are used to calculate agency and user costs.
  - The construction and maintenance data are agency cost inputs.
  - The service life data affect both agency and user costs (by determining when work zones will be in place). The work-zone-specific data affects user costs.
  - Each of the data inputs on this form is discussed in **Table 13.22 Alternative Level Data Options**.

**Table 13.25 Alternative Level Data Options**

Variable Name	Probability Distribution (CDOT Default)	HMA Value (CDOT Default)	PCC Value (CDOT Default)	Source
Alternative Description	User input	User input	User input	Site specific
Activity Description	User input	User input	User input	Site specific
Agency Construction Cost (\$1,000)	Triangular	User input	User input	<b>Figure 13.26</b> to <b>Figure 13.69</b> or site specific
Activity Service Life (years)	Triangular	User input	User input	<b>Section 13.2.3</b> or <b>Section 13.3</b>
User Work Zone Costs (\$1,000)	Deterministic	User input	User input	CDOT Work Zone software <b>Section 13.5.7</b>
Maintenance Frequency (years)	Deterministic	1 year	1 year	CDOT <sup>1</sup>
Agency Maintenance Cost (\$1,000)	Deterministic	\$1.027/lane mile <sup>1</sup>	\$ 0.640/lane mile <sup>1</sup>	CDOT <sup>1</sup>
Work Zone Length (miles)	Deterministic	User input	User input	Site specific
Work Zone Capacity (vphpl)	Deterministic	User input	User input	CDOT Work Zone software <b>Section 13.5.7</b>
No of Lanes Open in Each Direction During Work Zone	Deterministic	User input	User input	Site specific
Work Zone Duration (days)	Deterministic	User input	User input	CDOT Work Zone software <b>Section 13.5.7</b>
Work Zone Speed Limit (mph)	User input	User input	User input	Site specific
<b>Note:</b> <sup>1</sup> Use site specific or latest data. Recalculate yearly cost to account for the number of lanes and project length.				

- **Work Zone Capacity** is equal to the WorkZone software's work zone capacity (inbound/outbound capacity) for the type of selected work. If two or more types of work are listed, use the lesser capacity value.

- **Work Zone Duration (days)** must be reasonable. For a PCC value, the WorkZone program may give a value of 5 days for the actual paving operation, thus, it is likely the designer will need to increase the days to a reasonable amount. The program is designed so the work zone will be in place for the paving operation and curing time.



**Alternative 1**

Alternative: 1

Alternative Description: HMA      Number of Activities: 4

Activity 1 | Activity 2 | Activity 3 | Activity 4

Activity Description: 9.0" HBP New Construction

**Activity Cost and Service Life Inputs**

Agency Construction Cost (\$1000):	<span style="border: 1px solid gray; padding: 2px;">9344.333</span>	Activity Service Life (years):	<span style="border: 1px solid gray; padding: 2px;">10</span>
User Work Zone Costs (\$1000):	<span style="border: 1px solid gray; padding: 2px;">2188.582</span>	Activity Structural Life (years):	<span style="border: 1px solid gray; padding: 2px;"></span>
Maintenance Frequency (years):	<span style="border: 1px solid gray; padding: 2px;">1</span>	Agency Maintenance Cost (\$1000):	<span style="border: 1px solid gray; padding: 2px;">1.27</span>

**Activity Work Zone Inputs**

Work Zone Length (miles):	<span style="border: 1px solid gray; padding: 2px;">10</span>	Work Zone Duration (days):	<span style="border: 1px solid gray; padding: 2px;">54</span>
Work Zone Capacity (vphpl):	<span style="border: 1px solid gray; padding: 2px;">1123</span>	Work Zone Speed Limit (mph):	<span style="border: 1px solid gray; padding: 2px;">45</span>
No of Lanes Open in Each Direction During Work Zone:	<span style="border: 1px solid gray; padding: 2px;">1</span>	Traffic Hourly Distribution:	<span style="border: 1px solid gray; padding: 2px;">Week Day 1</span>

Work Zone Hours

	Inbound		Outbound	
	Start	End	Start	End
First Period of Lane Closure:	<span style="border: 1px solid gray; padding: 2px;">8</span>	<span style="border: 1px solid gray; padding: 2px;">17</span>	<span style="border: 1px solid gray; padding: 2px;">8</span>	<span style="border: 1px solid gray; padding: 2px;">17</span>
Second Period of Lane Closure:	<span style="border: 1px solid gray; padding: 2px;"></span>	<span style="border: 1px solid gray; padding: 2px;"></span>	<span style="border: 1px solid gray; padding: 2px;"></span>	<span style="border: 1px solid gray; padding: 2px;"></span>
Third Period of Lane Closure:	<span style="border: 1px solid gray; padding: 2px;"></span>	<span style="border: 1px solid gray; padding: 2px;"></span>	<span style="border: 1px solid gray; padding: 2px;"></span>	<span style="border: 1px solid gray; padding: 2px;"></span>

Copy Activity  
Paste Activity

Open...
Save...
Ok
Cancel

**Figure 13.65 Alternative 1 (HMA) Screen**

The screenshot shows a software window titled "Alternative 2" with the following fields and values:

- Alternative: 2
- Alternative Description: PCC
- Number of Activities: 2
- Activity 1 | Activity 2 (selected)
- Activity Description: 12" PCCP New Construction
- Activity Cost and Service Life Inputs**
  - Agency Construction Cost (\$1000): 17752.666
  - User Work Zone Costs (\$1000): 4635.576
  - Maintenance Frequency (years): 1
  - Activity Service Life (years): 22
  - Activity Structural Life (years):
  - Agency Maintenance Cost (\$1000): 0.499
- Activity Work Zone Inputs**
  - Work Zone Length (miles): 10
  - Work Zone Capacity (vphpl): 1136
  - No of Lanes Open in Each Direction During Work Zone: 1
  - Work Zone Duration (days): 100
  - Work Zone Speed Limit (mph): 55
  - Traffic Hourly Distribution: Week Day 1
- Work Zone Hours**

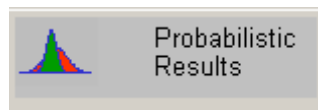
	Inbound		Outbound	
	Start	End	Start	End
First Period of Lane Closure:	0	24	0	24
Second Period of Lane Closure:				
Third Period of Lane Closure:				

Buttons at the bottom: Open..., Save..., Ok, Cancel. Buttons on the right: Copy Activity, Paste Activity.

Figure 13.66 Alternative 2 (PCCP) Screen

### 13.7.11 Analyzing Probabilistic Results

After a simulation run, probabilistic results are available for analysis. A simulation must be run prior to viewing probabilistic results. **Figure 13.72 Probabilistic Results Screen** shows the results of a probabilistic simulation.



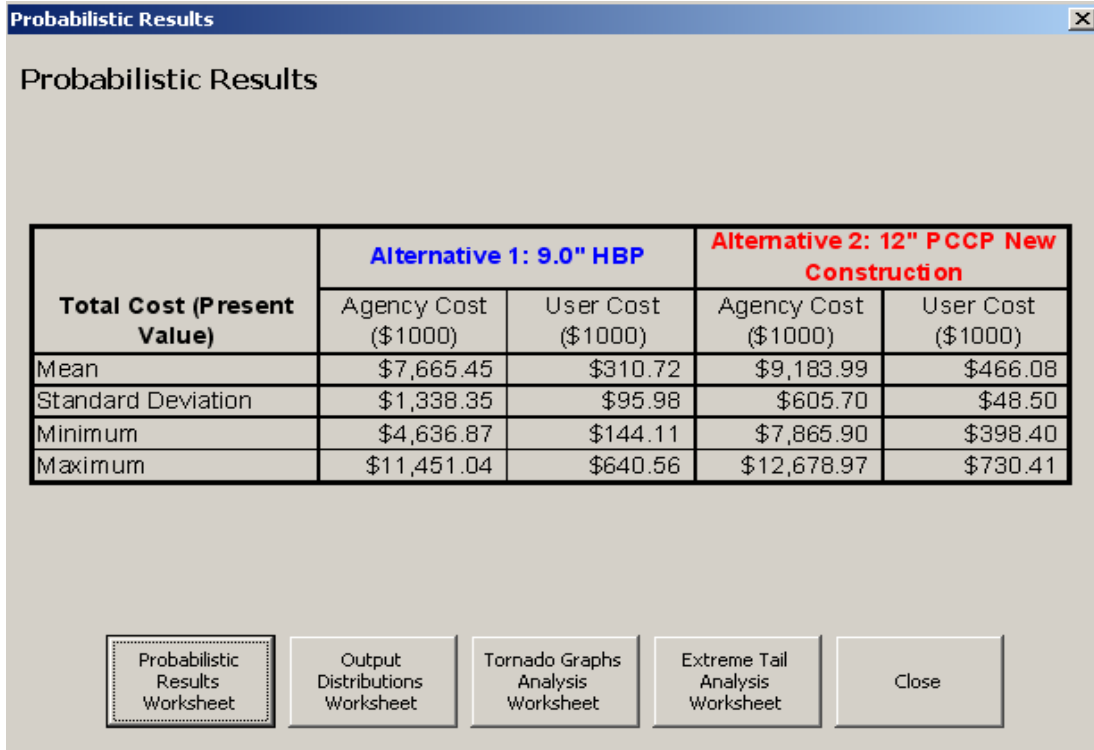


Figure 13.67 Probabilistic Results Screen

### 13.7.12 Executing the Simulation

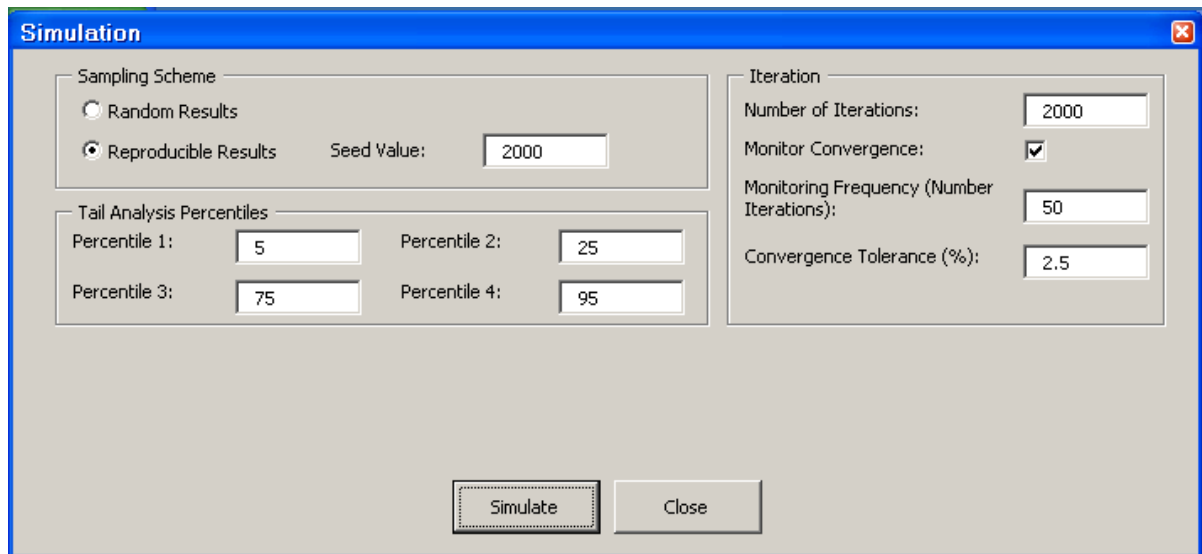
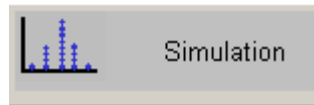
Running a simulation is a necessary step toward performing a probabilistic analysis. To conduct a probabilistic analysis, RealCost uses a Monte Carlo simulation which allows modeling of uncertain quantities with probabilistic inputs. The simulation procedure samples these inputs and produces outputs that are described by a range of potential values and likelihood of occurrence of specific outputs. The simulation produces the probabilistic outputs. The simulation screen is shown in **Figure 13.69 Simulation Screen**.

- **Sampling Scheme:** This section of the form determines where the software will draw its simulation numbers. Choosing *Random Results* causes the simulation seed value (where the simulation starts) to come from the computer’s internal clock. While not truly random, this seed value cannot be influenced by the software user, and it produces different values with each simulation.



**Table 13.26 Simulation Data Options**

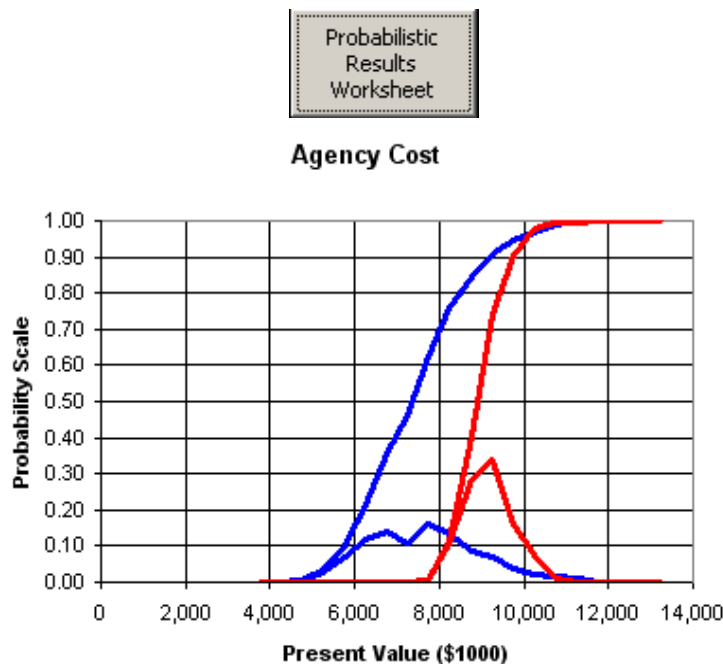
Variable Name	Probability Distribution (CDOT Default)	Value (CDOT Default)	Source
Random Results	De-select	no	RealCost Manual
Reproducible Results	Select	yes	RealCost Manual
Seed Value	Deterministic	2,000	RealCost Manual
Number of Iterations	Deterministic	2,000	RealCost Manual
Monitor Convergence	Select	yes	RealCost Manual
Monitoring Frequency (Number of Iterations)	Deterministic	50	RealCost Manual
Convergence Tolerance (%)	Deterministic	2.5	RealCost Manual
Tail Analysis Percentiles		See below	RealCost Manual
Percentile 1	Deterministic	5	RealCost Manual
Percentile 2	Deterministic	10	RealCost Manual
Percentile 3	Deterministic	75	CDOT
Percentile 4	Deterministic	95	RealCost Manual



**Figure 13.68 Simulation Screen**

### 13.7.13 Analyzing Probabilistic Agency Costs

Agency Costs are critical to an insightful LCCA and are good estimates of the various agency cost items associated with initial construction, periodic maintenance and rehabilitation activities. Construction costs pertain to putting the asset into initial service. Data on construction costs are obtained from historical records, current bids, and engineering judgment (particularly when new materials and techniques are employed). Refer to **Figure 13.73 Agency Cost Results Screen** for a graphical representation of agency costs. Similarly, costs must be attached to the maintenance and rehabilitation activities identified in the previous steps to maintain the asset above predetermined conditions, performance, and safety levels. These costs include preventive activities planned to extend the life of the asset, day-to-day routine maintenance intended to address safety and operational concerns, and rehabilitation or restoration activities. Another consideration affecting the total agency cost is the value of the alternative at the end of the analysis period. One type of terminal value is called ‘salvage value,’ usually the net value from the recycling of materials at the end of a project’s life. A second type of terminal value is the ‘Remaining Service Life’ (RSL) value of an alternative (the residual value of an improvement when its service life extends beyond the end of the analysis period). The RSL value may vary significantly among different alternatives, and should be included in the LCCA.

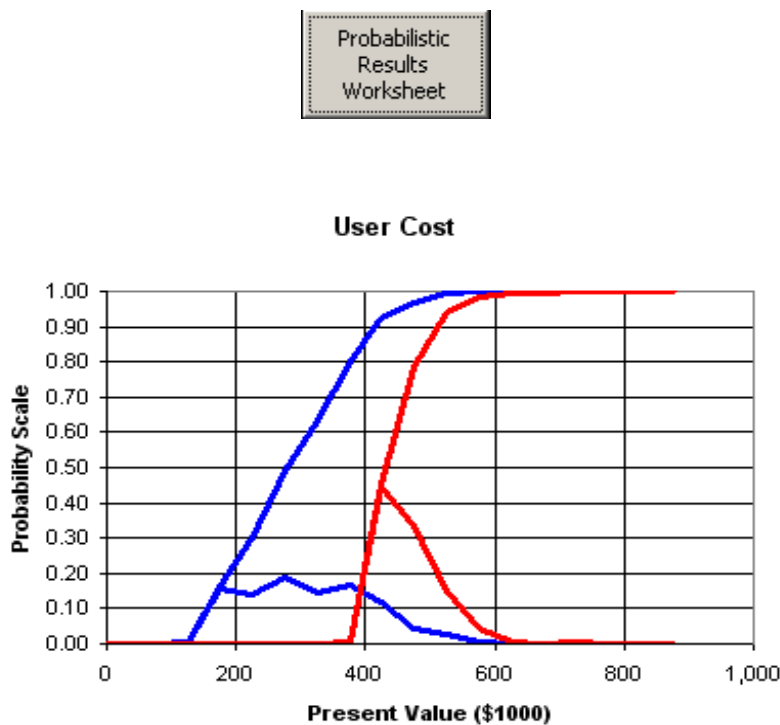


**Figure 13.69 Agency Cost Results Screen**

### 13.7.14 Analyzing Probabilistic User Cost

Best-practice LCCA calls for including the costs accruing to the transportation agency as described above and costs incurred by the traveling public. In the LCCA, user costs of primary interest include vehicle operating costs, travel time, and crashes. Such user costs typically arise from the

timing, duration, scope, and number of construction and rehabilitation work zones characterizing each project alternative. Because work zones typically restrict the normal capacity of the facility and reduce traffic flow, work zone user costs are caused by speed changes, stops, delays, detours, and incidents. While user costs do occur during normal operations, these costs are often similar between alternatives and may be removed from most analyses. Incorporating user costs into the LCCA enhances the validity of the results, but at the same time is a challenging task. User costs can also be defined as the cost of travel that is borne by individual users. Highway user costs are the sum of motor vehicle running cost, the value of travel time, and traffic accident cost. Bus transit user costs on a particular highway segment are the fares, the value of travel time, and traffic accident costs; **Figure 13.74 User Cost Results Screen**.



**Figure 13.70 User Cost Results Screen**

### 13.8 Comparing Probabilistic Results

To calculate agency and user cost, the designer must select values that cross both agency and user cost lines at the 75 percent probability scale. Once the designer has determined both values, a total of both probabilistic values can be calculated. For example:

**Agency Cost**

Blue: PCCP Lines 75% PV \$13,000,000

Red: HMA Lines 75% PV \$18,000,000

**User Cost**

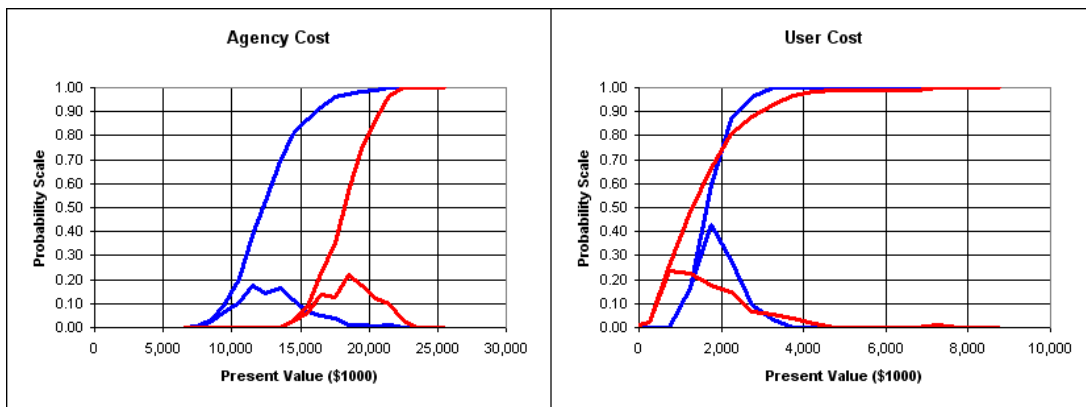
Blue: PCCP Lines 75% PV \$2,000,000  
Red: HMA Lines 75% PV \$2,000,000

Therefore:

PCCP Present Value at 75% Probability = \$13,000,000 + \$2,000,000 = \$15,000,000

HMA Present Value at 75% Probability = \$18,000,000 + \$2,000,000 = \$20,000,000

Refer to **Figure 13.75 Agency-User Cost Results Screens** for a graphical representation of the probability versus agency and user costs.



Equivalent Designs are considered equal if the equation below is 10 percent or less:

$$\frac{(\text{large NPV value} - \text{small NPV value}) \times 100}{(\text{small NPV value})} \quad \text{Eq. 13.2}$$

Comparing the two alternatives yields:

$$\frac{(\$20,000,000 - \$15,000,000)}{\$15,000,000} \times 100 = 33.3\%$$

A comparison that yields results within 10 percent may be considered to have equivalent designs. A comparison that yields results within 5 percent would certainly be considered to have equivalent designs. Refer to **Section 13.9 Pavement Type Selection Committee (PTSC)** when the alternatives are within 10 percent. Other secondary factors can and should be used to help in the pavement selection. For more information, contact the Pavement Design Program Manager at 303-398-6561.

### 13.9 Pavement Type Selection Committee (PTSC)

Whenever the cost analysis does not show a LCCA with a clear 10 percent advantage for one of the feasible alternatives, other secondary factors can be used to help in the selection process. Most of these factors are very difficult to quantify in monetary units. Decision factors considered

important in selecting the preferred alternatives are chosen and ranked with some decision factors having a greater influence on the final decision than others. The PTSC members could complete the rating sheet independently or collectively so that the final results represent a group decision and not just one individual. Other important factors can be considered to help select the best alternative when the life cycle costs comparison yields results within 10 percent. These secondary factors may include initial construction cost, future maintenance requirements, performance of similar pavements in the area, adjacent existing pavements, traffic control during construction (safety and congestion), user costs, conservation of materials and energy (recycling), environmental factors, availability of local materials and contractor capabilities, incorporation of experimental features, stimulation of competition, and local municipal factors. The procedure for selecting the best alternative among these secondary factors is given below.

### **13.9.1 Purpose**

The purpose of the Committee will be to:

- Ensure the decision for the pavement type is in alignment with the unique goals of the project and statewide consistency of decision making.
- Provide industry with the opportunity to review the life cycle cost analysis (LCCA) document.
- Formalize the decision process of the Region's pavement type selection.
- Create accountability of the decision of pavement type at the level of Chief Engineer.
- Improve credibility of the decision by following a documented process and clearly communicating the reasons for the decision.

### **13.9.2 Scope**

Reconstruction or new construction of corridor projects with large quantities of pavement where the initial life cycle cost analysis (LCCA) results indicate the pavement types are within 10 percent of each other, the percentage difference will be calculated in such a manner that the alternative with lower the LCCA will be the basis, and therefore will be the LCCA value in the denominator.

### **13.9.3 Membership**

The membership in the PTSC should include all of the following individuals:

- Region Materials Engineer and Resident Engineer
- Headquarters Pavement Design Program Manager
- Region Program Engineer(s) and Transportation Director
- Region Maintenance Superintendent
- Headquarters Materials and Geotechnical Branch Manager
- Headquarters Project Development Branch Manager
- Federal Highway Administration's Pavement and Materials Engineer

### 13.9.4 Roles of Membership

The following outlines the individual's roles in the PTSC:

- The Region Materials Engineer, Resident Engineer, Region Maintenance Superintendent and Headquarters Pavement Design Manager and Program Engineer will be responsible for the technical details including pavement design, costs, truck traffic, construction timing and sequencing, and the LCCA.
- The Program Engineer and Transportation Director will be responsible for identifying the project goals and the corresponding importance of the elements within the LCCA to match the project goals.
- The Branch Managers will ensure the statewide uniformity of the process and prepare the documentation of the recommendation that will be forwarded to the Chief Engineer.
- The Chief Engineer will make the final decision on the pavement type.

The PTSC will:

- Conduct a critical and independent review of the LCCA.
- Allow industry a period of 2 weeks to review the committee supported LCCA and provide written comments regarding the input assumptions.
- Review written comments from industry to ensure that they are adequately addressed.
- Adjust the LCCA as appropriate. Proceed to the next step if the revised LCCA indicates the pavement alternatives are within 10 percent.
- Create a list of elements that correlate to the corridor project goals. The following possible elements along with a brief description are shown in **Table 13.24 Possible Elements for Pavement Type Selection Process**.
- Apply a rating scale, from the most to least important for each element to match the project goals.
- Determine the alternative that the element favors.
- Sum the most important elements for each alternative to establish if there is a clear advantage. If the alternatives have an equal amount of most important goals, run this step again for the secondary goals, then for the least important if necessary.
- Make a recommendation for pavement type to the Chief Engineer.

**Table 13.27 Possible Elements for Pavement Type Selection Process**

<b>Element</b>	<b>Description</b>
Total LCCA	Overall cost of the alternative
Initial cost	Availability of current funds to construct the corridor project
User cost during construction	Adverse effects to the traveling public during the construction phase
User cost during maintenance	Future traffic volume may adversely affect the traveling public
Future rehabilitation efforts	Feasibility of maintenance funds required for future work
Conservation of materials	Recycling the existing materials into the corridor project
Impact to local businesses	Access to stores may affect the revenue of the business
Constructability	Required construction techniques
Intersections	Design issues to ensure structural adequacy
Warranty	Benefit of the experimental feature
Evaluation of new technology	Advances in technologies may benefit CDOT or the public
Traffic control	If multiple phases are anticipated or the closure of one lane versus a detour

The above process should be completed by the time of the field inspection review meeting.

After the Chief Engineer has concurred with the preferred alternative for the corridor, no changes to the pavement type will be made unless directed by the Chief Engineer.

### 13.10 Alternate Bid

Alternate bidding may be considered if the Regional Materials Engineer does not want to use a Pavement Type Selection Committee. As mentioned in **Section 13.9 Pavement Type Selection Committee (PTSC)**, a PTSC is a long process involving many individuals often resulting multiple meetings and scheduling difficulties. As an alternative, the RME may choose to use alternate bidding to determine the pavement selection.

Alternate bidding allows the asphalt and concrete industries to bid on the same project based on pavement designs provided by CDOT. Essentially, CDOT provides a set of design plans based on feasible alternatives used in the LCCA to each industry, the industries then review and bid on those plans. The lowest bidder usually gets the contract. Alternate bidding eliminates any bias in the selection process but also increases competition between paving industries. Advantages and disadvantages to alternate bidding are listed below:

#### Benefits of Alternate Bidding

- Equal opportunity for both concrete and asphalt industries to participate
- Increases the bid pool

- Enhances competition between industries and contractors
- Lower bid prices, better value for the taxpayer
- May lead to innovative solutions
- Enhanced competition between paving industries

#### Disadvantages

- Two-sets of typicals and quantities, one for asphalt and one for concrete
- May require additional meetings and/or controversy between industries

### 13.11 Redesign of Projects

Shelf, corridor, or specific project segments should identify ROW, Utility and other impacts based on the “worse” case scenario for the pavement types evaluated since additional pavement thickness may require the purchase of more ROW.

There are cost and schedule impacts associated with redesign. Before determining if there is a need to perform a redesign for projects, the Region Materials Engineer should evaluate other risks factors and their costs, such as:

- Revised ROW, utility, fencing or other plans sheets.
- Acquisition of additional ROW, fence or utility reallocations.
- Change in future traffic projections that significantly modify the ultimate pavement section thickness.
- Changes in design methodologies and or design methodology inputs that significantly modify the ultimate pavement section thickness.
- Changes in the Discount Rate that are greater than two standard deviations from the original rate used at the time of design.
- Collection of new data or experiences in the corridor based on completed projects, new subsurface borings, or other data.

After evaluating multiple factors, the Region Materials Engineer shall make a determination when the shelf, corridor, or specific project segment requires a new LCCA.



## References

1. Perkins, Melody, *Years to First Rehabilitation of Superpave Hot Mix Asphalt*, Report No. CDOT-2014-10, Colorado Department of Transportation, July, 2014.
2. Goldbaum, Jay, *Life Cycle Cost Analysis State-of-the-Practice*, Final Report, Report No. CDOT-R1-R-00-3, Colorado Department of Transportation, March 2000.
3. Demos, George Paul, *Life Cycle Cost Analysis and Discount Rate on Pavements for the Colorado Department of Transportation*, Final Report, Report No. CDOT-2006-17, Colorado Department of Transportation, October 2006.
4. *Life-Cycle Cost Analysis Primer*, Report FHWA IF-02-047, Office of Asset Management, U.S. Department of Transportation, Federal Highway Administration, 400 7<sup>th</sup> Street, SW, Room 3211, Washington, DC 20590, August 2002.
5. *Life-Cycle Cost Analysis in Pavement Design - In Search of Better Investment Decisions*, Pavement Division Interim Technical Bulletin, Publication No. FHWA-SA-98-079, U.S. Department of Transportation, Federal Highway Administration, 400 7<sup>th</sup> Street, SW, Washington, DC 20590, September 1998.
6. *Economic Analysis Primer*, Publication No. FHWA IF-03-032, U.S. Department of Transportation, Federal Highway Administration, Office of Asset Management, 400 7<sup>th</sup> Street, SW, Room 3211, Washington, DC 20590, August 2002.
7. Harris, Scott, *Colorado Department for Transportation's Current Procedure for Life Cycle Cost Analysis and Discount Rate Calculations*, Final Report, Report No. CDOT-2009-2, Colorado Department of Transportation, January 2009.
8. Shuler, Scott and Schmidt, Christopher, *Performance Evaluation of Various HMA Rehabilitation Strategies, Final Report*, Report No. CDOT-2008-9, Colorado Department of Transportation, December 2008.

## CHAPTER 14

# PAVEMENT JUSTIFICATION REPORTS

### 14.1 Introduction

The intent of this chapter is to provide advice, recommendations, and information needed for a Pavement Justification Report (PJR) to ensure continued quality of pavement structural designs. The final structural design section must be based on a thorough investigation of project specific conditions including materials, environmental conditions, projected traffic, life cycle economics, and performance of other similar structural sections with similar conditions in the same area.

### 14.2 Pavement Justification Report

The designer shall assemble a PJR for all appropriate projects. As stated in **CHAPTER 13, Pavement Type Selection and Life Cycle Cost Analysis**, not every project will require a LCCA, but every project should have a rational basis for the selection of the pavement type or rehabilitation alternative. The PJR documents the analysis and procedure the Region used to arrive at its selection of pavement type or rehabilitation method. HMA overlays less than 2 inches are considered a preventive maintenance treatment, and therefore a PJR report may not be required. The designer needs to submit a pavement justification letter (supporting documentation may not be required) to Pavement Design Manager in the Materials and Geotechnical Branch on all surface treatment projects and all new or reconstruction projects with Hot Mix Asphalt (HMA) or Portland Cement Concrete Pavement (PCCP) material costs greater than \$3,000,000. The PDPM will not need PJRs for access and local agency projects. As a minimum, the report should include the following:

- An analysis supporting the pavement type selection or rehabilitation method
- Life cycle cost analysis of alternate designs
- Pavement distress survey of existing pavements
- Pavement thickness calculations of alternate designs
- Surfacing plan sheet quantities (FIR or post-FIR)
- Final recommendations for typical sections

A copy of the pavement justification report should be maintained in the Region.

#### 14.2.1 General Information

The following items, as applicable, should be included in a PJR for each CDOT project:

- The proposed type of construction such as rehabilitation or reconstruction
- Proposed location and type of facility
- Special construction requirements such as:
  - Backfilling
  - Use of geotextile
  - Temporary dewatering

- Geometric problems
- Utilities
- Tabulation of input design data and assumed values (both flexible and rigid pavements)
- Applicable CDOT forms, worksheets, and checklists
- References

### **14.2.2 Site Conditions**

The following applicable items should be included in a PJR on the site conditions:

- Fill and cut situations
- Excavation requirements
- Backfilling requirements
- Topography, elevation, and land use
- General geology
- Geotechnical investigation
  - Drill exploratory borings at site
  - Location and date of task
  - Subsurface conditions (boring logs)
- Laboratory testing
- Environmental and drainage issues
- Design approaches to provide removal of water from paved areas such as trench drain and blanket drain (drain detail and length)
- Drainage coefficients
- Other construction-related issues to the site

### **14.2.3 Subgrade Materials**

The following applicable items should be included in a PJR on the subgrade materials:

- Soil and bedrock classification using AASHTO method
- Hveem test/ R-values, resilient modulus, correlation of soil classification and k-value
- Slope stability requirements
- Special requirements for subgrade

### **14.2.4 Design Traffic**

- Traffic data
- Reliability factor

### **14.2.5 Pavement Materials Characteristics**

- Layer coefficients for subbase, base, base course materials, and pavement course materials
- Pavement distress types and severity (PMS Data)
- Non-Destructive Testing (NDT) and Falling Weight Deflectometer (FWD)

### 14.2.6 Pavement Design and Selection Process

The PJR should include all appropriate documentation on the pavement design and selection process used to determine pavement type and thickness. Refer to the following items for general guidelines in performing the pavement design and selection process:

- Follow steps in **CHAPTERS 6 and 7** for the pavement selection process for new construction/reconstruction projects.
- Follow steps in **CHAPTERS 8, 9 and 10** for the rehabilitation alternative selection process for resurfacing, rehabilitation, and restoration projects.
- Follow steps in **CHAPTERS 11 and 12** for the pavement selection process for intersections.
- Perform LCCA using **CHAPTER 13** as a guide.
- Tabulate results of pavement design and LCCA.

### 14.3 Guidelines for Data on Plan Sheets

An example of data placed on plan sheets is shown on **Table 14.1 Pavement Data on Plan Sheets**. The following items should be placed on plan sheets:

- Pavement design information
- Preliminary soil boring information
- Coring information of existing pavement, for information only, if applicable.
- State cold milling thicknesses and locations of paving fabric (for information only) if applicable.
- When specifying Class E concrete state required strength for a required time period.
- When specifying concrete items, state the required sulfate level for project.

**Table 14.1 Pavement Data on Plan Sheets**

<b>Design Parameters</b>		
Design Life (years)	10	
Heavy Trucks (cumulative)	1,030,050	
Operational Speed (mph)	65	
Effective Binder Content (%)	10.7	
Voids (%)	5.5	
Milling Thickness (inches)	1	
Overlay Thickness (inches)	1.5	
HMA Grading	SX	
HMA Design Gyration	75	
HMA Grading (top lift)	PG 58-28	
<b>Distress Prediction Summary</b>		
	<b>Target</b>	<b>Prediction</b>
Terminal IRI (inches/mile)	200	97.27
Reliability (%)	90	100
Permanent Deformation (inches)	0.8	0.18
Reliability (%)	90	100
AC Total Fatigue Cracking (%)	25	1.64
Reliability (%)	90	100
AC Total Transverse Cracking (feet/mile)	2,500	205.53
Reliability (%)	90	100
Permanent Deformation – AC Only (inches)	0.65	0.09
Reliability (%)	90	100
AC Bottom-up Fatigue Cracking (%)	35	0
Reliability (%)	90	100
AC Thermal Cracking (feet/mile)	1,500	1
Reliability (%)	90	100
AC Top-Down Fatigue Cracking (feet/mile)	3,000	286.05
Reliability (%)	90	100

## **APPENDIX A**

# **PROCEDURES FOR FORENSIC STUDY OF DISTRESS OF HOT MIX ASPHALT AND PORTLAND CEMENT CONCRETE**

### **A.1 Introduction**

This section covers the procedure for evaluating premature distress of Hot Mix Asphalt (HMA), Stone Matrix Asphalt (SMA) and Portland Cement Concrete Pavement (PCCP). The procedure calls for reviewing the type of distress with a visual analysis and recommending a sampling and testing program; this could be called a forensic study. Finally, the cause, potential solution, and recommendation for rehabilitation will be reported.

### **A.2 Formation of and Evaluation Team**

A team will be established to perform the evaluation. The Region Materials Engineer, in consultation with all potential team participants, will make the final determination as to the level of investigation required. The team may include members from the following areas or disciplines:

- Materials and Geotechnical Branch
- Project Development Branch
- Region Materials
- Region Design
- Region Construction (Project Engineer/Resident Engineer)
- Region Maintenance (Maintenance Superintendent/Supervisor)
- Industry
- National Experts

Contractor participation should be dependent on the status of the project; closed or not.

### **A.3 Levels of Investigation**

Based on the degree of complexity, severity of the pavement distress, and the urgency of the required response, the following three-tiered investigation levels are recommended:

#### **A.3.1 Level I (CDOT Region)**

The team may consist of Region personnel with expertise in various areas of disciplines including materials, design, construction, and maintenance. Based upon preliminary information and data, the pavement distress is determined to have a low degree of complexity and severity. Preliminary survey indicates if the cause can be easily identified. The investigation should include at least a visual analysis, investigational requirements, and required core samples and testing. The designer

should complete the final report if the problem is resolved. If further information is needed, the investigation should proceed to Level II.

### **A.3.2 Level II (CDOT Statewide)**

The team may consist of individuals from **Section A.3.1 Level I (CDOT Region)** along with personnel from CDOT Materials and Geotechnical Branch, Project Development Branch, FHWA, and industry representation (ACPA, Asphalt Institute, CAPA, etc.). Findings from the first level of investigation will be re-evaluated. If the pavement distress is concluded to have a moderate degree of complexity and severity and re-evaluation of initial findings indicates the cause is difficult to ascertain, then the investigation should include at least the following:

- Visual analysis
- Investigational requirements
- Required core samples and testing
- Pavement slab samples may be obtained for further testing
- Deflection analysis may also be conducted

The designer should complete the final report if the problem is resolved. If not, the investigation will proceed to Level III.

### **A.3.3 Level III (National Effort)**

The team will consist of individuals from **Sections A.3.1 Level I (CDOT Region)** and **A.3.2 Level II (CDOT Statewide)** along with national experts from FHWA, AASHTO, and other state DOTs, or government entities. Findings from the first and second levels of investigation will be re-evaluated again. The pavement distress is concluded to have a high degree of complexity and severity. The cause of the pavement distress is determined to be highly complex. The investigation should include at least the following steps:

- Visual analysis
- Investigational requirements
- Required core samples and testing
- Pavement slab samples may be obtained for further testing
- Deflection analysis may also be conducted
- Other tests as necessary

## **A.4 Site Investigation**

### **A.4.1 Visual Analysis**

The first step in investigating the pavement distress is to perform a complete and comprehensive visual analysis of the entire project. Emphasis will be placed on the distressed areas. Refer to **Figure A.1 Pavement Condition Evaluation Checklist (Rigid)** and **Figure A.2 Pavement Condition Evaluation Checklist (Flexible)** for pavement evaluation checklists. These figures are restatements of **Figure 8.2 Pavement Condition Evaluation Checklist (Flexible)** and **Figure**

**9.2 Pavement Condition Evaluation Checklist (Rigid).** Guidelines on how to perform the visual distress survey can be found in the *Distress Identification Manual for the Long-Term Pavement Performance Program*. This FHWA publication (1) includes a comprehensive breakdown of common distresses for both flexible and rigid pavements. Information gathered should include:

- Date
- Reviewers
- Project location and size
- Traffic data
- Weather information
- Extent of distress
- Detailed information concerning each distressed area
- Photographs of the typical distress on the project will be included
- Any other problems that are visible (drainage, frost problems, dips or swells, etc.) should be recorded

In general, each individual distress type should be rated for severity and the extent (amount) of the distress noted. When determining severity, each distress type can be rated as low, medium (or moderate), or high. This will not apply for some distresses, such as bleeding, which will be characterized in terms of number of occurrences.

When measuring and recording the extent or amount of a certain distress, each should be rated consistent with the type of distress. For example, alligator cracking is normally measured in terms of affected area. As a result, the overall amount of alligator cracking is recorded in terms of total square feet of distress. Alternatively, for quick surveys, the overall amount of alligator cracking can be recorded as a percentage of the overall area (i.e. 10%).

Other distresses, such as cracking, are recorded as the total number of cracks or number of cracks per mile, and the overall length of the cracks. For example, for transverse or reflection cracking it is appropriate to record the amount of distress in terms of the number of cracks per mile (for each severity level), while for longitudinal cracks it is appropriate to record the total length recorded. Any assumptions made during the investigation should also be noted.

The decision to use the Falling Weight Deflectometer (FWD) will be determined based upon visual analysis. When the decision has been made to use FWD, the following steps will be followed:

- Deflection tests will be taken throughout the problem areas to determine the extent of the distress.
- Normal deflection testing frequency is ten sites per mile. However, within an area of concern, a minimum of 30 testing sites will need to be selected.
- For comparison and control purposes, it is recommended to perform a minimum of 10 tests outside each end of the area of concern, per lane segment.
- For the control segment, a 200-foot interval between FWD test sites will be used.
- The deflection analysis will be reviewed for an elastic modulus of each layer to determine the in-place strength.
- The required design overlay thickness analysis will then be performed.



## PAVEMENT EVALUATION CHECKLIST (RIGID)

PROJECT NO.: \_\_\_\_\_ LOCATION: \_\_\_\_\_  
 PROJECT CODE (SA #): \_\_\_\_\_ DIRECTION: \_\_\_\_\_ MP \_\_\_\_\_ TO MP \_\_\_\_\_  
 DATE: \_\_\_\_\_ BY: \_\_\_\_\_  
 TITLE: \_\_\_\_\_

### TRAFFIC

- Existing \_\_\_\_\_ 18k ESAL/YR
- Design \_\_\_\_\_ 18k ESAL

### EXISTING PAVEMENT DATA

- |                                     |                            |
|-------------------------------------|----------------------------|
| - Subgrade (AASHTO)                 | - Shoulder Condition       |
| - Base (type/thickness)             | (good, fair, poor)         |
| - Pavement Thickness                | - Joint Sealant Condition  |
| - Soil Strength (R/M <sub>R</sub> ) | (good, fair, poor)         |
| - Swelling Soil (yes/no)            | - Lane Shoulder Separation |
| - Roadway Drainage Condition        | (good, fair, poor)         |
| (good, fair, poor)                  |                            |

### DISTRESS EVALUATION SURVEY

Type	Distress Severity*	Distress Amount*
Blowup		
Corner Break		
Depression		
Faulting		
Longitudinal Cracking		
Pumping		
Reactive Aggregate		
Rutting		
Spalling		
Transverse and Diagonal Cracks		
OTHER		

\* Distress Identification Manual for the Long-Term Pavement Performance Program, U.S. Department of Transportation, Federal Highway Administration, Publication No. FHWA-RD-03-031, June 2003.

**Figure A.1 Pavement Condition Evaluation Checklist (Rigid)**

## PAVEMENT EVALUATION CHECKLIST (FLEXIBLE)

PROJECT NO.: \_\_\_\_\_ LOCATION: \_\_\_\_\_  
 PROJECT CODE (SA #): \_\_\_\_\_ DIRECTION: \_\_\_\_\_ MP \_\_\_\_\_ TO MP \_\_\_\_\_  
 DATE: \_\_\_\_\_ BY: \_\_\_\_\_  
 TITLE: \_\_\_\_\_

**TRAFFIC**

- Existing \_\_\_\_\_ 18k ESAL/YR
- Design \_\_\_\_\_ 18k ESAL

**EXISTING PAVEMENT DATA**

- Subgrade (AASHTO)
- Base (type/thickness)
- Soil Strength (R/M<sub>R</sub>)
- Roadway Drainage Condition (good, fair, poor)
- Shoulder Condition (good, fair, poor)

**DISTRESS EVALUATION SURVEY**

Type	Distress Severity*	Distress Amount*
Alligator (Fatigue) Cracking		
Bleeding		
Block Cracking		
Corrugation		
Depression		
Joint Reflection Cracking (from PCC Slab)		
Lane/Shoulder Joint Separation		
Longitudinal Cracking		
Transverse Cracking		
Patch Deterioration		
Polished Aggregate		
Potholes		
Raveling/Weathering		
Rutting		
Slippage Cracking		
OTHER		

\* Distress Identification Manual for the Long-Term Pavement Performance Program, U.S. Department of Transportation, Federal Highway Administration, Publication No. FHWA-RD-03-031, June 2003.

**Figure A.2 Pavement Condition Evaluation Checklist (Flexible)**

#### **A.4.2 Review of Construction Documents**

Pertinent information from the mix design, binder tests, mixture tests, QC/QA results, and project diary should be reviewed.

#### **A.4.3 Investigational Requirements**

After the visual analysis report has been evaluated, the second step of this procedure requires the determination of the investigational requirements. The requirements will depend on the type and extent of the pavement failure. It is recommended to obtain samples of the pavement adjacent to the distress area for comparison and control purposes. A minimum of 5 samples per lane is required outside each end of the distress area. A list of investigational requirements may include:

- Core sampling and testing plan
- Slab sampling of pavement for testing and evaluation
- Base and subgrade sampling and testing
- Deflection analysis
- Transverse cracking in concrete slab

#### **A.4.4 Required Core Samples and Testing**

Samples of materials at the pavement distress location shall be taken so tests can be performed to evaluate the problem areas. For reporting purposes, the core location should be as accurate as possible. The samples shall be submitted to the Materials and Geotechnical Branch for testing unless otherwise specified.

#### **A.4.5 Core Samples from Hot Mix Asphalt and PCCP**

Samples shall be taken of each HMA, SMA or PCCP layer with at least five 4-inch cores from all locations (bad area, a shoulder next to the bad area, and a good area). Larger cores are preferred. Each layer of HMA, SMA or PCCP should be tested separately. Contact the Materials and Geotechnical Branch for sampling and removal processes and procedures. In some cases, slab samples may indicate distresses not usually seen in core samples.

#### **A.4.6 Base and Subgrade Samples**

When obtaining samples of the base and subgrade materials, a sufficient area of HMA, SMA or PCCP should be removed for adequate testing and sampling of each layer of material. Testing shall include but not limited to:

- Applicable Colorado, AASHTO and ASTM test procedures
- Nuclear gauge density and moisture determination
- Soil classification
- R-value
- Proctor testing

## A.5 Final Report

A summary of the tests and other investigational requirements will be submitted to the Materials Advisory Council (MAC) upon the completion of all testing and analysis. The final report will be catalogued in the Technology Transfer Library and copies will be available for loan. The report should include some or all of the following items as applicable:

- **Project Overview:**
  - Type of pavement (HMA, SMA or PCCP)
  - Location and size of project
  - Traffic data
  - Weather conditions
  - When distress developed
  - Historical distresses
  
- **Visual Inspection:**
  - Type, extent and location of distress
  - Photographs
  
- **Summary of Construction Records:**
  - Mix design
  - Central laboratory check tests (stability, Lottman, binder tests, compacted specimen tests, concrete compressive/flexural strength and chemical tests)
  - Quality control test results (density, gradation, asphalt and portland cement)
  - Project diaries
  
- **Core Sampling and Testing Results:**
  - Core location and thickness
  - Density and air voids
  - Asphalt content
  - Gradation
  - Vacuum extraction and asphalt cement penetration
  - Geologic analysis of aggregates
  - Portland cement chemical tests
  - Petrographic analysis
  - Alkali-Silica Reactivity (ASR) tests
  - Modulus of elasticity
  - Resilient modulus
  
- **Slab Sample:**
  - Thickness
  - Areas of deformation
  - Stripping
  - Determination of subsurface deformation
  - Any other items of note
  
- **Results of Sampling and Testing of Base and Subgrade:**

- R-value
  - Gradation
  - Classification testing
  - Moisture and density
  - Proctor results
- **Deflection Analysis:**
    - Overlay thickness required
    - Comparison to original overlay thickness
    - Comparison with component analysis
  - **Conclusions and Recommendations:**
    - Apparent cause of failure
    - Potential solutions to prevent future problems with other pavements
    - Recommendations for rehabilitation of the distress location

## **A.6 Funding Sources**

Funds for an investigation may come from the Regions and/or Staff Branches depending on the level of investigation. The Research Branch annually allocates funds for experimental and implementation programs. Therefore, if a situation arises one should submit a request for assistance to the Research Implementation Council (RIC) as soon as deemed appropriate.

## Reference

1. *Distress Identification Manual for the Long-Term Pavement Performance Program*, U.S. Department of Transportation, Federal Highway Administration, Publication No. FHWA-RD-03-031, June 2003.

## APPENDIX B FORMS

The Colorado Department of Transportation (CDOT) uses the following forms:


<b>COLORADO DEPARTMENT OF TRANSPORTATION DESIGN DATA</b>				Orig. date: _____		Project code # (SA#) _____		STIP # _____					
<input type="checkbox"/> Metric <input type="checkbox"/> English				Rev. date: _____		Project # _____							
Page 1 of 2				Revision # _____		PE project code _____		PE project # _____					
Status: <input type="checkbox"/> Preliminary <input type="checkbox"/> Final <input type="checkbox"/> Revised				Region # _____									
Prepared by: _____		Revised by: _____		Project description									
Date: _____		Date: _____		County1 _____		County2 _____		County3 _____					
Submitted by Project Manager: _____		Approved by Preconstruction Engineer: _____		Municipality _____									
Date: _____				System code: <input type="checkbox"/> IM <input type="checkbox"/> NHS <input type="checkbox"/> STP <input type="checkbox"/> Other									
				Oversight by: <input type="checkbox"/> CDOT <input type="checkbox"/> FHWA <input type="checkbox"/> Other									
				Planned length: _____									
Geographic location													
Type of terrain <input type="checkbox"/> level <input type="checkbox"/> plains <input type="checkbox"/> rolling <input type="checkbox"/> urban <input type="checkbox"/> mountainous													
Description of proposed construction/improvement (attach map showing site location)													
<b>1 Traffic</b> (Note: use columns A, B, and/or C to identify facility described below)													
		Current year: _____			Future year: _____		Facility location						
Facility		ADT	DHV	DHV % trucks	ADT	DHV	Industrial	Commercial	Residential	Other			
A							<input type="checkbox"/>	<input type="checkbox"/>	<input type="checkbox"/>	<input type="checkbox"/>			
B							<input type="checkbox"/>	<input type="checkbox"/>	<input type="checkbox"/>	<input type="checkbox"/>			
C							<input type="checkbox"/>	<input type="checkbox"/>	<input type="checkbox"/>	<input type="checkbox"/>			
<b>2 Rdwy class</b>													
Route		Refpt	Endrpt	Functional classification		Facility type		Rural code					
1.													
2.													
3.													
<b>3 Design standards</b> (identify substandard items with an * in 1st column & clarify in remarks)													
		A=				B=				C=			
		Standard	Existing	Proposed	Ultimate	Standard	Existing	Proposed	Ultimate	Standard	Existing	Proposed	Ultimate
Surface type													
Typical section type													
# of travel lanes													
Width of travel lanes													
Shoulder width lt./median													
Shoulder width rt./outside													
Side slope dist. ("z")													
Median width													
Posted speed													
Design speed													
Max. superelevation													
Min. radius													
Min. horizontal SSD													
Min. vertical SSD													
Max grade													
Project under <input type="checkbox"/> 1R <input type="checkbox"/> 3R <input type="checkbox"/> 4R <input type="checkbox"/> Other: _____ criteria						Existing guardrail meets current standards: <input type="checkbox"/> yes <input type="checkbox"/> no							
<input type="checkbox"/> Variance in minimum design standards required						Comments:							
<input type="checkbox"/> Justification attached <input type="checkbox"/> Request to be submitted													
<input type="checkbox"/> Bridge (see item 4) <input type="checkbox"/> See remarks													
<input type="checkbox"/> Safety project not all standards addressed													
<input type="checkbox"/> Stage construction (explain in remarks)													
Resurfacing projects													
<input type="checkbox"/> Recommendations concerning safety aspects attached													

CDOT Form #463 12/03

**Figure B.1 Design Data (Page 1 of 2) (CDOT Form 463 12/03)**





COLORADO DEPARTMENT OF TRANSPORTATION Maintenance Project Request Form Form 463 M(revised)				
Today's Date: xx/xx/20xx		Proposed Ad Date: xx/xx/20xx		Proposed Completion Date: xx/xx/20xx
Requestor Name: xxx		Phone: xxx-xxx-xxxx	E-Mail Address: xxx.xxx@dot.state.co.us	
Region No.: X	Main. Sect. No.: X	Project Type: Type of Project	FY: XX	Budget: \$ XXX.XXX.00
State Hwy No.: XXX	MP Limits: MP xxx.xx to xxx.xx	County(ies): XXXXXX	City(ies): XXXXXX	
Maintenance Superintendent/Resident Engineer: XX			Phone: XXX-XXX-XXXX	
Design Project Manager: XX		Phone: XXX-XXX-XXXX	Cell: XXX-XXX-XXXX	
Construction Project Engineer: XX		Phone: XXX-XXX-XXXX	Cell: XXX-XXX-XXXX	
SAP CODING INFORMATION				
**SAP Work Order #: XXXXXXXXXXXX		**SAP Purchase Requisition #: XXXXXXXXXXXX		
**Requires Release by Business Office and Maintenance Superintendent prior to Advertisement				
Cost Center	Approp Code	Sub. Obj.	N/P	Report Category
XXXX	XXX	X	N or P	XXXX
Fund Number	Funds Center	Functional Area	GL Account	WBS Element
XXX	RXXXX-XXX	XXXX	XXXXXXXXXX	RXXXXXXXXX
SCOPE AND PROJECT DETAILS				
(Please provide as much detail as possible regarding Scope of Work) Roadway widths, project limits, preliminary quantities, repair/treatment type ( Class of repair, type of surface treatment), temporary/permanent pavement marking, excavation and drainage considerations, Contract Time (Milestone, Working/Calendar Day) and Estimated Construction Duration; ADA Requirements (1.5 inch depth or greater).				
XX				
<b>Material Requirements:</b> Pavement treatment types and recommendations; Structure material considerations; Testing/Inspection requirements; Pavement Marking Types; Project Special Provisions.				
xxx				
<b>Traffic Control Requirements:</b> Regional Lane Closure Policy (Variance Considerations); Posted Speed/Reductions; Working Hour Restrictions (Night, Day, Special Events); Public Information; Pedestrian/Bicycle Considerations, Flagging; Signage, Preliminary Quantities.				
xxx				
CLEARANCES				
(See M-Project Manual, ROW, Utilities and Environmental Sections for more information regarding clearances)				
REGION ROW				
1. Existing ROW Boundaries Determined and Confirmed? Y/N		2. All project requirements constructed within boundary of existing ROW? Y/N		
3. Are Railroad or Temporary Easements Required? Y/N explain				
4. Is work in vicinity of National Forest, BLM, US Army Corps of Engineer Property? Y/N explain				
Notes: xxx				
REGION UTILITIES				
Note any known or observable utility/railroad facilities within project limits: xxx				
Are utility relocations anticipated? Y/N explain				
REGION ENVIRONMENTAL/STORM WATER MANAGEENT PLAN (SWMP)				
Environmental Clearance Form 128 from the respective Region Environmental Manager. SAP Approval Required				
SWMP/ Estimated Preliminary Items, Quantities and Force Accounts: xxx				
Additional Clearance/Considerations may include: Historical Clearance, Noise Variance, Hazardous Materials Testing (Lead, Asbestos, etc.), Army Corps of Engineers Permit, Habitat Protection (Swallows, Prairie Dogs, Preble Mouse, etc.), Dewatering Treatment.				
Information for Project Number and Project Definition obtained from SAP		M-Proj Number: RXXXX-XXX		M-Proj Definition: XXXXX

CDOT FORM # 463M Rev-4/10

Figure B.3 Maintenance Project – Request Form (CDOT Form 463M Rev 4/10)

## **APPENDIX C**

### **DEFLECTION TESTING AND BACKCALCULATION**

#### **C.1 Introduction**

Deflection testing is the measurement of the structural strength of the roadway. CDOT has utilized many devices to evaluate the strength of the existing road: the Falling Weight Deflectometer (FWD), the Dynaflect, the Benkelman Beam, and the heel of the Engineer's shoe. CDOT has owned a FWD since April 19, 1988. The FWD is a device capable of applying dynamic loads to the pavement surface, similar in magnitude and duration to that of a single heavy moving wheel. Tests show the response of the pavement system measured in terms of vertical deformation, or deflection, over a given area using seismometers (geophones). Deflection testing devices are considered non-destructive testing (NDT) devices. The FWD as a NDT device should never apply a load to the pavement so great that it will not rebound fully.

FHWA (LTPP) approached CDOT in 2002 to become a Regional Calibration Center, and the MAC discussed the topic in 2003. CDOT agreed to become a national calibration center in 2003 taking the program over from Nevada DOT. The SHRP/LTPP FWD Calibration Protocol was implemented in 1992 and since then, hundreds of calibrations have been performed in the U.S. Since that time the experience gained calibrating FWDs has shed light on opportunities for improving the calibration process, however changes in computer technology have rendered some calibration equipment obsolete. Many State Highway Agencies, including CDOT, had expressed interest in updating the FWD calibration software and equipment and establish a long term plan for support of the calibration facilities and their services. A Transportation Pooled Fund Study TPF-5(039) entitled “*Falling Weight Deflectometer (FWD) Calibration Center and Operational Improvements*” was conducted over several years and revised the calibration protocol, updated the equipment, and produced new calibration software. CDOT was extensively involved in the pooled fund study in developing and testing the new calibration procedures and software. Details can be found at [http://www.fhwa.dot.gov/pavement/pub\\_details.cfm?id=729](http://www.fhwa.dot.gov/pavement/pub_details.cfm?id=729).

The CDOT FWD will be calibrated annually using the CDOT FWD calibration center. Any consultant engineering company that performs design work for CDOT requiring FWD data shall schedule the CDOT FWD to perform the FWD testing. If the CDOT FWD is not available to collect the data, the consultant engineering company may hire a consultant FWD. The consultant's FWD shall be calibrated at an approved FWD calibration center not more than one year prior to performing the FWD data collection. For more information on FWD test protocols, consult with the Concrete and Physical Properties Program (CPPP) Unit of the CDOT Materials and Geotechnical Branch.

The most cost effective strategy will most likely involve maximum utilization of resources. The existing pavement should be considered as a resource that is already in place. The structural value of the existing pavement needs to be thoroughly investigated and determined. Deflection measurements and analysis will yield structural values of in-place pavements and identify weak zones. During the pavement analysis portion of the thickness design, the designer should compare the information obtained from the deflection data against that noted in the distress survey. Deflection readings do not always address the total scope of corrective action needed, especially

in areas with substantial distress present. It is recommended the designer use a profile plot of distress and deflection to identify areas requiring additional consideration. In areas of high distress, verifying the deflection analysis with a component analysis may be desirable.

Deflection testing and backcalculations are most highly recommended to obtain a k-value of a soil. This method is suitable for analyzing existing pavements to obtain a k-value. Sometimes a design of similar pavements in the same general location on the same type of subgrade may be appropriate, i.e. at an interchange location.

A procedure is outline in the 1998 AASHTO Supplement to compute the dynamic k-value using FWD. The dynamic k-value must be converted to the initial static k-value and dividing the mean dynamic k-value by two (2) to estimate the mean static k-value for design.

Several software tools are available for production data processing and analysis. The purpose of this section is to provide guidelines for engineers to follow when setting up FWD testing and analyzing the results. CDOT recommends using the software MODTAG.

MODTAG is a software tool that allows an engineer to analyze FWD data quickly and efficiently using empirical (Appendix L of the *AASHTO Guide for Design of Pavement Structures – 1993*) and mechanistic-empirical (MODCOMP) methods and procedures. MODTAG is an in-house software tool developed in cooperation by Virginia DOT and Cornell University's Local Roads Program. MODTAG operates in US Customary and Metric Units, however, some of the routines are not available when a metric analysis is selected. MODTAG is being provided without technical/engineering or software support to users outside Virginia DOT. Additional information on analyzing the testing results can be found in the document titled *MODTAG Users Manual* in the software MODTAG.

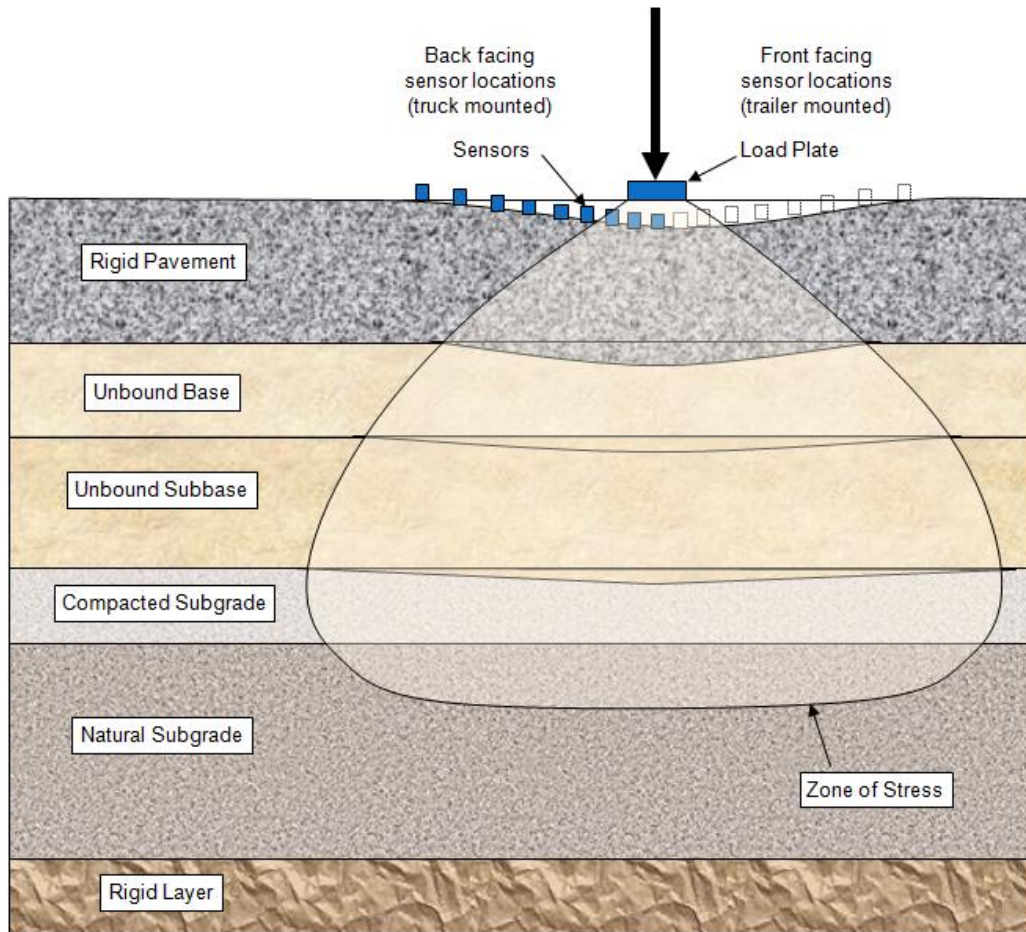
This appendix is based on CDOT's truck mounted JILS-20T FWD with on board JTEST™ software. If other FWD owners use this appendix, they should follow the manufacturers' recommendations. For example, the one drop setting and drop weight is associated with CDOT's FWD, refer to **Figure C.1 Depiction of FWD Load Distribution Through Pavement**.

## **C.2 FWD Testing: Flexible Pavements**

For flexible pavements, FWD testing is used to assess the structural capacity of the pavement and estimate the strength of subgrade soils. The elastic modulus for the surface, base and subbase layers can also be determined.

### **C.2.1 FWD Testing Pattern: Flexible Pavement**

The FWD testing pattern selected for a project should relate to the project's size and layout. The Pavement Engineer should consider the number of lanes to be tested, total length of the project, and any unusual circumstances that would require a change in the testing pattern.



**Figure C.1 Depiction of FWD Load Distribution Through Pavement**

- **Project Layout:** The project layout will influence the FWD testing pattern. For projects where the pavement is to be repaired in each direction, the travel lanes in each direction should be tested. Typically, this should be the outside travel lane. For projects where only one direction will be repaired and more than two lanes exist, then testing should be conducted on the outside lane and possibly the inside lane. The inside lane should be tested if:
  - Pavement structure is different from the outside lane
  - More load related distress is present as compared to the outside lane
  - Heavy truck traffic uses the lane (lane is prior to a left exit)

For projects that contain multiple intersections, FWD testing may not be possible due to traffic. However, testing should be conducted at approaches and departures to an intersection.

- **Project Size:** The project size is determined by the directional length of pavement to be repaired, not necessarily the centerline length and will influence the test spacing.

For example, a project with a centerline distance of one mile to be repaired in two directions has a directional length of two miles. Therefore, the test spacing should be based on two miles. **Table C.1 Flexible Pavement Test Spacing Guidelines** contains guidelines based on project size, test spacing, and estimated testing days.

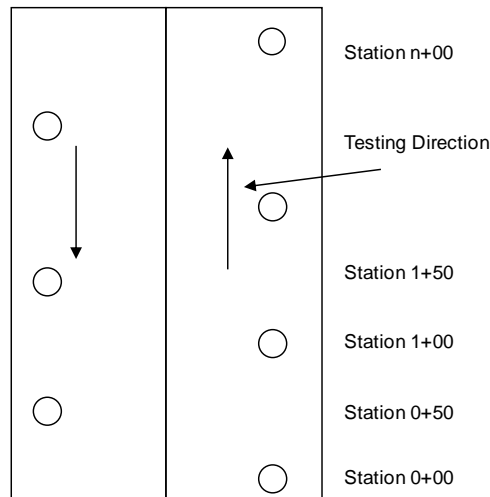
- **Testing Days:** **Table C.1 Flexible Pavement Test Spacing Guidelines** shows the approximate testing days of doing the drop testing. Additional time must be allotted for traffic control setup and travel time to the test site. The project may also require a pre-testing meeting with the Pavement Engineer.

**Table C.1 Flexible Pavement Test Spacing Guidelines**

Project Size (miles)	Test Spacing (feet)	Approximate Number of Tests	Testing Days
0 – 0.5	25	75	½ day
0.5 – 1.0	50	90	½ day
1.0 – 2.0	50	175	1 day
2.0 – 4.0	100	175	1 day
4.0 – 8.0	150	200	1 to 1 ½ days
> 8.0	200	>200	> 1 ½ days

**Note:** A testing day is defined as 200 locations tested.

For two or three lane bi-directional roadways not separated by a median, the testing should be staggered by one-half the test spacing. See **Figure C.2 Flexible Staggered Testing Pattern** for clarification. For projects separated by a median, a staggered testing pattern is not required.



**Figure C.2 Flexible Pavement Staggered Testing Pattern**

- **Basin Testing Location:** For flexible pavements, FWD testing should be conducted in the wheel path closest to the nearest shoulder. This type of testing is known as basin testing since deflection measurements from all sensors may be used (see **Figure C.1 Depiction of FWD Load Distribution Through Pavement**). The purpose of this testing is to characterize the structural condition of the pavement where damage from truck loading should be the greatest. For the outside lanes, testing should be conducted in the right wheel path; for inside lanes, testing should be conducted in the left wheel path.

### C.2.2 FWD Drop Sequence: Flexible Pavement

Drop sequences vary based on pavement type and the type of information being gathered. A drop sequence is defined as the order in which impulse loads are applied to the pavement. This includes the “seating drops” and the recorded impulse loads. Below is the recommended drop sequence for basin testing on flexible pavements:

- Two seating drops at 6,000 pounds
- Three recorded drops at 6,000 pounds
- Three recorded drops at 9,000 pounds
- Three recorded drops at 12,000 pounds
- Three recorded drops at 16,000 pounds

Therefore, at each test location the FWD will perform 14 drops and record four sets of deflection/impulse load data. By performing multiple drops at a location, the pavement will react as a homogeneous structure and reduce errors in measurement. Additionally, recording and analyzing data from four different load levels, the Pavement Engineer can determine if materials on the project are stress sensitive (non-linearly elastic), if a hard bottom (water table, bedrock or extremely stiff layer) is present, and/or if compaction/liquefaction is occurring in the subgrade.

### C.2.3 FWD Sensor Spacing: Flexible Pavement

FWD sensor spacing to record pavement deflection data is dependent on the pavement type, and the testing purpose (load transfer testing vs. basin testing). For basin testing on flexible pavements, the recommended spacing from the center of the load plate is given below:

0, 8, 12, 18, 24, 36, 48, 60, and 72 (inches)

### C.2.4 Surface Temperature Measurement: Flexible Pavement

Ideally, the pavement temperature will be recorded directly from temperature holes at each test location as the test is being performed. While this is the preferred approach for research projects, it is not practical for production level testing (maintenance and rehabilitation projects). Therefore, for production level testing the economic and practical approach is by measuring the surface temperature at each test location using an infrared thermometer. The FWD can automatically measure and record the pavement surface temperature to the FWD file. If the FWD is not equipped

with an infrared thermometer, the operator can use a hand held thermometer and record the temperature to a file. By measuring and monitoring the surface temperature during testing, the FWD operator can suspend testing if the pavement becomes too hot.

### C.3 FWD Testing: Rigid Jointed Plain Concrete Pavements

For rigid pavements, FWD testing is used to assess the structural capacity of the pavement, estimate the strength of subgrade soils, assess load transfer at joints, and detect voids at joints. In addition to the structural capacity, the elastic modulus of the surface, base and sub-base layers can be determined.

#### C.3.1 FWD Testing Pattern: Rigid Pavement

The FWD testing pattern selected for a jointed concrete pavement project should be related to the project's layout, project size, and slab length. The Pavement Engineer should consider the number of lanes to be tested, total number of slabs, length of the project, and any unusual circumstances that would require a change in the testing pattern.

- **Project Layout:** The project layout will influence the FWD testing pattern. For projects where the pavement is to be repaired in each direction, the travel lanes in each direction should be tested. Typically, this should be the outside travel lane. For projects where only one direction will be repaired and more than two lanes exist, then testing should be conducted on the outside lane and possibly the inside lane. The inside lane should be tested if:
  - Pavement structure is different from the outside lane
  - More load related distress is present as compared to the outside lane
  - Heavy truck traffic uses the lane (lane is prior to a left exit)

Due to traffic, FWD testing may not be possible for projects with multiple intersections, however, where possible testing should be conducted at approaches and departures to an intersection.

- **Slab Length and Project Size:** The number of jointed concrete slabs in a project will determine test spacing. For projects with short slab lengths, it may not be practical to test every slab (basin and joint testing). In addition to slab length, the size of a project will influence the test spacing. The project size is determined by the directional length of pavement to be repaired, not necessarily the centerline length. For example, a project with a centerline distance of 1 mile and will be repaired in two directions has a directional length of 2 miles. Therefore, the test spacing should be based on two miles. **Table C.2 Jointed Plain Concrete Pavement Test Spacing Guidelines** contains guidelines based on project size, approximate slab length, test spacing, and estimated testing days. A testing day is defined as 175 locations tested (joints, corners and basins).

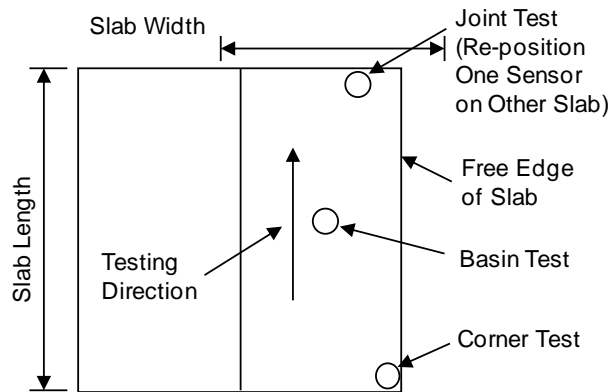
- **Testing Days:** **Table C.2 Jointed Plain Concrete Pavement Test Spacing Guidelines** shows the approximate testing days of actually doing the drop testing. Additional time must be allotted for traffic control setup and travel time to the test site. It may also be required to have a pre-testing meeting with the Pavement Engineer.
- **Rigid and Composite Basin Testing:** The standard procedure will be basin testing only. If additional testing of joint and corner testing is required, a special request is to be submitted.
- **Testing Location:** For jointed concrete pavements, three types of FWD testing are generally conducted; and basin, joint, and slab corner testing. Each test provides information on the structural integrity of the pavement.
- **Basin Testing:** For jointed concrete pavement basin testing should be conducted near the center of the slab (see **Figure C.3 JPCP Testing Pattern**). Testing provides information on the elastic modulus of the PCC and strength of base materials and subgrade soils.
- **Joint Testing:** For jointed concrete pavements, joint testing should be conducted in the wheel path closest to the free edge of the slab (see **Figure C.3 JPCP Testing Pattern**). Typically, for the outside lanes, testing will be conducted in the right wheel path. For inside lanes, testing should be conducted in the left wheel path. If more than two lanes exist and the middle lanes are to be tested, then the nearest free edge must be determined. This testing provides information on joint load transfer; how well a joint through either aggregate interlock and/or dowel bars can transfer a wheel load from one slab to an adjacent slab.
- **Corner Testing:** For jointed concrete pavements, corner testing should be conducted at the slab's free edge corner (see **Figure C.3 JPCP Testing Pattern**). Typically, for the outside lanes, testing will be conducted in the right corner edge of the slab. For inside lanes, testing should be conducted in the left corner edge of the slab. If more than two lanes exist, then the middle lanes should only be tested if pumping is suspected in the middle lanes. The Pavement Engineer will determine if pumping is present and if testing should be conducted. Unless otherwise directed by the Pavement Engineer, corner testing shall be conducted on the leave side of the joint where voids are typically located. This testing provides information on the possibility of the presence of voids under a slab corner.



**Table C.2 Jointed Plain Concrete Pavement Test Spacing Guidelines**

Project Size (miles)	Slab Length (feet)	Basin Test Spacing (no. of slabs)	Joint/Corner Spacing (no. of slabs)	Approximate Number of Tests	Testing Days
0 - 0.5	< 20	every 6th slab	every 2nd J/C	115	1 day
0.5 – 1.0	< 20	every 9th slab	every 3rd J/C	180	1 day
1.0 – 2.0	< 20	every 12th slab	every 4th J/C	250	1 – 2 days
2.0 – 4.0	< 20	every 15th slab	every 5th J/C	380	1½ - 3 days
4.0 – 8.0	< 20	every 20th slab	every 10th J/C	220	1½ - 3 days
> 8.0	< 20	every 20th slab	every 10th J/C	450	> 3 days

**Note:** Basin testing using spacings of every 20<sup>th</sup> slab is more applicable to network than project testing.



**Figure C.3 JPCP Testing Pattern**

### C.3.2 FWD Drop Sequence – Rigid Pavement

When collecting pavement structure data, the correct drop sequence is required. Drop sequences vary based on pavement type and information being gathered. A drop sequence is defined as the order in which impulse loads are applied to the pavement. This includes the “seating drops” and the recorded impulse loads.

- **Basin Testing:** Below is the recommended drop sequence for basin testing on jointed concrete pavements:
  - Two seating drops at 6,000 pounds
  - Three recorded drops at 6,000 pounds
  - Three recorded drops at 9,000 pounds
  - Three recorded drops at 12,000 pounds
  - Three recorded drops at 16,000 pounds

Therefore, at each test location the FWD will perform 14 drops and record four sets of deflection and impulse load data. By performing multiple drops at a location, the pavement will react as a homogeneous structure, as well as, reduce the errors in measurement. Additionally, by recording and analyzing data from four different load levels, the Pavement Engineer can determine if the materials on the project are stress sensitive (non-linearly elastic), if a hard bottom (water table, bedrock or extremely stiff layer), and if compaction/liquefaction is occurring in the subgrade.

- **Joint Testing:** Below is the recommended drop sequence for joint testing on jointed concrete pavements:
  - Two seating drops at 6,000 pounds
  - Three recorded drops at 6,000 pounds
  - Three recorded drops at 9,000 pounds
  - Three recorded drops at 12,000 pounds
  - Three recorded drops at 16,000 pounds

Therefore, at each test location the FWD will perform 14 drops and record four sets of deflection and impulse load data. Two sensors are needed for the analysis, the sensor at the load and the second sensor on the other side of the joint.

- **Corner Testing:** Below is the recommended drop sequence for corner testing on jointed concrete pavements:
  - Two seating drop at 6,000 pounds
  - Three recorded drops at 9,000 pounds
  - Three recorded drops at 12,000 pounds
  - Three recorded drops at 16,000 pounds

In order to use the AASHTO procedure for the detection of voids, three different load levels are required. Thus, at each test location the FWD will need to perform 10 drops and record three sets of deflection and impulse load data. Only one sensor is needed in the analysis, the sensor at the load.

### C.3.3 FWD Sensor Spacing – Rigid Pavement

FWD sensor spacing to record pavement deflection data is dependent on the pavement type and the type of testing. For jointed concrete pavements, three types of testing are performed - joint, corner and basin.

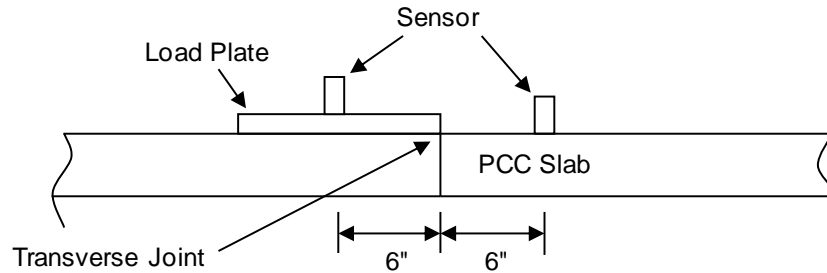
- **Basin Testing:** For basin testing on jointed concrete pavements, below is the recommended spacing:

0, 8, 12, 18, 24, 36, 48, 60, and 72 (inches)

- **Joint Testing:** For joint testing on jointed concrete pavements, only two sensors are required. Below is the required spacing:

0 and 12 (inches)

The sensors are to be placed on each side of the joint and are 6 inches from the joint (see **Figure C.4 Joint Load Transfer Testing Sensor Spacing**).

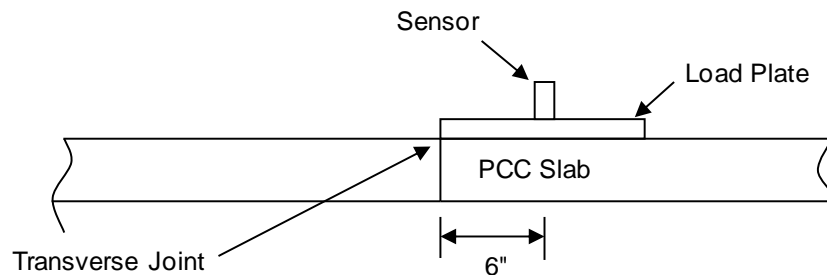


**Figure C.4 Joint Transfer Testing Sensor Spacing**

- **Corner Testing:** For joint testing on jointed concrete pavements, only one sensor is required. Below is the required sensor location:

0-inches – at the load

The sensor is to be placed on the leave side of the joint, 6 inches from the joint (**Figure C.5 Corner Testing Sensor Location**).



**Figure C.5 Corner Testing Sensor Location**

### C.3.4 Surface Temperature Measurement: Rigid Pavement

Ideally, the pavement temperature will be recorded directly from temperature holes at each test location as the FWD test is being performed. While this is the preferred approach for research projects, it is not practical for production level testing (network level or maintenance and

rehabilitation projects). Therefore, for production level testing the economic and practical approach is by measuring the surface temperature at each test location. This can be easily done using an infrared thermometer. The FWD can automatically measure and record the pavement surface temperature to the FWD file. If the FWD is not equipped with an Infrared thermometer, then the FWD operator can use a hand held thermometer and record the temperature to a file. By measuring and monitoring the surface temperature during testing, the FWD operator can suspend testing if the pavement becomes too hot. **Note:** Pavement temperature is recorded for joint and corner testing only.

## C.4 FWD Testing: Composite Pavement

The FWD testing pattern selected for a project should be related to the project's size and layout. The Pavement Engineer should consider the number of lanes to be tested, total length of the project, and any unusual circumstances that would require a change in the testing pattern. In addition, the AC overlay thickness should be considered. If the thickness is less than four inches, then the load transfer of the underlying PCC joints may be performed.

- **Project Layout:** The project layout will influence the FWD testing pattern. For projects where the pavement is to be repaired in each direction, the travel lanes in each direction should be tested. Typically, this should be the outside travel lane. For projects where only one direction will be repaired and more than two lanes exist, then testing should be conducted on the outside lane and possibly the inside lane. The inside lane should be tested if:
  - Pavement structure is different from the outside lane
  - More load related distress is present as compared to the outside lane
  - Heavy truck traffic uses the lane (lane is prior to a left exit)

For projects that contain multiple intersections, FWD testing may not be possible due to traffic. However, testing should be conducted at approaches and departures to an intersection.

- **Project Size:** The project size is determined by the directional length of pavement to be repaired, not necessarily the centerline length will influence the test spacing. For example, a project with a centerline distance of 1 mile and to be repaired in two directions has a directional length of 2 miles. Therefore, the test spacing should be based on two miles. **Table C.3 Composite Pavement Test Spacing Guidelines** contains guidelines based on project size, test spacing, and estimated testing days if load transfer testing is not performed. If load transfer testing is desired, then the appropriate spacing should be determined in the field. As a guideline, please refer to Joint/Corner Spacing column in **Table C.2 Jointed Plain Concrete Pavement Test Spacing Guidelines**. A testing day is defined as 200 locations tested.
- **Testing Days:** **Table C.3 Composite Pavement Test Spacing Guidelines** shows the approximate testing days of actually doing the drop testing. Additional time must be

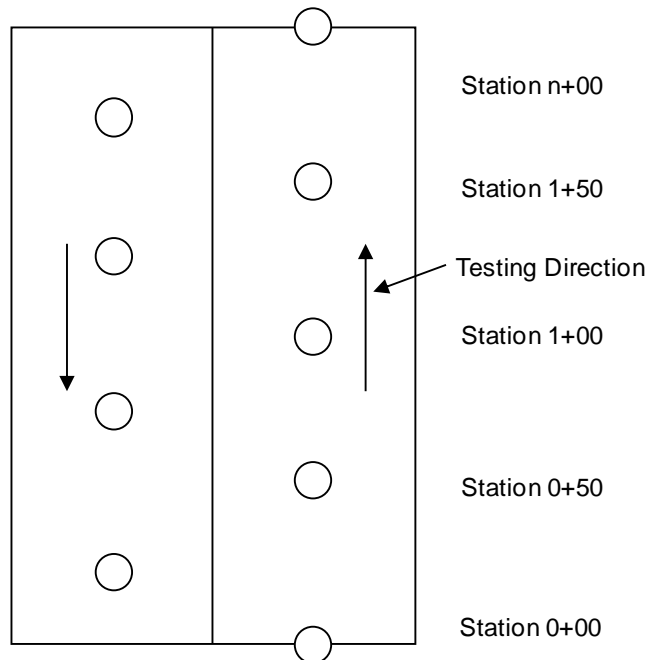
allotted for traffic control setup and travel time to the test site. It may also be required to have a pre-testing meeting with the Pavement Engineer.

- **Composite Basin Testing:** The standard procedure will be basin testing only. If additional testing of joint testing is required, a special request is to be submitted.

**Table C.3 Composite Pavement Test Spacing Guidelines**

Project Size (miles)	Test Spacing (feet)	Approximate Number of Tests	Testing Days
0 – 0.5	25	75	½ day
0.5 – 1.0	50	90	½ day
1.0 – 2.0	50	175	1 day
2.0 – 4.0	100	175	1 day
4.0 – 8.0	150	200	1 to 1½ days
> 8.0	200	> 200	> 1½ days

For two or three lane bi-directional roadways not separated by a median, the testing should be staggered by one-half the test spacing. Refer to **Figure C.6 Staggered Testing Pattern** for clarification. For projects that are separated by a median, a staggered testing pattern is not required.



**Figure C.6 Staggered Testing Pattern**

- **Testing Locations:** For composite pavements, two types of FWD testing are generally conducted, basin and joint. Each test provides information on the structural integrity of the pavement.
- **Basin Testing:** For composite pavements, basin testing should be conducted in the middle of the lane or near the center of the slab. This testing provides information on the elastic modulus of the AC, PCC and strength of base materials and subgrade soils.
- **Joint Testing:** For composite pavements, joint testing should be conducted in the wheel path closest to the free edge of the slab (see **Figure C.6 Staggered Testing Pattern**). Typically, for the outside lanes, testing will be conducted in the right wheel path. For inside lanes, testing should be conducted in the left wheel path. If more than two lanes exist and the middle lanes are to be tested, then the nearest free edge must be determined. This testing provides information on joint load transfer; how well a joint, through either aggregate interlock and/or dowel bars, can transfer a wheel load from one slab to an adjacent slab.

#### C.4.1 FWD Drop Sequence: Composite Pavement

When collecting pavement structure data, the correct drop sequence is required. Drop sequences vary based on pavement type and information being gathered. A drop sequence is defined as the order in which impulse loads are applied to the pavement. This includes the “seating drops” and the recorded impulse loads.

- **Basin Testing** - below is the recommended drop sequence for basin testing on composite pavements:
  - Two seating drops at 6,000 pounds
  - Three recorded drops at 6,000 pounds
  - Three recorded drops at 9,000 pounds
  - Three recorded drops at 12,000 pounds
  - Three recorded drops at 16,000 pounds

Therefore, at each test location the FWD will perform 14 drops and record four sets of deflection and impulse load data. By performing multiple drops at a location, the pavement will react as a homogeneous structure as well as reduce the errors in measurement. Additionally, by recording and analyzing data from four different load levels, the Pavement Engineer can determine if the materials on the project are stress sensitive (non-linearly elastic), if a hard bottom (water table, bedrock or extremely stiff layer), and if compaction/liquefaction is occurring in the subgrade.

- **Joint Testing** - below is the recommended drop sequence for joint testing on composite pavements:
  - Two seating drops at 6,000 pounds
  - Three recorded drops at 6,000 pounds

- Three recorded drops at 9,000 pounds
- Three recorded drops at 12,000 pounds
- Three recorded drops at 16,000 pounds

Therefore, at each test location the FWD will perform 14 drops and record four sets of deflection and impulse load data. Two sensors are needed for the analysis, the sensor at the load and the second sensor on the other side of the joint.

#### C.4.2 FWD Sensor Spacing: Composite Pavement

FWD sensor spacing to record pavement deflection data is dependent on the pavement type, and the type of testing. For composite pavements, two types of testing are performed; joint and basin.

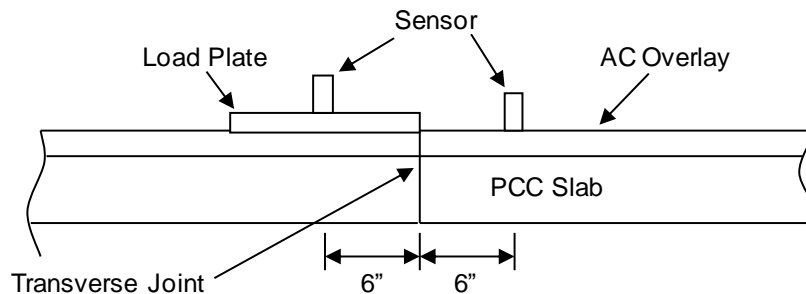
- **Basin Testing:** For basin testing on composite pavements, below is the recommended spacing:

0, 8, 12, 18, 24, 36, 48, 60, and 72 (inches)

- **Joint Testing:** For joint testing on composite pavements, only two sensors are required. Below is the required spacing:

0 and 12 (inches)

The sensors are to be placed on each side of the joint and 6 inches from the joint (see **Figure C.7 Joint Load Transfer Testing Sensor Spacing**).



**Figure C.7 Joint Load Transfer Testing Sensor Spacing**

#### C.4.3 Pavement Temperature Readings: Composite Pavement

Ideally, the pavement temperature will be recorded directly from temperature holes at each test location as the FWD test is being performed. While this is the preferred approach for research projects, it is not practical for production level testing (network level or maintenance and rehabilitation projects). Therefore, for production level testing the economic and practical approach to determine the mid-depth pavement temperature is by measuring the surface

temperature at each test location using an infrared thermometer. The FWD can automatically measure and record the pavement surface temperature to the FWD file. If the FWD is not equipped with an infrared thermometer, the FWD operator can use a hand held thermometer and record the temperature to a file. Using temperature correlation models such as the BELLS3 equation, the mid-depth AC material temperature can be estimated.

## C.5 Field Test Report

Besides the FWD drop file, additional documentation of the FWD project is necessary. A suggested Field Test Report is presented in **Figure C.8 Field Test Report**. A log entry should only be made for special conditions, such as a test location skipped because it was on a bridge. The FWD operator does not test for frost depth.

## C.6 FWD Data Processing

CDOT uses AASHTO PDDX file format in its FWD files. The following is an example of data collected at a test site:

```
*****  
[Test Location 1]  
TestLocation = 45.592  
TestLane = 1  
TestTemperatures = 93.5,105.1  
TestComment = 13:01  
NumberOfDrops = 3  
DropData_1 = 9120.00, 18.32, 12.43, 9.69, 6.95, 5.37, 3.32, 2.43  
DropData_2 = 9040.00, 17.98, 12.24, 9.57, 6.90, 5.42, 3.30, 2.43  
DropData_3 = 8990.00, 17.91, 12.18, 9.56, 6.92, 5.36, 3.31, 2.46  
↓  
↓  
*****
```

On the "*Test Temperatures = 93.5,105.1*" line, the first value of 93.5 is the air temperature and the second value of 105.1 is the pavement surface temperature.

The "Test Comment = 13:01" indicates the time of the test is 1:01 PM. The time uses the 24 hour format.

In order to process FWD data, many steps are required. These steps include gathering information on the pavement's surface condition, conducting a preliminary analysis on the deflection data, performing pavement coring and subgrade boring operations, processing of all the data collected, and analyzing, interpreting and reporting on the data results. Each one of these steps has numerous tasks associated with them. These steps are detailed in the following sections.





### C.6.1 Pre-Analysis

Once FWD data are collected, it is important to perform a preliminary analysis on the deflection data. Please refer to the *MODTAG Users Manual* for further instruction on pre-analysis.

### C.6.2 Pavement Surface Condition Survey

Prior to collecting any FWD data, the engineer should conduct a detailed pavement condition and patching survey. These surveys will help the engineer establish possible problem areas with the pavement and set-up the appropriate FWD testing plan. Testing could be concentrated in specific areas while other areas could be avoided completely. Refer to **Section 8.2.5 Non-Destructive Testing, Coring and Material Testing Program** and **Section 9.2.4 Non-Destructive Testing**. Once these data are collected, the engineer can plot the results on a straight-line diagram. This will be extremely beneficial when other data are collected and analyzed.

### C.6.3 Pavement Coring and Subgrade Boring

In order to conduct an analysis of FWD data, the exact pavement structure must be known. For most roadways, the exact structure is not known; therefore, pavement coring is required. Coring provides thicknesses to be used as seed values for backcalculation analysis. Cores should be retained for further evaluation in the laboratory. Pavement cores identify layer types and conditions to help validate surface course moduli. In addition, while the engineer may know what type of subgrade soils exists in the project area, they cannot be sure without boring the subgrade and extracting samples. These materials collected in field can be analyzed in the lab, to validate FWD data analysis results.

The thickness of the existing pavement layers must be known. Cores must be taken at a minimum of one core per mile for pavement layer and base layer thickness measurements. When pavement length is less than one mile, a minimum of one core will be taken. If a review of the as built plans from previous projects indicates there are locations with varying thicknesses, more cores will be taken to verify the existing pavement thickness.

For the materials above the subgrade, the coring and boring crew should record:

- **Layer Materials:** asphalt, PCC, granular, cement treated, etc
- **Layer Thickness:** thickness for each different layer
- **Layer Condition:** AC material stripped, PCC deteriorated, granular material contaminated, etc.
- **Material Types:** For AC materials, identify various layer types

For the subgrade and base materials refer to **Section 4.2 Soil Survey Investigation** for three steps that are necessary to conduct a subgrade and base investigation. One should document findings and test results on CDOT Forms #554 (Soil Survey Field Report) and #555 (Preliminary Soil Survey). Refer to **Figure C.9 Coring Log Example**.

### C.6.4 Full Data Processing

Once pavement condition and materials data are collected, then the engineer can perform the data processing. The type of data processing depends on 1) pavement type; flexible, rigid or composite, and 2) testing performed; basin, joint load transfer, or corner void. Please refer to the *MODTAG Users Manual* for further instructions.

### C.6.5 Data Analysis, Interpretation and Reporting

Except for operating the FWD processing programs, the data analysis and interpretation is the most difficult portion. Once the analysis and interpretation is complete, the results must be presented in such a manner to be used in the pavement design programs. Please refer to the *MODTAG Users Manual* for further information.

COLORADO DEPARTMENT OF TRANSPORTATION											LOCATION						
PRELIMINARY PAVEMENT STRUCTURE INVESTIGATION											I-76, US 85 to Burlington Canal						
Date: 4/13/06 Page: 1 of 2 NOTE: If samples are submitted leave sieve analysis section blank.											PROJECT NO.						
											SUBACCOUNT 15361						
STATION AND LOG	TEST NO.	DESCRIPTION	PERCENT PASSING										LIQUID LIMIT	PLASTIC INDEX	CLASSIFICATION AND GROUP INDEX	MOISTURE %	Mr P.S.I.
			1"	3/4"	1/2"	3/8"	#4	#8	#16	#50	#200						
I-76, US 85 to Burlington Canal																	
Eastbnd. @ MP 12.5, Lane #2																	
0-4.5"	1	HBP	Lift Thickness: 0-1.5", 1.5-2.5", 2.5-4.5" (New 1/2" mix)														
4.5-12"		PCCP	Lift Thickness: 4.5-12"														
12-28"		Roadbase	100	99	97	90	78	66	39	18.5			Class 3				
Eastbnd. @ MP 13, Lane #2																	
0-4.5"	2	HBP	Lift Thickness: 0-1.5", 1.5-2", 2-4.5" (New 1/2" mix)														
4.5-12.75"		PCCP	Lift Thickness: 4.5-12.75"														
12.75+"		Roadbase similar as #1															
Eastbnd. @ MP 13.5, Lane #2																	
0-4.25"	3	HBP	Lift Thickness: 0-1.5", 1.5-2", 2-4.25" (New 1/2" mix)														
4.25+"		PCCP	Did not core PCCP because of similar depths														
Eastbnd. @ MP 13.5, Shoulder																	
0-6.75"	4	HBP	Lift Thickness: 0-1.5", 1.5-2.25", 2.25-3", 3-4.25" (New 1/2" mix), 4.25-6.75" (Old 1/2" mix) highly visible air voids														
6.75-12+"		Roadbase	100	96	92	77	58	38	15	6.2			Class 2				
Eastbnd. @ MP 14.5, Lane #2																	
0-4"	5	HBP	Lift Thickness: 0-1", 1-1.75", 1.75-4" (New 1/2" mix)														
4-12.25"		PCCP	Lift Thickness: 4-12.25"														
12.25-16"		Roadbase	100	100	99	97	92	87	81	58	27.8						
16+"		Soil															
Eastbnd. @ MP 16, Lane #2																	
0-4.5"	6	HBP	Lift Thickness: 0-2", 2-4.5" (New 1/2" mix)														
4.5+"		PCCP	Did not core PCCP because of similar depths														
Eastbnd. @ MP 16, Shoulder																	
0-6.5"	7	HBP	Lift Thickness: 0-1.75" (New 1/2" mix), 1.75-2.5" (Chip Seal), 2.5-4.5", 4.5-6.5" (New 1/2" mix)														
6.5+"		Roadbase similar as #4															

REGION DESIGN  
REGION MATERIALS ENGINEER

C.D.O.T. FORM #555  
1/92

Figure C.9 Coring Log Example

### **C.6.6 Results Reporting – Flexible Pavements**

FWD Analysis results are used to report on the condition of the existing pavement and to provide information for use in future pavement designs. For flexible pavements, the existing conditions and pavement design information should be reported and include:

- Effective structural number (if designing with software prior to M-E Design)
- Subgrade resilient modulus
- Remaining life or condition factor

### **C.6.7 Results Reporting – Jointed and Composite Pavements**

FWD Analysis results are used to report the condition of the existing pavement and provide information for use in future pavement designs. For jointed and composite pavements, the existing conditions and pavement design information should be reported and include: :

- Elastic modulus of the concrete
- Composite modulus of subgrade reaction (k-value) (if designing with software prior to M-E Design)
- Load transfer efficiency and J-factor
- Corners with possible voids

### **C.6.8 Data Analysis and Interpretation – Jointed and Composite Pavements**

More than one analysis approach should be used to minimize errors in interpretation. By using multiple approaches, the engineer can determine if the results correlate between programs or are vastly different. Once results are obtained, then engineering judgment must be employed to see if the results are reasonable.

## References

1. *Chapter VI - Pavement Evaluation and Design*, Virginia Department of Transportation, 1401 Broad Street, Richmond, VA 23219, January 2004.
2. *MODTAG Users Manual Version 4*, Virginia Department of Transportation and Cornell University, Virginia Department of Transportation, 1401 Broad Street, Richmond, VA 23219, June 2006.
3. *Instructional Guide for Back-Calculation and the Use of MODCOMP3*, Version 3.6, CLRP Publication No. 94-10, by Dr. Lynne H. Irwin, Cornell University, Local Roads Program, March 1994.
4. ModTag Analyser, Version 4.0.6, Software.

## **APPENDIX D**

### **LOW VOLUME ROAD PAVEMENT MAINTENANCE**

#### **D.1 Introduction**

*The New Economy: Materials and Pavement Options and Considerations* is a finalized white paper, written by Colorado Department of Transportation (CDOT) Materials Advisory Committee on January 16, 2007. The white paper is important document and is included in this manual as guidance for the pavement engineer. The authors and members of the Materials Advisory Committee at the time of the issuance were:

Tim Aschenbrener, CDOT Materials and Geotechnical Branch  
Bill Schiebel, Region 1 Materials  
Richard Zamora, Region 2 Materials  
Rex Goodrich, Region 3 Materials  
Gary DeWitt, Region 4 Materials  
Mike Coggins, Region 5 Materials  
Masoud Ghaeli, Region 6 Materials  
Glenn Frieler, Concrete Pavement Program Manager  
Jay Goldbaum, Pavement Design Program Manager  
Roy Guevara, Asphalt Pavement Program Manager  
Corey Stewart, Pavement Management Program Manager

#### **D.2 White Paper: The New Economy**

##### **Introduction**

There is a new economy relative to petroleum products. National prices set records in 2006 for crude oil (over \$70 per barrel) and gasoline (over \$3 per gallon). In the Rocky Mountain West there has been an increase in the use of cokers at asphalt refineries which has provided an additional tightening of the supply of asphalt binder. The tighter supply has also had an impact on cost. Unmodified asphalt binder prices exceeded \$450 per ton. These economic changes have been behind the recently introduced term, “new economy.” CDOT’s surface treatment program relies heavily on petroleum products, and the new economy warrants a discussion on the relative impacts and options available to CDOT.

The National Asphalt Pavement Association (NAPA) and Colorado Asphalt Pavement Association (CAPA) have concerns regarding the new economy. They have published methods to encourage owners to be more cost effective. NAPA has focused on the hot-mix asphalt (HMA) materials and pavement design with recommendations on reclaimed asphalt pavement (RAP), appropriate use of polymers, large-stone aggregate mixtures, thin-lift overlays and roofing shingles. CAPA has focused some on HMA materials and pavement design areas (RAP, specification changes, etc) but has also included the project development process (partnering, constructability reviews, etc.). The methods NAPA and CAPA have documented are valid and need to be considered. However, they do not necessarily represent a complete list of options the owner should consider.

The purpose of this white paper is to document seven strategies that should be considered by the owner in light of the new economy. Some of these are old, tried and true strategies that will now be cost effective more often than in the past. Other strategies are new ideas that can be investigated to get the most from the limited surface treatment program funds. We need to remember that the common strategies used in the past will still work and may still be cost effective; however, we need to be sure to look at a variety of options with the prices of the new economy. Automatically choosing the proven strategies of the past may not be the most cost effective solution.

## **Preventive Maintenance**

Nationally, pavement preservation has been touted as a more cost effective process to maintain the surface condition. It represents a key component of a long-range plan to preserve and prolong the service life of the existing roadway system. Its goal is to keep the pavements that are in good and fair condition in that condition rather than let them deteriorate to a poor condition. When in a poor condition, more costly treatments are needed. States such as Georgia and Michigan have documented that for every \$1 spent on maintaining and preserving roads in good to fair condition, you can save approximately \$5 to \$8 on major rehabilitation and reconstruction. Treating the pavements at the right time with the right maintenance treatments is very cost effective. These cost analyses were for the “old economy” so the “new economy” analyses should be even more persuasive.

Colorado Policy Memo 18 dated October 15, 2003 has started Colorado in the direction of more preventive maintenance. CDOT has committed 5% of the surface treatment program budget to be dedicated to preventive maintenance. With the new economy, it may be time to increase the amount dedicated to preventive maintenance.

### Strategy 1: Use more preventive maintenance treatments that have worked.

Standard preventive maintenance treatments that are frequently used by CDOT have been incorporated into the draft CDOT Preventive Maintenance Manual available on the Pavement Management website.

- Chip seals are a commonly used maintenance treatment. Sometimes they are used for corrective maintenance and other times they are used for preventive maintenance. When it comes to preventive maintenance, chip seals provide the biggest bang for the buck. They dramatically slow the deterioration of the underlying asphalt by sealing out water and preventing further oxidation of the underlying asphalt, caused in part by the damaging effects of the sun. An asphalt overlay achieves the same but at a much higher cost. When the structural capacity of the pavement is adequate, a chip seal is often the best value tool in our toolbox for increasing the pavement life. It is necessary to extend the life of HMA overlay treatments as anticipated Surface Treatment budgets may not be sufficient to sustain network conditions.

A recent Region 5 chip seal project was bid at around \$3/SY for 385,000 SY of roadway. A similar 3” HMA overlay project cost about \$12/SY for 241,000 SY of roadway. In this example, the chip

seal was approximately 1/4 the cost of a 3" overlay. Chip seals will continue to be widely used by CDOT and, considering our limited funding, are an essential tool for preserving and maintaining our roads.

Regions 4 and 5 have started doing chip seals for preventive maintenance at the 3<sup>rd</sup> to 5<sup>th</sup> year of life of an overlay. The goal is to extend the time to the next overlay from 8 to 10 years to 12 to 15 years. By placing 2 or 3 chip seals, the need for the next overlay can be delayed. The chip seals are much less costly than overlays making this strategy cost effective.

### Strategy 2: Examine new preventive maintenance techniques.

CDOT should continue to evaluate new treatment strategies and expand upon existing treatment options. Examples of additional treatment options are as follows:

- There are 2 types of Brazier mixes. Understanding the difference is important to a successful application. The original Brazier mix is similar to an asphalt sand mix. The new generation of Brazier mix is a milled asphalt mixed with emulsion in a pug mill prior to placement. A technique called Armor Cote from Nebraska DOT, consisting of small rounded river rock mixed with emulsion, is being studied for a possible treatment.
- Further, project selection is critical. When trying these new techniques, it is important to follow the experimental feature protocol. Region 4 is experimenting with the Brazier mix.
- Cape seals are another new and potentially effective preventive maintenance treatment. Region 4 is experimenting with it. Project selection guidelines and materials and construction specifications need to be followed. The performance will be monitored to see if this is a viable new alternative.

## **Rehabilitation Strategies**

### Strategy 3: Use more 100 percent recycling.

There are several different types of 100 percent recycling that have been used in Colorado for many years. These options have performed very well when appropriate project selection guidelines have been used and the projects were constructed properly.

- Hot-in-place recycling has been used for many years in Colorado. Regions 3 and 5 have used the three types of hot-in-place recycling on the appropriate projects and have had very good success to date. Some of the projects that have been placed have even won awards. It is interesting to note that the City and County of Denver focuses on the heater repaving option in the major metropolitan area. Using curb line milling, the heater repaving process provides 2 inches of treatment for the cost of 1 inch of new material. The heater-remixing process provides 2 inches of treatment for less than the cost of a 1-inch overlay. Even though the fuel costs of hot-in-place recycling have increased, it is only a fraction of the increase that has been experienced for HMA pavements.



- Full-depth reclamation (FDR) is relatively new to Colorado. This is a version of foamed asphalt that was identified on a recent European scanning tour. In some cases FDR includes an additive and in other cases it does not. Region 4 has used this treatment on many projects with low traffic in the eastern part of the State. This treatment allows for a full depth treatment of the existing pavement section with the addition of just 2-6 inches of new HMA. The feedback on construction and performance to date has been very positive. Test sections in service for several years have shown no reflective cracking.
- Cold-in-place recycling has also been used for many years in Colorado. This is a tried and true method that has worked in the past. The specifications and project selection guidelines are CDOT standards. Once again, the existing pavement can have a deep treatment of up to 8 inches if specialized emulsion and equipment are used. Typical cold-in-place recycling is typically 4 inches deep and then only need 2 to 6 inches of overlay. This method should still be considered.
- Additionally, consideration should be given to performing combinations of various treatments depending on distresses observed during a project level pavement analysis.

Strategy 4: Focus on cost effective wearing surfaces.

- Stone matrix asphalt (SMA) shows a lot of promise. After first being introduced to the United States from a European scanning tour, SMA has shown to be a highly effective wearing surface on the high volume roadways in Colorado. Although the initial costs are higher than conventional HMA, the performance data indicates it is a cost effective choice in those locations.
- Expanding on CDOT's successful implementation of SMA, thin-lift SMA is now being studied and may even be more cost effective than SMA when only a functional overlay is required. The use of a smaller nominal maximum aggregate size (3/8-inch) and a thinner lift (1-inch) will allow for this wearing surface to be more cost effective initially. Data from other states have shown that the thin SMA performs well as a wearing course. Colorado has limited data to date, but we have learned that compaction and aggregate size are critical. Colorado will use thin-lift SMAs on several projects during the 2007 construction season. This may also be a preventative maintenance treatment.
- Micro-surfacing has been used by CDOT to correct minor rutting and to restore the skid resistance of the pavement surface. It is composed of polymer modified asphalt with crushed aggregate, mineral fillers, and field control additives. Due to the quick reaction time, an experienced Contractor is desired. Colorado has had mixed results using micro-surfacing as a wearing surface.
- When using more expensive wearing surfaces, shoulders can be treated differently. When focusing on the wearing surface, it is not necessary to treat the wider shoulders with the same premium HMA pavement that is placed on the shoulders. Consideration should be given to a more economical mix.

Strategy 5: Use more portland cement concrete pavement.

- Thin white topping is a CDOT standard. After 10 years of experimentation, the specifications and project selection guidelines have been refined to provide a product that has proven success. When examining major rehabilitations, this option should be given strong consideration.

Strategy 6: Examine new rehabilitation strategies.

- An Ultra-thin Whitetopping Overlay (UTW) is a pavement rehabilitation technique that has been marketed by the American Concrete Pavement association (ACPA). UTW projects have provided durable wearing surfaces for pavements that are not subject to frequent heavy truck loadings, and where a substantial thickness of asphalt exists. Given its success in limited applications, UTW is now being considered for a range of other applications. In fact, a few states have pilot projects using UTW as an alternative to asphalt overlays for interstate roads. There are, however, still a lot of unknowns about the process. CDOT's Pavement Design Program and Region 6 have gathered design and construction information and would be glad to share that with anyone that wants to consider this experimental feature. When there is a need to place 4-inches of HMA pavement, ultra-thin white topping may be a cost-effective alternative for pavement rehabilitation.
- Cement-treated bases and roller-compacted concrete (RCC) have been used in the past as strong bases to build up the structural layer coefficient of the pavement section. Possibilities exist for utilization of lesser quality of rock and utilization of asphalt placement equipment. A reduced quantity of HMA overlay that results from a stronger base is one motivation for considering these treatments. Colorado has not used RCC in the past, but is considering potential applications in light of the new economy. There is minimal experience nationally at this time with using RCC for highway applications, but RCC may be evaluated as a finished driving surface. Detour pavements may be the ideal location to begin evaluation of RCC pavement.
- Some geotextiles can reduce the structural layer coefficient needed for rehabilitation with an HMA overlay. Some research has shown that the use of a geo-grid can provide a structural benefit. Region 3 is reviewing this literature and is giving consideration to this treatment. If the overlay can be reduced by a nominal amount, then the use of the geo-grid may be cost effective. Region 1 is evaluating the use of high-tensile strength paving geogrids to mitigate severe crack reflection. These products are specially designed for placement within the asphalt layers. Successful performance may yield an alternative to hot and cold in-place recycling prior to overlay. Considerations need to be made for future rehabilitations that may include milling or 100% recycling options.

**New Products**

Strategy 7: Examine new products.

- AggCote is a product of the American Gilsonite Company that is an additive for Hot Mix Asphalt pavement that may increase the material's resistance to stripping and subsequently increases resistance to rutting. The product is a mineral called Gilsonite that is mined in Utah and works by "priming" the aggregates before the liquid asphalt is applied. The AggCote increases the bond strength between the aggregate and asphalt cement, increasing the resistance to stripping while still maintaining the flexural properties of the binder for thermal crack resistance.

Lab studies conducted by CDOT concluded that AggCote does work well in all areas that the manufacturer claims. The product consistently provides both increased durability and rut resistance over the current alternative of hydrated lime. This is all with lab mixed samples only. It is unknown if these same results can be produced with plant mixed material in the field.

AggCote is currently a more expensive alternative to lime but it is undetermined if the benefits are worth the additional costs when this product is applied in the field. Field testing may determine if AggCote's benefits outweigh the additional costs. With the price of crude oil increasing, the benefits and cost savings of using AggCote may soon surpass that of lime. AggCote can replace some asphalt cement used in the mix and does not require the aggregates to be hydrated and dried, which is another area for fuel savings.

It would be worthwhile to pilot this product on a project and do extensive field testing and comparisons of this product versus hydrated lime.

- Asphalt membranes have been an effective way to protect our bridge decks. However, they often have performance issues due to their unique nature, placement, and environment. Alternate bridge deck protection should be considered. A membrane that shows promise is Dega-deck. Region 1 has experimented with this new product. Applications where short application times are necessary have given support to the Dega-deck process.

## Closure

From this discussion it can be observed that every Region within CDOT is proactively evaluating additional options because of costs in the new economy. There are many old strategies being used at increasing levels, and new ideas that are being investigated to get the most from the limited surface treatment program funds. This information is provided to encourage the continued and expanded uses of CDOT's standard products when cost effective and to encourage the exploration of innovative products.

In looking at these pavement rehabilitation and maintenance strategies, it is important to remember to do the right treatment at the right time. Be sure to use structural fixes when the structure needs it. A recently published document that provides guidance for identifying the right treatment at the right time is *Guidelines for Selection of Rehabilitation Strategies for Asphalt Pavement* report number CDOT-DTD-R-2000-08 written by Bud Brakey.

## References

1. CDOT Policy Memo 18, Pavement Preventive Maintenance Initiatives, Oct.1, 2003.
2. Brakey, Bud, *Guidelines for Selection of Rehabilitation Strategies for Asphalt Pavement*, Report No. CDOT-DTD-R-2000-08, Colorado Department of Transportation, 2000.
3. American Concrete Pavement Association, Ultra Thin Whitetopping Calculator, [http://www.pavement.com/Concrete\\_Pavement/Technical/UTW\\_Calculator/index.asp](http://www.pavement.com/Concrete_Pavement/Technical/UTW_Calculator/index.asp), (1/16/2007).

## APPENDIX E

# PAVEMENT TREATMENT GUIDE FOR HIGHWAY CATEGORIES

### E.1 Introduction

This guide is intended to assist the Region Materials Engineers (RME) when making pavement design decisions in accordance with the hierarchical stratification of highway categories. The Transportation Commission, per Policy Directive 14, identified Interstates and NHS as having the highest standards and the highest priority when directing surface treatment funds. Other highways will have reduced funding and treatment priority in accordance with traffic volume. Surface Treatment Program investments on highways should be in accordance with the defined goals and objectives for each. This document identifies treatment parameters for each category of highway.

These guidelines do not apply to capacity related projects, realignment projects, pavement safety issues, or new construction; such projects will follow current *CDOT Pavement Design Manual* processes.

### E.2 Definitions

#### E.2.1 Highway Categories

- **Interstate:** Any highway on the Interstate Highway System. This is the most important highway category in the State of Colorado.
- **NHS:** Any highway on the National Highway System, excluding interstates.
- **Other Highways:** Any highway not on the NHS or interstate.
- **High Volume:** A high volume highway includes segments with annual average daily traffic (AADT) greater than 4,000 or average annual daily truck traffic (AADTT) greater than 1,000.
- **Medium Volume:** A medium volume facility includes segments with AADT between 2,000 and 4,000 or AADTT between 100 and 1,000.
- **Low Volume:** A facility with Low Volume includes segments with AADT less than 2,000 and AADTT less than 100.

#### E.2.2 Treatment Categories

- **Reconstruction:** Complete removal, redesign, and replacement of the pavement structure (asphalt or concrete) from subgrade to surface. A minimum design life of 20 years for asphalt pavements and 30 years for concrete pavements is used for these projects.

- **Major Rehabilitation:** Heavy duty pavement treatments that improve the structural life to the highway. These are asphalt treatments typically thicker than 4 inches, and may include, but are not limited to, full depth reclamation, thin concrete overlays, deep cold-in-place recycles, and thick overlays. Concrete treatments in this category may include, but are not limited to, asphalt overlays (thicker than 4 inches), extensive slab replacements, and rubblization.
- **Minor Rehabilitation:** Moderate pavement treatments that improve the structural life to the highway. These are asphalt treatments between 2 and 4 inches thick, and may include mill and fills, shallow cold-in-place recycles, overlays, leveling courses with overlays. Concrete treatments in this category may include black toppings (thinner than 4 inches), dowel and tie bar repairs, and diamond grinding.
- **Pavement Maintenance:** Thin functional treatments 1<sup>1</sup>/<sub>2</sub> inches in thickness or less, intended to extend the life of the highway by maintaining the driving surface.

### E.3 Policy and Process

CDOT's most important highway facilities are interstates. These national networks provide interconnectivity across the state and across the nation. Interstate projects shall be built, rehabilitated, and maintained in accordance with AASHTO Pavement Design Standards, ensuring that they meet Federal standards and provide reliable service to the traveling public.

The High Volume category includes NHS and other highways. These highways serve a large segment of the traveling public and provide critical routes for the transportation of goods and services across regional boundaries. These projects shall also follow AASHTO Pavement Design Standards.

Medium Volume category may contain segments on the NHS and Other Highways. These projects shall be treated primarily with minor rehabilitation and pavement maintenance treatments. Major rehabilitation can be considered when drivability is poor and project level analysis reveals a compromised pavement structure.

The Low Volume category may include segments on the NHS or other highways and are to be maintained above acceptable drivability standards with pavement maintenance treatments. Minor rehabilitation treatments can be considered when drivability is poor and project level analysis reveals a compromised pavement structure or safety issues are identified. When designing these treatments the RME will consider using reliability levels at the bottom of the range for the appropriate functional classification of the highway. The RME will also consider using lower reliability binders for thermal cracking, especially if reflective cracking is expected to occur. A pavement justification report (PJR) shall be performed for every project however; a life cycle cost analysis will not be required for these low volume projects. If the RME and the Program Engineer determines that more than a pavement maintenance treatment is needed, they will prepare a detailed PJR documenting why the selected treatment is cost effective and obtain concurrence from

the Chief Engineer. The PJR will include the date that concurrence was obtained from the Chief Engineer. The Chief Engineer's decision will establish the typical remedial action for the project.

## APPENDIX F HMA MATERIALS INPUT LIBRARY

### F.1 Introduction

This appendix presents the library of inputs for typical CDOT HMA mixtures. These inputs can be used in lieu of site-specific or mixture-specific data.

### F.2 Mix Types and Properties

**Table F.1 Properties of Typical CDOT HMA Mixtures** presents the binder type, gradation, and volumetric properties of typical CDOT HMA mixtures and the selection of one typical CDOT mixture that is closest to the HMA mix to be used in the design. The following sections in this Appendix present the laboratory measured engineering properties including dynamic modulus, creep compliance, and indirect tensile strength.

#### F.2.1 Dynamic Modulus

**Table F.2 Dynamic Modulus Values of Typical CDOT HMA Mixtures** presents Level 1 dynamic modulus values of typical CDOT HMA mixtures. The dynamic modulus values were measured in accordance with the AASHTO TP 62 - Standard Method of Test for Determining Dynamic Modulus of Hot Mix Asphalt (HMA) protocols. **Section S.1.5.2 Asphalt Dynamic Modulus  $E^*$**  presents a discussion on HMA dynamic modulus properties.

#### F.2.2 Asphalt Binder

**Table F.3 Asphalt Binder Complex Shear Modulus ( $G^*$ ) and Phase Angle ( $\delta$ ) Values of Typical CDOT HMA Mixtures** presents Level 1 complex shear modulus,  $G^*$  and phase angle,  $\delta$  values of typical CDOT HMA mixtures. Under this effort, binder characterization tests were not performed to measure the rheology properties of the binders used in Superpave mixtures listed in **Table F.2 Dynamic Modulus Values of Typical CDOT HMA Mixtures**, rather allow the use of lab measured  $E^*$  values in the M-E Design software.  $G^*$  and  $\delta$  values were back calculated using the estimated  $E^*$  shift factors and  $G^*-\eta$  conversion relationships in the MEPDG. **Chapter 6, Principles of Design for Flexible Pavement** presents a discussion on HMA binder properties.

#### F.2.3 Creep Compliance and Indirect Tensile Strength

**Table F.4 Creep Compliance Values of Typical CDOT HMA Mixtures** and **Table F.5 Indirect Tensile Strength Values of Typical CDOT HMA Mixtures** present laboratory measured (Level 1) indirect tensile strength and creep compliance values of typical CDOT HMA mixtures, respectively. Testing was conducted in accordance with the AASHTO T 322 - Standard Method of Test for Determining the Creep Compliance and Strength of Hot-Mix Asphalt (HMA) Using the Indirect Tensile Test Device. **Section S.1.11 Tensile Creep and Strength for Hot Mix Asphalt** presents a discussion on HMA creep compliance and indirect tensile strength properties.



**Table F.1 Properties of Typical CDOT HMA Mixtures**

Mix ID	FS1918-9	FS1920-3	FS1938-1	FS1940-5	FS1958-5	FS1959-8	FS1919-2	FS1939-5	FS1960-2	CIR*
Sample No.	United 58-28-2	#183476	#16967C	#17144B	Wolf Creek Pass	I-70 Gypsum to Eagle	#181603	#194140	I-25 N of SH34	CIR with Emulsion
Binder Grade	PG 58-28	PG 58-28	PG 64-22	PG 58-28	PG 58-34	PG 64-28	PG 76-28	PG 76-28	PG 76-28	PG 58-28
Gradation	SX	SX	SX	SX	SX	SX	SMA	SX	SMA	-
Passing ¾" sieve	100	100	100	100	100	95	95	100	100	95
Passing ⅜" sieve	83	88	89	82	81	87	46	87	69	74
Passing No. 4 sieve	53	62	69	56	54	65	22	62	25	46
Passing No. 200 sieve	6.5	7.1	6.8	5.9	5	7.1	8	6.6	8.1	1.9
Mix AC Binder	5	5.6	5.4	5.5	7	5.4	6.2	5.4	6.5	5.8
VMA (%)	16.2	17	16.3	17.2	19.6	16.4	16.9	16.3	17.1	13.3
VFA (%)	65.9	64.1	68.5	68.2	73.4	65.5	72	68.2	76.8	26.6
Air Voids (%)	5.5	6.1	5.1	5.5	5.2	5.7	4.7	5.2	4.0	13.0
V <sub>eff</sub> (%)	10.7	10.9	11.2	11.7	14.4	10.7	12.2	11.1	13.1	0.3

\*CIR values are averaged from 10 sites per CDOT's Dynamic Modulus of Cold-In-Place Recycling (CIR) Material Report, 2018.

**Table F.2 Dynamic Modulus Values of Typical CDOT HMA Mixtures**

Mix ID	Temperature (°F)	Testing Frequency			
		0.5 Hz	1 Hz	10 Hz	25 Hz
<b>FS1918</b> PG 58-28 Gradation SX	14	2,067,099	2,488,999	2,785,899	2,873,299
	40	930,800	1,472,800	2,008,399	2,196,999
	70	207,600	439,600	838,700	1,039,200
	100	52,500	101,200	215,300	291,900
	130	24,100	35,400	60,900	78,900
<b>FS1919</b> PG 76-28 Gradation SMA	14	1,875,400	2,299,039	2,624,309	2,726,019
	40	846,575	1,309,050	1,799,540	1,983,379
	70	230,100	427,271	753,122	918,360
	100	76,296	127,286	231,357	296,468
	130	40,803	55,308	84,229	102,895
<b>FS1920</b> PG 58-28 Gradation SX	14	1,913,059	2,346,169	2,663,359	2,759,109
	40	820,000	1,323,520	1,846,660	2,037,379
	70	181,430	379,863	730,105	911,130
	100	47,935	89,742	185,976	250,629
	130	22,739	32,752	54,793	70,107
<b>FS1938</b> PG 64-22 Gradation SX	14	2,333,549	2,642,179	2,861,449	2,927,779
	40	1,309,490	1,791,270	2,219,829	2,365,949
	70	379,514	695,090	1,127,310	1,318,450
	100	87,238	174,824	349,546	452,545
	130	29,326	49,265	92,795	122,034
<b>FS1939</b> PG 76-28 Gradation SX	14	1,821,960	2,284,749	2,635,719	2,743,629
	40	761,414	1,245,330	1,773,800	1,972,669
	70	186,328	368,894	694,551	866,370
	100	59,960	102,426	195,476	256,712
	130	32,727	44,234	68,258	84,345
<b>FS1940</b> PG 58-28 Gradation SX	14	1,989,039	2,422,519	2,730,149	2,820,819
	40	831,755	1,354,270	1,895,720	2,091,109
	70	177,386	367,904	716,158	900,206
	100	51,014	88,693	175,626	234,927
	130	27,500	36,567	56,022	69,361
<b>FS1958</b> PG 58-34 Gradation SX	14	1,291,280	1,808,320	2,249,869	2,393,659
	40	424,726	794,978	1,289,510	1,499,050
	70	98,659	198,153	405,545	529,690
	100	37,405	59,422	109,288	143,776
	130	23,504	29,885	43,077	51,915
<b>FS1959</b> PG 64-28 Gradation SX	14	1,687,360	2,134,249	2,493,389	2,608,869
	40	697,463	1,127,680	1,612,900	1,802,220
	70	173,403	334,774	616,373	765,125
	100	54,259	93,163	175,106	227,742
	130	27,890	38,645	60,413	74,657
<b>FS1960</b> PG 76-28 Gradation SMA	14	1,860,030	2,300,499	2,637,329	2,741,889
	40	850,728	1,324,800	1,828,840	2,017,009
	70	246,113	453,444	796,133	969,276
	100	88,308	145,258	261,320	333,687
	130	49,660	66,719	100,905	123,005

Mix ID	Temperature (°F)	Testing Frequency			
		0.5 Hz	1 Hz	10 Hz	25 Hz
CIR	14	1,339,800	1,398,500	1,590,400	1,664,700
	40	862,600	917,600	1,107,000	1,184,300
	70	45,5800	496,300	645,100	710,100
	100	217,900	242,100	337,200	381,700
	130	99,900	112,500	165,100	191,100

**Table F.3 Asphalt Binder Complex Shear Modulus ( $G^*$ ) and Phase Angle ( $\delta$ ) Values of Typical CDOT HMA Mixtures**

Mix ID	Temperature (°F)	Binder $G^*$ ( $P_a$ )	Phase Angle (degree)
FS1918 PG 58-28 Gradation SX	136.4	2,227.6	80
	147.2	1,068.2	82
	158.0	540.1	84
FS1919 PG 76-28 Gradation SMA	158.0	1,233	64
	168.8	673	66
	179.6	383	68
FS1920 PG 58-28 Gradation SX	136.4	2,056	80
	147.2	985	82
	158.0	498	84
FS1938 PG 64-22 Gradation SX	147.2	1,857	81.6
	158.0	889	83.1
	168.8	451	85
FS1939 PG 76-28 Gradation SX	158.0	1,559	64
	168.8	859	66
	179.6	493	68
FS1940 PG 58-28 Gradation SX	136.4	1,758	80
	147.2	835	82
	158.0	419	84
FS1958 PG 58-34 Gradation SX	136.4	3,093	80
	147.2	1,519	82
	158.0	784	84
FS1959 PG 64-28 Gradation SX	147.2	3,051	81.6
	158.0	1,495	83.1
	168.8	772	85
FS1940 PG 76-28 Gradation SMA	158.0	1,733	64
	168.8	959	66
	179.6	552	68
CIR	135.4	1,758	80
	147.2	835	82
	158.0	419	84

**Table F.4 Creep Compliance Values of Typical CDOT HMA Mixtures**

Mix ID	Loading Time (s)	Testing Temperature		
		-4°F	14°F	32°F
<b>FS1918</b> PG 58-28 Gradation SX	1	2.78E-07	3.91E-07	2.65E-07
	2	3.11E-07	4.79E-07	3.91E-07
	5	3.48E-07	5.57E-07	6.33E-07
	10	3.74E-07	6.94E-07	9.55E-07
	20	4.22E-07	8.31E-07	1.28E-06
	50	4.63E-07	1.08E-06	1.99E-06
	100	5.28E-07	1.35E-06	2.72E-06
<b>FS1919</b> PG 76-28 Gradation SMA	1	4.01E-07	4.45E-07	6.88E-07
	2	4.28E-07	5.41E-07	8.96E-07
	5	4.98E-07	6.37E-07	1.27E-06
	10	5.51E-07	7.85E-07	1.69E-06
	20	6.17E-07	9.33E-07	2.23E-06
	50	7.19E-07	1.18E-06	3.14E-06
	100	7.96E-07	1.39E-06	4.01E-06
<b>FS1920</b> PG 58-28 Gradation SX	1	3.38E-07	4.31E-07	5.28E-07
	2	3.66E-07	5.02E-07	7.44E-07
	5	4.1E-07	6.27E-07	1.12E-06
	10	4.53E-07	7.61E-07	1.51E-06
	20	4.92E-07	8.55E-07	1.98E-06
	50	5.53E-07	1.11E-06	3.03E-06
	100	6.02E-07	1.31E-06	4.05E-06
<b>FS1938</b> PG 64-22 Gradation SX	1	3.34E-07	4.19E-07	4.99E-07
	2	3.53E-07	4.64E-07	6.19E-07
	5	3.79E-07	5.15E-07	7.49E-07
	10	4.05E-07	5.7E-07	9.08E-07
	20	4.31E-07	6.26E-07	1.08E-06
	50	4.87E-07	7.27E-07	1.43E-06
	100	5.05E-07	8.41E-07	1.79E-06
<b>FS1939</b> PG 76-28 Gradation SX	1	3.46E-07	4.12E-07	7.13E-07
	2	3.83E-07	4.76E-07	9.57E-07
	5	4.34E-07	5.97E-07	1.33E-06
	10	4.85E-07	7.25E-07	1.8E-06
	20	5.29E-07	8.45E-07	2.29E-06
	50	5.99E-07	1.05E-06	3.25E-06
	100	6.87E-07	1.32E-06	4.24E-06
<b>FS1940</b> PG 58-28 Gradation SX	1	3.53E-07	3.82E-07	6.92E-07
	2	3.81E-07	4.62E-07	8.61E-07
	5	4.21E-07	5.92E-07	1.23E-06
	10	4.64E-07	7.07E-07	1.69E-06
	20	5.11E-07	8.15E-07	2.21E-06
	50	5.9E-07	1.1E-06	3.22E-06
	100	6.35E-07	1.27E-06	4.47E-06

Mix ID	Loading Time (s)	Testing Temperature		
		-4°F	14°F	32°F
FS1958 PG 58-34 Gradation SX	1	4.82E-07	5.95E-07	9.61E-07
	2	5.30E-07	8.18E-07	1.48E-06
	5	6.05E-07	1.05E-06	2.18E-06
	10	6.85E-07	1.35E-06	3.14E-06
	20	7.71E-07	1.62E-06	4.19E-06
	50	8.72E-07	2.12E-06	6.23E-06
	100	1.00E-06	2.63E-06	8.74E-06
FS1959 PG 64-28 Gradation SX	1	3.61E-07	4.73E-07	7.12E-07
	2	4.04E-07	5.74E-07	9.97E-07
	5	4.51E-07	7.35E-07	1.52E-06
	10	5.11E-07	8.78E-07	1.99E-06
	20	5.67E-07	1.04E-06	2.59E-06
	50	6.57E-07	1.37E-06	3.75E-06
	100	7.68E-07	1.66E-06	4.66E-06
FS1960 PG 76-28 Gradation SMA	1	3.64E-07	4.64E-07	7.35E-07
	2	4.05E-07	5.70E-07	1.04E-06
	5	4.43E-07	7.15E-07	1.51E-06
	10	5.06E-07	8.79E-07	2.04E-06
	20	5.48E-07	1.03E-06	2.61E-06
	50	6.40E-07	1.31E-06	3.61E-06
	100	7.44E-07	1.70E-06	4.69E-06
CIR	1	3.34E-07	4.19E-07	4.99E-07
	2	3.53E-07	4.64E-07	6.19E-07
	5	3.79E-07	5.15E-07	7.49E-07
	10	4.05E-07	5.70E-07	9.08E-07
	20	4.31E-07	6.26E-07	1.08E-06
	50	4.87E-07	7.27E-07	1.43E-06
	100	5.05E-07	8.41E-07	1.79E-06

**Table F.5 Indirect Tensile Strength Values of Typical CDOT HMA Mixtures**

Mix ID	Indirect Tensile Strength at 14°F
FS1918 (PG 58-28, Gradation SX)	555.9
FS1919 (PG 76-28, Gradation SMA)	515.0
FS1920 (PG 58-28, Gradation SX)	519.0
FS1938 (PG 64-22, Gradation SX)	451.0
FS1939 (PG 76-28, Gradation SX)	595.0
FS1940 (PG 58-28, Gradation SX)	451.0
FS1958 (PG 58-34, Gradation SX)	446.0
FS1959 (PG 64-28, Gradation SX)	519.0
FS1960 (PG 76-28, Gradation SMA)	566.0
CIR	451.0

## APPENDIX G PCC MATERIALS INPUT LIBRARY

### G.1 Introduction

This appendix presents the library of inputs for typical CDOT PCC mixtures. These inputs can be used in lieu of site-specific or mixture-specific data.

### G.2 Mix Types

**Table G.1 Properties of Typical CDOT PCC Mixtures** presents the mix proportions and fresh concrete properties of typical CDOT PCC mixtures. The fresh concrete properties include slump, air content and unit weight.

The slump was documented in accordance with *ASTM C143 Standard Test Method for Slump of Portland Cement Concrete*. The air content of the concrete was tested by the pressure method according to *ASTM C231 Standard Test Method for Air Content of Freshly Mixed Concrete by the Pressure Method*. Unit weight was determined in accordance with *ASTM C138 Standard Test Method for Unit Weight, Yield and Air Content (Gravimetric) of Concrete*.

**Table G.2 Materials and Sources Used in Typical CDOT PCC Mixtures** presents the sources of materials used in these mixtures. Select one of these typical CDOT mixtures from the tables that is closer to the concrete mix to be used in the design. The following sections in this Appendix present their laboratory measured engineering properties including compressive strength, flexural strength, static elastic modulus, coefficient of thermal expansion and Poisson's ratio.

#### G.2.1 Compressive and Flexural Strength

**Table G.3 Compressive Strength of Typical CDOT PCC Mixtures** presents Level 1 compressive strength values of typical CDOT PCC mixtures. Testing was conducted in accordance with the *ASTM C 39 Standard Test Method for Compressive Strength of Cylindrical Concrete Specimens*. **Table G.4 Flexural Strength of Typical CDOT PCC Mixtures** presents Level 1 flexural strength values of typical CDOT PCC mixtures. Testing was conducted in accordance with the *ASTM C 79 Standard Test Method for Flexural Strength of Concrete*.

#### G.2.2 Static Elastic Modulus and Poisson's Ratio

**Table G.5 Static Elastic Modulus and Poisson's Ratio of Typical CDOT PCC Mixtures** presents Level 1 static elastic modulus and Poisson's ratio of typical CDOT PCC mixtures. Testing was conducted in accordance with the *ASTM C 469 Standard Test Method for Static Modulus of Elasticity and Poisson's Ratio of Concrete in Compression*.

### G.2.3 Coefficient of Thermal Expansion

**Table G.6 CTE Values of Typical CDOT PCC Mixtures** presents laboratory measured (Level 1) coefficient of thermal expansion values of typical CDOT HMA mixtures, respectively. Standard 4 inch diameter by 8 inch high cylinders were tested in accordance with *AASHTO T336 Standard Method of Test for Coefficient of Thermal Expansion of Hydraulic Cement Concrete*.

**Table G.1 Properties of Typical CDOT PCC Mixtures**

Mix ID	Region	Cement Type	Cement Content (lbs/yd <sup>3</sup> )	Fly ash Content (lbs/yd <sup>3</sup> )	Water/Cement Ratio	Slump (in)	Air Content (%)	Unit Weight (pcf)
2008160	2	I/II	575	102	0.44	3.75	6.3	139.8
2009092	3	I/II	515	145	0.42	4.00	6.8	138.6
2009105	1, 4, 6	I/II	450	113	0.36	1.50	6.8	140.6
2008196	5	I/II	480	120	0.44	1.25	6.0	140.8

**Table G.2 Materials and Sources Used in Typical CDOT PCC Mixtures**

Mix ID	2008160	2009092	2009105	2008196
Region	2	3	4, 1, 6	5
Cement	GCC-Pueblo	Mountain	Cemex-Lyons	Holsim
Fly ash	Boral-Denver Terminal	SRMG – Four Corners	Headwaters-Jim Bridger	SRMG – Four Corners
Aggregates	RMMA Clevenger Pit	Soaring Eagle Pit	Aggregate Industries	SUSG Weaselskin Pit (fine aggregate) C&J Gravel Home Pit (coarse aggregate)
Water Reducer	BASF Pozzoloth 200N BASF PolyHeed 1020 (mid-range)	BASF PolyHeed 997	BASF Masterpave	BASF PolyHeed 997
Air Entrainment	BASF MB AE 90	BASF Micro Air	BASF Pave-Air 90	BASF MB AE 90

**Table G.3 Compressive Strength of Typical CDOT PCC Mixtures**

Mix Design ID	Region	Compressive Strength (psi)				
		7-day	14-day	28-day	90-day	365-day
2008160	2	4,290	4,720	5,300	6,590	6,820
2009092	3	3,740	4,250	5,020	5,960	7,140
2009105	1, 4, 6	3,780	4,330	5,370	5,560	6,390
2008196	5	4,110	4,440	5,340	5,730	5,990

**Table G.4 Flexural Strength of Typical CDOT PCC Mixtures**

Mix Design ID	Region	Flexural Strength, psi				
		7-day	14-day	28-day	90-day	365-day
2008160	2	660	760	900	935	940
2009092	3	570	645	730	810	850
2009105	1, 4, 6	560	620	710	730	735
2008196	5	640	705	905	965	970

**Table G.5 Static Elastic Modulus and Poisson's Ratio of Typical CDOT PCC Mixtures**

Mix Design ID	Region	Elastic Modulus, ksi					Poisson's Ratio
		7-day	14-day	28-day	90-day	365-day	
2008160	2	3,140	3,260	3,550	3,970	4,240	0.21
2009092	3	3,560	3,860	4,300	4,550	4,980	0.2
2009105	1, 4, 6	3,230	3,500	4,030	4,240	4,970	0.2
2008196	5	3,280	3,510	3,930	4,170	4,210	0.21

**Table G.6 CTE Values of Typical CDOT PCC Mixtures**

Mix ID	Sample	CTE in/in./°C	CTE in/in./°F*10 <sup>-6</sup>
2008160	1	8.5	4.72
	2	8.5	4.72
2009092	1	8.8	4.89
	2	8.6	4.78
2009105	1	8.8	4.89
	2	8.7	4.83
2008196	1	8.8	4.89
	2	8.6	4.78



## **APPENDIX H**

# **HISTORICAL CDOT 18,000 POUND EQUIVALENT AXLE LOAD CALCULATIONS**

### **H.1 Introduction**

The appendix documents how 18,000-pound Equivalent Single Axle Load (18-kip ESAL) calculations were defined for CDOT.

### **H.2 Traffic Projections**

There are certain input requirements needed for 18-kip ESAL calculations. They are:

- Vehicle or truck volumes
  - Lane distributions
  - Direction distributions
  - Class distributions
  - Growth factors
- Vehicle or truck weights
  - Axle weight
  - Axle configuration (single, tandem)
- Traffic equivalence load factors

This section describes the process on obtaining or calculating 18-kip ESAL numbers.

#### **H.2.1 Volume Counts**

Volume counts are expressed as Annual Average Daily Traffic (AADT) counts. AADT is the annual average two-way daily traffic volume. It represents the total traffic on a section of roadway for the year, divided by 365. It includes both weekday and weekend traffic volumes. The count is given in vehicles per day and includes all CDOT (or FHWA) vehicle classification types.

#### **H.2.2 Lane and Directional Distributions**

The most heavily used lane is referred to as the design lane. Generally, the outside lanes are the design lanes. Traffic analysis determines a percent of all trucks traveling on the facility for the design lanes, this is also referred to as a lane distribution factor.

The percent of trucks in the design direction is applied to the two directional AADT to account for any differences to truck volumes by direction. The percent trucks in the design direction is referred to as the directional distribution factor. Generally, the directional distribution factor is a 50/50 percent split. If the number of lanes and volumes are not the same for each direction, it may be appropriate to design a different pavement structure for each direction of travel.

CDOT uses a design lane factor to account for the lane distribution and directional distribution. Both distributions are combined into one factor, the design lane factor. **Table H.1 Design Lane Factor** shows the relationship of the design lane factor and the lane and directional distributions.

**Table H.1 Design Lane Factor**

Type of Facility	Number of Lanes in Design Direction	CDOT Method	DARWin™ Procedure	
		Design Lane Factor	Percent of Total Trucks in the Design Lane (Outside Lane)	Directional Split (Design Direction/ Non-design Direction)
One Way	1	1.00	100	NA
2-lanes	1	0.60	100	60/40
4-lanes	2	0.45	90	50/50
6-lanes	3	0.30	60	50/50
8-lanes	4	0.25	50	50/50

**Note:** *Highway Capacity Manual, 2000* (Exhibit 12-13) recommends using a default value for a directional split of 60/40 on a two-lane highway may it be rural or urban (3).

### H.2.3 Vehicle Classification

CDOT uses a classification scheme of categorizing vehicles into three bins. CDOT 18-kip ESAL calculations were based on “generalized, averaged, and non-site-specific equivalency factors” using a 3-bin vehicle classification scheme. These vehicle classifications types are (1):

- Passenger vehicles, types 1 to 3 and 0 to 20 feet long
- Single unit trucks, types 4 to 7 and 20 to 40 feet long
- Combination trucks, types 8 to 13 and greater than 40 feet long

A fourth bin is sometimes used and may be shown as unclassified vehicles. These bins are further broken down into 13 classes. The 13-classification scheme follows FHWA vehicle type classification. Two additional classes may be used as a fourth bin. Class 14 is for unclassifiable vehicles and Class 15 is not used at the present time. The 13 classes of FHWA are separated into groupings of whether the vehicle carries passengers or commodities. Non-passenger vehicles are subdivided by number of axles and number of units, including both power and trailer units. Exceptions may be a large camping and recreational vehicles, which crosses over into the commodities grouping. **Note:** The addition of a light trailer to a vehicle does not change the classification of the vehicle. Refer to **Figure H.1 CDOT Vehicle Classifications**. Listed are FHWA vehicle classes with definitions (2):

**Class 1 - Motorcycles** - All two or three-wheeled motorized vehicles. Typical vehicles in this category have saddle type seats and are steered by handlebars rather than steering wheels. This category includes motorcycles, motor scooters, mopeds, motor-powered bicycles, and three-wheel motorcycles. This vehicle type may be reported at the option of the State.

**Class 2 - Passenger Cars** - All sedans, coupes, and station wagons manufactured primarily for the purpose of carrying passengers and including those passenger cars pulling recreational or other light trailers.

**Class 3 - Other Two-Axle, Four-Tire Single Unit Vehicles** - All two-axle, four-tire, vehicles, other than passenger cars. Included in this classification are pickups, panels, vans, and other vehicles such as campers, motor homes, ambulances, hearses, carryalls, and minibuses. Other two-axle, four-tire single-unit vehicles pulling recreational or other light trailers are included in this classification. Because automatic vehicle classifiers have difficulty distinguishing class 3 from class 2, these two classes may be combined into class 2.

**Class 4 - Buses** - All vehicles manufactured as traditional passenger-carrying buses with two axles and six tires or three or more axles. This category includes only traditional buses (including school buses) functioning as passenger-carrying vehicles. Modified buses should be considered to be a truck and should be appropriately classified.

**Note:** In reporting information on trucks the following criteria should be used:

- a. Truck tractor units traveling without a trailer will be considered single-unit trucks.
- b. A truck tractor unit pulling other such units in a "saddle mount" configuration will be considered one single-unit truck and will be defined only by the axles on the pulling unit.
- c. Vehicles are defined by the number of axles in contact with the road. Therefore, "floating" axles are counted only when in the down position.
- d. The term "trailer" includes both semi- and full trailers.

**Class 5 - Two-Axle, Six-Tire, Single-Unit Trucks** - All vehicles on a single frame including trucks, camping and recreational vehicles, motor homes, etc., with two axles and dual rear wheels.

**Class 6 - Three-Axle Single-Unit Trucks** - All vehicles on a single frame including trucks, camping and recreational vehicles, motor homes, etc., with three axles.

**Class 7 - Four or More Axle Single-Unit Trucks** - All trucks on a single frame with four or more axles.

**Class 8 - Four or Fewer Axle Single-Trailer Trucks** - All vehicles with four or fewer axles consisting of two units, one of which is a tractor or straight truck power unit.

**Class 9 - Five-Axle Single-Trailer Trucks** - All five-axle vehicles consisting of two units, one of which is a tractor or straight truck power unit.

**Class 10 - Six or More Axle Single-Trailer Trucks** - All vehicles with six or more axles consisting of two units, one of which is a tractor or straight truck power unit.

**Class 11 - Five or fewer Axle Multi-Trailer Trucks** - All vehicles with five or fewer axles consisting of three or more units, one of which is a tractor or straight truck power unit.

**Class 12 - Six-Axle Multi-Trailer Trucks** - All six-axle vehicles consisting of three or more units, one of which is a tractor or straight truck power unit.

**Class 13 - Seven or More Axle Multi-Trailer Trucks** - All vehicles with seven or more axles consisting of three or more units, one of which is a tractor or straight truck power unit.


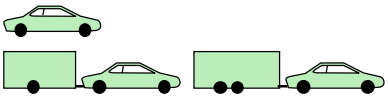
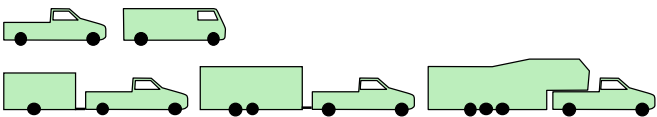
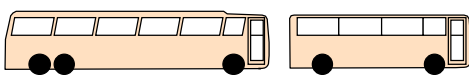
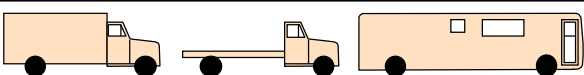
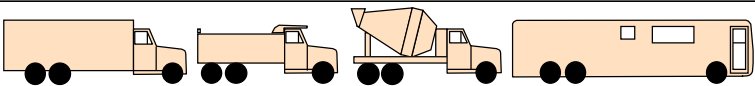
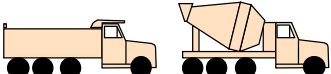
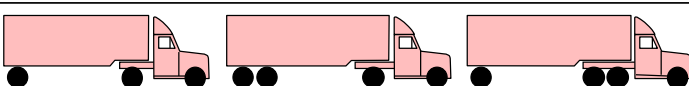
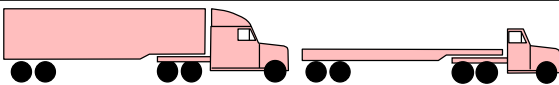
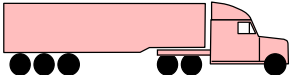
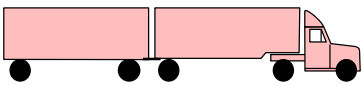
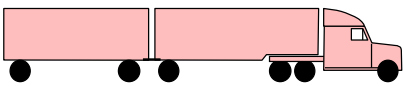
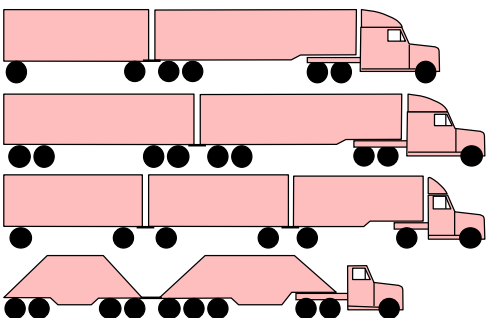
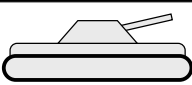
	Class	Schema	Description
Light-weight Vehicles	1		all motorcycles plus two wheel axles
	2		all cars plus one/two axle trailers
	3		all pickups and vans single/dual wheels plus one/two/three axle trailers
Single Unit Vehicles	4		buses single/dual wheels
	5		two axle, single unit single/dual wheels
	6		three axle, single unit
	7		four axle, single unit
Combination Unit Vehicles	8		four or less axles, single trailers
	9		five axles, single trailers
	10		six or more axles, single trailers
	11		five or less axles, multi-trailers
	12		six axles, multi-trailers
	13		seven or more axles, multi-trailers
Unclassified Vehicles	14		Unclassifiable vehicle
	15		Not used

Figure H.1 CDOT Vehicle Classifications

## H.2.4 Growth Factors

The number of vehicles using a pavement tends to increase with time. Each roadway segment has a growth factor assigned to that segment. CDOT uses a 20-year growth factor. A simple growth rate assumes the AADT increases by the same amount each year. A compound growth rate assumes the AADT percent growth rate for any given year is applied to the volume during the preceding year. CDOT uses a compound growth rate. See **Equation H.3**.

## H.2.5 Vehicle or Truck Weights

The 18,000-pound Equivalent Single Axle Load (18-kip ESAL) is a concept of converting a mixed traffic stream of different axle loads and axle configurations into a design traffic number. The 18-kip ESAL is a conversion of each expected axle load into an equivalent number of 18,000-pound single axle loads and the sum over the design period.

## H.2.6 Traffic Equivalence Load Factors

The equivalence load factor is a numerical factor that expresses the relationship of a given axle load to another axle load in terms of their effect on the serviceability of a pavement structure. All axle loads are equated in terms of the equivalent number of repetitions of an 18,000-pound single axle. Using the 3-bin vehicle classification scheme, factors were assigned to each.

The damaging effect of an axle is different for a flexible pavement and a rigid pavement; therefore, there are different equivalency factors for the two types of pavement. **Table H.2 Colorado Equivalency Factors** shows the statewide equivalency factors determined by a study of Colorado traffic in 1987.

**Table H.2 Colorado Equivalency Factors**

3-Bin Vehicle Classification	Flexible Pavement	Rigid Pavement
Passenger Cars and Pickup Trucks	0.003	0.003
Single Unit Trucks	0.249	0.285
Combination Trucks	1.087	1.692

## H.2.7 Discussion and Calculation of Traffic Load for Pavement Design

Traffic is one of the major factors influencing the loss of a pavement's serviceability. Traffic information required by the pavement designer includes axle loads, axle configurations, and number of applications. The damaging effect of the passage of an axle of any load can be represented by a number of 18-kip ESAL. The load damage factor increases as a function of the ratio of any given axle load raised to the fourth power.

**Example:** One application of a 12,000 pound single axle will cause a damage equal to 0.2 applications of an 18,000 pound single axle load and about five applications of a 12,000-pound single axle will cause the same damage as one 18,000 pound single axle load thus,

a 20,000 pound single axle load is 8 times as damaging as the 12,000 pound single axle load.

The determination of design ESALs is an important consideration for the design of pavement structures. An approximate correlation exists between 18-kip ESAL computed using flexible pavement and rigid pavement equivalency factors. As a general rule of thumb, converting from rigid pavement 18-kip ESAL to flexible pavement 18-kip ESAL requires multiplying the rigid pavement 18-kip ESAL by 0.67.

**Example:** 15 million rigid pavement 18-kip ESAL is approximately equal to 10 million flexible pavement 18-kip ESALs. Five million flexible pavement 18-kip ESAL equal 7.5 million rigid pavement 18-kip ESALs.

Failure to utilize the correct type of 18-kip ESAL will result in significant errors in the design. Conversions must be made, for example, when designing an asphaltic concrete overlay of a flexible pavement (flexible 18-kip ESAL required) and when designing an alternative portland cement concrete overlay of the same flexible pavement (rigid 18-kip ESAL required). CDOT has some sites on the highway system where instruments have been placed in the roadway to measure axle loads as a vehicle passes over the site. These stations, called Weigh-in-Motion (WIM) sites, can provide accurate information for the existing traffic load. An estimate of growth over the design period will be needed to calculate the traffic load during the design period. The link <http://dtdapps.coloradodot.info/Otis/TrafficData> is used to access traffic load information. Traffic analysis for pavement structure design is supplied by the Division of Transportation Development (DTD) Traffic Analysis Unit. The traffic data figures to be incorporated into the design procedure are in the form of 18 kip equivalent single axle load applications (18-kip ESALs). All vehicular traffic on the design roadway is projected for the design year in the categories of passenger cars, single unit trucks, and combination trucks with various axle configurations. The actual projected traffic volumes for each category are weighted by the appropriate load equivalence factors and converted to a cumulative total 18-kip ESAL number to be entered into the flexible or rigid pavement design equation. Adjustments for directional distribution and lane distribution will be made by the DTD Traffic Analysis Unit. The number supplied will be used directly in the pavement design calculation. Recall that this 18-kip ESAL number is the cumulative yearly ESAL for the design lane in one direction. This 18-kip cumulative number must be a 20-year ESAL to be used for the asphalt mix design for SuperPave™ gyratory compaction effort (revolutions). The designer must inform the DTD Traffic Analysis Unit that the intended use of the 18-kip ESAL is for flexible or rigid pavement design (see **Table H.2 Colorado Equivalency Factors**), since different load equivalence factors apply to different pavement types. If a comparison of flexible and rigid pavements is being made, 18-kip ESAL for each pavement type must be requested.

The procedure to predict the design ESALs is to convert each expected axle load into an equivalent number of 18-kip ESAL and to sum these over the design period. Thus, a mixed traffic stream of different axle loads and configurations is converted into a number of 18-kip ESALs. See *1993 AASHTO Guide for Design of Pavement Structure* Appendix D, pages D1-28 for Conversion of Mixed Traffic to Equivalent Single Axle Loads for Pavement Design.

The DTD provides traffic projections Average Annual Daily Traffic (AADT) and ESAL. The designer must request 10, 20, and 30 year traffic projections for flexible pavements and 20 and 30 year traffic projections for rigid pavements from the Traffic Section of DTD. Requests for traffic projections should be coordinated with the appropriate personnel of DTD. The pavement designer can help ensure accurate traffic projections are provided by documenting local conditions and planned economic development that may affect future traffic loads and volumes.

DTD should be notified of special traffic situations when traffic data are requested. Some special situations may include:

- A street that is or will be a major arterial route for city buses.
- A roadway that will carry truck traffic to and from heavily used distribution or freight centers.
- A highway that will experience an increase in traffic due to a connecting major, high-traffic roadway.
- A highway that will be constructed in the near future.
- A roadway that will experience a decrease in traffic due to the future opening of a parallel roadway facility.

## H.2.8 Traffic Projections

The following steps are used by CDOT to calculate ESALs:

**Step 1.** Determine the AADT and the number of vehicles of various classifications and sizes currently using the facility. The designer should make allowances for traffic growth, basing the growth rate on DTD information or other studies. Assuming a compound rate of growth, **Equation H.1** is used by CDOT to calculate the 20-year growth factor. The future AADT is determined by:

$$T_f = (1+r)^n \quad \text{Eq. H.1}$$

Where:

- $T_f$  = CDOT 20-year growth factor
- $r$  = rate of growth expressed as a fraction
- $n$  = 20 (years)

$$T = [((T_1 \times T_f) - T_1) / 20] \times D + T_1 \quad \text{Eq. H.2}$$

Where:

- $T$  = future AADT
- $T_1$  = current AADT
- $D$  = design period (years)
- $T_f$  = CDOT 20-year growth factor

**Step 2.** Determine the midpoint volume (**Equation H.3**) by adding the current and future traffic and dividing by two.

$$T_m = (T_1 + T) / 2$$

**Eq. H.3**

Where:

$T_m$  = traffic volume at the midpoint of the design period

$T_1$  = current AADT

- Step 3.** Multiply the midpoint traffic volume by the percentage of cars, single unit trucks, and combination trucks.
- Step 4.** Multiply the number of vehicles in each classification by the appropriate 18-kip equivalency factor. See **Table H.2 Colorado Equivalency Factors**. Then add the numbers from each classification to yield a daily ESAL value.
- Step 5.** Multiply the total 18-kip ESAL for the roadway by the design lane factor that correlates to the number of lanes for each direction shown in **Table H.2 Colorado Equivalency Factors**. This will be the 18-kip ESAL for the design lane over the design period.

**Example:** Determine the 20-year design period ESALs for a 4-lane flexible pavement (2 lanes per direction) if the current traffic volume is 16,500 with 85% cars, 10% single unit trucks, and 5% combination trucks. The traffic using the facility grows at an annual rate of 3.5%.

$$T_f = (1 + 0.035)^{20} = 1.99$$

$$T = [((16500 \times 1.99) - 16500) / 20] \times 20 + 16,500 = 32,835$$

$$T_m = (16,500 + 32,835) / 2 = 24,668$$

$$\text{Cars} = 24,668 \times 0.85 = 20,968$$

$$\text{Single Unit Trucks} = 24,668 \times 0.10 = 2,467$$

$$\text{Combination Trucks} = 24,668 \times 0.05 = 1,233$$

$$\text{Daily ESALs for Cars} = 20,968 \times 0.003 = 62.9$$

$$\text{Daily ESALs for Single Unit Trucks} = 2,467 \times 0.249 = 614.3$$

$$\text{Daily ESALs for Combination Trucks} = 1,233 \times 1.087 = 1,340.3$$

$$\text{Total Daily ESALs} = 2,017.5$$

$$\text{Total Design Period ESALs} = 2,017.5 \times 365 \times 20 = 14,727,750$$

$$\text{Design lane ESALs} = 14,727,750 \times 0.45 = 6,627,500$$



## References

1. *Development of Site-Specific ESAL, Final Report*, CDOT-DTD-R-2002-9, Project Manager, Ahmad Ardani, Colorado Department of Transportation and Principal Investigator, Sirous Alavi, Nichols Consulting Engineers, Chtd., July 1, 2002.
2. *Heavy Vehicle Travel Information System*, Field Manual, FHWA publication PDF version, May 2001 (revised), obtained at website, <http://www.fhwa.dot.gov/ohim/tvtw/hvtis.htm>
3. *Highway Capacity Manual*, Transportation Research Board, National Research Council, Washington, D.C., 2000.

## **APPENDIX I**

### **GEOSYNTHETICS IN M-E DESIGN**

#### **Definitions**

##### **Geotextile Fabric**

Geotextile fabrics are permeable textiles or fabrics used to separate, filter, reinforce, protect, or drain. They can allow filtration and separation of granular layers. Geotextiles are high in strength to allow for maximum slope support, reinforcement and erosion control. There are three types of geotextiles: non-woven, woven or knitted.

##### **Woven**

A continuous chain of polymeric filaments or yarn of polyester, polypropylene, polyethylene, polyamide, or polyvinylidene chloride formed into a stable network that is water permeable.

##### **Non-woven**

A sheet or web structures bonded together by entangling fiber or filaments (and by perforating films) mechanically, thermally or chemically. They are flat or tufted permeable sheets that are made directly from separate fibers, molten plastic or plastic film.

##### **Knitted**

Knitted geotextiles are manufactured using a knitting process. In this process, an interlocking series of loops of yarn is made.

##### **Geogrid**

Geogrids are commonly made of polymer materials, such as polyester, polyvinyl alcohol, polyethylene or polypropylene. They may be woven or knitted from yarns, heat-welded from strips of material, or produced by punching a regular pattern of holes in sheets of material, then stretched into a grid pattern.

The key feature of all geogrids is that the openings between the adjacent sets of longitudinal and transverse ribs, called “apertures,” are large enough to allow for soil strike-through from one side of the geogrid to the other. The junctions are, of course, where the longitudinal and transverse ribs meet and are connected. They are sometimes called “nodes”.

##### **Biaxial Geogrid**

A geogrid with high strength in both longitudinal and transverse directions. It is made through the process of extruding, sheet forming, punching, and stretching which forms longitudinal and transverse ribs and junction knobs.

##### **Soft Subgrade**

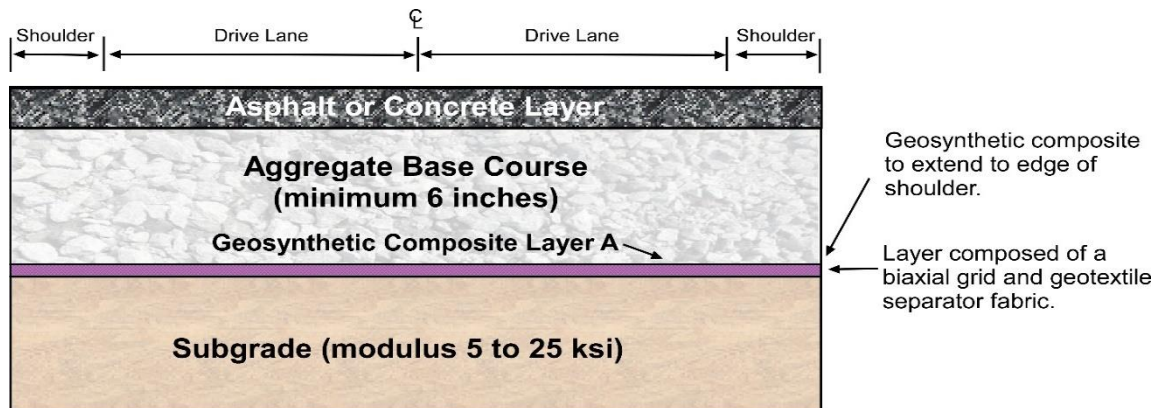
Soft subgrade is soil having a resilient modulus greater than 500 and less than 5,000 psi.

## I.1 Purpose

The purpose of this guide is to assist pavement design engineers when using AASHTOWare's Pavement Mechanistic Empirical Design (PMED) in selecting an appropriate geosynthetic geotextile and biaxial geogrid to be placed on the subgrade for the purpose of enhancing the subgrade's modulus used in the design of a pavement structure. This guide includes a standard enhancement to the subgrade modulus that will be allowed for a baseline composite system for products meeting the minimum requirements shown in Tables 1 and 2. Alternate high performance geotextile or alternate geogrid composite systems are acceptable, provided they meet the requirements of Section I.7 Benefits of a geosynthetic system comprised of a geogrid in conjunction with a separator fabric include the following:

- Prevent premature failure and reduce long-term maintenance cost
- Reduce subbase and/or aggregate base thickness
- Increase performance life and reliability of the pavement
- Prevent contamination of the base materials
- Better performance of a pavement over expansive soils or soils subject to freeze/thaw cycles
- Reduce disturbance of soft or sensitive subgrade during construction
- Potential cost savings

This geosynthetic guide is based on utilizing a composite system of biaxial geogrid for reinforcement and confinement of the basecourse material along with a geotextile fabric. The geotextile fabric is included to prevent fines from migrating from the subgrade into the aggregate basecourse (ABC) over the life of the pavement. Even though the composite system reinforces the aggregate subbase and/or basecourse layer it may also benefit and/or enhance the subgrade's resistance to deformation. This guide shall only be used when a geotextile and biaxial geogrid are used together and will be referred to as a composite system. The composite system section should be installed at the bottom of the base course material. **Figure I.1 Typical Section** shows the typical section with the composite system extending to the width of the aggregate base course layer and subgrade with a modulus between 5 to 25 ksi. However, the modulus may extend up to 40 ksi.



**Figure I.1 Typical Section**

## I.2 Application

### I.2.1 Appropriate Applications

The subgrade stabilization application is generally appropriate for trafficked structures constructed over soils with the following properties;

- A minimum aggregate thickness of 6 inches.
- Geosynthetics can be applicable for a variety of following project conditions using soils classified using the American Association of State Highway and Transportation Officials (AASHTO) and/or the Unified Soil Classification System (USCS). These soils include;  
Poor (low strength) soils, clayey sand (SC), lean clay (CL), silty clay (ML-CL), high plastic clay (CH) silt (ML), high plasticity of micaceous silt (MH) organic soil (OL/OH), and peat (PT)
- High water table
- Soils with high sensitivity to moisture
- Shallow utilities or contaminated soils

### I.2.2 Aggregate Base Course

The aggregate used for base course material shall meet the applicable DOT requirements.

## I.3 GEOTEXTILE PROPERTIES

Separation geotextiles shall have been tested by the National Transportation Product Evaluation Program (NTPEP) and meet the properties shown in **Table I.1 Property Requirements of Separation Geotextile**. Biaxial geogrid material shall meet the properties shown in **Table I.2 Property Requirements of Geogrid Material**. Consult with the RME per type of class of geotextile to use.

**Table I.1 Property Requirements of Separation Geotextile**

Property	Test Method	Separation Material	
		Woven	Nonwoven
Elongation at break (%)	ASTM D 4632	< 50	≥50
Grab tensile strength (lb.) (min.)	ASTM D 4632	250	160
Trapezoidal Tear Strength (lb.) (min.)	ASTM D 4533	90	60
Puncture strength (lb.) (min.)	ASTM D 6241	500	310
Permittivity (sec <sup>-1</sup> ) (min.)	ASTM D 4491	0.5	0.5
Apparent maximum opening size (inch) (max.)	ASTM D 4751	0.0165	0.0083
Ultraviolet stability (retained after 500 hours exposure) (%) (min) <sup>1</sup>	ASTM D 4355	70	70
<p><b>Note:</b></p> <ol style="list-style-type: none"> <li>1. Evaluation per ASTM D 5035 for strength and elongation.</li> </ol> <ul style="list-style-type: none"> <li>• Woven slit film geotextiles shall not be used.</li> <li>• Specifications are based on Minimum Average Roll Values (MARV) in the weaker principle direction.</li> <li>• Apparent opening size is based on maximum average roll value.</li> </ul>			

**Table I.2 Property Requirements of Geogrid Material**

Property	Test	Value
Aperture size (in.) nominal dimension	ASTM D 374	1.0 (MD) x 1.3 (XMD)
Rib thickness (in.)	ASTM D 374	0.05
Junction thickness (in.)	ASTM D 374	0.120
Junction efficiency, % of rib ultimate tensile strength <sup>1</sup> (min.)	ASTM D 7737 Method A	93%
Tensile strength, 2% strain (lb/ft)	ASTM D 6637 Method B	410 (MD) x 620 (XMD)
Geosynthetic Sheet Stiffness/Modulus (lbs/in) (min.)	ASTM D 6637 Method B	2,500 (XMD) <sup>2</sup>
Ultimate Strength (lb/ft)	ASTM D 6637 Method B	1,310 (MD) x 1,970 (XMD)
Ultraviolet resistance (%) minimum retained tensile strength after 500 hours	ASTM D 4355	70
Flexural stiffness (mg-cm)	ASTM D 7748	750,000
Aperture Stability (kg-cm/deg)	ASTM D 7864	6.5
<b>Note:</b>		
<ol style="list-style-type: none"> <li>1. Junction efficiency is the ratio of (ASTM D 7737 Junction Strength) / (ASTM D 6637 Method "A" Single Rib) x 100%.</li> <li>2. Sheet stiffness/modulus value = Tensile Strength @ 2% strain ÷ 0.02 ÷ 12</li> </ol> <ul style="list-style-type: none"> <li>• Minimum Average Roll Values (MARVs) in accordance with ASTM 4759, unless indicated otherwise.</li> <li>• Machine Direction (MD) Cross Machine Direction (XMD).</li> <li>• Independent testing shall be performed by an accredited laboratory through the Geosynthetic Accreditation Institute-Laboratory Accreditation Program.</li> </ul>		

## I.4 SOFT SUBGRADE AND EXPANSIVE SOILS

This design guide presumes any soft subgrade has been addressed prior to the placement of a composite system. For the purpose of this guide, soft subgrade is defined as having a resilient modulus greater than 500 and less than 5,000 psi. Expansive soils shall be mitigated prior to using this geosynthetic composite system. Soils with a swell of greater than 2 percent are considered an expansive soil. Soft subgrades should be treated with either the geosynthetic composite system specified herein, or a Class 1A enhanced geotextile, per AASHTO M 288. Addressing a soft subgrade will require a two-step process; the first step is to place a geosynthetic composite or enhanced geotextile above the prepared subgrade followed by a stabilization aggregate layer. Step 1 is only needed if the subgrade has a modulus of less than 5,000 psi. The second step is to place

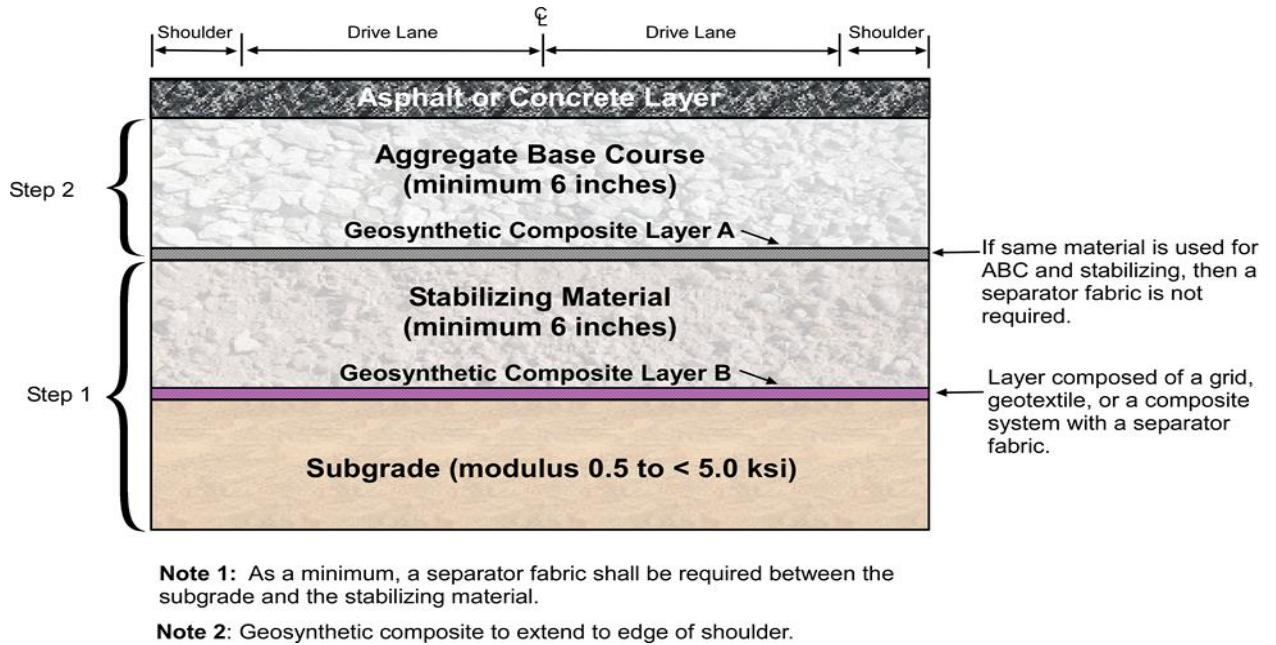
ABC (Layer B) over the stabilized layer. Only a geogrid is necessary if the stabilization and aggregate base course layers are composed of the same material. If the material differs, then a geosynthetic composite consisting of a geogrid and separator fabric is required. (see Figure 2).

**Stabilization Layer:** A stabilization layer consists of a free-draining granular material or aggregate base course and shall be a minimum of 6 inches in thickness. Proof roll tests should be performed to confirm the improved support conditions. Additional thickness may be required to pass a proof rolling specification per CDOT Standard Specification 203.08 or other DOT method.

**Stabilizing Material:** This material must be compatible with the geosynthetic being used and the gradation shall not be greater than the 3-inch sieve. Other gradations may be used per the engineer and manufacturer's recommendations. Stabilizing material may be, but not limited to the specifications for, Class I or Class II Structural Backfill, any class of Aggregate Base Course, recycled asphalt or concrete, pit run, or onsite material. The stabilizing material should be angular, have less than 12% passing the #200 sieve, a liquid limit less than 35, and a plastic index of less than 6. If the aggregate base course layer and stabilizing layer are composed of the same material, a separator fabric is not needed in Layer B (see **Figure I.2 Two Step Process to Stabilize Soft Subgrade Materials**). The inclusion of a stabilization layer over soft soils will improve subgrade support conditions to an equivalent modulus of 5,000 psi.

**Aggregate Base Course Layer:** Once the improved subgrade support conditions have been verified using the geosynthetic composite system or the enhanced stabilization geotextile, one may proceed with step two to enhance the subgrade modulus outlined in this guide using a geosynthetic composite.

The geosynthetic composite does not negate the need for subgrade treatments per Chapter 4 or any other requirements that may be in this pavement design manual. Thus, the composite may only be used to increase the resilient modulus of the subgrade to reduce either the stabilizing material or ABC layer thickness unless the base layers are needed to improve the subgrade conditions as described in Chapter 4. For example, if the subgrade requires improvement due to expansive, swelling, or high plastic index properties a reduction in the thickness of the subbase or ABC may not be appropriate. The designer should contact the RME for guidance if this situation occurs.



**Figure I.2 Two Step Process to Stabilize Soft Subgrade Materials**

## I.5 PAVEMENT DESIGN

In March of 2017, The National Cooperative Highway Research Program (NCHRP) released report NCHRP 1-50 titled *Quantifying the Influence of Geosynthetics on Pavement Performance*. This project focused on the use of geosynthetics in unbound base/subbase layers or as a base/subgrade interface layer for flexible and rigid pavements. Researchers developed a methodology for quantifying the influence of geosynthetics on pavement performance for use in Pavement Mechanistic-Empirical Design (PMED) by using an 8-ft diameter by 6-ft high circular steel tank to conduct tests on various structural pavement elements. A database of pertinent pavement responses with and without reinforcement of the base layer collected under realistic pavement loading conditions was assembled. Using this approach, a large database of critical stresses and strains controlling the performance of geosynthetic-reinforced pavements pavement responses was established for a wide range of geosynthetic-reinforced pavement structures. The results of the full-scale tests were used to develop sets of pavement data to construct the Artificial Neural Network (ANN) model of the critical strains and stresses in pavements. A geosynthetic-reinforced pavement with given material properties was then equivalent to an unreinforced pavement with the modified material properties to obtain the identical pavement responses.

### Artificial Neural Network Model

The ANN was validated by using five sections from the Long Term Pavement Performance database and five sections from the Texas Pavement Management Information System. Therefore, the ANN could be used for any thickness of uniform subgrade soil, aggregate subbase/base, HMA, or PCCP. A copy of the ANN can be found at:

<http://www.trb.org/Publications/Blurbs/176362.aspx>



To analyze a pavement structure reinforced using the geogrid at the bottom of the base course, as illustrated in **Figure I.3 ANN Input Screen**, the following steps are taken to perform the analysis:

1. To start the program, double click the application file “Composite Geosynthetic–Base Course Model.exe”;
2. Click “Geogrid at the Bottom” on the left side of the program interface under “Geosynthetic Location”;
3. Input the properties of the pavement layers and the sheet stiffness/modulus found from Table 2 under “Pavement Structure”. The Base Anisotropic Ratio should be kept at 0.35; and
4. Click “Run Analysis”.

Section	Parameter	Value
Geosynthetics Location	Geogrid at the Bottom of Base Course	<input checked="" type="radio"/>
	Geogrid in the Middle of Base Course	<input type="radio"/>
	Geotextile at the Bottom of Base Course	<input type="radio"/>
	Geotextile in the Middle of Base Course	<input type="radio"/>
Pavement Structure	HMA Thickness (in)	4
	Base Thickness (in)	10
	HMA Modulus (ksi)	300
	Base Modulus (ksi)	25
	Base Anisotropic Ratio	0.35
	Geosynthetic Sheet Stiffness (lb/in)	1200
	Subgrade Modulus (ksi)	10

**Figure I.3 ANN Input Screen**

The “Results” window will pop up, as shown in Figure 4. It can be observed from **Figure I.4 ANN Output Screen** that placing the geogrid at the bottom of the base course increases the subgrade modulus from 10.0 ksi to 21.1 ksi. The designer shall only use the enhanced modulus for the subgrade; any enhancement shall not change the soil classification. The designer shall not increase the modulus of the ABC if any increase is shown for the modified base modulus.

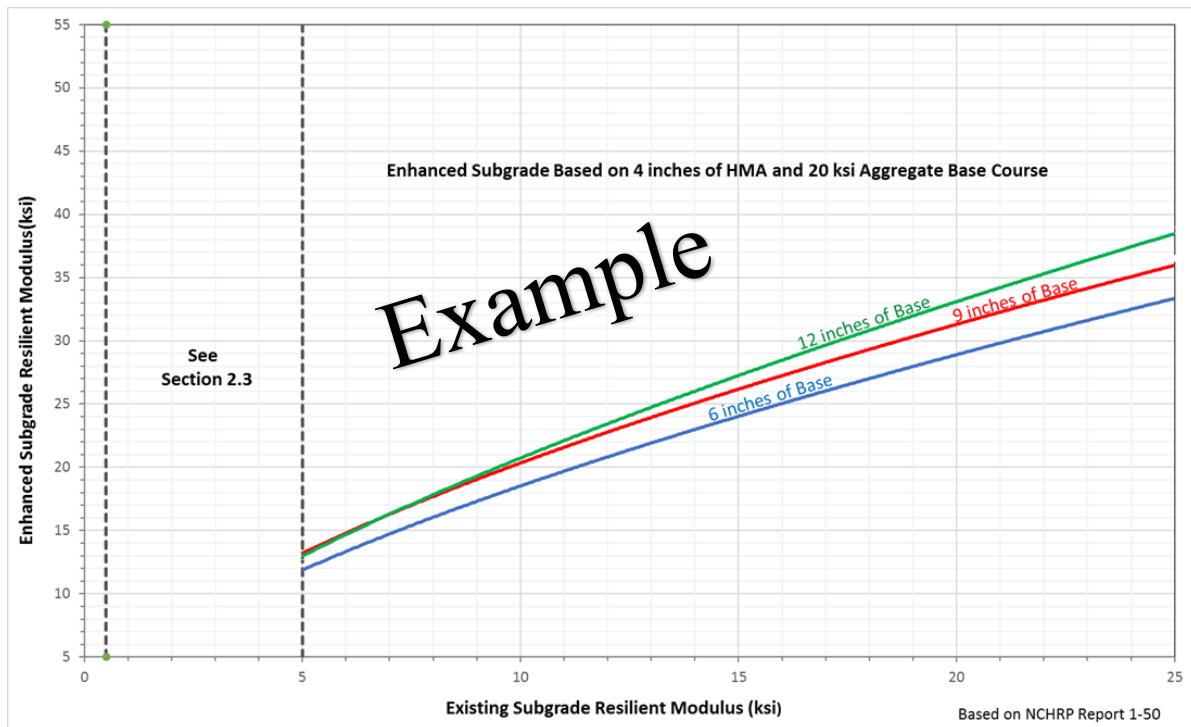
```

Results - Notepad
File Edit Format View Help

Unreinforced Pavement Structure
1. Compressive strain at bottom of base:1061.00
2. Average strain in the base:853.46
3. Tensile strain at bottom of HMA surface:467.44
=====
With Geogrid at the Bottom
1. Compressive strain at bottom of base:572.63
2. Average strain in the base:856.09
3. Tensile strain at bottom of HMA surface:464.40
=====
Subgrade modulus with unreinforced pavement structure:10.0(ksi)
Modified subgrade modulus:21.1(ksi)
Base modulus with unreinforced pavement structure:25.0(ksi)
Modified base modulus:25.0(ksi)
    
```

**Figure I.4 ANN Output Screen**

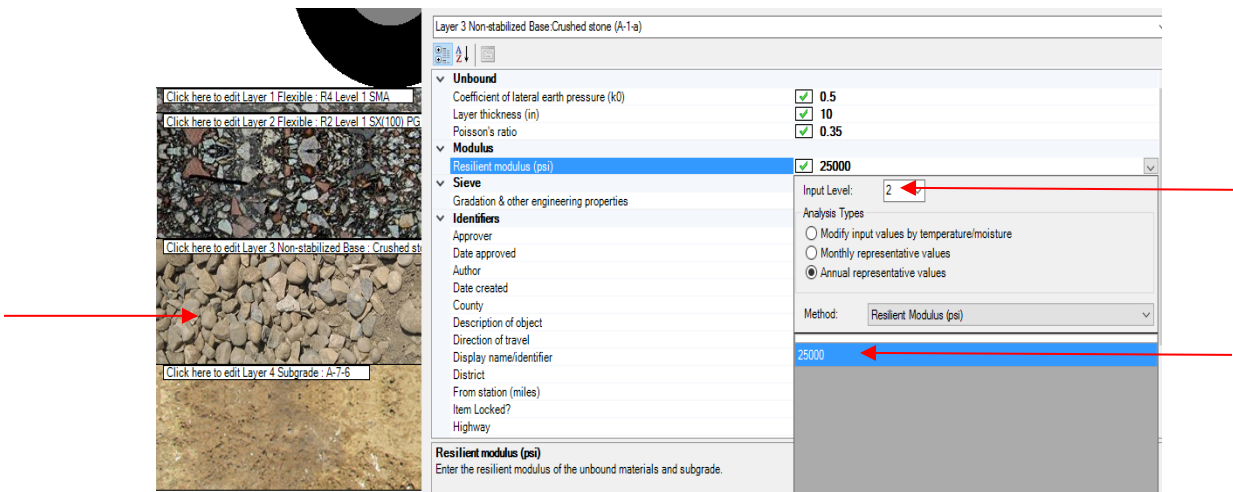
**Figure I.5 An Example of ANN Results Using a Geosynthetic Composite System at the Bottom of ABC** illustrates the results from the ANN at various strengths of subgrade soil and various thicknesses of aggregate base course when placed under four inches of HMA along with the composite section placed bottom of the ABC.



**Figure I.5 An Example of ANN Results Using a Geosynthetic Composite System at the Bottom of ABC**

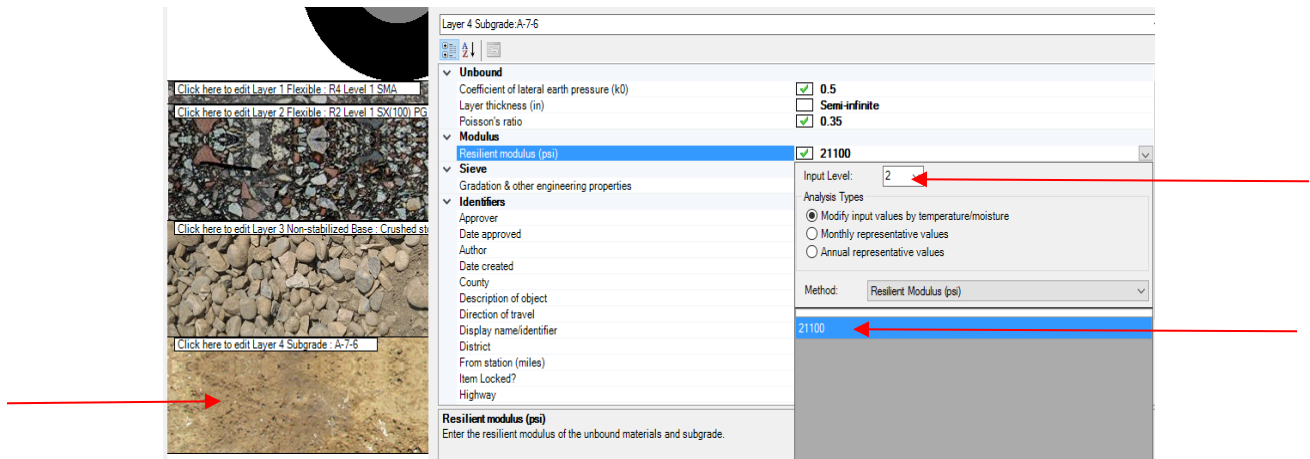
## I.6 PAVEMENT MECHANISTIC EMPIRICAL DESIGN (PMED)

The increase in the subgrade’s resilient modulus shall only be used to reduce the thickness of the subgrade or ABC; it shall never be used to reduce the pavement thickness. The geosynthetic composite does not negate the need for subgrade treatments per Chapter 4 or any other requirements that may be in this pavement design manual. The geosynthetic composite system does not change the soil classification of the subbase, subgrade, or stabilizing material. For best results when using this guide in PMED, the designer should set input level to level 2 and set the resilient modulus in the ABC that was the ANN input as the Annual Representative Value as shown in **Figure I.6 Setting the Annual Representative Value of ABC in PMED** . The reason for setting the modulus in the ABC layer to the annual representative values is due to the geocomposite constraining and stiffening the layer. Thus, changes in the modulus caused by temperature and weather would be reduced. It should be noted, although fixing the ABC’s modulus will have an effect on the design, the benefit may be insignificant in most cases.



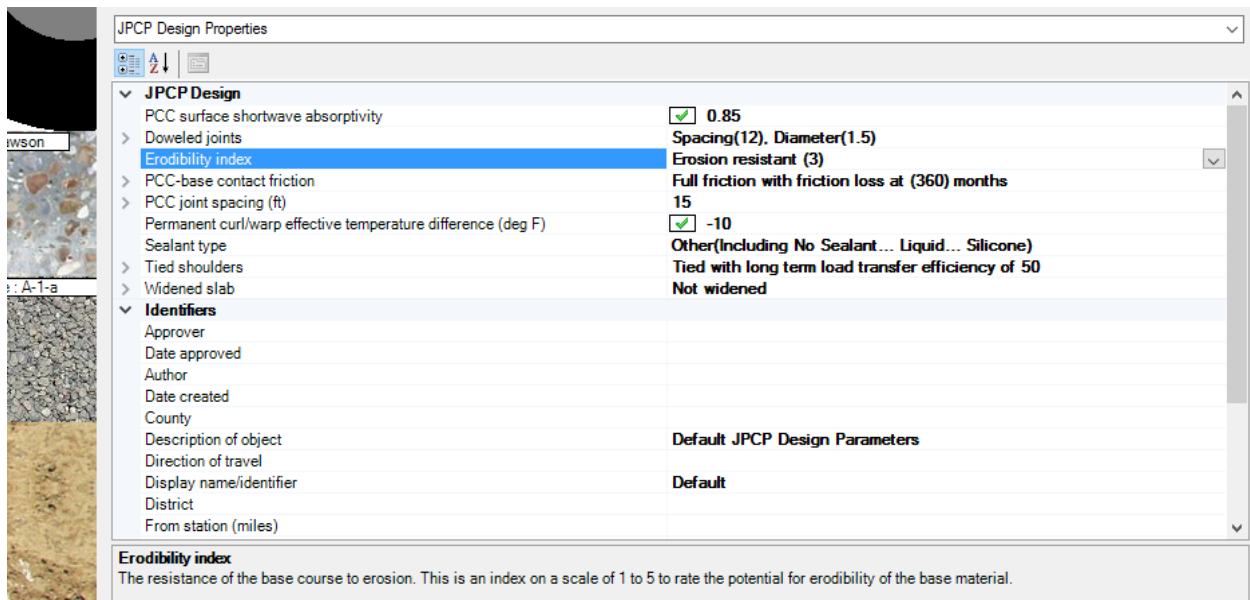
**Figure I.6 Setting the Annual Representative Value of ABC in PMED**

To adjust the modulus of the subgrade in PMED, the designer should set input level to Level 2 and set the subgrade resilient modulus as the modified subgrade modulus from ANN output as shown in **Figure I.7 Adjusting the Resilient Modulus of the Subgrade in PMED**.



**Figure I.7 Adjusting the Resilient Modulus of the Subgrade in PMED**

There is a reduction in the migration of fines through the composite system for concrete pavements, therefore, the layer below the aggregate base course is less susceptible to erosion. For this guide, it is recommended to modify the Erodibility Index to Erosion Resistance 3. This modification is shown in **Figure I.8 Example of the Increase in Erosion Resistance**. Similar to the HMA model, the designer should also set the resilient modulus in the ABC as the Annual Representative Value as shown in **Figure I.6 Setting the Annual Representative Value of ABC in PMED**. No ANN model was developed for concrete pavements because it was found that critical stresses in concrete pavements were insensitive to the type of geosynthetics or location of geosynthetics.



**Figure I.8 Example of the Increase in Erosion Resistance**

### **I.6.1 Side by Side Design Verification**

The designer must verify that they have only reduced the thickness of the aggregate base course or stabilizing material by performing a side-by-side M-E Design pavement analysis. The designers shall produce an original passing design using the original subgrade's resilient modulus value. A second design using the modified subgrade's resilient modulus must be created. Both the original and the modified designs shall be submitted to the RME for review to verify the original pavement thickness has not been altered.

## **I.7 OTHER DESIGN CONSIDERATIONS**

Alternate geosynthetic systems, not meeting the criteria in Tables I.1 or I.2, can be used. However, any proposed system shall provide the minimum long-term separation, filtration, and reinforcement benefits as the baseline composite system which uses products meeting the requirements listed in Tables I.1 and I.2. Prior to construction, the Contractor shall justify the minimum subgrade modulus values by providing field testing of the alternate system immediately adjacent to and within 50 feet of the baseline system using the proposed materials, pavement section, and construction practices for the project. The alternate system must meet or exceed the field tested benefit of the baseline composite system. The design shall be reviewed and approved by the Engineer prior to incorporation into the project.

## **I.8 CERTIFICATIONS OF COMPLIANCE**

The Contractor shall submit to the Engineer the following information regarding each geosynthetic material prior to use:

- Manufacturer/supplier's name and current address
- Full product name
- Geosynthetic polymer type(s)
- Roll number(s)
- Lot number(s)
- Roll dimension (width and length)
- Certified test results for minimum average roll values. Certified tests shall be from an accredited GAI-LAP laboratory.
- (Geotextiles only) Manufacture date, the manufacture date shall occur within its current NTPEP product 3-year evaluation cycle.
- (Geogrids only) Currently, NTPEP does not have a category for geogrids, however if in the future a category is added the following will be required, manufacture date, the manufacture date shall occur within its current NTPEP product 3-year evaluation cycle.

Rolls shall be permanently marked with clearly legible print or labeled at both ends of the roll's outer wrapping and on both ends of the roll core's interior. There shall be a means of positively

identifying the product at the time of its delivery. If the permanent marking contains this information the labels may be omitted

All geotextiles shall be tested by NTPEP. The manufacture and any subsequent private labeler facility shall be listed as compliant by NTPEP within the current calendar year, or immediate past calendar year with an application for an audit during the current calendar year.

Product acceptance may be determined by comparing the manufacturer test data against these specifications and using independent assurance testing, verification sampling and testing, and facility audits.

The Contractor shall furnish a certified test report from an approved testing laboratory with each shipment of material. Laboratory test reports shall include the actual numerical test data obtained. The Department/Contractor shall test the geosynthetics properties listed in Tables I.1 and I.2 using laboratories accredited by the Geosynthetic Accreditation Institute. For testing geosynthetics, a “lot” is defined as a single day’s production.

The Department may sample and test product from a facility or project at any time to verify compliance with guide requirements. Failure may result in the product being rejected or removed.

## **I.9 DELIVERY, STORAGE, AND HANDLING**

The following shall be established for proper storage and protection of geosynthetics on a jobsite.

### **I.9.1 Delivery**

Delivery of product shall comply with manufacturer recommendations. Only full rolls shall be supplied to the project. At a minimum, geotextile rolls shall be furnished with suitable wrapping (including the ends) to protect against moisture, insect, rodent, mildew, abrasion, and extended ultraviolet exposure prior to placement. The protective wrapping shall be maintained during periods of shipment and storage. Each roll shall be labeled to provide product identification sufficient for inventory and process control purposes. Geosynthetics that are not properly protected may be subject to rejection.

### **I.9.2 Storage**

Rolls shall be stored in a manner which protects them from the following: site construction damage, precipitation, extended ultraviolet radiation including sunlight, strong acids or bases, flames including welding sparks, temperatures in excess of 140°F, and other environmental conditions that may damage the physical property values of the geosynthetic.

If stored outdoors, the rolls shall be elevated and protected with a waterproof cover. The geosynthetics shall be kept dry until installation and not stored directly on the ground. The Contractor shall prevent excessive mud, wet concrete, epoxy, or other deleterious materials from coming in contact with the geosynthetic materials. Rolls are to be stored at temperatures above - 20 °F (-29 °C). The rolled materials may be laid flat or stood on end. The Contractor shall not expose geosynthetic materials to direct sunlight for a period longer than recommended by the manufacturer. The Contractor shall follow the manufacturer’s recommendations regarding protection from direct sunlight.

### **I.9.3 Acceptance**

At the time of installation, the Department shall reject a geosynthetic at the time of installation if it has defects, rips, holes, flaws, deterioration, or damage incurred during manufacture, transport, handling or storage.

## **I.10 CONSTRUCTION OF BASE REINFORCEMENT**

A representative of the geosynthetic manufacturer or approved agent of the manufacturer shall be on the project when work begins.

Prior to placement, the surface shall be compacted as directed by the Engineer. The surface shall be prepared to be as smooth as possible and free from debris, obstructions, and depressions that could result in gaps, tears, or punctures in the geosynthetic during cover operations.

The contractor shall place the composite system at the proper elevation and alignment, in continuous strips without joints, seams or connections as shown on the construction drawings, and provide the minimum overlap according to the manufacturer's recommendations. Installation of the geosynthetic shall occur according to the guidelines provided by the manufacturer or as directed by the Engineer.

### **I.10.1 Securing Methods**

The geosynthetic may be temporarily secured in place with ties, staples, pins, sand bags, or backfill as required by fill properties, fill placement, weather conditions, or as directed by the Engineer.

### **I.10.2 Geosynthetic Placement**

Orient the geosynthetic rolls parallel to the roadway centerline. Use widths that produce overlaps of parallel rolls at the centerline and shoulders and no overlaps along wheel paths. If the geosynthetic shifts or becomes misaligned, realign it and anchor it according to the manufacturer's recommendations.

### **I.10.3 Overlaps**

Overlap of the geosynthetic shall be a minimum of 12 inches at all splices or joints per the manufacturer's recommendations. Construct joints at the end of a roll so the previous roll laps over the subsequent roll in the direction of the cover material placement. Overlap the geosynthetic in the same direction as placement with the preceding layer lapped on top of the following layer.

### **I.10.4 Curves**

The geosynthetic shall be cut and shingled to conform to the curves.

### **I.10.5 Surface Preparation**

The Contractor shall place, spread, and compact granular fill material in such a manner that it minimizes the development of wrinkles in, or movement of the composite system.

A minimum loose fill thickness of six inches is recommended prior to operation of tracked vehicles over the geogrid. Keep the turning of vehicles to a minimum to prevent tracks from displacing the fill and damaging the geosynthetic. Rubber tired equipment may pass over the geosynthetic reinforcement at slow speeds (less than 5 mph) when integrally-formed geogrids are used and if subgrade conditions permit. Do not use rubber-tired equipment directly on the geogrid when woven, multi-layer systems are used. Avoid sudden braking and sharp turning movements. Do not end-dump cover material directly on the geocomposite except as a starter course. Limit construction vehicle size and mass so rutting in the initial layer above the geosynthetic is not more than 3 inches deep or half the layer thickness.

### **I.10.6 Repairing Damaged Areas**

Any roll of geosynthetic damaged before, during, or after installation shall be replaced at no additional cost to the Department. Proper replacement consists of replacing the affected area and overlapping the geosynthetic a minimum of 12 inches on all sides adjacent to the damaged area. The Contractor shall align apertures of the patch with the underlying geogrid and mechanically tie the patch to the underlying geogrid.



## **SUPPLEMENT**

# **MATERIAL PROPERTIES OF SUBGRADE, SUBBASE, BASE, FLEXIBLE AND RIGID LAYERS**

### **S.1 Introduction**

The designer needs to have a basic knowledge of soil properties to include soil consistency, sieve analysis, unit weight, water content, specific gravity, elastic modulus, Poisson's ratio, unconfined compression strength, modulus of rupture, and indirect tensile strength. Resilient modulus and R-value needs to be understood. The *Mechanistic-Empirical (M-E) Pavement Design Guide* (24) will aggressively use these properties in the design of pavements.

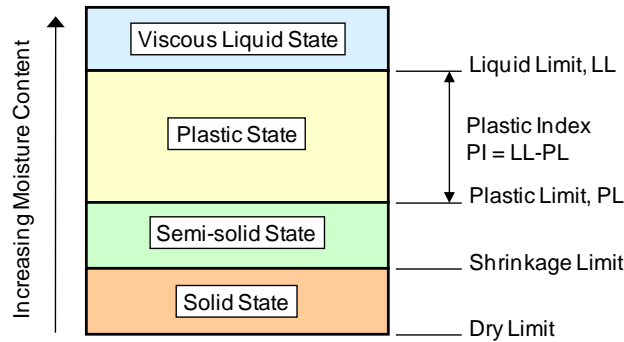
The Resilient Modulus ( $M_R$ ) was selected to replace the soil support value used in previous editions as noted when it first appeared in the *AASHTO Guide for Design of Pavement Structures 1986* (2). The AASHTO guide for the design of pavement structures, which was proposed in 1961 and then revised in 1972 (1), characterized the subgrade in terms of soil support value (SSV). SSV has a scale ranging from 1 to 10, with a value of 3 representing the natural soil at the Road Test. AASHTO Test Method T 274 determined the  $M_R$  referenced in the 1986 AASHTO Guide. The compacted layer of the roadbed soil was to be characterized by the  $M_R$  using correlations suitable to obtain a  $M_R$  value. Procedures for assigning appropriate unbound granular base and subbase layer coefficients based on expected  $M_R$  values were also given in the 1986 AASHTO Guide. The *1993 AASHTO Guide for Design of Pavement Structures* (3): Appendix L, lists four different approaches to determine a design resilient modulus value. These are laboratory testing Non-Destructive Testing (NDT) backcalculation, estimating resilient modulus from correlations with other properties, and original design and construction data (4).

#### **S.1.1 Soil Consistency**

Soil consistency is defined as the amount of effort required to deform a soil. This level of effort allows the soil to be classified as either soft, firm, or hard. The forces that resist the deformation and rupture of soil are cohesion and adhesion. Cohesion is a water-to-water molecular bond, and adhesion is a water-to-solid bond (17). These bonds depend on water, so consistency directly relates to moisture content, which provides a further classification of soil as dry consistence, moist consistence, and wet consistence.

The Atterberg Limits takes this concept a step further, by labeling the different physical states of soil based on its water content as liquid, plastic, semi-solid, and solid. The boundaries that define these states are known as the liquid limit (LL), plastic limit (PL), shrinkage limit (SL), and dry limit (DL). The liquid limit is the moisture content at which soil begins to behave like a liquid and flow. The plastic limit is the moisture content where soil begins to demonstrate plastic properties, such as rolling a small mass of soil into a long thin thread. The plasticity index (PI) measures the range between LL and PL where soil is in a plastic state. The shrinkage limit is defined as the moisture content at which no further volume change occurs as the moisture content is continually reduced (18). The dry limit occurs when moisture no longer exists within the soil.

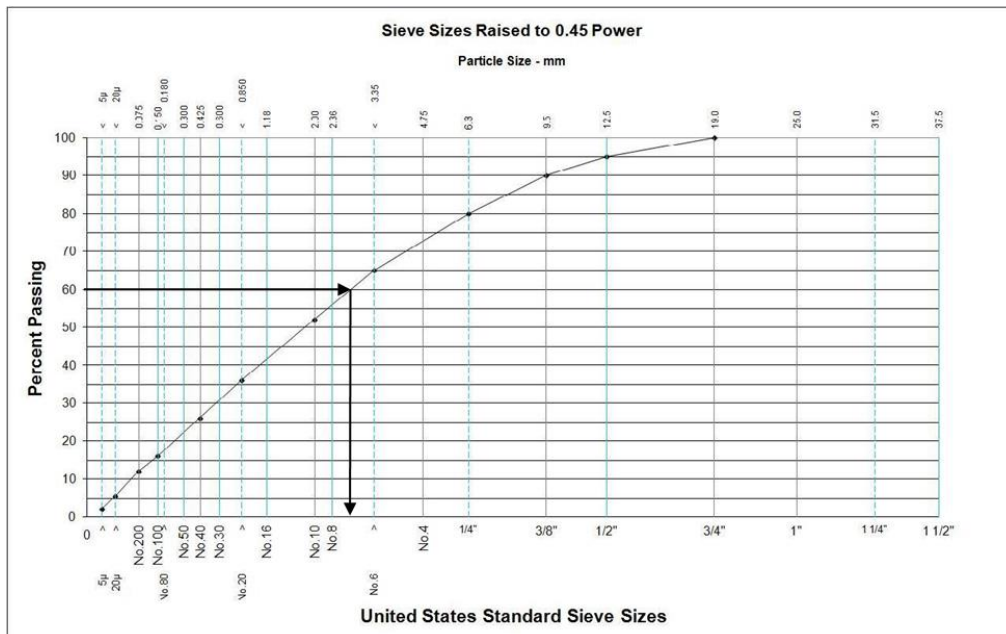
The Atterberg limits are typically used to differentiate between clays and silts. The test method for determining LL of soils is AASHTO T 89-02. AASHTO T 90-00 presents the standard test method for determining PL and PI.



**Figure S.1 Atterberg Limits**

### S.1.2 Sieve Analysis

The sieve analysis is performed to determine the particle size distribution of unbound granular and subgrade materials. In the M-E Design program, the required size distribution are the percentage of material passing the No. 4 sieve (P<sub>4</sub>) and No. 200 sieve (P<sub>200</sub>). D<sub>60</sub> represents a grain diameter in inches for which 60% of the sample will be finer and passes through that sieve size. In other words, 60% of the sample by weight is smaller than diameter D<sub>60</sub>. D<sub>60</sub> = 0.1097 inches.



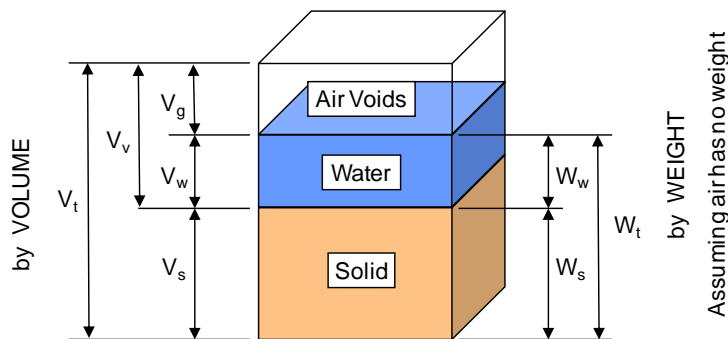
**Figure S.2 Gradation Plot**

**Table S.1 Nominal Dimensions of Common Sieves**

US Nominal Sieve Size	Size (mm)	US Nominal Sieve Size	Size (mm)
2"	50.0	No. 8	2.36
1 1/2"	37.5	No. 10	2.00
1 1/4"	31.5	No. 16	1.18
1"	25.0	No. 20	850 μm
3/4"	19.0	No. 30	600 μm
1/2"	12.5	No. 40	425 μm
3/8"	9.5	No. 50	300 μm
1/4"	6.3	No. 80	180 μm
No. 4	4.75	No. 100	150 μm
No. 6	3.35	No. 200	75 μm

### S.1.3 Unit Weight, Water Content, and Specific Gravity

Maximum dry density ( $\gamma_{dry\ max}$ ) and optimum gravimetric moisture content ( $w_{opt}$ ) of the compacted unbound material is measured using AASHTO T 180 for bases or AASHTO T 99 for other layers. Specific gravity ( $G_s$ ) is a direct measurement using AASHTO T 100 (performed in conjunction with consolidation tests - AASHTO T 180 for unbound bases or AASHTO T 99 for other unbound layers).



**Figure S.3 Soil Sample Constituents**

**Unit Weight:**

$$\gamma = \frac{W_t}{V_t} = \frac{W_w + W_s}{V_g + V_w + V_s}$$

**Eq. S.1**

**Dry Density (mass):**

$$\gamma_{\text{dry}} = \frac{W_s}{V_t} = \frac{W_s}{V_g + V_w + V_s} \quad \text{Eq. S.2}$$

In the consolidation (compaction) test the dry density cannot be measured directly, what are measured are the bulk density and the moisture content for a given effort of compaction.

**Bulk Density** or oven-dry unit mas:

$$\gamma_{\text{dry}} = \frac{W_s + W_w}{V_t} = \frac{W_t}{V_t(1+w)} = \frac{\gamma}{1+w} = \frac{(W_t/V_t)}{(1 + (W_w/W_s))} \quad \text{Eq. S.2}$$

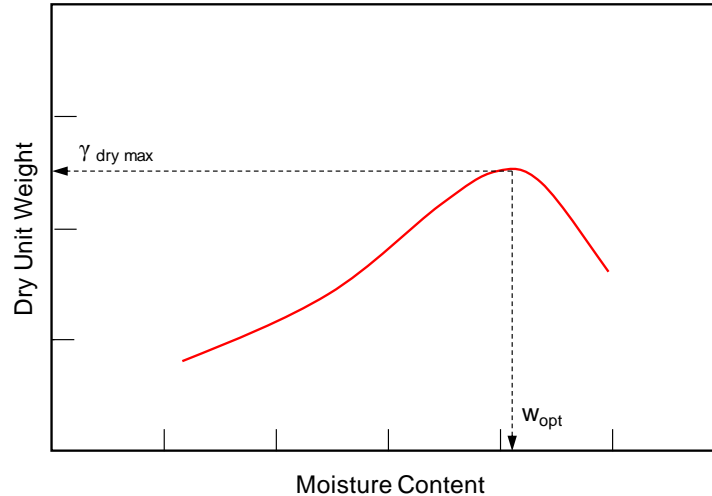
**Specific Gravity:**

$$G_s = \frac{\gamma_s}{\gamma_w} = \frac{(W_s/V_s)}{\gamma_w} = \frac{\gamma_s}{62.4} \quad \text{Eq. S.4}$$

Where:

- $\gamma$  = Unit weight (density), pcf
- $\gamma_{\text{dry}}$  = Dry density, pcf
- $\gamma_{\text{bulk}}$  = Bulk density, pcf
- $\gamma_{\text{dry max}}$  = Maximum dry unit weight, pcf
- $G_s$  = Specific gravity (oven dry)
- $W_t$  = total weight
- $W_w$  = weight of water
- $W_s$  = weight of solids
- $V_t$  = total volume
- $V_v$  = volume of voids
- $V_g$  = volume of air (gas)
- $V_w$  = volume of water
- $V_s$  = volume of solids
- $w$  = water content
- $w_{\text{opt}}$  = optimum water content
- $\gamma_s$  = density of solid constituents
- $\gamma_w = 62.4$  pcf at 4 °C

The maximum dry unit weight and optimum water content are obtained by graphing as shown in **Figure S.4 Plot of Maximum Dry Unit Weight and Optimum Water Content.**



**Figure S.4 Plot of Maximum Dry Unit Weight and Optimum Water Content**

### S.1.4 Pavement Materials Chemistry

#### Periodic Table

The periodic table is a tabular method of displaying the 118 chemical elements, refer to **Figure S.5 Periodic Table**. Elements are listed from left to right as the atomic number increases. The atomic number identifies the number of protons in the nucleus of each element. Elements are grouped in columns, because they tend to show patterns in their atomic radius, ionization energy, and electronegativity. As you move down a group the atomic radii increases, because the additional electrons per element fill the energy levels and move farther from the nucleus. The increasing distance decreases the ionization energy, the energy required to remove an electron from the atom, as well as decreases the atom's electronegativity, which is the force exerted on the electrons by the nucleus. Elements in the same period or row show trends in atomic radius, ionization energy, electron affinity, and electronegativity. Within a period moving to the right, the atomic radii usually decreases, because each successive element adds a proton and electron, which creates a greater force drawing the electron closer to the nucleus. This decrease in atomic radius also causes the ionization energy and electronegativity to increase the more tightly bound an element becomes.

#### pH Scale

Water ( $H_2O$ ) is a substance that can share hydrogen ions. The cohesive force that holds water together can also cause the exchange of hydrogen ions between molecules. The water molecule acts like a magnet with a positive and negative side, this charge can prove to be greater than the hydrogen bond between the oxygen and hydrogen atom causing the hydrogen to join the adjacent molecule (19). This process can be seen molecularly **Figure S.6 Dissociation of Water** and is expressed chemically in **Equation S.5**.

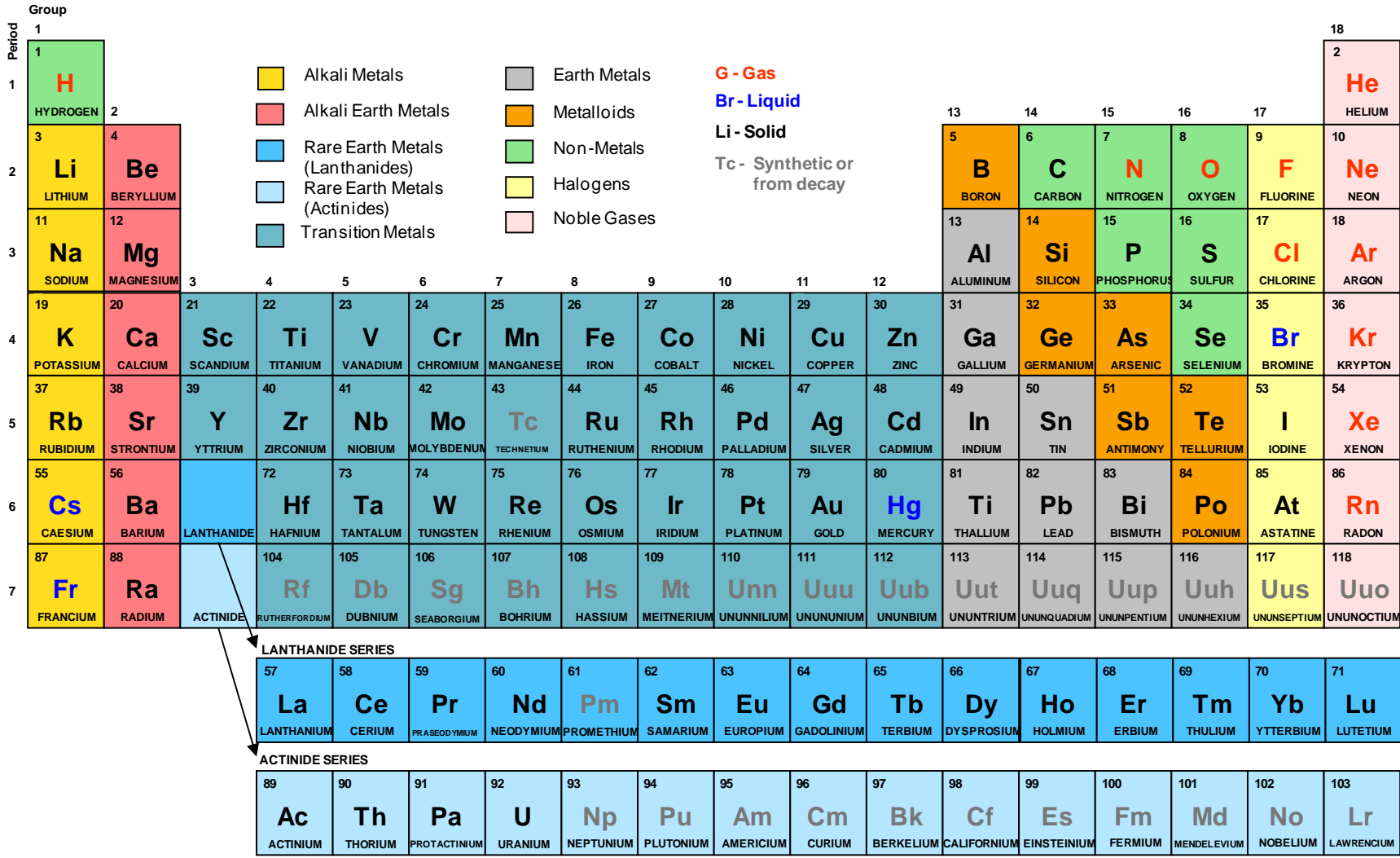


Figure S.5 Periodic Table

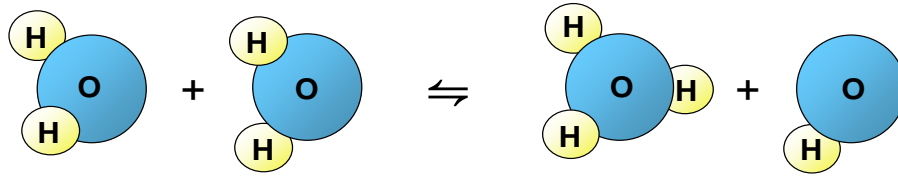


Figure S.6 Dissociation of Water



The pH of a solution is the negative logarithmic expression of the number of  $\text{H}^+$  ions in a solution. When this is applied to water with equal amounts of  $\text{H}^+$  and  $\text{OH}^-$  ions the concentration of  $\text{H}^+$  will be 0.00000001, the pH is then expressed as  $-\log 10^{-7} = 7$ . From the neutral water solution of 7 the pH scale ranges from 0 to 14, zero is the most acidic value and 14 is the most basic or alkaline, refer to **Figure S.7 pH Scale**.

An acid can be defined as a proton donor, a chemical that increases the concentration of hydronium ions  $[\text{H}_3\text{O}^+]$  or  $[\text{H}^+]$  in an aqueous solution. Conversely, we can define a base as a proton acceptor, a chemical that reduces the concentration of hydronium ions and increases the concentration of hydroxide ions  $[\text{OH}^-]$  (18).

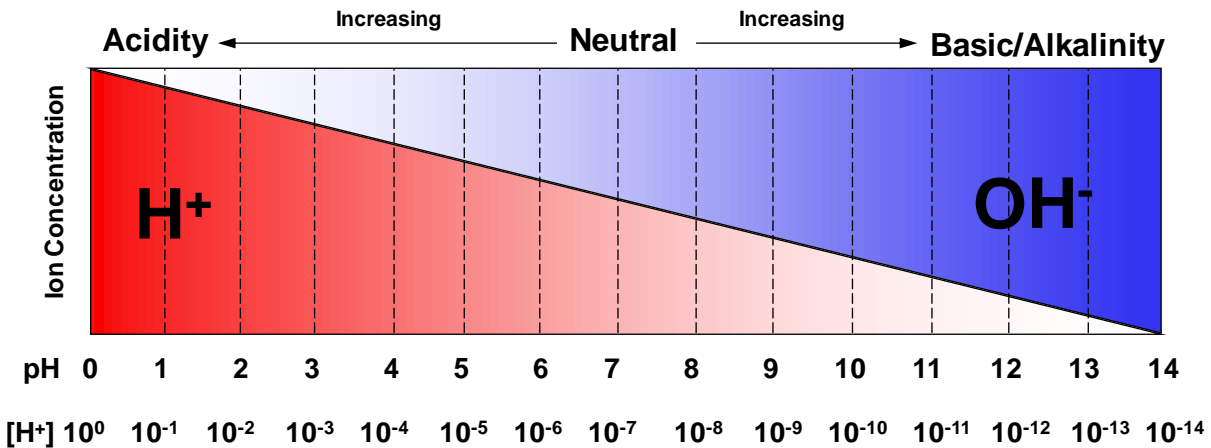


Figure S.7 pH Scale

### S.1.5 Elastic Modulus

Elastic Modulus (E):

$$E = \frac{\sigma}{\epsilon} \quad \text{Eq. S.6}$$

Where:

$$\text{Stress} = \sigma = \text{Load/Area} = P/A \quad \text{Eq. S.7}$$

$$\text{Strain} = \epsilon = \frac{\text{Change in length}}{\text{Initial length}} = \frac{\Delta L}{L_0} \quad \text{Eq. S.8}$$

A material is elastic if it is able to return to its original shape or size immediately after being stretched or squeezed. Almost all materials are elastic to some degree as long as the applied load does not cause it to deform permanently. The modulus of elasticity for a material is basically the slope of its stress-strain plot within the elastic range.

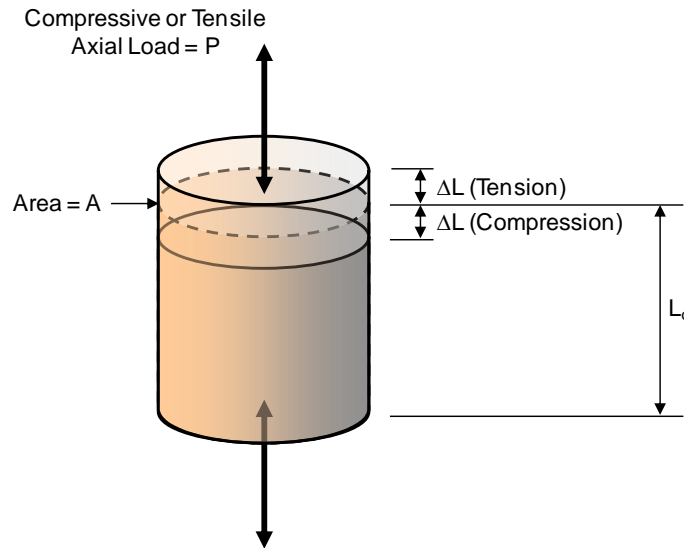


Figure S.8 Elastic Modulus

### Concrete Modulus of Elasticity

The static Modulus of Elasticity ( $E_c$ ) of concrete in compression is determined by ASTM C 469. The chord modulus is the slope of the chord drawn between any two specified points on the stress-strain curve below the elastic limit of the material.

$$E_c = \frac{(\sigma_2 - \sigma_1)}{(\epsilon_2 - 0.000050)} \quad \text{Eq. S.9}$$

Where:

$E_c$  = Chord modulus of elasticity, psi

$\sigma_1$  = Stress corresponding to 40% of ultimate load

$\sigma_2$  = Stress corresponding to a longitudinal strain;  $\epsilon_1 = 50$  millionths, psi

$\epsilon_2$  = Longitudinal strain produced by stress  $\sigma_2$



## Asphalt Dynamic Modulus $|E^*|$

The complex Dynamic Modulus ( $|E^*|$ ) of asphalt is a time-temperature dependent function. The  $|E^*|$  properties are known to be a function of temperature, rate of loading, age, and mixture characteristics such as binder stiffness, aggregate gradation, binder content, and air voids. To account for temperature and rate of loading, the analysis levels will be determined from a master curve constructed at a reference temperature of 20°C (70°F) (5). The description below is for developing the master curve and shift factors of the original condition without introducing aged binder viscosity and additional calculated shift factors using appropriate viscosity.

$|E^*|$  is the absolute value of the complex modulus calculated by dividing the maximum (peak to peak) stress by the recoverable (peak to peak) axial strain for a material subjected to a sinusoidal loading.

A sinusoidal (Haversine) axial compressive stress is applied to a specimen of asphalt concrete at a given temperature and loading frequency. The applied stress and the resulting recoverable axial strain response of the specimen is measured and used to calculate the  $|E^*|$  and phase angle. See **Equation S.10** for  $|E^*|$  general equation and **Equation S.11** for phase angle equation. Dynamic modulus values are measured over a range of temperatures and load frequencies at each temperature. Refer to **Table S.2 Recommended Testing Temperatures and Loading Frequencies**. Each test specimen is individually tested for each of the combinations. The table shows a reduced temperature and loading frequency as recommended. See **Figure S.9 Dynamic Modulus Stress-Strain Cycles** for time lag response. See **Figure S.10  $|E^*|$  vs. Log Loading Time Plot at Each Temperature**. To compare test results of various mixes, it is important to normalize one of these variables. 20°C (70°F) is the variable that is normalized. Test values for each test condition at different temperatures are plotted and shifted relative to the time of loading. See **Figure S.11 Shifting of Various Mixture Plots**. These shifted plots of various mixture curves can be aligned to form a single master curve (26). See **Figure S.12 Dynamic Modulus  $|E^*|$  Master Curve**. The  $|E^*|$  is determined by AASHTO PP 61-09 and PP 62-09 test methods (27-28).

**Table S.2 Recommended Testing Temperatures and Loading Frequencies**

PG 58-XX and Softer		PG 64-XX and PG 70-XX		PG 76-XX and Stiffer	
Temp. (°C)	Loading Freq. (Hz)	Temp. (°C)	Loading Freq. (Hz)	Temp. (°C)	Loading Freq. (Hz)
4	10, 1, 0.1	4	10, 1, 0.1	4	10, 1, 0.1
20	10, 1, 0.1	20	10, 1, 0.1	20	10, 1, 0.1
35	10, 1, 0.1, 0.01	40	10, 1, 0.1, 0.01	45	10, 1, 0.1, 0.01

$$|E^*| = \sigma_0 / \epsilon_0$$

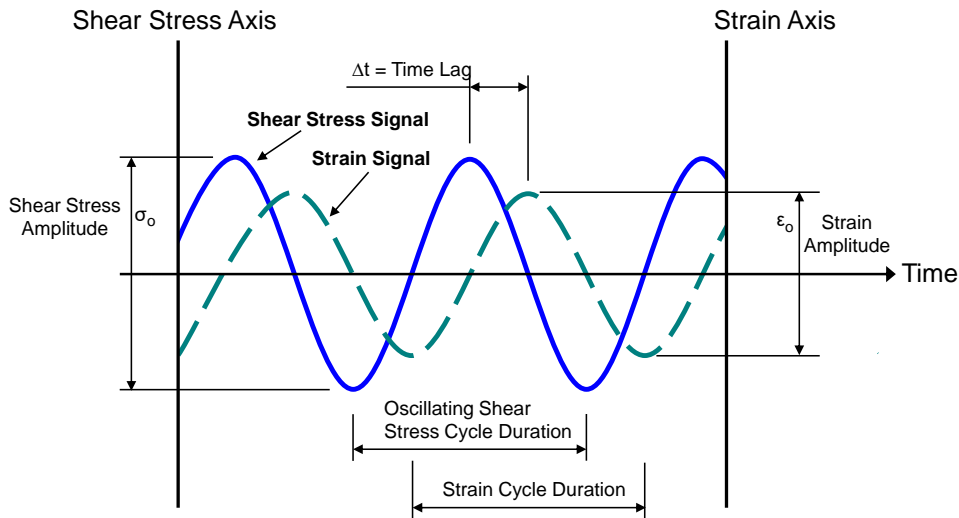
**Eq. S.10**

Where:

$|E^*|$  = Dynamic modulus

$\sigma_0$  = Average peak-to-peak stress amplitude, psi

$\epsilon_0$  = Average peak-to-peak strain amplitude, coincides with time lag (phase angle)



**Figure S.9 Dynamic Modulus Stress-Strain Cycles**

The phase angle  $\theta$  is calculated for each test condition and is:

$$\theta = 2\pi f \Delta t$$

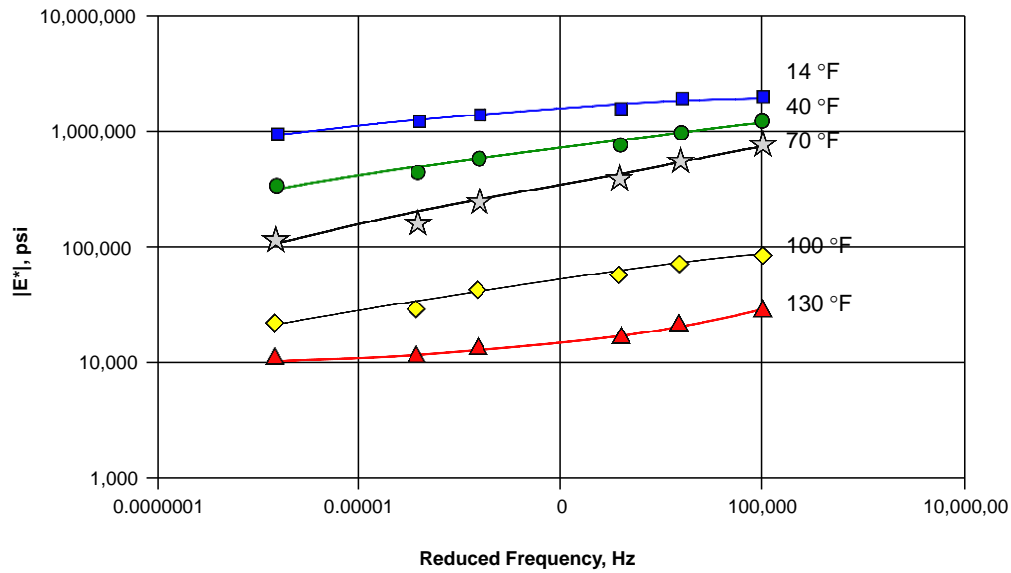
**Eq. S.11**

Where:

$\theta$  = phase angle, radian

$f$  = frequency, Hz

$\Delta t$  = time lag between stress and strain, seconds



The  $|E^*|$  master curve can be represented by a sigmoidal function as shown (27):

$$\log|E^*| = \delta + \frac{(\text{Max} - \delta)}{1 + e^{\beta + \gamma \left\{ \log f + \frac{\Delta E_\sigma}{19.14714} \left[ \left( \frac{1}{T} \right) - \left( \frac{1}{T_r} \right) \right] \right\}}}$$

Eq. S.12

Where:

- $|E^*|$  = Dynamic modulus, psi
- $\Delta$ ,  $\beta$  and  $\gamma$  = fitting parameters
- Max = limiting maximum modulus, psi
- $f$  = loading frequency at the test temperature, Hz
- $E_\sigma$  = energy (treated as a fitting parameter)
- $T$  = test temperature, °K
- $T_r$  = reference temperature, °K

Fitting parameters  $\delta$  and  $\alpha$  depend on aggregate gradation, binder content, and air void content. Fitting parameters  $\beta$  and  $\gamma$  depend on the characteristics of the asphalt binder and the magnitude of  $\delta$  and  $\alpha$ . The sigmoidal function describes the time dependency of the modulus at the reference temperature.

The maximum limiting modulus is estimated from HMA volumetric properties and limiting binder modulus.

$$|E^*|_{\max} = P_c \left[ 4,200,000 \left( 1 - \frac{\text{VMA}}{100} \right) + 435,000 \left( \frac{\text{VFA} \times \text{VMA}}{10,000} \right) + \frac{1 - P_c}{\frac{1 - \frac{\text{VMA}}{100}}{4,200,000} + \frac{\text{VMA}}{435,000(\text{VFA})}} \right] \quad \text{Eq. 13}$$

Where:

$$P_c = \frac{\left[ 20 + \frac{435,000(\text{VFA})}{\text{VMA}} \right]^{0.58}}{650 + \left[ \frac{435,000(\text{VFA})}{\text{VMA}} \right]^{0.58}} \quad \text{Eq. S.14}$$

$|E^*|_{\max}$  = limiting maximum HMA dynamic modulus, psi  
VMA = voids in the mineral aggregate, percent  
VFA = voids filled with asphalt, percent

The shift factors describe the temperature dependency of the modulus.

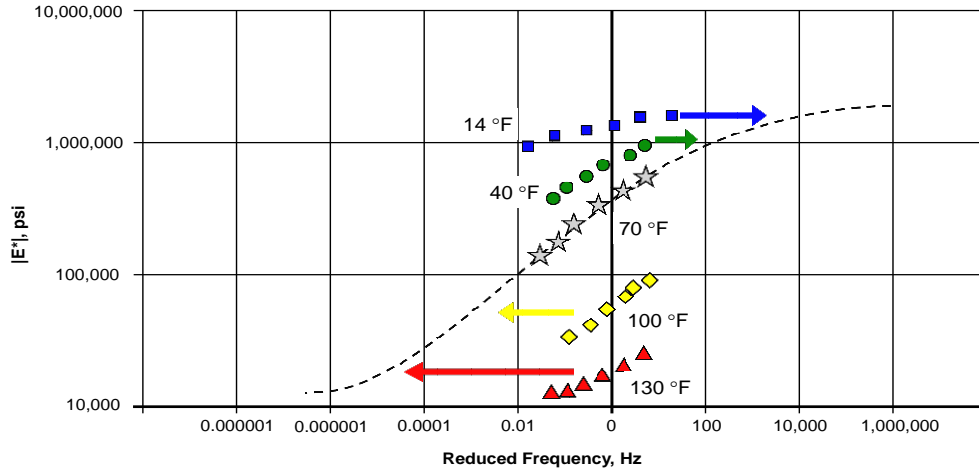
Shift factors to align the various mixture curves to the master curve are shown in the general form as (27):

$$\text{Log} [\alpha_{(T)}] = \frac{\Delta E_a}{19.14714} [ (1/T) \setminus (1/T_r) ] \quad \text{Eq. S.15}$$

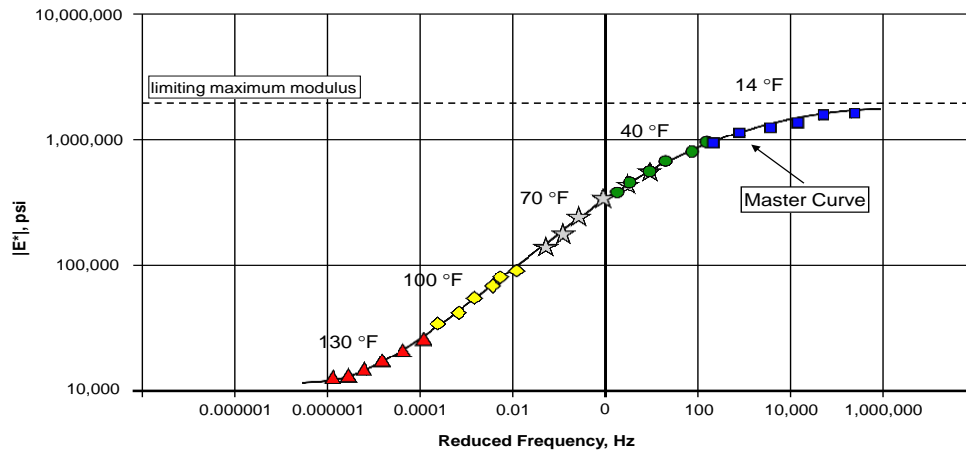
Where:

$\alpha_{(T)}$  = shift factor at temperature (T)  
 $\Delta E_a$  = activation energy (treating as a fitting parameter)  
T = test temperature, °K  
T<sub>r</sub> = reference temperate, °K

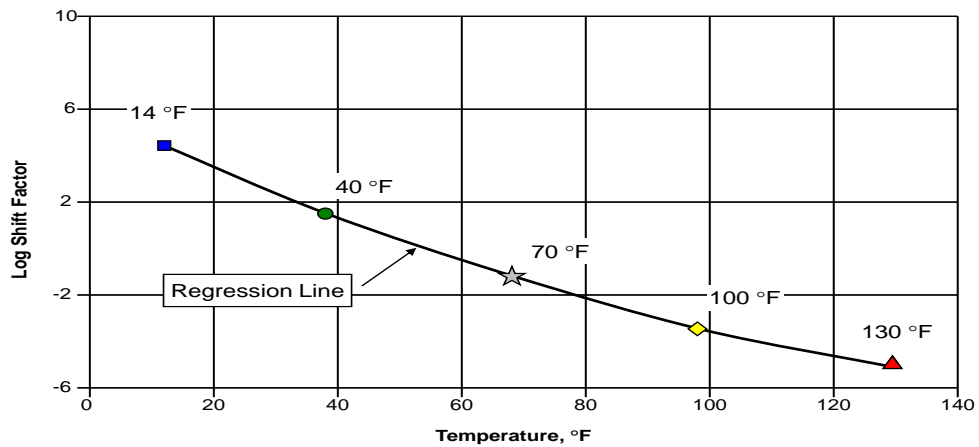
A shift factor plot as a function of temperature for the mixtures is shown in **Figure S.13 Shift Factor Plot**.



**Figure S.10 Shifting of Various Mixture Plots**



**Figure S.11 Dynamic Modulus |E\*| Master Curve**



**Figure S.12 Shift Factor Plot**

### S.1.6 Binder Complex Shear Modulus

The complex shear modulus,  $G^*$  is the ratio of peak shear stress to peak shear strain in dynamic (oscillatory) shear loading between a oscillating plate a fixed parallel plate. The test uses a sinusoidal waveform that operates at one cycle and is set at 10 radians/second or 1.59 Hz. The oscillating loading motion is a back and forth twisting motion with increasing and decreasing loading. Stress or strain imposed limits control the loading. The one cycle loading is a representative loading due to 55 mph traffic. If the material is elastic, then the phase lag is zero.  $G'$  represents this condition and is said to be the storage modulus. If the material is wholly viscous, then the phase lag is  $90^\circ$  out of phase.  $G''$  represents the viscous modulus.  $G^*$  is the vector sum of  $G'$  and  $G''$ . Various artificially aged specimens and/or in a series of temperature increments may be tested. The DSR test method is applicable to a temperature range of  $40^\circ\text{F}$  and above.

$$G^* = \tau_{\max} / \gamma_{\max} \quad \text{Eq. S.16}$$

$$\tau_{\max} = \frac{2T_{\max}}{\pi r^3} \quad \text{Eq. S.17}$$

$$\gamma_{\max} = \theta_{\max} (r) / h \quad \text{Eq. S.18}$$

Where:

$G^*$  = binder complex shear modulus

$\tau_{\max}$  = maximum shear stress

$\gamma_{\max}$  = maximum shear strain

$T_{\max}$  = maximum applied torque

$r$  = radius of specimen

$\theta_{\max}$  = maximum rotation angle, radians

$h$  = height of specimen

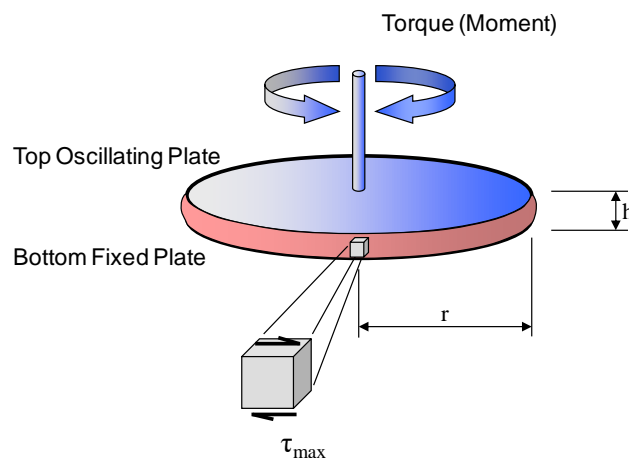
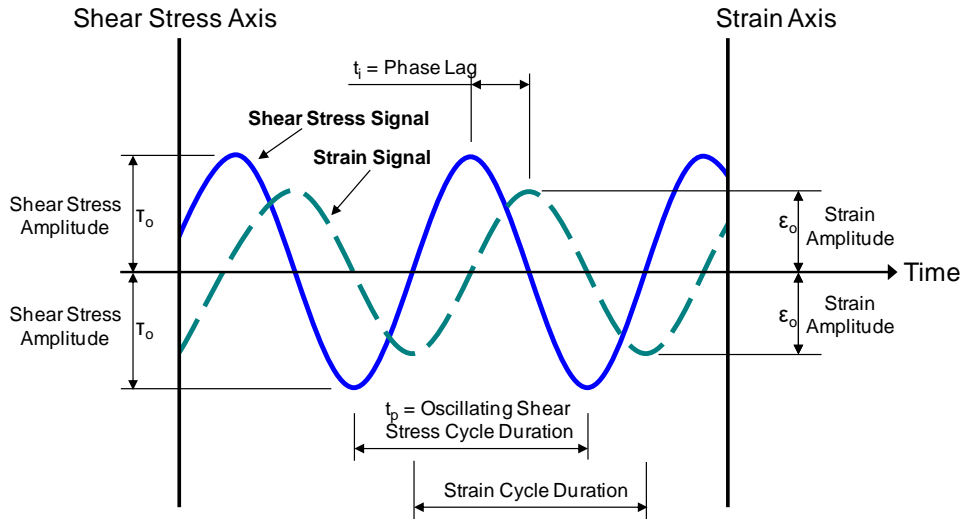


Figure S.13 Binder Complex Shear Modulus Specimen Loading



**Figure S.14 Binder Complex Shear Modulus Shear-Strain Cycles**

A relationship between binder viscosity and binder complex shear modulus (with binder phase angle) at each temperature increment of 40, 55, 70 (reference temperature), 85, 100, 115 and 130°F are obtained by:

$$\eta = \frac{G^*}{10} (1 / \sin \delta) \times 4.8628 \quad \text{Eq. S.19}$$

Where:

- $\eta$  = viscosity
- $G^*$  = binder complex shear modulus
- $\delta$  = binder phase angle

The regression parameters are found by using Equation S.20 by linear regression after log-log transformation of the viscosity data and log transformation of the temperature data:

$$\text{Log} (\log \eta) = A = \text{VTS} \times \log T_R \quad \text{Eq. S.20}$$

Where:

- $\eta$  = binder viscosity
- A, VTS = regression parameters
- $T_R$  = temperature, degrees Rankin

### S.1.7 Poisson's Ratio

The ratio of the lateral strain to the axial strain is known as Poisson's ratio,  $\mu$ :

$$\mu = \epsilon_{\text{lateral}} / \epsilon_{\text{axial}} \quad \text{Eq. S.21}$$

Where:

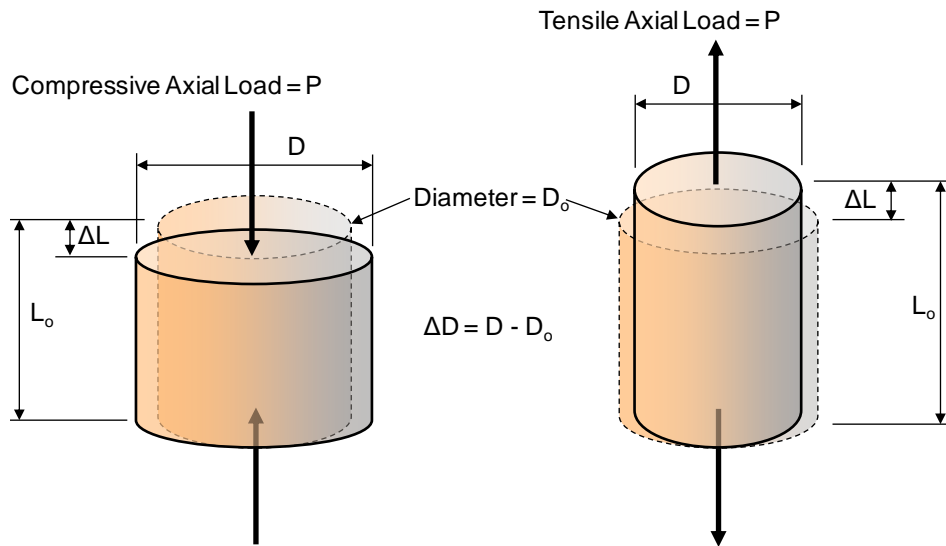
$\mu$  = Poisson's ratio

$\epsilon_{\text{lateral}}$  = strain width or diameter  
= change in diameter/original diameter  
=  $\Delta D / D_0$

**Eq. S.22**

$\epsilon_{\text{axial}}$  = strain in length  
= change in length/original length  
=  $\Delta L / L_0$

**Eq. S.23**



**Figure S.15 Poisson's Ratio**

### S.1.8 Coefficient of Lateral Pressure

The coefficient of lateral pressure ( $k_0$ ) is the term used to express the ratio of the lateral earth pressure to the vertical earth pressure:

Cohesionless Materials:

$$k_0 = \mu / (1 - \mu)$$

**Eq. S.24**

Cohesive Materials:

$$k_0 = 1 - \sin \theta$$

**Eq. S.25**

Where:

$k_0$  = coefficient of lateral pressure

$\mu$  = Poisson's ratio

$\theta$  = effective angle of internal friction



### S.1.9 Unconfined Compressive Strength

Unconfined compressive strength ( $f'_c$ ) is shown in Equation **Eq. S.26**. The compressive strength of soil cement is determined by ASTM D 1633. The compressive strength for lean concrete and cement treated aggregate is determined by AASHTO T 22, lime stabilized soils are determined by ASTM D 5102, and lime-cement-fly ash is determined by ASTM C 593.

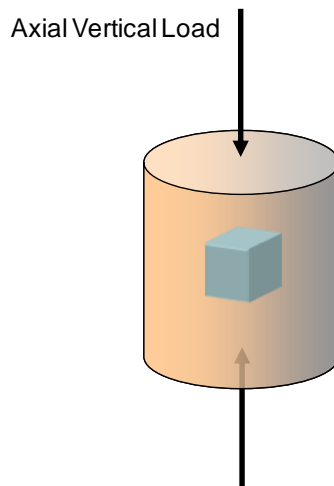
$$f'_c = P / A \quad \text{Eq. S.26}$$

Where:

$f'_c$  = unconfined compressive strength, psi

P = maximum load

A = cross sectional area



**Figure S.16 Unconfined Compressive Strength**

### S.1.10 Modulus of Rupture

The Modulus of Rupture ( $M_r$ ) is maximum bending tensile stress at the surface of a rectangular beam at the instant of failure using a simply supported beam loaded at the third points. The  $M_r$  is a test conducted solely on portland cement concrete and similar chemically stabilized materials. The rupture point of a concrete beam is at the bottom. The classical formula is shown in Equation **Eq. S.27**. The  $M_r$  for lean concrete, cement treated aggregate, and lime-cement-fly ash are determined by AASHTO T 97. Soil cement is determined by ASTM D 1635.

$$\sigma_{b,max} = (M_{max}c) / I_c \quad \text{Eq. S.27}$$

Where:

$M_{max}$  = maximum moment

c = distance from neutral axis to the extreme fiber

$I_c$  = centroidal area moment of inertia

If the fracture occurs within the middle third of the span length the  $M_r$  is calculated by:

$$S'_c = (PL) / (bd^2) \quad \text{Eq. S.28}$$

If the fracture occurs outside the middle third of the span length by not more than 5% of the span length the  $M_r$  is calculated by:

$$S'_c = (3Pa) / (bd^2) \quad \text{Eq. S.29}$$

Where:

$S'_c$  = modulus of rupture, psi

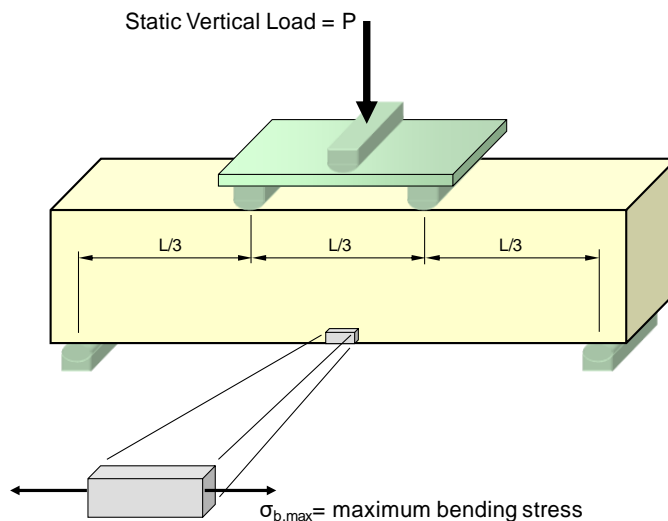
$P$  = maximum applied load

$L$  = span length

$b$  = average width of specimen

$d$  = average depth of specimen

$a$  = average distance between line of fracture and the nearest support on the tension surface of the beam



**Figure S.17 Three-Point Beam Loading for Flexural Strength**

### S.1.11 Tensile Creep and Strength for Hot Mix Asphalt

The tensile creep is determined by applying a static load along the diametral axis of a specimen. The horizontal and vertical deformations measured near the center of the specimen are used to calculate tensile creep compliance as a function of time. The Creep Compliance,  $D(t)$  is a time-dependent strain divided by an applied stress. The Tensile Strength,  $S_t$  is determined immediately after the tensile creep (or separately) by applying a constant rate of vertical deformation (loading movement) to failure. AASHTO T 322 - Determining the Creep Compliance and Strength of Hot-Mix Asphalt (HMA) Using the Indirect Tensile Test Device, using 6 inch diameter by 2 inch height molds, determines Creep Compliance and Tensile Strength. CDOT uses CP-L 5109 - *Resistance*

of Compacted Bituminous Mixture to Moisture Induced Damage to determine the tensile strength using 4 inch diameter by 2.5 inch height molds for normal aggregate mixtures.

### Creep Compliance

$$D_{(t)} = \epsilon_t / \sigma \quad \text{Eq. S.30}$$

Where:

$D_{(t)}$  = creep compliance at time, t

$\epsilon_t$  = time-dependent strain

$\sigma$  = applied stress

### Tensile Strength

$$S_t = 2P / (\pi tD) \quad \text{Eq. S.31}$$

Where:

$S_t$  = tensile strength, psi

P = maximum load

T = specimen height

D = specimen diameter

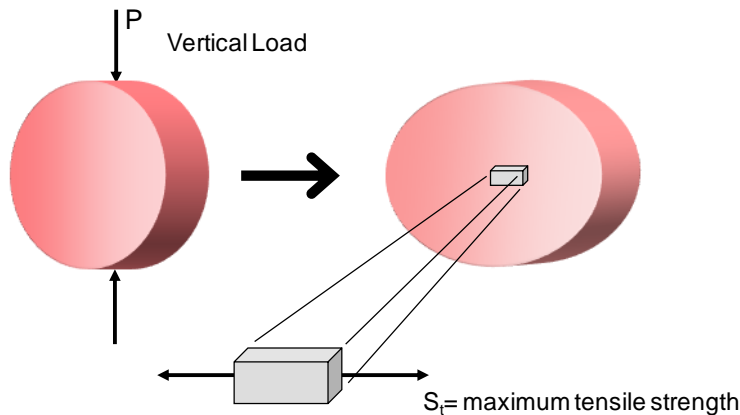
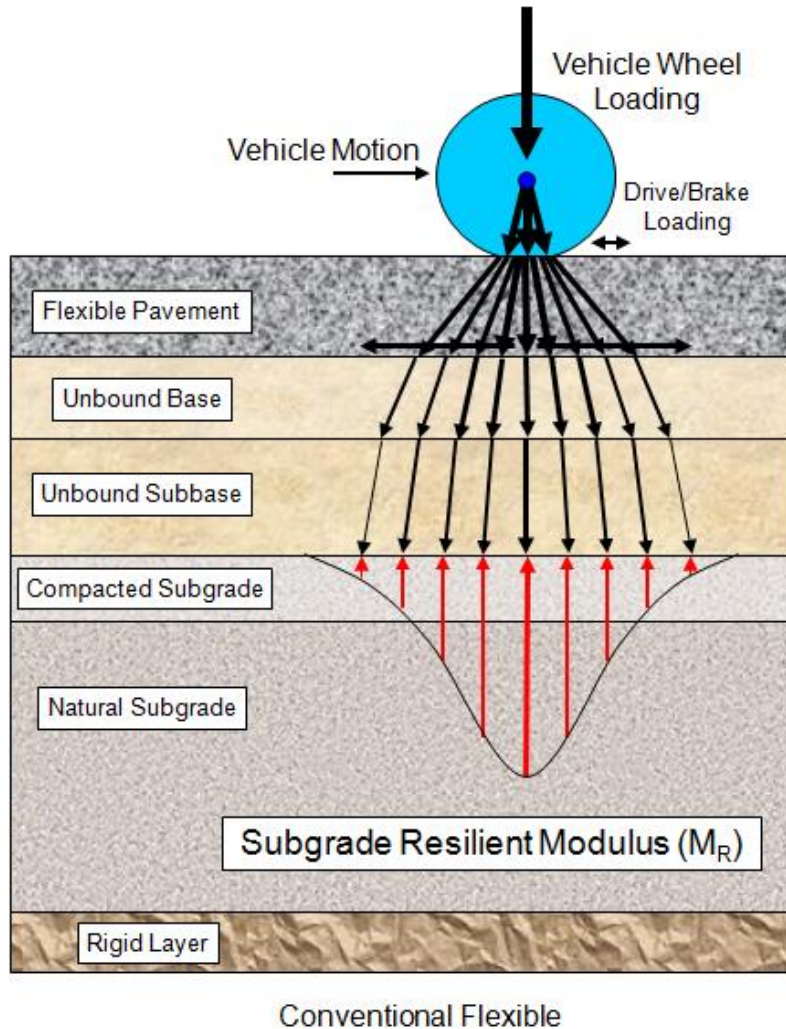


Figure S.18 Indirect Tensile Strength

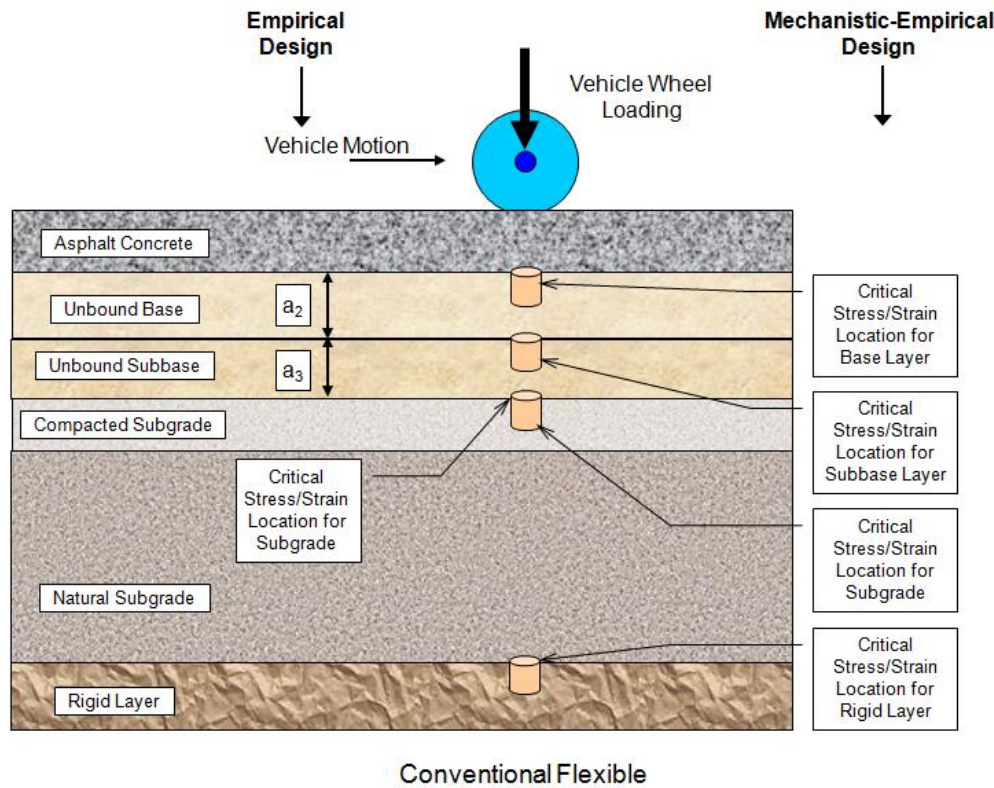
## S.2 Resilient Modulus of Conventional Unbound Aggregate Base, Subbase, Subgrade, and Rigid Layer

The subgrade resilient modulus is used for the support of pavement structure in flexible pavements. The graphical representation (see **Figure S.21 Distribution of Wheel Load to subgrade Soil ( $M_r$ )**) is the traditional way to explain the interaction of subgrade reaction to a moving wheel load. As the wheel load moves toward an area of concern, the subgrade reacts with a larger reaction.

When the wheel loading moves away the subgrade reaction  $i$  is less. That variable reaction is the engineering property Resilient Modulus. Critical locations in the layers have been defined for the Mechanistic-Empirical Design. Refer to **Figure S.22 Critical Stress/Strain Locations for Bases, Subbases, Subgrade, and Rigid Layer**. CDOT has historically used the empirical design methodology using structural coefficients of base ( $a_2$ ) and subbase ( $a_3$ ) layers. The rigid layer was only accounted for when it was close to the pavement structure.



**Figure S.19 Distribution of Wheel Load of Subgrade Soil ( $M_R$ )**



**Figure S.20 Critical Stress/Strain Locations for Bases, Subbases, Subgrade, and Rigid Layer**

### S.2.1 Laboratory $M_r$ Testing

The critical location for the subgrade is at the interface of the subbase and subgrade. The material subgrade element has the greatest loads at this location when the wheel loadings are directly above. Refer to **Figure S.31 Critical Stress Locations for Stabilized Subgrade**.

While the modulus of elasticity is stress divided by strain for a slowly applied load, resilient modulus is stress divided by strain for rapidly applied loads, such as those experienced by pavements.

Resilient modulus is defined as the ratio of the amplitude of the repeated cyclical (resultant) axial stress to the amplitude of resultant (recoverable) axial strain.

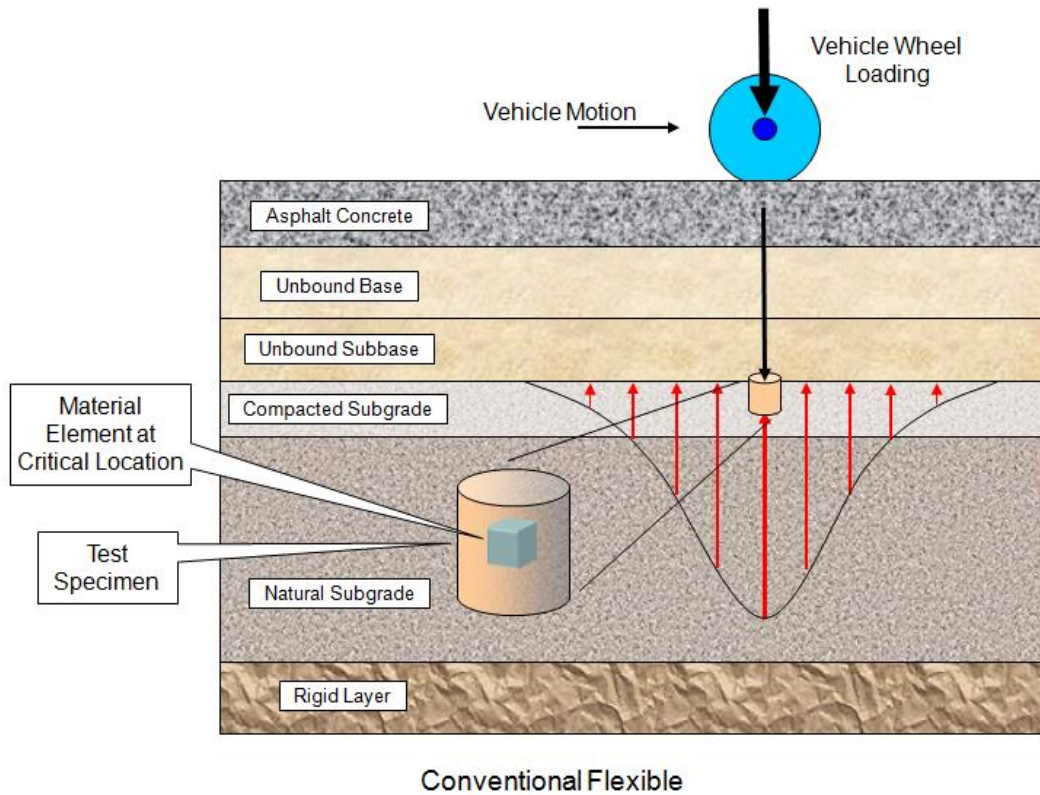
$$M_r = \sigma_d / \epsilon_r \quad \text{Eq. S.32}$$

Where:

$M_r$  = resilient modulus

$\sigma_d$  = repeated wheel load stress (deviator stress) = applied load/cross sectional area

$\epsilon_r$  = recoverable strain =  $\Delta L/L$  = recoverable deformation / gauge length



**Figure S.21 Subgrade Material Element at Critical Location**

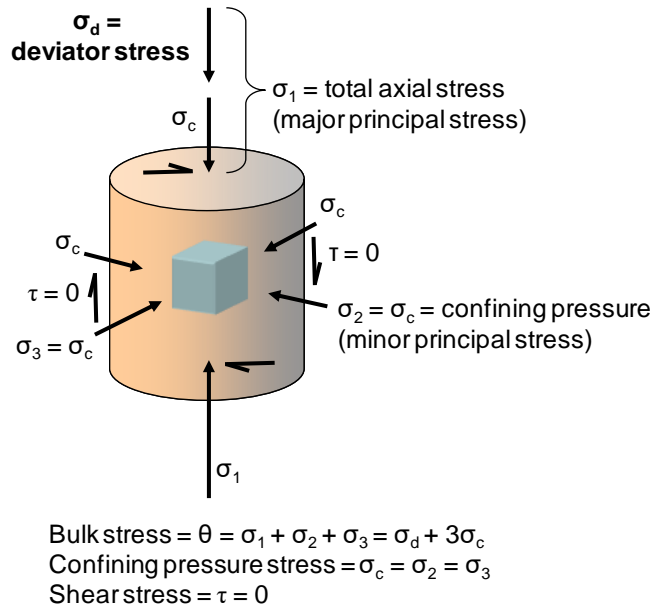
The test is similar to the standard triaxial compression test, except the vertical stress is cycled at several levels to model wheel load intensity and duration typically encountered in pavements under a moving load. The confining pressure is also varied and sequenced through in conjunction with the varied axial loading to specified axial stresses. The purpose of this test procedure is to determine the elastic modulus value (stress-sensitive modulus) and by recognizing certain nonlinear characteristics for subgrade soils, untreated base and subbases, and rigid foundation materials. The stress levels used are based on type of material within the pavement structure. The test specimen should be prepared to approximate the in-situ density and moisture condition at or after construction (5). The test is to be performed in accordance with the latest version of AASHTO T 307. **Figure S.24 Resilient Modulus Test Specimen Stress State** and **Figure S.25 Resilient Modulus Test Specimen Loading** are graphical representations of applied stresses and concept of cyclical deformation applied deviator loading.

Traditionally, the stress parameter used for sandy and gravelly materials, such as base courses, is the bulk stress.

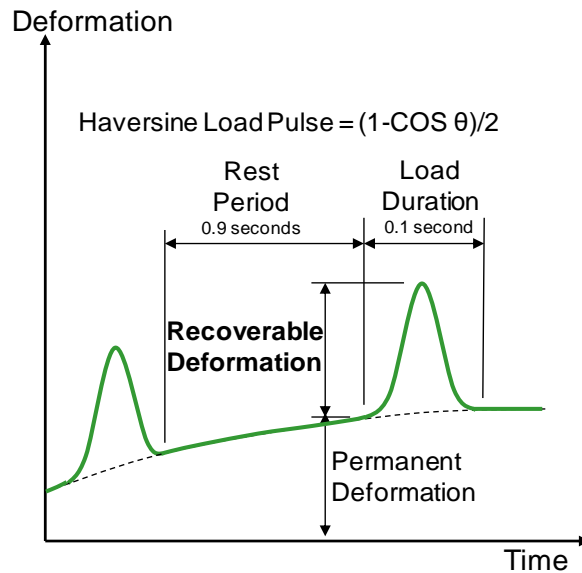
$$\theta = \sigma_1 + \sigma_2 + \sigma_3 \quad \text{Eq. S.33}$$

For cohesive subgrade materials, the deviatoric stress is used.

$$\sigma_d = \sigma_1 - \sigma_3 \quad \text{Eq. S.34}$$



**Figure S.22 Resilient Modulus Test Specimen Stress State**



**Figure S.23 Resilient Modulus Test Specimen Loading**

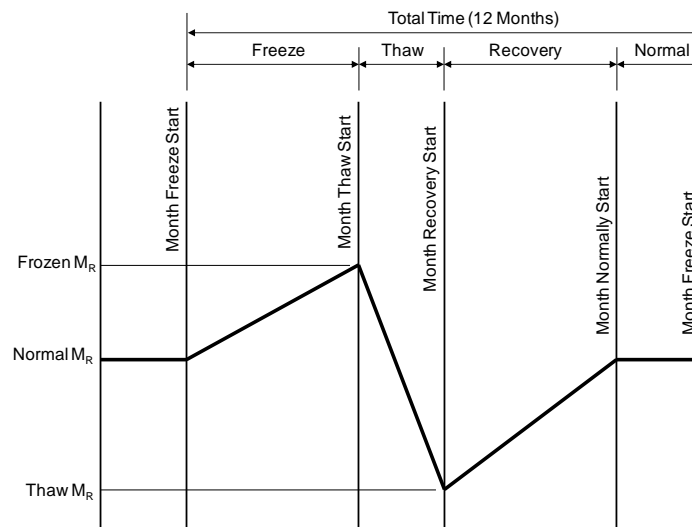
In recent years, the octahedral shear stress, which is a scalar invariant (it is essentially the root-mean-square deviatoric stress), has been used for cohesive materials instead of the deviatoric stress.

$$\tau_{oct} = 1/3 * \sqrt{[(\sigma_1 - \sigma_2)^2 + (\sigma_1 - \sigma_2)^2 + (\sigma_1 - \sigma_2)^2]} \quad \text{Eq. S.35}$$

The major material characteristics associated with unbound materials are related to the fact that moduli of these materials may be highly influenced by the stress state (non-linear) and in-situ moisture content. As a general rule, coarse-grained materials have higher moduli as the state of confining stress is increased. In contrast, clayey materials tend to have a reduction in modulus as the deviatoric or octahedral stress component is increased. Thus, while both categories of unbound materials are stress dependent (non-linear), each behaves in an opposite direction as stress states are increased (5).

### S.2.2 Field $M_R$ Testing

An alternate procedure to determine the  $M_R$  value is to obtain a field value. Determination of an in-situ value is to backcalculate the  $M_R$  from deflection basins measured on the pavement's surface. The most widely used deflection testing devices are impulse loading devices. CDOT uses the Falling Weight Deflectometer (FWD) as a Nondestructive Test (NDT) method to obtain deflection measurements. The FWD device measures the pavement surface deflection and deflection basin of the loaded pavement, making it possible to obtain the pavement's response to load and the resulting curvature under load. A backcalculation software program analyzes the pavements response from the FWD data. Unfortunately, layered elastic moduli backcalculated from deflection basins and laboratory measured resilient modulus are not equal for a variety of reasons. The more important reason is that the uniform confining pressures and repeated vertical stresses used in the laboratory do not really simulate the actual confinement and stress state variation that occurs in a pavement layer under the FWD test load or wheel loading (9). Additional information on NDT is provided in **APPENDIX C**.



**Figure S.24 Resilient Modulus Seasonal Variation**

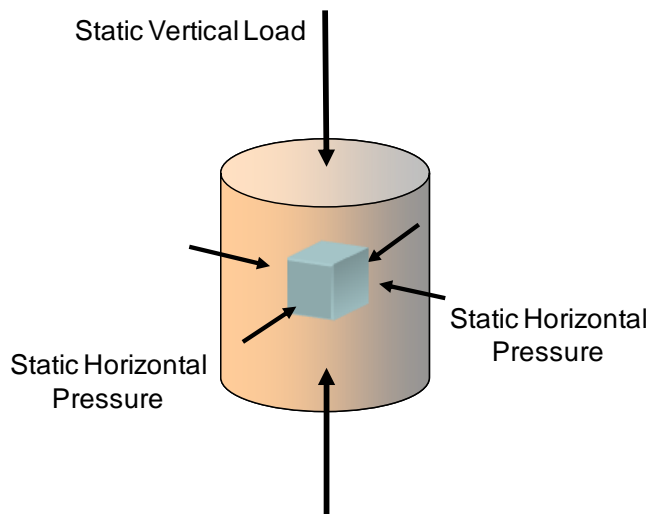


### S.3 Resistance Value (R-value)

The Resistance Value (R-value) test is a material stiffness test. The test procedure expresses a material's resistance to deformation as a function of the ratio of transmitted lateral pressure to applied vertical pressure. The R-value is calculated from the ratio of the applied vertical pressure to the developed lateral pressure and is essentially a measure of the material's resistance to plastic flow. Another way the R-value may be expressed is it is a parameter representing the resistance to the horizontal deformation of a soil under compression at a given density and moisture content. The R-value test, while being time and cost effective, does not have a sound theoretical base and it does not reflect the dynamic behavior and properties of soils. The R-value test is static in nature and irrespective of the dynamic load repetition under actual traffic.

CDOT uses Hveem stabilometer equipment to measure strength properties of soils and bases. This equipment yields an index value called the R-value. The R-value to be used is determined in accordance with Colorado Procedure - Laboratory 3102, Determination of Resistance Value at Equilibrium, a modification of AASHTO T 190, *Resistance Value and Expansion Pressure of Compacted Soils*.

The inability of the stabilometer R-value to realistically reflect the engineering properties of granular soils with less than 30 percent fines has contributed to its poor functional relationship to  $M_r$  in that range (7).



**Figure S.25 Resistance R-value Test Specimen Loading State**

A number of correlation equations have been developed. The Asphalt Institute (8) has related  $M_r$  to R-value repeated in the 1986 AASHTO Guide and expressed as follows (2)(5)(6):

$$M_r = A + B \times (\text{R-value})$$

**Eq. S.36**

Where:

$M_r$  = units of psi

A = a value between 772 and 1,155

B = a value between 396 and 555

CDOT uses the correlation combining two equations:

$$S_1 = [ (R-5) / 11.29 ] + 3 \quad \text{Eq. S.37}$$

$$M_r = 10^{[(S_1 + 18.72) / 6.24]} \quad \text{Eq. S.38}$$

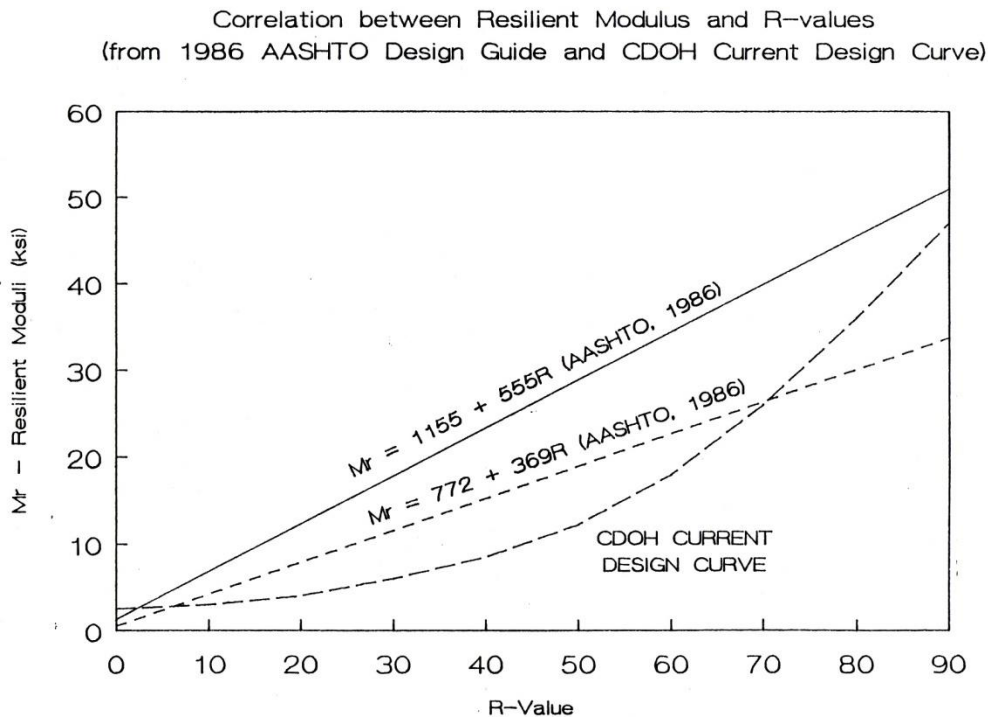
Where:

$M_r$  = resilient modulus, psi.

$S_1$  = soil support value

R = R-value obtained from the Hveem stabilometer

**Figure S.28 Correlation Plot Between Resilient Modulus and R-value** plots the correlations of roadbed soils. In the **Figure S.29 Correlation Plot Between Resilient Modulus and R-value**, the CDOH/CDOT current design curve and the referenced 1986 AASHTO equations were based on the AASHTO Test Method T 274 to determine the  $M_r$  value. The plot is to show the relative relationship of each equation to each other.

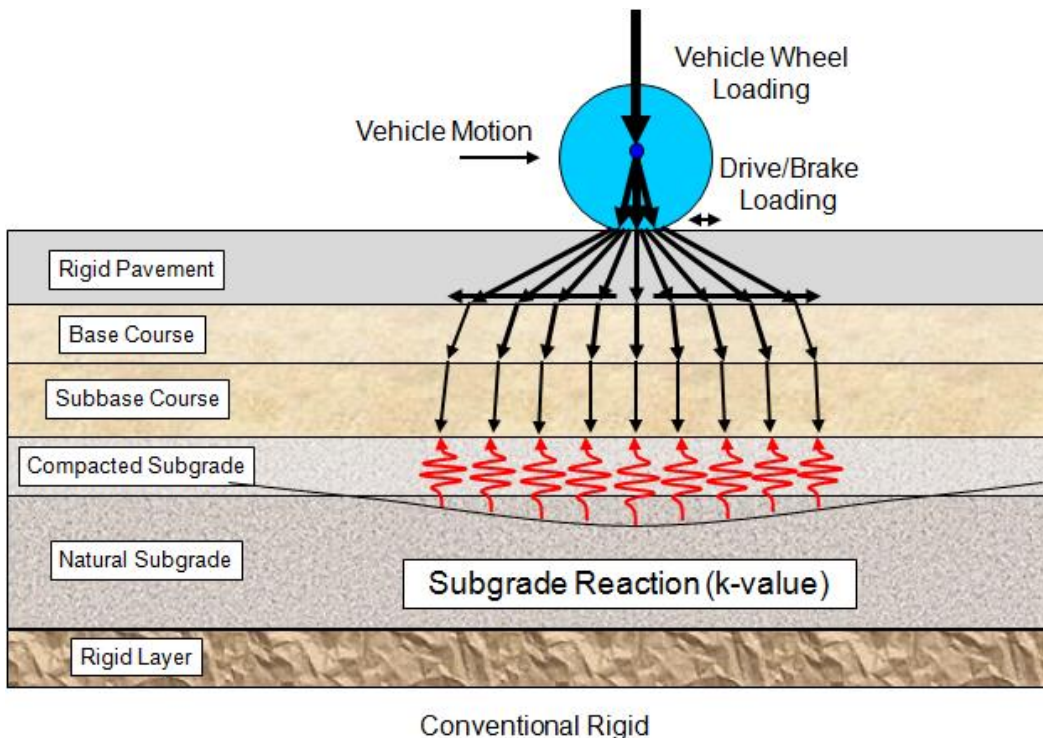


**Figure S.26 Correlation Plot between Resilient Modulus and R-value**  
(Resilient Properties of Colorado Soils, pg 15, Figure 2.10, 1989 (6))

**Table S.3 Comparisons of  $M_r$  Suggested NCHRP 1-40D and Colorado Soils with R-values** is a comparison of  $M_r$  values. The test procedure was in accordance to AASHTO 307, Type 2 Material with a loading sequence in accordance with SHRP TP 46, Type 2 Material. Additional testing of Colorado soils with 2 and 4 percent above optimum moisture were conducted to simulate greater moisture contents if the in-situ soils have an increase in moisture. Generally, the strengths decreased, but not always. Colorado soils exhibit a lower  $M_r$  than the recommended values from publication NCHRP 1-37A, Table 2.2.51.

### S.4 Modulus of Subgrade Reaction (k-value)

The k-value is used for the support of rigid pavements structures. The graphical representation (**Figure S.28 Distribution of Wheel Load to Subgrade Reaction (k-value)**) is the traditional way to explain the interaction of subgrade reaction to a moving wheel load. As the wheel load moves toward an area of concern, the subgrade reacts with a slightly larger reaction and when the wheel loading moves away the subgrade reaction it is less. That variable reaction is the engineering property k-value. As an historical note, in the 1920's, Westergaard's work led to the concept of the modulus of subgrade reaction (k-value). Like elastic modulus, the k-value of a subgrade is an elastic constant which defines the material's stiffness or resistance to deformation. The value k actually represents the stiffness of an elastic spring.



**Figure S.27 Distribution of Wheel Load to Subgrade Reaction (k-value)**

**Table S.3 Comparisons of M<sub>r</sub> Suggested NCHRP 1-40D and Colorado Soils with R-values**

Research Results Digest of NCHRP Project 1-40D (July 2006)				Soil Classification	Colorado Soils (Unpublished Data 7/12/2002)			
Flexible Subgrades		Rigid Subgrades			R-value	Optimum M <sub>r</sub>	2% Over Optimum M <sub>r</sub>	4% Over Optimum M <sub>r</sub>
Opt. M <sub>r</sub> (mean)	Opt. M <sub>r</sub> (std dev)	Opt. M <sub>r</sub> (mean)	Opt. M <sub>r</sub> (std dev)					
29,650	15,315	13,228	3,083	A-1-a	yt	-	-	-
26,646	12,953	14,760	8,817	A-1-b	32	10,181	9,235	-
21,344	13,206	14,002	5,730	A-2-4	50	7,842	5,161	3,917
					37	11,532	5,811	4,706
					40	10,750	7,588	7,591
					38	7,801	7,671	-
-	-	-	-	A-2-5	-	-	-	-
20,556	12,297	16,610	6,620	A-2-6	35	8,024	4,664	4,343
					19	7,600	5,271	5,009
					45	8,405	5,954	5,495
					42	8,162	7,262	-
					37	7,814	5,561	4800*
					24	7,932	5,846	5210*
					49	10,425	9,698	8196*
16,250	4,598	-	-	A-2-7	13	7,972	4,702	3,511
					18	7,790	5,427	4,003
					29	8,193	5,558	5,221
					9	11,704	8,825	7,990
24,697	11,903	-	-	A-3	-	-	-	-
16,429	12,296	17,763	8,889	A-4	19	6,413	5,233	4,736
16,429	12,296	17,763	8,889	A-4	23	10,060	6,069	5,729
					49	7,583	7,087	6,311
					44	11,218	6,795	5794*
-	-	-	-	A-5	-	-	-	-
14,508	9,106	14,109	5,935	A-6	21	7,463	3,428	2,665
14,508 13,004	9,106 13,065	14,109 7,984	5,935 3,132	A-6 A-7-5	8	5,481	3,434	2,732
					12	5,162	3,960	2,953
					14	4,608	3,200	2,964
					10	13,367	4,491	3,007
					19	6,638	3,842	3,456
					10	7,663	4,244	3,515
					15	5,636	3,839	3,551
					17	7,135	4,631	3,821
					21	6,858	5,488	4,010
					14	6,378	4,817	4,234
					8	5,778	5,243	4,934
					40	17,436	7,438	5,870
					27	7,381	5,491	-
					17	8,220	6,724	-
					26	11,229	9,406	5,238
11,666	7,868	13,218	322	A-7-6	6	4,256	2,730	1,785
11,666	7,868	13,218	322	A-7-6	8	4,012	2,283	1,909
					10	5,282	2,646	1,960
					11	4,848	3,159	2,157
					5	6,450	3,922	2,331
					6	5,009	2,846	2,410
					6	5,411	3,745	2,577
					11	4,909	3,340	2,795
					15	9,699	4,861	3,018
					16	6,842	4,984	3,216
					29	8,873	4,516	3,308
					14	4,211	3,799	3,380
					7	7,740	5,956	4,107
					23	8,154	6,233	4,734
					27	7,992	6,552	5,210

### S.4.1 Static Elastic k-value

The gross k-value was used in previous AASHTO pavement design guides. It not only represented the elastic deformation of the subgrade under a loading plate, but also substantial permanent deformation. The static elastic portion of the k-value is used as an input in the 1998 AASHTO Supplement guide. The k-value can be determined by field plate bearing tests (AASHTO T 221 or T 222) or correlation with other tests. There is no direct laboratory test procedure for determining k-value. The k-value is measured or estimated on top of the finished roadbed soil or embankment upon which the base course and concrete slab is constructed. The classical equation for gross k-value is shown in **Equation S.39**.

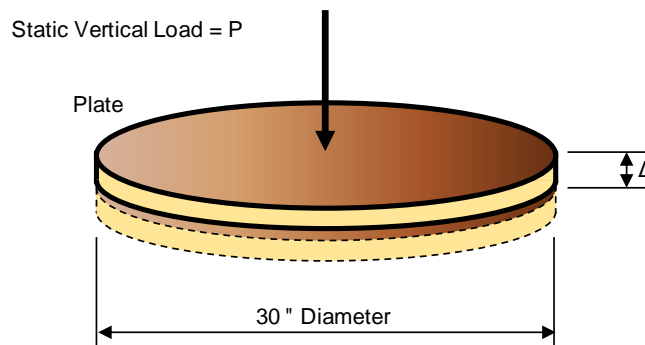
$$\mathbf{k\text{-value} = \rho / \Delta} \qquad \mathbf{Eq. S.39}$$

Where:

k-value = modulus of subgrade reaction (spring constant)

$\rho$  = applied pressure = area of 30" diameter plate

$\Delta$  = measured deflection



**Figure S.28 Field Plate Load Test for k-value**

### S.4.2 Dynamic k-value

In the *AASHTO Guide for Mechanistic-Empirical Design, A Manual of Practice*, the effective k-value used is the effective dynamic k-value (24). Dynamic means a quick force is applied, such as a falling weight not an oscillating force. CDOT obtains the dynamic k-value from the Falling Weight Deflectometer (FWD) testing with a backcalculation procedure. There is an approximate relationship between static and dynamic k-value. The dynamic k-value may be converted to the initial static value by dividing the mean dynamic k-value by two to estimate the mean static k-value. CDOT uses this conversion because it does not perform the static plate bearing test.

FWD testing is normally performed on an existing surface course. In the M-E Design Guide software the dynamic k-value is used as an input for rehabilitation projects only. The dynamic k-value is not used as an input for new construction or reconstruction. One k-value is entered as an input in the rehabilitation calculation. The one k-value is the arithmetic mean of like backcalculated values and is used as a foundation support value. The software also needs the

month the FWD is performed. The software uses an integrated climatic model to make seasonal adjustments to the support value. The software will backcalculate an effective single dynamic k-value for each month of the design analysis period for the existing unbound sublayers and subgrade soil. The effective dynamic k-value is essentially the compressibility of underlying layers (i.e., unbound base, subbase, and subgrade layers) upon which the upper bound layers and existing HMA or PCC layer is constructed. The entered k-value will remain as an effective dynamic k-value for that month throughout the analysis period, but the effective dynamic k-value for other months will vary according to moisture movement and frost depth in the pavement (24).

## S.5 Bedrock

**Table S.4 Poisson’s Ratio for Bedrock**

(Modified from Table 2.2.55 and Table 2.2.52, *Guide for Mechanistic-Empirical Design, Final Report*, NCHRP Project 1-37A, March 2004)

Material Description	$\mu$ (Range)	$\mu$ (Typical)
Solid, Massive, Continuous	0.10 to 0.25	0.15
Highly Fractured, Weathered	0.25 to 0.40	0.30
Rock Fill	0.10 to 0.40	0.25

**Table S.5 Elastic Modulus for Bedrock**

(Modified from Table 2.2.54, *Guide for Mechanistic-Empirical Design, Final Report*, NCHRP Project 1-37A, March 2004)

Material Description	E (Range)	E (Typical)
Solid, Massive, Continuous	750,000 to 2,000,000	1,000,000
Highly Fractured, Weathered	250,000 to 1,000,000	50,000
Rock Fill	Not available	Not available

## S.6 Unbound Subgrade, Granular, and Subbase Materials

**Table S.6 Poisson’s Ratios for Subgrade, Unbound Granular and Subbase Materials**  
(Modified from Table 2.2.52, *Guide for Mechanistic-Empirical Design, Final Report*, NCHRP Project 1-37A, March 2004)

Material Description	$\mu$ (Range)	$\mu$ (Typical)
Clay (saturated)	0.40 to 0.50	0.45
Clay (unsaturated)	0.10 to 0.30	0.20
Sandy Clay	0.20 to 0.30	0.25
Silt	0.30 to 0.35	0.325
Dense Sand	0.20 to 0.40	0.30
Course-Grained Sand	0.15	0.15
Fine-Grained Sand	0.25	0.25
Clean Gravel, Gravel-Sand Mixtures	0.354 to 0.365	0.36

**Table S.7 Coefficient of Lateral Pressure**  
(Modified from Table 2.2.53, *Guide for Mechanistic-Empirical Design, Final Report*, NCHRP Project 1-37A, March 2004)

Material Description	Angle of Internal Friction, $\phi$	Coefficient of Lateral Pressure, $k_0$
Clean Sound Bedrock	35	0.495
Clean Gravel, Gravel-Sand Mixtures, and Coarse Sand	29 to 31	0.548 to 0.575
Clean Fine to Medium Sand, Silty Medium to Coarse Sand, Silty or Clayey Gravel	24 to 29	0.575 to 0.645
Clean Fine Sand, Silty or Clayey Fine to Medium Sand	19 to 24	0.645 to 0.717
Fine Sandy Silt, Non-Plastic Silt	17 to 19	0.717 to 0.746
Very Stiff and Hard Residual Clay	22 to 26	0.617 to 0.673
Medium Stiff and Stiff Clay and Silty Clay	19 to 19	0.717

## S.7 Chemically Stabilized Subgrades and Bases

Critical locations in the layers have been defined for the M-E Design, refer to **Figure S.31 Critical Stress Locations for Stabilized Subgrade** and **Figure S.32 Critical Stress/Strain Locations for Stabilized Bases**. CDOT has historically used the empirical design methodology using structural coefficients of stabilized subgrade and base layers and assigned  $a_2$  for the structural coefficient.

Lightly stabilized materials for construction expediency are not included. They could be considered as unbound materials for design purposes (5).

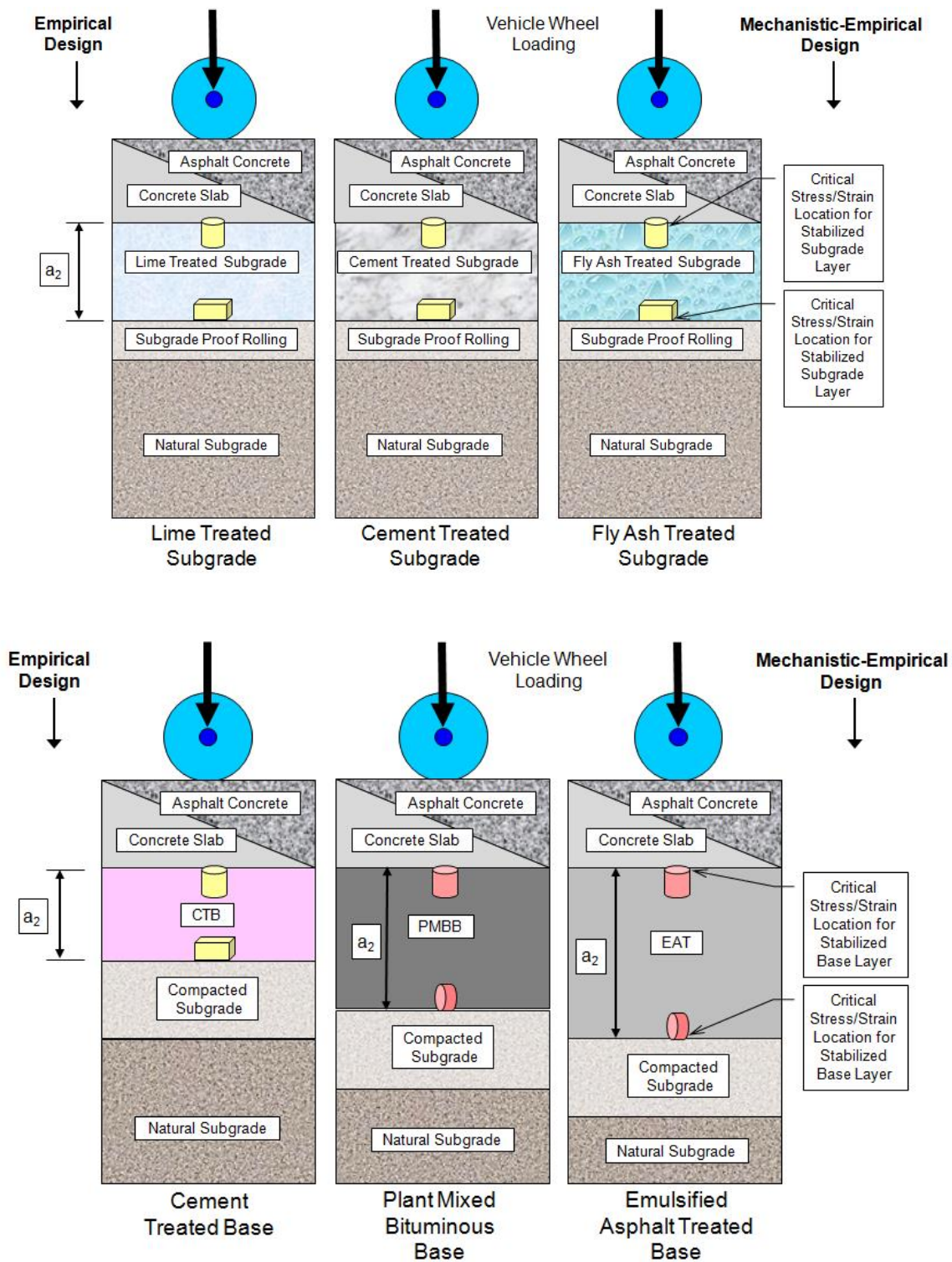


Figure S.29 Critical Stress Locations for Stabilized Subgrade



**Table S.8 Poisson’s Ratios for Chemically Stabilized Materials**

(Table 2.2.48, *Guide for Mechanistic-Empirical Design, Final Report*, NCHRP Project 1-37A, March 2004)

Chemically Stabilized Materials	Poisson's ratio, $\mu$
Cement Stabilized Aggregate (Lean Concrete, Cement Treated, and Permeable Base)	0.10 to 0.20
Soil Cement	0.15 to 0.35
Lime-Fly Ash Materials	0.10 to 0.15
Lime Stabilized Soil	0.15 to 0.20

**Table S.9 Poisson’s Ratios for Asphalt Treated Permeable Base**

(Table 2.2.16 and Table 2.2.17, *Guide for Mechanistic-Empirical Design, Final Report*, NCHRP Project 1-37A, March 2004)

Temperature, °F	$\mu$ (Range)	$\mu$ (Typical)
< 40 °F	0.30 to 0.40	0.35
40 °F to 100 °F	0.35 to 0.40	0.40
> 100 °F	0.40 to 0.48	0.45

**Table S.10 Poisson’s Ratios for Cold Mixed asphalt and Cold Mixed Recycled Asphalt Materials**

(Table 2.2.18 and Table 2.2.19, *Guide for Mechanistic-Empirical Design, Final Report*, NCHRP Project 1-37A, March 2004)

Temperature, °F	$\mu$ (Range)	$\mu$ (Typical)
< 40 °F	0.20 to 0.35	0.30
40 °F to 100 °F	0.30 to 0.45	0.35
> 100 °F	0.40 to 0.48	0.45

The critical location of vertical loads for stabilized subgrades are at the interface of the surface course and stabilized subgrade or top of the stabilized subgrade. The material stabilized subgrade element has the greatest loads at this location when the wheel loadings are directly above. Strength testing may be performed to determine compressive strength ( $f'_c$ ), unconfined compressive strength ( $q_u$ ), modulus of elasticity ( $E$ ), time-temperature dependent dynamic modulus ( $E^*$ ), and resilient modulus ( $M_r$ ).

The critical locations for flexural loading of stabilized subgrades are at the interface of the stabilized subgrade and non-stabilized subgrade or bottom of the stabilized subgrade. The material stabilized subgrade element has the greatest flexural loads at this location when the wheel loadings are directly above. Flexural testing may be performed to determine flexural strength ( $MR$ ).

### S.7.1 Top of Layer Properties for Stabilized Materials

Chemically stabilized materials are generally required to have a minimum compressive strength. Refer to **Table S.11 Minimum Unconfined Compressive Strengths for Stabilized Layers** for suggested minimum unconfined compressive strengths. 28-day values are used conservatively in design.

E, E\*, and M<sub>r</sub> testing should be conducted on stabilized materials containing the target stabilizer content, molded, and conditioned at optimum moisture and maximum density. Curing must also be as specified by the test protocol and reflect field conditions (5). **Table S.13 Typical M<sub>r</sub> Values for Deteriorated Stabilized Materials** presents deteriorated semi-rigid materials stabilized showing the deterioration or damage of applied traffic loads and frequency of loading. The table values are required for HMA pavement design only.

**Table S.11 Minimum Unconfined Compressive Strengths for Stabilized Layers**  
(Modified from Table 2.2.40, *Guide for Mechanistic-Empirical Design, Final Report*,  
NCHRP Project 1-37A, March 2004)

Stabilized Layer	Minimum Unconfined Compressive Strength, psi <sup>1, 2</sup>	
	Rigid Pavement	Flexible Pavement
Subgrade, Subbase, or Select Material	200	250
Base Course	500	750
Asphalt Treated Base	Not available	Not available
Plant Mix Bituminous Base	Not available	Not available
Cement Treated Base	Not available	Not available

**Note:**  
<sup>1</sup> Compressive strength determined at 7-days for cement stabilization and 28-days for lime and lime cement fly ash stabilization.  
<sup>2</sup> These values shown should be modified as needed for specific site conditions.

**Table S.12 Typical E, E\*, or M<sub>r</sub> Values for Stabilized Materials**  
(Modified from Table 2.2.43, *Guide for Mechanistic-Empirical Design, Final Report*,  
NCHRP Project 1-37A, March 2004)

Stabilized Material	E or M <sub>r</sub> (Range), psi	E or M <sub>r</sub> (Typical), psi
Soil Cement (E)	50,000 to 1,000,000	500,000
Cement Stabilized Aggregate (E)	700,000 to 1,500,000	1,000,000
Lean Concrete (E)	1,500,000 to 2,500,000	2,000,000
Lime Stabilized Soils (M <sub>r</sub> <sup>1</sup> )	30,000 to 60,000	45,000
Lime-Cement-Fly Ash (E)	500,000 to 2,000,000	1,500,000
Permeable Asphalt Stabilized Aggregate (E*)	Not available	Not available
Permeable Cement Stabilized Aggregate (E)	Not available	750,000
Cold Mixed Asphalt Materials (E*)	Not available	Not available
Hot Mixed Asphalt Materials (E*)	Not available	Not available

**Note:** <sup>1</sup> For reactive soils within 25% passing No. 200 sieve and PI of at least 10.

**Table S.13 Typical M<sub>r</sub> Values for Deteriorated Stabilized Materials**  
(Modified from Table 2.2.44, *Guide for Mechanistic-Empirical Design, Final Report*,  
NCHRP Project 1-37A, March 2004)

Stabilized Material	Typical Deteriorated M <sub>r</sub> (psi)
Soil Cement	25,000
Cement Stabilized Aggregate	100,000
Lean Concrete	300,000
Lime Stabilized Soils	15,000
Lime-Cement-Fly Ash	40,000
Permeable Asphalt Stabilized Aggregate	Not available
Permeable Cement Stabilized Aggregate	50,000
Cold Mixed Asphalt Materials	Not available
Hot Mixed Asphalt Materials	Not available

## S.7.2 Bottom of Layer Properties for Stabilized Materials

Flexural Strengths or Modulus of Rupture (M<sub>r</sub>) should be estimated from laboratory testing of beam specimens of stabilized materials. M<sub>r</sub> values may also be estimated from unconfined (q<sub>u</sub>) testing of cured stabilized material samples. **Table S.14 Typical Modulus of Rupture (M<sub>r</sub>) Values for Stabilized Materials** shows typical values. The table values are required for HMA pavement design only

**Table S.14 Typical Modulus of Rupture ( $M_r$ ) Values for Stabilized Materials**  
(Modified from Table 2.2.47, *Guide for Mechanistic-Empirical Design, Final Report*,  
NCHRP Project 1-37A, March 2004)

Stabilized Material	Typical Modulus of Rupture $M_r$ (psi)
Soil Cement	100
Cement Stabilized Aggregate	200
Lean Concrete	450
Lime Stabilized Soils	25
Lime-Cement-Fly Ash	150
Permeable Asphalt Stabilized Aggregate	None
Permeable Cement Stabilized Aggregate	200
Cold Mixed Asphalt Materials	None
Hot Mixed Asphalt Materials	Not available

Tensile strength for hot mix asphalt is determined by actual laboratory testing in accordance with CDOT CP-L 5109 or AASHTO T 322 at 14 °F. Creep compliance is the time dependent strain divided by the applied stress and is determined by actual laboratory testing in accordance with AASHTO T 332.

### S.7.3 Other Properties of Stabilized Layers

#### S.7.3.1 Coefficient of Thermal Expansion of Aggregates

Thermal expansion is the characteristic property of a material to expand when heated and contract when cooled. The coefficient of thermal expansion is the factor that quantifies the effective change one degree will have on the given volume of a material. The type of course aggregate exerts the most significant influence on the thermal expansion of portland cement concrete (3). National recommended values for the coefficient of thermal expansion in PCC are shown in **Table S.15 Recommended Values of PCC Coefficient of Thermal Expansion**.

**Table S.15 Recommended Values of PCC Coefficient of Thermal Expansion**  
(Table 2.10, *AASHTO Guide for Design of Pavement Structures*, 1993)

Type of Course Aggregate	Concrete Thermal Coefficient ( $10^{-6}$ inch/inch/°F)
Quartz	6.6
Sandstone	6.5
Gravel	6.0
Granite	5.3
Basalt	4.8
Limestone	3.8

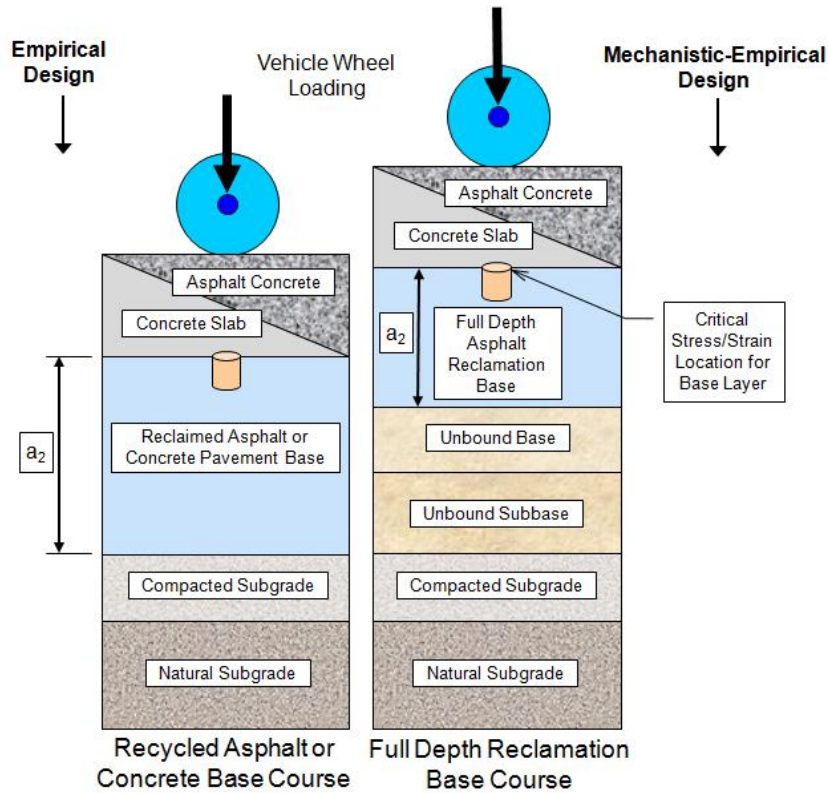
The Long-Term Pavement Performance (LTPP) database shows a coefficient of thermal expansion of siliceous gravels in Colorado. Siliceous gravels are a group of sedimentary "sand gravel" aggregates that consist largely of silicon dioxide (SiO<sub>2</sub>) makeup. Quartz a common mineral of the silicon dioxide, may be classified as such, and is a major constituent of most beach and river sands.

**Table S.16 Unbound Compacted Material Dry Thermal Conductivity and Heat Capacity**  
(Modified from Table 2.3.5, *Guide for Mechanistic-Empirical Design, Final Report*,  
NCHRP Project 1-37A, March 2004)

Material Property	Soil Type	Range of $\mu$	Typical $\mu$
Dry Thermal Conductivity, K (Btu/hr-ft-°F)	A-1-a	0.22 to 0.44	0.30
	A-1-b	0.22 to 0.44	0.27
	A-2-4	0.22 to 0.24	0.23
	A-2-5	0.22 to 0.24	0.23
	A-2-6	0.20 to 0.23	0.22
	A-2-7	0.16 to 0.23	0.20
	A-3	0.25 to 0.40	0.30
	A-4	0.17 to 0.23	0.22
	A-5	0.17 to 0.23	0.19
	A-6	0.16 to 0.22	0.18
	A-7-5	0.09 to 0.17	0.13
A-7-6	0.09 to 0.17	0.12	
Dry Heat Capacity, Q (Btu/lb-°F)	All soil types	0.17 to 0.20	Not available

**Table S.17 Chemically Stabilized Material Dry Thermal Conductivity and Heat Capacity**  
(Modified from Table 2.2.49, *Guide for Mechanistic-Empirical Design, Final Report*,  
NCHRP Project 1-37A, March 2004)

Material Property	Chemically Stabilized Material	Range of $\mu$	Typical $\mu$
Dry Thermal Conductivity, K (Btu/hr-ft-°F)	Lime	1.0 to 1.5	1.25
Dry Heat Capacity, Q (Btu/lb-°F)	Lime	0.2 to 0.4	0.28



**Figure S.30 Critical Stress Locations for Recycled Pavement Bases**

**Table S.18 Asphalt Concrete and PCC Dry Thermal Conductivity and Heat Capacity**  
(Modified from Table 2.2.21 and Table 2.2.39, *Guide for Mechanistic-Empirical Design*,  
Final Report, NCHRP Project 1-37A, March 2004)

Material Property	Chemically Stabilized Material	Range of $\mu$	Typical $\mu$
Dry Thermal Conductivity, K (Btu/hr-ft-°F)	Asphalt concrete	Not available	0.44 to 0.81
	PCC	1.0 to 1.5	1.25
Dry Heat Capacity, Q (Btu/lb-°F)	Asphalt concrete	Not available	0.22 to 0.40
	PCC	0.20 to 0.28	0.28

### S.7.3.2 Saturated Hydraulic Conductivity

Saturated Hydraulic Conductivity ( $k_{sat}$ ) is required to determine the transient moisture profiles in compacted unbound materials. Saturated hydraulic conductivity may be measured direct by using a permeability test AASHTO T 215.

## S.8 Reclaimed Asphalt and Recycled Concrete Base Layer

The critical location vertical loads for reclaimed asphalt or recycled concrete bases are at the interface of the surface course and top of the recycled pavement. The recycled pavement element has the greatest loads at this location when the wheel loadings are directly above. Strength testing may be performed to determine modulus of elasticity (E) and/or resilient modulus ( $M_r$ ). These bases are considered as unbound materials for design purposes. If the reclaimed asphalt base is stabilized and if an indirect tension ( $S_t$ ) test can be performed then these bases may be considered as bound layers.

**Table S.19 Cold Mixed Asphalt and Cold Mixed Recycled Asphalt Poisson's Ratios**

(Table 2.2.18 and Table 2.2.19, *Guide for Mechanistic-Empirical Design, Final Report*, NCHRP Project 1-37A, March 2004) [A Restatement of **Table S.10**]

Temperature (°F)	Range of $\mu$	Typical $\mu$
< 40	0.20 to 0.35	0.30
40 to 100	0.30 to 0.45	0.35
> 100	0.40 to 0.48	0.45

**Table S.20 Typical E, E\*, or  $M_r$  Values for stabilized Materials**

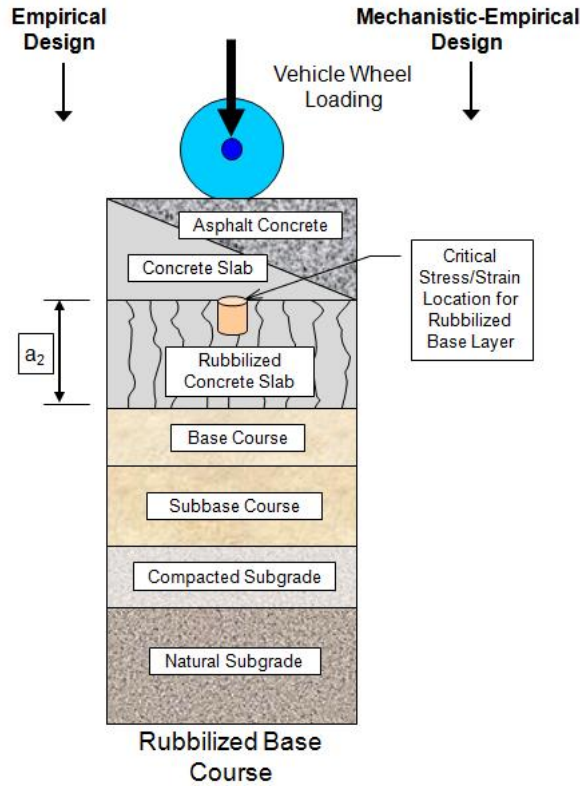
(Modified from Table 2.2.43., *Guide for Mechanistic-Empirical Design, Final Report*, NCHRP Project 1-37A, March 2004) [A restatement of **Table S.12**]

Stabilized Material	Range of E or $M_r$ (psi)	Typical E or $M_r$ (psi)
Soil Cement (E)	50,000 to 1,000,000	500,000
Cement Stabilized Aggregate (E)	700,000 to 1,500,000	1,000,000
Lean Concrete (E)	1,500,000 to 2,500,000	2,000,000
Lime Stabilized Soils ( $M_r$ <sup>1</sup> )	30,000 to 60,000	45,000
Lime-Cement-Fly Ash (E)	500,000 to 2,000,000	1,500,000
Permeable Asphalt Stabilized Aggregate (E*)	Not available	Not available
Permeable Cement Stabilized Aggregate E	Not available	750,000
Cold Mixed Asphalt Materials (E*)	Not available	Not available
Hot Mixed Asphalt Materials (E*)	Not available	Not available

**Note:** <sup>1</sup> For reactive soils within 25% passing No. 200 sieve and PI of at least 10.

## S.9 Fractured Rigid Pavement

Rubblization is a fracturing of existing rigid pavement to be used as a base. The rubblized concrete responds as a high-density granular layer.



**Figure S.31 Critical Stress Location for Rubblized Base**

**Table S.21 Poisson's Ratio for PCC Materials**

(Table 2.2.29, *Guide for Mechanistic-Empirical Design, Final Report.*, NCHRP Project 1-37A, Mar. 2004)

PCC Materials		Range of $\mu$	Typical $\mu$
PCC Slabs (newly constructed or existing)		0.15 to 0.25	0.20 (use 0.15 for CDOT)
Fractured Slab	Crack/seat	0.15 to 0.25	0.20
	Break/seat	0.15 to 0.25	0.20
	Rubblized	0.25 to 0.40	0.30



**Table S.22 Typical  $M_r$  Values for Fractured PCC Layers**  
(Table 2.2.28, *Guide for Mechanistic-Empirical Design, Final Rpt.*,  
NCHRP Project 1-37A, Mar. 2004)

Fractured PCC Layer Type	Ranges of $M_r$ (psi)
Crack and Seat or Break and Seat	300,000 to 1,000,000
Rubblized	50,000 to 150,000

## S.10 Pavement Deicers

### S.10.1 Magnesium Chloride

Magnesium Chloride ( $MgCl_2$ ) is a commonly used roadway anti-icing/deicing agent in conjunction with, or in place of salts and sands. The  $MgCl_2$  solution can be applied to traffic surfaces prior to precipitation and freezing temperatures in an anti-icing effort. The  $MgCl_2$  effectively decreases the freezing point of precipitation to about 16° F. If ice has already formed on a roadway,  $MgCl_2$  can aid in the deicing process.

Magnesium chloride is a proven deicer that has done a great deal for improving safe driving conditions during inclement weather, but many recent tests have shown the magnesium may have a negative impact on the life of concrete pavement. Iowa State University performed a series of experiments testing the effects of different deicers on concrete. They determined that the use of magnesium and/or calcium deicers may have unintended consequences in accelerating concrete deterioration (20).  $MgCl_2$  was mentioned to cause discoloration, random fracturing and crumbling (20).

In 1999, a study was performed to identify the environmental hazards of  $MgCl_2$ . This study concluded that it was highly unlikely the typical  $MgCl_2$  deicer would have any environmental impact greater than 20 yards from the roadway. It is even possible that  $MgCl_2$  may offer a positive net environmental impact if it limits the use of salts and sands. The study's critical finding was that any deicer must limit contaminants, as well as, the use of rust inhibiting additives like phosphorus (21).

The 1999 study led to additional environmental studies in 2001. One study concluded that  $MgCl_2$  could increase the salinity in nearby soil and water, which is more toxic to vegetation than fish (22). Another study identified certain 30%  $MgCl_2$  solutions deicers used in place of pure  $MgCl_2$  had far higher levels of phosphorus and ammonia. These contaminants are both far more hazardous to aquatic life than  $MgCl_2$  alone (23).

## References

1. *AASHTO Interim Guide for Design of Pavement Structures 1972*, published by American Association of State Highway and Transportation Officials, Washington, DC, 1972.
2. *AASHTO Guide for Design of Pavement Structures 1986*, American Association of State Highway and Transportation Officials, Washington, DC, 1986.
3. *AASHTO Guide for Design of Pavement Structures 1993*, American Association of State Highway and Transportation Officials, Washington, DC, 1993.
4. George, K.P., *Resilient Modulus Prediction Employing Soil Index Properties*, Final Report Number FHWA/MS-DOT-RD-04-172, Federal Highway Administration and Mississippi Department of Transportation, Research Division, P O Box 1850, Jackson MS 39215-1850, report conducted by the Department of Civil Engineering, The University of Mississippi, Nov 2004.
5. *Guide for Mechanistic-Empirical Design*, Final Report, NCHRP Project 1-37A, National Cooperative Highway Research Program, Transportation Research Board, National Research Council, Submitted by ARA, INC., ERES Consultants Division, Champaign, IL, March 2004.
6. Yeh, Shan-Tai, and Su, Cheng-Kuang, *Resilient Properties of Colorado Soils*, Final Report CDOH-DH-SM-89-9, Colorado Department of Highways, December 1989.
7. Chang, Nien-Yin, Chiang, Hsien-Hsiang, and Jiang, Lieu-Ching, *Resilient Modulus of Granular Soils with Fines Contents*, Final Research Report CDOT 91-379, Colorado Department of Transportation, May 1994.
8. *Research and Development of the Asphalt Institute's Thickness Design Manual, Ninth Edition*, Research Report No. 82-2, pg. 60-, The Asphalt Institute, 1982.
9. *Design Pamphlet for the Determination of Layered Elastic Moduli for Flexible Pavement Design in Support of the 1993 AASHTO Guide for the Design of Pavement Structures*, Final Report FHWA-RD-97-077, U.S. Department of Transportation, Federal Highway Administration, Research and Development, Turner-Fairbank Highway Research Center, 6300 Georgetown Pike, Mclean VA 22101-2296, September 1997.
10. *Standard Method of Test for Determining Dynamic Modulus of Hot-Mix Asphalt Concrete Mixtures*, AASHTO Designation: TP 62-03 (2005), American Association of State Highway and Transportation Officials, 444 North Capital Street, N.W., Suite 249, Washington, DC 20001, 25<sup>th</sup> Edition 2005.
11. *Review of the New Mechanistic-Empirical Pavement Design Guide - A Material Characterization Perspective*, Morched Zeghal, National Research Council Canada,

- Yassin E., Adam, Carleton University, Osman Ali, Carleton University, Elhussein H. Mohamed, National Research Council Canada, Paper prepared for presentation at the Investing in New Materials, Products and Processes Session of the 2005 Annual Conference of the Transportation Association of Canada, Calgary, Alberta.
12. *Changes to the Mechanistic-Empirical Pavement Design Guide Software Through Version 0.900, July 2006*, National Cooperative Highway Research Program (NCHRP).
  13. *Simple Performance Tests: Summary of Recommended Methods and Database*, NCHRP Report 547, Witczak, Matthew, Arizona State University, Transportation Research Board, Washington, D.C., 2005.
  14. *Development of a New Revised Version of the Witczak E\* Predictive Models for Hot Mix Asphalt Mixtures*, Final Report, Prepared for NCHRP, Witczak, Dr. M.W., Project Principal Investigator, Arizona State University, October 2005. This report is an Appendix to NCHRP Report 547 *Simple Performance Tests and Advanced Materials Characterization Models* for NCHRP Project 9-19 in DVD format designated as CRP-CD-46.
  15. *Use of the Dynamic Modulus (E\*) Test as a Simple Performance Test for Asphalt Pavement Systems (AC Permanent Deformation Distress) Volume I of IV*, Final Report, Prepared for NCHRP, Witczak, Dr. M.W., Project Principal Investigator, Arizona State University, October 2005. This report is an Appendix to NCHRP Report 547 *Simple Performance Tests and Advanced Materials Characterization Models* for NCHRP Project 9-19 in DVD format designated as CRP-CD-46.
  16. *Soil Mechanics & Foundations Lecture 3.1*, Prepared by Liu, Lanbo Referencing *Principles of Geotechnical Engineering 6<sup>th</sup> Edition*, London: Thomson Engineering. 2006
  17. *Atterberg Limits*, Wikipedia, 22 September 2007. 10 October 2007.  
<[http://en.wikipedia.org/wiki/Atterberg\\_limits](http://en.wikipedia.org/wiki/Atterberg_limits)>
  18. *Acids, Bases, and pH*, Carpi, Anthony 1998-1999, 24 Sept 2007.  
<<http://www.visionlearning.com/en/library/Chemistry/1/Acids-and-Bases/58>>
  19. *Dissociation of Water and the pH Scale*, University of British Columbia Department of Chemistry, 24 September 2007. <http://www.chem.ubc.ca/courseware/pH/>
  20. Cody, Robert D., Cody, Anita M., Spry, Paul G., Guo-Liang Gan, *Concrete Deterioration by Deicing Salts: An Experimental Study*, Iowa State University, Center for Transportation Research and Education, Ames, Iowa, May 1996.
  21. Lewis, William M., *Study of Environmental Effects of Magnesium Chloride Deicers in Colorado*, Report No. CDOT-DTD-R-99-10, Colorado Department of Transportation, November 1999.

22. Fischel, Marion, *Evaluation of Selected Deicers Base on A Review of the Literature*, Report No. CDOT-DTD-R-2001-15, Colorado Department of Transportation, October 2001.
23. Lewis, William M., *Evaluation and Comparison of Three Chemical Deicers for Use in Colorado*, Report No. CDOT-DTD-R-2001-17, Colorado Department of Transportation, August 2001.
24. AASHTO *Mechanistic-Empirical Pavement Design Guide, A Manual of Practice*, July 2008, Interim Edition, American Association of State Highway and Transportation Officials, 444 North Capitol St. NW, Suite 249, Washington, DC 20001.
25. *Supplement to the AASHTO Guide for Design of Pavement Structures, Part II, - Rigid Pavement Design & Rigid Pavement Joint Design*, American Association of State Highway and Transportation Officials, Washington, DC, 1998.
26. *Refining the Simple Performance Tester for Use in Routine Practice*, NCHRP Report 614, National Cooperative Highway Research Program, Transportation Research Board, Washington, DC, 2008.
27. *Standard Practice for Developing Dynamic Modulus Master Curves for Hot Mix Asphalt (HMA) Using the Asphalt Mixture Performance Tester (AMPT)*, AASHTO Designation: PP 61-09, American Association of State Highway and Transportation Officials, 444 North Capital Street, N.W., Suite 249, Washington, DC 20001.
28. *Standard Practice for Developing Dynamic Modulus Master Curves for Hot Mix Asphalt (HMA)* AASHTO Designation: PP 62-09, American Association of State Highway and Transportation Officials, 444 North Capital Street, N.W., Suite 249, Washington, DC 20001.
29. *AASHTO Mechanistic-Empirical Pavement Design Guide, A Manual of Practice, Interim Edition, July 2008*, American Association of State Highway and Transportation Officials, Washington, DC, 2008.