



COLORADO

Department of Transportation

2016 M-E Pavement Design Manual



INTRODUCTION

Purpose of Manual

The purpose of the Pavement Design Manual is to provide the Colorado Department of Transportation (CDOT) and consultant pavement designers with a uniform and detailed procedure for designing pavements on CDOT projects. This manual should be used after July 1, 2015.

Organization of the Manual

The manual is organized in a manner that affords the users with simple and methodical steps in the design of pavements for the Colorado state highway system. The contents are arranged carefully to provide users with sufficient flexibility in selecting and focusing on the appropriate topics and chapters that will suit their specific pavement design needs. There are four major pavement design categories presented in this manual. These categories include new construction/reconstruction, rehabilitation with overlays, rehabilitation without overlays, and intersection designs. Each category contains CDOT's current procedures utilized in the design of both flexible and rigid pavements. Also included are relevant and required input data provided in separate chapters on major topics including pavement design information, subgrade and base materials, pavement type selection and life cycle cost analysis, pavement justification report (PJR), and appendices. These chapters are provided to support and document the entire pavement design process. The Introduction Pavement Design Manual Organization Flow Chart depicts a general overview of how this manual is organized.

Importance of Pavement Design

CDOT spends more than 30 percent of its annual construction and maintenance budget on pavements. Therefore, pavements need to be properly designed using an analytical process with accurate design inputs. A pavement design needs to be performed during the early phase of project development. This step ensures that pavement design is used to estimate and establish the project cost rather than the project cost dictating the pavement design.

Training

This manual provides general and detailed information about pavement design processes and procedures applicable to various locations in the State of Colorado. Information on more comprehensive training courses entitled Pavement Design and Life Cycle Cost Analysis and other materials-related training classes is available through the CDOT Materials and Geotechnical Branch, Pavement Management and Design Program.

Approved Pavement Design Methods

The AASHTO mechanistic-empirical (M-E) design procedure using AASHTOWare Pavement M-E Design software (formerly DARWin-ME™) is the recommended method to determine pavement design thickness. The CDOT strongly recommends using the AASHTO Interim Mechanistic Empirical Pavement Design Guide (MEPDG) Manual of Practice along with latest CDOT Pavement Design Manual.

Coordinating Designs with Other Agencies

Other agencies should contact either the Region Materials Engineer (RME) or the Pavement Design Program Manager (PDPM) concerning CDOT and Region policies relating to pavement issues.

Data Collection

The data collected for new construction and rehabilitation projects are somewhat different. The pavement rehabilitation project will take the largest data collection effort. In many instances, it may be necessary to design for both pavement reconstruction and pavement rehabilitation. The final selection between the two will involve a study of costs, traffic handling, and other related items

Pavement Justification Report (PJR) and Other Documentation

A PJR is a formal engineering document that presents all analyses, data, and other considerations used to design a pavement. Guidelines for the information that needs to be included in a pavement design report are contained in this manual. For the special cases identified below that do not require a pavement design report, the documentation should include a brief description of the criteria, engineering considerations, and/or Region policy used in the decision process. For other reporting requirements, contact the RME for guidance. The PJR shall be sent to the CDOT Region Materials Engineer. A copy of the PJR on all surface treatment projects and all new or reconstruction projects with Hot Mix Asphalt (HMA) or Portland Cement Concrete Pavement (PCCP) material costs greater than \$2,000,000 will be sent to the PDPM. Access and local agency project PJR's will not be required to be submitted to the PDPM.

Projects Needing a Pavement Justification

HMA overlays less than 2 inches are considered a preventive maintenance treatment, and therefore a PJR report may not be required. Nevertheless, considering the significant investment that thin overlays represent, these treatments should be considered in an overall pavement preservation program. For design categories not covered above, contact the RME or the PDPM for guidance about recommended design procedures and documentation requirements.

Responsibility, Approval, and Signature Authority

Pavement design and documentation is primarily the responsibility of the engineer of record and must be reviewed and approved by the RME. In the event that the RME position is vacant, the pavement designs shall be forwarded to the CDOT Materials and Geotechnical Branch Manager. For the pavement design work done by a consultant, the PJR report shall be stamped, signed, and dated by the consultant and shall include his/her Professional Engineer's License number. The development of pavement design in CDOT is done in English units, which is the standard.

SUMMARY OF MANUAL REVISIONS

<u>SECTION</u>	<u>MAJOR REVISIONS</u>
Introduction Acronyms and Definitions	
Chapter 1	
Chapter 2	
Chapter 3	
Chapter 4	
Chapter 5	
Chapter 6	
Chapter 7	
Chapter 8	
Chapter 9	
Chapter 10	
Chapter 11	
Chapter 12	
Chapter 13	
Chapter 14	
Appendix A	
Appendix B	
Appendix C	
Appendix D	
Appendix E	
Appendix F	
Appendix G	
Appendix H	
Supplement	
Globe Update	

ACKNOWLEDGMENTS

The Materials and Geotechnical Branch of the Colorado Department of Transportation thanks the following individuals who contributed their expertise, knowledge, and time in the reviewing the CDOT Pavement Design Manual.

PAVEMENT DESIGN CONTRIBUTOR

Headquarters

Bill Schiebel
Materials and Geotechnical Branch Manager
4670 Holly Street, Unit A
Denver, CO 80216
(303)398-6501
Bill.Schiebel@state.co.us

Michael Stanford
Asphalt Program Manager
4670 Holly Street, Unit A
Denver, CO 80216
(303)398-6576
Michael.Stanford@state.co.us

Eric Prieve
Concrete and Physical Properties
Program Manager
4670 Holly Street, Unit A
Denver, CO 80216
(303)398-6542
Eric.Prieve@state.co.us

Ty Ortiz
Geohazards
4670 Holly Street, Unit A
Denver, CO 80216
(303)398-6601
Ty.Ortiz@state.co.us

David Thomas
Soils and Geotechnical
4670 Holly Street, Unit A
Denver, CO 80216
(303)398-6604
David.Thomas@state.co.us

Jay Goldbaum
Pavement Design Program Manager
4670 Holly Street, Unit A
Denver, CO 80216
(303)398-6561
Jay.Goldbaum@state.co.us

Melody Perkins
Pavement Design Engineer
4670 Holly Street, Unit A
Denver, CO 80216
(303)398-6562
Melody.Perkins@state.co.us

Special Assistance

Vacant
Research Engineer
4201 E. Arkansas Avenue
Shumate Building
Denver, CO 80222
(303)757-9975

Donna Harmelink
FHWA Pavements/Operations Engineer
12300 West Dakota Ave., Suite 180
Lakewood, Co 80228
(720)963-3021
Donna.Harmelink@dot.gov

Region 1

Jan Chang
Region Materials Engineer
4670 Holly Street, Unit B
Denver, CO 80216
(303)398-6801
James.Chang@state.co.us

Vacant
Region Materials Engineer
4670 Holly Street, Unit C
Denver, CO 80216
(303)398-6701
Masoud.Ghaeli@state.co.us

Shamshad Hussain
Assistant Region Materials Engineer
4670 Holly Street, Unit B
Denver, CO 80216
(303)398-6802
Shamshad.Hussain@state.co.us

Kevin Moore
Assistant Region Materials Engineer
4670 Holly Street, Unit B
Denver, CO 80216
(303)398-6803
Kevin.Moore@state.co.us

Bob Mero
Assistant Region Materials Engineer (6)
4670 Holly Street, Unit C
Denver, CO 80216
(303)398-6703
Bob.Mero@state.co.us

Laura Conroy
Assistant Region Materials Engineer (6)
4670 Holly Street, Unit C
Denver, CO 80216
(303)398-6801
Laura.Conroy@state.co.us

Region 2

Craig Wieden
Region Materials Engineer
905 Erie Ave.
Pueblo, CO 81001
(719)546-5438
Craig.Wieden@state.co.us

Jody Pieper
Assistant Region Materials Engineer
905 Erie Ave.
Pueblo, CO 81001
(719)562-5532
Jody.Pieper@state.co.us

Region 3

Jeremy J. Lucero
Region Materials Engineer
2328 G Road
Grand Jct. CO. 81505
(970)683-7562
Jeremy.Lucero@state.co.us

Coulter Golden
Assistant Region Materials Engineer
2328 G Road
Grand Jct. CO. 81505
(970)683-7561
Coulter.Golden@state.co.us

Region 4

Gary DeWitt
Region Materials Engineer
3971 W. Service Road
Evans, CO 80620
(970)350-2379
Gary.DeWitt@state.co.us

Rick Chapman
Assistant Region Materials Engineer
3971 W. Service Road
Evans, CO 80620
(970)350-2380
Rick.Chapman@state.co.us

Region 5

Tim Webb
Acting Region Materials Engineer
3803 N. Main Ave., Suite 200
Durango, CO 81301
(970)385-1625
Tim.Webb@state.co.us

TABLE OF CONTENTS

INTRODUCTION	1
SUMMARY OF MANUAL REVISIONS	3
ACKNOWLEDGMENTS	4
TABLE OF CONTENTS.....	6
LIST OF FIGURES	18
LIST OF TABLES.....	26
LIST OF EQUATIONS	30
ACRONYMS COMMON TO CDOT	34
DESIGN OF PAVEMENT STRUCTURES DEFINITIONS.....	38
Major Rehabilitation	46
Minor Rehabilitation.....	46
Pavement Maintenance	48
Reconstruction	50
MECHANISTIC-EMPIRICAL (M-E) PAVEMENT DESIGN BASIC DEFINITIONS.....	56
ESTIMATING FORMULAS, CALCULATIONS, AND CONVERSION FACTORS	59
CHAPTER 1	61
INTRODUCTION	61
1.1 Introduction.....	61
1.2 Scope and Limitations.....	61
1.2.1 Limitations	61
1.2.2 Scope.....	62
1.3 Overview of AASHTO Pavement Mechanistic-Empirical Design Procedure	62
1.4 Overview of AASHTOWare Pavement M-E Design Software.....	64
1.4.1 Installing M-E Design Software	64
1.4.2 Uninstalling M-E Design Software.....	64
1.4.3 Running M-E Design Software.....	66
1.5 Working with M-E Design Database.....	70
1.5.1 Saving to M-E Design Database	72
1.5.2 Retrieving or Importing from M-E Design Database	78
References.....	83
CHAPTER 2	85
PAVEMENT DESIGN INFORMATION	85
2.1 Introduction.....	85
2.2 Site and Project Identification.....	85
2.3 Project Files/Records Collection and Review.....	85
2.3.1 Project Data Collection	85
2.3.2 Field Survey	85
2.3.3 Initial Selection	85
2.3.4 Physical Testing	85
2.3.5 Evaluation and selection	85
2.3.6 Historic M-E Design Software Files.....	86
2.3.7 Records Review	86
2.4 Site Investigation	87
2.4.1 Abutting Land Usage	87

2.4.2	Existing/Proposed Project Geometrics	87
2.4.3	Geotechnical Investigations	87
2.4.4	Condition Survey	88
2.4.5	Drainage Characteristics	88
2.5	Construction and Maintenance Experience	89
2.6	Pavement Management System (PMS) Condition Data.....	89
2.7	Design Performance Criteria and Reliability (Risk).....	91
2.8	Defining Input Hierarchy	100
2.9	Drainage.....	101
2.9.1	Subdrainage Design	102
	References.....	103
	CHAPTER 3	108
	TRAFFIC AND CLIMATE.....	105
3.1	Traffic	105
3.1.1	CDOT Traffic Data.....	106
3.1.2	Traffic Inputs Hierarchy	107
3.1.3	Volume Counts	108
3.1.4	Lane and Directional Distributions.....	109
3.1.5	Growth Factors for Trucks.....	110
3.1.6	Vehicle Classification	111
3.1.6.1	Level 1 Vehicle Class Inputs	115
3.1.6.2	Level 2 Vehicle Class Inputs	115
3.1.6.3	Level 3 Vehicle Class Inputs	115
3.1.7	Number of Axles per Truck	118
3.1.7.1	Level 1 Number of Axles Per Truck.....	118
3.1.7.2	Level 2 Number of Axles Per Truck.....	118
3.1.7.3	Level 3 Number of Axles Per Truck.....	118
3.1.8	Monthly Adjustment Factors (trucks).....	119
3.1.8.1	Level 1 Monthly Adjustment Factors	119
3.1.8.2	Level 2 Monthly Adjustment Factors	119
3.1.8.3	Level 3 Monthly Adjustment Factors	119
3.1.9	Hourly Distribution Factors (trucks).....	121
3.1.9.1	Level 1 Hourly Distribution Factors	121
3.1.9.2	Level 2 Hourly Distribution Factors	121
3.1.9.3	Level 3 Hourly Distribution Factors	121
3.1.10	Axle Load Distribution	122
3.1.10.1	Level 1 Axle Load Distribution Factors	122
3.1.10.2	Level 2 Axle Load Distribution Factors	123
3.1.10.3	Level 3 Axle Load Distribution Factors	123
3.1.11	Vehicle Operational Speed (trucks)	129
3.1.12	Lateral Wander of Axle Loads.....	129
3.1.13	Axle Configuration and Wheelbase	130
3.1.14	Tire Pressure	132
3.1.15	Traffic Files in Electronic Format for the M-E Design Software.....	132
3.2	Climate.....	132
3.1.16	Creating Project-Specific Climate Input Files	132

References.....	143
CHAPTER 4	144
SUBGRADE.....	144
4.1 Introduction.....	144
4.2 Soil Survey Investigation.....	144
4.3 Subgrade and Embankment	146
4.4 Subgrade Characterization for the M-E Design.....	147
4.4.1 General Characterization	147
4.4.2 Modeling Subgrade Layers in M-E Design Software.....	154
4.4.3 Recommended Inputs for Subgrade/Embankment Materials	155
4.4.3.1 Inputs for New HMA and JPCP.....	155
4.4.3.2 Inputs for HMA Overlay of Existing Flexible Pavements.....	158
4.4.3.3 Inputs for Overlays of Existing Rigid Pavements.....	159
4.5 Rigid Layer	163
4.6 Rock Fill.....	164
4.7 Frost Susceptible Soils.....	164
4.8 Sulfate Subgrade Soils	170
4.9 Expansive Subgrade Soils.....	171
4.10 Stabilizing Agents.....	175
4.10.1 Lime Treated Subgrade.....	176
4.10.2 Cement Treated Subgrade.....	178
4.10.3 Fly Ash and Lime/Fly Ash Treated Subgrade	179
4.11 Geosynthetic Fabrics and Mats.....	179
4.11.1 Introduction.....	179
4.11.2 Separator Layer.....	181
4.12 Material Sampling and Testing.....	182
References.....	183
CHAPTER 5	186
GRANULAR AND TREATED BASE MATERIALS	186
5.1 Bases	186
5.2 Sampling Base Materials During Soil Survey Investigation	186
5.3 Aggregate Base Course (ABC).....	186
5.3.1 Unbound Layer Characterization in the M-E Design	189
5.3.2 Modeling Unbound Aggregate Base Layers in M-E Design Software.....	192
5.4 Treated Base Course	193
5.4.1 Characterization of Treated Base in the M-E Design	194
5.4.2 Modeling Treated Base in the M-E Design	197
5.5 Permeable Bases	198
5.6 Reclaimed Asphalt and Concrete Pavement	199
5.6.1 Reclaimed Asphalt Pavement Base	200
5.6.1.1 Reclaimed Asphalt Pavement (RAP) Base.....	200
5.6.1.2 Full Depth Asphalt Reclaimed Base (FDR).....	201
5.6.2 Reclaimed Concrete Pavement Base (RCP)	202
5.7 Base Layer Made of Rubblized Rigid Pavement.....	202
5.8 Material Sampling and Testing.....	203
References.....	204

CHAPTER 6	207
PRINCIPLES OF DESIGN FOR FLEXIBLE PAVEMENT	207
6.1 Introduction.....	207
6.2 M-E Design Methodology for Flexible Pavement.....	207
6.3 Select Trial Design Strategy	208
6.3.1 Flexible Pavement Design Types.....	208
6.3.2 Concept of Perpetual Pavements	210
6.3.3 Establish Trial Design Structure	211
6.4 Select the Appropriate Performance Indicator Criteria for the Project.....	212
6.5 Select the Appropriate Reliability Level for the Project.....	216
6.6 Assemble the M-E Design Software Inputs.....	216
6.6.1 General Information.....	216
6.6.1.1 Design Period.....	216
6.6.1.2 Construction Dates and Timeline.....	216
6.6.1.3 Identifiers	216
6.6.2 Traffic	217
6.6.3 Climate.....	217
6.6.4 Pavement Layer Characterization	217
6.6.4.1 Asphalt Concrete Characterization	217
6.6.4.2 Unbound Layers and Subgrade Characterization	219
6.7 Run the M-E Design Software.....	219
6.8 Evaluate the Adequacy of the Trial Design	221
6.9 Modifying Trial Designs.....	222
6.10 HMA Thickness with ABC.....	235
6.11 Required Minimum Thickness of Pavement Layer	235
6.12 Asphalt Materials Selection	236
6.12.1 Aggregate Gradation.....	236
6.12.2 Selection of SuperPave™ Gyratory Design.....	238
6.12.3 Binder Selection.....	240
6.12.4 Example 1	243
6.12.5 Asphalt Binder Characterization for M-E Design	250
6.13 Asphalt Mix Design Criteria.....	251
6.13.1 Fractured Face Criteria	251
6.13.2 Air Void Criteria.....	252
6.13.3 Criteria for Stability	253
6.13.4 Moisture Damage Criteria.....	253
6.14 Effective Binder Content (by volume).....	253
6.15 Rumble Strips.....	254
References.....	255
CHAPTER 7	256
PRINCIPLES OF DESIGN FOR RIGID PAVEMENT.....	256
7.1 Introduction.....	256
7.2 M-E Design Methodology for Rigid Pavement	256
7.3 Select Trial Design Strategy	257
7.3.1 Rigid Pavement Layers.....	257
7.3.2 Establish Trial Design Structure	258

7.4	Select the Appropriate Performance Indicator Criteria for the Project.....	259
7.5	Select the Appropriate Reliability Level for the Project.....	260
7.6	Assemble the M-E Design Software Inputs.....	260
7.6.1	General Information.....	260
7.6.1.1	Design Period.....	260
7.6.1.2	Project Timeline.....	261
7.6.1.3	Identifiers	261
7.6.2	Traffic	261
7.6.3	Climate.....	261
7.6.4	Pavement Layer Characterization.....	261
7.6.4.1	Portland Cement Concrete	261
7.6.4.2	Asphalt Treated Base Characterization.....	264
7.6.4.3	Chemically Stabilized Base Characterization.....	264
7.6.4.4	Unbound Material Layers and Subgrade Characterization.....	264
7.6.5	JPCP Design Features	264
7.7	Run the M-E Design Software.....	265
7.8	Evaluate the Adequacy of the Trial Design	266
7.9	Modifying Trial Designs.....	267
7.10	Joint Spacing (L).....	275
7.11	Slab/Base Friction.....	275
7.12	Effective Temperature Differential (°F)	276
7.13	Dowel Bars (Load Transfer Devices) and Tie Bars.....	277
7.14	Lane Edge Support Condition (E).....	279
7.15	Base Erodibility	279
7.16	Sealant Type.....	280
7.17	Concrete Pavement Minimum Thickness	281
7.18	Concrete Pavement Texturing, Stationing, and Rumble Strips	281
7.19	Concrete Pavement Materials Selection	281
7.19.1	Understanding pH in Concrete Mixes.....	282
7.19.2	Alkali Aggregate Reactivity	282
7.19.3	Sulfate Resistant Concrete Pavement	283
	References.....	286
	CHAPTER 8	289
	PRINCIPLES OF DESIGN FOR PAVEMENT REHABILITATION WITH FLEXIBLE OVERLAYS	289
8.1	Introduction.....	289
8.1.1	Structural Versus Functional Overlays	290
8.1.2	Guidelines	290
8.2	Determine Existing Pavement Condition.....	291
8.2.1	Records Review	291
8.2.2	Field Evaluation	292
8.2.3	Visual Distress	292
8.2.4	Drainage Survey.....	292
8.2.5	Non-Destructive Testing, Coring and Material Testing Program.....	293
8.3	Determine Cause and Mechanism of Distress	295
8.4	Define Problems and Inadequacies of Existing Pavement	295

8.5	Identify Possible Constraints	297
8.6	Select Feasible Strategy for Flexible Pavement Rehabilitation Trial Designs	297
8.6.1	Feasible AC Overlay Alternatives	297
8.6.2	Structural HMA Overlays	300
8.7	Proper Pre-Overlay Treatments and Other Design Considerations	300
8.7.1	Distress Types that Require Pre-Overlay Treatments.....	300
8.7.2	Pre-Overlay Treatments and Additional Considerations	301
8.7.3	Recycling the Existing Pavement	302
8.7.3.1	Cold Planing or Milling	302
8.7.3.2	Types of Hot In-Place Recycling.....	304
8.7.3.2.1	Surface Recycling (Heating and Scarifying Treatment)	304
8.7.3.2.2	Remixing (Heating and Remixing Treatment).....	305
8.7.3.2.3	Repaving (Heating and Repaving Treatment).....	306
8.7.3.3	Selecting the Appropriate Hot In-Place Recycling Process.....	307
8.7.4	Reflection Crack Control	308
8.7.5	Pavement Widening.....	309
8.7.6	Preventive Maintenance.....	309
8.8	Conventional Overlay	310
8.9	Existing Portland Cement Concrete Slab.....	310
8.9.1	Flexible Overlay On Rigid Pavement	310
8.10	Overlay Using Micro-Surfacing	311
8.11	Full Depth Reclamation (FDR).....	312
8.12	Rubblization and Flexible Pavement Overlay	312
8.13	Stone Matrix Asphalt Project and Material Selection Guidelines	312
8.13.1	Recommended Minimum Thickness Layers	313
8.14	Characterizing Existing Pavement Condition for AC Overlay Design	314
8.15	Low Volume Road Rehabilitation	315
8.15.1	General Information.....	315
8.15.2	Rehabilitation Techniques	317
8.16	Assemble the M-E Design Software Inputs.....	322
8.16.1	General Information.....	322
8.16.1.1	Design Period.....	322
8.16.1.2	Construction Dates and Timeline.....	322
8.16.1.3	Identifiers	322
8.16.2	Traffic	322
8.16.3	Climate.....	322
8.16.4	Pavement Layer Characterization.....	322
8.16.4.1	Characterization of HMA Overlay Layer	323
8.16.4.2	Characterization of Existing HMA Layer.....	323
8.16.4.3	Characterization of Existing PCC Layer (intact)	324
8.16.4.4	Characterization of Existing PCC Layer (fractured)	325
8.16.4.5	Characterization of Unbound Base Layers and Subgrade	327
8.16.4.6	Characterization of Treated Bases	327
8.17	Run the M-E Design Software.....	327
8.18	Evaluate the Adequacy of the Trial Design	331
8.19	Modifying Trial Designs.....	331

References.....	333
CHAPTER 9	334
PRINCIPLES OF DESIGN FOR PAVEMENT REHABILITATION WITH RIGID OVERLAY	
.....	334
9.1 M-E Introduction	334
9.1.1 CDOT Required Procedure for Rigid Overlays.....	335
9.2 Determine Existing Pavement Condition.....	336
9.2.1 Records Review	336
9.2.2 Field Evaluation	336
9.2.3 Visual Distress	336
9.2.4 Non-Destructive Testing.....	338
9.2.5 Coring and Material Testing Program	340
9.2.6 Lane Condition Uniformity.....	340
9.3 Determine Cause and Mechanism of Distress	340
9.4 Define Problems and Inadequacies of Existing Pavement	341
9.5 Identify Possible Constraints	343
9.6 Selecting a Feasible Strategy for Rigid Pavement Rehabilitation Trial Designs.....	343
9.6.1 Bonded Concrete Overlays	343
9.6.1.1 PCC over PCC	343
9.6.1.2 PCC over HMA.....	343
9.6.2 Feasible of Alternatives for Bonded Concrete Overlays	344
References.....	356
CHAPTER 10	357
REHABILITATION OF PORTLAND CEMENT CONCRETE PAVEMENT	357
10.1 Introduction.....	357
10.2 Scope and Limitations.....	357
10.3 Colorado Documented Design Methods.....	358
10.4 Project Information	362
10.5 Pavement Evaluation	363
10.5.1 Functional and Structural Condition.....	363
10.5.1.1 Structural Condition.....	364
10.5.1.2 Functional Condition	364
10.5.1.3 Problem Classifications between Structural and Functional Condition	365
10.5.2 Material Condition and Properties	365
10.5.2.1 Non-destructive Testing.....	365
10.5.2.2 Destructive Testing	367
10.5.3 Drainage Condition.....	370
10.5.4 Lane Condition Uniformity.....	370
10.6 Pavement Rehabilitation Techniques.....	370
10.6.1 Diamond Grinding	372
10.6.2 Concrete Crack Sealing.....	375
10.6.3 Concrete Joint Resealing.....	377
10.6.4 Partial Depth Repair.....	379
10.6.5 Full Depth Concrete Pavement Repair	380
10.6.6 Dowel Bar Retrofit.....	384
10.6.7 Cross Stitching.....	386

10.6.8	Slab Stabilization and Slabjacking.....	388
10.7	Selecting the Appropriate Pavement Rehabilitation Techniques.....	390
	References.....	392
CHAPTER 11	397
PRINCIPLES OF DESIGN FOR FLEXIBLE PAVEMENT INTERSECTIONS.....		397
11.1	Introduction.....	397
11.2	Design Considerations	397
11.3	Design Period.....	398
11.4	Traffic Analysis	398
11.5	Design Methodology.....	398
11.6	Assessing Problems with Existing Intersections.....	398
11.7	Performance Characteristics of Existing Intersections	399
11.8	Utilities.....	401
CHAPTER 12	402
PRINCIPLES OF DESIGN FOR RIGID PAVEMENT INTERSECTIONS.....		402
12.1	Introduction.....	402
12.2	Design Considerations	402
12.3	Design Period.....	402
12.4	Traffic Analysis	402
12.5	Design Methodology.....	403
12.6	Rigid Pavement Joint Design for Intersections.....	403
12.7	Assessing Problems with Existing Intersections.....	410
12.8	Detail for Abutting Asphalt and Concrete	410
12.9	Roundabout Pavement Design.....	411
12.9.1	Roundabout Geometry.....	412
12.9.1.1	Minimum Radius	412
12.9.1.2	Inscribed Circle Diameter.....	412
12.9.1.3	Circulatory Roadway Width.....	413
12.9.1.4	Central Island.....	413
12.9.2	General Joint Layout.....	413
12.9.3	Details of PCCP Joints.....	416
12.9.4	Typical Section	417
	References.....	418
CHAPTER 13	419
PAVEMENT TYPE SELECTION AND LIFE CYCLE COST ANALYSIS.....		419
13.1	Introduction.....	419
13.2	Implementation of a LCCA	420
13.2.1	Analysis Period	421
13.2.2	Performance Life	421
13.2.3	Rehabilitation Selection Process.....	421
13.3	Examples of the Rehabilitation Selection Process.....	423
13.3.1	Core Data Matches Historical Data	423
13.3.2	No Core Data and No Historical Data	423
13.3.3	Portland Cement Concrete Pavement	424
13.3.4	Restoration, Rehabilitation and Resurfacing Treatments	425
13.4	Discount Rate.....	425

13.5	Life Cycle Cost Factors	427
13.5.1	Initial Construction Costs	427
13.5.1.1	Asphalt Cement Adjustment	428
13.5.2	Maintenance Cost.....	428
13.5.3	Design Costs	429
13.5.4	Pavement Construction Engineering Costs.....	429
13.5.5	Traffic Control Costs	430
13.5.6	Serviceable Life	430
13.5.7	User Costs	430
13.5.7.1	User Cost Program.....	430
13.6	Probabilistic Life Cycle Cost Analysis	443
13.7	FHWA RealCost Software.....	443
13.7.7	RealCost Switchboard.....	444
13.7.8	Real world example using the RealCost software	445
13.7.9	Project Details Options	446
13.7.10	Analysis Options.....	447
13.7.11	Traffic Data Options	449
13.7.12	Value of User Time.....	452
13.7.13	Traffic Hourly Distribution.....	453
13.7.14	Added Time and Vehicle Costs Options.....	454
13.7.15	Saving and Opening Project-Level Inputs	456
13.7.16	Alternative-Level Data Input Forms	483
13.7.17	Executing the Simulation.....	487
13.7.18	Analyzing Probabilistic Results.....	488
13.7.19	Analyzing Probabilistic Agency Costs	489
13.7.20	Analyzing Probabilistic User Cost.....	490
13.8	Comparing Probabilistic Results	491
13.9	Pavement Type Selection Committee (PTSC).....	493
13.9.7	Purpose.....	493
13.9.8	Scope.....	493
13.9.9	Membership	494
13.9.10	Roles of Membership.....	494
13.9.11	Process	494
	References.....	496
	CHAPTER 14.....	497
	PAVEMENT JUSTIFICATION REPORTS	497
14.1	Introduction.....	497
14.2	Pavement Justification Report (PJR)	497
14.2.1	General Information in a PJR	497
14.2.2	Site Conditions.....	498
14.2.3	Subgrade Materials	498
14.2.4	Design Traffic	498
14.2.5	Pavement Materials Characteristics	498
14.2.6	Pavement Design and Selection Process.....	498
14.3	Guidelines for Data on Plan Sheets	499
	APPENDIX A.....	500

PROCEDURES FOR FORENSIC STUDY OF DISTRESS OF HOT MIX ASPHALT AND PORTLAND CEMENT CONCRETE.....	500
A.1 Introduction.....	500
A.2 Formation of an Evaluation Team	500
A.3 Levels of Investigation.....	500
A.3.1 Level I (CDOT Region)	500
A.3.2 Level II (CDOT Statewide)	501
A.3.3 Level III (National Effort)	501
A.4 Site Investigation	502
A.4.1 Visual Analysis	502
A.4.2 Review of Construction Documents	505
A.4.3 Investigational Requirements.....	505
A.4.4 Required Core Samples and Testing.....	505
A.4.4.1 Core Samples from Hot Mix Asphalt and PCCP.....	505
A.4.4.2 Base and Subgrade Samples	506
A.5 Final Report	506
A.6 Funding Sources.....	507
Reference	508
APPENDIX B	509
FORMS	509
APPENDIX C	512
DEFLECTION TESTING AND BACKCALCULATION	512
C.1 Introduction.....	512
C.2 FWD Testing – Flexible Pavements	514
C.2.1 FWD Testing Pattern - Flexible Pavement	514
C.2.2 FWD Drop Sequence – Flexible Pavement	517
C.2.3 FWD Sensor Spacing – Flexible Pavement	517
C.2.4 Surface Temperature Measurement – Flexible Pavement	517
C.3 FWD Testing – Rigid Jointed Plain Concrete Pavements	518
C.3.1 FWD Testing Pattern – Rigid Pavement.....	518
C.3.2 FWD Drop Sequence – Rigid Pavement	520
C.3.3 FWD Sensor Spacing – Rigid Pavement	521
C.3.4 Surface Temperature Measurement – Rigid Pavement	522
C.4 FWD Testing – Composite Pavements	523
C.4.1 FWD Testing Pattern – Composite Pavement	523
C.4.2 FWD Drop Sequence – Composite Pavements	525
C.4.3 FWD Sensor Spacing – Composite Pavement.....	526
C.4.4 Pavement Temperature Readings – Composite Pavement	526
C.5 Field Test Report.....	527
C.6 FWD Data Processing.....	529
C.6.1 Pre-Analysis	529
C.6.2 Pavement Surface Condition Survey	530
C.6.3 Pavement Coring and Subgrade Boring.....	530
C.6.4 Full Data Processing	531
C.6.5 Data Analysis, Interpretation and Reporting	531
C.6.5.1 Results Reporting – Flexible Pavements	532

C.6.5.2	Results Reporting – Jointed and Composite Pavements	532
C.6.5.3	Data Analysis and Interpretation – Jointed and Composite Pavements	532
	References	533
APPENDIX D	534
THE NEW ECONOMY; MATERIALS AND PAVEMENT OPTIONS AND CONSIDERATIONS	534
D.1	Introduction	534
D.2	White Paper - The New Economy	534
	References	540
PAVEMENT TREATMENT GUIDE FOR HIGHWAY CATEGORIES	541
D.1	Introduction	541
D.1	Definitions	541
D.1.1	Highway Categories	541
D.1.2	Treatment Categories	541
D.2	Policy and Process	542
APPENDIX E	543
HMA MATERIALS INPUT LIBRARY	543
E.1	Introduction	543
E.2	Mix Types and Properties	543
E.2.1	Dynamic Modulus	543
E.2.2	Creep Compliance and Indirect Tensile Strength	543
APPENDIX F	545
HMA MATERIALS INPUT LIBRARY	545
F.1	Introduction	545
F.2	Mix Types and Properties	545
F.2.1	Dynamic Modulus	545
F.2.2	Asphalt Binder	545
F.2.3	Creep Compliance and Indirect Tensile Strength	545
APPENDIX G	553
PCC MATERIALS INPUT LIBRARY	553
G.1	Introduction	553
G.2	Mix Types	553
G.2.1	Compressive and Flexural Strength	553
G.2.2	Static Elastic Modulus and Poisson’s Ratio	553
G.2.3	Coefficient of Thermal Expansion	553
APPENDIX H	556
HISTORICAL CDOT 18,000-POUND EQUIVALENT AXLE LOAD CALCULATIONS	556
H.1	Introduction	556
H.2	Traffic Projections	556
H.2.1	Volume Counts	556
H.2.2	Lane and Directional Distributions	556
H.2.3	Vehicle Classification	557
H.2.4	Growth Factors	560
H.2.5	Vehicle or Truck Weights	560
H.2.6	Traffic Equivalence Load Factors	560
H.2.7	Discussion and Calculation of Traffic Load for Pavement Design	560

H.2.8	Traffic Projections	562
	References	564
	SUPPLEMENT	565
	MATERIAL PROPERTIES OF SUBGRADE, SUBBASE, BASE, FLEXIBLE AND RIGID LAYERS	565
S.1	Introduction	565
S.1.1	Soil Consistency	565
S.1.2	Sieve Analysis	566
S.1.3	Unit Weight, Water Content, and Specific Gravity	568
S.1.4	Pavement Materials Chemistry	570
S.1.4.1	Periodic Table	570
S.1.4.2	pH Scale	572
S.1.5	Elastic Modulus	573
S.1.5.1	Concrete Modulus of Elasticity	574
S.1.5.2	Asphalt Dynamic Modulus $ E^* $	574
S.1.6	Binder Complex Shear Modulus	579
S.1.7	Poisson's Ratio	581
S.1.8	Coefficient of Lateral Pressure	582
S.1.9	Unconfined Compressive Strength	582
S.1.10	Modulus of Rupture	583
S.1.11	Tensile Creep and Strength for Hot Mix Asphalt	584
S.2	Resilient Modulus of Conventional Unbound Aggregate Base, Subbase, Subgrade, and Rigid Layer	585
S.2.1	Laboratory M_R Testing	587
S.2.2	Field M_R Testing	590
S.2.3	Adjustment to Laboratory and Field M_R Values for Climate	590
S.3	Resistance Value (R-value)	591
S.4	M_R and R-value Correlation	592
S.5	Modulus of Subgrade Reaction (k-value)	595
S.5.1	Static Elastic k-value	595
S.5.2	Dynamic k-value	596
S.6	Bedrock	597
S.7	Unbound Subgrade, Granular, and Subbase Materials	598
S.8	Chemically Stabilized Subgrades and Bases	599
S.8.1	Top of Layer Properties for Stabilized Materials	601
S.9.2	Bottom of Layer Properties for Stabilized Materials	603
S.9.3	Other Properties of Stabilized Layers	604
S.9.3.1	Coefficient of Thermal Expansion of Aggregates	604
S.9.3.2	Dry Thermal Conductivity (K) and Heat Capacity (Q)	605
S.9.3.3	Saturated Hydraulic Conductivity	606
S.10	Reclaimed Asphalt and Recycled Concrete Base Layer	607
S.11	Fractured Rigid Pavement	608
S.12	Pavement Deicers	610
S.12.2	Magnesium Chloride	610
	References	611

LIST OF FIGURES

Figure 1.1 M-E Design Process	63
Figure 1.2 Location of M-E Design Software HELP Document.....	65
Figure 1.3 M-E Design Software Default Window	65
Figure 1.4 M-E Design Software HELP Document	66
Figure 1.5 M-E Design Software Splash Screen	67
Figure 1.6 Open M-E Design Projects.....	68
Figure 1.7 M-E Design Software Main Window.....	68
Figure 1.8 M-E Design Software Project Tab	69
Figure 1.9 M-E Design Software Color-coded Inputs to Assist User Input Accuracy.....	69
Figure 1.10 M-E Design Software Splash Screen Showing Database Login Location.....	71
Figure 1.11 M-E Design Software Splash Screen Showing Database Login Information.....	71
Figure 1.12 Saving an Entire Project to M-E Design Database (Option 1).....	72
Figure 1.13 Saving an Entire Project to M-E Design Database (Option 2).....	73
Figure 1.14 Window Showing Successful Project Save.....	73
Figure 1.15 Changing the Project Display Name/Identifier	74
Figure 1.16 Saving Traffic Data	75
Figure 1.17 Saving Specific Traffic Elements.....	75
Figure 1.18 Saving Axle Load Distribution Elements.....	76
Figure 1.19 Window Showing Successful Axle Load Distribution Save.....	76
Figure 1.20 Error Saving Axle Load Distribution	77
Figure 1.21 Defining Identifiers for Axle Load Distribution	77
Figure 1.22 Editing Display Name/Identifiers for Axle Load Distribution.....	78
Figure 1.23 Importing an Entire Project from M-E Design Database	79
Figure 1.24 Selecting a Project to Import from M-E Design Database	79
Figure 1.25 Getting an Element from the M-E Design Database	80
Figure 1.26 Advanced Search Blank Window in M-E Design Database	81
Figure 1.27 Advanced Search Window with Information.....	81
Figure 1.28 Selecting a Project Using Advanced Search Tool.....	82
Figure 2.1 Performance Criteria and Reliability in the M-E Design Software for a Sample Flexible Pavement Design	97
Figure 2.2 Performance Criteria and Reliability in the M-E Design Software for a Sample JPCP Design.....	97
Figure 2.3 Functional Classification Map.....	99
Figure 3.1 Traffic Inputs in the M-E Design Software.....	106
Figure 3.2 M-E Design Software Screenshot of AADTT.....	109
Figure 3.3 M-E Design Software Screenshot of Growth Rate.....	110
Figure 3.4 CDOT Vehicle Classifications	114
Figure 3.5 M-E Design Software Screenshot of Vehicle Class Distribution.....	116
Figure 3.6 Vehicle Class Distribution Factors for CDOT Clusters	117
Figure 3.7 Truck Traffic Classification Groups.....	117
Figure 3.8 M-E Design Screenshot of Number of Axles Per Truck.....	118
Figure 3.9 M-E Design Screenshot of Monthly Adjustment Factors	120
Figure 3.10 Level 2 Hourly Distribution Factors.....	122
Figure 3.11 Single Axle Distribution in the M-E Design Software.....	123

Figure 3.12 CDOT Averages of Single Axle Load Distribution (Classes 5 and 9 only).....	128
Figure 3.13 CDOT Averages of Tandem Axle Load Distribution (Classes 6 and 9 only).....	128
Figure 3.14 M-E Design Software Screenshot of Traffic Lateral Wander	129
Figure 3.15 Schematic of Mean Wheel Location	130
Figure 3.16 Schematic of Design Lane Width.....	130
Figure 3.17 Axle Configuration and Wheelbase in the M-E Design Software	131
Figure 3.18 Schematic of Axle Configuration and Wheel Base.....	131
Figure 3.19 Climate Tab in the M-E Design Software	134
Figure 3.20 Location of Colorado Weather Stations	135
Figure 3.21 Region 1 Weather Stations and Highway Surface Type Map.....	137
Figure 3.22 Region 2 Weather Stations and Highway Surface Type Map.....	138
Figure 3.23 Region 3 Weather Stations and Highway Surface Type Map.....	139
Figure 3.24 Region 4 Weather Stations and Highway Surface Type Map.....	140
Figure 3.25 Region 5 Weather Stations and Highway Surface Type Map.....	141
Figure 4.1 Subgrade Preparation.....	146
Figure 4.2 Special Cases of Embankment Fill.....	148
Figure 4.3 Subgrade Material Properties in the M-E Design.....	149
Figure 4.4 M-E Design Software Screenshot for Other Engineering/Physical Properties of Subgrade	150
Figure 4.5 M-E Design Software Screenshot for Level 2 Resilient Modulus Input.....	156
Figure 4.6 M-E Design Software Screenshot for Level 3 Resilient Modulus Input.....	158
Figure 4.7 k-value vs. Soil Classification	161
Figure 4.8 k-values vs. Degree of Saturation for A-4 Through A-7 Soils.....	162
Figure 4.9 Colorado Annual Freezing Index (degrees-Fahrenheit days).....	167
Figure 4.10 Frost Depth to FI	168
Figure 4.11 Frost Susceptible Soil Classifications	169
Figure 4.12 Subexcavated Subgrade Layers.....	172
Figure 4.13 Effective Depth of Moisture Treatment	174
Figure 4.14 Recommended Depth of Moisture Treatment	174
Figure 4.15 Lime/Cement Stabilization Flow Chart.....	175
Figure 4.16 Lime Treated Structural Subgrade Layer	177
Figure 4.17 Cross Section of Lime Treated Cut Section Subgrade	178
Figure 4.18 Cement Treated Structural Subgrade Layer	178
Figure 4.19 Fly Ash Treated Structural Subgrade Layer.....	179
Figure 5.1 Unbound Aggregate Base Course Layers.....	187
Figure 5.2 Limiting Modulus Criteria of Unbound Aggregate Base Layers	190
Figure 5.3 Limiting Modulus Criteria of Unbound Subbase Layers	191
Figure 5.4 Stabilized Treated Structural Base Layers	194
Figure 5.5 M-E Design Software Screenshot for Treated Base Inputs.....	195
Figure 5.6 Structural Permeable Aggregate Base Course Layers.....	199
Figure 5.7 Reclaimed Asphalt and Concrete Pavement Base Layers.....	200
Figure 5.8 Rubblized Base Course.....	202
Figure 6.1 Asphalt Concrete Pavement Layer Systems.....	209
Figure 6.2 Structural Layers	210
Figure 6.3 Perpetual Pavement Design Concept.....	211
Figure 6.4 M-E Design Software Screenshot of Flexible Pavement Trial Design Structure	212

Figure 6.5 M-E Design Software Screenshot Showing General Information (left), Performance Criteria and Reliability (right)	212
Figure 6.6 Performance Prediction Model Coefficients for Flexible Pavement Designs (Marshall Mix)	213
Figure 6.7 Performance Prediction Model Coefficients for Flexible Pavement Designs (Superpave Mix)	214
Figure 6.8 Performance Prediction Model Coefficients for Flexible Pavement Designs (PMA Mix).....	215
Figure 6.9 Asphalt Concrete Layer and Material Properties in the M-E Design Software	218
Figure 6.10 Sample Flexible Pavement Trial Design PDF Output Report.....	220
Figure 6.11 Sensitivity of HMA Alligator Cracking to Truck Volume.....	224
Figure 6.12 Sensitivity of HMA Alligator Cracking to AC Thickness	225
Figure 6.13 Sensitivity of HMA Alligator Cracking to Asphalt Binder Content	225
Figure 6.14 Sensitivity of HMA Alligator Cracking to Air Voids	226
Figure 6.15 Sensitivity to HMA Alligator Cracking to Base Type	226
Figure 6.16 Sensitivity of HMA Alligator Cracking to Base Thickness	227
Figure 6.17 Sensitivity of HMA Alligator Cracking to Climate	227
Figure 6.18 Sensitivity of Total Rutting to Truck Volume.....	228
Figure 6.19 Sensitivity of Total Rutting to AC Thickness	228
Figure 6.20 Sensitivity of Total Rutting to Asphalt Binder Grade	229
Figure 6.21 Sensitivity of Total Rutting to Air Voids	229
Figure 6.22 Sensitivity of Total Rutting to Base Type	230
Figure 6.23 Sensitivity of Total Rutting to Climate	230
Figure 6.24 Sensitivity of HMA Transverse Cracking to Thickness.....	231
Figure 6.25 Sensitivity of HMA Transverse Cracking to Asphalt Binder Grade.....	231
Figure 6.26 Sensitivity of HMA Transverse Cracking to Asphalt Binder Content	232
Figure 6.27 Sensitivity of HMA Transverse Cracking to Base Type	232
Figure 6.28 Sensitivity of HMA Transverse Cracking to Climate	233
Figure 6.29 Sensitivity of HMA IRI to Truck Volume	233
Figure 6.30 Sensitivity of HMA IRI to AC Thickness	234
Figure 6.31 Sensitivity of HMA IRI to Asphalt Binder Grade.....	234
Figure 6.32 Sensitivity of HMA IRI to Base Thickness.....	235
Figure 6.33 PG Binder Grades.....	242
Figure 6.34 Colorado 98 Percent Reliability LTPP High Pavement Temperature Weather Station Models	244
Figure 6.35 Colorado 98 Percent Reliability LTPP Low Pavement Temperature Weather Station Models	245
Figure 6.36 LTPP Interface Form for Weather Station Selection (version 3.1).....	246
Figure 6.37 LTPP Weather Station Output Data (version 3.1).....	247
Figure 6.38 LTPP PG Binder Selection at 98 Percent Reliability	248
Figure 7.1 Rigid Pavement Layers.....	258
Figure 7.2 M-E Design Software Screenshot of Rigid Pavement Trial Design Structure.....	259
Figure 7.3 M-E Design Software Screenshot Showing General Information, Performance Criteria and Reliability.....	259
Figure 7.4 Performance Prediction Model Coefficients for Rigid Pavement Designs	260
Figure 7.5 PCC Layer and Material Properties in the M-E Design Software.....	262

Figure 7.6 M-E Design Software Screenshot of JPCP Design Features.....	265
Figure 7.7 Sample Rigid Pavement Design PDF Output Report.....	266
Figure 7.8 Sensitivity of JPCP Transverse Cracking to PCC Thickness.....	269
Figure 7.9 Sensitivity of JPCP Transverse Cracking to PCC Coefficient of Thermal Expansion.....	269
Figure 7.10 Sensitivity of JPCP Transverse Cracking to Traffic Volume.....	270
Figure 7.11 Sensitivity of JPCP Transverse Cracking to Design Reliability	270
Figure 7.12 Sensitivity of JPCP Faulting to PCC Thickness.....	271
Figure 7.13 Sensitivity of JPCP Faulting to PCC Coefficient of Thermal Expansion	271
Figure 7.14 Sensitivity of JPCP Faulting to Traffic Volume.....	272
Figure 7.15 Sensitivity of JPCP Faulting to Design Reliability	272
Figure 7.16 Sensitivity of JPCP IRI to PCC Thickness.....	273
Figure 7.17 Sensitivity of JPCP Faulting to PCC Coefficient of Thermal Expansion	273
Figure 7.18 Sensitivity of JPCP IRI to Traffic Volume.....	274
Figure 7.19 Sensitivity of JPCP IRI to Design Reliability	274
Figure 7.20 Curling and Warping	276
Figure 7.21 Details of Dowel Bar Placement	278
Figure 7.22 Idealized Sketch of Cracking Pattern in Concrete Mass Caused By Internal Expansion.....	283
Figure 7.23 Sulfate Attack	284
Figure 8.1 Rehabilitation Alternative Selection Process	289
Figure 8.2 Pavement Condition Evaluation Checklist (Flexible)	294
Figure 8.3 Performance Prediction Model Coefficients for Flexible Pavement Rehabilitation Designs (Marshall Mix)	328
Figure 8.4 Performance Prediction Model Coefficients for Flexible Pavement Rehabilitation Designs (Superpave Mix).....	329
Figure 8.5 Performance Prediction Model Coefficients for Flexible Pavement Rehabilitation Designs (PMA Mix).....	330
Figure 9.1 Rehabilitation Alternative Selection Process	334
Figure 9.2 Pavement Condition Evaluation Checklist (Rigid)	337
Figure 9.3 Sample TWT Project Location Map.....	354
Figure 9.4 Input and Required Thickness Form for Thin Concrete overlay Design	355
Figure 10.1 CPR Sequencing.....	371
Figure 10.2 Dimensions for Grinding and Grooving.....	374
Figure 10.3 Dimensional Grinding Texture for Hard and Soft Aggregate.....	375
Figure 10.4 Grout Retention Disk.....	383
Figure 10.5 Typical Dowel Bar Retrofit Installation	385
Figure 10.6 Typical Dowel Bar Retrofit Sequencing of the Installation	386
Figure 10.7 Typical Slab Stabilization Hole Layout	389
Figure 10.8 Typical Slab Raising in Slabjacking.....	390
Figure 10.9 Typical Slabjacking Hole Layout.....	390
Figure 11.1 Rutting in Subgrade or Base.....	399
Figure 11.2 Plastic Flow	400
Figure 11.3 Rutting in Asphalt Layer	400
Figure 12.1 Typical Joint Layout for a Rigid Pavement Intersection.....	406
Figure 12.2 Typical Joint Layout for a Rigid Pavement Intersection.....	406

Figure 12.3 Typical Joint Layout for a Rigid Pavement Intersection.....	407
Figure 12.4 Typical Joint Layout for a Rigid Pavement Intersection.....	407
Figure 12.5 Typical Joint Layout for a Rigid Pavement Intersection.....	408
Figure 12.6 Typical Joint Layout for a Rigid Pavement Intersection.....	408
Figure 12.7 Typical Joint Layout for a Rigid Pavement Intersection.....	409
Figure 12.8 Detail of Asphalt and Concrete Slab Joint	411
Figure 12.9 Basic Geometric Elements of a Roundabout.....	412
Figure 12.10 Isolating the Circle	414
Figure 12.11 Pave-through Layout	414
Figure 12.12 Six Step Jointing Layout	415
Figure 12.13 Basic Joints and Zones of a Roundabout.....	416
Figure 12.14 Typical Section of an Urban Double-lane Roundabout	417
Figure 13.1 Pavement Selection Process Flow Chart	420
Figure 13.2 Unmodified HMA Cash Flow Diagram	423
Figure 13.3 Cold Plaining and Overlay with Polymer Modified HMA Cash Flow Diagram	424
Figure 13.4 PCCP Cash Flow Diagram	425
Figure 13.5 The RealCost Switchboard.....	445
Figure 13.6 Project Details Input Screen	446
Figure 13.7 Analysis Option Screen	448
Figure 13.8 Traffic Data Option Screen	451
Figure 13.9 Value of User Option Screen.....	452
Figure 13.10 Traffic Hourly Distribution Screen	454
Figure 13.11 Added Time and Vehicle Stopping Costs Screen.....	456
Figure 13.12 Saving and Opening Project-Level Inputs.....	457
Figure 13.13 PCCP Normalized Dollar Amount per Year	466
Figure 13.14 PCCP Normalized Dollar Amount per Thickness.....	466
Figure 13.15 PCCP Normalized Dollar Amount per Thickness.....	467
Figure 13.16 PCCP Normalized Dollar Amount per Total Square Yards for Projects Less Than 10,000 Square Yards	467
Figure 13.17 PCCP Normalized Dollar Amount for Projects of 6 Inches or Less in Thickness and Less Than 10,000 Square Yards in Size	468
Figure 13.18 PCCP Normalized Dollar Amount for Projects of 8 to 9 Inches in Thickness and Less Than 10,000 Square Yards in Size.....	468
Figure 13.19 PCCP Normalized Dollar Amount for Projects of 9 to 10 Inches in Thickness and Less Than 10,000 Square Yards in Size	468
Figure 13.20 PCCP Normalized Dollar Amount for Projects of 10 to 11 Inches in Thickness and Less Than 10,000 Square Yards in Size	469
Figure 13.21 PCCP Normalized Dollar Amount for Projects of 11 to 12 Inches in Thickness and Less Than 10,000 Square Yards in Size	469
Figure 13.22 PCCP Normalized Dollar Amount for Projects of 12 Inches or Greater in Thickness and Less Than 10,000 Square Yards in Size	469
Figure 13.23 PCCP Normalized Dollar Amount per Total Square Yards for Projects Greater Than 10,000 Square Yards.....	470
Figure 13.24 PCCP Normalized Dollar Amount for Projects of 8 to 9 Inches in Thickness and Greater Than 10,000 Square Yards in Size.....	470
Figure 13.25 PCCP Normalized Dollar Amount for Projects of 9 to 10 Inches in	

Thickness and Greater Than 10,000 Square Yards in Size.....	470
Figure 13.26 PCCP Normalized Dollar Amount for Projects of 10 to 11 Inches in Thickness and Greater Than 10,000 Square Yards in Size.....	471
Figure 13.27 PCCP Normalized Dollar Amount for Projects of 11 to 12 Inches in Thickness and Greater Than 10,000 Square Yards in Size.....	471
Figure 13.28 PCCP Normalized Dollar Amount for Projects of 12 Inches or Greater in Thickness and Greater Than 10,000 Square Yards in Size.....	471
Figure 13.29 HMA Overlay Normalized Dollar per Year and Project Size.....	472
Figure 13.30 HMA Overlay Normalized Dollar per Product Type and Project Size.....	472
Figure 13.31 HMA Overlay Normalized Dollar per Product Type and Project Size.....	473
Figure 13.32 HMA Overlay Normalized Dollar Amount for Projects Less Than 10,000 Tons.	473
Figure 13.33 HMA Overlay Normalized Unit Costs for SX(100) PG 64-28 on Projects Less than 10,000 Tons.....	474
Figure 13.34 HMA Overlay Normalized Unit Costs for SX(100) PG 64-22 on Projects Less than 10,000 Tons.....	474
Figure 13.35 HMA Overlay Normalized Unit Costs for SX(100) PG 58-28 on Projects Less than 10,000 Tons.....	474
Figure 13.36 HMA Overlay Normalized Unit Costs for SX(100) PG 76-28 on Projects Less than 10,000 Tons.....	475
Figure 13.37 HMA Overlay Normalized Unit Costs for Furnish HMA on Projects Less than 10,000 Tons.....	475
Figure 13.38 HMA Overlay Normalized Unit Costs for Projects with Greater than 10,000 Tons.....	475
Figure 13.39 HMA Overlay Normalized Unit Costs for SX(100) PG 64-22 on Projects Greater than 10,000 Tons.....	476
Figure 13.40 HMA Overlay Normalized Unit Costs for SX(75) on Projects Greater than 10,000 Tons.....	476
Figure 13.41 HMA Overlay Normalized Unit Costs for SX(100) PG 58-28 on Projects Greater than 10,000 Tons.....	476
Figure 13.42 HMA Overlay Normalized Unit Costs for SX(100) PG 64-28 on Projects Greater than 10,000 Tons.....	477
Figure 13.43 HMA Overlay Normalized Unit Costs for SX(100) PG 76-28 on Projects Greater than 10,000 Tons.....	477
Figure 13.44 HMA Mill and Fill Normalized Dollar per Year and Project Size.....	478
Figure 13.45 HMA Mill and Fill Normalized Dollar per Product Type.....	478
Figure 13.46 HMA Mill and Fill Normalized Dollar per Product Type.....	479
Figure 13.47 HMA Mill and Fill Normalized Unit Costs for Projects Less than 10,000 Tons..	479
Figure 13.48 HMA Mill and Fill Normalized Unit Costs for SX(100) PG 64-22 on Projects Less than 10,000 Tons.....	480
Figure 13.49 HMA Mill and Fill Normalized Unit Costs for SX(100) PG 76-28 on Projects Less than 10,000 Tons.....	480
Figure 13.50 HMA Mill and Fill Normalized Unit Costs for SX(100) PG 58-28 on Projects Less than 10,000 Tons.....	480
Figure 13.51 HMA Mill and Fill Normalized Unit Costs for Projects Greater than 10,000 Tons.....	481
Figure 13.52 HMA Mill and Fill Normalized Unit Costs for SX(100) PG 76-28 on Projects	

Greater than 10,000 Tons.....	481
Figure 13.53 HMA Mill and Fill Normalized Unit Costs for SX(100) PG 64-22 on Projects Greater than 10,000 Tons.....	481
Figure 13.54 HMA Mill and Fill Normalized Unit Costs for SMA on Projects Greater than 10,000 Tons.....	482
Figure 13.55 HMA Mill and Fill Normalized Unit Costs for SX(100) PG 64-22 on Projects Greater than 10,000 Tons.....	482
Figure 13.56 HMA Mill and Fill Normalized Unit Costs for SX(100) PG 58-34 on Projects Greater than 10,000 Tons.....	482
Figure 13.57 Alternative 1 (HMA) Screen	485
Figure 13.58 Alternative 2 (PCCP) Screen.....	486
Figure 13.59 Probabilistic Results Screen	489
Figure 13.60 Agency Cost Results Screen.....	490
Figure 13.61 User Cost Results Screen.....	491
Figure 13.62 Agency-User Cost Results Screens	492

APPENDIX A

Figure A.1 Pavement Condition Evaluation Checklist (Rigid)	503
Figure A.2 Pavement Condition Evaluation Checklist (Flexible)	504

APPENDIX B

Figure B.1 Design Data (Page 1 of 2) (CDOT Form 463 12/03)	510
Figure B.2 Maintenance Project - Request Form (CDOT Form 463M Rev 4/10)	511

APPENDIX C

Figure C.1 Depiction of FWD Load Distribution through Pavement.....	514
Figure C.2 Flexible Pavement Staggered Testing Pattern	516
Figure C.3 JPCP Testing Pattern	520
Figure C.4 Joint Load Transfer Testing Sensor Spacing	522
Figure C.5 Corner Testing Sensor Location	522
Figure C.6 Staggered Testing Pattern	524
Figure C.7 Joint Load Transfer Testing Sensor Spacing	526
Figure C.8 Field Test Report	528
Figure C.9 Coring Log Example.....	531

APPENDIX H

Figure H.1 CDOT Vehicle Classifications	559
---	-----

SUPPLEMENT

Figure S.1 Atterberg Limits	566
Figure S.2 Gradation Plot	567
Figure S.3 Soil Sample Constituents	568
Figure S.4 Plot of Maximum Dry Unit Weight and Optimum Water Content.....	569
Figure S.5 Periodic Table	571
Figure S.6 Dissociation of Water.....	572

Figure S.7 pH Scale	572
Figure S.8 Elastic Modulus.....	573
Figure S.9 Dynamic Modulus Stress-Strain Cycles.....	575
Figure S.10 $ E^* $ vs. Log Loading Time Plot at Each Temperature	576
Figure S.11 Shifting of Various Mixture Plots	578
Figure S.12 Dynamic Modulus $ E^* $ Master Curve	578
Figure S.13 Shift Factor Plot	579
Figure S.14 Binder Complex Shear Modulus Specimen Loading	580
Figure S.15 Binder Complex Shear Modulus Shear-Strain Cycles	580
Figure S.16 Poisson's ratio.....	582
Figure S.17 Unconfined Compressive Strength.....	583
Figure S.18 3-Point Beam Loading for Flexural Strength.....	584
Figure S.19 Indirect Tensile Strength	585
Figure S.20 Distribution of Wheel Load to Subgrade Soil (M_r).....	586
Figure S.21 Critical Stress/Strain Locations for Bases, Subbases, Subgrade, and Rigid Layer.	587
Figure S.22 Subgrade Material Element at Critical Location.....	588
Figure S.23 Resilient Modulus Test Specimen Stress State	589
Figure S.24 Resilient Modulus Test Specimen Loading	589
Figure S.25 Resilient Modulus Seasonal Variation	591
Figure S.26 Resistance R-value Test Specimen Loading State	592
Figure S.27 Correlation Plot between Resilient Modulus and R-value	593
Figure S.28 Distribution of Wheel Load to Subgrade Reaction (k-value)	595
Figure S.29 Field Plate Load Test for k-value.....	596
Figure S.30 Critical Stress Locations for Stabilized Subgrade.....	599
Figure S.31 Critical Stress/Strain Locations for Stabilized Bases	600
Figure S.32 Critical Stress Locations for Recycled Pavement Bases	607
Figure S.33 Critical Stress Location for Rubblized Base	609

LIST OF TABLES

Table 1.1 Recommended Pavement Design Procedures.....	62
Table 2.1 Moisture-Related Distress in Flexible Pavements	90
Table 2.2 Moisture-Related Distress in Rigid Pavements	91
Table 2.3 Reliability (Risk).....	92
Table 2.4 Recommended Threshold Values of Performance Criteria for New Construction or Reconstruction Projects	93
Table 2.5 Recommended Threshold Values of Performance Criteria for Rehabilitation Projects.....	95
Table 2.6 Selection of Input Hierarchical Level.....	101
Table 3.1 Hierarchy of Traffic Inputs	107
Table 3.2 Recommendations of Traffic Inputs at Each Hierarchical Level	108
Table 3.3 Design Lane Factor	109
Table 3.4 Growth Rate Determined Using OTIS 20 Year Growth Factor	111
Table 3.5 Level 2 Vehicle Class Distribution Factors	116
Table 3.6 Level 2 Number of Axles Per Truck.....	119
Table 3.7 Level 2 Monthly Adjustment Factors	120
Table 3.8 Hourly Distribution Factors	121
Table 3.9 Level 2 Single Axle Load Distribution Factors (Percentages)	124
Table 3.10 Level 2 Tandem Axle Load Distribution Factors (Percentages)	125
Table 3.11 Level 2 Tridem Axle Load Distribution Factors (Percentages).....	126
Table 3.12 Level 2 Quad Axle Load Distribution Factors (Percentages).....	127
Table 3.13 Recommendations for Climatic Inputs	133
Table 3.14 Geographic Coordinates and Data Availability of Colorado Weather Stations	135
Table 4.1 M-E Design Major Subgrade Categories.....	144
Table 4.2 Recommended Subgrade Inputs in New Flexible and New JPCP Designs.....	151
Table 4.3 Recommended Subgrade Inputs for HMA Overlays of Existing Flexible Pavement	152
Table 4.4 Recommended Subgrade Inputs for Overlays of Existing Rigid Pavement.....	153
Table 4.5 Level 3 Resilient Modulus For Embankments and Subgrade.....	157
Table 4.6 Average Backcalculated to Laboratory Determined Elastic Modulus Ratios	159
Table 4.7 k-Value Ranges for Various Soil Types	163
Table 4.8 Treatment of Expansive Soils	172
Table 4.9 Probable Swell Damage Risk	173
Table 4.10 Application and Associated Functions of Geosynthetics in Roadway Systems.....	181
Table 5.1 CDOT Classification for Aggregate Base Course	188
Table 5.2 Characterization of Treated Base in the M-E Design	195
Table 5.3 Level 1 Input Requirement and Corresponding Testing Protocols for Characterization of Treated Bases in the M-E Design	196
Table 5.4 Level 2 Correlations for Elastic Modulus of Treated Bases	196
Table 5.5 Level 2 Correlations for Flexural Strength of Treated Bases	197
Table 5.6 Level 3 Default Elastic Modulus and Flexural Strength of Treated Bases.....	197
Table 5.7 CDOT Classification for Reclaimed Asphalt Pavement.....	201
Table 6.1 HMA Input Properties and Recommendations for HMA Material Characterization.	219
Table 6.2 Modifying Flexible Pavement Trial Designs.....	223
Table 6.3 Master Range Table for Stone Matrix Asphalt.....	237

Table 6.4 HMA Grading Size and Location Application	238
Table 6.5 HMA Grading Size and Layer Thickness	238
Table 6.6 Environmental Categories.....	239
Table 6.7 Recommended SuperPave™ Gyrotory Design Revolution (N _{DES})	240
Table 6.8 Available Asphalt Cement Grades in Colorado.....	241
Table 6.9 SuperPave™ Weather Data Summary.....	248
Table 6.10 Environmental Categories (Restated).....	249
Table 6.11 Recommended SuperPave™ Gyrotory Design Revolution (N _{DES})	250
Table 6.12 Recommended Sources of Inputs for Asphalt Binder Characterization	251
Table 6.13 Fractured Face Criteria	252
Table 6.14 Minimum VMA Requirements.....	252
Table 6.15 Criteria for Stability and Voids Filled with Asphalt (VFA).....	253
Table 6.16 Moisture Damage Criteria	253
Table 7.1 PCC Material Inputs and Recommendations for New JPCP Design	262
Table 7.2 Modifying Rigid Pavement Trial Designs	268
Table 7.3 Reinforcing Size Table	278
Table 7.4 Dowel Bar Target Placement Tolerances	279
Table 7.5 Material Types and Erodibility Class	280
Table 7.6 Minimum Thicknesses for Highways, Roadways and Bicycle Paths.....	281
Table 7.7 Concrete Classification	282
Table 7.8 Requirements to Protect Against Damage to Concrete by Sulfate Attack from External Sources of Sulfates.....	285
Table 8.1 Common Distresses Causes of Flexible Pavements and Associated Problem Types.	296
Table 8.2 List of Recommended Overlay Solutions to Functional Problems.....	298
Table 8.3 Selection Guidelines for HIR Process Distress-Related Considerations.....	307
Table 8.4 SMA Functional and Structural Recommended Minimum Thickness Layers	313
Table 8.5 Characterization of Existing Flexible Pavement for the M-E Design	314
Table 8.6 Characterization of Existing Rigid Pavement for the M-E Design	315
Table 8.7 Characterization of Existing Flexible and Semi-Rigid Pavement for the M-E Design.....	323
Table 8.8 Characterization of Existing JPCP for the M-E Design	325
Table 8.9 Characterization of Fractured Concrete Pavement for the M-E Design.....	326
Table 8.10 Recommended Fractured Slab Design Modulus Values for Level 1 Characterization	326
Table 8.11 Recommended Fractured Slab Design Modulus Values for Level 3 Characterization	326
Table 8.12 Recommendations for Modifying Trial Design to Reduce Distress/Smoothness for HMA Overlays of JPCP.....	332
Table 9.1 Required Concrete Overlay Procedure	335
Table 9.2 Distress Levels for Assessing Drainage Adequacy of JPCP	338
Table 9.3 Load Transfer Efficiency Quality	339
Table 9.4 Common Distresses Causes of Rigid Pavements and Associated Problem Types.....	341
Table 9.5 Design Factors for Rigid Pavement.....	345
Table 10.1 Structural Adequacy for JPCP	364
Table 10.2 Functional Adequacy for JPCP.....	365
Table 10.3 Load Transfer Efficiency Quality	366

Table 10.4 Distress Levels for Durability of JPCP.....	368
Table 10.5 Strength Correlation Formulas.....	369
Table 10.6 Distress Levels for Assessing Drainage Adequacy of JPCP	370
Table 10.7 Trigger Values for Diamond Grinding	373
Table 10.8 Limit Values for Diamond Grinding	373
Table 10.9 Hot Poured Crack Sealant Estimated Quantities	377
Table 10.10 Sealant Severity Level	378
Table 10.11 Sealant Survey Sampling Frequency	378
Table 10.12 Minimum Cost Effective Distance between Two Patches.....	382
Table 10.13 Guidelines for PCC Treatment Selection.....	391
Table 12.1 Recommended Inscribed Circle Diameters	413
Table 13.1 Default Input Values for Treatment Periods to be used in a LCCA	422
Table 13.2 Present Worth Factors for Discount Rates.....	426
Table 13.3 Discount Factors for Discrete Compounding	427
Table 13.4 Annual Maintenance Costs	429
Table 13.5 Analysis Data Inputs and Analysis Options	447
Table 13.6 Traffic Data Options	449
Table 13.7 Value of User Time Data Options	452
Table 13.8 Traffic Hourly Distribution Data Options	453
Table 13.9 Added Time and Vehicle Costs Data Options	455
Table 13.10 Results of Heater Remixing	459
Table 13.11 Results of Heater Scarifying	459
Table 13.12 Results of Full Depth Reclamation.....	459
Table 13.13 Cold In-Place Recycling.....	460
Table 13.14 PCCP Projects Less Than 10,000 Square Yards.....	460
Table 13.15 PCCP Projects Greater Than 10,000 Square Yards	461
Table 13.16 HMA Overlay Projects Less Than 10,000 Tons.....	462
Table 13.17 HMA Overlay Projects Greater Than 10,000 Tons	463
Table 13.18 HMA Mill and Fill for Projects Less Than 10,000 Tons.....	464
Table 13.19 HMA Mill and Fill for Projects Greater Than 10,000 Tons	465
Table 13.20 Alternative-Level Data Options.....	484
Table 13.21 Simulation Data Options.....	487

APPENDIX C

Table C.1 Flexible Pavement Test Spacing Guidelines.....	515
Table C.2 Jointed Plain Concrete Pavement Test Spacing Guidelines.....	519
Table C.3 Composite Pavement Test Spacing Guidelines.....	524

APPENDIX F

Table F.1 Properties of Typical CDOT HMA Mixtures.....	547
Table F.2 Dynamic Modulus Values of Typical CDOT HMA Mixtures	548
Table F.3 Asphalt Binder Complex Shear Modulus (G^*) and Phase Angle (δ) Values of Typical CDOT HMA Mixtures	549

APPENDIX G

Table G.1 Properties of Typical CDOT PCC Mixtures	554
---	-----

Table G.2 Materials and Sources Used in Typical CDOT PCC Mixtures.....	554
Table G.3 Compressive Strength of Typical CDOT PCC Mixtures.....	554
Table G. 4 Flexural Strength of Typical CDOT PCC Mixtures	554
Table G.5 Static Elastic Modulus and Poisson’s Ratio of Typical CDOT PCC Mixtures	555
Table G.6 CTE values of Typical CDOT PCC Mixtures	555

APPENDIX H

Table H.1 Design Lane Factor	557
Table H.2 Colorado Equivalency Factors	560

SUPPLEMENT

Table S. 1 Nominal Dimensions of Common Sieves	567
Table S.2 Recommended Testing Temperatures and Loading Frequencies.....	575
Table S.3 Comparisons of M_r between Suggested NCHRP 1-40D Values and Colorado Soils with R-values	594
Table S.4 Poisson's Ratio for Bedrock.....	597
Table S.5 Elastic Modulus for Bedrock.....	597
Table S.6 Poisson's Ratios for Subgrade, Unbound Granular and Subbase Materials	598
Table S.7 Coefficient of Lateral Pressure	598
Table S.8 Poisson's Ratios for Chemically Stabilized Materials	600
Table S.9 Poisson's Ratios for Asphalt Treated Permeable Base	601
Table S.10 Poisson's Ratios for Cold Mixed Asphalt and	601
Table S.11 Minimum Unconfined Compressive Strengths for Stabilized Layers.....	602
Table S.12 Typical E, E^* , or M_r Values for Stabilized Materials	602
Table S.13 Typical M_r Values for Deteriorated Stabilized Materials.....	603
Table S.14 Typical Modulus of Rupture (M_r) Values for Stabilized Materials.....	603
Table S.15 Recommended Values of PCC Coefficient of Thermal Expansion	604
Table S.16 LTPP Values of PCC Coefficient of Thermal Expansion of Siliceous Gravel in Colorado.....	605
Table S.17 Dry Thermal Conductivity (K) and Heat Capacity (Q) for Unbound Compacted Material.....	605
Table S.18 Dry Thermal Conductivity (K) and Heat Capacity (Q) for Chemically Stabilized Material	606
Table S.19 Dry Thermal Conductivity (K) and Heat Capacity (Q) for Asphalt Concrete and PCC Material.....	606
Table S.20 Poisson's Ratios for Cold Mixed Asphalt and Cold Mixed Recycled Asphalt Materials	608
Table S.21 Typical E, E^* , or M_r Values for Stabilized Materials	608
Table S.22 Poisson's Ratio for PCC Materials	609
Table S.23 Typical M_r Values for Fractured PCC Layers	609

LIST OF EQUATIONS

$T_f = (1 + r)^n$	Eq. 3-1	110
$Mr = 3438.6 * R^{0.2753}$	Eq. 4-1	156
$FI = \sum_{i=1}^n (0 - T_i)$	Eq. 4-2	164
FI = Annual Freezing Index °C days = 59Annual Freezing Index (°F days)	Eq. 4-3	168
Frost Depth meters = 0.0014 x FI	Eq. 4-4	168
$D_{15B} \leq 5 \times D_{85S}$, and	Eq. 4-5	181
$D_{50B} \leq 25 \times D_{50S}$	Eq. 4-6	181
$SiO_2 + 2NaOH + H_2O \rightarrow Na_2SiO_3 \cdot 2H_2O$	Eq. 7-1	282
$CaMg(CO_3)_2 + 2NaOH \rightarrow Mg(OH)_2 + CaCO_3 + NaCO_3$	Eq. 7-2	283
$LTE = \frac{\delta_u}{\delta_l} \times 100$	Eq. 9-1	339
$\sigma_{FE} = 1.87x\sigma_{TE}$	Eq. 9-2	348
$\sigma_{ex} = 1.51 * \sigma_{th}$	Eq. 9-3	349
$\epsilon_{ac} = 0.897 * \epsilon_{pcc} - 0.776$	Eq. 9-4	349
$\sigma_{\%} = 3.85 * \Delta T$	Eq. 9-5	349
$(\sigma_{pcc})^{1/2} = 18.879 + 2.918 t_{pcc} / t_{ac} + 425.44 / l_e - 6.955 \times 10^{-6} E_{ac} - 9.0366 \log k + 0.0133 L$	Eq. 9-6	350
$(\sigma_{pcc})^{1/2} = 17.669 + 2.668 t_{pcc} / t_{ac} + 408.52 / l_e - 6.455 \times 10^{-6} E_{ac} - 8.3576 \log k + 0.00622 L$	Eq. 9-7	350
$(\epsilon_{ac})^{1/4} = 8.224 - 0.2590 t_{pcc} / t_{ac} - 0.04419 l_e - 6.898 \times 10^{-7} E_{ac} - 1.1027 \log k$	Eq. 9-8	350
$(\epsilon_{ac})^{1/4} = 7.923 - 0.2503 t_{pcc} / t_{ac} - 0.04331 l_e - 6.746 \times 10^{-7} E_{ac} - 1.0451 \log k$	Eq. 9-9	350
$\text{Log}10(N) = (0.97187 - SR) / 0.0828$	Eq. 9-10	351
$N = (4.2577 / (SR - 0.43248))^{3.268}$	Eq. 9-11	351
N = Unlimited	Eq. 9-12	351
$N = C * 18.4 * (4.32 \times 10^{-3}) * (1 / \epsilon_{ac})^{3.29} * (1 / E_{ac})^{0.854}$	Eq. 9-13	352
$F_{ESAL} = 0.985 + 10.057 * (t_{pcc})^{-3.456}$	Eq. 9-14	353
$F_{ESAL} = (1.286 - 2.138 / t_{pcc})^{-1}$	Eq. 9-15	353
$LTE = \frac{\delta_u}{\delta_l} \times 100$	Eq. 10-1	366
Flexural Strength = 190 + 0.097 x compressive strength	Eq. 10-2	368
Flexural Strength = 247 + 0.068 x compressive strength	Eq. 10-3	368
Flexural Strength = 217 + 0.75 x compressive strength, r2 = 0.45	Eq. 10-4	369

$$\frac{(\text{large NPV value} - \text{small NVP value}) \times 100}{(\text{small NVP value})} \quad \text{Eq. 13-1Error! Bookmark not defined.}$$

APPENDIX H

$$T_f = (1+r)^n \quad \text{Eq. H.1 562}$$

$$T = \left(\left((T_1 * T_f) - T_1 \right) / 20 \right) * D + T_1 \quad \text{Eq. H.2 562}$$

$$T_m = (T_1 + T) / 2 \quad \text{Eq. H.3 562}$$

SUPPLEMENT

$$\gamma = \frac{W_t}{V_t} = \frac{W_w + W_s}{V_g + V_w + V_s} \quad \text{Eq. S.1 568}$$

$$\gamma_{\text{dry}} = \frac{W_s}{V_t} = \frac{W_s}{V_g + V_w + V_s} \quad \text{Eq. S.2 568}$$

$$\gamma_{\text{bulk}} = \frac{W_s + W_w}{V_t} = \frac{W_t}{V_t(1+w)} = \frac{\gamma}{1+w} = \frac{\frac{W_t}{V_t}}{\left(1 + \frac{W_w}{W_s}\right)} \quad \text{Eq. S.3 568}$$

$$G_s = \frac{\gamma_s}{\gamma_w} = \frac{\frac{W_s}{V_s}}{\gamma_w} = \frac{\gamma_s}{62.4} \quad \text{Eq. S.4 569}$$

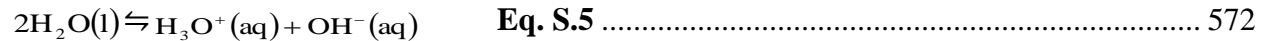

$$E = \frac{\sigma}{\epsilon} \quad \text{Eq. S.6 573}$$

$$\frac{\text{Load}}{\text{Area}} = \frac{P}{A} \quad \text{Eq. S.7 573}$$

$$\frac{\text{Change in Length}}{\text{Original Length}} = \frac{\Delta L}{L_o} \quad \text{Eq. S.8 573}$$

$$E_c = \frac{(\sigma_2 - \sigma_1)}{(\epsilon_2 - 0.000050)} \quad \text{Eq. S.9 574}$$

$$|E^*| = \frac{\sigma_o}{\epsilon_o} \quad \text{Eq. S.10 575}$$

$$\emptyset = 2\pi f \Delta t \quad \text{Eq. S.11 575}$$

$$\log|E^*| = \delta + \frac{(\text{Max} - \delta)}{1 + e^{\beta + \gamma \left\{ \log f + \frac{\Delta E_a}{19.14714} \left[\left(\frac{1}{T} \right) - \left(\frac{1}{T_r} \right) \right] \right\}}} \quad \text{Eq. S.12 576}$$

$$|E^*|_{\max} = P_c \left[4,200,000 \left(1 - \frac{\text{VMA}}{100} \right) + 435,000 \left(\frac{\text{VFA} \times \text{VMA}}{10,000} \right) + \frac{1 - P_c}{\frac{1 - \frac{\text{VMA}}{100}}{4,200,000} + \frac{\text{VMA}}{435,000(\text{VFA})}} \right] \quad \text{Eq. S.13 .. 577}$$

$$P_c = \frac{\left[20 + \frac{435,000(\text{VFA})}{\text{VMA}} \right]^{0.58}}{650 + \left[\frac{435,000(\text{VFA})}{\text{VMA}} \right]^{0.58}} \quad \text{Eq. S.14 577}$$

$$\log[\alpha(T)] = \frac{\Delta E_\alpha}{19.14714} \left(\frac{1}{T} - \frac{1}{T_r} \right) \quad \text{Eq. S.15 577}$$

$$G^* = \frac{\tau_{\max}}{\gamma_{\max}} \quad \text{Eq. S.16 579}$$

$$\tau_{\max} = \frac{2T_{\max}}{\pi r^3} \quad \text{Eq. S.17 579}$$

$$\gamma_{\max} = \frac{\theta_{\max}(r)}{h} \quad \text{Eq. S.18 579}$$

$$\eta = \frac{G^*}{10} \left(\frac{1}{\sin \delta} \right)^{4.8628} \quad \text{Eq. S.19 581}$$

$$\log \log \eta = A = VTS \log T_r \quad \text{Eq. S.20 581}$$

$$\mu = \frac{\epsilon_{\text{lateral}}}{\epsilon_{\text{axial}}} \quad \text{Eq. S.21 581}$$

$$\frac{\text{Change in Diameter}}{\text{Original Diameter}} = \frac{\Delta D}{D_o} \quad \text{Eq. S.22 581}$$

$$\frac{\text{Change in Length}}{\text{Original Length}} = \frac{\Delta L}{L_o} \quad \text{Eq. S.23 581}$$

$$k_o = \frac{\mu}{1 - \mu} \quad \text{Eq. S.24 582}$$

$$k_o = 1 - \sin \phi \quad \text{Eq. S.25 582}$$

$$f'_c = \frac{P}{A} \quad \text{Eq. S.26 583}$$

$$\sigma_{b,\max} = \frac{M_{\max} c}{I_c} \quad \text{Eq. S.27 583}$$

$$S'_c = \frac{Pl}{bd^2} \quad \text{Eq. S.28 584}$$

$S'_c = \frac{3Pa}{bd^2}$	Eq. S.29	584
$D(t) = \frac{\epsilon_t}{\sigma}$	Eq. S.30	585
$S_t = \frac{2P}{\pi tD}$	Eq. S.31	585
$Mr = \frac{\sigma_d}{\epsilon_r}$	Eq. S.32	588
$\theta = \sigma_1 + \sigma_2 + \sigma_3$	Eq. S.33	590
$\sigma_d = \sigma_1 - \sigma_3$	Eq. S.34	590
$\tau_{oct} = \frac{1}{3}\sqrt{(\sigma_1 - \sigma_2)^2 + (\sigma_2 - \sigma_3)^2 + (\sigma_3 - \sigma_1)^2}$	Eq. S.35	590
$Mr_{psi} = A + B(R\text{-value})$	Eq. S.36	592
$S1 = R - 5 / 11.29 + 3$	Eq. S.37	592
$Mr = 10^{[(S1 + 18.72) / 6.24]}$	Eq. S.38	592
$k\text{-value} = p\Delta$	Eq. S.39	596

ACRONYMS COMMON TO CDOT

AADT	Annual Average Daily Traffic
AASHO	American Association of State Highway Officials (1914 – 1949)
AASHTO	American Association of State Highway and Transportation Officials (1950 - Present)
ASTM	American Society for Testing and Materials
ABC	Aggregate Base Course
ACI	American Concrete Institute
ACPA	American Concrete Pavement Association
ADT	Average Daily Traffic
AMC	Annual Maintenance Cost
ARA	Asphalt Rejuvenating Agent
ASR	Alkali Silica Reactivity
CAPA	Colorado Asphalt Pavement Association
CBR	California Bearing Ratio
CDOT	Colorado Department of Transportation
CFR	Code of Federal Regulations
CIR	Cold In-Place Recycling
CP	Colorado Procedure
CTB	Cement Treated Base
CPPP	Concrete and Physical Properties Program
DARWin™	Design Analysis and Rehabilitation for Windows
DTD	Division of Transportation Development

EATB	Emulsified Asphalt Treated Base
ESAL	Equivalent Single Axle Load
FASB	Foamed Asphalt Stabilized Base
FDR	Full Depth Reclamation
FHWA	Federal Highway Administration
FIR	Field Inspection Review
FOR	Final Office Review
FMM	Field Materials Manual
FWD	Falling Weight Deflectometer
HBP	Hot Bituminous Pavement
HIR	Hot In-Place Recycling
HMA	Hot Mix Asphalt
HMAP	Hot Mix Asphalt Pavement
IRI	International Roughness Index
JPCP	Jointed Plain Concrete Pavement
LCCA	Life Cycle Cost Analysis
LL	Liquid Limit
LS	Loss of Support
LTB	Lime Treated Base
LTPP	Long Term Pavement Performance
MMS	Maintenance Management System
MGPEC	Metropolitan Government Pavement Engineering Council
M_R	Resilient Modulus

MR	Modulus of Rupture
MUTCD	Manual on Uniform Traffic Control Devices
NMAS	Nominal Maximum Aggregate Size
N _{DES}	Recommended SuperPave™ Gyratory Design Revolution
NDT	Nondestructive Testing
NLPM	Network Level Pavement Manager
PCCP	Portland Cement Concrete Pavement
PDM	Pavement Design Manual
PG	Performance Grade
PI	Plasticity Index
PJR	Pavement Justification Report
PMBB	Plant Mix Bituminous Base
PMBP	Plant Mix Bituminous Pavement
PDPM	Pavement Design Program Manager
PM	Pavement Manager
PMS	Pavement Management System
PMSC	Plant Mix Seal Coat
PTSC	Pavement Type Selection Committee
PSI	Present Serviceability Index
PWF	Present Worth Factor
RAP	Reclaimed Asphalt Pavement
RCP	Reclaimed Concrete Pavement
RCC	Roller Compacted Concrete

RIC	Research Implementation Council
RME	Region Materials Engineer
RSL	Remaining Service Life
SHRP	Strategic Highway Research Program
SMA	Stone Matrix Asphalt
SN	Structural Number
TCP	Traffic Control Plan
VFA	Voids Filled With Asphalt
VMA	Voids in the Mineral Aggregate
WIMS	Weigh-In-Motion Station
WSN	Weighted Structural Number
WWF	Welded Wire Fabric

DESIGN OF PAVEMENT STRUCTURES DEFINITIONS

ADT (Current Year)

The average two-way daily traffic, in the number of vehicles, for the current year. The average 24-hour volume, being the total number during a stated period, divided by the number of days in that period. Unless otherwise stated, the period is a year. This term is commonly abbreviated as ADT.

ADT (Design Year)

The average two-way daily traffic for the future year used as a target in design.

AADT

The annual average two-way daily traffic volume. It represents the total traffic on a section of roadway for the year, divided by 365. It includes both weekday and weekend traffic volumes.

AAD-T

The annual average daily truck traffic volume. It represents the total truck traffic on a section of roadway for the year, divided by 365. It includes both weekday and weekend traffic volumes.

Analysis Period

The period of time for which the economic analysis is to be made. Ordinarily, the period will include at least one rehabilitation activity.

Approach Slab

Section of pavement just prior to joint, crack, or other significant roadway feature relative to the direction of traffic.

Arterial Highway

A highway primarily for through traffic, usually on a continuous route.

Asphalt Mix Design

The process and documentation of proportions of asphalt cement, mineral aggregate with the percentages of each component and size of particle that will result in a homogeneous mix and can be compacted into asphaltic concrete.

Asphalt Rejuvenating Agent (ARA)

A bituminous emulsion sprayed on new asphalt pavements to seal them from the adverse environmental effects of air and water. ARA is also used on dry, weathered asphalt pavements to give them new vitality and plasticity.

Asphalt Overlay

One or more courses of asphalt construction on an existing pavement. The overlay may include a leveling course, to correct the contour of the old pavement, followed by uniform course or courses to provide needed thickness.

At-Grade Intersection

An intersection where all roadways join or cross at the same level.

Axle Load

The total load transmitted by all wheels on a single axle extending across the full width of the vehicle. Tandem axles 40 inches or less apart will be considered as a single axle.

Base Course

The layer or layers of specified or selected material of designed thickness placed on a subbase or subgrade to support a surface course.

Bituminous

A term used to designate materials that are derived from petroleum, coal tar, etc.

Bituminous Surface Treatment

Alternate layers of bituminous binder material and stone chips.

Binder

Asphalt Cement used to hold stones together for paving.

Bleeding

A type of asphalt pavement distress identified by a film of bituminous material on the pavement surface that creates a shiny, glass-like, reflective surface that may be tacky to the touch in warm weather.

Block Cracking

The occurrence of cracks that divide the asphalt surface into approximately rectangular pieces, typically one square foot or more in size.

Blowup

The result of localized upward movement or shattering of a slab along a transverse joint or crack.

California Bearing Ratio (CBR) Test

An empirical measure of bearing capacity used for evaluating bases, subbases, and subgrades for pavement thickness design.

Cement Treated Base

A base consisting of a mixture of either mineral aggregate or granular soil and portland cement mixed and spread on a prepared subgrade to support a surface course.

Centerline

The painted line separating opposing traffic lanes.

Channels

A ditch or canal adjacent the roadway

Chipping

Breaking or cutting off small pieces from the surface.

Chip Seal

A seal coat consisting of the application of asphalt followed by a cover aggregate.

Cohesive Failure

The loss of a material's ability to bond to itself. Results in the material splitting or tearing apart from itself (i.e., joint sealant splitting).

Cold In-Place Recycled Pavement

A pavement rehabilitation process that consists of pulverizing the existing pavement to a depth of one inch or more, followed by reshaping and compaction. This operation may be performed with the addition of a stabilizer.

Composite Pavement

A pavement structure composed of an asphalt concrete wearing surface and portland cement concrete slab. An asphalt concrete overlay on a Portland Cement Concrete (PCC) slab is also called a composite pavement.

Control of Access

The condition where the right of owners or occupants of abutting land or other persons to access, light, air, or view in connection with a highway is controlled by a public authority.

Collector

A road of the intermediate functional category that collects traffic from the local roads to arterials or distributes traffic to local roads from arterials.

Concrete Overlay (Whitetopping)

The procedure for placing Portland Cement Concrete (PCC) overlays over existing Hot Mix Asphalt (HMA) pavements. Concrete Overlay may be either conventional, thin, or ultra-thin depending on the required thickness of the PCC overlay. In general, conventional Concrete Overlay uses 8 inches or greater:

- Thin Concrete Overlay uses greater than 4 but less than 8 inches.
- Ultra-Thin Concrete Overlay uses 4 inches or less thickness of PCC overlay.

Constant Dollars

Un-inflated dollars that represent the prevailing prices for all elements at the base year for the analysis.

Corner Break

A portion of a jointed concrete pavement separated from the slab by a diagonal crack intersecting the transverse and longitudinal joint, which extends down through the slab, allowing the corner to move independently from the rest of the slab.

Corrective Maintenance

Corrective maintenance could be a planned or unplanned strategy that restores the existing roadway to the intended design life. Typically, this process occurs within the first five years after construction..

Cross-Stitching

A Repair technique for longitudinal cracks and joints that are in reasonably good condition. The purpose of cross-stitching is to maintain aggregate interlock and provide added reinforcement and strength to the crack or joint. The technique uses deformed tie bars inserted into holes drilled across a crack at angles of 35-45 degrees depending upon the slab thickness.

Corrective Maintenance

Could be a planned or unplanned strategy that restores the existing roadway to the intended design life. Typically, this process occurs within the first five years after construction.

DARWin™

A software that performs the complex calculations for design and analysis of pavement structures. DARWin™ is an acronym for Design, Analysis, and Rehabilitation for Windows. Please use the latest version of the software, which is version 3.1

Deflection Analysis

The procedure used to establish pavement strength indices based on pavement deflections induced by a force.

Deformed Bar

A reinforcing bar for rigid slabs. Most often used to tie slabs together in the longitudinal direction across lane lines including tying travel lanes and shoulders.

Design Period

The number of years from initial construction or rehabilitation until terminal service life. This term should not be confused with pavement life or analysis period. By adding asphalt overlays as required, pavement life may be extended indefinitely, or until geometric considerations or other factors make the pavement obsolete. The initial design period is the number of years for which the volume and type of traffic and the resultant wheel or axle load application are forecast, and on which the pavement designs are calculated.

Design Traffic (18k ESAL)

The design traffic will be the total number of equivalent 18,000-lb single-axle load (18k ESAL) applications expected during the Design Period. This can be calculated or obtained from CDOT personnel at the Traffic Analysis Unit of the Division of Transportation Development.

Deterministic Life Cycle Cost Analysis

A traditional cost comparison process, where each item of interest is assigned a fixed, discrete value, usually a value most likely to occur based on historical data and user judgment. This value includes all costs over the life of the project, such as construction, maintenance, and rehabilitation adjusted to a present value.

Diamond Grinding

A process of improving a pavements ride by creating a smooth, uniform profile by removing faulting, slab warping, studded tire wear, and patching unevenness.

Discount Rate

A value in percent used for comparing the alternative uses of funds over a time period. The discount rate may be defined as the difference between the market interest rate and inflation rate using constant dollars over the analysis period.

Dowel

A load transfer device in a rigid slab, usually consisting of a plain, epoxy coated round steel bar. Most often used to provide load transfer between slabs in the transverse direction that are within the same lane.

Drainage Coefficients

Factors used to modify structural layer coefficients in flexible pavements or stresses in rigid pavements as a function of how well the pavement structure can handle the adverse effect of water infiltration.

Durability Cracking

The breakup of concrete due to freeze-thaw expansive pressures within certain aggregates. Also called “D” cracking.

Economic Analysis

A justification of the expenditure required and the comparative worth of a proposed improvement as compared to other alternate plans.

Economic Life

Economic life is the total useful life of a pavement structure including the extended service life gained when the initial pavement is supplemented by the addition of structural layers. It also defines the period of time beyond which further use is not economical.

Edge Cracking

Fracture and materials loss in pavements without paved shoulders which occurs along the pavement perimeter. Caused by soil movement beneath the pavement.

Embankment (embankment soil)

The prepared or natural soil underlying the pavement structure.

Emulsified Asphalt Treated Base

A base consisting of a mixture of mineral aggregate and emulsified asphalt spread on a subgrade to support a surface course.

Equivalence Factor

A numerical factor that expresses the relationship of a given axle load to another axle load in terms of their effect on the serviceability of a pavement structure. All axle loads are equated in terms of the equivalent number of repetitions of an 18,000-pound single axle.

Equivalent Single Axle Loads (ESALs)

The effect on pavement performance of any combination of axle loads of varying magnitude expressed in terms of the number of 18,000-lb single-axle loads required to produce an equivalent effect. This is calculated by summing the equivalent 18,000-pound single axle loads (18k ESALs) used to combine mixed traffic to design traffic for the Design Period. The value of 18k ESALs is obtained as an accumulative total from the beginning of use until and including the design year. The 18k ESAL is calculated by multiplying the annual design traffic volume by the Traffic Equivalence Factor (e) at a given terminal serviceability index (P_t)

Expansion Factor

A factor expressing the expected traffic growth trend on a particular section of highway.

Expressway

A divided arterial highway for through traffic with full or partial control of access and generally with grade separations at major intersections.

Fatigue Cracking

A series of small, jagged, interconnecting cracks caused by failure of the asphalt concrete surface under repeated traffic loading (also called alligator cracking).

Fault

Difference in elevation between opposing sides of a joint or crack.

Flexible Pavement

A pavement structure of which the surface course is made of asphaltic concrete, that maintains intimate contact with and distributes loads to the subbase or subgrade and depends upon aggregate interlock, particle friction, and cohesion for stability.

Foamed Asphalt Stabilized Base

A base consisting of wet unheated aggregates and asphalt cement mixed while the asphalt cement is in a foamed state.

Fog Seal

A seal coat consisting of the application of diluted asphalt emulsion without an aggregate cover.

Free Edge

Pavement border that is able to move freely.

Freeway

An expressway with full control of access and all at-grade intersections eliminated.

Full Depth Asphalt

A pavement structure consisting of one and only one layer that is asphaltic concrete. There is no base, subbase, or intermediary layer of gravel between the asphaltic concrete layer and the subgrade.

Full Depth Reclamation

A rehabilitation technique in which the full thickness of asphalt pavement and a predetermined portion of the underlying materials (base, subbase and/or subgrade) is uniformly pulverized and blended to provide an upgraded, homogeneous base material. This new stabilized base course may be used for an asphalt or concrete wearing surface.

Functional Deficiency

Any condition that adversely affects the roadway user. These include poor surface friction and texture, hydroplaning and splash from wheel path rutting, and excess surface distortion.

Functional Maintenance is a planned strategy of low cost treatments that are meant to sustain the roadway and its appurtenances in a manner that delivers a condition in order to keep traffic moving.

Grade Separation

A crossing of two highways, or a highway and a railroad, at different levels.

Granular Base

A base consisting of mineral aggregate laid and compacted on a subbase or subgrade to support a surface course.

Grooving

Grooving restores skid resistance to concrete pavements. It increases the surface friction and surface drainage capabilities of a pavement by creating small longitudinal or transverse channels that drain water from underneath the tire, reducing the hydroplaning potential.

Hairline Crack

A fracture that is very narrow in width, less than 0.125 inches (3 mm).

Hinged Joint

A joint between two rigid pavement slabs in which flexure is permitted but separation and vertical displacement of abutting rigid slabs are prevented by metal ties and mechanical or aggregate interlock.

Hot Mix Asphalt

High quality, thoroughly controlled hot mixture of AC (binder) and high quality aggregate, which can be compacted into a uniform mass, to act as a surface course and carry traffic. Stone Matrix Asphalt (SMA) and Polymer Modified Asphalt (PMA) are both types of HMA. In historic documents, HMA may also be referred to as Plant Mixed Bituminous Pavement and Hot Bituminous Pavement.

Hot Bituminous Pavement

A combination of mineral aggregate and bituminous material, mixed in a central plant, laid and compacted while hot, to act as a surface course and carry traffic. Hot Bituminous Pavement is an older designation usage. Also known as Plant Mixed Bituminous Pavement, see Hot Mix Asphalt for current designation.

Hot In-Place Recycled Pavement - Heater Remixing

A pavement rehabilitation process that consists of reworking the existing pavement with a heating device, reshaping, and compaction. This operation may be performed with or without the addition of a rejuvenating agent, aggregates, or new asphalt mix.

Hot In-Place Recycled Pavement – Heater Repaving

A pavement rehabilitation process that consists of reworking the existing pavement with a heating device. During the lay down process of the old rejuvenated material a virgin lift will be added reshaped and compacted.

Hot In-Place Recycled Pavement – Heater Scarifying

A pavement rehabilitation process that consists of reworking the existing pavement with a heating device. A rejuvenating agent will be added to the old mix reshaped and compacted.

Hveem Stabilometer

A device for the measurement of the lateral pressure transmitted by a soil or aggregate being subjected to a vertical load. The pressure obtained is used to compute the R-value, which is the internal resistance or the internal friction property of a bituminous pavement or a base. The data obtained is used to compute the relative stability.

Hydroplaning

To skid on wet pavement because water on the pavement causes the tires to lose contact with it.

Joint Seal Damage

Any distress associated with the joint sealant, or lack of joint sealant.

Keyway

A groove on either vertical or horizontal face of a concrete slab. A keyway is often molded in concrete structures. A keyway molded on a vertical face of a concrete slab will provide interlock and load transfer to an adjacent slab. A keyway molded on a horizontal face of a concrete structure will provide interlock and resist horizontal movement of a concrete structure molded over the keyway.

Lane Factor

Factors used to convert total 18k ESAL to Design Lane 18k ESAL given the number of lanes.

Lane to shoulder drop-off

The difference in elevation between the traffic lane and shoulder.

Lane to shoulder Separation

Widening of the joint between the traffic lane and the shoulder.

Lime-Treated Base

A base consisting of a mixture of soil, hydrated lime and water, usually mixed in place and placed to support a pavement structure, or the components thereof.

Load Transfer Device

A mechanical means designed to carry loads across a joint in a rigid slab.

Local Street or Local Road

A street or road primarily for access to residence, business, or other abutting property.

Longitudinal

Parallel to the pavement centerline.

Maintenance

The preservation of the entire roadway, including surface, shoulders, roadsides, structures, and such traffic control devices as are necessary for its safe and efficient utilization.

Major Rehabilitation

Pavement treatments that consist of structural enhancements that extend the serviceable life of an existing pavement and improve its load-carrying capability.

Map Cracking

A series of interconnected hairline cracks in portland cement concrete pavements that extend only into the upper surface of the concrete. Includes cracking typically associated with alkali-silica reactivity (ASR).

Mechanistic-Empirical Pavement Design Guide

The guide, and its accompanying software, provides a uniform basis for the design of flexible, rigid, and composite pavements, using mechanistic-empirical approaches that more realistically characterize in-service pavements and improve the reliability of designs.

Micro-surfacing

A seal coat consisting of the application of polymer modified emulsion followed by a cover of aggregates selected for properties of hardness and angularity.

Minor Rehabilitation

Pavement treatments consisting of functional or structural enhancements made to the existing pavement sections to improve pavement performance or extend serviceable life.

Modulus of Elasticity (E)

A measure of the rigidity of a material and its ability to distribute loads defined by the ratio of strain to stress in a portland cement concrete pavement slab.

Modulus of Subgrade Reaction (k-value)

Westergard's modulus of subgrade reaction for use in rigid pavement design (the load in pounds per square inch on a loaded area of the roadbed soil or subbase divided by the deflection, in inches, of the roadbed soil or subbase), psi/in. The modulus of subgrade reaction is the supporting capability of a soil measured by its ability to resist penetration of a series of loaded stacked plates.

Modulus of Rupture (S'_c)

The modulus of rupture of portland cement concrete pavement is an index of the flexural strength of the portland cement concrete pavement. It is a measure of the extreme fiber stress developing under slab bending, the mode in which most concrete pavements are loaded. The modulus of rupture required by the design procedure is the mean value determined after 28 days using third-point loading (AASHTO T97).

Nominal Maximum Aggregate Size

One sieve size larger than the first sieve to retain more than 10 percent of the material" (Roberts et al., 1996).

Overlays

- a. **Leveling Course:** The layer of material placed on an existing paved surface to eliminate irregularities prior to placing an overlay or a surfacing course. Milling procedures are to be considered the primary method to address rutting and are to be used instead of a leveling course to remove ruts whenever possible.
- b. **Overlaying Course:** Surfacing Course, either plant mixed or road mixed, placed over an existing pavement structure, after placement of a leveling course, as appropriate.

Partial Depth Reclamation

A rehabilitation technique, in which a portion of the asphalt pavement is pulverized, mixed with a stabilizing agent and then placed back on the remaining pavement surface. Partial depth reclamation is limited to correcting only those distresses that are surface problems in the asphalt layer.

Patch

An area where the pavement has been removed and replaced with a new material.

Patch Deterioration

Distress occurring within a previously repaired area.

Pavement

The part of roadway having a constructed surface for the facilitation of vehicular movement.

Pavement Design (design, structure design)

The specifications for materials and thickness of the pavement components.

Pavement Joints

The designed vertical planes of separation or weakness. Complete details of concrete pavement joints are given in the Standard Specifications and the Division's Standard Plans "M & S" Standards.

Joints used in portland cement concrete pavement are:

- a. Construction Joints:** Joints made necessary by a prolonged interruption in placing of concrete. They are formed by placing concrete up to one side of a planned joint and allowing it to set before the concrete is placed on the other side of the joint. They may be either longitudinal or transverse.
- b. Contraction Joints:** Joints placed either transversely at recurrent intervals or longitudinally between traffic lanes to control cracking.
- c. Expansion Joints:** Transverse joints located to provide for expansion without damage to themselves, adjacent slabs, or structures.
- d. Relief Joints at Bridges:** Joints placed between two PCCP slabs in bridge structure(s) to relieve stresses and strains.
- e. Weakened Plane Joints (Longitudinal and Transverse):** Weakened plane joints are placed both longitudinally and transversely in PCCP. CDOT specifies using a saw to cut the weakened planes at T/3 in PCCP.

Pavement Maintenance

Typically, these treatments are preventive in nature and are intended to keep the pavement in serviceable condition. They may be classified as corrective, preventive, reactive or functional.

Pavement Management

Pavement management is the evaluation, documentation, and analysis of the amount, quality and type of pavement under the responsibility of any given owner or agency. It is also the planning and budgeting for the upkeep and replacement of paved assets.

Pavement Performance

The trend of serviceability with load applications.

Pavement Rehabilitation

Work undertaken to extend the service life of an existing facility. This includes placement of additional surfacing material and/or completing any other work necessary to return an existing roadway, including shoulders, to a condition of structural or functional adequacy. This could include the complete removal and replacement of the pavement structure.

Pavement Structure

The combination of subbase, base course, and surface course placed on a prepared subgrade to support the traffic load and distribute it to the roadbed.

Pavement Section

A layered system designed to distribute concentrated traffic loads to the subgrade. Performance of the pavement structure is directly related to the physical properties of the subgrade soils and traffic loadings. Most soils can be adequately represented for pavement design purposes by means of the soil support value for flexible pavements and a modulus of subgrade reaction for rigid pavements.

Performance Period

The period of time that the initially constructed or rehabilitated pavement structure will last (perform) before reaching its terminal serviceability. This is also called the design period.

Permeability

The property of soils, which permits the passage of any fluid. Permeability depends on grain size, void ratio, shape, and arrangement of pores.

Plant Mixed Bituminous Base

A base consisting of mineral aggregate and bituminous material, mixed in a central plant, laid and compacted while hot, on a subbase or a subgrade, to support a surface course.

Plant Mixed Bituminous Pavement

A combination of mineral aggregate and bituminous material, mixed in a central plant, laid and compacted while hot, to act as a surface course and carry traffic. Plant Mixed Bituminous Pavement is an older designation usage. Also known as Hot Bituminous Pavement, see Hot Mix Asphalt for current designation.

Plant Mixed Seal Coat

A seal coat consisting of a combination of mineral aggregate and bituminous material mixed in a central plant, laid and compacted while hot.

Polished Aggregate

Surface mortar and texturing worn away to expose coarse aggregate in the concrete.

Popouts

Small pieces of pavement broken loose from the surface.

Pothole

A bowl-shaped depression in the pavement surface.

Prepared Roadbed

In place roadbed soils compacted or stabilized according to provisions of applicable specifications.

Present Serviceability Index (PSI)

A number derived by formula for estimating the serviceability rating from measurements of certain physical features of the pavement.

Preventive Maintenance

Preventive maintenance is a planned strategy of cost-effective treatments performed on an existing roadway system and its appurtenances that preserves the system, retards future deterioration, and maintains or improves the functional condition of the system without significantly increasing the structural capacity.

Prime Coat

Bituminous material used on aggregate base courses to provide good adhesion to the Hot Mix Asphalt layer placed above.

Probabilistic Life Cycle Cost Analysis

A process where probabilistic LCCA inputs are described by probability functions that convey both the range of likely inputs and the likelihood of their occurrence. Probabilistic LCCA also allows for the simultaneous computation of differing assumptions for many different variables. Probabilistic LCCA allow the value of individual data inputs to be defined by a frequency (probability) distribution.

Pumping

The ejection of foundation material, either wet or dry, through joints or cracks, or along edges of rigid slabs resulting from vertical movements of the slab.

Punchout

A localized area of a continuously reinforced concrete pavement bounded by two transverse cracks and a longitudinal crack. Aggregate interlock decreases over time and eventually is lost, which leads to steel rupture, and allows the pieces to be punched down into the subbase and subgrade.

Raveling

The wearing away of the pavement surface caused by the dislodging of aggregate particles.

Reactive Maintenance

Reactive maintenance is an unplanned, therefore, unscheduled; sometime immediate treatments performed on an existing roadway system and its appurtenances that is necessary to avoid serious consequences.

Reconstruction

Treatments requiring full removal and replacement and or improvement of the existing pavement structure which includes subbase, base course, and surface course due to pavement condition and structural capabilities. LCCA is required. Typical AASHTO criteria are addressed and design is to current standards.

Reflection Cracking

The fracture of asphalt concrete above joints in the underlying pavement layer(s).

Reinforcement

Steel embedded in a rigid slab to resist tensile stresses and detrimental opening of cracks.

Reliability

The probability, expressed as a percentage that a pavement structure will carry the traffic for which it is designed over the design or analysis period.

Remaining Service Life (RSL)

The remaining service life is the number of years a pavement is expected to last until maintenance and rehabilitation treatments no longer improve or maintain the surface condition.

Resilient Modulus (M_R)

A measure of the modulus of elasticity of roadbed soil or other pavement material.

Resilient Modulus (M_r)

In the M-E Design, the subgrade resilient modulus M_r is measured at optimum moisture content and density. This M_r is different than the AASHTO 1993 empirical design procedure which was basically a “wet of optimum” M_r . The input M_r is then internally adjusted to field conditions by the M-E Design software on a month to month basis based on water table depth, precipitation, temperature, soil suction and other factors.

Rigid Pavement

A pavement structure of which the surface course is made of portland cement concrete.

Rigid Slab

A section of portland cement concrete pavement bounded by joints and edges, designed for continuity of flexural stress.

Roadbed

The graded portion of a highway within top and side slopes, prepared as a foundation for the pavement structure and shoulder.

Roadbed Material

The material below the pavement structure in cuts and embankments, and in embankment foundations, extending to such depth as affects the support of the pavement structure.

Roadway

The portion of a highway, including shoulders, for vehicular use.

Roundabout

A circular intersection with yield control of all entering traffic, channelized approaches, counter-clockwise circulation, and appropriate geometric curvature to ensure that travel speeds on the circulatory roadway are typically less than (30 mph).

Rutting

Longitudinal surface depressions in the wheel paths.

Sand Seal

A seal coat consisting of the application of asphalt emulsion followed by a sand cover aggregate.

Scaling

The deterioration of the upper 0.125 to 0.5 inches of the concrete surface, resulting in the loss of surface mortar.

Seal Coat

A thin treatment consisting of bituminous material, usually with cover aggregate, applied to a surface as an armor coat or for delineation. The term includes but is not limited to sand seal, chip seal, slurry seal, and fog seal.

Service Life

The service life is the number of years a pavement is expected to last from completion of construction until pavement failure.

Serviceability

The ability, at the time of observation, of a pavement to serve traffic using the facility. Also, serviceability is a pavement's ability to provide adequate support and a satisfactory ride at any specific time.

Serviceability Index

The Serviceability Index is a number that is indicative of the pavement's ability to serve traffic at any specific time in its life.

Shoving

Permanent, longitudinal displacement of a localized area of the pavement surface caused by traffic pushing against the pavement.

Single Axle Load

The total load transmitted by all wheels whose centers may be included between two parallel transverse vertical planes 40 inches apart, extending across the full width of the vehicle.

Skid Hazard

Any condition that might contribute to making a pavement slippery when wet.

Slot Stitching

A technique for repairing longitudinal cracks or joints. Slot-stitching is an extension of the more recent dowel bar retrofit technique, which is used to add dowel bars to existing transverse joints. The purpose of slot-stitching is to provide positive mechanical interconnection between two slabs or segments. The deformed bars placed in the slots hold the segments together serving to maintain aggregate interlock and provide added reinforcement and strength to the crack or joint. These bars also prevent the crack or joint from vertical and horizontal movement or widening. Larger diameter bars (>25mm) (>1 inch) also serve to provide long-term load transfer capabilities.

Slurry Seal

A seal coat consisting of a semi fluid mixture of asphaltic emulsion and fine aggregate. This type of seal is usually placed in very thin course of $\frac{1}{8}$ to $\frac{1}{4}$ inches.

Soil Support Value

A number that expresses the relative ability of a soil or aggregate mixture to support traffic loads through the pavement structure.

Spalling

Cracking, breaking, chipping, or fraying of the concrete slab surface within 2 feet of a joint or crack.

Squeegee Seal

A seal coat similar to a sand seal, consisting of the application of asphalt emulsion and sand. The application of a squeegee seal differs from that of a sand seal in that a surface drag is used to spread the emulsion to seal cracks.

Stabilometer R-Value

A numerical value expressing the measure of a soil's or aggregate's ability to resist the transmission of vertical load in a lateral or horizontal direction. A test for evaluating bases, subbases, and subgrades for pavement thickness design. Measured with a stabilometer.

Standard Normal Deviate (Z_R)

The standard normal deviate is a statistical value identical to Z-scale value used in the standard normal distribution. It is a measure of the deviation of any observations from the mean of all observations expressed in terms of the number of standard deviations. The standard normal deviate, Z can be calculated from the equation, $Z = (\text{observed value} - \text{mean of all observed values}) / \text{standard deviation of all observations}$. Each calculated Z value corresponds to a certain level of significance, confidence interval, certainty or reliability value in a standard normal distribution curve.

Stone Matrix Asphalt (SMA)

A mixture of crushed coarse aggregate, crushed fine aggregate, mineral filler, asphalt cement, and stabilizing agent typically used as a wearing course. A stabilizing agent is used to prevent drain down of the asphalt cement and typically consists of fibers, polymers, or limestone dust (powder).

Structural Deficiency

Any condition that adversely affects the load carrying capability of the pavement structure. These include inadequate thickness as well as cracking, distortion, and disintegration. Several types of distress (i.e., distress was caused by poor construction techniques, low temperature cracking) are not initially caused by traffic loads, but do become more severe under traffic, to the point that they also detract from the load carrying capability of the pavement.

Structural Layer Coefficient (a_1, a_2, a_3)

The empirical relationship between structural number (SN) and layer thickness that expresses the relative ability of a material to function as a structural component of the pavement and express the relative strength of a layer in a pavement structure.

Structural Number (SN)

An index derived from an analysis of traffic, roadbed soil conditions, and environment that may be converted to thickness of flexible pavement layers by using suitable structural layer coefficients related to the type of materials being used in each layer of the pavement structure.

Subbase

The layer or layers of specified or selected material of designed thickness placed on a subgrade to support a base course. Subgrade treated with lime, fly ash, cement kiln dust, or combination thereof stabilization will be considered subbase.

Subgrade

The top surface of a roadbed upon which the pavement structure and shoulders are constructed

Surface Course

The uppermost component of a pavement structure designed to accommodate the traffic load, the top layer of which resists skidding, traffic abrasion, and the disintegrating effects of climate. The top layer is also sometimes called the wearing course.

Surface Life

A period of time where treatments can be performed on a pavement that maintain or improve the surface condition.

Tack Coat

A light application of emulsified asphalt applied to an existing asphalt or portland cement concrete pavement surface. It is used to ensure a bond between the surface being paved and the overlaying course. Typically 0.10 gal/yd² of diluted CSS1h.

Tandem Axle Load

The total load transmitted to the road by two consecutive axles whose centers may be included between parallel vertical planes spaced more than 40 inches and not more than 96 inches apart, extending across the full width of the vehicle.

Tie Bar

A deformed steel bar or connector embedded across a longitudinal joint for a rigid slab to prevent separation of abutting slabs.

Tining

A process by which it is achieved by a mechanical device equipped with a tining head (metal rake) that moves laterally across the width of the paving surface.

Treated Base

A layer of base material stabilized with asphalt, Portland cement or other suitable stabilizers.

Traffic Equivalence Factor (e)

A numerical factor that expresses the relationship of a given axle load to another axle load in terms of their effect on the serviceability of a pavement structure. All axle loads are equated in terms of the equivalent number of repetitions of an 18k ESAL single axle.

Transverse

Perpendicular to the pavement centerline.

Triple Axle Load

The total load transmitted to the road by three consecutive axles whose centers may be included between parallel planes spaced more than 40 inches and no more than 96 inches apart, extending across the full width of the vehicle.

Water Bleeding

Seepage of water from joints or crack.

Weathering

The wearing away of the pavement surface caused by the loss of asphalt binder.

Weigh-In-Motion (WIM) Station

The process of measuring the dynamic tire forces of a moving vehicle and estimating the corresponding tire loads of the static vehicle.

Welded Wire Fabric (WWF)

A two-way reinforcement system for rigid slabs, fabricated from cold-drawn steel wire, having parallel longitudinal wires welded at regular intervals to parallel transverse wires. The wires may be either smooth or deformed.

Whitetopping (old definition)

The procedure for placing Portland Cement Concrete (PCC) overlays over existing Hot Mix Asphalt (HMA) pavements. Whitetopping may be either conventional, thin, or ultra-thin depending on the required thickness of the PCC overlay. In general, conventional whitetopping uses 8 inches or greater:

- Thin Whitetopping uses greater than 4 but less than 8 inches.
- Ultra-Thin Whitetopping uses 4 inches or less thickness of PCC overlay.

MECHANISTIC-EMPIRICAL (M-E) PAVEMENT DESIGN BASIC DEFINITIONS

These definitions may be slightly different from the definitions stated above. These basic definitions are to agree with the usage as in the Mechanistic-Empirical (M-E) Pavement Design Guide. Some have been modified to clarify this manual's notation.

Basic Definitions of the Roadway

Roadbed

The graded portion of a highway between top and side slopes, prepared as a foundation for the pavement structure and shoulder.

Surface Course

One or more layers of a pavement structure designed to accommodate the traffic load, the top layer of which resists skidding, traffic abrasion, and the disintegrating effects of climate. The top layer of flexible pavements is sometimes called the "wearing" course.

Base

Base - The layer or layers of specified or select material of designed thickness placed on a subbase or subgrade to support a surface course. The layer directly beneath the PCC slab is called the base layer.

- *Aggregate Base* - A base course consisting of compacted mineral aggregates. Also, granular base, unbound granular base.
- *Asphalt Concrete Base* - Asphalt concrete used as a base course. Also, asphalt base course, asphalt-stabilized base - hot-mixed, asphalt-treated base (ATB), bituminous aggregate base, bituminous concrete base, bituminous base, hot-mixed asphalt base, and plant mix bituminous base (PMBB).
- *Cold Mix Asphalt* - Asphalt concrete mixtures composed of aggregate and/or asphalt emulsions or cutback asphalts, which do not require heating during mixing. Also, emulsified asphalt treated base (EAT).
- *Permeable Aggregate Base* - A crushed mineral aggregate base treated or untreated having a particle size distribution such that when compacted the interstices will provide enhanced drainage properties. Also, granular drainable layer, untreated permeable base, free-draining base, and stabilized treated permeable base.
- *Asphalt Treated Permeable Base* - A permeable base containing a small percentage of asphalt cement to enhance stability. Also, asphalt-treated open-graded base, asphalt-treated base - permeable.

- *Cement Treated Base (CTB)* - A base course consisting of mineral aggregates blended in place or through a pugmill with a small percentage of Portland cement to provide cementitious properties and strengthening. Also, aggregate cement, cement-stabilized graded aggregate, cement-stabilized base.
- *Lean Concrete Base* - A base course constructed of mineral aggregates plant mixed with a sufficient quantity of Portland cement to provide a strong platform for additional pavement layers and placed with a paver.
- *Lime-Fly Ash Base* - A blend of mineral aggregate, lime, fly ash and water, combined in proper proportions and producing a dense mass when compacted.
- *Cement Treated Permeable Base* - An open-graded aggregate base treated with Portland cement to provide enhanced base strength and reduce erosion potential.

Subbase

The layer or layers of specified or selected materials of designed thickness placed on a subgrade to support a base course. **Note:** The layer directly below the PCC slab is now called a base layer, not a subbase layer. Also, granular subbase and unbound granular subbase.

Subgrade

- *Subgrade* - The top surface of a roadbed upon which the pavement structure and shoulders are constructed.
- *Select Material* - A suitable native material obtained from a specified source, such as a particular roadway cut or borrow area, having specified characteristics to be used for a specific purpose.
- *Soil Cement* - A mechanically compacted mixture of soil, Portland cement, and water, used as a layer in a pavement system to reinforce and protect the subgrade or subbase. Also, cement-treated subgrade (CTS).
- *Lime Stabilized Subgrade* - A prepared and mechanically compacted mixture of hydrated lime, water, and soil supporting the pavement system that has been engineered to provide structural support.

Fabric Layers

- *Geosynthetics* - A planar material manufactured from a polymeric material used with soil, rock, earth or other geotechnical-related materials and serve six primary functions: filtration, drainage, separation, reinforcement, fluid blockage, and protection. Typical geosynthetics include geotextiles, geomembranes, and geogrids.
- *Geotextiles* - Permeable fabric made of textile materials used as filters to prevent soil migration, separators to prevent soil mixing and as reinforcement to add shear strength to a soil.

- *Geomembranes* - Impermeable polymer sheeting used as fluid barriers to prevent migration of liquid pollutants in soil.
- *Geogrids* - Polymeric grid material having relatively high tensile strength and a uniformly distributed array of large apertures (openings). The apertures allow soil particles on either side to come in direct contact, thereby increasing the interaction between the geogrid and surrounding soils. Used primarily for reinforcement.

ESTIMATING FORMULAS, CALCULATIONS, AND CONVERSION FACTORS

Estimating Formulas

Diluted emulsified asphalt at 0.10 gal./sq. yd. (diluted) (slow setting)

Bituminous pavement at 110 lbs./sq. yd./1" thickness

Aggregate Base Course (Class 6) at 133 lbs./cu. ft.

Aggregate Base Course (Class 2) at 133 lbs./cu. ft.

Filter material at 110 lbs./cu. ft.

Hydrated lime at: 26.4 lbs./sq. yd./ 8 in. depth at 4% lime

39.6 lbs./sq. yd./12 in. depth at 4% lime = 4.4 lb/cu. ft.

59.4 lbs./sq. yd./12 in. depth at 6% lime

Asphalt Rejuvenating Agent at 0.15 gal./sq. yd. (diluted)

Asphalt Rejuvenating Agent at 0.15 gal./sq. yd. (Non-Diluted Asphalt Rejuvenating Agent for use with item 404- Heater and Scarifying Treatment)

Micro-Surfacing Seal Coat at 35 lbs./sq. yd. (Based on an average rut depth of 3/4")

Quantities of crack sealant were estimated based on the level of cracking and the following ratios.

The quantities shown here are for information only.

Heavy	2 tons per lane mile
Medium	1 ton per lane mile
Light	0.5 ton per lane mile
Very light	0.25 ton per lane mile

Conversion Factors

1 ton = 0.90718 metric ton

1 lb/cu. ft = 16.018 Kg/cu. meter

1 psi/in. = 0.271 kpa/mm

0.10 gal./sq. yd. = 0.453 L/sq. Meter

0.15 gal./sq. yd. = 0.70 L/sq. Meter

110 lbs/sq. yd./one inch = 2.34 kg/sq. meter/25.4 millimeter

110 lbs/cu. ft. = 1762 kg./cu. Meter

133 lbs/cu. ft. = 2130 kg/cu. meter

2 inches = 50.8 mm or 50 mm (rounded for pavement design)

4 inches = 101.6 mm or 100 mm (rounded for pavement design)

1/2 inch = 12.7 mm or 12.5 (rounded for pavement design)

A U.S. gallon (determined by fluid volume at 72 deg. F, at sea level) of fresh water weighs exactly 8.3452641 lbs.

Incentive/Disincentive Calculations

$$I/DP = (PF - 1)(QR)(UP)(W/100)$$

Where:

I/DP	=	Incentive/Disincentive Payment
PF	=	Pay Factor
QR	=	Quantity in Tons of HMA Represented by the Process
UP	=	Unit Bid Price of Asphalt Mix
W	=	Element Factor from Table 105-2

When AC is paid for separately UP shall be:

$$UP = [(Ton_{HMA})(UP_{HMA}) + (Ton_{AC})(UP_{AC})]/Ton_{HMA}$$

Where:

Ton _{HMA}	=	Tons of Asphalt Mix
UP _{HMA}	=	Unit Bid Price of Asphalt Mix
Ton _{AC}	=	Tons of Asphalt Cement
UP _{AC}	=	Unit Bid Price of Asphalt Cement

For the joint density element:

$$UP = UPHMA$$

Where: UP_{HMA} is as defined above.

When AC is paid for separately UP shall be:

$$UP = [(BTon_{HMA})(BUP_{HMA}) + (BTon_{AC})(BUP_{AC})]/BTon_{HMA}$$

Where:

BTon _{HMA}	=	Bid Tons of Asphalt Mix
BUP _{HMA}	=	Unit Bid Price of Asphalt Mix
BTon _{AC}	=	Bid Tons of Asphalt Cement
BUP _{AC}	=	Unit Bid Price of Asphalt Cement

CHAPTER 1 INTRODUCTION

1.1 Introduction

The Colorado Department of Transportation (CDOT) has adopted the AASHTO Interim Mechanistic-Empirical Pavement Design Guide (MEPDG) Manual of Practice for pavement design and analysis along with the AASHTOWare Pavement M-E Design software, otherwise called the M-E Design software. The M-E Design software uses the methodology and pavement design models described in the AASHTO Interim MEPDG Manual of Practice. The pavement design models in the M-E Design software were calibrated and validated using extensive Colorado pavement performance data.

This manual presents the following information to assist CDOT pavement design engineers to perform pavement designs using the AASHTO Interim MEPDG Manual of Practice and the M-E Design software:

- An overview of the AASHTO Pavement M-E Design procedure.
- An overview of the M-E Design software
- Guidelines for obtaining all needed inputs for design/analysis.
- Guidance to perform pavement design/analysis using the software.
- Examples of pavement design using the Design Guide software.

This guidance will assure adequate strength and durability to carry the predicted traffic loads for the design life of each project. Alternative designs (flexible and rigid) should be considered for each project, as appropriate, for the specific project conditions. The final design should be based on a thorough investigation of specific project conditions, projected traffic, life-cycle economics, and on the performance of comparable projects with similar structural sections under similar conditions.

1.2 Scope and Limitations

1.2.1 Limitations

Design of the pavement structure includes the determination of the thickness of subbases, bases, and surfacing to be placed over subgrade soils. An important aspect of this design is the selection of available materials that are most suited to the intended use. Their grouping in horizontal layers under the pavement, from poorer layers on the bottom to better layers on the top, should be such that the most benefit will be derived from the inherent qualities of each material. In establishing the depth of each layer, the objective is to provide a minimum thickness of overlying material that will reduce the unit stress on the next lower layer commensurate with the load-carrying capacity of the material within that layer.

The design of the roadbed cross-section is not an exact science. With many variables to be correlated, reducing the problem to exact mathematical terms so commonly applied to structures is extremely difficult. Present practice, as discussed herein, stems from mechanistic procedures and empirical relationships developed from test tracks and other pavement experiments as well as the observation of pavements under service throughout the state. Research continues on this subject, and current design methods may, therefore, be subject to frequent modification.

1.2.2 Scope

Pavement structure sections, except for experimental construction for research, are to be designed using methods or standards described in **Table 1.1 Recommended Pavement Design Procedures**. Although the M-E Design allows pavement design and analysis of seventeen pavement types including new flexible, new rigid, flexible and rigid overlays; however, not all of these pavement types have been calibrated for Colorado conditions. Furthermore, this design procedure does not include performance prediction models for thin and ultra-thin Concrete Overlay designs. Designers are advised as much as possible follow recommendations presented in **Table 1.1 Recommended Pavement Design Procedures** for selecting appropriate pavement design/analysis methodology for a given pavement type.

Table 1.1 Recommended Pavement Design Procedures

Pavement Type	Design Methodology	
	CDOT 2016 Pavement M-E Design Manual	CDOT 2014 Pavement Design Manual (18k ESAL Design)
New HMA	✓	
Flexible Overlays of Existing HMA	✓	
Flexible Overlays of Existing Rigid	✓	
New Rigid	✓	
PCC Overlays of Existing Rigid	✓	
Thin and Ultrathin Concrete Overlay		✓
Concrete Pavement Restoration	✓	
Flexible Pavement for Intersections	✓	
Rigid Pavement for Intersections	✓	

1.3 Overview of AASHTO Pavement Mechanistic-Empirical Design Procedure

The AASHTO Pavement M-E Design Procedure is based on **mechanistic-empirical** design concepts. This means that the design procedure calculates pavement responses such as stresses, strains, and deflections under axle loads and climatic conditions and then accumulates the damage over the design analysis period. The procedure then empirically relates calculated damage over time to pavement distresses and smoothness based on performance of actual projects in Colorado. More details are found in the following documents:

- AASHTO. Mechanistic-Empirical Pavement Design Guide, A Manual of Practice, July 2008, Interim Edition, American Association of State Highway and Transportation Officials, Washington, DC, 2008.
- AASHTO. Guide for the Local Calibration of the Mechanistic-Empirical Pavement Design Guide, November 2010, American Association of State Highway and Transportation Officials, Washington, DC, 2010.
- NCHRP 1-37A Project. 2002 Design Guide: Design of New and Rehabilitated Pavement Structures. National Cooperative Highway Research Program. National Academy of Sciences, DC, 2004.

The pavement design computations using the M-E Design procedure and software are an **iterative process** as shown in the flowchart in **Figure 1.1 M-E Design Process**. The software provides:

- A user interface to input design variables.
- Computational models for month by month analysis and performance prediction.
- Results and outputs from the analyses for decision making.
- Outputs in both PDF and EXCEL formats suitable for use in design reports.

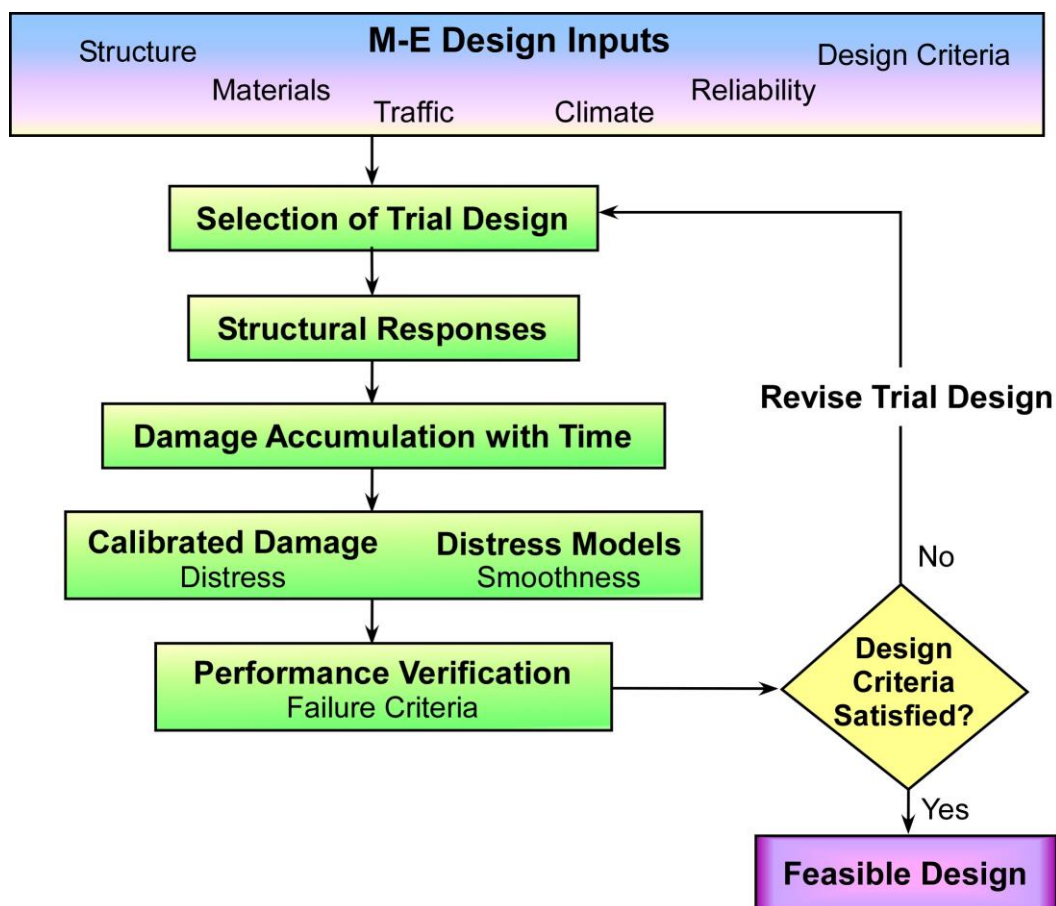

Figure 1.1 M-E Design Process

The design iterative process with the M-E Design procedure involves the following key steps:

1. The designer develops a trial design and obtains all inputs.
2. The software computes the traffic, climate, damage, key distresses (fatigue cracking, rutting, joint faulting, etc.), and International Roughness Index (IRI) over the design life on a month by month basis (2 week basis for HMA pavement).
3. The predicted performance (distress and IRI) over the design life is compared to the design performance criteria at a desired level of design reliability. Does the design Pass or Fail to meet the design reliability for each distress and IRI?
4. The design may be modified as needed to meet performance and reliability requirements. DARWin-ME has the ability to iterate on design thickness until all of the performance and reliability criteria are met.

1.4 Overview of AASHTOWare Pavement M-E Design Software

The AASHTOWare Pavement M-E Design software is a production-ready software tool for performing pavement designs using the methodology described in the AASHTO MEPDG Manual of Practice. The M-E Design software performs a wide range of analysis and calculations in a rapid, easy to use format. With its many customized features, the M-E Design software will help simplify the pavement design process and result in improved, cost-effective designs. The following subsections provide a brief overview of the process involved in installing, uninstalling and running the M-E Design software.

A very detailed and comprehensive user manual for the M-E Design software is available with the software. Since the details of this process are likely to change over time, they are not repeated here. The HELP document can be easily obtained in two ways:

- From Windows Start menu click All Programs and then select AASHTO DARWin-ME folder (see **Figure 1.2 Location of M-E Design Software HELP Document**).
- Press F1 key after opening the software (see **Figure 1.3 M-E Design Software Default Window** and **Figure 1.4 M-E Design Software HELP Document**).

1.4.1 Installing M-E Design Software

For more information on installing the M-E Design software files, minimum software requirements, licensing agreements, contact CDOT IT System Administrator or refer to the M-E Design software HELP document.

1.4.2 Uninstalling M-E Design Software

Never just delete the various files of the M-E Design software. Always uninstall the software using the procedure the M-E Design software HELP document. For more information on

uninstalling the M-E Design software files, contact CDOT IT System Administrator or refer to the M-E Design software HELP document.

Note: This process does not remove the “hcd” (weather station files) under the folder. This folder must be manually deleted if desired. If existing old MEPDG weather station files exist it is recommended to remove all of these and download the new weather stations.

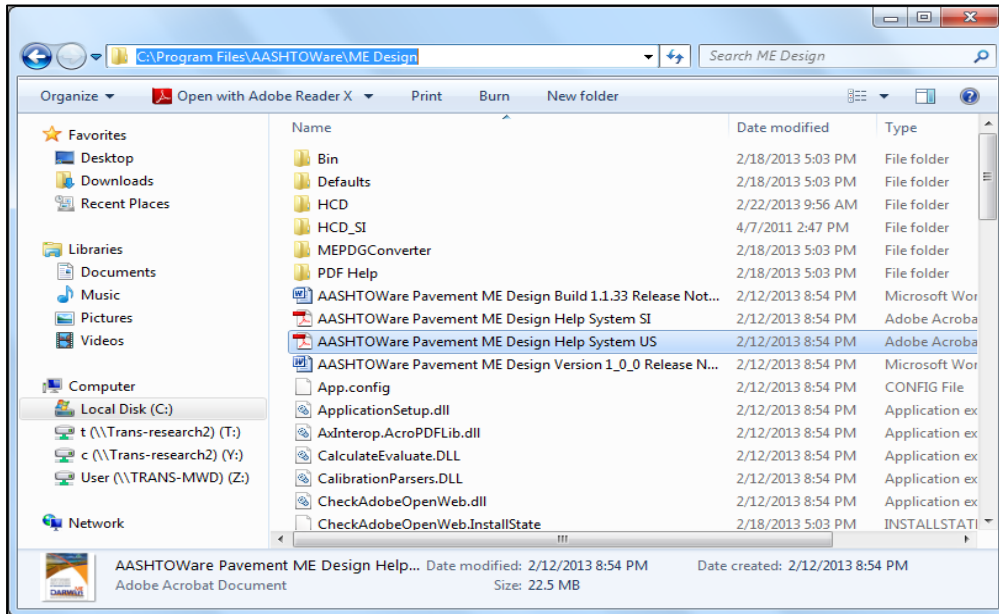

Figure 1.2 Location of M-E Design Software HELP Document

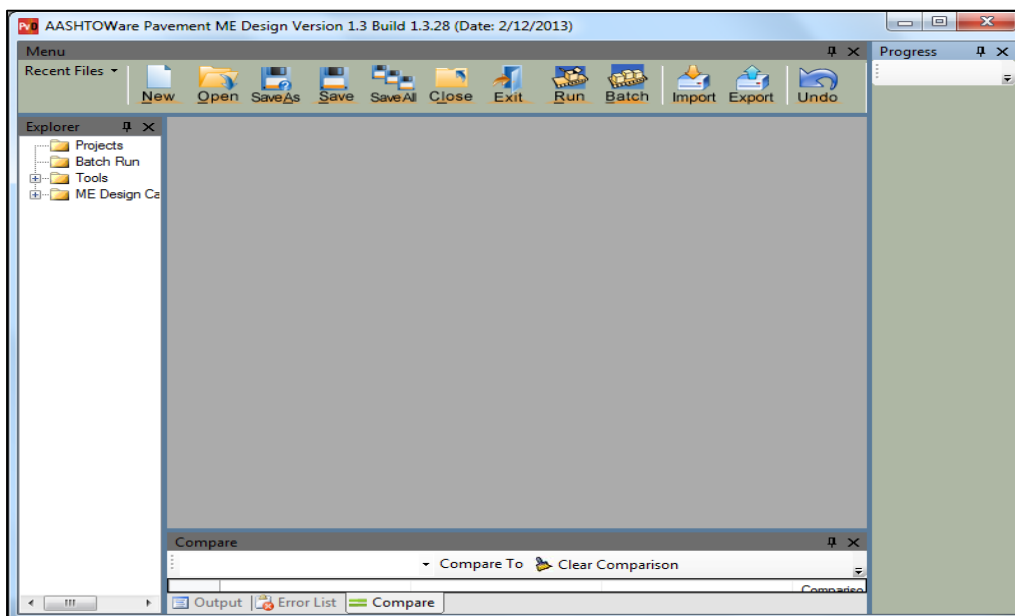

Figure 1.3 M-E Design Software Default Window

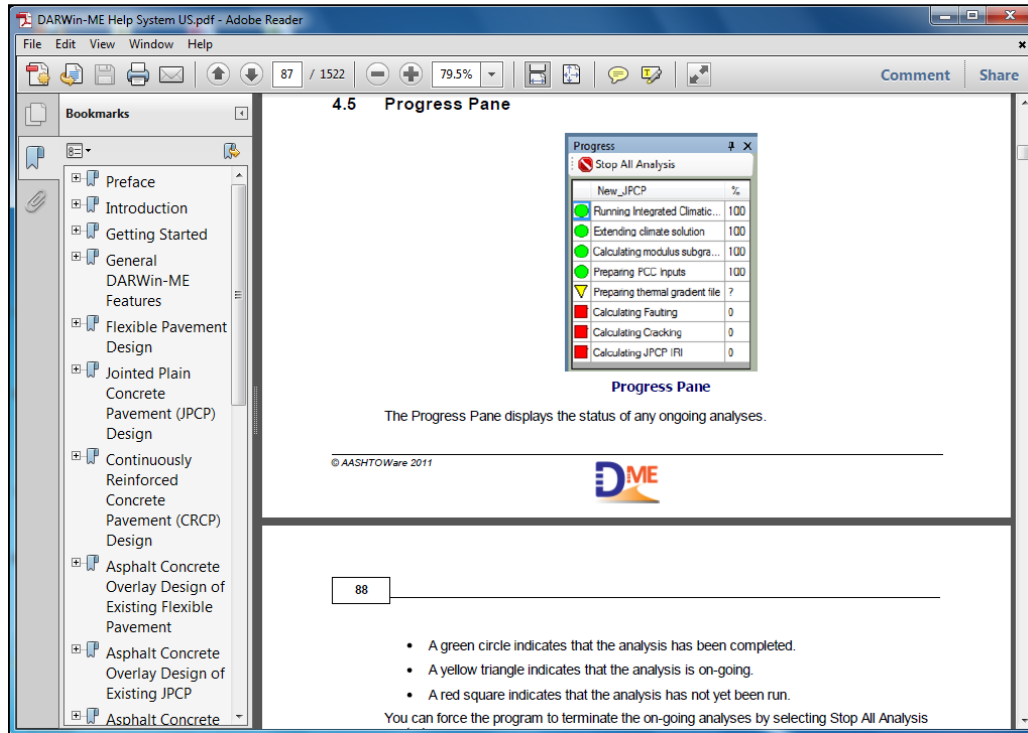

Figure 1.4 M-E Design Software HELP Document

1.4.3 Running M-E Design Software

A M-E Design program will be added to your Windows Start menu during installation and an icon will be added to the PC desktop.

Click the Start button in the bottom left corner of your screen to find the M-E Design software:

1. Go to the Programs option to see a list of folders and programs.
2. Select the DARWin-ME folder and click on the design guide icon.

The program can also be run by double-clicking the *M-E Design* icon on the desktop. The software opens with a splash screen shown in **Figure 1.5 M-E Design Software Splash Screen**. A new file must be opened for each new project, much like opening a new file for each document on a word processor or other standard Windows applications. However, a maximum of ten projects can be opened together by clicking “*Open*” menu in M-E Design and selecting ten projects (see **Figure 1.6 Open M-E Design Projects**). Select “*New*” from the menu of the tool bar to open a new project. A typical layout of the program is shown in **Figure 1.7 M-E Design Software Main Window** and **Figure 1.8 M-E Design Software Project Tab**.

The user first provides the general project information and then inputs three main categories: Traffic, Climate, and Structure. All inputs for the software program are color coded as shown in **Figure 1.9 M-E Design Software Color-coded Inputs to Assist User Input Accuracy**. Input

screens that require user entry of data are coded red. Those that have default values but not yet verified and accepted by the user are coded yellow. Default inputs that have been verified and accepted by the user or when the user enters design-specific inputs are coded green. The program will not run until all input screens are either yellow or green.

The user may choose to run the analysis by clicking on the “Run” button after all inputs are provided for the trial design. The software executes the damage analysis and the performance prediction engines for the trial design input when this is done. The user can view input and output summaries created by the program when the execution of the run is complete. The program creates a summary of all inputs of the trial design. It also provides an output summary of the distress and performance prediction in both tabular and graphical formats. All charts are plotted in both PDF and Microsoft Excel and can be easily incorporated into electronic documents and reports.



Figure 1.5 M-E Design Software Splash Screen

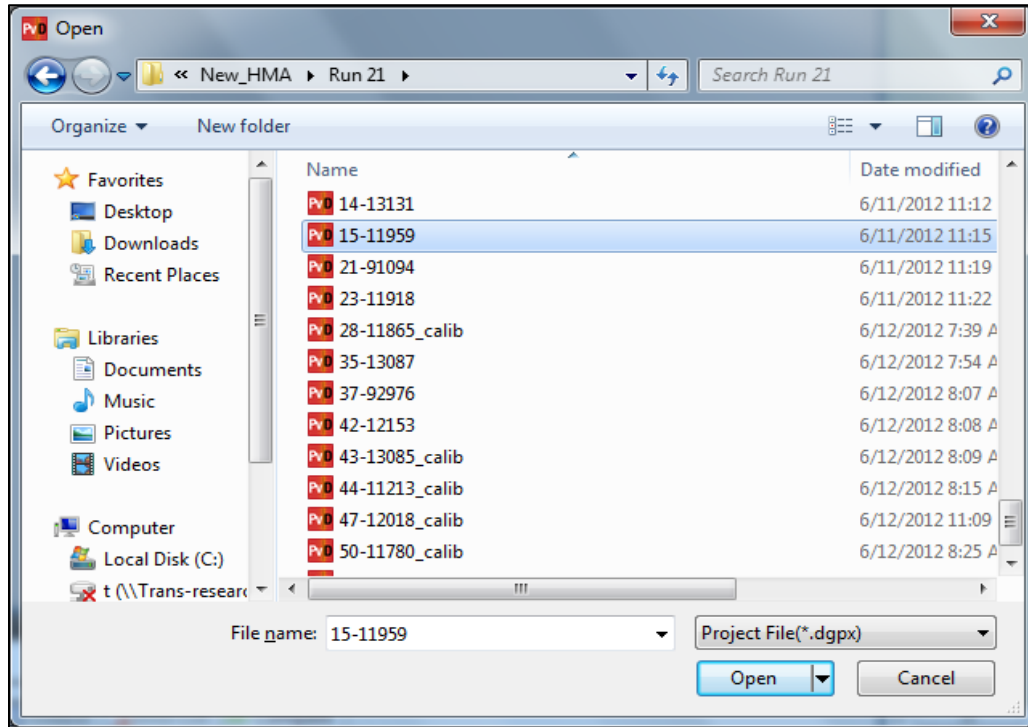

Figure 1.6 Open M-E Design Projects

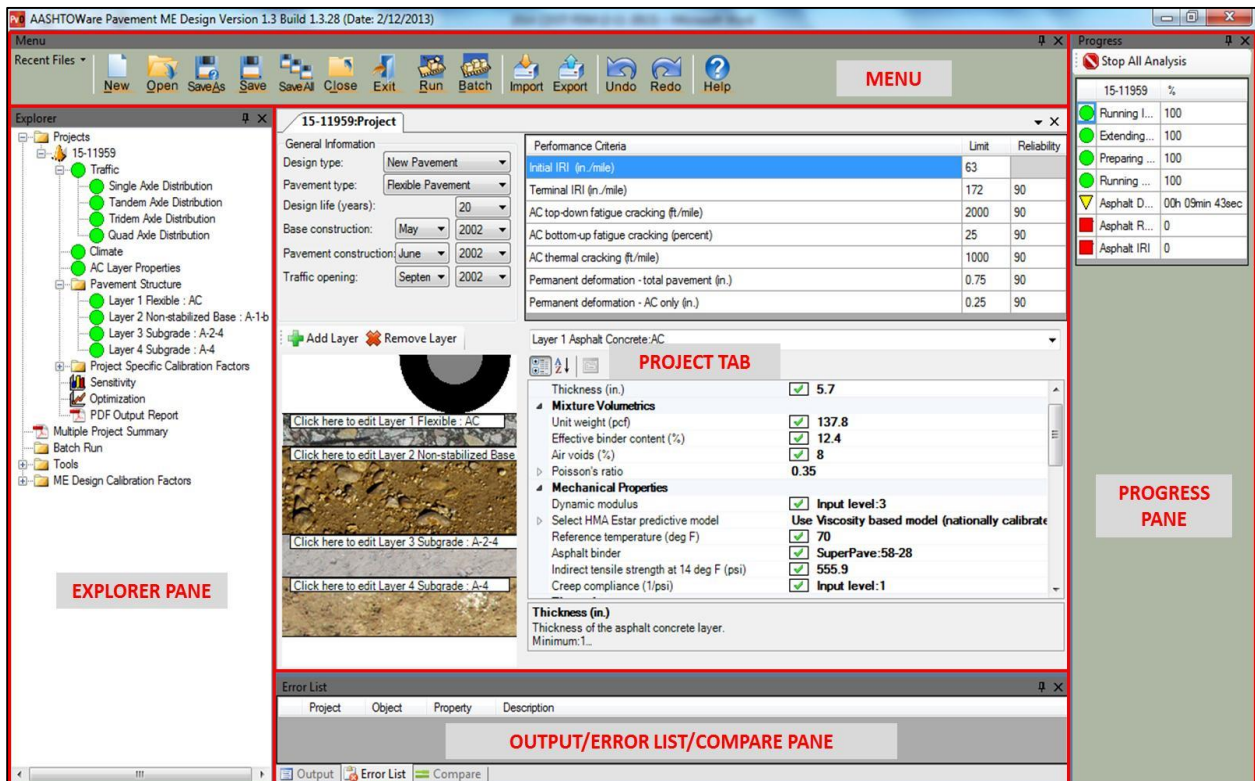

Figure 1.7 M-E Design Software Main Window

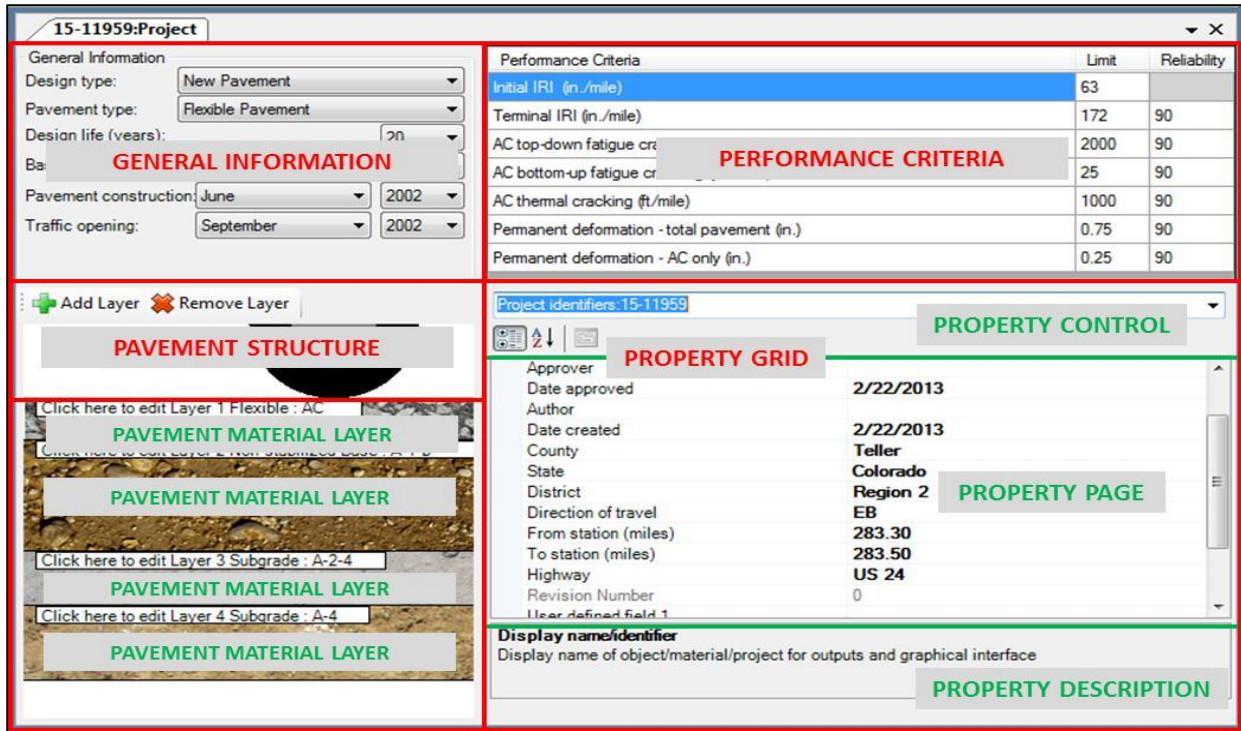

Figure 1.8 M-E Design Software Project Tab

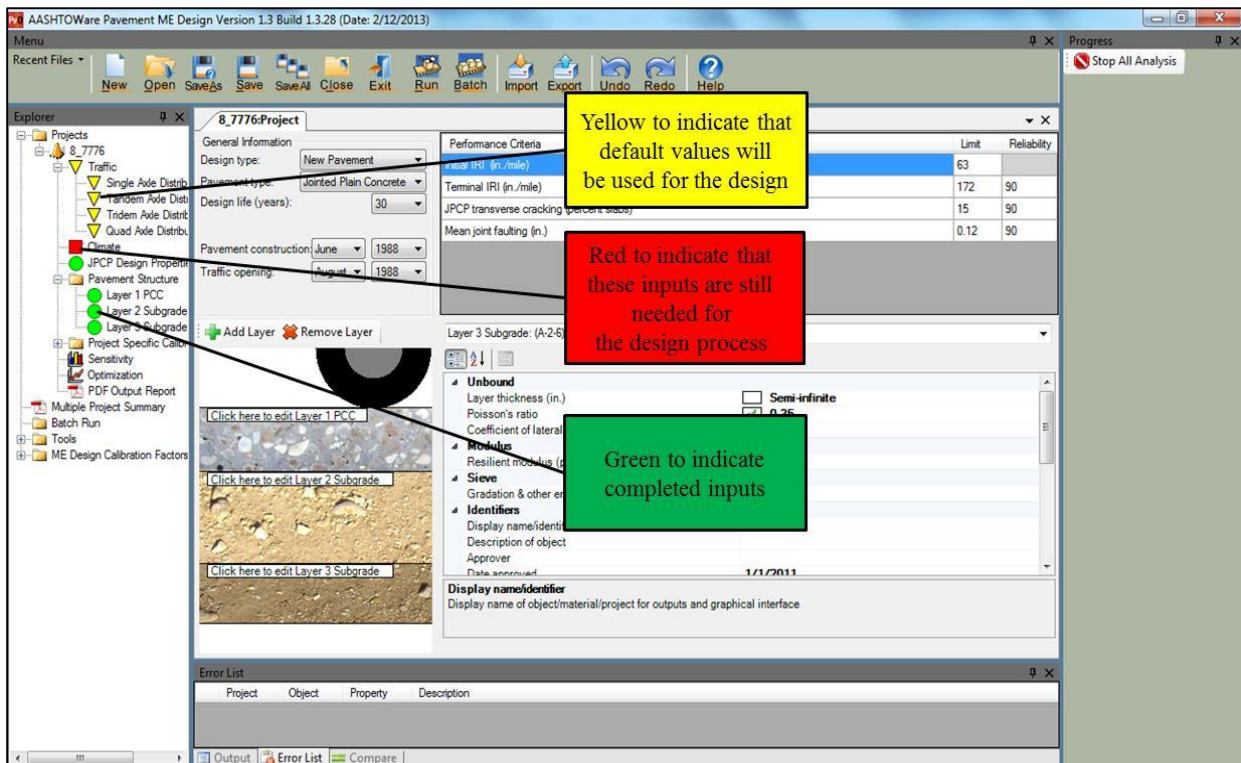

Figure 1.9 M-E Design Software Color-coded Inputs to Assist User Input Accuracy

1.5 Working with M-E Design Database

ME Design now includes an enterprise option for saving, searching, and loading projects utilizing a relational database. This feature allows users to store and retrieve data at varying degrees of granularity, from entire projects down through data from individual objects such as pavement layers, materials, traffic, climate, backcalculation, etc. This section briefly describes how to set up a ME Design database in both MS SQL and ORACLE environments.

Download and Access Instructions

Blank ME Design databases for MS SQL and Oracle can be found from Database Resource Documents section at <http://www.me-design.com/>. The user must have a valid user name and password to access the website. The login credentials will be supplied by AASHTO at the time of software purchase.

Database Installation

The following sections describe the installation process for creating a blank ME Design database.

Installation Requirements

The requirements for installing and creating a ME Design database are as follows:

- A user with administrative privileges on the target machine will be required to set up the ME Design database
- The maximum size of the ME Design database shall be no greater than 10GB
- Oracle 10g Release 2 or Microsoft SQL Server 2005 or later versions of either
- Microsoft SQL Server 2005 Express or later editions of MS SQL Server Express
- Oracle Client 10g Release 2 or greater (contains the Oracle Provider for OLEDB)

Once the database is installed, the user can open the ME Design software and select “Open ME Design with database connection” check box (see **Figure 1.10 M-E Design Software Splash Screen Showing Database Login Location**).

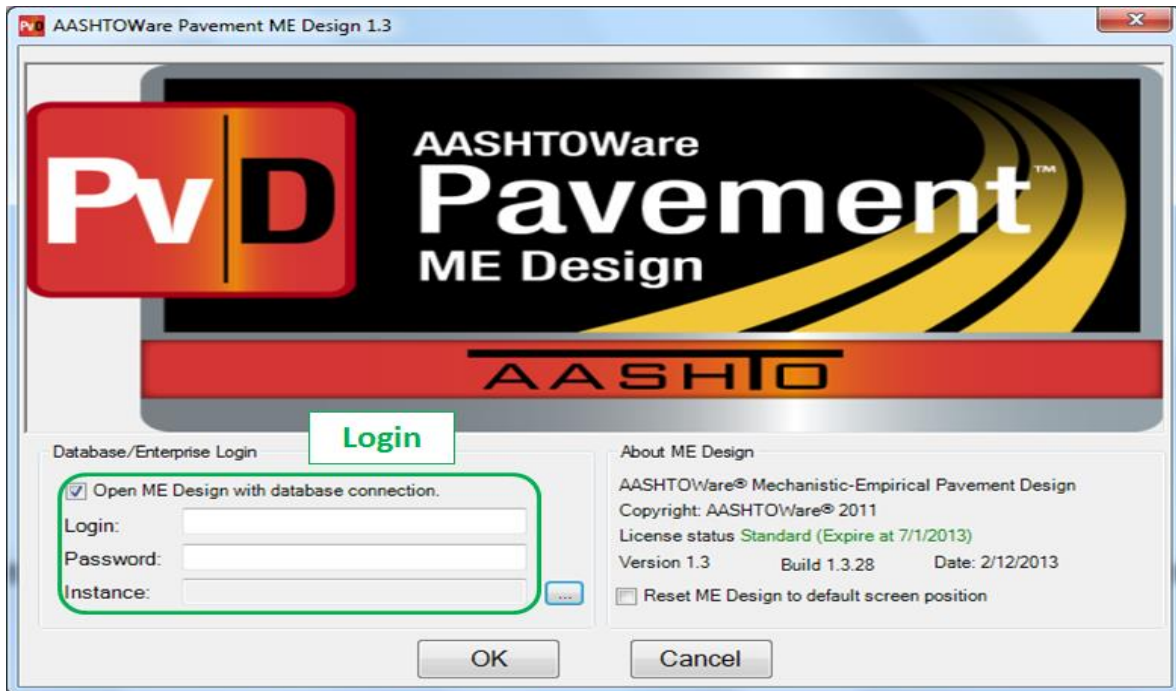

Figure 1.10 M-E Design Software Splash Screen Showing Database Login Location

Enter the Login name and Password supplied by the CDOT IT department to access ME Design database (see **Figure 1.11 M-E Design Software Splash Screen Showing Database Login Information**).

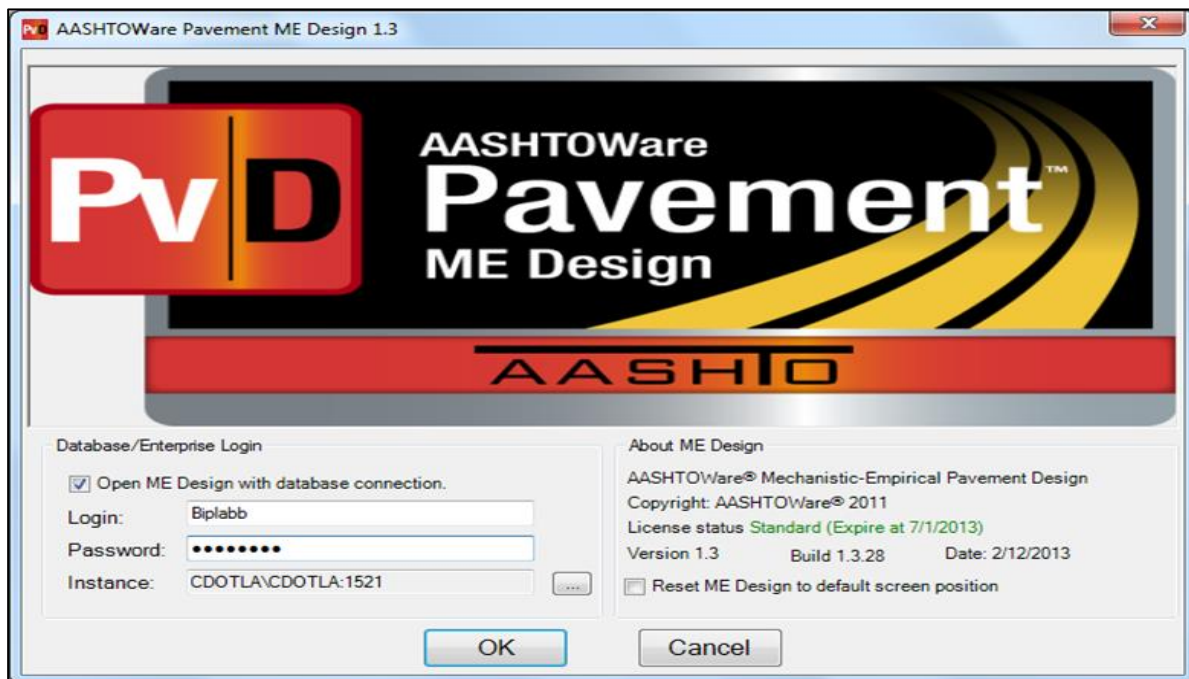

Figure 1.11 M-E Design Software Splash Screen Showing Database Login Information

1.5.1 Saving to M-E Design Database

This section will discuss how to save ME Design elements to the database. It will also highlight the differences in how the elements are saved on each screen and supply screenshots for each example. Note that in order for the “Save to Database” option to be available, the user must connect to a ME Design database during the login process.

Saving Projects

When a user saves a project, all elements of the project are saved in the database. If any of the project elements have an error, then the user will be informed of the error with a message box and will be asked to correct it before continuing. There are two ways to save a project to the database, (1) right click on the project name under the “Projects” node and select “Save to Database” (see **Figure 1.12 Saving an Entire Project to M-E Design Database (Option 1)**) or (2) click to highlight the project name under the “Projects” node and click “Insert” icon on the menu bar across the top of the application (see **Figure 1.13 Saving an Entire Project to M-E Design Database (Option 2)**).

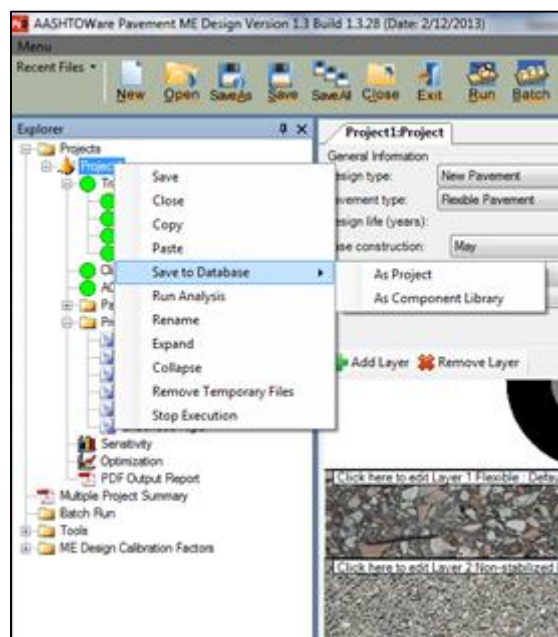

Figure 1.12 Saving an Entire Project to M-E Design Database (Option 1)

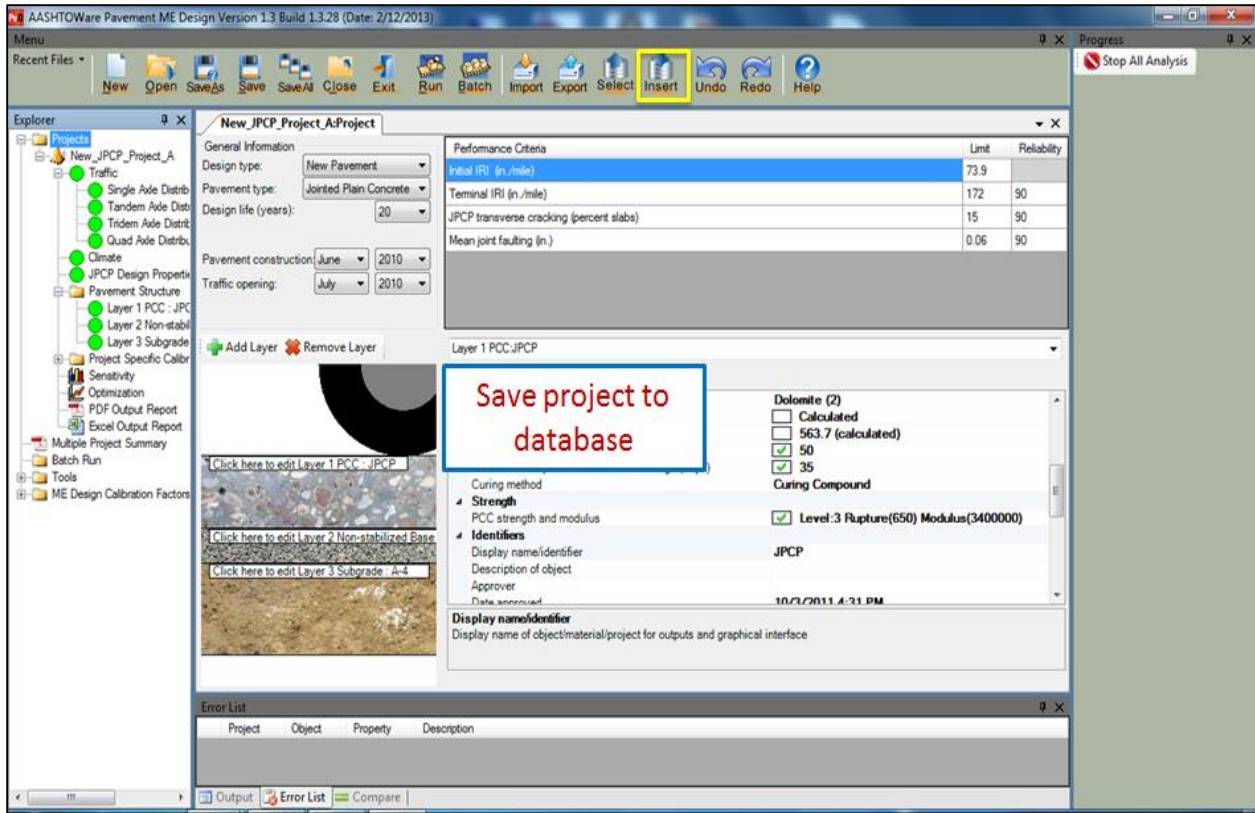

Figure 1.13 Saving an Entire Project to M-E Design Database (Option 2)

If the project contains no errors the message, “Project Inserted Successfully” will pop up (see **Figure 1.14 Window Showing Successful Project Save**). Click OK to close the message box.

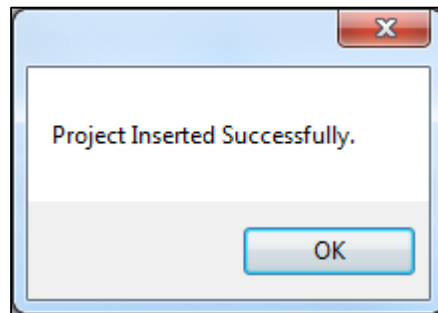

Figure 1.14 Window Showing Successful Project Save

Once a project is saved to the database, the project cannot be saved again under the same name. Only project elements can be “saved over” (updated) once they exist in the database. To change the “Display name/Identifier” of your project right click on the project title in the Explorer pane and select “Rename” (see **Figure 1.15 Changing the Project Display Name/Identifier**). Choose a new name for your project and then right click on the project in the Explorer again and select “Save to Database”. The project will now save with the new name.

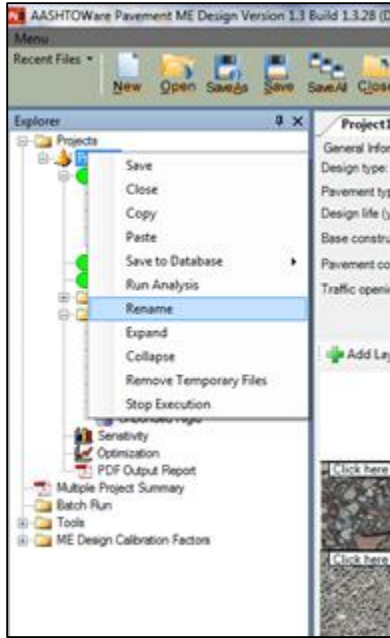

Figure 1.15 Changing the Project Display Name/Identifier

Saving Project Elements

Saving project elements is similar to the steps described in Saving Projects. Project elements include but are not limited to the following:

- Traffic
 - Single Axle Distribution
 - Tandem Axle Distribution
 - Tridem Axle Distribution
 - Quad Axle Distribution
- Climate
- Any layers added under “Pavement Material Layers” node
- Backcalculation

There is one primary difference between saving a project (in its entirety) and saving elements within the project. Unlike projects, project elements can be saved over and over again without having to modify any element identifiers. This means if the user saves a project element such as “Traffic”, makes changes to it, and wishes to save it again, then it will update the correct project with the new traffic information (instead of creating a new one).

All the elements described above have a “Save to Database” method associated with them, with a few special cases for traffic and its associated elements. The traffic element provides two unique saving methodologies. Right clicking on the “Traffic” node and selecting “Save to Database” will save information under the “Traffic” node only (see **Figure 1.16 Saving Traffic Data**).

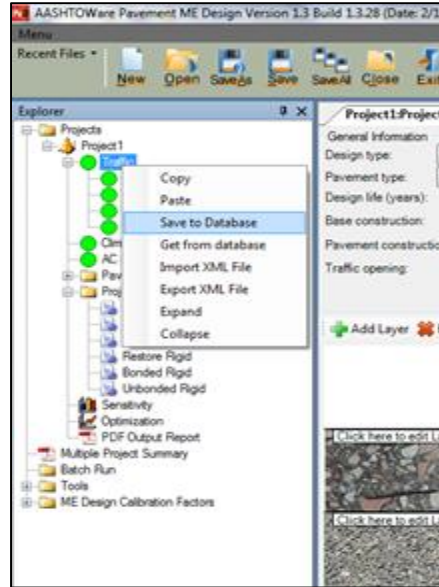

Figure 1.16 Saving Traffic Data

The user may also elect to double click on the “Traffic” node which will open the traffic interface. The user can then right click on any of the views within the interface (Vehicle Class Distribution and Growth, Monthly Adjustment, or Axles Per Truck) and select “Save to Database” to save the applicable traffic element to the database (see **Figure 1.17 Saving Specific Traffic Elements**). **Note this is the only way to save these particular traffic elements independently, as they do not appear in the Explorer tree.**

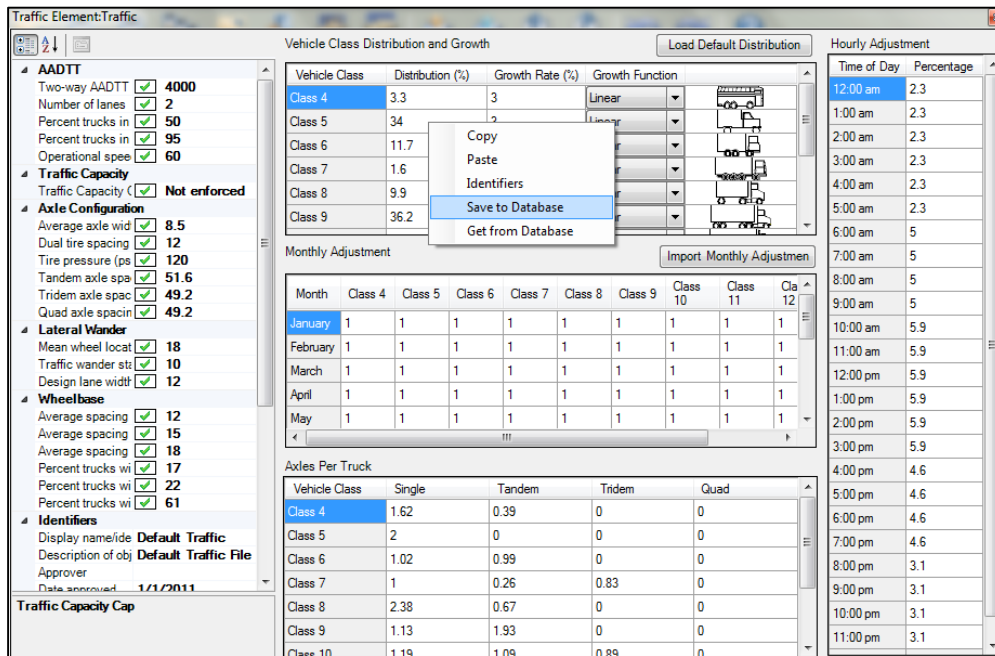

Figure 1.17 Saving Specific Traffic Elements

In contrast, saving any one of the axle load elements automatically saves all the others as well.

Figure 1.18 Saving Axle Load Distribution Elements shows how to save axle load distribution elements in ME Design database.

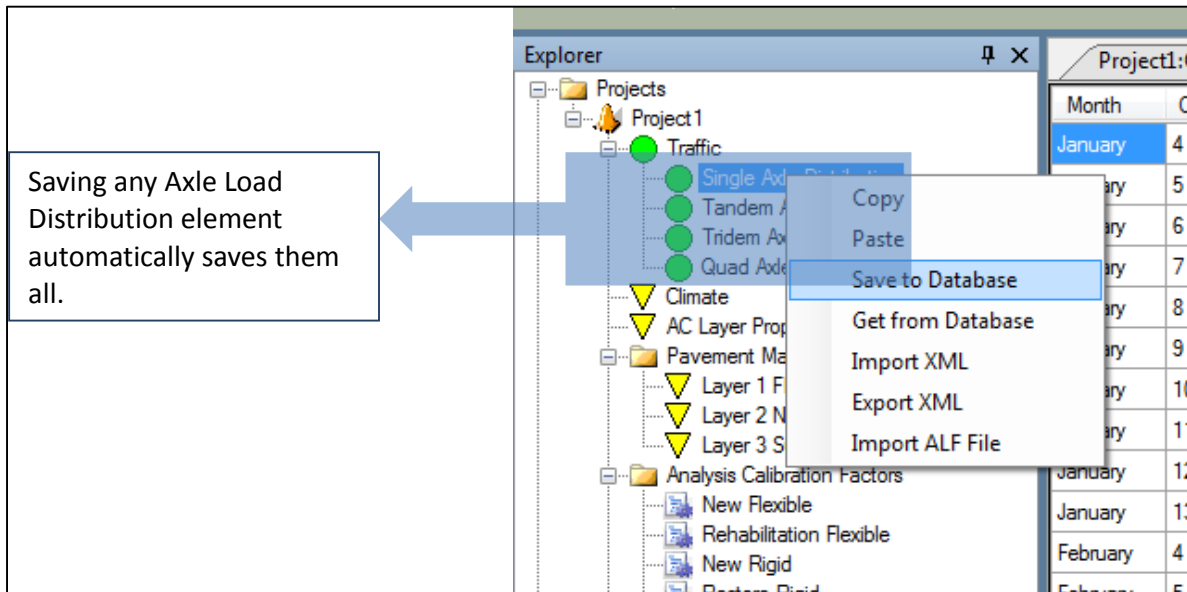

Figure 1.18 Saving Axle Load Distribution Elements

If the axle load distribution contains no errors the message, “Axle Load inserted successfully” will pop up (see **Figure 1.19 Window Showing Successful Axle Load Distribution Save**). Click OK to close the message box.

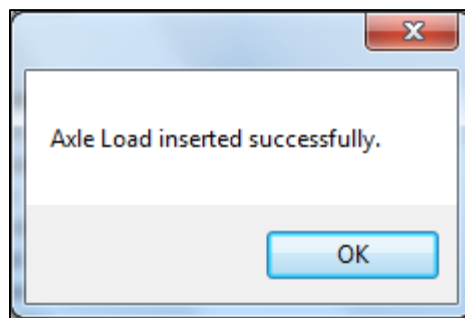

Figure 1.19 Window Showing Successful Axle Load Distribution Save

However, if the user receives the following error message shown in **Figure 1.20 Error Saving Axle Load Distribution** while saving the project element then either the user needs to change the existing name of the element/project they are trying to save, or needs to fill in the Display Name/Identifier field for the element.

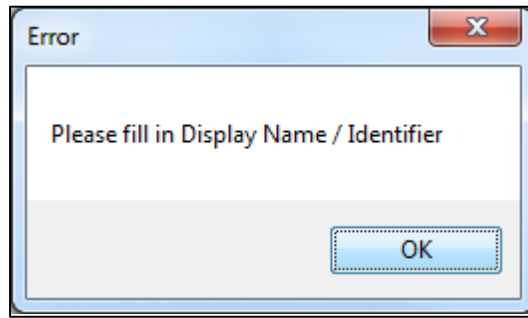

Figure 1.20 Error Saving Axle Load Distribution

So, this means the user needs to open the axle load distribution interface, right click and select Identifiers (see **Figure 1.21 Defining Identifiers for Axle Load Distribution**).

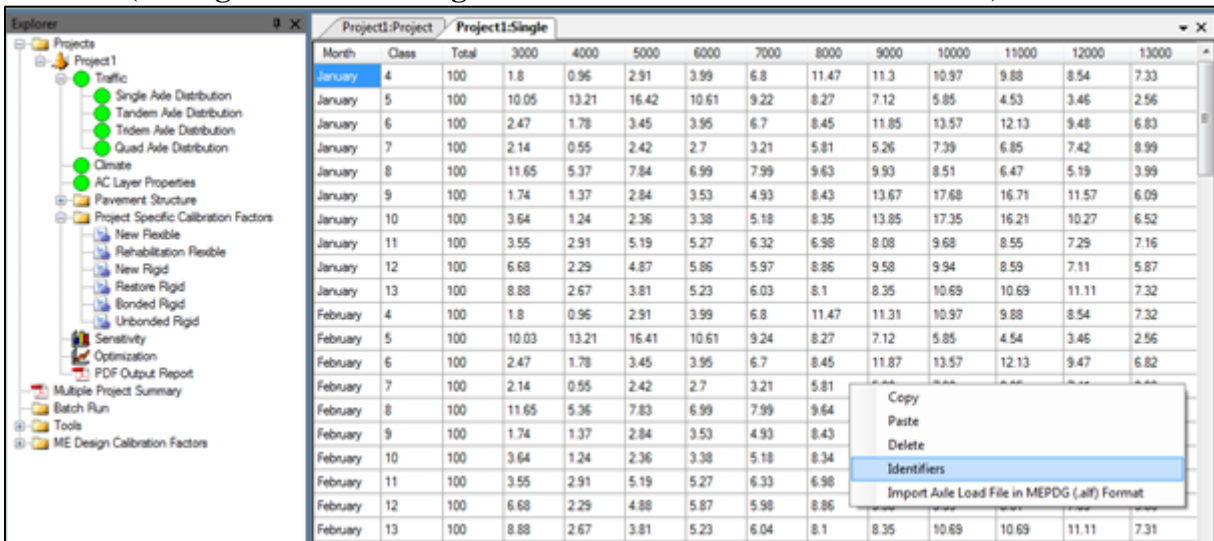

Figure 1.21 Defining Identifiers for Axle Load Distribution

The user can fill in the Display Name/ Identifier field shown in **Figure 1.22 Editing Display Name/Identifiers for Axle Load Distribution** and close the window. Now, axle load distribution element is saved to the database.

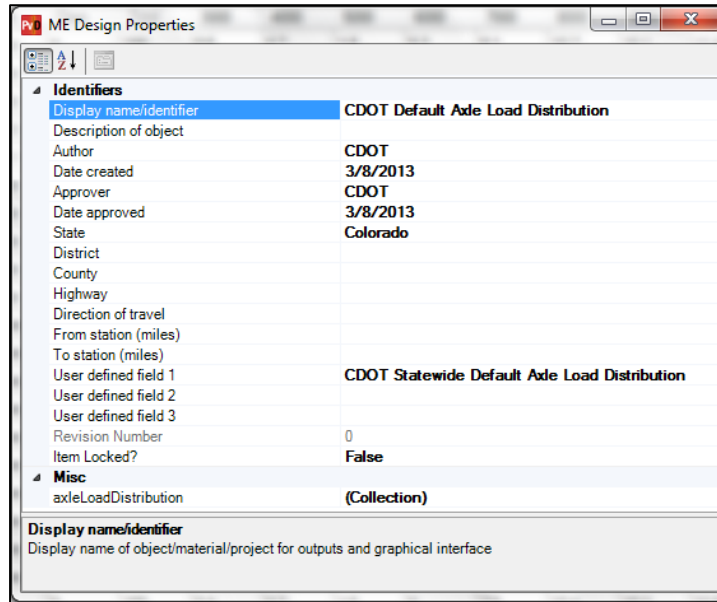

Figure 1.22 Editing Display Name/Identifiers for Axle Load Distribution

1.5.2 Retrieving or Importing from M-E Design Database

The data import process works similar to the save process, the user should right click on the project or element they wish to import and select "Get from Database". This will load the database information into the appropriate project.

Importing a Project

There are two ways to import an entire project from the database, (1) right click on the project name under the "Projects" node and select "Get from Database" or (2) click to highlight the project name under the "Projects" node and click "Select" icon on the menu bar across the top of the application (see **Figure 1.23 Importing an Entire Project from M-E Design Database**).

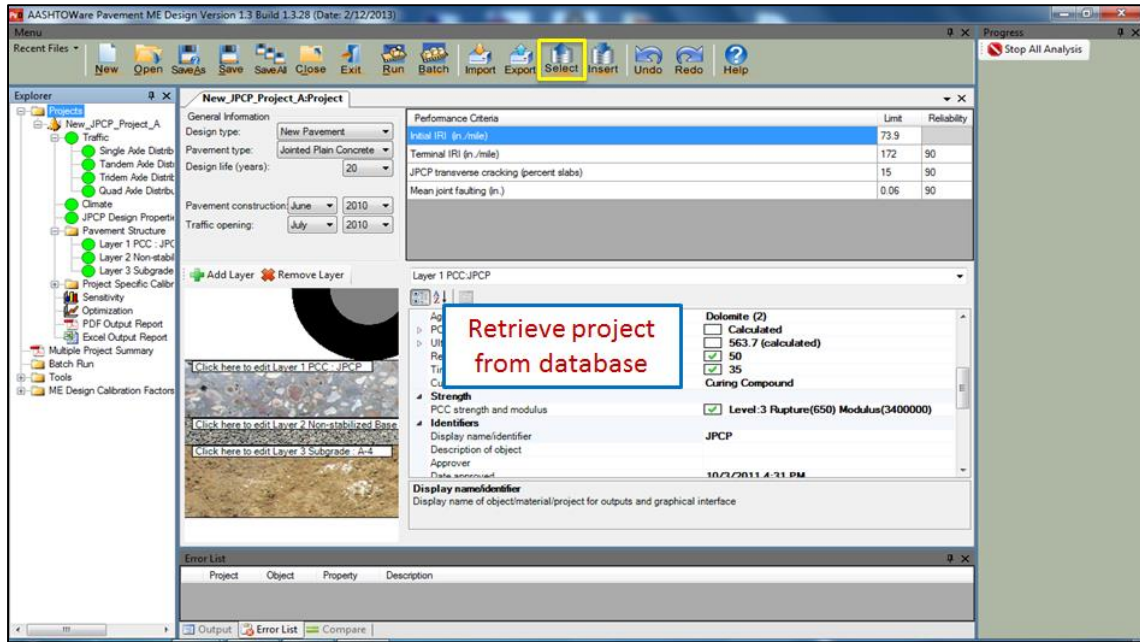

Figure 1.23 Importing an Entire Project from M-E Design Database

This will open the search tool in ME Design. This tool allows users to search for the database objects they wish to pull into the current project, or to load an existing project from memory. **Note that if a user selects an element, but has no active projects in the explorer, a new project will be created.** One of these projects from the list can then be selected and loaded into the user interface. Click “OK” to import project or project element from the database (see **Figure 1.24 Selecting a Project to Import from M-E Design Database**).

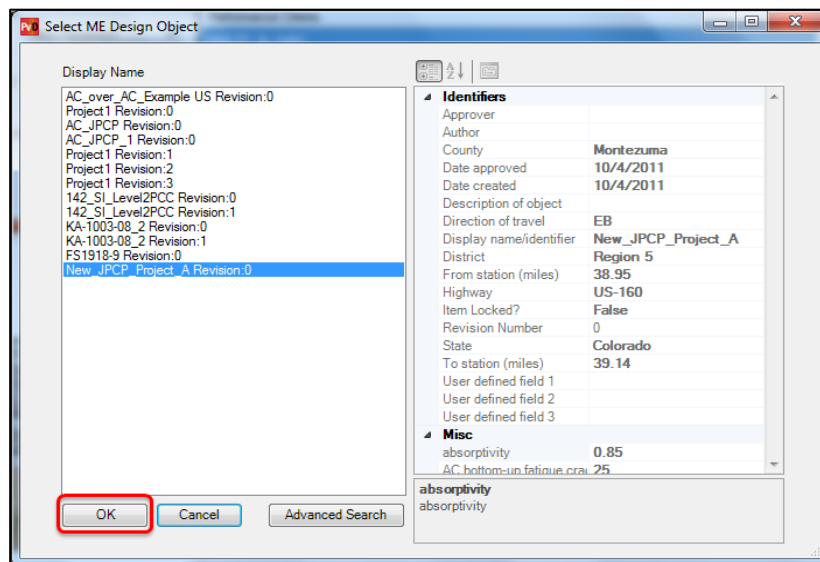

Figure 1.24 Selecting a Project to Import from M-E Design Database

Once the statement has been generated the user clicks on the “Search” button and is presented with the following screen.

Getting Project Elements

To import project elements, simply right click on the element you wish to import and click “Get from Database”. This will bring up a window asking the user to select the element they wish to retrieve from the database. For example, to load climate data from the database, the user should right click on “Climate” and select “Get from Database”(see **Figure 1.25 Getting an Element from the M-E Design Database**).

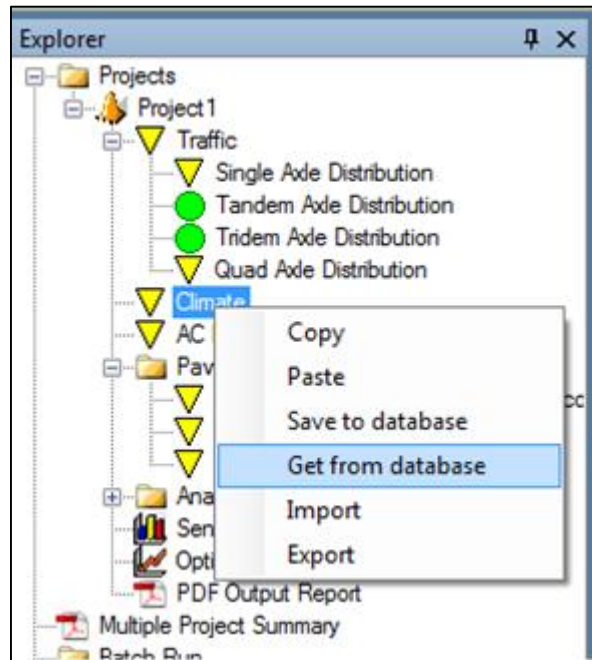

Figure 1.25 Getting an Element from the M-E Design Database

The ME Design element is then loaded into the current project.

Using Advanced Search Tool

After opening the search tool in ME Design, click “Advanced Search” option. This will open advanced search tool which allows user to form queries to search for the database objects they wish to pull into the current project, or to load an existing project from memory. **Note that if a user selects an element, but has no active projects in the explorer, a new project will be created.** Projects and project elements can be queried for using the advanced search tool to find data which matches specific ME Design criteria. In the example below, the user has selected Project. Next, they select the variable (s) they wish to use to search on, and select their associated values. **Figure 1.26 Advanced Search Blank Window in M-E Design Database** shows advanced search window.

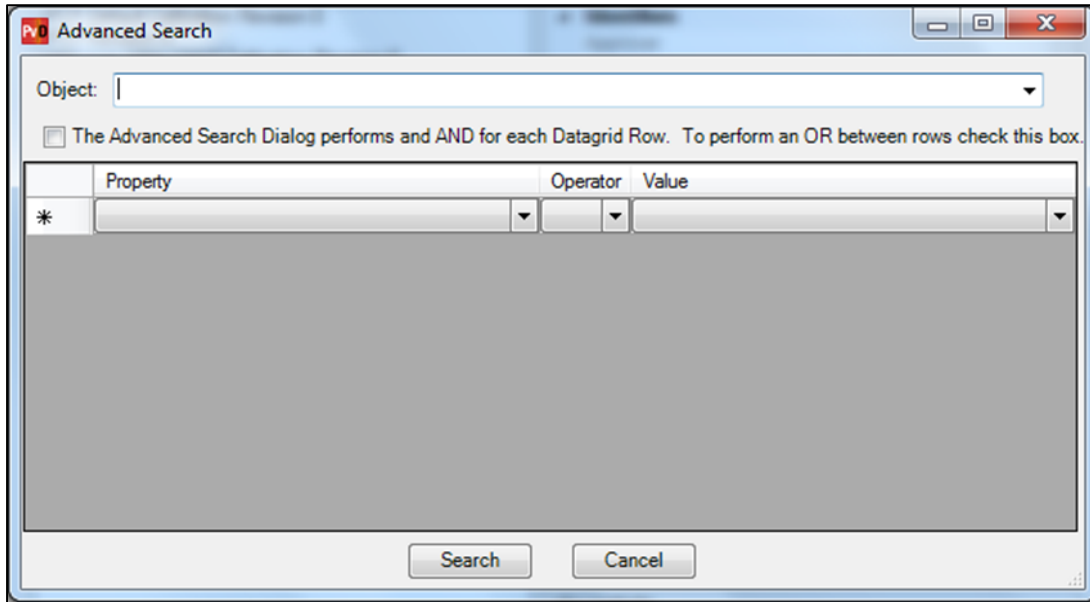

Figure 1.26 Advanced Search Blank Window in M-E Design Database

First the user selects the “object type” (in this case “Project”) they want to filter on. Next, they select a property associated with that object type (in this case “Display name”). Finally, they select a value to match with the property (in this case “HMA over HMA”). The user then selects which type of operator to apply to the statement (in this case “=”). **Figure 1.27 Advanced Search Window with Information** shows the above information.

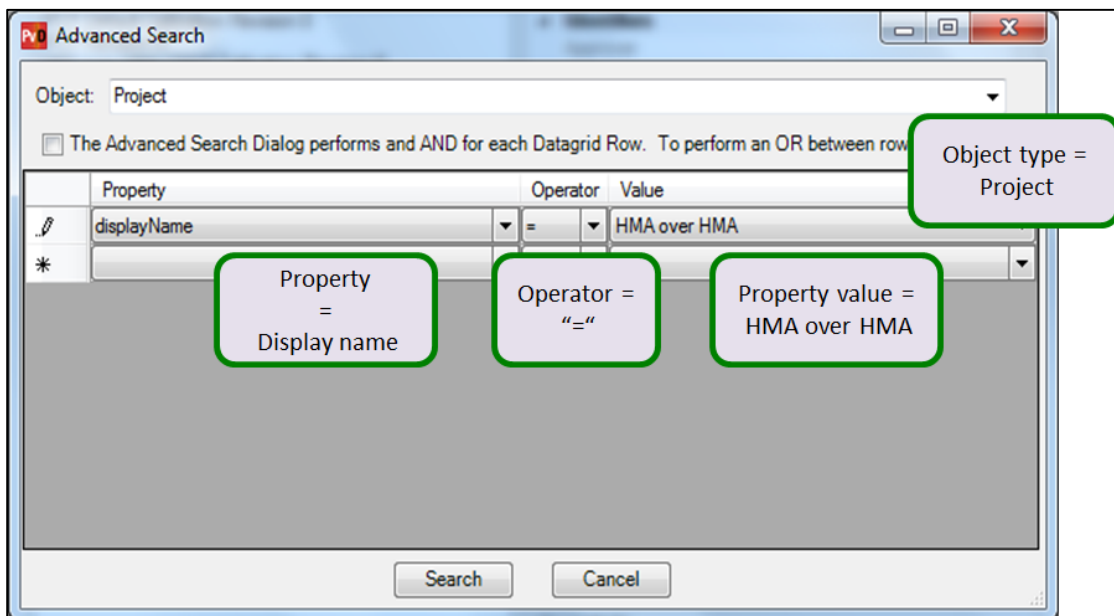

Figure 1.27 Advanced Search Window with Information

Pressing the search button runs the filter and produces a list of projects or project elements for users to select from. In this case, the entire statement is generated and shown in **Figure 1.28 Selecting a Project Using Advanced Search Tool**, where Display name = HMA over HMA. Press “OK” to import the project or project element in the ME Design interface.

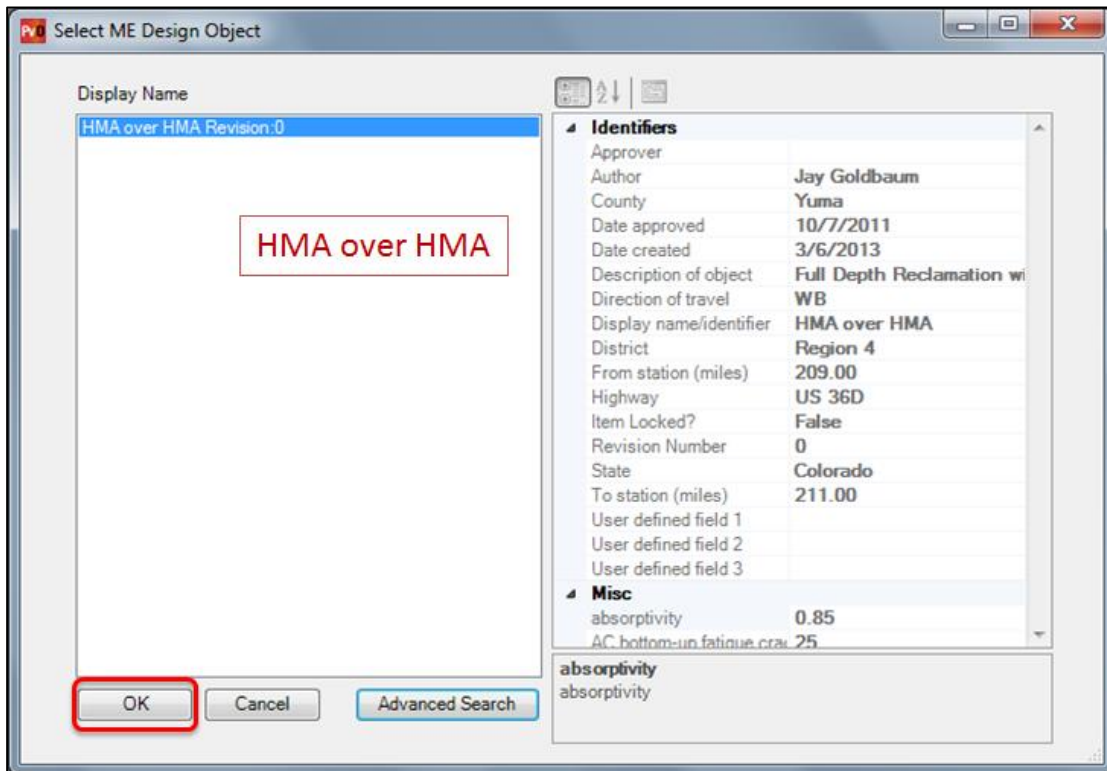

Figure 1.28 Selecting a Project Using Advanced Search Tool

A Special Note on Traffic

As mentioned previously, the traffic element works slightly different from the other ME Design elements. All of the traffic elements for retrieving data from the database mirror the functionality of the save operation. (i.e. Retrieving a Single Axle distribution element imports tandem, tridem, and quad axle distribution elements as well).

References

1. *AASHTO Mechanistic-Empirical Pavement Design Guide, A Manual of Practice, Interim Edition, July 2008*, American Association of State Highway and Transportation Officials, Washington, DC, 2008.
2. *AASHTO Guide for the Local Calibration of the Mechanistic-Empirical Pavement Design Guide*, November 2010, American Association of State Highway and Transportation Officials, Washington, DC, 2010.
3. CDOT Final_Calibration_June_12_2012

CHAPTER 2 PAVEMENT DESIGN INFORMATION

2.1 Introduction

This chapter provides pavements designers the general information required for conducting pavement design and analysis using the M-E Design software. This section does not include traffic, climate and material related inputs.

2.2 Site and Project Identification

Site/project location information is used to identify the project under design. This input has no bearing on design but is very helpful in documenting a design for review and recordkeeping. The M-E Design software provides the ability to enter site or project identification information such as the location of the project, jurisdiction, identification numbers, beginning and ending milepost, direction of traffic, and date created and approved.

2.3 Project Files/Records Collection and Review

2.3.1 Project Data Collection

Information gathered should include such items as "As Built" plans from previous projects, pavement design data, materials and soil properties, climate conditions, determination of traffic inputs, and any information relevant to major maintenance.

2.3.2 Field Survey

A pavement evaluation should be conducted to determine the cause of the pavement deterioration. Information gathered in this survey includes review items such as distress, drainage conditions, roughness, traffic control options, safety considerations, and any other overall project conditions assessments including an estimate of remaining service life. For new alignments, the soil survey investigation records are reviewed.

2.3.3 Initial Selection

Preliminary alternate designs are developed to repair the existing distress and prevent future problems. The first cuts, based on an evaluation of various candidate alternatives, are made at this time. A determination of additional data needs is made.

2.3.4 Physical Testing

Testing includes collection of additional information such as coring, deflection testing, resilient modulus, permeability, moisture content, etc.

2.3.5 Evaluation and Selection

The selection of new construction and rehabilitation techniques includes identifying the various constraints associated with the project such as:

- Funding (first cost consideration)
- Traffic Control
- Design Period
- Geometric Problems
- Right of Way
- Utilities
- Vertical Clearance Problems (i.e. overhead clearance).

2.3.6 Historic M-E Design Software Files

Pavement design/analysis projects created in M-E Design software are saved as .dgp files. After a design/analysis run has been successfully completed, the application will generate and display a PDF file and a Excel Spreadsheet containing input summary and output results of the trial design. There are several project or CDOT specific input files for traffic, climate, material characterization associated with the pavement design/analysis projects.

The M-E Design software includes a database option that facilitate enterprise level data management for archiving and searching projects, comparing inputs of any two projects and creating input data libraries. Each object, i.e. any discrete item such as pavement material layer data, axle load distribution factors, climate and design features or the project itself, has a unique informational tag called identifiers. The designers can use identifiers to identify, search, filter, save and retrieve information in a database environment.

The designer should review the data files available with the software system as well as the database. Project records including the project files, input files, calibration factors and the output records should be stored in the appropriate data storage systems specified by the CDOT. For reasons of software update and input changes, the designer should keep track of the software version, project time stamps and input modifications using the identifiers of M-E Design software objects.

2.3.7 Records Review

Review of historic and current project files and/or records is an important aspect of pavement design/analysis as a review of these records will reveal key details of interest and significance to the pavement designer. Reviewing the project files and/or records will be the most beneficial to the pavement designer who has not been with the project since its original construction. In reviewing the project files and/or records, the pavement designer should especially be on the alert for any information relating to pavement design and construction. The Regions should keep copies of the information in the original report between 5 to 8 years.

Records review typically comprises of the following activities:

- Review construction and maintenance files.

- Review previous distress surveys and the pavement management records. If possible, establish performance trends and deterioration rates.
- Review previous Falling Weight Deflectometer (FWD) deflection test data.
- Review previous pavement borings and laboratory test results of pavement materials and subgrade soils.
- For existing pavements, perform a windshield survey or an initial surveillance of the roadway's surface, drainage features, and other related items.
- Identify roadway segments with similar or different surface and subsurface features. As much as possible, isolate each unique factor that will influence pavement performance.
- Identify the field testing/materials sampling requirements for each segment and the associated traffic control requirements.
- Determine if the pavement performed better or worse than similar designs.

The information gathered in records review can be used to divide the a new alignment or existing pavement into units with similar site conditions. For existing pavements, it can be further divided into units with similar design features and performance characteristics.

2.4 Site Investigation

It may be advantageous to visit the proposed project site a few times during the development of a pavement or rehabilitation design. Most likely, the pavement designer may find it desirable to make a brief visit to the project site as the first step in the scoping process. As the investigation proceeds, events may develop which will make it desirable to revisit the project site. During visits to the project site, the following are some of the items that should be determined:

2.4.1 Abutting Land Usage

The abutting land usage will be a needed item of design information. Land usage will have an effect on the selection of a pavement type or the selection of a rehabilitation design procedure. If the abutting land is rural, then a note should be made of its use such as farming, ranching, or other, with descriptive details as needed. If the property is urban, a record of usage in terms of residential or commercial is helpful. Additional details on type of residences or type of commercial usage are also helpful.

2.4.2 Existing/Proposed Project Geometrics

Notes should be made as to vertical and horizontal alignment characteristics and type of typical section. Data concerning the typical section should indicate the average and maximum "cut" and "fill" heights and the extent of these over the project. Items such as number of travel lanes and shoulders should be noted. Notes on type and extent of curb and gutter should be made. Vertical clearances at structures should be recorded.

2.4.3 Geotechnical Investigations

Geotechnical investigations are performed to determine the subgrade soil properties needed for pavement structural design considerations and to determine if subgrade stabilization/ modification

is needed. While pavement design is based on the response of the soil to short-term loads, long-term soil response may dramatically affect the roadway. For example, roadways constructed over soft soils may experience long-term settlements. Important subgrade parameters obtained through a geotechnical investigation not limited to the soil classification include the following: Atterberg Limits, sulfate content, stabilization requirements, test for expansive soils, and other design considerations. Geotechnical investigations are typically required for new construction and reconstruction projects. Contact the Regional Materials Engineer or CDOT Materials and Geotechnical Branch to request a geotechnical investigation. See Section **4.2 Soil Survey Investigation** of this manual for more information, as well as Chapter 200 of the Field Materials Manual.

2.4.4 Condition Survey

Pavement condition is a key input required for the determination of feasible rehabilitation alternatives. CDOT Pavement Management System (PMS) provides network-level pavement condition data for use in preliminary evaluation of the project. If there is no PMS data for a roadway section of interest, conduct a manual distress survey of the project to assess the pavement condition and establish the causes of distresses/failure.

2.4.5 Drainage Characteristics

Drainage characteristics should be noted during the visit to the project. Items such as the general terrain drainage, the highway drainage, and the existing pavement drainage need to be noted. Another drainage item is bridge drainage structures. The number of bridges and how the existing pavement terminates at the bridge ends is important to note. Also, note if the bridges have bridge approach slabs. The condition of the bridge end/approach slab and the approach slab/pavement interface conditions are of special interest when concrete pavement exists.

Distresses can be related to particular moisture properties of the materials in the pavement. If the existence of these properties is not recognized and corrected where possible, the rehabilitation work will be wasted by allowing the same type of moisture-related distress to occur again. The recognition of the amount, severity, and cause of moisture damage also plays an important role in the selection of the rehabilitation scheme to be utilized on the pavement. This information will help in the structural evaluation of the pavement.

Moisture-related distresses develop from two major groupings of factors that influence the moisture condition in a pavement. These two major groups of factors include: External factors such as the climatic factors in an area that regulates the supply of moisture to the pavement; and internal factors are those properties of the pavement materials whose interaction with moisture influences pavement performance.

The recognition of each distress and the mechanism causing that distress are necessary if the correct rehabilitation procedures are to be selected. Each distress type that develops within a pavement will be load or environment-related or a combination of the two. Moisture will serve to accelerate this deterioration when it is environment-related. To prevent future deterioration, the moisture problems must be recognized and corrected.

The fact that moisture problems may appear in any layer emphasizes the necessity of having a logical procedure for examining the pavement in order to determine the cause of the problem. Nondestructive testing (NDT) will indicate the overall structural level of the pavement. However, NDT alone cannot identify which component of the pavement is responsible for the strength loss. The distress analysis must be utilized in conjunction with the NDT analysis in order to identify potential moisture-related problems. If the subgrade has moisture problems that caused the distress, as determined in the distress survey, it may do no good to overlay the pavement, recycle it, or rework and stabilize the base without also addressing the subgrade. If the base or subbase has moisture problems, it will be wasteful to rehabilitate, restore, or overlay without addressing the moisture problems through reworking or stabilization of the base and/or consideration of drainage of the granular layer. **Table 2.1 Moisture-Related Distress in Flexible Pavements** and **Table 2.2 Moisture-Related Distress in Rigid Pavements** contain a breakdown of the more common moisture-related distresses for flexible and rigid pavements.

2.5 Construction and Maintenance Experience

On any given project, there are always construction and maintenance experiences with pavement structures that were never entered into the permanent records relating to the project. Usually, it was not realized that information such as this would be useful in the future. The Program Engineers, Resident Engineers, Project Engineers, Construction Inspectors, and other personnel involved with the project may have useful information if interviewed. The Region Maintenance Superintendent and other maintenance personnel may have pavement performance data that do not appear elsewhere in the records. Frequently, maintenance forces have repaired substantial sections of the project and this information is not always readily available in the records.

2.6 Pavement Management System (PMS) Condition Data

The PMS provides network-level pavement condition information for planning and programming purposes. PMS data are used to help select reconstruction, rehabilitation, and preventive maintenance projects and evaluate performance trends. It also provides pavement condition information that is useful for performing a preliminary evaluation of a project.

For M-E Design, site-specific or project-specific past performance data is used to characterize existing pavement condition for use in rehabilitation design. The specifics of how PMS condition data is used is presented in Chapters 8 and 9 for rehabilitation designs using flexible and rigid overlays, respectively.

CDOT collects and reports pavement performance data on a 1/10-mile basis for network. Data is collected in only one direction of all two-lane highways. CDOT PMS data of relevance to the M-E Design are the following:

- International Roughness Index (IRI)

- Rutting
- Faulting
- Cracking distress.

For more information about PMS data, contact the PMS unit or the Region Pavement Manager.

Table 2.1 Moisture-Related Distress in Flexible Pavements

Type	Distress Manifestation	Moisture Problem	Climatic Problem	Material Problem	Load Associated	Structural Defect Begins In		
						Asphalt	Base	Subgrade
Surface Defect	Bleeding	No	Accentuated by High Temp.	Bitumen	No	Yes	No	No
	Raveling	No	No	Aggregate	Slightly	Yes	No	No
	Weathering	No	Humidity and Light-dried Bitumen	Bitumen	No	Yes	No	No
Surface Deformation	Bump or Distortion	Excess Moisture	Frost Heave	Strength-Moisture	Yes	No	Yes	Yes
	Corrugation Or Rippling	Slight	Climatic & Suction Relations	Unstable Mix	Yes	Yes	Yes	Yes
	Shoving	No		Unstable Mix Loss of Bond	Yes	Yes	No	No
	Rutting	Excess in Granular Layers	Suction & Material	Compaction Properties	Yes	Yes	Yes	Yes
	Depression	Excess	Suction & Materials	Settlement, Fill Material	Yes	No	No	Yes
	Potholes	Excess	Frost Heave	Strength-Moisture	Yes	No	Yes	Yes
Cracking	Longitudinal	Yes	Spring-Thaw Strength Loss		Yes	Faulty Construction	Yes	Yes
	Alligator	Yes, Drainage		Possible Mix Problems	Yes	Yes, Mix	Yes	Yes
	Transverse	Yes	Low-Temp. F-T Cycles	Thermal Properties	No	Yes, Temp. Susceptible	Yes	Yes

Table 2.2 Moisture-Related Distress in Rigid Pavements

Type	Distress Manifestation	Moisture Problem	Climatic Problem	Material Problem	Load Associated	Structural Defect Begins In		
						Surface	Bases	Subgrade
Surface Defects	Spalling	Possible	No		No	Yes	No	No
	Crazing	No	No	Rich Mortar	No	Yes - weak surface	No	No
Surface	Blow-up	No	Temperature	Thermal Properties	No	Yes	No	No
	Pumping	Yes	Moisture	Fines in Base Moisture Sensitive	Yes	No	Yes	Yes
	Faulting	Yes	Moisture-Suction	Settlement Deformation	Yes	No	Yes	Yes
	Curling	Possible	Moisture and Temp.		No	Yes	No	No
Cracking	Corner	Yes	Yes	Follows Pumping	Yes	No	Yes	Yes
	Diagonal	Yes	Possible	Cracking Follows Moisture Buildup	Yes	No	Yes	Yes
	Transverse							
	Longitudinal							
	Punch Out	Yes	Yes	Deformation Following Cracking	Yes	No	Yes	Yes
Joint	Produces Damage Later	Possible	Proper Filler and Clean Joints	No	Joint	No	No	

2.7 Design Performance Criteria and Reliability (Risk)

Performance verification forms the basis of the acceptance or rejection of a trial design evaluated using the M-E Design software. A successful design is one where all the selected performance threshold limits are satisfied at their chosen levels of reliability at the end of the design life.

M-E Design requires the designer to specify the critical levels or threshold values of pavement distresses and smoothness to judge the adequacy of a design. The type of distresses used in performance verification is specific to the pavement type (i.e. flexible or rigid) and design (i.e. rehabilitation or new design). In addition, the design reliability levels are required to account for uncertainty and variability that is expected to exist in pavement design and construction, as well as in the application of traffic loads and climatic factors over the design life. The threshold and reliability levels for distresses and smoothness significantly impact construction costs and performance. The designer must set realistic numerical limits or threshold values for each performance criterion and reasonable reliability levels for a given design life.

Limits on the various performance criteria should be considered together with design reliability and the design period. Both performance criteria and reliability factors are determined based on the functional classification of the roadway and whether it is in an urban or a rural location. Once selected the limits should be used consistently throughout the pavement type selection and design calculations. Consultation of the mix design(s) with the RME shall occur.

Recommended Range for Reliability. The reliability is a factor of safety to account for the inherent variations in construction, materials, traffic, climate and other design inputs.

Table 2.3 Reliability (Risk) provides the recommended values for the pavement structure to survive the design period traffic. Reliability values recommended for use in previous editions of the AASHTO Design Guide should not be used with the M-E Design. Reliability is not dependent on either type of pavement or type of project.

Table 2.3 Reliability (Risk)

Functional Classification	Value for Reliability
Interstate	80-95
Principal Arterials – Other Freeways and Expressways	75-95
Principal Arterials – Other	75-95
Minor Arterial	70-95
Major Collectors	70-90
Minor Collectors	50-90
Local	50-80

Table 2.4 Recommended Threshold Values of Performance Criteria for New Construction or Reconstruction Projects and **Table 2.5 Recommended Threshold Values of Performance Criteria for Rehabilitation Project** provide the threshold values recommended in the M-E Design for pavements. The M-E Design also requires the designer to enter the expected initial smoothness, expressed as IRI, at the time of construction. It is recommended to use an initial IRI value of 50 inches/mile for all HMA projects and 75 inches/mile for all PCC projects as they reflect targets that are documented using smoothness data from flexible and rigid pavements constructed between 2005 and 2013. It is recommended that the same reliability value be used for all distresses; **any** changes should have Region Materials and Staff Materials approval.

Table 2.4 Recommended Threshold Values of Performance Criteria for New Construction or Reconstruction Projects

Pavement Type	Performance Criteria	Maximum Value at End of the Design Life	Determines the Years to First Rehabilitation*
Flexible Pavement	Terminal IRI (inches per mile)		Interstate – 160 Principal Arterials (Freeways and Expressways) – 200 Principal Arterials (Others) – 200 Minor Arterial – 200 Major Collectors – 200 Minor Collectors – TBD Local – TBD
	AC Top-down Fatigue Cracking (feet per mile)		Interstate – 2,000 Principal Arterials (Freeways and Expressways) – 2,500 Principal Arterials (Others) – 2,500 Minor Arterial – 3,000 Major Collectors – 3,000 Minor Collectors – TBD Local – TBD
	AC Bottom-up Fatigue Cracking (percent lane area)	Interstate – 10 Principal Arterials (Freeways and Expressways) – 25 Principal Arterials (Others) – 25 Minor Arterial – 35 Major Collectors – 35 Minor Collectors – TBD Local – TBD	
	AC Thermal Fracture (feet per mile)	Interstate – 1,500 Principal Arterials (Freeways and Expressways) – 1,500 Principal Arterials (Others) – 1,500 Minor Arterial – 1,500 Major Collectors – 1,500 Minor Collectors – TBD Local – TBD	
	Permanent Deformation (total inches)		Interstate – 0.55 Principal Arterials (Freeways and Expressways) – 0.65 Principal Arterials (Others) – 0.65 Minor Arterial – 0.80 Major Collectors – 0.80 Minor Collectors – TBD Local – TBD

Pavement Type	Performance Criteria	Maximum Value at End of the Design Life	Determines the Years to First Rehabilitation*
	Permanent Deformation – AC Only (inches)		Interstate – 0.40 Principal Arterials (Freeways and Expressways) – 0.50 Principal Arterials (Others) – 0.50 Minor Arterial – 0.65 Major Collectors – 0.65 Minor Collectors – TBD Local – TBD
Rigid Pavement (JPCP)	Terminal IRI (inches per mile)		Interstate – 160 Principal Arterials (Freeways and Expressways) – 200 Principal Arterials (Others) – 200 Minor Arterial – 200 Major Collectors – 200 Minor Collectors – TBD Local – TBD
	Transverse Slab Cracking (percent)		Interstate – 7.0 ¹ Principal Arterials (Freeways and Expressways) – 7.0 ¹ Principal Arterials (Others) – 7.0 ¹ Minor Arterial – 7.0 ¹ Major Collectors – 7.0 ¹ Minor Collectors – TBD Local – TBD
	Mean Joint Faulting (inches)	Interstate – 0.12 Principal Arterials(Freeways and Expressways) – 0.14 Principal Arterials (Others) – 0.14 Minor Arterial – 0.20 Major Collectors – 0.20 Minor Collectors – TBD Local – TBD	

* The minimum age to the first rehabilitation for flexible pavements shall be 12 years and the minimum age for rigid pavements shall be 27 years.

¹ Threshold value is under review.

Table 2.5 Recommended Threshold Values of Performance Criteria for Rehabilitation Projects

Pavement Type	Performance Criteria	Maximum Value at End of the Design Life *
Flexible Pavement	Terminal IRI (inches per mile)	Interstate – 160 Principal Arterials (Freeways and Expressways) – 200 Principal Arterials (Others) – 200 Minor Arterial – 200 Major Collectors – 200 Minor Collectors – TBD Local – TBD
	AC Top-down Fatigue Cracking (feet per mile)	Interstate – 2,000 Principal Arterials (Freeways and Expressways) – 2,500 Principal Arterials (Others) – 2,500 Minor Arterial – 3,000 Major Collectors – 3,000 Minor Collectors – TBD Local – TBD
	AC Bottom-up Fatigue Cracking (percent lane area)	Interstate – 10 Principal Arterials (Freeways and Expressways) – 25 Principal Arterials (Others) – 25 Minor Arterial – 35 Major Collectors – 35 Minor Collectors – TBD Local – TBD
	AC Thermal Fracture (feet per mile)	Interstate – 1,500 Principal Arterials (Freeways and Expressways) – 1,500 Principal Arterials (Others) – 1,500 Minor Arterial – 1,500 Major Collectors – 1,500 Minor Collectors – TBD Local – TBD
	Permanent Deformation (total inches)	Interstate – 0.55 Principal Arterials (Freeways and Expressways) – 0.65 Principal Arterials (Others) – 0.65 Minor Arterial – 0.80 Major Collectors – 0.80 Minor Collectors – TBD Local – TBD

Pavement Type	Performance Criteria	Maximum Value at End of the Design Life *
	Permanent Deformation AC Only (inches)	Interstate – 0.40 Principal Arterials (Freeways and Expressways) – 0.50 Principal Arterials (Others) – 0.50 Minor Arterial – 0.65 Major Collectors – 0.65 Minor Collectors – TBD Local – TBD
	AC Total Cracking Bottom-up + Reflective (percent)	Interstate – 5 ¹ Principal Arterials (Freeways and Expressways) – 10 ¹ Principal Arterials (Others) – 10 ¹ Minor Arterial – 15 ¹ Major Collectors – 15 ¹ Minor Collectors – TBD Local – TBD
Rigid Pavement (JPCP)	Terminal IRI (inches per mile)	Interstate – 160 Principal Arterials (Freeways and Expressways) – 200 Principal Arterials (Others) – 200 Minor Arterial – 200 Major Collectors – 200 Minor Collectors – TBD Local – TBD
	Transverse Slab Cracking (percent)	Interstate – 7.0 ¹ Principal Arterials (Freeways and Expressways) – 7.0 ¹ Principal Arterials (Others) – 7.0 ¹ Minor Arterial – 7.0 ¹ Major Collectors – 7.0 ¹ Minor Collectors – TBD Local – TBD
	Mean Joint Faulting (inches)	Interstate – 0.12 Principal Arterials (Freeways and Expressways) – 0.14 Principal Arterials (Others) – 0.14 Minor Arterial – 0.20 Major Collectors – 0.20 Minor Collectors – TBD Local – TBD
<p>* The minimum age for flexible pavements shall be 10 years and the minimum age for rigid pavements shall be 20 years. ¹ Threshold value is under review.</p>		

Figure 2.1 Performance Criteria and Reliability in the M-E Design Software for a Sample Flexible Pavement Design presents the M-E Design software screenshot showing performance

criteria and the corresponding design reliability values selected for the design/analysis of a sample flexible pavement design.

Figure 2.2 Performance Criteria and Reliability in the M-E Design Software for a Sample JPCP Design presents the M-E Design software screenshot showing performance criteria and the corresponding design reliability values selected for the design/analysis of a sample rigid pavement design.

The screenshot shows the M-E Design software interface for project 15-11959. On the left, under 'General Information', the design type is 'New Pavement', pavement type is 'Flexible Pavement', design life is 20 years, base construction is May 2002, pavement construction is June 2002, and traffic opening is September 2002. On the right, a table lists performance criteria with their limits and reliabilities.

Performance Criteria	Limit	Reliability
Initial IRI (in./mile)	63	
Terminal IRI (in./mile)	172	90
AC top-down fatigue cracking (ft/mile)	2000	90
AC bottom-up fatigue cracking (percent)	25	90
AC thermal cracking (ft/mile)	1000	90
Permanent deformation - total pavement (in.)	0.75	90
Permanent deformation - AC only (in.)	0.25	90

Figure 2.1 Performance Criteria and Reliability in the M-E Design Software for a Sample Flexible Pavement Design

The screenshot shows the M-E Design software interface for project 25-10326. On the left, under 'General Information', the design type is 'New Pavement', pavement type is 'Jointed Plain Concrete', design life is 20 years, pavement construction is June 1996, and traffic opening is September 1996. On the right, a table lists performance criteria with their limits and reliabilities.

Performance Criteria	Limit	Reliability
Initial IRI (in./mile)	63	
Terminal IRI (in./mile)	172	90
JPCP transverse cracking (percent slabs)	15	90
Mean joint faulting (in.)	0.12	90

Figure 2.2 Performance Criteria and Reliability in the M-E Design Software for a Sample JPCP Design

The appropriate functional classification for a certain roadway can be determined from the information on CDOT Form #463, Design Data, completed for the specific highway project being designed. A blank CDOT Form #463 is shown in the Appendix of the CDOT Project Development Manual and **APPENDIX B - FORMS** of this manual. As an example, CDOT Form #463 identifies a segment of SH 83 as a principal arterial; the reliability for this roadway can be obtained from

Table 2.3 Reliability (Risk). As the table shows, the reliability for this road may range from 75 to 95 percent. This is a high profile road, so the reliability is set 95 percent.

CDOT has a map available designating highway functional classifications. See **Figure 2.3 Functional Classification Map**. The map may be downloaded from the website:

http://alphainternal.dot.state.co.us/App_DTD_DataAccess/Downloads/StatewideMaps/func_clas_s_pdf.pdf

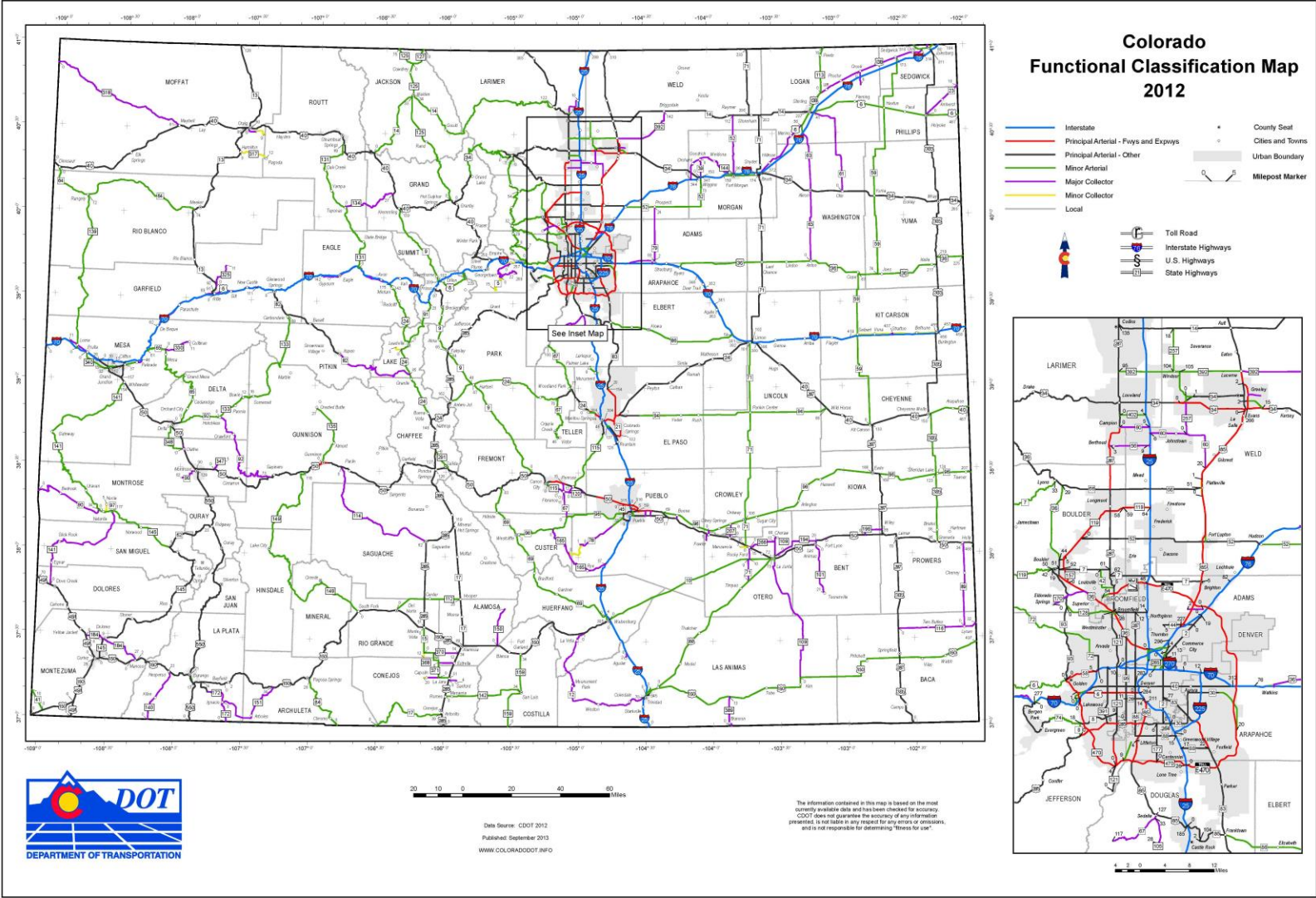

Figure 2.3 Functional Classification Map

2.8 Defining Input Hierarchy

The M-E Design employs a hierarchical approach to input parameters with regard to traffic, material, and condition of existing pavement. This feature was not found in previous versions of the AASHTO Guide. This approach provides the designer with a lot of flexibility in obtaining the design inputs for a design project based on the criticality of the project and the available resources.

For many of the design inputs, the M-E Design allows the designer to select any of three levels of inputs:

- **Level 1** inputs are project-specific or site-specific inputs that are obtained from direct testing or measurements. Obtaining Level 1 inputs requires more resources and time than other levels. Level 1 input would typically be used for designing heavily trafficked pavements or wherever there is dire safety or economic consequences of early failure. Examples include measuring dynamic modulus of hot mix asphalt (HMA) using laboratory testing, measuring PCC elastic moduli using laboratory testing, or using traffic classification data using on-site measurement.
- **Level 2** inputs are estimated from correlations or regression equations, derived from a limited testing program or obtained from the agency database. This level could be used when resources or testing equipment are not available for tests required for Level 1. Examples include estimating resilient modulus of unbound materials and subgrade from R-values, estimating PCC elastic moduli from compressive strength tests, or using traffic classification data based on functional class of highway in the state.
- **Level 3** inputs are based on “best-estimated” or typical values for the local region. This level might be used for design where there are minimal consequences of early failure (i.e. lower volume roads). Examples include using default resilient modulus values for unbound materials, estimating PCC elastic moduli from 28-day compressive or flexural strength tests, or using default traffic classification data.

The designer can also select a mix of input levels for a given project. For instance, the designer can select the HMA creep compliance at Level 1, subgrade resilient modulus at Level 2, and traffic load spectra at Level 3 for analyzing a flexible pavement trial design. The computational algorithms, procedures and performance models for predicting distress and smoothness are exactly the same irrespective of the input level used in the design; however, the accuracy of the inputs as defined by the input level may affect the accuracy of performance prediction results.

The input hierarchy provides a powerful tool to show the advantages of good engineering design (using Level 1 inputs) in improving the reliability of the design and the possibility to reduce pavement construction and rehabilitation costs. It is recommended that the designer obtain the inputs for a given design project that are appropriate and practical for the magnitude of project under design. Larger, more significant projects require more accurate design inputs.

The selection of the hierarchical level for a specific input depends on several factors, including:

- Sensitivity of the pavement performance to a given input.
- The criticality of the project.
- The information available at the time of design.
- The resources and time available to the designer to obtain the inputs.

The designer should give due considerations to the above mentioned factors and select a predominant level of input hierarchy based on the recommendations presented in **Table 2.6 Selection of Input Hierarchical Level**. **Note:** *that the term “Predominant input hierarchy” implies that the designer should as much as possible provide inputs at the selected input level.*

Table 2.6 Selection of Input Hierarchical Level

Criticality/ Sensitivity of Design	Description	Predominant Input Hierarchy
Very critical	High volume interstates, urban freeways and expressways	Level 1
Critical	Principal arterials, rural interstates, heavy haul (i.e. mining, logging routes)	Level 1 or Level 2
Somewhat critical	Minor arterial and collectors	Level 2 or Level 3
Not critical	Local roads	Level 3

2.9 Drainage

Water is a fundamental variable in most problems associated with pavement performance and is directly or indirectly responsible for many of the distresses found in pavement systems. A well-drained pavement section is required to maintain the strength coefficients assigned to individual components of a hot mix asphalt pavement section. Edge drains, cross drains, and drainage layers all must tie into a collection system or some means to carry collected water away from intersections and the pavement section. Installing drainage systems that collect and impound water rather than diverting it away from the pavement section should never be allowed.

The M-E Design procedure does not consider the effects of drainage directly in pavement design/analysis methodology. Drainage effects are considered indirectly through seasonal adjustments of unbound material and subgrade moisture and related impacts on its strength/modulus.

As good drainage is a prerequisite to any good design, designers must always consider strategies for combating the effects of water in a pavement system such as:

- Preventing water from entering the pavement
- Providing drainage to remove excess water quickly
- Building the pavement strong enough to resist the combined effect of load and water.

It is preferable to exclude water from the pavement and provide for rapid drainage. The cost of improving the drainage should be compared to the cost of building a stronger pavement. It is more likely that drainage improvements will outperform a stronger pavement. To obtain adequate pavement drainage, the designer should consider providing three types of drainage systems that may include surface drainage, groundwater drainage and structural drainage.

It is important to understand the roadway geometry, particularly the drainage gradients in the roadway prism, when selecting base type. As long as the base will be able to carry drainage away from the pavement structure, a gravel base will perform adequately. It is also important to note that these values apply only to the effects of drainage on untreated base and subbase layers.

2.9.1 Subdrainage Design

Subdrainage is an important consideration in new construction or reconstruction and in the resurfacing, restoration, and rehabilitation of pavement systems. Detailed procedures for pavement subsurface design are provided in several publications, including:

- CDOT Drainage Design Manual
- AASHTO 1986 Guide's Appendix AA - Guidelines for the Design of Highway Internal Drainage Systems
- FHWA's DRIP software
- MEPDG 2004 Design Documents Part 3 Chapter 1

The pavement designer should coordinate with the respective Region Hydraulics Engineer and/or Staff Hydraulics Engineer if necessary where a pavement drainage problem is anticipated. The pavement designer may consult the references provided above.

References

1. *AASHTO Mechanistic-Empirical Pavement Design Guide, A Manual of Practice, Interim Edition, July 2008*, American Association of State Highway and Transportation Officials, Washington, DC, 2008.
2. DRIP 2.0 Software Program < <http://isddc.dot.gov/OLPFiles/FHWA/010942.pdf> >

CHAPTER 3 TRAFFIC AND CLIMATE

Traffic and climate related inputs required for conducting pavement design and analysis using the M-E Design software are discussed in this chapter. **Traffic**

Traffic data is one of the key data inputs required for the structural design/analysis of pavement structures. Traffic information required by the pavement designer to estimate the magnitude and frequency of loads that are applied to a pavement throughout its design life. Typical information includes axle loads, axle configurations and number of applications.

Prior to the M-E Design, a number of 18,000-pound Equivalent Single Axle Load (18-kip ESAL) represented the amount of traffic and its characteristics. For M-E Design methodology, traffic input requirements are more detailed and can be categorized as follows (see **Figure 3.1 Traffic Inputs in the M-E Design Software**):

- Base year traffic information
 - Analysis period or pavement design life
 - Date newly constructed or rehabilitated pavement is opened to traffic
 - Two-way average annual daily truck traffic (AADTT)
 - Number of lanes in design direction
 - Truck direction distribution factor
 - Lane distribution factor
 - Operational speed
- Traffic adjustment factors
 - Monthly adjustment factors
 - Vehicle class distribution
 - Truck hourly distribution
 - Growth rate and type
 - Number of axles per truck
 - Axle load distribution factors
- General traffic inputs
 - Lateral wander of axle loads
 - Axle configuration
 - Wheelbase
 - Tire pressure

This section primarily deals with traffic input requirements for pavement designs using M-E Design software. The 18-kip ESALs are still required for asphalt binder selection (see **Section 6.12.3 Binder Selection**) and pavement designs using the CDOT thin and ultra-thin Concrete Overlay design procedures. Refer to CDOT 2012 Pavement Design Manual for information on traffic characterization using the ESALs approach.

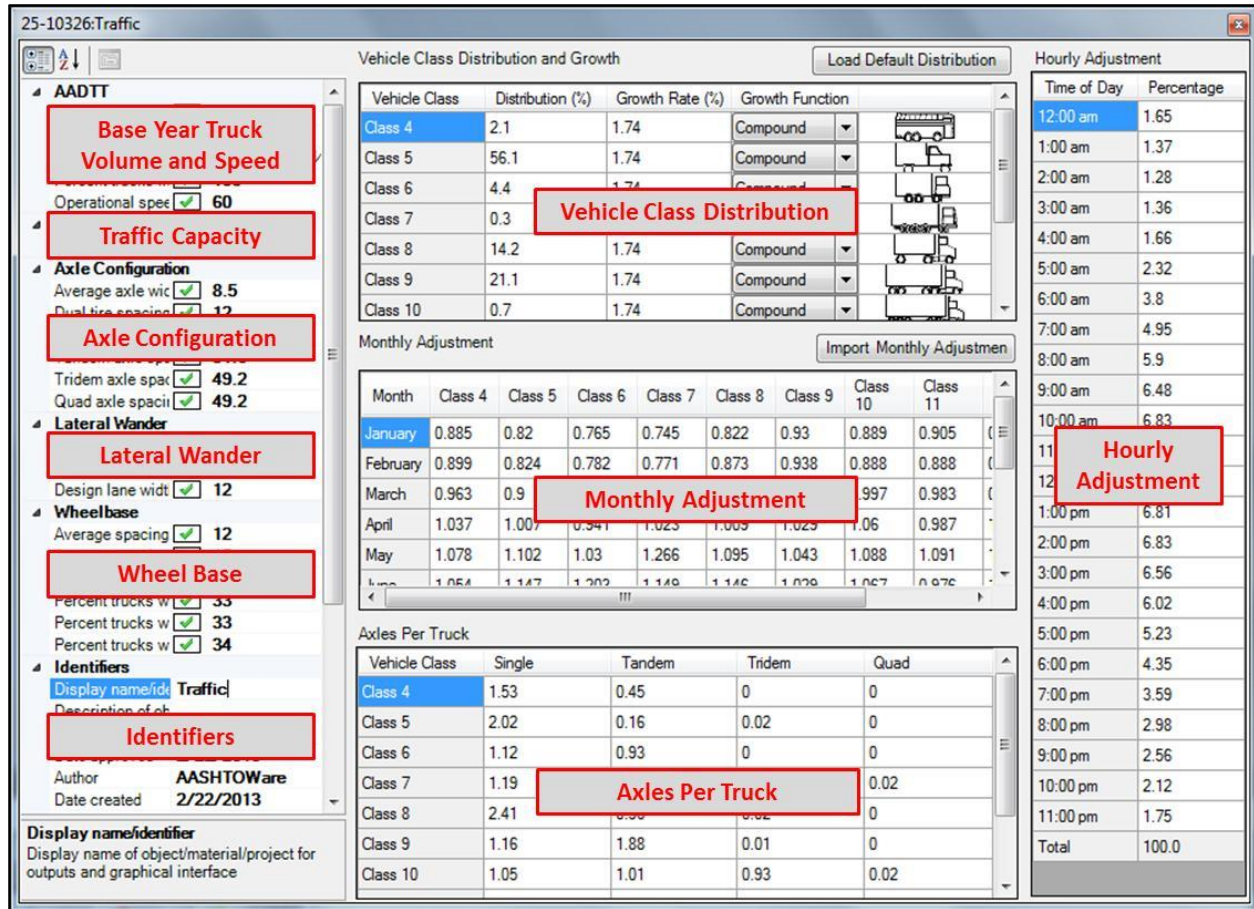

Figure 3.1 Traffic Inputs in the M-E Design Software

3.1.1 CDOT Traffic Data

The Department has some sites on the highway system where instruments have been placed in the roadway to measure axle loads as a vehicle passes over the site. These stations, called Weigh-in-Motion (WIM) sites, can provide accurate information for the existing traffic load. An estimate of growth over the design period will be needed to calculate the traffic load during the design period. The link <http://dtdapps.coloradodot.info/Otis/TrafficData> is used to access traffic load information.

The Division of Transportation Development (DTD) Traffic Analysis Unit supplies traffic analysis for pavement structure design. All vehicular traffic on the design roadway is projected for the design year in the categories of passenger cars, single unit trucks, and combination trucks with various axle configurations. The DTD Traffic Analysis Unit will make adjustments for directional distribution and lane distribution.

The DTD provides traffic projections Average Annual Daily Traffic (AADT) and ESAL. The designer must request 10, 20, and 30-year traffic projections for flexible pavements and 20 and 30-year traffic projections for rigid pavements from the Traffic Section of DTD. Requests for traffic projections should be coordinated with the appropriate personnel of DTD. The pavement

designer can help ensure that accurate traffic projections are provided by documenting local conditions and planned economic development that may affect future traffic loads and volumes. DTD should be notified of special traffic situations when traffic data are requested. Some special situations may include:

- A street that is or will be a major arterial route for city buses
- A roadway that will carry truck traffic to and from heavily used distribution or freight centers
- A highway that will experience an increase in traffic due to a connecting major, high-traffic
- A highway that will be constructed in the near future
- A roadway that will experience a decrease in traffic due to the future opening of a parallel roadway facility.

3.1.2 Traffic Inputs Hierarchy

The M-E Design methodology defines three levels of traffic data inputs based on how well the pavement designer can estimate future truck traffic characteristics for the roadway being designed. **Table 3.1 Hierarchy of Traffic Inputs** presents the hierarchy description of traffic inputs and their common data sources. Refer to **Table 2.6 Selection of Input Hierarchical Level** for selection of an appropriate hierarchical level for traffic inputs. **Table 3.2 Recommendations of Traffic Inputs at Each Hierarchical Level** presents the traffic inputs requirements of the M-E Design method and the recommendations for obtaining these inputs at each hierarchical input level.

Table 3.1 Hierarchy of Traffic Inputs

Input Hierarchy	Description
Level 1	Site-specific traffic data (volume counts, traffic adjustment factors and axle load distribution). Determined from site-specific measurements of weigh-in-motion (WIM) data.
Level 2	Site-specific traffic volume counts and CDOT averages of traffic adjustment factors and axle load data. Derived averages from CDOT weigh-in-motion (WIM) and automatic vehicle classification (AVC) historical data.
Level 3	Site-specific traffic volume counts and national averages (M-E Design software defaults) of traffic adjustment factors and axle load data.

Table 3.2 Recommendations of Traffic Inputs at Each Hierarchical Level

Input	Level 1	Level 2	Level 3
AADTT	Use project specific historical traffic volume data Refer Section 3.1.3 Volume Counts		
Traffic Growth Rate and Type	Use project specific historical traffic volume data Refer Section 3.1.5 Growth Factors for Trucks		
Lane and Directional Distribution Factor	Use project specific values	Refer Section 3.1.4 Lane and Directional Distributions	
Vehicle Class Distribution	Use project specific values	Use CDOT Averages Refer Table 3.5 Level 2 Vehicle Class Distribution Factors	Use M-E Design software defaults
Monthly Adjustment Factor	Use project specific values	Use CDOT Averages Refer Table 3.7 Level 2 Monthly Adjustment Factors	
Hourly Distribution Factor	Use project specific values	Use CDOT Averages Refer Table 3.8 Hourly Distribution Factors	
Axle Load Distribution	Use project specific values	Use CDOT Averages Refer Section 3.1.10 Axle Load Distribution	
Operational Speed	Use posted or design speed (Levels 1 and 2 not available)		
Number of Axles Per Truck	Use project specific values	Use CDOT Averages Refer Table 3.6 Level 2 Number of Axles Per Truck	
Lateral Traffic Wander	Use M-E Design software defaults (Levels 1 and 2 not available) See 3.1.12 Lateral Wander of Axle Loads		
Axle configuration	Use M-E Design software defaults (Levels 1 and 2 not available) See Section 3.1.13 Axle Configuration and Wheelbase		
Wheelbase	Use project specific values	Use national defaults See Section 3.1.13 Axle Configuration and Wheelbase	
Tire pressure	Use M-E Design software defaults (Levels 1 and 2 not available) See Section 3.1.14 Tire Pressure		

3.1.3 Volume Counts

The M-E Design characterizes traffic volume as Annual Average Daily Truck Traffic (AADTT) – See **Figure 3.2 M-E Design Software Screenshot of AADTT**. AADTT is a product of Annual Average Daily Traffic (AADT) and percent trucks (FHWA vehicle Classes 4 through 13). Project-specific AADTT for the base year is required for pavement design/analysis for all hierarchical input levels.

AADTT		
Two-way AADTT	✓	745
Number of lanes	✓	2
Percent trucks in design direction	✓	50
Percent trucks in design lane	✓	90
Operational speed (mph)	✓	60

Figure 3.2 M-E Design Software Screenshot of AADTT

CDOT reports both AADT and AADTT . Historical AADT and/or AADTT estimates for a specific project segment can be accessed from the link:

<http://dtdapps.coloradodot.info/Otis/TrafficData>.

3.1.4 Lane and Directional Distributions

The most heavily used lane is referred to as the design lane. Generally, the outside lanes are the design lanes. Traffic analysis determines a percent of all trucks traveling on the facility for the design lanes. This also referred to a lane distribution factor.

The percent of trucks in the design direction is applied to the two directional AADT to account for any differences to truck volumes by direction. The percent trucks in the design direction is referred to as the directional distribution factor. Generally, the directional distribution factor is a 50/50 percent split. If the number of lanes and volumes are not the same for each direction, it may be appropriate to design a different pavement structure for each direction of travel.

CDOT uses a design lane factor to account for the lane distribution and directional distribution. Both distributions are combined into one factor, the design lane factor. **Table 3.3 Design Lane Factor** shows the relationship of the design lane factor and the lane and directional distributions.

Figure 3.2 M-E Design Software Screenshot of AADTT presents the M-E Design software screenshot of lane and directional distribution factors.

Table 3.3 Design Lane Factor

Type of Facility	Number of Lanes in Design Direction	Design Lane Factor	Percent of Total Trucks in the Design Lane (Outside Lane)	Directional Split (Design Direction/Non-design Direction)
One Way	1	1.00	100	NA
2-lanes	1	0.60	100	60/40
4-lanes	2	0.45	90	50/50
6-lanes	3	0.30	60	50/50
8-lanes	4	0.25	50	50/50

Note 1: Highway Capacity Manual, 2000 (Exhibit 12-13) recommends using a default value for a directional split of 60/40 on a two-lane highway may it be rural or urban (3).

3.1.5 Growth Factors for Trucks

The number of vehicles using a pavement tends to increase with time. A simple growth rate assumes that the AADT is increased by the same amount each year. A compound growth rate assumes that the AADT percent growth rate for any given year is applied to the volume during the preceding year. CDOT uses the compound growth rate. Use **Eq. 3.1** or **Table 3.4 Growth Rate Determined Using OTIS 20 Year Growth Factor**.

$$T_f = (1 + r)^n \quad \text{Eq. 3-1}$$

Where:

- T_f = growth factor
- R = rate of growth expressed as a fraction
- n = number of years

The CDOT traffic analysis unit may be consulted to estimate the increase in truck traffic over time (**using the M-E Design approach**). The M-E Design software has the capability to use different growth rates for different truck classes, but assumes that the growth rate remains the same throughout the analysis period – See **Figure 3.3 M-E Design Software Screenshot of Growth Rate**. The estimated traffic volumes to be used in the pavement design can be subjected to roadway capacity limits.

Project-specific growth rates are required for pavement design/analysis for all hierarchical input levels. An estimate of truck volume growth over the design period can be accessed from the link <http://dtdapps.coloradodot.info/Otis/TrafficData>.











Vehicle Class Distribution and Growth					Load Default Distribution
Vehicle Class	Distribution (%)	Growth Rate (%)	Growth Function		
Class 4	2.1	1.74	Compound	▼	
Class 5	56.1	1.74	Compound	▼	
Class 6	4.4	1.74	Compound	▼	
Class 7	0.3	1.74	Compound	▼	
Class 8	14.2	1.74	Compound	▼	
Class 9	21.1	1.74	Compound	▼	
Class 10	0.7	1.74	Compound	▼	
Class 11	0.7	1.74	Compound	▼	
Class 12	0.2	1.74	Compound	▼	
Class 13	0.2	1.74	Compound	▼	
Total	100			▼	

Figure 3.3 M-E Design Software Screenshot of Growth Rate

Table 3.4 Growth Rate Determined Using OTIS 20 Year Growth Factor

20 Year Growth Factor (OTIS)	r (%)
1.00	0
1.05	0.245
1.10	0.478
1.15	0.703
1.20	0.916
1.25	1.122
1.30	1.320
1.35	1.512
1.40	1.697
1.45	1.877
1.50	2.048
1.55	2.196
1.60	2.378
1.65	2.535
1.70	2.689
1.75	2.840
1.80	2.983
1.85	3.123
1.90	3.261
1.95	3.393
2.00	3.526
2.05	3.655
2.10	3.784
2.15	3.902
2.20	4.021
2.25	4.139

20 Year Growth Factor (OTIS)	r (%)
2.30	4.256
2.35	4.364
2.40	4.475
2.45	4.584
2.50	4.690
2.55	4.793
2.60	4.894
2.65	4.995
2.70	5.092
2.75	5.179
2.80	5.283
2.85	5.377
2.90	5.464
2.95	5.559
3.00	5.647
3.05	5.834
3.10	5.820
3.15	5.905
3.20	5.988
3.25	6.070
3.30	6.149
3.35	6.232
3.40	6.310
3.45	6.386
3.50	6.465

3.1.6 Vehicle Classification

The M-E Design requires vehicle class distribution. Vehicle class distribution represents the percentage of each truck class (Classes 4 through 13) within the truck traffic distribution, within the AADTT for the base year. The sum of the percent AADTT of all truck classes should equal 100. This normalized distribution is determined from an analysis of AVC data and represent data collected over multiple years. Note that the M-E Design method does not include vehicle classes 1 to 3 (i.e. light weight vehicles) and 14 and 15 (i.e. unclassified vehicles).

CDOT uses a classification scheme of categorizing vehicles into three bins. These vehicle classification types are (1):

- Passenger vehicles, Types 1-3 and 0-20 feet,
- Single unit trucks, Types 4-7 and 20-40 feet, and
- Combination trucks, Types 8-13 and greater than 40 feet long.

These bins are further broken down into 13 classes. The 13-classification scheme follows FHWA vehicle type classification. For some situations, a fourth bin containing all unclassified vehicles is used. Additional classes, Class 14 and 15, may also be included in the fourth bin.

CDOT vehicle classes are presented in **Figure 2.3 Functional Classification Map**. FHWA vehicle classes with definitions are presented as follows (2):

- Class 1 - Motorcycles** - All two or three-wheeled motorized vehicles. Typical vehicles in this category have saddle type seats and are steered by handlebars rather than steering wheels. This category includes motorcycles, motor scooters, mopeds, motor-powered bicycles, and three-wheel motorcycles. This vehicle type may be reported at the option of the State.
- Class 2 - Passenger Cars** - All sedans, coupes, and station wagons manufactured primarily for the purpose of carrying passengers and including those passenger cars pulling recreational or other light trailers.
- Class 3 - Other Two-Axle, Four-Tire Single Unit Vehicles** - All two-axle, four-tire, vehicles, other than passenger cars. Included in this classification are pickups, panels, vans, and other vehicles such as campers, motor homes, ambulances, hearses, carryalls, and minibuses. Other two-axle, four-tire single-unit vehicles pulling recreational or other light trailers are included in this classification. Because automatic vehicle classifiers have difficulty distinguishing class 3 from class 2, these two classes may be combined into class 2.
- Class 4 - Buses** - All vehicles manufactured as traditional passenger-carrying buses with two axles and six tires or three or more axles. This category includes only traditional buses (including school buses) functioning as passenger-carrying vehicles. Modified buses should be considered to be a truck and should be appropriately classified.
- Class 5 - Two-Axle, Six-Tire, Single-Unit Trucks** - All vehicles on a single frame including trucks, camping and recreational vehicles, motor homes, etc., with two axles and dual rear wheels.
- Class 6 - Three-Axle Single-Unit Trucks** - All vehicles on a single frame including trucks, camping and recreational vehicles, motor homes, etc., with three axles.
- Class 7 - Four or More Axle Single-Unit Trucks** - All trucks on a single frame with four or more axles.
- Class 8 - Four or Fewer Axle Single-Trailer Trucks** - All vehicles with four or fewer axles consisting of two units, one of which is a tractor or straight truck power unit.
- Class 9 - Five-Axle Single-Trailer Trucks** - All five-axle vehicles consisting of two units, one of which is a tractor or straight truck power unit.

Class 10 - Six or More Axle Single-Trailer Trucks - All vehicles with six or more axles consisting of two units, one of which is a tractor or straight truck power unit.

Class 11 - Five or fewer Axle Multi-Trailer Trucks - All vehicles with five or fewer axles consisting of three or more units, one of which is a tractor or straight truck power unit.

Class 12 - Six-Axle Multi-Trailer Trucks - All six-axle vehicles consisting of three or more units, one of which is a tractor or straight truck power unit.

Class 13 - Seven or More Axle Multi-Trailer Trucks - All vehicles with seven or more axles consisting of three or more units, one of which is a tractor or straight truck power unit.

Note: In reporting information on trucks the following criteria should be used:

- a. Truck tractor units traveling without a trailer will be considered single-unit trucks.
- b. A truck tractor unit pulling other such units in a "saddle mount" configuration will be considered one single-unit truck and will be defined only by the axles on the pulling unit.
- c. Vehicles are defined by the number of axles in contact with the road. Therefore, "floating" axles are counted only when in the down position.
- d. The term "trailer" includes both semi- and full trailers.

	Class	Schema	Description
Light-weight Vehicles	1		all motorcycles plus two wheel axles
	2		all cars plus one/two axle trailers
	3		all pickups and vans single/dual wheels plus one/two/three axle trailers
Single Unit Vehicles	4		buses single/dual wheels
	5		two axle, single unit single/dual wheels
	6		three axle, single unit
	7		four axle, single unit
Combination Unit Vehicles	8		four or less axles, single trailers
	9		five axles, single trailers
	10		six or more axles, single trailers
	11		five or less axles, multi-trailers
	12		six axles, multi-trailers
	13		seven or more axles, multi-trailers
Unclassified Vehicles	14		Unclassifiable vehicle
	15		Not used

Figure 3.4 CDOT Vehicle Classifications

For the M-E Design, the vehicle class distribution inputs can be defined at three hierarchical input levels. See **Figure 3.5 M-E Design Software Screenshot of Vehicle Class Distribution**. Three input levels are described in the following sections.

3.1.6.1 Level 1 Vehicle Class Inputs

Level 1 inputs are the actual measured site data (over 24-hours) and must be used for highways with heavy seasonal and atypical traffic. This data can be obtained from the CDOT DTD.

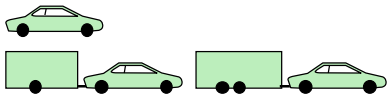
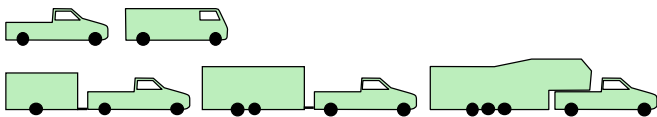
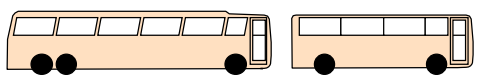
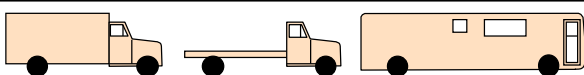
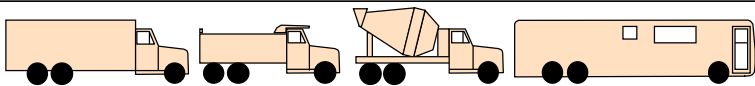
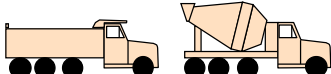
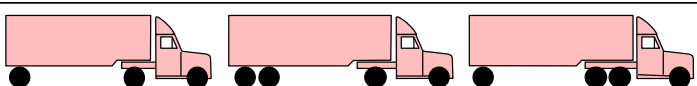
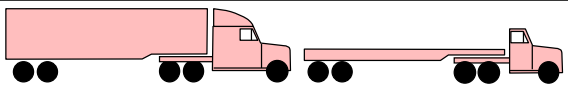
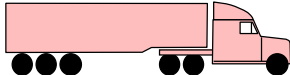
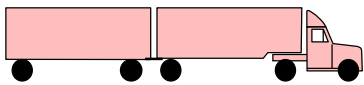
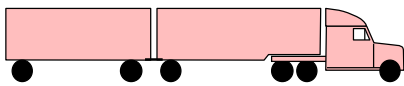
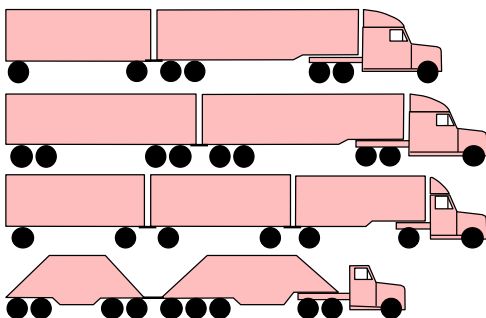
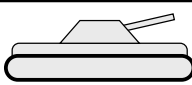
3.1.6.2 Level 2 Vehicle Class Inputs

Level 2 inputs are the regional average values determined from traffic analyses of data from various WIM and AVC sites in Colorado. The traffic data analyses indicated three vehicle class distribution clusters defined according to location and highway functional class. The descriptions of vehicle class clusters are presented as follows:

- Cluster 1 – This distribution had one large primary peak for Class 5 vehicles. The percentage ranged from 40 to 75 for this group. There was a secondary peak for classes 8 and 9 trucks and percentage of trucks ranged from 10 to 30 percent. The main highway functional class was 4-lane Rural Principal Arterial – non-Interstate (US highways and state routes). There were few sections of urban freeways.
- Cluster 2 – This distribution had two distinct peaks for Class 5 and 9 vehicles. The percentage of Class 5 ranged from 5 to 35. The percentage of Class 9 ranged from 40 to 80. The main highway functional class was 4-lane Rural Principal Arterial – Interstate/US highways.
- Cluster 3 – This distribution had two distinct peaks for Class 5 and 9 vehicles. The percentage of Class 5 and Class 9 ranged from 15 to 50. There were similar percentages of Class 5 and 9 trucks with Class 9 trucks being slightly more than other truck types. The main highway functional classes were 2-lane rural Other Principal Arterial, 2-lane Rural Major Collector, and 4-lane urban Principal Arterial.

Selection of the appropriate cluster type must be based on project location and functional class as a minimum as shown in **Table 3.5 Level 2 Vehicle Class Distribution Factors** and **Figure 3.6 Vehicle Class Distribution Factors for CDOT Clusters**. Designers must choose the default set of vehicle class distribution for the cluster that most closely describes the design traffic stream for the roadway under design.

3.1.6.3 Level 3 Vehicle Class Inputs

For situations, where CDOT clusters are not suitable and Level 1 data is not available, designers may use an appropriate default Truck Traffic Class (TTC) group in the M-E Design software. TTC factors were developed based using traffic data from over a 100 WIM and AVC sites located nationwide. The data was obtained FHWA LTPP program data.

Designers may select the most appropriate one from seventeen TTC groups that best describes the truck traffic mix of a given project. **Figure 3.7 Truck Traffic Classification Groups** presents a screenshot of the seventeen TTC groups and their descriptions in the M-E Design software.

Vehicle Class	Distribution (%)	Growth Rate (%)	Growth Function	
Class 4	2.1	1.74	Compound	
Class 5	56.1	1.74	Compound	
Class 6	4.4	1.74	Compound	
Class 7	0.3	1.74	Compound	
Class 8	14.2	1.74	Compound	
Class 9	21.1	1.74	Compound	
Class 10	0.7	1.74	Compound	
Class 11	0.7	1.74	Compound	
Class 12	0.2	1.74	Compound	
Class 13	0.2	1.74	Compound	
Total	100			

Figure 3.5 M-E Design Software Screenshot of Vehicle Class Distribution

Table 3.5 Level 2 Vehicle Class Distribution Factors

Vehicle Class	Cluster 1 4-lane Rural Principal Arterial – Non-Interstate (US Highways and State routes)	Cluster 2 4-lane Rural Principal Arterial – Interstate/US Highways	Cluster 3 2-lane Rural Other Principal Arterial, 2- lane Rural Major Collector, and 4-lane Urban Principal Arterial
4	2.1	2.7	5.1
5	56.1	19.3	32.3
6	4.4	4.5	18
7	0.3	0.3	0.3
8	14.2	4.6	4.9
9	21.1	61.9	36.8
10	0.7	1.6	1.2
11	0.7	2.7	0.7
12	0.2	1.3	0.5
13	0.2	1.1	0.2

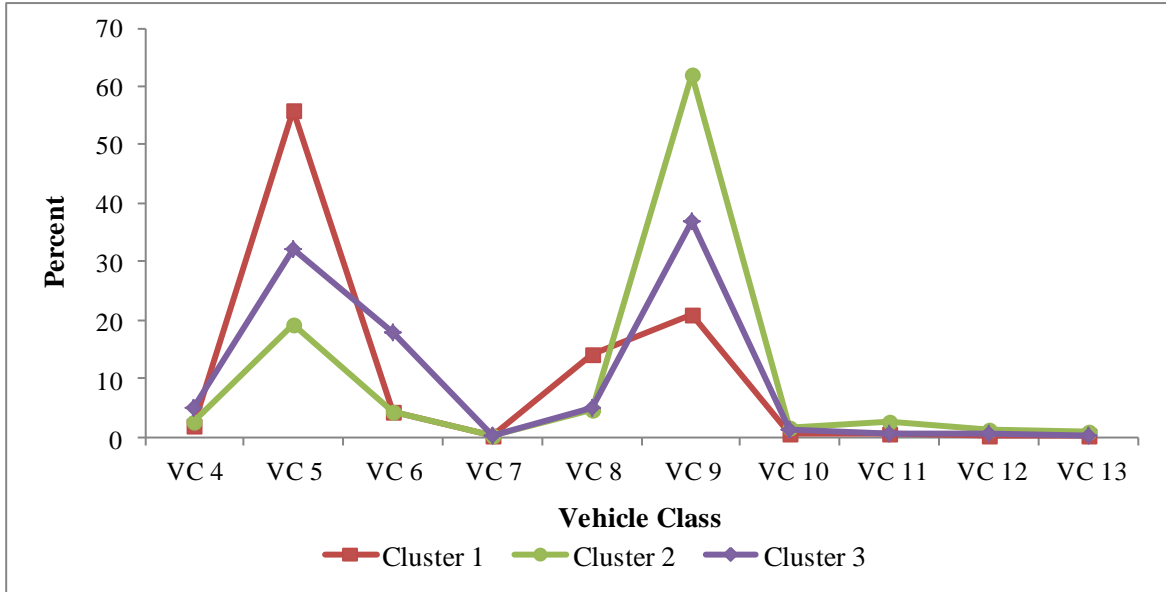

Figure 3.6 Vehicle Class Distribution Factors for CDOT Clusters

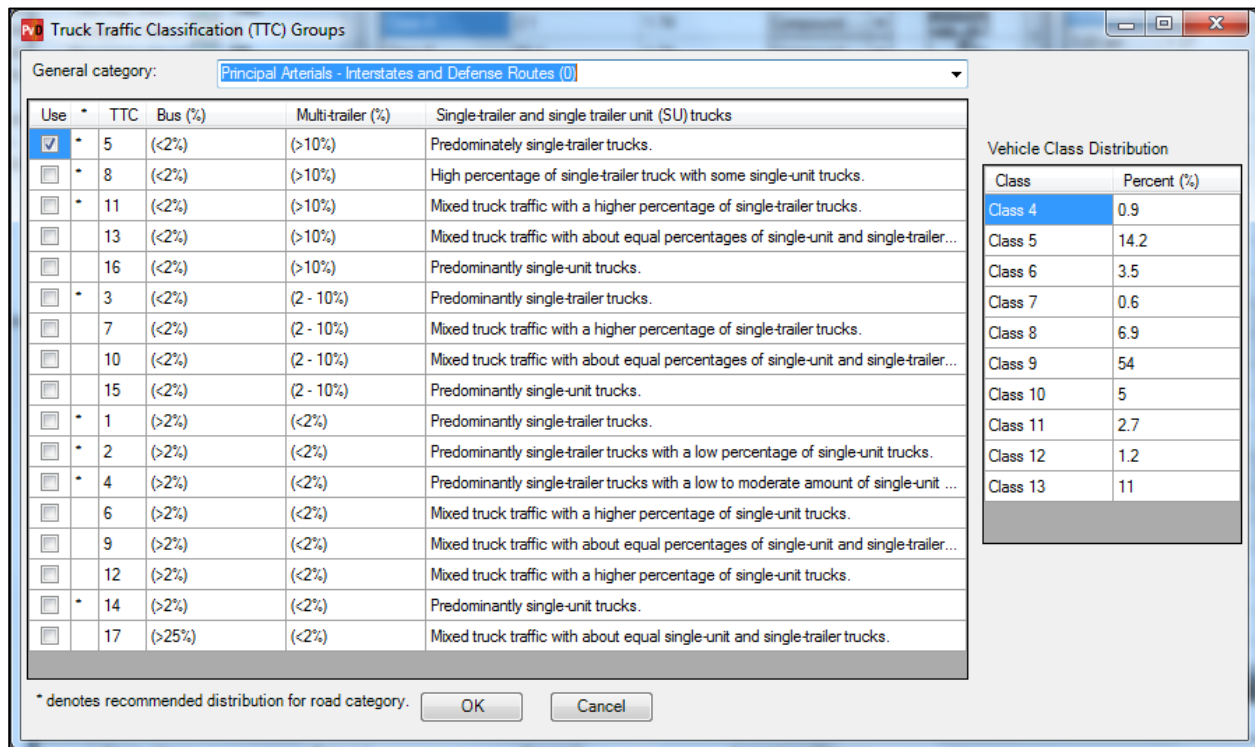

Figure 3.7 Truck Traffic Classification Groups

3.1.7 Number of Axles per Truck

This input represents the average number of axles for each truck class (FHWA vehicle Class 4 to 13) and each axle type (single, tandem, tridem, and quad). For the M-E Design, the number of axles per truck can be defined at three hierarchical input levels. **Figure 3.8 M-E Design Screenshot of Number of Axles Per Truck** presents the M-E Design software screenshot for the number of axles per truck. Three input levels are described in the following sections.

3.1.7.1 Level 1 Number of Axles Per Truck

Level 1 inputs are the actual measured site data and must be used for highways with heavy seasonal and atypical traffic. This data can be obtained from the CDOT DTD.

3.1.7.2 Level 2 Number of Axles Per Truck

Level 2 inputs are the statewide averages values determined from traffic analyses of data from various WIM and AVC sites in Colorado. Refer to **Table 3.6 Level 2 Number of Axles Per Truck** for CDOT statewide averages.

3.1.7.3 Level 3 Number of Axles Per Truck

Level 3 inputs are the M-E Design software defaults. This level is not recommended.

Vehicle Class	Single	Tandem	Tridem	Quad
Class 4	1.53	0.45	0	0
Class 5	2.02	0.16	0.02	0
Class 6	1.12	0.93	0	0
Class 7	1.19	0.07	0.45	0.02
Class 8	2.41	0.56	0.02	0
Class 9	1.16	1.88	0.01	0
Class 10	1.05	1.01	0.93	0.02
Class 11	4.35	0.13	0	0
Class 12	3.15	1.22	0.09	0
Class 13	2.77	1.4	0.51	0.04

Figure 3.8 M-E Design Screenshot of Number of Axles Per Truck

Table 3.6 Level 2 Number of Axles Per Truck

Vehicle Class	Single Axle	Tandem Axle	Tridem Axle	Quad Axle
4	1.53	0.45	0.00	0.00
5	2.02	0.16	0.02	0.00
6	1.12	0.94	0.00	0.00
7	1.19	0.07	0.45	0.02
8	2.41	0.56	0.02	0.00
9	1.16	1.9	0.01	0.00
10	1.15	1.01	0.93	0.02
11	4.35	0.29	0.02	0.00
12	3.27	1.22	0.09	0.00
13	2.77	1.4	0.51	0.04

3.1.8 Monthly Adjustment Factors (trucks)

Truck traffic monthly adjustment factors represent the proportion of the annual truck traffic for a given truck class that occurs in a specific month. The sum of monthly factors for all months for each vehicle class must equal 12. These monthly distribution factors may be determined from WIM, AVC, or manual truck traffic counts. Axle data shall come from CDOT’s data base.

For the M-E Design, the monthly adjustment factors can be defined at three hierarchical input levels. See **Figure 3.9 M-E Design Screenshot of Monthly Adjustment Factors**. Three input levels are described in the following sections.

3.1.8.1 Level 1 Monthly Adjustment Factors

Level 1 inputs are the actual measured site data and must be used for highways with heavy seasonal and atypical traffic. This data can be obtained from the CDOT DTD.

3.1.8.2 Level 2 Monthly Adjustment Factors

Levels 2 inputs are the statewide averages values determined from traffic analyses of data from various WIM and AVC sites in Colorado. Refer to **Table 3.7 Level 2 Monthly Adjustment Factors** for level 2 averages. The axle data and clusters shall come from CDOT’s data base.

3.1.8.3 Level 3 Monthly Adjustment Factors

Level 3 inputs are the M-E Design software defaults. This level is not recommended for use on CDOT projects.

Table 3.7 Level 2 Monthly Adjustment Factors

Month	VC4	VC5	VC6	VC7	VC8	VC9	VC10	VC11	VC12	VC13
Jan	0.885	0.820	0.765	0.745	0.822	0.930	0.889	0.905	0.918	0.862
Feb	0.899	0.824	0.782	0.771	0.873	0.938	0.888	0.888	0.976	0.830
Mar	0.963	0.900	0.843	1.066	0.993	0.990	0.997	0.983	0.919	0.925
Apr	1.037	1.007	0.941	1.023	1.009	1.029	1.060	0.987	1.031	1.050
May	1.078	1.102	1.030	1.266	1.095	1.043	1.088	1.091	1.123	0.999
Jun	1.054	1.147	1.203	1.149	1.146	1.029	1.067	0.976	1.083	1.035
Jul	1.103	1.209	1.467	1.279	1.175	0.995	1.090	1.057	1.082	1.255
Aug	1.117	1.158	1.275	1.034	1.148	1.049	1.089	1.101	1.055	0.968
Sep	1.064	1.114	1.116	1.032	1.050	1.041	1.066	1.070	0.976	1.081
Oct	1.029	1.011	0.966	0.979	0.985	1.043	1.017	1.031	0.944	1.103
Nov	0.912	0.906	0.857	0.862	0.879	1.004	0.951	0.998	1.001	1.031
Dec	0.859	0.802	0.755	0.794	0.825	0.909	0.798	0.913	0.892	0.861

Monthly Adjustment Import Monthly Adjustment

Month	Class 4	Class 5	Class 6	Class 7	Class 8	Class 9	Class 10	Class 11	Class 12	Class 13
January	0.885	0.82	0.765	0.745	0.822	0.93	0.889	0.905	0.918	0.862
February	0.899	0.824	0.782	0.771	0.873	0.938	0.888	0.888	0.976	0.83
March	0.963	0.9	0.843	1.066	0.993	0.99	0.997	0.983	0.919	0.925
April	1.037	1.007	0.941	1.023	1.009	1.029	1.06	0.987	1.031	1.05
May	1.078	1.102	1.03	1.266	1.095	1.043	1.088	1.091	1.123	0.999
June	1.054	1.147	1.203	1.149	1.146	1.029	1.067	0.976	1.083	1.035
July	1.103	1.209	1.467	1.279	1.175	0.995	1.09	1.057	1.082	1.255
August	1.117	1.158	1.275	1.034	1.148	1.049	1.089	1.101	1.055	0.968
Septem...	1.064	1.114	1.116	1.032	1.05	1.041	1.066	1.07	0.976	1.081
October	1.029	1.011	0.966	0.979	0.985	1.043	1.017	1.031	0.944	1.103
Novem...	0.912	0.906	0.857	0.862	0.879	1.004	0.951	0.998	1.001	1.031
Decem...	0.859	0.802	0.755	0.794	0.825	0.909	0.798	0.913	0.892	0.861

Figure 3.9 M-E Design Screenshot of Monthly Adjustment Factors

3.1.9 Hourly Distribution Factors (trucks)

The hourly distribution factors represent the percentage of the total truck traffic within each hour of the day. Hourly distribution factors are required for the analysis of rigid pavements only. Site-specific hourly distribution factors may be estimated from WIM, AVC, or manual truck traffic counts.

For the M-E Design, the hourly distribution factors can be defined at three hierarchical input levels. Three input levels are described in the following sections.

3.1.9.1 Level 1 Hourly Distribution Factors

Level 1 inputs are the actual measured site data and must be used for highways with heavy seasonal and atypical traffic. This data can be obtained from the CDOT DTD.

3.1.9.2 Level 2 Hourly Distribution Factors

Level 2 inputs are the statewide averages values determined from traffic analyses of data from various WIM and AVC sites in Colorado. Refer to **Table 3.8 Hourly Distribution Factors** and **Figure 3.10 Level 2 Hourly Distribution Factors** for Level 2 averages. The axle data and clusters shall come from CDOT's data base.

3.1.9.3 Level 3 Hourly Distribution Factors

Level 3 inputs are the M-E Design software defaults. This level is not recommended.

Table 3.8 Hourly Distribution Factors

Time Period	Distribution, percent	Time Period	Distribution, percent
12:00 a.m. - 1:00 a.m.	1.65	12:00 p.m. - 1:00 p.m.	6.75
1:00 a.m. - 2:00 a.m.	1.37	1:00 p.m. - 2:00 p.m.	6.81
2:00 a.m. - 3:00 a.m.	1.28	2:00 p.m. - 3:00 p.m.	6.83
3:00 a.m. - 4:00 a.m.	1.36	3:00 p.m. - 4:00 p.m.	6.56
4:00 a.m. - 5:00 a.m.	1.66	4:00 p.m. - 5:00 p.m.	6.02
5:00 a.m. - 6:00 a.m.	2.32	5:00 p.m. - 6:00 p.m.	5.23
6:00 a.m. - 7:00 a.m.	3.8	6:00 p.m. - 7:00 p.m.	4.35
7:00 a.m. - 8:00 a.m.	4.95	7:00 p.m. - 8:00 p.m.	3.59
8:00 a.m. - 9:00 a.m.	5.9	8:00 p.m. - 9:00 p.m.	2.98
9:00 a.m. - 10:00 a.m.	6.48	9:00 p.m. - 10:00 p.m.	2.56
10:00 a.m. - 11:00 a.m.	6.83	10:00 p.m. - 11:00 p.m.	2.12
11:00 a.m. - 12:00 p.m.	6.85	11:00 p.m. - 12:00 a.m.	1.75

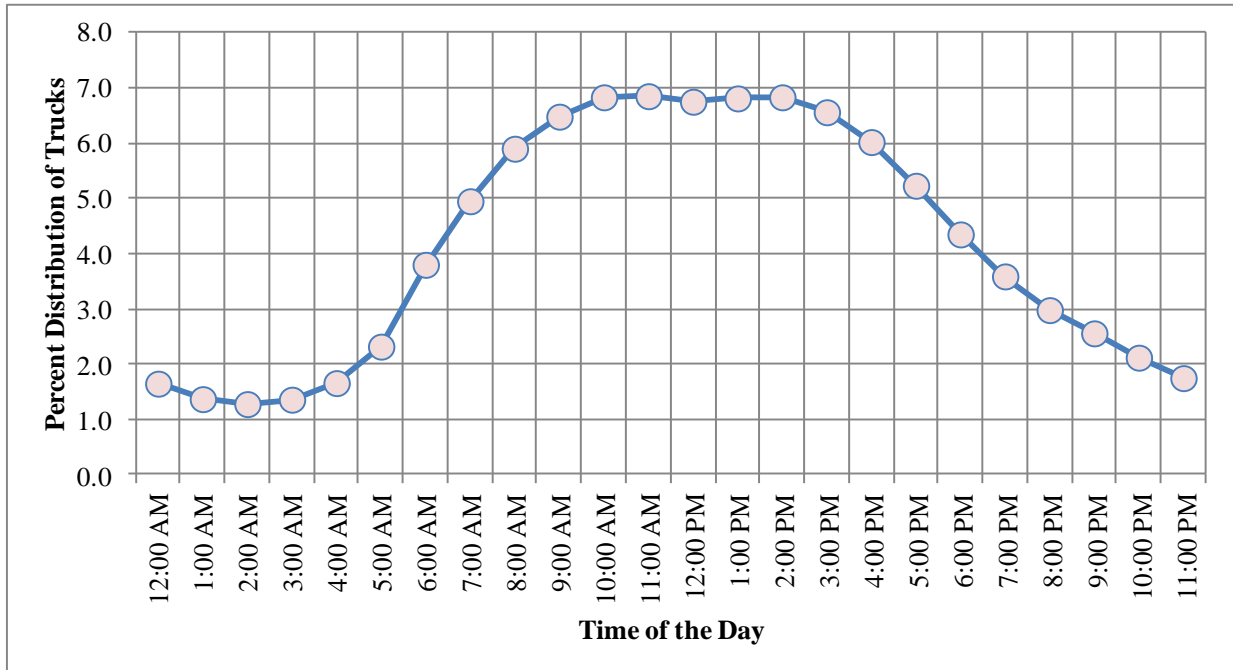

Figure 3.10 Level 2 Hourly Distribution Factors

3.1.10 Axle Load Distribution

The axle load distribution factors simply represent the percentage of the total axle applications within each load interval for a specific axle type (single, tandem, tridem, and quad) and vehicle class (Classes 4 through 13). A definition of load intervals for each axle type is provided below:

- Single axles – 3,000 lb to 40,000 lb at 1,000-lb intervals.
- Tandem axles – 6,000 lb to 80,000 lb at 2,000-lb intervals.
- Tridem and quad axles – 12,000 lb to 102,000 lb at 3,000-lb intervals.

Developing site-specific axle load distribution factors involves the processing of massive amount of WIM data. The processing should be completed external to the M-E Design software using any traffic loading analysis software.

For the M-E Design, the axle load distribution factors can be defined at three hierarchical input levels. See **Figure 3.11 Single Axle Distribution in the M-E Design Software** for a screenshot of axle load distribution factors in the M-E Design software. Three input levels are described in the following sections.

3.1.10.1 Level 1 Axle Load Distribution Factors

Level 1 inputs are the actual measured site data and must be used for highways with unique traffic characteristics and heavy haul routes (i.e. mining, lumber and agricultural routes). This data can be obtained from the CDOT DTD.

Month	Class	Total	3000	4000	5000	6000	7000	8000	9000	10000	11000	12000	13000	14000
January	4	99.97	0.28	0.73	1.77	5.18	8.12	12.73	10.08	11.45	9.11	9.81	6.59	7.11
January	5	100.01	3.69	9.71	14.2	17.72	12.56	11.97	7.19	6.2	3.63	3.19	1.71	1.93
January	6	100.02	2.73	2.86	3.85	4.77	4.61	7.48	9.46	14.63	11.36	10.35	5.42	5.76
January	7	100.01	3.78	3.45	2.25	2.75	3.07	3.85	3.32	6.38	7.33	8.54	6.63	6.61
January	8	100.01	7.61	6.63	7.1	8.63	8.44	11.24	9.57	10.41	6.57	5.67	3.15	3.56
January	9	100.02	1.42	2.5	2.93	3.43	3.39	5.89	9.34	18.41	17.14	14.29	5.72	4.45
January	10	99.99	0.92	1.23	1.93	3.3	3.66	6.43	9.17	16.61	15.03	13.75	6.74	6.86
January	11	100.02	1.69	2.17	3.87	6.46	6.14	7.89	8.72	12.31	9.15	8.6	5.12	6.85
January	12	99.98	2.2	3.48	5.08	7.98	7.27	10.22	11.02	14	9.32	8.24	4.47	5
January	13	100.01	3.13	3.18	3.4	6.19	5.25	7.45	7.88	9.91	7.39	8.07	5.02	7.52
February	4	99.99	0.23	0.81	1.74	5.33	8.49	12.67	10.35	11.55	9.15	9.72	6.51	7.1
February	5	100.02	3.98	10.45	15.97	19.7	13.19	11.09	6.08	5.2	2.96	2.58	1.39	1.6
February	6	100.01	2.73	2.85	3.84	4.81	5.06	7.94	9.89	14.79	11.42	10.11	5.22	5.35
February	7	100.03	4.9	1.93	2.27	1.32	4.43	3.99	2.65	4.74	8.66	9.29	7.32	8.44
February	8	99.97	7.33	6.45	7.07	8.51	8.59	11.42	9.48	10.35	6.54	5.62	3.22	3.55
February	9	100	1.47	2.53	2.94	3.44	3.43	6.13	9.36	18.27	16.86	14.31	5.79	4.65
February	10	100	0.97	1.18	1.98	3.36	3.84	6.83	9.38	16.42	14.83	14.36	7.49	6.52
February	11	100.01	0.95	2.18	3.59	6.29	5.7	7.97	8.71	12.13	8.99	8.68	5.57	7.37
February	12	99.99	1.56	2.55	4.06	9.1	7.09	9.61	11.67	12.98	9.67	8.91	4.65	6.85
February	13	99.97	3	3.05	3.24	5.78	4.5	8.1	9.66	9.37	7.94	7.68	5.86	8.8
March	4	100	0.27	0.74	1.61	5.05	7.8	12.35	10.28	11.6	9.29	9.89	6.47	7.27
March	5	100	4.73	10.98	15.79	19.04	12.61	10.96	6.15	5.26	3.02	2.66	1.44	1.63

Figure 3.11 Single Axle Distribution in the M-E Design Software

3.1.10.2 Level 2 Axle Load Distribution Factors

Level 2 inputs are the statewide averages values determined from traffic analyses of data from various WIM and AVC sites in Colorado. **Table 3.9 Level 2 Single Axle Load Distribution Factors (Percentages)** through **Table 3.12 Level 2 Quad Axle Load Distribution Factors (Percentages)** presents the CDOT averages of axle load distribution factors for single, tandem, tridem and quad axles for each truck class, respectively. The axle data and clusters shall come from CDOT’s data base.

Figure 3.12 CDOT Averages of Single Axle Load Distribution (Classes 5 and 9 only) presents the load distributions of single axles for vehicle Classes 5 and 9. **Figure 3.13 CDOT Averages of Tandem Axle Load Distribution (Classes 6 and 9 only)** presents the load distributions of tandem axles for vehicle Classes 5 and 9.

Electronic versions of the Level 2 axle load distribution factors can be obtained from the CDOT Pavement Design office.

3.1.10.3 Level 3 Axle Load Distribution Factors

Level 3 inputs are the M-E Design software defaults. This level is not recommended for use on CDOT projects.

Table 3.9 Level 2 Single Axle Load Distribution Factors (Percentages)

Mean Axle Load, lbs.	Vehicle/Truck Class									
	4	5	6	7	8	9	10	11	12	13
3000	0.24	4.71	2.19	3.49	8.44	1.39	0.76	1.85	1.51	2.59
4000	0.78	11.26	2.75	3.13	7.28	2.51	1.41	2.11	2.97	3.03
5000	1.77	16.33	3.98	2.56	7.40	3.00	2.30	3.59	4.66	3.27
6000	5.24	18.85	5.03	2.64	8.36	3.54	3.49	6.44	8.65	5.20
7000	8.19	12.49	4.79	2.86	8.10	3.41	3.73	6.09	7.66	4.89
8000	12.87	10.93	7.67	3.92	10.75	5.87	6.41	8.41	10.14	7.37
9000	10.32	6.13	9.77	3.87	9.17	9.19	9.18	9.19	11.54	8.06
10000	11.46	5.22	15.52	5.65	10.06	18.64	17.04	12.53	14.27	10.20
11000	9.21	2.97	12.24	6.04	6.37	17.62	15.60	9.05	9.77	8.25
12000	9.87	2.56	10.78	7.46	5.59	14.63	14.47	8.87	8.93	8.60
13000	6.45	1.39	5.47	6.33	3.07	5.65	7.00	5.49	4.75	5.97
14000	7.05	1.62	5.52	8.39	3.56	4.26	6.33	6.88	5.34	8.08
15000	4.78	1.15	3.54	7.22	2.55	2.32	3.63	5.22	3.41	6.20
16000	2.68	0.69	2.06	5.82	1.55	1.50	1.92	3.20	1.74	3.64
17000	2.53	0.79	2.15	7.44	1.76	1.64	1.80	3.50	1.70	3.88
18000	1.56	0.52	1.42	4.57	1.18	1.23	1.05	2.15	0.76	2.19
19000	1.35	0.51	1.28	4.82	1.15	1.11	0.80	1.84	0.63	1.96
20000	0.83	0.33	0.79	3.63	0.73	0.68	0.54	1.01	0.35	1.20
21000	0.76	0.32	0.67	2.78	0.65	0.51	0.51	0.82	0.26	0.94
22000	0.47	0.21	0.42	1.79	0.38	0.30	0.31	0.40	0.20	0.58
23000	0.41	0.22	0.36	1.46	0.34	0.23	0.26	0.29	0.18	0.51
24000	0.23	0.15	0.23	0.76	0.20	0.16	0.22	0.26	0.09	0.42
25000	0.20	0.16	0.21	0.62	0.19	0.14	0.20	0.14	0.08	0.45
26000	0.13	0.12	0.15	0.53	0.13	0.09	0.14	0.08	0.05	0.47
27000	0.11	0.08	0.13	0.60	0.12	0.08	0.13	0.08	0.07	0.29
28000	0.06	0.03	0.08	0.33	0.07	0.05	0.08	0.06	0.04	0.12
29000	0.07	0.03	0.08	0.31	0.07	0.04	0.08	0.06	0.04	0.17
30000	0.06	0.02	0.06	0.30	0.05	0.03	0.06	0.05	0.03	0.10
31000	0.03	0.02	0.04	0.09	0.04	0.02	0.04	0.03	0.01	0.07
32000	0.03	0.02	0.04	0.16	0.04	0.02	0.04	0.03	0.01	0.08
33000	0.02	0.01	0.03	0.11	0.03	0.01	0.03	0.02	0.01	0.06
34000	0.02	0.01	0.03	0.05	0.03	0.01	0.05	0.02	0.00	0.09
35000	0.01	0.01	0.02	0.02	0.02	0.01	0.01	0.01	0.00	0.03
36000	0.01	0.01	0.02	0.01	0.02	0.01	0.03	0.01	0.01	0.05
37000	0.01	0.00	0.02	0.04	0.02	0.00	0.01	0.01	0.00	0.03
38000	0.01	0.01	0.02	0.02	0.02	0.00	0.01	0.02	0.00	0.05
39000	0.00	0.00	0.01	0.01	0.01	0.00	0.02	0.00	0.00	0.03
40000	0.00	0.00	0.01	0.03	0.02	0.00	0.01	0.00	0.00	0.02
41000	0.14	0.14	0.42	0.16	0.45	0.09	0.31	0.18	0.11	0.89

Table 3.10 Level 2 Tandem Axle Load Distribution Factors (Percentages)

Mean Axle Load, lbs.	Vehicle/Truck Class									
	4	5	6	7	8	9	10	11	12	13
6000	0.41	38.29	2.94	12.80	18.36	3.21	0.90	4.34	2.19	3.22
8000	1.51	24.51	7.75	2.15	9.01	5.20	1.57	1.62	3.19	3.76
10000	2.68	16.41	12.42	3.45	9.79	7.57	3.08	3.78	4.89	5.06
12000	4.17	8.75	12.11	3.65	10.51	8.61	5.30	6.50	9.15	7.11
14000	4.46	4.66	9.72	3.15	10.15	8.29	7.08	13.11	10.75	8.50
16000	4.82	2.61	7.83	0.70	8.39	7.24	8.17	8.03	11.61	8.73
18000	6.53	1.60	6.30	2.20	6.65	6.08	8.73	8.03	12.58	8.04
20000	8.19	1.03	5.26	0.65	5.50	5.21	8.66	8.31	12.86	7.51
22000	9.39	0.71	4.49	3.40	4.33	4.74	8.02	9.39	10.78	7.33
24000	10.04	0.49	3.86	4.00	3.33	4.50	7.08	9.00	8.14	6.27
26000	9.41	0.31	3.47	6.15	2.41	4.53	6.35	8.10	5.33	5.05
28000	8.81	0.21	3.20	2.10	1.83	4.77	6.00	6.46	3.37	4.19
30000	8.53	0.14	3.32	4.35	1.60	5.41	5.67	4.88	2.06	4.46
32000	6.48	0.08	2.94	3.15	1.19	5.40	4.73	2.95	0.97	3.34
34000	4.95	0.05	2.71	5.85	1.08	5.48	4.21	2.16	0.55	2.91
36000	3.51	0.03	2.48	5.85	0.97	4.66	3.51	1.02	0.33	2.83
38000	2.10	0.02	2.15	7.55	0.88	3.28	2.54	0.61	0.34	2.16
40000	1.29	0.02	1.74	6.05	0.74	2.01	1.99	0.44	0.27	2.17
42000	0.78	0.01	1.39	4.00	0.60	1.20	1.64	0.32	0.15	1.34
44000	0.52	0.01	1.05	2.50	0.50	0.77	1.10	0.19	0.09	0.83
46000	0.37	0.01	0.75	3.85	0.39	0.52	0.81	0.09	0.04	0.84
48000	0.26	0.00	0.52	1.20	0.30	0.36	0.70	0.09	0.12	0.93
50000	0.19	0.00	0.37	1.60	0.23	0.26	0.53	0.08	0.03	0.62
52000	0.13	0.02	0.34	4.15	0.19	0.19	0.37	0.05	0.02	0.87
54000	0.11	0.01	0.24	1.15	0.15	0.14	0.26	0.04	0.02	0.31
56000	0.08	0.01	0.18	1.40	0.13	0.10	0.20	0.05	0.04	0.28
58000	0.05	0.00	0.12	0.15	0.11	0.07	0.16	0.03	0.01	0.23
60000	0.04	0.00	0.08	1.00	0.08	0.05	0.15	0.03	0.02	0.15
62000	0.03	0.00	0.06	0.75	0.07	0.04	0.11	0.07	0.01	0.12
64000	0.02	0.00	0.05	0.60	0.05	0.03	0.07	0.02	0.00	0.22
66000	0.01	0.00	0.03	0.00	0.05	0.02	0.05	0.01	0.00	0.09
68000	0.01	0.00	0.03	0.00	0.03	0.02	0.10	0.01	0.00	0.11
70000	0.01	0.00	0.01	0.00	0.03	0.01	0.03	0.01	0.00	0.04
72000	0.00	0.00	0.02	0.40	0.02	0.01	0.03	0.01	0.00	0.05
74000	0.01	0.00	0.01	0.00	0.03	0.01	0.01	0.01	0.00	0.05
76000	0.00	0.00	0.01	0.00	0.02	0.00	0.02	0.01	0.00	0.03
78000	0.00	0.00	0.00	0.00	0.02	0.00	0.01	0.01	0.00	0.02
80000	0.00	0.00	0.00	0.00	0.02	0.00	0.01	0.01	0.00	0.02
82000	0.05	0.00	0.05	0.00	0.23	0.04	0.06	0.16	0.05	0.25

Table 3.11 Level 2 Tridem Axle Load Distribution Factors (Percentages)

Mean Axle Load, lbs.	Vehicle/Truck Class									
	4	5	6	7	8	9	10	11	12	13
12000	0.00	65.36	0.00	4.82	11.33	38.87	15.53	0.00	19.21	3.20
15000	0.00	17.43	0.00	3.96	7.69	11.93	10.88	0.00	6.55	4.21
18000	0.00	8.73	0.00	3.78	9.59	8.99	9.05	0.00	6.99	4.87
21000	0.00	4.26	0.00	6.28	9.32	5.50	7.23	0.00	14.85	3.31
24000	0.00	1.65	0.00	3.79	7.83	3.82	6.03	0.00	3.22	2.59
27000	0.00	0.98	0.00	5.04	7.42	3.24	6.05	0.00	0.63	3.11
30000	0.00	0.48	0.00	4.84	7.77	2.90	5.79	0.00	3.41	3.75
33000	0.00	0.24	0.00	5.82	5.88	2.90	5.78	0.00	6.59	4.29
36000	0.00	0.34	0.00	8.30	5.45	2.93	6.49	0.00	6.02	5.24
39000	0.00	0.12	0.00	8.19	4.74	2.65	5.87	0.00	5.54	6.88
42000	0.00	0.11	0.00	9.17	4.17	2.76	5.58	0.00	6.16	7.31
45000	0.00	0.06	0.00	8.36	3.60	2.52	4.06	0.00	2.33	6.91
48000	0.00	0.06	0.00	7.35	3.02	2.14	2.71	0.00	5.15	6.34
51000	0.00	0.06	0.00	4.93	2.75	2.12	2.23	0.00	4.50	6.75
54000	0.00	0.03	0.00	3.28	1.49	1.67	1.68	0.00	2.97	7.60
57000	0.00	0.04	0.00	3.77	1.64	1.46	1.36	0.00	2.37	5.84
60000	0.00	0.01	0.00	1.22	1.32	0.98	1.05	0.00	0.00	5.41
63000	0.00	0.01	0.00	2.88	0.62	0.60	0.69	0.00	3.23	4.18
66000	0.00	0.00	0.00	0.86	0.47	0.46	0.53	0.00	0.10	2.55
69000	0.00	0.00	0.00	0.55	0.49	0.35	0.40	0.00	0.16	1.56
72000	0.00	0.00	0.00	0.50	0.36	0.25	0.26	0.00	0.00	1.08
75000	0.00	0.00	0.00	0.46	0.38	0.21	0.22	0.00	0.00	0.78
78000	0.00	0.00	0.00	0.43	0.57	0.15	0.13	0.00	0.00	0.57
81000	0.00	0.00	0.00	0.25	0.36	0.13	0.10	0.00	0.00	0.43
84000	0.00	0.01	0.00	0.42	0.24	0.08	0.08	0.00	0.00	0.34
87000	0.00	0.00	0.00	0.09	0.12	0.07	0.05	0.00	0.00	0.33
90000	0.00	0.00	0.00	0.53	0.24	0.06	0.03	0.00	0.00	0.22
93000	0.00	0.00	0.00	0.01	0.09	0.04	0.02	0.00	0.00	0.11
96000	0.00	0.00	0.00	0.02	0.09	0.03	0.02	0.00	0.00	0.03
99000	0.00	0.00	0.00	0.01	0.03	0.01	0.01	0.00	0.00	0.04
102000	0.00	0.01	0.00	0.10	0.90	0.17	0.06	0.00	0.00	0.18

Table 3.12 Level 2 Quad Axle Load Distribution Factors (Percentages)

Mean Axle Load, lbs.	Vehicle/Truck Class									
	4	5	6	7	8	9	10	11	12	13
12000	0.00	0.00	0.00	0.00	0.00	41.50	39.41	0.00	0.00	13.63
15000	0.00	0.00	0.00	3.73	0.00	0.00	6.08	0.00	0.00	3.04
18000	0.00	0.00	0.00	0.00	0.00	0.00	5.50	0.00	0.00	4.15
21000	0.00	0.00	0.00	16.67	0.00	0.15	16.55	0.00	0.00	4.46
24000	0.00	0.00	0.00	0.17	0.00	0.00	0.60	0.00	0.00	19.83
27000	0.00	0.00	0.00	0.00	0.00	0.00	1.10	0.00	0.00	1.99
30000	0.00	0.00	0.00	0.00	0.00	0.00	0.78	0.00	47.75	1.84
33000	0.00	0.00	0.00	0.00	0.00	8.35	1.16	0.00	14.70	5.11
36000	0.00	0.00	0.00	0.00	0.00	50.00	2.23	0.00	19.35	1.89
39000	0.00	0.00	0.00	0.00	0.00	0.00	1.60	0.00	13.80	4.63
42000	0.00	0.00	0.00	0.00	0.00	0.00	0.96	0.00	0.00	5.71
45000	0.00	0.00	0.00	0.00	0.00	0.00	3.04	0.00	0.00	1.21
48000	0.00	0.00	0.00	15.00	0.00	0.00	2.14	0.00	1.90	3.81
51000	0.00	0.00	0.00	0.00	0.00	0.00	1.34	0.00	0.00	3.76
54000	0.00	0.00	0.00	0.00	0.00	0.00	1.39	0.00	0.00	4.01
57000	0.00	0.00	0.00	0.00	0.00	0.00	1.95	0.00	2.45	1.80
60000	0.00	0.00	0.00	33.33	0.00	0.00	5.33	0.00	0.00	3.31
63000	0.00	0.00	0.00	0.00	0.00	0.00	2.20	0.00	0.00	2.49
66000	0.00	0.00	0.00	14.47	0.00	0.00	3.08	0.00	0.00	3.46
69000	0.00	0.00	0.00	16.67	0.00	0.00	0.88	0.00	0.00	2.80
72000	0.00	0.00	0.00	0.00	0.00	0.00	0.46	0.00	0.00	1.38
75000	0.00	0.00	0.00	0.00	0.00	0.00	0.14	0.00	0.00	2.04
78000	0.00	0.00	0.00	0.00	0.00	0.00	0.08	0.00	0.00	0.45
81000	0.00	0.00	0.00	0.00	0.00	0.00	0.25	0.00	0.00	0.28
84000	0.00	0.00	0.00	0.00	0.00	0.00	0.19	0.00	0.00	1.60
87000	0.00	0.00	0.00	0.00	0.00	0.00	0.01	0.00	0.00	0.03
90000	0.00	0.00	0.00	0.00	0.00	0.00	0.00	0.00	0.00	0.71
93000	0.00	0.00	0.00	0.00	0.00	0.00	0.00	0.00	0.00	0.00
96000	0.00	0.00	0.00	0.00	0.00	0.00	0.00	0.00	0.00	0.00
99000	0.00	0.00	0.00	0.00	0.00	0.00	1.61	0.00	0.00	0.00
102000	0.00	0.00	0.00	0.00	0.00	0.00	0.00	0.00	0.00	0.56

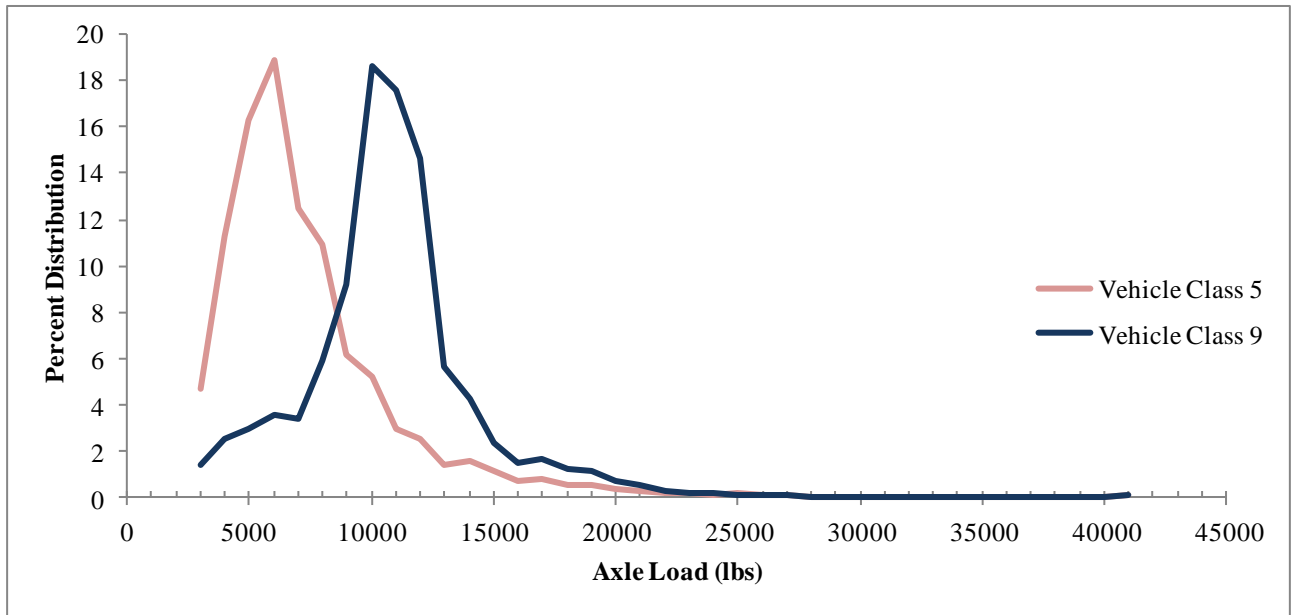

Figure 3.12 CDOT Averages of Single Axle Load Distribution (Classes 5 and 9 only)

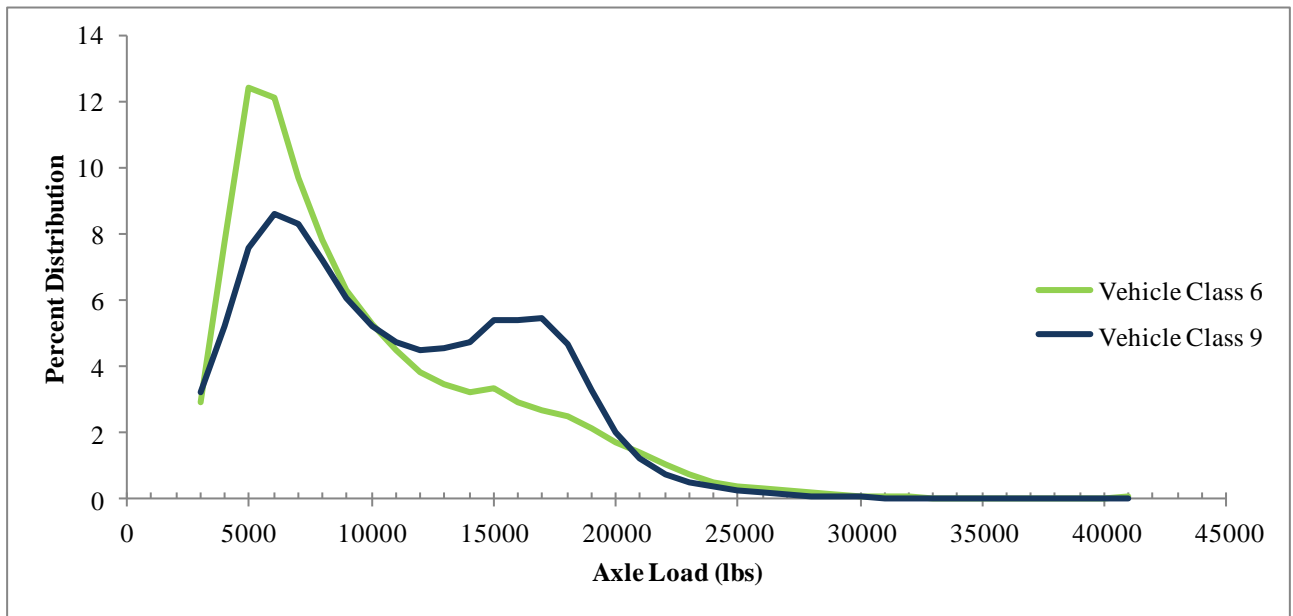

Figure 3.13 CDOT Averages of Tandem Axle Load Distribution (Classes 6 and 9 only)

3.1.11 Vehicle Operational Speed (trucks)

The vehicle operational speed of trucks or the average travel speed generally depends on many factors, including the roadway facility type (Interstate or otherwise), terrain, percentage of trucks in the traffic stream, and so on. Truck speed has a significant impact on the HMA dynamic modulus (E^*) and the predicted performance. Lower speeds result higher incremental damage i.e. more fatigue cracking or deeper ruts or faulting. The posted truck speed limit is suggested for use, unless the local site conditions, such as a steep upgrade or bus stop, indicate for lower speed.

3.1.12 Lateral Wander of Axle Loads

The inputs required for characterizing lateral wander (See **Figure 3.14 M-E Design Software Screenshot of Traffic Lateral Wander**) include:

- **Mean wheel location** – This is the distance from the outer edge of the wheel to the pavement marking – See **Figure 3.15 Schematic of Mean Wheel Location**. M-E Design software provides a default value of 18 inches. A default value of 18 inches is recommended unless a measure value is available.
- **Traffic wander standard deviation** – This is the standard deviation of the lateral traffic wander. The wander is used to determine the number of axle load applications over a point for predicting distress and performance. For standard lane widths, a standard deviation value of 10 inches is suggested unless a measured value is available. A lower or higher lateral wander value is suggested for narrower or wider lanes, respectively.
- **Design lane width** – This is the distance between the lane markings on either side of the design lane – See **Figure 3.16 Schematic of Design Lane Width**.

▲ Lateral Wander		
Mean wheel location (in.)	<input checked="" type="checkbox"/>	18
Traffic wander standard deviation (in.)	<input checked="" type="checkbox"/>	10
Design lane width (ft)	<input checked="" type="checkbox"/>	12
▲ Wheelbase		

Figure 3.14 M-E Design Software Screenshot of Traffic Lateral Wander



Figure 3.15 Schematic of Mean Wheel Location

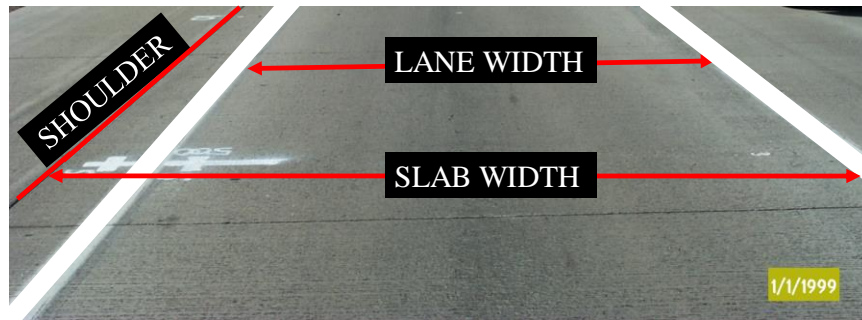

Figure 3.16 Schematic of Design Lane Width

3.1.13 Axle Configuration and Wheelbase

The inputs needed to describe the configurations of the typical tire and axle loads (see **Figure 3.17 Axle Configuration and Wheelbase in the M-E Design Software** and **Figure 3.18 Schematic of Axle Configuration and Wheel Base**) include:

- Average axle-width – This input is the distance between two outside edges of an axle. The recommended value of axle width for trucks is 8.5 feet.
- Dual tire spacing – This input is the distance between centers of a dual tire. The recommended value of dual tire spacing for trucks is 12 inches.

▲ Axle Configuration		
Average axle width (ft)	✓	8.5
Dual tire spacing (in.)	✓	12
Tire pressure (psi)	✓	120
Tandem axle spacing (in.)	✓	51.6
Tridem axle spacing (in.)	✓	49.2
Quad axle spacing (in.)	✓	49.2
▲ Lateral Wander		
▲ Wheelbase		
Average spacing of short axles (ft)	✓	12
Average spacing of medium axles (ft)	✓	15
Average spacing of long axles (ft)	✓	18
Percent trucks with short axles	✓	33
Percent trucks with medium axles	✓	33
Percent trucks with long axles	✓	34
▲ Identifiers		

Figure 3.17 Axle Configuration and Wheelbase in the M-E Design Software

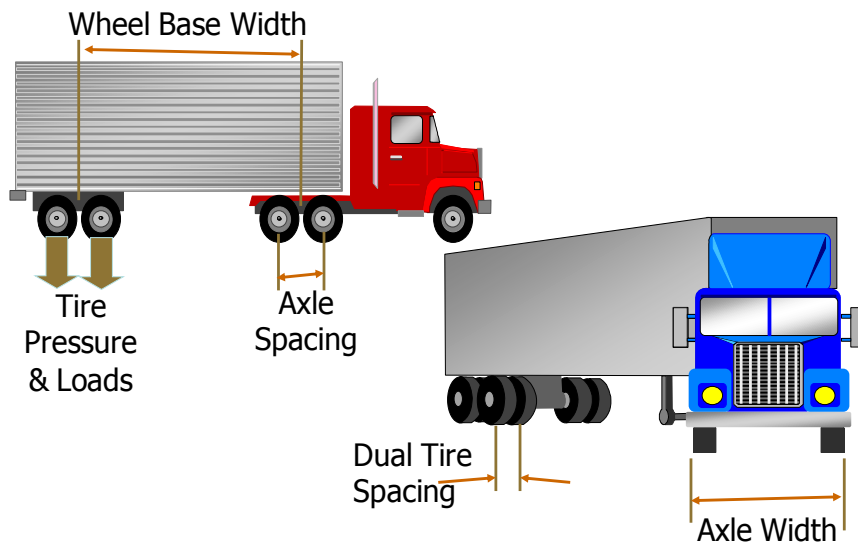

Figure 3.18 Schematic of Axle Configuration and Wheel Base

- Axle spacing – This input is the distance between the two consecutive axles of a tandem, tridem, or quad. It is used in determining the number of load applications for JPCP top-down cracking. The spacing of the axles is recorded in the WIM database. These values have been found to be relatively constant for the standard truck classes. The following values are suggested for use, unless the predominant truck class has different axle spacing:
 - Tandem axle spacing – 51.6 inches
 - Tridem axle spacing – 49.2 inches
 - Quad axle spacing – 49.2 inches

- **Wheelbase** – This input is the distance between the centers of the front and rear axles. It is used in determining the number of load applications for JPCP top-down cracking. The wheelbase is recorded in the WIM database. The following national averages are suggested for use, unless site-specific wheelbase values are available:
 - Percent of trucks with short spacing (10-13.5 feet) – 17.5
 - Percent of trucks with medium spacing (13.5 to 16.5 feet) – 21.6
 - Percent of trucks with long spacing (16.5 to 20.0 feet) – 60.9

3.1.14 Tire Pressure

Tire pressure may vary with the tire type used in the vehicles. A constant value of hot inflation tire pressure representing the average operating conditions should be used. The hot inflation pressure is typically about 10 to 15 percent greater than the cold inflation pressure. A tire pressure value of 120 psi is suggested for use unless a special loading condition is simulated.

3.1.15 Traffic Files in Electronic Format for the M-E Design Software

Designers can create their own traffic input files in electronic formats by directly inputting the data using the traffic input interface of the M-E Design software. This is not recommended for most of the required inputs with exceptions for simple inputs such as AADTT, growth rate etc.

For more complex input types such as the axle load distribution or axles per truck, the designers can add Level 1 and 2 inputs in electronic format from the CDOT DTD. Level 3 input data can be retrieved directly from the M-E Design software.

3.2 Climate

Climate data for the M-E Design software is obtained from weather stations located throughout the state. Information from these stations (temperature, precipitation, wind speed, percent sunshine and relative humidity) are used to predict the temperature and moisture profiles within the pavement structure. In addition, the M-E Design software requires the depth to groundwater table (GWT) as an input. Note that the GWT depth value entered in the M-E Design software is the depth below the final pavement surface.

For critical designs, the GWT data can be obtained from Colorado Division of Water Resources database, United States Department of Agriculture (USDA) Natural Resources Conservation Service (NRCS) Soil Survey Geographic (SSURGO) database or project-specific soil borings. For non-critical designs, guesstimate the GWT depth based on designer's experience.

3.1.16 Creating Project-Specific Climate Input Files

The M-E Design software will identify the six closest weather stations for a given project location based on its geographic coordinates i.e. latitude, longitude and elevation. Designers can select one or more weather stations based on the proximity to the project location. A single weather station

can be selected when the project is within reasonable proximity, or up to six surrounding weather stations can be selected and combined into a virtual weather station for a project. The software does all this automatically after selection by the user. Proximity is defined in terms of both distance and elevation. The recommendations for selecting climatic inputs are presented in **Table 3.13 Recommendations for Climatic Inputs**. A screenshot of the climate tab from the M-E Design software is presented in **Figure 3.19 Climate Tab in the M-E Design Software**.

Climatic data is currently available for 42 weather stations in Colorado. **Figure 3.20 Location of Colorado Weather Stations** shows the location of weather stations in Colorado. In addition, the weather stations located near the states of neighboring states (Utah, Wyoming, Nebraska, New Mexico, Oklahoma Kansas and Arizona) can be used. **Table 3.14 Geographic Coordinates and Data Availability of Colorado Weather Stations** presents the geographic coordinates of Colorado weather stations, including start and end dates of available hourly weather records.

Table 3.13 Recommendations for Climatic Inputs

Climate Inputs	Recommendations
Weather station within 50 miles	Import specific weather station
Weather station more than 50 miles	Create virtual weather station that includes 2 or more surrounding weather stations
Depth of water table (feet)	Actual – see County Soil Reports* or project geotechnical reports or estimate based on area, typically ranges from 3 to 100 feet.
* The United States Department of Agriculture (USDA) Natural Resources Conservation Service (NRCS) Soil Survey Geographic (SSURGO) database. Note that another available resource for estimating depth of water table for a project site is the Colorado Division of Water Resources database and geologic well logs available online at http://www.nrcs.usda.gov/wps/portal/nrcs/main/soils/survey/geo/ .	

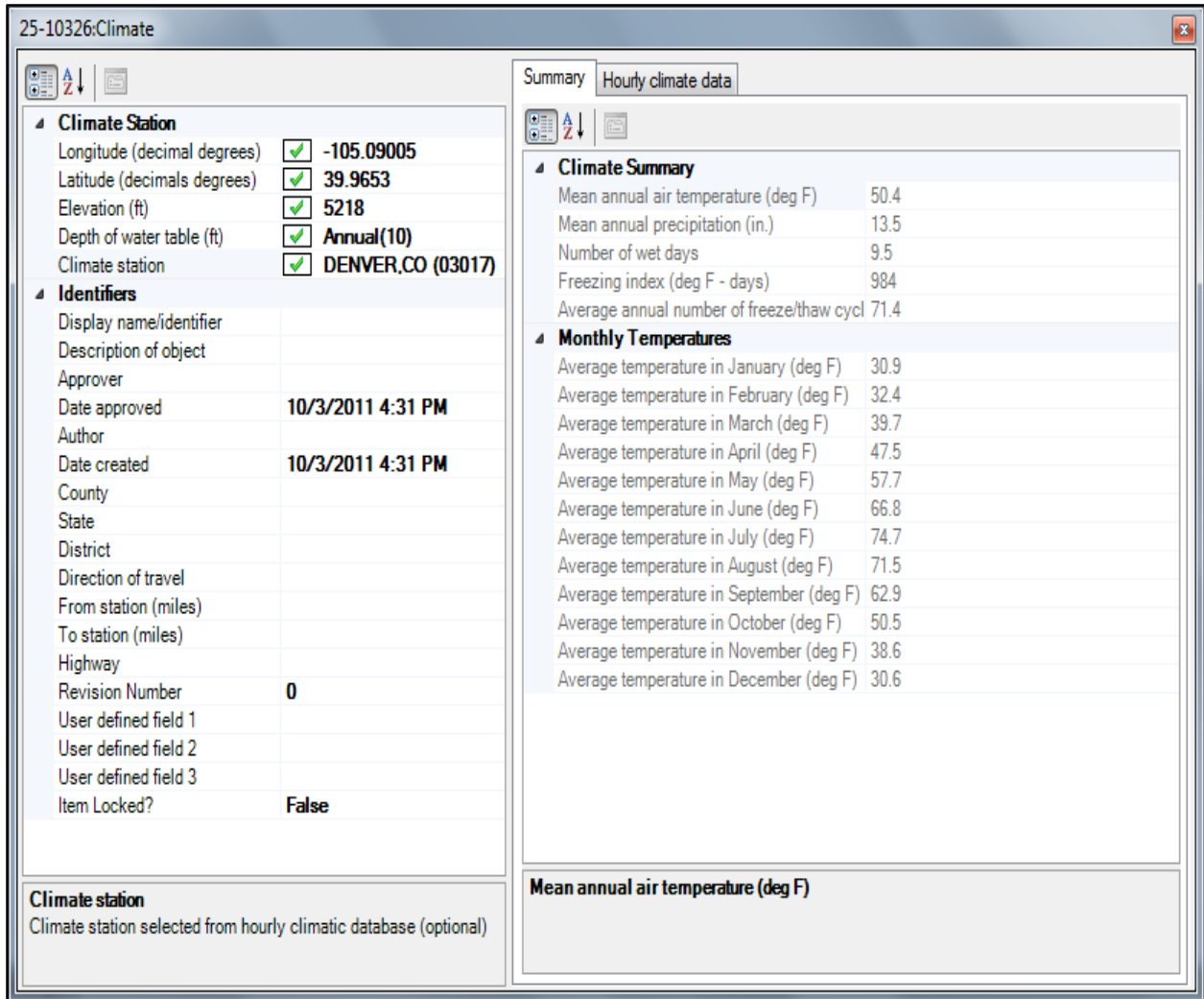

Figure 3.19 Climate Tab in the M-E Design Software

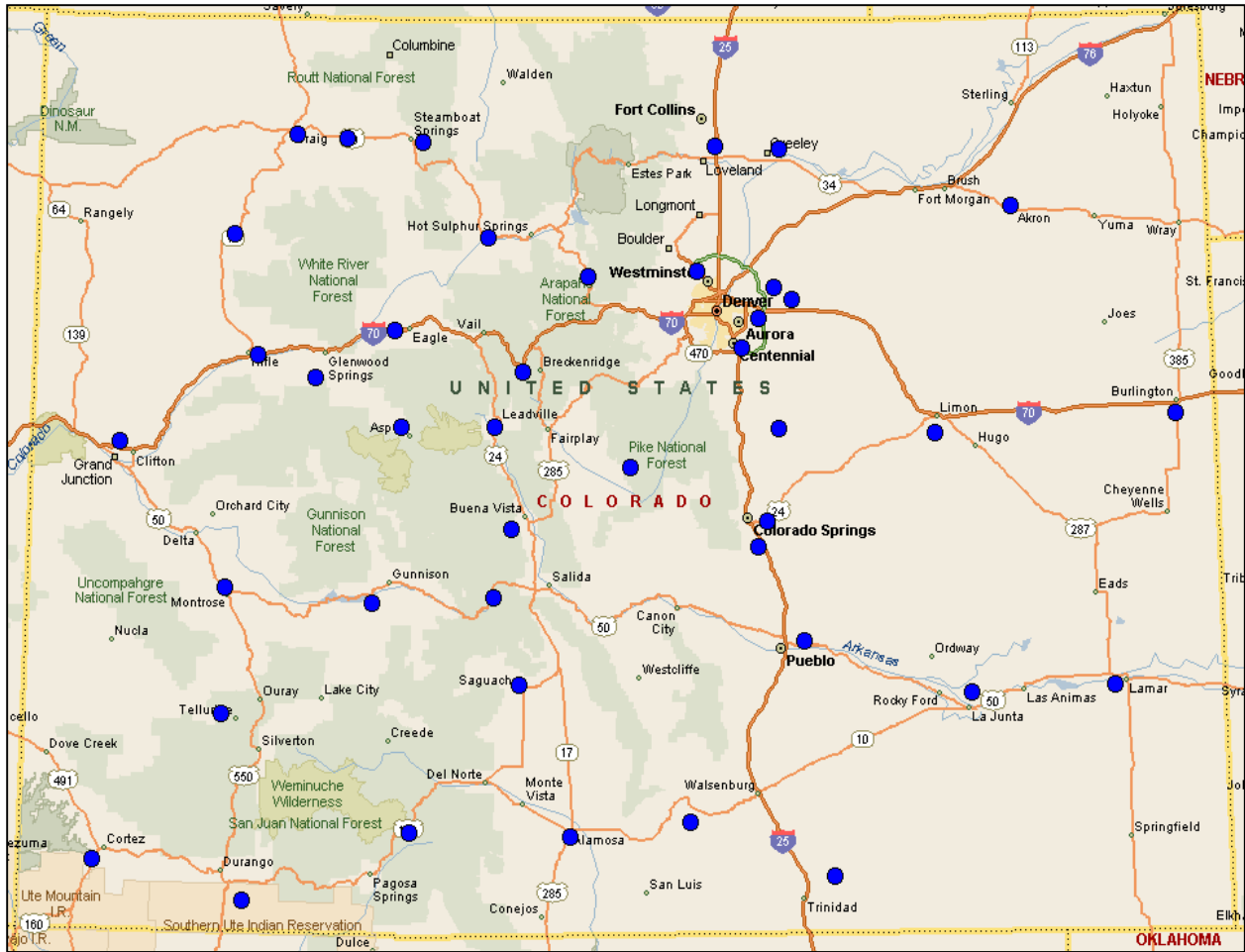

Figure 3.20 Location of Colorado Weather Stations

Table 3.14 Geographic Coordinates and Data Availability of Colorado Weather Stations

Station Number	Station	Latitude	Longitude	Elevation	Start Date	End Date	Years of Data
24015	Akron/Washington Co	40.172	-103.232	4621	6/1/1973	3/31/2010	36.9
23061	Alamoas Muni(AWOS)	37.436	-105.866	7540.9	1/1/1973	3/31/2010	37.3
93073	Aspen Pitkin Co SAR	39.223	-106.868	7742	1/1/1973	3/31/2010	37.3
03065	Broomfield/Jeff Co	39.909	-105.117	5669.9	9/1/1984	3/31/2010	25.6
23036	Buckley AFB	39.702	-104.752	5662	1/1/2000	3/31/2010	10.3
03026	Burlington	39.245	-102.284	4216.8	2/1/1999	3/31/2010	11.2
93067	Centennial Airport	39.57	-104.849	5828	10/1/1983	3/31/2010	26.5
93037	Colorado Springs Municipal AP	38.812	-104.711	6169.9	1/1/1973	3/31/2010	37.3
03038	Copper Mountain Resort	39.467	-106.15	12074	8/1/2004	3/31/2010	5.7
93069	Cortez/Montezuma Co	37.303	-108.628	5914	1/1/1973	3/31/2010	37.3
12341	Cottonwood Pass	38.783	-106.217	9826	7/1/2005	3/31/2010	4.8

Colorado Department of Transportation
2016 Pavement Design Manual

Station Number	Station	Latitude	Longitude	Elevation	Start Date	End Date	Years of Data
24046	Craig-Moffat	40.495	-107.521	6192.8	9/1/1996	3/31/2010	13.6
03017	Denver Intl AP	39.833	-104.658	5431	1/1/1995	3/31/2010	15.3
12342	Denver Nexrad	39.783	-104.55	5606.9	5/1/2006	3/31/2010	3.9
93005	Durango/La Plata AP	37.143	-107.76	6685	1/1/1973	3/31/2010	37.3
23063	Eagle Co Airport	39.643	-106.918	6535	1/1/1973	3/31/2010	37.3
03040	Elbert Co Airport	39.217	-104.633	7060	6/1/2004	3/31/2010	5.8
94015	Fort Carson/Butts	38.7	-104.767	5869.4	1/1/1969	3/31/2010	41.3
94062	Fort Collins Airport	40.452	-105.001	5016	5/1/1986	3/31/2010	23.9
23066	Grand Junction AP	39.134	-108.538	4838.8	1/1/1973	3/31/2010	37.3
24051	Greeley/Weld Cnty AP	40.436	-104.618	4648.9	8/1/1991	3/31/2010	18.7
93007	Gunnison Cnty AP	38.452	-107.034	7673.8	4/1/1976	3/31/2010	34.0
94025	Hayden/Yampa (AWOS)	40.481	-107.217	6602	1/1/1973	5/31/2010	37.4
94076	Kremmling Airport	40.054	-106.368	7411	6/1/2004	3/31/2010	5.8
23067	La Junta Muni AP	38.051	-103.527	4214.8	1/1/1961	3/31/2010	49.3
03042	La Veta Pass	37.5	-105.167	10216.7	7/1/2004	3/31/2010	5.8
03013	Lamar Muni Airport	38.07	-102.688	3070	1/1/1980	3/31/2010	30.3
93009	Leadville/Lake Cnty AP	39.228	-106.316	9926.7	7/1/1987	3/31/2010	22.8
93010	Limon Muni AP	39.189	-103.716	5365.1	1/1/2004	3/31/2010	6.2
94050	Meeker	40.049	-107.885	6390	12/1/1978	3/31/2010	31.4
93013	Montrose Rgnl AP	38.505	-107.898	5758.8	1/1/1973	3/31/2010	37.3
12343	Mount Werner/Steamboat	40.467	-106.767	10633.1	4/1/2005	5/31/2010	5.2
03039	Pagosa Springs Wol	37.45	-106.8	11790.9	6/1/2004	3/31/2010	5.8
93058	Pueblo Airport	38.29	-104.498	4720.1	6/1/1954	3/31/2010	55.9
03016	Rifle/Garfield AP	39.526	-107.726	5543.9	7/1/1987	3/31/2010	22.8
03069	Saguache Muni AP	38.097	-106.169	7826	10/1/2004	3/31/2010	5.5
03041	Salida/Monarch Pass	38.483	-106.317	12030.7	6/1/2004	3/31/2010	5.8
12344	Sunlight Mtn Glenwood Spg	39.433	-107.383	10603.5	6/1/2005	3/31/2010	4.8
03011	Telluride Regional AP	37.954	-107.901	9078	12/1/2000	3/31/2010	9.3
23070	Trinidad/Animas Cnty AP	37.259	-104.341	5743	1/1/1973	3/31/2010	37.3
12345	Wilkerson Pass	39.05	-105.517	11279.4	6/1/2005	3/31/2010	4.8
12346	Winter Park Resort	39.883	-105.767	9091.1	5/1/1986	6/30/1993	7.2

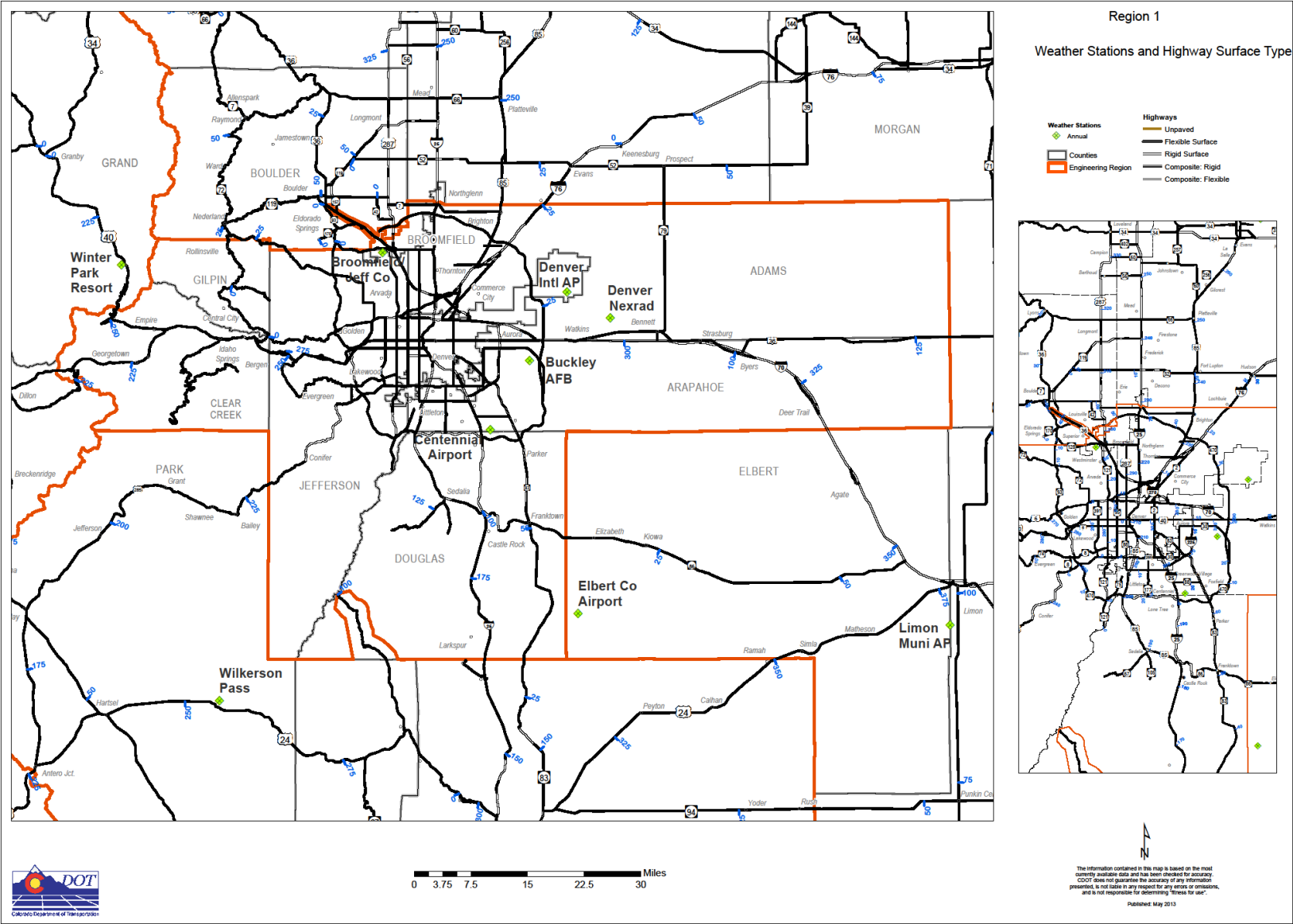

Figure 3.21 Region 1 Weather Stations and Highway Surface Type Map

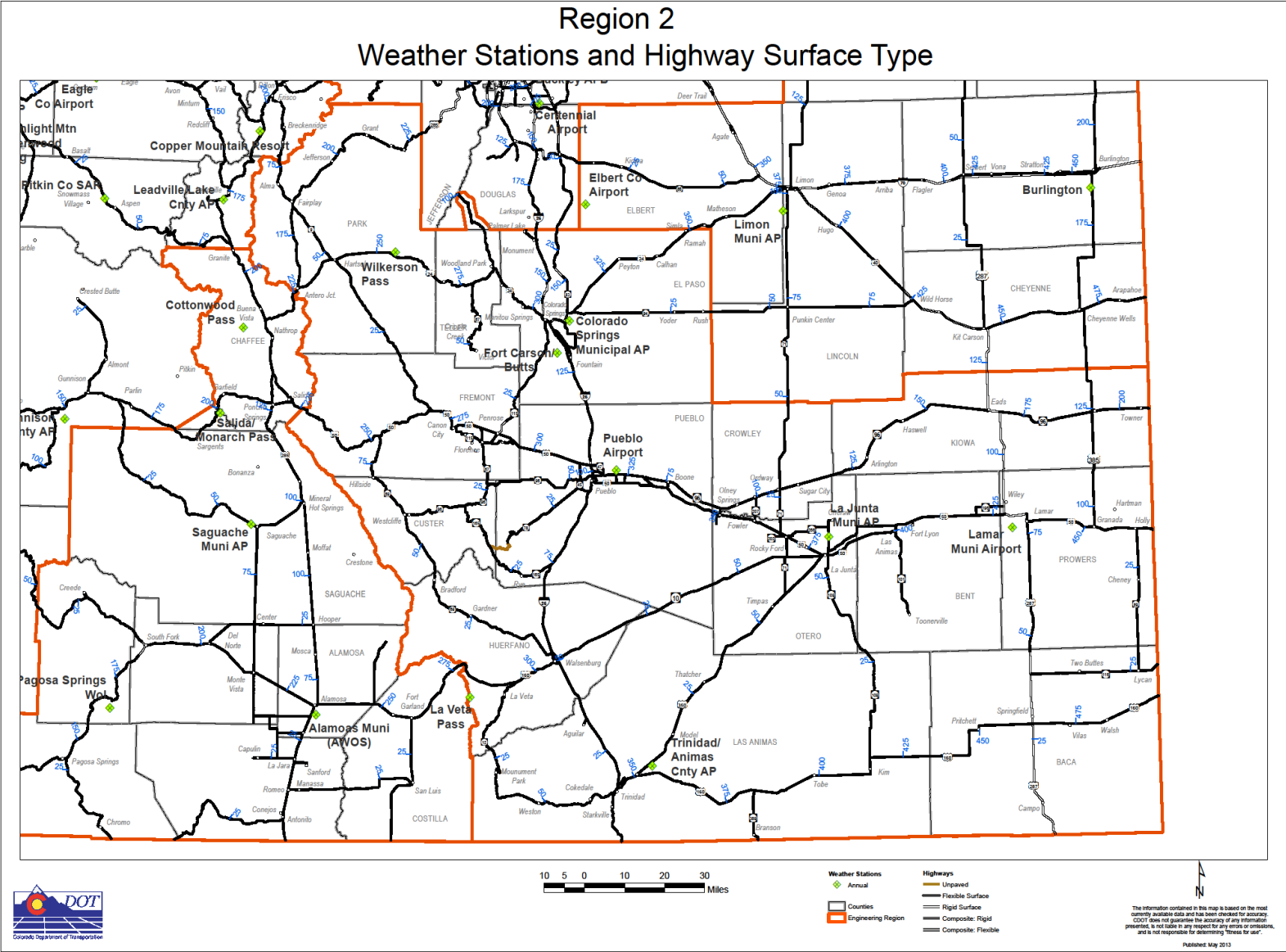

Figure 3.22 Region 2 Weather Stations and Highway Surface Type Map

Region 3 Weather Stations and Highway Surface Type

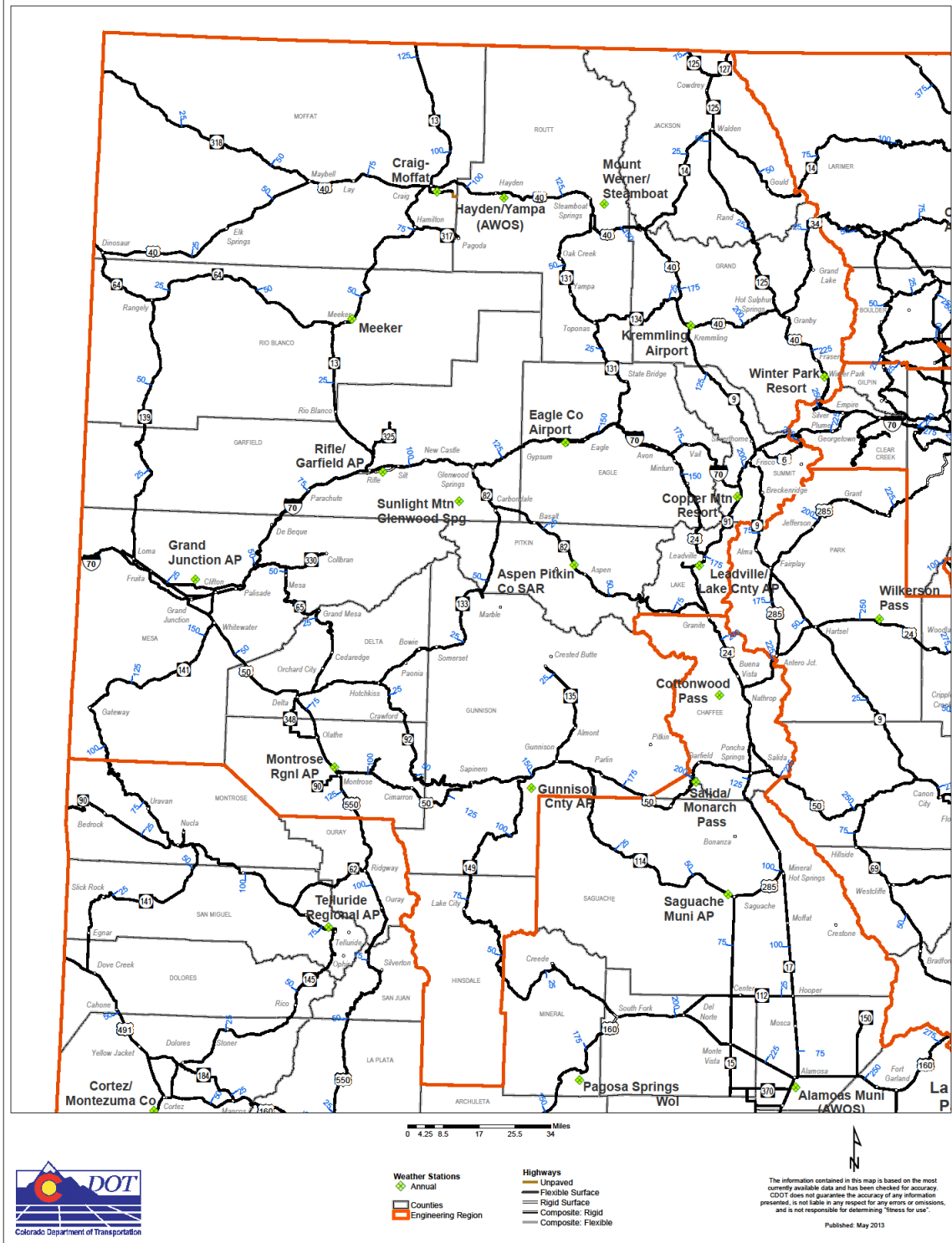

Figure 3.23 Region 3 Weather Stations and Highway Surface Type Map

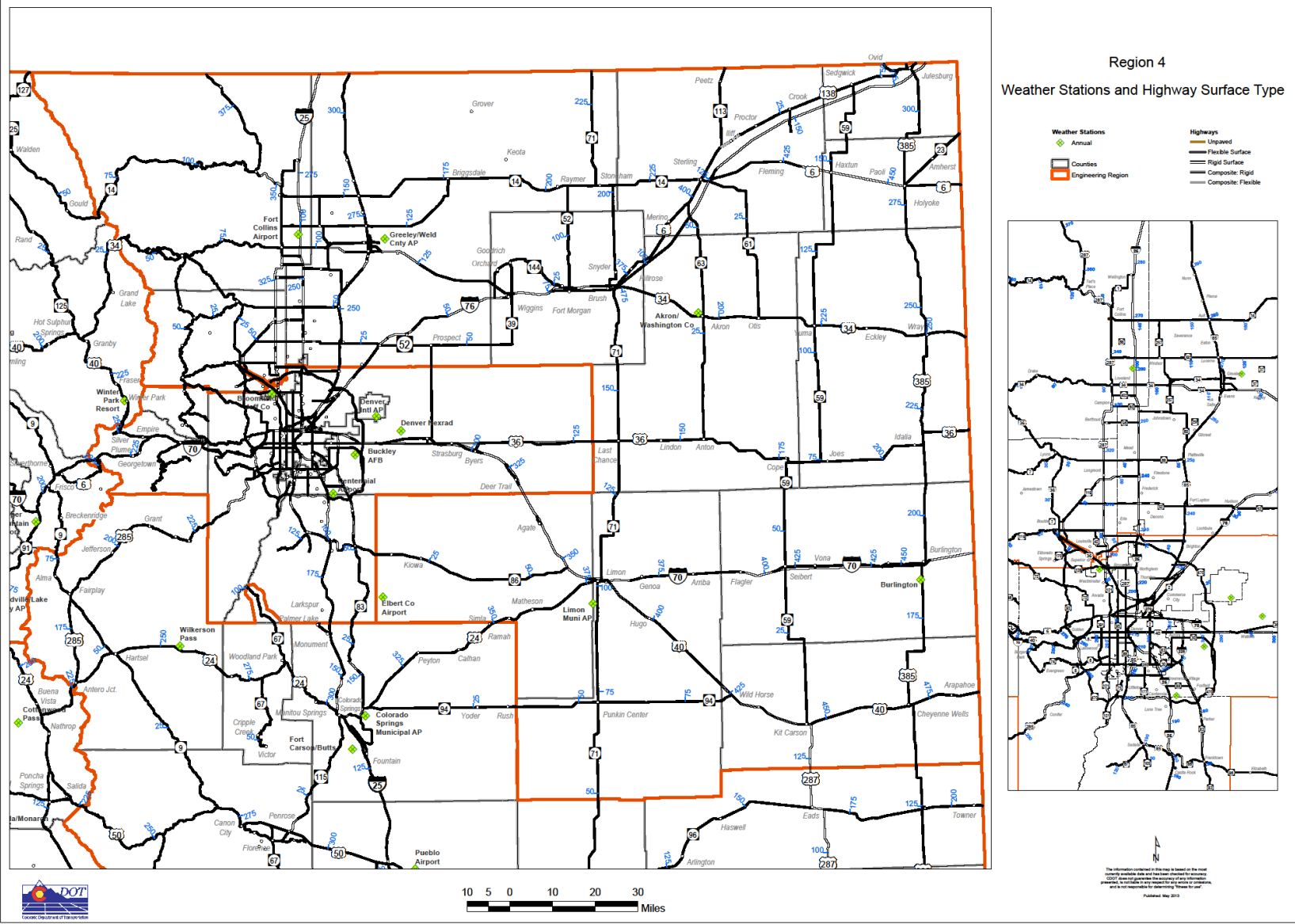

Figure 3.24 Region 4 Weather Stations and Highway Surface Type Map

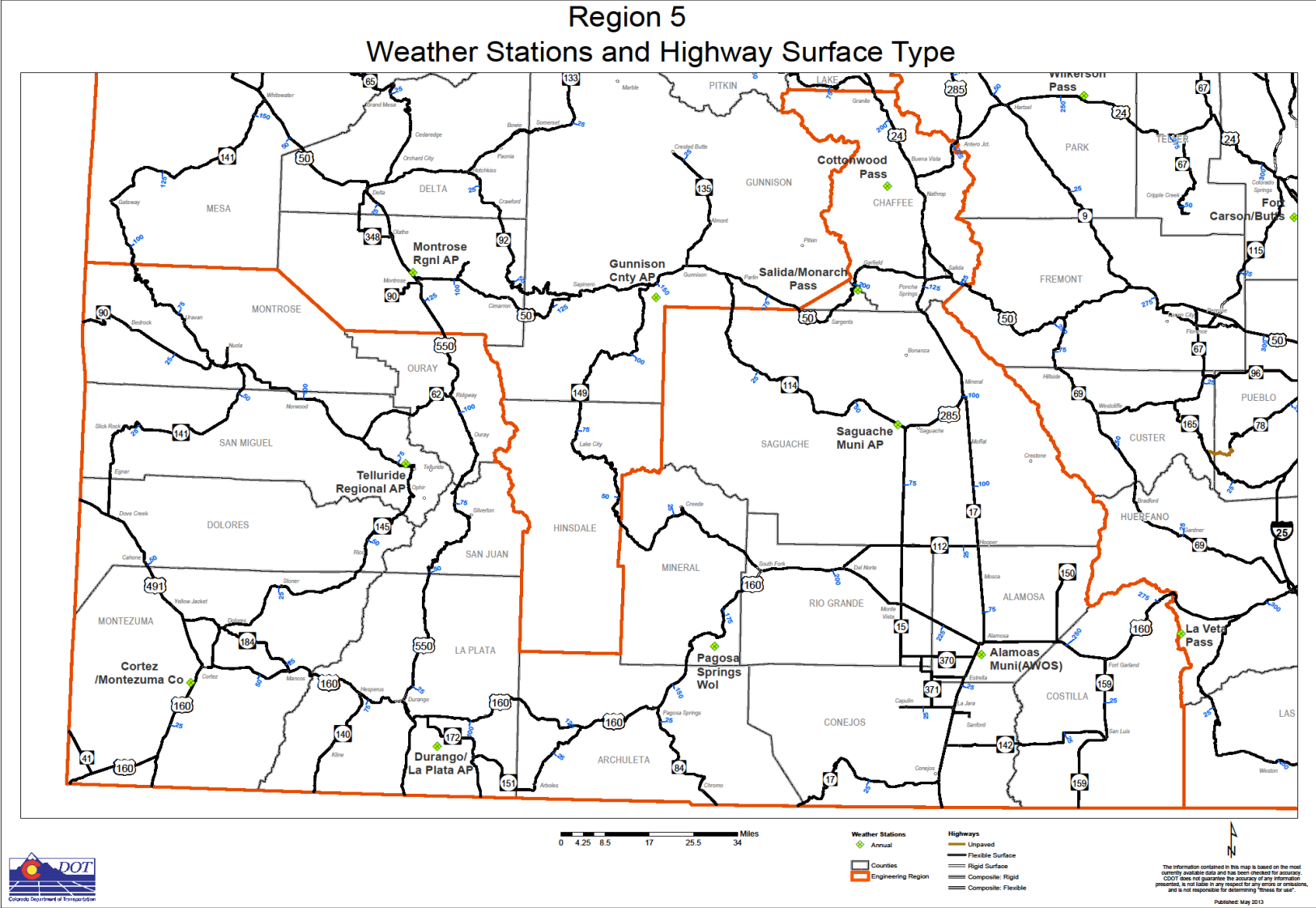

Figure 3.25 Region 5 Weather Stations and Highway Surface Type Map

References

1. *Heavy Vehicle Travel Information System*, Field Manual, FHWA publication PDF version, May 2001 (revised), obtained at website, <http://www.fhwa.dot.gov/ohim/tvtw/hvtis.htm>
2. *Highway Capacity Manual*, Transportation Research Board, National Research Council, Washington, D.C., 2000.
3. *AASHTO Mechanistic-Empirical Pavement Design Guide, A Manual of Practice, Interim Edition, July 2008*, American Association of State Highway and Transportation Officials, Washington, DC, 2008.

CHAPTER 4 SUBGRADE

4.1 Introduction

Subgrade is the top surface of a roadbed upon which the pavement structure and shoulders are constructed. The subgrade can be further subdivided and described as a man-made compacted layer of the same soil as beneath it (natural subgrade) or imported soil. This chapter provides procedures and recommended guidelines for determining the design parameters of the subgrade soils or foundation for use in new and rehabilitated pavement designs. The subgrade support is a key fundamental input in pavement design as the selection of overlying layer types, thicknesses and properties are very dependent on the subgrade properties. For the M-E Design, regardless of the pavement type, the subgrade is characterized in a similar manner. The M-E Design procedure categorizes major subgrade types as shown in **Table 4.1 M-E Design Major Subgrade Categories**.

Table 4.1 M-E Design Major Subgrade Categories

Material Category	Sub-Category
Rigid Foundation	Solid, Massive and Continuous Highly Fractured, Weathered
Subgrade Soils	Gravelly Soils (A-1; A-2) Sandy Soils Loose Sands (A-3) Dense Sands (A-3) Silty Sands (A-2-4; A-2-5) Clayey Sands (A-2-6; A-2-7) Silty Soils (A-4; A-5) Clayey Soils Low Plasticity Clays (A-6) Dry-Hard Moist Stiff Wet/Saturated-Soft High Plasticity Clays (A-7) Dry-Hard Moist Stiff Wet/Saturated-Soft

4.2 Soil Survey Investigation

The M-E Design begins with a preliminary soil survey. The steps necessary to conduct the soil survey investigation include:

Step 1. Obtain clearance and locates. When required, provide for necessary landowner permission to trespass. Obtain necessary utility clearance or locates prior to the start of work.

Step 2. Determine sampling locations and methods. Test holes can be drilled, dug by hand, power augered, back hoed, or completed by any other practical method. The method used should ensure the attainment of representative, uncontaminated samples. Sampling and testing procedures should conform to the following requirements:

- Determine horizontal and vertical test hole locations for virgin alignment. Test holes should be no farther apart than approximately 500 feet in continuous cut sections and no farther than approximately 1,000 linear feet in other sections. In addition, test holes should be drilled whenever there is a variation in soil or geological conditions. Sampling locations and depths should be coordinated with the Region Materials Engineer (RME) in order to obtain sufficient number of test holes and materials to outline subsurface complexities.
- Determine water table depth by drilling at least one boring a minimum of ten feet in depth. If the water table is not encountered within the ten feet, additional depth should be coordinated with the RME. Borings drilled to determine water table should occur at a minimum distance of 1,000 linear feet, if a variation in geologic or geomorphic conditions occurs, or as determined by the RME.
- Determine coring locations for pavement rehabilitation of existing roadways and coordinate with the Region Materials Engineer. Coring should be spaced to provide sufficient data of pavement thickness and condition to perform pavement design. Researching as-constructed plans will help in determine coring locations. Cores should be retained for further evaluation in the laboratory. Refer to Section **C.6.3 Pavement Coring and Subgrade Boring**.
- Collect subgrade soil samples and test for:
 - Classification per AASHTO M 145 and U.S. Army Corps of Engineers
 - Soil moisture density relation per AASHTO T 99
 - Resistance value, Colorado Procedure-L 3101 and L 3102
 - Swell consolidation test, ASTM D 4546 at 200-psf surcharge.
 - Determining the Sulfate Ion Content in Water or Water Soluble Sulfate Ion Content in Soil, Colorado Procedure-L 2103. Refer to Chapter 200 of the CDOT Field Materials Manual.

Step 3. Provide documentation of sample locations and other details required in CDOT Forms #554 (Soil Survey Field Report) and #555 (Preliminary Soil Survey). More information on the preliminary soil survey can be referred to in Chapter 200 of the Field Materials Manual.

The engineering properties of the subgrade are obtained from the soil subgrade investigation. The designer should assemble all information gathered during the soil investigation survey. This information will form the basis for characterizing subgrade properties for design.

4.3 Subgrade and Embankment

Subgrade can be categorized as (see **Figure 4.1 Subgrade Preparation**):

Conventional: Man-made compacted layer (typically 12 inches) of the subgrade soil over the uncompacted natural soil material. Conventional subgrade involves the pre-reconditioning of the natural subgrade material into a compacted layer. Pre-reconditioning typically involves proof rolling usually before placement of other engineered layers.

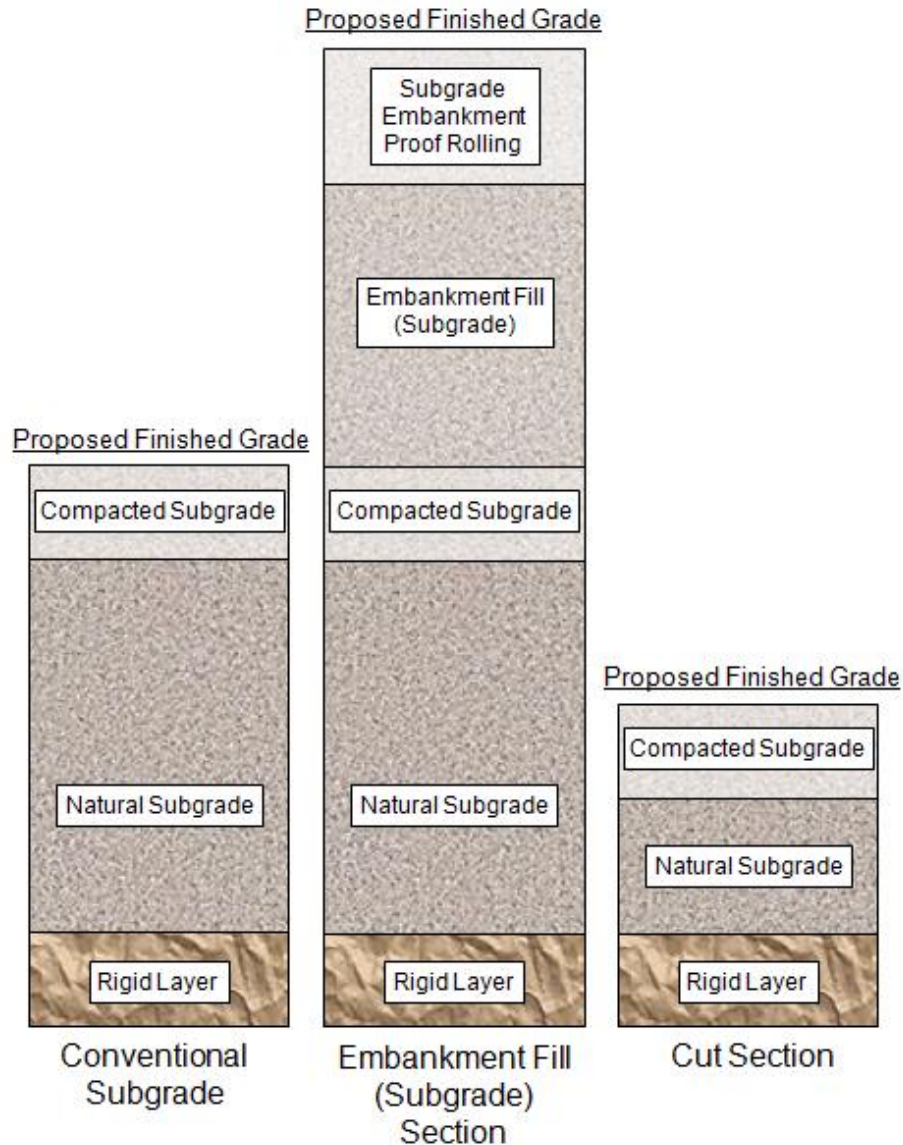

Figure 4.1 Subgrade Preparation

- **Embankment Fill:** Placement of a thick layer of imported soil or rock material over the uncompacted natural soil, typically in a fill section. The typical soil or rock embankment material has a maximum dry density of not less than 90 pounds per cubic foot. Other

properties such as resilient modulus (M_r) must be as specified in the contract plans and specifications and presented below:

- Soil Embankment shall consist predominantly of materials smaller than 4.75mm (No. 4) sieve in diameter. Soil embankment is constructed with moisture density control in accordance with the requirements of Subsection 203.07 - Construction of Embankment and Treatment of Cut Areas with Moisture and Density Control of CDOT Standard Specification for Road and Bridge Construction.
- Rock embankment shall consist of materials with 50 percent or more by weight, at field moisture content, of particles with least dimension diameters larger than 4.75 mm (No. 4) sieve and smaller than 6 inches. Rock embankment is constructed without moisture density control in accordance with the requirements of Subsection 203.08 - Construction of Embankments without Moisture and Density Control of CDOT Standard Specification for Road and Bridge Construction.
- **Cut Section:** Finished subgrade cut section scarified to a depth of 6 inches with moisture applied or removed as necessary and compacted to a specified relative compaction.

The designer needs to be aware of a few fill embankment requirements. Claystone or soil-like nondurable shale, as defined by Colorado Procedure 26, shall not be treated as sound rock and shall be pulverized, placed, and compacted as soil embankment. Claystone or soil-like non-durable shale particles greater than 12 inches in diameter shall not be placed in the embankment (17).

A special case of compacted subgrade is a fill section where the fill is comprised of two layers of subgrades with different engineering properties for each. The lower fill may comprise of a lesser resilient modulus than the upper layer. For illustration purposes, the upper embankment fill layer is shown here as special subgrade. The upper layer may require engineered material with a higher resilient modulus than the lower layer such as a M_r value of 25,000 psi the top 2 feet of subgrade, and the lower layer may have a M_r value of 10,000 psi. See **Figure 4.2 Special Cases of Embankment Fill**.

4.4 Subgrade Characterization for the M-E Design

4.4.1 General Characterization

Subgrade characterization procedure for the M-E Design is dependent on pavement type and design (new or rehabilitation). The inputs required for subgrade characterization are the resilient modulus and other physical/engineering properties including soil classification, moisture content and corresponding dry density, saturated hydraulic conductivity etc. - See **Figure 4.3 Subgrade Material Properties in the M-E Design** and **Figure 4.4 M-E Design Software Screenshot for Other Engineering/Physical Properties of Subgrade**.

Note that, in the M-E Design, the subgrade resilient modulus M_r is measured at optimum moisture content and density. This M_r is different than the AASHTO 1993 empirical design procedure which

was basically a “wet of optimum” M_r . The input M_r is then internally adjusted to field conditions by the M-E Design software on a month to month basis based on water table depth, precipitation, temperature, soil suction and other factors. Select the software option "Modify input values by temperature/moisture" to allow the software seasonally adjust the input M_r to field conditions.

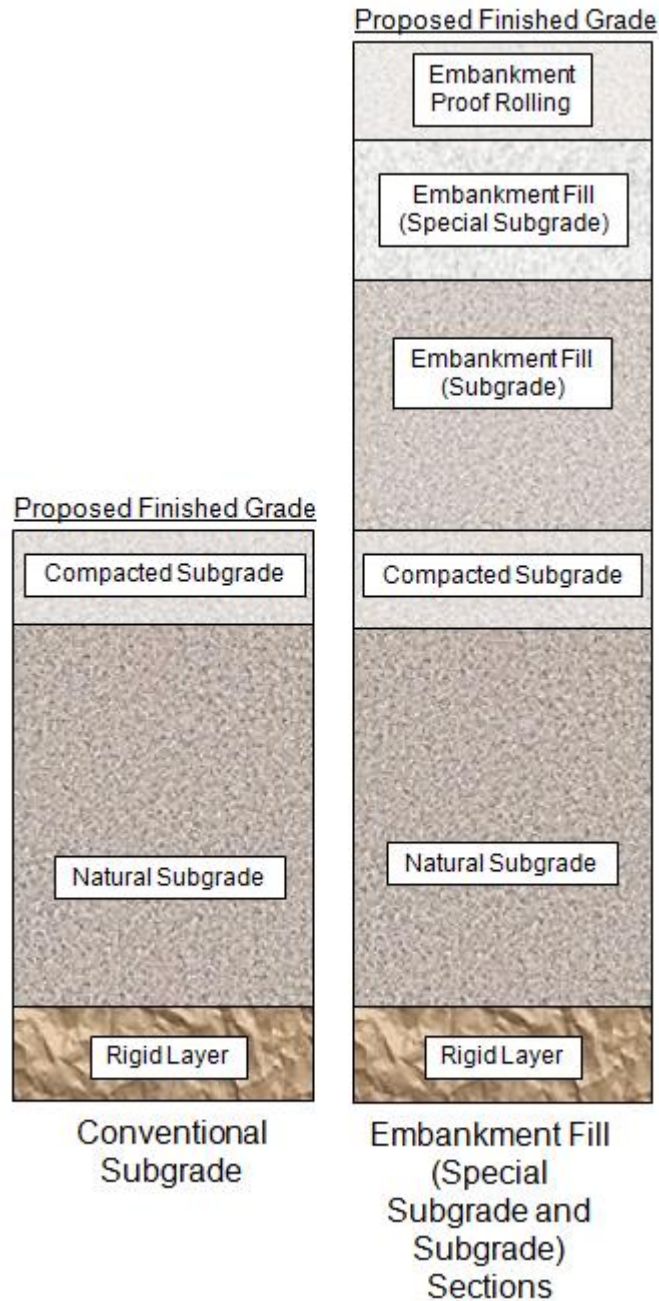

Figure 4.2 Special Cases of Embankment Fill

The input requirements for subgrade characterization are presented by pavement type and design:

- New Flexible and New JPCP - **Table 4.2 Recommended Subgrade Inputs in New Flexible and New JPCP Designs.**
- HMA Overlays of Existing Flexible Pavement - **Table 4.3 Recommended Subgrade Inputs for HMA Overlays of Existing Flexible Pavement.**
- Overlays of Existing Rigid Pavement - **Table 4.4 Recommended Subgrade Inputs for Overlays of Existing Rigid Pavement.**

Layer 4 Subgrade: A-4	
<input type="checkbox"/> Semi-infinite	
Layer thickness (in.)	
Poisson's ratio	<input checked="" type="checkbox"/> 0.35
Coefficient of lateral earth pressure (k0)	<input checked="" type="checkbox"/> 0.5
<input checked="" type="checkbox"/> 9764	
Resilient modulus (psi)	
<input checked="" type="checkbox"/> A-4	
Gradation & other engineering properties	
A-4	
Display name/identifier	
Layer thickness (in.) Thickness of the unbound layer. Minimum: 1 Maximum: 360	

Figure 4.3 Subgrade Material Properties in the M-E Design

Sieve Size	Percent Passing
0.001mm	
0.002mm	
0.020mm	
#200	60.6
#100	
#80	73.9
#60	
#50	
#40	82.7
#30	
#20	
#16	
#10	89.9
#8	
#4	93
3/8-in.	95.6
1/2-in.	96.7
3/4-in.	98
1-in.	98.7
1 1/2-in.	99.4
2-in.	99.6
2 1/2-in.	
3-in.	
3 1/2-in.	99.8

Liquid Limit	<input type="text" value="21"/>
Plasticity Index	<input type="text" value="5"/>
<input type="checkbox"/> Is layer compacted?	
<input type="checkbox"/> Maximum dry unit weight (pcf)	<input type="text" value="118.4"/>
<input type="checkbox"/> Saturated hydraulic conductivity (ft/hr)	<input type="text" value="8.325e-06"/>
<input type="checkbox"/> Specific gravity of solids	<input type="text" value="2.7"/>
<input type="checkbox"/> Optimum gravimetric water content (%)	<input type="text" value="11.8"/>
<input type="checkbox"/> User-defined Soil Water Characteristic Curve (SWCC)	

af	68.8376536119812
bf	0.998285126875545
cf	0.475715611755117
hr	500

Figure 4.4 M-E Design Software Screenshot for Other Engineering/Physical Properties of Subgrade

Table 4.2 Recommended Subgrade Inputs in New Flexible and New JPCP Designs

Pavement and Design Type	Material Property	Input Hierarchy		
		Level 1	Level 2	Level 3
New Flexible and New JPCP	Resilient Modulus	Not Available	CDOT lab testing See Section 4.4.3.1 Inputs for New HMA and JPCP	AASHTO Soil Class
	Gradation	Not Available	Colorado Procedure 21-08	Use CDOT defaults
	Atterberg Limit ¹	Not Available	AASHTO T 195	Use CDOT defaults
	Poisson's ratio	Not Available	Use software defaults	Use M-E Design software default of 0.4
	Coefficient of lateral pressure	Not Available	Use software defaults	Use M-E Design software default of 0.5
	Maximum dry density	Not Available	AASHTO T 180	Estimate internally using gradation, plasticity index, and liquid limit. ²
	Optimum moisture content	Not Available	AASHTO T 180	
	Specific gravity	Not Available	AASHTO T 100	
	Saturated hydraulic conductivity	Not Available	AASHTO T 215	
Soil water characteristic curve parameters	Not Available	Not Applicable		
<p>Note: ¹ Use PI = 1 for drainage reasons if non-plastic ² The M-E Design software internally computes the values of the following properties based on the inputs for Gradation, Liquid Limit, Plasticity Index and Is Layer Compacted. If the designer choose to modify the internally computed default values, the designer can override the default values. The software updates the default values to user-defined values upon clicking outside the input screen of the software.</p>				

Table 4.3 Recommended Subgrade Inputs for HMA Overlays of Existing Flexible Pavement

Pavement and Design Type	Material Property	Input Hierarchy		
		Level 1	Level 2	Level 3
HMA Overlays of Existing Flexible Pavement	Resilient Modulus	FWD Deflection Testing and Backcalculated Resilient Modulus	CDOT lab testing See Section 0 Inputs for HMA Overlay of Existing Flexible Pavements	AASHTO Soil Class
	Gradation	Colorado Procedure 21-08		Use CDOT defaults
	Atterberg Limit ¹	AASHTO T 195		Use CDOT defaults
	Poisson's ratio	Use software defaults		Use M-E Design software default of 0.4
	Coefficient of lateral pressure	Use software defaults		Use M-E Design software default of 0.5
	Maximum dry density	AASHTO T 180		Estimate internally using gradation, plasticity index, and liquid limit. ²
	Optimum moisture content	AASHTO T 180		
	Specific gravity	AASHTO T 100		
	Saturated hydraulic conductivity	AASHTO T 215		
	Soil water characteristic curve parameters	Not Applicable		
<p>Note: ¹ Use PI = 1 for drainage reasons if non-plastic ² The M-E Design software internally computes the values of the following properties based on the inputs for Gradation, Liquid Limit, Plasticity Index and Is Layer Compacted. If the designer choose to modify the internally computed default values, the designer can override the default values. The software updates the default values to user-defined values upon clicking outside the input screen of the software.</p>				

Table 4.4 Recommended Subgrade Inputs for Overlays of Existing Rigid Pavement

Pavement and Design Type	Material Property	Input Hierarchy		
		Level 1	Level 2	Level 3
Overlays of Rigid Pavement	Resilient Modulus	FWD Deflection Testing and Backcalculated Dynamic k-value ³	CDOT lab testing See Section 4.4.3.3 Inputs for Overlays of Existing Rigid Pavements	AASHTO Soil Class
	Gradation	Colorado Procedure 21-08		Use CDOT defaults
	Atterberg Limit ¹	AASHTO T 195		Use CDOT defaults
	Poisson's ratio	Use software defaults		Use M-E Design software default of 0.4
	Coefficient of lateral pressure	Use software defaults		Use M-E Design software default of 0.5
	Maximum dry density	AASHTO T 180		Estimate internally using gradation, plasticity index, and liquid limit. ²
	Optimum moisture content	AASHTO T 180		
	Specific gravity	AASHTO T 100		
	Saturated hydraulic conductivity	AASHTO T 215		
	Soil water characteristic curve parameters	Not Applicable		
<p>Note:</p> <p>¹ Use PI = 1 for drainage reasons if non-plastic</p> <p>² The M-E Design software internally computes the values of the following properties based on the inputs for Gradation, Liquid Limit, Plasticity Index and Is Layer Compacted. If the designer choose to modify the internally computed default values, the designer can override the default values. The software updates the default values to user-defined values upon clicking outside the input screen of the software.</p> <p>³ The k-value represents the subgrade layer as well as unbound layers including granular aggregate base and subbase layers.</p>				

4.4.2 Modeling Subgrade Layers in M-E Design Software

The M-E Design software divides the pavement structure, including subgrade, into sublayers for analysis purposes. The sublayering scheme is performed internally by the M-E Design software. The software divides the top 8 feet of a pavement structure and subgrade into a maximum of 19 sublayers. The remaining subgrade is treated as a semi-infinite layer. To properly characterize subgrade for M-E design, the designer should consider the following:

- **Modeling Embankments**
 - When a full-depth flexible or semi-rigid pavement is placed directly on a thick embankment fill, the top 12 inches is modeled as an aggregate base layer, while the remaining embankment is modeled as the subgrade layer 1. The M_r and other physical/engineering properties remain the same for both these layers. The natural subgrade below the embankment fill is modeled as the subgrade layer 2.
- **Modeling Thick Aggregate Bases**
 - When a thick granular aggregate base (more than 12 inches) is used, the top 12 inches is modeled as an aggregate base layer, while the remaining aggregate is modeled as the subgrade layer 1. The M_r and other physical/engineering properties remain the same for both these layers. The compacted or natural subgrade below the thick aggregate base is modeled as lower subgrade layers as appropriate.
- **Modeling Compacted Subgrade**
 - The compacted and natural subgrade are modeled as separate subgrade layers.
- **Need for improvement**
 - The designer needs to establish the need for improving or strengthening the existing subgrade based on subsurface investigation results. Typically, if the subgrade has a M_r less than 10,000 psi, subgrade improvement could be considered.
- **Effects of frost susceptible/ active soils**
 - The M-E Design software does not directly predict the increase in distresses caused by expansive, frost susceptible, and collapsible soils. Treatments to such problematic soils could be considered (outside the M-E Design analysis) as a part of the design strategy.
- **Modeling Bedrock**
 - Bedrock or any hard layer that are encountered more than about 20 feet will have an insignificant effect on the calculated pavement responses and predicted

distresses/IRI. Inclusion of bedrock in the pavement structure below 20 feet is not recommended.

- **Modeling Geosynthetics**

- Filter fabrics, geotextiles, and geogrids cannot be directly included in the pavement structure.

4.4.3 Recommended Inputs for Subgrade/Embankment Materials

4.4.3.1 Inputs for New HMA and JPCP

Level 1 Inputs

Level 1 inputs are not available for new HMA and JPCP designs in this manual since they are project specific values.

Level 2 Inputs

The designer must input a single value of design M_r . Two approaches are available for Level 2 design subgrade M_r :

- **Laboratory Resilient Modulus:** The design M_r may be obtained through laboratory resilient modulus tests conducted in accordance with AASHTO T 307, Determining the Resilient Modulus of Soils and Aggregate Materials. Subgrade design M_r should reflect the range of stress states likely to be developed beneath flexible or rigid pavements subjected to moving wheel loads. Therefore, the laboratory measured M_r should be adjusted for the expected in-place stress state for use in the M-E Design software. Stress state is determined based on the depth at which the material will be located within the pavement system (i.e., the stress states for specimens to be used as base or subbase or subgrade may differ considerably).
- **CDOT Resilient Modulus – R value Correlation:** The design M_r may be obtained through correlations with other laboratory tested soil properties such as the R-value. **Eq. 4-1** gives an approximate correlation of Resistance value (R-value) to M_r . This equation is valid only for AASHTO T 190 procedure. If the R – Value of the existing subgrade or embankment material is estimated to be greater than 50, a FWD analysis or resilient modulus by AASHTO T 307 should be performed. The R-value is considered a static value and the M_r value is considered a dynamic value. CDOT uses Hveem stabilometer equipment to measure strength properties of soils and bases. This equipment yields an index value called the R-value. The R-value is determined in accordance with Colorado Procedure - Laboratory 3102, Determination of Resistance Value at Equilibrium, a modification of AASHTO T 190, Resistance Value and Expansion Pressure of Compacted Soils.

$$M_r = 3438.6 * R^{0.2753}$$

Eq. 4-1

where:

M_r = resilient modulus (psi)

R = the R-value obtained from the Hveem stabilometer

Designers should note that the Hveem equipment does not directly provide resilient modulus values. It does provide the R-value which is then used to obtain an approximation of resilient modulus from correlation formulas. This equation should be used for R-values of 50 or less. Research is currently being done for soils with R-values greater than 50.

The M-E Design software allows the designer to estimate M_r using other soil properties (see **Figure 4.5 M-E Design Software Screenshot for Level 2 Resilient Modulus Input**):

- California Bearing Ratio (CBR)
- R-value
- Layer Coefficient (a_i)
- Dynamic Cone Penetrometer (DCP) Penetration
- Plasticity Index (PI) and Gradation (i.e., Percent Passing No. 200 sieve)

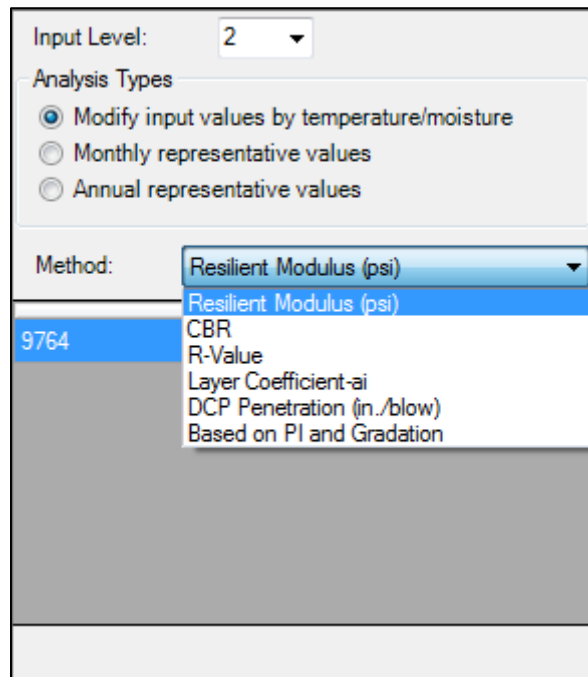

Figure 4.5 M-E Design Software Screenshot for Level 2 Resilient Modulus Input

The mathematical relationship between the M_r value and the above mentioned soil properties are hardcoded in the M-E Design software, and the estimation is done internally. The M_r - R-value correlation in the M-E Design software follows the relationship provided in the AASHTO 1993 Pavement Design Guide and is different from CDOT's M_r - R-value correlation.

Other engineering properties may be obtained as recommended in **Table 4.2 Recommended Subgrade Inputs in New Flexible and New JPCP Designs**.

Level 3 Inputs

For input Level 3, the typical M_R values presented in **Table 4.5 Level 3 Resilient Modulus For Embankments and Subgrade** are recommended. Table 4.5 should **only** be used during the preliminary pavement design when a resilient modulus or R-values are unavailable. The final pavement design shall use Level 1 or 2 resilient modulus value specific to the project that is obtained either in a laboratory or via Equation 4-1. Note that the M_r values presented in this table are optimum moisture content and maximum dry density. **Figure 4.6 M-E Design Software Screenshot for Level 3 Resilient Modulus Input** presents the screenshot showing the Level 3 M_r input in the M-E Design software.

Table 4.5 Level 3 Resilient Modulus For Embankments and Subgrade

AASHTO Soil Classification	Resilient Modulus (M_r) at Optimum Moisture, psi	
	Flexible Pavements	Rigid Pavements
A-1-a	19,700	14,900
A-1-b	16,500	14,900
A-2-4	15,200	13,800
A-2-5	15,200	13,800
A-2-6	15,200	13,800
A-2-7	15,200	13,800
A-3	15,000	13,000
A-4	14,400	18,200
A-5	14,000	11,000
A-6	17,400	12,900
A-7-5	13,000	10,000
A-7-6	12,800	12,000

The screenshot shows a software interface for Level 3 Resilient Modulus Input. At the top, there is a dropdown menu for 'Input Level' set to '3'. Below this is a section titled 'Analysis Types' with three radio button options: 'Modify input values by temperature/moisture' (which is selected), 'Monthly representative values', and 'Annual representative values'. Underneath is a 'Method:' dropdown menu set to 'Resilient modulus (psi)'. The main area of the interface is a large grey rectangle, with a blue horizontal bar at the top containing the number '9764'. A thin white bar is visible at the very bottom of the interface.

Figure 4.6 M-E Design Software Screenshot for Level 3 Resilient Modulus Input

The M-E Design software using predictive equations based on soil class, gradation, plasticity index and liquid limit internally calculates other engineering properties.

4.4.3.2 Inputs for HMA Overlay of Existing Flexible Pavements

Level 1 Inputs

For overlays of existing flexible pavement designs, Level 1 design subgrade M_r (at in-situ moisture content) is obtained through FWD testing and backcalculation of pavement deflection data. See **APPENDIX C - Deflection Testing and Backcalculation Method** contains detailed information on how to perform FWD testing and process pavement deflection data to obtain backcalculated elastic moduli.

The subgrade elastic modulus (E_R) values obtained from backcalculation of FWD deflection data do not match with the resilient modulus values measured in the laboratory. The FWD backcalculated elastic modulus values represent field conditions under dynamic loading and require an adjustment to laboratory test conditions. The adjustment factors to convert FWD backcalculated elastic modulus to laboratory resilient modulus values are presented in **Table 4.6 Average Backcalculated to Laboratory Determined Elastic Modulus Ratios**. In the M-E Design software, the backcalculated in-situ subgrade M_r should be entered in conjunction with the in-situ subgrade moisture content. Average moisture content measured at the time of FWD testing is recommended for use.

Other engineering properties may be obtained as recommended in **Table 4.2 Recommended Subgrade Inputs in New Flexible and New JPCP Designs**.

Table 4.6 Average Backcalculated to Laboratory Determined Elastic Modulus Ratios

Layer Type	Location	Mean E_R/M_r Ratio
Unbound Granular Base and Subbase Layers	Granular base/subbase between two stabilized layers (cementitious or asphalt stabilized materials).	1.43
	Granular base/subbase under a PCC layer.	1.32
	Granular base/subbase under an HMA surface or base layer.	0.62
Embankment and Subgrade Soils	Embankment or subgrade soil below a stabilized subbase layer or stabilized soil.	0.75
	Embankment or subgrade soil below a flexible or rigid pavement without a granular base/subbase layer.	0.52
	Embankment or subgrade soil below a flexible or rigid pavement with a granular base or subbase layer.	0.35
<i>E_R = Elastic modulus backcalculated from deflection basin measurements. M_r = Elastic modulus of the in-place materials determined from laboratory repeated load resilient modulus test.</i>		

Level 2 Inputs

Follow the guidelines presented for [Level 2 inputs for New HMA and JPCP](#).

Level 3 Inputs

Follow the guidelines presented for [Level 3 inputs for New HMA and JPCP](#).

4.4.3.3 Inputs for Overlays of Existing Rigid Pavements

Level 1 Inputs

The modulus of subgrade reaction (k-value) is the requirement input for rigid rehabilitation designs, including unbonded concrete overlays, HMA over existing JPCP and JPCP over AC designs. The M-E design also requires the month of FWD testing. This is used for seasonal adjustments of the backcalculated k-value.

The “effective” dynamic k-value represents the compressibility of underlying layers (i.e., unbound base, subbase, and subgrade layers) upon which the upper bound layers and existing HMA or PCC layer is constructed. Note that the k-value used in the 1998 AASHTO Supplement is a static elastic k-value, while in the M-E Design, the dynamic k-value is used.

The dynamic k-value is obtained through FWD testing and backcalculation of pavement deflection data. See **APPENDIX C - Deflection Testing and Backcalculation Method** contains detailed information on how to perform FWD testing and process pavement deflection data to obtain the dynamic modulus of subgrade reaction.

Other engineering properties may be obtained as recommended in **Table 4.2 Recommended Subgrade Inputs in New Flexible and New JPCP Designs**.

Level 2 Inputs

Provide Level 2 subgrade M_r obtained from field testing such as R-value tests. Follow the guidelines presented for [Level 2 inputs for New HMA and JPCP](#).

The M-E Design software will internally convert the input M_r to an effective single dynamic k-value for these layers as a part of input processing. This conversion is performed internally for each month of the design analysis period for these layers and utilized directly to compute critical stresses and deflections in the incremental damage accumulation over the analysis period.

Other engineering properties may be obtained as recommended in **Table 4.2 Recommended Subgrade Inputs in New Flexible and New JPCP Designs**.

Level 3 Inputs

Follow the guidelines presented for [Level 3 inputs for New HMA and JPCP](#).

Estimating or Measuring the k-value

The 1998 AASHTO Supplement outlines three procedures to estimate or measure the k-value. There is no direct laboratory procedure for determining the initial k-value, however, there are three procedures for estimating the initial k-value. One of the procedures uses correlations and has three methods of correlations to determine the initial k-value. The three procedures are:

- Correlations with soil type and other soil properties or tests
- Correlation using soil classification
- Correlation to California Bearing Ratio
- Correlation by Dynamic Cone Penetrometer Plate bearing tests
- Deflection testing and backcalculation (recommended)

A procedure not described in the 1998 AASHTO Supplement is to use an R-value correlated to the dynamic MR and using a simplified older AASHTO relationship equation to obtain a k-value.

After selecting which procedure to use, the designer continues with steps to adjust the initial k-value. Two adjustment steps follow. The first step is to adjust the initial k-value to a seasonal effective k-value for the effects of a shallow rigid layer, if present, and/or an embankment above the natural subgrade.

Correlations of Initial k-value using Soil Classifications

Initial k-values may be correlated to the soil type and basic physical properties. In general, the static k-value can be determined using a simplified graphical depiction of soil classification in **Figure 4.8 k-value vs. Soil Classification**. Greater detail can be found using **Table 4.7 k-value Ranges for Various Soil Types**

Cohesionless Soils (A-1 and A-3)

Recommended k-value ranges for insensitive to moisture variation A-1 and A-3 soils are summarized in Table 11 of the 1998 AASHTO Supplement as shown in **Table 4.7 k-value Ranges**

for Various Soil Types. Shown in **Table 4.7** are typical ranges of dry density and CBR for each soil type.

Granular Materials (A-2)

Recommended k-values for granular materials that fall between A-1 and A-3 soils are summarized in Table 11 of the 1998 AASHTO Supplement as shown in **Table 4.7 k-value Ranges for Various Soil Types.** Shown in **Table 4.7** are typical ranges of dry density and CBR for each soil type.

Cohesive Soils (A-4 through A-7)

Recommended k-values for AASHTO classification of fine-grained A-4 through A-7 soils as a function of saturation are shown in the 1998 AASHTO Supplement and shown in **Figure 4.9 k-values Versus Degree of Saturation for A-4 through A-7 Soils.** Each line represents the middle range of reasonable values ± 40 psi/in.

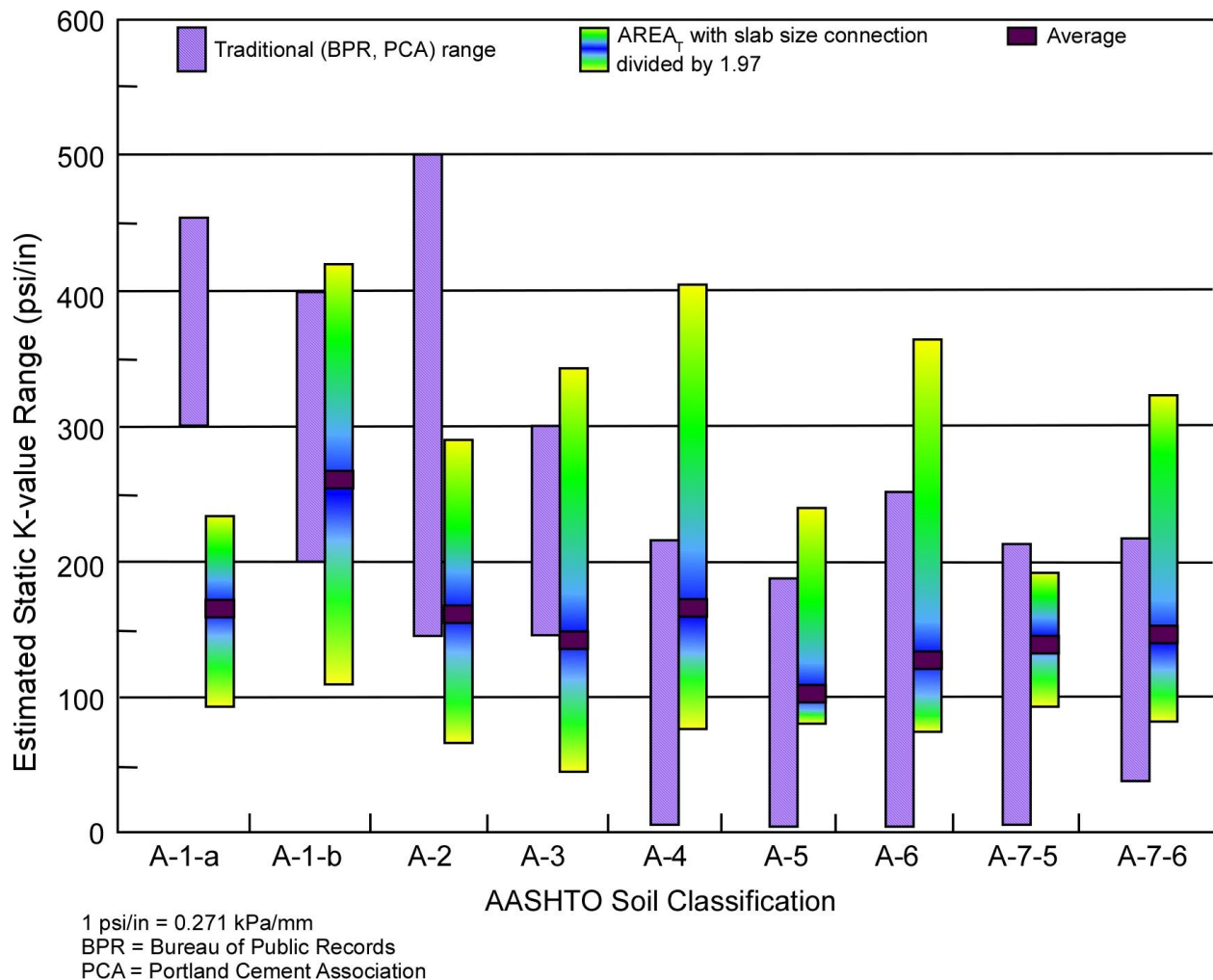

Figure 4.7 k-value vs. Soil Classification

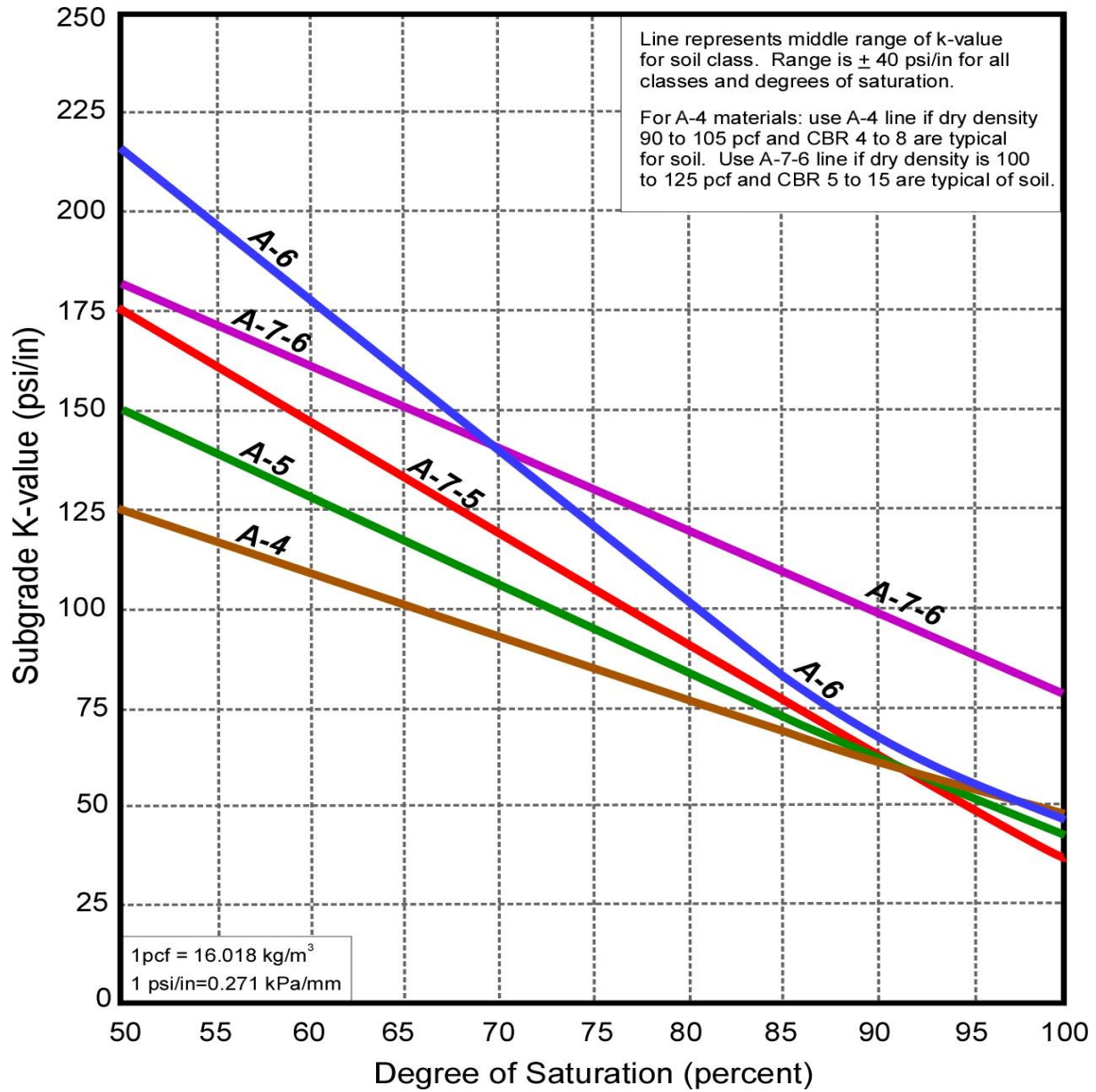

Figure 4.8 k-values vs. Degree of Saturation for A-4 Through A-7 Soils

Table 4.7 k-Value Ranges for Various Soil Types

AASHTO Classification	Description	Unified Class	Dry Density (lb/ft ³)	CBR (percent)	k-value (psi/in)
Coarse-grained soils					
A-1-a, well graded	Gravel	GW, GP	125 - 140	60 - 80	300 - 450
A-1a, poorly graded			120 - 130	35 - 60	300 - 400
A-1-b	Coarse sand	SW	110 - 130	20 - 40	200 - 400
A-3	Fine sand	SP	105 - 120	15 - 25	150 - 300
A-2 soils (granular materials with high fines)					
A-2-4, gravelly	Silty gravel	GM	130 - 145	40 - 80	300 - 500
A-2-5, gravelly	Silty sandy gravel				
A-2-4, sandy	Silty sand	SM	120 - 135	20 - 40	300 - 400
A-2-4, sandy	Silty gravelly sand				
A-2-6, gravelly	Clayey gravel	GC	120 - 140	20 - 40	200 - 450
A-2-7, gravelly	Clayey sandy gravel				
A-2-6, sandy	Clayey sand	SC	105 - 130	10 - 20	150 - 350
A-2-7, sandy	Clayey gravelly sand				
Fine-grained soils					
A-4	Silt	ML, OL	90 - 105	4 - 8	25 - 165*
	Silt/sand/gravel mixture		100 - 125	5 - 15	40 - 220 *
A-5	Poorly graded silt	MH	80 - 100	4 - 8	25 - 190*
A-6	Plastic clay	CL	100 - 125	5 - 15	25 - 255*
A-7-5	Moderately plastic elastic clay	CL, OL	90 - 125	4 - 15	25 - 215*
A-7-6	Highly plastic elastic clay	CH, OH	80 - 110	3 - 5	40 - 220*

* K-value of fine grained soil is highly dependent on degree of saturation. See Figure 40.

These recommended k-value ranges apply to a homogeneous soil layer at least 10 ft (3 m) thick. If an embankment layer less than 10 ft (3 m) thick exists over a softer subgrade, the k-value for the underlying soil should be estimated from this table and adjusted for the type and thickness of embankment material using Figure 43. If a layer of bedrock exists within 10 ft (3 m) of the top of the soil, the k should be adjusted using Figure 43.

The notes refer to figures in the 1998 AASHTO Supplement.

4.5 Rigid Layer

A rigid layer is defined as the lower soil stratum that has a high resilient or elastic modulus (greater than 100,000 psi). A rock layer may consist of bedrock, severely weathered bedrock, igneous, metamorphic, and sedimentary material or combinations of each, which cannot be excavated without blasting or the use of large mechanical equipment used for ripping the bedrock, or even over-consolidated clays. For example, a thick shale or claystone layer would be considered a rigid layer.

In the M-E Design, the presence of a rigid layer within 10 feet of the pavement surface may have an influence on the structural responses of pavement layers. The designer may need to use multiple subgrade layers especially when the depth to the rigid layer exceeds 100 inches. Note the thickness

of the last subgrade layer is limited to 100 inches when a rigid layer is added to the pavement structure definition in the M-E Design software. However, the rigid layer can be ignored for pavement design when the depth exceeds 20 feet.

The M-E Design software recommended default elastic modulus values are 750,000 psi for solid, massive and continuous bedrock and 500,000 psi for highly fractured and weathered bedrock. The suggested default value for Poisson's ratio is 0.15.

4.6 Rock Fill

In pavement design, a rock fill would be a rigid layer. Rock fill is defined in Subsection 203.03 - Embankment of *CDOT Standard Specification for Road and Bridge Construction*, 2011 (34). Rock fill shall consist of sound, durable stones, boulders, or broken rock not less than six inches in the smallest dimension. At least 50 percent of the rock used shall have a volume of 2 cubic feet or more, as determined by physical or visual measurement.

4.7 Frost Susceptible Soils

In areas subject to frost, soils may be removed and replaced with selected, nonsusceptible material. Where such soils are too extensive for economical removal, they may be covered with a sufficient depth of suitable material to overcome the detrimental effects of freezing and thawing. The need for such measures and the type and thickness of material required must be determined on the basis of local experience and types of materials (20). Frost heaving may be caused by crystallization of ice lenses in voids of soils containing fine particles. Bearing capacity may be reduced substantially during thawing periods. Frost heaving can be more severe during freeze-thaw periods because water is more readily available. Several cycles of freeze and thaw may occur during a winter season and cause more damage than one longer period of freezing in more northerly areas of the state.

To compute the monthly or annual freezing index and estimate frost heave depth, the following equation is used:

$$FI = \sum_{i=1}^n (0 - T_i) \quad \text{Eq. 4-2}$$

Where:

FI = freezing index, degrees Celsius (°C) degree-days

T_i = average daily air temperature on day i, °C

n = days in the specified period when average daily temperature is below freezing

i = number of days below freezing

When using this equation, only the days where the average daily temperature is below freezing are used. Therefore, the freezing index is the negative of the sum of all average daily temperatures below 0 °C within the given period (29).

See **Figure 4.9 Colorado Annual Freezing Index (degrees-Fahrenheit days)** for a map of Colorado showing isopieth lines for the annual freezing index. The isopieth lines are in units of degree-Fahrenheit days. The highest Freezing Index values are in the mountains, Berthoud Pass, Taylor Park, and Climax. The lowest values are on the western side of the state, Gateway, Uravan, and Palisade. Note that the Freezing Index values do not necessarily follow elevations.

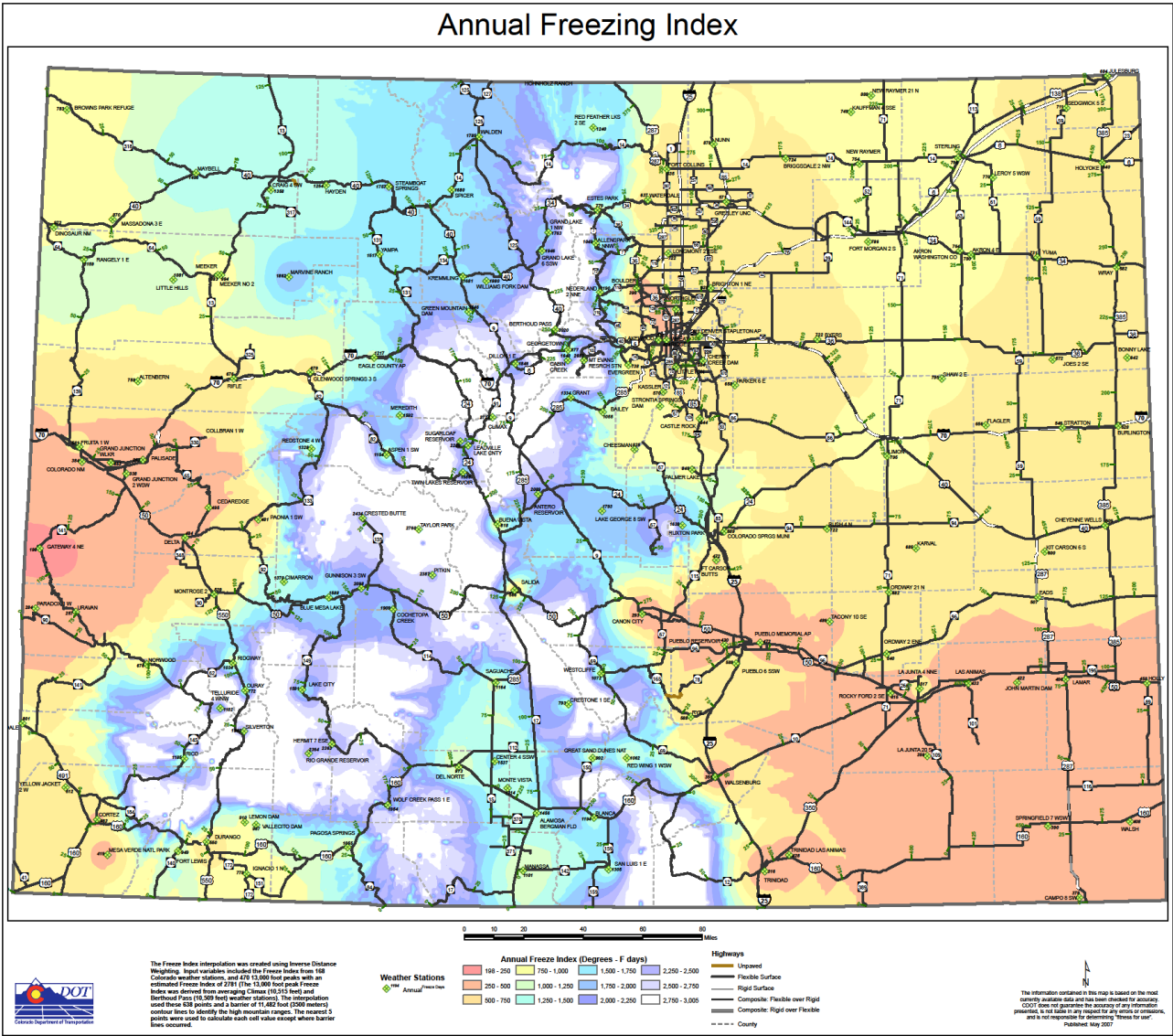

Figure 4.9 Colorado Annual Freezing Index (degrees-Fahrenheit days)

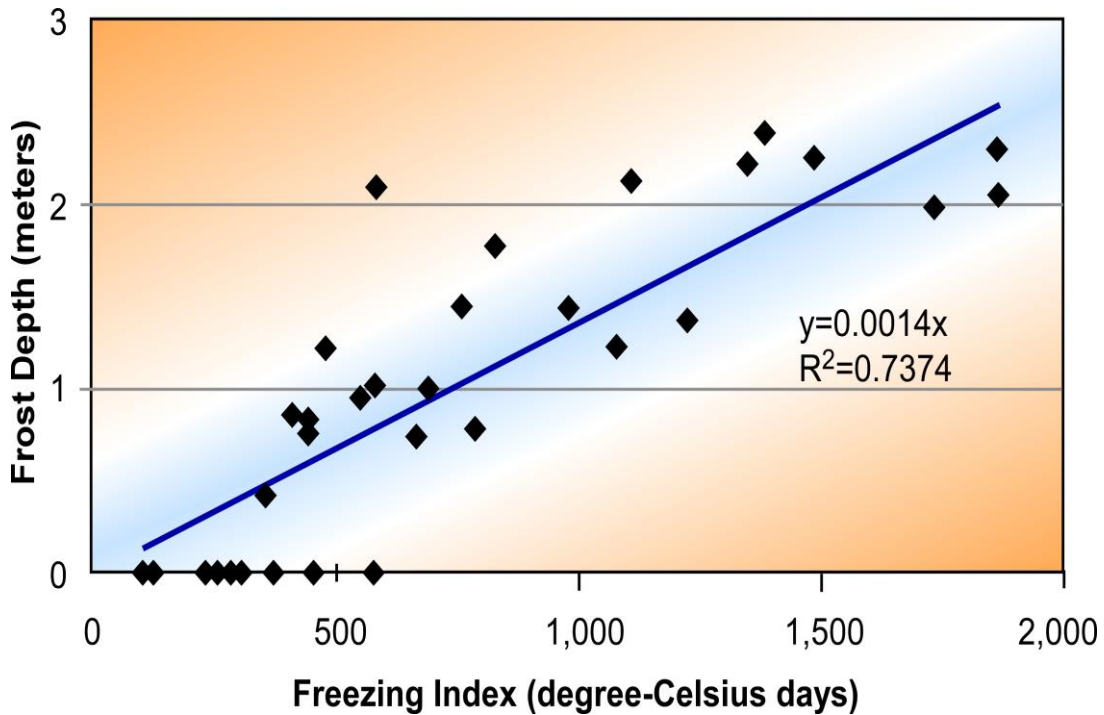

Figure 4.10 Frost Depth to FI

See **Eq. 4-3** to convert Annual Freezing Index (degrees-Fahrenheit days) to (degrees-Celsius days). The conventional conversion formula has the term 32°F and is all ready accounted for in the number of days below freezing.

$$FI = \text{Annual Freezing Index } (^\circ\text{C days}) = \left(\frac{5}{9}\right) \text{Annual Freezing Index } (^\circ\text{F days}) \quad \text{Eq. 4-3}$$

There is a relationship between Annual Freezing Index (FI) and frost depth. The seasonal monitoring program with FHWA Long-Term Pavement Performance sites analyzed this relationship (30). See **Eq. 4-4**.

$$\text{Frost Depth (meters)} = 0.0014 \times FI \quad \text{Eq. 4-4}$$

Where:

Frost depth in meters

FI = annual freezing index (degrees-Celsius days)

A graph was developed to show the relationship. See

Figure 4.10 Frost Depth to FI. The scattered is influenced by local conditions at the sites. Refer to **Figure 4.12 Frost Susceptible Soil Classifications** for possible scatter.

Frost Susceptibility Classifications

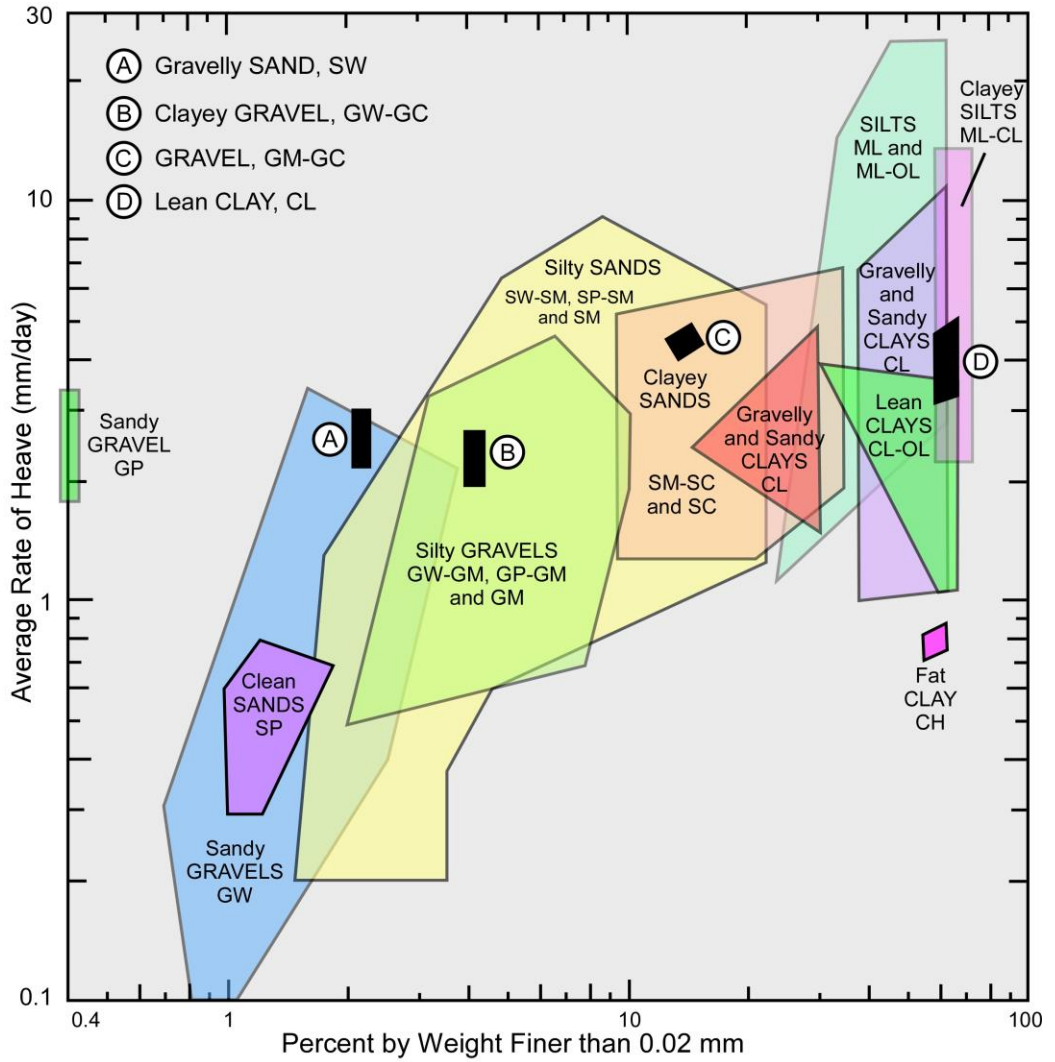

Summary Envelopes

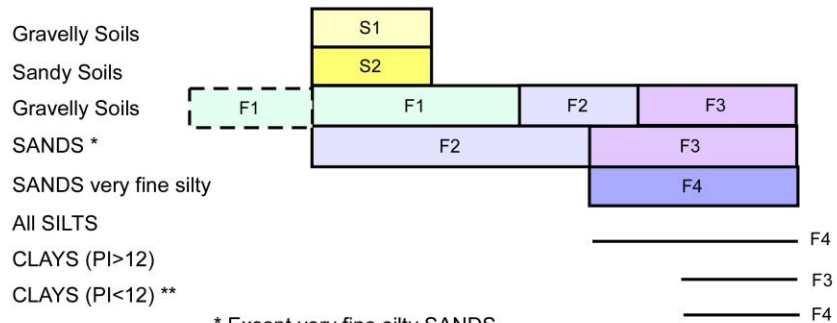

Modified from the U.S Army Corps of Engineers

* Except very fine silty SANDS
** Varved CLAYS and other fine-grained banded sediments

Figure 4.11 Frost Susceptible Soil Classifications

Frost susceptible soils have been classified into general groups (16):

- Gravels, crushed rock, sands, and similar materials exhibit little or no frost action when clean and free draining under normal freezing conditions.
- Silts are highly frost susceptible. The relatively small voids, high capillary potential/action, and relatively good permeability accounts for this characteristic.
- Clays are cohesive and, although their potential capillary action is high, their capillary rate is low. Although frost heaving can occur in clay soils, it is not as severe as for silts, since the impervious nature of clays makes passage of water slow. The supporting capacity of clays must be reduced greatly during thaws, although significant heave has not occurred.

Figure 4.11 Frost Susceptible Soil Classifications shows frost susceptibility for various soil classifications (31). The figure shows rates of heave in laboratory freezing tests on remolded soils. Because of the severity of the remolded laboratory test, the rates of heave shown in the figure are generally greater than may be expected under normal field conditions.

Muck is an unsuitable material with a minimum of 15 percent organic material, in either natural subgrade, fill embankment or cut sections and should be disposed of. Muck may be soil made from decaying plant materials. Problems with highly organic soils are related to their extremely compressible nature. Those of relatively shallow depth, are often most economically excavated and replaced with suitable select material. Deeper deposits have been alleviated by placing surcharge embankments for preconsolidation with provisions on removal of water (20).

In using the pavement design procedures, it is understood to use the final material properties of the soils in final construction. The design procedures use the proposed final properties as inputs to the design analysis. Therefore, the calculation of depth of frost penetration and suitable low frost susceptible soils must be performed prior to pavement design.

4.8 Sulfate Subgrade Soils

Sulfate induced problems in soils stabilized using calcium-based stabilizing agents such as lime and Portland cement has been documented since the late 1950's in the United States. A number of highly qualified cement chemists has studied the mechanism in an effort to understand and control sulfate attack on Portland cement concrete structures. It is very important for the designers to understand the fundamentals of sulfate-induced distress and the risk levels when sulfate soils are stabilized with lime or with other calcium-based stabilizing agents.

Sulfates typically are concentrated closer to the surface in the drier, western regions. Moving eastward into wetter and more humid climates, the general rule is that sulfates tend to concentrate at deeper depths if present. For preliminary soil information, two valuable tools can be used to assess the presence and significance of sulfates within an area. These are the United States Department of Agriculture's County Soils Report, and the "Web Soil Survey" developed by the Natural Resources Conservation Service (NRCS) of the United States Department of Agriculture.

The “Web Soil Survey” is located at <http://websoilsurvey.nrcs.usda.gov/app/>. This website allows the user to locate the construction job site of interest and identify where sulfates typically occur and at what depth to expect significant concentrations.

The County Soils Report provides agricultural and engineering data for each soil. It is conveniently tabulated and generally shows the presence of gypsum and other sulfate salts, as well as the depth of significant concentrations, if any. This is an extremely valuable reconnaissance tool. It is very important not only to identify the presence of sulfates but also the depth of occurrence. For example, a soil may be essentially sulfate free in the upper 2 or 3 feet but have sulfate concentrations at a depth of 6 feet. In this case, sulfates would not be of concern during normal surface stabilization operations but could be of concern in cut and fill areas.

If sulfates are present and identified in the Soils Report, a field testing plan should be established with the Geotechnical Engineer. The frequency of testing depends on the level of sulfates present and the geological information for the region. If initial testing confirms the presence of sulfates in concentrations that may present problems, additional testing for the concentration of water-soluble sulfates may be warranted prior to recommending lime stabilization of the subgrade. Refer to Chapter 200 of CDOT Field Materials Manual for more information on sulfates.

4.9 Expansive Subgrade Soils

Soils that are excessively expansive should receive special consideration. One solution is to cover these soils with a sufficient depth of select material to overcome the detrimental effects of expansion. Expansive soils may often be improved by compaction at water contents over the optimum. In other cases, it may be more economical to treat expansive soils by stabilizing with a suitable stabilizing agent, such as lime (20).

One treatment of expansive soils is done by performing the following subexcavation method. Subexcavate the expansive soil (dry dense unweathered shales and dry dense clays) and backfill with impermeable soil at 95 percent of maximum dry density at or above optimum moisture, in accordance with AASHTO Designation T 99. This treatment should carry through the cut area and transitions from cut to fill until the depth of fill is approximately equal to the depth of treatment.

Table 4.8 Treatment of Expansive Soils is to be used as a guide to determine the depth of treatment as Revised from Colorado Department of Highways Memo #323, (Construction) Swelling Soils, 1/5/1966. Projects on the Interstate and National Highway System will require treatment of expansive soils. Treatment may take the form of subexcavation and replace with impermeable soil or subexcavate and recompact with moisture control of the same soil. Refer to **Figure 4.12 Subexcavated Subgrade Layers**. Granular soils should not be used as backfill for subexcavation or replacement of expansive subgrade soils without a filter separator layer and edge drains to collect and divert the water from the pavement structure (26).

Table 4.8 Treatment of Expansive Soils

Plasticity Index	Depth of Treatment Below Normal Subgrade Elevation
10 – 20	2 feet
20 – 30	3 feet
30 – 40	4 feet
40 – 50	5 feet
More than 50	Placed in the bottom of the fills of less than 50 feet or greater than 6 feet in height, or wasted

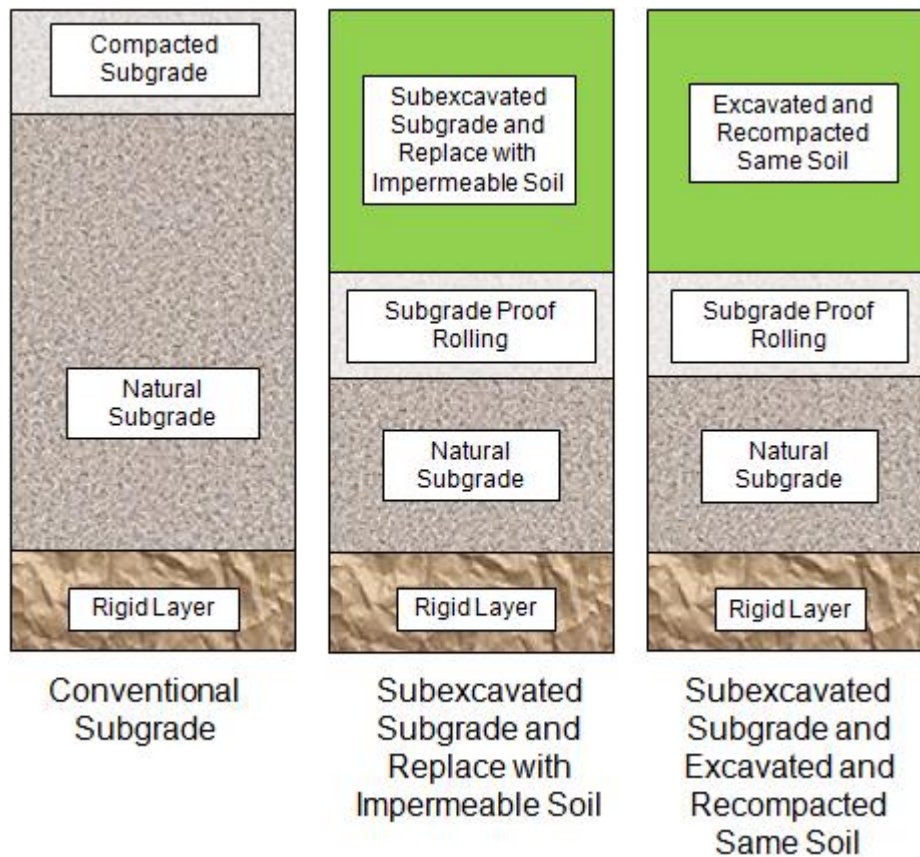

Figure 4.12 Subexcavated Subgrade Layers

Risk of swell potential is always a concern to the designer. A categorized of the "swell damage risk" is shown in **Table 4.9 Probable Swell Damage Risk**. The designer should use **Table 4.9 Probable Swell Damage Risk** and **Table 4.8 Treatment of Expansive Soils** to decide the risk.

Table 4.9 Probable Swell Damage Risk

Swell (%)	Swell Pressure (psf) (at 200 psf surcharge)	Probable Swell Damage Risk
0	0	None
0 - 1	0 - 1,000	Low
1 - 5	1,000 - 5,000	Medium
5 - 20	5,000 - 10,000	High
Over 20	Over 10,000	Very High

The Metropolitan Government Pavement Engineers Council (MGPEC) has published potential swell risk characterized by the driver's perception. Under the Section - Swelling Soils of the publication *Development of Pavement Design Concepts*, April 1998 (24) documents the driver's perception concept. A driver's perception of a bump is directly related to the slope of the bump. A driver's perception of pavement roughness is related to the vehicle speed. A design criteria separation of below and above 35 mph was found to be an appropriate separation. Slopes representing the maximum allowable movement before causing discomfort to the driving public have been analyzed relating to the vehicle speed. Streets with speeds less than 35 mph have a discomfort level of a 2 percent change. Higher speed streets and highways have a discomfort level of a 1 percent change. The slope of the heave is also related to the depth of the moisture treatment (subexcavation by means of excavate and recompact). **Figure 4.12 Effective Depth of Moisture Treatment and Figure 4.23 Recommended Depth of Moisture Treatment** graph the concept of slope of the bump and depth of recommended moisture treatment. **Table 4.9, Figure 4.12 and Figure 4.13** use the percent swell to determine the depth of subgrade treatment. **Table 4.8 Treatment of Expansive Soils** uses the Plasticity Index to determine the depth of subgrade treatment. The designer should consider each of the methods and know the field conditions to make a reasonable decision.

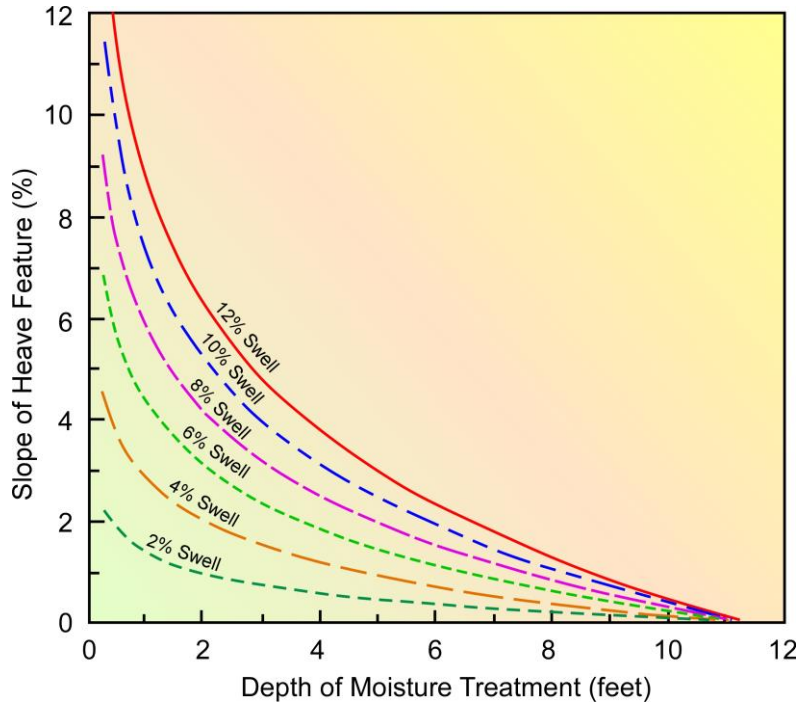

Figure 4.13 Effective Depth of Moisture Treatment

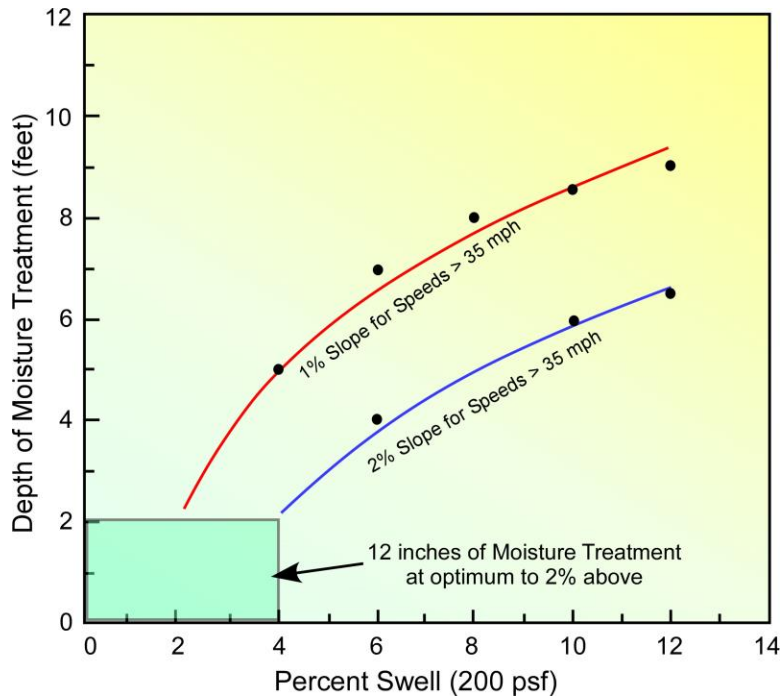

Figure 4.14 Recommended Depth of Moisture Treatment

4.10 Stabilizing Agents

The strength and stability of all subgrade soils improve on compaction. For certain subgrade soils, the strength gained, even after compaction may not be adequate. Similarly, silty and clayey subgrade soils may be collapsible or expansive in nature, and thus not suitable for pavement construction. Stabilization of soils is an effective method for improving the properties of soil and pavement system performance. Mechanical stabilization is the process in which the properties of subgrade soils are improved by blending and compacting the subgrade soils without the use of admixtures or stabilizing agents. However, unstable and expansive subgrade soils may be stabilized through chemical stabilization. For many soils, many stabilizing agents may be effective by improving soil properties in-place rather than removing and replacing material or increasing base thickness. Availability or financial considerations may be the determining factor on which a stabilizing agent is used. The objective of stabilizing agents is to increase the strength and stiffness of soil, improve workability and constructability of the soil, and reduce the Plasticity Index (PI) and swell potential for expansive clays. The following are the various stabilizing agents used for chemical stabilization.

Approved stabilizing agents are asphalt, lime, lime/fly ash, fly ash, portland cement, and approved chemical stabilizers. Other agents may be used with the prior approval of the Department. The approved stabilizing agents are combined with selected aggregate or soils or with native materials to improve their stability and strength as load carrying elements of structural sections. The type and amount of stabilizing agent should be developed from tests of available materials and then cost comparisons made against untreated materials.

Lime generally performed better on fine-grained materials, cement on coarse-grained soils, and fly ash performed well mostly on silty sands. Cement also provides highly effective clay stabilization, usually with the added benefit of higher strength gain but quality control may be difficult. However, the following chart, **Figure 4.15 Lime/Cement Stabilization Flow Chart**, provides a good estimate of the lime and cement for a certain soil type dependent upon gradation and PI.

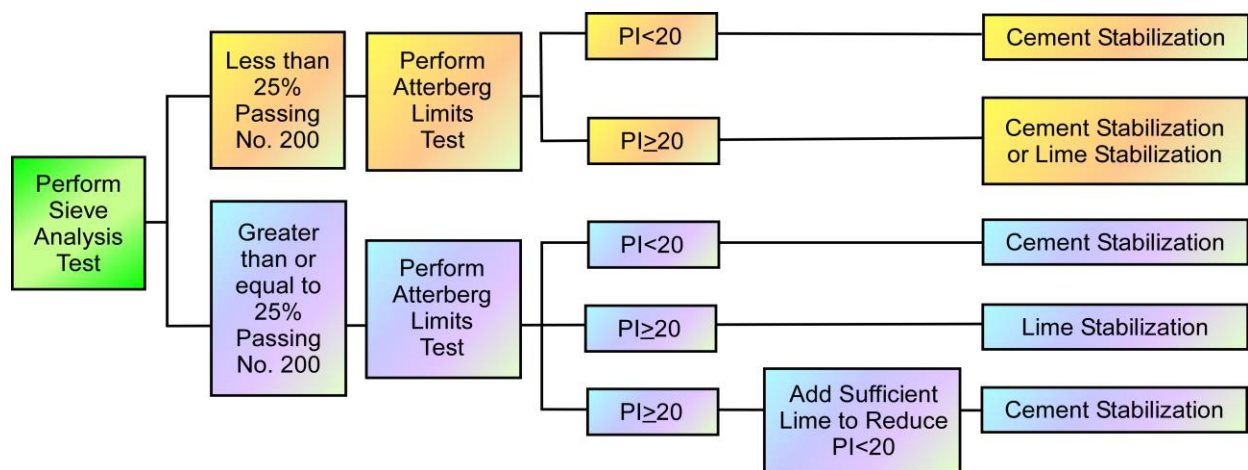

Figure 4.15 Lime/Cement Stabilization Flow Chart

4.10.1 Lime Treated Subgrade

When swell potential as determined by ASTM D 4546 is found to be greater than 0.5 percent using a 200 psf surcharge then stabilization should be used, as per CDOT *Standard Specification for Road and Bridge Construction, 2011* specification book, Table 307-1. If the R-value of the subgrade soil is greater than 40, the use of a base layer is not recommended in the structural layering of a potential swelling soil. Soil with a PI of more than 50 should be placed in the bottom of the fills of less than 50 feet in height, or wasted. The backfill soil should be uniform and all lenses or pockets of very high swelling soil should be removed and replaced with the predominant type of soil that has a PI less than 50. If removal is not practical or subgrade soils were determined to have a PI greater than 10, in-place treatment such as a lime-treated subgrade is recommended. However, a subgrade proposed for lime treatment should be investigated for sulfates. In some cases, such as construction over a rocky subgrade or when having to maintain traffic over a widened section, an aggregate base may be desirable.

Lime treated subgrade consists of blending the existing subgrade material with a minimum of 3 percent lime, by weight, per design, to the specified depth and compaction. Refer to **Figure 4.16 Lime Treated Structural Subgrade Layer**. Lime may be either quicklime or hydrated lime, shall conform to the requirements of ASTM C 977 along with a rate of slaking test for quicklime in accordance with ASTM C 110, and shall be the product of a high-calcium limestone as defined by ASTM C 51. The use of dolomitic quicklime or magnesia quicklime with magnesium oxide contents in excess of 4 percent, carbonated hydrated lime, and lime kiln dust or cement kiln dust shall not be allowed unless approved by the RME.

Some soils, when treated with lime, will form cementitious compounds resulting in a relatively high strength material. Lime reduces the ability of clays to absorb water thus increasing internal friction and shear strength. Lime provides greater workability by changing the clays into friable sand-like material and reduces the Plasticity Index (PI) and swell potential.

The designer should test the soil for the concentration of water-soluble sulfates prior to recommending lime stabilization of the subgrade. Water-soluble sulfate content should be less than 0.2 percent by mass. Sulfate content greater than 0.2 percent can cause an adverse reaction among the lime, soil, sulfate ions, and water. This can lead to loss of stability and cause swelling or heave. Additionally, excessive lime in the subgrade can create leaching of calcium into the ground water. For more information, see Chapter 200 of the CDOT Field Materials Manual.

Additional treatment of the natural subgrade may be needed. If lime treatment depth seems to be too thick to be practical, the swell potential subgrade may need to be excavated and recompacted to a depth as shown in **Table 4.8 Treatment of Expansive Soils**. The recompaction shall be at 2 ± 1 percent above optimum moisture control. Refer to **Figure 4.16 Lime Treated Structural Subgrade Layer**.

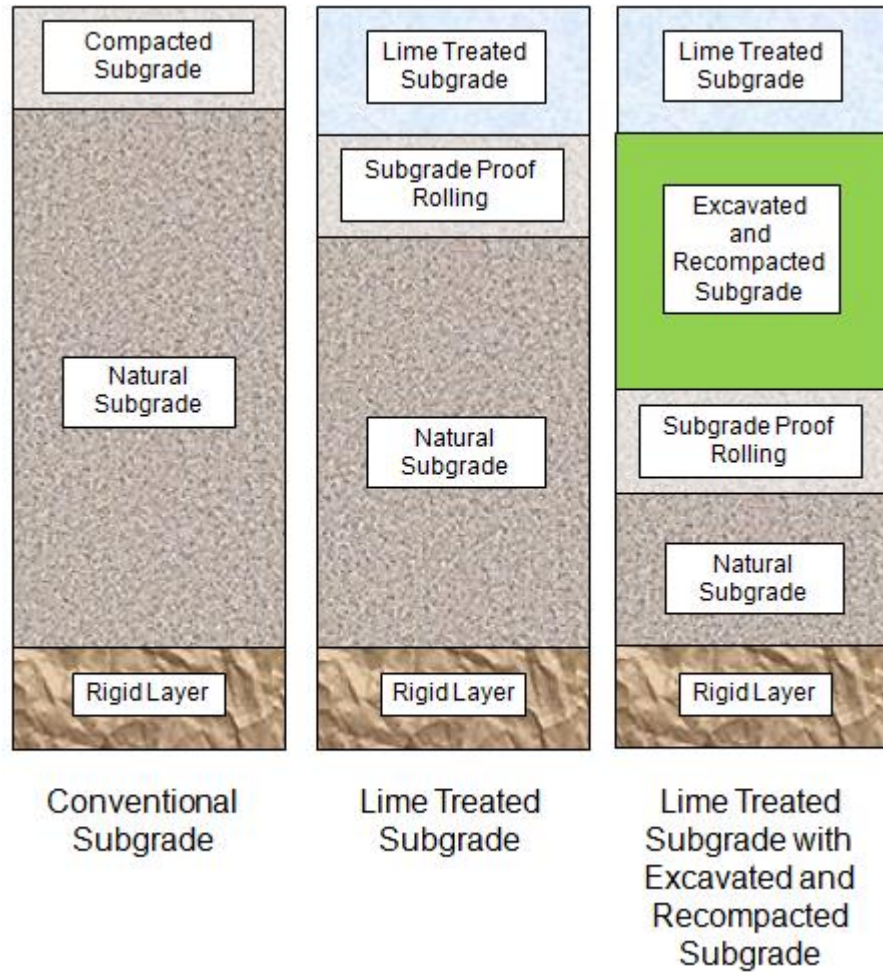

Figure 4.16 Lime Treated Structural Subgrade Layer

Figure 4.17 Cross Section of Lime Treated Cut Section Subgrade shows the extent of the subexcavation, excavated and recompacted treatment, or moisture treatment in cross sectional view.

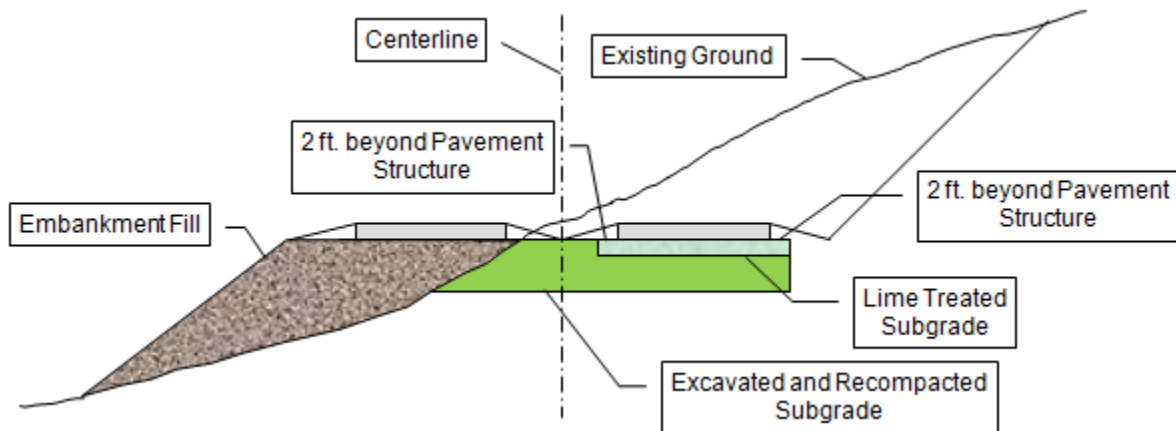

Figure 4.17 Cross Section of Lime Treated Cut Section Subgrade

4.10.2 Cement Treated Subgrade

Cement is typically used to stabilize fine and coarse sands and low PI clays where the PI is less than 20. Refer to **Figure 4.18 Cement Treated Structural Subgrade Layer**. Cement treated subgrade will have higher unconfined strengths, low permeability, and inhibits leaching. Cement treated subgrade reduces permeability of the soil and can rapid set within 2 hours of the subgrade treated being treated. Normal percentages used in cement treated subgrade are from 2 percent up to 15 percent by weight.

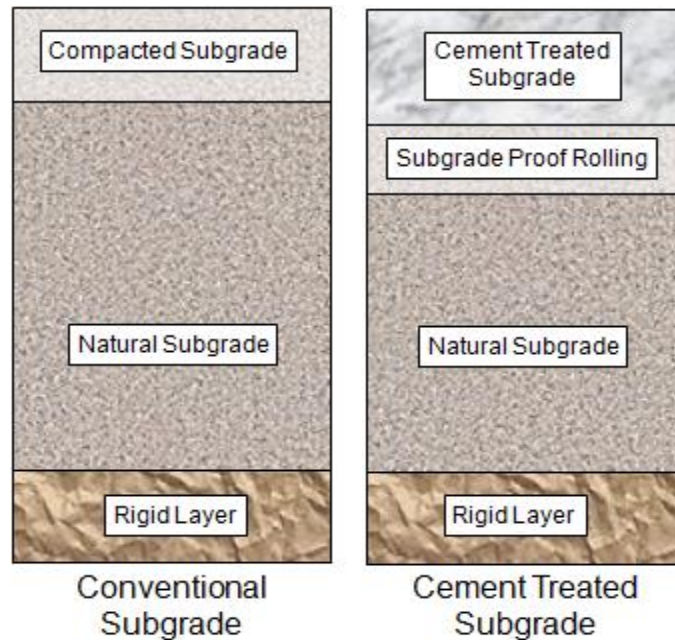

Figure 4.18 Cement Treated Structural Subgrade Layer

4.10.3 Fly Ash and Lime/Fly Ash Treated Subgrade

CDOT recommends the use of Class C fly ash as a stabilizing agent due to its calcium content. It can be used in sands and clays with low PI's and at percentages of up to 25 percent. Fly ash percentages in the subgrade of greater than 25 percent can lead to a decrease in density and durability issues. Fly ash treated subgrade will typically see increased unconfined compressive strengths similar to lime and increased sand maximum densities. Refer to **Figure 4.19 Fly Ash Treated Structural Subgrade Layer**.

When used, the typical lime/fly ash content of a mixture ranges from 12 to 30 percent with lime to fly ash ratios of 1:3 to 1:4 being common. Class C fly ash is recommended for these mixtures. The designer may use high carbon Class C fly ash for soil stabilization.

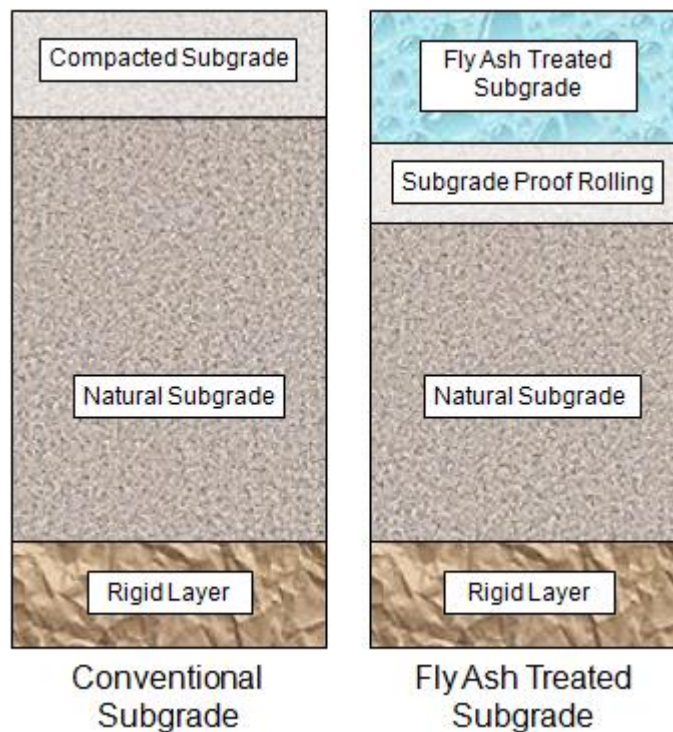

Figure 4.19 Fly Ash Treated Structural Subgrade Layer

4.11 Geosynthetic Fabrics and Mats

4.11.1 Introduction

Geosynthetic fabrics and mats can be used as reinforcement in a variety of ways within and below the pavement section. Any time poor or marginally acceptable in-situ soils are encountered, geosynthetic fabrics and mats should be considered. CDOT Soils and Rockfall Program personnel are available to help in the selection of the most appropriate product. Technical representatives for individual brand materials are also available.

Listed below are conditions when an in-situ subgrade is encountered and where a geosynthetic may be used as a viable alternative. The listing and **Table 4.10 Application and Associated Functions of Geosynthetics in Roadway Systems** are from the publication *FHWA-NHI-07-092, Geosynthetic Design & Construction Guidelines Reference Manual, August 2008, Chapter 5.0 (33)*.

- Poor Soils
 - USCS: SC, CL, CH, ML, MH, OL, OH and PT
 - AASHTO: A-5, A-6, A-7-5 and A-7-6
- Low undrained shear strength
 - Shear Strength= $\tau_f = c_u < 2,000$ psf (90 kPa), c_u is the undrained strength
 - CBR < 3 (Note: soaked saturated CBR as determined with ASTM D 4429)
 - R-value (California) $\approx < 20$
 - $M_R \approx < 4,500$ psi (30 MPa)
- High water table
- High sensitivity – dynamic disturbance results in viscous flow.

Table 4.10 Application and Associated Functions of Geosynthetics in Roadway Systems shows additional guidance of when and how geosynthetics can be used as a separator, stabilizer, base reinforcement, or a drainage material.

Table 4.10 Application and Associated Functions of Geosynthetics in Roadway Systems
(Table 5.1 FHWA-NHI-07-092, *Geosynthetic Design & Construction Guidelines Reference Manual*, August 2008)

Application	Function(s)	Subgrade Strength	Qualifier
Separator	Separation Secondary: filtration*	2,000 psf ≤ c _u ≤ 5,000 psf (90 kPa ≤ c _u ≤ 240 kPa) 3 ≤ CBR ≤ 8 4,500 psi ≤ M _R ≤ 11,600 psi (30 MPa ≤ M _R ≤ 80 MPa)	Soils containing high fines (A-1-b, A-2-4, A-2-5, A-2-6, A-4, A-5, A-6, A-7-5, A-7-6).
Stabilization	Separation, filtration and some reinforcement (especially CBR < 1) Secondary: separation	c _u < 2,000 psf (90) kPa CBR < 3 M _R < 4,500 psi (30 MPa)	Wet, saturated fine grained soils (i.e. silt, clay and organic soils).
Base Reinforcement	Reinforcement Secondary: separation	600 psf ≤ c _u ≤ 5,000 psf (30 kPa ≤ c _u ≤ 240 kPa) 3 ≤ CBR ≤ 8 1,500 psi ≤ M _R ≤ 11,600 psi (10 MPa ≤ M _R ≤ 80 MPa)	All subgrade conditions. Reinforcement located within 6 to 12 inches (150 to 300 mm) of pavement.
Drainage	Transmission and filtration Secondary: separation	Not applicable	Poorly drained subgrade.

* - Always evaluate filtration requirements.

For additional information on material use and approved products, the CDOT Materials Bulletin dated 25 January 2008, clarifies the terminology and application of geosynthetics (32).

4.11.2 Separator Layer

If coarse, open-graded base or subbase courses are used, it may be necessary to provide a means for preventing the intrusion of the underlying fine-grained roadbed soils. Historically preventive measures usually consist of providing a layer of suitable material to act as a barrier between the roadbed soils and the susceptible subbase or base. An engineered aggregate layer serves this purpose. To ensure that the gradation of the separator layer will prevent subgrade fines from migrating up, the following criteria are imposed (20, 22). **Eq. 4-5** may be referred to as the piping ratio.

$$D_{15B} \leq 5 \times D_{85S}, \text{ and} \quad \text{Eq. 4-5}$$

$$D_{50B} \leq 25 \times D_{50S} \quad \text{Eq. 4-6}$$

Where:

D_{15B} = particle size wherein 15 percent of the base or subbase course particles are smaller than this size.

D_{85S} = particle size wherein 85 percent of the roadbed soil particles are smaller than this size.

D_{50B} = particle size wherein 50 percent of the base or subbase course particles are smaller than this size.

D_{50S} = particle size wherein 85 percent of the roadbed soil particles are smaller than this size.

Separation fabrics used to separate fine grain silts and clays from open-graded drainage mats and subbase/base materials are an especially valuable and cost-effective application. Without them, a soft subgrade could inundate the more open void spaces of drainage mats and base courses, thereby decreasing their strength and ability to drain.

4.12 Material Sampling and Testing

Sampling involves coring the existing pavement to determine layer thicknesses, to permit visual inspection of the subsurface condition, and to obtain material samples of unbound layers for further testing. For an existing pavement, the types of tests performed on the extracted materials should depend on the type of distress observed. Contact the Region Materials Engineer and see Chapter 200 of the Field Materials Manual for information on recommended sampling intervals and further guidance on available material test methods.

References

1. *Guidelines for Stabilization of Soils Containing Sulfates*, Technical Memorandum, by Austin White Lime, Chemical Lime, Texas Lime, distributed by National Lime Association, Arlington, VA, August 2000.
2. Hunter, D., *Lime-Induced Heave in Sulfate-Bearing Clay Soil*, ASCE Journal of Geotechnical Engineering Vol. 114 Issue 2, 1988 pp. 150-167.
3. Little, D. N., *Handbook for Stabilization of Pavement Subgrades and Base Courses with Lime*, National Lime Association, Kendall/Hunt Publishing Company, Dubuque, Iowa, 1995.
4. Hopkins, T. C., T. L. Beckham, L. Sun, B. Ni and B. Butcher, *Long-Term Benefits of Stabilizing Soil Subgrades*, Kentucky Transportation Center, College of Engineering, University of Kentucky, Lexington, Kentucky, 2002.
5. Copas, T. L. and H. A. Pennock, *Lime- Fly Ash-Stabilized Bases and Subbases*, NCHRP Synthesis of Highway Practice 37, TRB, National Research Council, Washington, D.C., 1976.
6. McManis, K. L. and A. Arman, *Class C Fly Ash as a Full or Partial Replacement for Portland Cement or Lime*, Transportation Research Record 1219, TRB, National Research Council, Washington, D.C., 1989, pp. 68-81.
7. Nicholson, P. G., V. Kashyap, and C.F. Fujii, *Lime and Fly Ash Admixture Improvement of Tropical Hawaiian Soils*, Transportation Research Record 1440, TRB, National Research Council, Washington, D.C., 1994, pp. 71-78.
8. Petry, T. M., *Performance-Based Testing of Chemical Stabilizers*, Transportation Research Record 1589, TRB, National Research Council, Washington, D.C., 1997, pp. 36-41.
9. Prusinski, J. R., and S. Bhattacharja, *Effectiveness of Portland Cement and Lime in Stabilizing Clay Soils*, Transportation Research Record 1652, TRB, National Research Council, Washington, D.C., 1999, pp. 215-227.
10. Parsons, R. L., and J. P. Milburn, *Engineering Behavior of Stabilized Soils*, Transportation Research Record 1837, TRB, National Research Council, Washington, D.C., 2003, pp. 20-29.
11. *1972 Roadway Design Manual*, Colorado Department of Transportation.
12. *1980 Roadway Design Manual*, Colorado Department of Transportation.
13. *Standard Specifications for Road and Bridge Construction*, Colorado Department of Transportation, Denver, Co, 2005.

14. Yeh, Shan-Tai, and Su, Cheng-Kuang, *Resilient Properties of Colorado Soils*, Final Report CDOH-DH-SM-89-9, Colorado Department of Highways, December 1989.
15. Chang, Nien-Yin, Chiang, Hsien-Hsiang, and Jiang, Lieu-Ching, *Resilient Modulus of Granular Soils with Fines Contents*, Final Research Report CDOT 91-379, Colorado Department of Transportation, May 1994.
16. *Guide for Mechanistic-Empirical Design*, Final Report, NCHRP Project 1-37A, National Cooperative Highway Research Program, Transportation Research Board, National Research Council, Submitted by ARA, INC., ERES Consultants Division, Champaign, IL, March 2004.
17. *CDOT Field Materials Manual*, Colorado Department of Transportation, 2004.
18. *AASHTO Guide for Design of Pavement Structures*, American Association of State Highway and Transportation Officials, Washington, DC, 1993.
19. Supplement to the AASHTO Guide for Design of Pavement Structures, Part II, - Rigid Pavement Design & Rigid Pavement Joint Design, American Association of State Highway and Transportation Officials, Washington, DC, 1998.
20. *AASHTO Interim Guide for Design of Pavement Structures 1972*, published by American Association of State Highway and Transportation Officials, Washington, DC, 1972.
21. DRIP 2.0 Software Program <<http://www.fhwa.dot.gov/pavement/software.cfm>>
22. Mallela, Jagannath, Larson, Gregg, Wyatt, Tim, Hall, Jim, and Barker, Walter, *User's Guide for Drainage Requirement In Pavements- Drip 2.0 Microcomputer Program*, ERES Consultants, Division of Applied Research Associates, Inc., 505 W. University Avenue, Champaign, IL 61820 and prepared for Federal Highway Administration, 400 Seventh Street, SW, Washington, DC 20590, July 2002.
23. *LTPP Data Analysis Phase I: Validation of Guidelines for k-Value Selection and Concrete Pavement Performance Prediction*, Publication FHWA-RD-96-198, Federal Highway Administration, Research and Development, Turner-Fairbank Highway Research Center, 6300 Georgetown Pike, McLean, VA 22101-2296, January 1997.
24. *Development of Pavement Design Concepts*, prepared by CTL/Thompson, Inc., Consulting Engineers, 1971 West 12th Ave, Denver, CO 80204 and prepared for the Metropolitan Government Pavement Engineers Council, April 1998.
25. *FHWA Reclaimed Asphalt Concrete - User Guideline - Granular Base*, <<http://www.fhwa.dot.gov/research>> (1/25/2006).

26. Ardani, Ahmad, *Expansive Soil Treatment Methods in Colorado*, Final Report CDOT-DTD-R-92-2, Colorado Department of Transportation, March 1992.
27. Colorado Department of Highways Memo #323, (Construction) Swelling Soils, 1/5/1966.
28. *Basic Asphalt Recycling Manual*, Federal Highway Administration, 400 Seventh Street, SW, Washington, DC 20590 and Asphalt Recycling and Reclaiming Association, #3 Church Circle, PMB 250, Annapolis, MD 21401, 2001.
29. *Long-Term Pavement Performance Information Management System: Pavement Performance Database User Reference Guide*, Publication No. FHWA-RD-03-088 (Interim Update), Federal Highway Administration, Research, Development and Technology, Turner-Fairbank Highway Research Center, 6300 Georgetown Pike, McLean, VA 22101-2296, September 2005.
30. Long-Term Pavement Performance (LTPP) Data Analysis Support: National Pooled Fund Study TPF-5(013), Effects of Multiple Freeze Cycles and Deep Frost Penetration on Pavement Performance and Cost, Publication No. FHWA-HRT-06-121, Federal Highway Administration, Research and Development, Turner-Fairbank Highway Research Center, 6300 Georgetown Pike, McLean, VA 22101-2296, November 2006.
31. *Engineering and Design Pavement Criteria for Seasonal Frost Conditions, Mobilization Construction*, Engineering Manual EM1110-3-138, Department of the Army, Corps of Engineers, Office of the Chief of Engineers, Washington, D.C. 20314, April 9, 1984.
32. CDOT Materials Bulletin, 2008 Number 1, Geosynthetics and Geotextiles, Project Development Branch (for Materials and Geotechnical Branch), January 25, 2008.
33. *FHWA-NHI-07-092, Geosynthetic Design & Construction Guidelines Reference Manual*, NHI Course No. 132013, National Highway Institute, Federal Highway Administration, U.S. Department of Transportation, Washington, D.C., August 2008.
34. *Standard Specifications for Road and Bridge Construction*, Colorado Department of Transportation, Denver, Co, 2011.
<http://www.coloradodot.info/business/designsupport/construction-specifications/2011-Specs>
35. *AASHTO Mechanistic-Empirical Pavement Design Guide, A Manual of Practice, Interim Edition, July 2008*, American Association of State Highway and Transportation Officials, Washington, DC, 2008.

CHAPTER 5

GRANULAR AND TREATED BASE MATERIALS

5.1 Bases

A base course is a layer of material beneath the surface course pavement. The design and construction of a pavement structure may include one or more base courses. It is constructed on the subbase course, or, if no subbase is used, directly on the natural subgrade. Bases may be used in various combinations to design the most economical structural section for the specific project. Bases should be non-erodible, especially under rigid pavements. Bases may be constructed of gravels, mixtures of soil and aggregate, mixtures of asphalt and aggregate, mixtures of cement and aggregate or soil, or other innovative materials. Bases may be made of unbound materials, such as gravel, or bound materials, such as lime treated subgrade (17).

5.2 Sampling Base Materials During Soil Survey Investigation

Base and subbase material samples are collected for information and testing during the soil survey investigation. The purpose of material sampling is to gather information for the design of the pavement rehabilitation, and the new pavement structure. Follow the steps described in **Section 4.2 Soil Survey Investigation** for conducting soil survey investigations.

During the investigation, collect base and subbase samples for information and testing:

- Thickness
- Gradation CP 21, PI and LL (AASHTO T 89 and T 90)
- Resistance value, Colorado Procedure-L 3101 and L 3102
- Fill all sample holes. Provide and place patching material similar to the existing surface.
- Combine similar soil and aggregate types encountered and note locations and depths.

5.3 Aggregate Base Course (ABC)

Aggregate base is normally specified as the lowest element of any structural section because it generally results in the most economical design. It may consist of more than one layer. Refer to **Figure 5.1 Unbound Aggregate Base Course Layers**.

Aggregate base courses under flexible pavements provide a significant increase in structural capacity. Pavement design of flexible pavement depends on the wheel loads being distributed over a greater area as the depth of the pavement structure increases. Thick granular layers aim to improve the natural soil subgrade foundation of weak, fine-grained subgrades and are generally greater than 18 inches thick (16). Added benefits include improved drainage by preventing the accumulation of free water, protection against frost damage, preventing intrusion of fine-grained roadbed soils in base layers, providing a uniform underlying surface course support, and to providing a construction platform.

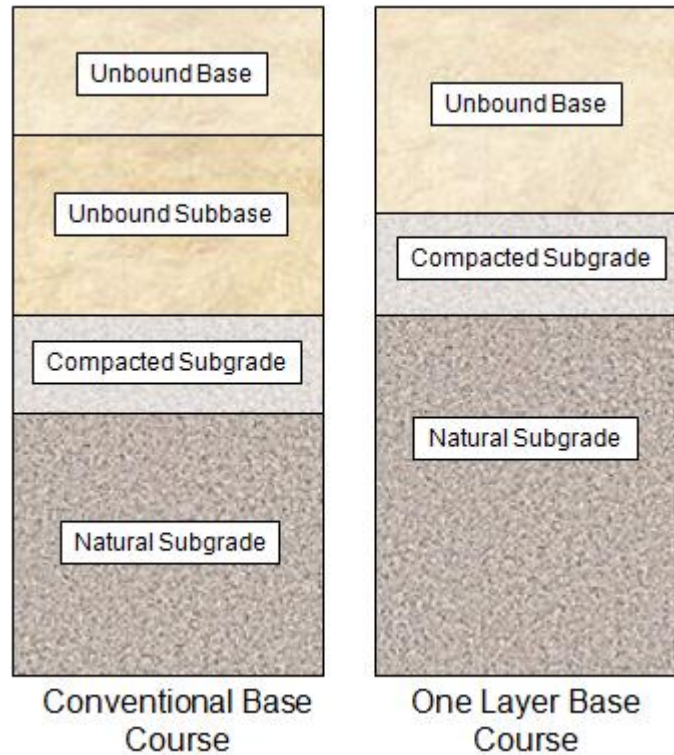

Figure 5.1 Unbound Aggregate Base Course Layers

Subbase layers are usually distinguished from the base course layers by less stringent specification requirements for strength, plasticity, and gradation. Because the subbase course must be of significantly better quality than the roadbed soil, the subbase is often omitted if roadbed soils are of high quality. When the roadbed soils are of relatively poor quality and the design procedure indicates the requirement for substantial thickness of pavement, alternate designs should be prepared for structural sections with and without subbase. A selection may be made based on availability and relative costs suitable for base and subbase (20). Unbound subbase layers may be of pit-run gravels. The pit-run gravels are comprised of rounded rock, sand, and soil mixture. Typically, sand or granular materials, or course grained materials with limited fines, corresponding to AASHTO A-1 and A-2 soils may be used. California Bearing Ratio (CBR) and/or resilient modulus testing may measure strength and stiffness of the subbase. Subbases having strengths and stiffness of CBR values 6 percent or greater, corresponding resilient moduli (M_R) of approximately 8,000 psi, R-value of 50, or structural coefficient (a_3) of 0.06 would be designated as an aggregate subbase material.

CDOT bases may range from M_r from 20,000 to 48,675 psi. Slight differences of the suggested values can be found in charts, graphs, and correlation tables of other publications. CDOT Aggregate Base Course Class 1, 2 or 3 would be classified as a subbase. Class 1 and 2 are more restrictive because of the sieve sizing than Class 3 (pit-run). Aggregate base courses Class 4 and Class 6 limit the fines from 3 to 12 percent passing the No. 200 sieve. When the gradation approaches the 12 percent passing, the base becomes impermeable. When the gradation approaches the 3 percent limit they tend to be more permeable.

Aggregate base courses under rigid pavements provide a drainage layer, reduce pumping, provide protection against frost damage, provide uniform, stable, permanent support, and provide support for the heavy equipment, used during rigid pavement placement. There is some increase in structural capacity when a base is placed under a rigid pavement, but typically not a significant amount (17). Bases provide uniform support of rigid pavements across the joints and under the entire slab. A non-erodable base is most desirable. To limit pumping of fines through the joints, a good base course gradation such as an Aggregate Base Course (Class 6) limits the fines from 3 to 12 percent passing the No. 200 sieve. The base course is considered a structural layer of the pavement along with the concrete slab, thus its thickness and modulus are important design values (19).

Aggregates for bases should be crushed stone, crushed slag, crushed gravel, natural gravel, or crushed reclaimed concrete or asphalt material and shall conform to the requirements of Section 703.03 and **Table 5.1 CDOT Classification for Aggregate Base Course** and **Table 5.7 CDOT Classification for Reclaimed Asphalt Pavement** and quality requirements of AASHTO M 147. Placement and compaction of each lift layer shall continue until a density of not less than 95 percent on the maximum density determined in accordance with AASHTO T 180 has been achieved (13). FHWA also recommends using only crushed aggregates in the unbound base layer to maintain good mechanical interlock. The design thickness should be rounded up to the next 1.0 inch increment.

Table 5.1 CDOT Classification for Aggregate Base Course

Sieve Size	Mass Percent Passing Square Mesh Sieves						
	LL not greater than 35			LL not greater than 30			
	Class 1	Class 2	Class 3	Class 4	Class 5	Class 6	Class 7
6"			100				
4" (100 mm)		100					
3" (75 mm)		95-100					
2-1/2" (60 mm)	100						
2" (50 mm)	95-100			100			
1-1/2" (37.5 mm)				90-100	100		
1" (25 mm)					95-100		100
3/4" (19 mm)				50-90		100	
#4 (4.75 mm)	30-65			30-50	30-70	30-65	
#8 (2.36 mm)						25-55	20-85
#200 (75 µm)	3-15	3-15	20 max.	3-12	3-15	3-12	5-15
NOTE: Class 3 material shall consist of bank or pit-run material.							

5.3.1 Unbound Layer Characterization in the M-E Design

In the M-E Design, the unbound layer characterization is similar to that of subgrade characterization. The inputs required for unbound layer characterization are the resilient modulus and other physical/engineering properties including soil classification, moisture content and corresponding dry density, saturated hydraulic conductivity, etc.

The input requirements for unbound layers follow the same guidelines used in the subgrade material characterization:

- New Flexible and New JPCP - **Table 4.2 Recommended Subgrade Inputs in New Flexible and New JPCP Designs**
- HMA Overlays of Existing Flexible Pavement - **Table 4.3 Recommended Subgrade Inputs for HMA Overlays of Existing Flexible Pavement**
- Overlays of Existing Rigid Pavement - **Table 4.4 Recommended Subgrade Inputs for Overlays of Existing Rigid Pavement**

In addition, the design M_r of the aggregate base and subbase layers must be adjusted for limiting modulus criteria and modified accordingly. This check is necessary to avoid decompaction and the build up of tensile stresses in the unbound layers.

The M_r of the unbound material in each layer is a function of the layer thickness and the modulus of the next underlying layer (including subgrade layers). Note that the unbound materials are stress-dependent; the M_r value decreases with increasing depth as the induced stresses attenuate. Therefore, to avoid decompaction, the M_r of the aggregate base and subbase layers should not exceed the limiting modulus criteria determined using **Figure 5.2 Limiting Modulus Criteria of Unbound Aggregate Base Layers** and **Figure 5.3 Limiting Modulus Criteria of Unbound Subbase Layers**. The AASHTO Interim MEPDG Manual of Practice recommends that the design M_r value of the unbound material be capped at the corresponding limiting modulus.

Use of **Figure 5.2 Limiting Modulus Criteria of Unbound Aggregate Base Layers** and **Figure 5.3 Limiting Modulus Criteria of Unbound Subbase Layers** involves entering the graph with a known value of the modulus of lower layer and the thickness of the next overlying layer. The figures limit the maximum values of 100,000 psi and 40,000 psi for base and subbase course materials, respectively. For instance, if the M_r of underlying subgrade layer is 10,000 psi and the thickness of the overlying subbase layer is 8 inches, the M_r of the overlying layer is limited to approximately 18,500 psi.

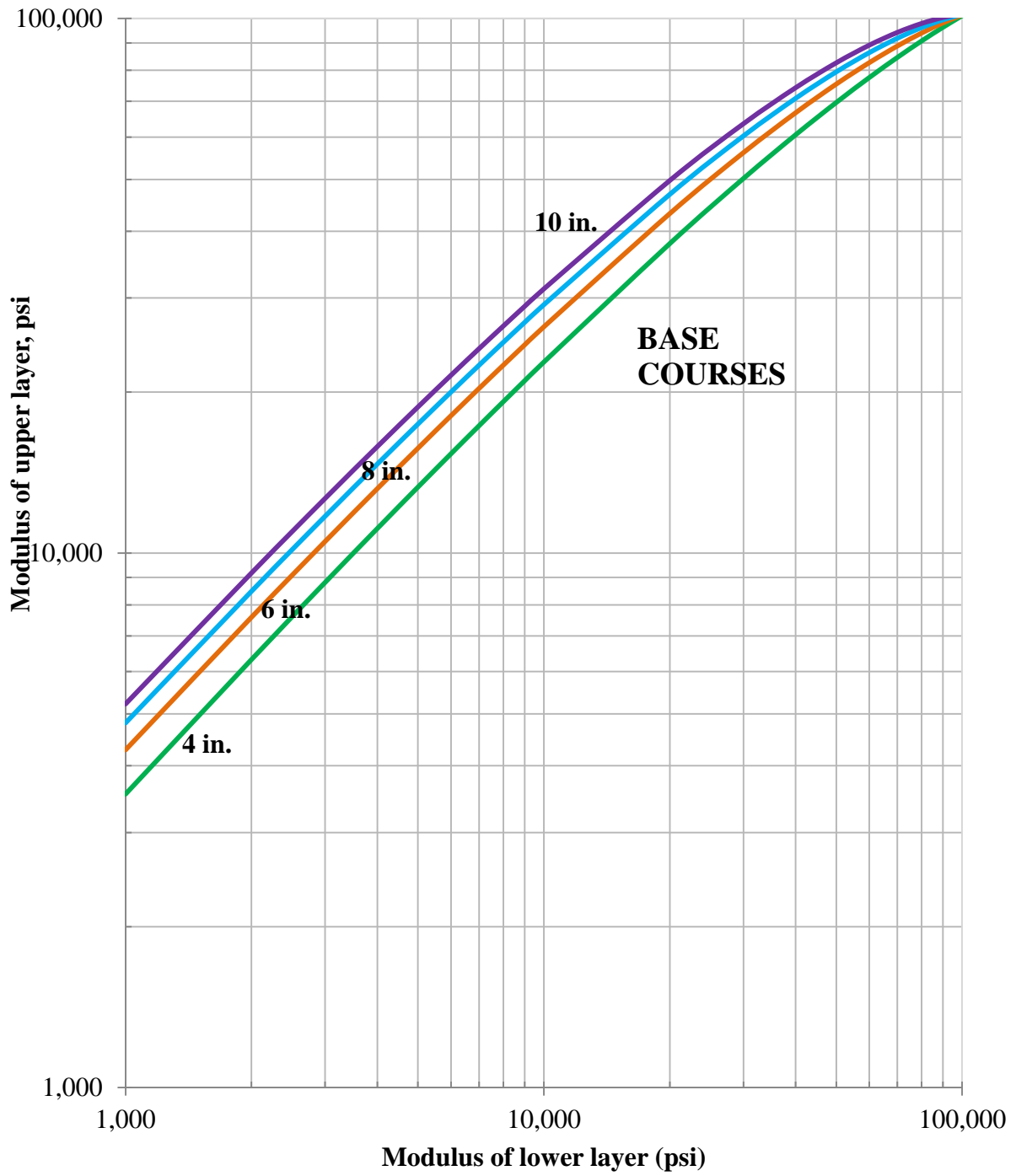

Figure 5.2 Limiting Modulus Criteria of Unbound Aggregate Base Layers

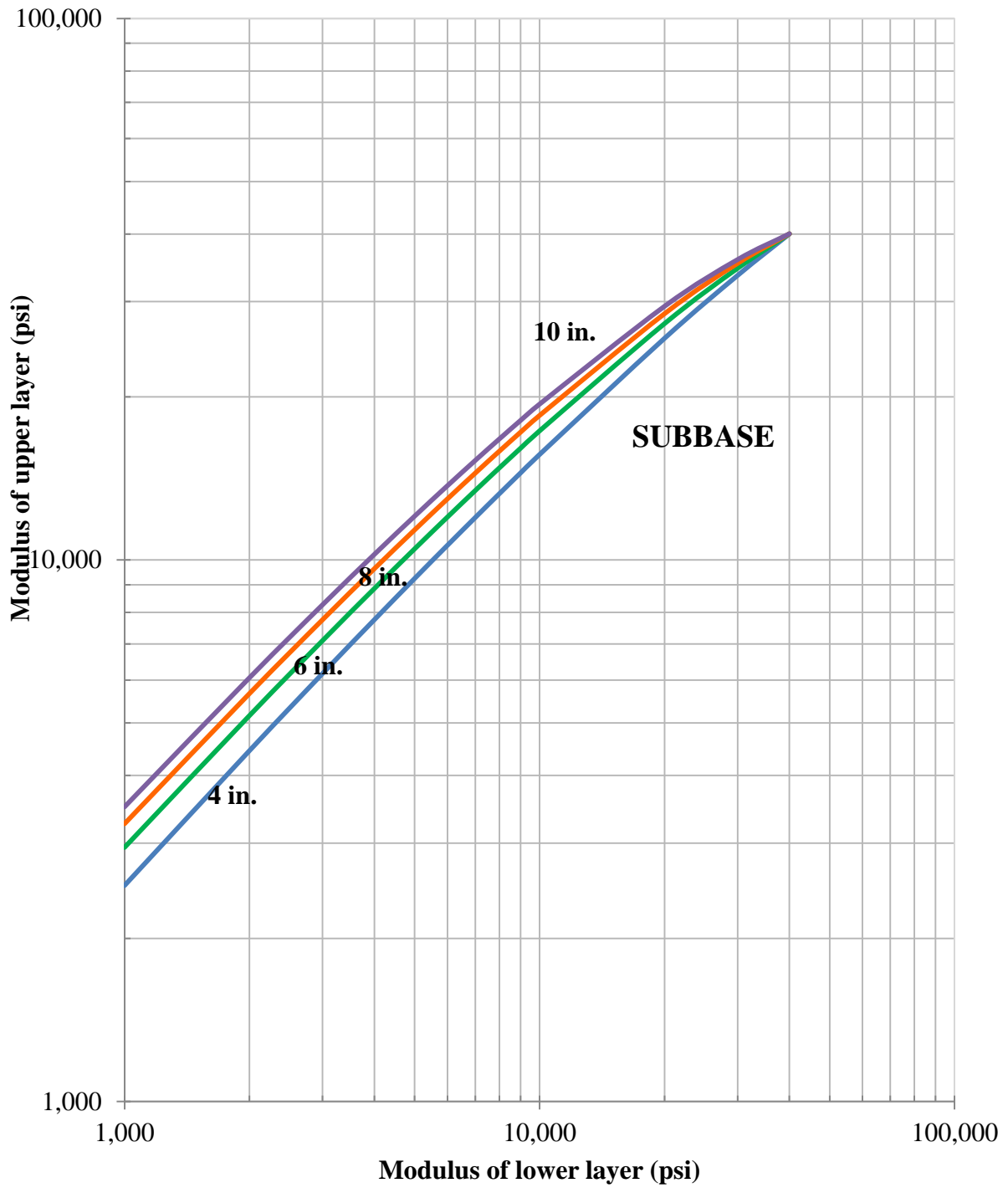

Figure 5.3 Limiting Modulus Criteria of Unbound Subbase Layers

5.3.2 Modeling Unbound Aggregate Base Layers in M-E Design Software

To properly characterize unbound layers for M-E Design, the designer should consider the following:

- **Modeling Thick Aggregate Bases**
 - When a thick granular aggregate base (more than 12 inches) is used, the top 12 inches is modeled as an aggregate base layer, while the remaining aggregate is modeled as the subgrade Layer 1. The M_r and other physical/engineering properties remain the same for both these layers. The compacted or natural subgrade below the thick aggregate base is modeled as lower subgrade layers as appropriate.
- **Modeling Thin Aggregate Bases**
 - If a thin aggregate base layer is used between two thick unbound materials, the thin layer should be combined with the weaker or lower layer.
 - When similar aggregate base and subbase materials are combined, the material properties of the combined layer should be those from the thicker layer. Averaging the material properties is not recommended. When similar materials have about the same thickness, the material with the lower modulus value should be used.
- **Limiting Modulus Criteria**
 - The designer must make sure that the M_r of the unbound layer does not exceed the limiting modulus determined using Figure 5.2 Limiting Modulus Criteria of Unbound Aggregate Base Layers and Figure 5.3 Limiting Modulus Criteria of Unbound Subbase Layers.
- **Stabilized Layer**
 - Granular base materials treated with a small amount of stabilizers, such as asphalt, emulsion, cement, lime or other pozzolanic materials, for constructability reasons should be defined as an unbound layer or combined with other unbound layers, as necessary.
- **Soil Aggregate Materials**
 - Sand and other soil-aggregate materials should be defined separately from crushed stone or crushed aggregate base materials.

5.4 Treated Base Course

The use of bases in the design of rigid pavements is a function of the structural quality of the pavement material characterized by the modulus of rupture and elastic modulus. In comparison to the strength of the concrete slab, the structural contributions of the underlying layers are relatively small. Treated or untreated bases can be used under rigid pavements, but their use is not mandatory. **Figure 5.4 Stabilized Treated Structural Base Layers** shows several materials historically used by CDOT as bases on the effective modulus of subgrade reaction.

Treated bases under flexible pavements are similar to rigid pavements. The structural capacity is increased while decreasing the flexible pavement thickness. They are used to strengthen a weak subgrade. The treated bases are another design tool to be used in the layering system to place lower quality materials in the bottom courses.

Plant Mix Bituminous Base (PMBB) is composed of a mixture of aggregate, filler if required, hydrated lime, and bituminous material. The aggregate and bituminous materials are mixed in a central batch plant. Several aggregate fractions are sized, uniformly graded and combined in such proportions that the resulting composite blend meets the job-mix formula. PMBB is a very good non-erodable base.

Emulsified Asphalt Treated Base (EATB) is composed of a mixture of aggregate, water if required, and emulsified asphalt. The aggregate and emulsified asphalt is mixed in a central batch plant. Aggregates are specified by meeting the classification of aggregate base course. In certain instances subgrades may be used if, they are sandy and do not have an excessive amount of material finer than the No. 200 sieve. Placement and spreading is by approved spreading devices capable of achieving specified surface tolerances. Compaction is to not less than 95% of AASHTO T 180.

Cement Treated Base (CTB) is a mixture of aggregate and portland cement. The aggregate is obtained from scarifying the existing roadway and shall meet specified gradation. Mixing is accomplished by means of a mixer that will thoroughly blend the aggregate with the cement. The mixer is equipped with a metering device that will introduce the required quantity of water during the mixing cycle. Another option is to have the aggregate proportioned and mixed with cement and water in a central batch plant. Compaction is to at least 95 percent of AASHTO T 134 - Moisture-Density Relations of Soil-Cement Mixtures.

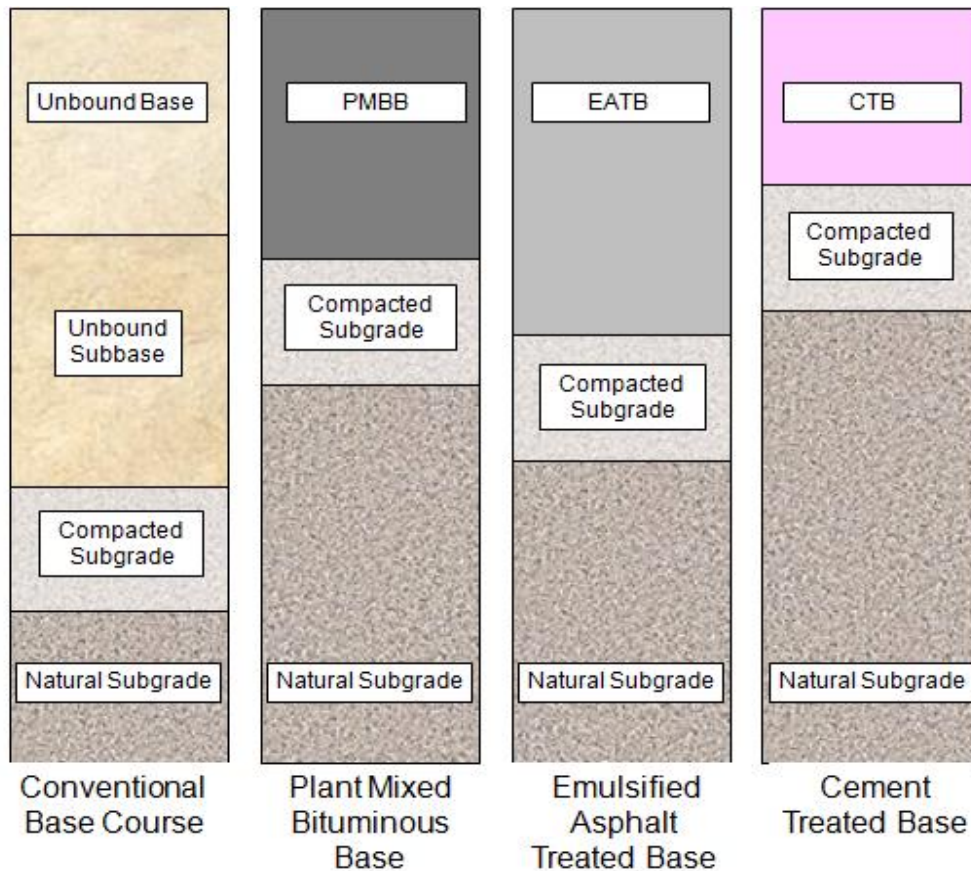

Figure 5.4 Stabilized Treated Structural Base Layers

5.4.1 Characterization of Treated Base in the M-E Design

The treated base materials include lean concrete, cement stabilized, open graded cement stabilized, soil cement, lime-cement-fly ash, and lime treated materials. **Figure 5.5 M-E Design Software Screenshot for Treated Base Inputs** presents a screenshot of treated base materials.

Materials with chemical stabilizers engineered to provide long-term strength and durability should be considered as a chemically stabilized layer (i.e. cement treated, lean concrete, pozzolonic treated). Lime and/or lime-fly ash stabilized soils engineered to provide structural support can also be considered as a chemically stabilized layer. These mixtures have a sufficient amount of stabilizer mixed in with the soil. Typically such layers are placed directly under the PCC or lowest asphalt layer.

On the other hand, aggregate or granular base materials lightly treated with small amounts of chemical stabilizers to enhance constructability or expedite construction (i.e. lower the plasticity index, improve the strength) should not be considered as a chemically stabilized layer. Typically, lightly stabilized materials are placed deeper in the pavement structure.

The materials inputs required for characterizing treated base layer in the M-E Design are presented in **Table 5.2 Characterization of Treated Base in the M-E Design**.

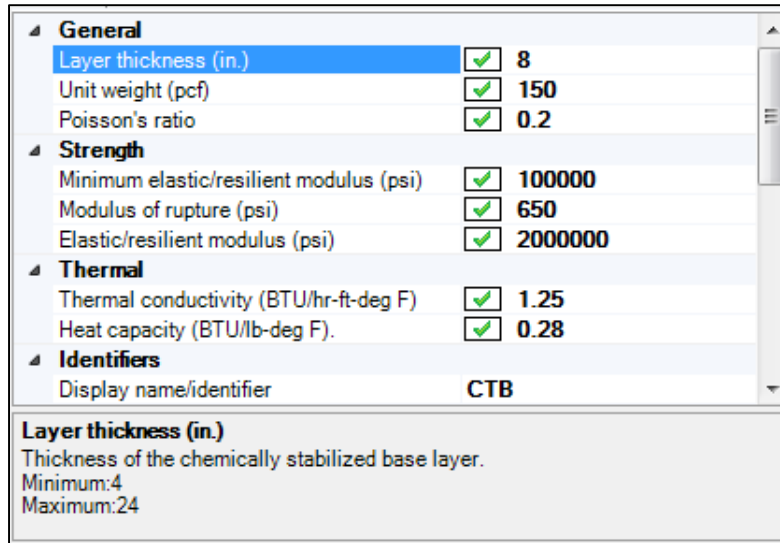

Figure 5.5 M-E Design Software Screenshot for Treated Base Inputs

Table 5.2 Characterization of Treated Base in the M-E Design

Input Property	Level 1	Level 2	Level 3
Elastic / Resilient Modulus	See Table 5.3 Level 1 Input Requirement and Corresponding Testing Protocols for Characterization of Treated Bases in the M-E Design	See Table 5.4 Level 2 Correlations for Elastic Modulus of Treated Bases	See Table 5.6 Level 3 Default Elastic Modulus and Flexural Strength of Treated Bases
Modulus of Rupture (for flexible pavements)		See Table 5.5 Level 2 Correlations for Flexural Strength of Treated Bases	
Minimum Elastic / Resilient Modulus (for flexible pavements)	Use the following values: <ul style="list-style-type: none"> Lean concrete = 300,000 psi Cement stabilized aggregate = 100,000 psi Open graded cement stabilized = 50,000 psi Soil cement = 25,000 psi Lime-cement-fly ash = 40,000 psi Lime stabilized soils = 15,000 psi 		
Poisson's Ratio	Use typical values: <ul style="list-style-type: none"> Lean concrete & cement stabilized aggregate = 0.1 to 0.2 Soil cement = 0.15 to 0.35 Lime-fly ash materials = 0.1 to 0.15 Lime stabilized soil = 0.15 to 0.2 		
Thermal Conductivity	Use the M-E Design software default value of 1.25 BTU/hr-ft-°F		
Heat Capacity	Use the M-E Design software default value of 0.28 BTU/lb-°F		
Total Unit Weight	Use the M-E Design software default value of 150 lb/ft ³		

Table 5.3 Level 1 Input Requirement and Corresponding Testing Protocols for Characterization of Treated Bases in the M-E Design

Design Type	Material Type	Measured Property	Source of Data		Recommended Test Protocol and Data Source
			Test	Estimate	
New	Lean concrete & Cement-treated aggregate	Elastic modulus	X		ASTM C 469
		Flexural strength	X		AASHTO T97
	Lime-cement-fly ash	Resilient modulus		X	No test protocols available. Estimate using Levels 2 and 3
	Soil cement	Resilient modulus	X		Mixture Design and Testing Protocol (MDTP) in conjunction with AASHTO T307 ³
	Lime stabilized soil	Resilient modulus		X	No test protocols available. Estimate using Levels 2 and 3
Existing	Lean concrete & Cement-treated aggregate	FWD backcalculated modulus	X		ASTM D4694
	Lime-cement-fly ash				
	Soil cement				
	Lime stabilized soil				

Table 5.4 Level 2 Correlations for Elastic Modulus of Treated Bases

Material Type	Recommended Correlations
Lean concrete ¹	$E = 57000\sqrt{f'_c}$ (18) where, E is the modulus of elasticity, psi; f'_c = compressive strength, psi tested in accordance with AASHTO T22
Cement treated aggregate ¹	
Open graded cement stabilized	No correlations are available.
Soil cement ²	$E = 1200 * q_u$ (18) where, E is the modulus of elasticity, psi; q_u = unconfined compressive strength, psi tested in accordance with ASTM D 1633, "Standard Test Method for Compressive Strength of Molded Soil-Cement Cylinders"
Lime-cement-fly ash ²	$E = 500 + q_u$ (19) where, E is the modulus of elasticity, psi; q_u = unconfined compressive strength, psi tested in accordance with ASTM C 593, "Standard Specification for Fly Ash and Other Pozzolans for Use with Lime"
Lime stabilized soils ²	$M_r = 0.124q_u + 9.98$ (17) where, M_r = resilient modulus, ksi, q_u = unconfined compressive strength, psi. tested in accordance with ASTM D 5102, "Standard Test Method for Unconfined Compressive Strength of Compacted Soil-Lime Mixtures"
Note: ¹ Compressive strength f'_c can be determined using AASHTO T22. ² Unconfined compressive strength q_u can be determined using the MDTP.	

Table 5.5 Level 2 Correlations for Flexural Strength of Treated Bases

Material Type	Test Protocol	Typical M_r (psi)
Lean concrete	AASHTO T22	M_r can be conservatively estimated as being 20 percent of the unconfined compressive strength (q_u)
Cement treated aggregate		
Soil cement	ASTM D 1633	
Lime-cement-fly ash	ASTM C 593	
Lime stabilized soils	ASTM D 5102	
Open graded cement stabilized aggregate	Not available	

Table 5.6 Level 3 Default Elastic Modulus and Flexural Strength of Treated Bases

Material Type	E or M_r Range (psi)	E or M_r Typical (psi)	Typical M_r (psi)
Lean concrete	1,500,000 to 2,500,000	2,000,000	450
Cement stabilized aggregate	700,000 to 1,500,000	1,000,000	200
Open graded cement stabilized aggregate	—	750,000	200
Soil cement	50,000 to 1,000,000	500,000	100
Lime-cement-fly ash	500,000 to 2,000,000	1,500,000	150
Lime stabilized soils*	30,000 to 60,000	45,000	25

*For reactive soils within 25 percent passing No. 200 sieve and PI of at least 10.

5.4.2 Modeling Treated Base in the M-E Design

To properly model a treated base or a stabilized subgrade in the M-E Design software, the designer should consider the following:

- **Plant Mix Bituminous Base** – This layer is produced in a central batch plant in a similar way conventional asphalt mixtures are produced. These materials should be considered as or combined with an HMA base layer.
- **Emulsified Asphalt Treated Base** – This layer is composed of crushed stone base materials and emulsified asphalt. This layer should be combined with the crushed stone base materials or considered as an unbound aggregate mixture.
- **Cement Treated Base** – Cement treated and other pozzolanic stabilized materials that are engineered to provide structural support should be treated as a separate layer. Where a small portion of cement and/or other pozzolanic materials are added to granular base

materials for constructability issues, such layers should be considered as an unbound material, and combined with those unbound layers, if necessary.

- Lime and/or Lime-fly Ash Stabilized Soils - Could be also considered a stabilized material if the layer is engineered to provide structural support; otherwise, it could be considered as an unbound layer that is insensitive to moisture and the resilient modulus or stiffness of these layers can be held constant over time.

5.5 Permeable Bases

Open-graded aggregate bases are becoming popular. Permeable bases may be unstabilized or stabilized and should be placed in a layer at least 4 inches thick. Care must be taken when designing with permeable bases, as they are subject to freeze-thaw cycles.

Unstabilized permeable bases contain smaller size aggregates to provide interlock, but have lower permeability. Typically, the coefficient of permeability is 1,000 to 3,000 feet/day. Unstabilized bases are difficult to compact and density is difficult to measure. CDOT does not recommend using an unstabilized permeable base.

Stabilized permeable bases are open-graded aggregates that have been stabilized with asphalt cement or portland cement. Stabilized bases provide a stable working platform for construction equipment. Stabilization of the base does not appreciably affect the permeability of the material and provides a very stable base during the construction phase. The coefficient of permeability is > 3,000 feet/day.

Asphalt stabilized permeable bases contain 2 to 2.5 percent asphalt by weight. Care must be used in construction to prevent over rolling the base which can lead to degradation of the aggregate and loss of permeability. The base should be laid at a temperature of 200°F to 250°F and compacted between 100°F and 150°F.

Cement stabilized bases have 2 to 3 bags of portland cement /cubic yard. This provides a very strong base that is easily compacted with a vibratory screed and plate. Curing can be done by covering the base with polyethylene sheeting for 3 to 5 days or with a fine water mist sprayed several times the day after the base is placed.

The designer is suggested to use FHWA's software DRIP 2.0. The software has capabilities to perform roadway geometry calculations for the drainage path, sieve analysis calculations, inflow calculations, permeable base design, separator design (geotextile or aggregate layer), and edgedrain design. Refer to **Figure 5.6 Structural Permeable Aggregate Base Course Layers**. The software may be obtained from the website: <http://www.fhwa.dot.gov/pavement/desi.cfm>.

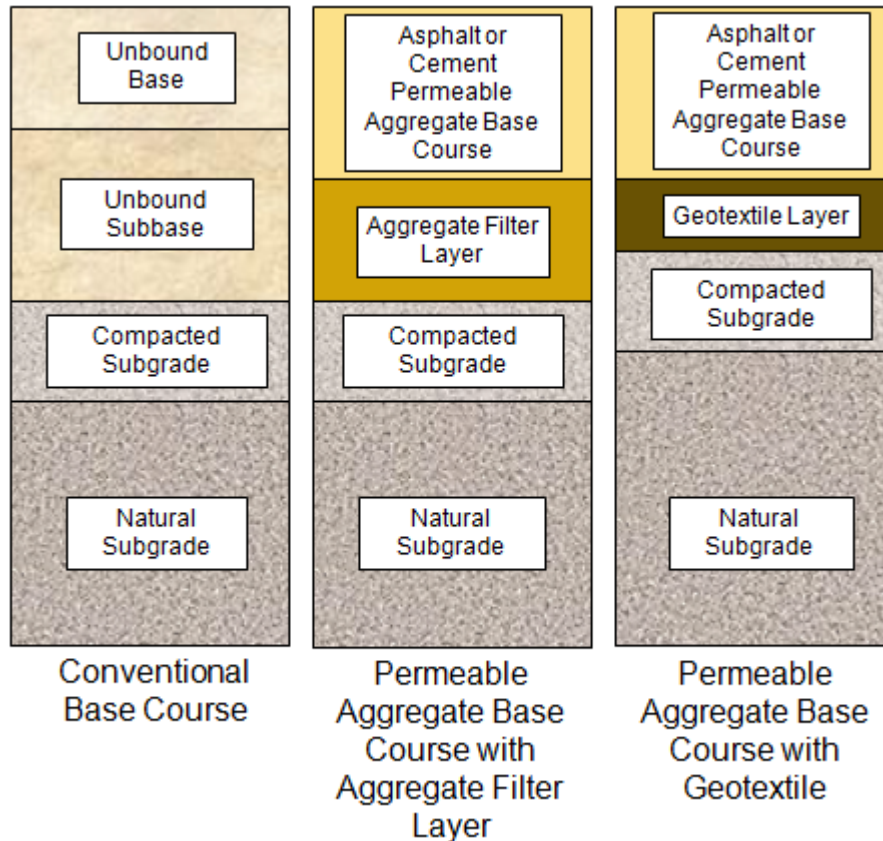

Figure 5.6 Structural Permeable Aggregate Base Course Layers

Drainage is particularly important where heavy flows of water are encountered (i.e., springs or seeps); where detrimental frost conditions are present; or where soils are particularly susceptible to expansion with increase in water content. Special subsurface drainage may include provisions of a permeable material beneath the pavement for interception and collection of water, and pipe drains for collection and transmission of water. Special surface drainage may require such facilities as dikes, paved ditches, and catch basins (20).

5.6 Reclaimed Asphalt and Concrete Pavement

Refer to **Figure 5.7 Reclaimed Asphalt and Concrete Pavement Base Layers** for using reclaimed asphalt or concrete for a base layer.

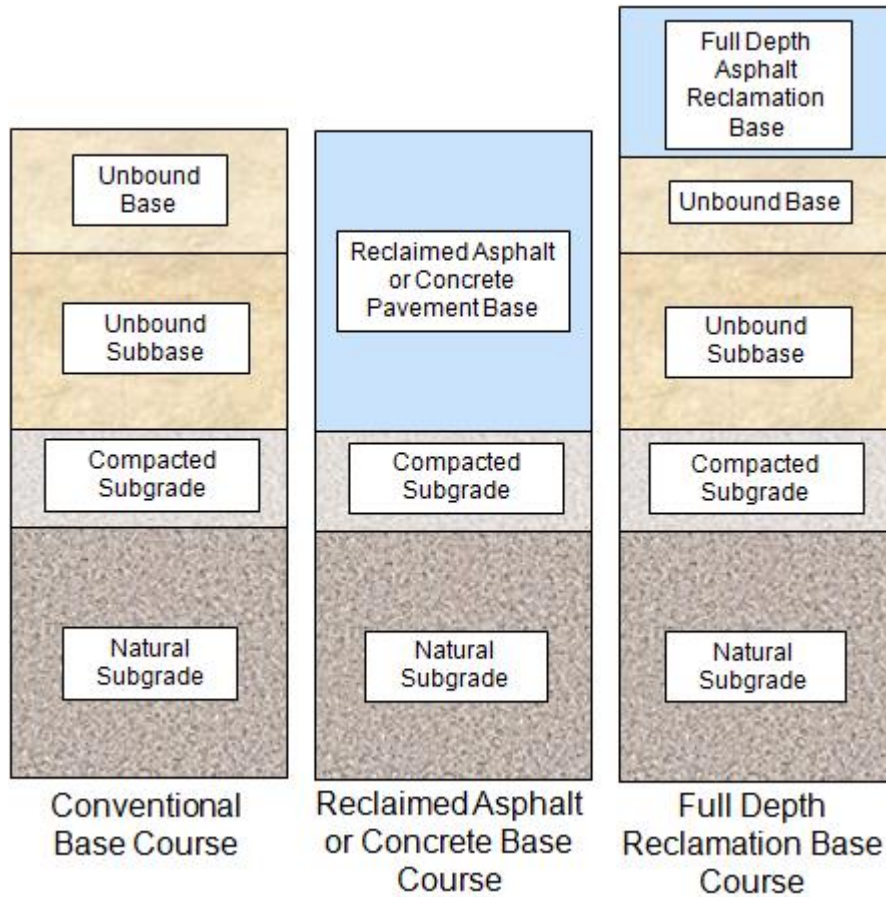

Figure 5.7 Reclaimed Asphalt and Concrete Pavement Base Layers

5.6.1 Reclaimed Asphalt Pavement Base

Recycled asphalt pavement may be used as a granular base or subbase provided it meets gradation and minimum R-values specified in contract documents. Recycled asphalt used as an aggregate base is discussed in this section as a cold recycling process compared to a hot process. Refer to **Section 8.7.3.2 Types of Hot In-Place Recycling** for explanation on the hot recycling process. The cold recycling process of asphalt is recovered, crushed, screened, and blended with conventional aggregates, and is then placed as a conventional granular material.

5.6.1.1 Reclaimed Asphalt Pavement (RAP) Base

Aggregate for Reclaimed Asphalt Pavement (RAP) base shall meet the grading requirements of **Table 5.7 CDOT Classification for Reclaimed Asphalt Pavement**. The aggregate shall have a liquid limit of non-viscous (NV), plasticity index of non-plastic (NP), and a Los Angeles percentage of wear of 45 or less. Placement and compaction of each lift layer shall continue until a density of at least 100 percent on the maximum wet density determined in accordance with Colorado Procedure 53 has been achieved (13).

**Table 5.7 CDOT Classification for Reclaimed Asphalt Pavement
Aggregate Base Course**

Sieve Size	Mass Percent Passing Square Mesh Sieves	
	ABC (RAP)	
	Lower Limit	Upper Limit
2" (50 mm)	100	
1-1/2" (37.5 mm)		
1" (25 mm)	85	100
3/4" (19 mm)	75	100
1/2" (12.5 mm)	55	90
3/8" (9.5 mm)	45	80
#4 (4.75 mm)	25	55
#8 (2.36 mm)		
#16 (1.18 mm)	5	25
#30 (600 µm)		
#50 (300 µm)		
#100 (150 µm)		
#200 (75 µm)	0	5

5.6.1.2 Full Depth Asphalt Reclaimed Base (FDR)

A full depth asphalt reclaimed base is an in-place process that pulverizes the existing pavement and thoroughly mixes the individual surface and granular base course layers into a relatively homogeneous mixture and recompact as a granular base (25). Stabilizing agents may be added with a laboratory mix design to optimize the quantity of stabilizing agent and other properties of the reclaim mix. Pavement distresses that can be treated by full depth asphalt reclamation are (28):

- Cracking from age, fatigue, slippage, edge, block, longitudinal, reflection, and discontinuity.
- Reduced ride quality due to swell, bumps, sags, and depressions, which are not contributed to swelling soils.
- Permanent deformations in the form of rutting, corrugation, and shoving.
- Loss of bonding between layers and stripping.
- Loss of surface integrity due to raveling, potholes, and bleeding.
- Inadequate structural capacity.

5.6.2 Reclaimed Concrete Pavement Base (RCP)

Reclaimed concrete pavement (RCP) may be used as a granular base or subbase, similar to recycled asphalt. RCP is a recycling of recovered, crushed, and screened concrete pavement that is then placed as a conventional granular material. RCP shall meet all conventional granular material requirements. RCP has all the steel removed in the recovering process.

5.7 Base Layer Made of Rubblized Rigid Pavement

Rubblization is a fracturing of existing rigid pavement. The rubblized concrete responds as a high-density granular material. The rough, hard particles provide an internal friction to resist rutting while the lack of tension prevents cracking in the surface layer. The reasoning is the more concrete there is to expand and contract as the temperature changes, the greater the movement of the slab, and the greater the opening of joints and cracks. Rubblization reduces the size of concrete pieces so that the expansion and contraction causes a minimum of movement. The space between the fractured pieces moves less so that the cracks are not reflected through the surface course. An edge drain system needs to be installed to remove the water that is captured between the fractured concrete slabs. The fractured concrete pavement has been found to be more permeable than a dense graded compacted base layer **Figure 5.8 Rubblized Base Course**.

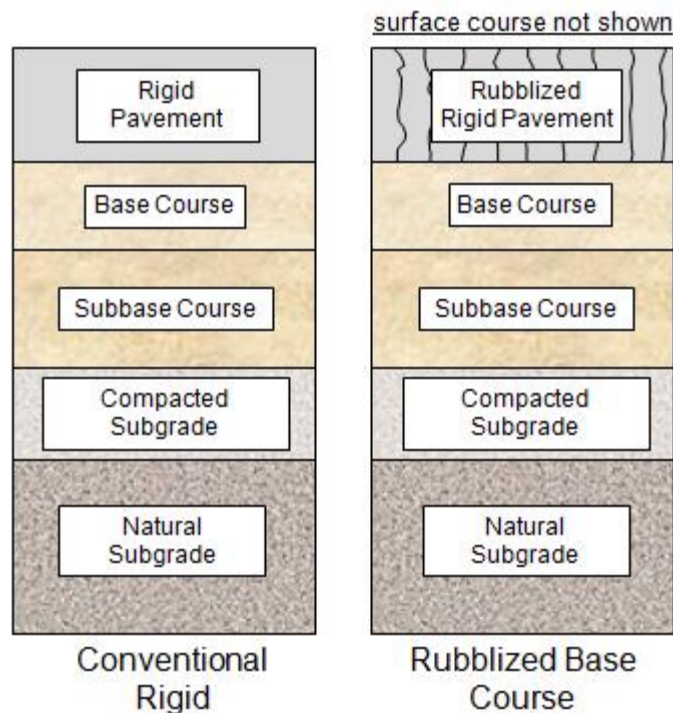

Figure 5.8 Rubblized Base Course

5.8 Material Sampling and Testing

Sampling involves coring the existing pavement to determine layer thicknesses, to permit visual inspection of the subsurface condition, and to obtain material samples of unbound layers for further testing. For an existing pavement, the types of tests performed on the extracted materials should depend on the type of distress observed. Contact the Region Materials Engineer and see Chapter 200 of the Field Materials Manual for information on recommended sampling intervals and further guidance on available material test methods.

References

1. *Guidelines for Stabilization of Soils Containing Sulfates*, Technical Memorandum, by Austin White Lime, Chemical Lime, Texas Lime, distributed by National Lime Association, Arlington, VA, August 2000.
2. Hunter, D., *Lime-Induced Heave in Sulfate-Bearing Clay Soil*, ASCE Journal of Geotechnical Engineering Vol. 114 Issue 2, 1988 pp. 150-167.
3. Little, D. N., *Handbook for Stabilization of Pavement Subgrades and Base Courses with Lime*, National Lime Association, Kendall/Hunt Publishing Company, Dubuque, Iowa, 1995.
4. Hopkins, T. C., T. L. Beckham, L. Sun, B. Ni and B. Butcher, *Long-Term Benefits of Stabilizing Soil Subgrades*, Kentucky Transportation Center, College of Engineering, University of Kentucky, Lexington, Kentucky, 2002.
5. Copas, T. L. and H. A. Pennock, *Lime- Fly Ash-Stabilized Bases and Subbases*, NCHRP Synthesis of Highway Practice 37, TRB, National Research Council, Washington, D.C., 1976.
6. McManis, K. L. and A. Arman, *Class C Fly Ash as a Full or Partial Replacement for Portland Cement or Lime*, Transportation Research Record 1219, TRB, National Research Council, Washington, D.C., 1989, pp. 68-81.
7. Nicholson, P. G., V. Kashyap, and C.F. Fujii, *Lime and Fly Ash Admixture Improvement of Tropical Hawaiian Soils*, Transportation Research Record 1440, TRB, National Research Council, Washington, D.C., 1994, pp. 71-78.
8. Petry, T. M., *Performance-Based Testing of Chemical Stabilizers*, Transportation Research Record 1589, TRB, National Research Council, Washington, D.C., 1997, pp. 36-41.
9. Prusinski, J. R., and S. Bhattacharja, *Effectiveness of Portland Cement and Lime in Stabilizing Clay Soils*, Transportation Research Record 1652, TRB, National Research Council, Washington, D.C., 1999, pp. 215-227.
10. Parsons, R. L., and J. P. Milburn, *Engineering Behavior of Stabilized Soils*, Transportation Research Record 1837, TRB, National Research Council, Washington, D.C., 2003, pp. 20-29.
11. *1972 Roadway Design Manual*, Colorado Department of Transportation.
12. *1980 Roadway Design Manual*, Colorado Department of Transportation.
13. *Standard Specifications for Road and Bridge Construction*, Colorado Department of Transportation, Denver, Co, 2005.

14. Yeh, Shan-Tai, and Su, Cheng-Kuang, *Resilient Properties of Colorado Soils*, Final Report CDOH-DH-SM-89-9, Colorado Department of Highways, December 1989.
15. Chang, Nien-Yin, Chiang, Hsien-Hsiang, and Jiang, Lieu-Ching, *Resilient Modulus of Granular Soils with Fines Contents*, Final Research Report CDOT 91-379, Colorado Department of Transportation, May 1994.
16. *Guide for Mechanistic-Empirical Design*, Final Report, NCHRP Project 1-37A, National Cooperative Highway Research Program, Transportation Research Board, National Research Council, Submitted by ARA, INC., ERES Consultants Division, Champaign, IL, March 2004.
17. *CDOT Field Materials Manual*, Colorado Department of Transportation, 2004.
18. *AASHTO Guide for Design of Pavement Structures*, American Association of State Highway and Transportation Officials, Washington, DC, 1993.
19. Supplement to the AASHTO Guide for Design of Pavement Structures, Part II, - Rigid Pavement Design & Rigid Pavement Joint Design, American Association of State Highway and Transportation Officials, Washington, DC, 1998.
20. *AASHTO Interim Guide for Design of Pavement Structures 1972*, published by American Association of State Highway and Transportation Officials, Washington, DC, 1972.
21. DRIP 2.0 Software Program < <http://www.fhwa.dot.gov/pavement/desi.cfm> >
22. Mallela, Jagannath, Larson, Gregg, Wyatt, Tim, Hall, Jim, and Barker, Walter, *User's Guide for Drainage Requirement In Pavements- Drip 2.0 Microcomputer Program*, ERES Consultants, Division of Applied Research Associates, Inc., 505 W. University Avenue, Champaign, IL 61820 and prepared for Federal Highway Administration, 400 Seventh Street, SW, Washington, DC 20590, July 2002.
23. *LTPP Data Analysis Phase I: Validation of Guidelines for k-Value Selection and Concrete Pavement Performance Prediction*, Publication FHWA-RD-96-198, Federal Highway Administration, Research and Development, Turner-Fairbank Highway Research Center, 6300 Georgetown Pike, McLean, VA 22101-2296, January 1997.
24. *Development of Pavement Design Concepts*, prepared by CTL/Thompson, Inc., Consulting Engineers, 1971 West 12th Ave, Denver, CO 80204 and prepared for the Metropolitan Government Pavement Engineers Council, April 1998.
25. *FHWA Reclaimed Asphalt Concrete - User Guideline - Granular Base*, <<http://www.fhwa.dot.gov/research>> (1/25/2006).

26. Ardani, Ahmad, *Expansive Soil Treatment Methods in Colorado*, Final Report CDOT-DTD-R-92-2, Colorado Department of Transportation, March 1992.
27. Colorado Department of Highways Memo #323, (Construction) Swelling Soils, 1/5/1966.
28. *Basic Asphalt Recycling Manual*, Federal Highway Administration, 400 Seventh Street, SW, Washington, DC 20590 and Asphalt Recycling and Reclaiming Association, #3 Church Circle, PMB 250, Annapolis, MD 21401, 2001.
29. *Long-Term Pavement Performance Information Management System: Pavement Performance Database User Reference Guide*, Publication No. FHWA-RD-03-088 (Interim Update), Federal Highway Administration, Research, Development and Technology, Turner-Fairbank Highway Research Center, 6300 Georgetown Pike, McLean, VA 22101-2296, September 2005.
30. Long-Term Pavement Performance (LTPP) Data Analysis Support: National Pooled Fund Study TPF-5(013), Effects of Multiple Freeze Cycles and Deep Frost Penetration on Pavement Performance and Cost, Publication No. FHWA-HRT-06-121, Federal Highway Administration, Research and Development, Turner-Fairbank Highway Research Center, 6300 Georgetown Pike, McLean, VA 22101-2296, November 2006.
31. *Engineering and Design Pavement Criteria for Seasonal Frost Conditions, Mobilization Construction*, Engineering Manual EM1110-3-138, Department of the Army, Corps of Engineers, Office of the Chief of Engineers, Washington, D.C. 20314, April 9, 1984.
32. CDOT Materials Bulletin, 2008 Number 1, Geosynthetics and Geotextiles, Project Development Branch (for Materials and Geotechnical Branch), January 25, 2008.
33. *FHWA-NHI-07-092, Geosynthetic Design & Construction Guidelines Reference Manual*, NHI Course No. 132013, National Highway Institute, Federal Highway Administration, U.S. Department of Transportation, Washington, D.C., August 2008.
34. *Standard Specifications for Road and Bridge Construction*, Colorado Department of Transportation, Denver, Co, 2011.
<http://www.coloradodot.info/business/designsupport/construction-specifications/2011-Specs>
35. *AASHTO Mechanistic-Empirical Pavement Design Guide, A Manual of Practice, Interim Edition, July 2008*, American Association of State Highway and Transportation Officials, Washington, DC, 2008.

CHAPTER 6

PRINCIPLES OF DESIGN FOR FLEXIBLE PAVEMENT

6.1 Introduction

Design of flexible pavement structures involves the consideration of numerous factors, of which the most important are: truck volume, weight and distribution of axle loads, HMA and underlying material properties, and the supporting capacity of the subgrade soils. Typical reconstruction projects should have a design life of 10 years for reconstructions and 20 years and rehabilitations unless mitigating circumstances exist.

Methods are presented in this section for the design of the flexible pavement structure with respect to thickness of the subbase, base, and surface courses and the quality and strength of the materials in place. Interaction between pavement materials and climate is evaluated as part of the M-E Design.

6.2 M-E Design Methodology for Flexible Pavement

The M-E Design of flexible pavements is an iterative process. The key steps in the design process include the following:

1. **Select a trial design strategy.**
2. **Select the appropriate performance indicator criteria for the project.** Establish criteria for acceptable pavement performance (i.e. distress/IRI) at the end of the design period. CDOT criteria for acceptable performance is based on highway functional class and location. The performance criteria was established to reflect magnitudes of key pavement distresses and smoothness that trigger major rehabilitation or reconstruction.
3. **Select the appropriate reliability level for the project.** The reliability is in essence a factor of safety to account for inherent variations in construction, materials, traffic, climate and other design inputs. The level of reliability selected should be based on the criticality of the design. CDOT criteria for desired reliability is based on highway functional class and location. The desired level of reliability is selected for each individual performance indicator.
4. **Assemble all inputs for the pavement trial design under consideration.** Define subgrade support, asphalt concrete and other paving material properties, traffic loads, climate, pavement type and design and construction features. The inputs required to run the M-E Design software may be obtained using one of three hierarchical levels of effort and need not be consistent for all of the inputs in a given design. Hierarchical level for a given input is selected based on the importance of the project, importance of the input, and the resources at the disposal of the user.

5. **Run the M-E Design software.** The software calculates changes in layer properties, damage, key distresses, and the IRI over the design life. The key steps include:
 - a) Processes input to obtain monthly values of traffic inputs and seasonal variations of material and climatic inputs needed in the design evaluations for the entire design period.
 - b) Computes structural responses (stresses and strains) using multilayer elastic theory or finite element based pavement response models for each axle type and load and for each damage-calculation increment throughout the design period.
 - c) Calculates accumulated distress and/or damage at the end of each analysis period for the entire design period.
 - d) Predicts key distresses (rutting, bottom-up/top-down fatigue cracking, thermal cracking) at the end of each analysis period throughout the design life using the calibrated mechanistic-empirical performance models.
 - e) Predicts IRI as a function of initial IRI, distresses that accumulate over time, and site factors at the end of each analysis increment.
6. **Evaluate the adequacy of the trial design.** The trial design is considered “adequate” if none of the predicted distresses/IRI exceed the performance indicator criteria at the design reliability level chosen for the project. If any of the criteria has been exceeded, determine how this deficiency can be remedied by altering material types and properties, layer thicknesses, or other design features.
7. **Revise the trial design, as needed.** If the trial design is deemed “inadequate”, revise the inputs/trial design and re-run the program. Iterate until all the performance criteria have been met. When they have been met, the trial design becomes a feasible design alternative.

The design alternatives that satisfy all performance criteria are considered feasible from a structural and functional viewpoint and can be further considered for other evaluations, such as life cycle cost analysis. Consultation of the mix design(s) with the RME shall occur. A detailed description of the design process is presented in the interim edition of the AASHTO Mechanistic-Empirical Pavement Design Guide Manual of Practice (AASHTO 2008).

6.3 Select Trial Design Strategy

6.3.1 Flexible Pavement Design Types

Designers can select from among several flexible pavement options as shown below:

- **Conventional Flexible Pavements:** Flexible pavements that consist of relatively thin asphalt concrete layer placed over an unbound aggregate base layer and subgrade.
- **Deep-strength AC Pavements:** Flexible pavements that consist of a relatively thick asphalt concrete layer placed over an unbound aggregate base layer and subgrade.
- **Full-depth AC Pavements:** Asphalt concrete layers placed directly over the subgrade.

Figure 6.1 Asphalt Concrete Pavement Layer Systems illustrates well-known CDOT combinations of asphalt concrete structural pavement layers.

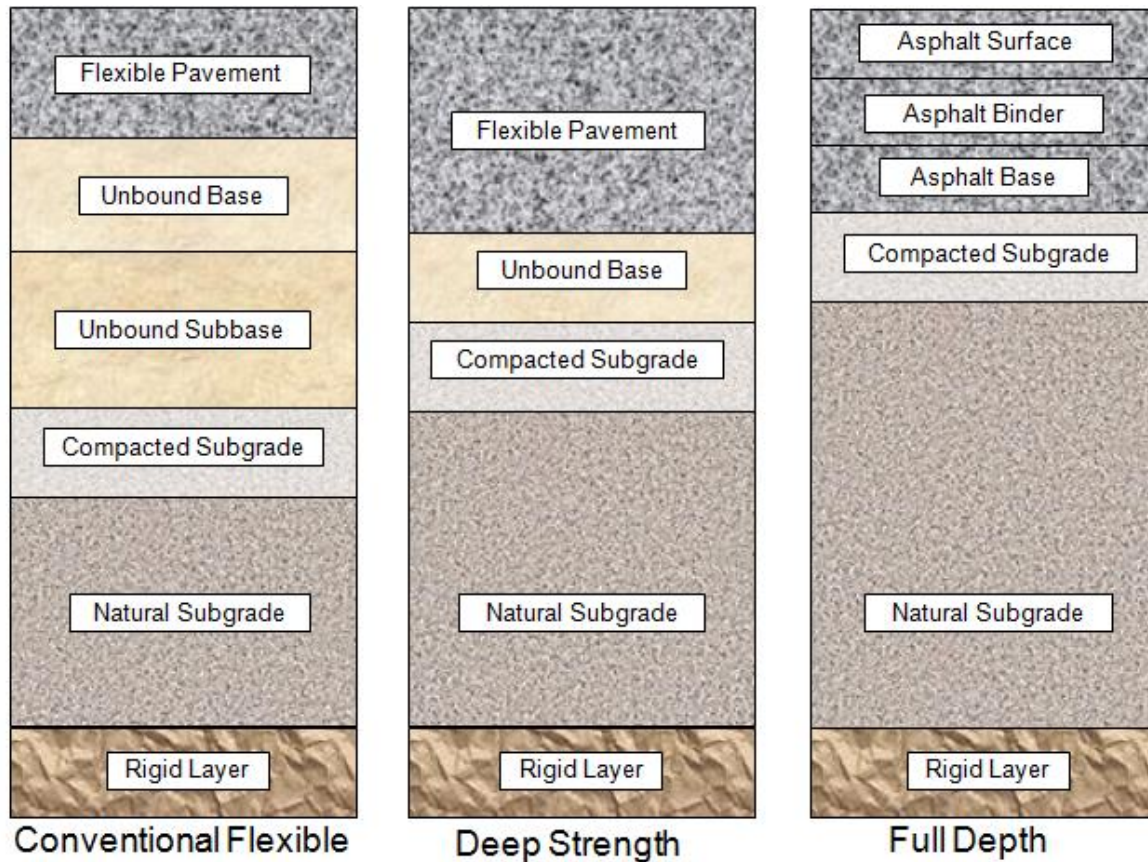

Figure 6.1 Asphalt Concrete Pavement Layer Systems

The asphalt concrete layer in **Figure 6.1 Asphalt Concrete Pavement Layer Systems** may comprise of several layers of asphalt concrete courses – a surface course, intermediate or binder course, and a base course (see **Figure 6.2 Structural Layers**). The surface, binder, and base courses are typically different in composition and are placed in separate construction operations (3).

- **Surface Course** - The surface course normally contains the highest quality materials. It provides characteristics such as friction, smoothness, noise control, rut and shoving resistance, and drainage. In addition, it serves to prevent the entrance of excessive quantities of surface water into the underlying HMA courses, bases, and subgrade.
- **Intermediate/Binder Course** - The intermediate course, sometimes called binder course, consists of one or more lifts of structural HMA placed below the surface course. Its purpose is to distribute traffic loads so that stresses transmitted to the pavement foundation will not result in permanent deformation of that course. Additionally, it facilitates the construction of the surface course.

- **Base Course** - The base course consists of one or more HMA lifts located at the bottom of the structural HMA course. Its major function is to provide the principal support of the pavement structure. It should contain durable aggregates, which would not be damaged by moisture or frost action.

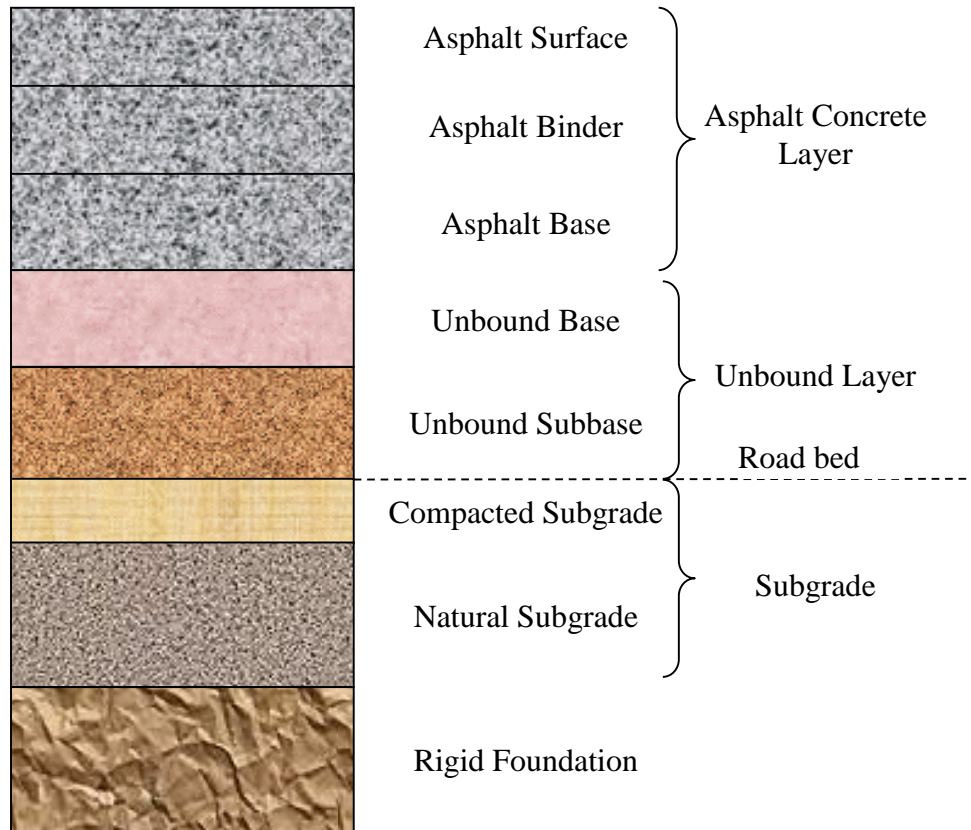

Figure 6.2 Structural Layers

6.3.2 Concept of Perpetual Pavements

A perpetual pavement is defined as an asphalt pavement designed and built to last longer than 50 years without requiring major structural rehabilitation or reconstruction, and needing only periodic surface renewal in response to distresses confined to the top of the pavement (6). A 20-year traffic design period is to be used for the traffic loading. Full depth and deep-strength asphalt pavement structures have been constructed since the 1960s. Full-depth pavements are constructed directly on subgrade soils and deep-strength sections are placed on relatively thin (4 to 6 inches) granular base courses. One of the chief advantages of these pavements is that the overall section of the pavement is thinner than those employing thick granular base courses. Such pavements have the added advantage of significantly reducing the potential for fatigue cracking by minimizing the tensile strains at the bottom of the asphalt layer (7). See **Figure 6.1 Asphalt Concrete Pavement Layer Systems**. An asphalt perpetual pavement structure is designed with a durable, rut resistant, and wear resistant top layer with a rut resistant intermediate layer and a fatigue resistant base layer. See **Figure 6.3 Perpetual Pavement Design Concept**.

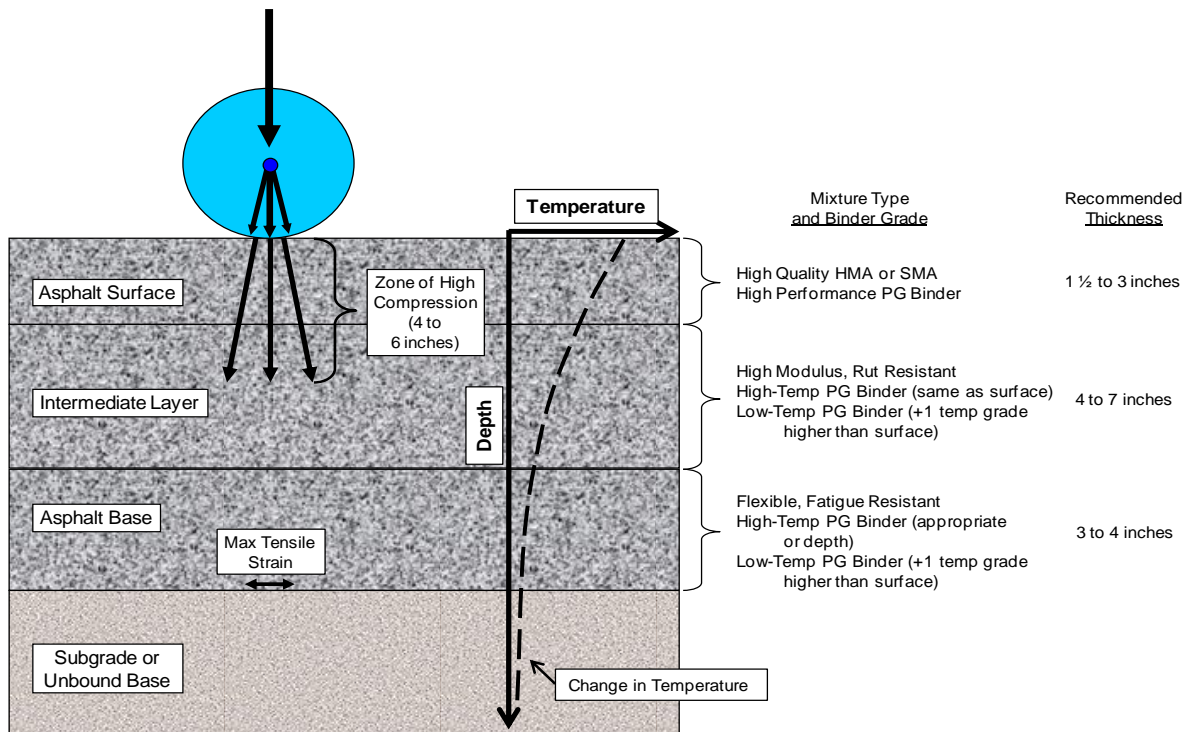

Figure 6.3 Perpetual Pavement Design Concept

This concept may be used in conventional, deep strength, or full depth asphalt structural layering. In mechanistic design, the principles of physics are used to determine a pavement's reaction to loading. Knowing the critical points in the pavement structure, one can design against certain types of failure or distress by choosing the right materials and layer thicknesses (7). Therefore, the uppermost structural layer resists rutting, weathering, thermal cracking, and wear. SMAs or dense-graded SuperPave mixtures provide these qualities. The intermediate layer provides rutting resistance through stone-on-stone contact and the durability is imparted by the proper selection of materials. Resistance to bottom-up fatigue cracking is provided by the lowest asphalt layer having a higher binder content or by the total thickness of pavement reducing the tensile strains in this layer to an insignificant level (6).

6.3.3 Establish Trial Design Structure

The designer must establish a trial design structure (combination of material types and thicknesses). This is done by first selecting the pavement type of interest in the M-E Design software (See **Figure 6.5 M-E Design Software Screenshot Showing General Information (left), Performance Criteria and Reliability (right)**); upon selecting, the M-E Design software automatically provides the top layers of the selected pavement type. The designer may add or remove pavement structural layers, modify layer material type and thickness as appropriate. **Figure 6.4 M-E Design Software Screenshot of Flexible Pavement Trial Design Structure** shows an example of flexible pavement trial design with pavement layer configuration on the left and layer properties of the AC surface course on the right.

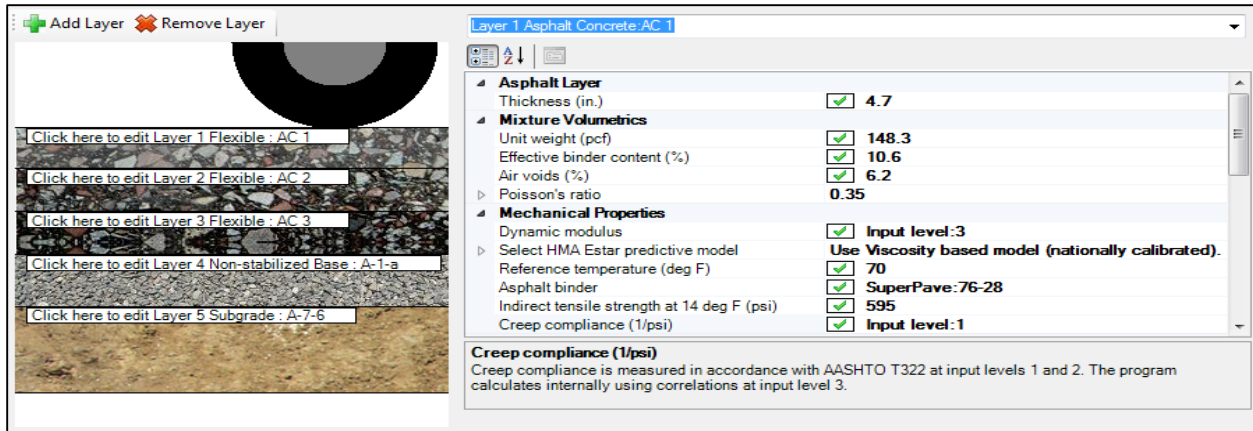

Figure 6.4 M-E Design Software Screenshot of Flexible Pavement Trial Design Structure

6.4 Select the Appropriate Performance Indicator Criteria for the Project

Table 2.4 Recommended Threshold Values of Performance Criteria for New Construction or Reconstruction Projects presents recommended performance criteria for flexible pavement design. The designer should enter the appropriate performance criteria based on functional class. An appropriate initial smoothness (IRI) is also required. For new flexible pavements, the recommended initial IRI is 50 inches/mile.

Figure 6.5 M-E Design Software Screenshot Showing General Information (left), Performance Criteria and Reliability (right) shows performance criteria for a sample flexible pavement trial design.

The coefficients of performance prediction models considered in the design of a new flexible pavement are shown in Figure 6.6 Performance Prediction Model Coefficients for Flexible Pavement Designs (Marshall Mix) through Figure 6.8 Performance Prediction Model Coefficients for Flexible Pavement Designs (PMA Mix). The value of AC rutting coefficient (BR1) is based on HMA mix type.

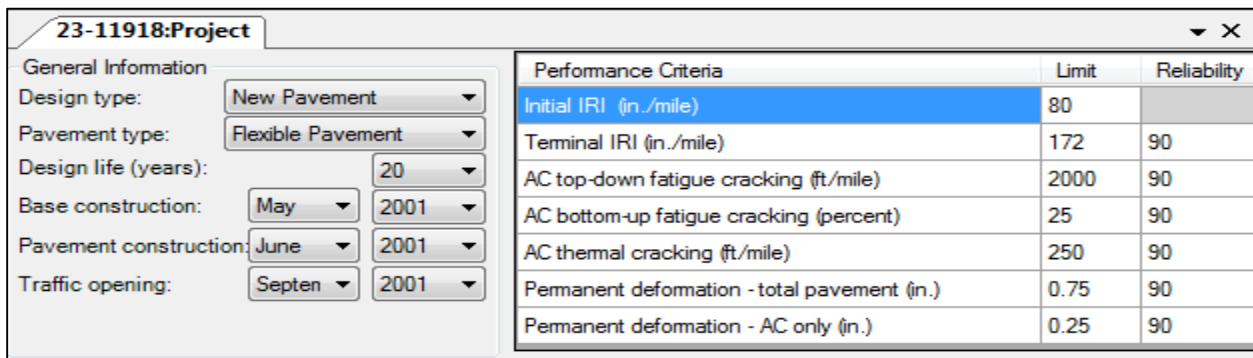

Figure 6.5 M-E Design Software Screenshot Showing General Information (left), Performance Criteria and Reliability (right)

New Flexible Pavement-Calibration Settings	
AC Cracking	
AC Cracking C1 Top	<input checked="" type="checkbox"/> 7
AC Cracking C2 Top	<input checked="" type="checkbox"/> 3.5
AC Cracking C3 Top	<input checked="" type="checkbox"/> 0
AC Cracking C4 Top	<input checked="" type="checkbox"/> 1000
AC Cracking Top Standard Deviation	$200 + 2300 / (1 + \exp(1.072 - 2.1654 * \text{LOG}_{10}(\text{TOP} + 0.0001)))$
AC Cracking C1 Bottom	<input checked="" type="checkbox"/> 0.021
AC Cracking C2 Bottom	<input checked="" type="checkbox"/> 2.35
AC Cracking C3 Bottom	<input checked="" type="checkbox"/> 6000
AC Cracking Bottom Standard Deviation	$1 + 15 / (1 + \exp(-3.1472 - 4.1349 * \text{LOG}_{10}(\text{BOTTOM} + 0.0001)))$
AC Fatigue	
AC Fatigue K1	<input checked="" type="checkbox"/> 0.007566
AC Fatigue K2	<input checked="" type="checkbox"/> 3.9492
AC Fatigue k3	<input checked="" type="checkbox"/> 1.281
AC Fatigue BF1	<input checked="" type="checkbox"/> 130.3674
AC Fatigue BF2	<input checked="" type="checkbox"/> 1
AC Fatigue BF3	<input checked="" type="checkbox"/> 1.217799
AC Rutting	
AC Rutting K1	<input checked="" type="checkbox"/> -3.35412
AC Rutting K2	<input checked="" type="checkbox"/> 1.5606
AC Rutting K3	<input checked="" type="checkbox"/> 0.3791
AC Rutting BR1	<input checked="" type="checkbox"/> 7.6742
AC Rutting BR2	<input checked="" type="checkbox"/> 1
AC Rutting BR3	<input checked="" type="checkbox"/> 1
AC Rutting Standard Deviation	$0.1414 * \text{Pow}(\text{RUT}, 0.25) + 0.001$
CSM Cracking	
CSM Fatigue	
IRI	
IRI Flexible C1	<input checked="" type="checkbox"/> 50
IRI Flexible C2	<input checked="" type="checkbox"/> 0.55
IRI Flexible C3	<input checked="" type="checkbox"/> 0.0111
IRI Flexible C4	<input checked="" type="checkbox"/> 0.02
IRI Flexible Over PCCC1	<input checked="" type="checkbox"/> 40.8
IRI Flexible Over PCCC2	<input checked="" type="checkbox"/> 0.575
IRI Flexible Over PCCC3	<input checked="" type="checkbox"/> 0.0014
IRI Flexible Over PCCC4	<input checked="" type="checkbox"/> 0.00825
Subgrade Rutting	
Granular Subgrade Rutting K1	<input checked="" type="checkbox"/> 2.03
Granular Subgrade Rutting BS1	<input checked="" type="checkbox"/> 0.22
Granular Subgrade Rutting Standard Deviation	$0.0104 * \text{Pow}(\text{BASERUT}, 0.67) + 0.001$
Fine Subgrade Rutting K1	<input checked="" type="checkbox"/> 1.35
Fine Subgrade Rutting BS1	<input checked="" type="checkbox"/> 0.37
Fine Subgrade Rutting Standard Deviation	$0.0663 * \text{Pow}(\text{SUBRUT}, 0.5) + 0.001$
Thermal Fracture	
AC thermal cracking Level 1K	<input checked="" type="checkbox"/> 6.3
AC thermal cracking Level 1 Standard Deviation	$0.1468 * \text{THERMAL} + 65.027$
AC thermal cracking Level 2K	<input checked="" type="checkbox"/> 0.5
AC thermal cracking Level 2 Standard Deviation	$0.2841 * \text{THERMAL} + 55.462$
AC thermal cracking Level 3K	<input checked="" type="checkbox"/> 6.3
AC thermal cracking Level 3 Standard Deviation	$0.3972 * \text{THERMAL} + 20.422$
Identifiers	

Figure 6.6 Performance Prediction Model Coefficients for Flexible Pavement Designs (Marshall Mix)

New Flexible Pavement-Calibration Settings	
AC Cracking	
AC Cracking C1 Top	<input checked="" type="checkbox"/> 7
AC Cracking C2 Top	<input checked="" type="checkbox"/> 3.5
AC Cracking C3 Top	<input checked="" type="checkbox"/> 0
AC Cracking C4 Top	<input checked="" type="checkbox"/> 1000
AC Cracking Top Standard Deviation	$200 + 2300/(1+\exp(1.072-2.1654*\text{LOG}10(\text{TOP}+0.0001)))$
AC Cracking C1 Bottom	<input checked="" type="checkbox"/> 0.021
AC Cracking C2 Bottom	<input checked="" type="checkbox"/> 2.35
AC Cracking C3 Bottom	<input checked="" type="checkbox"/> 6000
AC Cracking Bottom Standard Deviation	$1+15/(1+\exp(-3.1472-4.1349*\text{LOG}10(\text{BOTTOM}+0.0001)))$
AC Fatigue	
AC Fatigue K1	<input checked="" type="checkbox"/> 0.007566
AC Fatigue K2	<input checked="" type="checkbox"/> 3.9492
AC Fatigue k3	<input checked="" type="checkbox"/> 1.281
AC Fatigue BF1	<input checked="" type="checkbox"/> 130.3674
AC Fatigue BF2	<input checked="" type="checkbox"/> 1
AC Fatigue BF3	<input checked="" type="checkbox"/> 1.217799
AC Rutting	
AC Rutting K1	<input checked="" type="checkbox"/> -3.35412
AC Rutting K2	<input checked="" type="checkbox"/> 1.5606
AC Rutting K3	<input checked="" type="checkbox"/> 0.3791
AC Rutting BR1	<input checked="" type="checkbox"/> 6.7
AC Rutting BR2	<input checked="" type="checkbox"/> 1
AC Rutting BR3	<input checked="" type="checkbox"/> 1
AC Rutting Standard Deviation	$0.1414*\text{Pow}(\text{RUT},0.25)+0.001$
CSM Cracking	
CSM Fatigue	
IRI	
IRI Flexible C1	<input checked="" type="checkbox"/> 50
IRI Flexible C2	<input checked="" type="checkbox"/> 0.55
IRI Flexible C3	<input checked="" type="checkbox"/> 0.0111
IRI Flexible C4	<input checked="" type="checkbox"/> 0.02
IRI Flexible Over PCCC1	<input checked="" type="checkbox"/> 40.8
IRI Flexible Over PCCC2	<input checked="" type="checkbox"/> 0.575
IRI Flexible Over PCCC3	<input checked="" type="checkbox"/> 0.0014
IRI Flexible Over PCCC4	<input checked="" type="checkbox"/> 0.00825
Subgrade Rutting	
Granular Subgrade Rutting K1	<input checked="" type="checkbox"/> 2.03
Granular Subgrade Rutting BS1	<input checked="" type="checkbox"/> 0.22
Granular Subgrade Rutting Standard Deviation	$0.0104*\text{Pow}(\text{BASERUT},0.67)+0.001$
Fine Subgrade Rutting K1	<input checked="" type="checkbox"/> 1.35
Fine Subgrade Rutting BS1	<input checked="" type="checkbox"/> 0.37
Fine Subgrade Rutting Standard Deviation	$0.0663*\text{Pow}(\text{SUBRUT},0.5)+0.001$
Thermal Fracture	
AC thermal cracking Level 1K	<input checked="" type="checkbox"/> 6.3
AC thermal cracking Level 1 Standard Deviation	$0.1468 * \text{THERMAL} + 65.027$
AC thermal cracking Level 2K	<input checked="" type="checkbox"/> 0.5
AC thermal cracking Level 2 Standard Deviation	$0.2841 * \text{THERMAL} + 55.462$
AC thermal cracking Level 3K	<input checked="" type="checkbox"/> 6.3
AC thermal cracking Level 3 Standard Deviation	$0.3972 * \text{THERMAL} + 20.422$
Identifiers	

Figure 6.7 Performance Prediction Model Coefficients for Flexible Pavement Designs (Superpave Mix)

New Flexible Pavement-Calibration Settings	
AC Cracking	
AC Cracking C1 Top	<input checked="" type="checkbox"/> 7
AC Cracking C2 Top	<input checked="" type="checkbox"/> 3.5
AC Cracking C3 Top	<input checked="" type="checkbox"/> 0
AC Cracking C4 Top	<input checked="" type="checkbox"/> 1000
AC Cracking Top Standard Deviation	$200 + 2300 / (1 + \exp(1.072 - 2.1654 * \text{LOG}10(\text{TOP} + 0.0001)))$
AC Cracking C1 Bottom	<input checked="" type="checkbox"/> 0.021
AC Cracking C2 Bottom	<input checked="" type="checkbox"/> 2.35
AC Cracking C3 Bottom	<input checked="" type="checkbox"/> 6000
AC Cracking Bottom Standard Deviation	$1 + 15 / (1 + \exp(-3.1472 - 4.1349 * \text{LOG}10(\text{BOTTOM} + 0.0001)))$
AC Fatigue	
AC Fatigue K1	<input checked="" type="checkbox"/> 0.007566
AC Fatigue K2	<input checked="" type="checkbox"/> 3.9492
AC Fatigue k3	<input checked="" type="checkbox"/> 1.281
AC Fatigue BF1	<input checked="" type="checkbox"/> 130.3674
AC Fatigue BF2	<input checked="" type="checkbox"/> 1
AC Fatigue BF3	<input checked="" type="checkbox"/> 1.217799
AC Rutting	
AC Rutting K1	<input checked="" type="checkbox"/> -3.35412
AC Rutting K2	<input checked="" type="checkbox"/> 1.5606
AC Rutting K3	<input checked="" type="checkbox"/> 0.3791
AC Rutting BR1	<input checked="" type="checkbox"/> 4.3
AC Rutting BR2	<input checked="" type="checkbox"/> 1
AC Rutting BR3	<input checked="" type="checkbox"/> 1
AC Rutting Standard Deviation	$0.1414 * \text{Pow}(\text{RUT}, 0.25) + 0.001$
CSM Cracking	
CSM Fatigue	
IRI	
IRI Flexible C1	<input checked="" type="checkbox"/> 50
IRI Flexible C2	<input checked="" type="checkbox"/> 0.55
IRI Flexible C3	<input checked="" type="checkbox"/> 0.0111
IRI Flexible C4	<input checked="" type="checkbox"/> 0.02
IRI Flexible Over PCCC1	<input checked="" type="checkbox"/> 40.8
IRI Flexible Over PCCC2	<input checked="" type="checkbox"/> 0.575
IRI Flexible Over PCCC3	<input checked="" type="checkbox"/> 0.0014
IRI Flexible Over PCCC4	<input checked="" type="checkbox"/> 0.00825
Subgrade Rutting	
Granular Subgrade Rutting K1	<input checked="" type="checkbox"/> 2.03
Granular Subgrade Rutting BS1	<input checked="" type="checkbox"/> 0.22
Granular Subgrade Rutting Standard Deviation	$0.0104 * \text{Pow}(\text{BASERUT}, 0.67) + 0.001$
Fine Subgrade Rutting K1	<input checked="" type="checkbox"/> 1.35
Fine Subgrade Rutting BS1	<input checked="" type="checkbox"/> 0.37
Fine Subgrade Rutting Standard Deviation	$0.0663 * \text{Pow}(\text{SUBRUT}, 0.5) + 0.001$
Thermal Fracture	
AC thermal cracking Level 1K	<input checked="" type="checkbox"/> 6.3
AC thermal cracking Level 1 Standard Deviation	$0.1468 * \text{THERMAL} + 65.027$
AC thermal cracking Level 2K	<input checked="" type="checkbox"/> 0.5
AC thermal cracking Level 2 Standard Deviation	$0.2841 * \text{THERMAL} + 55.462$
AC thermal cracking Level 3K	<input checked="" type="checkbox"/> 6.3
AC thermal cracking Level 3 Standard Deviation	$0.3972 * \text{THERMAL} + 20.422$
Identifiers	

Figure 6.8 Performance Prediction Model Coefficients for Flexible Pavement Designs (PMA Mix)

6.5 Select the Appropriate Reliability Level for the Project

Table 2.3 Reliability (Risk) presents recommended reliability levels for flexible pavement designs. The designer should select an appropriate reliability level based on highway functional class and location. **Figure 6.5 M-E Design Software Screenshot Showing General Information** (left), Performance Criteria and Reliability shows design reliability values for a sample flexible pavement trial design.

6.6 Assemble the M-E Design Software Inputs

6.6.1 General Information

6.6.1.1 Design Period

The design period for new flexible pavement construction and reconstruction is at least 20 years. For special designs, the designer may use a different design period as appropriate.

6.6.1.2 Construction Dates and Timeline

The following inputs are required to specify the construction dates and timeline (see **Figure 6.5 M-E Design Software Screenshot Showing General Information (left), Performance Criteria and Reliability** (right)):

- Base/subbase construction month and year.
- Pavement construction month and year.
- Traffic open month and year.

The designer may select the most likely month and year for construction completion of key activities listed above. Selection is based on designer's experience, agency practices or estimated from the planned construction schedule. For large projects that extend into different paving seasons, it is suggested that each paving season be evaluated separately and that the designer should judge the acceptability of the trial design based on the more conservative situation. The M-E Design does not consider staged construction events, nor does it consider the impact of construction traffic on damage computations.

Note that the pavement performance predictions begin from the month the pavement is open to traffic, while the changes to pavement material properties due to time and environmental conditions are considered beginning from the month and year the material was placed.

6.6.1.3 Identifiers

Identifiers are helpful in documenting the project location and for recordkeeping. The M-E Design software allows designers to enter site or project identification information such as the location of the project (route signage, jurisdiction, etc.), identification numbers, beginning and ending milepost, direction of traffic, and date.

6.6.2 Traffic

Several inputs are required for characterizing traffic for M-E Design and are described in detail in **Section 3.1 Traffic**.

6.6.3 Climate

The climate input requirements for the M-E Design are described in detail in **Section 3.2 Climate**.

6.6.4 Pavement Layer Characterization

As shown in **Figure 6.2 Structural Layers**, a typical flexible pavement design comprises of the following pavement layers: asphalt concrete, unbound aggregate base layers and subgrade. The inputs required for the M-E Design software for characterizing these layers are described in the following sections.

6.6.4.1 Asphalt Concrete Characterization

Asphalt concrete types used in Colorado includes:

- **Hot Mix Asphalt (HMA)**: Composed of aggregates with an asphalt binder and certain anti-stripping additives.
- **Stone Matrix Asphalt (SMA)**: Gap-graded HMA that maximizes rutting resistance and durability with a stable stone-on-stone skeleton held together by a rich mixture of AC, filler, and stabilizing agents.

The designers should apply the following guidelines when defining an asphalt concrete layer:

- As much as possible, and as appropriate, the asphalt concrete layers must be combined into three layers: surface, intermediate and base. Asphalt layers with similar HMA mixtures could be combined into a single layer.
- When multiple layers are combined, the properties of the combined layer should be the weighted average of the individual layers.
- The M-E Design does not consider very thin layers (thickness less than 1.5 inches).
- Weakly stabilized asphalt materials (i.e. sand-asphalt) should not be considered an asphalt concrete layer.

Designers are required to input volumetric properties such as air voids, effective asphalt content by volume, aggregate gradation, mix density and asphalt binder grade (see **Figure 6.9 Asphalt Concrete Layer and Material Properties in the M-E Design Software**). The designers are also required to input the engineering properties such as the dynamic modulus, creep compliance, indirect tensile strength of HMA materials, and the viscosity versus temperature properties of rolling thin film oven (RTFO) aged asphalt binders. These inputs can be obtained following the input hierarchy levels depending on the criticality of the project.

The volumetric properties entered into the program need to be representative of the in-place asphalt concrete mixture. The project-specific in-place mix properties will not be available at the design stage. The designer should use typical values available from previous construction records or target values from the project specifications.

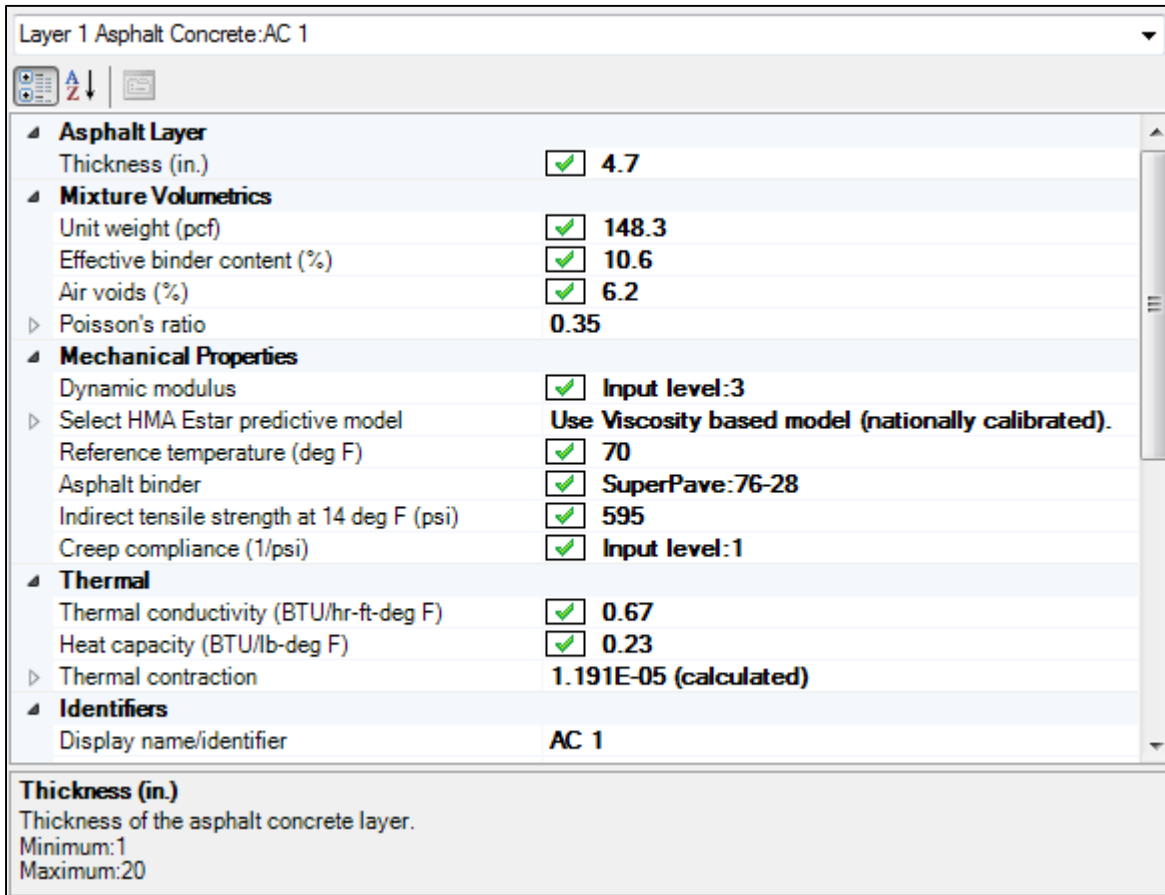

Figure 6.9 Asphalt Concrete Layer and Material Properties in the M-E Design Software

Table 6.1 HMA Input Properties and Recommendations for HMA Material Characterization presents the HMA inputs requirements of the M-E Design method and the recommendations for obtaining these inputs at each hierarchical input level. For Levels 2 and 3, the Level 1 inputs of typical CDOT HMA mixtures can also be used – See Appendix F. Refer to **Table 2.6 Selection of Input Hierarchical Level** for selection of an appropriate hierarchical level for HMA characterization.

Table 6.1 HMA Input Properties and Recommendations for HMA Material Characterization

Input Property	Level 1	Level 2	Level 3
Dynamic modulus (E*)	Use mix specific E*. Use AASHTO TP62 test results.	Use gradation (provided in APPENDIX E)	
Asphalt binder properties	Use binder properties from laboratory testing of HMA using AASHTO T315		Use binder grade (provided in APPENDIX E)
Tensile strength at 14 °F	Use AASHTO T322 test results	Use tensile strength and creep compliance (provided in APPENDIX E)	
Creep compliance			
Poisson's ratio	Use the M-E Design software option - <i>Is Poisson's ratio calculated?</i>		Use 0.35
Air voids	Use air voids (provided in APPENDIX E)		
Volumetric asphalt content	Use volumetric asphalt content (provided in APPENDIX E)		
Total unit weight	Use total unit weight (provided in APPENDIX E).		
Surface shortwave absorptivity	Use 0.85		
Coefficient of thermal contraction of the mix	Use 1.3E-05 in./in./°F (mix CTE) and 5.0 E-06 in./in./°F (aggregate CTE)		
Thermal conductivity	Use 0.67 Btu/(ft)(hr)(°F)		
Heat capacity	Use 0.23 BTU/lb.- °F		
Reference temperature	Use 70 °F		

6.6.4.2 Unbound Layers and Subgrade Characterization

Refer to **Section 5.3.1 Unbound Layer Characterization in the M-E Design** for unbound aggregate base layer characterization.

Refer to **Section 4.4 Subgrade Characterization for the M-E Design** for subgrade characterization.

6.7 Run the M-E Design Software

Designers should examine all inputs for accuracy and reasonableness prior to running the M-E Design software. Run the software to obtain outputs required for evaluating if the trial design is adequate. After a trial run has been successfully completed, the M-E Design software will generate a report in form of a PDF and/or Microsoft Excel file. See **Figure 6.10 Sample Flexible Pavement**

Trial Design PDF Output Report. The report contains the following information: inputs, reliability of design, materials and other properties, and predicted performance.

After the trial run is complete, the designer should again examine all inputs and outputs for accuracy and reasonableness, respectively. The output report also includes the estimates of material properties and other properties on a month-by-month basis over the entire design period in either tabular or graphical form. For a flexible pavement trial design, the report provides the following:

- Monthly estimates of HMA dynamic modulus for each sublayer
- Monthly estimates of resilient modulus of unbound layers and subgrade for each sublayer
- Cumulative trucks (FHWA Class 4 through 13) over the design period
- Cumulative ESALs over the design period (as an intermediate file in the project folder)
- Monthly estimates of AADTT
- Monthly estimates of climate parameters

The designer should at least examine the above mentioned parameters once to assess their reasonableness before accepting a trial design as complete.

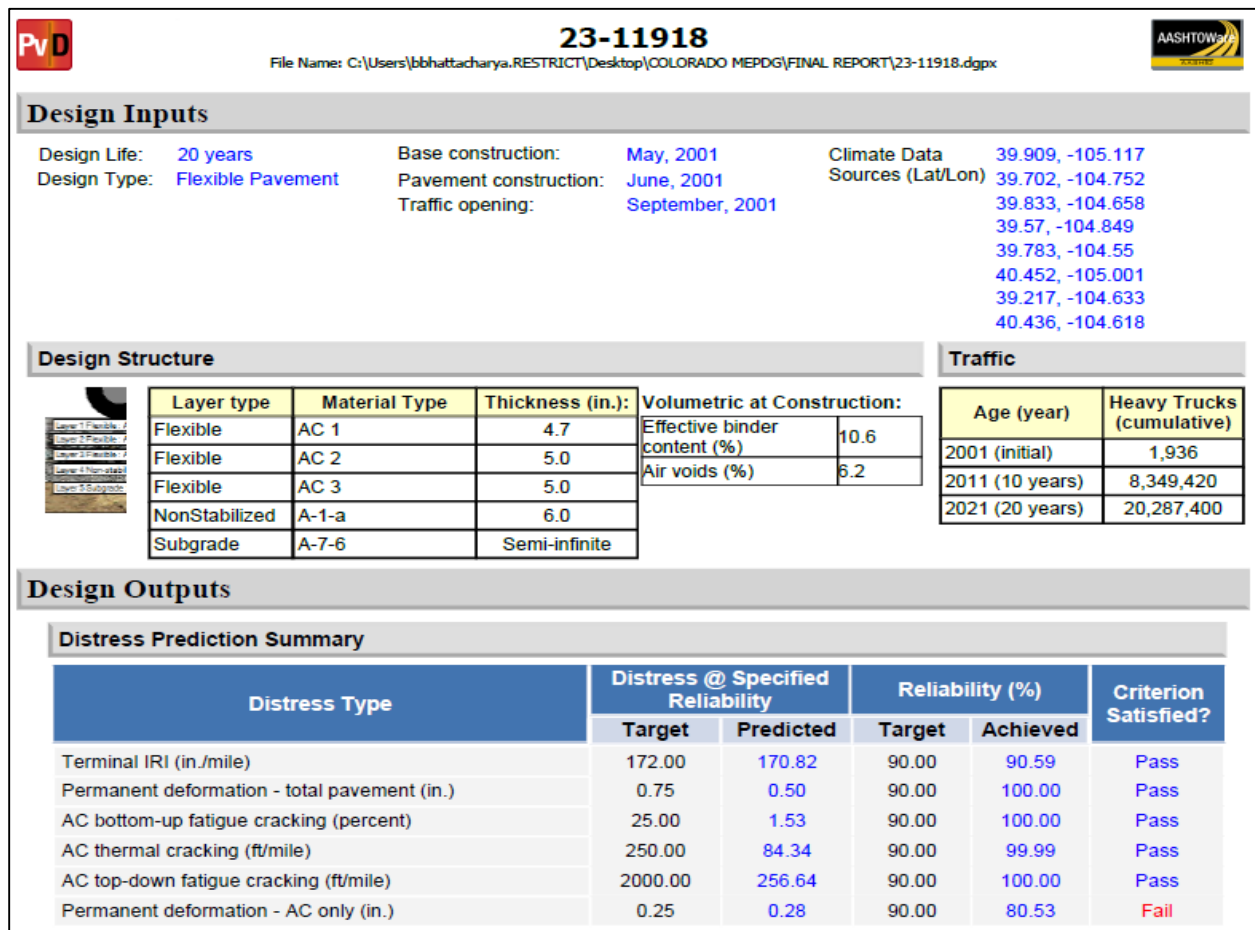

Figure 6.10 Sample Flexible Pavement Trial Design PDF Output Report

6.8 Evaluate the Adequacy of the Trial Design

The output report of a flexible pavement trial design includes the monthly accumulation of the following key distress types for the entire design period at their mean values and chosen reliability values:

- Alligator fatigue cracking – It is the traditional wheel path cracking that initiates at the bottom of the HMA layer and propagates to the surface under repeated load applications. Beyond a critical threshold, the rate of cracking accelerates and may require significant repairs and lane closures.
- Transverse cracking – Thermal cracks typically appear as transverse cracks on pavement surface due to low temperatures, hardening of the asphalt, and/or daily temperature cycles. Excessive transverse cracking may adversely affect ride quality.

The designer should examine the results to evaluate if the performance criteria for each of the above-mentioned indicators are met at the desired reliability. If the alligator fatigue cracking or the transverse cracking criteria have not been met, the trial design is deemed unacceptable and revised accordingly to produce a satisfactory design.

The output report also includes the monthly accumulation of the following secondary distress types and smoothness indicators for the entire design period at their mean values and chosen reliability values.

- Permanent deformation – The report includes both HMA rutting and the total permanent deformation (includes rutting on unbound layers and subgrade). Excessive rutting may cause safety concerns.
- Surface-initiated fatigue cracking or longitudinal cracking – These load-related cracks appear at the HMA surface and propagate downwards. Beyond a critical threshold, the rate of cracking accelerates and may require significant repairs and lane closures.
- IRI – This roughness index represents the profile of the pavement in the wheel paths. Higher IRI indicates unacceptable ride quality.

The designer should examine the results to evaluate if the performance criteria for permanent deformation, surface-initiated fatigue cracking or longitudinal cracking, and IRI meet the minimum of 12 years at the desired reliability. If any of the criteria have not been met, the trial design is deemed unacceptable and revised accordingly to produce a satisfactory design.

Another important output is the reliability levels of each performance indicator at the end of the design period. If the reliability value predicted for the given performance indicator is greater than the target/desired value, the trial design passes for that indicator. If the reverse is true, then the trial design fails to provide the desired confidence and the performance indicator will not reach the critical value during the pavement's design life. In such an event, the designer needs to alter the trial design to correct the problem.

The strategies for modifying a trial design are discussed in **Section 6.9 Modifying Trial Designs**. The designer can use a range of thicknesses to optimize the thickness of the trial design to make it

more acceptable. In addition, the software allows the designer to perform sensitivity analysis for key inputs. The results of the sensitivity analysis can be used to further optimize the trial design if modifying AC thickness alone does not produce a feasible design alternative. Detail description of thickness optimization procedure and sensitivity analysis is provided in the Software HELP Manual.

6.9 Modifying Trial Designs

An unsuccessful trial design may require revisions to ensure that all performance criteria are satisfied. The trial design is revised by modifying the design inputs systematically. In addition to layer thickness, many other design factors influence performance predictions. The design acceptance in the M-E Design is distress-specific; in other words, the designer needs to first identify the performance indicator that failed to meet the performance targets and modify one or more design inputs that has a significant impact on a given performance indicator. The impact of design inputs on performance indicators is typically obtained by performing sensitivity analysis.

The strategies to produce a satisfactory design by modifying design inputs can be broadly categorized into:

- Pavement layer considerations
- Increasing layer thickness
- Modifying layer type and layer arrangement
- Foundation improvements (i.e. stabilize the upper subgrade soils)
- Pavement material improvements:
 - Use of higher quality materials (i.e. use of polymer modified asphalt, crushed stones)
 - Material design modifications (i.e. increase asphalt content, reduce amount of fines, modify gradations etc.)
 - Construction quality (i.e. reduce HMA air voids, increase compaction density, decrease as-constructed pavement smoothness)

Again, when modifying the design inputs, the designer needs to be aware of the sensitivity of these inputs to various distress types. Changing a single input to reduce one distress might result in an increase in another distress. For instance, the designer may consider using harder asphalt to reduce HMA rutting, but that will likely increase the predicted transverse cracking. **Table 6.2 Modifying Flexible Pavement Trial Designs** presents summary of inputs that may be modified to optimize trial designs and produce a feasible design alternative.

Table 6.2 Modifying Flexible Pavement Trial Designs

Distress/IRI	Design Inputs that Impact
AC Rutting	<ul style="list-style-type: none"> • Use a polymer modified asphalt for the HMA surface layer. • Increase the dynamic modulus of the HMA mixtures. • Reduce the asphalt content in the HMA mixtures. • Increase the amount of crushed aggregate. • Increase the amount of manufactured fines in the HMA mixture.
Transverse Cracking	<ul style="list-style-type: none"> • Decrease the stiffness of the AC surface mix (use softer asphalt, increase asphalt binder, increase indirect tensile strength, reduce creep compliance). • Increase AC layer thickness.
Alligator Cracking	<ul style="list-style-type: none"> • Increase HMA layer thickness. • Increase HMA dynamic modulus for HMA layers thicker than 5 inches and decrease HMA dynamic modulus for HMA layers thinner than 3 inches. • Revise mixture design of HMA base layer (increase asphalt binder content, achieve higher density and lower air voids during compaction, use harder asphalt/polymer modified asphalt but ensure that good compaction is achieved, increase percent manufactured fines, increase percent crushed aggregates). • Reduce stiffness gradients between upper and lower layers (the use higher quality/stiffer HMA layer on top of poor quality/low resilient modulus granular base or foundation tend to increase fatigue cracking). • Increase the thickness or stiffness of a high quality unbound base layer or use of a stabilized layer.
Unbound Base Rutting	<ul style="list-style-type: none"> • Increase the resilient modulus of the aggregate base. • Increase the density of the aggregate base. • Stabilize the upper foundation layer for weak, frost susceptible, or swelling soils; use thicker granular layers. • Place a layer of select embankment material with adequate compaction. • Increase the HMA thickness. • Address drainage related issues to protect from the detrimental effects of moisture.
Subgrade Rutting	<ul style="list-style-type: none"> • Increase the layer stiffness and layer thickness of any layers above the subgrade layers: <ul style="list-style-type: none"> ▪ Increase HMA layer thickness or stiffness. ▪ Increase unbound layer thickness or stiffness. ▪ Include a stabilized drainable base. • Improve the engineering properties of the subgrade material:

Distress/IRI	Design Inputs that Impact
	<ul style="list-style-type: none"> ▪ Increase the stiffness (modulus) of the subgrade layer(s) itself through the use of stabilized subgrade material with lime. ▪ Effective use of subsurface drainage systems, geotextile fabrics, and impenetrable moisture barrier wraps to protect from the detrimental effects of moisture. ▪ Increase the grade elevation to increase the distance between the subgrade surface and ground water table.
IRI	<ul style="list-style-type: none"> • Reduce initial IRI (achieving smoother as-constructed pavement surface through more stringent smoothness criteria). • Improve roadbed foundation (replace frost susceptible or expansive subgrade with non-frost susceptible or stabilized subgrade materials). • Place subsurface drainage system to remove ground water.

Figure 6.11 Sensitivity of HMA Alligator Cracking to Truck Volume through **Figure 6.32 Sensitivity of HMA IRI to Base Thickness** Figure 6.30 Sensitivity of HMA IRI to AC Thickness presents sensitivity plots of a sample flexible pavement trial design showing the effects of key inputs, such as traffic volume, asphalt binder content, asphalt binder grade, air voids, base type base thickness and climate on key distresses/IRI. Note that the plots do not exhaustively cover the effects of all key factors on rigid pavement performance; other significant factors are not shown herein.

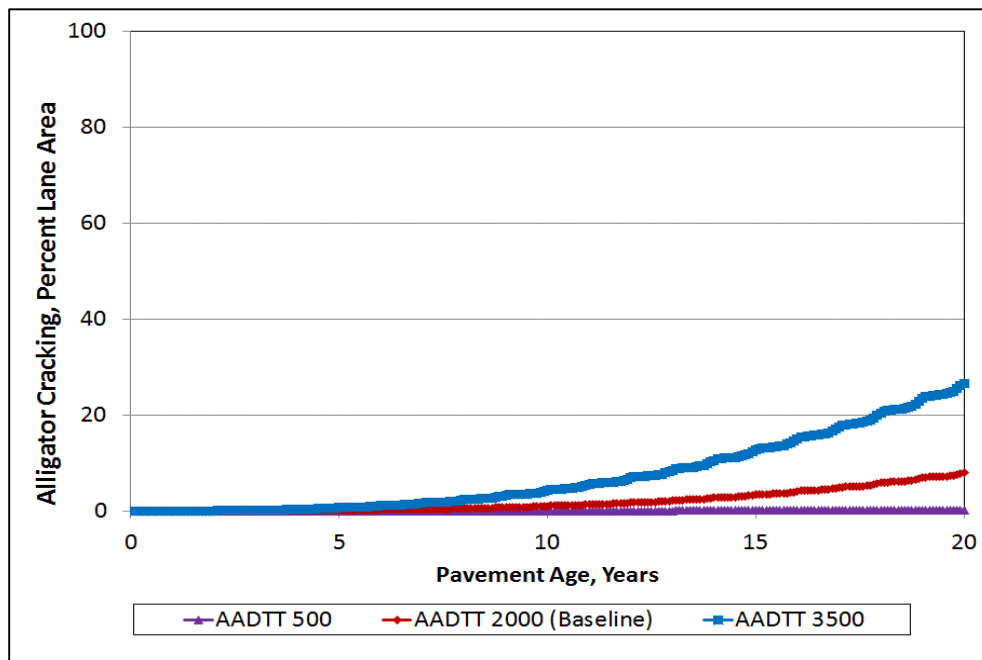

Figure 6.11 Sensitivity of HMA Alligator Cracking to Truck Volume

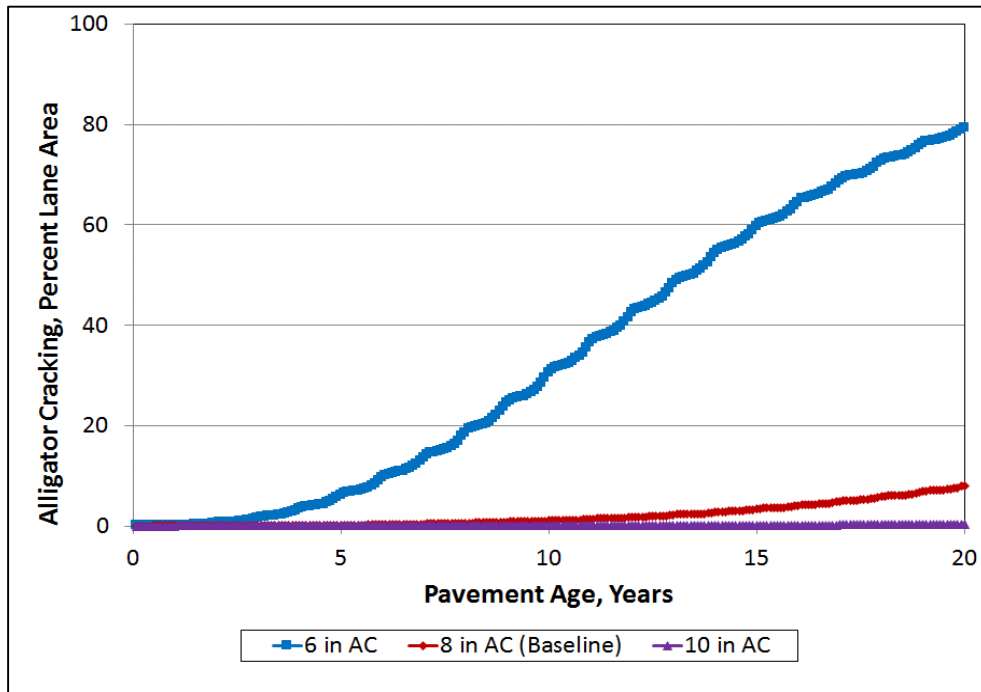

Figure 6.12 Sensitivity of HMA Alligator Cracking to AC Thickness

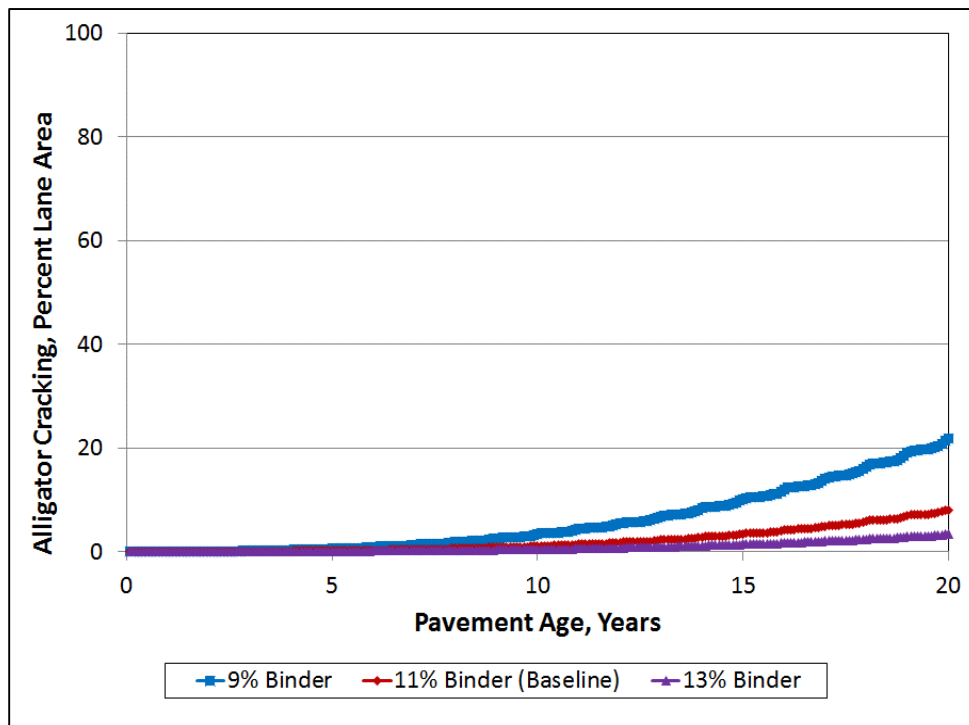

Figure 6.13 Sensitivity of HMA Alligator Cracking to Asphalt Binder Content

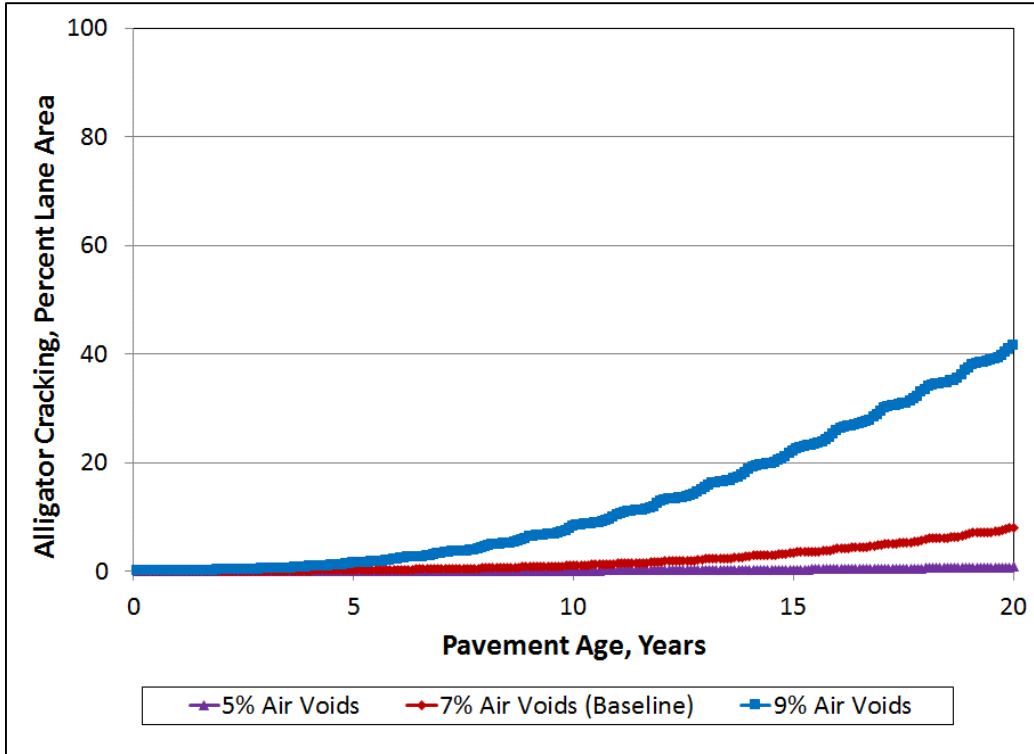

Figure 6.14 Sensitivity of HMA Alligator Cracking to Air Voids

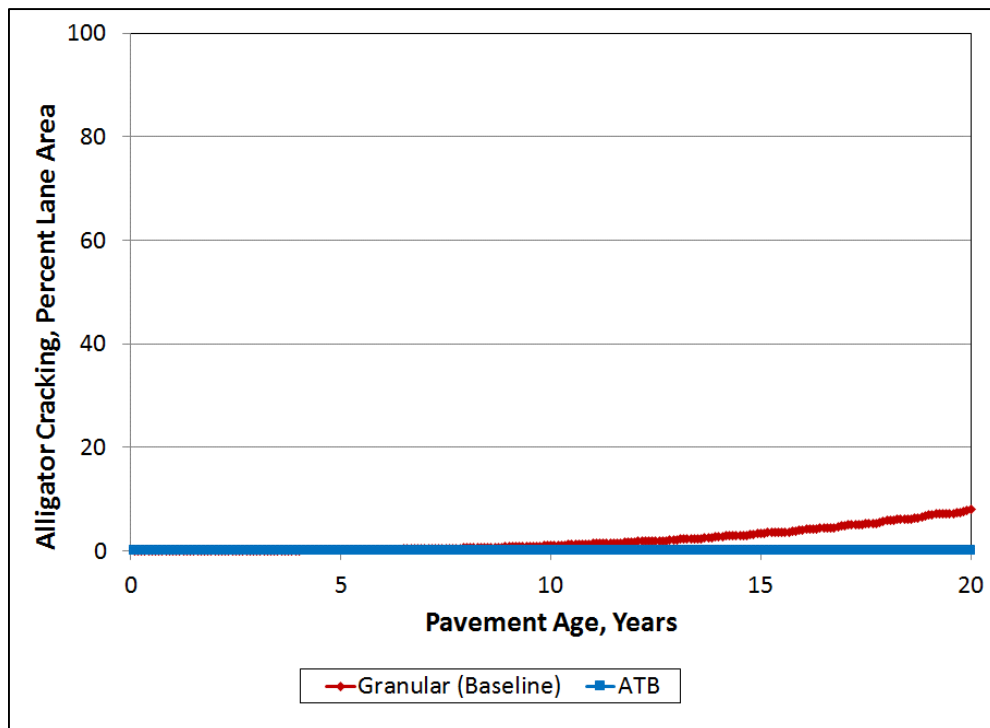

Figure 6.15 Sensitivity to HMA Alligator Cracking to Base Type

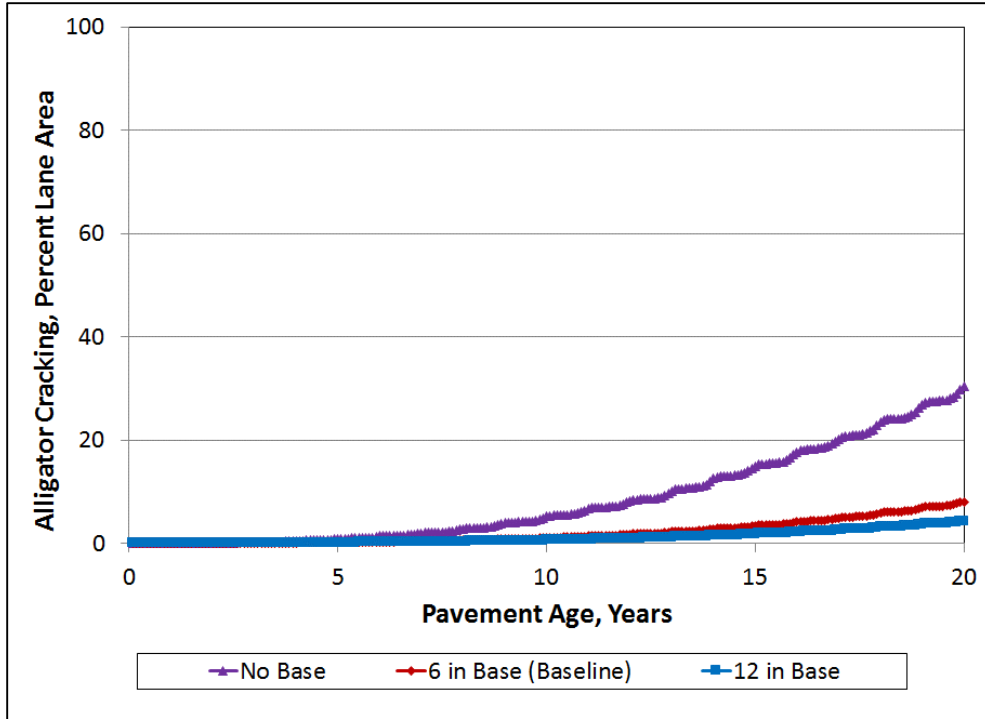

Figure 6.16 Sensitivity of HMA Alligator Cracking to Base Thickness

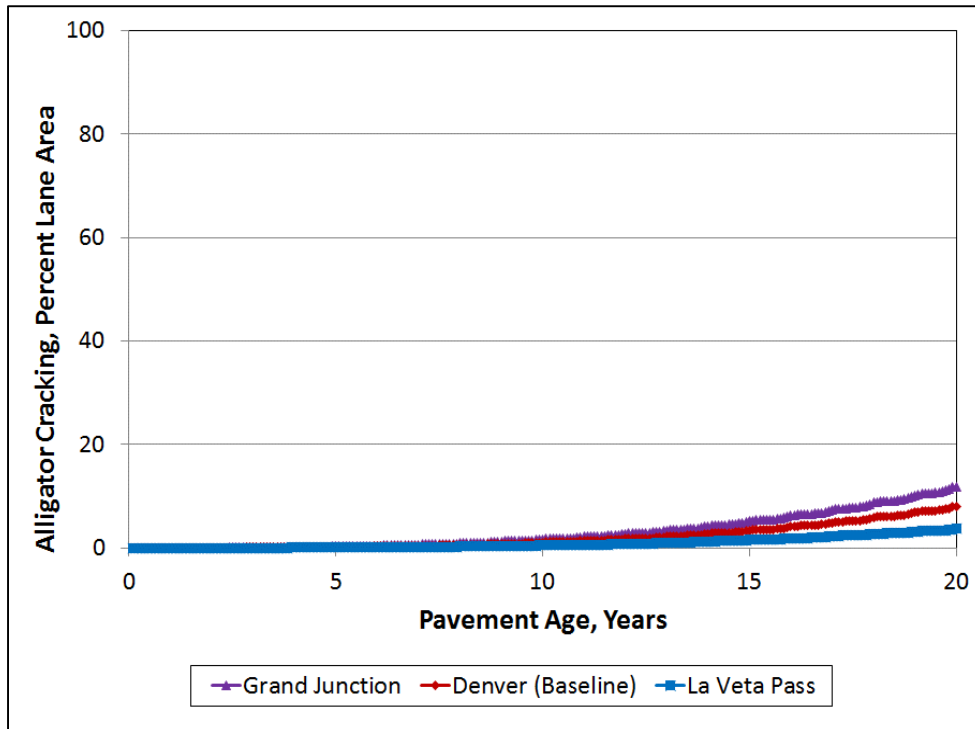

Figure 6.17 Sensitivity of HMA Alligator Cracking to Climate

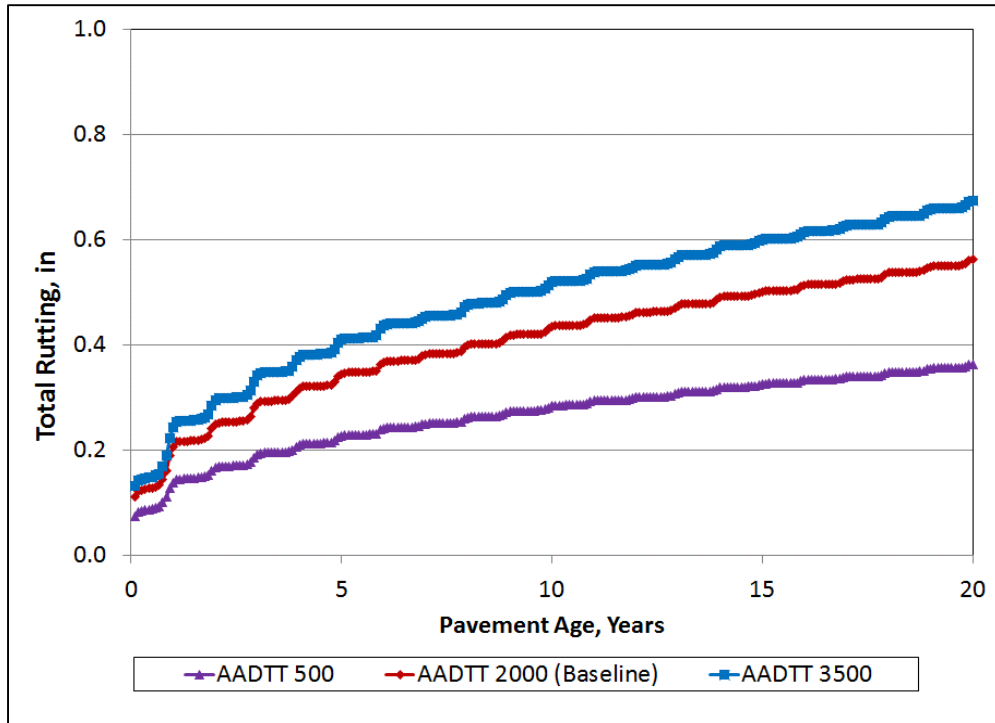

Figure 6.18 Sensitivity of Total Rutting to Truck Volume

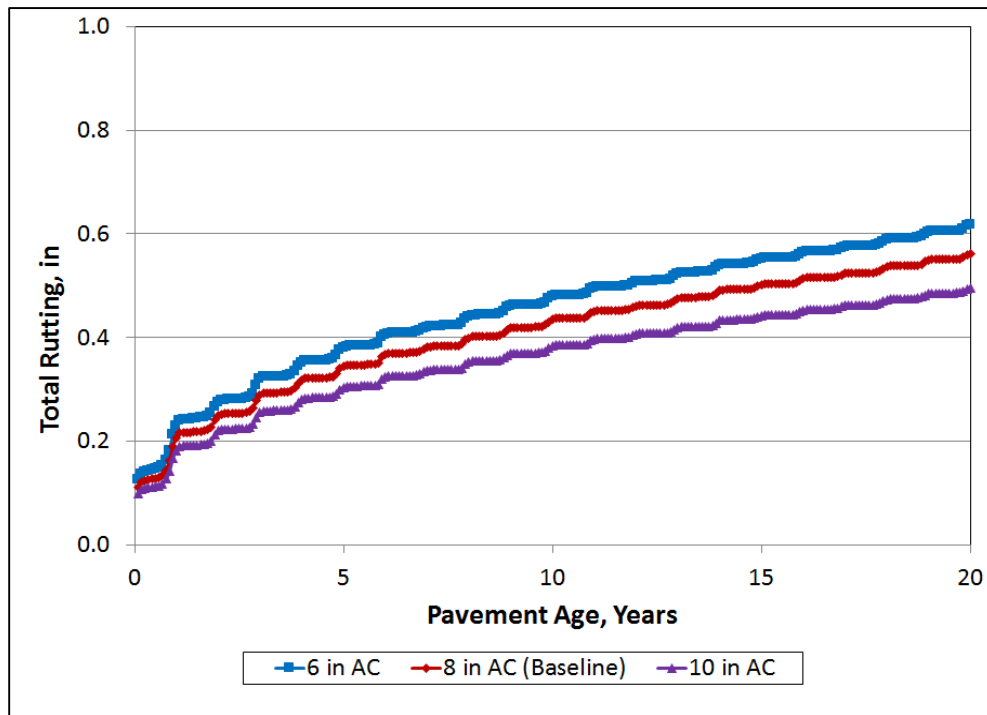

Figure 6.19 Sensitivity of Total Rutting to AC Thickness

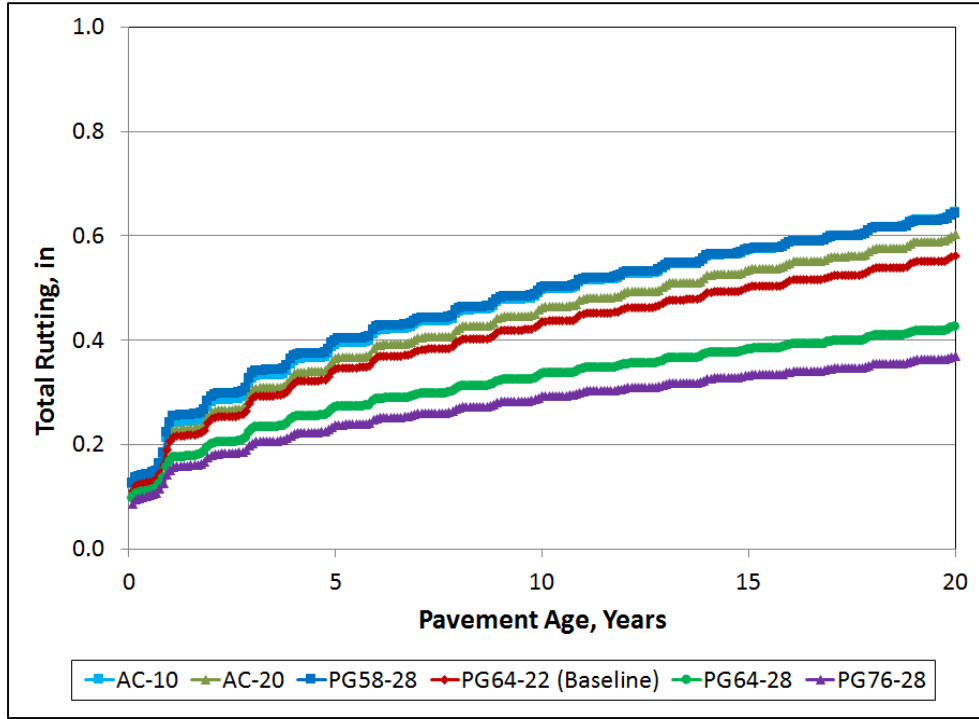

Figure 6.20 Sensitivity of Total Rutting to Asphalt Binder Grade

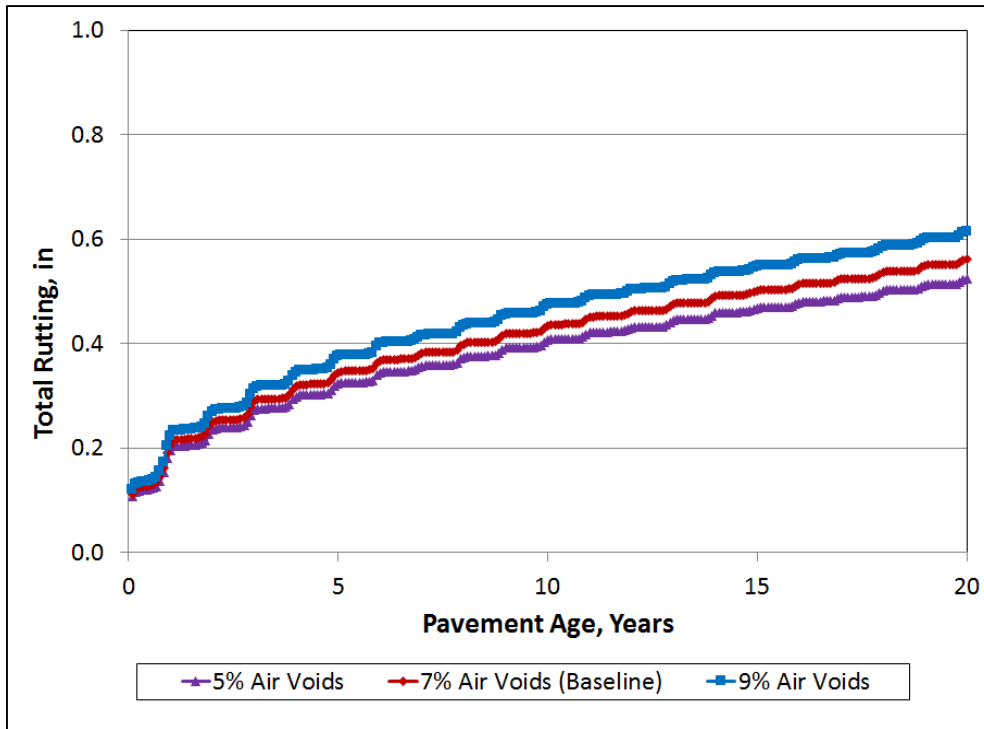

Figure 6.21 Sensitivity of Total Rutting to Air Voids

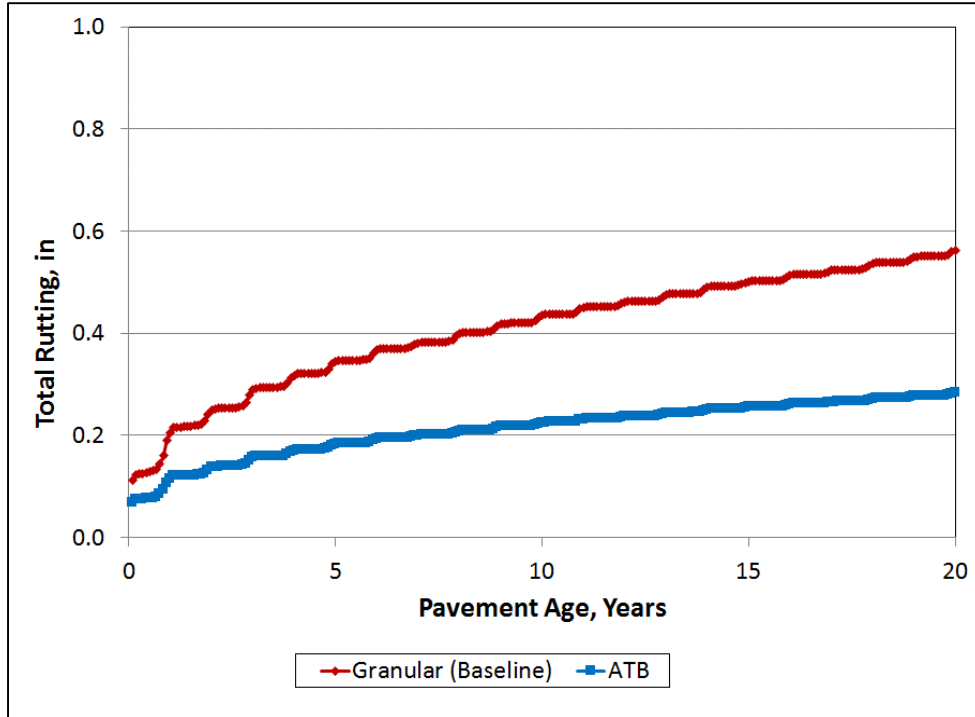

Figure 6.22 Sensitivity of Total Rutting to Base Type

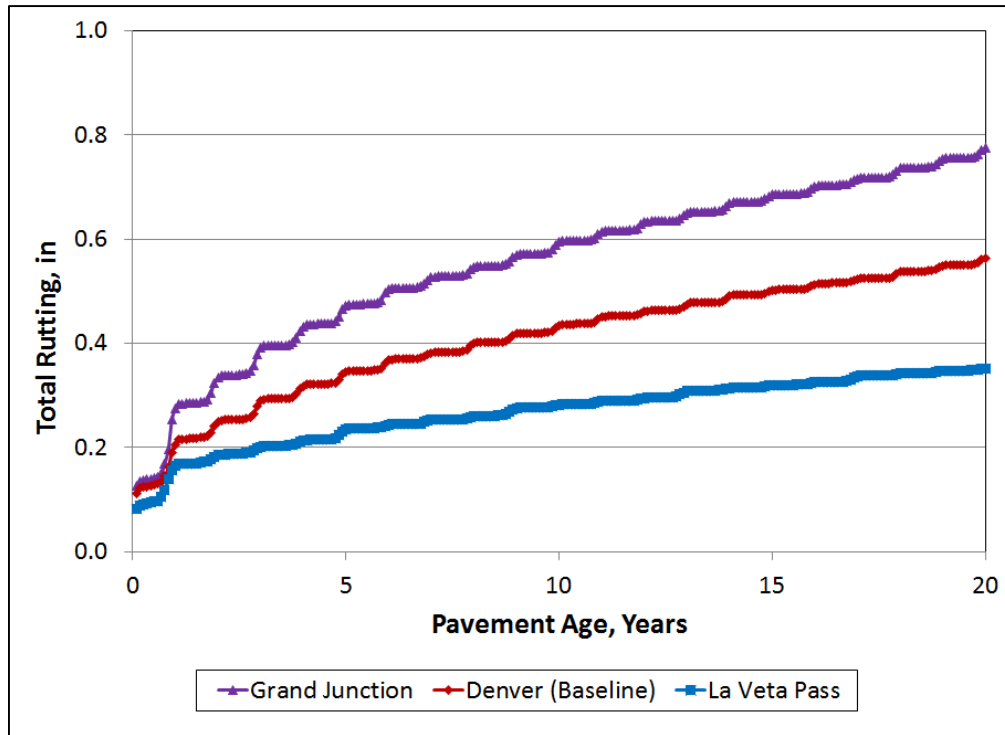

Figure 6.23 Sensitivity of Total Rutting to Climate

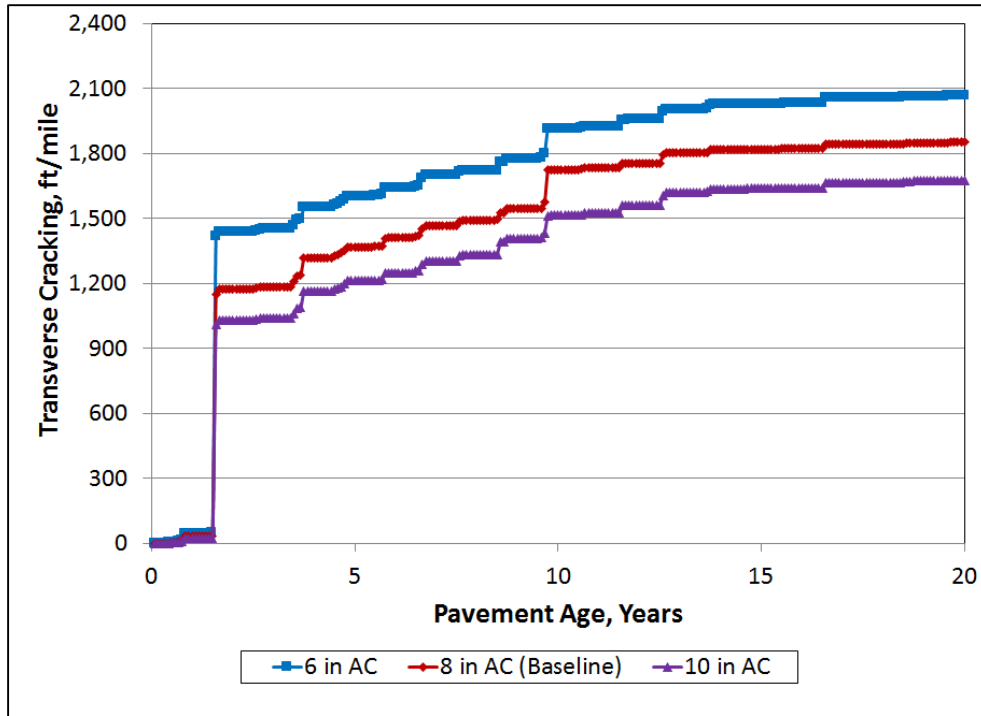

Figure 6.24 Sensitivity of HMA Transverse Cracking to Thickness

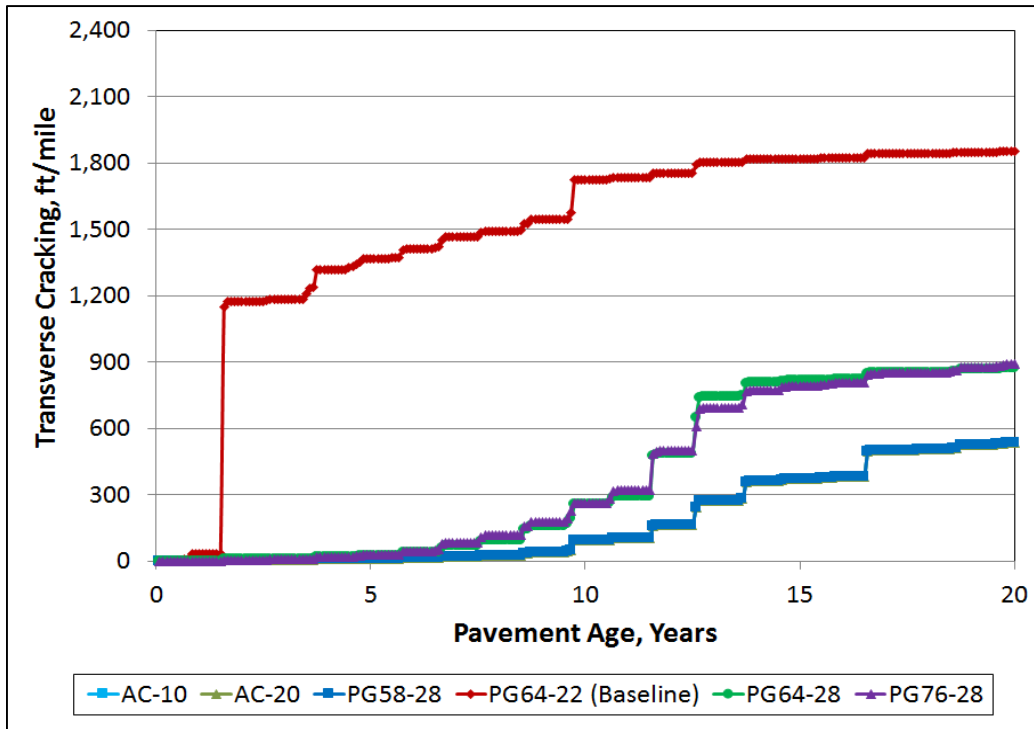

Figure 6.25 Sensitivity of HMA Transverse Cracking to Asphalt Binder Grade

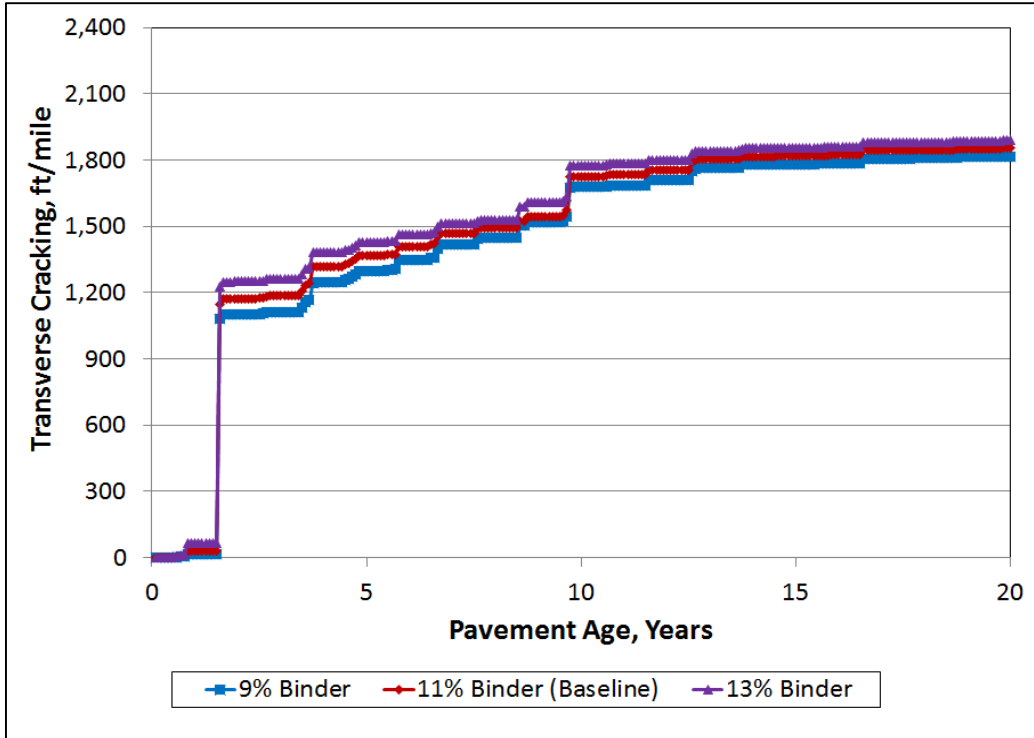

Figure 6.26 Sensitivity of HMA Transverse Cracking to Asphalt Binder Content

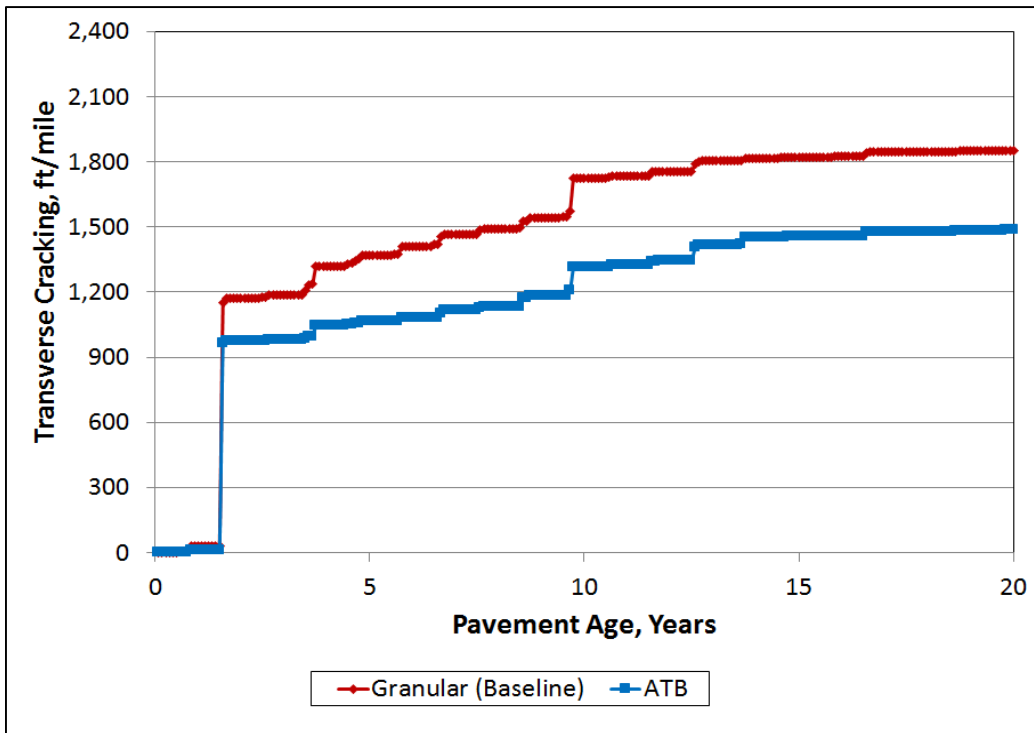

Figure 6.27 Sensitivity of HMA Transverse Cracking to Base Type

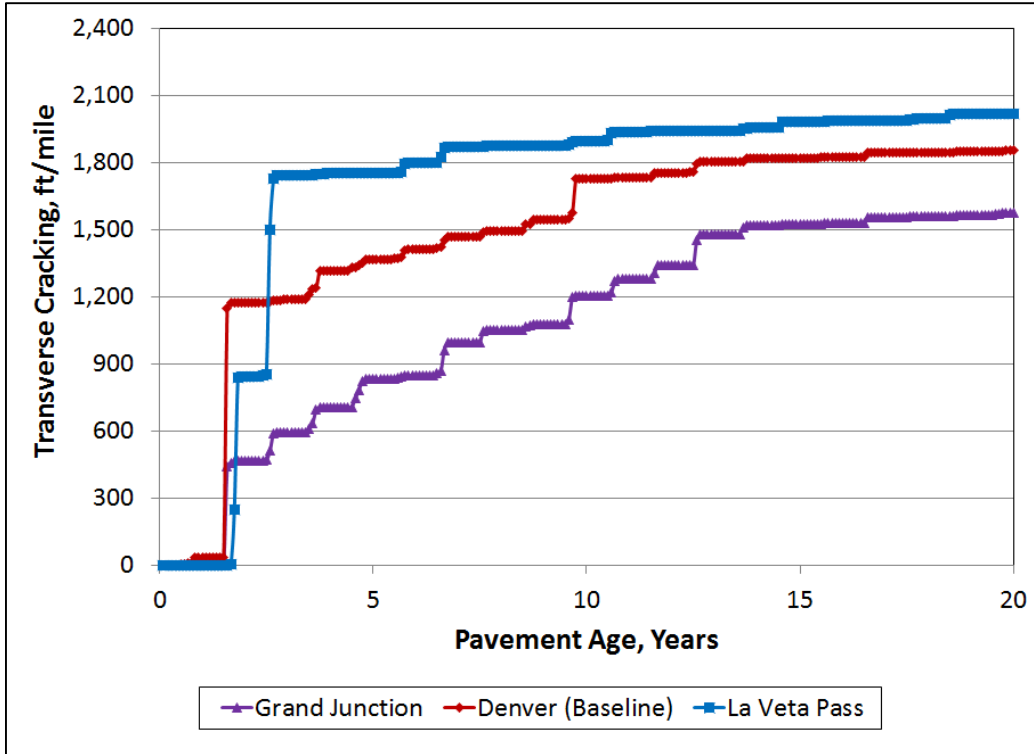

Figure 6.28 Sensitivity of HMA Transverse Cracking to Climate

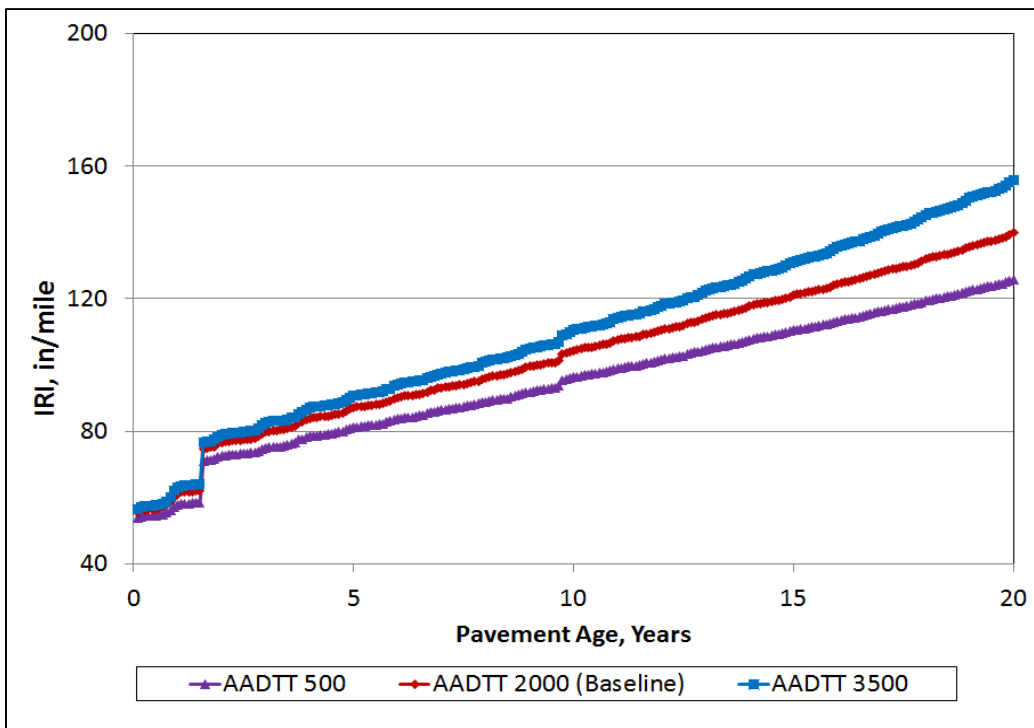

Figure 6.29 Sensitivity of HMA IRI to Truck Volume

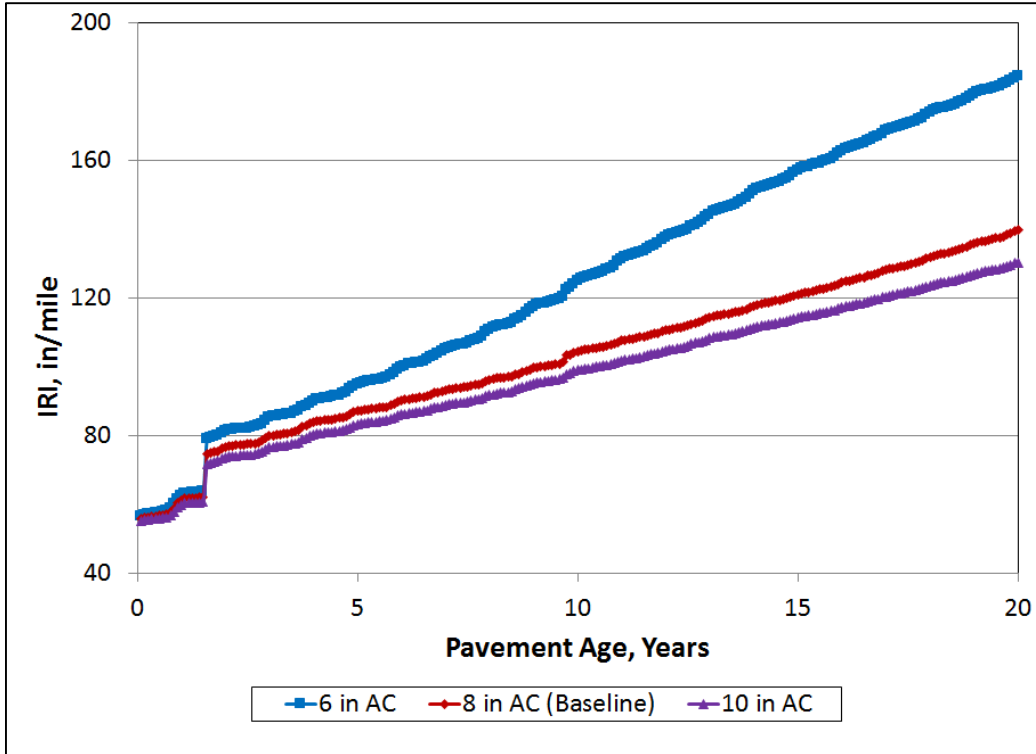

Figure 6.30 Sensitivity of HMA IRI to AC Thickness

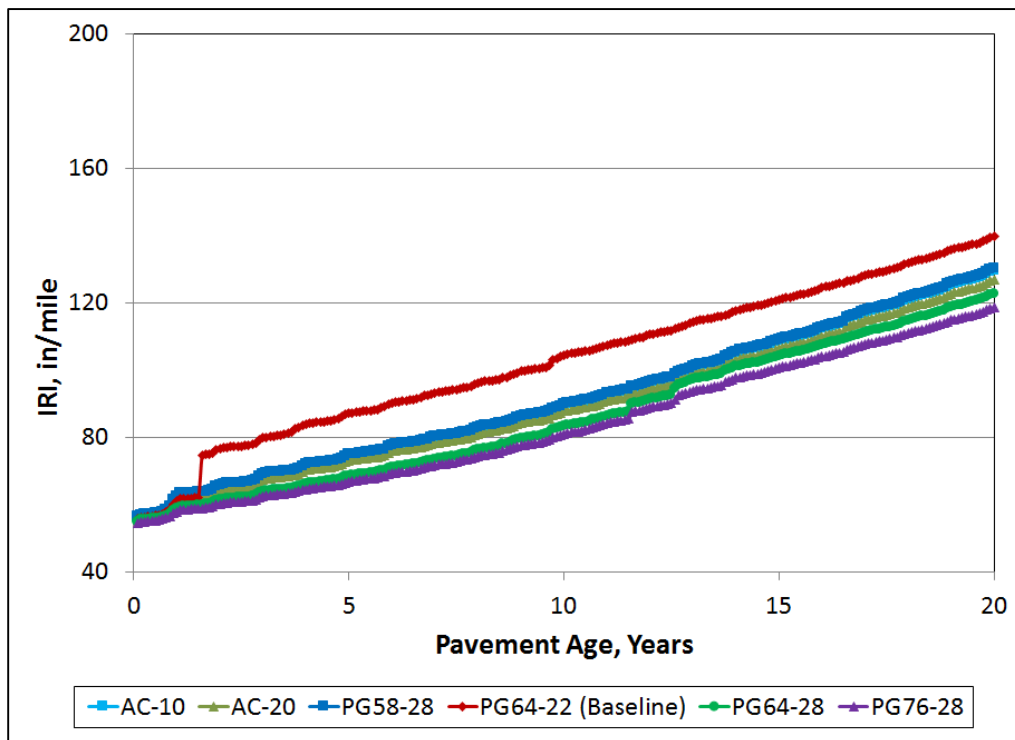

Figure 6.31 Sensitivity of HMA IRI to Asphalt Binder Grade

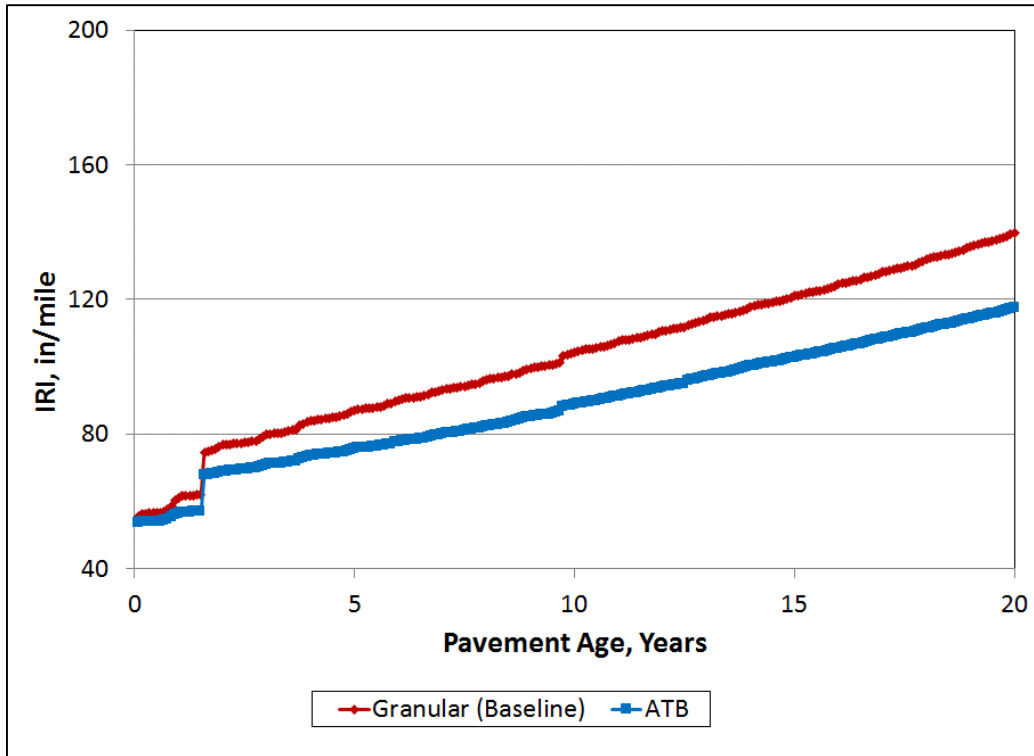

Figure 6.32 Sensitivity of HMA IRI to Base Thickness

6.10 HMA Thickness with ABC

As a minimum, the designer should include 4 inches of ABC for any thickness of HMA when the design truck traffic is less than 1,000 trucks per day. Six inches of ABC should be used for any thickness of HMA when the design truck traffic is greater than 1,000 trucks per day.

6.11 Required Minimum Thickness of Pavement Layer

Compaction of a hot mix asphalt pavement during its construction is the single most important factor that affects the ultimate performance of the pavement. Achieving adequate compaction increases pavement performance by decreasing rutting, reducing damage due to moisture and oxidation, and increasing the stability of the mix. Factors affecting the cooling rate of the mat include the layer thickness, the temperature of the mix when placed, ambient temperature, temperature of the base, and wind conditions. Layer thickness is the single most important variable in the cooling rate of an asphalt mat, especially for thin layers. This is especially true in cool weather because thin layers of asphalt mat have less capacity to retain heat than thicker lifts of pavement. The thicker layers of asphalt mat help to maintain the temperature at a workable level, thus increasing the time available for compaction. Because of the increased difficulty in achieving density and the importance of achieving compaction, a minimum layer thickness for construction of HMA pavement is two inches. A designer of special mixes, such as stone matrix asphalt or thin

lift HMA should look at minimum thickness requirements of the particular product. The minimum thickness of these special mixes is likely to be a dimension other than two inches.

6.12 Asphalt Materials Selection

6.12.1 Aggregate Gradation

Definitions of aggregate size:

Nominal Maximum Aggregate Size (NMAS) - The size of aggregate of the smallest sieve opening through which the entire amount of aggregate is permitted to pass.

Note: For Item 403 - HMA and SMA, the Nominal Maximum Size is defined as one sieve size larger than the first sieve to retain more than ten percent of the aggregate.

Maximum Aggregate Size is defined as one size larger than nominal maximum size.

The flexible pavement usually consists of $\frac{3}{4}$ inch nominal maximum aggregate size (NMAS) in the lower layers, hot mix asphalt (HMA) Grading S. The top layer, which is the surface layer, should be stone matrix asphalt (SMA). SMA mixes are often used in areas that are expected to experience extreme traffic loading. When low to high traffic loads are expected, a $\frac{1}{2}$ inch NMAS, Grading SX, should be used.

CDOT uses the No. 30 sieve as one of the job-mix formula tolerance sieves. **Table 6.3 Master Range Table for Stone Matrix Asphalt** is based (with some exceptions) on NCHRP No. 4 and $\frac{3}{8}$ inch and AASHTO $\frac{1}{2}$ inch and $\frac{3}{4}$ inch SMA gradations ranges, where the No. 30 sieve range is included in the $\frac{1}{2}$ inch and $\frac{3}{4}$ inch gradations.

SMA Gradation Nomenclature Example:

The $\frac{3}{4}$ inch (19.0 mm) gradation is named the $\frac{3}{4}$ inch Nominal Maximum Aggregate Size gradation because the first sieve that retains more than 10 percent is the $\frac{1}{2}$ inch sieve, and the next sieve larger is the $\frac{3}{4}$ inch sieve.

Table 6.3 Master Range Table for Stone Matrix Asphalt

Sieve Size	Percent by Weight Passing Square Mesh Sieves			
	#4 (4.75 mm) Nominal Maximum	3/8" (9.5 mm) Nominal Maximum	1/2" (12.5 mm) Nominal Maximum	3/4" (19.0 mm) Nominal Maximum
1 " (25 mm)				100
3/4" (19.0 mm)			100	90-100
1/2" (12.5 mm)	100	100	90-100	50-88
3/8" (9.5 mm)	100	90-100	50-80	25-60
#4 (4.75 mm)	90-100	26-60	20-35	20-28
#8 (2.36 mm)	28-65	20-28	16-24	16-24
#16 (1.18mm)	22-36			
#30 (600 μm)	18-28	12-18	12-18	12-18
#50 (300 μm)	15-22	10-15		
#100 (150 μm)				
#200 (75 μm)	12-15	8-12	8-11	8-11

A CDOT study (1) found less thermal segregation in the top lift when Grading SX mixes were used. HMA Grading SX can also be used where layers are very thin or where the pavement must taper into an existing pavement. A study from Auburn University (2) found little difference in the stability or rutting of 3/4 inch and 1/2 inch NMA mixes. CDOT cost data for 2005 showed a slight increase in the cost per ton of Grading SX mixes as compared to Grading S mixes with the same bid quantities.

HMA with a 1-inch NMA, Grading SG, should not be used in the surface layer. Although Grading SG mixes have been used in specialized situations, they are not currently used or accepted on a regular basis for pavement mixes. CDOT has found that the production and placement of Grading SG mixes are prone to segregation and the use should be discouraged.

For structural overlays, the minimum allowed layer thickness will be two inches. For functional overlays used in preventive maintenance or other treatments, thinner lifts are allowed.

Table 6.4 HMA Grading Size and Location Application and **Table 6.5 HMA Grading Size** and give guidance for mix selection and recommended layer thicknesses for various layers and nominal maximum aggregate sizes.

Table 6.4 HMA Grading Size and Location Application

CDOT HMA Grade	Nominal Maximum Aggregate Size (NMAS)	Application
SF	No. 4 sieve	Leveling Course, Rut Filling, Scratch Course, etc.
ST	$\frac{3}{8}$ inch	Thin Lifts and Patching
SX	$\frac{1}{2}$ inch	Top Layer (Preferred)
S	$\frac{3}{4}$ inch	Top Layer, Layers Below the Surface, Patching
SG	1 inch	Layers Below the Surface, Deep Patching

Table 6.5 HMA Grading Size and Layer Thickness

CDOT HMA Grade	Nominal Maximum Aggregate Size (NMAS)	Structural/Overlay Layer Thickness (inches)	
		Minimum	Maximum
SX	$\frac{1}{2}$ inch	2.00	3.00
S	$\frac{3}{4}$ inch	2.25	3.50
SG	1 inch	3.00	4.00
		Functional Overlay Layer Thickness (Inches)	
SF	No. 4 sieve	0.75*	1.50
ST	$\frac{3}{8}$ inch	1.125	2.50
*Layers of SF mixes may go below 1 inch as needed to taper thin lifts to site conditioning (i.e. rut filling).			

6.12.2 Selection of SuperPave™ Gyrotory Design

To choose the appropriate number of revolutions of a SuperPave™ gyrotory asphalt mix design on a particular project, determining the design 18k ESALs and the high temperature environment for the project is necessary. The following steps should be followed to determine the proper SuperPave™ gyrotory design revolutions for a given project:

Step 1. Determine 18k ESALs.

To obtain the correct SuperPave™ gyratory compaction effort (revolutions), the 18k ESALs must be a 20-year cumulative 18k ESAL of the design lane in one direction. The compaction effort simulates the construction compaction roller to obtain the correct voids properties to resist the intended traffic in the design lane. The department’s traffic analysis unit of the Division of Transportation Development (DTD) automatically provides on their website an ESAL calculator. One must use a 20-year design with the appropriate number of lanes with flexible pavement specified. Even a 10-year asphalt overlay must use a 20-year cumulative 18k ESAL number of the design lane to be able to continue with this procedure. If 18k ESAL calculations are calculated using a spreadsheet or manually, one must use the 20-year 18k ESAL of the design lane.

Step 2. Reliability for the 7-day Average Maximum Air Temperature.

The next decision is to determine what type of project is being designed. For new construction or reconstruction, asphalt cement with 98 percent reliability for both low and high temperature properties is recommended. For overlays, asphalt cement with 98 percent reliability for high temperature properties (rutting resistance) and 50 percent reliability for low temperature properties (cracking resistance) is recommended. Asphalt cements with lower than 98 percent reliability against rut resistance should not be specified. In the SuperPave™ system, anything between 50 percent and 98 percent reliability is considered 50 percent reliability for the purpose of binder selection. The low temperatures are specified at a lower reliability for overlays because of reflection cracking.

Step 3. Determine weather data for the project.

Obtain the highest 7-day average maximum air temperature, based on weather data in the project area from the computer program LTPPBind 3.1 (beta). Refer to **Section 6.12.3 Binder Selection** for a further explanation of LTPPBind 3.1 (beta). From the appropriate high temperature, find the environmental category for the project from **Table 6.6 Environmental Categories**. The Environmental Categories are from CDOT Pavement Management Program, Environmental Zones. The Environmental Zones (Categories) are one of four pavement groupings to group pavements into families that have similar characteristics.

Table 6.6 Environmental Categories

Highest 7-Day Average Air Temperature	High Temperature Category
> 97°F (> 36°C)	Hot (SE and West)
> 88° to 97°F (> 31° to 36°C)	Moderate (Denver, Plains and West)
81° to 88°F (27° to 31°C)	Cool (Mountains)
< 81°F (< 27°C)	Very Cool (High Mountains)

Step 4. Selection of the number of design gyrations (N_{DES}).

Select the N_{DES} from **Table 6.7 Recommended SuperPave™ Gyrotory Design Revolution (N_{DES})**. For example, **Table 6.7** shows that for 5,000,000 18k ESALs and a high temperature category of “Cool”, the design revolutions should be 75.

Table 6.7 Recommended SuperPave™ Gyrotory Design Revolution (N_{DES})

CDOT Pavement Management System Traffic Classification (20 year Design ESAL)	20 Year Total 18k ESAL in the Design Lane	High Temperature Category			
		Very Cool	Cool	Moderate	Hot
Low	< 100,000	50	50	50	50
	100,000 to < 300,000	50	75	75	75
Medium	300,000 to < 1,000,000	75	75	75	75
	1,000,000 to < 3,000,000	75	75	75	100
High	3,000,000 to < 10,000,000	75	75	100	100
Very High	10,000,000 to < 30,000,000	---	---	100	---
Very Very High	\geq 30,000,000	---	---	125	---

Based on Standard Practice for SuperPave™ Volumetric Design for Hot-Mix Asphalt (HMA), AASHTO Designation R 35-04.

6.12.3 Binder Selection

Performance graded (PG) binders have two numbers in their designation, such as PG 58-34. Both numbers describe the pavement temperatures in degrees Celsius at which the pavement must perform. The first number (58 in the example) is the high temperature standard grade for the pavement, and the second number (minus 34 in the example) is the low temperature standard grade. PG 64-28 (rubberized) or PG 76-28 (polymerized) or bituminous mixtures should only be placed directly on an existing pavement or milled surface that does not show signs of stripping or severe raveling. Cores should be taken to determine if stripping is present. Colorado local suppliers only have the capacity to supply a limited number of asphalt cement grades, because of a limited number of tanks. **Table 6.8 Available Asphalt Cement Grades in Colorado** show available grades that maybe used on CDOT projects or that are available for use on CDOT projects.

Table 6.8 Available Asphalt Cement Grades in Colorado

Polymer Modified	Unmodified
PG 76-28	
PG 70-28	PG 64-22
PG 64-28	PG 58-28
PG 58-34	
The Region Materials Engineer may select a different gyratory design revolution for the lower HMA lifts.	

LTPPBIND 3.1 (beta) is a working version, dated September 15, 2005. Beta only means that it is going through the 508-compliance process for the visually disabled users as required by the Federal Government. The computer program may be obtained from the following web address: <http://www.fhwa.dot.gov/pavement/ltpb/ltpbind.cfm>

The program allows the user to select the asphalt binder grade for the appropriate project site conditions. In the "Preferences" under the "File" menu, use 12.5mm (½ inch) for the target rut depth for a CDOT default value. The computer program has a help menu to assist the user and supporting technical information regarding the computation of design temperatures required for the selection of the asphalt binder grade as provided in the "Climatic Data" and "Algorithms" sections. The algorithms are broken down under four subsections. Each algorithm equation is shown and briefly explained for high temperature, low temperature, PG with depth, and PG grade bumping.

- High Temperature - The high temperature is based on a rutting damage model. The LTPP high temperature model was not used in this version since it provided very similar results to the SHRP model at 98 percent reliability. Initially the user must select a preference for a target rut depth. The default is 12.5 mm (½ inches). The user has the option to change the target rut depth.
- Low Temperature - The low temperature is based on LTPP climatic data using air temperature, latitude and depth to surface.
- PG with Depth - LTPP pavement temperature algorithms were used to adjust PG for a depth into the pavement. The LTPP algorithms are empirical models developed from seasonal monitoring data.
- PG Grade Bumping - PG grade bumping was based on the rutting damage concept for high temperature adjustments. Adjustments were developed as the difference between PG for standard traffic conditions (ESAL of 3 million and high speed) and PG site conditions. 187 sites throughout the U.S. for five different target rut depths were analyzed. The PG adjustments were then averaged by different ESAL ranges, traffic speeds and base PG.

The following steps should be followed to determine the proper SuperPave™ asphalt cement grade for a given project:

Step 1. Determine proper reliability to satisfy pavement temperature property requirements.

The first decision is to determine what type of project is being designed. For new construction or reconstruction, asphalt cement with 98 percent reliability for both low and high pavement temperature properties is recommended. For overlays, asphalt cement with 98 percent reliability for high pavement temperature properties (rutting resistance) and 50 percent reliability for low pavement temperature properties (cracking resistance) are recommended. Asphalt cements with lower than 98 percent reliability against rut resistance should not be specified. In the SuperPave™ system, anything between 50 and 98 percent reliability is considered 50 percent reliability for the purpose of binder selection. The low pavement temperatures are specified at a lower reliability for overlays because of reflection cracking. See **Figure 6.33 PG Binder Grades** for a graphical representation of reliability.

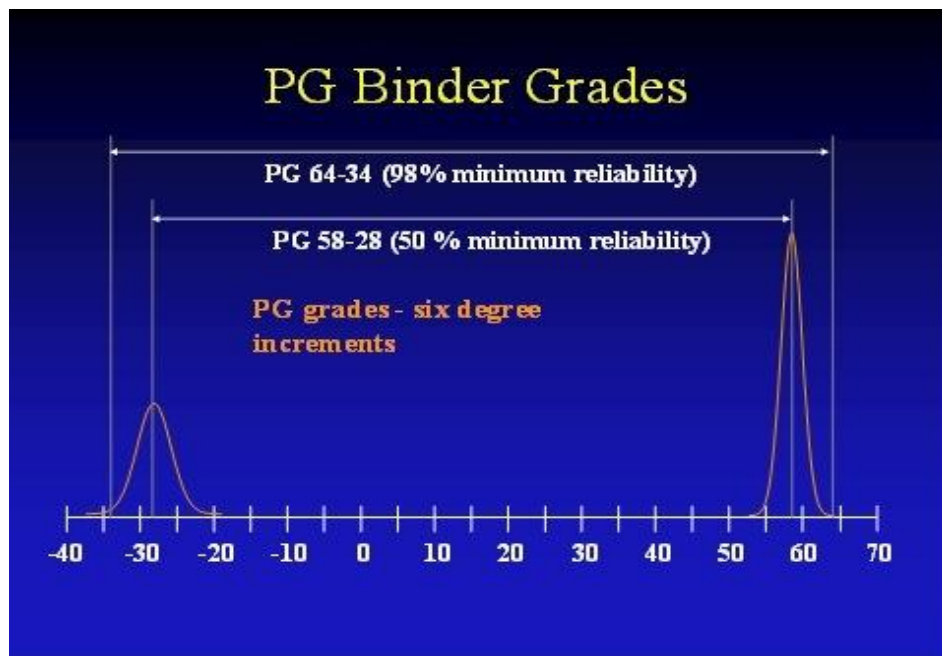

Figure 6.33 PG Binder Grades

Step 2. Determine weather data for the project.

Obtain the SuperPave™ recommended asphalt cement grade, based on weather data and traffic in the project area. Recommendations on 98 percent reliability high and low pavement temperature weather stations are found in **Figure 6.34 Colorado 98 Percent Reliability LTPP High Pavement Temperature Weather Station Models** and **Figure 6.35 Colorado 98 Percent Reliability LTPP Low Pavement Temperature Weather Station Models**, neither of which accounts for grade bumping. The program also calculates the reliability of various asphalt cements for a given location. Each RME has a copy of this program. This source will yield the 98 and 50 percent reliability asphalt cement for a project area with a free flowing traffic condition, which is described in Step 3. For example, when the recommendations call for a PG 58-22 for a given project, due to the available binder grades in Colorado, a PG 64-22 would be specified. This

selection provides for rut resistance while preserving the same level of resistance to cracking. Because of the danger of rutting, in no case should the recommended high temperature requirements be lowered based on availability.

Step 3. Select Location of Roadway.

Place the cross hair on the location of area of interest in the weather data program LTPP Bind. The program selects five weather stations surrounding the area of interest. The designer has the option to use any number of weather stations that are representative of the climate at the area of interest.

Step 4. Adjust HMA Performance Grade Binder to meet layer depth, traffic flow and loading requirements.

SuperPave™ high temperature reliability factors are based on historical weather data and algorithms to predict pavement temperature. At a depth layer of one inch or more below the surface, high temperature recommendations are changed because of their depth and the temperatures at that pavement depth.

For pavements with multiple layers, a lesser grade may be specified for lower layers based on the amount of material needed and other economical design decisions. In many cases, the requirements for lower layers might be obtained with an unmodified or more economical grade of asphalt cement. It is recommended that at least 10,000 tons of mix in the lower layer is needed before a separate asphalt cement is specified for the lower layer.

Adjustments can be made to the base high temperature binder through the PG Binder Selection screen. Adjustments to reliability, depth of layer, traffic loading, and traffic speed (fast and slow) will be required. These adjustments are called grade bumping. Additional grade bumping may be performed for stop and go traffic characteristics, such as in intersections. This extra grade bump may be applied and is suggested to have prior regional experience on doing such.

6.12.4 Example 1

A new roadway project will be constructed near Sugarloaf Reservoir. It will have two lanes per direction and a traffic characteristic of slow moving because it is a winding mountain road. Find the appropriate binder grade. N_{DES} for the surface layer is obtained in the same manner as the previous example and has a design revolution of 75.

Step 1. Determine 18k ESAL.

Design Lane ESALs = 4,504,504 from DTD web site.

This is a 20-year 18k ESAL in the design lane.

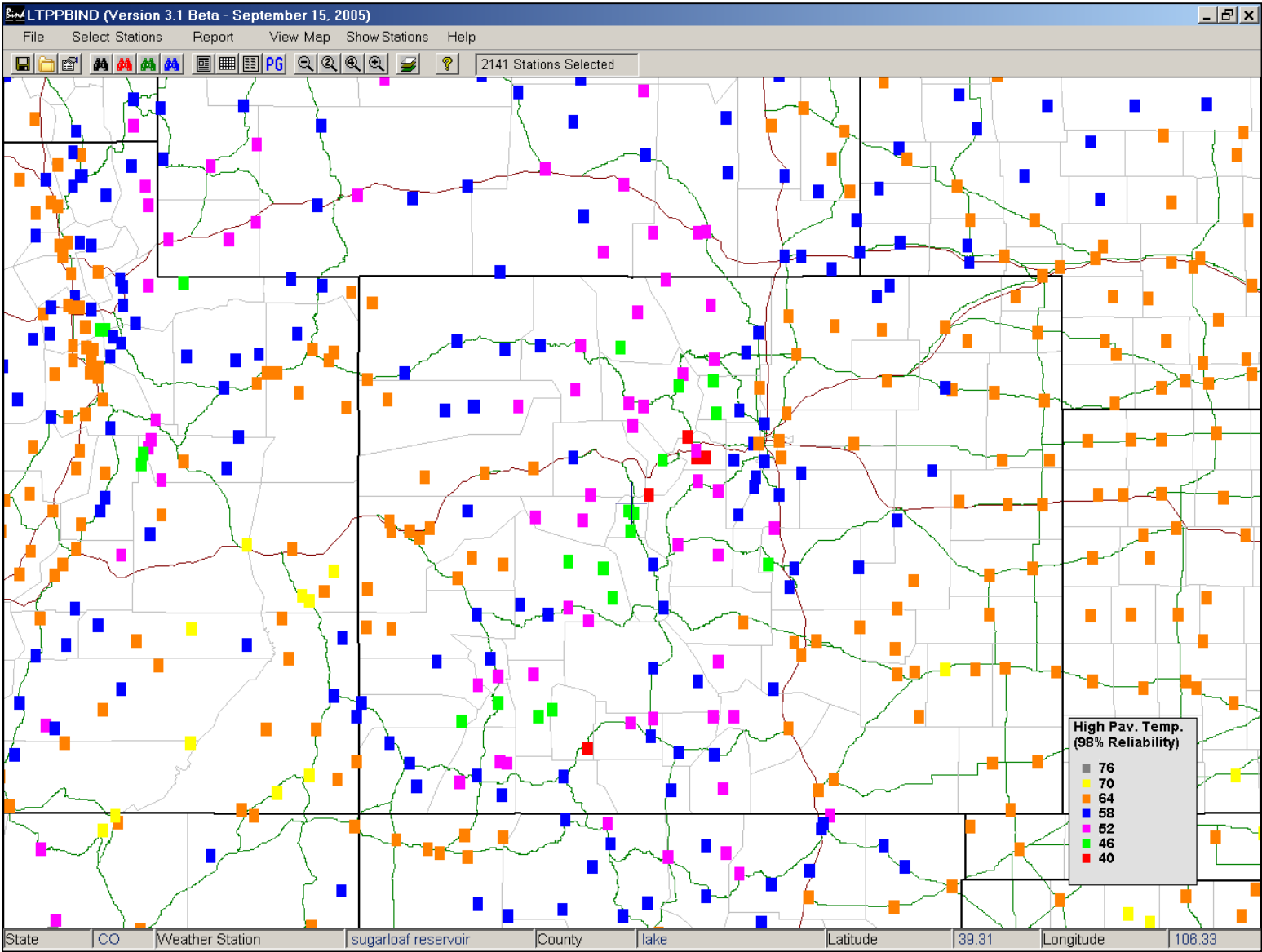

Figure 6.34 Colorado 98 Percent Reliability LTPP High Pavement Temperature Weather Station Models

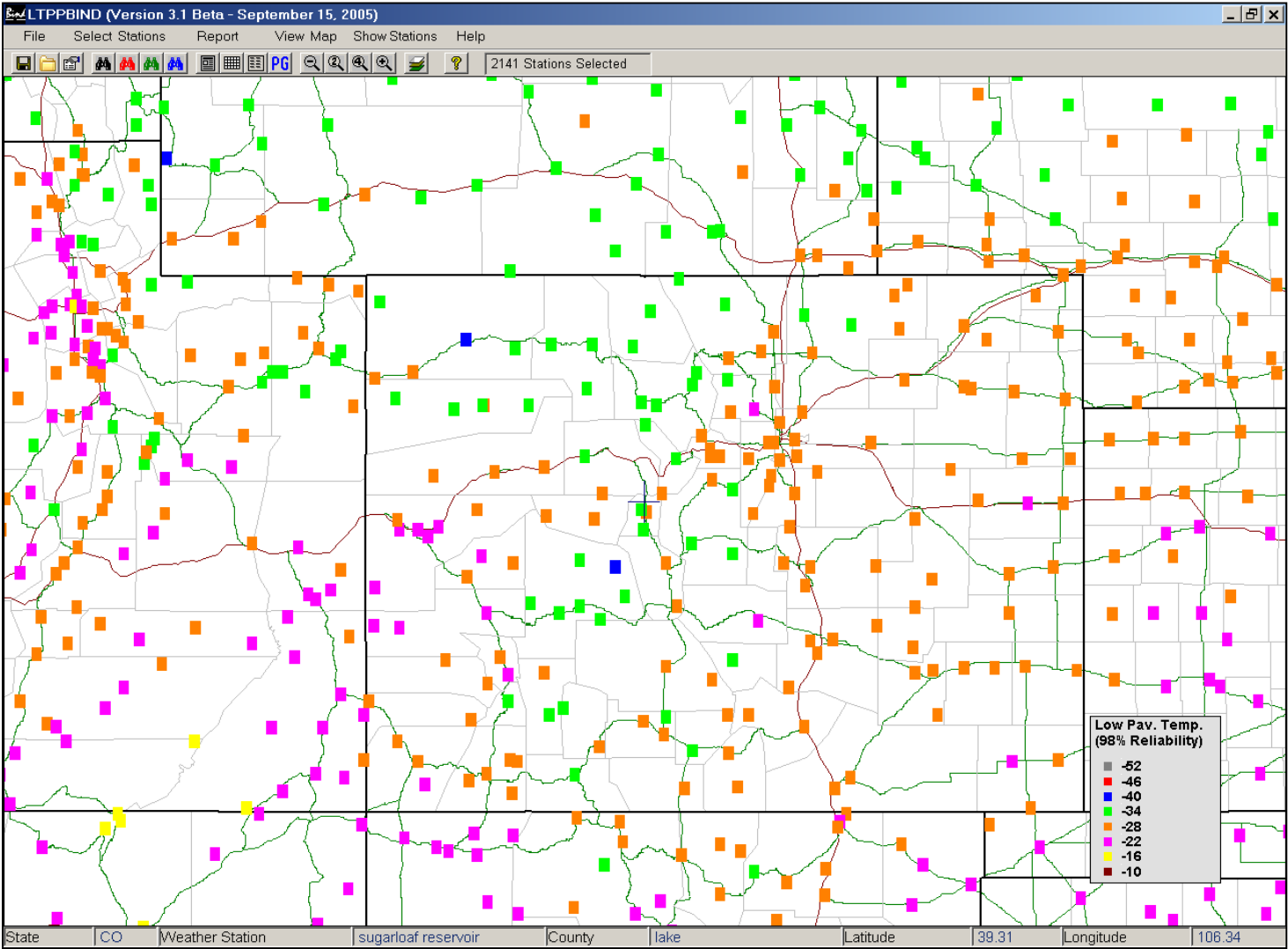

Figure 6.35 Colorado 98 Percent Reliability LTPP Low Pavement Temperature Weather Station Models

Step 2. Use LTPP Software Database.

Use LTPPBind software database to obtain the data from the nearest weather station. Sugarloaf Reservoir has a weather station. Appropriate weather stations can be determined from information on state, county, coordinates, location, and/or station ID. **Figure 6.36 LTPP Interface Form for Weather Station Selection (version 3.1)** is where the cross hair is placed for the new roadway project. **Figure 6.37 LTPP Weather Station Output Data (version 3.1)** shows the data at the weather station Sugarloaf Reservoir.

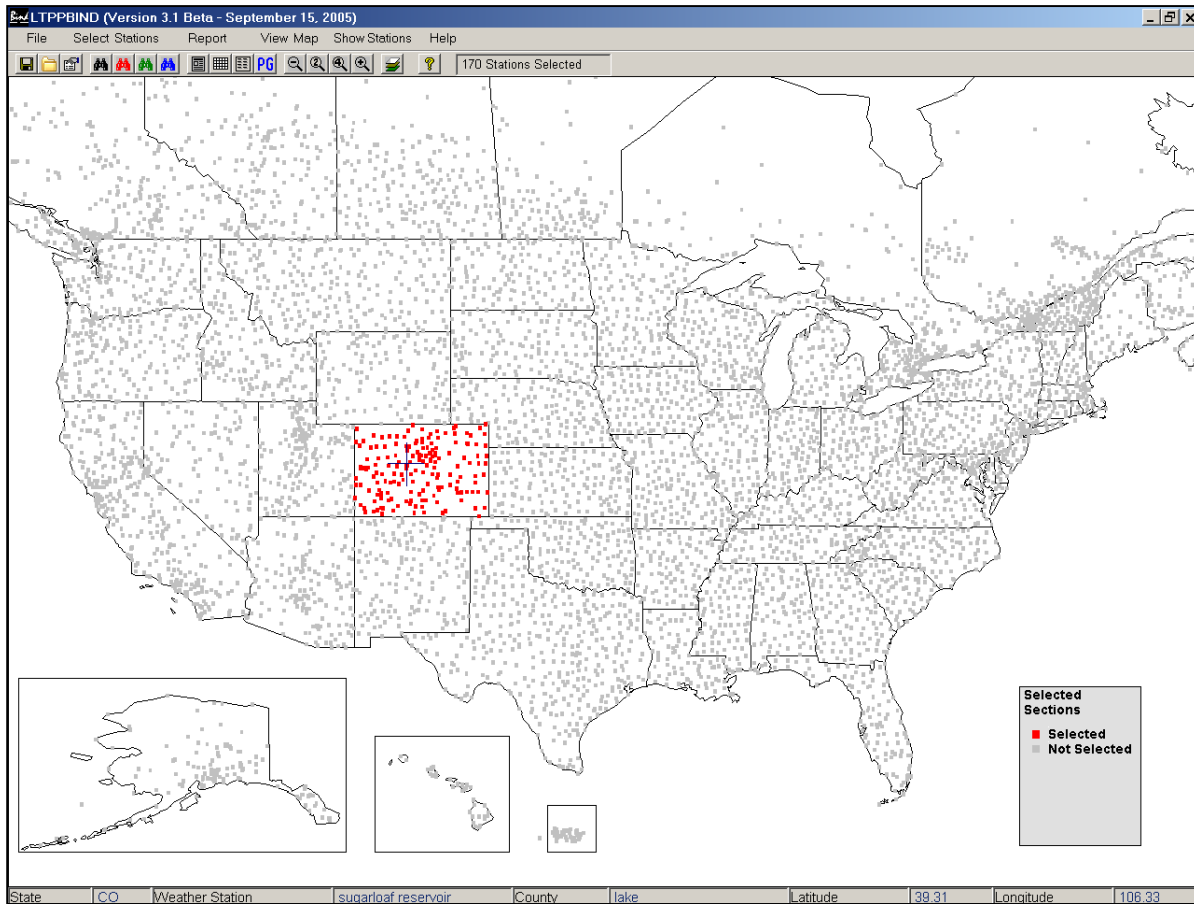

Figure 6.36 LTPP Interface Form for Weather Station Selection (version 3.1)

Step 3. Select the Desired Weather Stations.

The LTPPBind software gives the option to select the weather stations that provide the best weather data at the project location. See the upper table in **Figure 6.38 LTPP PG Binder Selection at 98 Percent Reliability**. Check the first three weather stations. Uncheck the two weather stations that are furthest from the project. The two weather stations are too far from the site and not representative of site conditions.

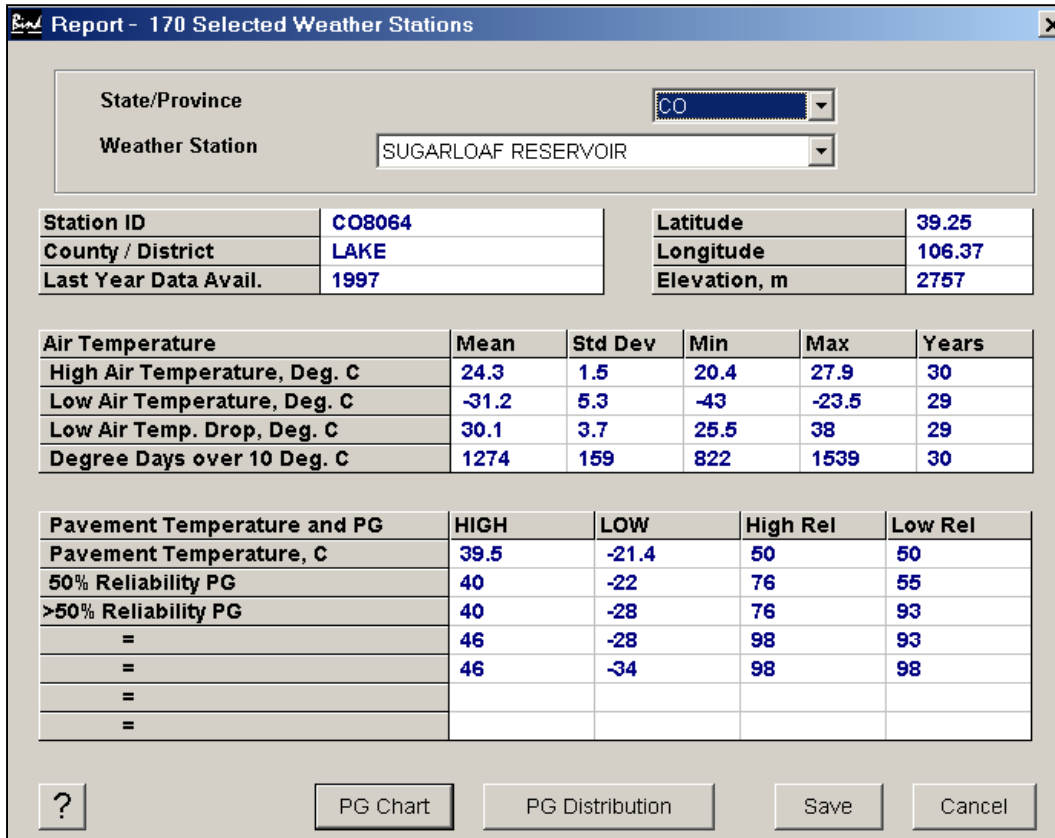

Figure 6.37 LTPP Weather Station Output Data (version 3.1)

Step 4. Select the Temperature Adjustments.

Because this is a principal arterial and because this is a new construction project, 98 percent reliability is chosen with a layer depth of zero (0) for the surface layer. Again, see **Figure 6.38 LTPP PG Binder Selection at 98 Percent Reliability** for the selection.

Step 5. Select the Traffic Adjustments for High Temperature.

Select the appropriate traffic loading and traffic speed. The design lane ESALs are 4,504,504 and the traffic speed is slow. Grade bumping is automatic and is demonstrated by toggling in appropriate cells.

Parameter	A=8 km	B=10 km	C=16 km	D=25 km	E=35 km
Station ID	✓ CO8064	✓ CO4885	✓ CO1660	✗ CO8501	✗ CO5507
Elevation, m	9046	9229	10516	8548	7966
Degree-Days >10 C	1274	1328	761	1442	2083
Low Air Temperature, C	-31.2	-30.5	-30.4	-31.4	-29.9
Low Air Temp. Std Dev	5.3	3.5	2.9	4.3	3.4

Input Data

Latitude, Degree: 39.31 Lowest Yearly Air Temperature, C: -30.7
 Yearly Degree-Days >10 Deg.C: 1121 Low Air Temp. Standard Dev., Deg: 3.9

Temperature Adjustments

Base HT PG: 52
 Desired Reliability, %: 98
 Depth of Layer, mm: 0

Traffic Adjustments for HT

Traffic Loading	Traffic Speed	
	Fast	Slow
Up to 3 M. ESAL	0.0	2.3
3 to 10 M. ESAL	7.8	10.3
10 to 30 M. ESAL	12.0	13.9
Above 30 M. ESAL	15.5	17.7

PG Temperature	HIGH	LOW
PG Temp. at 50% Reliability	37.7	-21.1
PG Temp. at Desired Reliability	39.2	-28.3
Adjustments for Traffic	10.3	
Adjustments for Depth	0.0	0.0
Adjusted PG Temperature	49.5	-28.3
Selected PG Binder Grade	52	-34

Figure 6.38 LTPP PG Binder Selection at 98 Percent Reliability

The following data summarized in Table 6.9 SuperPave™ Weather Data Summary are obtained from three out of five weather stations.

Table 6.9 SuperPave™ Weather Data Summary

98 Percent Reliability	
Depth of Layer	0 mm
Traffic Loading and Speed Adjustment	10.3°C (Slow)
PG Binder Grade	52 -34

Step 6. Select Final Binder

Table 6.8 Available Asphalt Cement Grades in Colorado, lists the binder grades that are available in Colorado. A PG 58-28 (unmodified) is available, but it does not meet the low temperature requirement. The lowest temperature that binders available in Colorado can meet is -34° C. This is available in PG 58-34 (polymer modified). Therefore, at 98 percent reliability use PG 58-34.

Step 7. Find that temperature that falls into the environmental category.

Use **Table 6.10 Environmental Categories (Restated)** to obtain the Highest 7-Day Average Air Temperature, 24.3°C. Go to **Table 6.10 Environmental Categories (Restated)** and find that this temperature falls into the category Very Cool (High Mountains).

Table 6.10 Environmental Categories (Restated)

Highest 7-Day Average Air Temperature	High Temperature Category
> 36°C (> 97°F)	Hot (SE and West)
> 31° to 36°C (> 88° to 97°F)	Moderate (Denver, Plains & West)
27° to 31°C (81° to 88°F)	Cool (Mountains)
< 27°C (< 81°F)	Very Cool (High Mountains)

Step 8. Select the Gyratory Design Revolution (N_{DES}).

Table 6.11 Recommended SuperPave™ Gyratory Design Revolution (N_{DES}), shows that for 4,504,504 18k ESAL and a high temperature category of “Very Cool,” the design revolutions should be 75.

**Table 6.11 Recommended SuperPave™ Gyratory Design Revolution (N_{DES})
(Table 6.7 Restated)**

CDOT Pavement Management System Traffic Classification (20 year Design ESAL)	20 Year Total 18k ESAL in the Design Lane	High Temperature Category			
		Very Cool	Cool	Moderate	Hot
Low	< 100,000	50	50	50	50
	100,000 to < 300,000	50	75	75	75
Medium	300,000 to < 1,000,000	75	75	75	75
	1,000,000 to < 3,000,000	75	75	75	100
High	3,000,000 to < 10,000,000	75	75	100	100
Very High	10,000,000 to < 30,000,000	---	---	100	---
Very Very High	≥ 30,000,000	---	---	125	---

Based on Standard Practice for SuperPave™ Volumetric Design for Hot-Mix Asphalt (HMA), AASHTO Designation R 35-04.

6.12.5 Asphalt Binder Characterization for M-E Design

For flexible pavement design using the M-E Design software, the viscosity of the asphalt binder is a critical input parameter to incorporate the viscoelastic response (i.e. time-temperature dependency) of asphalt concrete mixtures in pavement design. The asphalt binder viscosity is used in the determination of dynamic modulus values of asphalt mixtures for both unaged and aged conditions. The key input parameters that define the viscosity temperature relationship are the slope (A) and intercept (VTS) resulting from a regression of the asphalt binder viscosity values measured or estimated at different temperatures of interest.

Laboratory testing of asphalt binders is required to develop viscosity temperature relationships at Level 1 input hierarchy. For performance grade binders, the asphalt binder viscosity values can be estimated from the dynamic shear rheometer test data conducted in accordance with AASHTO T315, “Determining the Rheological of Asphalt Binder Using a Dynamic Shear Rheometer (DSR).” Alternatively, for conventional grade binders (i.e. penetration grade or viscosity grade), the asphalt binder viscosity values can be obtained from a series of conventional tests, including absolute and kinematic viscosities, specific gravity, softening point, and penetrations. At hierarchical input Level 3, the default values of A-VTS parameters included in the M-E Design software are used based on the asphalt binder grade selection.

For flexible pavement rehabilitation designs, the age-hardened binder properties can be established using asphalt binder extracted from field cores of asphalt pavement layers that will remain in place

after rehabilitation. For the projects where asphalt is not extracted, historical information and data may be used.

Table 6.12 Recommended Sources of Inputs for Asphalt Binder Characterization presents recommended sources for asphalt binder characterization at different hierarchical input levels. Refer to the AASHTO Interim MEPDG Manual of Practice and MEPDG Documentation for more information.

Table 6.12 Recommended Sources of Inputs for Asphalt Binder Characterization

Materials Category	Measured Property	Recommended Test Protocol	Hierarchical Input Level		
			3	2	1
Asphalt binder	Asphalt binder complex shear modulus (G^*) and phase angle (δ)(at 3 test temperatures) OR <i>Conventional binder test data:</i> Penetration OR Ring and ball softening point Absolute viscosity Kinematic viscosity Specific gravity OR Brookfield viscosity	AASHTO T315 AASHTO T49 OR AASHTO T53 AASHTO T202 AASHTO T201 AASHTO T228 OR AASHTO T316		X	X
	<i>Asphalt binder grade:</i> PG grade OR Viscosity grade OR Penetration grade	AASHTO M320 OR AASHTO M226 OR AASHTO M20	X		
	Rolling thin film oven aging	AASHTO T315		X	X

6.13 Asphalt Mix Design Criteria

6.13.1 Fractured Face Criteria

For an aggregate to meet CDOT's fractured face criteria, the aggregate retained on the No. 4 sieve must have at least two mechanically induced fractured faces (2) see **Table 6.13 Fractured Face Criteria**.

Table 6.13 Fractured Face Criteria

% Fractured Faces of 20 Year 18k ESAL in Design Lane	SF	ST	SX	S	SG	SMA
Non-Interstate Highways or Pavements With < 10,000,000 Total 18K ESALs	60%	60%	60%	60%	90%	90%
Interstate Highways or Pavements With > 10,000,000 Total 18K ESALs	70%	70%	70%	70%	90%	90%

6.13.2 Air Void Criteria

A design air void range of 3.5 to 4.5 percent with a target of 4.0 percent will be used on all SX, S, SG, and ST mixes. A design air void range of 4.0 to 5.0 percent with a target of 4.5 percent will be used on all SF Mixes. See **Table 6.14 Minimum VMA Requirements** for design air voids and minimum VMA requirements. The air void criteria will be applied to the approved design mix. The nominal maximum size is defined as one size larger than the first sieve to retain more than 10 percent. Interpolate specified VMA values for design air voids between those listed. All mix designs shall be run with a gyratory compactor angle of 1.25 degrees. CDOT Form #43 will establish construction targets for asphalt cement and all mix properties at air voids up to 1.0 percent below the mix design optimum. Extrapolate VMA values for production (Form 43) air voids beyond those listed in **Table 6.14 Minimum VMA Requirements**.

Table 6.14 Minimum VMA Requirements

Nominal Maximum Size¹ mm (in)	Design Air Voids^{2,3}			
	3.5%	4.0%	4.5%	5.0%
37.5 (1 ½)	11.6	11.7	11.8	N/A
25.0 (1)	12.6	12.7	12.8	
19.0 (¾)	13.6	13.7	13.8	
12.5 (½)	14.6	14.7	14.8	
9.5 (¾)	15.6	15.7	15.8	16.9

¹ The Nominal Maximum Size is defined as one size larger than the first sieve to retain more than 10 percent.
² Interpolate specified VMA values for design air voids between those listed.
³ Extrapolate specified VMA values for production air voids between those listed.

Criteria for voids at (N_{DES}) are listed in **Table 6.14 Minimum VMA Requirements**.

6.13.3 Criteria for Stability

Criteria for stability and voids filled with asphalt (VFA) are shown in **Table 6.15 Criteria for Stability and Voids Filled with Asphalt (VFA)**.

Table 6.15 Criteria for Stability and Voids Filled with Asphalt (VFA)

SuperPave™ Gyratory Revolutions (N _{DES})	Hveem Minimum Stability*	VFA (%)
125	30	65-75
100	30	65-75
75	28	65-80
50	**	70-80
* Hveem Stability criteria for mix design approval and for field verification. ** Hveem Stability is not a criterion for mixes with a (N _{DES}) of 50. Note: 1-inch mix (CDOT Grade SG) has no stability requirements.		

6.13.4 Moisture Damage Criteria

Moisture damage criteria are shown in **Table 6.16 Moisture Damage Criteria**.

Table 6.16 Moisture Damage Criteria

Characteristic	Value
Minimum dry split tensile strength, (psi)	30
Minimum tensile strength ratio, CP-L 5109, (%)	80
Minimum tensile strength ratio, CP-L 5109, Stone Matrix Asphalt, (%)	70

6.14 Effective Binder Content (by volume)

Effective binder content (P_{be}) is the amount of binder not absorbed by the aggregate, i.e., the amount of binder that effectively forms a bonding film on the aggregate surfaces. Effective binder content is what the service performance is based on. Effective binder content is calculated based on the aggregate bulk specific gravity (G_{sb}) and the aggregate effective specific gravity

(G_{se}). The higher the aggregate absorption, the greater the difference between G_{se} and G_{sb}. The effective binder content by volume is the effective binder content (P_{be} times the ratio of the bulk specific gravity of the mix (G_{mm}) and the specific gravity of the binder (G_b) The formula is:

$$P_{be} \text{ (by volume)} = P_{be} * (G_{mm} / G_b)$$

Where

P_{be} = Effective asphalt content, percent by total weight of mixture

G_{mm} = Bulk specific gravity of the mix

G_b = Specific gravity of asphalt (usually 1.010)

P_{be} is determined as follows:

$$P_{be} = P_b - (P_{ba}/100) * P_s$$

Where

P_b = Asphalt, percent by total weight of mixture

P_{ba} = Absorbed asphalt, percent by total weight of aggregate

P_s = Aggregate, percent by total weight of mixture

P_{ba} is determined as follows:

$$P_{ba} = 100 ((G_{se} - G_{sb}) / (G_{sb} * G_{se})) * G_b$$

Where

P_{ba} = Absorbed asphalt, percent by total weight of aggregate

G_{se} = Effective specific gravity of aggregate

G_{sb} = Bulk specific gravity of aggregate

6.15 Rumble Strips

When Rumble Strips are installed, they shall be of the style and location as shown on Standard Plan Sheet No. M-614-1, Rumble Strips.

References

1. Gilbert, K., *Thermal Segregation*, 2005, CDOT Report No. CDOT-DTD-R-2005-16. <http://www.coloradodot.info/programs/research/pdfs/2005/thermalsegregation.pdf>..
2. Brown, E.R. and Bassett, C.E. *Effects of Maximum Aggregate Size on Rutting Potential and Other Properties of Asphalt-Aggregate Mixtures 1990*. Transportation Research Record 1259, TRB, National Research Council, Washington, D.C., 1990, pp. 107-119.
3. *HMA Pavement Mix Type Selection Guide*, FHWA Information Series 128, Federal Highway Administration, 400 7th Street S.W., Washington, DC 20590 and National Asphalt Pavement Association (NAPA), 5100 Forbes Blvd, Lanham, MD 20706, January 2001.
4. *Guide for Mechanistic-Empirical Design, Final Report*, NCHRP Project 1-37A, National Cooperative Highway Research Program, Transportation Research Board, National Research Council, Submitted by ARA, INC., ERES Consultants Division, Champaign, IL, March 2004.
5. Locander, Robert, *Analysis of Using Reclaimed Asphalt Pavement (RAP) as a Base Material*, Final Report, CDOT Report No. CDOT-2009-5, Colorado Department of Transportation, February 2009.
6. *Perpetual Pavements - A Synthesis*. Asphalt Pavement Alliance. 5100 Forbes Boulevard, Lanham, MD 20706 : Asphalt Pavement Alliance, 1/2002. Synthesis.
7. *Perpetual Bituminous Pavements*. Transportation Research Board (TRB). 2101 Constitution Avenue, NW, Washington, DC 20418 : Transportation Research Board, National Research Center, December 2001. Research Circular. TRB Committee on General Issues in Asphalt Technology (A2D05). Number 503, ISSN 0097-8515.
8. *AASHTO Mechanistic-Empirical Pavement Design Guide, A Manual of Practice, Interim Edition, July 2008*, American Association of State Highway and Transportation Officials, Washington, DC, 2008.

CHAPTER 7 PRINCIPLES OF DESIGN FOR RIGID PAVEMENT

7.1 Introduction

Rigid pavement design is based on the mechanistic-empirical (M-E) design concepts. The design procedure utilizes distress and smoothness prediction models developed and calibrated locally. The MEPDG Design Guide and the AASHTO Interim MEPDG Manual of Practice documents provide a detailed description of the M-E concepts for rigid pavement designs.

The design procedures described in this chapter can be used for design of new or reconstructed rigid pavements. There are no fundamental differences in the pavement design procedure for new alignment and reconstruction; however, the potential reuse of the materials from the existing pavement structure can be an important issue. Refer to **CHAPTER 9** when rehabilitation designs are necessary with rigid overlays or restoration projects.

The design life for typical thin white topping should be 10 to 20 years for rehabilitations and 30 years for reconstruction. An overview of the proven concrete pavement practices that the Colorado Department of Transportation (CDOT) has implemented over the last several years is documented in the Final Research Report CDOT-DTD-R-2006-9, *Implementation of Proven PCCP Practices in Colorado*, dated April 2006 (8).

7.2 M-E Design Methodology for Rigid Pavement

The M-E Design of rigid pavements is an iterative process. The key steps in the design process include the following:

- **Select a trial design strategy.**
- **Select the appropriate performance indicator criteria for the project.** Establish criteria for acceptable pavement performance (i.e. distress/IRI) at the end of the design period. CDOT criteria for acceptable performance is based on highway functional class and location. The performance criteria was established to reflect magnitudes of key pavement distresses and smoothness that trigger major rehabilitation or reconstruction.
- **Select the appropriate reliability level for the project.** The reliability is in essence a factor of safety to account for inherent variations in construction, materials, traffic, climate and other design inputs. The level of reliability selected should be based on the criticality of the design. CDOT criteria for desired reliability is based on highway functional class and location. The desired level of reliability is selected for each individual performance indicators.
- **Assemble all inputs for the pavement trial design under consideration.** Define subgrade support, PCC and other paving material properties, traffic loads, climate, pavement type and design and construction features. The inputs required to run the M-E Design software may be obtained using one of three hierarchical levels of effort and need not be consistent for all of

the inputs in a given design. Hierarchical level for a given input is selected based on the importance of the project, importance of the input, and the resources at the disposal of the user.

- **Run the M-E Design software.** The software calculates changes in layer properties, damage, key distresses, and the IRI over the design life. The key steps include:
 - Processes input to obtain monthly values of traffic inputs and seasonal variations of material and climatic inputs needed in the design evaluations for the entire design period.
 - Computes structural responses (stresses and strains) using finite element based pavement response models for each axle type and load and for each damage-calculation increment throughout the design period.
 - Calculates accumulated distress and/or damage at the end of each analysis period for the entire design period.
 - Predicts key distresses (JPCP transverse cracking and joint faulting) at the end of each analysis period throughout the design life using the calibrated mechanistic-empirical performance models.
 - Predicts smoothness (IRI) as a function of initial IRI, distresses that accumulate over time, and site factors at the end of each analysis increment.
- **Evaluate the adequacy of the trial design.** The trial design is considered “adequate” if none of the predicted distresses/IRI exceed the performance indicator criteria at the design reliability level chosen for the project. If any of the criteria has been exceeded, determine how this deficiency can be remedied by altering material types and properties, layer thicknesses, or other design features.
- **Revise the trial design, as needed.** If the trial design is deemed “inadequate”, revise the inputs/trial design and rerun the program. Iterate until all the performance criteria have been met. When they have been met, the trial design becomes a feasible design alternative.

The design alternatives that satisfy all performance criteria are considered feasible from a structural and functional viewpoint and can be further considered for other evaluations, such as life cycle cost analysis. A detailed description of the design process is presented in the interim edition of the AASHTO Mechanistic-Empirical Pavement Design Guide Manual of Practice (AASHTO 2008).

7.3 Select Trial Design Strategy

7.3.1 Rigid Pavement Layers

Figure 7.1 Rigid Pavement Layers shows a conventional rigid layered system. The PCC slab may be placed over base or subbase layers but may be placed directly on a prepared subgrade. The base (layer directly beneath the PCC slab) and subbase layers (layer placed below the base layer) may include unbound aggregates, asphalt stabilized granular, cement stabilized, lean concrete, crushed concrete, lime stabilized, recycled asphalt pavement (RAP), and other materials. Base/subbase layers may be dense graded or permeable drainage layers. Transverse joints are

closely spaced in JPCP, typically between 10 and 20 feet, to minimize transverse cracking from temperature and moisture gradients. JPCP may have tied or untied longitudinal joints.

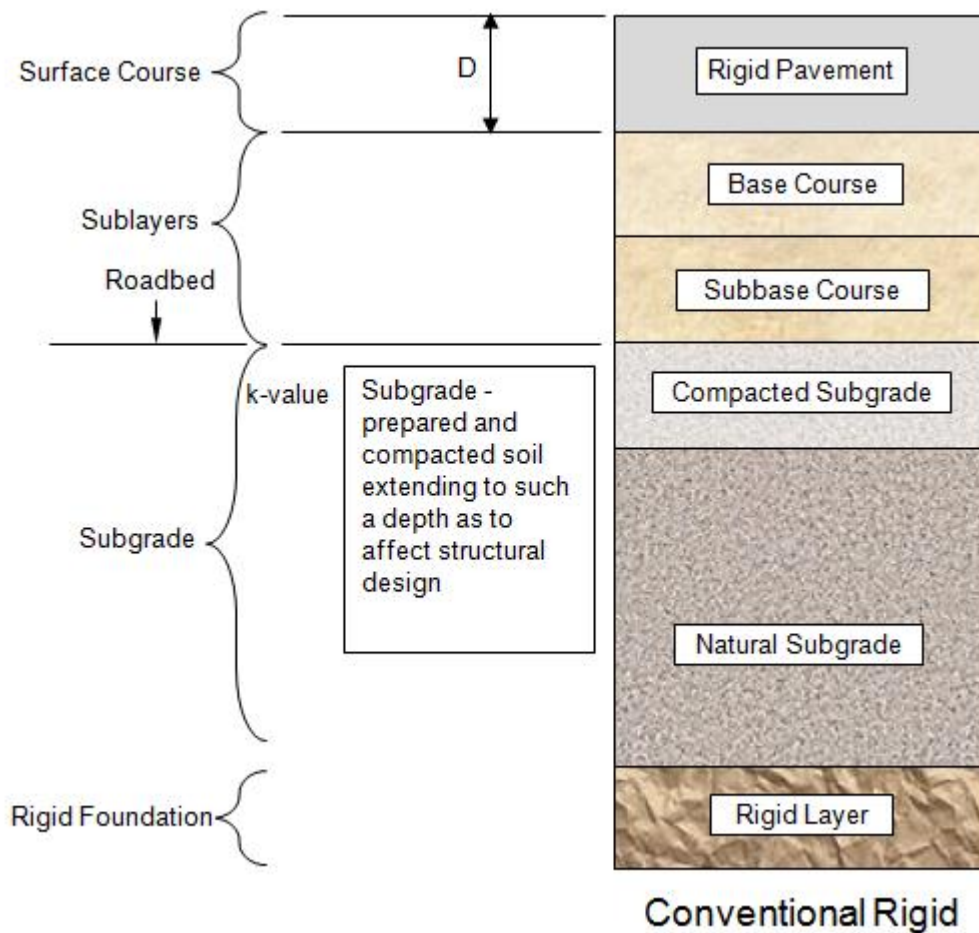

Figure 7.1 Rigid Pavement Layers

7.3.2 Establish Trial Design Structure

The designer must establish a trial design structure (combination of material types and thicknesses). This is done by first selecting the pavement type of interest in the M-E Design software -See **Figure 7.3 M-E Design Software Screenshot Showing General Information, Performance Criteria and Reliability** ; upon selecting, the M-E Design software automatically provides the top layers of the selected pavement type. The designer may add or remove pavement structural layers, and modify layer material type and thickness as appropriate.

Figure 7.2 M-E Design Software Screenshot of Rigid Pavement Trial Design Structure shows the pavement layer configuration of a sample rigid pavement trial design on the left and layer properties of the PCC slab on the right.

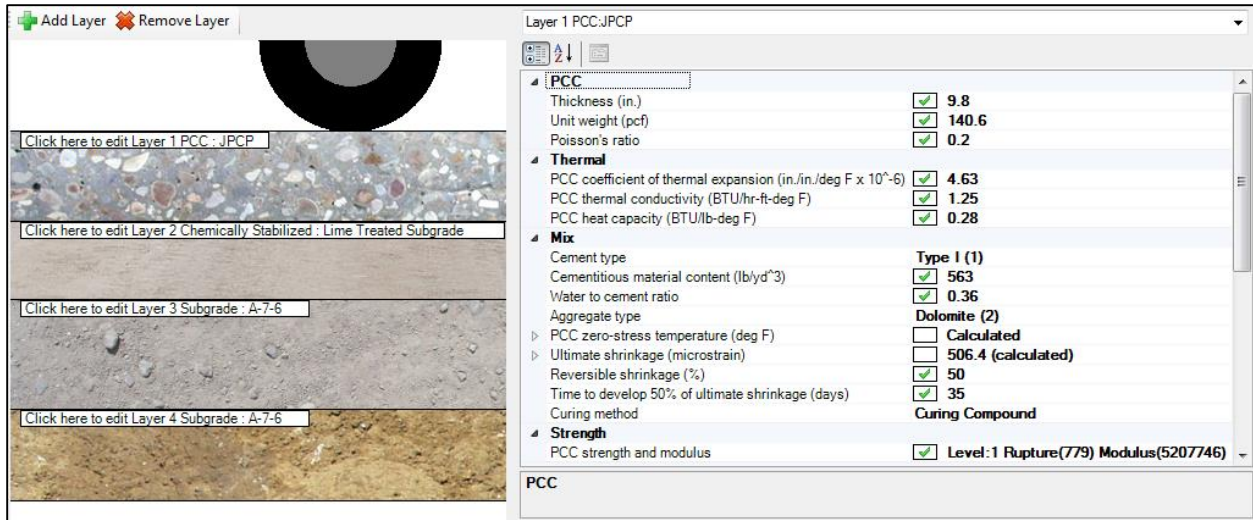

Figure 7.2 M-E Design Software Screenshot of Rigid Pavement Trial Design Structure

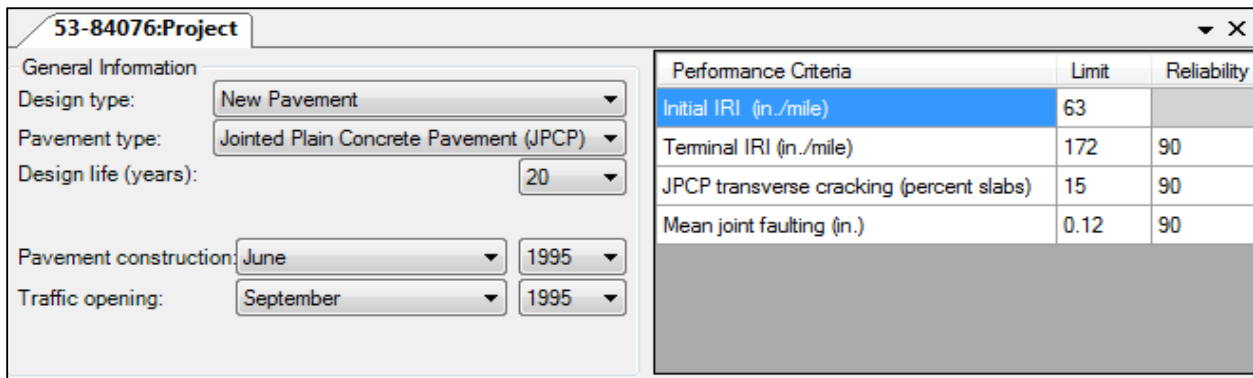

Figure 7.3 M-E Design Software Screenshot Showing General Information, Performance Criteria and Reliability

7.4 Select the Appropriate Performance Indicator Criteria for the Project

Table 2.4 Recommended Threshold Values of Performance Criteria for New Construction or Reconstruction Projects presents recommended performance criteria for rigid pavement design. The designer should enter the appropriate performance criteria based on functional class. An appropriate initial smoothness (IRI) is also required. For new rigid pavements, the recommended initial IRI is 75 inches/mile. This recommendation is for regular paving projects; for projects with incentive-based smoothness acceptance, the designer may modify this value as needed. **Figure 7.3 M-E Design Software Screenshot Showing General Information, Performance Criteria and Reliability** shows performance criteria for a sample rigid pavement trial design. The coefficients of performance prediction models considered in the design of a rigid pavement are shown in **Figure 7.4 Performance Prediction Model Coefficients for Rigid Pavement Designs**.

Category	Sub-category	Value
PCC Cracking	PCC Cracking C1	2
	PCC Cracking C2	1.22
	PCC Cracking C4	0.6
	PCC Cracking C5	-2.05
	PCC Reliability Cracking Standard Deviation	$Pow(57.08*CRACK,0.33)+1.5$
PCC Faulting	PCC Faulting C1	0.5104
	PCC Faulting C2	0.00838
	PCC Faulting C3	0.00147
	PCC Faulting C4	0.008345
	PCC Faulting C5	5999
	PCC Faulting C6	0.8404
	PCC Faulting C7	5.9293
	PCC Faulting C8	400
	PCC Reliability Faulting Standard Deviation	$0.0831*Pow(FAULT,0.3426)+0.00521$
PCC IRI-CRCP	PCC IRI J1	0.8203
	PCC IRI J2	0.4417
	PCC IRI J3	1.4929
	PCC IRI J4	25.24
PCC IRI-JPCP	PCC IRI JPCP Std.Dev.	5.4

Figure 7.4 Performance Prediction Model Coefficients for Rigid Pavement Designs

7.5 Select the Appropriate Reliability Level for the Project

Table 2.3 Reliability (Risk) presents recommended reliability levels for rigid pavement designs. The designer should select an appropriate reliability level based on highway functional class and location. See **Figure 7.3 M-E Design Software Screenshot Showing General Information, Performance Criteria and Reliability**.

7.6 Assemble the M-E Design Software Inputs.

7.6.1 General Information

7.6.1.1 Design Period

The design period for new rigid pavement construction and reconstruction is 20 or 30 years. It is recommended that a 30-year design period be used for rigid pavements. Selection of a design period other than 10, 20, or 30 years needs to be supported by a LCCA or other overriding considerations.

7.6.1.2 Project Timeline

The following inputs are required to specify the project timeline in the design – See **Figure 7.3 M-E Design Software Screenshot Showing General Information, Performance Criteria and Reliability** :

- Pavement construction month and year.
- Traffic open month and year.

The designer may select the most likely month and year when the PCC surface layer is scheduled to be placed and when the pavement section is scheduled to be opened to traffic. Changes to the surface layer material properties due to time and environmental conditions are considered beginning from the pavement construction date. Due to warping, curling and other factors, if the actual month(s) of construction is unknown then the month of August should be used.

7.6.1.3 Identifiers

Identifiers are helpful in documenting the project location and for recordkeeping. The M-E Design software allows designers to enter site or project identification information, such as, the location of the project (route signage, jurisdiction, etc.), identification numbers, beginning and ending milepost, direction of traffic, and date.

7.6.2 Traffic

Several inputs are required for characterizing traffic for the M-E Design and are described in detail in **Section 0**

.

7.6.3 Climate

The climate input requirements for the M-E Design are described in detail in **Section 3.2 Climate**.

7.6.4 Pavement Layer Characterization

As shown in **Figure 7.1 Rigid Pavement Layers**, a typical rigid pavement design comprises of the following pavement layers: PCC, treated and/or unbound aggregate base and subgrade. The inputs required for the M-E Design software for characterizing these layers are described in the following sections.

7.6.4.1 Portland Cement Concrete

The inputs required for PCC layer characterization are divided into three categories (see **Figure 7.5 PCC Layer and Material Properties in the M-E Design Software**):

- General and Thermal Properties – This category includes layer thickness, Poisson's ratio, Coefficient of Thermal Expansion (CTE), thermal conductivity, heat capacity.
- PCC Mix-Related Properties – This category includes cement type (Types I, II, or III), cement content, water/cement (or w/c) ratio, aggregate type, PCC zero-stress temperature, ultimate shrinkage at 40 percent relative humidity, reversible shrinkage and curing method.
- Strength and Stiffness Properties – This category includes modulus of rupture (flexural strength), static modulus of elasticity, and/or compressive strength.

These inputs are required for predicting pavement responses to applied loads, long-term strength and elastic modulus, and effect of climate (temperature, moisture, and humidity) on PCC expansion and contraction.

Table 7.1 PCC Material Inputs and Recommendations for New JPCP Design presents recommendations for inputs used in PCC material characterization for new JPCP design. For Levels 2 and 3, the Level 1 inputs of typical CDOT PCC mixtures can also be used – See **APPENDIX G**. Refer to **Table 2.6 Selection of Input Hierarchical Level** for selection of an appropriate hierarchical level for material inputs.

Layer 1 PCC:JPCP		
PCC		
Thickness (in.)	<input checked="" type="checkbox"/>	9.8
Unit weight (pcf)	<input checked="" type="checkbox"/>	140.6
Poisson's ratio	<input checked="" type="checkbox"/>	0.2
Thermal		
PCC coefficient of thermal expansion (in./in./deg F x 10 ⁻⁶)	<input checked="" type="checkbox"/>	4.63
PCC thermal conductivity (BTU/hr-ft-deg F)	<input checked="" type="checkbox"/>	1.25
PCC heat capacity (BTU/lb-deg F)	<input checked="" type="checkbox"/>	0.28
Mix		
Cement type		Type I (1)
Cementitious material content (lb/yd ³)	<input checked="" type="checkbox"/>	563
Water to cement ratio	<input checked="" type="checkbox"/>	0.36
Aggregate type		Dolomite (2)
PCC zero-stress temperature (deg F)	<input type="checkbox"/>	Calculated
Calculated internally?		True
User-specified PCC set temperature	<input type="checkbox"/>	
Ultimate shrinkage (microstrain)	<input type="checkbox"/>	506.4 (calculated)
Calculated internally?		True
User-specified PCC ultimate shrinkage	<input type="checkbox"/>	
Reversible shrinkage (%)	<input checked="" type="checkbox"/>	50
Time to develop 50% of ultimate shrinkage (days)	<input checked="" type="checkbox"/>	35
Curing method		Curing Compound
Strength		
PCC strength and modulus	<input checked="" type="checkbox"/>	Level:1 Rupture(779) Modulus(5207746)
Identifiers		
Display name/identifier		JPCP

Figure 7.5 PCC Layer and Material Properties in the M-E Design Software
Table 7.1 PCC Material Inputs and Recommendations for New JPCP Design

Input Property (Strength)	Input Hierarchy		
	Level 1	Level 2	Level 3
Elastic Modulus	Use mix specific values. Use ASTM C469 test results.		Use typical values from Appendix G. Select a mix that is closer to the one to be used for the project. Use a default ratio of 1.20 for 20-year / 28-day strength gain of elastic modulus and flexural strength.
Flexural Strength	Use mix specific values. Use AASHTO T97 test results.		
Compressive Strength		Use mix specific values. Use AASHTO T22 test results.	
Unit Weight	Use mix specific values. Use mix AASHTO T121 test results	Use typical values from APPENDIX G	
Poisson's Ratio	Use mix specific values. Use ASTM C469 test results.	Use typical values from APPENDIX G	
Coefficient of Thermal Expansion	Use mix specific values. Use AASHTO TP60 test results.	Use typical values from APPENDIX G	
Surface Shortwave Absorptivity	Use 0.85		
Thermal Conductivity	Use 1.25		
Heat Capacity	Use 0.28		
Cement Type	Use mix specific data	Use typical values from the CDOT PCC input library. Select a mix that is closer to the one to be used for the project.	
Cementitious Material Content	Use mix specific data	Use typical values from the CDOT PCC input library. Select a mix that is closer to the one to be used for the project.	
Water to Cement Ratio	Use mix specific data	Use typical values from the CDOT PCC input library. Select a mix that is closer to the one to be used for the project.	
Curing Method	Select an appropriate method based on Section 412.14 of CDOT Standard Specifications for Road and Bridge Construction		
PCC Zero-stress Temperature	Internally calculated		
Ultimate Shrinkage	Internally calculated		
Reversible Shrinkage	Use 50 percent		
Time to develop 50 percent of ultimate shrinkage	Use 35 days		

7.6.4.2 Asphalt Treated Base Characterization

The asphalt treated base layer is modeled as a HMA layer. The material input requirements for asphalt treated base are identical to those of conventional HMA layer, as described in **Section 6.6.4.1 Asphalt Concrete Characterization**, with an exception to indirect tensile strength and creep compliance values. For JPCP designs, no sub-layering is done within the asphalt treated base layer.

Refer to **Section 6.6.4.1 Asphalt Concrete Characterization** for information on input requirements for the asphalt treated base layer.

7.6.4.3 Chemically Stabilized Base Characterization

Refer to **Section 5.4.1 Characterization of Treated Base in the M-E Design** for treated base characterization.

7.6.4.4 Unbound Material Layers and Subgrade Characterization

Refer to **Section 5.3.1 Unbound Layer Characterization in the M-E Design** for unbound aggregate base layer characterization.

Refer to **Section 4.4 Subgrade Characterization for the M-E Design** for subgrade characterization.

7.6.5 JPCP Design Features

JPCP design features and construction practices influence long-term performance. The common design features that are considered in M-E Design software (see **Figure 7.6 M-E Design Software Screenshot of JPCP Design Features**) include:

- Surface shortwave absorptivity – See **Table 7.1 PCC Material Inputs and Recommendations for New JPCP Design**
- Joint spacing – Refer to **Section 7.10 Joint Spacing (L)**
- PCC-base contact friction – Refer to **Section 7.11 Slab/Base Friction**
- Permanent curl/warp effective temperature difference – Refer to **Section 7.12 Effective Temperature Differential (°F)**
- Widened slab – Refer to **Section 7.14 Lane Edge Support Condition (E)**
- Dowel bars – Refer to **Section 7.13 Dowel Bars (Load Transfer Devices) and Tie Bars**
- Tied shoulders – Refer to **Sections 7.13 Dowel Bars (Load Transfer Devices) and Tie Bars** and **7.14 Lane Edge Support Condition (E)**
- Base type and erodibility index – Refer to **Section 7.15 Base Erodibility**
- Sealant type – Refer to **Section 7.16 Sealant Type**

7.7 Run the M-E Design Software

Designers should examine all inputs for accuracy and reasonableness prior to running the M-E Design software. Run the software to obtain outputs required for evaluating if the trial design is adequate. After a trial run has been successfully completed, the M-E Design software will generate a report in form of a PDF and/or Microsoft Excel file. See **Figure 7.7 Sample Rigid Pavement Design PDF Output Report**. The report contains the following information: inputs, reliability of design, materials and other properties, and predicted performance.

After the trial run is complete, the designer should again examine all inputs and outputs for accuracy and reasonableness, respectively. The output report also includes the estimates of material properties and other properties on a month-by-month basis over the entire design period in either tabular or graphical form.

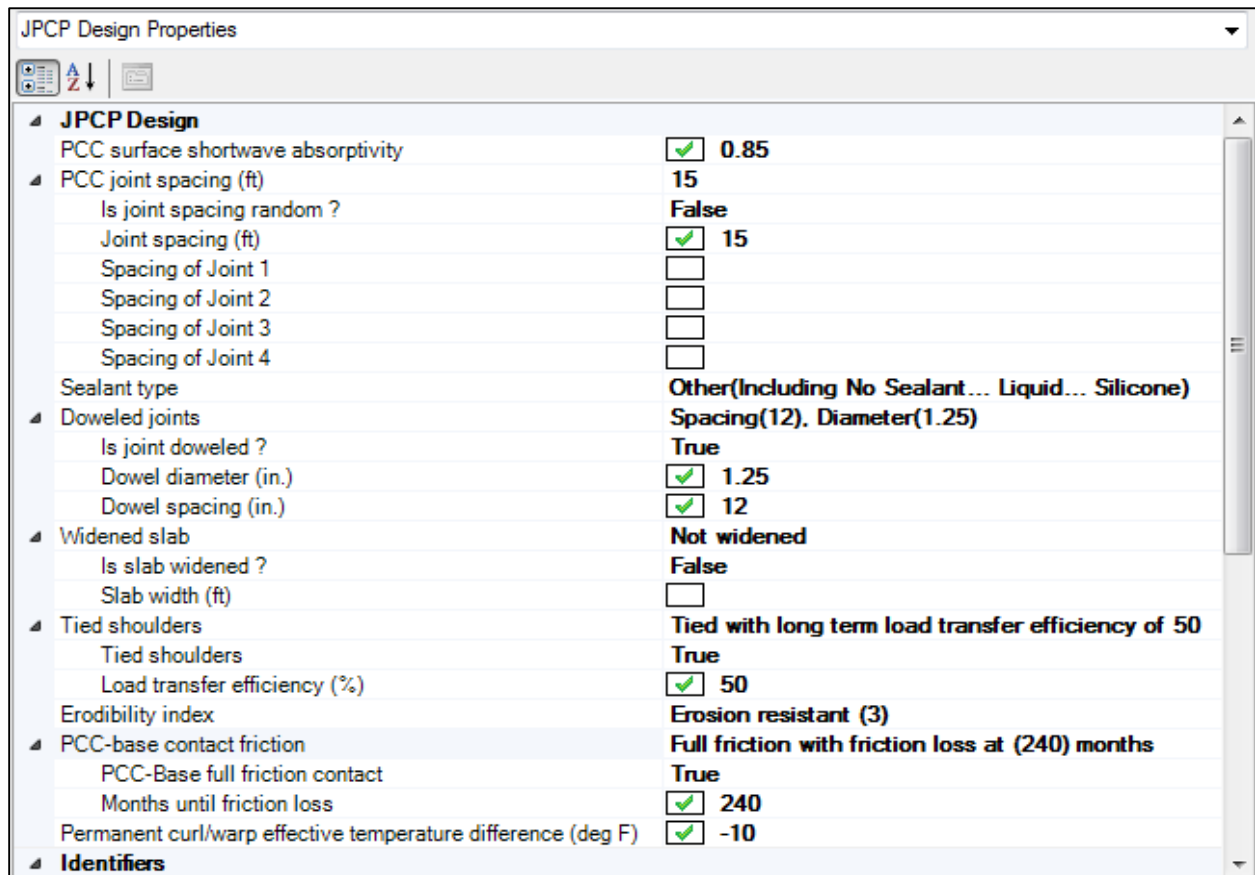

Figure 7.6 M-E Design Software Screenshot of JPCP Design Features

For a JPCP pavement trial design, the report provides the following:

- PCC flexural strength/modulus of rupture
- PCC elastic modulus

- Unbound material resilient modulus
- Subgrade k-value
- Cumulative trucks (FHWA Class 4 through 13) over the design period

The designer should at least examine the above mentioned parameters once to assess their reasonableness before accepting a trial design as complete.

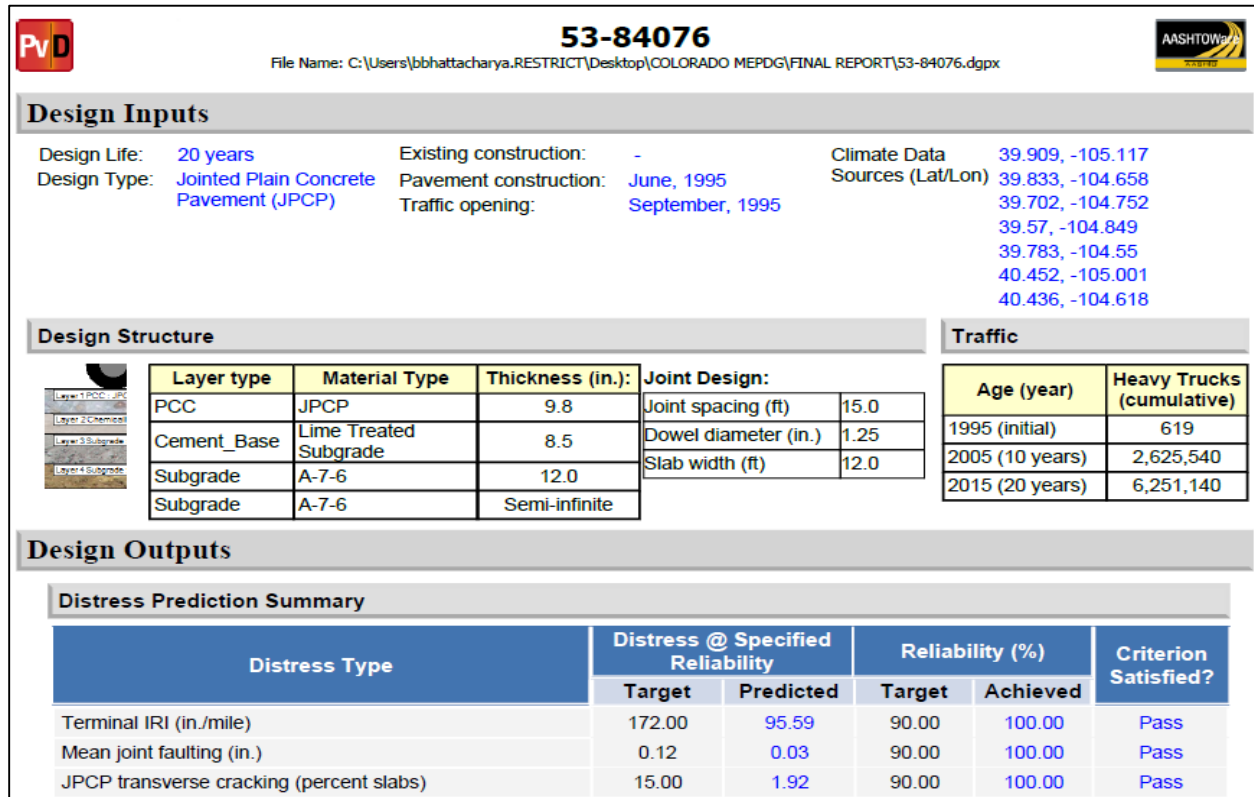

Figure 7.7 Sample Rigid Pavement Design PDF Output Report

7.8 Evaluate the Adequacy of the Trial Design

The output report of a rigid pavement trial design includes the monthly accumulation of the following key distress types for the entire design period at their mean values and chosen reliability values:

- **Joint Faulting:** This is an indicator of erosion of sublayers and the effectiveness of joint LTE. A critical value is reached when joint faulting results in excess roughness, which is unacceptable to drivers and difficult to remove through re-texturing.

The designer should examine the results to evaluate if the performance criteria for joint faulting are met at the desired reliability. If joint faulting has not been met, the trial design is deemed unacceptable and revised accordingly to produce a satisfactory design.

The output report also includes the monthly accumulation of the following secondary distress types and smoothness indicators for the entire design period at their mean values and chosen reliability values.

- **Percent Slabs Cracked:** This is the mean predicted transverse cracks that form because of fatigue damage at both the top and bottom of the slab. Beyond a critical threshold, the rate of cracking accelerates and may require significant repairs and lane closures.
- **IRI:** This is a function of joint faulting and slab cracking along with climate and subgrade factors. Higher IRI indicates unacceptable ride quality.

The designer should examine the results to evaluate if the performance criteria for percent slabs cracked and IRI meet the minimum of 27 years at the desired reliability. If any of the criteria have not been met, the trial design is deemed unacceptable and revised accordingly to produce a satisfactory design.

Another important output is the reliability levels of each performance indicator at the end of the design period. If the reliability value predicted for the given performance indicator is greater than the target/desired value, the trial design passes for that indicator. If the reverse is true, then the trial design fails to provide the desired confidence that the performance indicator will not reach the critical value during the pavement's design life. In such an event, the designer needs to alter the trial design to correct the problem.

The strategies for modifying a trial design are discussed in **Section 7.9 Modifying Trial Designs**. The designer can use a range of thicknesses to optimize the thickness of the trial design to make it more acceptable. In addition, the software allows the designer to perform sensitivity analysis for key inputs. The results of the sensitivity analysis can be used to further optimize the trial design if modifying PCC thickness alone does not produce a feasible design alternative. Detail description of the thickness optimization procedure and sensitivity analysis is provided in the Software HELP Manual.

7.9 Modifying Trial Designs

An unsuccessful trial design may require revisions to ensure that all performance criteria are satisfied. The trial design is revised by modifying the design inputs systematically. In addition to layer thickness, many other design factors influence performance predictions. The design acceptance in the M-E Design is distress-specific; in other words, the designer needs to first identify the performance indicator that failed to meet the performance targets and modify one or more design inputs that has a significant impact on a given performance indicator accordingly. The impact of design inputs on performance indicators is typically obtained by performing sensitivity analysis.

The strategies to produce a satisfactory design by modifying design inputs can be broadly categorized into:

- Pavement layer considerations:
 - Increasing layer thickness.

- Modifying layer type and layer arrangement.
- Foundation improvements.
- Pavement material improvements:
 - Use of higher quality materials.
 - Material design modifications.
 - Construction quality.

Again, when modifying the design inputs, the designer needs to be aware of the sensitivity of these inputs to various distress types. Changing a single input to reduce one distress might result in an increase in another distress. **Table 7.2 Modifying Rigid Pavement Trial Designs** presents summary of inputs that may be modified to optimize trial designs and produce a feasible design alternative.

Table 7.2 Modifying Rigid Pavement Trial Designs

Distress/IRI	Design Inputs that Impact
Transverse Cracking	<ul style="list-style-type: none"> • Increase slab thickness. • Increase PCC strength. • Minimize permanent curl/warp through curing procedures that eliminate built-in temperature gradient. • PCC tied shoulder (separate placement or monolithic placement better). • Widened slab (1 to 2 feet). • Use PCC with lower coefficient of thermal expansion.
Joint Faulting	<ul style="list-style-type: none"> • Increase slab thickness. • Reduce joint width over analysis period. • Increase erosion resistance of base (specific recommendations for each type of base). • Minimize permanent curl/warp through curing procedures that eliminate built-in temperature gradient. • PCC tied shoulder. • Widened slab (by 1 to 2 feet).
IRI	<ul style="list-style-type: none"> • Require more stringent smoothness criteria and greater incentives • Increase slab thickness. • Ensure PCC has proper entrained air content. • Decrease joint spacing. • Widen the traffic lane slab by 2 feet. • Use a treated base (if nonstabilized dense graded aggregate was specified). • Include dowels or increase diameter of dowels.

Figure 7.8 Sensitivity of JPCP Transverse Cracking to PCC Thickness through **Figure 7.19 Sensitivity of JPCP IRI to Design Reliability** presents sensitivity plots of a sample rigid pavement trial design showing the effects of key inputs, such as traffic volume, PCC thickness, PCC Coefficient of thermal expansion and design reliability on key distresses/IRI. Note that the plots do not exhaustively cover the effects of all key factors on rigid pavement performance; other significant factors are not shown herein.

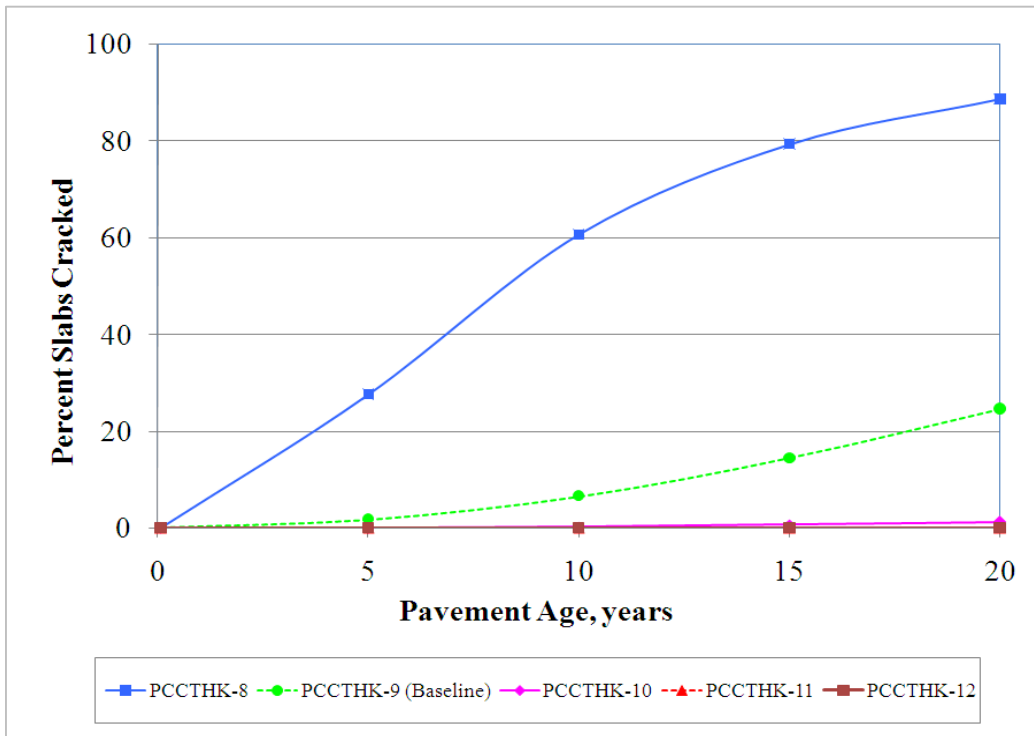

Figure 7.8 Sensitivity of JPCP Transverse Cracking to PCC Thickness

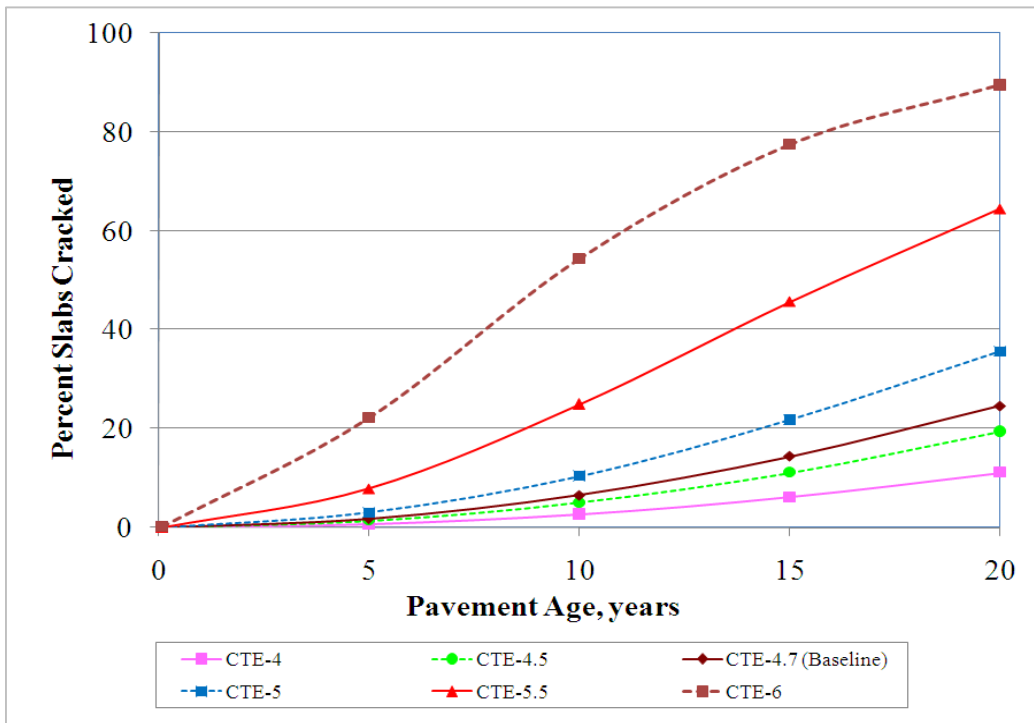

Figure 7.9 Sensitivity of JPCP Transverse Cracking to PCC Coefficient of Thermal Expansion

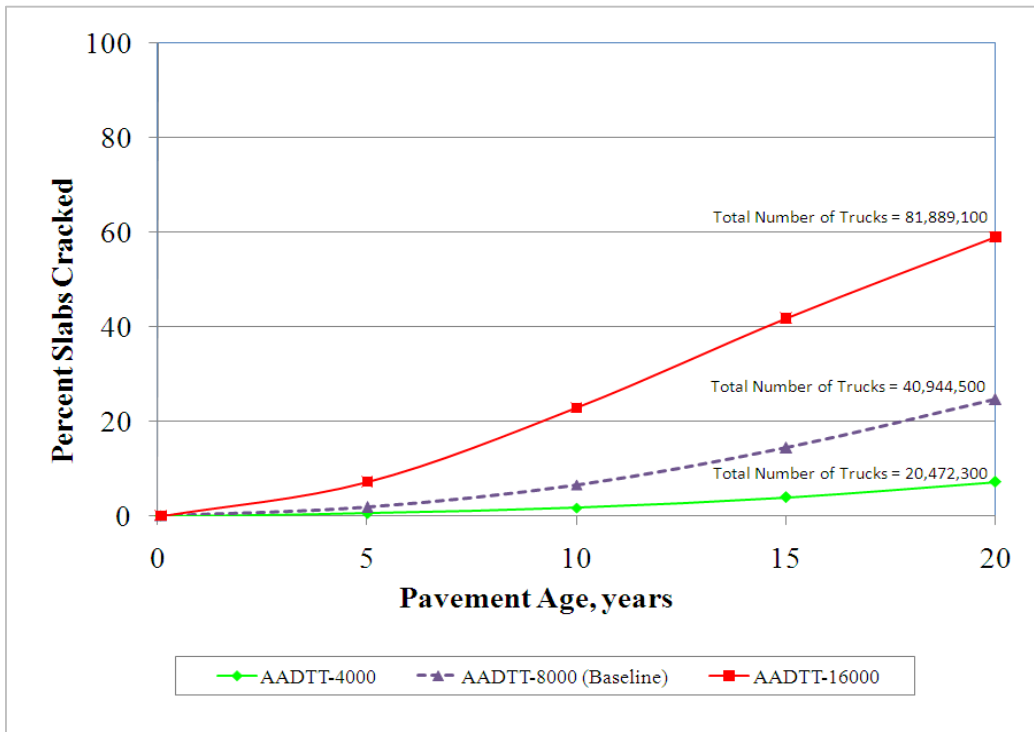

Figure 7.10 Sensitivity of JPCP Transverse Cracking to Traffic Volume

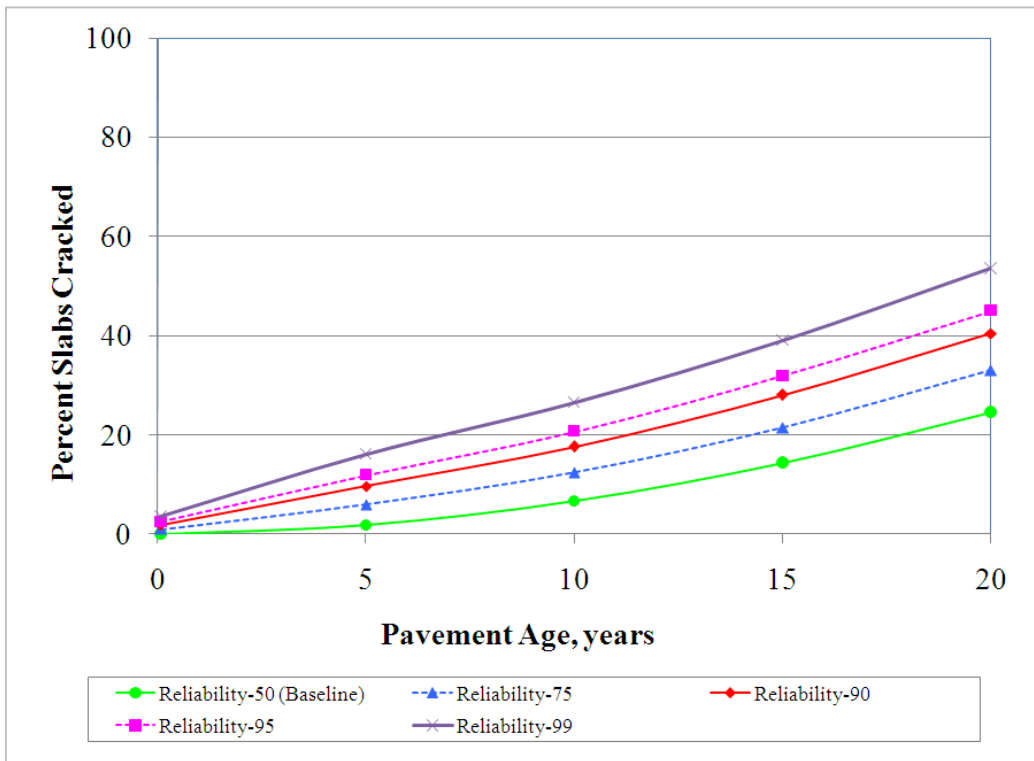

Figure 7.11 Sensitivity of JPCP Transverse Cracking to Design Reliability

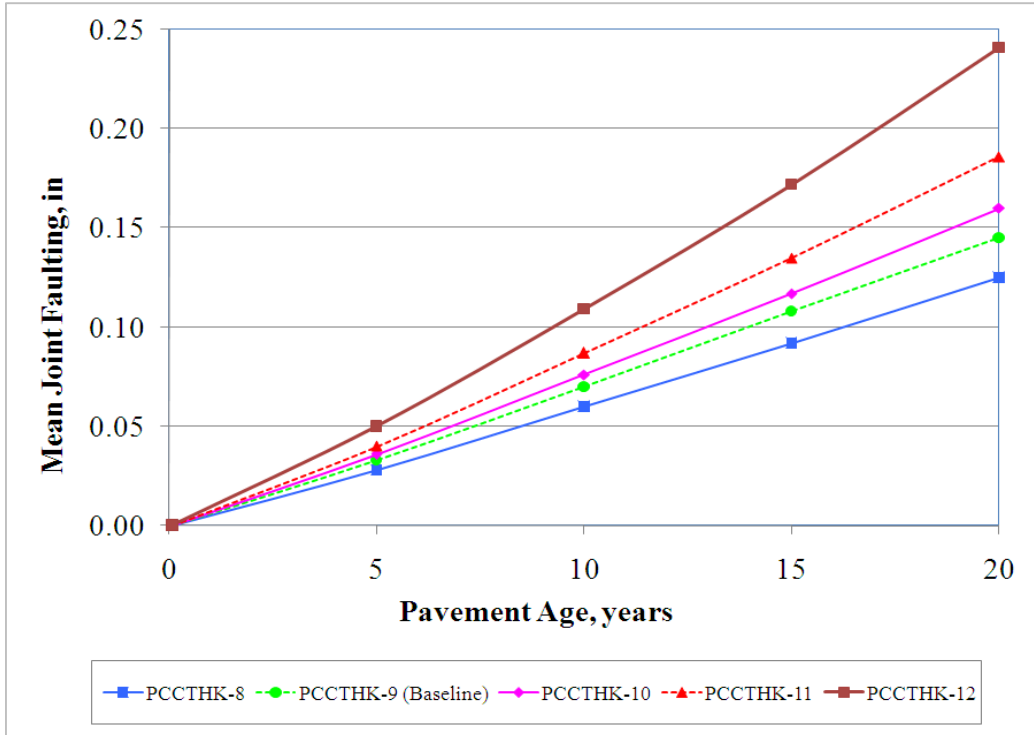

Figure 7.12 Sensitivity of JPCP Faulting to PCC Thickness

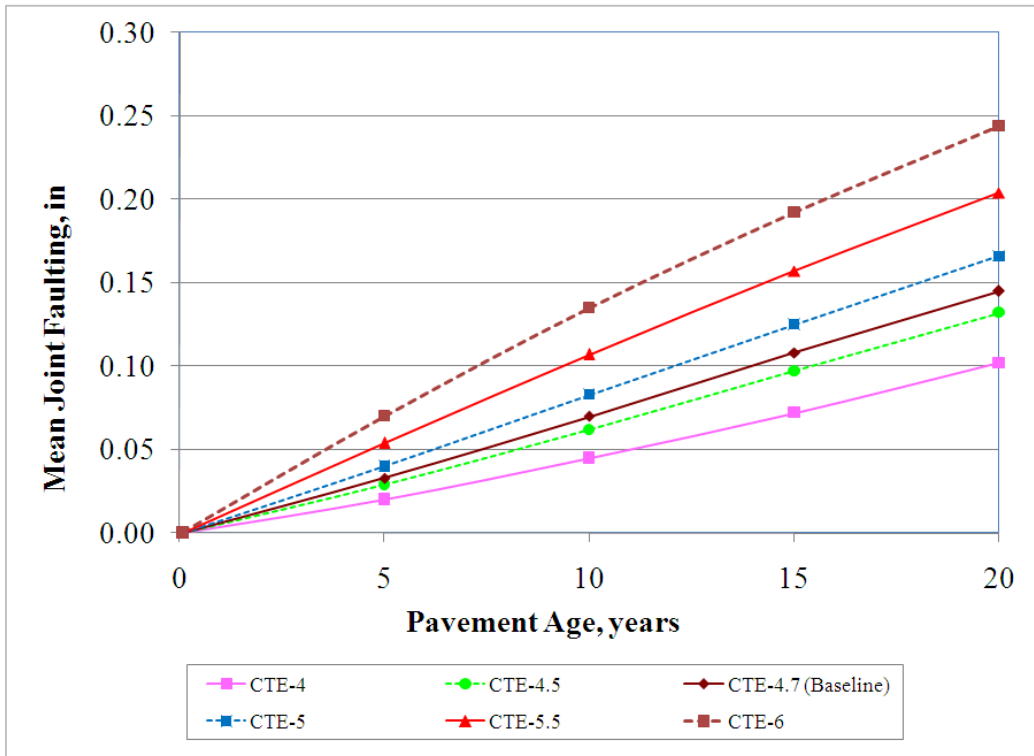

Figure 7.13 Sensitivity of JPCP Faulting to PCC Coefficient of Thermal Expansion

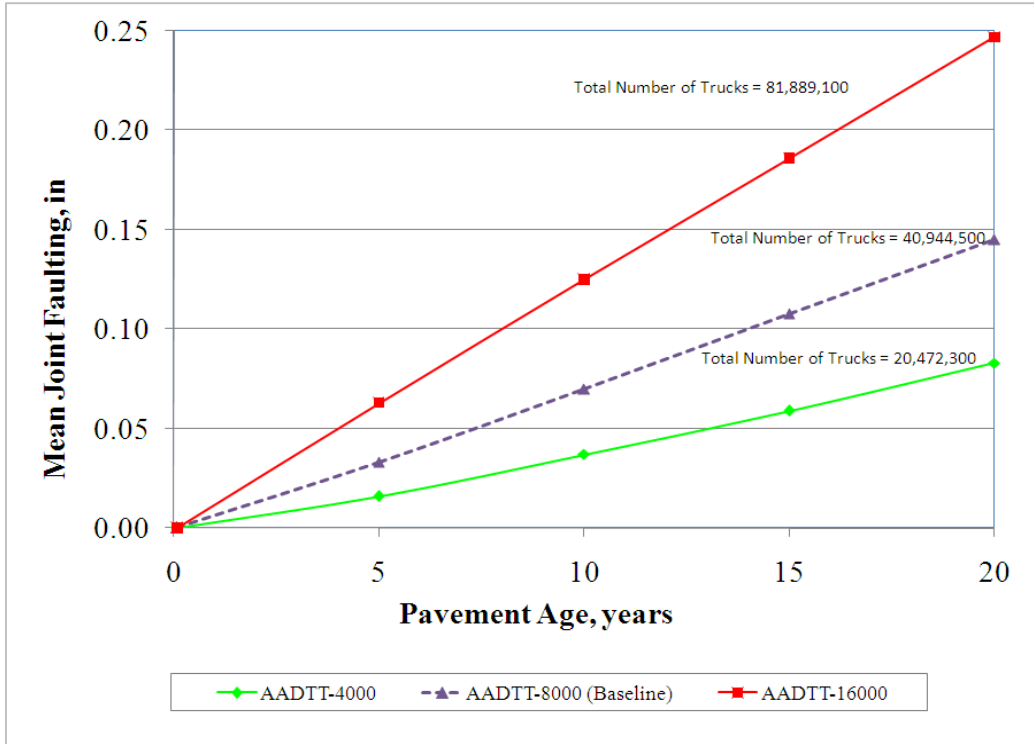

Figure 7.14 Sensitivity of JPCP Faulting to Traffic Volume

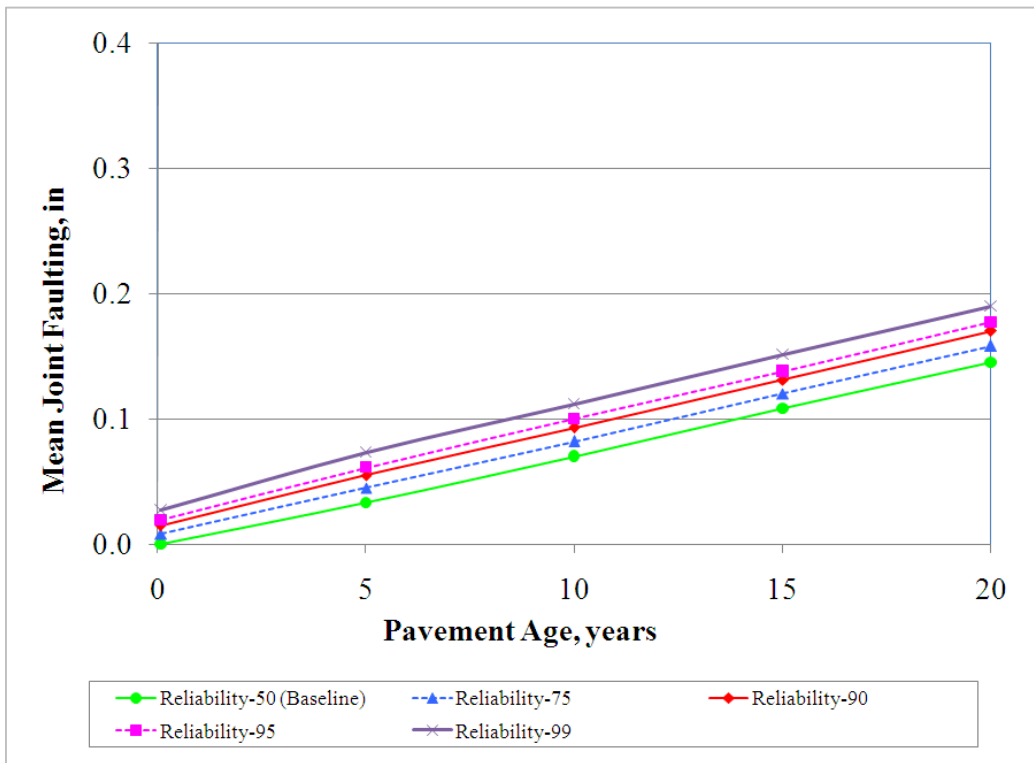

Figure 7.15 Sensitivity of JPCP Faulting to Design Reliability

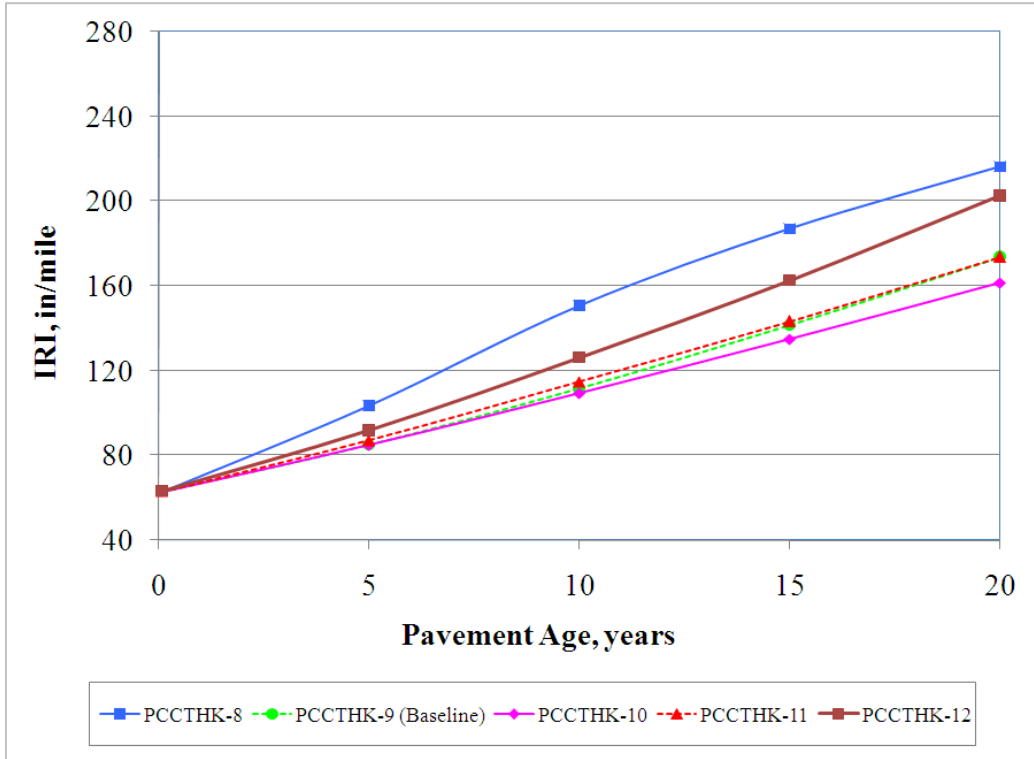

Figure 7.16 Sensitivity of JPCP IRI to PCC Thickness

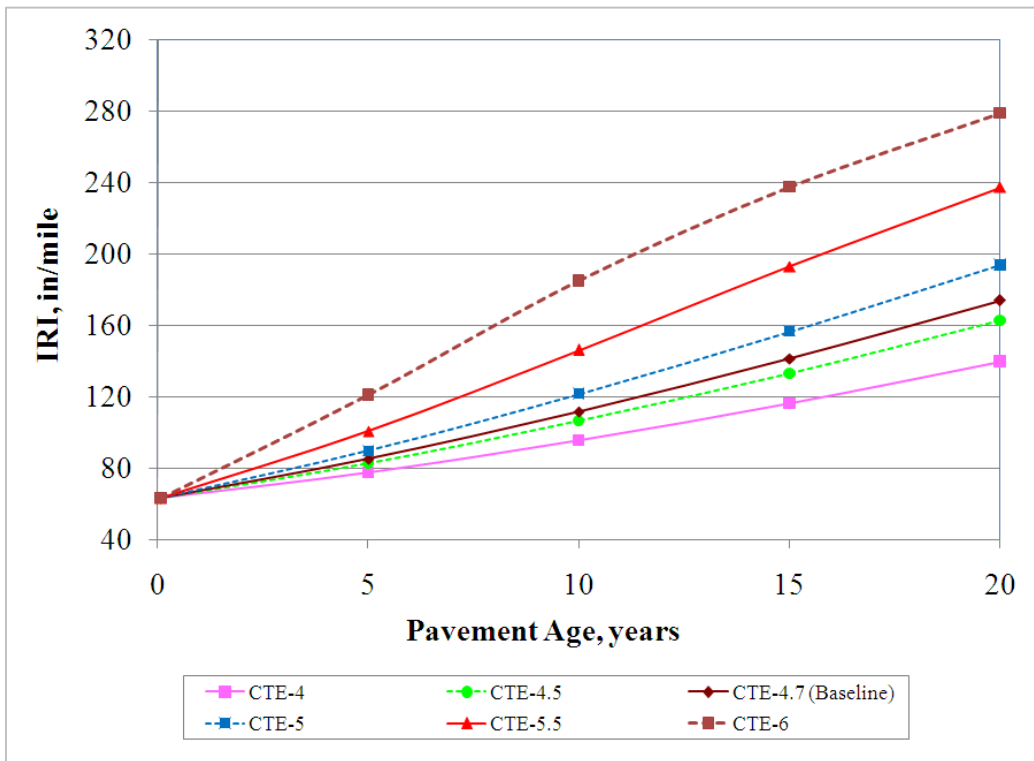

Figure 7.17 Sensitivity of JPCP Faulting to PCC Coefficient of Thermal Expansion

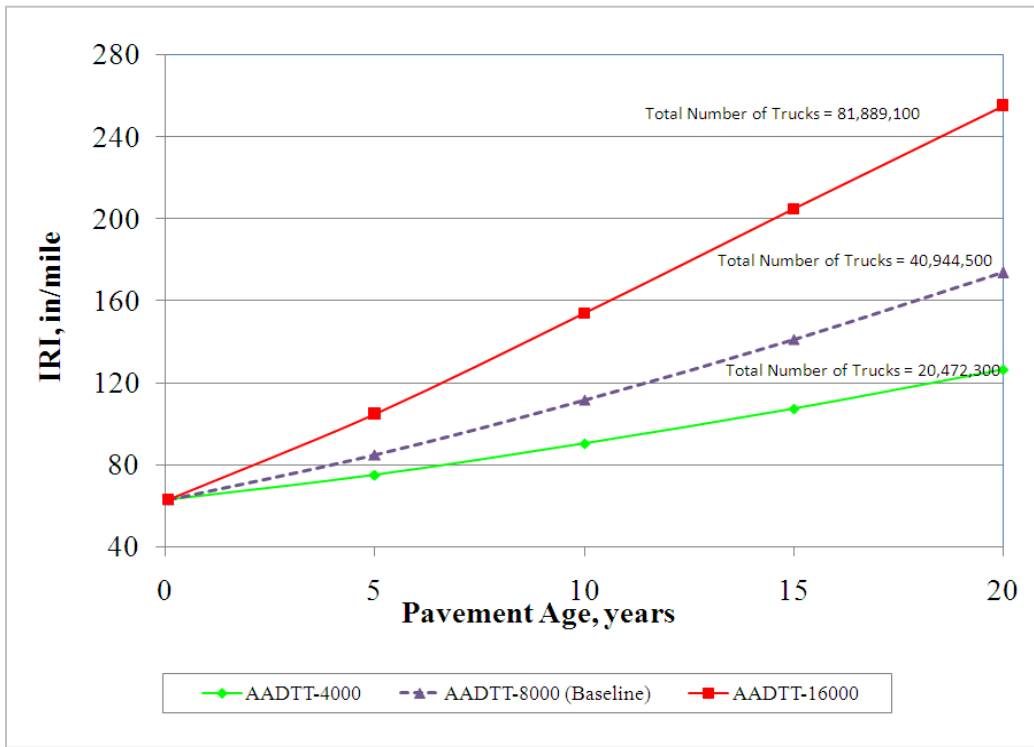

Figure 7.18 Sensitivity of JPCP IRI to Traffic Volume

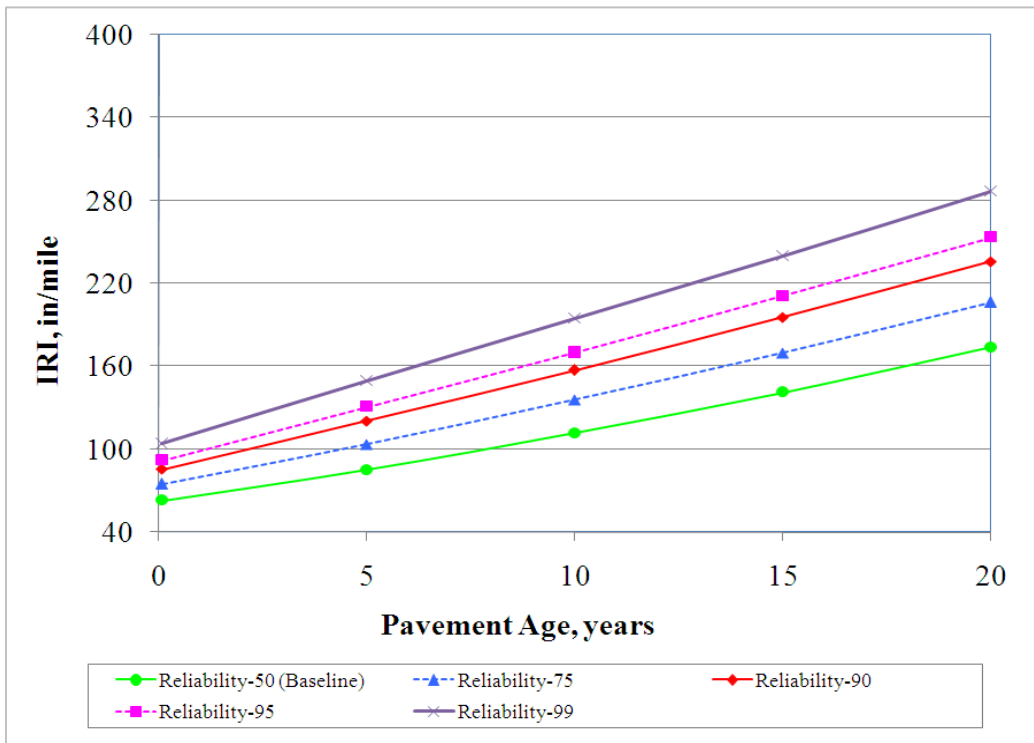

Figure 7.19 Sensitivity of JPCP IRI to Design Reliability

7.10 Joint Spacing (L)

In general, the spacing of both transverse and longitudinal contraction joints depends on local conditions of materials and environment, whereas expansion and contraction joints are primarily dependent on layout and construction capabilities. For contraction joints, when a positive temperature gradient, or base frictional resistance increases; the spacing increases as the concrete tensile strength increases. Spacing is also related to the slab thickness and the joint sealant capabilities.

Determination of the required slab thickness includes an input for joint spacing. As joint spacing increases, stresses due to thermal curling and moisture warping increase. CDOT designs their PCCP using the Jointed Plain Concrete Pavement (JPCP) method. For a detailed illustration, see CDOT's current Standard Plan Sheet M-412-1. CDOT uses a joint spacing of 15 feet maximum for concrete pavement thicknesses over 6 inches, 12 feet maximum for concrete thicknesses of 6 inches or less, and a minimum of 8 feet for any full depth pavement.

7.11 Slab/Base Friction

The time over which full contact friction exists between the PCC slab and the underlying layer (usually the base course) is an input in M-E Design. This factor indicates (1) whether or not the PCC slab/base interface has full friction at construction and (2) how long full friction will be available at the interface if present after construction. This factor is a significant input in JPCP cracking predictions in that a monolithic slab/base structure is obtained when full friction exists at the interface.

Global calibration of JPCP performance prediction models showed that full contact friction existed over the life of the pavements for all base types, with the exception for cement treated or lean concrete base. Therefore, it is recommended that the designer set the “months to full contact friction” between the JPCP and the base course equal to the design life of the pavement for unbound aggregate, asphalt stabilized, and cementitious stabilized base courses.

For cement treated or lean concrete base, the months of full contact friction may be reduced if attempts are made to debond the base from the PCC slab. The age at which debonding occurs can be confirmed through construction specifications and/or historical records. If no efforts were made to debond the interface, the designer is recommended to use 10 years of full interface friction.

The inputs required for M-E Design software are as follows:

- Presence or absence PCC-Base full-friction contact.
- Months until friction loss.
 - Use the design life (in months) for asphalt treated and aggregate base types.
 - Use 120 months for lean concrete and cement treated base.

7.12 Effective Temperature Differential (°F)

An effective temperature differential includes the effects of temperature, precipitation, and wind. Wind is considered because it has an influence on the surface if it is moist. It may be drier at the surface of the slab and creates a larger differential. The same concept may be applied to the temperature differences.

Curling is slab curvature produced by a temperature gradient throughout the depth of the slab and warping is moisture-induced slab curvature. As shown in

Figure 7.20 Curling and Warping, a positive gradient occurs when temperature and/or moisture levels at the top of a PCC slab are higher than at the bottom of the PCC slab, resulting in downward curvature. In contrast, negative gradients occur when the temperature and moisture in the slab are greater at the bottom, resulting in upward slab curvature. Curling and warping actions may offset each other or augment each other. During summer days, curling may be counteracted by warping. During summer nights, the curling and warping actions may compound each other. Gradients, as shown in

Figure 7.20 Curling and Warping, are primarily non-linear in nature (5).

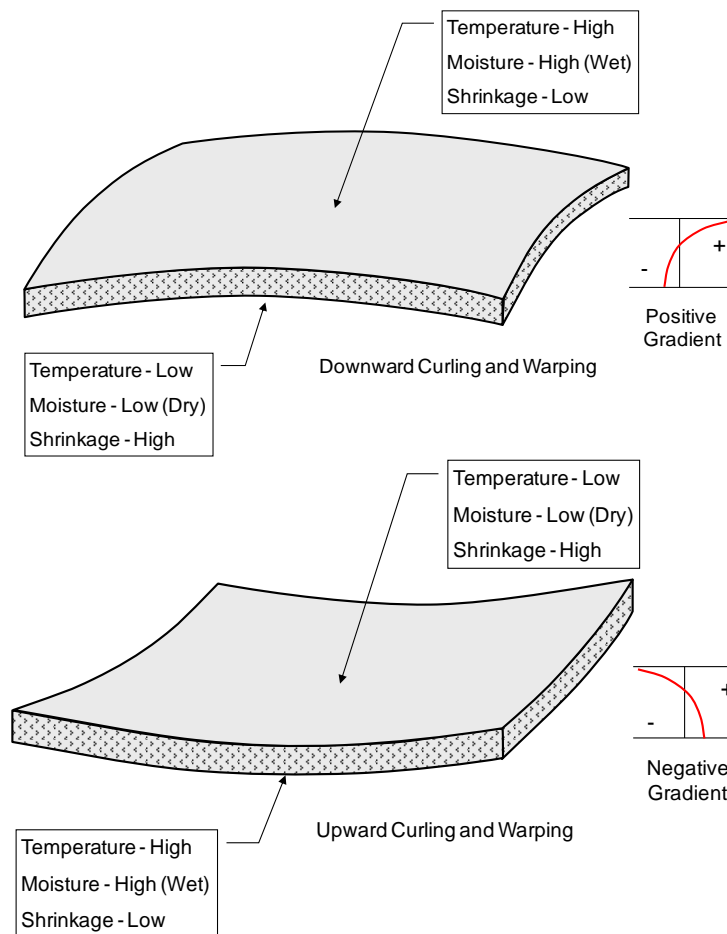

Figure 7.20 Curling and Warping

The magnitude of thermal and moisture gradients within a pavement are influenced by factors of daily temperature and relative humidity conditions, base layer type, slab geometry with constraints, shrinkage characteristics, and concrete mixture characteristics. The key characteristics of concrete mixtures that influence pavement response to thermal gradients are coefficient of thermal expansion, thermal conductivity, and specific heat (5).

Paving operations are often performed during the mornings and daytime of hot sunny days, a condition that tends to expose the newly paved slabs to a high temperature difference from the intense solar radiation and heat of hydration. Depending on the exposure conditions, a significant amount of positive temperature gradient may be present at the time of hardening. On the other hand, shrinkage occurs with the surface drying and bottom moisture wicking into the base/subbase. This resultant condition has been termed the "zero-stress temperature gradient" and is permanently locked into the slab at the time of construction. The permanent components of curling and warping are considered together and are indistinguishable. Creep occurs over time and negates the effects of the permanent curvature but only a portion of the permanent curling and warping actually affects the long term pavement response (7). Refer to CDOT Final Research Report CDOT-DTD-R-2006-9, *Implementation of Proven PCCP Practices in Colorado*, dated April 2006 (8) for additional discussion on curling.

The M-E Design recommended value for permanent curl/warp is -10°F (obtained through optimization) for all new and reconstructed rigid pavements in all climatic regions. This is an equivalent linear temperature difference from top to bottom of the slab.

7.13 Dowel Bars (Load Transfer Devices) and Tie Bars

Load transfer is used to account for the ability of a concrete pavement structure to transfer (distribute) load across discontinuities, such as joints or cracks. Load transfer devices, aggregate interlock, and the presence of tied longitudinal joints along with tied shoulders all have an effect.

All new rigid pavements, new construction and reconstruction, including ramps, auxiliary lanes, acceleration/deceleration lanes, and urban streets will require epoxy coated smooth dowel bars in the transverse joints for load transfer. Smooth dowel bars aid the transfer of load across joints and allow thermal contraction in the PCCP. Since these transverse joints must be allowed to expand and contract, deformed tie bars should never be used as load transfer devices in the transverse direction. Most pavements should be dowelled.

If the pavement has shoulders, the shoulders must be portland cement concrete and tied to the travel lanes. Two major advantages of using tied portland cement concrete shoulders is the reduction of slab stress and increased service life. Concrete shoulders of three feet or greater may be considered a tied shoulder. Pavements with monolithic or tied curb and gutter that provide additional stiffness and keep traffic away from the edge may be treated as a tied shoulder. Studies have shown that on interstate projects, increasing the outside slab an additional two feet is equivalent to a tied shoulder. In a typical situation with 12-foot lane widths, the paint stripe is placed at 12 feet and the longitudinal joint is sawed and tied at 14 feet. Requiring the longitudinal joint to coincide with the lane line is recommended in urban locations. 14-foot longitudinal joints

may not be appropriate for ramps, since ramps are usually much thinner in comparison to the main line pavement.

Dowel bar diameter and tie bar size vs. for thickness of concrete pavement and type of base is tabulated and noted in CDOT Standard Drawing M-412-1, Sheet 5, Reinforcing Size Table (9). The table is reproduced in **Table 7.3 Reinforcing Size Table**.

Table 7.3 Reinforcing Size Table

Pavement Thickness (T) inches	Dowel Bar Diameter inches
$T < 8$	1
$8 \geq T \leq 10$	1.25
$10 > T \leq 15$	1.50

Tie bars for longitudinal joints shall conform to AASHTO M284 and shall be Grade 60, epoxy-coated, and deformed. Tie bar length is to be 30 inches and spaced at 36 inches on center. Tie bar size is No. 5 when pavement is placed on unbound bases. Tie bar size is No. 6 when pavement is placed on lime treated soil, asphalt treated, cement treated, milled asphalt or recycled asphalt pavement bases.

Dowel bars for transverse joints shall conform to AASHTO M254 for the coating and to ASTM A615, Grade 60 for the core material and shall be epoxy-coated, smooth, and lightly greased, pre-coated with wax or asphalt emulsion, or sprayed with an approved material for their full length.

Details illustrating dowel placement tolerances are shown on CDOT Standard Drawing M-412-1, Sheet 1 (9). Dowel bar placement is at $T/2$ depth. Refer to **Figure 7.21 Details of Dowel Bar Placement**.

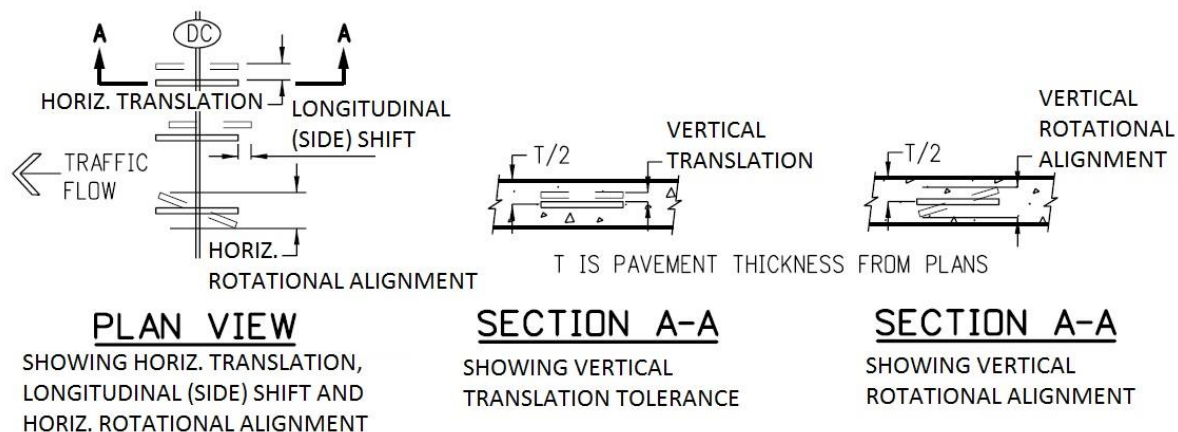

Figure 7.21 Details of Dowel Bar Placement

The tolerances are referenced in Subsection 412.13(b)2 of the CDOT *Standard Specification for Road and Bridge Construction*, 2011 (23) and as revised. The tolerance table is reproduced in **Table 7.4 Dowel Bar Target Placement Tolerances**. Tolerances are based on *NCHRP Report 637, Guidelines for Dowel Alignment in Concrete Pavements* (22).

Table 7.4 Dowel Bar Target Placement Tolerances

Position	Tolerance inches
Horizontal and Vertical Translation	1
Longitudinal (Side) Shift Translation	3
Horizontal and Vertical Rotational Alignment	1.5

For tied concrete shoulders, the M-E Design requires the input of the long-term or terminal deflection load transfer efficiency (LTE) between the lane (PCC outer lane slab) and shoulder longitudinal joint. The LTE is defined as the ratio of deflections of the unloaded and loaded slabs. The higher the LTE, the greater the support provided by the shoulder to reduce critical responses of the mainline slabs. Typical long-term deflection LTE are:

- 50 to 70 percent for a monolithically constructed and tied PCC shoulder.
- 30 to 50 percent for a separately constructed tied PCC shoulder.
- Untied concrete shoulders or other shoulder types do not provide significant support; therefore, a low LTE value should be used.

7.14 Lane Edge Support Condition (E)

Conventional lane width (12 feet) with free edge
 Conventional lane width (12 feet) with tied concrete shoulder
 Wide slab (i.e. 14 feet) with conventional traffic lane width (12 feet).

Refer to CDOT Final Research Report CDOT-DTD-R-2006-9, *Implementation of Proven PCCP Practices in Colorado*, dated April 2006 (8) and Refer to *Evaluation of Premature PCCP Longitudinal Cracking in Colorado*, Final Research Report CDOT-DTD-R-2003-1, dated January 2003 (11) for additional discussion on widen slabs.

7.15 Base Erodibility

The erodibility index allows the designer to select the resistance of base to erosion. The potential for base or subbase erosion (layer directly beneath the PCC layer) has a significant impact on the initiation and propagation of pavement distress. Different base types are classified based on long-term erodibility behavior as follows:

- Class 1 – Extremely erosion resistant materials
- Class 2 – Very erosion resistant materials
- Class 3 – Erosion resistant materials
- Class 4 – Fairly erodible materials
- Class 5 – Very erodible materials

Rigorous definitions of the material types that qualify under these various categories are presented in **Table 7.5 Material Types and Erodibility Class**.

Table 7.5 Material Types and Erodibility Class

Erodibility Class	Material Description and Testing
1	(a) Lean concrete with approximately 8 percent cement; or with long-term compressive strength > 2,500 psi. (> 2,000 psi. at 28-days) and a granular subbase layer or a stabilized soil layer, or a geotextile fabric is placed between the treated base and subgrade, otherwise Class 2. (b) Hot mixed asphalt concrete with 6 percent asphalt cement that passes appropriate stripping tests (see Figure 2.2.8) and aggregate tests and a granular subbase layer or a stabilized soil layer (otherwise Class 2). (c) Permeable drainage layer (asphalt treated aggregate (see Figure 2.2.8 and table 2.2.57 for guidance) or cement treated aggregate (see Table 2.2.58 for guidance) and with an appropriate granular or geotextile separation layer placed between the treated permeable base and subgrade.
2	(a) Cement treated granular material with 5 percent cement manufactured in plant, or long-term compressive strength 2,000 to 2,500 psi (1,500 to 2,000 psi at 28-days) and a granular subbase layer or a stabilized soil layer, or a geotextile fabric is placed between the treated base and subgrade; otherwise Class 3. (b) Asphalt treated granular material with 4 percent asphalt cement that passes the appropriate stripping test and a granular subbase layer or a treated soil layer or a geotextile fabric is placed between the treated base and subgrade; otherwise Class 3.
3	(a) Cement-treated granular material with 3.5 percent cement manufactured in plant, or with long-term compressive strength 1,000 to 2,000 psi (750 psi to 1,500 at 28-days). (b) Asphalt treated granular material with 3 percent asphalt cement that passes appropriate stripping test.
4	Unbound crushed granular material having dense gradation and high quality aggregates.
5	Untreated soils (PCC slab placed on prepared/compacted subgrade)

7.16 Sealant Type

Sealant type applied for transverse joints is a key input used in joint spalling model. Recall that the spalling model is used for predicting JPCP smoothness. The sealant options are liquid, silicone, and preformed.

7.17 Concrete Pavement Minimum Thickness

Table 7.6 Minimum Thicknesses for Highways, Roadways and Bicycle Paths

Traffic, 18k ESALs	Portland Cement Concrete Pavement (inches)
Greater than 1,000,000	8.0
Less than or equal to 1,000,000 or Driveway, Sidewalk, Bicycle Path, and Maintenance Pavement	6.0

The minimum thickness requirement may be changed on a project-to-project basis depending upon traffic, soil conditions, bases, etc. (see **Table 7.6 Minimum Thickness for Highways, Roadways and Bicycle Paths**).

7.18 Concrete Pavement Texturing, Stationing, and Rumble Strips

Final surface of the pavement shall be uniformly textured with a broom, burlap drag, artificial turf, or diamond ground to obtain a specified average texture depth of the panel being greater than 0.05 inch. Refer to CDOT Final Research Report CDOT-2012-10, *Assessment of Concrete Pavement Texturing Methodologies in Colorado*, dated October 2012 (25).

Also, refer to CDOT Final Research Report CDOT-DTD-R-2005-22, *PCCP Texturing Methods*, dated January 2005 (12).

Stationing shall be stamped into the outside edge of the pavement, as shown on the plans. The stationing shall be stamped at 500-foot interval on each outside mainline shoulder as shown on Standard Plan No. M-412-1, *Concrete Pavement Joints*.

When Rumble Strips are installed, they shall be of the style and location as shown on Standard Plan Sheet No. M-614-1, Rumble Strips.

7.19 Concrete Pavement Materials Selection

Concrete pavement is a construction paving material that consists of cement (commonly Portland cement), other cementitious materials (fly ash), aggregate (gravel and sand), and water along with chemical admixtures. The concrete solidifies and hardens after mixing and placement due to a chemical process known as hydration. The water reacts with cement, which bonds the other components together, eventually creating a hard stone-like material.

CDOT designates a concrete pavement mix as a Class P. **Table 7.7 Concrete Classification** shows the specified mix properties. Class E is a fast track mix that may be substituted for Class P.

Table 7.7 Concrete Classification

Concrete Class	Required Field Compressive Strength (psi)	Cementitious Content: Minimum (lbs/yd ³)	Air Content: % Range (Total)	Water Cement Ratio: Maximum
P	4,200 at 28 days	660	4-8	0.44
E	4,200 at 28 days	660	4-8	0.44

Class P and E are defined in Section 601 Structural Concrete and 701 Hydraulic Cement of CDOT *Standard Specification for Road and Bridge Construction*, 2011 (23) and as revised.

7.19.1 Understanding pH in Concrete Mixes

A brief explanation of pH is presented in Section **S.1.4.2 pH Scale** in the **SUPPLEMENT** Chapter. When applied to pavement design, freshly poured concrete can have a pH of 11 to 13 making it very alkaline. This high initial alkalinity helps resist corrosion, but as concrete ages, the pH can drop to around 8 increasing the degradation of steel reinforcement and load transfer devices. The high alkalinity of concrete can also affect the performance of fresh and hardened concrete when admixtures are used.

7.19.2 Alkali Aggregate Reactivity

The high alkalinity of concrete can cause serious problems when interacting with different parts of the mix, namely alkali-silica and alkali-carbonate reactions. Alkali-silica reactivity (ASR) is the process in which certain minerals in the aggregate along with the presence of moisture are broken down by the highly alkaline environment of concrete. This process produces a gel-like substance that expands adding tensile forces to the concrete matrix, which then leads to external cracking of the concrete slab (13). The cracking then allows more water to infiltrate into the concrete creating more gel and more expansion. Ultimately, the concrete destroys itself. The ASR chemical reaction is expressed in equation **Eq. 7-1** (15) below.

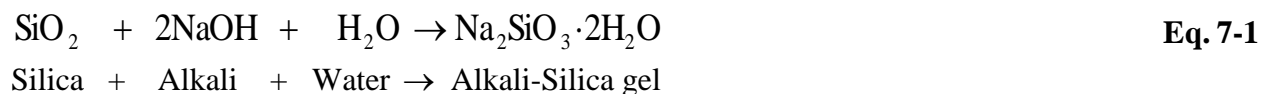

Alkali-carbonate reactivity (ACR) is much less common than ASR, but it does have similar expansive properties that occur within the aggregate and deteriorate concrete pavement. The ACR reaction is dependent on certain types of clay rich, or impure, dolomitic limestones that are rarely used in concrete, because of their inherently weak structure (14). The ACR chemical reaction known as dedolomitization is represented in equation **Eq. 7-2** (15).

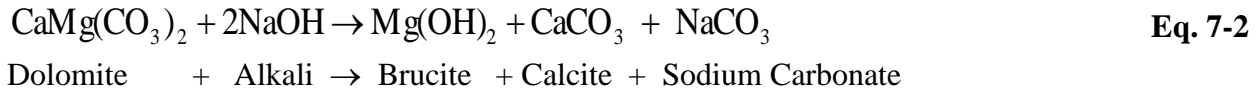

The cracking pattern is shown in **Figure 7.22 Idealized Sketch of Cracking Pattern in Concrete Mass Caused By Internal Expansion.**

"Sandgravel" aggregates in parts of Kansas, Nebraska, Colorado, Wyoming, especially those from the Platte, Republican, and Laramie Rivers, have been involved in the deterioration of concrete (17). In 1983 a team was formed to evaluate the concrete pavement condition in Colorado and to recommend rehabilitation methods for these pavements. This team identified that one-third of the pavements inspected suffered from ASR (19). A follow up study conducted in 1987 focused on the cause of ASR in Colorado. The study concluded that aggregates in the Denver Metro area showed no signs of ASR reaction, but aggregate from the Three Bells pit near Windsor demonstrated rapid signs of expansion. This study led CDOT to modify its specifications and require low alkali cement for all concrete pavement, it also identified the need for Class F fly ash in areas where reactive aggregates have been a problem (20).

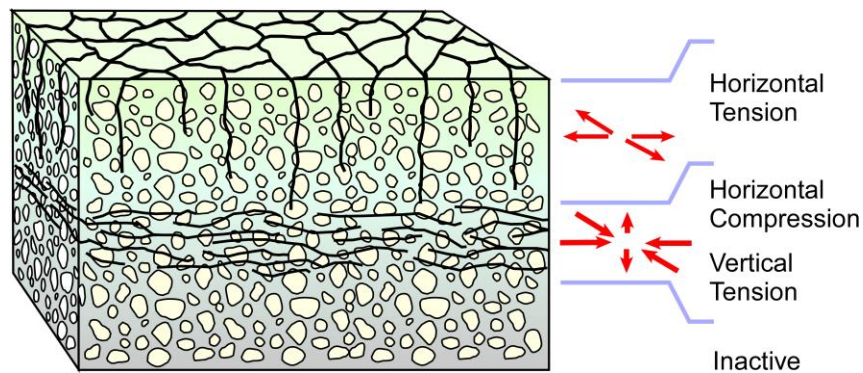

Figure 7.22 Idealized Sketch of Cracking Pattern in Concrete Mass Caused By Internal Expansion

(Figure 93, Petrographic Methods of Examining Hardened Concrete: A Petrographic Manual, July 2006)

7.19.3 Sulfate Resistant Concrete Pavement

Sulfates may be found in soil and water. These sulfates may also be referred to as "alkali". The sulfates in soils and water are the main source of external sulfate attack on concrete pavement. Although the mechanism of sulfate attack is complex, it is primarily thought to be caused by two chemical reactions: 1) the formation of gypsum through the combination of sulfate and calcium ions, and/or 2) the formation of ettringite through the combination of sulfate ions and hydrated calcium aluminate (18). Ettringite is a high-sulfate, calcium sulfoaluminate mineral: $\text{Ca}_6[\text{Al}(\text{OH})_6]_2(\text{SO}_4)_3 \cdot 26\text{H}_2\text{O}$ which naturally occurs in curing concrete. The problem appears when ettringite forms after the concrete has set, this is known as Delayed Ettringite Formation (DEF). This process is extremely harmful, because as ettringite crystals form they expand and

create internal tensile stresses in the cement matrix (21). These stresses will cause the concrete to crack, but may not be apparent for 3-10 years (18).

The sulfate attack is a chemical reaction between sulfates and the calcium aluminate (C_3A) in cement, resulting in surface softening (22). See **Figure 7.23 Sulfate Attack**.

Steps taken to prevent the development of distress due to external sulfate attack include minimizing the tricalcium aluminate content in the cement or reducing the quantity of calcium hydroxide in the hydrated cement paste through the use of pozzolanic materials. It is also recommended that a w/c ratio less than 0.45 to help mitigate external sulfate attack (18).

Severity levels of potential exposure to sulfate attack have been developed. **Table 7.8 Requirements to Protect Against Damage to Concrete by Sulfate Attack from External Sources of Sulfates** shows the classification levels of potential exposure. Concrete pavement mix designs must provide protection against sulfate attack, thus cementitious material requirements are modified. As the severity of potential exposure increases, the cementitious material requirements also become more stringent and the water cement ratio becomes less stringent. Refer to Section 601 Structural Concrete of CDOT *Standard Specification for Road and Bridge Construction*, 2011 (23) and as revised for additional cementitious material requirements.

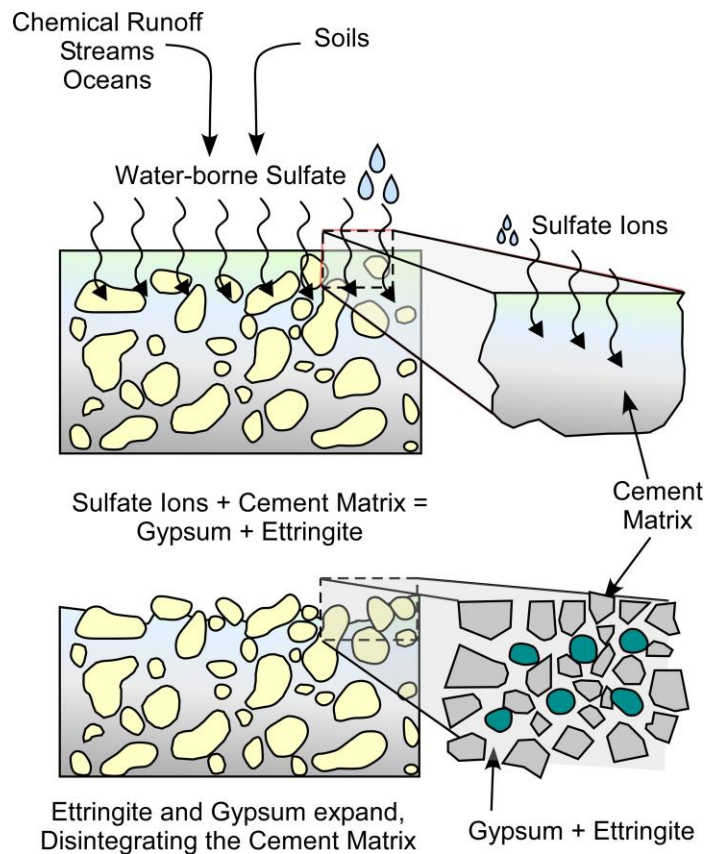

Figure 7.23 Sulfate Attack

(Figure 5-18: *Integrated Materials and Construction Practices for Concrete Pavement: State-of-the-33 Practice Manual*)

Table 7.8 Requirements to Protect Against Damage to Concrete by Sulfate Attack from External Sources of Sulfates

Severity of Potential Exposure	Water-soluble Sulfate (SO₄), Percent Dry Soil	Sulfate (SO₄) in water, ppm	Water Cement Ratio, Maximum	Cementitious Material Requirements
Class 0 exposure	0.00 to 0.10	0 to 150	0.50	Class 0 requirements
Class 1 exposure	0.11 to 0.20	150 to 1500	0.50	Class 1 requirements
Class 2 exposure	0.21 to 2.00	1501 to 10,000	0.45	Class 2 requirements
Class 3 exposure	2.01 or greater	10,001 or greater	0.40	Class 3 requirements

References

1. *AASHTO Guide for Design of Pavement Structures*, American Association of State Highway and Transportation Officials, Washington, DC, 1993.
2. *Supplement AASHTO Guide for Design of Pavement Structures, Part II, - Rigid Pavement Design & Rigid Pavement Joint Design*, American Association of State Highway and Transportation Officials, Washington, DC, 1998.
3. *Techniques for Pavement Rehabilitation*, Nichols Consulting Engineers, Chtd., U.S. Department of Transportation, Federal Highway Administration and National Highway Institute, Arlington, Virginia, Sixth Edition, January 1998.
http://www.fhwa.dot.gov/pavement/pub_details.cfm?id=375
4. *LTPP Data Analysis Phase I: Validation of Guidelines for k-Value Selection and Concrete Pavement Performance Prediction*, Publication FHWA-RD-96-198, Federal Highway Administration, Research and Development, Turner-Fairbank Highway Research Center, 6300 Georgetown Pike, McLean, VA 22101-2296, January 1997.
5. Wells, Steven A., *Early Age Response of Jointed Plain Concrete Pavements to Environmental Loads*, thesis was presented and defended on July 27, 2005, University of Pittsburgh, School of Engineering, 2005.
6. *Computer-Based Guidelines for Concrete Pavements, Volume II: Design and Construction Guidelines and HIPERPAV[®] II User's Manual*, Publication No. FHWA-HRT-04-122, U.S. Department of Transportation, Federal Highway Administration, Research and Development, Turner-Fairbank Highway Research Center, 6300 Georgetown Pike, Mclean VA 22101-2296, February 2005.
7. *Guide for Mechanistic-Empirical Design*, Final Report, NCHRP Project 1-37A, National Cooperative Highway Research Program, Transportation Research Board, National Research Council, Submitted by ARA, INC., ERES Consultants Division, Champaign, IL, March 2004.
8. Ardani, Ahmad, *Implementation of Proven PCCP Practices in Colorado*, Final Report, Report No. CDOT-DTD-R-2006-9, Colorado Department of Transportation, Research Branch, April 2006.
9. CDOT Standard Plans, Concrete Pavement Joints M-412-1, July 2006.
10. *Standard Specifications for Road and Bridge Construction*, Colorado Department of Transportation, Denver, Co, 2005.

11. Ardani, Ahmad, Hussain, Shamshad, and LaForce, Robert, *Evaluation of Premature PCCP Longitudinal Cracking in Colorado*, Final Report, Report No. CDOT-DTD-R-2003-1, Colorado Department of Transportation, Research Branch, January 2003.
12. Ardani, Ahmad and Outcalt, William (Skip), *PCCP Texturing Methods*, Final Report, Report No. CDOT-DTD-R-2005-22, Colorado Department of Transportation, Research Branch, January 2005.
13. *Alkali Silica Reactivity*, Canadian Strategic Highway Research Program, Transportation Association of Canada, Technical Brief #13, April 1996, 1 October 2007. <http://www.cshrp.org/products/csbf-e13.pdf>
14. *Alkali Aggregate Reaction*, Concrete Technology, Portland Cement Association, 2007, 2 October 2007. http://www.cement.org/tech/cct_dur_AAR.asp
15. *Alkali-Aggregate Reaction in Roads & Bridges*, West, Graham, London: Thomas Telford Ltd. 1996 pp. 10-12.
16. *Petrographic Methods of Examining Hardened Concrete: A Petrographic Manual*, Publication No. FHWA-HRT-04-150, 1401 East Broad Street, Richmond, VA 23219 and Federal Highway Administration, Office of Infrastructure R&D, 6300 Georgetown Pike, McLean, VA 22101, July 2006.
17. *Standard Practice for Concrete for Civil Works Structures*, Publication No. EM 1110-2-2000, Department of the Army, US Army Corps of Engineers, Washington, DC 20314-1000, 1 February 1994.
18. *Guidelines for Detection, Analysis, and Treatment of Materials-Related Distress in Concrete Pavements - Volume 1: Final Report*, Report No. FHWA-RD-01-163, U.S. Department of Transportation, Federal Highway Administration, Research, Development and Technology, Turner-Fairbank Highway Research Center, 6300 Georgetown Pike, Mclean VA 22101-2296, August 2002.
19. *Rehabilitation of Concrete Pavements*, Report No. CDOH-83-1, Colorado Department of Highways, U.S. Department of Transportation, Federal Highway Administration, January 1983.
20. *Colorado Reactive Aggregate*, Report No. CDOH-DH-DML-87-5, Colorado Department of Highways, U.S. Department of Transportation, Federal Highway Administration, June 1987.
21. *Integrated Materials and Construction Practices for Concrete Pavement: State-of-the-Practice Manual*, FHWA Publication No. HIF-07-004, U.S. Department of Transportation, Federal Highway Administration, October 2007.

22. *Guidelines for Dowel Alignment in Concrete Pavements*, NCHRP Report 637, National Cooperative highway Research Program, Transportation Research Board, Washington, D.C., 2009.
23. *Standard Specifications for Road and Bridge Construction*, Colorado Department of Transportation, Denver, Co, 2011.
<http://www.coloradodot.info/business/designsupport/construction-specifications/2011-Specs>
24. *AASHTO Mechanistic-Empirical Pavement Design Guide, A Manual of Practice, Interim Edition, July 2008*, American Association of State Highway and Transportation Officials, Washington, DC, 2008.
25. Rasmussen, Robert Otto and Sohaney, Richard C., *Assessment of Concrete Pavement Texturing Methodologies in Colorado*, CDOT Final Research Report CDOT-2012-10, dated October 2012 (24).

CHAPTER 8

PRINCIPLES OF DESIGN FOR PAVEMENT REHABILITATION WITH FLEXIBLE OVERLAYS

8.1 Introduction

This chapter describes the information needed to create cost effective rehabilitation strategies using the M-E Design software. Policy decision making that advocates applying the same standard fixes to every pavement does not produce successful pavement rehabilitation. Successful rehabilitation depends on decisions that are based on the specific condition and design of the individual pavement. The rehabilitation design process begins with collection and detailed evaluation of project information in order to determine the cause of the pavement distress. Finally, a choice needs to be made to select an engineered rehabilitation technique(s) that will correct the distresses.

Overlays are used to remedy structural or functional deficiencies of existing flexible pavements and extend their useful service life. It is important that the designer consider the type of deterioration present when determining whether the pavement has a structural or functional deficiency, so that an appropriate overlay type and design can be developed. See **Figure 8.1 Rehabilitation Alternative Selection Process** for the flowchart of rehabilitation alternative selection process. Designers must consider all of these steps, however, to produce feasible rehabilitation with flexible overlay design alternatives.

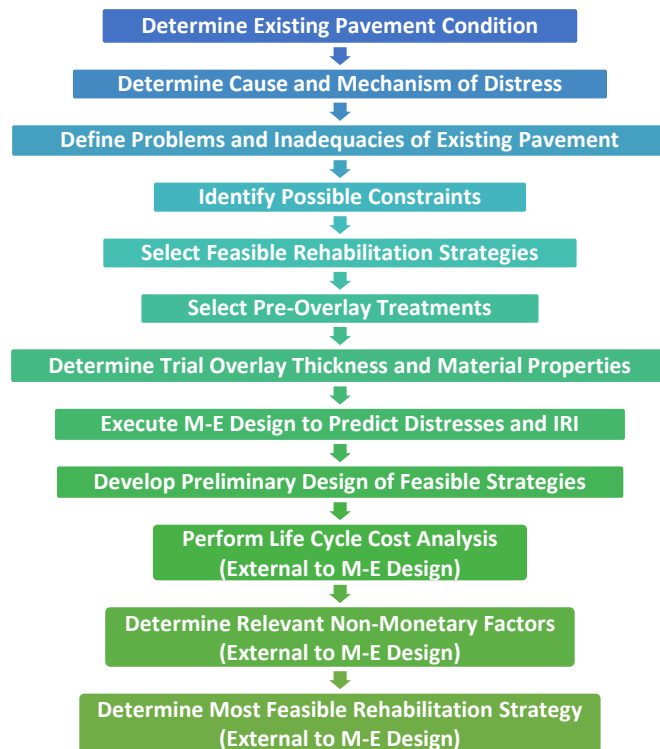

Figure 8.1 Rehabilitation Alternative Selection Process

8.1.1 Structural Versus Functional Overlays

The overlay design procedures in this section provide an overlay thickness to correct a structural deficiency. If no structural deficiency exists, an overlay thickness equal to zero will be obtained. Structural deficiency arises from any condition that adversely affects the load carrying capability of the pavement structure. These include inadequate thickness as well as cracking, distortion, and disintegration. It should be noted that several types of distress, i.e. distresses caused by poor construction techniques, are not initially caused by traffic loads, but do become more severe under traffic to the point that they also detract from the load carrying capability of the pavement. An overlay lift thickness should be at about two inches when correcting structural deficiencies.

Functional deterioration is defined as any condition that adversely affects the highway user. Overlay designs, including thickness, preoverlay repairs and reflection crack treatments, must address the causes of functional problems and prevent their recurrence. This can only be done through sound engineering, and requires experience in solving the specific problems involved. The overlay design required to correct functional problems should be coordinated with that required to correct any structural deficiencies. Functional deficiency arises from any conditions that adversely affect the highway user. These include poor surface friction and texture, hydroplaning and splash from wheel path rutting, and excess surface distortion. If a pavement has only a functional deficiency, it would not be appropriate to develop an overlay design using a structural deficiency design procedure.

Leveling courses could be part of a functional rehabilitation strategy, since the thickness varies throughout, they do not improve the structural value. This does not mean, that the pavement does not need an overlay to correct a functional deficiency. If the deficiency is primarily functional, then a minimal overlay should remedy the functional problem. If the pavement has a structural deficiency as well, a structural overlay thickness that is adequate to carry future traffic over the design period is needed.

8.1.2 Guidelines

The following guidelines may help determine what type of rehabilitation is needed. Additional information concerning mix designs and properties may be found in **APPENDIX E**.

Major Rehabilitation

Pavement treatments that consist of structural enhancements that extend the serviceable life of an existing pavement and improve its load-carrying capability.

- Minimum design life of 10 years for asphalt or concrete. Pavement design criteria and LCCA shall be performed as required.
- Thin bonded concrete overlays of asphalt.
- Typical treatments include resurfacing with full depth reclamation, slab replacement and rubblization along with those found with Minor Rehabilitation.

Minor Rehabilitation

Pavement treatments consisting of functional or structural enhancements made to the existing pavement sections to improve pavement performance or extend serviceable life.

- Functional enhancements will be documented to address issues of concern to ensure proper treatment selection. No design life criteria will be required for functional treatments. LCCA is optional for functional treatments as the intent is to replace existing pavement structure and correct functional and or age-related issues with the existing pavement structure.
- Structural enhancements will have a minimum design life of 10 years for asphalt or concrete. Pavement design criteria and LCCA shall be performed as required.
- Typical treatments in addition to resurfacing may include milling, leveling course, cold-in-place recycling or hot in-place recycling, diamond grinding, a small amount of full-depth or partial depth panel replacement, dowel and tie bar repairs, stitching cracks, routing and sealing the joints and cracks.

Pavement Maintenance

Typically, these treatments are preventive in nature and are intended to keep the pavement in serviceable condition. They may be classified as corrective, preventive, reactive or functional.

- A LCCA is not required for pavement maintenance treatments as the intent is to replace or maintain the existing pavement structure and correct construction related issues, functional and or age-related issues with the existing pavement structure and to perform corrective maintenance treatments as needed.
- Preventive maintenance projects will be performed on pavements in good or fair condition.
- Functional maintenance projects, when applicable, will be used to correct functional and or age-related issues with the existing pavement structure and to perform corrective maintenance treatments as needed. These projects will primarily be performed on low volume roadways.
- Typical treatments include thin functional treatments 1 ½” in thickness or less or other treatments only intended to maintain the existing pavement. Examples include thin HMA/SMA overlays, chip seals, crack sealing, panel replacement, dowel and tie bar repairs, diamond grinding, and crack stitching.

8.2 Determine Existing Pavement Condition

8.2.1 Records Review

Obtaining specific project information is the first step in the process of rehabilitation. Five basic types of detailed project information are necessary; design, construction, traffic, environmental, and pavement condition. One should conduct a detailed records review before an evaluation of project can be made. Refer to **Section 2.3 Project Files/Records Collection and Review** for more information on records review.

8.2.2 Field Evaluation

A detailed field evaluation of the existing pavement condition and distresses is necessary for rehabilitation design. As a minimum, designers must consider the following as part of pavement evaluation:

- Existing pavement design, condition of pavement materials, especially durability problems and subgrade soil.
- Distress types present, severities, and quantities.
- Future traffic loadings.
- Climate.
- Existing subdrainage facilities condition.

It is important that the existing pavement condition evaluation be conducted to identify functional and structural deficiencies to enable designers to select an appropriate combination of preoverlay repair treatments, reflection crack treatments and flexible overlay designs to correct the deficiencies present.

8.2.3 Visual Distress

Prior to the selection of corrective measures, the types of distress have to be identified and documented. In order to determine the pavement distress and condition, a field inspection is mandatory. Isolating areas of distress can pinpoint different solutions for different sections along a project. The cause of distresses is not always easily identified and may consist of a combination of problems. **Figure 8.2 Pavement Condition Evaluation Checklist (Flexible)** provides guidance for existing pavement evaluation (a similar checklist is available in **Figure 9.2 Pavement Condition Evaluation Checklist (Rigid)** for rigid pavement). For information on how to conduct the distress survey, refer to **Appendix A.4 Site Investigation**.

CDOT has a distress manual documenting pavement distress, description, severity levels and additional notes. The distress manual is presented in Appendix B - Colorado DOT Distress Manual for HMA and PCC Pavements in the publication *Development of a Pavement Maintenance Program for the Colorado Department of Transportation*, Final Report, CDOT-DTD-R-2004-17, August 2004. The report is in pdf format and can be downloaded from the web page <http://www.coloradodot.info/programs/research/pdfs/2004/preventivemaintenance.pdf>.

8.2.4 Drainage Survey

Condition of drainage structures and systems such as ditches, longitudinal edge drains, transverse drains, joint and crack sealant, culverts, storm drains, inlets, and curb and gutters are all important to convey water away from the pavement structure. Visual distress will reveal the types and extents of distresses present in the pavement that are either caused by or accelerated by moisture. Drainage assessment can also be benefited by data obtained from coring and material testing.

8.2.5 Non-Destructive Testing, Coring and Material Testing Program

In addition to a survey of the surface distress, a coring and testing program is recommended to verify or identify the cause of the observed surface distress. The locations for coring should be selected following the distress survey to assure that all significant pavement conditions are represented. If NDT is used, the data from that testing should also be used to help select appropriate sites for additional coring.

The objective of the coring is to determine material thicknesses and conditions. A great deal of information will be gained by a visual inspection of the cored material. However, it should be kept in mind that the coring operation causes a disturbance of the material especially along the cut face of asphaltic concrete material. For example, in some cases coring has been known to disguise the presence of stripping. Consequently, at least some of the asphalt cores should be split apart to check for stripping. The appropriate core diameter will be as determined by the RME.

The testing program should be directed toward determining how the existing materials compare with similar materials that would be used in a new pavement, how the materials may have changed since the pavement was constructed, and whether or not the materials are functioning as expected. The types of tests to be performed will depend on the material types and the types of distress observed. A typical testing program may include strength tests for asphaltic concrete and portland cement concrete cores, gradation tests to look for evidence of degradation and/or contamination of granular materials, and extraction tests to determine binder contents and gradations of asphaltic concrete mixes. Portland cement concrete cores exhibiting durability problems may be examined by a petrographer to identify the cause of the problem. For flexible pavement evaluation, NDT testing is used to determine the elastic modulus of each of the structural layers, including subgrade, at non-distressed locations. Refer to **APPENDIX C**.

PAVEMENT EVALUATION CHECKLIST (FLEXIBLE)

PROJECT NO.: _____ LOCATION: _____
 PROJECT CODE (SA #): _____ DIRECTION: _____ MP _____ TO MP _____
 DATE: _____ BY: _____
 TITLE: _____

TRAFFIC

- Existing 18k ESAL/YR
 - Design 18k ESAL

EXISTING PAVEMENT DATA

- Subgrade (AASHTO) - Roadway Drainage Condition
 (good, fair, poor)
 - Base (type/thickness) - Shoulder Condition
 (good, fair, poor)
 - Soil Strength (R/M_R)

DISTRESS EVALUATION SURVEY

Type	Distress Severity*	Distress Amount*
Alligator (Fatigue) Cracking		
Bleeding		
Block Cracking		
Corrugation		
Depression		
Joint Reflection Cracking (from PCC Slab)		
Lane/Shoulder Joint Separation		
Longitudinal Cracking		
Transverse Cracking		
Patch Deterioration		
Polished Aggregate		
Potholes		
Raveling/Weathering		
Rutting		
Slippage Cracking		
OTHER		

* Distress Identification Manual for the Long-Term Pavement Performance Program, U.S. Department of Transportation, Federal Highway Administration, Publication No. FHWA-RD-03-031, June 2003.

Figure 8.2 Pavement Condition Evaluation Checklist (Flexible)
(A restatement of Figure A.2)

8.3 Determine Cause and Mechanism of Distress

Knowing the exact cause of distress is a key input required by designers for assessing the feasibility of rehabilitation design alternatives. Additionally, the evaluation of existing pavement conditions is a critical element in M-E based rehabilitation design. An assessment of existing pavement conditions is performed using outputs from distress and drainage surveys, and usually coring and testing of materials. The observation should begin with a review of all information available regarding the design, construction, and maintenance history of the pavement. This should be followed by a detailed survey to identify the type, amount, severity, and location of surface distresses. Some key distress types that are indicators of structural deficiencies are as follows:

- Fatigue or alligator cracking in the wheel paths. Patching and a structural overlay are required to prevent this distress from reoccurring.
- Rutting in the wheel paths.
- Transverse or longitudinal cracks that develop into potholes.
- Localized failing areas where the underlying layers are disintegrating and causing a collapse of the asphaltic concrete surface, i.e. major shear failure of base course or subgrade, or stripping of the bituminous base course. This is a very difficult problem to repair and an investigation should be carried out to determine its extent. If the failure is not extensive, full depth patching and a structural overlay should remedy the problem. If the failure is too extensive for full depth patching, reconstruction or a structural overlay designed for the weakest area is required.
- There may be other types of distress that, in the opinion of the engineer, would detract from the performance of an overlay.

Depending on the types and amounts of deterioration present, rehabilitation options with or without pre-overlay treatments are to be considered. **Table 8.1 Common Distresses Causes of Flexible Pavements and Associated Problem Types** presents a summary of distress causes present on existing flexible pavements.

8.4 Define Problems and Inadequacies of Existing Pavement

Accurately identifying existing problems is key factor when selecting appropriate rehabilitation design alternatives for the trial design. Information gathered and presented using the pavement condition evaluation checklist must be reviewed by the designer using guidance presented in **Table 8.1 Common Distresses Causes of Flexible Pavements and Associated Problem Types** to define possible problems with the existing pavement. A review of the extent and severity of distresses present will allow the designer to determine if the existing pavement deficiencies are primarily structural, functional, or materials durability related. It also allows the designer to determine if there is a fundamental drainage problem causing the pavement to deteriorate prematurely.

Table 8.1 Common Distresses Causes of Flexible Pavements and Associated Problem Types

Distress Types	Load	Environment			Materials	Construction
		Moisture	Temperature	Subgrade		
Alligator cracking	P	C	C	C	C	C
Bleeding	C	N	C	N	P	C
Block cracking and contraction / shrinkage fracture	N	C	P	N	P	C
Corrugation	P	C	C	N	C	N
Depression	C	C	N	C	P	P
Edge cracking	P	C	N	C	N	P
Transverse “thermal” cracks	N	N	P	N	P	C
Longitudinal cracks in the wheelpath	P	N	C	C	C	P
Longitudinal cracks outside the wheelpath	N	N	P	C	P	P
Potholes	P	C	C	N	C	C
Pumping	P	P	C	C	N	N
Raveling and weathering	N	C	C	N	P	C
Rutting	P	C	C	C	P	C
Shoving	P	C	C	C	P	N
Swelling and bumps	N	P	C	C	P	N

Notes: P= Primary Factor; C= Contributing Factor; N= Negligible Factor.

Once an existing pavement deficiency is characterized (functional, structural, durability, or combination of these) the next step is to select feasible design alternatives and perform a trial design. A description of common pavement problem types is presented as follows:

- Functional deterioration:** Functional deficiency arises from any conditions that adversely affect the highway user. These include poor surface friction and texture, hydroplaning and splash from wheel path rutting, and excess surface distortion. If a pavement has only a functional deficiency, it would not be appropriate to develop an overlay design using a structural deficiency design procedure. Overlay designs, including thickness, preoverlay repairs and reflection crack treatments, must address the causes of functional problems and prevent their recurrence. This can only be done through sound engineering, and requires experience in solving the specific problems involved. The overlay design required to correct functional problems should be coordinated with that required to correct any structural deficiencies.
- Structural deterioration:** This is defined as any condition that adversely affects the load carrying capability of the pavement structure. These include inadequate thickness as well as cracking, distortion, and disintegration. It should be noted that several types of distress,

i.e., distresses caused by poor construction techniques, are not initially caused by traffic loads, but do become more severe under traffic to the point that they also detract from the load carrying capability of the pavement.

- **Material durability deterioration:** This is defined as any condition that negatively impacts the integrity of paving materials leading to disintegration and eventual failure of the materials. Research indicates that poor durability performance can often be attributed to the existing pavement material constituents, mix proportions, and climatic factors, such as excessive moisture and intense freeze-thaw cycles. Examples of durability problems include AC stripping, aggregate damage from repeated freeze thaw cycles, secondary mineralization, embedded shale deposits, and alkali-aggregate.

8.5 Identify Possible Constraints

The feasibility of any type of overlay design depends on the following major considerations:

- Construction feasibility of the overlay.
- Traffic control.
- Materials and equipment availability.
- Climatic conditions.
- Construction problems such as noise, air and/water pollution, hazardous materials/waste, subsurface utilities, overhead bridge clearance, shoulder thickness and side slope extensions in the case of limited right-of-way, etc.
- Traffic disruptions.

Designers must consider all of the factors listed above along with others not mentioned to determine whether a flexible overlay or reconstruction is the best rehabilitation solution for a given situation.

8.6 Select Feasible Strategy for Flexible Pavement Rehabilitation Trial Designs

8.6.1 Feasible AC Overlay Alternatives

AC overlays are a cost effective rehabilitation technique used to correct existing pavement functional and structural deficiencies. The type and thickness of the required overlay are based on an evaluation of present pavement conditions and estimates of future traffic. In general the designer must apply the following rules when considering rehabilitation alternatives involving AC overlays:

- **When a pavement surface evaluation indicates adequate structural strength but the condition of the surface needs correction:** A functional overlay may be used. Surface conditions that may require correction include excessive permeability, surface raveling, surface roughness, rutting, and low skid resistance. **Table 8.2 List of Recommended Overlay Solutions to Functional Problems** provides a list of recommended overlay solutions to functional problems. Thus, for an existing pavement deemed as primarily

functional deficient, a minimal AC overlay (i.e. 1 to 2 inches) is recommended to remedy the problem. Note, leveling courses included as part of a rehabilitation strategy can be deemed as a functional overlay since their thickness varies along a project and, thus do not improve the pavement's structural capacity. The thickness of the leveling course must however be sufficient to correct the functional deficiency. Note, if an existing pavement has low to moderate distress, less than ½ inch rut depth, good drainage, and physical characteristics then other cost effective treatments may be appropriate, i.e. heater scarification. Note, if the existing pavement has low to moderate distress, rut depth between ½ inch and 1 inch, good drainage, and physical characteristics, a hot mix asphalt leveling course consisting of Grading SX, ST, or SF with smaller nominal aggregate size prior to the overlay may be a cost effective alternative.

For PCC pavements with minor functional or durability issues, thin asphalt overlays can be placed to correct surface distress. These overlays can range in thickness from the minimum 2 inch HMA overlay to a 3 inch overlay. Thin asphalt overlays are not to be placed over severely cracked, step faulted, shattered, or broken pavements.

Table 8.2 List of Recommended Overlay Solutions to Functional Problems

Functional Problem	Cause	Possible Overlay Solution
Surface Friction	Polishing or Bleeding of Surface	Thin overlay or micro-surfacing, milling maybe required.
Hydroplaning	Wheel Path Rutting	Thin overlay or micro-surfacing, milling may be required.
Surface Roughness	Distortion Due to Swells and Heaves	Leveling overlay with varying thickness.
Transverse and Longitudinal Cracking	Traffic Load, Climate and Materials	Conventional overlay and full depth repair may remedy this problem.
Potholes	Traffic Load	Conventional overlay and full depth repair may remedy this problem.
Raveling of the Surface	Climate and Materials	Thin overlay or micro-surfacing or HIR.
Raveling from Stripping	Inadequate Freeze Thaw Resistance	Removal of entire layer affected by stripping.

- **When a pavement surface evaluation indicates possible structural deficiencies: A more detailed analysis should be undertaken to determine the following:**
 - Do structural deficiencies exist?
 - If so can the deficiency be corrected by an HMA overlay?
 - Would the typical HMA overlay thickness be sufficient to accommodate predicted future traffic for the selected design period?

If the answer to all of the above questions is yes, then a thick HMA overlay to correct structural deficiencies is warranted. Note, a thick HMA overlay may be used to correct base or subgrade deficiencies, thus for pavements deemed as structurally deficient, a

structural overlay thickness that is adequate to carry future traffic over the design period is needed. The HMA overlay lift thickness should be at least 2 inches when correcting structural deficiencies.

Note: Although structural HMA overlays can generally be used for all structurally deficient existing pavements, conditions where an HMA overlay is not considered feasible for existing flexible or semi-rigid pavements are listed as follows:

- The use of thick flexible pavement overlays that do not satisfy the structural requirements of the pavement structure.
- Existing stabilized base show signs of serious deterioration and requires a large amount of repair to provide a uniform support for the HMA overlay.
- Existing granular base must be removed and replaced due to infiltration and contamination of clay fines or soils, or saturation of the granular base with water due to inadequate drainage.

Thicker HMA overlays may be used to provide additional structural capacity for the existing PCC pavement. Minor slab repairs are required to mitigate the continuation of PCC slab deterioration before an HMA overlay is placed.

- **When the existing pavement shows severe rutting or distortion or is severely cracked:** Total reconstruction may be warranted. Reflective cracking potential should be considered in making a determination whether to reconstruct or overlay the roadway. For instance, excessive structural rutting indicates the existing materials lack sufficient stability to prevent rutting from reoccurring, or the amount of high-severity alligator cracking is so great that complete removal and replacement of the existing pavement surface layer is dictated.

Existing, worn-out PCC pavements are prone to reflection cracking when an HMA overlay is placed. Horizontal and vertical movements occurring within the underlying PCC layer cause reflection cracking. Reflection cracking can occur at any PCC joint or crack. Reflection cracking can be mitigated if the existing PCC slab is rubblized into fragments.

- **When the existing pavement significant durability problems:** Total reconstruction may also be warranted if there is evidence of significant material durability problems for the existing pavement. For instance, stripping in existing HMA layers may warrant those layers need to be removed and replaced. Existing PCC pavements with reactive aggregates are expected to deteriorate even after an overlay is placed. In such situations, total reconstruction may be warranted.

8.6.2 Structural HMA Overlays

The AC overlay design in this Chapter provides an HMA overlay thickness to correct a structural deficiency. Conventional HMA or Stone Matrix Asphalt (SMA) overlays are similar to the thin wearing course overlays. Again, they are a single operation of placing flexible pavement over existing flexible pavements or rigid pavements. Generally, they are a thicker overlay than the thin wearing courses.

Thin preventive maintenance overlays or surface treatments can sometimes be placed to slow the rate of deterioration of pavements showing initial cracking, but do not exhibit any immediate structural or functional deficiency. Generally, preventive maintenance overlays should be done only on pavements with no obvious signs of major distress and have a Drivable Life (DL) of 6 years or more. This type of overlay includes thin flexible pavement and various surface treatments that help keep out moisture. Preventive maintenance overlays are generally single operations. The overlays may be a thin wearing course over existing flexible pavements or rigid pavements.

8.7 Proper Pre-Overlay Treatments and Other Design Considerations

Rehabilitation with conventional HMA overlays will only be effective if all significant deterioration in the existing HMA or PCC pavement is repaired prior to HMA overlay placement. Although existing pavement deterioration is mostly manifested by visible distress at the surface, significant amounts of damage can be presented in the subsurface which may not be visible at the surface. Subsurface pavement damage may be detected through destructive and nondestructive forensic evaluations. Nondestructive testing (NDT) using the deflection method is detailed in **APPENDIX C**. The designer should use a single or combination of several corrective techniques that will provide the best overall solution to extend the pavement life. The M-E Design does not consider pre-overlay treatments as part of the overlay design process; however, the designer will need to consider the effect of some treatments applied when characterizing existing pavement.

8.7.1 Distress Types that Require Pre-Overlay Treatments

Regardless of the nature of existing damage and distress, all significant distresses and damage should be repaired before an overlay is placed. The following types of distress should be repaired prior to the overlay of flexible pavements. If they are not repaired, the service life of the overlay will be greatly reduced.

- Alligator (Fatigue) Cracking: All areas of high severity alligator cracking must be patched. Localized areas of medium severity alligator cracking should be patched unless a paving fabric or other means of reflective crack control is used. The patching must include removal of any soft subsurface material.
- Longitudinal and Transverse Cracks: High severity longitudinal and transverse cracks should be patched. Longitudinal and transverse cracks that are open greater than 0.25 inches should be filled with a sand asphalt mixture or other suitable crack filler. Transverse cracks that experience significant opening and closing, a method of reflective crack control is recommended. Crack filling should be performed independently and at least one year in

advance of an overlay operation to allow sufficient curing time for the sealant. This is particularly important on overlays with thicknesses of two inches or less where tearing, shoving and wash boarding can occur during the rolling operation due to the influence of crack filler material expanding up into the fresh hot bituminous pavement.

- **Rutting:** Remove ruts by milling or placement of a leveling course. If rutting is severe, an investigation into which layer is causing the rutting should be conducted to determine whether an overlay is feasible.
- **Surface Irregularities:** Depressions, humps, and corrugations require investigation and treatment of their cause. In most cases, removal and replacement will be required.

Note: Distress in the existing pavement is likely to adversely affect the performance of the overlay. Much of the deterioration that occurs results from not repairing the existing pavement. In such situations, an overlay would not contribute much to extending the drivable life of the existing pavement, thus existing distress/damage should be repaired prior to overlay placement. The designer should also consider the cost tradeoffs of pre-overlay repair and overlay type. For example, if the existing pavement is severely deteriorated, selecting an overlay type less sensitive to the existing pavement condition, may be more cost effective than an extensive preoverlay repair (i.e. unbonded PCC overlays over an existing PCC pavement rather than a thick HMA overlay).

8.7.2 Pre-Overlay Treatments and Additional Considerations

Several pre-overlay repair types are routinely deployed to correct structural deficiencies prior to overlay placement. Selection of appropriate pre-overlay treatment must be done only after a thorough evaluation of the existing pavement has been conducted. The evaluation process should include:

- A review of the historical construction data.
- Inspecting the surface for severe distresses.
- Checking the crown or cross slope for any drainage problems.
- Taking cores at an approximate frequency of 2 cores per lane mile across the full width of the driving lanes to determine the following:
 - Rut depth prior to coring.
 - Total thickness of HMA.
 - In-place air voids.
 - Moisture susceptibility.
 - Depth to any paving fabric.
 - Depth to next layer.

Asphalt pavement rehabilitation includes the removal and replacement of a portion of the existing pavement. An example would be removing by milling the driving lane's wheel rutting and recycling the removed material. Rehabilitation techniques may also include rejuvenation of the existing pavement prior to overlay, i.e. heater-scarify or cold recycle of the existing pavement to remove irregularities to rejuvenate an oxidized pavement. Other techniques including full depth patching, base removal and replacement, use of fabric, etc., should all be analyzed.

Corrective action for rutted pavements should consist of removal by milling. This process should be used instead of a leveling course whenever possible. The use of a leveling course should be restricted to applications where rut depths are minimal (less than ½ inch), or rutting is not a result of low stability. In-place recycling can be an acceptable alternative as part of a comprehensive rehabilitation action when addressing rutting.

8.7.3 Recycling the Existing Pavement

Recycling a portion of an existing flexible pavement layer may be considered as an option in the design of an overlay. Complete recycling of the flexible pavement layer may sometimes be done in conjunction with the removal of a deteriorated base course.

The M-E Design considers recycled asphalt concrete materials as part of flexible overlay design. The options for recycling existing flexible pavements include:

- Cold In-Place Recycling (CIP)
- Hot In-Place Recycling (HIR)
- Full Depth Reclamation (FDR)

Details on characterizing recycled materials for the M-E Design is presented in **Section 8.16.4.2 Characterization of Existing HMA Layer**. Brief descriptions of pre-overlay treatments are presented in the following sections.

8.7.3.1 Cold Planing or Milling

Cold planing or milling has been widely used for removing existing hot mix asphalt pavement in order to restore the surface to a specified grade and cross-slope free of imperfections. A decision to remove a portion of the present HMA should be based on sound economic and engineering principles. The need to remove all or part of the existing pavement should be evaluated for every project. The planing depth should be uniform throughout the project and should go at least ½ inch into the underlying pavement layer. Planing should be used for the following reasons:

- To correct severe rutting in asphalt pavement due to low air voids;
- To avoid areas where the existing pavement grade cannot be raised;
- To remove moisture or rut susceptible mixes;
- To eliminate a pavement mix problem, such as severe raveling, that should be removed rather than overlaid.
- To create a butt joint to match the existing grade.

The reasons for milling a rutted pavement before placing an overlay include the following:

- Milling removes the low void materials from the wheel path. The minimum depth for milling should be a half-inch below the bottom of the wheel path. When the existing ruts are greater than a half-inch it is recommended that cores be taken during the design phase to establish the required removal depth. Milling should extend to a depth where the existing material has air voids in the range of 3 to 5 percent.

- Milling leaves a roughened surface that provides an excellent bond with the overlay. Milling machines with automatic grade control restore both longitudinal grade and transverse grade, thus improving the smoothness of the final overlay.
- Milling eliminates the need for leveling courses and therefore the problems associated with compacting material of varying width and thickness is eliminated.

As a result of the grooves produced during milling, the pavement will have an increased surface area and additional tack coat is required to assure adequate bond.

It is important to remember that when milling, the designer must take into account the loss of structural value when material is removed. A structural replacement depth must be included to account for the removed material. This is in addition to the design depth required to satisfy traffic loadings. When preparing pavement rehabilitation that includes milling, the designer must determine the appropriate depth for milling, show the appropriate depth on the plans and allow enough quantity for the structural replacement of the milled material in the surfacing requirements. The depth of milling is a critical input in the M-E Design to account for the continuation of fatigue damage and rutting in the existing pavement structure.

Widths of the cold planers vary and a number of passes may be needed for a full width planed surface. The milled material may be hauled away and/or stockpiled for use in the HMA overlay. Traffic may be run on the exposed surface, however it is recommended to keep the surface exposed only for a short period. The duration of exposed surface depends on the traffic, location, and type of project.

If the existing pavement has low to moderate distress, less than ½ inch rut depth, and good drainage, then other cost effective treatments may be appropriate such as heater scarification. If the existing pavement has low to moderate distress, rut depth between ½ inch and 1 inch, and good drainage, then a hot mix asphalt leveling course consisting of Grading SX, ST, or SF with smaller nominal aggregate size placed prior to the overlay may be a cost effective alternative.

Under some conditions, variable depth planing may be appropriate. As an example, when planing is used to correct a crown or cross-slope problem. Circumstances have occurred when a layer was not completely removed by planing which lead to delaminating under traffic and a rough ride quality prior to the overlay. The rut depth and HMA thickness information should be included on the Plan and Profile sheets or in tabular form to ensure proper planing depth throughout the project. Planing adjacent to vertical obstructions such as a guardrail and barrier wall is difficult with most equipment therefore; it is recommended that the designer specify a maximum clearance for the planing equipment. During the planing process, irregularities may occur before the area is overlaid with HMA, therefore it is recommended that the designer include a separate HMA patching pay item for about 5 percent of the planing square yards. This HMA patching item should be paid by the ton. The designer should work closely with the Region Materials Engineer to ensure that the crown or cross-slope is addressed in the design and to specify the proper HMA patching material.

8.7.3.2 Types of Hot In-Place Recycling

CDOT uses three HIR processes to correct surface distresses of structurally adequate flexible pavements. These HIR processes include heating and scarifying treatment, heating and remixing treatment, and heating and repaving treatment. To date, heating and scarifying treatment is a standard specification and the other two processes are project special provisions.

8.7.3.2.1 Surface Recycling (Heating and Scarifying Treatment)

The existing pavement is heated, scarified, sprayed with rejuvenating agent, mixed with an auger, leveled off with a screed, and rolled with a rubber-tired roller. The depth of scarification usually specified for the surfacing recycling process is between $\frac{3}{4}$ and $1\frac{1}{2}$ inches with 1 inch being most common. A tack coat may be required if another layer of HMA will be added after surface recycling. This process normally requires a wearing course which must be calculated separately from the surface recycling process. Normally, the wearing course is placed by a paving supplier/contractor. Grinding may be required since the surface smoothness is not controlled and this treatment may make the surface rough and may vary the cross-slope. Projects with tight curves may require grinding.

Preliminary Engineering Job-Mix Formula

CDOT will perform a preliminary engineering job-mix formula for estimating purposes. Cores will be obtained to verify the mat thickness and materials to be surface recycled. Cores can be categorized into like pavement materials, and a design should be performed on each set of similar samples. It is necessary to obtain 50 pounds of sample material per mix design. The mix design will be performed as per CP-L 5140.

Contractor Job-Mix Formula

The contractor must submit a job-mix formula as per CP 52, a list of materials, and target values to be used on the project to the Region Materials Engineer at least one week prior to the start of construction. A duplicate copy of the job-mix formula, list of materials, and target values to be used should be sent to the Materials and Geotechnical Branch.

Structural Design

Design structural requirements will be met for engineering applications, and a minimum 2-inch overlay thickness will be used in conjunction with the surface recycling. For maintenance applications, a minimum of 55 pounds per square yard of additional HMA is recommended or a chip seal coat may be used as a wearing surface.

Construction Considerations

The surface recycling is generally not performed through more than one lift of the existing mat. Geotextile fabrics should not be present within the top 2 inches of the existing pavement structure prior to the remixing process. In addition, geotextile fabrics should not be installed within the top

2 inches of the new pavement structure. Surface recycling can be performed either full width or in the driving lanes only. Traffic control for the paving trains must be taken into consideration. Surface recycling usually requires two separate paving operations, one for the recycling and the other for the wearing course. It is recommended that the wearing course be placed within 7 days after surface recycling. For engineering applications, the type and the amount of rejuvenating agent will be determined as per CP-L 5140. Controlling the application rate is very important to the success of this treatment, so education of project personnel on the use of the data is very important.

8.7.3.2.2 Remixing (Heating and Remixing Treatment)

The remixing process heats, mills and removes 1½ to 2 inches of the existing pavement, then adds in rejuvenating agent, virgin aggregate or new HMA. All materials are mixed in a pug mill to form a single, homogenous mix. A remixing process sometimes occurs when additional aggregates are needed for strength and stability. Treatment depths for the single stage method are generally between 1 and 2 inches with 1½ inches being most common. Treatment depths for the multiple stage method are between 1½ and 3 inches with 2 inches usually being the most common. Each succeeding multiple stage operation remixes the layer below the previously worked layer that has been stockpiled into a windrow. No tack coat is required for the single operation. This process requires grade control on the laydown machine.

Preliminary Engineering Job-Mix Formula

CDOT will perform a preliminary engineering job-mix formula for estimating purposes. Cores will be obtained to verify the mat thickness and materials to be recycled. Cores can be categorized into like pavement materials, and a design should be performed on each set of similar samples. It is necessary to obtain 50 pounds of sample material per mix design. The mix design will be performed as per CP-L 5140.

Contractor Job-Mix Formula

CDOT Form #43, per CP 52, reviewed and approved by the Region Materials Engineer will be executed between the Engineer and the Contractor to establish the job-mix formula one week prior to construction. The Contractor must send a duplicate copy of the executed Form #43 to the Materials and Geotechnical Branch.

Structural Design

For engineering and maintenance applications, the design structural requirements will be met. The remixing process is generally followed by a 2 inch overlay or other surfacing materials.

Construction Considerations

Geotextile fabrics should not be present within the top 2 inches of the existing pavement structure prior to the remixing process. In addition, geotextile fabrics should not be installed within the top 2 inches of the new pavement structure. The remixing process can be performed either full width

or in the driving lanes only. If only the driving lanes are remixed and the resulting lane/shoulder drop off is 1 inch or less, the drop off may be tapered for safety consideration. Traffic control for a long paving train must be taken into consideration. The process of remixing requires only one paving operation. The remixing process may be performed through multiple layers by using multiple stages. For engineering applications, the type and the amount of virgin aggregate, asphalt cement, and rejuvenating agent will be determined as per CP-L 5140. The typical additional mix rates are 30 to 70 pounds per square yard of HMA, with 50 pounds per square yard being most common. Controlling the application rate and grade is very important to the success of this treatment, so education of project personnel on the use of the data is very important. The job-mix formula for the complete mix will be as per the Contractor Mix Design Approval Procedures (CP 52). The amount of virgin aggregate, and/or HMA added should only be that amount required to offset longitudinal and transverse surface irregularities and surface inundations to provide a rideable surface. A chip seal may be supplied as a wearing surface for maintenance applications, and an overlay for structural applications.

8.7.3.2.3 Repaving (Heating and Repaving Treatment)

This process combines surface recycling with a simultaneous thin overlay of new hot mix asphalt. When placed simultaneously, a strong thermal bond is formed between the two layers. The depth of scarification usually specified for the surfacing recycling process is between $\frac{3}{4}$ and $1\frac{1}{2}$ inches with 1 inch being most common and a 1 to 2 inch integral overlay thickness is used. No tack coat is required for this single operation. This process requires grade control on the laydown machine.

Preliminary Engineering Job-Mix Formula

CDOT will perform a preliminary engineering job-mix formula for estimating purposes. Cores will be obtained to verify the mat thickness and materials to be surface recycled. Cores can be categorized into like pavement materials, and a design should be performed on each set of similar samples. It is necessary to obtain 50 pounds of sample material per mix design. The mix design will be performed as per CP-L 5140.

Contractor Job-Mix Formula

CDOT Form #43, per CP 52, reviewed and approved by the Region Materials Engineer will be executed between the Engineer and the Contractor to establish the job-mix formula one week prior to construction. The Contractor must send a duplicate copy of the executed Form #43 to the Materials and Geotechnical Branch.

Structural Design

The design structural requirements will be met for structural and maintenance applications so as to take advantage of the thermal bond this process creates. For maintenance applications, a minimum of 110 pounds per square yard of additional HMA is recommended. For structural applications, a minimum of 165 pounds per square yard of additional HMA is recommended.

Construction Considerations

The repaving method is generally not performed through more than one lift of the existing mat. Geotextile fabrics should not be present within the top 2 inches of the existing pavement structure prior to the repaving process, or within the top 2 inches of the new pavement structure. Repaving can be performed either full width or in the driving lanes only. If only the driving lanes are repaved and the resulting lane/shoulder drop off is 1 inch or less, the drop off may be tapered for safety consideration. Traffic control for a long paving train must be taken into consideration. Since the recycling and paving operation are done simultaneously, the process requires only one paving operation. The maximum repaving and overlay thickness should not exceed a total of 3 inches. For engineering applications, the type and the amount of rejuvenating agent will be determined as per CP-L 5140. Controlling the application rate and grade is very important to the success of this treatment, so education of project personnel is very important.

Job-mix formula for the virgin mix will be as per the Contractor Mix Design Approval Procedures (CP 52). It should be noted that when 220 pounds per square yard are added to the recycled mix, the driving lane would be approximately two inches higher than the shoulder. For safety consideration, the grade of the shoulder should be raised to match the repaved areas.

8.7.3.3 Selecting the Appropriate Hot In-Place Recycling Process

Table 8.3 Selection Guidelines for HIR Process Distress-Related Considerations below provides a general guideline for the preliminary selection of candidate recycling or reclamation methods for the rehabilitation of asphalt pavements.

Table 8.3 Selection Guidelines for HIR Process Distress-Related Considerations

Pavement Distress Mode	Candidate HIR Process		
	Remixing	Repaving	Surface Recycling
Raveling	A	A	A
Potholes	A	A	✓
Bleeding	A	✓	✓
Skid Resistance	✓	A	⊗
Rutting	A	✓	✓
Corrugations	A	✓	✓
Shoveling	A	✓	✓
Fatigue Cracking	A	A	⊗
Edge Cracking	A	A	⊗
Slippage Cracking Block Cracking Long./Trans./Reflect. Cracking	A	A	✓
Swells, Bumps, Sags, Depressions	A	✓	✓
Marginal Existing Pavement Strength	✓	✓	⊗

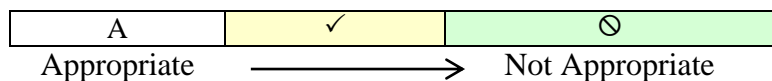

Non-Distress Related Considerations

Initial Cost ¹	Remixing ² \$3.75 - \$4.75 SY	Repaving ³ \$1.80 SY	Surface Recycling ⁴ \$1.43 SY
User Costs	See Section 13.5.6	See Section 13.5.6	See Section 13.5.6
Minimum turning radius greater than 500 feet	A	A	A
Minimum turning radius less than 500 feet.	⊘	⊘	A

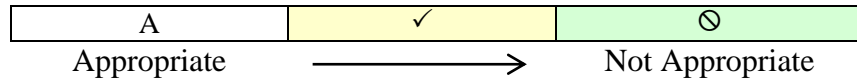

¹ The initial cost does not include the cost of any succeeding pavement layer that will be required to complete the work. The cost of any additional pavement overlay to be installed after each hot in-place recycling process should be considered in the cost evaluation step.

² Price is only for the process mat

³ Price is for full depth reclamation patching

⁴ Price is for cold in-place recycling, process mat

8.7.4 Reflection Crack Control

The basic mechanism of reflection cracking is strain concentration in the overlay due to movement in the vicinity of existing surface cracks. This movement may be bending or shear induced by loads, or may be horizontal contraction induced by temperature changes. Load induced movements are influenced by 1) the thickness of the overlay, and 2) the thickness and stiffness of the existing pavement. Temperature induced movements are influenced by daily and seasonal temperature variations, the coefficient of thermal expansion of the existing pavement, and the spacing of cracks.

Reflection cracks are a frequent cause of overlay deterioration. Some overlays are less susceptible to reflection cracking than others because of their materials and design. Similarly, some reflection crack control measures are more effective with some pavement and overlay types than with others. Additional steps must be taken to reduce the occurrence and severity of reflection cracking.

Pre-overlay repair (i.e., patching and crack filling, and heater scarifying) may help delay the occurrence and deterioration of reflection cracks. Additional reflection crack control measures that have been beneficial in some cases include the following:

- Removal of the pavement by milling or planing. Specific distresses are reduced or eliminated by removal of the pavement.
- Crack relief layers greater than 3 inches thick have been effective in controlling reflection of cracks subject to large movements. These crack relief layers can be achieved with cold recycling techniques.
- Crack filling at least one year prior to the overlay.
- Stress absorbing membrane interlayer.

The long term benefits of non-woven synthetic fabrics have been shown to be ineffectual as a crack resistance interlayer between the old pavement and the new overlay. They generally retard the cracks from propagating into the new overlay; however, the cracks reappear within a few years. Encountering the non-woven synthetic fabric interlayer has caused production problems in most subsequent rehabilitation strategies (i.e. cold planing, hot-in-place recycling processes, etc.). Due to these adverse effects, it is not recommended to use non-woven synthetic fabrics as a pre-overlay repair method.

8.7.5 Pavement Widening

Many overlays are placed in conjunction with pavement widening, either adding lanes or adding width to a narrow lane. This situation requires coordination between the design of the widened pavement section and the overlay, so that the surface will be both sections will be structurally and functionally adequate. Many lane-widening projects have developed serious deterioration along the longitudinal joint due to improper design.

Key design recommendations are as follows:

- The design lives of both the overlay and the new widening construction should be the same to avoid the need for future rehabilitation at significantly different ages.
- The widened cross section should generally closely match the existing pavement or cross section in material type and thickness. Widening which will carry traffic will be fully stabilized in accordance with standard procedures for new construction.
- The overlay should generally be the same thickness over the widening section as over the rest of the traffic lane.
- Longitudinal subdrainage may be placed along the outer edge of the widened section if needed.
- When a pavement is widened to the outside, the designer must be careful when placing a deeper pavement section outside the existing pavement section. By placing a deeper pavement section outside of the existing section, drainage under the pavement may be impeded and a bathtub section results.
- Many times in an urban setting, a widened outside lane becomes a future through lane. The designer must balance the immediate traffic needs with the possibility that in the future the lane will become a through lane. The through lane may extend for a couple of blocks to a full corridor length. In either case, it is likely it will need to handle heavy loads such as trucks and busses.
- Design subgrade resilient modulus value should be reviewed. Specifically, a resilient modulus that is consistent with that incorporated into the flexible pavement design equation must be used.

8.7.6 Preventive Maintenance

Preventive maintenance overlays and surface treatments are sometimes placed to slow the rate of pavement deterioration which show initial cracking, but which do not exhibit any immediate structural or functional deficiency. Generally, preventive maintenance overlays should be done only on pavements with no obvious signs of major distress and have a Drivable Life (DL) of 6

years or more. This type of overlay includes thin flexible pavement and various surface treatments that help keep out moisture. Preventive maintenance overlays are generally single operations. The overlays may be a thin wearing course over existing flexible pavements or rigid pavements

8.8 Conventional Overlay

Conventional Hot Mix Asphalt (HMA) or Stone Matrix Asphalt (SMA) overlays are similar to the thin wearing course overlays. Again, they are a single operation of placing flexible pavement over existing flexible pavements or rigid pavements. Generally, they are a thicker overlay than the thin wearing courses.

8.9 Existing Portland Cement Concrete Slab

The durability of an existing portland cement concrete slab greatly influences the performance of asphaltic concrete overlays. If reactive aggregate exists, the deterioration of the existing slab can be expected to continue after an overlay. The overlay must be designed with this progressive deterioration of the underlying slab in mind.

8.9.1 Flexible Overlay On Rigid Pavement

A flexible overlay over an existing rigid pavement (also known as "blacktopping") is a significant and often used rehabilitation overlay strategy. This type of rehabilitation represents the category in which overlay requirements is least known. Since the existing PCC pavement is usually cracked when an asphalt overlay is considered, the pavement structure is neither "rigid" nor "flexible" but in a "semi-rigid" condition. Even after the overlay is placed, cracking of the portland cement concrete pavement layer may increase, causing the rigidity of the overall pavement to approach a more flexible condition with time and traffic.

Thin asphalt overlays are used primarily to correct surface distress such as rutting, reactive aggregate, etc. These overlays can range in thickness from the minimum 2 inch HMA overlay to a 3 inch HMA overlay. In some cases, a leveling course may be required. Thin asphalt overlays are not to be placed over severely cracked, step faulted, shattered, or broken pavements. An advantage of thin (< 2 inches) overlays is that the clearance and roadside improvements associated with thick overlays are usually not necessary.

Thicker asphalt overlays are used to provide additional structural capacity for the existing pavement. Since the principal causes of cracking in an overlay are thermal contractions and expansions, and vertical differential deflections of the underlying slabs, some effort must be made to mitigate these stresses. Differential deflections at cracks or joints are considered to be more critical due to the quicker loading rate. The designer must consider the reflective cracking potential of the asphalt overlay over the existing rigid pavement.

At present, there are several techniques, which minimize or eliminate reflective cracking distress. They are:

- Use of thick (≥ 2 inches) asphalt overlays;
- Crack and seal the existing pavement followed by an overlay;
- Saw cutting matching transverse joints in overlay;
- Use of crack relief layers;
- Stress-absorbing membrane interlayer with an overlay;
- Fabric/membrane interlayers with an overlay; and
- Rubblization

Additional design and cost considerations such as vertical clearance at structures, drainage modifications, and increasing the height of railings and barriers need to be considered when evaluating thick asphalt overlays.

Design thickness will be rounded up to the next $\frac{1}{4}$ inch increment.

8.10 Overlay Using Micro-Surfacing

Micro-surfacing is a thin surface pavement system composed of polymer modified asphalt emulsion, 100 percent crushed aggregate, mineral filler, water, and field control additives. It is applied at a thickness of (0.4 to 0.5 inches) as a thin surface treatment primarily to improve the surface friction characteristics while producing a smooth wearing surface. Its other major use is to level wheel ruts on both moderate and high volume roads. The treatment has also been used to address pavement distresses such as flushing, raveling, and oxidation. Micro-surfacing is used to improve the functional condition, not the structural condition (load carrying capacity) of a roadway. Micro-surfacing has shown promising results in protecting the existing pavement and is estimated to extend the service life 4 to 7 years. It is particularly useful where a significant increase in thickness is not desired, such as curb and gutter sections. Micro-surfacing can be feathered out to the maximum mix aggregate size without edge raveling, and can generally be opened to traffic within one hour of placement. It is particularly suitable for high volume roads and urban areas. See revision of Section 409 and 702 - Micro-Surfacing of the Sample Project Special Provision for complete specifications related to Micro-Surfacing.

<http://www.coloradodot.info/business/designsupport/construction-specifications/2011-Specs/sample-construction-project-special-provisions>

Micro-surfacing can be used to address the following types of conditions as described in the Distress Identification Manual for the Long Term Pavement Performance Project (SHRP-P-38) published by the Strategic Highway Research Program (SHRP), National Research Council:

- Cracking - Low severity cracking of any form, including longitudinal, transverse or alligator. Micro-Surfacing will not stop reflective cracking.
- Raveling/Abrasion - Low to moderate severity levels. (Check existing pavement moisture resistance before specifying micro-surfacing.)
- Bleeding/Flushing - Low to moderate severity levels. (Check existing pavement moisture resistance before specifying Micro-Surfacing.)

Use a rut box followed by a wearing course when rutting is less than 1 inch in depth, where no plastic flow is occurring, and for rutting caused by compaction of the existing mat, inadequate subgrade or an unstable asphalt mat.

Fill ruts with multiple passes using a rut box with maximum 0.75 inch layers when filling ruts up to 3 inches deep on asphalt or concrete pavements prior to an overlay. A 0.125 inch to 0.25 inch crown is recommended for ruts over 1 inch to compensate for initial compaction.

8.11 Full Depth Reclamation (FDR)

Full Depth Reclamation is a rehabilitation or a reconstruction technique in which the full thickness of asphalt pavement and a predetermined portion of the underlying materials (base, subbase, and/or subgrade) are uniformly pulverized and blended to provide a homogeneous material without the use of heat (2). FDR is a two-phase operation. The first operation is to create the base material. Temporary traffic maybe placed on the roadway after this operation. The final operation is to place an overlay on top of the base material. For pavement design, the full depth reclaimed material is considered a base material.

8.12 Rubblization and Flexible Pavement Overlay

Existing, worn-out PCC pavements present a particular problem for rehabilitation due to the likelihood of reflection cracking when an HMA overlay is placed. Horizontal and vertical movements occurring within the underlying PCC layer cause reflection cracking. Reflection cracking can occur at any PCC joint or crack. The reflection cracking problem must be addressed in the HMA overlay design phase if long-term performance of the overlay is to be achieved (3).

The objective of rubblization is to eliminate reflection cracking in the HMA overlay by the total destruction of the existing slab action of the PCC pavement. This process is normally achieved by rubblizing the slab into fragments (4). Rubblization and overlay is a two-phase operation. The first operation is to create the rubblized base material. No traffic is placed on the roadway after this operation. The final operation is to place a flexible overlay on top of the rubblized base material. For pavement design, the rubblized material is considered a base material.

8.13 Stone Matrix Asphalt Project and Material Selection Guidelines

Stone Matrix Asphalt (SMA) is a gap-graded Hot Mix Asphalt (HMA) that maximizes rutting resistance and durability with a stable stone-on-stone skeleton held together by a rich mixture of asphalt binder, filler, and stabilizing agents. SMA is often considered a premium mix because of higher initial costs due to increased asphalt contents and the use of more durable aggregates. These mixes are almost exclusively used for surface courses on high volume interstates and highways. For a national perspective on designing SMA mixtures, refer to the National Cooperative Highway Research Program (NCHRP) Report 425, *Designing Stone Matrix Asphalt Mixtures for Rut-Resistant Pavements* (5).

The selection of a SMA mix on CDOT projects should be discussed with your Region Materials Engineer. The following conditions need to be present prior to considering the selection of a SMA mix for the wearing surface on the project.

- Total Average Annual Daily Traffic (AADT) greater than 20,000 in the design year
- The functional class of the roadway should be either a Principal Arterial, Freeway, or Interstate
- The underlying pavement should have a Lottman greater than 50 percent (Lottman to be tracked) with Air Voids greater than 3 percent.

Once the appropriate SMA project has been selected, in order to reduce the possibility of asphalt cement drain down or bleed spots, the SMA should contain cellulose fibers.

For ease of construction, it is recommended that the SMA extend full width of the pavement.

8.13.1 Recommended Minimum Thickness Layers

If no structural deficiency exists and a preventative maintenance treatment is desired, the structural number will be less than or equal to zero. This does not mean, however, that the pavement does not need an overlay to correct a functional deficiency. If the deficiency is primarily functional, the minimum SMA thickness will be 4 times the nominal maximum aggregate size. In this case, a fine-grained ($\frac{3}{8}$ inch or No. 4 sieve) aggregate size is suggested. See **Table 8.4 SMA Functional and Structural Recommended Minimum Thickness Layers**.

If the pavement has a structural deficiency, the required minimum SMA thickness will be 2 inches. As a general construction practice, the lift thickness should be at least 4 times the nominal maximum aggregate size.

The Pavement Designer should be aware when specifying thin lifts ($\frac{1}{2}$ to 1 inches and less) the verification of compaction density by nuclear density devices and coring is suspect and may be unattainable in providing reasonable results. Revisions to the Specifications may be needed for the elements of In-place Density and Joint Density pay factors.

Table 8.4 SMA Functional and Structural Recommended Minimum Thickness Layers

Nominal Maximum Aggregate Size (inches)	Functional Minimum Thickness (inches)	Structural Minimum Thickness (inches)
$\frac{3}{4}$	3	3
$\frac{1}{2}$	2	2
$\frac{3}{8}$	1 $\frac{1}{2}$	2
No. 4 sieve	$\frac{3}{4}$	2

8.14 Characterizing Existing Pavement Condition for AC Overlay Design

Characterization of the existing pavement is a critical element for determining the HMA overlay design features and thickness. Recommendations for characterization of existing pavements are presented in **Table 8.5 Characterization of Existing Flexible Pavement for the M-E Design** and **Table 8.6 Characterization of Existing Rigid Pavement for the M-E Design**.

Table 8.5 Characterization of Existing Flexible Pavement for the M-E Design

Surface Condition ¹	Pavement Condition
Little or no alligator cracking and low severity transverse cracking.	Excellent
Low severity alligator cracking <10 percent and/or Medium and high severity transverse cracking <5 percent Mean wheelpath rutting < 0.25 inch No evidence of pumping, degradation or contamination by fines. ²	Good
Low severity alligator cracking >10 percent and/or Medium severity alligator cracking <10 percent and/or 5 percent < medium and high severity transverse cracking <10 percent. Mean wheelpath rutting < 0.5 inch	Fair
Medium severity alligator cracking >10 percent and/or High severity alligator cracking <10 percent and/or Medium and high severity transverse cracking >10 percent. Mean wheelpath rutting > 0.5 inch Some evidence of pumping, degradation or contamination by fines. ^{2,3}	Poor
High severity alligator cracking ⁴ >10 percent and/or High severity transverse cracking >10 percent.	Very Poor

Notes:

¹All of the distress observed is at the pavement surface.

²Applicable for Flexible Pavement with granular base only.

³In addition to any evidence of pumping noted during the condition survey, samples of base material should be obtained and examined for evidence of erosion, degradation and contamination by fines, as well as, evaluated for drainage ability, and structural layer coefficients reduced accordingly.

⁴Patching all high severity alligator cracking is recommended. The asphaltic concrete surface and stabilized base structural layer coefficients selected should reflect the amount of high severity cracking remaining after patching.

Table 8.6 Characterization of Existing Rigid Pavement for the M-E Design

Surface Condition	Pavement Condition
Little or no JPCP transverse cracking. No signs of PCC durability problems (D-cracking, ASR, spalling etc).	Excellent
JPCP deteriorated cracked slabs (medium and high severity transverse and Longitudinal cracks & corner breaks) < 5 percent. Low severity durability problems. Mean joint faulting < 0.1 inch.	Good
JPCP deteriorated cracked slabs (medium and high severity transverse and Longitudinal cracks & corner breaks) < 10 percent. Low – medium severity durability problems. Mean joint faulting < 0.15 inches.	Fair
JPCP deteriorated cracked slabs (medium and high severity transverse and Longitudinal cracks & corner breaks) > 10 percent. Medium-high severity durability problems. Mean joint faulting < 0.25 inch.	Poor
High severity durability problems. Mean joint faulting > 0.25 inches.	Very Poor

8.15 Low Volume Road Rehabilitation

8.15.1 General Information

A low volume road is defined as a road with a two-directional average annual daily traffic (AADT) of less than 100 trucks per day and less than 1,000 cars per day. Approximately 810 centerline miles of the paved roads in Colorado are classified as low volume. Due to limited funding, CDOT needs to find additional, innovative rehabilitation strategies for these types of roadways. Prior to rehabilitation, the pavements are usually brittle, age hardened, and show a variety of transverse, longitudinal, and fatigue cracking. They may also exhibit signs of aggregate loss, reduced skid resistance, and rutting. Resurfacing thickness may depend on the condition of the existing pavement, increases or decreases of anticipated AADT. Following is a list of rehabilitation techniques that could be used on low volume roads and two tables, **Table 8.7. Rehabilitation Techniques vs. Observed Distresses** and **Table 8.8, Rehabilitation Techniques Benefits and Applications**.

Table 8.7 Rehabilitation Techniques vs. Observed Distresses

	Transverse Cracks (minor*)	Transverse Cracks (major)	Longitudinal Cracks (minor*)	Longitudinal Cracks (major)	Fatigue Cracks (minor*)	Fatigue Cracks (major)	Rutting (minor)	Rutting (major)	Reflection Cracks (minor*)	Reflection Cracks (major)	Raveling	Potholes	Polished Surface	Preserves Curb Reveal	Increases Structural Strength	Quick Application
Single Chip Seal (conventional)	◆	◆	◆	◆	◆	◆	△	◆	◆	◆	◆	◆	◆	△	◆	◆
Single Chip Seal (polymer-modified emulsion)	◆	◆	◆	◆	◆	◆	△	◆	◆	◆	◆	◆	◆	△	◆	◆
Single Chip Seal (rubberized)	◆	◆	◆	◆	◆	◆	△	◆	◆	◆	◆	◆	◆	△	◆	◆
Multiple Chip Seal or Armor Coat	◆	◆	◆	◆	◆	◆	◆	△	◆	△	◆	△	◆	△	◆	◆
Stress Absorbing Membrane Seal	◆	◆	◆	◆	◆	◆	◆	△	◆	△	◆	△	◆	△	◆	◆
Stress Absorbing Membrane Interlayer	◆	◆	◆	◆	◆	◆	◆	△	◆	△	◆	△	◆	△	◆	◆
Crack Seal or Polymer Modified Crack Seal	◆	◆	◆	◆	◆	◆	◆	◆	◆	◆	◆	◆	◆	◆	◆	◆
Crack Filling	◆	◆	◆	◆	◆	◆	◆	◆	◆	◆	◆	◆	◆	◆	◆	◆
Slurry Seal	◆	◆	◆	◆	◆	◆	◆	◆	△	◆	◆	◆	◆	◆	◆	◆
Crack Seal and Micro-Slurry	◆	◆	◆	◆	◆	◆	◆	△	◆	△	◆	△	◆	◆	◆	◆
Cape Seal	◆	◆	◆	◆	◆	◆	△	◆	◆	◆	◆	◆	◆	◆	◆	◆
Fog Coat	◆	◆	◆	◆	◆	◆	◆	◆	◆	◆	◆	◆	◆	◆	◆	◆
Thin Overlay (1.0-1.5 inches)	◆	◆	◆	◆	◆	◆	◆	◆	◆	◆	◆	◆	◆	◆	△	◆
Ultra-Thin Overlay (<1 inch) conventional asphalt	◆	△	◆	△	◆	△	◆	△	◆	△	◆	◆	◆	◆	◆	◆
Ultra-Thin Overlay (<1 inch) ST and SF mixes	◆	◆	◆	◆	◆	◆	◆	◆	◆	◆	◆	◆	◆	◆	△	◆
Ultra-Thin Overlay (<1 inch) micro-surfacing	◆	△	◆	△	◆	△	◆	△	◆	△	◆	△	◆	◆	◆	◆
Cold-In-Place Recycling	◆	◆	◆	◆	◆	◆	◆	◆	◆	◆	◆	◆	◆	△	△	△
Cold-In-Place and Chip Seal	◆	◆	◆	◆	◆	◆	◆	◆	◆	◆	◆	◆	◆	△	△	△
Cold Mix Paving	◆	◆	◆	◆	◆	◆	◆	◆	◆	◆	◆	△	◆	△	△	△
Hot In-Place Recycling	◆	◆	◆	◆	◆	◆	◆	◆	◆	◆	◆	◆	◆	△	△	△
Hot Chip Seal	◆	◆	◆	◆	◆	◆	◆	△	◆	△	◆	△	◆	△	◆	◆
Full Depth Replacement (patching)	◆	◆	◆	◆	◆	◆	◆	◆	◆	◆	◆	◆	◆	◆	◆	◆

* Minor cracks are up to 1/4 inches in width.

- ◆ Rehabilitation technique likely to fix the observed distress
- △ Rehabilitation technique has mixed results in fixing observed distress
- ◆ Rehabilitation technique unlikely to fix the observed distress

8.15.2 Rehabilitation Techniques

Single Chip Seal is a cost effective surface application used to maintain, protect and prolong the life of an asphalt pavement. The basic chip seal is composed of a binder, aggregate, and a flush coat or fog seal, and work best when used to preserve roads already in good condition. The process generally consists of a soft, flexible, polymer modified asphalt emulsion applied directly to the pavement followed by an application of No. 8 or ¼-inch aggregate before the emulsion sets up. A crushed and graded RAP may be used as a chip aggregate also. The thick asphalt membrane water proofs and bonds the new aggregate to the surface, providing a new skid resistant wearing course. The chip seals are usually applied on a 5-7 year cycle.

Double Chip Seal is a two layer chip seal where one layer is applied immediately after the other. Double chip seals are used on roads with moderate to severe cracking, open textured roads where surface fines have been lost, and on freshly leveled or milled roads where the surface is too open for a single chip seal. Sometimes a fabric is placed between the two layers to reduce the formation of reflective cracks.

Cape Seal is a two-step process where a chip seal is overlaid with a slurry seal. During the first step, the binder is applied to the existing road surface sealing cracks up to ¼ inches wide (cracks greater than ¼ inch wide should be crack sealed prior to binder application). The aggregate is then placed and pressed with pneumatic rollers. The second step involves applying a slurry seal usually within 48 hours after the initial binder application to help hold loose chip material in place and to provide a smoother texture.

Hot Chip Seal is a two-step surface treatment process that combines a regular chip seal with a thin lift of open-graded hot mix overlay. The hot mix overlay is usually a ¾ inch mix.

Slurry Seal is one of the most common, cost effective forms of asphalt pavement preservation. Generally, it is composed of a graded aggregate, emulsified asphalt (unmodified or polymer-modified), water, fines and other additives which are mixed until a mortar-like compound is achieved. A slurry seal is designed for easy and efficient spreading that forms a hard wearing surface by filling voids, cracks and eroded areas. Usually slurry seals are 1/8 to 3/8 inches thick. Depending on weather conditions, a slurry seal will set up quickly allowing a quick release to traffic.

Micro-Surfacing Refer to Section 8.10

Crack Seal is a long-term, cost effective way to maintain pavement life by preventing water intrusion and other damaging factors from entering transverse and longitudinal cracks. Crack sealing materials can be either unmodified or polymer-modified and are most effective when used on pavements that are 3 to 5 years old or when cracks are the first starting to appear. Crack sealing can be combined with many of the other rehabilitation techniques.

Cold Mix Paving is a blend of coarse and fine aggregate and/or a crushed and graded RAP, combined with an emulsified asphalt. Usually, a mix design is customized for project-specific

conditions and may be designed to provide flexible or rigid pavements. Cold mix paving provides early strength so traffic impedance is minimized and may be designed to perform over existing pavements with deteriorated bases.

ST and SF Mixes are fine aggregate asphalt mixes where the largest aggregate particle is either $\frac{3}{8}$ inches or from the No. 4 sieve. Further details of these mix designs can be found in Sections 403 and 703 of the *Colorado Department of Transportation Standard Specifications for Road and Bridge Construction, 2012*.

Fog Coat is a light spray application of dilute asphalt emulsion used to seal the existing asphalt surface, reduce raveling and enrich dry and weathered surfaces (5). Road surfaces to be treated with fog seal must have an open texture to allow the material to penetrate. Tight surfaces normally cannot be treated with this method. For areas requiring the newly sealed pavement be opened to traffic shortly after the application, a blotter coat of sand may be placed to prevent tires from 'picking up' the recently layered emulsion. The sand will generally be removed by the traffic over time. A fog seal should be used within the first two years of HMAs placement.

Thin Asphalt Overlays are surface mixes of typically $\frac{3}{4}$ to $1\frac{1}{2}$ inches placed on a prepared pavement surface showing no signs of structural distress. The surface may be milled or un-milled although milling is recommended because it provides a uniform, level surface and removes surface distresses. It is important that a thin overlay not be used to correct widespread structural distresses such as alligator or longitudinal cracking in the wheel path. However, this type of overlay may be applied to correct functional problems such as skid resistance, ride quality, and noise generation.

Full Depth Replacement Patching is a rehabilitation or a reconstruction technique in which the full thickness of asphalt pavement and a predetermined portion of the underlying materials (base, subbase, and/or subgrade) are removed and replaced.

Cold-In-Place Recycling is the recycling and reusing of the existing pavement layer, thus eliminating the costs of purchasing and transporting fresh aggregate. Usually, core samples are taken from the existing road and tested to determine the material constituents available so a proper mix design may be determined. Generally, two to five inches of the surface are pulverized to a pre-determined aggregate size, mixed with a rejuvenating asphalt emulsion and water, re-applied to the road and compacted. Because no heat is applied to the asphalt, noxious fumes are reduced, creating a safer environment for construction workers and the public.

Ultra-Thin Asphalt Overlays consist of a heavy application of a polymer modified emulsion followed immediately by a thin layer of gap-graded hot mixed asphalt. The emulsion is used to bond the new and old pavements and the asphalt mix usually incorporates a combination of trap rock and limestone creating a durable surface. Ultra-thin overlays may be installed in lifts of $\frac{1}{2}$ to $\frac{7}{8}$ inches, requiring minimal milling. Once it has been rolled, the road can be immediately opened to traffic.

Stress Absorbing Membranes are composed of a polymer modified asphalt emulsion, fiberglass strands and aggregate, which when placed, acts as a waterproof membrane and delays reflective cracking. Generally, fiber glass is sandwiched between two layers of asphalt emulsion prior to the application of the aggregate, and then either rolled into the surface or sprayed into place. The fiberglass increases the tensile strength and flexibility of the resurfacing product, as well as,

reduces the resulting strain. The process is fairly quick, allowing an area to be opened to traffic within 15 minutes of placement, and is rarely affected by temperature or humidity.

Manual Skin Patching is when a small surface area showing distress is manually repaired and sealed.

Table 8.8 Rehabilitation Techniques Benefits and Applications

Treatment	When applicable	Benefits
Single Chip Seal	<ul style="list-style-type: none"> ▪ Roadways with slight to moderate cracking 	<ul style="list-style-type: none"> ▪ Protects from oxidation and deterioration ▪ Seals and resists reflection of small surface cracks ▪ Reduces future cracking, distress and potholes ▪ Improves skid-resistance and safety ▪ Easy and quick application causing minimum disruption to the public ▪ Reduces moisture infiltration ▪ Improves overall appearance ▪ A crushed and graded RAP may be used as a chip aggregate
Double Chip Seal	<ul style="list-style-type: none"> ▪ Roadways with moderate to severe cracking ▪ open textured roads where surface fines have been lost ▪ Freshly leveled or scratched roads where the surface is too open and porous for a single chip 	<ul style="list-style-type: none"> ▪ Protects from oxidation and deterioration ▪ Seals and resists reflection of small surface cracks ▪ Reduces future cracking, distress and potholes ▪ Improves skid-resistance and safety ▪ Easy and quick application causing minimum disruption to the public ▪ Reduces moisture infiltration ▪ Improves overall appearance
Cape Seal	<ul style="list-style-type: none"> ▪ Roadways with slight to moderate cracking 	<ul style="list-style-type: none"> ▪ Protects from oxidation and deterioration ▪ More durable than a standard Slurry Seal ▪ No milling or utility adjustments are required ▪ Significantly reduces appearance of cracks ▪ Reduces moisture infiltration ▪ Improves overall appearance ▪ Eliminates the need to seal alligator cracking up to 1/4", larger cracks still need to be sealed. ▪ A Cape Seal is weather dependent, requires ambient temperatures of 65° F and no rain for 24 hours.
Hot Chip Seal	<ul style="list-style-type: none"> ▪ Used to seal and level roadways with moderate to heavy cracking and in need of re-profiling. ▪ Roadways must be structurally sound; any areas exhibiting structural failure should be repaired prior to sealing. 	<ul style="list-style-type: none"> ▪ Protects from oxidation and deterioration ▪ Reduces moisture infiltration ▪ Provides a strong wearing surface that will improve the profile of the existing asphalt. ▪ Improves skid-resistance and safety ▪ Quiet surface treatment ▪ Has a long life expectancy ▪ Improves overall appearance

Slurry seal	<ul style="list-style-type: none"> ▪ Roadways with slight to moderate cracking 	<ul style="list-style-type: none"> ▪ Protects from oxidation and deterioration ▪ Reduces moisture infiltration ▪ Thin restorative surface treatment ▪ Does not require milling or utility adjustment ▪ Improves skid-resistance and safety ▪ Improves overall appearance
Micro-Surfacing	<ul style="list-style-type: none"> ▪ Roadways with slight to severe cracking and rutting ▪ May be placed in multiple layers for greater thicknesses 	<ul style="list-style-type: none"> ▪ Protects from oxidation and deterioration ▪ Improves skid-resistance and safety ▪ Easy and quick application causing minimum disruption to the public ▪ Reduces moisture infiltration ▪ Improves overall appearance ▪ An environmentally safe product emitting no pollutants ▪ May be used to fill wheel ruts where pavements are structurally sound
Crack Seal	<ul style="list-style-type: none"> ▪ Sealing slight to severe longitudinal and transverse cracking 	<ul style="list-style-type: none"> ▪ Cost effective process to maintain existing pavement ▪ Reduces moisture infiltration ▪ Reduces the damage from freeze-thaw cycle ▪ Prevents sand, stones and dirt from entering open cracks and causing compressive stresses ▪ Prevents/ delays pothole formation
Cold Mix Paving	<ul style="list-style-type: none"> ▪ May be used to correct transverse, longitudinal, and fatigue cracking ▪ Will not correct base failures 	<ul style="list-style-type: none"> ▪ Conventional paving equipment used to place material ▪ Flexibility to perform well over deficient or severely deteriorated base. ▪ Limited disruption to the public
ST or SF Mix Overlay	<ul style="list-style-type: none"> ▪ May be used to correct transverse slight to moderate longitudinal, transverse, and fatigue cracking ▪ Will not correct base failures 	<ul style="list-style-type: none"> ▪ Protects from oxidation and deterioration ▪ Seals and resists reflection of small surface cracks ▪ Improves skid-resistance and safety ▪ Reduces moisture infiltration ▪ Improves overall appearance ▪ Conventional paving equipment used to place material
Fog Coat	<ul style="list-style-type: none"> ▪ Product must have low viscosity ▪ Will not correct cracks, base failures, or excessive stone loss ▪ Open surface textured pavements ▪ Should not be used on rubberized asphalt concrete or polymer modified mixes unless the pavement is over 5 years old ▪ Limited by weather, usually cannot be applied in winter 	<ul style="list-style-type: none"> ▪ Protects from oxidation and deterioration ▪ Reduces moisture infiltration ▪ Rejuvenates existing asphalt binder, increases flexibility ▪ Seals surface voids ▪ Improves overall appearance

Thin Overlay (1 to 1.5 inches), dense graded hot mix asphalt, ultra-thin bonded wearing coarse, and stone matrix asphalt	<ul style="list-style-type: none"> ▪ Must be on generally structurally sound pavements ▪ Product cools very quickly and may be difficult to compact at times 	<ul style="list-style-type: none"> ▪ Protects from oxidation and deterioration ▪ Reduces moisture infiltration ▪ Reduces tire/pavement noise ▪ Increased skid resistance ▪ Decreases back spray and increases visibility in wet weather ▪ Strong bond to existing pavement ▪ No displacement of tack coat from trucks delivering material to the paver ▪ Anti-hydroplaning/anti-splash from tires ▪ Preserves the curb reveal ▪ Helps level the existing pavement ▪ Quick application, minimum disruption to the public
Full Depth Replacement Patching	<ul style="list-style-type: none"> ▪ Poorly structurally sound pavements. 	<ul style="list-style-type: none"> ▪ Brand new interlaying layer utilizing the old surface ▪ Removes existing crack patterns ▪ Previous pavement is rejuvenated ▪ Bridge clearances and curb heights remain the same ▪ Protects from oxidation and deterioration ▪ Reduces moisture infiltration ▪ Reduces tire/pavement noise ▪ Increased skid resistance
Cold-In-Place Recycling	<ul style="list-style-type: none"> ▪ Total pavement resurfacing and rehabilitation ▪ Removes existing crack patterns 	<ul style="list-style-type: none"> ▪ Brand new interlaying layer utilizing the old surface ▪ Removes existing crack patterns ▪ Previous pavement is rejuvenated ▪ Bridge clearances and curb heights remain the same ▪ Hauling off excess/milled materials is minimized
Ultra-thin Overlays	<ul style="list-style-type: none"> ▪ Suitable for correcting raveling, longitudinal cracking that is not in the wheel path, and transverse cracking 	<ul style="list-style-type: none"> ▪ Protects from oxidation and deterioration ▪ Reduces moisture infiltration ▪ Reduces tire/pavement noise ▪ Increased skid resistance ▪ Decreases back spray and increases visibility in wet weather ▪ Strong bond to existing pavement ▪ No displacement of tack coat from trucks delivering material to the paver ▪ Anti-hydroplaning/anti-splash from tires ▪ Preserves the curb reveal ▪ Service life of 10-15 years ▪ Helps level the existing pavement ▪ Quick application, minimum disruption to the public
Hot In-Place Recycling	<ul style="list-style-type: none"> ▪ Corrects surface distresses of structurally adequate flexible pavements 	<ul style="list-style-type: none"> ▪ New interlaying layer utilizing the old surface ▪ Removes existing crack problems ▪ Bridge clearances and curb heights remain the same ▪ Reduces moisture infiltration ▪ Increased skid resistance
Stress Absorbing Membrane	<ul style="list-style-type: none"> ▪ For delaying reflective cracking 	<ul style="list-style-type: none"> ▪ Increases the tensile strength and flexibility of the surfacing product ▪ Removes existing crack patterns ▪ Reduces the resulting strain ▪ Quick process, minimal traffic delay

8.16 Assemble the M-E Design Software Inputs

8.16.1 General Information

8.16.1.1 Design Period

The design period for restoration, rehabilitation and resurfacing is 10 years. Selection of less than 10-year design periods needs to be documented and supported by a LCCA or other over riding considerations. For special designs, the designer may use a different design period as appropriate.

8.16.1.2 Construction Dates and Timeline

The following inputs are required to specify the project timeline in the design:

- Original pavement construction month and year.
- Overlay construction month and year.
- Traffic open month and year.

8.16.1.3 Identifiers

Identifiers are helpful in documenting the project location and for record keeping.

8.16.2 Traffic

Several inputs are required for characterizing traffic for the M-E Design and have been described in detail in **Section 0**

.

8.16.3 Climate

The climate input requirements for the M-E Design are described in detail in **Section 3.2 Climate**.

8.16.4 Pavement Layer Characterization

Asphalt overlay design process described herein includes:

- HMA overlay of existing flexible pavements.
- HMA overlay of existing intact JPCP pavement, including composite and second generation overlays.
- HMA overlay of fractured PCC pavement.

In M-E Design, the pavement layer characterization includes the characterization of the HMA overlay layer, existing pavement (i.e. flexible, intact or fractured PCC), treated and/or unbound base layer and subgrade.

8.16.4.1 Characterization of HMA Overlay Layer

Asphalt concrete overlay types used in Colorado may include HMA and SMA mixtures. The inputs required for the HMA overlay layer are the same as those of the new HMA layer. Refer to **Section 6.6.4.1 Asphalt Concrete Characterization**

8.16.4.2 Characterization of Existing HMA Layer

Asphalt layer thickness can be determined from plans or the soil survey of the completed roadbed; however, this information should be verified by field samples. If this information is not available, the thickness will be checked in the field at the time the soil and aggregate base course are sampled.

The existing HMA layer is characterized by a damaged modulus representative of the conditions at the time of overlay placement in accordance with **Table 8.7 Characterization of Existing Flexible and Semi-Rigid Pavement for the M-E Design**.

In the M-E Design, the pavement layers with recycled asphalt concrete materials, such as the hot in-place recycling or cold in-place recycling, could be treated as a new flexible pavement design strategy. The recycled materials can be modeled either as a new HMA layer or an unbound layer depending on the amount of asphalt binder or emulsion added to the recycled material. When modeling the recycled material layer as a new HMA layer, it is recommended to use Level 1 or Level 2 inputs to accurately model the properties of the recycled layer. When modeling the recycled material layer as an unbound aggregate layer, the designer may use a fixed M_r value representative of the in-place material (**Note:** use the *Annual representative values* option in the M-E Design software for a single value of M_r that is fixed for an entire year).

Full depth reclamation was not included in the global calibration of the M-E Design performance prediction models.

If milling of the existing HMA layer is planned, one needs to subtract the milled thickness from the existing pavement structure. For example, if the existing HMA layer is 5 inches and 1.5 inches of milling is planned, then the thickness entered should be 3.5 inches. The mill thickness should also be placed in the AC Layer Properties under the Rehabilitation section.

Table 8.7 Characterization of Existing Flexible and Semi-Rigid Pavement for the M-E Design

Layer	Input	Rehabilitation Input Level 1	Rehabilitation Input Level 2	Rehabilitation Input Level 3
Asphalt Concrete	Damaged Modulus	FWD backcalculated modulus, test frequency and AC-mix temperature	Estimated from Undamaged Modulus (reduction factor from measured alligator cracking)	Estimated from Undamaged Modulus (reduction factor from pavement rating)

	Undamaged Modulus	HMA dynamic modulus model Project Specific Inputs / Agency Historical Inputs	HMA dynamic modulus model with Project Specific Inputs	HMA dynamic modulus model with Agency Historical Inputs
	Fatigue Damage	Damaged modulus is measured by NDT	Percent Alligator Cracking from visual condition survey	Pavement Rating
	Rut depth	Trench Data (each layer)	User Input (by layer)	Total rutting at surface
Treated Base	Damaged Modulus	FWD backcalculated modulus	Estimated from Undamaged Modulus	Estimated from Undamaged Modulus
	Undamaged Modulus	Compressive Strength of Field Cores	Estimated from Compressive Strength of Field Cores	Estimated form Typical Compressive Strength
	Fatigue Damage	Percent Alligator Cracking from visual condition survey	Percent Alligator Cracking from visual condition survey	Pavement Rating
Unbound Base or Subbase	Modulus	FWD backcalculated modulus	Simple Test Correlations	Soil Classification
	Rut depth	Trench Data	User Input	User Input
Subgrade	Modulus	FWD backcalculated modulus	Simple Test Correlations	Soil Classification
	Rut depth	Trench Data	User Input	User Input

8.16.4.3 Characterization of Existing PCC Layer (intact)

For the existing JPCP slab, use the modulus of elasticity existing at the time of rehabilitation. This value will be higher than the 28-day modulus and either determined using the backcalculation of FWD data or estimated from the historical 28-day values in accordance with recommendations provided in **Table 8.8 Characterization of Existing JPCP for the M-E Design**. If the modulus of elasticity is determined from the FWD data, multiply the backcalculated PCC modulus by 0.8 to covert from dynamic to static modulus.

For existing JPCP, the past damage is estimated from the total of the percent of slabs containing transverse cracking (all severities) plus the percentage of slabs that were replaced on the project. Required inputs for determining past fatigue damage are as follows:

1. Before pre-overlay repair, percent slabs with transverse cracks plus percent previously repaired/replaced slabs. This represents the total percent slabs that have cracked transversely prior to any restoration work.
2. After pre-overlay repair, total percent repaired/replaced slabs (note, the difference between [2] and [1] is the percent of slabs that are still cracked just prior to HMA overlay).

Table 8.8 Characterization of Existing JPCP for the M-E Design

Layer Material	Input	Rehabilitation Input Level 1	Rehabilitation Input Level 2	Rehabilitation Input Level 3
Jointed Plain Concrete Pavement (JPCP)	Elastic Modulus for PCC	Field core (lab testing) or backcalculated FWD modulus (adjusted)	Estimated from Compressive Strength of Field Cores	Estimated from Historical Compressive Strength Data
	Modulus of Rupture	Field Beam (lab testing)	Estimated from Compressive Strength of Field Cores	Estimated from Historical Compressive Strength Data
	Past Fatigue Damage	Percent Slabs Cracked	Percent Slabs Cracked	Pavement Rating
Existing Asphalt Base or Subbase	Dynamic Modulus	FWD backcalculated modulus	HMA dynamic modulus model with Project Specific Inputs	HMA dynamic modulus model with Agency Historical Inputs
Existing Unbound Base or Subbase	Modulus	FWD backcalculated modulus	Simple Test Correlations	Soil Classification
Subgrade	Modulus	FWD backcalculated modulus	Simple Test Correlations	Soil Classification

Repairs and replacement refers to full-depth repair and slab replacement of slabs with transverse cracks. The percentage of previously repaired and replaced slabs is added to the existing percent of transverse cracked slabs to establish past fatigue damage caused since opening to traffic.

8.16.4.4 Characterization of Existing PCC Layer (fractured)

Two input levels, Level 1 and Level 3, are provided for characterization of the fractured slab’s modulus. Level 1 modulus values are functions of the anticipated variability of the slab fracturing process. When using these design values, the user must perform FWD testing of the fractured slab to ensure that not more than 5 percent of the in-situ fractured slab modulus values exceed 1000 ksi. Level 3 modulus values are functions of the fracture method used and the nominal fragment size.

The recommended Level 1 and Level 3 design values for the modulus of fractured slab are presented in

Table 8.10 Recommended Fractured Slab Design Modulus Values for Level 1 Characterization and **Table 8.11 Recommended Fractured Slab Design Modulus Values for Level 3 Characterization**, respectively.

Table 8.9 Characterization of Fractured Concrete Pavement for the M-E Design

Layer Material	Input	Input Level 1	Input Level 2	Input Level 3
Fractured Slab	Modulus	Tabulated with NDT Quality Assurance	None	Tabulated Based on Process and Crack Spacing
Existing Asphalt Base or Subbase	Dynamic Modulus	FWD backcalculated modulus	HMA dynamic modulus model with Project Specific Inputs	HMA dynamic modulus model with Agency Historical Inputs
	Rut Depth	Trench Data	User Input	User Input
Existing Unbound Base or Subbase	Modulus	FWD backcalculated modulus	Simple Test Correlations	Soil Classification
	Initial ϵ_p	Trench Data	User Input	User Input
Subgrade	Modulus	FWD backcalculated modulus	Simple Test Correlations	Soil Classification
	Rut Depth	Trench Data	User Input	User Input

Table 8.10 Recommended Fractured Slab Design Modulus Values for Level 1 Characterization

Expected Control on Slab Fracture Process	Anticipated Coefficient of Variation for the Fractured Slab Modulus, %	Design Modulus, psi
Good to Excellent	25	600,000
Fair to Good	40	450,000
Poor to Fair	60	300,000

Table 8.11 Recommended Fractured Slab Design Modulus Values for Level 3 Characterization

Type Fracture	Design Modulus, psi
Rubbilization	150,000
Crack and Seat	—
12 inch crack spacing	200,000
24 inch crack spacing	250,000
36 inch crack spacing	300,000

8.16.4.5 Characterization of Unbound Base Layers and Subgrade

The thickness of the base and subbase can be determined from plans or the soil survey of the completed roadbed and should be verified by field samples. When this information is not available, samples will be taken at the same locations where the soil samples are/were taken at a minimum frequency of one sample per mile. For subgrades, obtain samples to determine the actual moisture content.

For HMA overlays of existing HMA, semi-rigid and fractured PCC pavements, refer to **Table 4.3 Recommended Subgrade Inputs for HMA Overlays of Existing Flexible Pavement** for more information. For HMA overlays of existing rigid pavements, refer to **Table 4.4 Recommended Subgrade Inputs for Overlays of Existing Rigid Pavement** for more information.

8.16.4.6 Characterization of Treated Bases

The modulus reduction in the treated base layer of the existing semi-rigid pavement is characterized in accordance with the recommendations presented in **Table 8.7 Characterization of Existing Flexible and Semi-Rigid Pavement for the M-E Design** and **Table 5.2 Characterization of Treated Base in the M-E Design**.

8.17 Run the M-E Design Software

The coefficients of performance prediction models considered in the design of a flexible pavement rehabilitation are shown in **Figure 8.3 Performance Prediction Model Coefficients for Flexible Pavement Rehabilitation Designs (Marshall Mix)** through **Figure 8.5 Performance Prediction Model Coefficients for Flexible Pavement Rehabilitation Designs (PMA Mix)**. The value of AC rutting coefficient (BR1) is based on HMA mix type. These coefficients should only be used if pavement type AC over AC is selected.

Designers should examine all inputs for accuracy and reasonableness prior to running the M-E Design software. After the inputs have been examined, run the software to obtain outputs required and to evaluate if the trial design is adequate. After a trial run has been successfully completed, the M-E Design software will generate a report in the form of a PDF and/or Microsoft Excel file. The report contains the following information: inputs, reliability of design, materials and other properties, and predicted performance.

After the trial run is complete, the designer should again examine all inputs and outputs for accuracy and reasonableness, respectively. The output report also includes the estimates of material properties and other properties on a month-by-month basis over the entire design period in either tabular or graphical form. The designer should at least examine the key parameters once to assess their reasonableness before accepting a trial design as complete.

Flexible Pavement Rehabilitation-Calibration Settings	
AC Cracking	
AC Cracking C1 Top	<input checked="" type="checkbox"/> 7
AC Cracking C2 Top	<input checked="" type="checkbox"/> 3.5
AC Cracking C3 Top	<input checked="" type="checkbox"/> 0
AC Cracking C4 Top	<input checked="" type="checkbox"/> 1000
AC Cracking Top Standard Deviation	$200 + 2300/(1+\exp(1.072-2.1654*\text{LOG10}(\text{TOP}+0.0001)))$
AC Cracking C1 Bottom	<input checked="" type="checkbox"/> 0.021
AC Cracking C2 Bottom	<input checked="" type="checkbox"/> 2.35
AC Cracking C3 Bottom	<input checked="" type="checkbox"/> 6000
AC Cracking Bottom Standard Deviation	$1+15/(1+\exp(-3.1472-4.1349*\text{LOG10}(\text{BOTTOM}+0.0001)))$
AC Fatigue	
AC Fatigue K1	<input checked="" type="checkbox"/> 0.007566
AC Fatigue K2	<input checked="" type="checkbox"/> 3.9492
AC Fatigue K3	<input checked="" type="checkbox"/> 1.281
AC Fatigue BF1	<input checked="" type="checkbox"/> 130.3674
AC Fatigue BF2	<input checked="" type="checkbox"/> 1
AC Fatigue BF3	<input checked="" type="checkbox"/> 1.217799
AC Rutting	
AC Rutting K1	<input checked="" type="checkbox"/> -3.35412
AC Rutting K2	<input checked="" type="checkbox"/> 1.5606
AC Rutting K3	<input checked="" type="checkbox"/> 0.3791
AC Rutting BR1	<input checked="" type="checkbox"/> 7.6742
AC Rutting BR2	<input checked="" type="checkbox"/> 1
AC Rutting BR3	<input checked="" type="checkbox"/> 1
AC Rutting Standard Deviation	$0.1414*\text{Pow}(\text{RUT},0.25)+0.001$
CSM Cracking	
CSM Fatigue	
IRI	
IRI Flexible C1	<input checked="" type="checkbox"/> 50
IRI Flexible C2	<input checked="" type="checkbox"/> 0.55
IRI Flexible C3	<input checked="" type="checkbox"/> 0.0111
IRI Flexible C4	<input checked="" type="checkbox"/> 0.02
IRI Flexible Over PCCC1	<input checked="" type="checkbox"/> 40.8
IRI Flexible Over PCCC2	<input checked="" type="checkbox"/> 0.575
IRI Flexible Over PCCC3	<input checked="" type="checkbox"/> 0.0014
IRI Flexible Over PCCC4	<input checked="" type="checkbox"/> 0.00825
Reflective Cracking	
Reflective Cracking C	<input checked="" type="checkbox"/> 2.5489
Reflective Cracking D	<input checked="" type="checkbox"/> 1.2341
Subgrade Rutting	
Granular Subgrade Rutting K1	<input checked="" type="checkbox"/> 2.03
Granular Subgrade Rutting BS1	<input checked="" type="checkbox"/> 0.22
Granular Subgrade Rutting Standard Deviation	$0.0104*\text{Pow}(\text{BASERUT},0.67)+0.001$
Fine Subgrade Rutting K1	<input checked="" type="checkbox"/> 1.35
Fine Subgrade Rutting BS1	<input checked="" type="checkbox"/> 0.37
Fine Subgrade Rutting Standard Deviation	$0.0663*\text{Pow}(\text{SUBRUT},0.5)+0.001$
Thermal Fracture	
AC thermal cracking Level 1K	<input checked="" type="checkbox"/> 6.3
AC thermal cracking 1 Standard Deviation	$0.1468 * \text{THERMAL} + 65.027$
AC thermal cracking Level 2K	<input checked="" type="checkbox"/> 0.5
AC thermal cracking Level 2 Standard Deviation	$0.2841 * \text{THERMAL} + 55.462$
AC thermal cracking Level 3K	<input checked="" type="checkbox"/> 6.3
AC thermal cracking Level 3 Standard Deviation	$0.3972 * \text{THERMAL} + 20.422$
Identifiers	

Figure 8.3 Performance Prediction Model Coefficients for Flexible Pavement Rehabilitation Designs (Marshall Mix)

Flexible Pavement Rehabilitation-Calibration Settings	
AC Cracking	
AC Cracking C1 Top	7
AC Cracking C2 Top	3.5
AC Cracking C3 Top	0
AC Cracking C4 Top	1000
AC Cracking Top Standard Deviation	$200 + 2300/(1+\exp(1.072-2.1654*\text{LOG}_{10}(\text{TOP}+0.0001)))$
AC Cracking C1 Bottom	0.021
AC Cracking C2 Bottom	2.35
AC Cracking C3 Bottom	6000
AC Cracking Bottom Standard Deviation	$1+15/(1+\exp(-3.1472-4.1349*\text{LOG}_{10}(\text{BOTTOM}+0.0001)))$
AC Fatigue	
AC Fatigue K1	0.007566
AC Fatigue K2	3.9492
AC Fatigue K3	1.281
AC Fatigue BF1	130.3674
AC Fatigue BF2	1
AC Fatigue BF3	1.217799
AC Rutting	
AC Rutting K1	-3.35412
AC Rutting K2	1.5606
AC Rutting K3	0.3791
AC Rutting BR1	6.7
AC Rutting BR2	1
AC Rutting BR3	1
AC Rutting Standard Deviation	$0.1414*\text{Pow}(\text{RUT},0.25)+0.001$
CSM Cracking	
CSM Fatigue	
IRI	
IRI Flexible C1	50
IRI Flexible C2	0.55
IRI Flexible C3	0.0111
IRI Flexible C4	0.02
IRI Flexible Over PCCC1	40.8
IRI Flexible Over PCCC2	0.575
IRI Flexible Over PCCC3	0.0014
IRI Flexible Over PCCC4	0.00825
Reflective Cracking	
Reflective Cracking C	2.5489
Reflective Cracking D	1.2341
Subgrade Rutting	
Granular Subgrade Rutting K1	2.03
Granular Subgrade Rutting BS1	0.22
Granular Subgrade Rutting Standard Deviation	$0.0104*\text{Pow}(\text{BASERUT},0.67)+0.001$
Fine Subgrade Rutting K1	1.35
Fine Subgrade Rutting BS1	0.37
Fine Subgrade Rutting Standard Deviation	$0.0663*\text{Pow}(\text{SUBRUT},0.5)+0.001$
Thermal Fracture	
AC thermal cracking Level 1K	6.3
AC thermal cracking 1 Standard Deviation	$0.1468 * \text{THERMAL} + 65.027$
AC thermal cracking Level 2K	0.5
AC thermal cracking Level 2 Standard Deviation	$0.2841 * \text{THERMAL} + 55.462$
AC thermal cracking Level 3K	6.3
AC thermal cracking Level 3 Standard Deviation	$0.3972 * \text{THERMAL} + 20.422$
Identifiers	

Figure 8.4 Performance Prediction Model Coefficients for Flexible Pavement Rehabilitation Designs (Superpave Mix)

Flexible Pavement Rehabilitation-Calibration Settings	
AC Cracking	
AC Cracking C1 Top	7
AC Cracking C2 Top	3.5
AC Cracking C3 Top	0
AC Cracking C4 Top	1000
AC Cracking Top Standard Deviation	$200 + 2300 / (1 + \exp(1.072 - 2.1654 * \text{LOG}_{10}(\text{TOP} + 0.0001)))$
AC Cracking C1 Bottom	0.021
AC Cracking C2 Bottom	2.35
AC Cracking C3 Bottom	6000
AC Cracking Bottom Standard Deviation	$1 + 15 / (1 + \exp(-3.1472 - 4.1349 * \text{LOG}_{10}(\text{BOTTOM} + 0.0001)))$
AC Fatigue	
AC Fatigue K1	0.007566
AC Fatigue K2	3.9492
AC Fatigue K3	1.281
AC Fatigue BF1	130.3674
AC Fatigue BF2	1
AC Fatigue BF3	1.217799
AC Rutting	
AC Rutting K1	-3.35412
AC Rutting K2	1.5606
AC Rutting K3	0.3791
AC Rutting BR1	4.3
AC Rutting BR2	1
AC Rutting BR3	1
AC Rutting Standard Deviation	$0.1414 * \text{Pow}(\text{RUT}, 0.25) + 0.001$
CSM Cracking	
CSM Fatigue	
IRI	
IRI Flexible C1	50
IRI Flexible C2	0.55
IRI Flexible C3	0.0111
IRI Flexible C4	0.02
IRI Flexible Over PCCC1	40.8
IRI Flexible Over PCCC2	0.575
IRI Flexible Over PCCC3	0.0014
IRI Flexible Over PCCC4	0.00825
Reflective Cracking	
Reflective Cracking C	2.5489
Reflective Cracking D	1.2341
Subgrade Rutting	
Granular Subgrade Rutting K1	2.03
Granular Subgrade Rutting BS1	0.22
Granular Subgrade Rutting Standard Deviation	$0.0104 * \text{Pow}(\text{BASERUT}, 0.67) + 0.001$
Fine Subgrade Rutting K1	1.35
Fine Subgrade Rutting BS1	0.37
Fine Subgrade Rutting Standard Deviation	$0.0663 * \text{Pow}(\text{SUBRUT}, 0.5) + 0.001$
Thermal Fracture	
AC thermal cracking Level 1K	6.3
AC thermal cracking 1 Standard Deviation	$0.1468 * \text{THERMAL} + 65.027$
AC thermal cracking Level 2K	0.5
AC thermal cracking Level 2 Standard Deviation	$0.2841 * \text{THERMAL} + 55.462$
AC thermal cracking Level 3K	6.3
AC thermal cracking Level 3 Standard Deviation	$0.3972 * \text{THERMAL} + 20.422$
Identifiers	

Figure 8.5 Performance Prediction Model Coefficients for Flexible Pavement Rehabilitation Designs (PMA Mix)

8.18 Evaluate the Adequacy of the Trial Design

The output report of a AC overlay pavement trial design includes the monthly accumulation of the following key distress types and smoothness indicators for both overlay and existing pavement at their mean values and chosen reliability values.

- Terminal IRI
- AC top down fatigue cracking
- AC bottom up fatigue cracking
- AC thermal cracking
- Permanent deformation (total)
- Permanent deformation (AC only)
- Reflective cracking

The designer should examine the results to evaluate if the performance criteria for each of the above mentioned indicators have met the desired reliability. If any of the criteria have not been met, the trial design is deemed unacceptable and needs to be revised accordingly to produce a satisfactory design. The strategies for modifying a trial design are discussed in **Section 8.19 Modifying Trial Designs**. The software allows the designer to use a range of thicknesses to optimize the trial design's thickness and perform sensitivity analysis for key inputs. The results of the sensitivity analysis can be used to further optimize the trial design if modifying AC thickness alone does not produce a feasible design alternative. Detail description of the thickness optimization procedure and sensitivity analysis is provided in the Software HELP Manual.

8.19 Modifying Trial Designs

For HMA overlays of existing HMA, semi-rigid and fractured PCC pavements, guidance on how to alter the trial design to meet performance criteria are based on an individual distress basis. Refer to **Section 6.9 Modifying Trial Designs** for more information.

For HMA overlays of intact rigid pavements, refer to **Table 8.12 Recommendations for Modifying Trial Design to Reduce Distress/Smoothness for HMA Overlays of JPCP**.

Table 8.12 Recommendations for Modifying Trial Design to Reduce Distress/Smoothness for HMA Overlays of JPCP

Distress Type	Recommended Modifications to Design
Rutting in HMA	Refer to Table 6.2 Modifying Flexible Pavement Trial Designs.
Transverse Cracking in JPCP Existing Slab	<ul style="list-style-type: none"> • Repair more of the existing slabs that were cracked prior to overlay placement. • Increase HMA overlay thickness.
Reflection Cracking from Existing JPCP	<ul style="list-style-type: none"> • Apply an effective reflection crack control treatment such as saw and seal the HMA overlay over transverse joints. • Increase HMA overlay thickness.
Smoothness (IRI)	<ul style="list-style-type: none"> • Build smoother pavements initially through more stringent specifications. • Reduce predicted slab cracking and punchouts.

References

1. AASHTO Standing Committee on Highway, 1997.
2. *Basic Asphalt Recycling Manual*, Federal Highway Administration, 400 Seventh Street, SW, Washington, DC 20590 and Asphalt Recycling and Reclaiming Association, #3 Church Circle, PMB 250, Annapolis, MD 21401, 2001.
3. *Rubblization of Portland Cement Concrete Pavements*, Transportation Research Circular Number E-C087, Transportation Research Board, 500 Fifth Street, NW, Washington, DC 20001, January 2006.
4. *Distress Identification Manual for the Long-Term Pavement Performance Program*, U.S. Department of Transportation, Federal Highway Administration, Publication No. FHWA-RD-03-031, June 2003.
5. *Designing Stone Matrix Asphalt Mixtures for Rut-Resistant Pavements, Report 425*, Transportation Research Board, National Research Council, National Academy Press, Washington, D.C., 1999.

CHAPTER 9

PRINCIPLES OF DESIGN FOR PAVEMENT REHABILITATION WITH RIGID OVERLAY

9.1 M-E Introduction

Overlays are used to remedy structural or functional deficiencies of existing flexible or rigid pavements and extend their useful service life. It is important that the designer consider the type of deterioration present when determining whether the pavement has a structural or functional deficiency, so that an appropriate overlay type and design can be developed. See **Figure 9.1 Rehabilitation Alternative Selection Process** for the flowchart of rehabilitation alternative selection process. Note that not all of the steps presented in this figure are performed directly by the M-E Design, however designers must consider all of these steps to produce feasible rehabilitation with rigid overlay design alternatives.

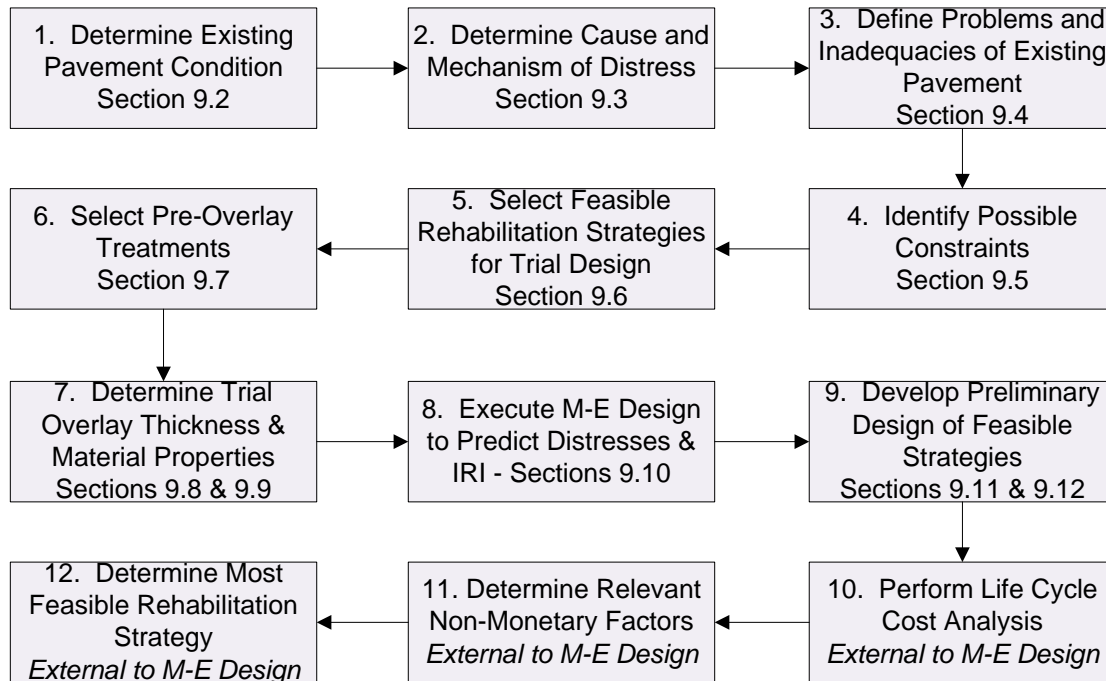

Figure 9.1 Rehabilitation Alternative Selection Process

This chapter describes the information needed to create cost effective rehabilitation strategies with PCC overlays using the M-E Design software and CDOT Thin Concrete Overlay design. Policy decision making that advocates applying the same standard fixes to every pavement does not always produce successful pavement rehabilitation. Successful rehabilitation depends on decisions that are based on the specific condition and design of the individual pavement. The rehabilitation design process begins with collection and detailed evaluation of project information. Once the data is gathered, an evaluation is in order to determine the cause of the pavement distress. Finally, a

choice needs to be made to select an engineered rehabilitation technique(s) that will correct the distresses.

9.1.1 CDOT Required Procedure for Rigid Overlays

Concrete Overlays are quickly becoming a popular method used nationwide to rehabilitate deteriorated asphalt pavements. Since the flexible asphalt surface is replaced by rigid concrete, the technique offers superior service, long life, low maintenance, low life-cycle cost, improved safety, and environmental benefits. The critical stress and strain prediction equations developed in an initial research report are part of a first-generation design procedure and was issued in December 1998 and titled *Guidelines for the Thickness Design of Bonded Whitetopping Pavement in the State of Colorado*, CDOT-DTD-R-98-10. An initial MS Excel worksheet was developed along with the report. The equations were verified and/or modified with the collection of additional data and was reported under August 2004, *Instrumentation and Field Testing of Thin Whitetopping Pavement in Colorado and Revision of the Existing Colorado Thin Whitetopping Procedure*, CDOT-DTD-R-2004-12. A revised MS Excel worksheet accompanies the report.

Concrete Overlay is the construction of a new PCCP over an existing HMA pavement. It is considered an advantageous rehabilitation alternative for badly deteriorated HMA pavements, especially those that exhibit such distress as rutting, shoving, and alligator cracking (ACPA 1998).

The primary concerns with Concrete Overlays are:

- The thickness design procedure
- Joint spacing
- The use and spacing of dowels and tie bars

In general, CDOT does not recommend thin Concrete Overlay thickness of less than 5 inches. Conventional Concrete Overlays use 8 inches or greater thickness. Ultra-thin Concrete Overlay, which uses 4 inches or less of PCCP, should not be used on Colorado's state highways. See **Table 9.1 Required Concrete Overlay Procedure** for required Concrete Overlay Thickness Procedure.

Table 9.1 Required Concrete Overlay Procedure

Required Thickness	
< 5.0 inches	Do not use
≥ 5.0 to < 8.0 inches	Use CDOT Thin Concrete Overlay Procedure
≥ 8.0 inches	Use AASHTO Overlay Design (M-E Design)

9.2 Determine Existing Pavement Condition

9.2.1 Records Review

Obtaining specific project information is the first step in the process of rehabilitation. Five basic types of detailed project information are necessary: design, construction, traffic, environmental, and pavement condition. Conduct a detailed records review before an evaluation of project can be made. Refer to **Section 2.3 Project Files/Records Collection and Review** for more information on records review.

9.2.2 Field Evaluation

A detailed field evaluation of the existing pavement condition and distresses is necessary for rehabilitation design. Designers must, as a minimum, consider the following as part of pavement evaluation:

- Existing pavement design, condition of pavement materials, especially durability problems and subgrade soil
- Distress types present, severities, and quantities
- Future traffic loadings
- Climate
- Existing subdrainage facilities condition

It is important that an existing pavement condition evaluation be conducted to identify functional and structural deficiencies so designers may select appropriate combinations of preoverlay repair treatments, reflection crack treatments and PCC overlay designs to correct the deficiencies present.

9.2.3 Visual Distress

The types of distress have to be identified and documented prior to the selection of corrective measures. The cause of distresses is not always easily identified and may consist of a combination of problems. **Figure 9.2 Pavement Condition Evaluation Checklist (Rigid)** provides guidance for existing pavement evaluation for rigid pavements. (a similar checklist is available in **Figure 8.2 Pavement Condition Evaluation Checklist (Flexible)** for flexible pavement). For information on how to conduct the distress survey, refer to **Section A.4 Site Investigation**.

CDOT has a distress manual documenting pavement distress, description, severity levels and additional notes. The distress manual is presented in Appendix B - Colorado DOT Distress Manual for HMA and PCC Pavements in the publication *Development of a Pavement Maintenance Program for the Colorado Department of Transportation*, Final Report, CDOT-DTD-R-2004-17, August 2004. The report is in pdf format and can be downloaded from the web page <http://www.coloradodot.info/programs/research/pdfs/2004/preventivemaintenance.pdf>. In order to determine the pavement distress and condition a field inspection is mandatory. Isolating areas of distress can pinpoint different solutions for different sections along a project.

PAVEMENT EVALUATION CHECKLIST (RIGID)

PROJECT NO.: _____ LOCATION: _____
 PROJECT CODE (SA #): _____ DIRECTION: _____ MP _____ TO MP _____
 DATE: _____ BY: _____
 TITLE: _____

TRAFFIC

- Existing _____ NUMBER OF TRUCKS
- Design _____ NUMBER OF TRUCKS

EXISTING PAVEMENT DATA

- | | |
|--|--|
| - Subgrade (AASHTO) | - Shoulder Condition
(good, fair, poor) |
| - Base (type/thickness) | - Joint Sealant Condition
(good, fair, poor) |
| - Pavement Thickness | - Lane Shoulder Separation
(good, fair, poor) |
| - Soil Strength (R/M _R) | |
| - Swelling Soil (yes/no) | |
| - Roadway Drainage Condition
(good, fair, poor) | |

DISTRESS EVALUATION SURVEY

Type	Distress Severity*	Distress Amount*
Blowup		
Corner Break		
Depression		
Faulting		
Longitudinal Cracking		
Pumping		
Reactive Aggregate		
Rutting		
Spalling		
Transverse and Diagonal Cracks		
OTHER		

* Distress Identification Manual for the Long-Term Pavement Performance Program, U.S. Department of Transportation, Federal Highway Administration, Publication No. FHWA-RD-03-031, June 2003.

Figure 9.2 Pavement Condition Evaluation Checklist (Rigid)
(A restatement of Figure A.1) Drainage Survey

Condition of drainage structures and systems such as ditches, longitudinal edge drains, transverse drains, joint and crack sealant, culverts, storm drains, inlets and curb and gutters are all important

to divert water away from the pavement structure. Visual observation will reveal the types and extents of distresses present in the pavement that are either caused by or accelerated by moisture. Drainage assessment can also be benefited by data obtained from coring and material testing. The permeability and effective porosity of base/subbase materials, as determined through laboratory tests or calculated from gradations, can be used to quantify drainability. See **Table 9.2 Distress Levels for Assessing Drainage Adequacy of JPCP**.

Table 9.2 Distress Levels for Assessing Drainage Adequacy of JPCP

Load-Related Distress	Highway Classification	Current Distress Level		
		Inadequate	Marginal	Adequate
Pumping - all severities (percent joints)	Interstate/Freeway	> 25	10 to 25	< 10
	Primary	> 30	15 to 30	< 15
	Secondary	> 40	20 to 40	< 20
Mean Transverse Joint/Crack Faulting (inches)	Interstate/Freeway	> 0.15	0.1 to 0.15	< 0.1
	Primary	> 0.20	0.125 to 0.20	< 0.125
	Secondary	> 0.3	0.15 to 0.3	< 0.15
Durability (all severity levels of D- cracking and reactive aggregate)	All	Predominantly medium and high severity	Predominantly low and medium severity	None or predominantly low severity
Corner Breaks -all severities (number/mile)	Interstate/Freeway	> 25	10 to 25	< 10
	Primary	> 30	15 to 30	< 15
	Secondary	> 40	20 to 40	< 20

9.2.4 Non-Destructive Testing

Non-destructive testing may use three methods of testing to determine structural adequacy.

- Deflection testing - to determine high deflections, layer moduli, and joint load transfer efficiencies.
- Profile testing - to determine joint/crack faulting.
- Ground Penetrating Radar - to determine layer thickness.

The data obtained from these methods would be project site-specific (i.e. Level 1 inputs). Deflection testing results are used to determine the following:

- Concrete elastic modulus and subgrade modulus of reaction (center of slab).
- Load transfer across joints/cracks (across transverse joints/cracks in wheelpath).
- Void detection (at corners).
- Structural adequacy (at non-distressed locations).

In addition to backcalculation of the pavement layer and subgrade properties; void detection, and deflection testing can also be used to evaluate the load transfer efficiency (LTE) of joints and cracks in rigid pavements. *Evaluation of Joint and Crack Load Transfer*, Final Report, FHWA-RD-02-088 is a study presenting the first systematic analysis of the deflection data under the LTPP program related to LTE.

$$LTE = \frac{\delta_u}{\delta_l} \times 100 \qquad \text{Eq. 9-1}$$

Where:

LTE = load transfer efficiency, percent

δ_u = deflection on unloaded side of joint or crack measured 6 inches from the joint/crack

δ_l = deflection on loaded side of joint or crack measured beneath the load plate the center of which is placed 6 inches from the joint/crack

Visual distresses present at the joint or crack should be recorded and quantified. Joint (and crack) distress information is useful in analyzing and filtering the results obtained from the LTE calculation. The load transfer rating as related to the load transfer efficiency is shown in **Table 9.3 Load Transfer Efficiency Quality**.

Table 9.3 Load Transfer Efficiency Quality

Load Transfer Rating	Load Transfer Efficiency (percent)
Excellent	90 to 100
Good	75 to 89
Fair	50 to 74
Poor	25 to 49
Very Poor	0 to 24

Crack LTE is a critical measure of pavement condition because it is an indicator of whether the existing cracks will deteriorate further. LTE tests are usually performed in the outer wheelpath of the outside lane. For JPCP, cracks are held together by aggregate interlock and joints designed with load transfer devices have steel and aggregate interlock. In general, cracks with a good load transfer (LTE greater than 75 percent) hold together quite well and do not significantly contribute to pavement deterioration. Cracks with poor load transfer (LTE less than 50 percent) are working cracks and can be expected to deteriorate to medium and high severity levels and will exhibit faulting over time. These cracks are candidates for rehabilitation.

9.2.5 Coring and Material Testing Program

Experience has shown that non-destructive testing techniques alone may not always provide a reasonable or accurate characterization of the in-situ properties, particularly for those of the top pavement layer. The determination of pavement layer type cannot be made through non-destructive testing. While historic information may be available, the extreme importance and sensitivity calls for a limited amount of coring at randomly selected locations to be used to verify the historic information. Pavement coring, base and subbase thicknesses and samples are recommended to be collected at an approximate frequency of one sample per one-half mile of roadway. Several major parameters are needed in the data collection process. They are as follows:

- Layer thickness.
- Layer material type.
- Examination of cores to observe general condition and material durability.
- In-situ material properties (i.e. modulus and strength).

Concrete slab durability may have a possible condition of severe "D" cracking and reactive aggregate. Petrographic analysis helps identify the severity of the concrete distresses when their cause is not obvious. Material durability problems are the result of adverse chemical or physical interactions between a paving material and the environment. The field condition survey and examination of cores for material durability reinforce each other.

9.2.6 Lane Condition Uniformity

On many four lane roadways, the outer truck lane deteriorates at a more rapid pace than the inner lane. The actual distribution of truck traffic across lanes varies with the roadway type, roadway location (urban or rural), the number of lanes in each direction, and the traffic volume. Because of these factors, it is suggested that lane distribution be measured for the project under consideration. Obtaining the actual truck lane distributions will determine the actual remaining life of the lane under consideration. Significant savings may result by repairing only the pavement lane that requires treatment.

9.3 Determine Cause and Mechanism of Distress

Knowing the exact cause of a distress is key input required by designers for assessing the feasibility of rehabilitation design alternatives. Assessment of existing pavement conditions is done using outputs from distress and drainage surveys, and usually some coring and testing of materials. A critical element in the M-E based rehabilitation design is the evaluation of existing pavement conditions. The observation should begin with a review of all information available regarding the design, construction, and maintenance history of the pavement. This should be followed by a detailed survey to identify the type, amount, severity, and location of surface distresses. Some of the key distress types are indicators of structural deficiencies:

- Deteriorated Cracked Slabs
- Corner breaks
- Mean Transverse Joint/Crack Faulting

- Pumping
- Spalling
- D-cracking
- Other localized failing areas
- There may be other types of distress that, in the opinion of the engineer, would detract from the performance of an overlay.

Depending on the types and amounts of deterioration present, rehabilitation options with or without pre-overlay treatments are considered. **Table 9.4 Common Distresses Causes of Rigid Pavements and Associated Problem Types** presents a summary of causes for distresses present on existing rigid pavements and associated problem types.

Table 9.4 Common Distresses Causes of Rigid Pavements and Associated Problem Types

Distress Types	Load	Environment			Materials	Construction
		Moisture	Temperature	Subgrade		
Alkali-aggregate reactivity	N	P	C	N	P	N
Blow-up	N	C	P	N	C	N
Corner breaks	P	C	C	N	N	N
Depression	N	C	N	P	N	C
D-cracking	N	P	P	N	P	N
Transverse joint faulting	P	P	C	C	C	N
Joint failure	N	C	C	N	P	C
Lane/shoulder dropoff	C	P	P	C	C	N
Longitudinal slab cracking	P	C	P	C	C	P
Spalling (longitudinal and transverse joints)	C	C	P	N	P	C
Polish aggregate	C	N	N	N	P	N
Popouts	N	C	C	N	P	C
Pumping	P	P	N	C	C	N
Random (map) cracking, scaling, and crazing	N	N	C	N	C	P
Shattered slab	P	C	N	C	C	N
Swell	N	P	P	C	C	N
Transverse slab cracking	P	N	C	C	C	P

Notes: P= Primary Factor; C= Contributing Factor; N= Negligible Factor.

9.4 Define Problems and Inadequacies of Existing Pavement

Information gathered and presented using the pavement condition evaluation checklist must be reviewed by the designer using guidance presented in **Table 9.4 Common Distresses Causes of Rigid Pavements and Associated Problem Types** and **Table 8.1 Common Distresses Causes of Flexible Pavements and Associated Problem Types** to define possible problems identified with the existing pavement. Accurately identifying existing problems is a key factor to be

considered when selecting appropriate rehabilitation design alternatives for the trial design. A review of the extent and severity of distresses present will allow the designer to determine when the existing pavement deficiencies are primarily structural, functional, or materials durability related. It also allows the designer to determine if there is a fundamental drainage problem causing the pavement to deteriorate prematurely.

Once an existing pavement deficiency is characterized, the next step is to select among feasible design alternatives and perform a trial design. A description of common pavement problem types is presented as follows:

- **Functional deterioration:** Functional deficiency arises from any condition(s) that adversely affect the highway user. These include poor surface friction and texture, faulting, hydroplaning and splash from wheel path rutting, and excess surface distortion. Cracking and faulting affect ride quality but are not classified under functional distress. These conditions reduce load carrying capacity as stated above. The integrity of the base, concrete slab and joint system is compromised under cracking and faulting. If a pavement has only a functional deficiency, it would not be appropriate to develop an overlay design using a structural deficiency design procedure. Overlay designs, including thickness, preoverlay repairs and reflection crack treatments, must address the causes of functional problems and prevent their reoccurrence. This can only be done through sound engineering, and requires experience in solving the specific problems involved. The overlay design required to correct functional problems should be coordinated with that required to correct any structural deficiencies.
- **Structural deterioration:** This is defined as any condition that adversely affects the load carrying capability of the pavement structure. Corner breaks, pumping, faulted joints and shattered slabs are some examples of structural related distresses. Evaluating the level of structural capacity requires thorough visual survey and materials testing. Non-destructive testing is important to characterize both pavement stiffness and subgrade support. Restoration is applicable only for pavements with substantial remaining structural capacity. Pavements that have lost much of their structural capacity require either a thick overlay or reconstruction. It should also be noted that several types of distress, i.e., distresses caused by poor construction techniques, are not initially caused by traffic loads, but do become more severe under traffic to the point that they also detract from the load carrying capability of the pavement.
- **Material durability deterioration:** This is defined as any condition that negatively impacts the integrity of paving materials leading to disintegration and eventual failure of the materials. Research indicates that poor durability performance can often be attributed to the existing pavement material constituents, mix proportions, and climatic factors such as excessive moisture and intense freeze-thaw cycles. Examples of durability problems include spalling, scaling and disintegration of cement-treated materials due to freeze thaw damage, map cracking and joint deterioration resulting from alkali-silica reactivity, stripping in HMA base, and contamination of unbound aggregate layers with fines from subgrade.

9.5 Identify Possible Constraints

The feasibility of any type of overlay design depends on the following major considerations:

- Construction feasibility of the overlay.
- Traffic control and disruptions.
- Materials and equipment availability.
- Climatic conditions.
- Construction problems such as noise, air and/water pollution, hazardous materials/waste, subsurface utilities, overhead bridge clearance, shoulder thickness and side slope extensions in the case of limited right-of-way, etc.

Designers must consider all of the factors listed above along with others not mentioned as they to determine whether a flexible overlay or reconstruction is the best rehabilitation solution for the given situation.

9.6 Selecting a Feasible Strategy for Rigid Pavement Rehabilitation Trial Designs

9.6.1 Bonded Concrete Overlays

9.6.1.1 PCC over PCC

Bonded Portland cement concrete (PCC) overlays over existing jointed plain concrete pavement (JPCP) involve the placement of a thin concrete layer, typically 3 to 7 inches, atop the prepared existing PCC surface to form a permanent monolithic PCC section. The monolithic section improves load carrying capacity by reducing the critical structural responses—top and bottom tensile stress in the longitudinal direction for JPCP cracking and slab edge corner deflections at the joint for JPCP faulting. Consult Region Materials Engineer for additional information.

For bonded PCC overlays over existing JPCP, achieving long-term bonding is essential. To ensure an adequate bond, the existing surface should be cleaned of all surface contaminants including oil, paint, and unsound concrete. Milling, sand blasting, water blasting or a combination of the above can accomplish this. Since all cracks in the old surface will reflect through the overlay, all joints and cracks in the original pavement must be reproduced in the overlay. For this reason, thin concrete overlays are restricted to pavements that are not heavily cracked. Thin concrete overlays should be used only when the existing concrete is in good condition or rehabilitated into a good condition.

9.6.1.2 PCC over HMA

Bonded PCC overlays over existing HMA involve the placement of a thin concrete layer, typically 3 to less than 8 inches, atop the existing HMA surface. These are used to restore the structural capacity and/or correct surface distresses of the existing HMA. The bond between the overlay and underlying HMA assists the horizontal shear transfer at the bond plane between the two types of

pavement. Because of this bond, the shear stresses are transferred into the underlying HMA material, thereby reducing the tensile stresses in the PCC. To ensure an adequate bond, the existing HMA surface should be cleaned of surface contaminants such as oil and unsound HMA. Pavement marking material should be removed if more than two layers of marking material have been applied to the pavement. HMA with more than one layer of chip seals or slurry seals should be evaluated for its bond to the existing HMA. Power sweeping, cold milling, water blasting or a combination of the above can accomplish this. It has been determined that older HMA (over a few years old) will provide an adequate macrotexture for bonding without the need to cold plane the existing aged pavement. The Concrete Overlay Task Force has recommended that an adequate platform for the PCC would be at least 3 inches of HMA, is in good condition and have a good bond to each other in the remaining 3 inches. FWD data should be obtained on every project.

9.6.2 Feasible of Alternatives for Bonded Concrete Overlays

The type of rehabilitation/restoration technique and thickness of the required overlay are based on an evaluation of present pavement conditions and estimates of future traffic. In general the designer must apply the following rules when considering rehabilitation alternatives involving bonded concrete overlays:

9.6.2.1 When an existing JPCP pavement surface evaluation indicates adequate structural strength but the condition of the surface needs correction:

Concrete pavement restoration (CPR) may be used to remedy the functional problem. CPR is a non-overlay option used to repair isolated areas of distress, or to prevent or slow overall deterioration, as well as to reduce the impact loadings on the concrete pavement without changing its grade. CPR includes diamond grinding, load transfer restoration, partial depth repairs, and full depth repairs.

9.6.2.2 When an existing JPCP pavement surface evaluation indicates inadequate structural strength to carry future traffic but the condition of the surface needs minor correction:

Bonded PCC overlays, in conjunction with surface restoration, may be used. Bonded overlays should be used only when the PCC slab is in good condition. The PCC slab must be in sound condition to help ensure good bonding and little reflection cracking. Pre-overlay repairs including milling, load transfer restoration, and joint spalling repair may be undertaken as necessary to perform surface corrections of the existing PCC slab.

9.6.2.3 When an existing HMA pavement surface evaluation indicates inadequate structural strength to carry future traffic but the condition of the surface needs minor correction:

Bonded PCC overlays, in conjunction with surface restoration, may be used. The HMA should be evaluated by a combination of visual inspections, non-destructive tests such as falling weight deflectometer (FWD) testing, and cores. The cores should be taken to determine damage not visible at the surface. Pre-overlay full-depth patching may be undertaken as necessary to repair

severe load associated cracking and potholes. Bonded overlays should be used only when at least 3 inches of HMA remains and the HMA layers have good adhesion to each other. Rutting or shoving in the existing HMA exceeding 2 inches will require milling. The milling operation should reduce the affected area to a maximum of 2 inches in depth. When severe load associated cracking and/or severe stripping is found in the underlying layers, it is recommended that FWD testing be used to determine the structural strength of the HMA. Cracks greater than $\frac{3}{4}$ inch prior to the PCC overlay should be filled with milling material or fine aggregate.

9.6.2.4 When the existing pavement has significant durability problems:

Unbonded PCC or conventional AC overlays over fractured concrete should be used. Unbonded overlays do not require much pre-overlay repair unless there is a spot of significant deterioration. A separator layer using a thin AC layer or paving fabric placed between the overlay and existing pavement should be used. Separating the existing and overlay PCC layers prevents distresses in the existing pavement from reflecting through the overlay. Slabs that move under traffic loads, isolated soft spots, pumping, or faulted areas should be stabilized prior to overlaying. Total reconstruction may also be warranted. CPR is not recommended for rigid pavements that have significant material durability problems or other severe deterioration.

9.6.3 The CDOT Thin Concrete Overlay Thickness Design

The purpose of bonded concrete overlays of asphalt is to add structural capacity and to eliminate the surface distresses on the existing asphalt pavement. Severe surface defects are corrected to provide an acceptable and relatively smooth surface on which to place the concrete. Cold milling is only required when asphalt mix has been placed within the last couple of years. The surface needs to be roughened to create a good interlocking bond. Also, by the use of cold milling, grade control can be accomplished at this time. The final operation is to pave the concrete with a conventional concrete paving machine.

Based on the field and theoretical analyses conducted during the research study, the following construction practices should be used:

- A good bond within the concrete/asphalt interface is essential for successful performance.
- For existing asphalt pavement being rehabilitated, the strain (and corresponding stress) in the concrete overlay is reduced by approximately 25 percent when the asphalt is milled prior to concrete placement. The strain (and corresponding stress) in concrete on new asphalt is increased by approximately 50 percent when the asphalt has not aged prior to concrete placement.

A minimum asphalt thickness of 3 inches (after cold planning or other remedial work) is recommended.

Table 9.5 Design Factors for Rigid Pavement contains the various design factors to be used in the concrete overlay design.

Table 9.5 Design Factors for Rigid Pavement

Factor	Source
Primary or Secondary	User Input (select Primary or Secondary)
Joint Spacing	24 to 72 inches (depending on thickness)
Trial concrete thickness	User Input
Concrete Modulus of Rupture	650 psi (CDOT default value)
Concrete Elastic Modulus	Table 7.1 PCC Material Inputs and Recommendations for New JPCP Design or FWD data
Concrete Poisson's Ratio	0.15 (CDOT default value)
Asphalt thickness	Soil profile report from laboratory
Asphalt Modulus of Elasticity (when existing HMA was new)	User Input (From FWD Data))
Asphalt Poisson's Ratio	0.35 (CDOT default value)
Asphalt fatigue life consumed	$\left[1 - \frac{\text{existing asphalt modulus}}{\text{asphalt modulus when new}} \right] * 100$ or estimated by designer
k-value of the Subgrade	Soil profile report from laboratory and correlation equations or Table 4.7 k-Value Ranges for Various Soil Types
Temperature differential	$\Delta T = 3^\circ \text{ F/in.}$ throughout the day (CDOT default value)
Design ESALs	DTD Traffic Analysis Unit

For more information, please see: CDOT Research Report No. CDOT-DTD-R-98-10, *Guidelines for the Thickness Design of Bonded Whitetopping Pavement in the State of Colorado, December 1998*, CDOT-DTD-R-2002-3, *Instrumentation and Field Testing of Whitetopping Pavements in Colorado and Revision of the TWT Design Procedure*, March 2002 and CDOT-DTD-R-2004-12, *Instrumentation and Field Testing of Thin Whitetopping Pavement in Colorado and Revision of the Existing Colorado Thin Whitetopping Procedure*, August 2004. The last two research reports can be found on web page <http://www.dot.state.co.us/publications/researchreports.htm#White>. A revised MS Excel worksheet was developed in conjunction with report CDOT-DTD-R-2004-12. The worksheet may be obtained from CDOT Materials and Geotechnical Branch, Pavement Design Unit 303-398-6561 or CDOT Research Branch 303-757-9506.

The proper selection of candidate projects for CDOT thin concrete overlay is of paramount importance to its continued use as a viable rehabilitation alternative. Listed are guidelines for the pavement designer on when to consider a project candidate for thin concrete overlay. The list was compiled from past good performing concrete overlay projects that had these characteristics.

- Determine the modulus of existing asphalt by an analysis using Falling Weight Deflectometer (FWD) data.
- Cold mill when the rut depth exceeds 2 inches or when new HMA is placed to improve mechanical bond.
- The condition of the asphalt pavement must be in relatively good condition for an overlay.
- An existing roadway having a good aggregate base is preferred.
- Concrete overlays works well with a divided roadway. The median serves as a non-tied longitudinal joint.
- The cross traffic must be added to the mainline traffic for the pavement design at these intersection locations.
- Selected projects should develop a detailed survey that includes at least 5 profile lines across the roadway and be included as part of the bidding documents.

A Project Special Provision has been developed and is to be used on thin concrete overlay projects. The Project Special Provision is on web page:

<http://www.coloradodot.info/business/designsupport/construction-specifications/2011-Specs/sample-construction-project-special-provisions/section-300-500-revisions>

The specification is titled Revision of Section 412, Portland Cement Concrete Pavement Thin Concrete Overlay. Additionally a thin concrete overlay typical joint layout plan sheet has been developed to go along with the project special provision. It is found on web page

http://www.coloradodot.info/business/designsupport/standard-plans/2006-m-standards/2006-project-special-details/2006_m_standards_project_special_details_index and is titled D-412-2, Thin Concrete Overlay Typical Joint Layout.

9.6.4 Development of Design Equations

Two different modes of distress may exist in pavements overlaid by concrete; corner cracking caused by corner loading and mid-slab cracking caused by joint loading. Both of these types of failure were considered in developing the original design equations (1998).

9.6.4.1 Corner Loading (1998)

Both a 20-kip Single Axle Load (SAL) and a 40-kip Tandem Axle Load (TAL) were applied to the slab corners of the concrete overlay. The corner loading case was found to produce the maximum concrete stress for relatively few conditions. In general, the corner loading case governed at higher values of the effective radius of relative stiffness. As the stiffness increases, the load-induced stress decreases. When the corner load case governed, relatively lower stresses resulted. The maximum stress, whether edge or corner, was used in the derivation of the concrete stress prediction equations.

9.6.4.2 Mid-Joint Loading (1998)

Load-induced longitudinal joint stresses for a 20-kip single axle load (SAL) and a 40-kip tandem axle load (TAL) were computed. Maximum tensile stresses at the bottom of each layer were calculated for both the concrete and asphalt. Maximum asphalt strains used in generating the design equations occurred for the joint loading condition. In most cases, the joint loading condition also produced the maximum stress at the bottom of the concrete layer.

9.6.4.3 Determination of Critical Load Location (1998)

The critical load location for the design of concrete pavement was determined during the original 1998 study by comparing the stress and strain data collected for each load position. The critical load location inducing the highest tensile stress in the concrete layer was when the load was centered along a longitudinal free edge joint. For concrete pavement, a free edge joint occurs when both the asphalt and concrete are formed against a smooth vertical surface such as a formed concrete curb and gutter. It is reasonable that free edge loading produces the highest stress, but it is likely more common that the joints loaded by traffic will not be free edges. The equation for original data is shown and could not be verified but is used in the 2004 procedure.

Original Critical Joint Stresses:

$$\sigma_{FE} = 1.87 \times \sigma_{TE} \quad \text{Eq. 9-2}$$

Where:

σ_{FE} = load-induced stress at a longitudinal free joint, psi

σ_{TE} = load-induced stress at a longitudinal tied joint, psi

9.6.4.4 Interface Bond on Load-Induced Concrete Stress

The effect of interface bonding was evaluated by comparing measured stresses for zero temperature gradient conditions to the computed stresses for fully bonded pavement systems. Stresses caused by loads at mid-joint and slab corner were computed using the finite element computer program ILLISLAB (ILSL2), assuming fully bonded concrete-asphalt interface. The program is based on plate bending theory for a medium-thick plate placed on a Winkler or spring foundation. All the test sections where existing asphalt was milled prior to concrete placement and based on the previous study (1998) was determined to be the best approach for promoting bond for existing asphalt substrate conditions.

2004 Interface Bond on Load-Induced Concrete Stresses:

$$\sigma_{ex} = 1.51 * \sigma_{th} \quad \text{Eq. 9-3}$$

Where:

σ_{ex} = measured experimental partially bonded stress, psi

σ_{th} = calculated fully bonded stress, psi

9.6.4.5 Interface Bond on Load-Induced Asphalt Strain

The effect of interface bond on the load-induced asphalt surface strain was also studied using field-collected data. If slabs were fully bonded, the concrete bottom strain would equal the asphalt surface strain. Asphalt strains are generally less than the concrete strains, which is the result of slippage between the layers. There is approximately a 10 percent loss of strain transfer from the concrete to the asphalt due to the partial bond between the layers.

2004 Interface Bond on Load-Induced Asphalt Strain:

$$\varepsilon_{ac} = 0.897 * \varepsilon_{pcc} - 0.776 \quad \text{Eq. 9-4}$$

Where:

ε_{ac} = measured asphalt surface strain, microstrain

ε_{pcc} = measured concrete bottom strain, microstrain

Stresses and strains at the bottom of the asphalt layer decrease with loss of bond. The design procedure assumes that average strain reductions reflecting partial bond at the interface are equally reflected at the bottom of the asphalt layer.

9.6.4.6 Temperature Restraint Stress

Temperature gradients throughout load testing ranged from -2°F/in. to 6°F/in. Measurable stress changes occurred with changing temperature gradient, which indicates that restraint stresses are present and raises concern that there could be loss of support conditions. However, minimizing the concrete overlay joint spacing is recommended (typically using 6 ft. by 6 ft. panels) for minimizing the effects of curling and warping restraint stresses and possible loss of support.

2004 Temperature Effects on Load-Induced Stresses:

$$\sigma_{\%} = 3.85 * \Delta T \quad \text{Eq. 9-5}$$

Where:

$\sigma_{\%}$ = percent change in stress from zero gradient

ΔT = temperature gradient, °F/in.

This relationship is applied to the partial bond stresses to account for the effect of temperature induced slab curling and loss of support effects on the load-induced concrete stresses. For CDOT projects, a default temperature gradient of 3°F/in. will be used.

9.6.4.7 Development of Prediction Equations for Design Stresses and Strains

Prediction equations were derived for computing design concrete flexural stresses and asphalt flexural strains. The 2004 equations have an increase in concrete flexural stress of 51 percent from fully bonded pavements would be required to account for the loss of bonding at the 95 percent confidence level. Asphalt strains are decreased by approximately 10 percent to account for the partial bonding condition at the 95 percent confidence level. Effects of temperature-induced slab curling on load-induced stresses were also included in the thickness design procedure, and all of the original 1998 adjustments for these stresses and strains were revised. The revised four equations are as follows:

2004 Concrete Stress For 20-kip SAL

$$(\sigma_{pcc})^{1/2} = 18.879 + 2.918 t_{pcc} / t_{ac} + 425.44 / I_e - 6.955 \times 10^{-6} E_{ac} - 9.0366 \log k + 0.0133 L \quad \text{Eq. 9-6}$$

$$R^2_{adj.} = 0.91$$

2004 Concrete Stress For 40-kip TAL

$$(\sigma_{pcc})^{1/2} = 17.669 + 2.668 t_{pcc} / t_{ac} + 408.52 / I_e - 6.455 \times 10^{-6} E_{ac} - 8.3576 \log k + 0.00622 L \quad \text{Eq. 9-7}$$

$$R^2_{adj.} = 0.92$$

2004 Asphalt Strain For 20-kip SAL

$$(\epsilon_{ac})^{1/4} = 8.224 - 0.2590 t_{pcc} / t_{ac} - 0.04419 I_e - 6.898 \times 10^{-7} E_{ac} - 1.1027 \log k \quad \text{Eq. 9-8}$$

$$R^2_{adj.} = 0.81$$

2004 Asphalt Strain For 40-kip TAL

$$(\epsilon_{ac})^{1/4} = 7.923 - 0.2503 t_{pcc} / t_{ac} - 0.04331 I_e - 6.746 \times 10^{-7} E_{ac} - 1.0451 \log k \quad \text{Eq. 9-9}$$

$$R^2_{adj.} = 0.82$$

Where:

- σ_{pcc} = maximum stress in the concrete slab, psi
- ϵ_{ac} = maximum strains at bottom of asphalt layer, microstrain
- E_{pcc} = concrete modulus of elasticity, assumed 4 million psi
- E_{ac} = asphalt modulus of elasticity, psi
- t_{pcc} = thickness of the concrete layer, in.
- t_{ac} = thickness of the asphalt layer, in.
- μ_{pcc} = Poisson's ratio for the concrete, assumed 0.15
- μ_{ac} = Poisson's ratio for the asphalt, assumed 0.35
- k = modulus of subgrade reaction, pci

$$l_e = \text{effective radius of relative stiffness for fully bonded slabs, in.}$$

$$= \left\{ \frac{E_{pcc} [t_{pcc}^3/12 + t_{pcc} (NA - t_{pcc}/2)^2] / [k(1 - \mu_{pcc}^2)] + E_{ac} [t_{ac}^3/12 + t_{ac} (t_{pcc} - NA + t_{ac}/2)^2] / [k(1 - \mu_{ac}^2)] \right\}^{1/4}$$

NA = neutral axis from top of concrete slab, in.

$$= [E_{pcc} t_{pcc}^2/2 + E_{ac} t_{ac} (t_{pcc} + t_{ac}/2)] / [E_{pcc} t_{pcc} + E_{ac} t_{ac}]$$

L = joint spacing, in.

Each of the equations developed to calculate the critical stresses and strains in a concrete overlay is dependent on the effective radius of relative stiffness of the layered system. The radius of relative stiffness appears in many of the equations dealing with stresses and deflections of concrete pavements. Concrete overlays include an additional structural layer of asphalt concrete. The stiffness contribution of the asphalt layer is incorporated into the effective radius of relative stiffness equation shown above.

Transverse joint spacing directly affects the magnitude of critical stresses in thin concrete overlays. Depending on the pavement design, the climate, season, and time of the day, curling stresses in concrete overlay can equal or exceed the load stresses. However, joint spacing is directly considered as an input in the CDOT design.

CDOT does not use dowels for transverse joints in thin concrete overlay designs; however, it recommends the use of tie bars in longitudinal joints. The 2004 equations are based on using tie bars in the longitudinal joints. The analysis was with all wheel loadings next to tied longitudinal joints. CDOT project design drawing D-412-2, Thin Concrete Overlay Typical Joint Layout provides for this requirement.

9.6.4.8 PCCP and HMA Pavement Fatigue

The Portland Cement Association (PCA) developed a fatigue criterion based on Miner's hypothesis that fatigue resistance not consumed by repetitions of one load is available for repetitions of other loads. In a design, the total fatigue should not exceed 100%. The concrete fatigue criterion was incorporated as follows:

For $SR > 0.55$

$$\text{Log}_{10}(N) = (0.97187 - SR) / 0.0828 \quad \text{Eq. 9-10}$$

For $0.45 \leq SR \leq 0.55$

$$N = (4.2577 / (SR - 0.43248))^{3.268} \quad \text{Eq. 9-11}$$

For $SR < 0.45$

$$N = \text{Unlimited} \quad \text{Eq. 9-12}$$

Where:

SR = flexural stress to strength ratio

N = number of allowable load repetitions

Asphalt pavements are generally designed based on two criteria, asphalt concrete fatigue and subgrade compressive strain. Subgrade compressive strain criterion was intended to control pavement rutting for conventional asphalt pavements. For concrete overlay pavements, when the asphalt layer is covered by concrete slabs, pavement rutting will not be the governing distress. The asphalt concrete fatigue equation developed by the Asphalt Institute was employed in the development of the concrete overlay design procedure. The asphalt concrete fatigue equation is as follows:

$$N = C * 18.4 * (4.32 \times 10^{-3}) * (1 / \epsilon_{ac})^{3.29} * (1 / E_{ac})^{0.854} \quad \text{Eq. 9-13}$$

Where:

- N = number of load repetitions for 20% or greater AC fatigue cracking
- ϵ_{ac} = maximum tensile strain in the asphalt layer
- E_{ac} = asphalt modulus of elasticity, psi
- C = correction factor = 10M
- $M = 4.84 * [(V_b / (V_v + V_b)) - 0.69]$
- V_b = volume of asphalt, percent
- V_v = volume of air voids, percent

For typical asphalt concrete mixtures, M would be equal to zero. The correction factor, C, would become one, and was omitted from the equation. However, since concrete overlay is designed to rehabilitate deteriorated asphalt pavement, the allowable number of load repetitions (N) needs to be modified to account for fatigue life consumed prior to concrete overlay construction. Therefore, the calculated repetitions must be multiplied by the fractional percentage representing the amount of fatigue life remaining in the asphalt concrete. For example, if it is determined that 25 percent of the asphalt fatigue life has been consumed prior to concrete overlay; the calculated allowable repetitions remaining must be multiplied by 0.75.

The concrete overlay pavement thickness design involves the selection of the proper concrete slab dimensions and thickness. Two criteria were used in governing the pavement design asphalt and concrete fatigue under joint or corner loading. Temperature and loss of support effects were also considered in the design procedure. A design example is presented in next section to illustrate how to use the developed procedure to calculate the required concrete overlay concrete thickness.

9.6.4.9 Converting Estimated ESALs to Concrete overlay ESALs

CDOT currently designs pavements using the procedure developed by the American Association of State Highway and Transportation Officials (AASHTO). This empirical procedure is based on pavement performance data collected during the AASHO Road Test in Ottawa, in the late 1950's and early 1960's. Traffic (frequency of axle loadings) is represented by the concept of the 18-kip Equivalent Single Axle Load (ESAL). Factors are used to convert the damage caused by repetitions of all axles in the traffic mix (single and tandem) to an equivalent damage due to 18-kip ESALs alone. Because the relative damage caused by ESALs is a function of the pavement thickness, a series of ESAL conversion factors have been developed for a range of concrete thicknesses. However, the minimum concrete thickness included in the AASHTO design manual

is 6 inches. Since concrete overlay thicknesses below 6 inches are anticipated, it was necessary to develop correction factors to convert ESAL estimations based on thicker concrete sections. In addition, because the ESAL method of design appears to overestimate the required PCC thickness, it was necessary to develop a conversion factor, which would make the empirical and mechanistic procedures more compatible.

CDOT provided axle distributions for two highway categories (Primary and Secondary) anticipated as typical concrete overlay traffic loading. The ESAL conversion factors were for an 8-in.-thick concrete pavement and a terminal serviceability of 2.5. The conversion factors were extrapolated for pavement thicknesses as low as 4 inches and the total ESALs were computed for a range of possible concrete overlay thicknesses. For each highway category, ESAL conversions were developed as a percentage of the total ESALs computed for an 8 inch thick concrete pavement. With these conversions, the designer only needs to obtain the design ESALs based on an assumed concrete thickness of 8 inches. For each trial concrete overlay thickness, the total ESAL estimation is adjusted based on the following conversion equations:

Primary Highway:

$$F_{ESAL} = 0.985 + 10.057 * (t_{pcc})^{-3.456} \quad \text{Eq. 9-14}$$

Secondary Highway:

$$F_{ESAL} = (1.286 - 2.138/t_{pcc})^{-1} \quad \text{Eq. 9-15}$$

Where:

F_{ESAL} = Conversion factor from ESAL estimation based on assumed; 8 inch thick concrete pavement

t_{pcc} = thickness of the concrete layer, inches.

For example, in the design of a 4.5-inch thick concrete overlay on a secondary highway, the estimated ESALs based on an assumed 8-in.-thick pavement, say 750,000, and should be converted to 925,000 using the secondary highway conversion equation.

9.6.5 Example Project CDOT Thin Concrete overlay Design

This example is a two-lane highway, designated State Highway 287 (SH 287) in Colorado. We will study cost for a typical project, 6 miles in length. The cross section has 2 lanes, each 12 feet wide and a 10 foot shoulder on each side. Thus, the pavement is 44 feet wide and the total pavement area is 154,880 square yards. The existing pavement structure is 5.5 inches Hot Mix Asphalt after cold milling over a 12 inch gravel base from the outside of one shoulder to the other shoulder. See **Figure 9.3 Sample TWT Project Location Map** for a map. Parameters and material properties used in the design include the following:

- Highway Category (Primary or Secondary) = Secondary
- Joint spacing, L = 72 in.
- Trial concrete thickness = 4.1 in.
- Concrete modulus of rupture, MR = 650 psi

- Concrete modulus of elasticity, $E_{pcc} = 4,000,000$ psi
- Concrete Poisson's ratio, $\mu_{pcc} = 0.15$
- Asphalt thickness, $t_{ac} = 5.5$ in.
- Asphalt modulus of elasticity, $E_{ac} = 350,000$ psi
- Asphalt Poisson's ratio, $\mu_{ac} = 0.35$
- Existing asphalt fatigue = 25 percent
- Existing modulus of subgrade reaction, $k = 200$ pci
- Temperature differential, $\Delta T = 3^\circ$ F/in throughout the day
- Design ESALs = 245,544

The 2004 revised MS Excel worksheet is shown in Figure 9.4 Input and Required Thickness Form for Thin Concrete overlay Design with the required concrete overlay thickness.

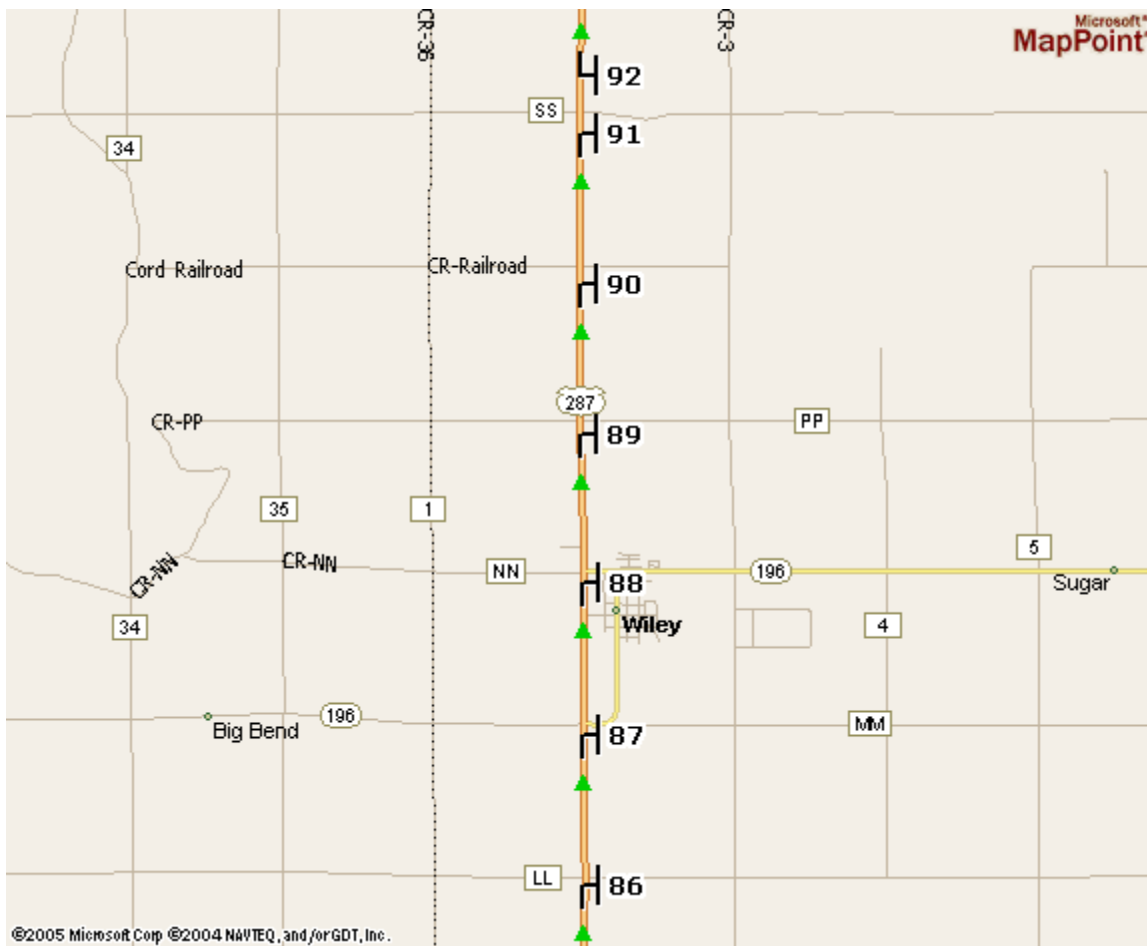

Figure 9.3 Sample TWT Project Location Map

CDOT 2004 Thin Whitetopping Design Procedure

Whitetopping Input Parameters

Highway Category (Primary or Secondary)*	Secondary
Joint Spacing, in.	72
Trial Concrete Thickness, in.	4.1
Concrete Flexural Strength, psi	650
Concrete Elastic Modulus, psi	4,000,000
Concrete Poisson's Ratio	0.15
Asphalt Thickness, in.	5.5
Asphalt Elastic Modulus, psi	350,000
Asphalt Poisson's Ratio	0.35
Asphalt Fatigue Life Previously Consumed, %	25
Subgrade Modulus, pci	200
Temperature Gradient, °F/in.	3
Design ESALs	245,544
Converted Concrete Thickness, in. =	5.24
ESAL Conversion Factor =	1.3072
Neutral Axis =	3.07
le =	27.36
L/le =	2.63

Critical Concrete Stresses and Asphalt Strains					
Load Induced		Bond Adjustment		Support Adjustment	
Stress, psi	μstrain	Stress, psi	μstrain	Stress, psi	μstrain
1	2	3	4	5	6
201	228	303	204	338	204

ESAL Fatigue Analysis						
No. of 18-kip ESALs	Concrete Fatigue Analysis			Asphalt Fatigue Analysis		
	Stress Ratio	Allowable ESALs	Fatigue, %	Asphalt μstrain	Allowable ESALs	Fatigue, %
7	8	9	10	11	12	13
3.2E+05	0.520	3.2E+05	99.9	204	1.5E+06	21.0

Concrete Fatigue, % = 99.9 Asphalt Fatigue, % = 46.0

Required Whitetopping Thickness = 4.25 in.

Figure 9.4 Input and Required Thickness Form for Thin Concrete overlay Design

References

1. *AASHTO Guide for Design of Pavement Structures*, American Association of State Highway and Transportation Officials, Washington, DC, 1993.
2. *Supplement AASHTO Guide for Design of Pavement Structures, Part II, - Rigid Pavement Design & Rigid Pavement Joint Design*, American Association of State Highway and Transportation Officials, Washington, DC, 1998.
3. *Whitetopping - State of the Practice*, Publication EB210.02P, American Concrete Pavement Association, 5420 Old Orchard Road, Suite A100, Skokie, IL, 1998.
4. *Guidelines for the Thickness Design of Bonded Whitetopping Pavement in the State of Colorado*, CDOT-DTD-R-98-10, Final Report, Scott M. Tarr, Mathew J. Sheehan, and Paul A. Okamoto, Colorado Department of Transportation, 4201 E. Arkansas Ave., Denver, CO, 80222, December 1998.
5. *Instrumentation and Field Testing of Thin Whitetopping Pavement in Colorado and Revision of the Existing Colorado Thin Whitetopping Procedure*, CDOT-DTD-R-2004-12, Final Report, Matthew J. Sheehan, Scott M. Tarr, and Shiraz Tayabji, Colorado Department of Transportation, 4201 E. Arkansas Ave., Denver, CO, 80222, August 2004.
6. *Distress Identification Manual for the Long-Term Pavement Performance Program*, U.S. Department of Transportation, Federal Highway Administration, Publication No. FHWA-RD-03-031, June 2003.
7. *AASHTO Mechanistic-Empirical Pavement Design Guide, A Manual of Practice, Interim Edition, July 2008*, American Association of State Highway and Transportation Officials, Washington, DC, 2008.

CHAPTER 10

REHABILITATION OF PORTLAND CEMENT CONCRETE PAVEMENT

10.1 Introduction

Prior to 1976, Federal-Aid Interstate funds could be used only for the initial construction of the system. All other non-maintenance work on the Interstate System was funded with Federal-Aid Primary or State funds. The Federal-Aid Highway Act of 1976 established the Interstate 3R program, which placed emphasis on the use of Federal funds for Resurfacing, Rehabilitation, and Restoration. The Federal-Aid Highway Act of 1978 required that 20 percent of each State's primary, secondary, and urban Federal-Aid funds be spent on 3R projects. The Federal-Aid Highway Act of 1981 added the fourth R, Reconstruction, so that existing facilities could be eligible for Federal funding. The Intermodal Surface Transportation Efficiency Act of 1991 (ISTEA) reclassifies the four Federal-Aid systems (Interstate, Primary, Secondary and Urban) into two Federal-Aid systems: the National Highway System (NHS) and the Non-NHS. Although the Interstate System is a part of the NHS, it retains its own identity and will receive separate funding. Due to the passage of 1998 TEA-21, funding is not available for surface transportation improvements but Federal funds are available for matching State and local funds to construct 4R projects (6). The above legislation and funding is the driving force behind the restoration of pavements and specifically this chapter.

This chapter provides a framework and describes the information needed to create cost effective rehabilitation strategies for Portland Cement Concrete Pavement (PCCP). Policy decision making that advocates applying the same standard fixes to every pavement does not produce successful pavement rehabilitation. Successful rehabilitation depends on decisions that are based on the specific condition and design of the individual pavement. Five basic types of detailed project information are necessary: design, construction, traffic, environmental, and pavement condition (1). Once the data is gathered, an evaluation is in order to determine the cause of the pavement distress. Finally, a choice needs to be made to select an engineered rehabilitation technique(s) that will correct the distresses.

10.2 Scope and Limitations

Pavement rehabilitation projects should substantially increase the service life of a significant length of roadway. The guidelines presented in this chapter will focus on restoration. The restoration presented refers to the pavement rehabilitation before an overlay or not needing one after the restoration. In this chapter, the words rehabilitation and restoration are pretty much interchangeable; one needs to understand the contents as presented. Resurfacing with an overlay is covered in **CHAPTER 8** and **CHAPTER 9** of this manual. **CHAPTER 8** is the design of flexible overlays. Most of the chapter deals with flexible overlays over flexible pavement. But, the same principles apply to flexible overlays over rigid pavements. **CHAPTER 9** mostly deals with rigid overlays over rigid pavement and the design of Concrete Overlays. Reconstruction involves complete removal of the pavement structure. Reconstruction would be the using the same

design procedures as in **CHAPTER 7**. Reconstruction techniques offer the choice of selecting virgin or recycled materials. Use of recycled material can often lower project costs (1)(3).

The pavement designer will encounter other definitions relating to rehabilitation. Both definitions will refer to functional and structural conditions. The intent is to show how encompassing rehabilitation is:

- AASHTO defines Preventive Maintenance (PM) as a "planned strategy of cost-effective treatments to an existing roadway system and its appurtenances that preserves the system, retards future deterioration, and maintains or improves the functional condition of the system (without substantially increasing structural capacity)" (8).
- The publication *Development of a Pavement Maintenance Program for the Colorado Department of Transportation, Final Report*, CDOT-DTD-R-2004-17, August 2004 suggests this definition for Preventive Maintenance (22).

“Preventive Maintenance: Work undertaken that preserves the existing pavement, retards future deterioration, and improves the functional life without substantially increasing the structural capacity.”

- An AASHTO sponsored working group defined Pavement Preservation as "the planned strategy of cost-effective pavement treatments to an existing roadway to extend the life or improve the serviceability of the pavement. It is a program strategy intended to maintain the functional or structural condition of the pavement. It is the strategy for individual pavements and for optimizing the performance of a pavement network" (8).

The above definitions stress the point that pavement maintenance and preservation are planned strategies and are to be cost-effective. The gathering of information, evaluation, and selections of treatments as outlined below are the same if the strategies were planned or not.

10.3 Colorado Documented Design Methods

By June 1952, 8 inches of concrete pavement over 6 inches of granular subbase was placed on the now northbound lanes only of Interstate 25 from Evans Avenue southward through a rural area to Castle Rock. In 1951 the grading project in preparation for the concrete pavement had a requirement of 90 percent AASHTO T-180 Modified Compaction on A-6 and A-7 soils with a swell that ranged from 4.3 to 9.9 percent. Shortly after the PCCP was placed, Colorado Department of Highways (CDOH) noticed cracking and warping of the slabs in certain areas. By the following summer, the cracking and rising of the slabs had become severe in these areas. The cracking increased throughout the project from October 1952 of 1,802 linear feet to 13,959 linear feet by September 1958. What followed in 1956/1957 was not a restoration of the existing concrete pavement, but constructing experiential sections investigating alternatives mitigating the swell potential on the new future southbound lanes. A number of design philosophies in place now are a result of these experiential sections. The final report was published in 1966 titled, *Pavement Study - Project I 092-2(4)* in cooperation with U.S. Bureau of Public Roads (16). The grading project for the experiential sections required 95 percent AASHTO T-99 Standard Compaction as

much on the wet side as feasible. Laboratory tests showed that the A-7-5(20) soils that swelled 9.9 percent at 90 percent Modified compaction swelled to only 2.8 percent at 95 percent Standard compaction. At this time, the Department felt that if the swell of the subgrade soils was less than 3 percent, 4 inches of subbase material plus 8 inches of PCCP would provide sufficient surcharge to nullify the detrimental effect of this small amount of swell. Five test sections were constructed from late 1957 to spring of 1958.

- Section A – ½ mile of 8 inch concrete pavement encasing a light welded wire reinforcing fabric placed 2 inches below the concrete surface with a joint spacing of 61.5 feet, concrete pavement was placed over 4 inches sand subbase treated with 2% cement.
- Section B – ½ mile of 8 inch concrete pavement encasing a heavy welded wire reinforcing fabric with a joint spacing of 106.5 feet, concrete pavement placed over 4 inches of sand subbase treated with 2 percent cement.
- Section C, "Control Section" - 1 mile of 8 inch non-reinforced concrete pavement with a joint spacing of 20 feet, placed on 4 inches cement-treated base.
- Section D – ½ mile of 10 inch non-reinforced concrete pavement with a joint spacing of 20 feet, placed on 4 inches cement-treated base.
- Section E - ½ mile of 8 inch concrete pavement with a joint spacing of 20 feet, placed on 20 inches of cement-treated base.

1966 results showed that the Section C "Control Section" had less cracking per mile than any other section; Section B had 718 feet/mile, Section D had 502 ft/mile, Section A had 396 feet/mile, Section E had 384 feet/mile, and Section C had 85 feet/mile. The tests sections would never be classified as severe when compared to the cracking of 1952-1957.

A number of important conclusions were presented. Remedial measures are necessary for high swelling soils as the 1966 report concluded. High swelling soils could be mitigated by applying moisture contents at or near optimum using standard 95 percent AASHTO T-99 Standard Compaction. If the subgrade soils had a swell less than 3 percent than no mitigation was necessary. DOH Memo #323, 1/5/66, (Construction) Swelling Soils was issued to address the depth of treatments in cuts sections. Refer to Chapter 2 of this Manual and Chapter 200 of the Field Materials Manual for additional information. Both manuals basically follow Memo #323. Current thinking is to use a moisture content of optimum plus 2 percent. Another important conclusion was not to use continuously reinforced concrete pavement. Two reasons were presented, first being that for joint maintenance as a whole, cost was about the same for all sections. Second, the extra cost of wire mesh reinforcement was not justified considering rideability. The difference between a present service index of 4.0 and one of 3.4 were both considered acceptable. The maintenance forces provided a practical remedial rehabilitation by placing a thin overlay to improve the appearance and ride. Currently, this is a viable option and the most often used treatment.

In 1983 the Colorado Department of Highways (now referred to as the Colorado Department of Transportation, CDOT) prepared a research report titled *Rehabilitation of Concrete Pavements*, Report No. CDOH-83-1 (9). In 1983, the Colorado Department of Highways conducted an in-depth evaluation of concrete pavements on the interstate system. The purpose of the evaluation was to determine the condition of the pavements and develop rehabilitation strategies for these

concrete pavements in anticipation of increased 4R funds from the Federal Government. The rehabilitation philosophy used in 1983 was to restore all of the concrete pavements to "Like New" condition with a 20-year design life. Design procedures presented at the end of the study were developed that time which utilizing thick concrete and asphalt as a means of achieving the 20-year design life. Nine types of distress were identified and thought to be the most frequently observed on interstate roadways in Colorado. The pavements ages ranged from 4 to 24 years with the average age being 18 years. The nine distresses were:

1. Reactive Aggregate
2. Longitudinal Cracking
3. Transverse Cracking
4. Rutting
5. Depression
6. Pumping
7. Spalling
8. Faulting
9. Corner Breaks

Reactive aggregates were found to be the most devastating in terms of cost and effective corrective methods. The study recommended fly ash to be use on a routine basis where reactive aggregate problems are known to exist. Currently fly ash is used in CDOT Class P concrete. Rutting was found to be the most prominent in the areas where studded tire traffic volume was higher. Currently the use of studded snow tires is waning; chemical de-icing products such as magnesium chloride and potassium acetate, are taking their place. Pumping was observed only in areas with relatively poor drainage and untreated granular base materials. In these areas the first stage of distress was found to be pumping followed by corner breaks, faulting, and ultimately slab block cracking. Currently pumping and faulting have been reduced by the use of load transfer devices. Dowel bar diameter significantly affects faulting per Long-Term Pavement Performance (LTPP) Tech Brief *LTPP Data Analysis: Frequently Asked Questions About Joint Faulting With Answers From LTPP*, FHWA-RD-97-101 (11). Presently untreated granular bases are still being used and bases are not being specified with concrete pavement being placed on natural soils. As a reference, refer to AASHTO M155-87(2000) - Standard Specification for Granular Material to Control Pumping Under Concrete Pavement for aggregate base requirements. In other instances treated soils such as lime treated subgrade are being specified in swelling soil conditions. Spalling at the joints was observed under two types of conditions. Plastic parting strip ribbons created spalling and where joint filler material was not replaced. Currently plastic parting strips have been eliminated and the standard for joint saw cutting has been revised using only a narrow single cut instead of two saw cuts with a wider top cut. Longitudinal cracking is still prominent. Two apparent reasons is the slab widths are too wide for the design thickness, and serious construction problems, *Structural Factors of Jointed Plain Concrete Pavements: SPS-2 -- Initial Evaluation and Analysis*, FHWA-RD-01-167. CDOT published a research report *Evaluation of Premature PCCP Longitudinal Cracking in Colorado*, Final Report, Report No. CDOT-DTD-R-2003-1, concluding swelling soils, shallow saw cut depth, and malfunctioning or improperly adjusted paver vibrators creating vibrator trails produces longitudinal cracking (13). The 14-foot wide slabs on rural interstates did not contribute to the cracking. A regional investigation is looking at the ends

of the tie-bars where voids occur at the location of longitudinal cracking. Other possible reasons may be wheel loadings applied before the concrete cures or thermal flashing.

Other conclusions were presented in the Report No. CDOH-83-1, 1983. First, rutting of low severity accounted for most of the distressed mileage. Second, reactive aggregates and faulting were most frequently occurring as high severity. Thirdly, medium severity of longitudinal cracking was observed.

The standard concrete pavement joint detail before 1983 required skewed and variable 13-19-18-12 transverse joint spacing and older standards of skewed or non-skewed equal 15 or 20 foot spacing depending on aggregate size. The transverse joints were not doweled except for the first 3 joints after the expansion joint. The saw depth was T/4 or older standards of 2 inches minimum. The longitudinal joints had tie-bars at 30 inch centers and size No. 4 for 8 inch thick pavement and No. 5 for thickness greater than 8 inches or older standards of No. 4 at 36 inch spacing. Most of the interstate pavement at that time was 8 inches thick. The design procedure was to obtain design traffic, soil support, concrete strength, and an applied load safety factor. The load safety factor was directly related to high predicted truck traffic.

In 1988, the report titled *Rehabilitation of Concrete Pavements Follow-Up Study*, Report No. CDOH-88-8 was released (10). The Colorado Department of Highways had been working under the guidelines of the previous study for 5 years. The intent was to review the effectiveness and suitability of the concepts developed in 1983. In 1983, approximately 81 miles of concrete were rated in the poor category. Over the period from 1983 to 1988 nearly 64 miles of concrete roadway were rehabilitated; however, the 1988 survey determined that approximately 98 miles of pavement were in the poor category. The rehabilitation philosophy used in 1983 to restore all of the concrete pavements to "Like New" condition with a 20-year design life was modified under this study. With the issuance of the *1986 AASHTO Design Guide*, FHWA allowed the states to use a design life as low as 8 years for rehabilitation. A section of roadway can now be analyzed using both an 8-year and 20-year design life to optimize the expenditure of resources to achieve acceptable levels of service. Examples of the new design procedures were included in the report. A rehabilitation plan was provided for a 10-year effort. Highlights were to start rehabilitating the worst sections first, use the 8-year design concept wherever it was possible and concentrating on sections having the highest levels of traffic. The focus of the study was to bring forth the rehabilitation by overlay design and not repair the nine distresses individually by restoration techniques.

Following the first report above, the need to showcase the latest state-of-the-art Concrete Pavement Restoration (CPR), a seminar and demonstration project was organized (Demonstration Project No. 69). The seminar was a cooperative effort between CDOH, ACPA and FHWA and was held a day after the AASHTO meeting on October 5, 1983 with approximately 200 state and highway officials and engineers along with industry representatives in attendance. The results of the seminar and notes in the construction of the demonstration were reported in *Evaluation of Concrete Pavement Restoration Procedures and Techniques*, Initial Report, Report No. CDOH-DTP-R-84-5 (14). The demonstration showcased the techniques of full depth repair, partial depth repair, undersealing, grinding, installing load transfer devices, joint sealing and crack sealing. The site was on eastbound Interstate 70 between Chambers Road and Tower Road. The pavement was 19 years old, 8 inches of concrete pavement over 6 inches of base course surfacing, 20 foot joint

spacing, skewed, with tie bars in the centerline longitudinal joint, no load transfer devices or steel in the transverse joints and with asphalt shoulders. *Concrete Pavement Restoration Demonstration*, Final Report, Report No. CDOH-DTD-R-88-6 (15) reports the subsequent evaluations for a period of three years after construction repair. Generally, most of the restoration techniques did not perform well in this demonstration project.

- Full-Depth Repair - 8 out of 13 replacement slabs cracked.
- Partial-Depth Repair - All 6 patches showed distress or have failed.
- Undersealing - Inconsistent data in slab deflections of grouted and non-grouted slabs and how well uniform support was obtained.
- Faulting and Grinding - Typically slabs faulted a third of unground sections.
- Load Transfer Device - Obsolete device worked well especially in conjunction with undersealing.
- Joint Sealing - 12 different types of joint sealer were applied, some worked some failed.
- Crack Sealing - Routed and sealed with same sealants used above, overall was not very successful, continued to crack and spall.

The pre-overlay design methods and techniques suggested in this Chapter are based on these reports as well as *Factors for Pavement Rehabilitation Strategy Selection* by American Concrete Pavement Association (ACPA) (1). The following sections are based on the ACPA publications.

10.4 Project Information

Obtaining specific project information is the first step in the process of rehabilitation. Five basic types of detailed project information are necessary before an evaluation can be made:

- Design Data - data includes the pavement type and thickness. The components of the pavement are layer materials, layer strengths, joint design, shoulder design, drainage system and previous repair or maintenance.
- Construction Data - if possible obtain original construction conditions. Field books, daily logs and weather conditions are helpful. Concrete mix designs would show aggregate size and additives that may influence the existing concrete conditions.
- Traffic Data - strategy selection requires past, current and expected traffic growth. This helps determine the remaining effective structural capacity of the existing pavement. Section 1.5 Traffic Projections in Chapter 1 outlines the methods and procedures to calculate traffic loads.
- Environmental Data - important factors are temperature, precipitation, and freeze-thaw conditions. These factors influence material integrity, structural capacity, and rideability.

Distress and/or Condition Data - a distress survey should report the type, severity and quantity of each distress. A detailed concrete pavement distress/condition survey is required before a rehabilitation project can be evaluated and designed. The types of distress in concrete pavements have to be identified and documented prior to the selection of corrective measures. The cause of distresses is not always easily identified and may consist of a combination of problems. The following types of distress are common to deteriorating concrete pavements: excessive deflection, differential deflection at joints, moisture related distress at cracks and joints, cracking due to

reactive aggregate, longitudinal and transverse cracking, spalling, faulting, pumping, rutting, and movement of slabs due to swelling soils. The condition survey should identify and document the types, location, and amount of distress encountered in the design selected for rehabilitation. Photographs are a good way to document many of the distresses mentioned above. **Figure 9.2 Pavement Condition Evaluation Checklist (Rigid)** should be used and placed in the pavement design report. To help determine the type of distress the pavement is exhibiting refer to FHWA *Distress Identification Manual* (4). This manual may be downloaded in pdf format by going to web page:

<http://www.fhwa.dot.gov/publications/research/infrastructure/pavements/ltp/reports/03031/>

CDOT has a distress manual documenting pavement distress, description, severity levels and additional notes (22). The distress manual is presented in Appendix B - Colorado DOT Distress Manual for HMA and PCC Pavements in the publication *Development of a Pavement Maintenance Program for the Colorado Department of Transportation*, Final Report, CDOT-DTD-R-2004-17, August 2004. The report is in pdf format and can be downloaded from the web page <http://www.coloradodot.info/programs/research/pdfs/2004/preventivemaintenance.pdf>.

In order to determine the pavement distress and condition, a field inspection is mandatory. Isolating areas of distress can pinpoint different solutions for different sections along a project. Non-destructive testing (NDT) and destructive testing (i.e. coring and boring) can determine the structural condition and material properties below the surface.

10.5 Pavement Evaluation

The second step is to analyze and evaluate the gathered project information. Pavement evaluation requires a systematic approach to quantify adequately and analyze the many variables that influence the selection of the appropriate rehabilitation technique. More engineering effort may be required for pavement rehabilitation than for new construction because of the additional elements of evaluating the existing pavement. An engineering evaluation must address several key issues such as functional and structural condition, materials condition, drainage conditions, and lane condition uniformity (1)(5)(6).

10.5.1 Functional and Structural Condition

CDOT Pavement Management System triggers the need for rehabilitation work on automated visual surface distresses in a single lane. The distresses are rated and weighted in an index equation. The equation is weighted heavily to ride, then rut and then cracking. That index equation is then converted into remaining service life (RSL). Lost in the RSL values is the distinction between functional and structural distress. Be careful on just relying on the rating obtained from pavement management. As of this date the observed surface distresses are limited to a few of the major pavement distresses. Pavement management will not pick up on Alkali Silica Reactivity (ASR) until the severe stage, showing up as surface cracking. Knowing that ASR exists may influence the restoration technique the designer selects. Each distress condition will have its own set of repair techniques. The project pavement design engineer must determine if the pavement condition is in a functional or structural distress.

10.5.1.1 Structural Condition

Structural deterioration is any condition that reduces the load carrying capacity of a pavement (6)(7). Corner breaks, pumping, faulted joints and shattered slabs are some examples of structural related distresses. Evaluating the level of structural capacity requires thorough visual survey and materials testing (7). Non-destructive testing is important to characterize both pavement stiffness and subgrade support. Restoration is applicable only for pavements with substantial remaining structural capacity. Pavements that have lost much of their structural capacity require either a thick overlay or reconstruction. To help assess the current structural adequacy of Jointed Plain Concrete Pavement (JPCP), the extent and severity distresses can be compared with value ranges provided in **Table 10.1 Structural Adequacy for JPCP**.

Table 10.1 Structural Adequacy for JPCP
(Extracted from March 2004, Guide for Mechanistic-Empirical Design,
Part 2 Design Inputs, Table 2.5.15, pg. 2.5.61 (17))

Load-Related Distress	Highway Classification	Current Distress Level		
		Inadequate	Marginal	Adequate
Deteriorated Cracked Slabs medium and high severity transverse and longitudinal cracks and corner breaks (percent slabs)	Interstate/Freeway	> 10	5 to 10	< 5
	Primary	> 15	8 to 15	< 8
	Secondary	> 20	10 to 20	< 10
Mean Transverse Joint/Crack Faulting (inches)	Interstate/Freeway	> 0.15	0.1 to 0.15	< 0.1
	Primary	> 0.2	0.125 to 0.2	< 0.125
	Secondary	> 0.3	0.15 to 0.3	< 0.15

10.5.1.2 Functional Condition

Functional deterioration is defined as a condition that adversely affects the highway user. Functional distresses include problems which influence the ride quality, but are not necessarily signs of reduced structural capacity. These may include poor surface friction and texture, hydroplaning and splash from wheel path rutting, and excess surface distortion. Cracking and faulting affect ride quality but are not classified under functional distress. These conditions reduce load carrying capacity as stated above. The integrity of the base, concrete slab and joint system is compromised under cracking and faulting. To help assess the current functional adequacy of Jointed Plain Concrete Pavement (JPCP), International Roughness Index (IRI) is compared with value ranges provided in **Table 10.2 Functional Adequacy for JPCP**.

Table 10.2 Functional Adequacy for JPCP
(Extracted from March 2004, Guide for Mechanistic-Empirical Design,
Part 2 Design Inputs, Table 2.5.19, pg. 2.5.65 (17))

Pavement Type	Highway Classification	IRI (inch/mile) Level		
		Inadequate (Not Smooth)	Marginal (Moderately Smooth)	Adequate (Smooth)
Rigid (JPCP) and Flexible	Interstate/Freeway	>175	100 to 175	<100
	Primary	>200	110 to 200	<110
	Secondary	>250	125 to 250	<125

10.5.1.3 Problem Classifications between Structural and Functional Condition

How would the pavement designer classify lane separation? It could be classified as a functional condition if the lane separation (longitudinal joint width) becomes too excessive where the handling of a motorcycle becomes dangerous or adversely affects the highway user. It becomes a structural condition when the lane separation starts to manifest itself during rain storms when water infiltrates the base by cross slope sheet flow. Also, edge wheel loading next to the lane separation will eventually accumulate stress damage until finally over-stressing to the allowable limit. Even though no cracked slabs are present at the time of the investigation, lane separation- will eventually be classified as a structural condition. The pavement designer could then say the integrity of the base, slab and joint system is compromised.

10.5.2 Material Condition and Properties

An evaluation of material condition should not be done using assumed conditions or unknown material strengths. These factors are measurable from actual response to non-destructive and destructive testing methods.

10.5.2.1 Non-destructive Testing

Non-destructive testing may use three methods of testing to determine structural adequacy (17).

- Deflection Testing - to determine high deflections, layer moduli, and joint load transfer efficiencies.
- Profile Testing - to determine joint/crack faulting.
- Ground Penetrating Radar - to determine layer thickness.

The data obtained from these methods would be a Level 1. The data would be project site-specific. Deflection testing results are used to determine the following:

- Concrete elastic modulus and subgrade modulus of reaction (center of slab).
- Load transfer across joints/cracks (across transverse joints/cracks in wheelpath).
- Void detection (at corners).
- Structural adequacy (at non-distressed locations).

In addition to backcalculation of pavement layer and subgrade properties and void detection, deflection testing can also be used to evaluate the load transfer efficiency (LTE) of joints and cracks in rigid pavements (18). *Evaluation of Joint and Crack Load Transfer*, Final Report, FHWA-RD-02-088 (19) is a study presenting the first systematic analysis of the deflection data under the LTPP program related to LTE.

$$LTE = \frac{\delta_u}{\delta_l} \times 100 \quad \text{Eq. 10-1}$$

Where:

LTE = load transfer efficiency, percent

δ_u = deflection on unloaded side of joint or crack measured 6 inches from the joint/crack

δ_l = deflection on loaded side of joint or crack measured beneath the load plate the center of which is placed 6 inches from the joint/crack

Visual distresses present at the joint or crack should be recorded and quantified. Joint (and crack) distress information is useful in analyzing and filtering the results obtained from the LTE calculation. The load transfer rating as related to the load transfer efficiency is shown in **Table 10.3 Load Transfer Efficiency Quality**.

Table 10.3 Load Transfer Efficiency Quality
(From March 2004, Guide for Mechanistic-Empirical Design, Part 2 Design Inputs, Table 2.5.9, pg. 2.5.49 (17))

Load Transfer Rating	Load Transfer Efficiency (percent)
Excellent	90 to 100
Good	75 to 89
Fair	50 to 74
Poor	25 to 49
Very Poor	0 to 24

Crack LTE is a critical measure of pavement condition because it is an indicator of whether the existing cracks will deteriorate further. LTE tests are usually performed in the outer wheelpath of the outside lane. For JPCP, cracks are held together by aggregate interlock, joints designed with load transfer devices have steel and aggregate interlock. In general, cracks with a good load transfer (LTE greater than 75 percent) hold together quite well and do not significantly contribute to pavement deterioration. Cracks with poor load transfer (LTE less than 50 percent) are working

cracks and can be expected to deteriorate to medium and high severity levels and will exhibit faulting over time. These cracks are candidates for rehabilitation.

10.5.2.2 Destructive Testing

Experience has shown that non-destructive testing techniques alone may not always provide a reasonable or accurate characterization of the in-situ properties, particularly for those of the top pavement layer (17). The determination of pavement layer type cannot be made through non-destructive testing. While historic information may be available, the extreme importance and sensitivity calls for a limited amount of coring at randomly selected locations to be used to verify the historic information. Pavement coring, base and subbase thicknesses and samples are recommended to be collected at an approximate frequency of one sample per one-half mile of roadway. Several major parameters are needed in the data collection process. They are as follows:

- Layer thickness.
- Layer material type.
- Examination of cores to observe general condition and material durability.
- In-situ material properties (e.g., modulus and strength).

Concrete slab durability may have a possible condition of severe "D" cracking and reactive aggregate. Petrographic analysis helps identify the severity of the concrete distresses when their cause is not obvious. Material durability problems are the result of adverse chemical or physical interactions between a paving material and the environment (17). The field condition survey and examination of cores for material durability reinforce each other. See **Table 10.4 Distress Levels for Durability of JPCP**. Listed are durability problems and causes.

D-Cracking - the fracture of layer aggregates particles, and subsequently the PCC mortar, as a result of water freezing (and expanding) in the pores of moisture-susceptible course aggregate.

- Freeze-thaw Damage - spalling and scaling in freeze-thaw climates due to inadequate entrained air voids. The lack of entrained air restricts the internal expansion of water in concrete during periods of freezing and thawing.
- Alkali-silica Reactivity - map cracking and joint deterioration resulting from the reaction of high silica or high carbonate aggregates and alkalis (sodium and potassium) in portland cement. The reaction produces a gel that absorbs water and swells, thus fracturing the cement matrix.
- Steel Corrosion - pavements located in regions where de-icing salts are used.
- Treated Base/subbase Disintegration - stripping of asphalt cement by water in asphalt-treated materials, or the disintegration of cement-treated materials due to freeze thaw cycles.
- Unbound Base/subbase Contamination by fines from subgrade.

Table 10.4 Distress Levels for Durability of JPCP
(From March 2004, Guide for Mechanistic-Empirical Design,
Part 2 Design Inputs, Table 2.5.22, pg. 2.5.70 (17))

Load-Related Distress	Highway Classification	Current Distress Level		
		Inadequate	Marginal	Adequate
Patch Deterioration - medium and high severity (percent surface area)	Interstate/Freeway	> 10	5 to 10	< 5
	Primary	> 15	8 to 15	< 8
	Secondary	> 20	10 to 20	< 10
D-cracking and ASR	All	Predominantly medium and high severity	Predominantly low and medium severity	None or predominantly low severity
Longitudinal Joint Spall - medium and high severity (percent length)	Interstate/Freeway	> 50	20 to 50	< 20
	Primary	> 60	25 to 60	< 25
	Secondary	> 75	30 to 75	< 30
Transverse Joint Spalling - medium and high severity (joints /mile)	Interstate/Freeway	> 50	20 to 50	< 20
	Primary	> 60	25 to 60	< 25
	Secondary	> 75	30 to 75	< 30
Stripping (treated base/subbase)	All	Unable to recover majority of cores due to disintegration or stripping	Unable to recover some cores due to disintegration or stripping	Cores are predominantly intact
Unbound Granular Base Contamination	All	Contamination of unbound granular base/subbase with fines from subgrade		

For rigid pavements, one of the more significant properties influencing performance is the flexural strength (modulus of rupture) of the concrete. General correlations between splitting tensile strength and flexural strength may be used as a source of input since cores can be obtained from the pavement.

Three correlation formulas may be used. The reports cannot be found but the formulas were kept. All are straight line relationships.

1971, Deville

$$\text{Flexural Strength} = 190 + 0.097 \times \text{compressive strength}$$

Eq. 10-2

1979, Mirza

$$\text{Flexural Strength} = 247 + 0.068 \times \text{compressive strength}$$

Eq. 10-3

1996, Lollar - using CDOT Region 1 (prior to 7/1/2013) data for masters degree
Flexural Strength = $217 + 0.75 \times \text{compressive strength}$, $r^2 = 0.45$ **Eq. 10-4**

There are many papers, articles, and opinions on the correlation between the different strength test types, and ACPA does not recommend any one test in particular. The listed national correlations are from ACPA website (20):

http://www.pavement.com/Concrete_Pavement/Technical/FATQ/Construction/Strength_Tests.asp. See **Table 10.5 Strength Correlation Formulas**.

Table 10.5 Strength Correlation Formulas

Source/Author	Equation in psi (pounds per square inch)
ACI Journal / Raphael, J.M.	$M_R = 2.3 * [F_c ^ { (2/3)}]$
	$F_{st} = 1.7 * [F_c ^ { (2/3)}]$
ACI Code	$M_R = 7.5 * [F_c ^ { (1/2)}]$
	$F_{st} = 6.7 * [F_c ^ { (1/2)}]$
Center for Transportation Research / Fowler, D.W.	$F_{st} = 0.72 \times M_R$
Center for Transportation Research / Carrasquillo, R.	$M_R \text{ (3rd Point)} = 0.86 \times M_R \text{ (Center Point)}$
Greer	$M_R = 21 + 1.254 F_{st}$
	$M_R = 1.296 F_{st}$
	$M_R = F_{st} + 150$
Hammit	$M_R = 1.02 F_{st} + 210.5$
Narrow & Ulbrig	$M_R = F_{st} + 250$
Grieb & Werner	$F_{st} = \frac{5}{8} M_R \text{ (river gravel)}$
	$F_{st} = \frac{2}{3} M_R \text{ (crushed limestone)}$
NOTE: When High-Performance Concrete (HPC) is used, the above relationships will not necessarily hold true. The HPC mixes with very low w/c ratios tend to be more brittle and show different behaviors.	

Where:

F_{st} = Splitting Tensile Strength

F_c = Compressive Strength

M_R (Modulus of Rupture) = Flexural Strength, third-point loading (unless otherwise noted)

In-situ material properties of bases, subbases and soils including soil strength, may be obtained using the Dynamic Cone Penetrometer (DCP). The proposed mechanistic-empirical design guide software allows users to input DCP test results directly or indirectly depending on the models of choice. The pavement design engineer uses the above material properties to obtain a resilient modulus of each layer. The field and laboratory testing would have a hierarchical Level 2 for inputs in the mechanistic-empirical design method. Level 3 would use similar values were obtained through regional or typical default values.

10.5.3 Drainage Condition

Condition of drainage structures and systems such as ditches, longitudinal edge drains, transverse drains, joint and crack sealant, culverts, storm drains, inlets and curb and gutters are all important to convey water away from the pavement structure. Visual distress will reveal the types and extents of distresses present in the pavement that are either caused by or accelerated by moisture. Drainage assessment can also be benefited by data obtained from coring and material testing. The permeability and effective porosity of base/subbase materials, as determined through laboratory tests or calculated from gradations, can be used to quantify drainability (17). See **Table 10.6 Distress Levels for Assessing Drainage Adequacy of JPCP**.

Table 10.6 Distress Levels for Assessing Drainage Adequacy of JPCP
(From March 2004, Guide for Mechanistic-Empirical Design,
Part 2 Design Inputs, Table 2.5.20, pg. 2.5.67 (17))

Load-Related Distress	Highway Classification	Current Distress Level		
		Inadequate	Marginal	Adequate
Pumping - all severities (percent joints)	Interstate/Freeway	> 25	10 to 25	< 10
	Primary	> 30	15 to 30	< 15
	Secondary	> 40	20 to 40	< 20
Mean Transverse Joint/Crack Faulting (inches)	Interstate/Freeway	> 0.15	0.1 to 0.15	< 0.1
	Primary	> 0.20	0.125 to 0.20	< 0.125
	Secondary	> 0.3	0.15 to 0.3	< 0.15
Durability –all severity levels of D-cracking and reactive aggregate	All	Predominantly medium and high severity	Predominantly low and medium severity	None or predominantly low severity
Corner Breaks - all severities (number/mile)	Interstate/Freeway	> 25	10 to 25	< 10
	Primary	> 30	15 to 30	< 15
	Secondary	> 40	20 to 40	< 20

10.5.4 Lane Condition Uniformity

On many four lane roadways, the outer truck lane deteriorates at a more rapid pace than the inner lane of shoulders. The actual distribution of truck traffic across lanes varies with the roadway type, roadway location (urban or rural), the number of lanes in each direction, and the traffic volume. Because of these many factors, it is suggested that lane distribution be measured for the project under consideration (6). Obtaining the actual truck lane distributions will determine the actual remaining life of the lane under consideration. Significant savings may result by repairing only the pavement lane that requires treatment.

10.6 Pavement Rehabilitation Techniques

Rehabilitation or restoration techniques are methods to preserve the integrity of the concrete pavement system or to bring the pavement system up to an acceptable level for future performance.

Concrete pavement restoration (CPR) is a series of engineered techniques designed to manage the rate of pavement deterioration in concrete roadways. Ideally, CPR is the first rehabilitation procedure applied to the concrete pavement. CPR is a non-overlay option used to repair isolated areas of distress, or to prevent or slow overall deterioration, as well as, to reduce the impact loadings on the concrete pavement without changing its grade (21). If the pavement needs more load carrying capacity or has deteriorated to poorer conditions, other procedures, such as bonded concrete overlay, unbonded concrete overlay, or asphalt overlay may be applied in conjunction with restoration. Pavement rehabilitation work shall not include normal periodic maintenance activities (2). Cleaning of cross culverts, inlets and underdrain outlets would be considered normal periodic maintenance activities. CPR may be a maintenance activity, contract work by maintenance purchase order or contract low bid. Either way the work performed is identical. A report was published in August 2004 to assist staff maintenance in developing a pavement maintenance program. Refer to Appendix A - Preventive Maintenance Program Guidelines in the publication *Development of a Pavement Maintenance Program for the Colorado Department of Transportation*, Final Report, CDOT-DTD-R-2004-17, August 2004 (22). The report is in pdf format and can be downloaded from the web page

<http://www.coloradodot.info/programs/research/pdfs/2004/preventivemaintenance.pdf>

Specific maintenance treatments were documented. These same concrete pavement treatments are described in this chapter. See **Figure 10.1 CPR Sequencing**.

- Diamond Grinding
- Concrete Crack Sealing
- Concrete Joint Resealing
- Partial Depth Repair
- Full Depth Concrete Pavement Repair
- Dowel Bar Retrofit

Two additional treatments will also be described.

- Cross Stitching
- Slab Stabilization

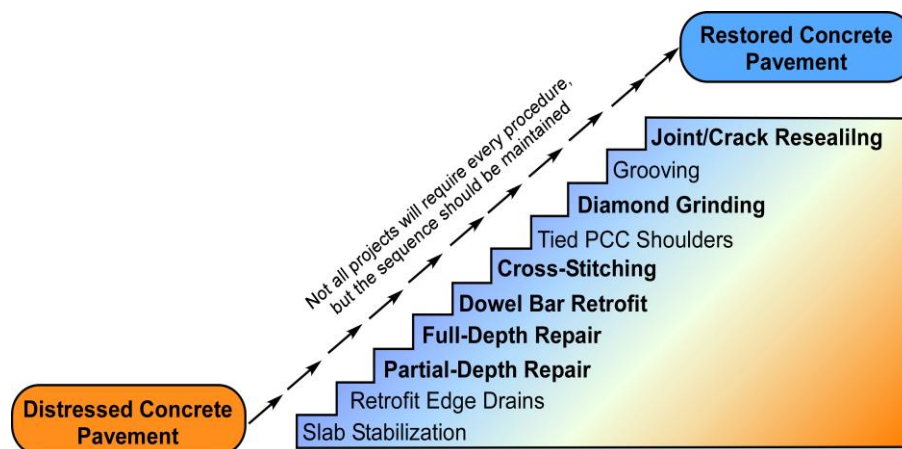

Figure 10.1 CPR Sequencing
Recommended Sequence of Restoration Activities (ACPA 2006)

10.6.1 Diamond Grinding

Diamond grinding and grooving are used to restore the surface of the PCCP. Diamond grinding is the removal of a thin layer of concrete generally about 0.25 inches (6 mm) from the surface of the pavement (36). Diamond grinding utilizes closely spaced diamond saw blades and corrects surface irregularities, such as cracking, rutting, warping, polishing, and joint faulting. Diamond grooving is the establishment of discrete grooves in the concrete pavement using diamond saw blades. The grooving is to break up the flow of water across the surface. Grooving may be performed longitudinally or transversely (36). CDOT's standard is to groove longitudinally. Grooving places the diamond blades $\frac{3}{4}$ inch apart and is used to prevent hydroplaning on wet pavements. Grinding and grooving operations produce a slurry consisting of ground concrete and water. Local environmental regulations should be consulted to determine acceptable disposal solutions. After the diamond grinding or grooving, all concrete joints and major cracks must be resealed.

Also, refer to **Section 7.18 Concrete Pavement Texturing, Stationing, and Rumble Strips**.

Cold milling may be done on PCCP, although it is more commonly used on asphalt pavements. Cold milling uses carbide tips to chip off the distressed surface. Cold milling can cause damage to transverse and longitudinal joints. Figure 3 in the publication *Diamond Grinding and Concrete Pavement Restoration* by ACPA (23) shows photographs of the difference between a diamond ground surface and a milled surface. Unless surface unevenness, aggregate fracturing, and joint spalling are tolerable, cold milling should not be allowed as a final surface.

When to use diamond grinding:

- Faulting at Joints and Cracks - Removal of roughness caused by excessive faulting has been the most common need for surface restoration. Trigger values indicate when a highway agency should consider diamond grinding and CPR to restore rideability. See **Table 10.7 Trigger Values for Diamond Grinding**. Limit values for diamond grinding define the point when the pavement has deteriorated so much that it is no longer cost effective to grind. See **Table 10.8 Limit Values for Diamond Grinding**. The two tables below show when it is appropriate and how much to diamond grind. The two tables are presented in FHWA technical report titled *Concrete Pavement Rehabilitation Guide for Diamond Grinding*, dated June 2001 (29). The report can be found on website <http://www.fhwa.dot.gov/pavement/concrete/diamond.cfm>.
- Smoothing out Rehabilitation Roughness - Partial-depth and full-depth repairs created differences in elevation between the repair and existing pavement. Diamond grinding smoothes out the repair.
- Wheelpath Rutting - Diamond grinding removes wheelpath ruts caused by studded tires, improves drainage in wet weather by eliminating pooling of water, and reduces the possibility of hydroplaning.
- Re-establish Macrotexture - Restores a polished surface to provide increased skid resistance, improves cornering friction numbers, and provides directional stability by tire tread-pavement-groove interlock.

- Reduce Noise Level – Re-textures worn and tined surfaces with a longitudinal texture and provides a quieter ride. Also removes the faults by leveling the surface, thus eliminating the thumping and slapping sound created by the faulted joints.
- Removes Slab Warping and Curling - Long joint spacing and stiff base support may result in curled slabs that are higher at the joints than at mid-panel, while warped slabs are higher at the mid-panel. Diamond grinding smoothes out the curled and warped slabs.
- Minor Cross Slope Changes - Minor cross slope changes helps transverse drainage and reduces the potential for hydroplaning.
- Pre-overlay Treatment - Creates a smooth base surface for thin micro-surfacing overlays.

Table 10.7 Trigger Values for Diamond Grinding

(From Table 1 Trigger Values for Diamond Grinding, Concrete Pavement Rehabilitation - Guide for Diamond Grinding June 2001 (29))

Traffic Volumes*	JPCP			JRCP			CRCP		
	High	Med	Low	High	Med	Low	High	Med	Low
Faulting mm-avg (inches avg)	2.0 (0.08)	2.0 (0.08)	2.0 (0.08)	4.0 (0.16)	4.0 (0.16)	4.0 (0.16)	N.A.		
Skid Resistance	Minimum Local Acceptable Levels								
PSR	3.8	3.6	3.4	3.8	3.6	3.4	3.8	3.6	3.4
IRI m/km (in/mi)	1.0 (63)	1.2 (76)	1.4 (90)	1.0 (63)	1.2 (76)	1.4 (90)	1.0 (63)	1.2 (76)	1.4 (90)
*Volumes: High ADT > 10,000; Med 3,000 < ADT < 10,000; Low ADT < 3,000									

Table 10.8 Limit Values for Diamond Grinding

(From Table 2 Limit Values for Diamond Grinding, Concrete Pavement Rehabilitation - Guide for Diamond Grinding June 2001 (29))

Traffic Volumes*	JPCP			JRCP			CRCP		
	High	Med	Low	High	Med	Low	High	Med	Low
Faulting mm-avg (inches avg)	9.0 (0.35)	12.0 (0.5)	15.0 (0.6)	9.0 (0.35)	12.0 (0.5)	15.0 (0.6)	N.A.		
Skid Resistance	Minimum Local Acceptable Levels								
PSR	3.0	2.5	2.0	3.0	2.5	2.0	3.0	2.5	2.0
IRI m/km (in/mi)	2.5 (160)	3.0 (190)	3.5 (222)	2.5 (160)	3.0 (190)	3.5 (222)	2.5 (160)	3.0 (190)	3.5 (222)
*Volumes: High ADT > 10,000; Med 3,000 < ADT < 10,000; Low ADT < 3,000									

For both diamond grinding and diamond grooving, the most important design element is the spacing of the blades on the grinding head. Grinding is made by using 50 to 60 circular saw blades per foot on a shaft to produce the desired texture. Grooving has a different cutting pattern. It has a uniform spacing of 0.75 inches (19 mm) between grooves. See Figure 10.2 Dimensions for Grinding and Grooving. See **Figure 10.3 Dimensional Grinding Texture for Hard and Soft Aggregate** for an earlier publications suggested dimensions for hard and soft aggregates.

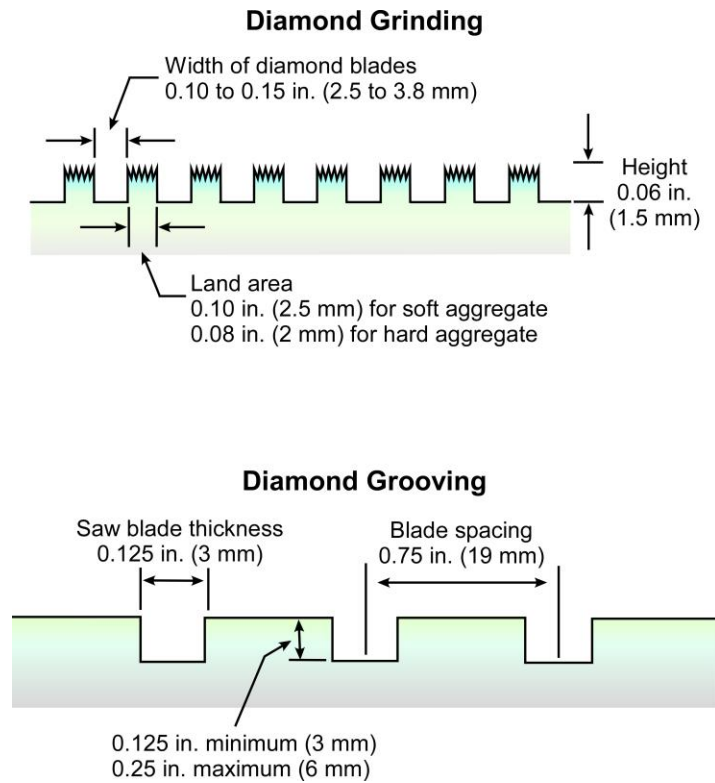
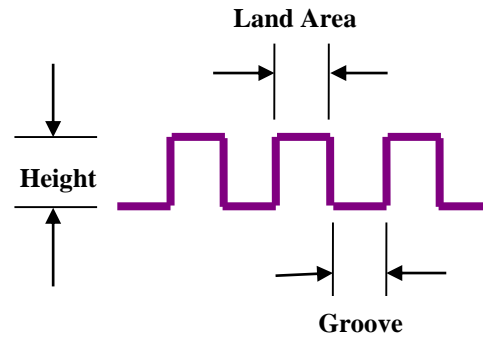

Figure 10.2 Dimensions for Grinding and Grooving
(From Figure 7, Concrete Pavement Rehabilitation and
Preservation Treatment, November 2005 (36))



	<i>Range of Values mm (in)</i>	<i>Hard Aggregate mm (in)</i>	<i>Soft Aggregate mm (in)</i>
<i>Grooves</i>	2.0 – 4.0 (0.08-0.16)	2.5 – 4.0 (0.1 – 0.16)	2.5 – 4.0 (0.1 – 0.16)
<i>Land Area</i>	1.5 – 3.5 (0.06-0.14)	2.0 (0.08)	2.5 (0.1)
<i>Height</i>	1.5 (0.06)	1.5 (0.06)	1.5 (0.06)
<i>No. Grooves per meter</i>	164 – 194 (50-60)	174 – 194 (53-60)	164 – 177 (50-54)

Figure 10.3 Dimensional Grinding Texture for Hard and Soft Aggregate
(From Figure 7, Concrete Pavement Rehabilitation -
Guide for Diamond Grinding, June 2001 (29))

CDOT has published research reports on textures of new pavements. Refer to CDOT Final Report CDOT-DTD-R-2005-22 *PCCP Texturing Methods*, dated January 2005 (37) and Final Report CDOT-DTD-R-2006-9, *Implementation of Proven PCCP Practices in Colorado*, dated April 2006 (38).

10.6.2 Concrete Crack Sealing

Crack sealing is a commonly performed pavement maintenance activity that serves two primary purposes. One objective is to reduce the amount of moisture that can infiltrate a pavement structure, thereby reducing moisture-related distresses such as pumping. A second objective is to prevent the intrusion of incompressible materials into cracks so that pressure-related distresses (such as spalling) are prevented (6).

Sealants may become ineffective anywhere from 1 to 4 years after placement. However, improvements in sealant materials, an increased recognition of the importance of a proper reservoir design, and an emphasis on effective crack/joint preparation procedures are expected to increase the expected life of sealant installations. At the same time, there is a persistent controversy over whether joint/crack sealing is needed at all (6). CDOT policy is to seal the cracks and not take the position that joint/crack sealing is not necessary.

What to crack seal:

- Plastic Shrinkage and Working Cracks - Cracks that remain tight usually do not require sealing. These cracks are typically very narrow (hairline), plastic shrinkage cracks and only penetrate to a partial depth. Once started, any crack may develop full depth through a slab. The crack may begin moving and functioning as a joint. Cracks which function as a joint are "working" cracks and are subject to nearly the same range of movement as transverse and longitudinal joints, therefore require sealing (24). If significant pavement integrity is being lost, then other remedial repairs are needed in conjunction with crack sealing.
- Number of Cracks in a Slab - Section 412.16 of CDOT *Standard Specification for Road and Bridge Construction*, 2011 (40) book specifies when cracks penetrate partial depth they may be epoxy injected with the written approval of the Engineer. New construction and reconstruction that have full depth cracks that separate the slab into two or more parts will not be sealed but the slab will be removed and replaced. Rehabilitation treatments are generally designed with a shorter design life than new construction. Thus, when cracks are full depth and the slab is separated into three or more parts the slab should be removed and replaced or repaired. Slabs remaining in place that are cracked will require sealing as well as the repaired slabs if appropriate.
- Crack Load Transfer Rating - Refer to **Section 10.5.2.1 Non-destructive Testing** for guidance on LTE and when to remove and replace or repair the slab parts or when to crack seal a good LTE crack.

Cracks are not straight and are therefore more difficult to shape and seal. Special crack saws are now available to help the operator follow crack wander. The saws have special blades with 7 to 8 inch diameters and are more flexible. The saws are supported by three wheels and the pivot wheel allows the saw to follow the crack. The desire is to obtain the same shape factor at the working cracks that is developed at the joints. Routers were used extensively in the past to create the seal reservoir. The trend now is to use the special crack saws. It is believed better reservoir results and increased productivity are obtained with these special crack saws. Crack sealing requires all of the cleaning steps used in joint resealing. That includes the use of a backer rod and uniform sealant installation (24). This treatment procedure follows the concept of the joint details and sealants as specified in CDOT Standard Plan *M-412-1 Concrete Pavement Joints*, sheet 5 of 5. CDOT publication *Development of a Pavement Preventive Maintenance Program for the Colorado Department of Transportation* (22) follows the Standard Plan M-412-1 concept as well. This treatment using silicone sealant is recommended when the existing concrete surface is the new riding surface. A project special provision is required to outline the method of construction and payment. Section 408, Joint and Crack Sealant in the *Standard Specification for Road and Bridge Construction*, 2011 (40) book consists of work with hot poured joint and crack sealant. Section 408 does not require routing or sawing to develop a seal reservoir. This treatment is recommended when an overlay is required. When routed or sawed cracks with backer rod is required, use Colorado Procedure (CP) 67-02 Standard Method of Test for Determining Adhesion of Joint Sealant to Concrete Pavement as the test method for crack sealing adequacy.

Estimating crack sealant is based on the severity level of cracking. These are estimated quantities only and were used in HMA crack sealing projects. The quantities shown are for information only and are only listed as an aid to the pavement designer for comparison purposes. See **Table 10.9 Hot Poured Crack Sealant Estimated Quantities**.

Table 10.9 Hot Poured Crack Sealant Estimated Quantities

Cracking Severity Level	Crack Sealant (tons) per lane mile
Heavy	2
Medium	1
Light	0.5
Very Light	0.25

10.6.3 Concrete Joint Resealing

Joint resealing is a commonly performed pavement maintenance activity that serves two primary purposes. One objective is to reduce the amount of moisture that can infiltrate a pavement structure, thereby reducing moisture-related distresses such as pumping. A second objective is to prevent the intrusion of incompressible materials into joints so pressure-related distresses (such as spalling) are prevented (6).

Sealants may become ineffective anywhere from 1 to 4 years after placement. However, improvements in sealant materials, an increased recognition of the importance of a proper reservoir design, and an emphasis on effective crack/joint preparation procedures are expected to increase the expected life of sealant installations. At the same time, there is a persistent controversy over whether joint/crack sealing is needed at all (6). CDOT policy is to seal the joints/cracks and not take the position that joint/crack sealing is not necessary. The above objectives and effectiveness are the same as stated in the section of concrete crack sealing. It was reiterated here for emphases.

What to joint seal:

- Joint Load Transfer Rating - Refer to **Section 10.5.2.1 Non-destructive Testing** for guidance on LTE and when to improve the LTE or when to reseal the joint.
- Joint Spalling - Studies show joint sealing and resealing reduces joint spalling by keeping out incompressibles even on short-panel pavements (24). Joint resealing is still recommended, even on pavements supported by permeable base layers.
- Type of Joints - Joint resealing is to be done on transverse and longitudinal joints. If the shoulder is of HMA that interface joint should also be resealed.

Existing sealant distresses (24):

- Adhesion Loss - The loss of bond between the sealant material and the concrete joint face.
- Cohesion Loss - The loss of internal bond within the sealant material.

- Oxidation/Hardening - The degradation of the sealant as a result of natural aging, long-term exposure to oxygen, ozone, ultra-violet radiation and/or the embedment of incompressibles into the sealant material.

Resealing is necessary when sealant distress affects average sealant condition and results in significant water and incompressible infiltration. The basis of this determination is typically engineering judgment. ACPA has suggested guidelines to assist in the engineering judgment. See **Table 10.10 Sealant Severity Level**. The length of the deterioration defines the severity level of deterioration along each surveyed joint.

Table 10.10 Sealant Severity Level

Severity Level	Length in Percent
Low	< 25
Moderate	≥ 25 to < 50
High	≥ 50

Every joint need not be surveyed to determine the average sealant condition. A statistical sampling can be done. Random and area sampling frequencies are provided for a statistical significant survey. The area sampling represents the average condition of the joints, therefore the selected area should be representative of the total length of the roadway in question. Longitudinal joints should be sampled at the same time the transverse joints are surveyed. See **Table 10.11 Sealant Survey Sampling Frequency**.

Table 10.11 Sealant Survey Sampling Frequency

Joint Spacing (ft)	Measurement Interval	Number of Joints (per mile)	Area (percent)
< 12	every 9th joint	+85	20
12 - 15	every 7th joint	85 - 70	20
15 - 20	every 5th joint	70 - 50	20
20 - 30	every 4th joint	50 - 35	20
30 +	every 4th joint	35	20

Joint resealing requires removing the old sealant, reshaping the reservoir and cleaning the reservoir. Removal of the old sealant may be done manually, use of a small plow, cutting with a knife or sawing method. Shaping the reservoir may be done using saw blades. Cleaning must remove dust, dirt or visible traces of old sealant. A backer rod is required followed by a uniform sealant installation process (24). The joint resealing procedure follows the concept of the joint details and sealants as specified in CDOT Standard Plan *M-412-1 Concrete Pavement Joints*, sheet 5 of 5. CDOT publication *Development of a Pavement Preventive Maintenance Program for the Colorado Department of Transportation* (22) follows the Standard Plan M-412-1 concept as well.

The joint resealing treatment using silicone sealant is recommended when the existing concrete surface is the new riding surface. A project special provision is required to outline the method of construction and payment for joint resealing. Section 408, Joint and Crack Sealant in the *Standard Specification for Road and Bridge Construction*, 2011 (40) book consists of work with hot poured joint and crack sealant. This treatment is recommended when an overlay is required. Use Colorado Procedure (CP) 67-02 Standard Method of Test for Determining Adhesion of Joint Sealant to Concrete Pavement as the test method for joint resealing adequacy. The frequency of the test is documented in the Frequency Guide Schedule for Minimum Material Sampling, Testing, and Inspection chapter of the current *CDOT Field Materials Manual*.

10.6.4 Partial Depth Repair

Partial-depth repair restores localized surface distress, such as spalling at joints and/or cracks in the upper one third to one half of a concrete pavement. Spalling is the breaking, cracking, chipping, or fraying of the slab edges that occurs within 2 inches of joints and cracks or their corners. Spalls that are smaller than 2 inches by 6 inches do not affect ride quality and do not need partial depth repair. Another localized surface distress may be severe scaling. A partial depth repair patch is usually very small (26). Partial depth repairs should be done after slab stabilization.

When not to use partial depth repairs (26):

- When spalls extend more than 6 to 10 inches from the joint and are moderately severe they indicate that more deterioration is taking place below the surface. Full depth repair is more appropriate for these types of distresses.
- A partial depth repair cannot correct a crack through the full thickness of the slab. Partial depth repair is not recommended when the deterioration is greater than $\frac{1}{3}$ to $\frac{1}{2}$ the slab depth.
- A partial depth repair is not appropriate for distresses such as D-cracking. These distresses are not confined to the surface.
- Partial depth repairs should not be used when spalls are caused by corrosion of metal.
- Pavements with little remaining structural life are not good candidates for partial depth repairs.

Guidelines on repair sizes (26):

- A patch typically covers an area less than $1\frac{1}{4}$ square yards and is only 2 to 3 inches deep.
- Patch boundaries should be square or rectangular and are easily shaped by saw cutting.
- Use a minimum length of 12 inches.
- Use a minimum width of 4 inches.
- Extend the patch limits beyond the distress by 3 to 4 inches.
- Do not patch if the spall is less than 6 inches long and less than $1\frac{1}{2}$ inches wide.
- If two patches will be less than 2 feet apart, then combine them into one large patch.
- Repair the entire joint length if there are more than two spalls along a transverse joint.
- During removal of the concrete, the patch depth is determined.

The recommended concrete removal method is by sawing and chipping. First, saw cuts are made around the perimeter of the repair area. The vertical faces provide a sufficient depth to prevent spalling of the repair material. Saw cuts should be at least 1½ inches deep preferably more. Then chipping can be done with light (less than 30 pounds) pneumatic hammers until sound and clean concrete is exposed. For best results, use 15 pound hammers or lighter. Spade bits are preferred, light hammers with gouge bits can damage sound concrete. However, if the depth of the patch exceeds about ½ of the slab thickness or exposes any dowel bars, switch to a full depth repair. Chipping without sawing the perimeter has shown that when a thin or feathered concrete edge is along the perimeter it is prone to spalling and debonding. All loose particles, oil (from pneumatic tools), dust and joint sealant materials must be thoroughly removed to create a good bond. Patches that cross or abut a working joint/crack require a compressible insert. The primary function is to keep the adjacent concrete from bearing against the new patch. The compressible insert provides space for when the slabs thermally expand. This is the primary reason for failure of partial depth repairs. The compressible insert should extend about one inch below and three inches beyond each patch area. At no time should the patch material be permitted to flow into or across the joint or crack. Curing is very important because of the partial depth repair's large surface-area-to-volume ratio makes them susceptible to rapid heat and moisture loss. After the patch material has hardened, the reservoir may need to be reformed by saw cutting and then resealed. Patch material may be found in CDOT's Approved Products List website under Concrete; Repair/Patching; Rapid Set, Horizontal. It is best to use the patch material manufacturer's recommended bonding agent and follow their instructions. Depending on the specified patch material, opening to traffic may be specified by minimum strength or minimum time after completing the patch repair. Care should be taken to ensure manufacturers w/c ratios are achieved, as additional water will result in dramatically reduced strength and durability.

10.6.5 Full Depth Concrete Pavement Repair

Full depth repair or full depth patching entails removing and replacing portions of (full depth patching) or the complete slab repair to the bottom of the concrete (27). Sometimes the repair must go into the base and subbase layers. Full depth repairs improve pavement rideability and structural integrity. The most common distress for using full depth repair is joint deterioration that includes any cracking, breaking or spalling of the slab edges. Below surface cracking and spalling requires full depth repairs. Any crack may develop full depth through a slab. The crack may begin moving and functioning as a joint. Cracks which function as joints are "working" cracks. Working cracks are subject to nearly the same range of movement as transverse and longitudinal joints and therefore require sealing (24). However, once the cracks develop severe spalling, pumping or faulting it would be necessary to restore the pavement structural integrity. Corner breaks and intersecting cracks in slabs are also candidates for full depth repairs. Refer to **Figure 10.1 CPR Sequencing** when other techniques are applied in conjunction with full depth repairs. The other techniques are cross stitching, retrofit dowel bars and tied PCC shoulders or curb and gutter. Full depth repair should be done after partial depth repair and slab stabilization. If during a partial depth repair the distress is more extensive than originally thought then a full depth repair may be substituted.

When to use full depth repair (27):

- When spalls extend more than 6 to 10 inches from the joint and are moderately severe they indicate that more deterioration is taking place below the surface. Full depth repair is more appropriate for these types of distresses.
- When transverse joints or transverse cracks deteriorate with a moderate severity level of faulting equal to or greater than ¼ inches other techniques and full depth repair is appropriate.
- When longitudinal joints or cracks deteriorate with a high severity level of faulting of ½ inches, or are wider than ¼ inches then full depth repair and other techniques are to be used.
- New construction and reconstruction with full depth cracks that separate the slab into two or more parts will not be sealed, and the slab will be removed and replaced. Rehabilitation treatments are generally designed with a shorter design life than new construction. Thus, when cracks are full depth and the slab is separated into three or more parts the slab should be removed and replaced or repaired.

To size the repair the pavement designer must know the mechanisms of the observed distresses. Generally the visible surface distresses show the minimum amount of repair area affected.

Guidelines on patch repair sizes (27):

- When the erosion action of pumping is present then the repair size should go beyond the limits of any base/subbase voids.
- In freeze-thaw climates the below slab deterioration may have to extend 3 feet beyond the visible distress.
- Parallel full lane width patching has been found to perform better than having interior corners of a partial width patch.
- If dowels (load transfer devices) are present, a minimum longitudinal patch length of 6 feet from the joint is acceptable to prevent slab patch rocking and to provide room for equipment such as dowel hole drill rigs. If the other side of the transverse joint does not need repair with a minimum patch width, extend the patch beyond the joint about 12 to 15 inches to remove the existing dowels and install new dowels.
- If no dowels are present, a minimum longitudinal patch length of 8 to 10 feet may be used. The extra length will provide more load distributing stability on the base/subgrade. If the minimum width patch falls within 6 feet of a joint that does not need repair, extend the patch to the transverse joint.
- Combining two smaller patches into one large patch can often reduce repair costs. When costs of the additional removal and patch material of a large patch is equivalent to the increased costs for additional sawing, sealing, drilling and grouting dowels and/or chipping the patch thickness face of two smaller patches a minimum cost effective distance has been calculated. When two patches will be closer than the distances as shown in **Table 10.12 Minimum Cost Effective Distance between Two Patches**, it is probably more effective to combine them.

Table 10.12 Minimum Cost Effective Distance between Two Patches

(Extracted from Table 2 Minimum cost-effective distance between two patches, *Guidelines for Full-Depth Repair*, Publication TB002.02P, American Concrete Pavement Association, 1995)

Slab Thickness (inches)	Patch Lane Width (feet)			
	9	10	11	12
8	15	13	12	11
9	13	12	11	10
10	12	11	10	9
11	11	10	9	8
12	10	9	8	8
15	8	8	7	6

Note: The above table does not apply to longitudinal patches. Longitudinal patches should be wide enough to remove the crack and any accompanying distress. Locate the longitudinal joint beyond the wheelpaths to avoid edge loading.

Slab Removal: Full depth saw cuts are to be made on all four sides to create a smooth, straight, vertical face. The saw cuts may require a full depth cut through the existing joint reservoir. These cuts may have to sever the existing tie bars for longitudinal cuts and dowel bars in the transverse cuts. The smooth faces improve the accuracy of new tie bar and dowel bar placement. Carbide tooth wheel saws can cause micro cracks in the surrounding concrete. It is recommended to use diamond bladed wheel saws. The preferred method to remove the existing deteriorated slab is to lift it out. A number of means to lift the slab out by the contractor is available. It may be necessary to provide additional saw cuts to facilitate the slab removal. Another method to remove the slabs after saw cutting is to break the deteriorated concrete into small fragments by drop hammers, hydraulic rams or jackhammers. The drawback to the break up method is it often damages the base/subbase and requires more patch preparation. Generally buffer cuts minimize the potential of damaging the surrounding concrete. These buffer cuts help absorb the energy and reduce spalling from the pavement breakers.

Patch Preparation: Sometimes it is necessary to remove and replace soft areas in the base/subbase. Good compaction is often difficult to achieve in the patch areas. It may be advantageous to fill the disturbed base/subbase areas with the patching concrete. Flow-fill is ideal for utility excavations. Flow-fill mix design properties are documented in Section 206.02 of CDOT *Standard Specifications for Road and Bridge Construction* specifications (40).

Install Load Transfer: Load transfer devices (dowel bars) should conform to the size and placement as specified on CDOT Standard Plan *M-412-1 Concrete Pavement Joints*. Dowel bars slip into holes drilled into the transverse edge of the existing slabs. Dowel drill rigs with gangs of drills are preferred to control drill alignment and wandering. Either standard pneumatic or hydraulic percussion drills are acceptable. Both can drill a typical dowel hole in about 30 seconds. Standard pneumatic drills may cause slightly more spalling on the existing slab face. Hole diameter is dependent on the type of anchoring material used. Cement type grouts require about 1/4 inch larger hole and epoxy materials should be 1/16 inch larger than the nominal dowel diameter. A grout

retention disk made of nylon or plastic shall be used for all dowel bars placed in the existing pavement. See **Figure 10.4 Grout Retention Disk**. An anchoring material should be used and not a compression fit. Adhesive anchoring materials are listed on CDOT's website for approved products conforming to AASHTO M235. After drilling, the dowel holes the holes should be cleaned with compressed air and apply the anchoring material as per the manufacturer's directions. Do not use any method that pours or pushes the material into the hole. Insert the dowel and with a twisting motion about one revolution to evenly distribute the material around the circumference of the dowel to provide a good bearing surface and bond. Apply a bond breaker coating onto the other half of the dowel bar that is to be imbedded into the fresh concrete.

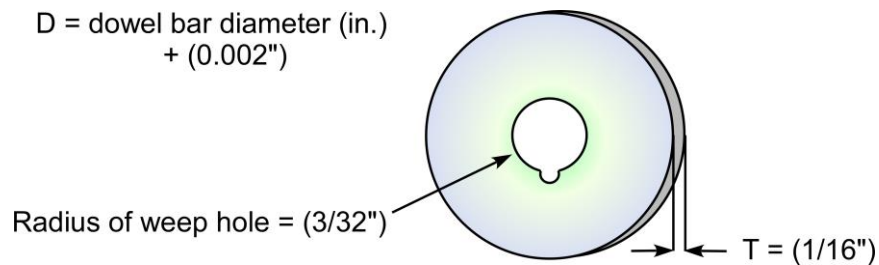

Figure 10.4 Grout Retention Disk

Install Tie Bars: Tie bar installation is similar to the load transfer devices. The size and placement is specified on CDOT Standard Plan *M-412-1 Concrete Pavement Joints*. Tie bars are placed in the longitudinal joint face of existing slabs. Full slab replacements and repairs greater than 15 feet require tie bars where previous tie bars existed. Hand held drills are acceptable because alignment is not critical. Tie bar requirements and pull out testing is specified in Section 412.13 of CDOT *Standard Specifications for Road and Bridge Construction* specifications (40). For repairs less than 15 feet long a bond breaker board ($1/4$ inch fiberboard) may be placed along the longitudinal face. For urban area repairs around maintenance access units (manholes) do not install tie bars but place a bond breaker board around the perimeter. Tie bars are used to tie the curb and gutter to the travel lanes. The curb and gutter acts as lateral support similar to widened and tied shoulders.

Concrete Material: All concrete pavement full depth patch repairs are to use a concrete material and not asphaltic materials (HMA). Asphalt patches heave and compress during warm weather when the existing concrete slabs expand. Generally, full depth repairs are done under traffic conditions. Time is of essence. Class E concrete is used for fast track pavements and is specified in Section 601.02 of CDOT *Standard Specifications for Road and Bridge Construction* specifications (40) or as revised.

Finishing: Strike-off, consolidation, floating and final surface finish is specified in Section 412.12 of CDOT *Standard Specifications for Road and Bridge Construction* specifications (40). The surface texture should be similar to the surrounding pavement.

Curing: The type and method of placement of membrane curing compounds and/or curing blankets for Class P and Class E concretes are specified in Section 412.14 of CDOT *Standard Specifications for Road and Bridge Construction* specifications (40).

Smoothness: If many closely spaced patches are required then consider specifying the pavement smoothness specification. The requirements are specified in Section 105.07 of CDOT *Standard Specifications for Road and Bridge Construction* specifications (40). If diamond grinding is required, the grinding should precede the joint sealing.

Joint Sealing: The final step is to saw the joint sealant reservoirs of the transverse and longitudinal joints, clean and then apply the joint sealant. Refer to Section **10.6.3 Concrete Joint Resealing**.

Strength or Time Method on Opening to Traffic: CDOT utilizes strength requirements or maturity relationships to determine the when to open the roadway repair to traffic. Both methods are specified in Section 412.12 of CDOT *Standard Specifications for Road and Bridge Construction* specifications (40).

Precast Panels: CDOT has been utilizing precast panels for the use in full depth repairs. Each panel is custom cast to fit the patch repair dimensions. The removal of the existing slabs is the same as above. The advantage of this method is being able to open the roadway to traffic in a shorter length of time than the above conventional method. This operation is well suited for night time work on busy day time highways. Refer to CDOT Final Report CDOT-DTD-R-2006-8 *Precast Concrete Paving Panels: The Colorado Department of Transportation Region 4 Experience, 2000 to 2006*, dated August 2006 (39). An example of a project's complete plans and specifications utilizing precast panels is available. The project was in Region 4, Project Number MTCE 04-061R, Region 4 FY06 I-25 MP 244 to MP 270 Concrete Slab Replacement, Subaccount Number M4061R.

10.6.6 Dowel Bar Retrofit

Dowel bar (load transfer devices) retrofit is a technique that increases the load transfer capability from one slab to the next through shear action (28). Slots are cut into the existing pavement at transverse joints/cracks with diamond-saw slot cutting (preferred method). Generally, three slots per wheel path are cut to a depth that allows the dowel bar to sit half way down in the slab with a half-inch of clearance to the bottom of the slot. Epoxy coated dowels must be a minimum of 14 inches long so that at least six inches will extend on each side of the joint or crack. A non-metallic expansion cap is placed on one end of the dowel and the dowel is placed on non-metallic chairs for clearance beneath the dowel. Horizontal and vertical alignments are critical. Refer to the Details Illustrating Dowel Placement Tolerances in CDOT *Standard Plan M-412-1 Concrete Pavement Joints* drawings. The slots are then backfilled using the same materials that would be used for partial depth repairs. The retrofit should last the remaining life of the pavement. Refer to **Figure 10.1 CPR Sequencing** when other techniques are applied in conjunction with dowel bar retrofit. The other techniques are cross stitching and tied PCC shoulders or curb and gutter. Dowel bar retrofit should be done after full or partial depth repair and slab stabilization and before diamond grinding.

When to use dowel bar retrofit (28):

- Generally load transfer devices should be installed at transverse joints and transverse working cracks with poor load transfer but otherwise little or no deterioration,

- Pavements exhibiting D-cracking are not good candidates for load transfer restoration because the concrete in the vicinity of the joints and cracks is likely to be weakened and thus retrofit load transfer devices would not have sound concrete on which to bear. For D-cracked pavements with concrete deterioration only in the vicinity of joints and cracks, full depth repair is more appropriate,
- Pavements with distress caused by alkali-silica reaction (ASR) or alkali-carbonate reaction (ACR) are not good candidates for load transfer restoration either.

Refer to **Section 10.5.2.1 Non-destructive Testing** for the definition and meaning of Load Transfer Efficiency. The load transfer rating as related to the load transfer efficiency is shown in **Table 10.3 Load Transfer Efficiency Quality**.

Dowel bars are either 1¼ or 1½ inches in diameter. The larger diameter dowel bars are used in thicker pavements (>10 inches). Dowel bars are spaced 12 inches on center in sets of three or four per wheelpath. Edge spacing from the longitudinal joint to the first dowel bar varies. The edge distance is dependent on whether tie bars are located at the longitudinal joint. Use 12 inches if tie bars are not present and 18 inches if they are.

Refer to **Figure 10.5 Typical Dowel Bar Retrofit Installation** for a conceptual drawing of the retrofit installation. See **Figure 10.6 Typical Dowel Bar Retrofit Sequencing of the Installation** for the installation procedure. Apply a bond breaker coating (i.e. a light coating of grease or oil) to the dowel bars along their full length to facilitate joint movement. Bond breaker application is specified in Section 709.03 of CDOT *Standard Specifications for Road and Bridge Construction* specifications (40).

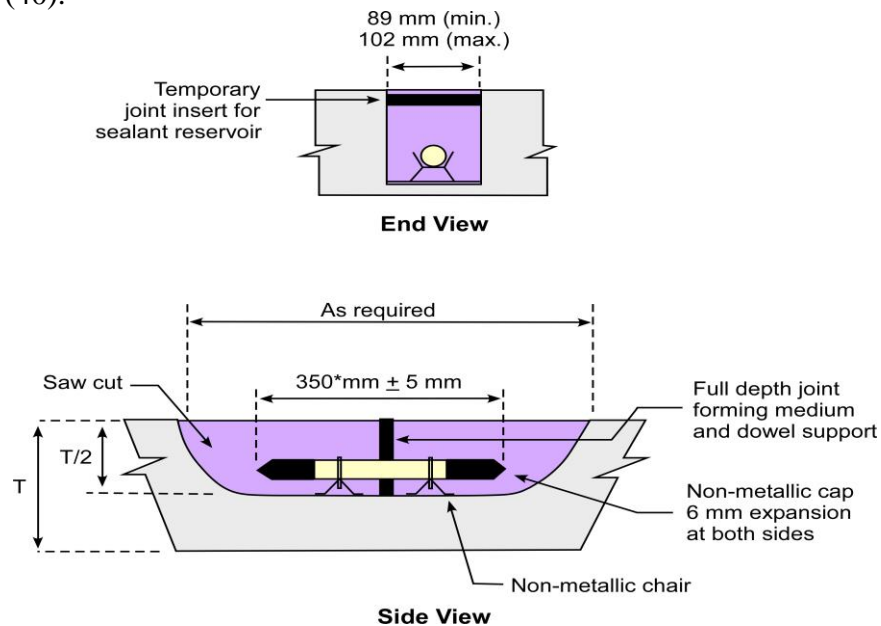

* For pavements with poor support conditions slightly longer bars should be considered.

Figure 10.5 Typical Dowel Bar Retrofit Installation
(Modified from Figure 4-9.3 Dowel Bar Load Transfer Device
Techniques for Pavement Rehabilitation, 1998 (6))

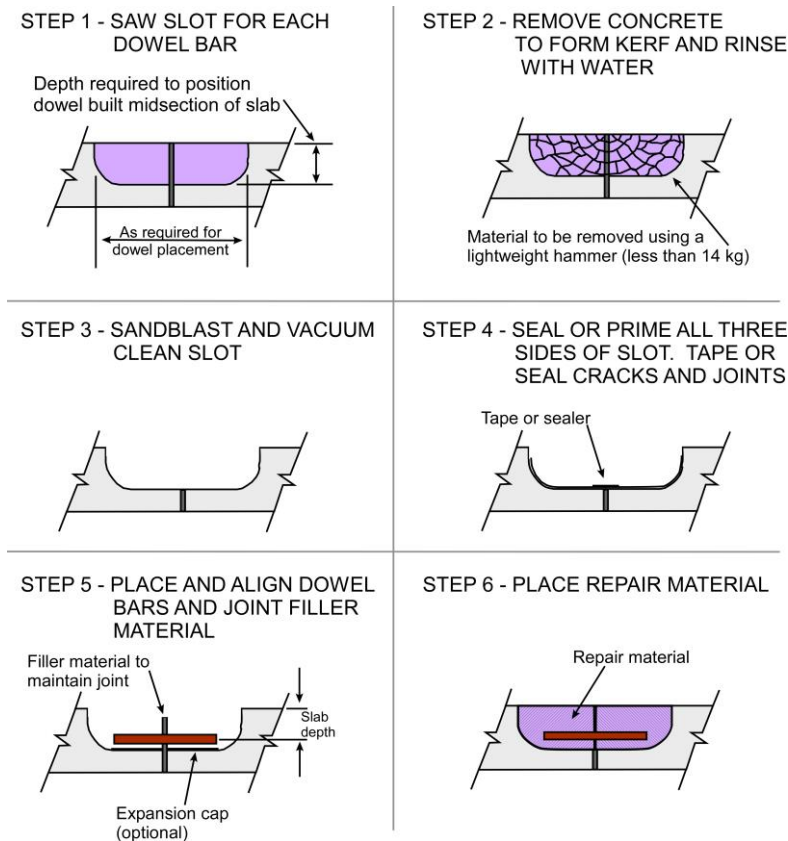

Figure 10.6 Typical Dowel Bar Retrofit Sequencing of the Installation
(From Figure 4-9.7 Construction Procedures for Retrofitted Dowel Bar Installation
Techniques for Pavement Rehabilitation 1998 (6))

10.6.7 Cross Stitching

Cross stitching longitudinal discontinuities, such as joints and cracks is a repair technique to facilitate in the lateral load transfer of an otherwise unsupported free edge. The free edge is where the most critical loadings occur in the slab. This free edge condition may exist at a lane-to-lane or lane-to-shoulder joint. Working longitudinal cracks may also develop and create an unsupported free edge condition. The cross stitching will help maintain the aggregate interlock in this situation if the crack doesn't widen too much. Cross stitching uses deformed tie bars inserted into holes drilled across a joint/crack at an angle. If the angle is less than 35° from the horizontal the Contractor has problems drilling the holes. This was observed on a CDOT project. The tie bars are placed and staggered with each other on each side of the joint/crack for the length of the discontinuity. The tie bars prevent joints and cracks from vertical and especially horizontal movement or widening. In new construction, tie bars are placed in plastic concrete to keep the joints tight in the hardened state and incompressibles and sheet flow of water into the base. The cross stitching repair technique for joints is to prevent further lane or shoulder separation and minimize the settlement of the slabs. Generally this technique is used where the overall pavement condition, and where the joints and cracks are in good condition. If the joints and cracks are spalled too much other rehabilitation repair methods may be appropriate.

Another similar technique is slot stitching. Slot stitching uses a modified dowel bar retrofit method. Slots are cut across the joints/cracks, deformed bars are placed in the slots and are backfill similarly to dowel bar retrofit. If an overlay will be placed either method is acceptable. If an overlay is not being placed after this repair, then the cross stitching has a more pleasing appearance than the slot stitching.

Both rehabilitation techniques are detailed and discussed in *Stitching Concrete Pavement Cracks and Joints*, Publication Special Report SR903P, ACPA and IGGA, 2001 (30). The publication illustrates the cross stitching bar dimensions and locations of drilled holes and slots layouts. Be aware that if diamond grinding is performed after cross stitching, then the placement of the bars should be deep enough so they are not impacted by the grinding machining. The amount of anchor adhesive cover over the bars should be sufficient to protect the bars from the elements. The project plans should detail the appropriate stitching method.

Refer to

Figure 10.1 CPR Sequencing when other techniques are applied in conjunction with the cross/slot stitching. Cross/slot stitching should be done after full/partial depth repair and slab stabilization and before diamond grinding and crack/joint sealing. Cross/slot stitching should last the remaining life of the pavement.

A special note is in order to understand the significance of tying the longitudinal joints and cracks. In the Section 3.4.3.8 Pavement Design Features, subheading Edge Support of the *Guide for Mechanistic-Empirical Design*, Final Report, NCHRP Project 1-37A (17) explains the structural effects of the edge support features are directly considered in the design process. The Design Guide evaluates the adequacy of the trial design through the prediction of key distresses and smoothness. The design process uses the Load Transfer Efficiency (LTE) equation for transverse joints related to shoulder type (HMA vs. PCC), tied PCC shoulders or widened slabs. The distresses are percent slabs cracked and faulted joints vs. time and are compared to the user defined allowable reliability limits. It appears that the Design Guide assumes all lane-to-lane joints are tied, but the designer has a choice on lane-to-shoulder jointing. LTE design inputs features are as follows:

- Tied PCC Shoulder – for tied concrete shoulders the long-term LTE between the lane and shoulder must to be provided. The LTE is defined as the ratio of deflections of the unloaded and loaded slabs. The higher the LTE, the greater the support provided by the shoulder to reduce critical responses of the mainline slabs. Typical long-term deflection LTE are:
 - 50 to 70 percent for monolithically constructed and tied PCC shoulder.
 - 30 to 50 percent for separately constructed tied PCC shoulder.
- Untied Concrete Shoulders or other shoulder types do not provide significant support; therefore, a low LTE value should be used (i.e. 10 percent due to the support from extended base course).
- Widened Slabs improve JPCP performance by effectively moving the mean wheelpath well away from the pavement edges where the critical loadings occur. The design input for widened slab is the slab width which can range from 12 to 14 feet.

10.6.8 Slab Stabilization and Slabjacking

The purpose of slab stabilization also called subsealing, undersealing or pavement grouting is to stabilize the pavement slab by the pressurized injection of a cement grout, pozzolan-cement grout, bituminous materials or polyurethane mixture through holes drilled in the slab. The cement grout will, without raising the slab, fill the voids under it, displace water from the voids, and reduce the damaging pumping action caused by excessive pavement deflections. Slab stabilization should be accomplished as soon as significant loss of support is detected at slab corners. Symptoms of loss of support include increased deflections, transverse joint faulting, corner breaks, and the accumulation of fines in or near joints or cracks on traffic lanes or shoulders (31)(32).

When to use slab stabilization (33):

- Slab stabilization should be performed only at joints and working cracks where loss of support is known to exist. Symptoms of loss of support include:
 - Increased deflections.
 - Transverse joint faulting.
 - Corner breaks.
 - Accumulation of underlying fine materials in or near joints or cracks on the traffic lane or shoulder.
- Slab stabilization should be performed before the voids become so large in area that they cause pavement failure. The only exception is when the pavement is to be overlaid with asphalt or concrete. In this case, slab stabilization is necessary, regardless of pavement condition. Slab stabilization is particularly important for asphalt overlays which have little resistance to shearing forces and reflect the underlying foundation problems.

Refer to **Figure 10.7 Typical Slab Stabilization Hole Layout** for a typical application and hole layout. Refer to **Figure 10.1 CPR Sequencing** when other techniques are applied in conjunction with slab stabilization. Slab stabilization should occur before partial depth repair and other repairs.

The slab stabilization technique is detailed and discussed in *Slab Stabilization Guidelines for Concrete Pavements*, Publication TB018P, ACPA, 1994 (32). The 20 page publication discusses void detection, materials, equipment, installation, post-testing, and opening to traffic.

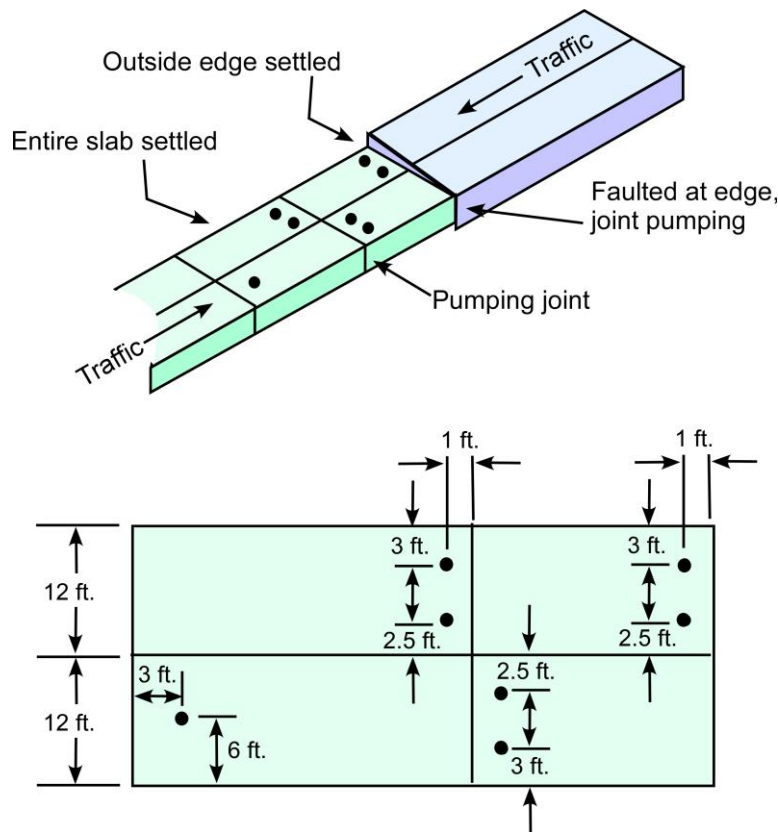

Figure 10.7 Typical Slab Stabilization Hole Layout
(From Figure 4-7.6 Location of holes depending on defect to be corrected
Techniques for Pavement Rehabilitation 1998 (6))

The purpose of slabjacking is to raise a slab in place permanently, prevent impact loading, correct faulty drainage, and prevent pumping at transverse joints by injection of a grout, pozzolan-cement grout or polyurethane mixture under the slab. The grout fills voids under the slab, thereby restoring uniform support. Slabjacking should be considered for any condition that causes nonuniform slab support, such as embankment settlement, settlement of approach slabs, settlement over culverts or utility cuts, voids under the pavements, differences in elevation of adjacent pavements, joints in concrete pavements that are moving or expelling water or soil fines, and pavement slabs that rock or teeter under traffic (31) (32). The performance of pavements subjected to slabjacking is somewhat dependent upon the origin of the corrected defect. For example, an embankment that slowly continues to settle will require periodic slabjacking. Periodic slabjacking may also be required on bridge approach slabs due to poor drainage design and improper embankment compaction (34). An example of a suggested slab jacking pumping sequence that provides a general guideline for obtaining satisfactory results is presented in manual *Techniques for Pavement Rehabilitation 1998 (6)*. It must be remembered that the sequence must be modified to meet the specific needs of a given project.

Refer to **Figure 10.8 Typical Slab Raising in Slabjacking** and **Figure 10.9 Typical Slabjacking Hole Layout** for a typical application using a stringline and hole layout.

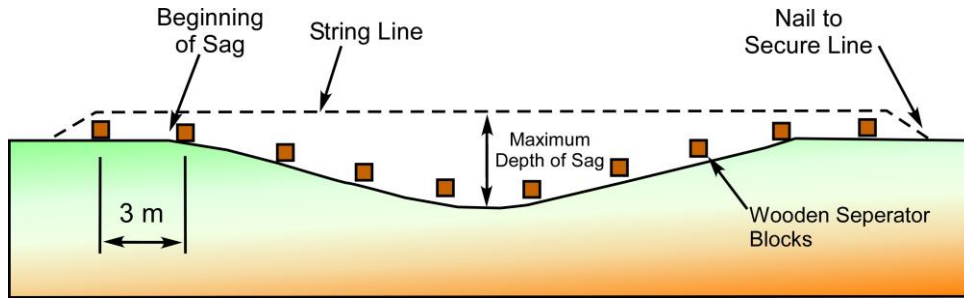

Figure 10.8 Typical Slab Raising in Slabjacking
(From Figure 4-7.9 Stringline method of slab jacking
Techniques for Pavement Rehabilitation 1998 (6))

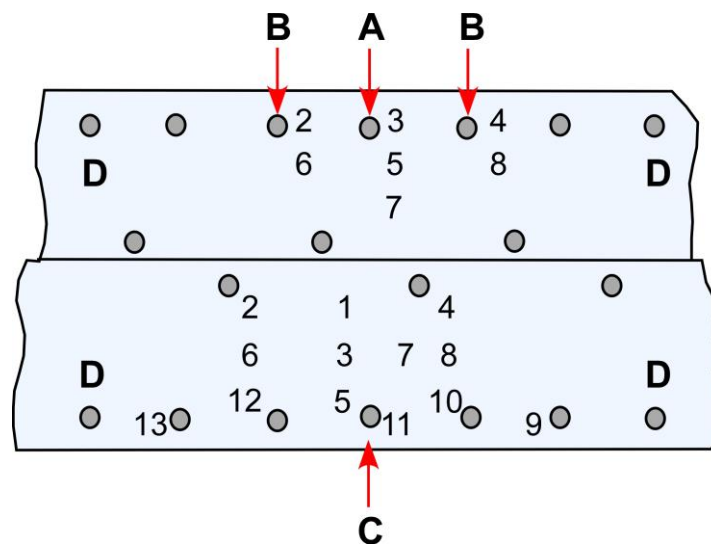

Figure 10.9 Typical Slabjacking Hole Layout
(From Figure 4-7.7 Location of holes and the order of grout pumping to correct settlement
Techniques for Pavement Rehabilitation 1998 (6))

An example of a project's complete plans and specifications utilizing slabjacking is available. The project was in Region 4, Project Number MTCE 04-061R, Region 4 FY06 I-25 MP 244 to MP 270 Concrete Slab Replacement, Subaccount Number M4061R and used water blown formulation of high density polyurethane.

10.7 Selecting the Appropriate Pavement Rehabilitation Techniques

Table 10.13 Guidelines for PCC Treatment Selection is from a complete bound report titled *Development of a Pavement Preventive Maintenance Program for the Colorado Department of Transportation*, October 2004, by Larry Galehouse (35). **Note:** The Final Report CDOT-DTD-R-2004-17, August 2004 (22) is not as complete as the October 2004 bound report. The tabular guidelines only include CDOT's treatments as reported in the bound report. Refer also to **Table 10.13 Guidelines for PCC Treatment Selection** for additional treatments and repairs.

Table 10.13 Guidelines for PCC Treatment Selection

(From Table Guidelines for Pavement Treatment Selection, *CDOT Preventive Maintenance Program Guidelines*, October 2004 (35))

Pavement Distresses	Parameters	Rigid Treatments					
		Diamond Grinding	Concrete Crack Resealing	Concrete Joint Resealing	Partial Depth Repair	Dowel Bar Retrofit	Full Depth Concrete Pavement Repair
Corner Breaks	Low	⊘	P	⊘	✓	⊘	✓
	Moderate	⊘	P	⊘	✓	⊘	✓
	High	✓	✓	⊘	✓	⊘	
Durability Cracking (“D” cracking)	Low	⊘	✓	⊘	✓	⊘	✓
	Moderate	⊘	✓	⊘	✓	⊘	✓
	High	⊘	⊘	⊘	⊘	⊘	P
Longitudinal Cracking	Low	⊘	P	⊘	⊘	⊘	✓
	Moderate	✓	P	⊘	P	⊘	✓
	High	P	P	⊘	P	⊘	✓
Transverse Cracking	Low	⊘	P	⊘	✓	✓	✓
	Moderate	✓	P	⊘	P	✓	✓
	High	P	P	⊘	P	✓	✓
Joint Seal Damage	Low	⊘	⊘	✓	⊘	⊘	⊘
	Moderate	⊘	⊘	P	⊘	⊘	⊘
	High	⊘	⊘	P	⊘	⊘	⊘
Longitudinal Joint Spalling	Low	⊘	⊘	P	⊘	⊘	⊘
	Moderate	⊘	⊘	P	P	⊘	✓
	High	⊘	⊘	P	P	⊘	✓
Transverse Joint Spalling	Low	⊘	⊘	P	P	⊘	✓
	Moderate	⊘	⊘	P	P	⊘	✓
	High	⊘	⊘	P	P	⊘	P
Map Cracking and Scaling	Low	⊘	⊘	⊘	✓	⊘	✓
	Moderate	⊘	⊘	⊘	P	⊘	✓
	High	⊘	⊘	⊘	⊘	⊘	⊘
Polished Aggregate	Significant	P	⊘	⊘	⊘	⊘	⊘
Condition Factors							
Traffic AADT-T	< 400	✓	✓	✓	✓	✓	✓
	400 - 6,000	✓	✓	✓	✓	✓	✓
	> 6,000	✓	✓	✓	✓	✓	✓
Ride	Poor	P	⊘	⊘	✓	⊘	✓
Rural	Min. Turning	✓	✓	✓	✓	✓	✓
Urban	Max. Turning	✓	✓	✓	✓	✓	✓
Drainage	Poor	⊘	⊘	⊘	⊘	⊘	⊘

P – Preferred Treatment Option
✓ – Acceptable Treatment Option
⊘ – Not Recommended

References

1. *Factors for Pavement Rehabilitation Strategy Selection*, Number 3.02, R & T Update, Concrete Pavement Research & Technology, American Concrete Pavement Association, Skokie, IL, February 2002.
2. *AASHTO Guide for Design of Pavement Structures*, American Association of State Highway and Transportation Officials, Washington, DC, 1993.
3. *Recycling Concrete Pavements*, TB014P, American Concrete Pavement Association, Skokie, IL, 1993.
4. *Distress Identification Manual for the Long-Term Pavement Performance Program*, Publication Number FHWA-RD-03-031, U.S. Department of Transportation, Federal Highway Administration, Washington, DC, March 2003.
<<http://www.fhwa.dot.gov/research/>>
5. *Techniques for Pavement Rehabilitation*, ERES Consultants, Inc., U.S. Department of Transportation, Federal Highway Administration, Washington, DC, 1992.
6. *Techniques for Pavement Rehabilitation*, Nichols Consulting Engineers, Chtd., U.S. Department of Transportation, Federal Highway Administration and National Highway Institute, Arlington, Virginia, Sixth Edition, January 1998.
< http://www.asce.org/uploadedFiles/Continuing_Education_-_New/techpave.pdf >
7. *Revision of AASHTO Pavement Overlay Design Procedures*, Final Report, Darter, M., Elliott, R., Hall, K., National Cooperative Highway Research Program, Transportation Research Board, Washington, DC, April 1992.
8. *Public Benefits of Highway System Preservation and Maintenance*, A Synthesis of Highway Practice, NCHRP Synthesis 330, National Cooperative Highway Research Program, Transportation Research Board, Washington, DC, 2004.
9. *Rehabilitation of Concrete Pavements*, Final Report, Report No. CDOH-83-1, Colorado Department of Highways, January, 1983.
10. *Rehabilitation of Concrete Pavements Follow-Up Study*, Follow-Up Report, Report No. CDOH-88-8, Colorado Department of Highways, April 1988.
11. *LTPP Data Analysis: Frequently Asked Questions About Joint Faulting With Answers From LTPP*, Publication No. FHWA-RD-97-101, U.S. Department of Transportation, Federal Highway Administration, Research and Development Turner-Fairbank Highway Research Center, McLean, VA, August 1997.
12. *Structural Factors of Jointed Plain Concrete Pavements: SPS-2 -- Initial Evaluation and Analysis*, Publication No. FHWA-RD-01-167, U.S. Department of Transportation, Federal

- Highway Administration, Research and Development Turner-Fairbank Highway Research Center, McLean, VA, April 2005.
13. Ardani, Ahmad, Hussain, Shamshad, and LaForce, Robert, *Evaluation of Premature PCCP Longitudinal Cracking in Colorado*, Final Report, Report No. CDOT-DTD-R-2003-1, Colorado Department of Transportation, Research Branch, January 2003.
 14. Wood, K. L., *Evaluation of Concrete Pavement Restoration Procedures and Techniques*, Initial Report, Report No. CDOH-DTP-R-84-5, Colorado Department of Highways, March 1984.
 15. Killian, John, *Concrete Pavement Restoration Demonstration*, Final Report, Report No. CDOH-DTD-R-88-6, Colorado Department of Highways, February 1988.
 16. *Pavement Study - Project I 092-2(4)*, Final Report, Colorado Department of Highways, Planning & Research Division, Research and Special Studies Section, 1966.
 17. *Guide for Mechanistic-Empirical Design*, Final Report, NCHRP Project 1-37A, National Cooperative Highway Research Program, Transportation Research Board, National Research Council, Submitted by ARA, INC., ERES Consultants Division, Champaign, IL, March 2004.
 18. *Supplement to the AASHTO Guide for Design of Pavement Structures, Part II, - Rigid Pavement Design & Rigid Pavement Joint Design*, American Association of State Highway and Transportation Officials, Washington, DC, 1998.
 19. *Evaluation of Joint and Crack Load Transfer*, Final Report, FHWA-RD-02-088, U.S. Department of Transportation, Federal Highway Administration, Research and Development Turner-Fairbank Highway Research Center, McLean, VA, October 2003.
 20. *ACPA Pavement Technology Construction-Related FATQ*, (23, June 2005).
< <http://resources.acpa.org/> >
 21. *The Concrete Pavement Restoration Guide*, Publication TB020.02P, American Concrete Pavement Association, Concrete Paving Technology, Skokie, IL, 1998.
 22. *Development of a Pavement Preventive Maintenance Program for the Colorado Department of Transportation*, Final Report, CDOT-DTD-R-2004-17, Colorado Department of Transportation, Research Branch, prepared by National Center for Pavement Preservation, Okemos, MI, August 2004.
 23. *Diamond Grinding and Concrete Pavement Restoration*, Publication TB008.01P, American Concrete Pavement Association, Concrete Paving Technology, Skokie, IL, 2000.

24. *Joint and Crack Sealing and Repair for Concrete Pavements*, Publication TB012P, American Concrete Pavement Association, Concrete Paving Technology, Skokie, IL, 1995.
25. *Standard Specifications for Road and Bridge Construction*, Colorado Department of Transportation, Denver, Co, 2005.
26. *Guidelines for Partial-Depth Spall Repair*, Publication TB003.02P, American Concrete Pavement Association, Concrete Paving Technology, Skokie, IL, 1998.
27. *Guidelines for Full-Depth Repair*, Publication TB002.02P, American Concrete Pavement Association, Concrete Paving Technology, Skokie, IL, 1995.
28. *Concrete Pavement Rehabilitation: Guide for Load Transfer Restoration*, Publication FHWA-SA-97-103, Federal Highway Administration, Washington, D.C., and Publication ACPA JP001P, American Concrete Pavement Association, Skokie, IL, 1997.
29. *Concrete Pavement Rehabilitation - Guide for Diamond Grinding*, FHWA Technical Report, Correa, Angel L. and Wong, Bing, Federal Highway Administration, 400 7th Street S.W., Washington, DC 20590, June 2001.
<<http://www.fhwa.dot.gov/pavement/concrete/diamond.cfm>>
30. *Stitching Concrete Pavement Cracks and Joints*, Publication Special Report SR903P, American Concrete Pavement Association, Concrete Paving Technology and Research, Skokie, IL and International Grooving & Grinding Association, Coxsackie, NY, 2001.
31. *O&M: Concrete Repair*, Publication UFC 3-270-04, Unified Facilities Criteria, U.S. Army Corps of Engineers, March 15, 2001.
32. *Slab Stabilization Guidelines for Concrete Pavements*, Publication TB018P, American Concrete Pavement Association, Concrete Paving Technology, Skokie, IL, 1994.
33. *Slab Stabilization*, Factsheet from Military Tri-Service Transportation Website, (03, January 2006).
< <https://transportation.erd.c.dren.mil/tsmcx/index.htm> >
34. *Slabjacking*, Factsheet from Military Tri-Service Transportation Website, (03, January 2006).
35. < <https://transportation.erd.c.dren.mil/tsmcx/index.htm> >
36. *CDOT Preventive Maintenance Program Guidelines*, prepared by National Center for Pavement Preservation, Okemos, MI, October 2004.
37. *Concrete Pavement Rehabilitation and Preservation Treatment*, Report FHWA-IF-06-005, CPTP TechBrief, November 2005.

38. Ardani Ahmad and Outcalt William (Skip), *PCCP Texturing Methods*, Final Report, Report No. CDOT-DTD-R-2005-22, Colorado Department of Transportation, Research Branch, January 2005.
39. Ardani Ahmad, *Implementation of Proven PCCP Practices in Colorado*, Final Report, Report No. CDOT-DTD-R-2006-9, Colorado Department of Transportation, Research Branch, April 2006.
40. DeWitt, Gary L., P.E., *Precast Concrete Paving Panels: The Colorado Department of Transportation Region 4 Experience, 2000 to 2006*, Final Report, Report No. CDOT-DTD-R-2006-8, Colorado Department of Transportation, Research Branch, August 2006.
41. *Standard Specifications for Road and Bridge Construction*, Colorado Department of Transportation, Denver, Co, 2011.
<http://www.coloradodot.info/business/designsupport/construction-specifications/2011-Specs>
42. Daniel P. Frentress and Dale S. Harrington, *Guide for Partial-Depth Repair of Concrete Pavements*, Iowa State University, Institute for Transportation, National Concrete Pavement Technology Center, April 2012.

CHAPTER 11

PRINCIPLES OF DESIGN FOR FLEXIBLE PAVEMENT INTERSECTIONS

11.1 Introduction

A standard pavement design is based on fast-moving traffic traveling one direction on long stretches of roadway where drainage is usually easy to handle. This is not the situation with intersections. Traffic loadings are greater at intersections because of compounding traffic directions. Also, it's necessary to design for slower stop-and-go traffic, which induces much heavier stresses on the pavement section. In addition, drainage is often compromised within intersections, leading to saturation of the pavement section and the underlying subgrade. Some mixes that have a history of good performance may not perform well in intersections, climbing lanes, truck weigh stations and other slow-speed areas. Special attention should be focused on high traffic volume intersections to ensure the same outstanding performance.

The key to achieving this desired performance is recognizing that these pavements may need to be treated differently than conventional roadways. Specifically, the pavement must be designed and constructed to withstand the more severe conditions. Well-designed, properly constructed HMA intersections provide an economical and long-lasting pavement.

11.2 Design Considerations

Determining whether to use a high performance HMA intersection design versus a conventional HMA design should be assessed on a project-by-project basis. Some general rules to consider are:

Special consideration needs to be given to intersections with heavy truck traffic and high traffic volumes. If the traffic loading for a 20-year design is a historic designation of one to three million ESALs or greater, a high performance asphalt intersection should be considered. When 20-year traffic loading of the two traffic streams have a historic designation of one million ESALs or greater within an intersection, a high performance intersection design should be considered. If high traffic volume intersections are within $\frac{1}{4}$ mile of each other, the entire roadway should be designed using a high performance intersection design. Acceleration and deceleration lanes should be included as part of the intersection design.

Sharp turns with slow-moving traffic should be included as part of the intersection design. If there are not enough high performance intersections within a project to warrant a high traffic volume intersection design throughout, but the intersections that are within the project are potentially subject to moderate to heavy traffic (historic designation of one million ESALs or greater), they should be blocked out and a high traffic volume intersection design used. When there is two-way traffic, the transition should extend at least 300 linear feet on either side of the intersection. When there is one-way traffic, the transition should be at least 300 linear feet on the deceleration side and 100 linear feet on the acceleration side of the intersection. The definitions and design factors necessary for flexible pavement design were introduced in previous sections.

It is suggested that a PG 76-28 binder be selected for use in asphalt intersections, providing it is available. In general, it is suggested that the Superpave™ procedure be followed to select appropriate binder grade for asphalt intersection design.

11.3 Design Period

The destructive effect of repeated wheel loads is the major factor that contributes to the failure of highway pavement. Since both the magnitude of the load and the number of its repetitions are important, provision is made in the design procedure to allow for the effects of the number and weight of all axle loads expected during the design period. The design period for new flexible pavement construction and reconstruction is at least 20 years. The design period for restoration, rehabilitation and resurfacing is 10 years. Selection of less than 10-year design period needs to be supported by a LCCA or other overriding considerations.

11.4 Traffic Analysis

In any pavement type, the destructive effect of repeated wheel loads is the major factor that contributes to the failure of highway pavement. Design traffic will be the historic 18,000-pound equivalent single axle load (18k ESAL) obtained from the CDOT's Traffic Analysis Unit of the Division of Transportation Development. The following website may assist the user in calculating an ESAL value <http://dtdapps.coloradodot.info/otis>. The actual projected traffic volumes for each category are weighted by the appropriate load equivalence factors and converted to a cumulative total historic 18k ESAL number to be entered into the flexible pavement design equation. The designer must inform the DTD Traffic Analysis Section that the intended use of the historic 18k ESAL is for flexible pavement design since different load equivalence factors apply to different pavement types. Cross traffic at intersections needs to be accounted for as part of the traffic count projection. Use only high quality aggregates. Select the SuperPave™ Gyratory design compaction effort one level higher than would be selected for normal roadway design. If a comparison of flexible and rigid pavements is being made, historic 18k ESALs for each pavement type must be requested. Another source of traffic load data can be weigh-in-motion data. Although these devices are not as plentiful, they are usually more accurate for measurements of traffic load in the present year. Projections for future traffic loads can be calculated similarly using growth factors provided by the DTD Traffic Analysis Unit.

11.5 Design Methodology

Design methodology for flexible intersections are similar to those found in **CHAPTER 6**.

11.6 Assessing Problems with Existing Intersections

A successful intersection rehabilitation project is dependent on proper project scoping. The keys to proper scoping are the following:

- Identifying the problem with the existing intersection.
- Removing enough of the pavement section to encompass the entire problem.

- Designing and reconstructing with a high performance hot mix asphalt mix design especially formulated for high traffic volume intersections.

11.7 Performance Characteristics of Existing Intersections

The AASHTO Joint Task Force on Rutting (1987) identified three types of rutting:

- Rutting in Base, See **Figure 11.1 Rutting in Subgrade or Base**.
- Plastic Flow Rutting, See **Figure 11.2 Plastic Flow**.
- Rutting in Asphalt Layer, See **Figure 11.3 Rutting in Asphalt Layer**.

Figure 11.1 Rutting in Subgrade or Base shows a weak subgrade or base will expedite damage in all pavements.

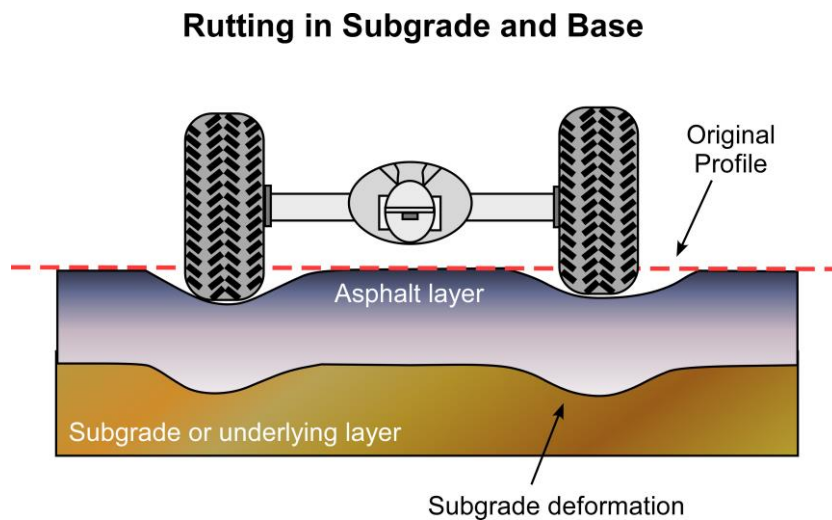

Figure 11.1 Rutting in Subgrade or Base

Figure 11.2 Plastic Flow shows plastic flow can result for various reasons that include the following:

- High pavement temperatures.
- Improper materials and mixture design.
- Rounded aggregate.
- Too much binder and/or filler.
- Insufficient or too high of VMA

Plastic flow or deformation in the asphalt layer occurs during warm summer months when pavement temperatures are high. At intersections, stopped and slow moving traffic allow exhaust to elevate asphalt surface temperatures even higher. Dripping engine oil and other vehicle fluids are also concentrated at intersections and tend to soften the asphalt. A properly designed mixture with a stiffer asphalt binder and strong aggregate structure will resist plastic deformation of the hot mix asphalt pavement.

Plastic Flow

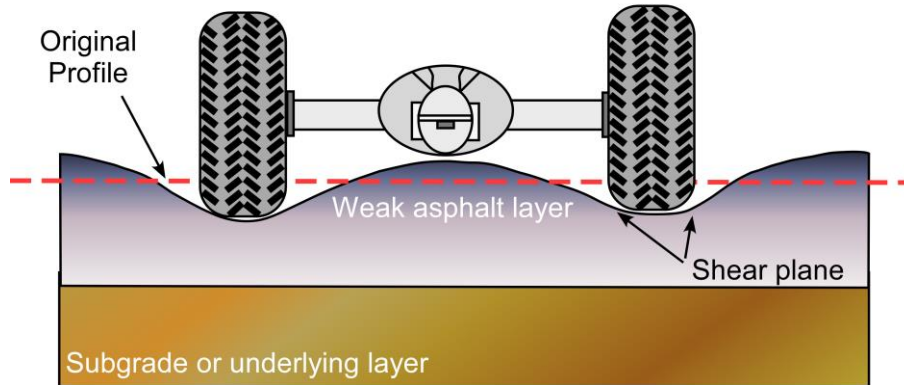

Figure 11.2 Plastic Flow

Figure 11.3 Rutting in Asphalt Layer shows HMA consolidation in the wheel paths. Proper compaction procedures and techniques will ensure that the target density is achieved. To prevent rutting in the asphalt layer, good quality control in the design and production of asphalt mixtures is crucial. Consolidation occurs in the wheel paths because of insufficient compaction of the pavement section.

Rutting in Asphalt Layer

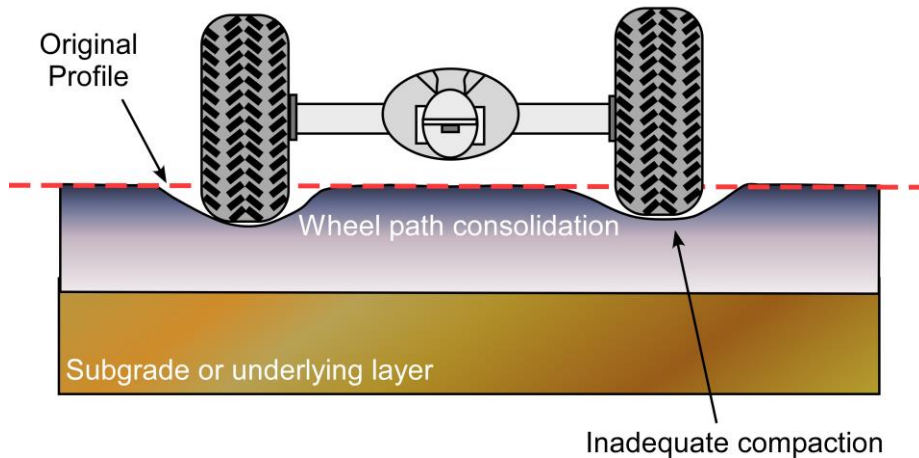

Figure 11.3 Rutting in Asphalt Layer

The following factors can contribute to lack of compaction:

- Insufficient compaction effort within the lower base layers of the pavement section.
- Too few roller passes during paving.
- Hot mix asphalt material cooling prior to achieving target density.

- High fluid content (asphalt moisture, dust).
- Too low of an asphalt content.
- Lack of cohesion in the mix, tender mix, and gradation problem with the mix can make it hard to compact.

Surface wear is the result of chains and studded tires wearing away the road surface in winter.

11.8 Utilities

Whether it be intersection rehabilitation or new construction, a utility study should be performed to determine if utilities being proposed, or those that are already installed, are adequate in size to handle the projected growth within their service area. It should be verified that existing utilities have been installed properly and utility trenches have been backfilled and compacted properly.

CHAPTER 12

PRINCIPLES OF DESIGN FOR RIGID PAVEMENT INTERSECTIONS

12.1 Introduction

The construction and reconstruction of urban intersections utilizing Portland Cement Concrete Pavement (PCCP) need to be given serious consideration by the designer. PCCP in an intersection offers many advantages, such as long life, reduction in maintenance costs, and elimination of wash boarding and rutting caused by the braking action of all types of traffic especially heavy buses and trucks. Also, PCCP in an intersection will eliminate the distress caused in asphalt pavements due to rolling traffic loads plus the deceleration and acceleration forces.

12.2 Design Considerations

The distance from the intersection where this deformation such as rutting and shoving occurs varies depending on the traffic situation, types of traffic, speed and stopping distance, and the number of vehicles per lane stopped at the intersection. Several approaches can be used. In some applications, PCCP can extend full width for several hundred feet on each side of the intersection. In other situations, the concrete lanes approaching the intersection extend 250 feet (deceleration lane), while those going away terminate about 60 feet (acceleration lane) beyond the curb return. These approaches can be used for both high volume streets and bus stops. For more moderate traffic, 50 to 100 feet on each side of the intersection is likely to be adequate. This distance can be based on an evaluation of the existing traffic and pavement conditions.

Dowels should be placed in the transverse joints of the dominant traffic stream, as well as, the cross street transverse joints. Tie bars should be placed in the longitudinal joints of the dominant traffic stream and cross street sections past the intersection.

Class P concrete is recommended for rigid pavements. If it is desirable to fast track an intersection reconstruction, Class E concrete can be used. Class E concrete is designed to achieve minimum of 2,500 psi in 12 hours or as required. It is possible to remove existing pavement, recondition the base materials, place Class E concrete and have the roadway open for traffic in 24 hours.

12.3 Design Period

The destructive effect of repeated wheel loads and the impacts of braking action are the major factors that contribute to the failure of highway pavement at the intersections. Since both the magnitude of the load, the number of its repetitions and the braking actions are important, provisions are made in the design procedure to allow for the effects of braking actions and the number and weight of all axle loads expected during the design period. The design period for new rigid pavement construction and reconstruction is 30 years.

12.4 Traffic Analysis

When two roadways intersect there are two streams of traffic that exert loads on the pavement. The total of the historic design 18,000-pound equivalent single axle loads (18k ESAL) for each stream of traffic should be used in the calculation for pavement thickness in the intersection. In any pavement, the destructive effect of repeated wheel loads is the major factor that contributes to the failure of highway pavement. Design traffic will be the 18k ESAL and can be obtained from the Traffic Analysis Unit of the Division of Transportation Development, <http://dtdapps.coloradodot.info/Otis/TrafficData>. The actual projected traffic volumes for each category are weighted by the appropriate load equivalence factors and converted to a historic cumulative total 18k ESAL number to be entered into the rigid pavement design equation. Since different load equivalence factors apply to different pavement types, the designer must inform the Traffic Analysis Section that the intended use of the historic 18k ESAL is for rigid pavement design.

Another source of traffic load data can be weigh-in-motion data. Although these devices are not as plentiful, they are usually more accurate for measurements of traffic load in the present year. Projections for future traffic loads can be calculated similarly using growth factors provided by the DTD Traffic Analysis Unit.

12.5 Design Methodology

Design methodologies for rigid intersections are similar to those found in Section **CHAPTER 7**.

12.6 Rigid Pavement Joint Design for Intersections

Joints are used in PCCP to aid construction and eliminate random cracking. There are two types of longitudinal joints. Longitudinal weakened plane joints relieve stresses and control longitudinal cracking. Longitudinal construction joints perform the same functions and also divide the pavement into suitable paving lanes.

Longitudinal weakened plane joints are spaced to coincide with lane markings, and are formed by sawing the hardened concrete to a depth of $\frac{1}{3}$ the pavement thickness.

Longitudinal construction joints should be tied with deformed reinforcing steel bars to hold the slabs in vertical alignment. Stresses in a slab are reduced when the slab is tied to adjacent slabs. Keyed joints may be used in a longitudinal construction joint, but tying the slabs is preferable.

The key may be formed by attaching a keyway at the mid-depth of a side form. With a slip form paver, the keyway can be formed as the paver advances. For detailed layout refer to the CDOT *Standard Plans (M & S) Standards July 2012*.

Transverse joints are spaced at short intervals in the slab. A maximum of 12 feet is recommended to insure crack control and for ease of construction. The joint should be sawed to a depth of at least $\frac{1}{3}$ the pavement thickness.

Dowel bars in the first three transverse joints where portland cement concrete pavement abuts asphalt pavement can prevent progressive slab movement.

Expansion joints are not required except at intersections.

The following summarizes the general design guides and information for constructing rigid pavement joints:

Joints are used in PCCP to aid construction and minimize random cracking. Odd shaped slabs and acute angles of less than 60 degrees should be avoided. Longitudinal joint spacing should be approximately 12 feet. Transverse joint spacing should be at regular 12 foot intervals with no more than a 15 foot spacing. Thinner slabs tend to crack at closer intervals than thicker slabs and long narrow slabs tend to crack more than square slabs. All contraction joints must be continuous through the curb and have a depth equal to $\frac{1}{3}$ of the pavement thickness. Transverse joints should be carried through the curb. Expansion joint filler must be full-depth and extend through the curb. Longitudinal joints should be tied to hold adjacent slabs in vertical alignment, as well as, curb and gutter.

The normal backfill behind the curb constrains the slabs and holds them together. Offsets at radius points should be at least 18 inches wide. Minor adjustments in joint location made by skewing or shifting to meet inlets and manholes will improve pavement performance. When pavement areas have many drainage structures, particularly at intersections, place joints to meet the structures, if possible. Depending on the type of castings, manhole and inlet frames may be boxed out and isolated using expansion joint filler. The frames may be wrapped with expansion joint filler or the frames may be cast rigidly into the concrete.

CDOT designs their PCCP using the JPCP (Jointed Plain Concrete Pavement) method. For a detailed illustration, see CDOT's *Standard Plans (M & S) Standards July 2006, M-412-1* and as revised.

Following the previous design of a new intersection near Sugarloaf Reservoir, the following steps and points should be followed to design slabs and location of joints:

Step 1. Draw all edge of pavement lines on a plan view. Plot all utility manholes, catch basins, water valves, etc. on the plan view. See **Figure 12.1**.

Step 2. Draw lines, which define the median, travel lanes and turning lanes. These lines define the longitudinal joints. See **Figure 12.2**.

Step 3. Determine locations in which the pavement changes width (i.e. channelization tapers, turning lane tapers and intersection radius returns). Joints at these locations are necessary to isolate irregular shapes. Triangles or circles, which are left intact with a rectangular portion of a slab, will create a plane of weakness that will break during temperature movements of the slab. Concrete simply likes to be square. See **Figure 12.3**.

Step 4. Draw transverse lines through each manhole or other utility. Joints need to be placed through utility structures in the pavement, or movement of the pavement will be restricted and cracking will result. When structures are located near a joint placed according to the steps above,

isolation can be provided by adjusting the joint to meet the structure. By doing this, numerous short joints will be avoided. Add transverse joints at all locations where the pavement changes width, extending the joints through the curb and gutter. Create an "intersection box". Do not extend joints that intercept a circumference-return-return line, except at the tangent points. The joints at the tangent point farthest from the mainline becomes an isolation joint in the cross road for T- and unsymmetrical intersections. See **Figure 12.4**.

Step 5. The intermediate areas between the transverse joints placed in Steps 3 and 4 may also require transverse joints. These joints are placed using a standard joint spacing. There is an old rule of thumb for joint placement in plain concrete pavements that says the joint spacing, in feet, should be no greater than two to two and a half times the slab thickness, in inches. However, in no case should the joint spacing exceed 15 feet. See **Figure 12.5**.

Step 6. Where an intersection is encountered, intermediate joints must be placed. This is done by extending the radius line of each turning radius three feet beyond the back of curb. The extension is made at approximately the 45° line for small radii and at approximately the 30° and 60° lines for larger radii. Joints are then connected to each of these points.

Step 7. Expansion joints are needed adjacent to any structure, i.e., bridges, buildings, etc., and at T intersections. T intersections are isolated at the radius return to the intersecting street. The same layout discussed in Step 6 is used out to that location.

Step 8. If there are manholes or other structures, which cannot be intersected by a joint, they must be isolated. These structures can be isolated by boxing out the structure during paving. Manholes can also be isolated by using a telescoping manhole, which can be poured integral with the pavement. The area around the structure should be reinforced to control cracking. The joints that form a box out should be expansion joints to allow some movement.

Step 9. Check the distances between the "intersection box" and the surrounding joints. See **Figure 12.6**.

Step 10. Lightly extend lines from the center of the curve(s) to the points defined by the "intersection box" and point(s) along any island. Add joints along these radius lines. Finally, make slight adjustments to eliminate dog legs in mainline edges. See **Figure 12.7**.

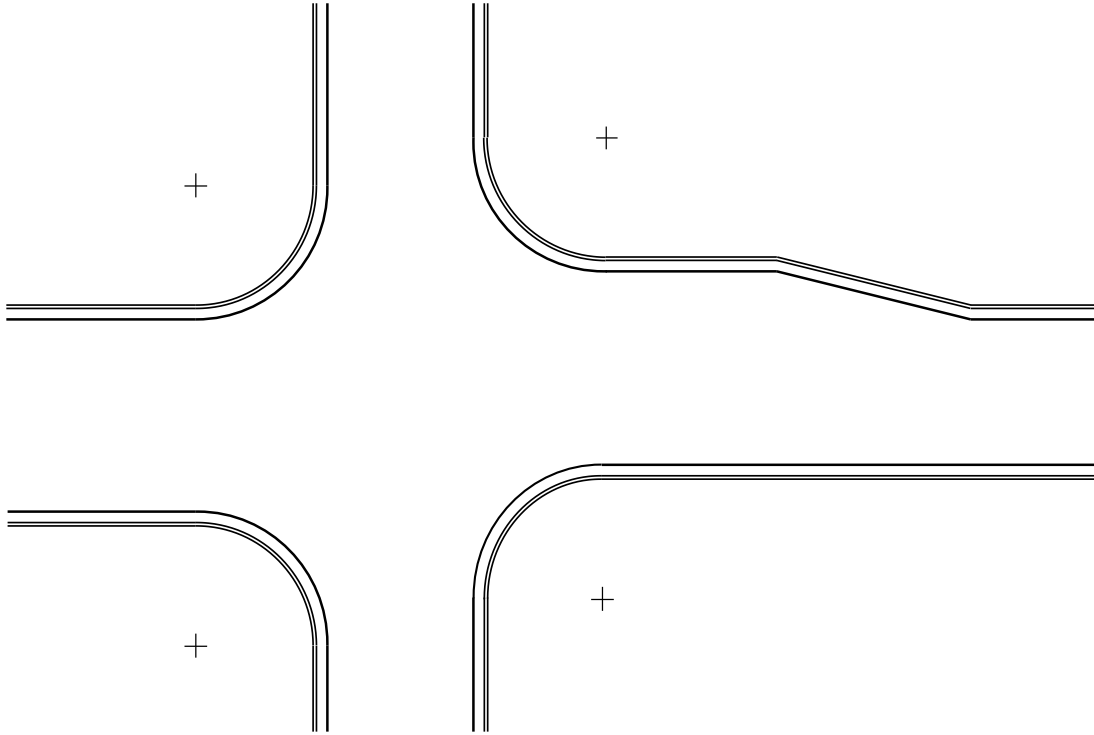

Figure 12.1 Typical Joint Layout for a Rigid Pavement Intersection
(Shows lane configuration, Step 1)

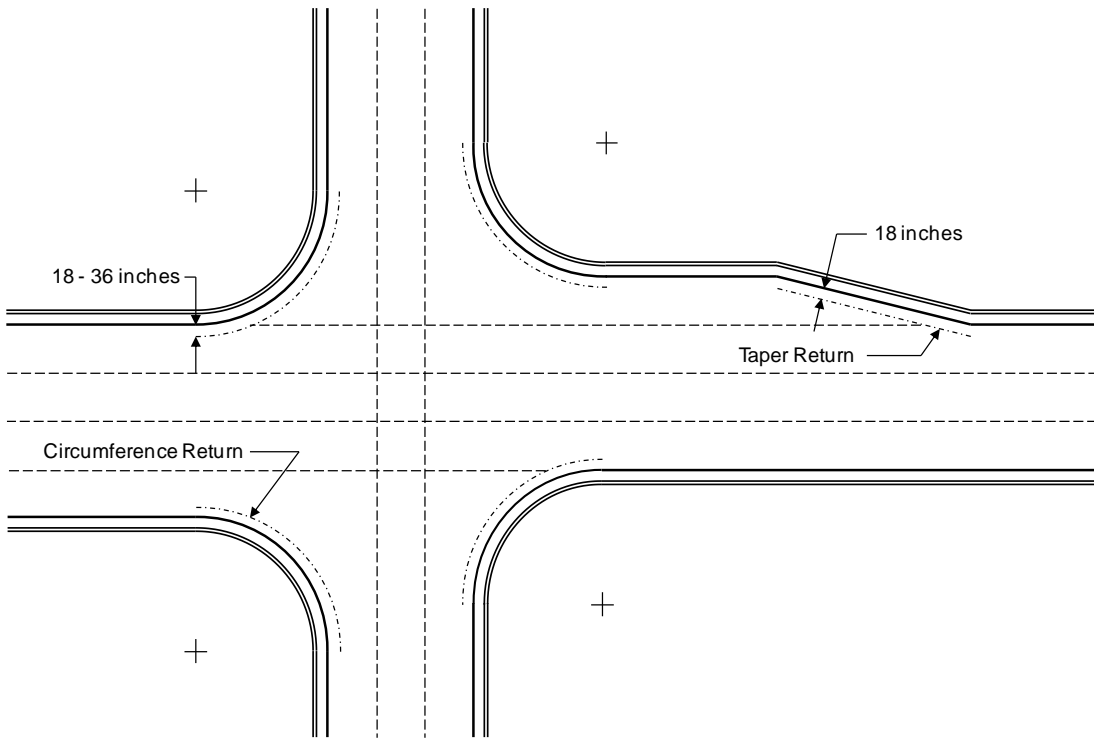

Figure 12.2 Typical Joint Layout for a Rigid Pavement Intersection
(Shows lane configuration, Step 2)

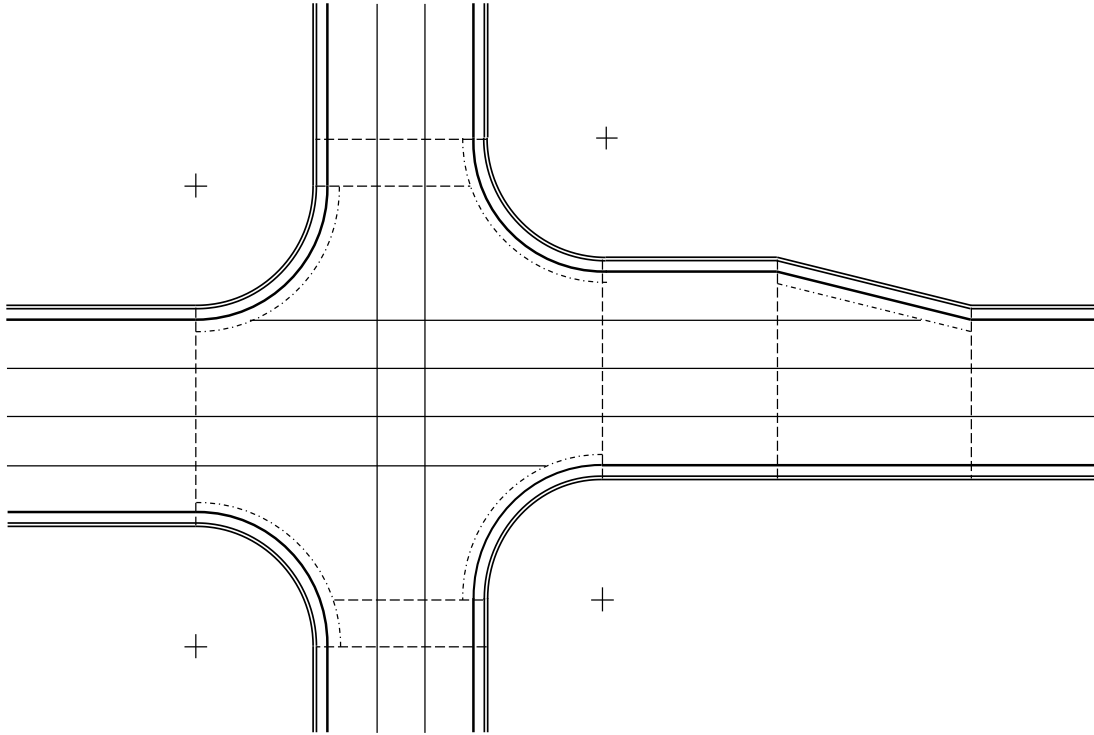

Figure 12.3 Typical Joint Layout for a Rigid Pavement Intersection
(Shows lane configuration, Step 3)

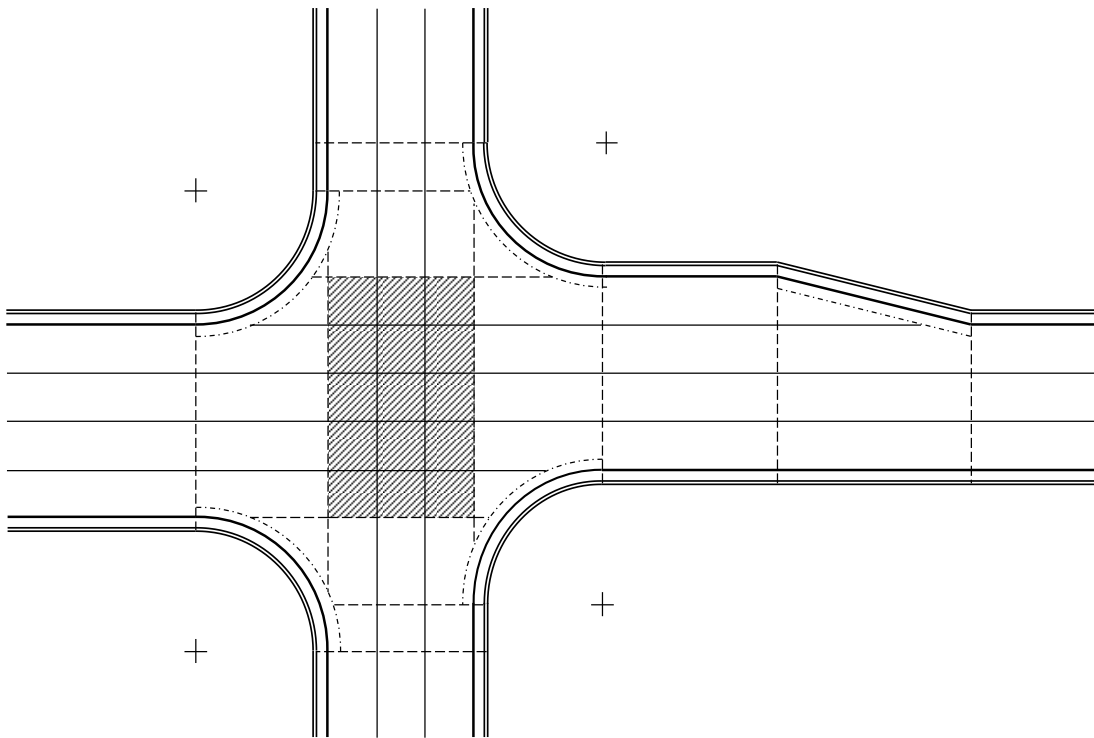

Figure 12.4 Typical Joint Layout for a Rigid Pavement Intersection
(Shows lane configuration, Step 4)

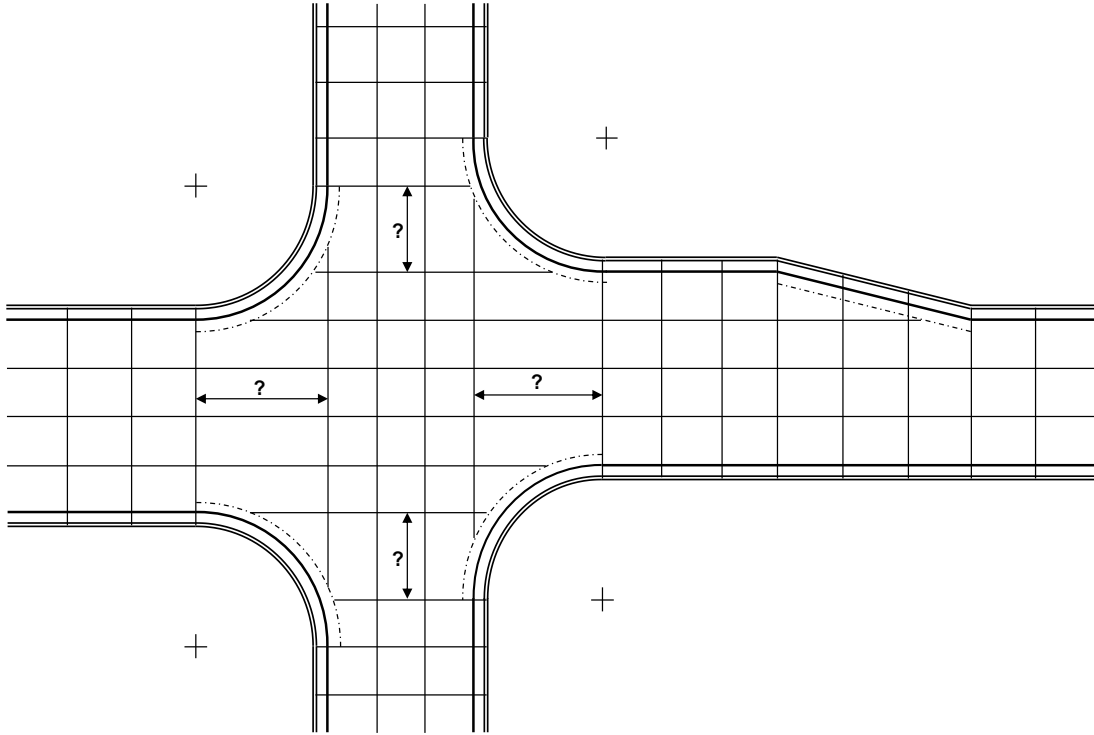

Figure 12.5 Typical Joint Layout for a Rigid Pavement Intersection
(Shows lane configuration, Steps 5 thru 8)

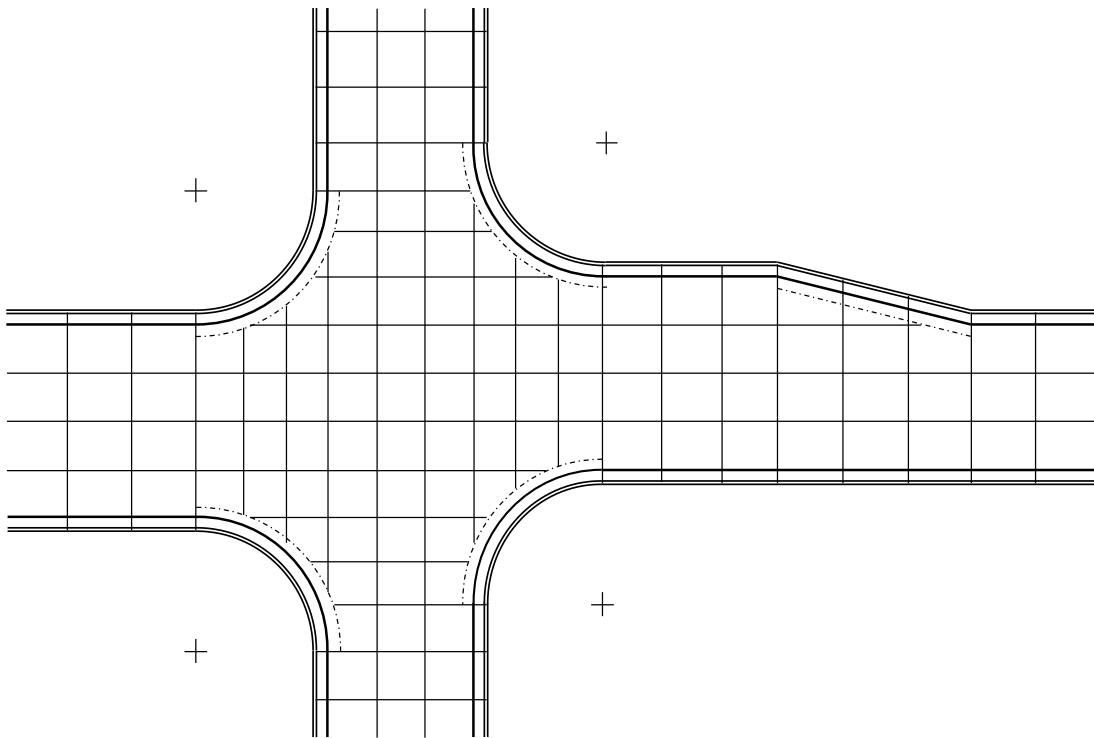

Figure 12.6 Typical Joint Layout for a Rigid Pavement Intersection
(Shows lane configuration, Step 9)

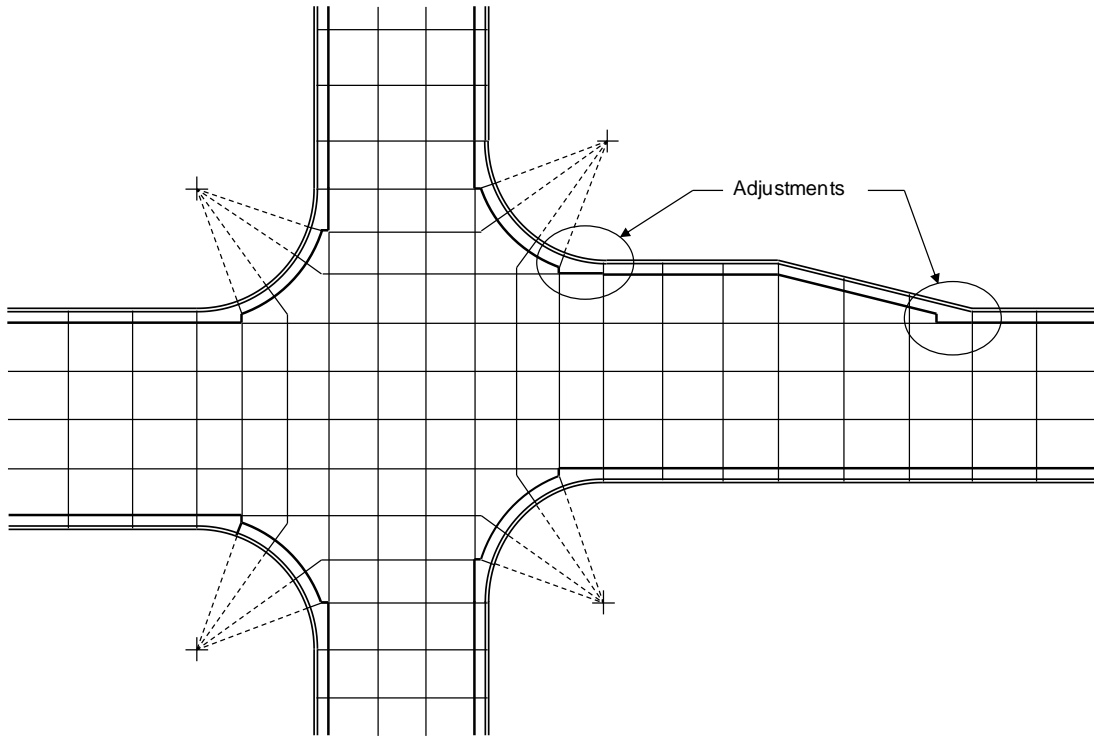

Figure 12.7 Typical Joint Layout for a Rigid Pavement Intersection
(Shows lane configuration, Steps 10)

12.7 Assessing Problems with Existing Intersections

A successful rigid pavement intersection rehabilitation project is dependent on proper project scoping. The keys to proper scoping include the following:

- Identifying the problem with the existing intersection
- Removing enough of the pavement section to encompass the entire problem
- Designing and reconstructing with a full depth PCCP especially formulated for high traffic volume intersections. Special caution should be exercised in Concrete Overlay intersections (using PCCP overlay and not a full depth PCCP design).

12.8 Detail for Abutting Asphalt and Concrete

To join asphalt and concrete slabs, refer to the schematic layout given in **Figure 12.8 Detail of Asphalt and Concrete Slab Joint**. In this detail, at least three consecutive machine-laid concrete slabs will be constructed and doweled at the transverse construction joints to prevent creeping or curling. The size of the dowels will conform to CDOT *Standard Plans (M & S) Standards July 2012 M-412-1 - Concrete Pavement Joints* and as revised (use the larger required dowel diameter in joining 2 different pavement thicknesses) and will be 18 inches long, and spaced under the wheel paths as shown on *Standard Plans (M & S) Standards July 2012 M-412-1*. A hand-poured concrete slab with a rough surface finish and with a depth equal to the design thickness will be constructed and joined to the first of the three machine-laid concrete slabs numbered 1, 2 and 3. Concrete slab 1 will have a depth of design thickness plus 2 inches. Concrete Slabs 2 and 3 will be constructed with a depth equal to the design thickness.

The bottom of the hand-poured concrete slab will be flushed with the bottom elevation of concrete Slab 1 leaving a 2-inch vertical drop from the adjacent concrete slab finish elevation. The HMA paving operation will terminate in the area of the hand-poured concrete slab that will be overlaid with a HMA overlay to fill the 2-inch vertical drop.

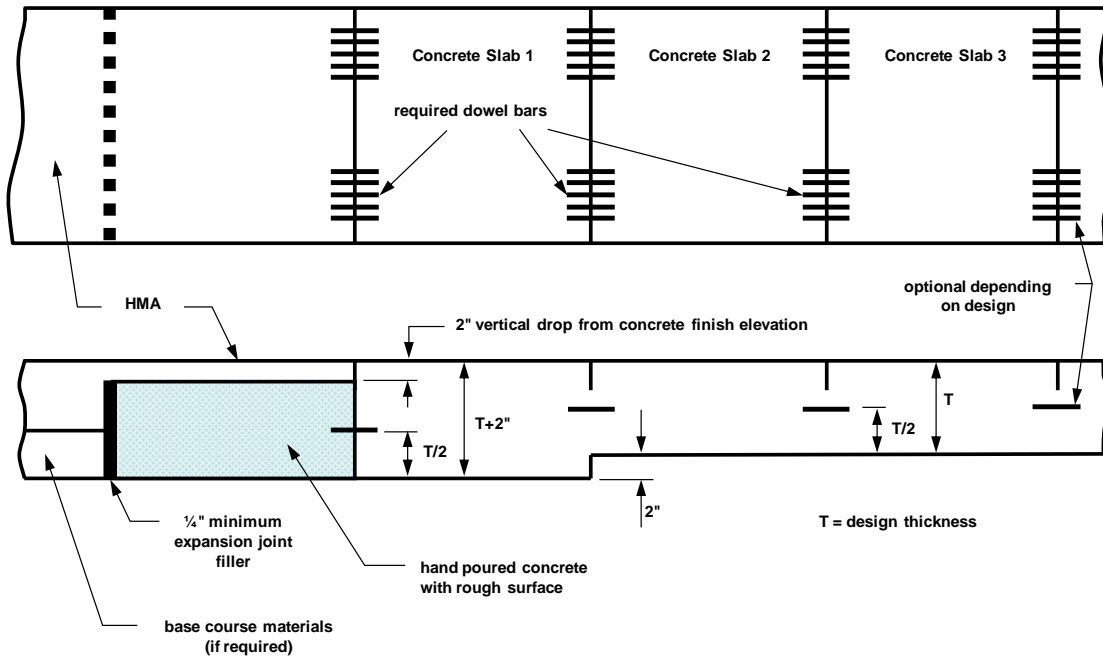

Figure 12.8 Detail of Asphalt and Concrete Slab Joint

12.9 Roundabout Pavement Design

Roundabouts are circular intersections with specific design and traffic control features. These features include yield control of all entering traffic, channelized approaches, and appropriate geometric curvature to ensure that travel speeds on the circulatory roadway are typically less than 30 mph. Thus, roundabouts are a subset of a wide range of circular intersection forms. Circular intersections that do not conform to the characteristics of modern roundabouts are called “traffic circles” (1).

Roundabouts have been categorized according to size and environment to facilitate discussion of specific performance or design issues. There are six basic categories based on environment, number of lanes, and size:

- Mini-roundabouts
- Urban compact roundabouts
- Urban single-lane roundabouts
- Urban double-lane roundabouts
- Rural single-lane roundabouts
- Rural double-lane roundabouts

The most likely categories CDOT will use are the Urban and Rural double-lane roundabouts. The double-lane roundabouts can be expected to handle the increased traffic volumes of a state highway. The following chapter sections will address the double-lane categories.

12.9.1 Roundabout Geometry

12.9.1.1 Minimum Radius

The minimum radius geometry of a roundabout is dependent on several variables including vehicle path radii, alignment of approaches and entries, entry width, circulatory roadway width, the size of the central island, entry and exit curves, size of the design vehicle and land constraints. The designer must incorporate the needs of all the aforementioned items for proper design. The AASHTO publication, *A Policy on Geometric Design of Highways and Streets* (2) provides the dimensions and turning path requirements for a variety of common highway vehicles. FHWA's *Roundabouts: An Informational Guide, Publication No. FHWA-RD-00-067, June 2010* (3) provides guidelines in choosing an appropriate minimum radius.

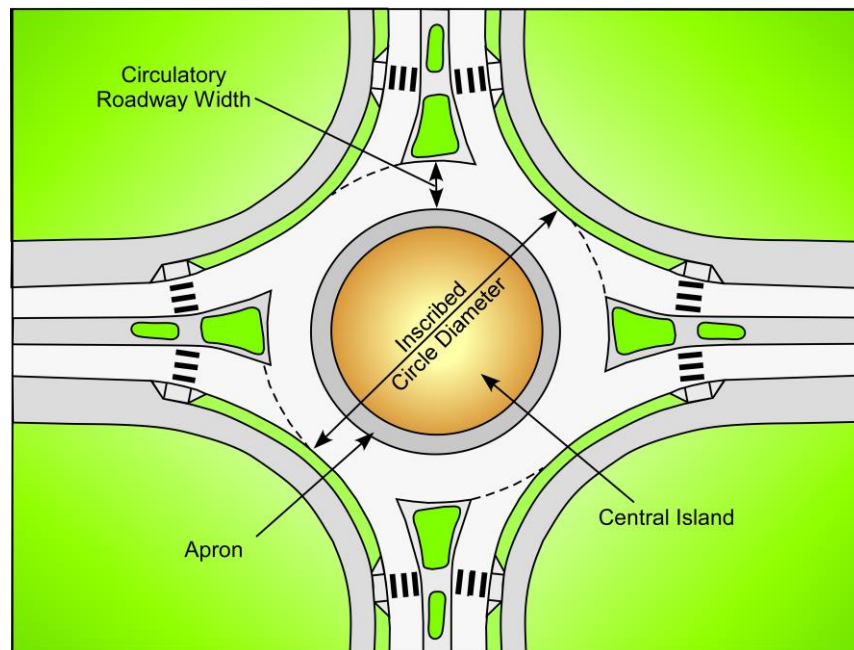

Figure 12.9 Basic Geometric Elements of a Roundabout

(Modified from Exhibit 6-2, *Basic Geometric Elements of a Roundabout, Roundabouts: An Informational Guide*, Federal Highway Administration, Publication No. FHWA-RD-00-067, June 2000 (3))

12.9.1.2 Inscribed Circle Diameter

Error! Reference source not found. shows the inscribed circle diameter, which is the distance across the circle inscribed by the outer curb of the circulatory roadway. In general, smaller inscribed diameters are better for overall safety because they help to maintain lower speeds. Larger inscribed diameters allow for a better approach geometry, decreased vehicle approach speeds, and a reduced angle between entering and circulating vehicle paths. Thus, roundabouts in high-speed environments may require diameters that are somewhat larger than those recommended for low-speed environments. Very large diameters (greater than 200 feet) should not be used because they will have high circulating speeds and more crashes with greater severity. **Table 12.1 Recommended Inscribed Circle Diameters** provides ranges of diameters for various site locations.

Table 12.1 Recommended Inscribed Circle Diameters

(From Exhibit 6-19, *Recommended Inscribed Circle Diameter Ranges, Roundabouts: An Informational Guide, Federal Highway Administration, Publication No. FHWA-RD-00-067, June 2010 (3)*)

Site Category	Inscribed Circle Diameter Range* (feet)
Mini-Roundabout	45-80
Urban Compact	80-100
Urban Single Lane	100-130
Urban Double Lane	150-180
Rural Single Lane	115-130
Rural Double Lane	180-200

*Assumes 90-degree angles between entries and roundabouts with four or fewer legs.

12.9.1.3 Circulatory Roadway Width

The required width of the circulatory roadway is determined from the width of the entries and the turning requirements of the design vehicle. In general, it should always be at least as wide as the maximum entry width. Suggested lane widths and roundabout geometries are found on Exhibit 6-22 of FHWA's *Roundabouts: An Informational Guide, Federal Highway Administration, Publication No. FHWA-RD-00-067*, dated June 2010 (3).

12.9.1.4 Central Island

The central island of a roundabout is the center area encompassed by the circulatory roadway. Central islands should be circular in shape with a constant-radius so drivers can maintain a constant speed. Islands should be raised, not depressed, as depressed islands are difficult for approaching drivers to recognize. An apron may be added to the outer edge of the central island when right-of-way, topography, or other constraints do not allow enlargement of the roundabout. An apron provides an additional paved area for larger vehicles, such as trucks, to negotiate the roundabout. An expansion joint should be used between the truck apron and the circular roadway.

12.9.2 General Joint Layout

The pavement designer may choose from two layout approaches. One is to isolate the circle from the legs and the other is to use a pave through layout, **Figure 12.10 Isolating the Circle** and **Figure 12.11 Pave-through Layout**. Once the approach layout is decided, a sequenced step-by-step procedure is utilized.

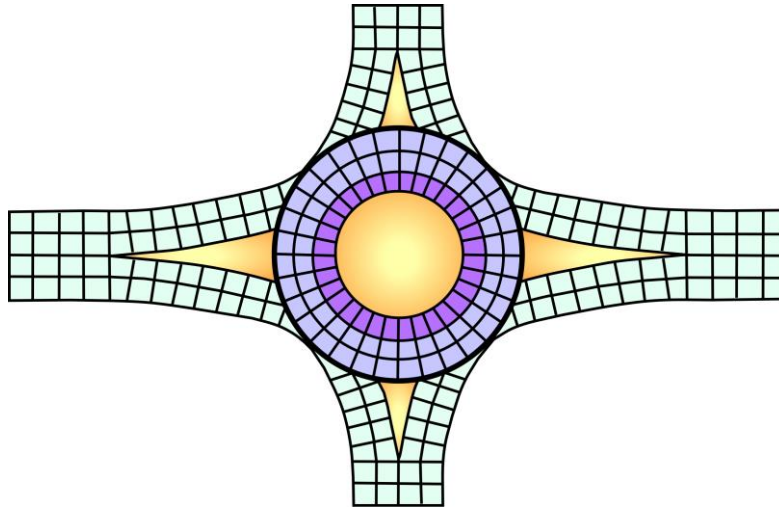

Figure 12.10 Isolating the Circle

(From Figure 1, Joint Layout for Roundabout, Isolating Circle from Legs,
Concrete Roundabouts: Rigid Pavement Well-Suited for Increasing Popular Intersection Type, ACPA,
June 2005 (4))

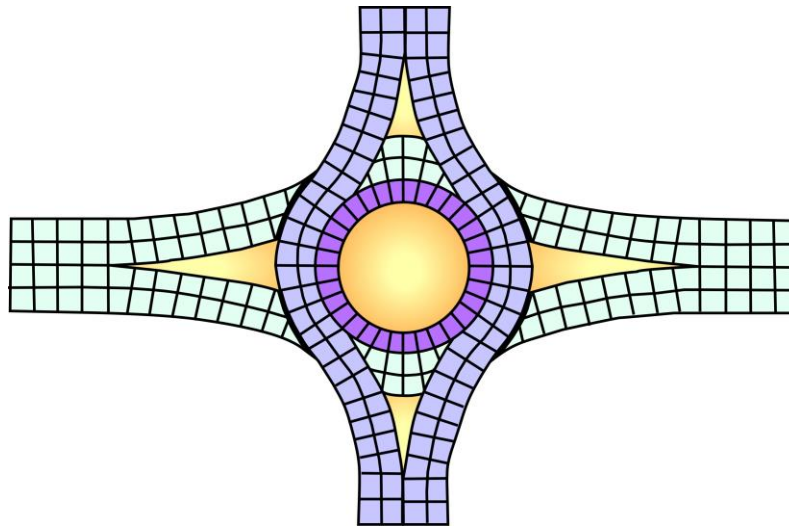
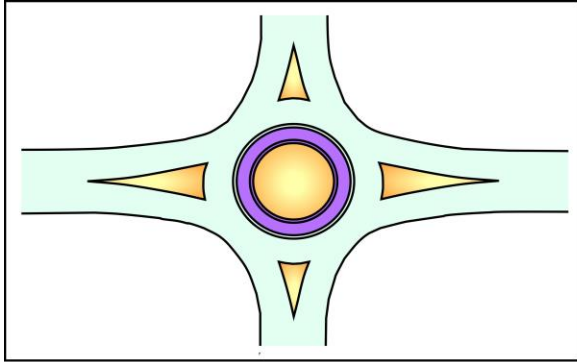

Figure 12.11 Pave-through Layout

(From Figure 2, Joint Layout for Roundabout, "Pave-Through" Option,
Concrete Roundabouts: Rigid Pavement Well-Suited for Increasing Popular Intersection Type, ACPA,
June 2005 (4))

ACPA recommends a six-step process on constructing joint layouts. **Figure 12.12 Six Step Jointing Layout** is an example illustrating an isolating circle for the general layout.



Step 1. Draw all pavement edge and back-of curb lines in the plan view. Draw location of all manholes, drainage inlets, and valve covers so that joints can intersect these.

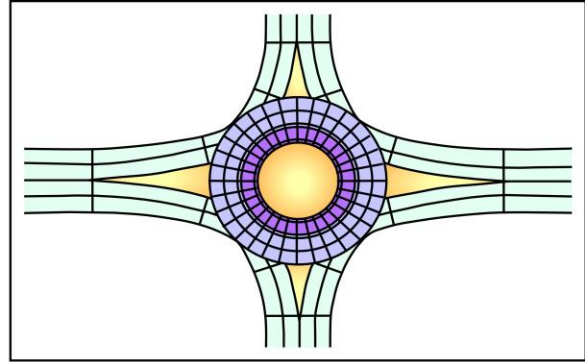

Step 4. On the legs, add transverse joints at all locations where a width change occurs in the pavement (at bullnose of median islands, begin and end of curves, tapers, tangents, curb returns, etc.). Extend these joints through the back of the curb and gutter.

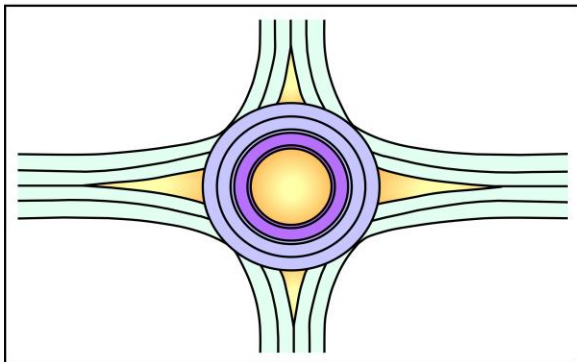

Step 2. Draw all lane lines on the legs and in the circular portion. If isolating circle from legs, do not extend these through the circle. If using "pave-through" method, determine which roadway will be paved through. Make sure no distance is greater than the maximum recommended width.

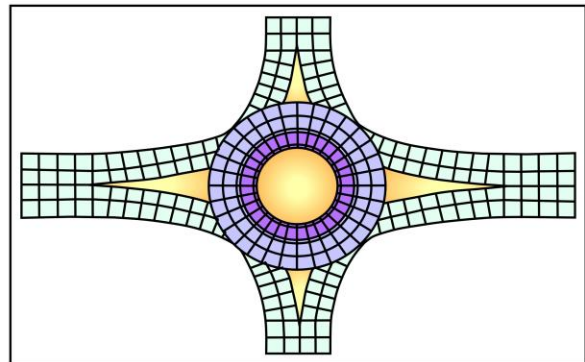

Step 5. Add transverse joints beyond and between those added in Step 4. Space joints out evenly between other joints, making sure not to violate maximum joint spacing.

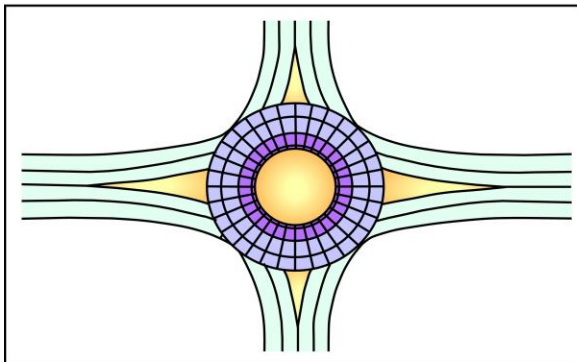

Step 3. In the circle, add "transverse" joints radiating out from the center of the circle. Make sure that the largest dimension of the pie-shaped slab is smaller than the maximum recommended. Extend these joints through the back of the curb and gutter.

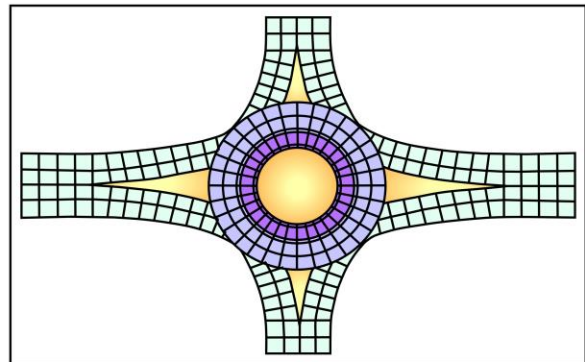

Step 6. Make adjustments for in-pavement objects, fixtures and to eliminate L-shapes, small triangular slabs, etc.

Figure 12.12 Six Step Jointing Layout

(From Page 3, Six Steps, *Concrete Roundabouts: Rigid Pavement Well-Suited for Increasing Popular Intersection Type*, ACPA, June 2005 (4))

12.9.3 Details of PCCP Joints

Additional detailing of the joints is necessary to achieve long lasting, crack free pavements. **Figure 12.13 Basic Joints and Zones of a Roundabout**, shows a roundabout broken into three zones based on joint layout; the central, approach, and transition zones. The central zone consists of concentric circles (longitudinal joints) intersected by radial, transverse joints. The longitudinal joints are tied to minimize outward migration of the slabs. Slabs should be square or pie shaped with a maximum width of 14 feet and a maximum length of 15 feet. If possible, establish uniform lane widths to accommodate a slip-form paver. The transition zone generally consists of irregular shaped slabs and is usually tied to the central zone. Joint angles should be greater than 60 degrees. In cases where odd shapes occur, dog legs through curve radius points may be needed to achieve an angle greater than 60 degrees. An expansion joint should be used to properly box out fixtures such as manholes and inlets. An expansion joint is usually placed between the transition and approach zones to act as a buffer from the radial outward movement of the roundabout and the inward movement of the approach roads. All transverse or horizontally moving joints should extend through the curb and gutter sections to ensure that their movement remains unrestricted and does not induce cracking in the adjoining slab. Generally, transverse joints are placed at 10 foot intervals in curb and gutter, however, since roundabout curb and gutter sections are tied or poured monolithically and the thickness is the same as the pavement thickness, the jointing may be increased to match the slab joint spacing. Longitudinal joints should be located close to, but offset from lane lines or pavement markings. Vehicles tend to track towards the center of the roundabout, thus, joints would be better placed inside lane lines.

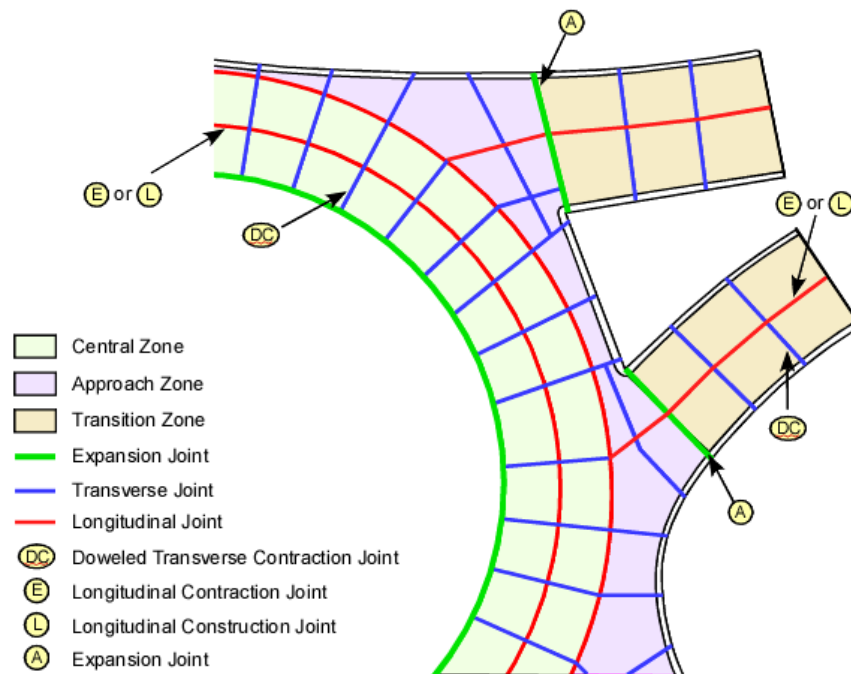

Figure 12.13 Basic Joints and Zones of a Roundabout

(Modified from Figure 4, Roundabout Zones, *Concrete Roundabout Pavements: A Guide to their Design and Construction*, Doc. No. TP-GDL-012, March 2004 (5))

Typically, state highway projects use load transfer devices (dowel bars) and tie-bars. These reinforcements must be detailed throughout the roundabout intersection. The dowel bars should be evenly distributed across the lane width and are generally spaced every 12 inches. The tie-bars are located in the longitudinal joints and are usually spaced every 36 inches. Tie bar requirements and pull out testing are specified in Section 412.13 of CDOT *Standard Specifications for Road and Bridge Construction* (6). Dowel bar and tie-bar joints to be used in the roundabouts are detailed in CDOT's *Standard Plans (M & S) Standards July 2012 M-412-1, Concrete Pavement Joints* and as revised.

12.9.4 Typical Section

The concrete pavement thickness is calculated by adding the truck traffic for each stream of traffic going through the roundabout intersection. Parts of the structural components are the curb and gutter sections. The curb and gutter sections are detailed in CDOT *Standard Plans (M & S) Standards July 2012 M-609-1, Curb, Gutters, and Sidewalks* and as revised. It is recommended to use Curb Type 2 (6 inch Barrier) (Section B) for the inner most ring curb barrier adjacent to the in-field, Curb and Gutter Type 2 (Section IIM) (6 inch Mountable – 2 foot Gutter) for the middle ring curb barrier, and Curb and Gutter Type 2 (Section IIB) (6 inch Barrier – 2 foot Gutter) for the outer ring barrier. The gutter thickness has been increased to the thickness of the pavement and tie-bars are used to tie the gutters to the pavement. This mimics a monolith pour. See Section 7.14 Lane Edge Support Condition (E) for more information.

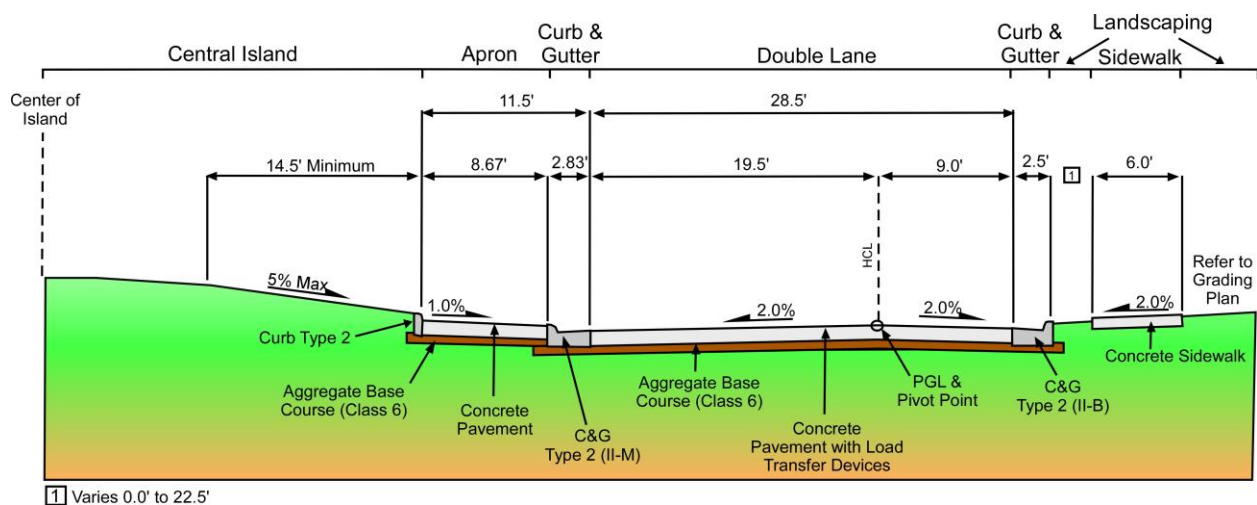

Figure 12.14 Typical Section of an Urban Double-lane Roundabout

References

1. *Roundabouts: An Informal Guide*, FHWA-RD-00-067, Federal Highway Administration, Turner-Fairbanks Highway Research Center, June 2000.
2. *A Policy on Geometric Design of Highways and Streets*, Washington, D.C, AASHTO, 1994.
3. *Roundabouts: An Informational Guide*, Publication No. FHWA-RD-00-67, U.S. Department of Transportation, Federal Highway Administration, Robinson, June 2010.
<http://www.fhwa.dot.gov/publications/research/safety/00067/000676.pdf>
4. *Concrete Roundabouts: Rigid Pavement Well-Suited for Increasing Popular Intersection Type*, Number 6.03, R & T Update, Concrete Pavement Research & Technology, American Concrete Pavement Association, Skokie, IL, June 2005.
5. *Concrete Roundabout Pavements, A Guide to their Design and Construction*, Document No. TP-GDL-012, Pavements Branch of the Road Network Infrastructure, TechMedia Publishing Pty Ltd., 2005.

CHAPTER 13

PAVEMENT TYPE SELECTION AND LIFE CYCLE COST ANALYSIS

13.1 Introduction

Some of the principal factors to be considered in choosing pavement type are soil characteristics, traffic volume and types, climate, life cycle costs, and construction considerations. All of the above factors should be considered in any pavement design, whether it is for new construction or rehabilitation.

Life cycle cost comparisons must be made between properly designed structural sections that would be approved for construction. The various costs of the design alternatives over a selected analysis period are the major consideration in selecting the preferred alternative. A Life Cycle Cost Analysis (LCCA) includes costs of initial design and construction, future maintenance, rehabilitation, and user costs. Colorado Department of Transportation (CDOT) uses the AASHTOWare™ DARWin™ M-E software program for designing flexible and rigid pavements. Federal Highway Administration (FHWA) RealCost software is to be used for probabilistic LCCA. It is imperative that careful attention should be given to the calculations involved and the data used in the calculations to ensure the most realistic and factual comparison between pavement types and rehabilitation strategies.

Several design variations are possible within each rehabilitation strategy. A suggested flowchart illustrating the selection process for new pavement construction is shown in **Figure 13.1 Pavement Selection Process Flow Chart**.

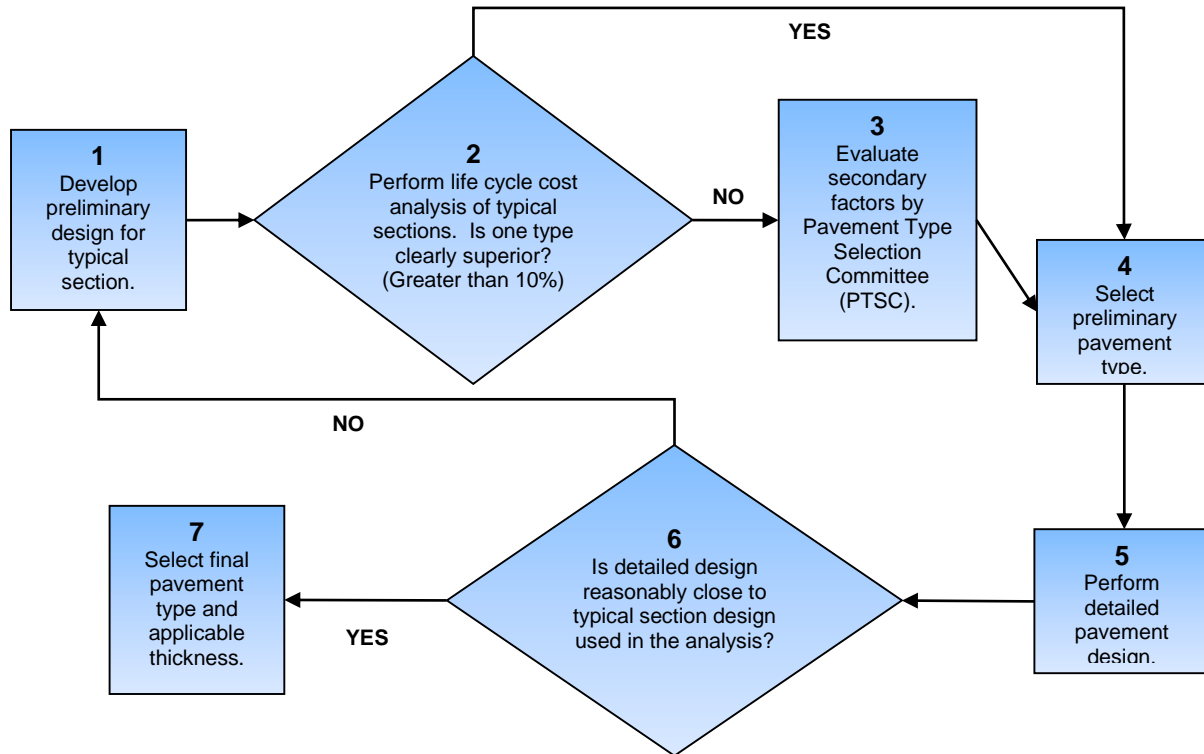

Figure 13.1 Pavement Selection Process Flow Chart

13.2 Implementation of a LCCA

A LCCA comparing concrete to asphalt pavements will be prepared for all new or reconstruction projects with more than \$2,000,000 initial pavement material cost. This includes pavement and base course material. A LCCA comparing asphalt and concrete should also be prepared for all surface treatment projects with more than \$2,000,000 initial pavement cost where both pavement types are considered feasible alternatives as determined by the RME. If the RME determines one pavement type is not a feasible alternative for a surface treatment project, they will include information supporting their decision in the Pavement Justification Report. Some examples of why alternatives may not be considered feasible are constructability of the alternative, lane closure limitations set by regional traffic policies, geometric constraints, and minimum required pavement thicknesses for various alternatives. It may be helpful to discuss constructability concerns with industry to ensure that CDOT does not overlook recent innovations in the paving industry. For CDOT projects, the net present value economic analysis will be used. Refer to the references at the end of this chapter for documents published that explain LCCA.

Examples of projects where a LCCA may not be necessary are:

- A concrete pavement, which is structurally sound and requires only resealing and/or minor rehabilitation work
- A concrete or asphalt pavement, which is structurally sound but may need skid properties restored or ride improved
- Minor safety improvements such as channelization, shoulder work, etc.

- Bridge replacement projects with minimal pavement work
- Locations where curb and gutter or barrier prohibit the use of alternative thicker treatments.

13.2.1 Analysis Period

The analysis period to be used is the period of time selected for making an LCCA of pavement costs. CDOT will be using a 40-year period for their LCCA. All alternatives being considered should be evaluated over this same period. If the service life of an alternative were 20 years, another rehabilitation project would have to be applied at the 20th year, and into the future, until the analysis period is covered.

13.2.2 Performance Life

Besides initial costs and discount rate, the performance life of the rehabilitation strategy is a major component of LCCA. Total economic life of the alternative is used to compare initial designs along with the performance lives gained from the future rehabilitation of the pavement.

CDOT uses an assortment of rehabilitation strategies for pavements. Potential pavement alternatives include, but are not limited to: Mill and fill, hot or cold in-place recycling, overlay, rubblization, and Concrete Overlays. Every approach to rehabilitation will include a type of treatment and the life of that treatment. Planned rehabilitation is used in the pavement analysis to make engineering comparisons of candidate strategies and is not used for future funding eligibility determinations.

To select a future strategy, the pavement designer will review the data from the Pavement Management System to determine what was done in the past. Each section of pavement could have its own unique rate of deterioration and performance life. The decision of using the same tactic or modifying the treatment will be determined by analyzing past treatments and the lives of those methods.

13.2.3 Rehabilitation Selection Process

CDOT has developed this selection process that takes full advantage of available pavement management performance data. It is believed the following guide will provide recommendations that are more representative of actual pavement performance on Colorado highways. The selection of the appropriate treatment should be based on an engineering analysis for the project. The following precedence is recommended for the selecting a rehabilitation strategy to be used in the LCCA:

The pavement designer should use the historical treatments on the same roadway with their associated service life. Past strategies could be determined by coring the pavement as well as historical plan investigations. The coring program is outlined in **APPENDIX C**. Typically, discrepancies arise in the pavement management data and the thickness of cores. The pavement designer may have to categorize a lift thickness as being a structural or a functional (preventive maintenance) overlay. The service life of a structural overlay is determined as the number of years between two structural overlays. If a functional

overlay was performed, a service life is not established and no adjustment is done on the expected service life. The cost of the functional treatment should be included as part of the maintenance cost and the cost shown in **Table 13.4** will need to be revaluated.

If the core and historical information is unknown, then refer to **Table 13.1** and estimate the performance life for various alternative treatments. The performance lives shown in **Table 13.1** are based on statewide average data. This information does not distinguish between traffic and environmental conditions. It only considers the historical timing of the rehabilitation treatments. Based on the current budgetary constraints, the optimal timing for these treatments may be different. Therefore, regional or local adjustments should be made using information from similar facilities with similar traffic levels if the data is available.

Table 13.1 Default Input Values for Treatment Periods to be used in a LCCA

Type of Treatment ⁽¹⁾	Performance in Years		
	Minimum	Most Likely	Maximum
Cold Planing and Overlay ⁽²⁾	6	12	21
2 to 4 inch Overlay ⁽²⁾	5	11	39
Stone Matrix Asphalt Overlay	5	9	17
Full Depth Reclamation and Overlay ⁽²⁾	10	12	15
Heating and Remixing and Overlay ⁽²⁾	4	7	14
Heating and Scarifying and Overlay ⁽²⁾	6	9	23
Cold In-Place Recycling and Overlay ⁽²⁾	3	8	16
Overall Weighted Statewide Average	5	10	26
<p>(1) This table will not be used to select project-specific rehabilitation strategies. The performance years are not intended to be a comparative tool between different treatment types, are default values to be entered into the probabilistic LCCA after the appropriate treatment has been selected based on project specific design criteria.</p> <p>(2) If modified asphalt cement is used, add 1 year to the most likely value.</p>			

13.3 Examples of the Rehabilitation Selection Process

13.3.1 Core Data Matches Historical Data

A reconstruction project is planned for 2010 and unmodified HMA is anticipated. Cores taken from the roadway indicated that the existing HMA thickness is 8.5 inches thick. The historical information from the Pavement Management System indicated the original construction project was built in 1976 with a total of 6 inches of unmodified HMA. In 1998, the second project milled 2 inches off the existing HMA and overlaid it with 4 inches of unmodified HMA. Since the core thickness is reasonably close to the historical data, the average service life of 17 $((1998-1976) + (2010-1998))/2$ should be used. The cash flow diagram is shown in **Figure 13.2**.

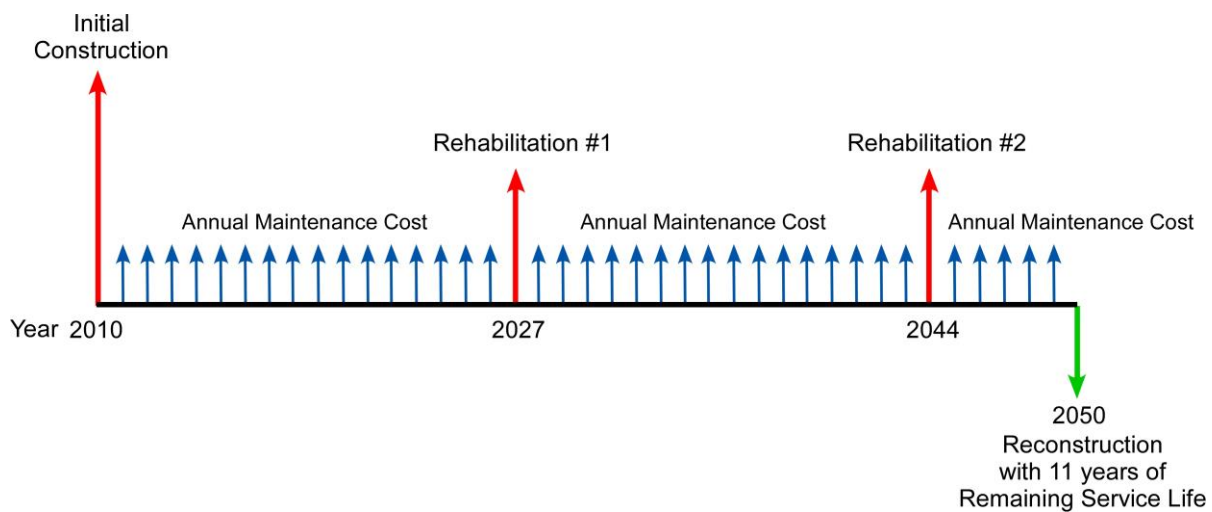

Figure 13.2 Unmodified HMA Cash Flow Diagram

13.3.2 No Core Data and No Historical Data

A reconstruction project is planned for 2010 and modified HMA is anticipated. Discernable lifts of HMA could not be found in the roadway cores and no historical information is available for this area. Since a curb and gutter will be constructed, future rehabilitation work will require cold planing and overlays. Based on **Table 13.1**, the most likely life expectancy for this rehabilitation strategy is 13 years (12 + 1 year for modified HMA). The cash flow diagram is shown in **Figure 13.3**.

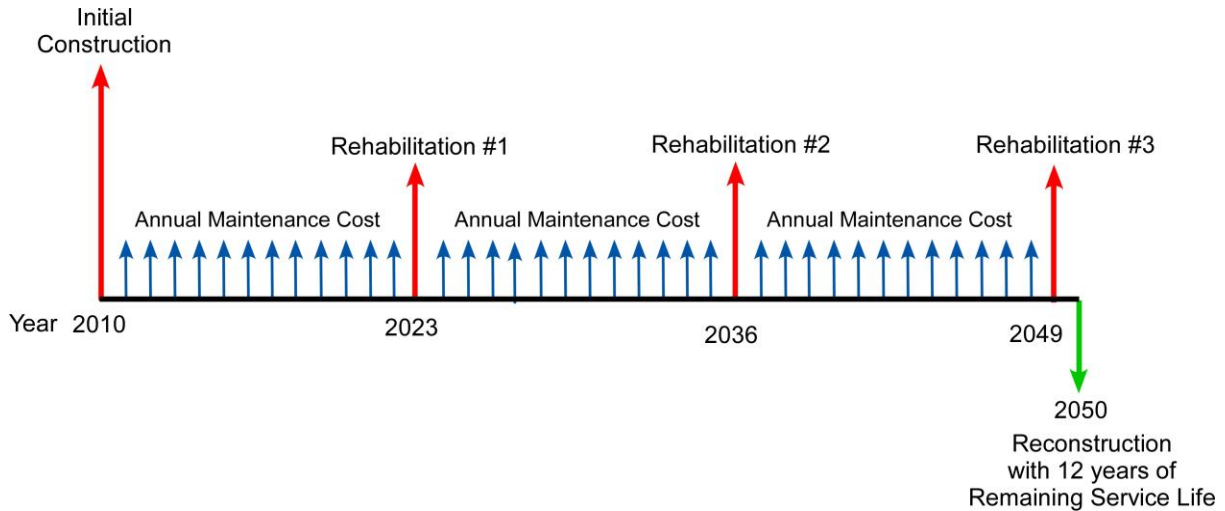

Figure 13.3 Cold Plaining and Overlay with Polymer Modified HMA Cash Flow Diagram

13.3.3 Portland Cement Concrete Pavement

The LCCA of a PCCP may be analyzed with either a 30-year initial design period or a 20-year initial design period:

Analysis Period: 40 years

Initial Design Period: 30 years,

Note: Add ¼ inch to thickness for future diamond grinding.

Rehabilitation: When available, the regional or local performance data should be used using similar facilities with similar traffic levels. If no local data is available, the default years to the first rehabilitation cycle for PCCP is a triangular distribution with a minimum value of 16 years the most likely value of 27 years and the maximum value of 40 years. This information is based on statewide average data. It does not distinguish between traffic levels or environmental conditions. It only considers the historical timing. Due to budgetary constraint, the optimal timing may be different. Therefore, these values should only be used in the absence of any other information.

- PCCP with dowel and tie bars will require ½ percent slab replacement in the travel lanes, full width diamond grinding with longitudinal and transverse joint resealing.
- PCCP without dowel or tie bars will require 1 percent slab replacement in the travel lanes, full width diamond grinding with longitudinal and transverse joint resealing.

This HMA alternative was developed for those PCCP projects that did not include dowel bars.

Based on an \$8 million project, the 40-year LCCA comparison between the 2-inch HMA overlay alternative at 20 and 30 years is about 5.5% more expensive than the PCCP rehabilitation at 27 years.

Recommendations: Since some local agencies use CDOT’s Pavement M-E Design Manual, we should keep the second bullet. However, we should delete the HMA rehabilitation option for PCCP in the CDOT Pavement M-E Design Manual.

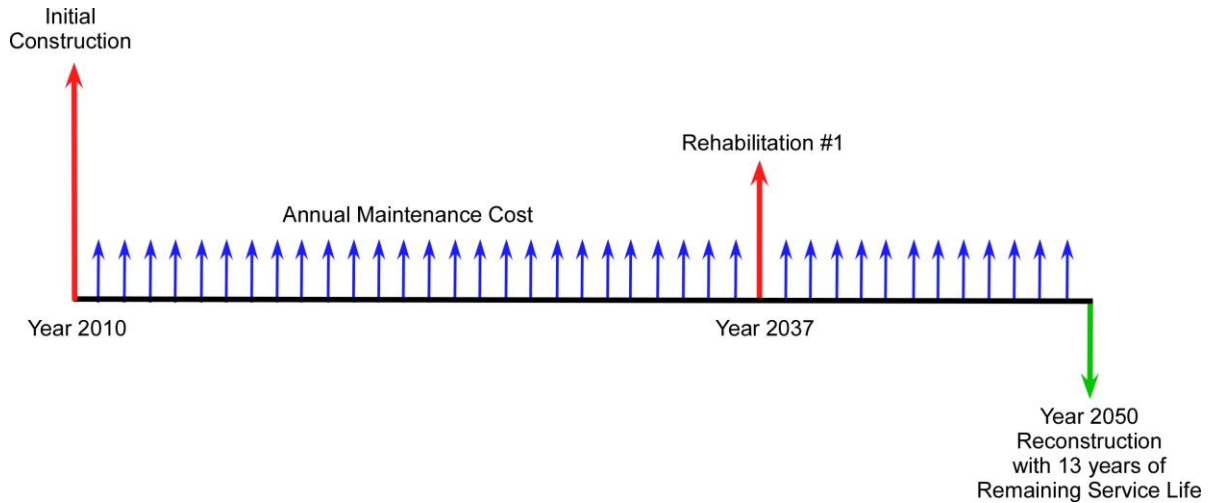

Figure 13.4 PCCP Cash Flow Diagram

13.3.4 Restoration, Rehabilitation and Resurfacing Treatments

The economic cost of these surface treatments are performed with the following parameters:

Analysis Period: 40 years
Design Period: 10, 20 or 30 years

13.4 Discount Rate

All future costs are adjusted according to a discount rate to a present worth. Costs incurred at any time into the future can be combined with initial construction costs to give a total cost over the life cycle. See **Table 13.2 Present Worth Factors for Discount Rates** present worth factors (for a single deposit at the n^{th} year, PWF_n and for a uniform series of deposits, S_n). The current discount rate is 2.36 percent with a standard deviation 0.33 percent (6).

The discount rate and standard deviation will be calculated annually. If the new 10-year average discount rate varies more than two standard deviations from the original discount rate used at the time of the design, in this case 0.66 percent. A new LCCA should be performed for all those projects that have been shelved since 2011 and not yet been awarded. The Pavement Designer is responsible for checking previous pavement designs to ensure that an appropriate discount rate was used and the pavement choice is still valid.

Table 13.2 Present Worth Factors for Discount Rates

n	Discount Rate	
	2.36%	
	PWF _n	S _n
5	0.8899	4.6646
6	0.8694	5.5340
7	0.8494	6.3834
8	0.8298	7.2131
9	0.8106	8.0238
10	0.7919	8.8157
11	0.7737	9.5894
12	0.7559	10.3453
13	0.7384	11.0837
14	0.7214	11.8051
15	0.7048	12.5099
16	0.6885	13.1984
17	0.6726	13.8710
18	0.6571	14.5282
19	0.6420	15.1701
20	0.6272	15.7973
21	0.6127	16.4100
22	0.5986	17.0086
23	0.5848	17.5934
24	0.5713	18.1647
25	0.5581	18.7229
30	0.4967	21.3264
35	0.4420	23.6433
40	0.3934	25.7051

The discounting factors are listed in **Table 13.3 Discount Factors for Discrete Compounding** in symbolic and formula form and a brief interpretation of the notation. Normally, it will not be necessary to calculate factors from these formulas. For intermediate values, computing the factors from the formulas may be necessary, or linear interpolation can be used as an approximation.

Table 13.3 Discount Factors for Discrete Compounding

Factor Name	Converts	Symbol	Formula	Interpretation of Notation
Single Payment Present Worth	F to P (Future single payment to present worth)	$(P/F, i\%, n)$	$(1 + i)^{-n}$	Find P, given F, using an interest rate of $i\%$ over n years
Uniform Series Present Worth	A to P (Annual payment to present worth)	$(P/A, i\%, n)$	$\frac{(1 + i)^n - 1}{i(1 + i)^n}$	Find P, given A, using an interest rate of $i\%$ over n years

The single payment present worth $P=F(P/F, i\%, n)$ notation is interpreted as, “Find P, given F, using an interest rate of $i\%$ over n years. Thus, an annuity is a series of equal payments, A , made over a period of time. In the case of an annuity that starts at the end of the first year and continues for n years, the purchase price, P , would be $P=A(P/A, i\%, n)$. See **Table 13.2 Present Worth Factors for Discount Rates**.

13.5 Life Cycle Cost Factors

The cost factors are values associated with the LCCA that cover the full cycle from initial design to the end of the analysis period. Any item that impacts the initial cost should be analyzed, and a determination made as to whether it should be included in the cost analysis. Such items would include shoulder construction, major utility considerations, mobilization, temporary access, traffic crossovers, etc. Some of the factors the designer should consider are as follows:

13.5.1 Initial Construction Costs

Pavement construction costs are the expenses incurred to build a section of pavement in accordance with the plans and specifications. The pavement construction cost is one of the most important factors in the LCCA and should be as accurate as possible. The current version of CDOT’s Cost Data manual should be used unless up-to-date bid prices are available for similar work in the same general area. Initial cost of PCCP and HMA should be based on the best available information. The designer should take into consideration project specific information, such as; special mixes, fast track mixes, pavement constructability, special binders, construction phasing, project location, and other pertinent information. These project details may alter the unit costs shown in the figures. The designer should exercise good judgment in the application of the PCCP and HMA unit costs. If there is a wide range of prices for a certain item, then it is best to run a sensitivity analysis to determine the effect of cost variation on the end result. Computing the initial cost of a design alternative involves not only the material quantity calculations, but also the other direct costs associated with the pavement alternative being considered. Difference in grading quantities required by different pavement alternatives should be considered where appropriate. For example, the comparison of a thick overlay alternative versus a removal and replacement alternative should

include the required shoulder quantity for the overlay. If traffic control costs vary from one alternative to another, this cost should be estimated and included as an initial cost. The different construction techniques, curing time, and duration of lane closures associated with PCCP or HMA have a significant impact on the user costs. For example, a HMA overlay could involve the closure of one lane of traffic at a time, while a concrete pavement overlay might necessitate complete roadway closure and detour construction. This will impact traffic control and user costs. The designer should utilize the resources of the Engineering Estimates Unit as necessary to supplement information used in the calculation of the unit cost. The supporting information and any worksheets for the unit cost should be included in the Pavement Justification Report.

13.5.1.1 Asphalt Cement Adjustment

Included in the unit cost of HMA should be an adjustment for the Force Account Item. This item revises the Contactor's bid price of HMA found in the Cost Data book based on the price of crude oil at the time of construction. The data varies from year to year, Region to Region, and by the various binders used by CDOT. In 2009, the average was an increase of \$3.30 per ton of HMA. In 2013, the average was an increase of \$4.24. The weighted average of over 6 million tons of HMA is an increase of \$1.03 per ton. Therefore, we recommend a triangular distribution with the minimum value of -\$2.56, a most likely value of \$1.03 and a maximum value of \$4.24 per ton of mix. The unit cost modification is based on data from projects that were awarded from 01/01/2009 through 12/31/2013.

13.5.2 Maintenance Cost

Maintenance costs should be based on the best available information. The CDOT Maintenance Management System compiled data on State Highway maintenance costs. The annual maintenance cost per lane mile is shown in **Table 13.4 Annual Maintenance Costs** This data was collected from January 1, 2002 to January 1, 2007.

Table 13.4 Annual Maintenance Costs

Region	Type of Pavement	Average Annual Cost Per Lane Mile (\$)	Standard Deviation	Lane Miles Surveyed (miles)
1	HMA	1,057	1,494	605
	PCCP	395	673	384
2	HMA	812	557	508
	PCCP	449	378	158
3	HMA	891	835	714
	PCCP	664	N/A	2
4	HMA	791	839	632
	PCCP	468	412	106
5	HMA	1,474	1,670	268
	PCCP	1,478	N/A	7
6	HMA	2,520	4,562	245
	PCCP	643	349	25
Statewide	HMA	1,270	2,377	2,972
	PCCP	499	553	682

The designer should exercise good judgment in the application of maintenance costs. Inappropriate selection can adversely influence the selection of alternatives to be constructed. If actual cost cannot be provided, use the following default values for average annual cost:

- \$1,270/lane-mile for asphalt pavements.
- \$499/lane-mile for portland cement concrete pavements.

13.5.3 Design Costs

The expected preliminary engineering (PE) costs for designing a new or rehabilitated pavement including materials, site investigation, traffic analysis, pavement design, and preparing plans with specifications vary from region to region and are in the range of 8 to 12 percent with the average being 10 percent of the total pavement construction cost.

13.5.4 Pavement Construction Engineering Costs

Included in the pavement construction cost should be the cost of engineering (CE). The CE and indirect costs can be found at the Site Manager Construction website.

13.5.5 Traffic Control Costs

Traffic control costs are the cost to place and maintain signs, signals, and markings and devices placed on the roadway to regulate, warn, or guide traffic. The traffic control costs vary from Region to Region and from day to night. The range is from 10 to 18 percent with the average being 15 percent of the total pavement construction cost. In some designs, the construction traffic control costs may be the same in both alternatives and excluded from the LCCA.

13.5.6 Serviceable Life

The serviceable life represents the value of an investment alternative at the end of the analysis period. The method CDOT uses to account for serviceable life is prorated - based on the cost of the final rehabilitation activity, design life of the rehabilitation strategy, and the time since the last rehabilitation. For example, over a 40-year analysis, alternative A requires a 10-year design life rehabilitation to be placed at year 31. In this case, alternative A will have 1 year of serviceable life remaining at the end of the analysis (40-31=9 years of design life consumed and 10-9=1 year of serviceable life). The serviceable life is 1/10 of the rehabilitation cost, as shown in Equation 13.1.

$$SL = (1 - (L_A / L_E)) * C \qquad \text{Eq. 13.1}$$

Where:

- SL = serviceable life
- L_A = the portion of the design life consumed
- L_E = the design life of the rehabilitation
- C = the cost of the rehabilitation

13.5.7 User Costs

These costs are considered to be indirect “soft” costs accumulated by the facility user in the work zone as they relate to roadway condition, maintenance activity, and rehabilitation work over the analysis period. For example, these costs include user travel time, increased vehicle operating costs (VOC), and crashes. Though these “soft” costs are not part of the actual spending for CDOT, they are costs borne by the road user and should be included in the LCCA. Due to the lack of crash cost data, for certain types of work zone activities, CDOT will not consider the costs due to crashes.

13.5.7.1 User Cost Program

UNDER DEVELOPMENT

Continue to use the user cost section of the 2015 Pavement Design Manual until further notice

This Page Intentionally Left Blank

This Page Intentionally Left Blank

This Page Intentionally Left Blank

This Page Intentionally Left Blank

This Page Intentionally Left Blank

This Page Intentionally Left Blank

This Page Intentionally Left Blank

This Page Intentionally Left Blank

This Page Intentionally Left Blank

This Page Intentionally Left Blank

This Page Intentionally Left Blank

This Page Intentionally Left Blank

13.6 Probabilistic Life Cycle Cost Analysis

Two different computational approaches can be used in LCCA, deterministic and probabilistic. The methods differ in the way they address the variability associated with the LCCA input values. In the deterministic approach, the analyst assigns each LCCA input variable a fixed, discrete value. The analyst determines the value most likely to occur for each parameter, usually basing the determination on historical evidence or professional judgment. Collectively, the input values are used to compute a single life-cycle cost estimate for the alternative under consideration. Traditionally, applications of LCCA have been deterministic. A deterministic life-cycle cost computation is straightforward and can be conducted manually with a calculator or automatically with a spreadsheet. Sensitivity analyses may be conducted to test input assumptions by varying one input, holding other inputs constant, and determining the effect of the variation on the outputs. The deterministic approach, however, fails to address simultaneous variation in multiple inputs, and it fails to convey the degree of uncertainty associated with the life-cycle cost estimates. Probabilistic LCCA inputs are described by probability functions that convey both the range of likely inputs and the likelihood of their occurrence. Probabilistic LCCA also allows for the simultaneous computation of differing assumptions for many different variables. Outputs, like inputs, express the likelihood that a particular life-cycle cost will actually occur. Because of the dramatic increases in computer processing capabilities of the last two decades, the process of probabilistic analysis has become more practical. Simulating and accounting for simultaneous changes in LCCA input parameters can now be accomplished easily and quickly.

13.7 FHWA RealCost Software

The RealCost software was created with two distinct purposes. The first is to provide an instructional tool for pavement design decision-makers who want to learn about LCCA. The software allows the student of LCCA to investigate the effects of cost, service life, and economic inputs on life-cycle cost. For this purpose, a graphical user interface (GUI) was designed to make the software easy to use. The second purpose is to provide an actual tool for pavement designers, which they can use to incorporate life-cycle costs into their pavement investment decisions.

RealCost automates FHWA's LCCA methodology as it applies to pavements. The software calculates life-cycle values for both agency and user costs associated with construction and rehabilitation. The software can perform both deterministic and probabilistic modeling of pavement LCCA problems. Outputs are provided in tabular and graphic format. Additionally, RealCost supports deterministic sensitivity analyses and probabilistic risk analyses. While RealCost compares two alternatives at a time, it has been designed to give the pavement engineer the ability to compare an unlimited number of alternatives. By saving the input files of all alternatives being considered, the analyst can compare any number of alternatives. Furthermore, the software has been designed so that an understanding of the LCCA process is sufficient to operate the software. The software automates FHWA's work zone user cost calculation method. This method for calculating user costs compares traffic demand to roadway capacity on an hour-by-hour basis, revealing the resulting traffic conditions. The method is computation intensive and ideally suited to a spreadsheet application. The software does not calculate agency costs or service lives for individual construction or rehabilitation activities. These values must be input by the analyst and should reflect the construction and rehabilitation practices of the agency. While

RealCost compares the agency and user life-cycle costs of alternatives, its analysis outputs alone do not identify which alternative is the best choice for implementing a project. The lowest life-cycle cost option may not be implemented when other considerations such as risk, available budgets, and political and environmental concerns are taken into account. As with any economic tool, LCCA provides critical information to the overall decision-making process, but not the answer itself. FHWA's RealCost software may be obtained at:

<http://www.fhwa.dot.gov/infrastructure/asstmgmt/lcca.cfm>

13.7.7 RealCost Switchboard

RealCost opens to the main menu form, called the “Switchboard,” a form superimposed on an Excel worksheet. The switchboard buttons, shown in **Figure 13.5 The RealCost Switchboard**, provide access to almost all of the functionality of the software: data entry, analysis, reports, and utilities. The Switchboard, shown in **Figure 13.5**, has five sections:

Project-Level Inputs

Data that will be used for all alternatives. These data document the project characteristics, define the common benefits that all alternatives will provide, and specify the common values (i.e., discount rate) that will be applied with each alternative.

Alternative-Level Inputs

Data that will be used for a specific design alternative. These data differentiate alternatives from each other.

Input Warnings

List of missing or potentially erroneous data. The software identifies and displays a list.

Simulation and Output

Forms used to view deterministic results, run Monte Carlo simulation of probabilistic inputs, view probabilistic results, and print reports.

Administrative Functions

Forms used to save, clear, and retrieve data and to close the Switchboard or RealCost.

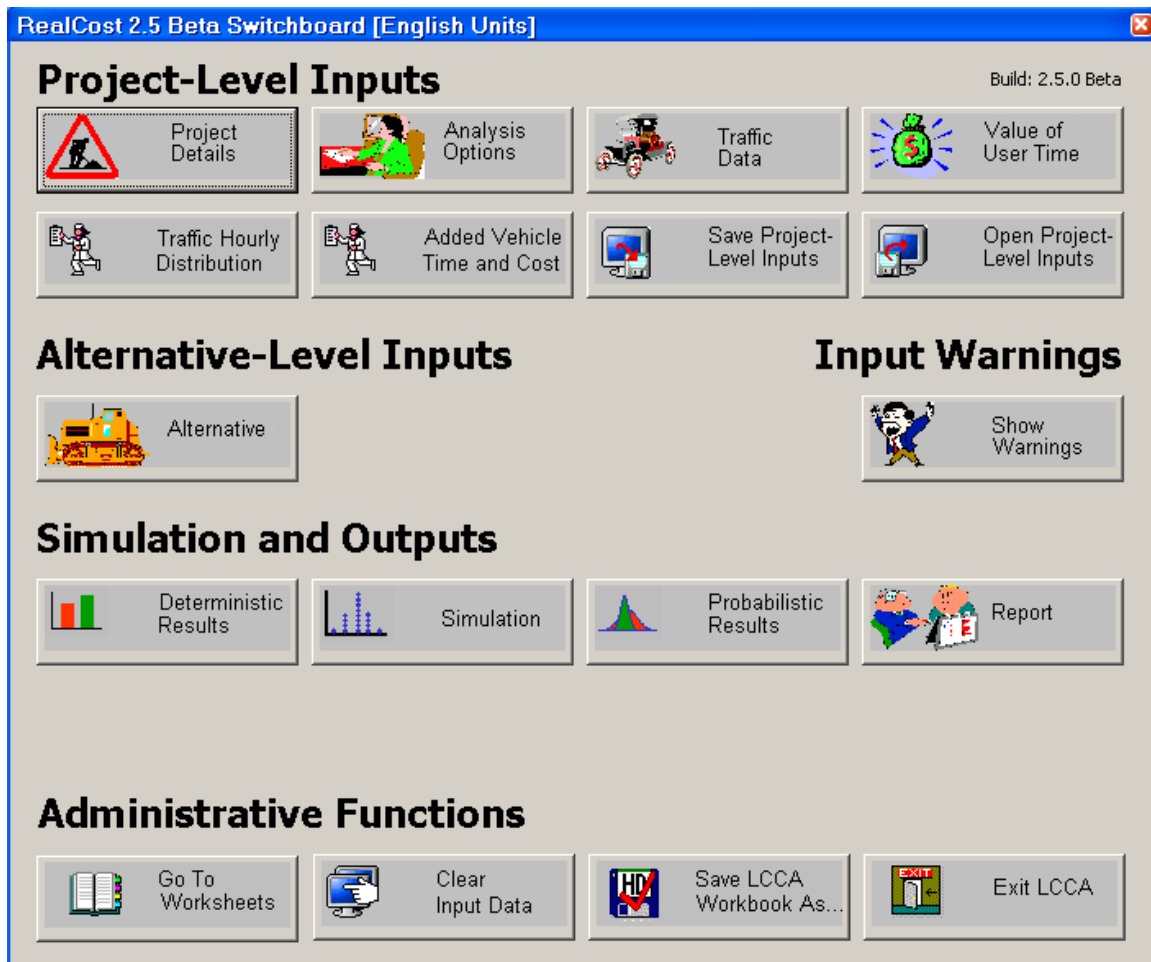

Figure 13.5 The RealCost Switchboard

13.7.8 Real world example using the RealCost software

Compare 9.0 inches HMA alternative to a 12 inches PCCP alternative on a 4-lane section of I-70 (2-lanes per direction) near Bethune Colorado from MP 417 to MP 427, which is located in Region 1 (prior to 7/1/2013). It is estimated that the HMA alternative will take 54 construction days working from 8:00 a.m. to 5:00 p.m. of a single lane closure per direction. The 12 inches PCCP alternative will take 100 construction days per direction using a cross over. Each of the HMA rehabilitation cycles will take approximately 20 construction days and the PCCP rehabilitation will take approximately 30 construction days each working from 8:00 a.m. to 5:00 p.m. detailed information on this example can be found below.

13.7.9 Project Details Options

The Project Details, **Figure 13.6 Project Details Input Screen** is used to identify and document the project. Data entered into this form are not used in the analysis. The analyst may enter data according to the field names on the form or may use the fields to include other project documentation details.

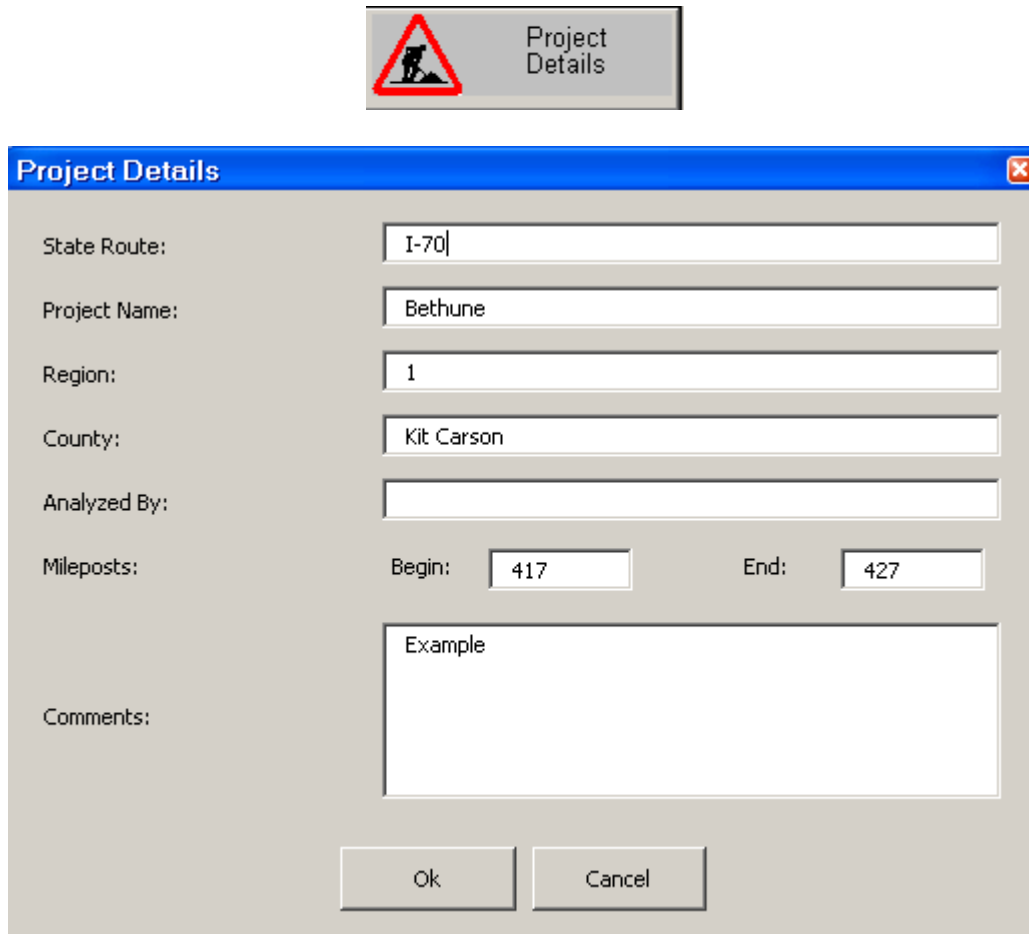

The image shows a software interface for entering project details. At the top, there is a button with a red triangle warning icon and the text "Project Details". Below this is a window titled "Project Details" with a close button in the top right corner. The window contains several input fields:

- State Route: I-70
- Project Name: Bethune
- Region: 1
- County: Kit Carson
- Analyzed By: (empty field)
- Mileposts: Begin: 417, End: 427
- Comments: Example

At the bottom of the window are two buttons: "Ok" and "Cancel".

Figure 13.6 Project Details Input Screen

13.7.10 Analysis Options

Generally, analysis options are decided by agency policy rather than the pavement design decision maker. Options defined in the Analysis Options form include the analysis period, discount rate, beginning year, inclusion of residual service life, and the treatment of user costs in the LCCA (see **Figure 13.7 Analysis Option Screen**). A checked box equals “yes,” an unchecked box equals “no.” The data inputs and analysis options available on this form are discussed in **Table 13.5 Analysis Data Inputs and Analysis Options**, with CDOT and FHWA’s recommendations.

Table 13.5 Analysis Data Inputs and Analysis Options

Variable Name	Probability Distribution (CDOT Default)	Value (CDOT Default)	Source
Analysis Units	Select Option English/Metric	English	CDOT
Analysis Period (Years)	User Specified	40	Sections 13.3.1, 13.3.2, and 13.3.3
Discount Rate (%)	Log Normal	Mean and Standard Deviation	Section 13.4 T-bill and inflation rate, 10-year moving average analysis
Beginning of Analysis Period	User Specified	Date (year)	Project start date
Included Agency Cost Remaining Service Life Value	Select Option	Yes	Section 13.5 (Serviceable Life)
Include User Costs in Analysis	Select Option	Yes	Section 13.5.7
User Cost Computation Method	Select Option Specified/Calculated	Specified	Section 13.5.7 Use predetermined user costs from CDOT WorkZone software*
Traffic Direction	Select Option Both/Inbound/Outbound	Both	Site specific
Include User Cost RSL	Select Option	Yes	Section 13.5.7
* When "Specified" is selected the manual calculated user cost from the WorkZone program will be used in the RealCost program.			

A dialog box titled "Analysis Options" with a blue header bar and a close button in the top right corner. The background is light grey. It contains several settings:

- Analysis Units: A dropdown menu showing "English".
- Analysis Period (years): A text box containing "40".
- Discount Rate (%): A text box with a small "..." button to its right.
- Beginning of Analysis Period: A text box containing "2004".
- Include Agency Cost Remaining Service Life Value: A checked checkbox.
- Include User Costs in Analysis: A checked checkbox.
- User Cost Computation Method: A dropdown menu showing "Specified".
- Traffic Direction: A dropdown menu showing "Both".
- Include User Cost Remaining Service Life Value: A checked checkbox.
- Number of Alternatives: A dropdown menu showing "2".

At the bottom, there are two buttons: "Ok" and "Cancel".

Figure 13.7 Analysis Option Screen

13.7.11 Traffic Data Options

Pavement engineers use traffic data to determine their design parameters. In RealCost, traffic (Figure 13.8 Traffic Data Option Screen) are used exclusively to calculate work zone.

Table 13.6 Traffic Data Options

Variable Name	Probability Distribution (CDOT Default)	Value (CDOT Default)	Source
AADT Construction Year (total for both directions)	Deterministic	User Input	Section 3.1.3
Single Unit Trucks as Percentage of AADT (%)	Deterministic	User Input	Section 3.1.3
Combination Trucks as Percentage of AADT (%)	Deterministic	User Input	Section 3.1.3
Annual Growth Rate of Traffic (%)	Triangular	Min. 0.34 Most Likely 1.34 Max. 2.34	Section 3.1.5
Speed Limit Under Normal Operating Conditions (mph)	Deterministic	User Input	Site specific
Lanes Open in Each Direction Under Normal Conditions	Deterministic	User Input	Site specific
Free Flow Capacity (vphpl)	Deterministic	User Input	CDOT WorkZone software (normal capacity per lane)
Queue Dissipation Capacity (vphpl)	Deterministic	User Input	CDOT WorkZone software (work zone capacity per lane)
Maximum AADT (total for both directions)	Deterministic	User Input	Site specific
Maximum Queue Length (miles)	Deterministic	5 miles	CDOT
Rural or Urban Hourly Traffic Distribution	Select Option Urban/Rural	User Input	CDOT WorkZone software (Functional class)

Free Flow Capacity (vphpl) is obtained from CDOT WorkZone software and is labeled "Normal Capacity per Lane" on the input screen. Queue Dissipation Capacity (vphpl) must be equal to or greater than the largest value of work zone capacity per lane under the alternatives input screens, otherwise an error is detected under the input error warnings check. An explanation is in order. The queue dissipation capacity is on a roadway when there is no work zone. The traffic comes to a complete stop or almost to a complete stop and the traffic starts and dissipates. This is similar to a traffic light or some object in the roadway. The queue dissipation capacity is then how much traffic the roadway will carry under these conditions. This is different than free flow and different than during a work zone normal traffic flow. The work zone normal traffic slows down but does not come to a complete stop or near stop. Therefore, the Queue Dissipation Capacity must be larger for the same roadway to be able to disperse more volume of traffic than a work zone condition.

Only a deterministic value is needed for the maximum AADT (both direction). The *Highway Capacity Manual* (2000) (HCM (2000)) lists various volumes of freeways with 4, 6, and 8 lanes and 4 lane arterial. It is fortunate that Denver, Colorado is listed in the tables and exhibits.

Exhibit 8-13 – Reported Maximum Directional Volumes on Selected Urban Streets in the HCM (2000) is shown as.

6-lane

Colorado State

Highway 2: 3,435 vehicles/hour

3,435 vehicles/hour * 2 directions = 6,870 vehicles/hour both directions

6,870 vehicles/hour both directions * 24 hours = 164,880 Maximum AADT both directions

Exhibit 8-19 – Reported Maximum Hourly One-Way Volumes On Selected Freeways in the Highway Capacity Manual (2000) (HCM (2000)) lists various volumes of freeways with 4, 6, and 8 lanes.

4-lane I-225: 4,672 vehicles/hour

4,672 vehicles/hour * 2 directions = 9,344 vehicles/hour both directions

9,344 vehicles/hour both directions * 24 hours = 224,256 Maximum AADT both directions

6-lane US 6: 7,378 vehicles/hour

7,378 vehicles/hour * 2 directions = 14,756 vehicles/hour both directions

14,756 vehicles/hour both directions * 24 hours = 354,144 Maximum AADT both directions

8-lane I-25: 8,702 vehicles/hour

8,702 vehicles/hour * 2 directions = 17,404 vehicles/hour both directions

17,404 vehicles/hour both directions * 24 hours = 417,696 Maximum AADT both directions

The pavement designer may select a reasonable Maximum AADT. If need be, an interpolation may be in order to fit the project specifics. An alternate method is to use the Free Flow Capacity (vphpl) multiplied by the number of lanes multiplied by the 2 directions multiplied by 24 hours.



Traffic Data

AADT Construction Year (total for both directions):	<input type="text" value="10372"/>
Single Unit Trucks as Percentage of AADT (%):	<input type="text" value="6.3"/>
Combination Trucks as Percentage of AADT (%):	<input type="text" value="22.9"/>
Annual Growth Rate of Traffic (%):	<input type="text" value="1.34000003"/>
Speed Limit Under Normal Operating Conditions (mph):	<input type="text" value="75"/>
Lanes Open in Each Direction Under Normal Conditions:	<input type="text" value="2"/>
Free Flow Capacity (vphpl):	<input type="text" value="1942"/>
Free Flow Capacity Calculator	
Queue Dissipation Capacity (vphpl):	<input type="text" value="1140"/>
Maximum AADT (total for both directions):	<input type="text" value="150000"/>
Maximum Queue Length (miles):	<input type="text" value="5"/>
Rural or Urban Hourly Traffic Distribution:	<input type="text" value="Rural"/>

Figure 13.8 Traffic Data Option Screen

13.7.12 Value of User Time

The Value of User Time form, shown in **Figure 13.9 Value of User Option Screen**, allows editing of the values applied to an hour of user time. The dollar value of user time is different for each vehicle type and is used to calculate user costs associated with delay during work zone operations.

Table 13.7 Value of User Time Data Options

Variable Name	Probability Distribution (CDOT Default)	Value (CDOT Default)	Source
Value of Time for Passenger Cars (\$/hour)	Deterministic	18.50	CDOT Work Zone Software Section 13.5.7
Value of Time for Single Unit Trucks (\$/hours)	Deterministic	43.50	CDOT Work Zone Software Section 13.5.7
Value of Time for Combination Trucks (\$/hour)	Deterministic	49.50	CDOT Work Zone Software Section 13.5.7

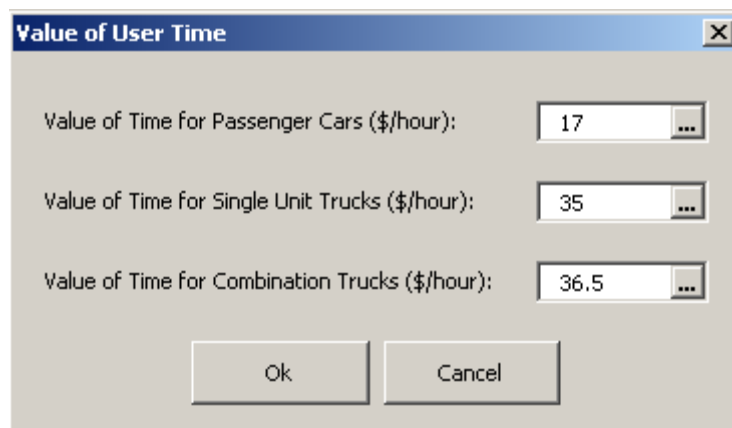

Figure 13.9 Value of User Option Screen

13.7.13 Traffic Hourly Distribution

To transform Annual Average Daily Traffic (AADT) to an hourly traffic distribution, default Rural and Urban Traffic hourly distributions from MicroBENCOST are provided with RealCost. The Traffic Hourly Distribution (**Figure 13.10 Traffic Hourly Distribution Screen**) form is used to adjust (or restore) these settings. Distributions are required to sum to 100 percent.

Table 13.8 Traffic Hourly Distribution Data Options

Variable Name (percent)	Probability Distribution (CDOT Default)	Value (CDOT Default)	Source
AADT Rural	Real Cost Default	Real Cost Default	Real Cost Software
Inbound Rural	Real Cost Default	Real Cost Default	Real Cost Software
AADT Urban	Real Cost Default	Real Cost Default	Real Cost Software
Inbound Urban	Real Cost Default	Real Cost Default	Real Cost Software



Traffic Hourly Distribution - Distribution 1

Distribution Name: Week Day 1

Hour	AADT Rural (%)	Inbound Rural (%)	Outbound Rural (%)	AADT Urban (%)	Inbound Urban (%)	Outbound Urban (%)
0 - 1	1.8	48	52	1.2	47	53
1 - 2	1.5	48	52	0.8	43	57
2 - 3	1.3	45	55	0.7	46	54
3 - 4	1.3	53	47	0.5	48	52
4 - 5	1.5	53	47	0.7	57	43
5 - 6	1.8	53	47	1.7	58	42
6 - 7	2.5	57	43	5.1	63	37
7 - 8	3.5	56	44	7.8	60	40
8 - 9	4.2	56	44	6.3	59	41
9 - 10	5	54	46	5.2	55	45
10 - 11	5.4	51	49	4.7	46	54
11 - 12	5.6	51	49	5.3	49	51
12 - 13	5.7	50	50	5.6	50	50
13 - 14	6.4	52	48	5.7	50	50
14 - 15	6.8	51	49	5.9	49	51
15 - 16	7.3	53	47	6.5	46	54
16 - 17	9.3	49	51	7.9	45	55
17 - 18	7	43	57	8.5	40	60
18 - 19	5.5	47	53	5.9	46	54
19 - 20	4.7	47	53	3.9	48	52
20 - 21	3.8	46	54	3.3	47	53
21 - 22	3.2	48	52	2.8	47	53
22 - 23	2.6	48	52	2.3	48	52
23 - 24	2.3	47	53	1.7	45	55
Total	100			100		

Restore Defaults Ok

Figure 13.10 Traffic Hourly Distribution Screen

13.7.14 Added Time and Vehicle Costs Options

“Added Time per 1,000 Stops (Hours)” and “Added Cost per 1,000 Stops (\$)” values are used to calculate user delay and vehicle costs due to speed changes that occur during work zone operations. This form (**Figure 13.11 Added Time and Vehicle Stopping Costs Screen**) is used to adjust the default values for added time and added cost per 1,000 stops. The “Idling Cost per Veh-Hr (\$)” is used to calculate the additional vehicle operating costs that result from traversing a traffic queue under stop and go conditions. The costs and times are different for each vehicle type.

The Restore Defaults button functions much the same as it does on the Traffic Hourly Distribution form. The default values are drawn from NCHRP Study 133, Procedures for Estimating Highway User Costs, Air Pollution, and Noise Effects.

Table 13.9 Added Time and Vehicle Costs Data Options

Variable Name	Probability Distribution (CDOT Default)	Value (CDOT Default)	Source
Added Time Passenger Cars	Real Cost Default	Real Cost Default	Real Cost Software
Added Time Single Unit Trucks	Real Cost Default	Real Cost Default	Real Cost Software
Added Time Combination Trucks	Real Cost Default	Real Cost Default	Real Cost Software
Added Cost Passenger Cars	Real Cost Default	Real Cost Default	Real Cost Software
Added Cost Single Unit Trucks	Real Cost Default	Real Cost Default	Real Cost Software
Added Cost Combination Trucks	Real Cost Default	Real Cost Default	Real Cost Software
Base Transportation Component CPI	Deterministic	142.8	Real Cost Software
Base Year	Deterministic	1996	Real Cost Software
Current Transportation Component CPI	Deterministic	User Input	CDOT
Current Year	Deterministic	User Input	CDOT
Idling Cost Per Veh-HR (\$) Passenger Cars	Real Cost Default	Real Cost Default	Real Cost Software
Idling Cost Per Veh-HR (\$) Single Unit Trucks	Real Cost Default	Real Cost Default	Real Cost Software
Idling Cost Per Veh-HR (\$) Combination Trucks	Real Cost Default	Real Cost Default	Real Cost Software

The Colorado Construction Cost Index may be obtained from the Agreements and Market Analysis Branch, Engineering Estimates and Market Analysis Unit. The unit publishes a quarterly report and is in Acrobat file format. The website is <http://www.coloradodot.info/business/eema> and is under the title [Colorado Construction Cost Index \(CCI\)](#).

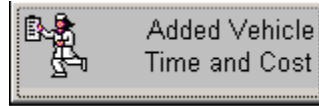

Added Time and Vehicle Stopping Costs

Initial Speed (mph)	Added Time per 1,000 Stops (Hours)			Added Cost per 1,000 Stops (\$)		
	Passenger Cars	Single Unit Trucks	Combination Trucks	Passenger Cars	Single Unit Trucks	Combination Trucks
0	0	0	0	0	0	0
5	1.02	0.73	1.1	2.7	9.25	33.62
10	1.51	1.47	2.27	8.83	20.72	77.49
15	2	2.2	3.48	15.16	33.89	129.97
20	2.49	2.93	4.76	21.74	48.4	190.06
25	2.98	3.67	6.1	28.67	63.97	256.54
30	3.46	4.4	7.56	36.1	80.23	328.21
35	3.94	5.13	9.19	44.06	96.88	403.84
40	4.42	5.87	11.09	52.7	113.97	482.21
45	4.9	6.6	13.39	62.07	130.08	562.14
50	5.37	7.33	16.37	72.31	145.96	642.41
55	5.84	8.07	20.72	83.47	160.89	721.77
60	6.31	8.8	27.94	95.7	178.98	798.99
65	6.78	9.53	31.605	109.02	195.84	849.64
70	7.25	10.27	39.48	123.61	209.06	921.03
75	7.71	11	47.9	139.53	224.87	992.42
80	8.17	11.73	57.68	156.85	240.68	1063.82

Idling Cost per Veh-Hr (\$): 0.6927 0.7681 0.8248

Cost Escalation:
 Base Transp. Component CPI: 142.8
 Base Year: 1996
 Current Transp. Component CPI: 142.8
 Current Year: 1996
 Escalation Factor: 1.00
 Escalate

Restore Defaults Ok

Figure 13.11 Added Time and Vehicle Stopping Costs Screen

13.7.15 Saving and Opening Project-Level Inputs

The last two buttons in the project-level input section of the Switchboard (see **Figure 13.12 Saving and Opening Project-Level Inputs**) are used to save and to retrieve (load) project-level inputs. **Note:** Alternative-level inputs are saved separately from project-level inputs. The mechanism to save and open alternative-level inputs is found on the Alternative 1 and Alternative 2 forms.

Project-level inputs are saved in a small, comma-delimited file. This file may be named via ordinary Windows conventions and is automatically saved with the *.LCC extension. Changing the file extension will prevent RealCost from recognizing the file.

Warning: Opening an *.LCC file will overwrite data in the Project-Level Inputs section.

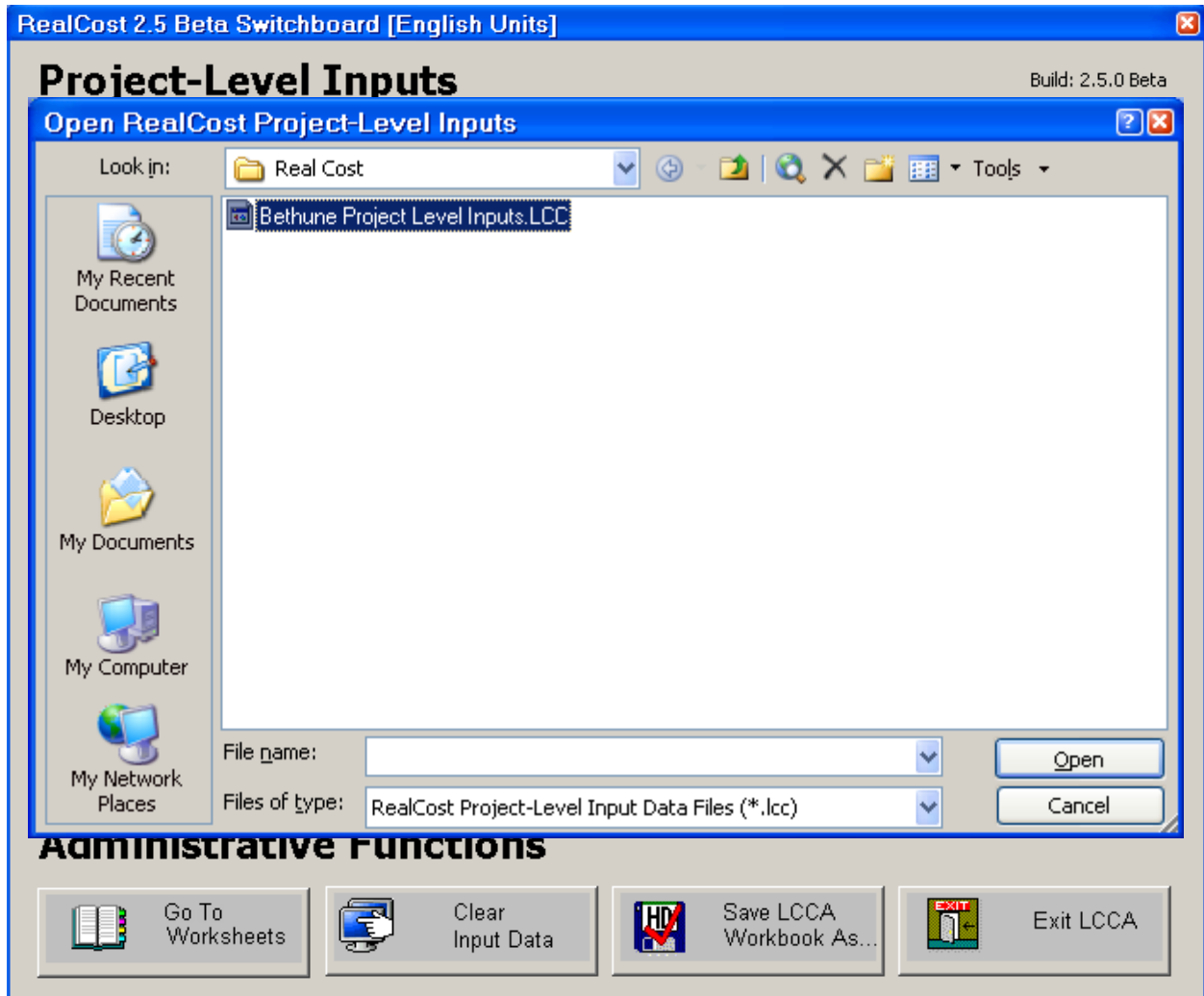

Figure 13.12 Saving and Opening Project-Level Inputs

Table 13.12 Number of Projects in the Study

Rehabilitation Technique	Components	Number of Projects
Heater Remixing	Process Mat	49
	Rejuvenating Agent	45
	Hydrating Lime	30
Heater Scarifying	Process Mat	19
	Rejuvenating Agent	17
Full Depth Reclamation (FDR)	-	54
Hot Mix Asphalt Overlay < 10,000 tons	All projects	84
	SX(100) PG 64-28	22
	SX(100) PG 64-22	34
	SX(100) PG 58-28	7
	SX(100) PG 76-28	7
	Furnish HMA	7
Hot Mix Asphalt Overlay > 10,000 tons	All projects	121
	SX(100) PG 64-22	36
	SX(100) PG 76-28	11
	SX(100) PG 58-28	11
	SX(100) PG 64-28	8
	SX(75)	21
Hot Mix Asphalt Mill and Fill < 10,000 tons	All projects	51
	SX(100) PG 64-22	15
	SX(100) PG 76-28	17
	SX(75) PG 58-28	7
Hot Mix Asphalt Mill and Fill > 10,000 tons	All projects	63
	SX(100) PG 64-22	10
	SX(75) PG 58-28	20
	SX(100) PG 64-28	5
	SX(100) PG 58-34	4
	SMA	13
Portland Cement Concrete Pavement < 10,000 square yards	All projects	184
Portland Cement Concrete Pavement > 10,000 square yards	All projects	67
Total		692

Table 13.10 Results of Heater Remixing

	Item	Amount
Process Mat	Number of Projects	49
	Total Square Yards	10,448,936
	Total Normalized Dollar Amount	\$35,675,622
	Normalized Average per Square Yard	\$3.41
Rejuvenating Agent	Number of Projects	45
	Total Gallons	698,230
	Total Normalized Dollar Amount	\$1,243,166
	Normalized Average per Gallon	\$45.45
Furnish HMA	Number of Projects	30
	Total Tons	115,302
	Total Normalized Dollar Amount	\$5,330,720
	Normalized Average per Ton	\$1.78

Table 13.11 Results of Heater Scarifying

	Item	Amount
Process Mat	Number of Projects	19
	Total Square Yards	3,676,832
	Total Normalized Dollar Amount	\$3,785,756
	Normalized Average per Square Yard	\$1.03
Rejuvenating Agent	Number of Projects	17
	Total Gallons	288,676
	Total Normalized Dollar Amount	\$388,644
	Normalized Average per Gallon	\$1.35

Table 13.12 Results of Full Depth Reclamation

Item	Amount
Number of Projects	22
Total Square Yards	2,033,398
Total Normalized Dollar Amount	\$3,992,506
Normalized Average per Square Yard	\$1.80

Table 13.13 Cold In-Place Recycling

	Item	Amount
All projects	Number of Projects	25
	Total Square Yards	4,809,986
	Total Normalized Dollar Amount	\$3,785,756
	Normalized Average per Square Yard	\$1.43
Rejuvenating Agent	Number of Projects	20
	Total Gallons	5,159,599
	Total Normalized Dollar Amount	\$10,037,689
	Normalized Average per Gallon	\$1.64
Hydrated Lime	Number of Projects	23
	Total Tons	15,876
	Total Normalized Dollar Amount	\$1,594,706
	Normalized Average per Ton	\$100.45

Table 13.14 PCCP Projects Less Than 10,000 Square Yards

	Item	Amount
All projects	Number of Projects	184
	Total Square Yards	383,088
	Total Normalized Dollar Amount	\$24,650,614
	Normalized Average per Square Yard	\$64.35
6 to 7 inches	Number of Projects	42
	Total Square Yards	31,569
	Total Normalized Dollar Amount	\$1,161,058
	Normalized Average per Square Yard	\$36.78
7 to 8 inches	Number of Projects	1
	Total Square Yards	5,917
	Total Normalized Dollar Amount	\$172,757
	Normalized Average per Square Yard	\$29.20
8 to 9 inches	Number of Projects	29
	Total Square Yards	55,627
	Total Normalized Dollar Amount	\$3,206,541
	Normalized Average per Square Yard	\$57.64
9 to 10 inches	Number of Projects	30
	Total Square Yards	81,124
	Total Normalized Dollar Amount	\$5,771,991
	Normalized Average per Square Yard	\$71.15
10 to 11 inches	Number of Projects	33
	Total Square Yards	84,032
	Total Normalized Dollar Amount	\$6,172,580
	Normalized Average per Square Yard	\$73.46
11 to 12 inches	Number of Projects	24

	Total Square Yards	58,018
	Total Normalized Dollar Amount	\$4,330,870
	Normalized Average per Square Yard	\$74.65
12 or greater inches	Number of Projects	19
	Total Square Yards	55,623
	Total Normalized Dollar Amount	2,895,314
	Normalized Average per Square Yard	\$52.04

Table 13.15 PCCP Projects Greater Than 10,000 Square Yards

	Item	Amount
All projects	Number of Projects	67
	Total Square Yards	3,599,664
	Total Normalized Dollar Amount	\$131,056,876
	Normalized Average per Square Yard	\$36.41
4 to 7 inches	Number of Projects	3
	Total Square Yards	300,164
	Total Normalized Dollar Amount	\$6,576,434
	Normalized Average per Square Yard	\$21.91
8 to 9 inches	Number of Projects	10
	Total Square Yards	253,232
	Total Normalized Dollar Amount	\$11,911,473
	Normalized Average per Square Yard	\$47.04
9 to 10 inches	Number of Projects	17
	Total Square Yards	487,941
	Total Normalized Dollar Amount	\$22,002,017
	Normalized Average per Square Yard	\$45.09
10 to 11 inches	Number of Projects	10
	Total Square Yards	359,992
	Total Normalized Dollar Amount	\$12,380,592
	Normalized Average per Square Yard	\$34.39
11 to 12 inches	Number of Projects	7
	Total Square Yards	482,129
	Total Normalized Dollar Amount	\$18,558,033
	Normalized Average per Square Yard	\$38.49
12 or greater inches	Number of Projects	13
	Total Square Yards	978,159
	Total Normalized Dollar Amount	\$37,517,776
	Normalized Average per Square Yard	\$38.36

Table 13.16 HMA Overlay Projects Less Than 10,000 Tons

	Item	Amount
All projects	Number of Projects	84
	Total Tons	328,045
	Total Normalized Dollar Amount	\$26,368,555
	Normalized Average per Ton	\$79.79
SX(100) PG 64-28	Number of Projects	22
	Total Tons	65,638
	Total Normalized Dollar Amount	\$5,736,291
	Normalized Average per Ton	\$87.39
SX(100) PG 64-22	Number of Projects	34
	Total Tons	169,785
	Total Normalized Dollar Amount	\$12,741,234
	Normalized Average per Ton	\$82.66
SX(100) PG 58-28	Number of Projects	7
	Total Tons	37,083
	Total Normalized Dollar Amount	\$2,477,618
	Normalized Average per Ton	\$66.81
SX(100) PG 76-28	Number of Projects	7
	Total Tons	32,173
	Total Normalized Dollar Amount	\$2,330,107
	Normalized Average per Ton	\$72.42
Furnish HMA	Number of Projects	7
	Total Tons	23,435
	Total Normalized Dollar Amount	\$1,496,769
	Normalized Average per Ton	\$63.87

Table 13.17 HMA Overlay Projects Greater Than 10,000 Tons

	Item	Amount
All projects	Number of Projects	121
	Total Tons	4,282,222
	Total Normalized Dollar Amount	\$248,255,441
	Normalized Average per Ton	\$57.97
SX(100) PG 64-28	Number of Projects	9
	Total Tons	196,537
	Total Normalized Dollar Amount	\$10,871,686
	Normalized Average per Ton	\$55.32
SX(100) PG 64-22	Number of Projects	36
	Total Tons	1,210,798
	Total Normalized Dollar Amount	\$68,523,424
	Normalized Average per Ton	\$56.59
SX(100) PG 58-28	Number of Projects	11
	Total Tons	416,493
	Total Normalized Dollar Amount	\$30,887,680
	Normalized Average per Ton	\$74.16
SX(100) PG 76-28	Number of Projects	11
	Total Tons	416,493
	Total Normalized Dollar Amount	\$30,887,680
	Normalized Average per Ton	\$79.73
SX (75)	Number of Projects	21
	Total Tons	719,034
	Total Normalized Dollar Amount	\$23,675,171
	Normalized Average per Ton	\$32.93

Table 13.18 HMA Mill and Fill for Projects Less Than 10,000 Tons

	Item	Amount
All projects	Number of Projects	51
	Total Tons	212,732
	Total Normalized Dollar Amount	\$16,296,645
	Normalized Average per Ton	\$76.61
SX(100) PG 64-22	Number of Projects	15
	Total Tons	28,333
	Total Normalized Dollar Amount	\$2,418,438
	Normalized Average per Ton	\$85.36
SX(100) PG 58-28	Number of Projects	7
	Total Tons	21,216
	Total Normalized Dollar Amount	2,730,082
	Normalized Average per Ton	\$128.68
SX(100) PG 76-28	Number of Projects	17
	Total Tons	110,791
	Total Normalized Dollar Amount	\$7,000,071
	Normalized Average per Ton	\$63.18

Table 13.19 HMA Mill and Fill for Projects Greater Than 10,000 Tons

	Item	Amount
All projects	Number of Projects	63
	Total Tons	1,751,060
	Total Normalized Dollar Amount	\$127,667,932
	Normalized Average per Ton	\$72.56
SX(100) PG 58-34	Number of Projects	4
	Total Tons	95,697
	Total Normalized Dollar Amount	\$8,251,056
	Normalized Average per Ton	\$86.22
SX(100) PG 64-22	Number of Projects	5
	Total Tons	136,753
	Total Normalized Dollar Amount	\$9,562,261
	Normalized Average per Ton	\$69.92
SX(100) PG 58-28	Number of Projects	21
	Total Tons	688,657
	Total Normalized Dollar Amount	\$48,738,394
	Normalized Average per Ton	\$70.77
SX(100) PG 76-28	Number of Projects	10
	Total Tons	207,138
	Total Normalized Dollar Amount	\$12,558,276
	Normalized Average per Ton	\$60.63
SMA	Number of Projects	13
	Total Tons	345,467
	Total Normalized Dollar Amount	\$30,229,383
	Normalized Average per Ton	\$87.50

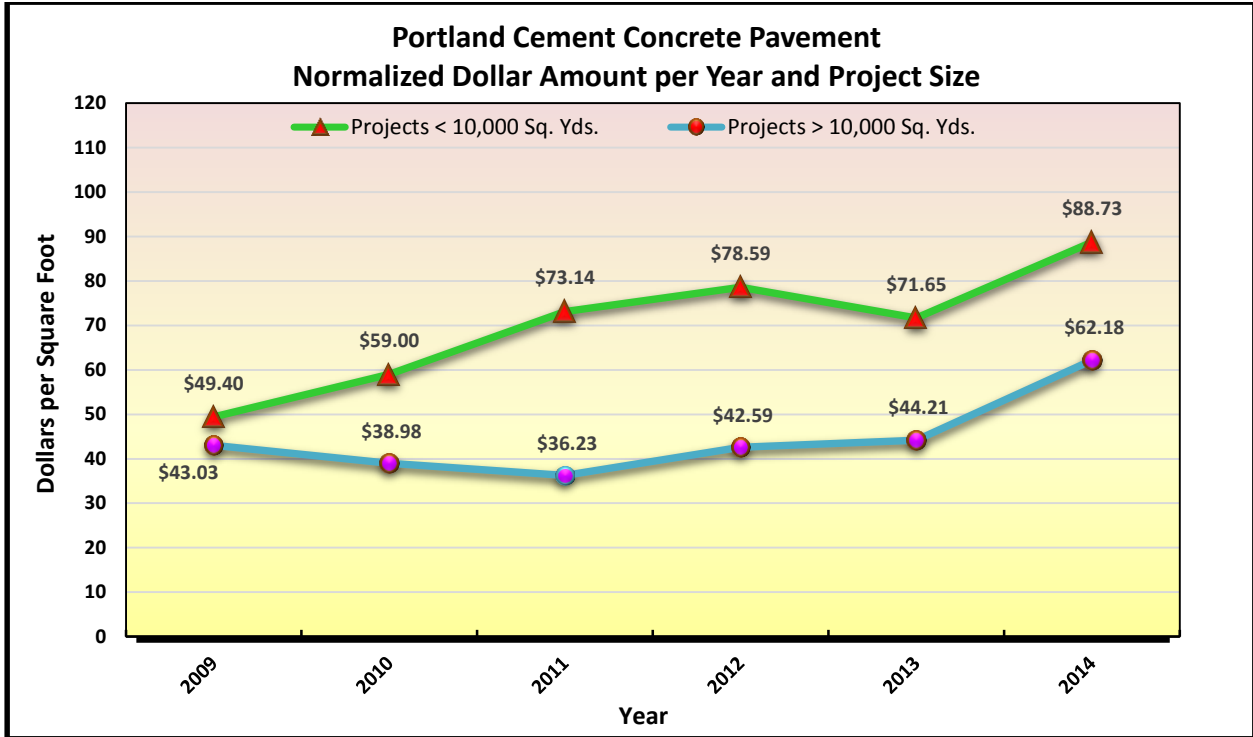

Figure 13.13 PCCP Normalized Dollar Amount per Year

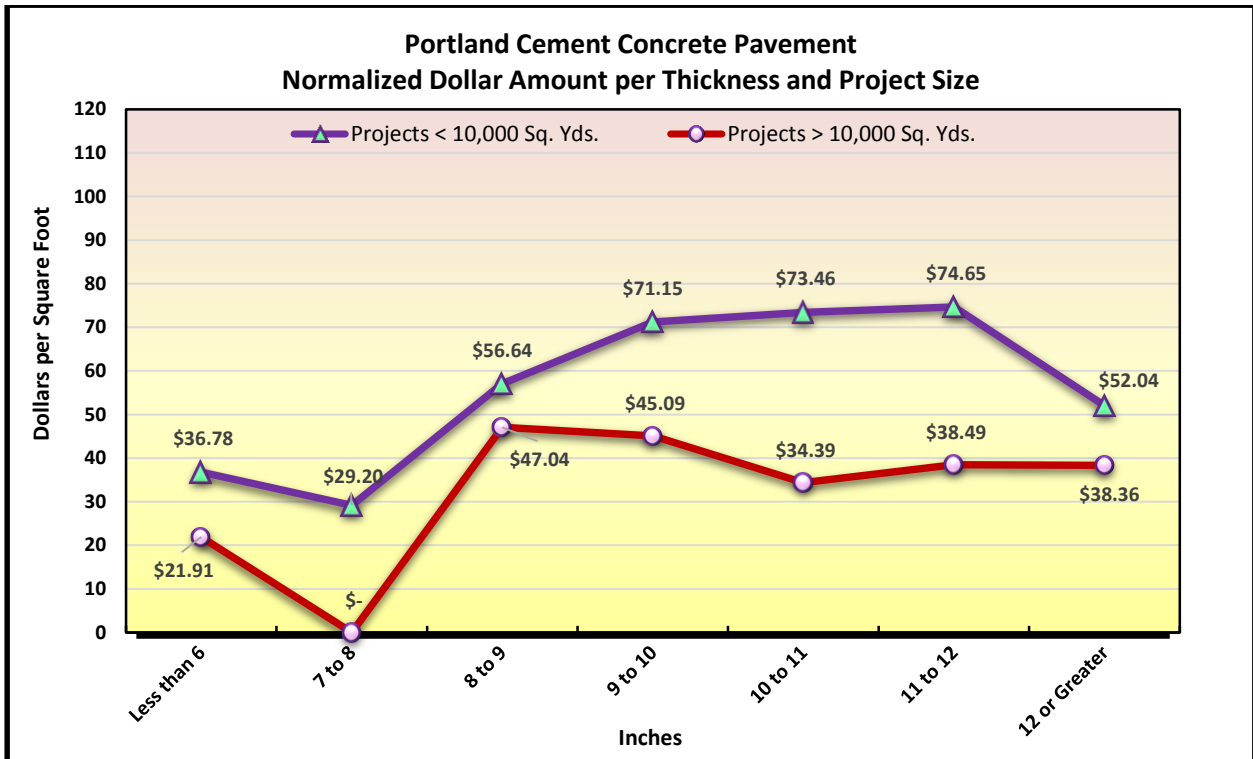

Figure 13.14 PCCP Normalized Dollar Amount per Thickness

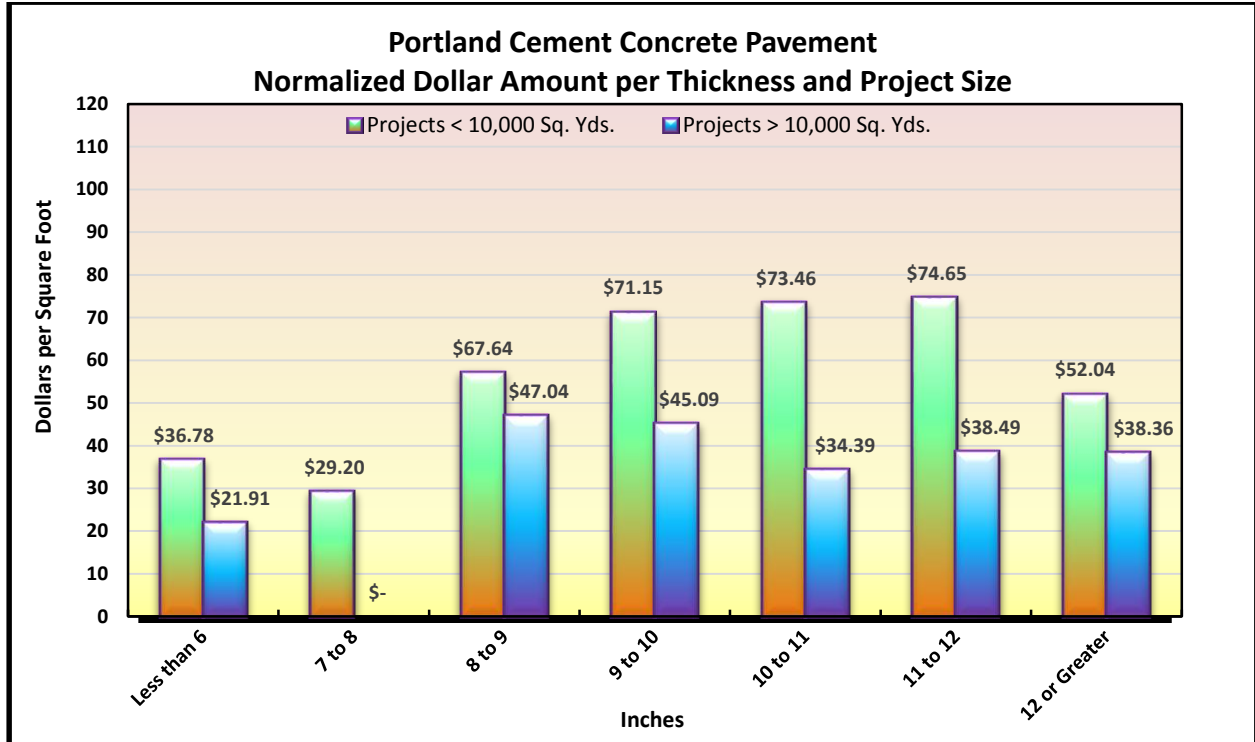

Figure 13.15 PCCP Normalized Dollar Amount per Thickness

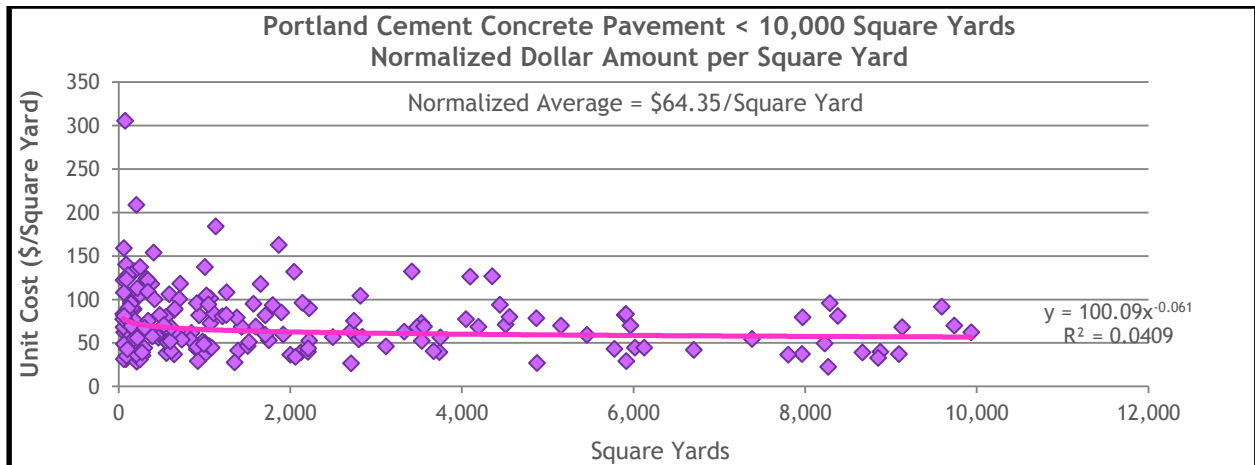

Figure 13.16 PCCP Normalized Dollar Amount per Total Square Yards for Projects Less Than 10,000 Square Yards

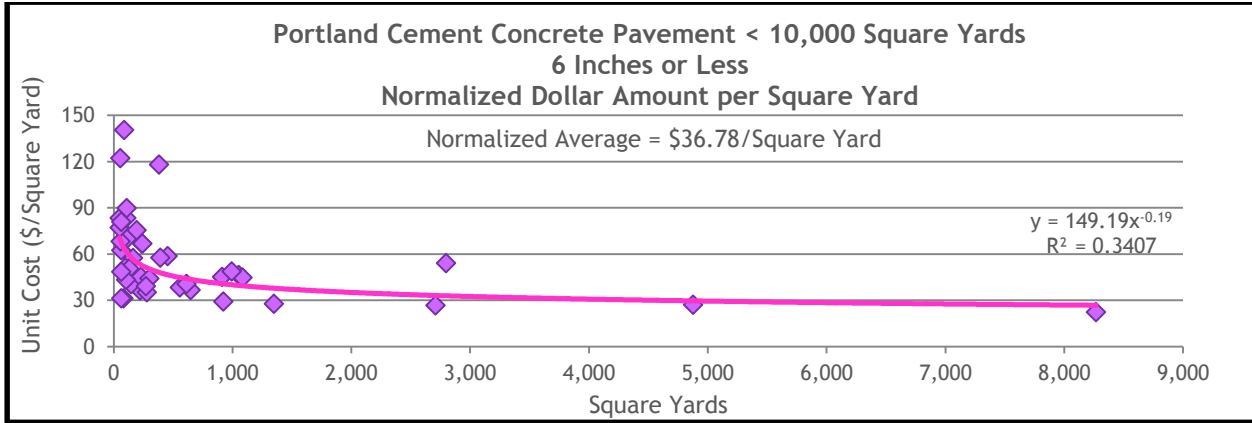

Figure 13.17 PCCP Normalized Dollar Amount for Projects of 6 Inches or Less in Thickness and Less Than 10,000 Square Yards in Size

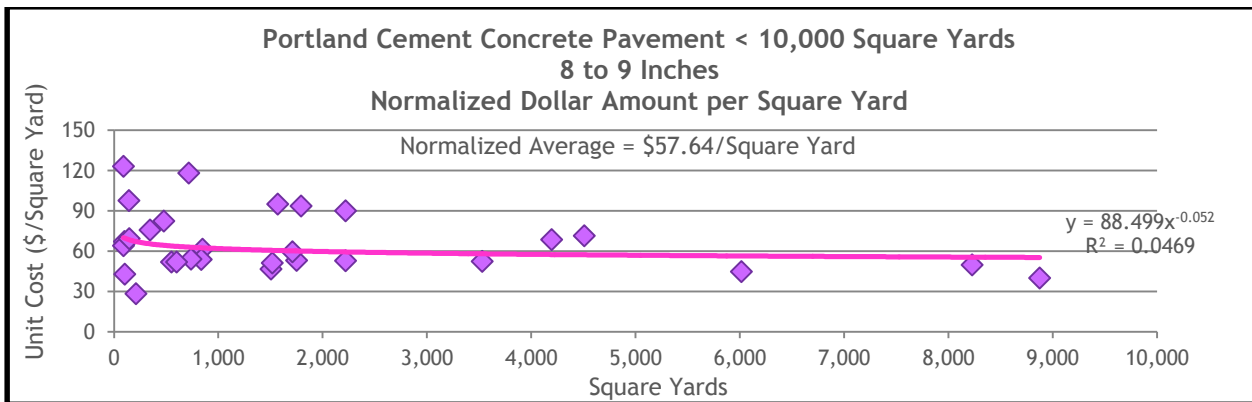

Figure 13.18 PCCP Normalized Dollar Amount for Projects of 8 to 9 Inches in Thickness and Less Than 10,000 Square Yards in Size

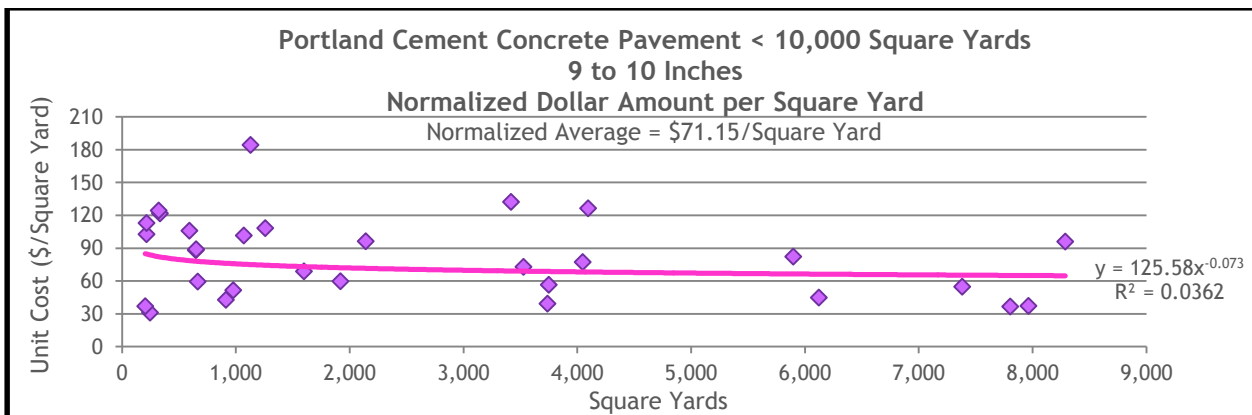

Figure 13.19 PCCP Normalized Dollar Amount for Projects of 9 to 10 Inches in Thickness and Less Than 10,000 Square Yards in Size

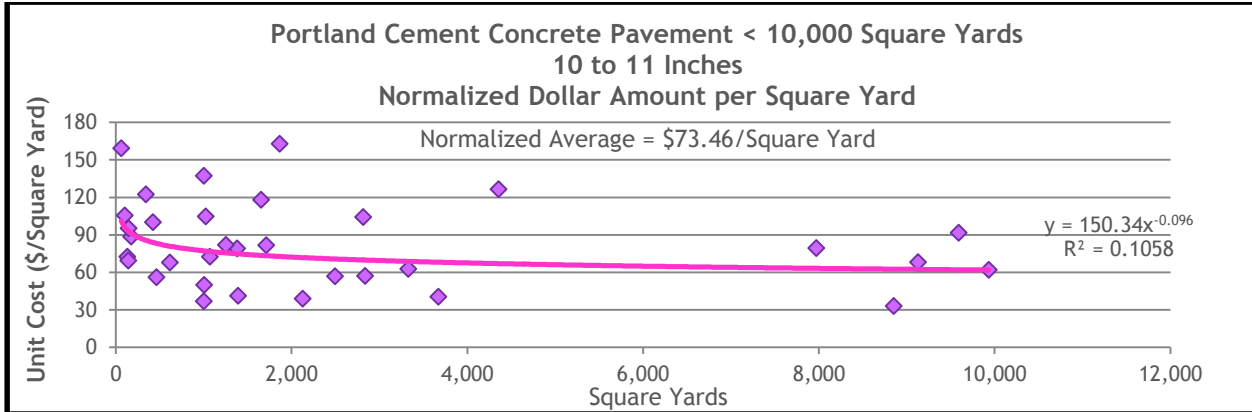

Figure 13.20 PCCP Normalized Dollar Amount for Projects of 10 to 11 Inches in Thickness and Less Than 10,000 Square Yards in Size

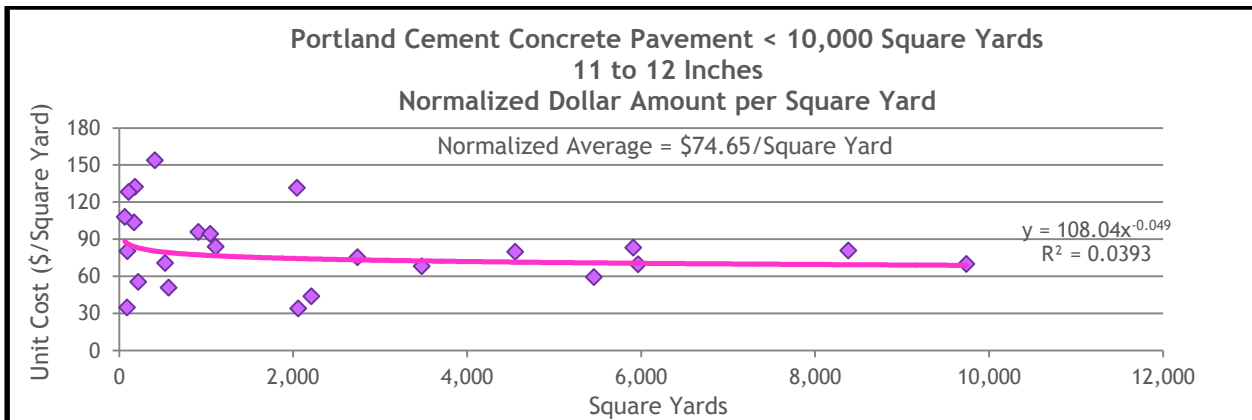

Figure 13.21 PCCP Normalized Dollar Amount for Projects of 11 to 12 Inches in Thickness and Less Than 10,000 Square Yards in Size

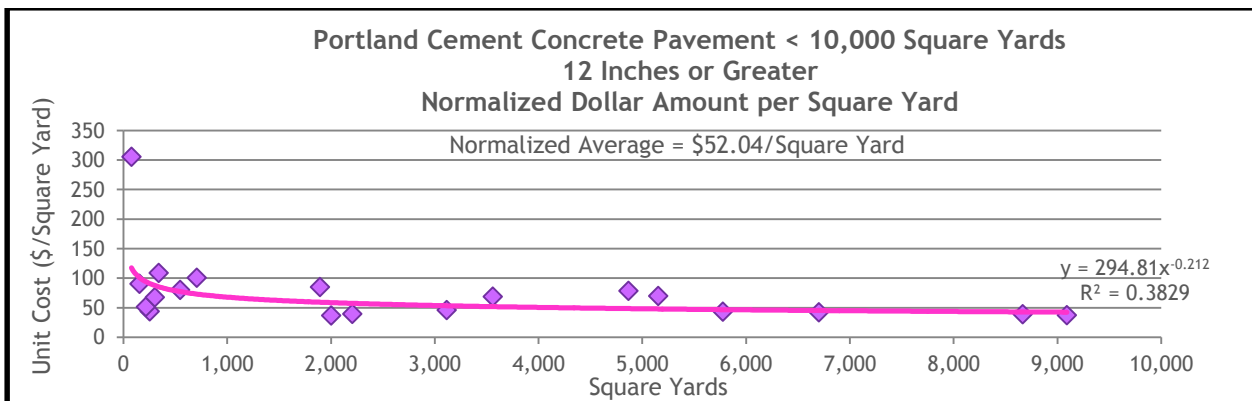

Figure 13.22 PCCP Normalized Dollar Amount for Projects of 12 Inches or Greater in Thickness and Less Than 10,000 Square Yards in Size

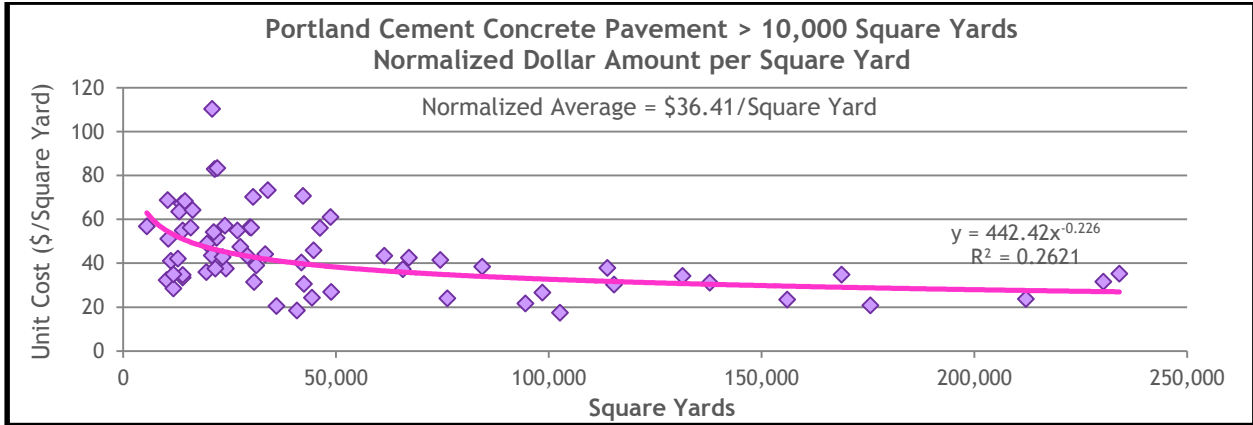

Figure 13.23 PCCP Normalized Dollar Amount per Total Square Yards for Projects Greater Than 10,000 Square Yards

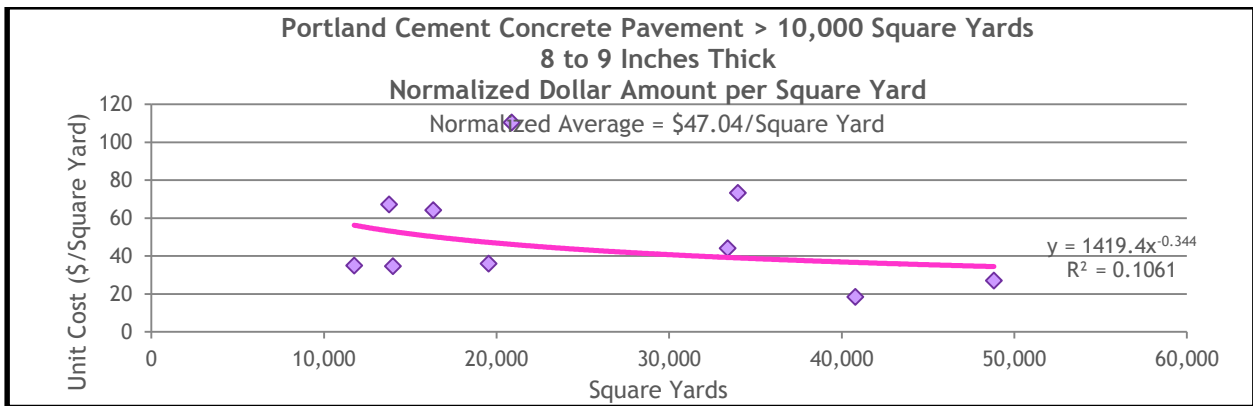

Figure 13.24 PCCP Normalized Dollar Amount for Projects of 8 to 9 Inches in Thickness and Greater Than 10,000 Square Yards in Size

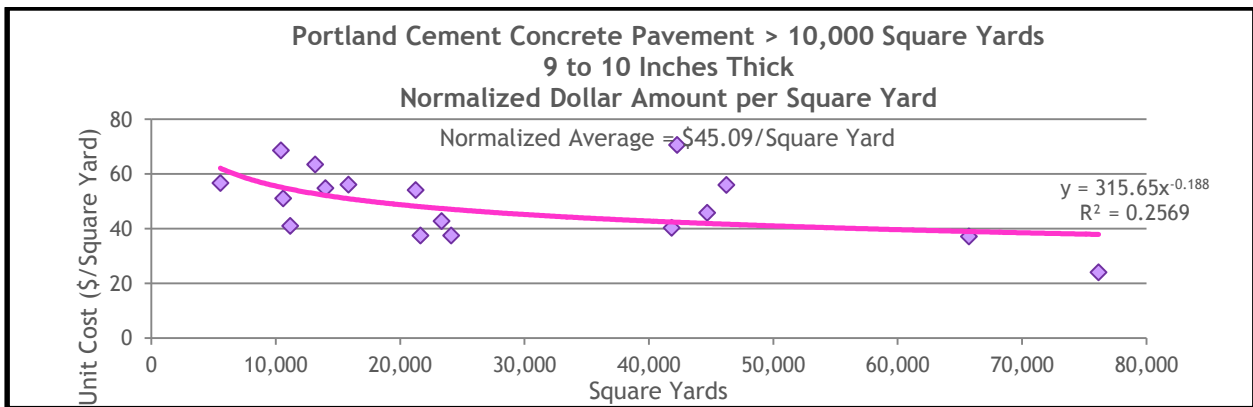

Figure 13.25 PCCP Normalized Dollar Amount for Projects of 9 to 10 Inches in Thickness and Greater Than 10,000 Square Yards in Size

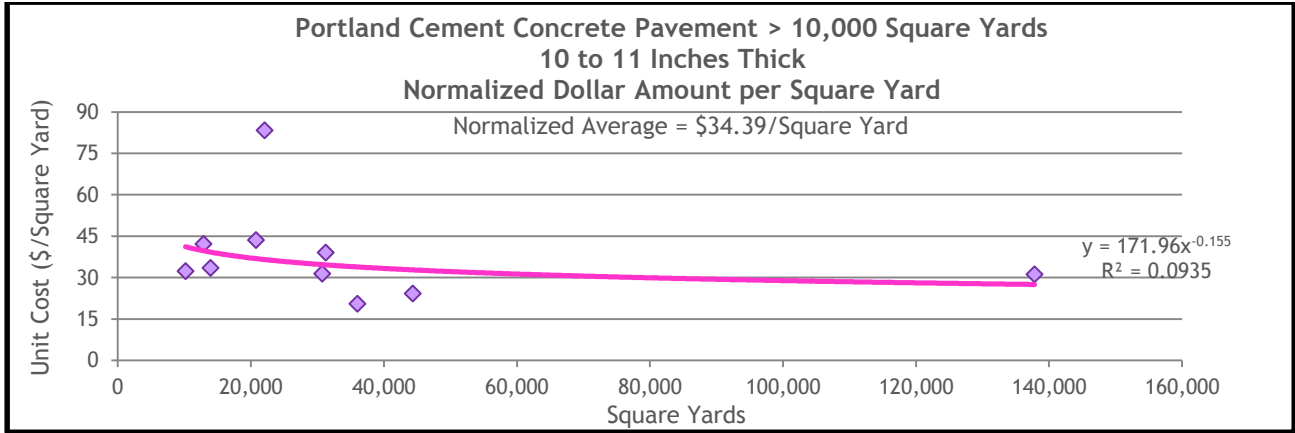

Figure 13.26 PCCP Normalized Dollar Amount for Projects of 10 to 11 Inches in Thickness and Greater Than 10,000 Square Yards in Size

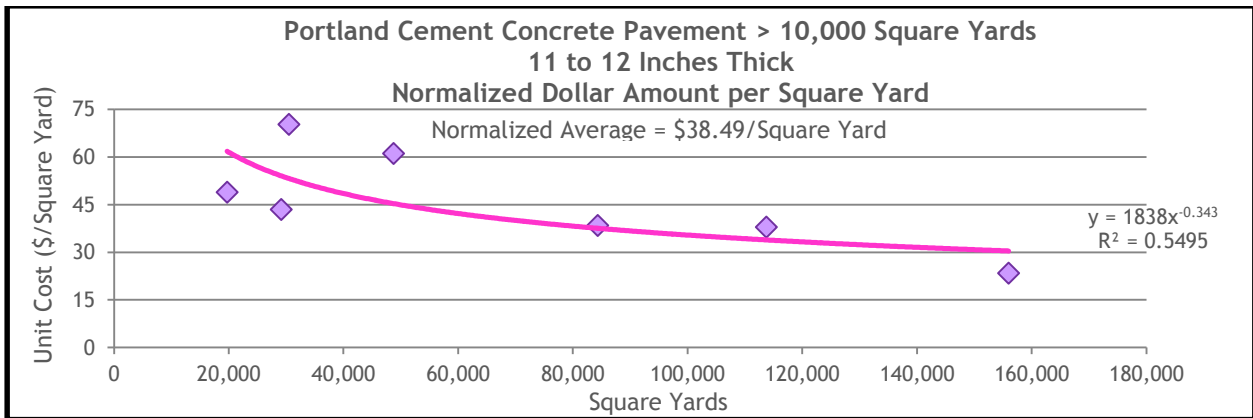

Figure 13.27 PCCP Normalized Dollar Amount for Projects of 11 to 12 Inches in Thickness and Greater Than 10,000 Square Yards in Size

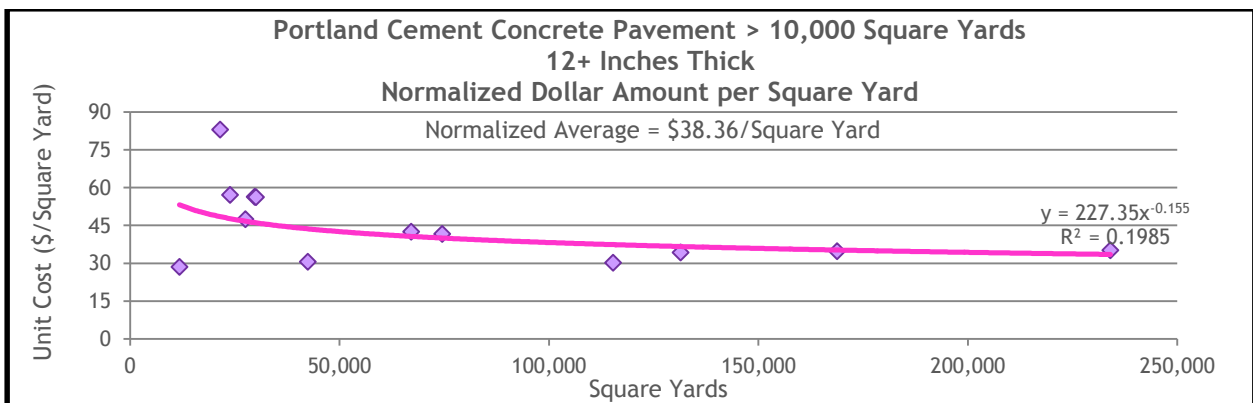

Figure 13.28 PCCP Normalized Dollar Amount for Projects of 12 Inches or Greater in Thickness and Greater Than 10,000 Square Yards in Size

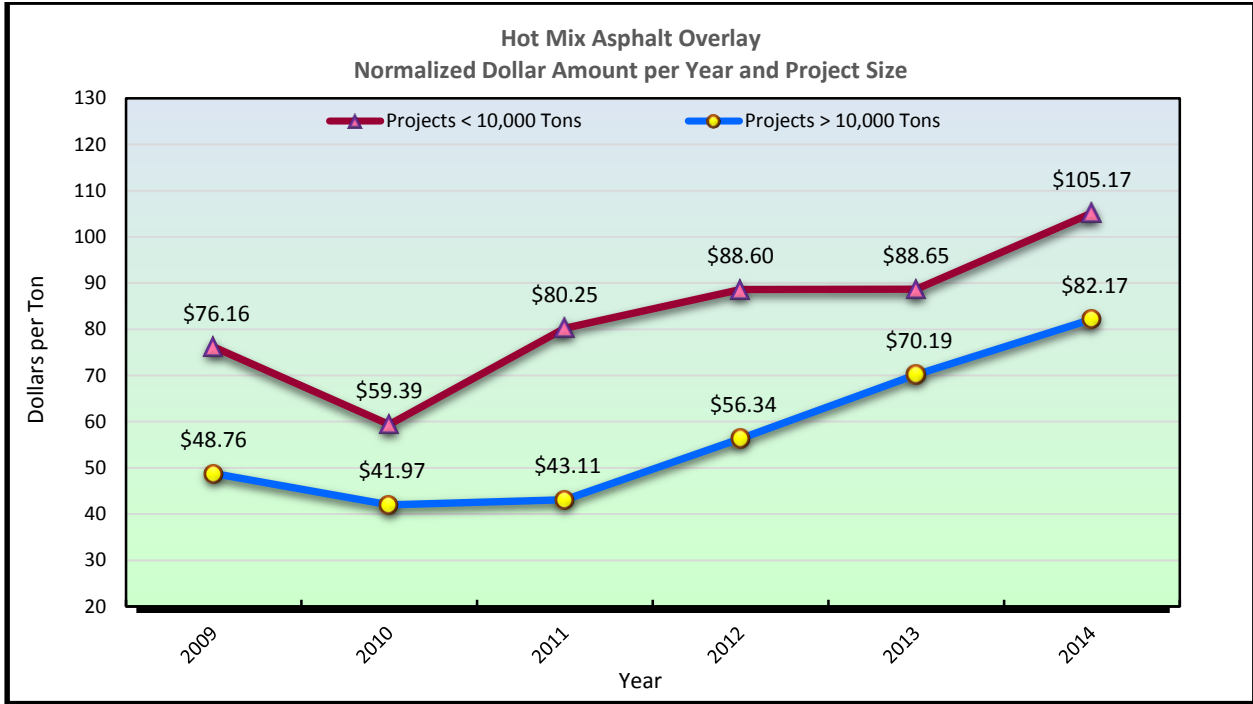

Figure 13.29 HMA Overlay Normalized Dollar per Year and Project Size

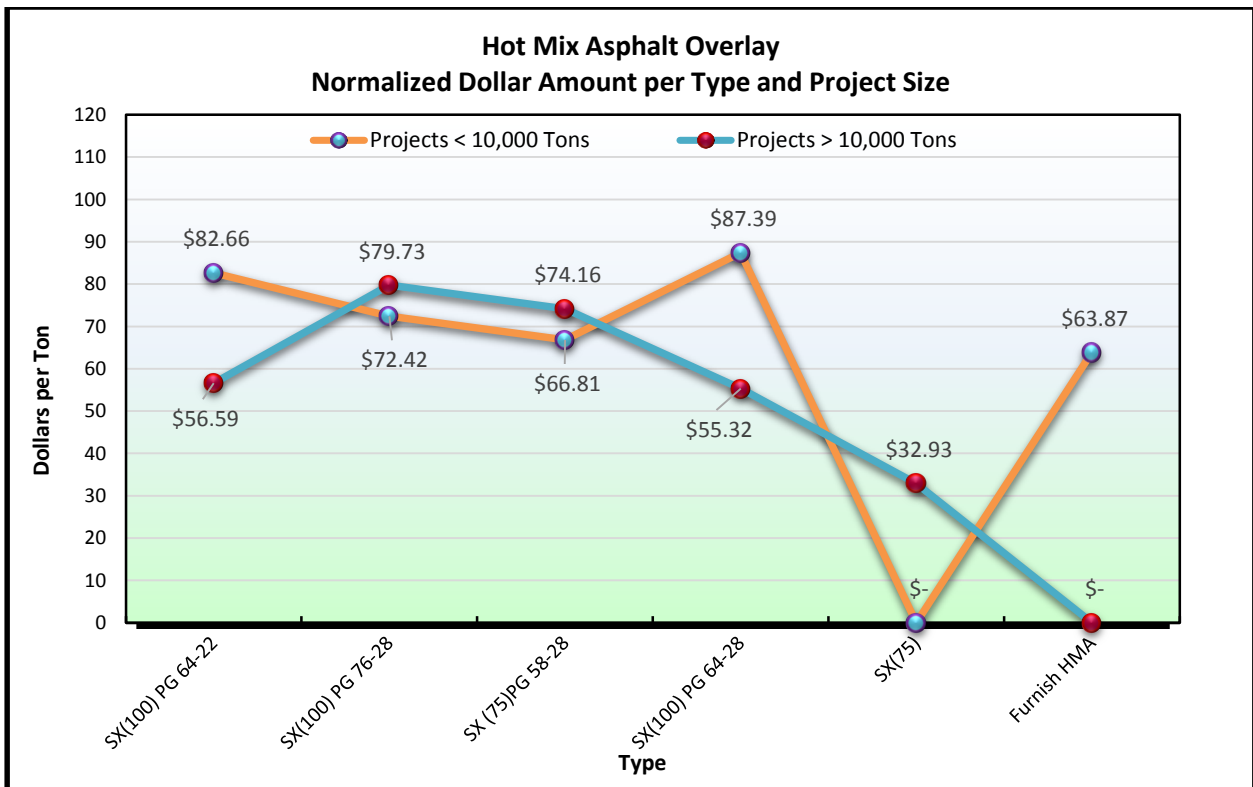

Figure 13.30 HMA Overlay Normalized Dollar per Product Type and Project Size

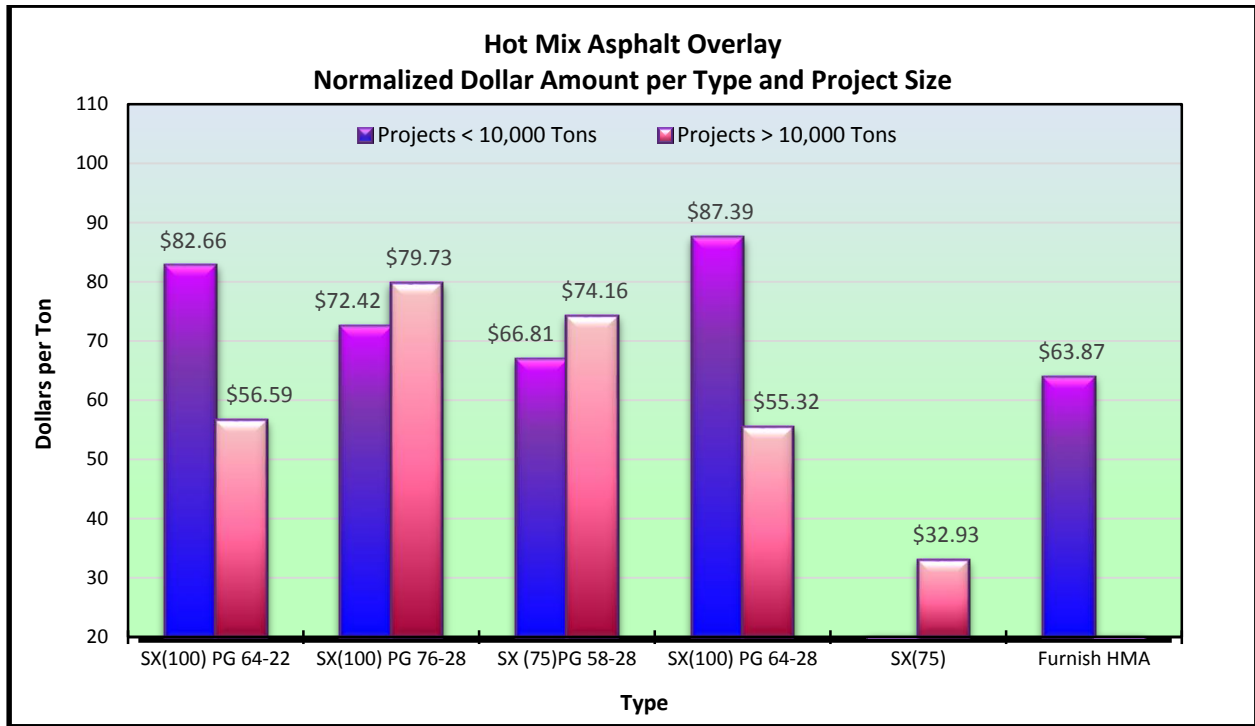

Figure 13.31 HMA Overlay Normalized Dollar per Product Type and Project Size

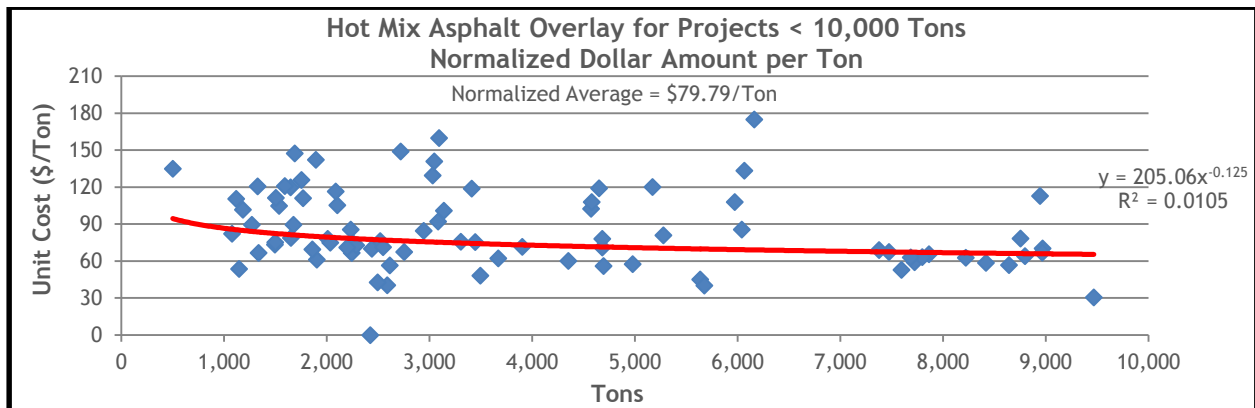

Figure 13.32 HMA Overlay Normalized Dollar Amount for Projects Less Than 10,000 Tons

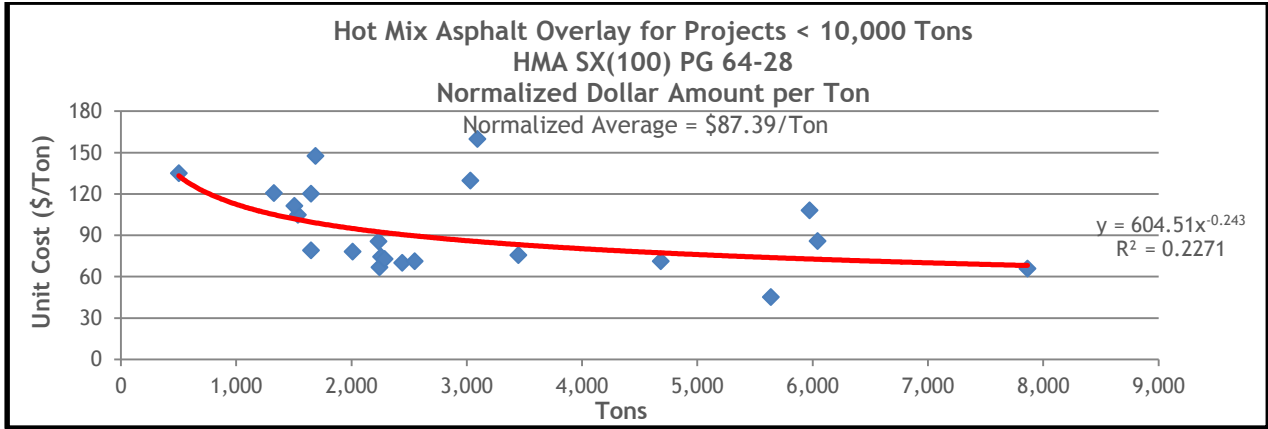

Figure 13.33 HMA Overlay Normalized Unit Costs for SX(100) PG 64-28 on Projects Less than 10,000 Tons

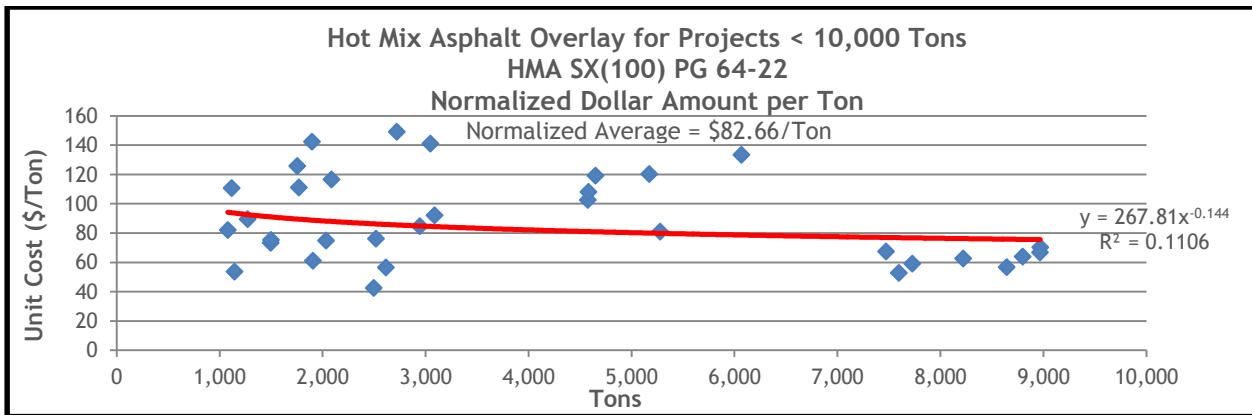

Figure 13.34 HMA Overlay Normalized Unit Costs for SX(100) PG 64-22 on Projects Less than 10,000 Tons

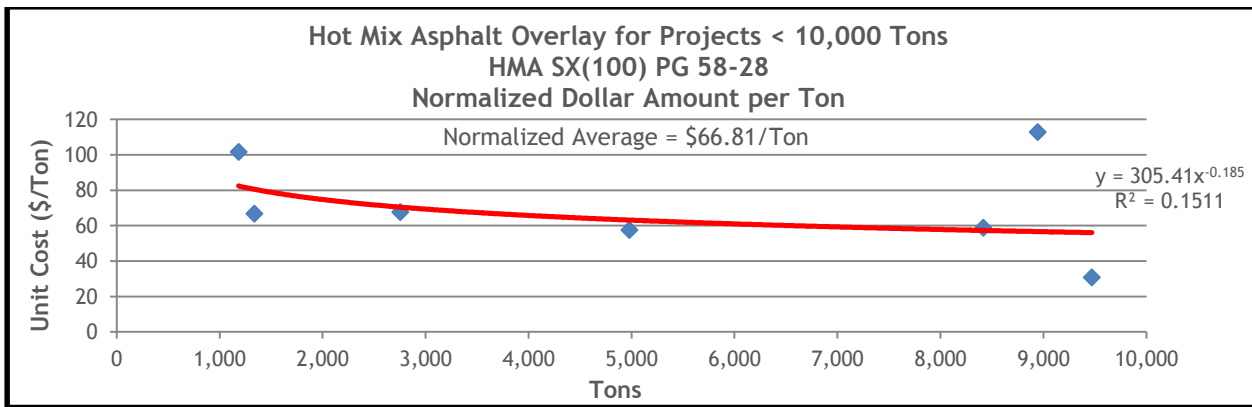

Figure 13.35 HMA Overlay Normalized Unit Costs for SX(100) PG 58-28 on Projects Less than 10,000 Tons

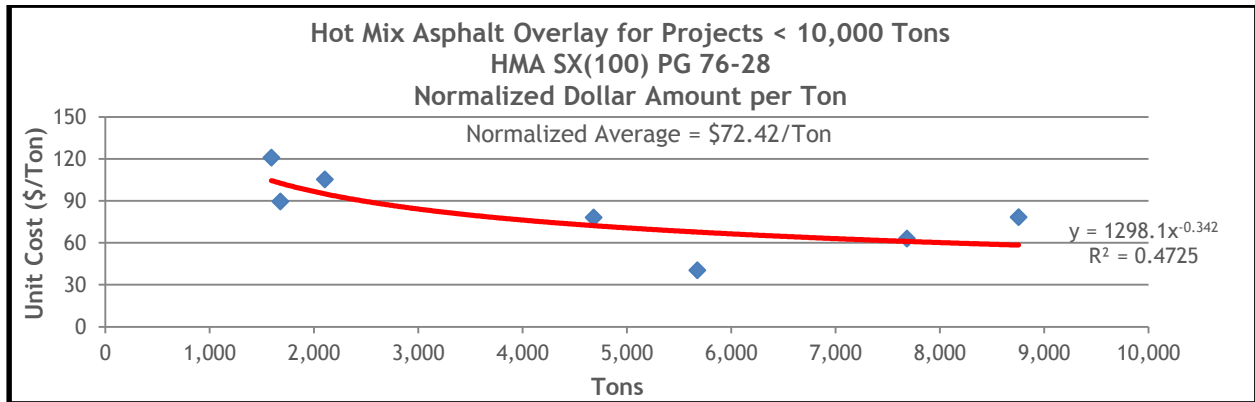

Figure 13.36 HMA Overlay Normalized Unit Costs for SX(100) PG 76-28 on Projects Less than 10,000 Tons

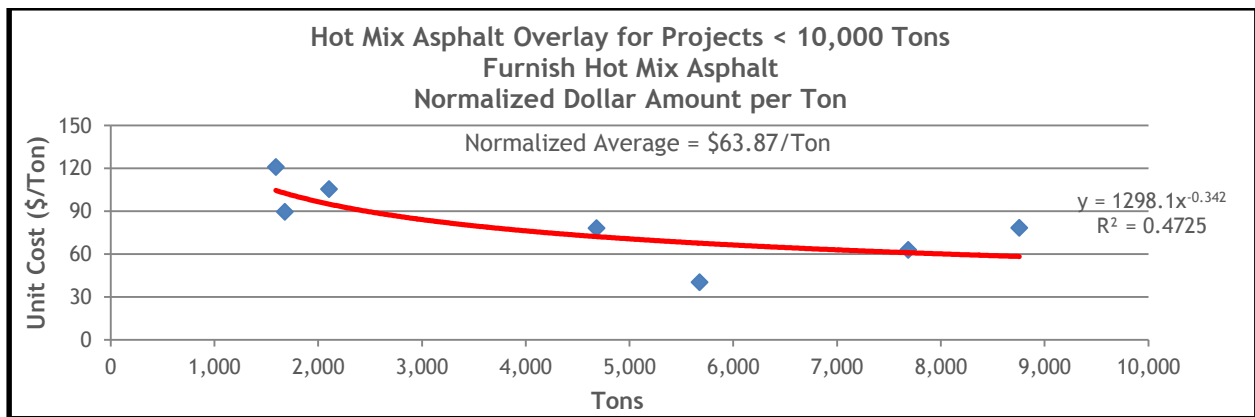

Figure 13.37 HMA Overlay Normalized Unit Costs for Furnish HMA on Projects Less than 10,000 Tons

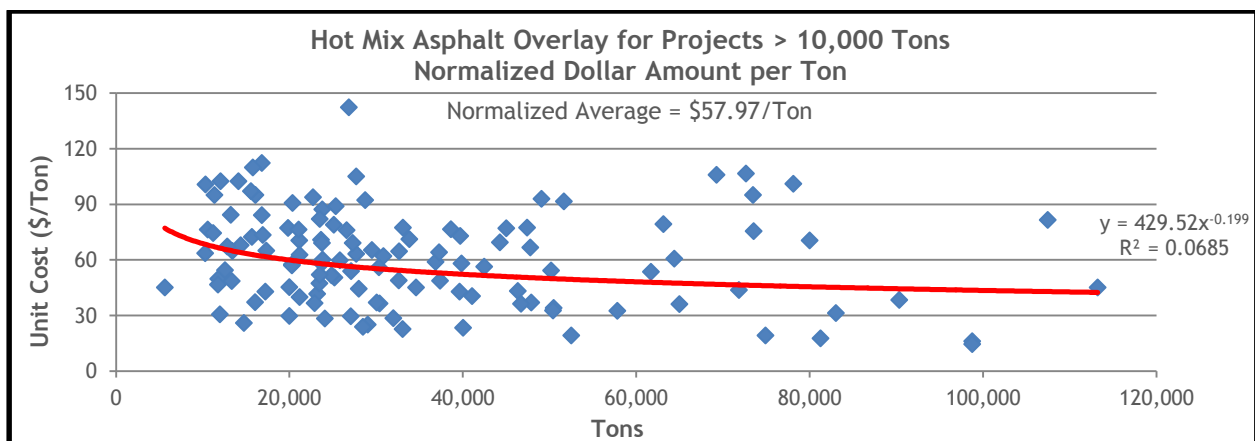

Figure 13.38 HMA Overlay Normalized Unit Costs for Projects with Greater than 10,000 Tons

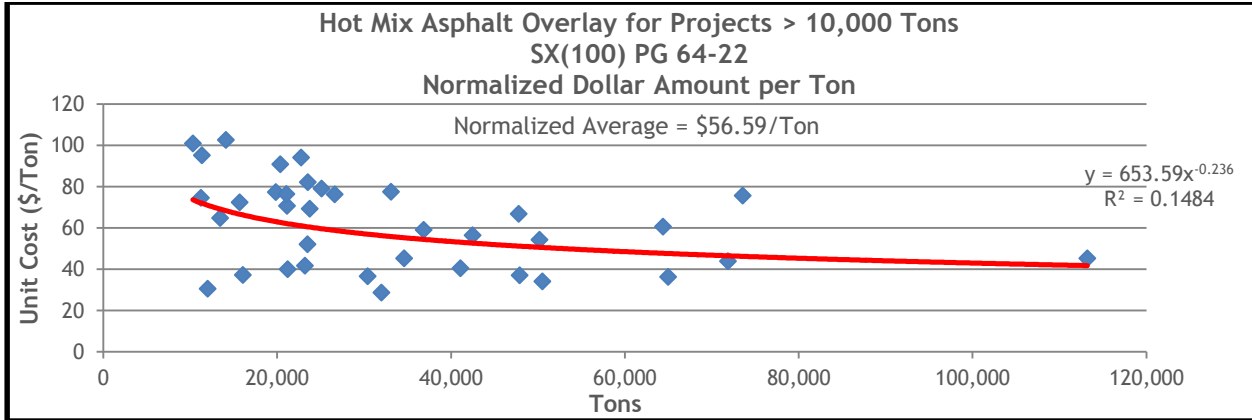

Figure 13.39 HMA Overlay Normalized Unit Costs for SX(100) PG 64-22 on Projects Greater than 10,000 Tons

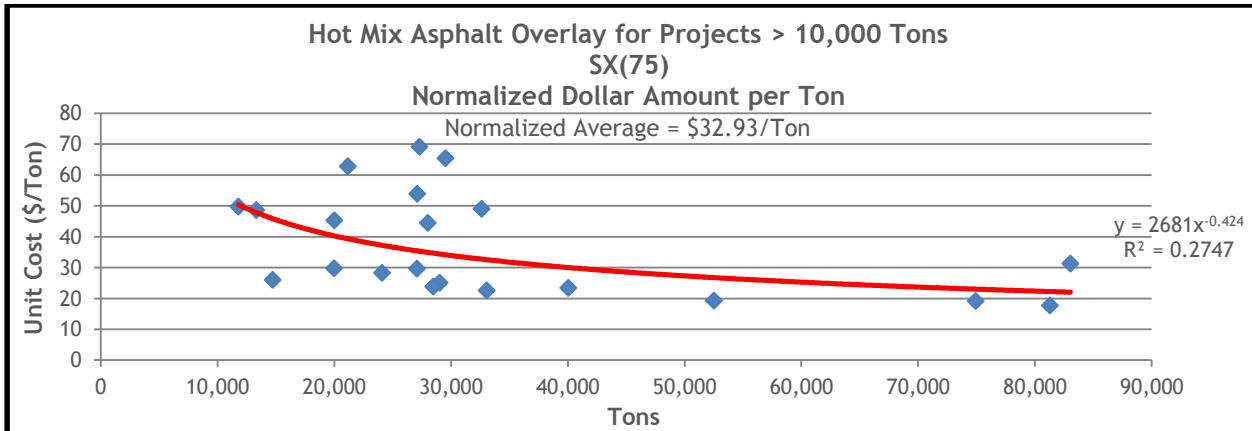

Figure 13.40 HMA Overlay Normalized Unit Costs for SX(75) on Projects Greater than 10,000 Tons

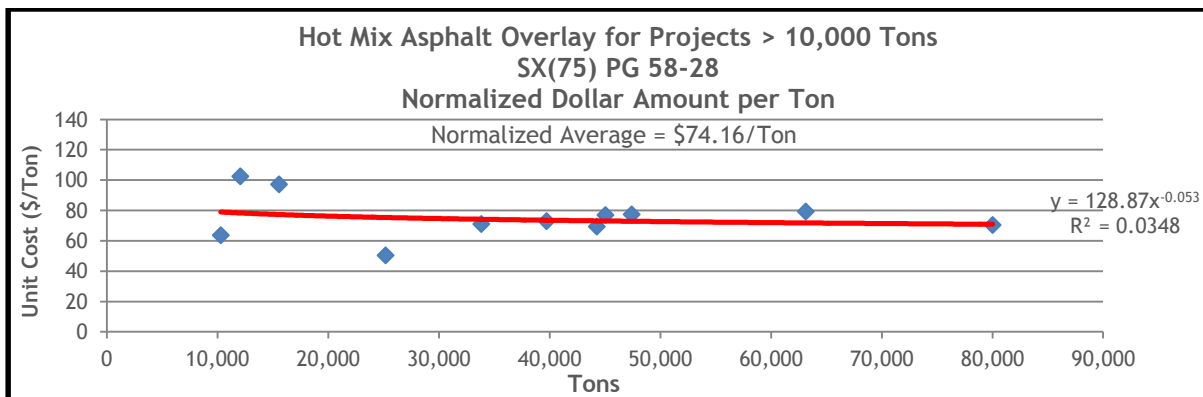

Figure 13.41 HMA Overlay Normalized Unit Costs for SX(100) PG 58-28 on Projects Greater than 10,000 Tons

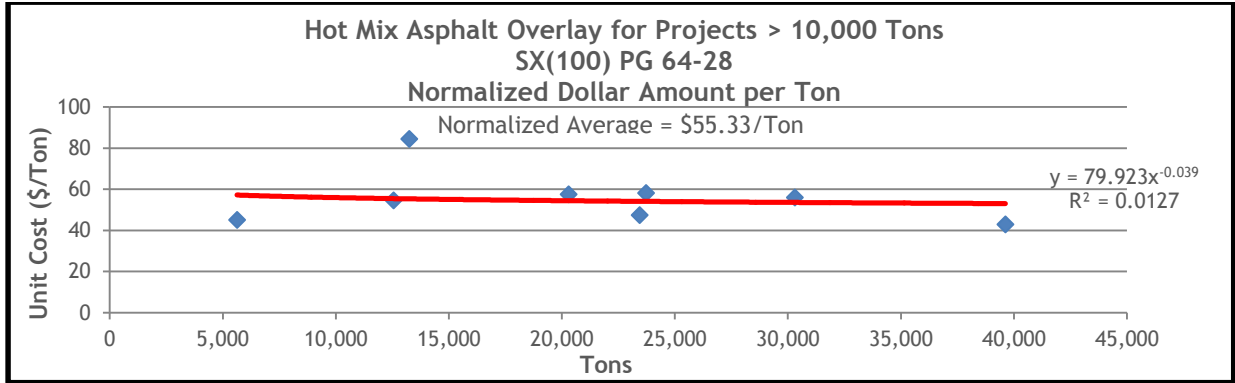

Figure 13.42 HMA Overlay Normalized Unit Costs for SX(100) PG 64-28 on Projects Greater than 10,000 Tons

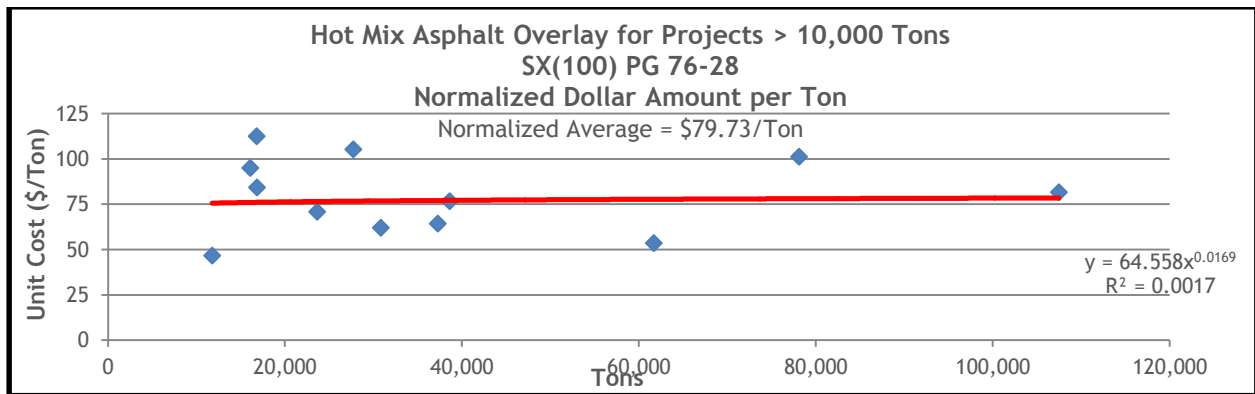

Figure 13.43 HMA Overlay Normalized Unit Costs for SX(100) PG 76-28 on Projects Greater than 10,000 Tons

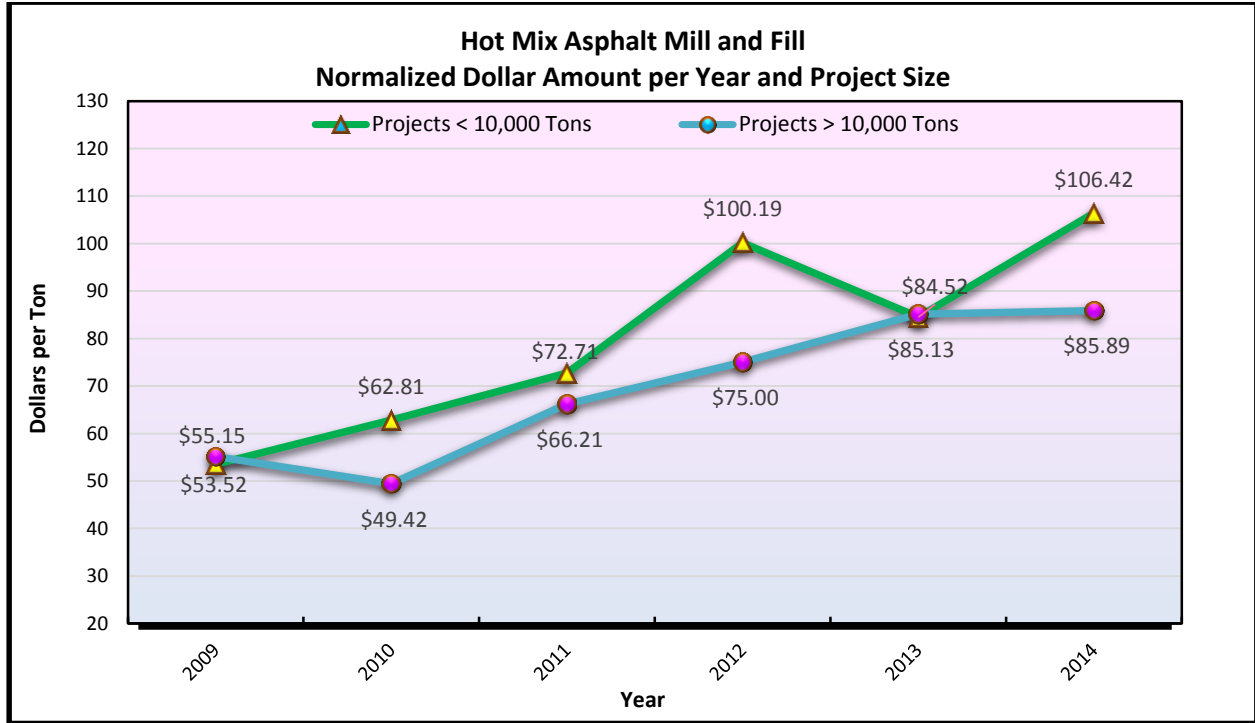

Figure 13.44 HMA Mill and Fill Normalized Dollar per Year and Project Size

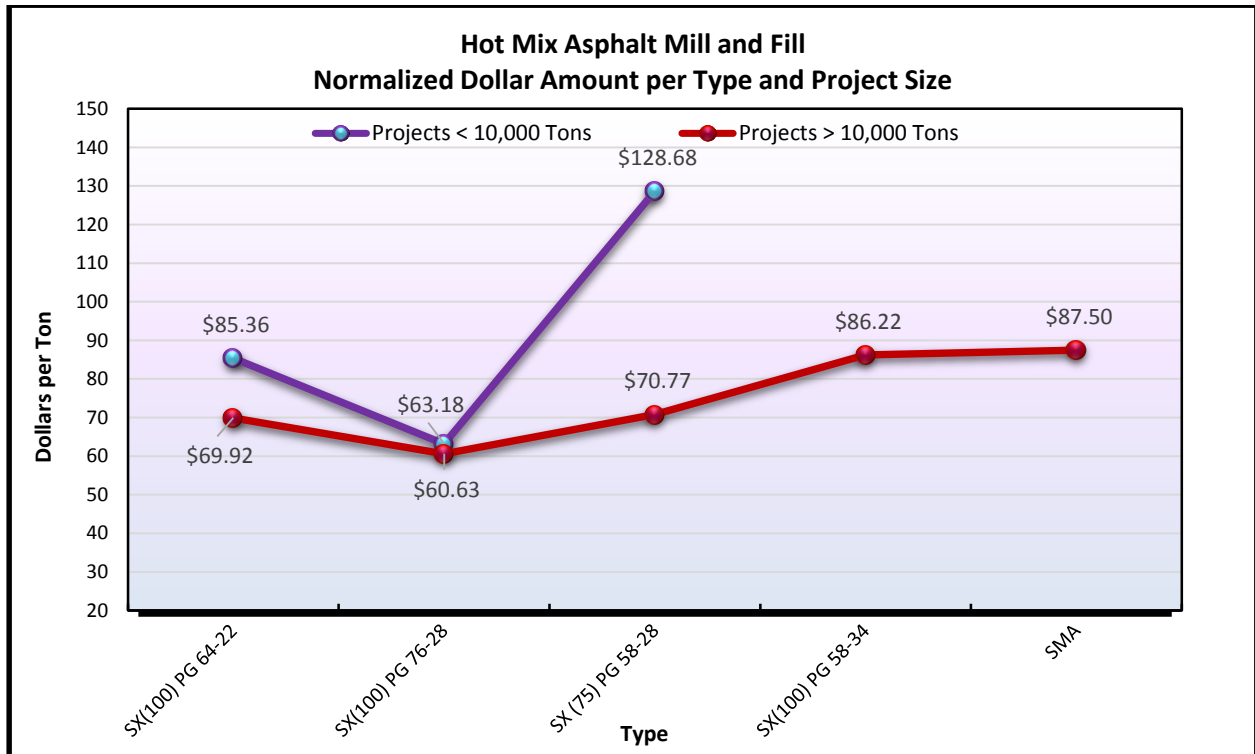

Figure 13.45 HMA Mill and Fill Normalized Dollar per Product Type

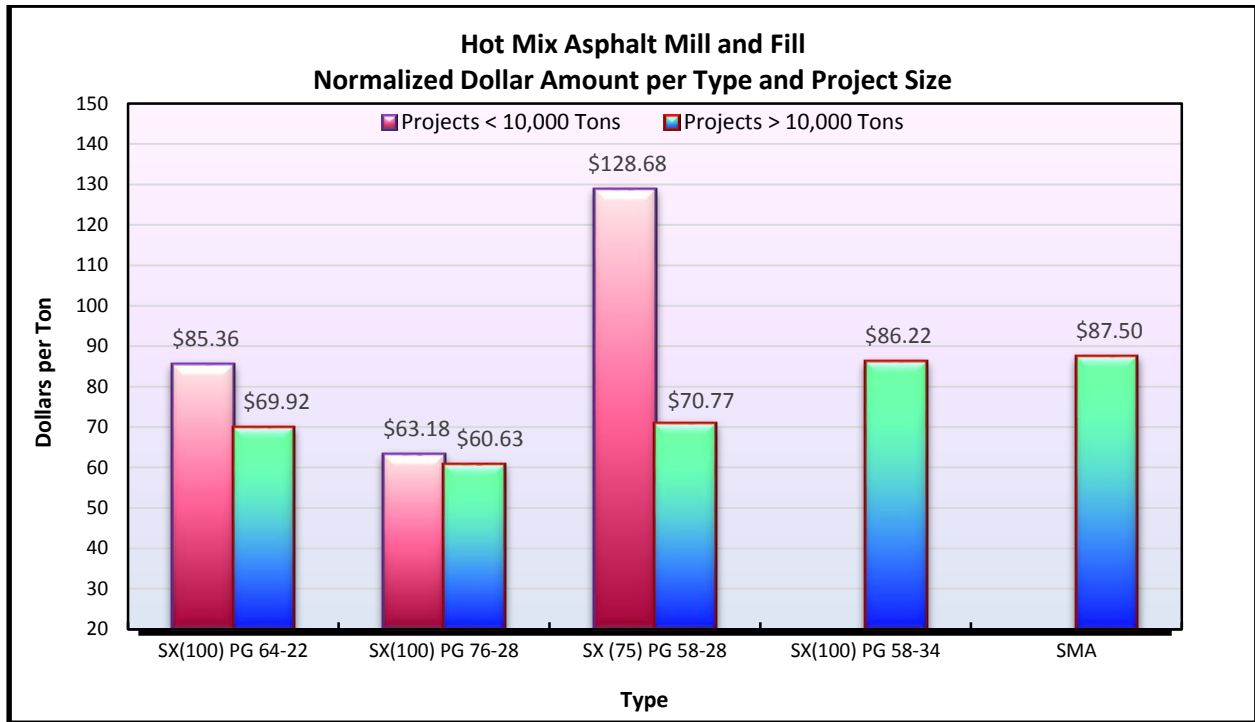

Figure 13.46 HMA Mill and Fill Normalized Dollar per Product Type

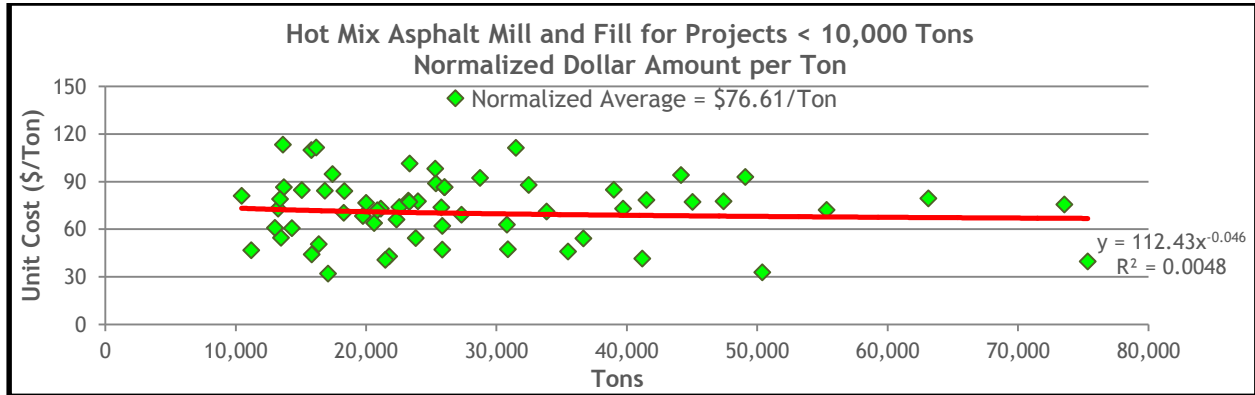

Figure 13.47 HMA Mill and Fill Normalized Unit Costs for Projects Less than 10,000 Tons

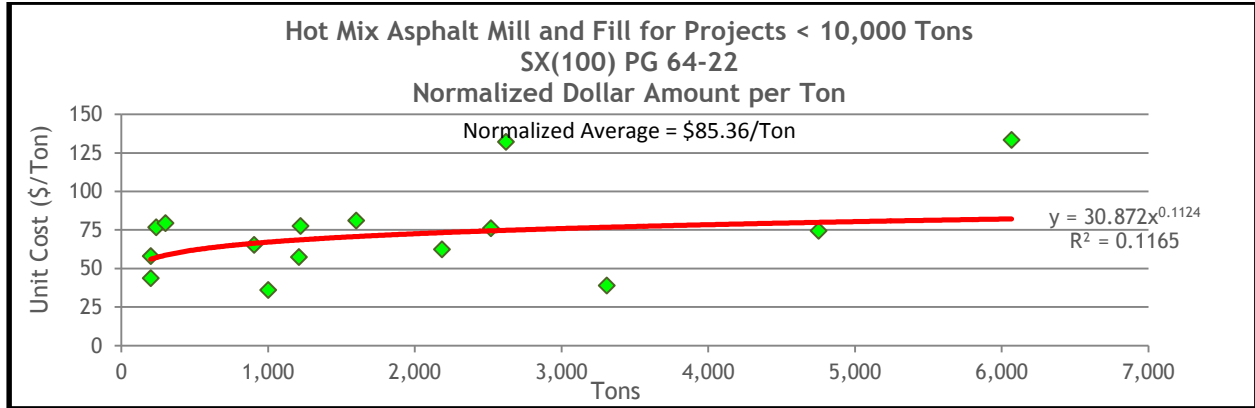

Figure 13.48 HMA Mill and Fill Normalized Unit Costs for SX(100) PG 64-22 on Projects Less than 10,000 Tons

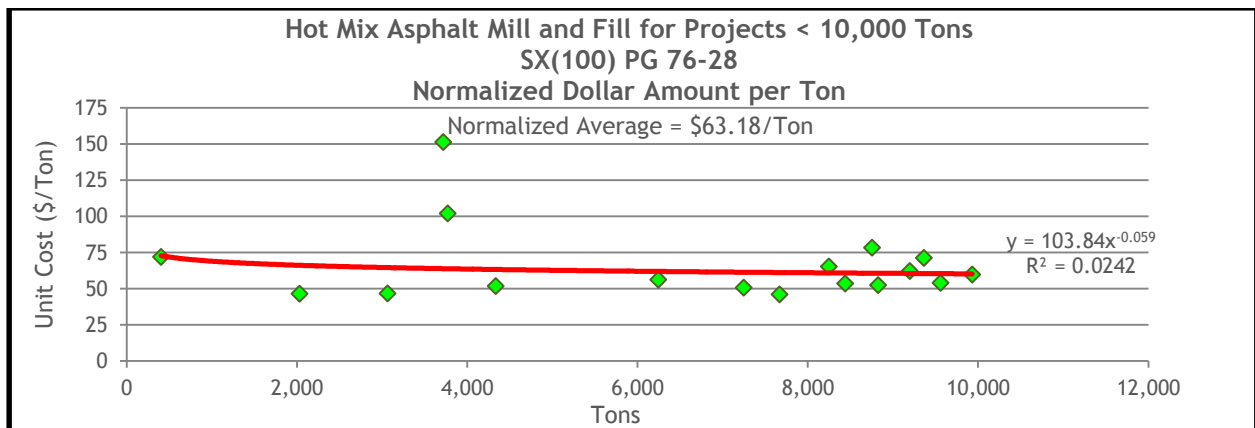

Figure 13.49 HMA Mill and Fill Normalized Unit Costs for SX(100) PG 76-28 on Projects Less than 10,000 Tons

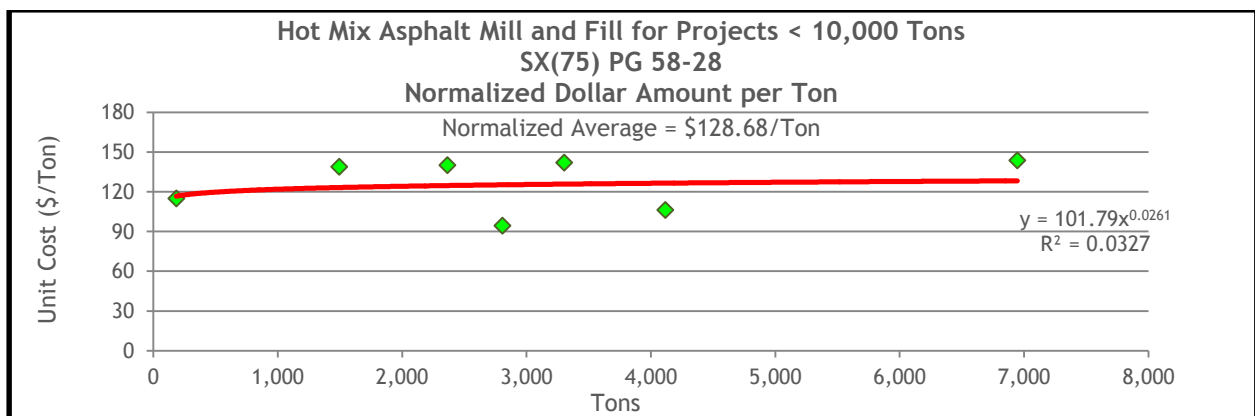

Figure 13.50 HMA Mill and Fill Normalized Unit Costs for SX(100) PG 58-28 on Projects Less than 10,000 Tons

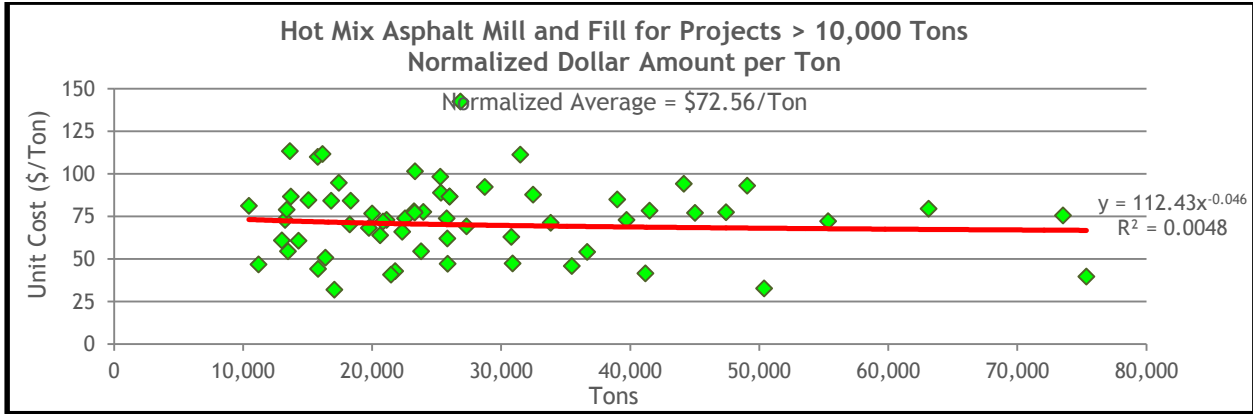

Figure 13.51 HMA Mill and Fill Normalized Unit Costs for Projects Greater than 10,000 Tons

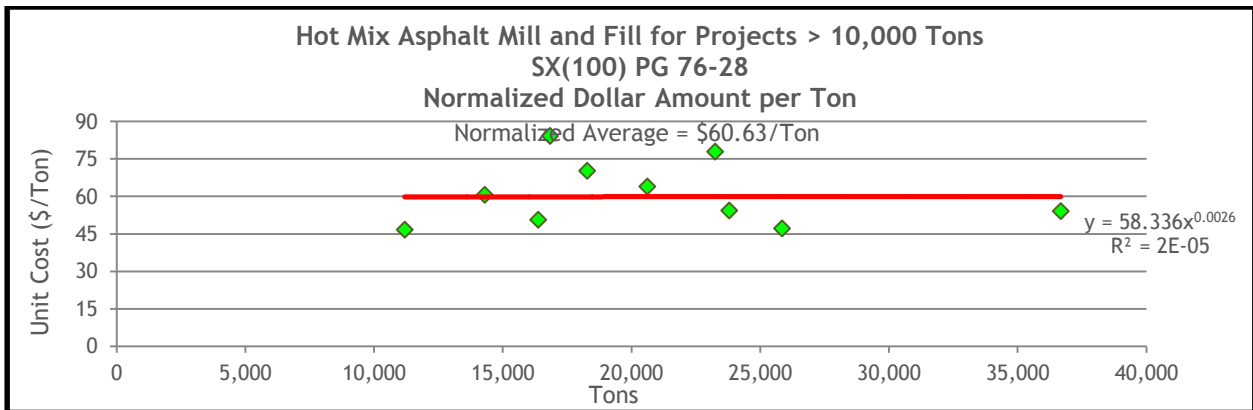

Figure 13.52 HMA Mill and Fill Normalized Unit Costs for SX(100) PG 76-28 on Projects Greater than 10,000 Tons

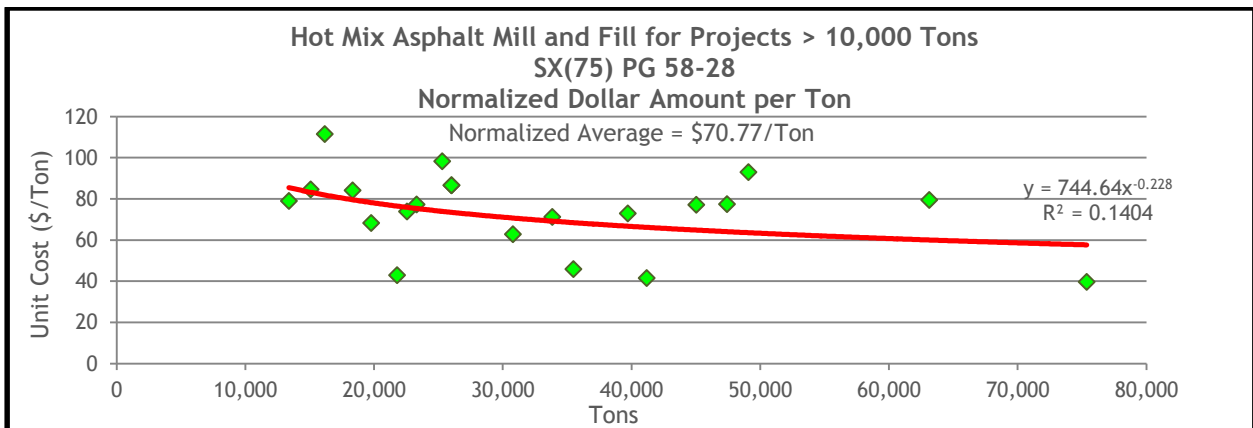

Figure 13.53 HMA Mill and Fill Normalized Unit Costs for SX(100) PG 64-22 on Projects Greater than 10,000 Tons

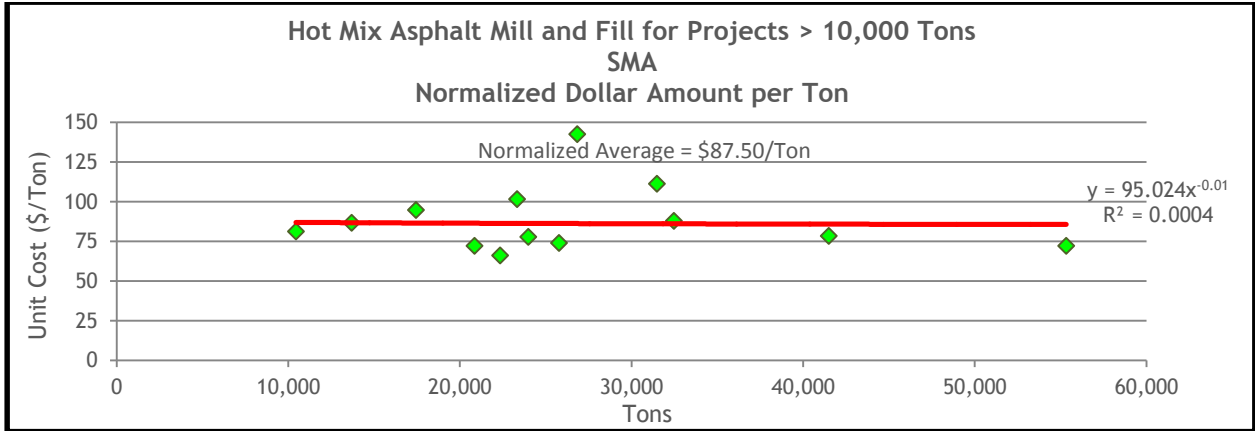

Figure 13.54 HMA Mill and Fill Normalized Unit Costs for SMA on Projects Greater than 10,000 Tons

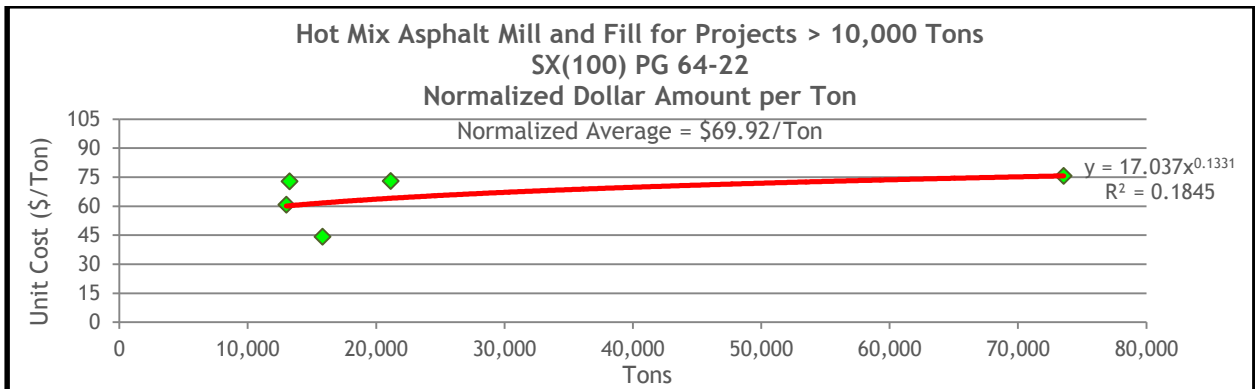

Figure 13.55 HMA Mill and Fill Normalized Unit Costs for SX(100) PG 64-22 on Projects Greater than 10,000 Tons

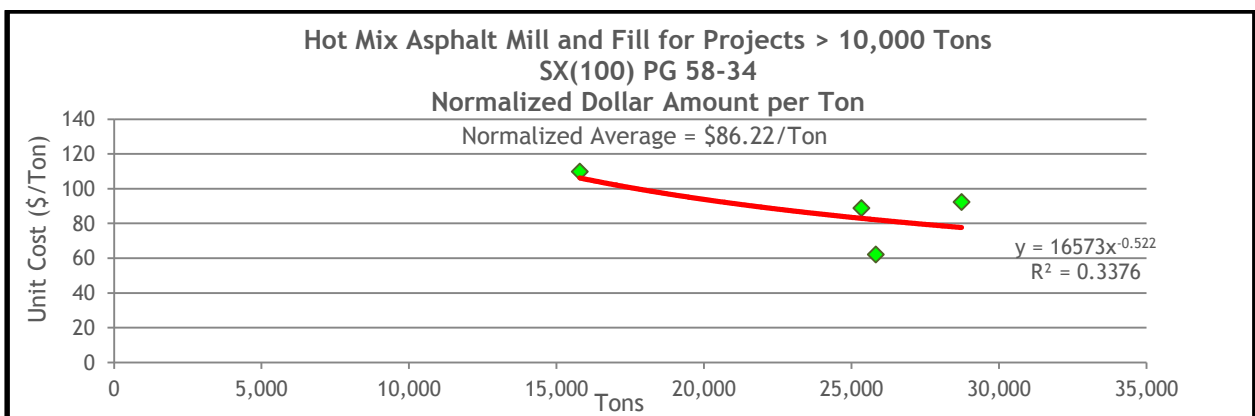

Figure 13.56 HMA Mill and Fill Normalized Unit Costs for SX(100) PG 58-34 on Projects Greater than 10,000 Tons

13.7.16 Alternative-Level Data Input Forms

Data that define the differences between alternatives - (the agency costs and work zone) specifics for component activities of each project alternative. These are alternative-level inputs. Each project alternative is composed of up to seven activities. The activities are performed in sequence. For example, Initial Construction precedes Rehabilitation 1 and Rehabilitation 3 precedes Rehabilitation 4. Data describing these activities are entered for each of the two project alternatives being compared. See (**Figure 13.66** and **Figure 13.67**) for a graphical representation. ALTERNATIVE 1 and ALTERNATIVE 2 inputs: CDOT has created an Excel worksheet for both pavement types to assist the designer in selecting the appropriate costs for both initial and rehabilitation costs and a graphical representation. The user can select cost of the pavement given quantity. The forms for Alternative 1 and Alternative 2 are identical. At the top of the form, a series of tabs access project alternative activities. Each tab accesses a different activity (see **Figure 13.68** and **Figure 13.69**). Data in this form are used to calculate agency and user costs. The construction and maintenance data are agency cost inputs. The service life data affect both agency and user costs (by determining when work zones will be in place). The work-zone-specific data affect user costs. Each of the data inputs on this form is discussed in **Table 13.22 Alternative-Level Data Options**.

Table 13.20 Alternative-Level Data Options

Variable Name	Probability Distribution (CDOT Default)	HMA Value (CDOT Default)	PCC Value (CDOT Default)	Source
Alternative Description	User Input	User Input	User Input	Site specific
Activity Description	User Input	User Input	User Input	Site specific
Agency Construction Cost (\$1000)	Triangular	User Input	User Input	Figure 13.13 to Figure 13.56 or Site specific
Activity Service Life (years)	Triangular	User Input	User Input	Section 13.2.3 or Section 13.3
User Work Zone Costs (\$1000)	Deterministic	User Input	User Input	CDOT Work Zone Software Section 13.5.7
Maintenance Frequency (years)	Deterministic	1 year	1 year	CDOT*
Agency Maintenance Cost (\$1000)	Deterministic	\$1.270/lane mile*	\$ 0.449/lane mile*	CDOT*
Work Zone Length (Miles)	Deterministic	User Input	User Input	Site specific
Work Zone Capacity (vphpl)	Deterministic	User Input	User Input	CDOT Work Zone Software Section 13.5.7
No of Lanes Open in Each Direction During Work Zone	Deterministic	User Input	User Input	Site specific
Work Zone Duration (days)	Deterministic	User Input	User Input	CDOT Work Zone Software Section 13.5.7
Work Zone Speed Limit (mph)	User Input	User Input	User Input	Site specific
Shaded cells will be calculated when user cost computation method has been selected as "Calculated". * Use site specific or latest data. Recalculate yearly cost to account for number of lanes and project length.				

Note 1: The Work Zone Capacity is equal to the WorkZone software's work zone capacity (Inbound/Outbound Capacity) for the type of selected work. If two or more types of work are listed, use the lesser value of the capacity.

Note 2: Work Zone Duration (days) must be reasonable. For a PCC value, the WorkZone program may give a value of 5 days for the actual paving operation. The designer needs to increase the days a reasonable amount to provide for concrete curing. The work zone will be in place for the paving operation and curing time.



Alternative 1

Alternative: 1

Alternative Description: HMA Number of Activities: 4

Activity 1 | Activity 2 | Activity 3 | Activity 4

Activity Description: 9.0" HBP New Construction

Activity Cost and Service Life Inputs

Agency Construction Cost (\$1000):	9344.333 ...	Activity Service Life (years):	10 ...
User Work Zone Costs (\$1000):	2188.582 ...	Activity Structural Life (years):	 ...
Maintenance Frequency (years):	1 ...	Agency Maintenance Cost (\$1000):	1.27 ...

Activity Work Zone Inputs

Work Zone Length (miles):	10	Work Zone Duration (days):	54 ...
Work Zone Capacity (vphpl):	1123 ...	Work Zone Speed Limit (mph):	45
No of Lanes Open in Each Direction During Work Zone:	1	Traffic Hourly Distribution:	Week Day 1 ▾

Work Zone Hours

	Inbound		Outbound	
	Start	End	Start	End
First Period of Lane Closure:	8	17	8	17
Second Period of Lane Closure:				
Third Period of Lane Closure:				

Copy Activity
Paste Activity

Open...
Save...
Ok
Cancel

Figure 13.57 Alternative 1 (HMA) Screen

Alternative 2

Alternative:

Alternative Description: Number of Activities:

Activity 1 | **Activity 2**

Activity Description:

Activity Cost and Service Life Inputs

Agency Construction Cost (\$1000): Activity Service Life (years):

User Work Zone Costs (\$1000): Activity Structural Life (years):

Maintenance Frequency (years): Agency Maintenance Cost (\$1000):

Activity Work Zone Inputs

Work Zone Length (miles): Work Zone Duration (days):

Work Zone Capacity (vphpl): Work Zone Speed Limit (mph):

No of Lanes Open in Each Direction During Work Zone: Traffic Hourly Distribution:

Work Zone Hours

	Inbound		Outbound	
	Start	End	Start	End
First Period of Lane Closure:	<input type="text" value="0"/>	<input type="text" value="24"/>	<input type="text" value="0"/>	<input type="text" value="24"/>
Second Period of Lane Closure:	<input type="text" value=""/>	<input type="text" value=""/>	<input type="text" value=""/>	<input type="text" value=""/>
Third Period of Lane Closure:	<input type="text" value=""/>	<input type="text" value=""/>	<input type="text" value=""/>	<input type="text" value=""/>

Copy Activity
Paste Activity

Open... Save... Ok Cancel

Figure 13.58 Alternative 2 (PCCP) Screen

13.7.17 Executing the Simulation

Running a simulation is a necessary step toward performing a probabilistic analysis. To conduct probabilistic analysis, RealCost uses Monte Carlo simulation, which allows modeling of uncertain quantities in the model with probabilistic inputs. The simulation procedure samples these inputs and produces outputs that are described by both a range of potential values and a likelihood of occurrence of specific outputs. The simulation produces the probabilistic outputs; without running a simulation, probabilistic outputs are not available. The Simulation Screen is shown in Error! eference source not found. The Sampling Scheme section of the form determines from where the software will draw its simulation numbers. Choosing Random Results causes the simulation seed value (where the simulation starts) to come from the computer's internal clock. While not truly random, this seed value cannot be influenced by the software user, and it produces different values with each simulation.

Table 13.21 Simulation Data Options

Variable Name	Probability Distribution (CDOT Default)	Value (CDOT Default)	Source
Random Results	De-Select	No	RealCost Manual
Reproducible Results	Select	Yes	RealCost Manual
Seed Value	Deterministic	2000	RealCost Manual
Number of Iterations	Deterministic	2000	RealCost Manual
Monitor Convergence	Select	Yes	RealCost Manual
Monitoring Frequency (Number Iterations)	Deterministic	50	RealCost Manual
Convergence Tolerance (%)	Deterministic	2.5	RealCost Manual
Tail Analysis Percentiles		See Below	RealCost Manual
Percentile 1	Deterministic	5	RealCost Manual
Percentile 2	Deterministic	10	RealCost Manual
Percentile 3	Deterministic	75	CDOT
Percentile 4	Deterministic	95	RealCost Manual

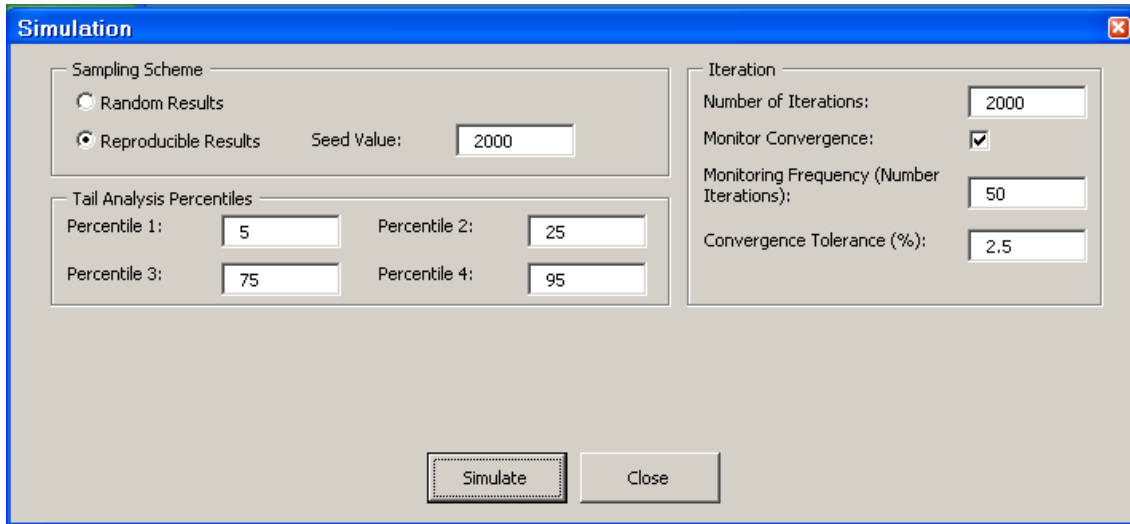

13.7.18 Analyzing Probabilistic Results

After a simulation run, probabilistic results are available for analysis. A simulation must be run prior to viewing probabilistic results **Figure 13.59 Probabilistic Results Screen** shows the results of a probabilistic simulation.

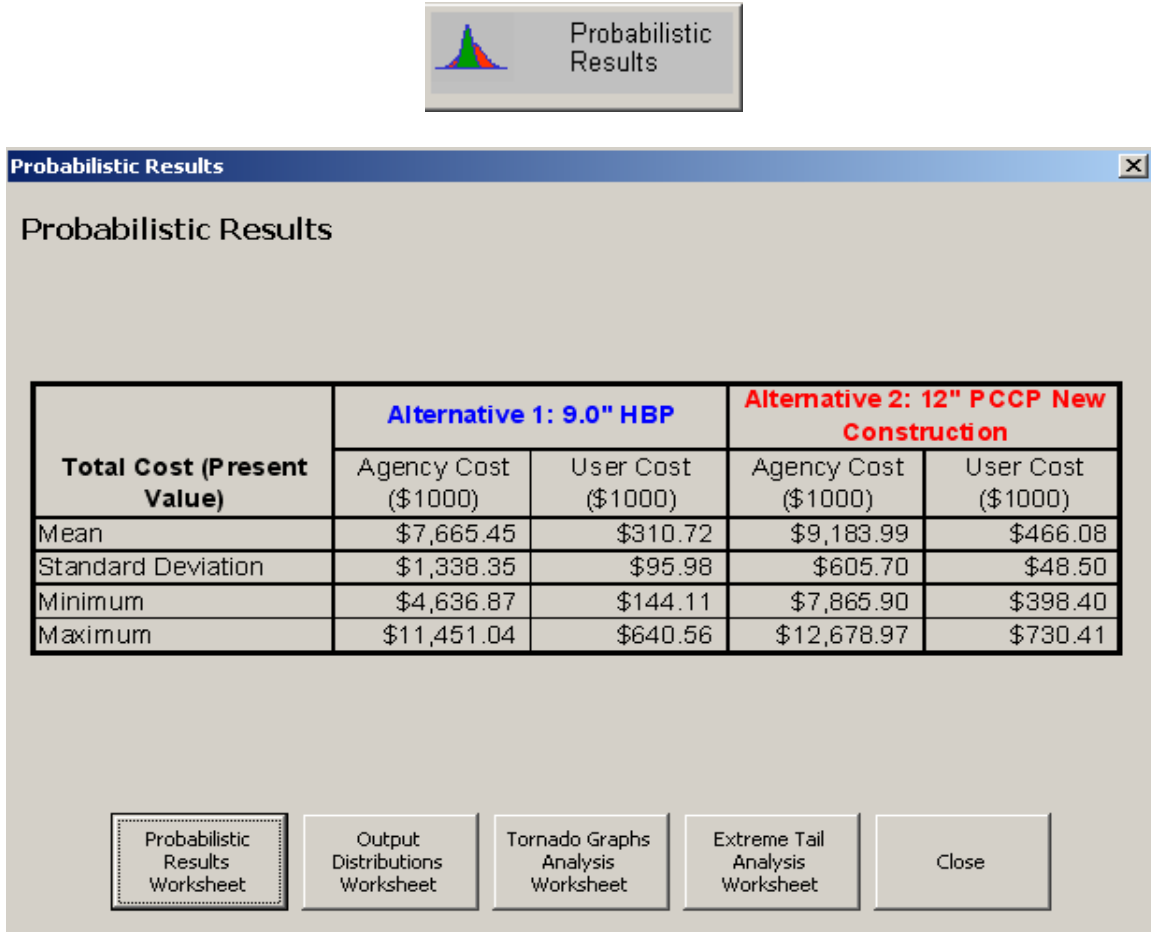

Figure 13.59 Probabilistic Results Screen

13.7.19 Analyzing Probabilistic Agency Costs

Agency Costs are critical to an insightful LCCA and are good estimates of the various agency cost items associated with initial construction, periodic maintenance and rehabilitation activities. Construction costs pertain to putting the asset into initial service. Data on construction costs are obtained from historical records, current bids, and engineering judgment (particularly when new materials and techniques are employed). See **Figure 13.60 Agency Cost Results Screen** for a graphical representation of Agency Costs. Similarly, costs must be attached to the maintenance and rehabilitation activities identified in the previous steps to maintain the asset above some predetermined condition, performance, and safety levels. These costs include those for preventive activities that are planned to extend the life of the asset, day-to-day routine maintenance intended to address safety and operational concerns, and rehabilitation or restoration activities. Another consideration affecting total agency costs is the value of the alternative at the end of the analysis period. One type of terminal value is called “salvage value,” usually the net value from the recycling of materials at the end of a project’s life. A second type of terminal value is the

“remaining service life” (RSL) value of an alternative (the residual value of an improvement when its service life extends beyond the end of the analysis period). The RSL value may vary significantly among different alternatives, and should be included in the LCCA.

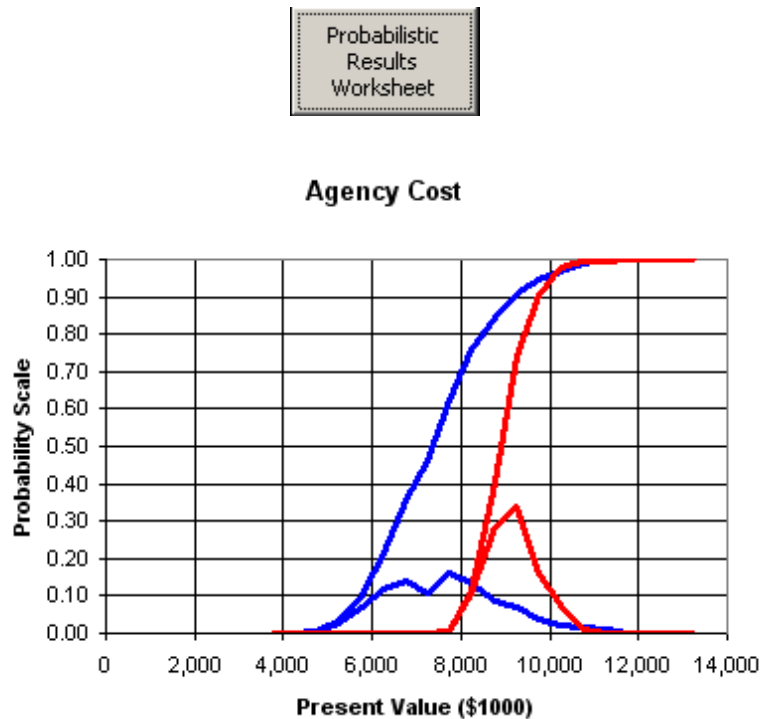

Figure 13.60 Agency Cost Results Screen

13.7.20 Analyzing Probabilistic User Cost

Best-practice LCCA calls for including both the costs accruing to the transportation agency, described above, and costs incurred by the traveling public. In LCCA, user costs of primary interest include vehicle operating costs, travel time costs, and crash costs. Such user costs typically arise from the timing, duration, scope, and number of construction and rehabilitation work zones characterizing each project alternative. Because work zones typically restrict the normal capacity of the facility and reduce traffic flow, work zone user costs are caused by speed changes, stops, delays, detours, and incidents. While user costs do result during normal operations, these costs are often similar between alternatives and may be removed from most analyses. Incorporating user costs into LCCA enhances the validity of the results, but at the same time is a challenging task. User costs can also be defined as the cost of travel that is borne by individual users. Highway user costs are the sum of motor vehicle running cost, the value of travel time, and traffic accident cost. Bus transit user costs on a particular highway segment are the fares, the value of travel time, and traffic accident costs. See **Figure 13.61 User Cost Results Screen**.

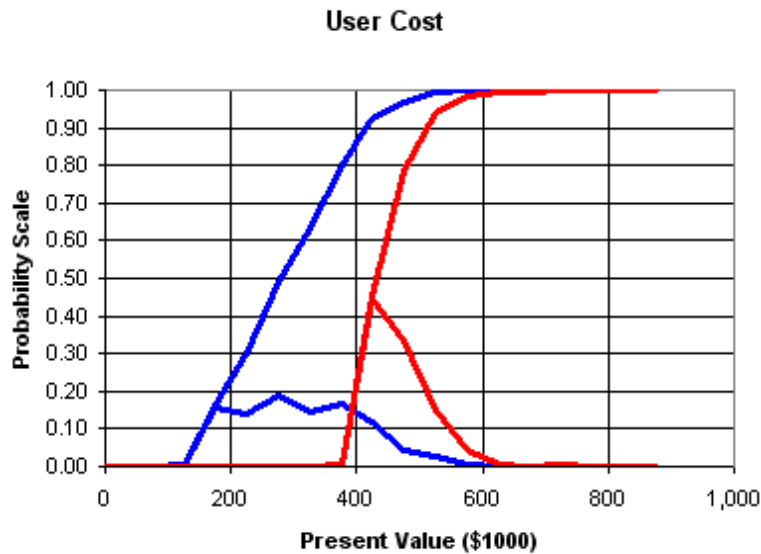
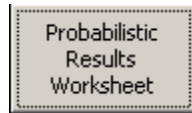

Figure 13.61 User Cost Results Screen

13.8 Comparing Probabilistic Results

To calculate Agency and User cost, the designer must select values that cross both Agency and User cost lines at the 75 percent probability scale. Once the designer has determined both values, a total of both PV's can be calculated. For example:

Agency Cost

Blue: PCCP Lines 75% PV \$13,000,000

Red: HMA Lines 75% PV \$18,000,000

User Cost

Blue: PCCP Lines 75% PV \$2,000,000

Red: HMA Lines 75% PV \$2,000,000

PCCP Present Value at 75% Probability = \$13,000,000 + \$2,000,000 = \$15,000,000

HMA Present Value at 75% Probability = \$18,000,000 + \$2,000,000 = \$20,000,000

Refer to **Figure 13.62 Agency-User Cost Results Screens** for a graphical representation of the probability vs. agency and user costs.

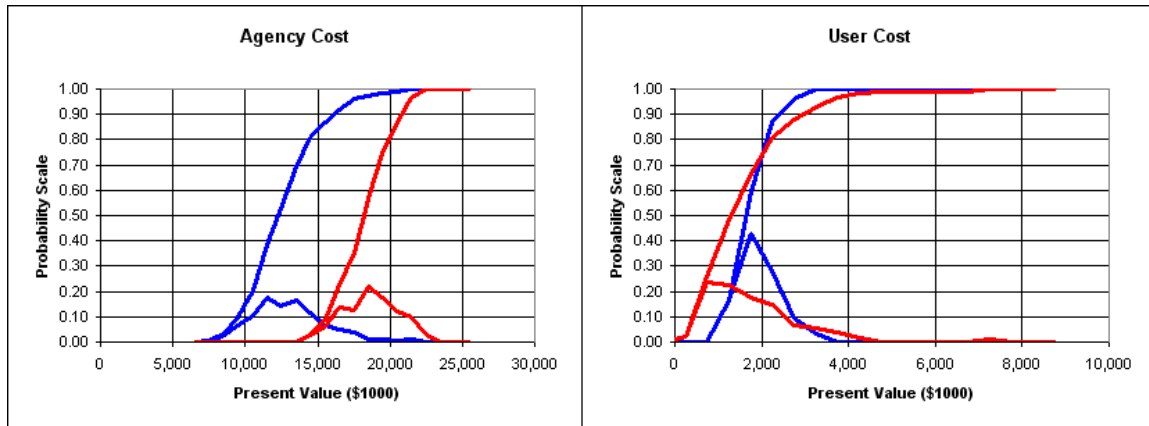

Figure 13.62 Agency-User Cost Results Screens

Equivalent Designs are considered equal if the equation below is 10% or less:

$$\frac{(\text{large NPV value} - \text{small NPV value}) \times 100}{(\text{small NPV value})} \quad \text{Eq. 13.2}$$

Comparing the two alternatives yields:

$$\frac{(\$20,000,000 - \$15,000,000)}{\$15,000,000} \times 100 = 33.3\%$$

A comparison that yields results within 10 percent may be considered to have equivalent designs. A comparison that yields results within 5 percent would certainly be considered to have equivalent designs. Refer to Section 13.9 Pavement Type Selection Committee (PTSC) when the alternatives are within 10 percent. Other secondary factors can and should be used to help in the pavement selection. For more information, contact the Pavement Design Program Manager at 303-398-6561.

13.9 Pavement Type Selection Committee (PTSC)

Whenever the cost analysis does not show a clear LCCA within 10 percent advantage for one of the feasible alternatives, other secondary factors can be used to help in the selection process. Most of these factors are very difficult to quantify in monetary units. Decision factors considered important in selecting the preferred alternatives are chosen. The design factors are ranked. Some decision factors typically have a greater influence on the final decision than others. The PTSC members could complete the rating sheet independently or collectively, so that the final results represent a group decision and not just one individual. Other important factors can be considered to help select the best alternative when the life cycle costs comparison yields results within 10 percent. These secondary factors may include initial construction cost, future maintenance requirements, and performance of similar pavements in the area, adjacent existing pavements, and traffic control during construction (safety and congestion), user costs, conservation of materials and energy (recycling), environmental factors, availability of local materials and contractor capabilities, incorporation of experimental features, stimulation of competition, and local municipal factors. The procedure for selecting the best alternative among these secondary factors is given below.

13.9.7 Purpose

The purpose of the Committee will be to:

- Ensure the decision for the pavement type is in alignment with the unique goals of the project.
- Provide industry with the opportunity to review the life cycle cost analysis (LCCA) document.
- Ensure statewide consistency of decision making.
- Formalize the decision process of the Region's pavement type selection.
- Create accountability of the decision of pavement type at the level of Chief Engineer.
- Improve credibility of the decision by following a documented process and clearly communicating the reasons for the decision.

13.9.8 Scope

Reconstruction or new construction of corridor projects with large quantities of pavement where the initial life cycle cost analysis (LCCA) results indicate the pavement types are within 10 percent of each other. The percentage difference will be calculated in such a manner that the alternative with lower LCCA will be the basis, and therefore will be the LCCA value in the denominator.

13.9.9 Membership

The membership in the PTSC should include all of the following individuals:

- Region Materials Engineer
- Resident Engineer
- Headquarters Pavement Design Program Manager
- Region Program Engineer(s)
- Region Transportation Director
- Region Maintenance Superintendent
- Headquarters Materials and Geotechnical Branch Manager
- Headquarters Project Development Branch Manager
- Federal Highway Administration's Pavement and Materials Engineer

13.9.10 Roles of Membership

The following outlines the individual's roles in the PTSC:

- The Region Materials Engineer, Resident Engineer, Region Maintenance Superintendent and Headquarters Pavement Design Manager and Program Engineer will be responsible for the technical details including pavement design, costs, ESALs, construction timing and sequencing, and the LCCA.
- The Program Engineer and Transportation Director will be responsible for identifying the project goals and the corresponding importance of the elements within the LCCA to match the project goals.
- The Branch Managers will ensure the statewide uniformity of the process and prepare the documentation of the recommendation that will be forwarded to the Chief Engineer.
- The Chief Engineer will make the final decision on the pavement type.

13.9.11 Process

The PTSC will:

- Conduct a critical and independent review of the LCCA.
- Allow industry a period of 2 weeks to review the committee supported LCCA and provide written comments regarding the input assumptions.
- Review written comments from industry to ensure that they are adequately addressed.
- Adjust the LCCA as appropriate. Proceed to the next step if the revised LCCA indicates the pavement alternatives are within 10 percent.
- Create a list of elements that correlate to the corridor project goals. The following possible elements along with a brief description are shown in the **Table 13.24 Possible Elements for Pavement Type Selection Process**.
- Apply a rating scale, from the most to least important for each element to match the project goals.
- Determine the alternative that the element favors.

- Sum the most important elements for each alternative to establish if there is a clear advantage. If the alternatives have an equal amount of most important goals, run this step again for the secondary goals, then for the least important if necessary.
- Make a recommendation for pavement type to the Chief Engineer.

Table 13.24 Possible Elements for Pavement Type Selection Process

Element	Description
Total LCCA	Overall cost of the alternative.
Initial cost	Availability of current funds to construct the corridor project.
User cost during construction	Adverse affects to the traveling public during the construction phase.
User cost during maintenance	Future traffic volume may adversely affect the traveling public.
Future rehabilitation efforts	Feasibility of maintenance funds required for future work.
Conservation of materials	Recycling the existing materials into the corridor project.
Impact to Local Businesses	Access to stores may affect the revenue of the business.
Constructability	Required construction techniques.
Intersections	Design issues to ensure structural adequacy.
Warranty	Benefit of the experimental feature.
Evaluation of new technology	Advances in technologies may benefit CDOT or the public if they are incorporated.
Traffic Control	If multiple phases are anticipated or the closure of one lane versus a detour.

The above process should be completed by the time of the field inspection review meeting.

After the Chief Engineer has concurred with the preferred alternative for the corridor, no changes to the pavement type will be made unless directed by the Chief Engineer.

References

1. Goldbaum, Jay, *Life Cycle Cost Analysis State-of-the-Practice*, Final Report, Report No. CDOT-R1-R-00-3, Colorado Department of Transportation, March 2000.
2. Demos, George Paul, *Life Cycle Cost Analysis and Discount Rate on Pavements for the Colorado Department of Transportation*, Final Report, Report No. CDOT-2006-17, Colorado Department of Transportation, October 2006.
3. *Life-Cycle Cost Analysis Primer*, Report FHWA IF-02-047, Office of Asset Management, U.S. Department of Transportation, Federal Highway Administration, 400 7th Street, SW, Room 3211, Washington, DC 20590, August 2002.
4. *Life-Cycle Cost Analysis in Pavement Design - In Search of Better Investment Decisions*, Pavement Division Interim Technical Bulletin, Publication No. FHWA-SA-98-079, U.S. Department of Transportation, Federal Highway Administration, 400 7th Street, SW, Washington, DC 20590, September 1998.
5. *Economic Analysis Primer*, Publication No. FHWA IF-03-032, U.S. Department of Transportation, Federal Highway Administration, Office of Asset Management, 400 7th Street, SW, Room 3211, Washington, DC 20590, August 2002.
6. Harris, Scott, *Colorado Department for Transportation's Current Procedure for Life Cycle Cost Analysis and Discount Rate Calculations*, Final Report, Report No. CDOT-2009-2, Colorado Department of Transportation, January 2009.
7. Shuler, Scott and Schmidt, Christopher, *Performance Evaluation of Various HMA Rehabilitation Strategies, Final Report*, Report No. CDOT-2008-9, Colorado Department of Transportation, December 2008.

CHAPTER 14 PAVEMENT JUSTIFICATION REPORTS

14.1 Introduction

The intent of this chapter is to provide advice, recommendations, and information needed for a pavement justification report (PJR) to ensure continued quality of pavement structural designs. The final structural design section must be based on a thorough investigation of project specific conditions including materials, environmental conditions, projected traffic, life cycle economics, and performance of other similar structural sections with similar conditions in the same area.

14.2 Pavement Justification Report (PJR)

The designer shall assemble a PJR for all appropriate projects. As stated in **CHAPTER 13**, not every project will require a life cycle cost analysis, but every project should have a rational basis for the selection of the pavement type or rehabilitation alternative. The PJR documents the analysis and procedure the Region used to arrive at its selection of pavement type or rehabilitation method. HMA overlays less than 2 inches are considered a preventive maintenance treatment, and therefore a PJR report may not be required. Submit pavement justification letter (supporting documentation may not be required) to Pavement Design Manager in the Materials and Geotechnical Branch on all surface treatment projects and all new or reconstruction projects with Hot Mix Asphalt (HMA) or Portland Cement Concrete Pavement (PCCP) material costs greater than \$2,000,000. The PDPM will not need PJRs for access and local agency projects. As a minimum, the report should include the following:

- An analysis supporting the pavement type selection or rehabilitation method.
- Life cycle cost analysis of alternate designs.
- Pavement distress survey of existing pavements.
- Pavement thickness calculations of alternate designs.
- Surfacing plan sheet quantities (FIR or post-FIR).
- Final recommendations for typical sections.

A copy of the pavement justification report should be maintained in the Region.

14.2.1 General Information in a PJR

The following items, as applicable, should be included in a PJR for each CDOT project:

- The proposed type of construction such as rehabilitation or, reconstruction.
- Proposed location and type of facility.
- Special construction requirements such as:
 - Backfilling.
 - Use of geotextile.
 - Temporary dewatering.
- Geometric problems.
- Utilities.
- Tabulation of input design data and assumed values (both flexible and rigid pavements).

- Applicable CDOT forms, worksheets, and checklists.
- References, etc.

14.2.2 Site Conditions

The following applicable items should be included in a PJR on the site conditions:

- Fill and cut situations.
- Excavation requirements.
- Backfilling requirements.
- Topography, elevation, and land use.
- General geology.
- Geotechnical Investigation.
 - Drill exploratory borings at site.
 - Location and date of task
 - Subsurface conditions (boring logs).
- Laboratory testing.
- Environmental and drainage issues.
- Design approaches to provide removal of water from paved areas such as trench drain and blanket drain (drain detail and length).
- Drainage coefficients.
- Other construction-related issues to the site.

14.2.3 Subgrade Materials

The following applicable items should be included in a PJR on the subgrade materials:

- Soil and bedrock classification using AASHTO method.
- Hveem test/ R-values, resilient modulus, correlation of soil classification and k-value.
- Slope stability requirements.
- Special requirements for subgrade.

14.2.4 Design Traffic

- Traffic data (design 18-kip ESAL and volume).
- Reliability factor.

14.2.5 Pavement Materials Characteristics

- Layer coefficients for subbase, base, base course materials, pavement course materials.
- Pavement distress types and severity (PMS Data).
- Nondestructive testing (NDT) and falling weight deflectometer (FWD).

14.2.6 Pavement Design and Selection Process

The PJR should include all appropriate documentation on the pavement design and selection process used to determine pavement type and thickness. Refer to the following items for general guidelines in performing the pavement design and selection process:

- Follow steps in **CHAPTER 6** and **CHAPTER 7** for Pavement Selection Process for new construction/reconstruction projects.
- Follow steps in **CHAPTER 8**, **CHAPTER 9** and **0** for Rehabilitation Alternative Selection Process for Resurfacing, Rehabilitation, and Restoration projects whichever is applicable or Follow steps in **CHAPTER 11** and **CHAPTER 12** for Pavement Selection Process for Intersections.
- Perform LCCA using **CHAPTER 13** as a guide.
- Tabulate results of pavement design and LCCA.

14.3 Guidelines for Data on Plan Sheets

The following items should be placed on plan sheets:

- Pavement design information
- Preliminary soil boring information.
- Coring information of existing pavement, for information only, if applicable.
- State cold milling thicknesses and locations of paving fabric, for information only, if applicable.
- When specifying Class E concrete state required strength in required time period.
- When specifying concrete items, state required sulfate level for project.

APPENDIX A

PROCEDURES FOR FORENSIC STUDY OF DISTRESS OF HOT MIX ASPHALT AND PORTLAND CEMENT CONCRETE

A.1 Introduction

This Section covers the procedure for evaluating premature distress of hot mix asphalt (HMA), Stone Matrix Asphalt (SMA) and Portland Cement Concrete Pavement (PCCP). The procedure calls for reviewing the type of distress with a visual analysis and recommending a sampling and testing program; this could be called a forensic study. Finally, the cause, potential solution, and recommendation for rehabilitation will be reported.

A.2 Formation of an Evaluation Team

A team will be established to perform the evaluation. The Region Materials Engineer, in consultation with all potential team participants, will make the final determination as to the level of investigation that will be required. The team may include members from the following areas or disciplines:

- Materials and Geotechnical Branch.
- Project Development Branch.
- Region Materials.
- Region Design.
- Region Construction (Project Engineer/Resident Engineer).
- Region Maintenance (Maintenance Superintendent/Supervisor).
- Industry.
- National Experts.

Contractor participation should be dependent on the status of the project, closed or not.

A.3 Levels of Investigation

Based on the degree of complexity and severity of the pavement distress and the urgency of the required response, the following three-tiered investigation levels are recommended:

A.3.1 Level I (CDOT Region)

The team may consist of Region personnel with expertise in various areas of disciplines including Materials, Design, Construction, and Maintenance. Based upon preliminary information and data, the pavement distress is determined to have a low degree of complexity and severity. Preliminary survey indicates the cause can be easily identified.

The investigation should include at least the following:

- Visual Analysis.
- Investigational requirements.
- Required core samples and testing.

Complete the final report if the problem is resolved. If not, the investigation should proceed to Level II.

A.3.2 Level II (CDOT Statewide)

The team may consist of individuals from Section **A.3.1 Level I (CDOT Region)** along with personnel from CDOT Materials and Geotechnical Branch, Project Development Branch, FHWA, and industry representation (ACPA, Asphalt Institute, CAPA, etc.). Findings from the first level of investigation will be re-evaluated. The pavement distress is concluded to have a moderate degree of complexity and severity. Re-evaluation of initial findings indicates the cause is difficult to ascertain.

The investigation should include at least the following:

- Visual analysis.
- Investigational requirements.
- Required core samples and testing.
- Pavement slab samples may be obtained for further testing.
- Deflection Analysis may also be conducted.

Complete the final report if the problem is resolved. If not, the investigation will proceed to Level III.

A.3.3 Level III (National Effort)

The team will consist of individuals from Sections **A.3.1 Level I (CDOT Region)** and **A.3.2 Level II (CDOT Statewide)** along with national experts from FHWA, AASHTO, and other state DOTs, or other government entities. Findings from the first and second levels of investigation will be re-evaluated again. The pavement distress is concluded to have a high degree of complexity and severity. The cause of the pavement distress is determined to be highly complex.

The investigation should include at least the following steps:

- Visual Analysis.
- Investigational requirements.
- Required core samples and testing.
- Pavement slab samples may be obtained for further testing.
- Deflection analysis may also be conducted.
- Other tests as necessary.

A.4 Site Investigation

A.4.1 Visual Analysis

The first step in investigating the pavement distress is to perform a complete and comprehensive visual analysis of the entire project. Emphasis will be placed on the distressed areas. See **Figure A.1 Pavement Condition Evaluation Checklist (Rigid)** and **Figure A.2 Pavement Condition Evaluation Checklist (Flexible)** for Pavement Evaluation Checklists for both pavement types. These figures are restatements of **Figure 8.2** and **Figure 9.2**. Guidelines on how to perform the visual distress survey can be found in the *Distress Identification Manual for the Long-Term Pavement Performance Program*. This FHWA publication (1) includes a comprehensive breakdown of common distresses for both flexible and rigid pavements.

Information gathered should include:

- Date.
- Reviewers.
- Project location and size.
- Traffic data.
- Weather information.
- Extent of distress.
- Detailed information concerning each distressed area.
- Photographs of the typical distress on the project will be included.
- Any other problems that are visible (drainage, frost problems, dips or swells, etc.) should be recorded.

In general, each individual distress type should be rated for severity and the extent (amount) of the distress noted. When determining severity, each distress type can be rated as low, medium (or moderate), or high. This will not apply for some distresses, such as bleeding, which will be characterized in terms of number of occurrences.

When measuring and recording the extent or amount of a certain distress, each should be rated consistent with the type of distress. For example, alligator cracking is normally measured in terms of affected area. As a result, the overall amount of alligator cracking is recorded in terms of total square feet of distress. Alternatively, for quick surveys, the overall amount of alligator cracking can be recorded as a percentage of the overall area (i.e. 10%).

Other distresses, such as cracking, are recorded as total number of cracks or number of cracks per mile, and the overall length of the cracks. For example, for transverse or reflection cracking it is appropriate to record the amount of distress in terms of number of cracks per mile (for each severity level), while for longitudinal cracks it is appropriate to record the total length recorded.

Any assumptions made during the investigation should also be noted.

PAVEMENT EVALUATION CHECKLIST (RIGID)

PROJECT NO.: _____ LOCATION: _____
 PROJECT CODE (SA #): _____ DIRECTION: _____ MP _____ TO MP _____
 DATE: _____ BY: _____
 TITLE: _____

TRAFFIC

- Existing _____ 18k ESAL/YR
- Design _____ 18k ESAL

EXISTING PAVEMENT DATA

- | | |
|-------------------------------------|----------------------------|
| - Subgrade (AASHTO) | - Shoulder Condition |
| - Base (type/thickness) | (good, fair, poor) |
| - Pavement Thickness | - Joint Sealant Condition |
| - Soil Strength (R/M _R) | (good, fair, poor) |
| - Swelling Soil (yes/no) | - Lane Shoulder Separation |
| - Roadway Drainage Condition | (good, fair, poor) |
| (good, fair, poor) | |

DISTRESS EVALUATION SURVEY

Type	Distress Severity*	Distress Amount*
Blowup		
Corner Break		
Depression		
Faulting		
Longitudinal Cracking		
Pumping		
Reactive Aggregate		
Rutting		
Spalling		
Transverse and Diagonal Cracks		
OTHER		

* Distress Identification Manual for the Long-Term Pavement Performance Program, U.S. Department of Transportation, Federal Highway Administration, Publication No. FHWA-RD-03-031, June 2003.

Figure A.1 Pavement Condition Evaluation Checklist (Rigid)

PAVEMENT EVALUATION CHECKLIST (FLEXIBLE)

PROJECT NO.: _____ LOCATION: _____
 PROJECT CODE (SA #): _____ DIRECTION: _____ MP _____ TO MP _____
 DATE: _____ BY: _____
 TITLE: _____

TRAFFIC

- Existing _____ 18k ESAL/YR
- Design _____ 18k ESAL

EXISTING PAVEMENT DATA

- Subgrade (AASHTO) _____
- Base (type/thickness) _____
- Soil Strength (R/M_R) _____
- Roadway Drainage Condition (good, fair, poor) _____
- Shoulder Condition (good, fair, poor) _____

DISTRESS EVALUATION SURVEY

Type	Distress Severity*	Distress Amount*
Alligator (Fatigue) Cracking		
Bleeding		
Block Cracking		
Corrugation		
Depression		
Joint Reflection Cracking (from PCC Slab)		
Lane/Shoulder Joint Separation		
Longitudinal Cracking		
Transverse Cracking		
Patch Deterioration		
Polished Aggregate		
Potholes		
Raveling/Weathering		
Rutting		
Slippage Cracking		
OTHER		

* Distress Identification Manual for the Long-Term Pavement Performance Program, U.S. Department of Transportation, Federal Highway Administration, Publication No. FHWA-RD-03-031, June 2003.

Figure A.2 Pavement Condition Evaluation Checklist (Flexible)

The decision to use the Falling Weight Deflectometer (FWD) will be determined based upon the visual analysis. When the decision has been made to use the FWD, the following steps will be followed:

Deflection tests will be taken throughout the problem areas to determine the extent of the distress. Normal deflection testing frequency is ten sites per mile. However, within an area of concern, a minimum of 30 FWD testing sites will need to be selected. For comparison and control purposes, it is recommended to perform a minimum of 10 FWD tests outside of each end of the area of concern per lane segment. For the control segment, a 200-foot interval between FWD test sites will be used. The deflection analysis will be reviewed for elastic modulus of each layer to determine the in-place strength of the problem. The required design overlay thickness analysis will then be performed.

A.4.2 Review of Construction Documents

Pertinent information from the mix design, binder tests, mixture tests, QC/QA results, and project diary should be reviewed.

A.4.3 Investigational Requirements

After the visual analysis report has been evaluated, the second step of this procedure requires the determination of the investigational requirements. The requirements will depend on the type and extent of the pavement failure. It is recommended to obtain samples of the pavement adjacent to the distress area for comparison and control purposes. A minimum of 5 samples per lane is required outside of each end of the distress area.

A list of investigational requirements may include:

- Core sampling and testing plan.
- Slab sampling of pavement for testing and evaluation.
- Base and subgrade sampling and testing.
- Deflection analysis.
- Transverse cracking in concrete slab.

A.4.4 Required Core Samples and Testing

Samples of materials at the pavement distress location shall be taken so the tests can be performed to evaluate the problem areas.

For reporting purposes, the core location should be as accurate as possible. The samples shall be submitted to the Materials and Geotechnical Branch for testing unless otherwise specified.

A.4.4.1 Core Samples from Hot Mix Asphalt and PCCP

Samples shall be taken of each HMA, SMA or PCCP layer with at least five 4-inch cores from all locations (bad area, a shoulder next to the bad area, and a good area). Larger cores are preferred

if possible. Each layer of HMA, SMA or PCCP should be tested separately. Contact the Materials and Geotechnical Branch for sampling and removal processes and procedures. In some cases, slab samples may indicate distresses not usually seen in core samples.

A.4.4.2 Base and Subgrade Samples

When obtaining samples of the base and subgrade materials, a sufficient area of HMA, SMA or PCCP should be removed for adequate testing and sampling of each layer of material.

Testing shall include but not limited to:

- Applicable Colorado, AASHTO and ASTM test procedures.
- Nuclear gauge density and moisture determination.
- Soil classification.
- R-value.
- Proctor testing.

A.5 Final Report

A summary of the tests and other investigational requirements will be submitted to the Materials Advisory Council (MAC) upon the completion of all testing and analysis. The final report will be catalogued in the Technology Transfer Library and copies will be available for loan. The report should include some or all of the following items as applicable:

- Project Overview:
 - Type of pavement (HMA, SMA or PCCP).
 - Location and size of project
 - Traffic data
 - Weather conditions
 - When distress developed
 - Historical distresses
- Visual Inspection:
 - Type, extent and location of distress
 - Photographs
- Summary of Construction Records:
 - Mix design
 - Central laboratory check tests (Stability, Lottman, Binder tests, Compacted Specimen Tests, Concrete Compressive/Flexural Strength, Chemical tests)
 - Quality Control test results (density, gradation, asphalt, portland cement)
 - Project diaries

- Core Sampling and Testing Results:
 - Thickness.
 - Core location and map.
 - Density and air voids.
 - Asphalt content.
 - Gradation.
 - Vacuum extraction and asphalt cement penetration.
 - Geologic analysis of aggregates.
 - Portland cement chemical tests.
 - Petrographic analysis.
 - Alkali-Silica Reactivity (ASR) tests.
 - Modulus of Elasticity.
 - Resilient Modulus.

- Slab Sample:
 - Thickness.
 - Areas of deformation.
 - Stripping.
 - Determination of subsurface deformation.
 - Any other items of note.

- Results of Sampling and Testing of Base and Subgrade:
 - R-value.
 - Gradation.
 - Classification testing.
 - Moisture and density.
 - Proctor results.

- Deflection Analysis:
 - Overlay thickness required.
 - Comparison to original overlay thickness.
 - Comparison with component analysis.

- Conclusions and Recommendations:
 - Apparent cause of failure.
 - Potential solutions to prevent future problems with other pavements.
 - Recommendations for rehabilitation of the distress location.

A.6 Funding Sources

Funds for investigation may come from the Regions and/or Staff Branches depending on the level of investigation. The Research Branch annually allocates funds for experimental and implementation programs. Therefore, if a situation arises, submit a request for assistance to the Research Implementation Council (RIC) as soon as deemed appropriate.

Reference

1. *Distress Identification Manual for the Long-Term Pavement Performance Program*, U.S. Department of Transportation, Federal Highway Administration, Publication No. FHWA-RD-03-031, June 2003.

APPENDIX B FORMS

The Colorado Department of Transportation (CDOT) uses the following forms:

COLORADO DEPARTMENT OF TRANSPORTATION DESIGN DATA <input type="checkbox"/> Metric <input type="checkbox"/> English Page 1 of 2 Status: <input type="checkbox"/> Preliminary <input type="checkbox"/> Final <input type="checkbox"/> Revised				Orig. date:		Project code # (SA#)		STIP #					
				Rev. date:		Project #		PE project code		PE project #			
				Revision #									
				Region #									
Prepared by:				Revised by:		Project description							
Date:				Date:		County1		County2		County3			
Submitted by Project Manager:				Approved by Preconstruction Engineer:		Municipality							
Date:						System code: <input type="checkbox"/> IM <input type="checkbox"/> NHS <input type="checkbox"/> STP <input type="checkbox"/> Other							
						Oversight by: <input type="checkbox"/> CDOT <input type="checkbox"/> FHWA <input type="checkbox"/> Other							
						Planned length:							
Geographic location													
Type of terrain <input type="checkbox"/> level <input type="checkbox"/> plains <input type="checkbox"/> rolling <input type="checkbox"/> urban <input type="checkbox"/> mountainous													
Description of proposed construction/improvement (attach map showing site location)													
1 Traffic (Note: use columns A, B, and/or C to identify facility described below)													
			Current year: _____			Future year: _____			Facility location				
Facility		ADT	DHV	DHV % trucks		ADT	DHV	Industrial	Commercial	Residential	Other		
A								<input type="checkbox"/>	<input type="checkbox"/>	<input type="checkbox"/>	<input type="checkbox"/>		
B								<input type="checkbox"/>	<input type="checkbox"/>	<input type="checkbox"/>	<input type="checkbox"/>		
C								<input type="checkbox"/>	<input type="checkbox"/>	<input type="checkbox"/>	<input type="checkbox"/>		
2 Rdwy class													
		Route	Refpt	Endrefpt	Functional classification		Facility type		Rural code				
1.													
2.													
3.													
3 Design standards (identify substandard items with an * in 1st column & clarify in remarks)													
		A=				B=				C=			
		Standard	Existing	Proposed	Ultimate	Standard	Existing	Proposed	Ultimate	Standard	Existing	Proposed	Ultimate
Surface type													
Typical section type													
# of travel lanes													
Width of travel lanes													
Shoulder width lt./median													
Shoulder width rt./outside													
Side slope dist. ("z")													
Median width													
Posted speed													
Design speed													
Max. superelevation													
Min. radius													
Min. horizontal SSD													
Min. vertical SSD													
Max grade													
Project under <input type="checkbox"/> 1R <input type="checkbox"/> 3R <input type="checkbox"/> 4R <input type="checkbox"/> Other: _____ criteria								Existing guardrail meets current standards: <input type="checkbox"/> yes <input type="checkbox"/> no					
<input type="checkbox"/> Variance in minimum design standards required <input type="checkbox"/> Justification attached <input type="checkbox"/> Request to be submitted <input type="checkbox"/> Bridge (see item 4) <input type="checkbox"/> See remarks								<input type="checkbox"/> Safety project not all standards addressed					
<input type="checkbox"/> Stage construction (explain in remarks)								Comments:					
Resurfacing projects													
<input type="checkbox"/> Recommendations concerning safety aspects attached													

CDOT Form #463 12/03

Figure B.1 Design Data (Page 1 of 2) (CDOT Form 463 12/03)

Page 2 of 2			Project code # (SA#)			Project #			Revise date			
4 Major structures												
S= to stay, R= to be removed, P= proposed new structure												
Structure ID#	▼	Length	Ref. point	Feature intersected	Standard width	Structure Rdwy	load	Horizontal clearance	Vertical clearance	Year built		
Proposed treatment of bridges to remain in place (address bridge rail, capacity, and allowable surfacing thickness)												
5 Project characteristics (proposed)						Median (type): <input type="checkbox"/> depressed <input type="checkbox"/> painted <input type="checkbox"/> raised <input type="checkbox"/> none						
<input type="checkbox"/> Lighting		<input type="checkbox"/> Handicap ramps		<input type="checkbox"/> Traffic control signals		<input type="checkbox"/> Striping						
<input type="checkbox"/> Curb and gutter		<input type="checkbox"/> Curb only		<input type="checkbox"/> Left-turn slots		<input type="checkbox"/> continuous width=						
<input type="checkbox"/> Sidewalk width=		<input type="checkbox"/> Bikeway width=		<input type="checkbox"/> Right-turn slots		<input type="checkbox"/> continuous width=						
<input type="checkbox"/> Parking lane width=		<input type="checkbox"/> Detours		<input type="checkbox"/> Signing		<input type="checkbox"/> construction <input type="checkbox"/> permanent						
<input type="checkbox"/> Landscaping requirements: (description)						<input type="checkbox"/> Other: (description)						
6 Right of Way				Yes	No	7 Utilities (list names of known utility companies)						
ROW &/or perm. easement required:				<input type="checkbox"/>	<input type="checkbox"/>							
Relocation required:				<input type="checkbox"/>	<input type="checkbox"/>							
Temp. easement required:				<input type="checkbox"/>	<input type="checkbox"/>							
Changes in access:				<input type="checkbox"/>	<input type="checkbox"/>							
Changes to connecting roads:				<input type="checkbox"/>	<input type="checkbox"/>							
8 Railroad crossings # of crossings: _____												
Recommendations												
9 Environmental			Type:	Approved on:			under Project Code:			Project #		
Comments												
10 Coordination												
<input type="checkbox"/> Withdrawn lands (power sites, reservoirs, etc.) cleared thru BLM or forest service office						Irrigation ditch name:						
<input type="checkbox"/> New traffic ordinance required						<input type="checkbox"/> Modify schedule of existing ordinance						
Municipality:												
Other:												
11 Construction method				noAd Reason:				Entity/Agency contact name:				
Advertised by:		<input type="checkbox"/> State		<input type="checkbox"/> Design		<input type="checkbox"/> Local F/A						
		<input type="checkbox"/> Local		<input type="checkbox"/> P.O.		<input type="checkbox"/> RR F/A						
		<input type="checkbox"/> None		<input type="checkbox"/> Study		<input type="checkbox"/> Utility F/A		Phone #:				
				<input type="checkbox"/> CDOT F/A		<input type="checkbox"/> Miscellaneous						
12 Remarks (include additional pages if needed)												

Original to Central Files - Copies to: Region Files, Region Environmental Program Manager, Staff ROW, Staff Bridge or other when appropriate.

Figure B.1 Design Data (Page 2 of 2) (CDOT Form 463 12/03)

COLORADO DEPARTMENT OF TRANSPORTATION Maintenance Project Request Form Form 463 M(revised)				
Today's Date: xx/xx/20xx		Proposed Ad Date: xx/xx/20xx	Proposed Completion Date: xx/xx/20xx	
Requestor Name: xxx		Phone: xxx-xxx-xxxx	E-Mail Address: xxx.xxx@dot.state.co.us	
Region No.: X	Main. Sect. No.: X	Project Type: Type of Project	FY: XX	Budget: \$ XXX.XXX.00
State Hwy No.: XXX	MP Limits: MP xxx.xx to xxx.xx	County(ies): XXXXXX		City(ies): XXXXXX
Maintenance Superintendent/Resident Engineer: XX			Phone: XXX-XXX-XXXX	
Design Project Manager: XX		Phone: XXX-XXX-XXXX	Cell: XXX-XXX-XXXX	
Construction Project Engineer: XX		Phone: XXX-XXX-XXXX	Cell: XXX-XXX-XXXX	
SAP CODING INFORMATION				
**SAP Work Order #: XXXXXXXXXXXX		**SAP Purchase Requisition #: XXXXXXXXXXXX		
**Requires Release by Business Office and Maintenance Superintendent prior to Advertisement				
Cost Center	Approp Code	Sub. Obj.	N/P	Report Category
XXXX	XXX	X	N or P	XXXX
Fund Number	Funds Center	Functional Area	GL Account	WBS Element
XXX	RXXXX-XXX	XXXX	XXXXXXXXXX	RXXXXXXXXX
SCOPE AND PROJECT DETAILS				
(Please provide as much detail as possible regarding Scope of Work) Roadway widths, project limits, preliminary quantities, repair/treatment type (Class of repair, type of surface treatment), temporary/permanent pavement marking, excavation and drainage considerations, Contract Time (Milestone, Working/Calendar Day) and Estimated Construction Duration; ADA Requirements (1.5 inch depth or greater). XX				
Material Requirements: Pavement treatment types and recommendations; Structure material considerations; Testing/Inspection requirements; Pavement Marking Types; Project Special Provisions. xxx				
Traffic Control Requirements: Regional Lane Closure Policy (Variance Considerations); Posted Speed/Reductions; Working Hour Restrictions (Night, Day, Special Events); Public Information; Pedestrian/Bicycle Considerations, Flagging; Signage, Preliminary Quantities. xxx				
CLEARANCES				
(See M-Project Manual, ROW, Utilities and Environmental Sections for more information regarding clearances)				
REGION ROW				
1. Existing ROW Boundaries Determined and Confirmed? Y/N		2. All project requirements constructed within boundary of existing ROW? Y/N		
3. Are Railroad or Temporary Easements Required? Y/N explain				
4. Is work in vicinity of National Forest, BLM, US Army Corps of Engineer Property? Y/N explain				
Notes: xxx				
REGION UTILITIES				
Note any known or observable utility/railroad facilities within project limits: xxx				
Are utility relocations anticipated? Y/N explain				
REGION ENVIRONMENTAL/STORM WATER MANAGEENT PLAN (SWMP)				
Environmental Clearance Form 128 from the respective Region Environmental Manager. SAP Approval Required SWMP/ Estimated Preliminary Items, Quantities and Force Accounts: xxx Additional Clearance/Considerations may include: Historical Clearance, Noise Variance, Hazardous Materials Testing (Lead, Asbestos, etc.), Army Corps of Engineers Permit, Habitat Protection (Swallows, Prairie Dogs, Preble Mouse, etc.), Dewatering Treatment.				
Information for Project Number and Project Definition obtained from SAP		M-Proj Number: RXXXX-XXX	M-Proj Definition: XXXXX	

CDOT FORM # 463M Rev-4/10

Figure B.2 Maintenance Project - Request Form (CDOT Form 463M Rev 4/10)

APPENDIX C

DEFLECTION TESTING AND BACKCALCULATION

C.1 Introduction

Deflection testing is the measurement of the structural strength of the roadway. CDOT has utilized many devices to evaluate the strength of the existing road: the Falling Weight Deflectometer (FWD), the Dynaflect, the Benkelman Beam, and the heel of the Engineer's shoe. CDOT has owned a FWD since April 19, 1988. The FWD is a device capable of applying dynamic loads to the pavement surface, similar in magnitude and duration to that of a single heavy moving wheel. The response of the pavement system measured in terms of vertical deformation, or deflection, of the pavement structure over a given area using seismometers (geophones). Deflection testing devices are considered non-destructive testing (NDT) devices. The FWD as a NDT device should never apply a load to the pavement so great that it will not rebound fully.

FHWA (LTPP) approached CDOT in 2002 to become a Regional Calibration Center. The MAC discussed this topic in 2003. CDOT agreed to become a national calibration center in 2003 taking the program over from Nevada DOT. The SHRP/LTPP FWD Calibration Protocol was implemented in 1992 and since then, hundreds of calibrations have been performed in the U.S. Since that time the experience gained calibrating FWDs has shed light on opportunities for improving the calibration process, however changes in computer technology have rendered some calibration equipment nearly obsolete. Many State Highway Agencies, including CDOT, had expressed interest in updating the FWD calibration software and equipment and establish a long term plan for support of the calibration facilities and their services. A Transportation Pooled Fund Study TPF-5(039) entitled "Falling Weight Deflectometer (FWD) Calibration Center and Operational Improvements" was conducted over several years and revised the calibration protocol, updated the equipment and produced new calibration software. (Details can be found at: http://www.fhwa.dot.gov/pavement/pub_details.cfm?id=729). CDOT was extensively involved in the pooled fund study in developing and testing the new calibration procedures and software.

The CDOT FWD will be calibrated annually using the CDOT FWD calibration center. Any consultant engineering company that performs design work for CDOT requiring FWD data shall schedule the CDOT FWD to perform the FWD testing. If the CDOT FWD is not available to collect the data, the consultant engineering company may hire a consultant FWD. The consultant's FWD shall be calibrated at an approved FWD calibration center not more than one year prior to performing the FWD data collection.

For more information on FWD test protocols, consult with the Concrete and Physical Properties Program (CPPP) Unit of the CDOT Materials and Geotechnical Branch.

The most cost effective strategy will most likely involve maximum utilization of resources. The existing pavement should be considered as a resource that is already in place. The structural value of the existing pavement needs to be thoroughly investigated and determined. Deflection measurements and analysis will yield structural values of in-place pavements and identify weak zones. During the pavement analysis portion of the thickness design, the designer should compare

the information obtained from the deflection data against that noted in the distress survey. Deflection readings do not always address the total scope of corrective action needed, especially in areas with substantial distress conditions present. It is recommended that the designer use a profile plot of distress and deflection to identify areas requiring additional consideration. In areas of high distress, verifying the deflection analysis with a component analysis may be desirable.

Deflection testing and backcalculations are most highly recommended to obtain a k-value of a soil. This method is suitable for analyzing existing pavements to obtain a k-value. Sometimes a design of similar pavements in the same general location on the same type of subgrade may be appropriate, i.e. at an interchange location.

A procedure is outline in the 1998 AASHTO Supplement to compute the dynamic k-value using FWD. The dynamic k-value must then be converted to the initial static k-value. Divide the mean dynamic k-value by two (2) to estimate the mean static k-value for design.

Several software tools are available for production data processing and analysis. The purpose of this section is to provide guideline for engineers to follow when setting up FWD testing on a project and for analyzing results. CDOT recommends using the software MODTAG.

MODTAG is a software tool to allow an engineer to analyze FWD data quickly and efficiently using empirical (Appendix L of the *AASHTO Guide for Design of Pavement Structures – 1993*) and mechanistic-empirical (MODCOMP) methods and procedures. MODTAG is an in-house software tool developed in cooperation by Virginia DOT and Cornell University's Local Roads Program. MODTAG operates in US Customary and Metric Units. However, some of the routines are not available when a metric analysis is selected. MODTAG is being provided without technical/engineering or software support to users outside Virginia DOT. Additional information on analyzing the testing results can be found in the document titled *MODTAG Users Manual* in the software MODTAG.

This appendix is based on CDOT's truck mounted JILS-20T FWD with on board JTEST™ software. If other FWD owners use this appendix, they should follow their manufacturers' recommendations. For example, the one drop setting and drop weight is associated with CDOT's FWD.

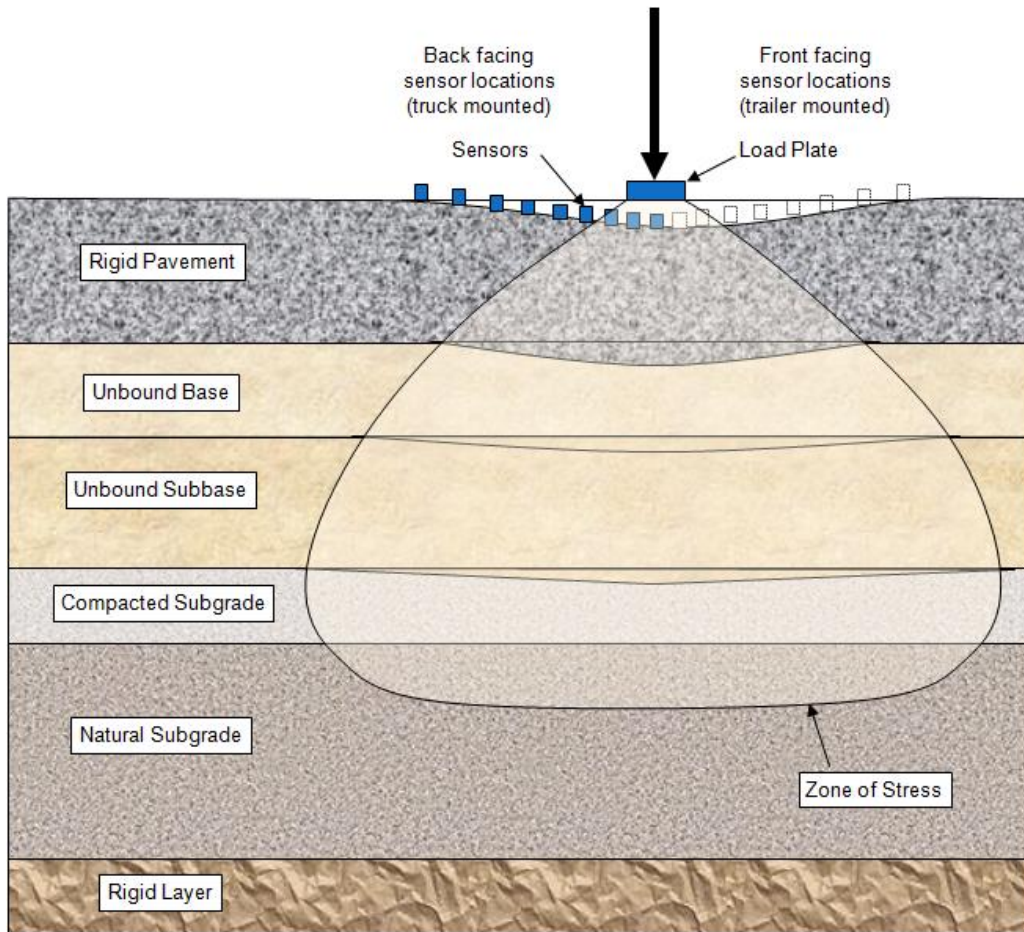

Figure C.1 Depiction of FWD Load Distribution through Pavement

C.2 FWD Testing – Flexible Pavements

For flexible pavements, FWD testing is used to assess the structural capacity of the pavement and estimate the strength of subgrade soils. In addition to the structural capacity, the elastic modulus for the surface, base and subbase layers can be determined.

C.2.1 FWD Testing Pattern - Flexible Pavement

The FWD testing pattern selected for a project should be related to the project's size and layout. The Pavement Engineer should consider the number of lanes to be tested, total length of the project, and any unusual circumstances that would require a change in the testing pattern.

- **Project Layout** - the project layout will influence the FWD testing pattern. For projects where the pavement is to be repaired in each direction, then travel lanes in each direction should be tested. Typically, this should be the outside travel lane. For projects where only one direction will be repaired and more than two lanes exist, then testing should be conducted on the outside lane and possibly inside lane. The inside lane should be tested if:

- Pavement structure is different from the outside lane,
- More load related distress is present as compared to the outside lane, or
- Heavy truck traffic uses the lane (lane is prior to a left exit).

For projects that contain multiple intersections, then FWD testing may not be possible due to traffic. However, where possible testing should be conducted at approaches and departures to an intersection.

- **Project Size** - the size of a project will influence the test spacing. The project size is determined by the directional length of pavement to be repaired, not necessarily the centerline length. For example, a project that has a centerline distance of one mile and will be repaired in two directions has a directional length of two miles. Therefore, the test spacing should be based on two miles. **Table C.1 Flexible Pavement Test Spacing Guidelines** contains guidelines based on project size, test spacing, and estimated testing days. A testing day is defined as 200 locations tested.
- **Testing Days** - **Table C.1 Flexible Pavement Test Spacing Guidelines** shows the approximate testing days of actually doing the drop testing. Additional time must be allotted for traffic control setup and travel time to the test site. It may also be required to have a pre-testing meeting with the Pavement Engineer.

Table C.1 Flexible Pavement Test Spacing Guidelines

Project Size (miles)	Test Spacing (feet)	Approximate Number of Tests	Testing Days
0 – 0.5	25	75	½ day
0.5 – 1.0	50	90	½ day
1.0 – 2.0	50	175	1 day
2.0 – 4.0	100	175	1 day
4.0 – 8.0	150	200	1 to 1 ½ days
> 8.0	200	>200	> 1 ½ days

For two or three lane bi-directional roadways not separated by a median, the testing should be staggered by one-half the test spacing. See **Figure C.2 Flexible Pavement Staggered Testing Pattern** for clarification. For projects that are separated by a median, a staggered testing pattern is not required.

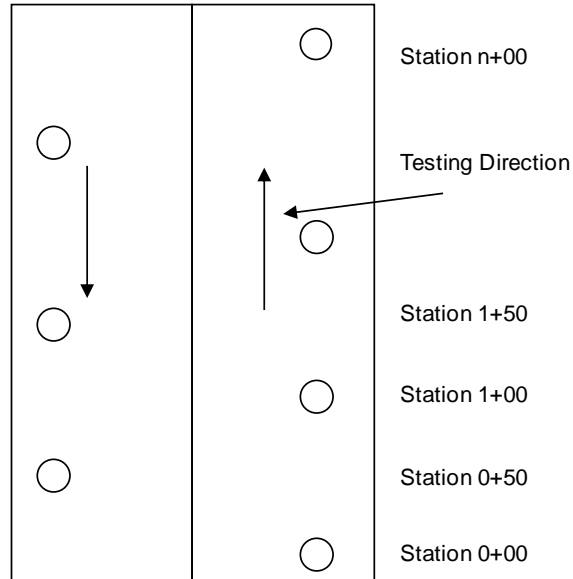

Figure C.2 Flexible Pavement Staggered Testing Pattern

Basin Testing Location - for flexible pavements, FWD testing should be conducted in the wheel path closest to the nearest shoulder. This type of testing is known as basin testing since deflection measurements from all sensors may be used; refer to **Figure C.1 Depiction of FWD Load Distribution through Pavement**. The purpose of this testing is to characterize the structural condition of the pavement where damage due to truck loading should be the greatest. For the outside lanes, testing should be conducted in the right wheel path. For inside lanes, testing should be conducted in the left wheel path.

C.2.2 FWD Drop Sequence – Flexible Pavement

Drop sequences vary based on pavement type and the type of information being gathered. Drop sequence is defined as the order in which impulse loads are applied to the pavement. This includes the “seating drops” and the recorded impulse loads. Below is the recommended drop sequence for basin testing on flexible pavements:

- Two Seating Drops at 6,000 pounds
- Three Recorded Drops at 6,000 pounds
- Three Recorded Drops at 9,000 pounds
- Three Recorded Drops at 12,000 pounds
- Three Recorded Drops at 16,000 pounds

Therefore, at each test location the FWD will perform 14 drops and record four sets of deflection and impulse load data. By performing multiple drops at a location, the pavement will react as a homogeneous structure as well as reduce the errors in measurement. Additionally, by recording and analyzing data from four different load levels, the Pavement Engineer can determine if the materials on the project are stress sensitive (non-linearly elastic), if a hard bottom (water table, bedrock or extremely stiff layer) is present, and if compaction/liquefaction is occurring in the subgrade.

C.2.3 FWD Sensor Spacing – Flexible Pavement

FWD sensor spacing to record pavement deflection data is dependent on the pavement type as well as the testing purpose (load transfer testing vs. basin testing). For basin testing on flexible pavements, the recommended spacing from the center of the load plate is given below:

0, 8, 12, 18, 24, 36, 48, 60, and 72 (inches)

C.2.4 Surface Temperature Measurement – Flexible Pavement

Ideally, the pavement temperature will be recorded directly from temperature holes at each test location as the FWD test is being performed. While this is the preferred approach for research projects, it is not practical for production level testing (maintenance and rehabilitation projects). Therefore, for production level testing the economic and practical approach is by measuring the surface temperature at each test location. This can be easily done using an infrared thermometer. The FWD can automatically measure and record the pavement surface temperature to the FWD file. If the FWD is not equipped with an Infrared thermometer, then the FWD operator can use a hand held thermometer and record the temperature to a file. By measuring and monitoring the surface temperature during testing, the FWD operator can suspend testing if the pavement becomes too hot.

C.3 FWD Testing – Rigid Jointed Plain Concrete Pavements

For rigid pavements, FWD testing is used to assess the structural capacity of the pavement, estimate the strength of subgrade soils, assess load transfer at joints, and detect voids at joints. In addition to the structural capacity, the elastic modulus for the surface, base and sub-base layers can be determined.

C.3.1 FWD Testing Pattern – Rigid Pavement

The FWD testing pattern selected for a jointed concrete pavement project should be related to the project's layout, project size, and slab length. The Pavement Engineer should consider the number of lanes to be tested, total number of slabs, length of the project, and any unusual circumstances that would require a change in the testing pattern.

- Project Layout - the project layout will influence the FWD testing pattern. For projects where the pavement is to be repaired in each direction, then travel lanes in each direction should be tested. Typically, this should be the outside travel lane. For projects where only one direction will be repaired and more than two lanes exist, then testing should be conducted on the outside lane and possibly inside lane. The inside lane should be tested if:
 - Pavement structure is different from the outside lane,
 - More load related distress is present as compared to the outside lane, or
 - Heavy truck traffic uses the lane (lane is prior to a left exit).

For projects that contain multiple intersections, then FWD testing may not be possible due to traffic. However, where possible testing should be conducted at approaches and departures to an intersection.

- Slab Length and Project Size - the number of jointed concrete slabs in a project will determine test spacing. For projects with short slab lengths, it may not be practical to test every slab (basin and joint testing).

In addition to slab length, the size of a project will influence the test spacing. The project size is determined by the directional length of pavement to be repaired, not necessarily the centerline length. For example, a project that has a centerline distance of 1 mile and will be repaired in two directions has a directional length of 2 miles. Therefore, the test spacing should be based on two miles. **Table C.2 Jointed Plain Concrete Pavement Test Spacing Guidelines** contains guidelines based on project size, approximate slab length, test spacing, and estimated testing days. A testing day is defined as 175 locations tested (joints, corners and basins).

- Testing Days - **Table C.2 Jointed Plain Concrete Pavement Test Spacing Guidelines** shows the approximate testing days of actually doing the drop testing. Additional time must be allotted for traffic control setup and travel time to the test site. It may also be required to have a pre-testing meeting with the Pavement Engineer.

- Rigid and Composite Basin Testing - The standard procedure will be basin testing only. If additional testing of joint and corner testing is required, a special request is to be submitted.

Table C.2 Jointed Plain Concrete Pavement Test Spacing Guidelines

Project Size (miles)	Slab Length (feet)	Basin Test Spacing (no. of slabs)	Joint/Corner Spacing (no. of slabs)	Approximate Number of Tests	Testing Days
0 - 0.5	< 20	Every 6th Slab	Every 2nd J/C	115	1 day
0.5 – 1.0	< 20	Every 9th Slab	Every 3rd J/C	180	1 day
1.0 – 2.0	< 20	Every 12th Slab	Every 4th J/C	250	1 – 2 days
2.0 – 4.0	< 20	Every 15th Slab	Every 5th J/C	380	1½ - 3 days
4.0 – 8.0	< 20	Every 20th Slab	Every 10th J/C	220	1½ - 3 days
> 8.0	< 20	Every 20th Slab	Every 10th J/C	450	> 3 days
Note: Basin testing using spacings of every 20 th slab is more applicable to network testing than project testing.					

- Testing Location - for jointed concrete pavements, three types of FWD testing are generally conducted – basin, joint, and slab corner testing. Each test provides information on the structural integrity of the pavement.

Basin Testing - for jointed concrete pavements, basin testing should be conducted near the center of the slab (See **Figure C.3 JPCP Testing Pattern**). This testing provides information on the elastic modulus of the PCC and strength of base materials and subgrade soils.

Joint Testing - for jointed concrete pavements, joint testing should be conducted in the wheel path closest to the free edge of the slab (See **Figure C.3 JPCP Testing Pattern**). Typically, for the outside lanes, testing will be conducted in the right wheel path. For inside lanes, testing should be conducted in the left wheel path. If more than two lanes exist and the middle lanes are to be tested, then the nearest free edge must be determined. This testing provides information on joint load transfer – how well a joint, through either aggregate interlock and/or dowel bars, can transfer a wheel load from one slab to an adjacent slab.

Corner Testing - for jointed concrete pavements, corner testing should be conducted at the slab's free edge corner (See **Figure C.3 JPCP Testing Pattern**). Typically, for the outside lanes, testing will be conducted in the right corner edge of the slab. For inside lanes, testing should be conducted in the left corner edge of the slab. If more than two lanes exist, then the middle lanes should only be tested if pumping is suspected in the middle lanes. The Pavement Engineer will determine if pumping is present and if testing should be conducted. Unless otherwise directed by the Pavement Engineer, corner testing shall be conducted on the leave side of the joint where voids are typically

located. This testing provides information on the possibility for the presence of voids under a slab corner.

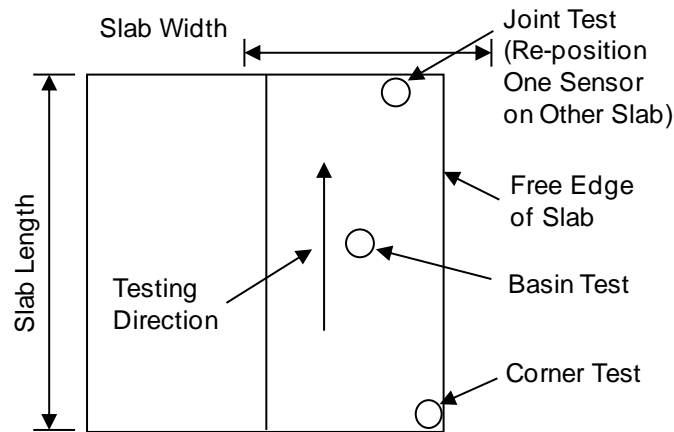

Figure C.3 JPCP Testing Pattern

C.3.2 FWD Drop Sequence – Rigid Pavement

When collecting pavement structure data, the correct drop sequence is required. Drop sequences vary based on pavement type and the type of information being gathered. Drop sequence is defined as the order in which impulse loads are applied to the pavement. This includes the “seating drops” and the recorded impulse loads.

- **Basin Testing** - below is the recommended drop sequence for basin testing on jointed concrete pavements:
 - Two Seating Drops at 6,000 pounds
 - Three Recorded Drops at 6,000 pounds
 - Three Recorded Drops at 9,000 pounds
 - Three Recorded Drops at 12,000 pounds
 - Three Recorded Drops at 16,000 pounds

Therefore, at each test location the FWD will perform 14 drops and record four sets of deflection and impulse load data. By performing multiple drops at a location, the pavement will react as a homogeneous structure as well as reduce the errors in measurement. Additionally, by recording and analyzing data from four different load levels, the Pavement Engineer can determine if the materials on the project are stress sensitive (non-linearly elastic), if a hard bottom (water table, bedrock or extremely stiff layer), and if compaction/liquefaction is occurring in the subgrade.

- **Joint Testing** - below is the recommended drop sequence for joint testing on jointed concrete pavements:
 - Two Seating Drops at 6,000 pounds
 - Three Recorded Drops at 6,000 pounds
 - Three Recorded Drops at 9,000 pounds
 - Three Recorded Drops at 12,000 pounds
 - Three Recorded Drops at 16,000 pounds

Therefore, at each test location the FWD will perform 14 drops and record four sets of deflection and impulse load data. Two sensors are needed for the analysis, the sensor at the load and the second sensor on the other side of the joint.

- **Corner Testing** - below is the recommended drop sequence for corner testing on jointed concrete pavements:
 - Two Seating Drop at 6,000 pounds
 - Three Recorded Drops at 9,000 pounds
 - Three Recorded Drops at 12,000 pounds
 - Three Recorded Drops at 16,000 pounds

In order to use the AASHTO procedure for the detection of voids, three different load levels are required; therefore, at each test location the FWD will need to perform 10 drops and record three sets of deflection and impulse load data. Only one sensor is needed in the analysis, the sensor at the load.

C.3.3 FWD Sensor Spacing – Rigid Pavement

FWD sensor spacing to record pavement deflection data is dependent on the pavement type as well as the type of testing. For jointed concrete pavements, three types of testing are performed - joint, corner and basin.

- Basin Testing - for basin testing on jointed concrete pavements, below is the recommended spacing:

0, 8, 12, 18, 24, 36, 48, 60, and 72 (inches)

- Joint Testing - for joint testing on jointed concrete pavements, only two sensors are required. Below is the required spacing:

0 and 12 (inches)

The sensors are to be placed on each side of the joint and are to be 6 inches from the joint (**Figure C.4 Joint Load Transfer Testing Sensor Spacing**).

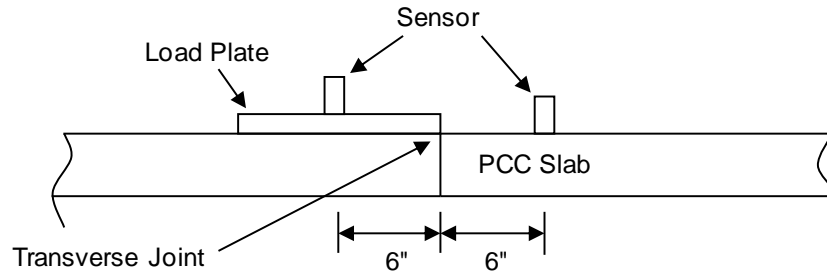

Figure C.4 Joint Load Transfer Testing Sensor Spacing

- Corner Testing - for joint testing on jointed concrete pavements, only one sensor is required. Below is the required sensor location:

0-inches - at the load

The sensor is to be placed on the leave side of the joint and is to be 6 inches from the joint (**Figure C.5 Corner Testing Sensor Location**).

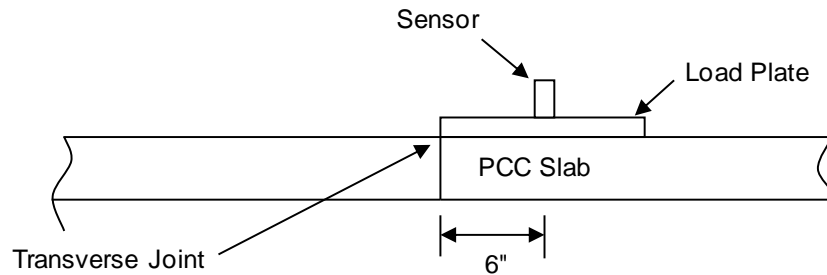

Figure C.5 Corner Testing Sensor Location

C.3.4 Surface Temperature Measurement – Rigid Pavement

Ideally, the pavement temperature will be recorded directly from temperature holes at each test location as the FWD test is being performed. While this is the preferred approach for research projects, it is not practical for production level testing (network level or maintenance and rehabilitation projects). Therefore, for production level testing the economic and practical approach is by measuring the surface temperature at each test location. This can be easily done using an infrared thermometer. The FWD can automatically measure and record the pavement surface temperature to the FWD file. If the FWD is not equipped with an Infrared thermometer, then the FWD operator can use a hand held thermometer and record the temperature to a file. By measuring and monitoring the surface temperature during testing, the FWD operator can suspend testing if the pavement becomes too hot. **Note:** Pavement Engineer - pavement temperature is recorded for joint and corner testing only.

C.4 FWD Testing – Composite Pavements

For composite pavements, falling weight deflectometer (FWD) testing is used to assess the structural capacity of the pavement and estimate the strength of subgrade soils as well as assess the load transfer at underlying joints. In addition to the structural capacity, the elastic modulus for the surface, base and subbase layers can be estimated.

C.4.1 FWD Testing Pattern – Composite Pavement

The FWD testing pattern selected for a project should be related to the project's size and layout. The Pavement Engineer should consider the number of lanes to be tested, total length of the project, and any unusual circumstances that would require a change in the testing pattern. In addition, the AC overlay thickness should be considered. If the thickness is less than four inches, then the load transfer of the underlying PCC joints may be performed.

- **Project Layout** - the project layout will influence the FWD testing pattern. For projects where the pavement is to be repaired in each direction, then travel lanes in each direction should be tested. Typically, this should be the outside travel lane. For projects where only one direction will be repaired and more than two lanes exist, then testing should be conducted on the outside lane and possibly inside lane. The inside lane should be tested if:
 - Pavement structure is different from the outside lane,
 - More load related distress is present as compared to the outside lane, or
 - Heavy truck traffic uses the lane (lane is prior to a left exit).

For projects that contain multiple intersections, then FWD testing may not be possible due to traffic. However, where possible testing should be conducted at approaches and departures to an intersection.

- **Project Size** - the size of a project will influence the test spacing. The project size is determined by the directional length of pavement to be repaired, not necessarily the centerline length. For example, a project that has a centerline distance of 1 mile and will be repaired in two directions has a directional length of 2 miles. Therefore, the test spacing should be based on two miles. **Table C.3 Composite Pavement Test Spacing Guidelines** contains guidelines based on project size, test spacing, and estimated testing days if load transfer testing is not performed. If load transfer testing is desired, then the appropriate spacing should be determined in the field. As a guideline, please refer to Joint/Corner Spacing column in **Table C.2 Jointed Plain Concrete Pavement Test Spacing Guidelines**. A testing day is defined as 200 locations tested.
- **Testing Days** - **Table C.3 Composite Pavement Test Spacing Guidelines** shows the approximate testing days of actually doing the drop testing. Additional time must be allotted for traffic control setup and travel time to the test site. It may also be required to have a pre-testing meeting with the Pavement Engineer.

- **Composite Basin Testing** - The standard procedure will be basin testing only. If additional testing of joint testing is required, a special request is to be submitted.

Table C.3 Composite Pavement Test Spacing Guidelines

Project Size (miles)	Test Spacing (feet)	Approximate Number of Tests	Testing Days
0 – 0.5	25	75	½ day
0.5 – 1.0	50	90	½ day
1.0 – 2.0	50	175	1 day
2.0 – 4.0	100	175	1 day
4.0 – 8.0	150	200	1 to 1½ days
> 8.0	200	> 200	> 1½ days

For two or three lane bi-directional roadways not separated by a median, the testing should be staggered by one-half the test spacing. See **Figure C.6 Staggered Testing Pattern** for clarification. For projects that are separated by a median, a staggered testing pattern is not required.

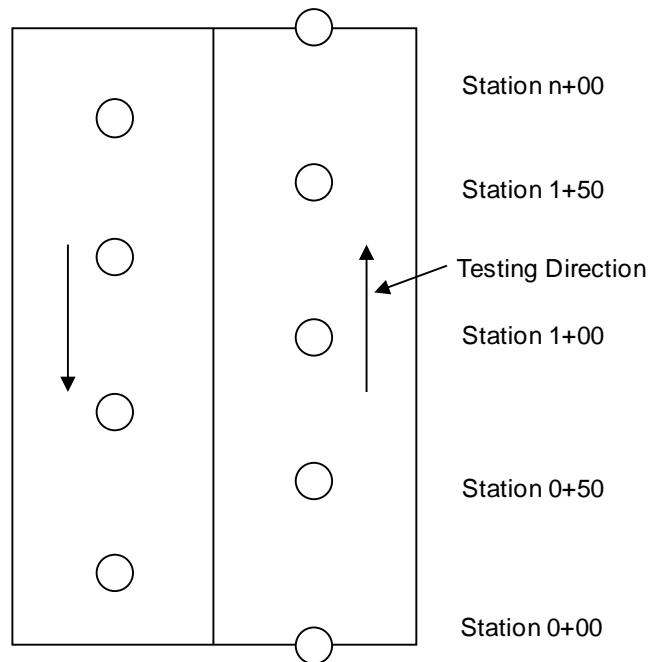

Figure C.6 Staggered Testing Pattern

Testing Locations - for composite pavements, two types of FWD testing are generally conducted – basin and joint. Each test provides information on the structural integrity of the pavement.

- **Basin Testing** - for composite pavements, basin testing should be conducted in the middle of the lane or near the center of the slab (See **Figure C.6 Staggered Testing Pattern**). This testing provides information on the elastic modulus of the AC, PCC and strength of base materials and subgrade soils.
- **Joint Testing** - for composite pavements, joint testing should be conducted in the wheel path closest to the free edge of the slab (See **Figure C.6 Staggered Testing Pattern**). Typically, for the outside lanes, testing will be conducted in the right wheel path. For inside lanes, testing should be conducted in the left wheel path. If more than two lanes exist and the middle lanes are to be tested, then the nearest free edge must be determined. This testing provides information on joint load transfer – how well a joint, through either aggregate interlock and/or dowel bars, can transfer a wheel load from one slab to an adjacent slab.

C.4.2 FWD Drop Sequence – Composite Pavements

When collecting pavement structure data, the correct drop sequence is required. Drop sequences vary based on pavement type and the type of information being gathered. Drop sequence is defined as the order in which impulse loads are applied to the pavement. This includes the “seating drops” and the recorded impulse loads.

- **Basin Testing** - below is the recommended drop sequence for basin testing on composite pavements:
 - Two Seating Drops at 6,000 pounds
 - Three Recorded Drops at 6,000 pounds
 - Three Recorded Drops at 9,000 pounds
 - Three Recorded Drops at 12,000 pounds
 - Three Recorded Drops at 16,000 pounds

Therefore, at each test location the FWD will perform 14 drops and record four sets of deflection and impulse load data. By performing multiple drops at a location, the pavement will react as a homogeneous structure as well as reduce the errors in measurement. Additionally, by recording and analyzing data from four different load levels, the Pavement Engineer can determine if the materials on the project are stress sensitive (non-linearly elastic), if a hard bottom (water table, bedrock or extremely stiff layer), and if compaction/liquefaction is occurring in the subgrade.

- **Joint Testing** - below is the recommended drop sequence for joint testing on composite pavements:
 - Two Seating Drops at 6,000 pounds
 - Three Recorded Drops at 6,000 pounds
 - Three Recorded Drops at 9,000 pounds
 - Three Recorded Drops at 12,000 pounds
 - Three Recorded Drops at 16,000 pounds

Therefore, at each test location the FWD will perform 14 drops and record four sets of deflection and impulse load data. Two sensors are needed for the analysis, the sensor at the load and the second sensor on the other side of the joint.

C.4.3 FWD Sensor Spacing – Composite Pavement

FWD sensor spacing to record pavement deflection data is dependent on the pavement type as well as the type of testing. For composite pavements, two types of testing are performed – joint, and basin.

- **Basin Testing** - for basin testing on composite pavements, below is the recommended spacing:

0, 8, 12, 18, 24, 36, 48, 60, and 72 (inches)
- **Joint Testing** - for joint testing on composite pavements, only two sensors are required. Below is the required spacing:

0 and 12 (inches)

The sensors are to be placed on each side of the joint and are to be 6 inches from the joint (See **Figure C.7 Joint Load Transfer Testing Sensor Spacing**).

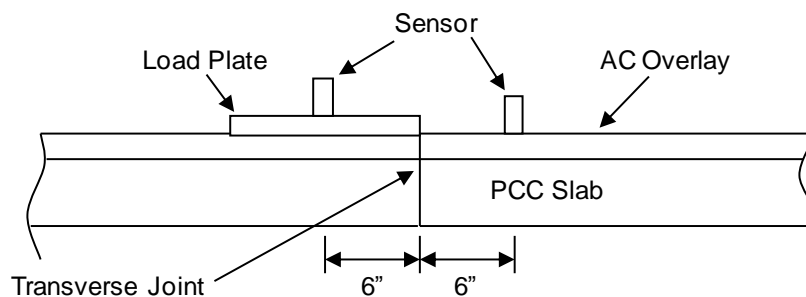

Figure C.7 Joint Load Transfer Testing Sensor Spacing

C.4.4 Pavement Temperature Readings – Composite Pavement

Ideally, the pavement temperature will be recorded directly from temperature holes at each test location as the FWD test is being performed. While this is the preferred approach for research projects, it is not practical for production level testing (network level or maintenance and rehabilitation projects). Therefore, for production level testing the economic and practical approach to determine the mid-depth pavement temperature is by measuring the surface temperature at each test location. This can be easily done using an infrared thermometer. The FWD can automatically measure and record the pavement surface temperature to the FWD file. If the FWD is not equipped with an Infrared thermometer, then the FWD operator can use a hand held thermometer and record the temperature to a file. Using temperature correlation models such as the BELLS3 equation, the mid-depth AC material temperature can be estimated.

C.5 Field Test Report

Additional documentation of the FWD project is necessary besides the FWD drop file. A suggested Field Test Report is presented (**Figure C.8 Field Test Report**).

A log entry should only be made for special conditions, such as test location skipped because it was on a bridge. The FWD operator does not test for frost depth.

C.6 FWD Data Processing

CDOT uses AASHTO PDDX file format in its FWD files. The following is an example of data collected at a test site:

```
*****  
[Test Location 1]  
TestLocation = 45.592  
TestLane = 1  
TestTemperatures = 93.5,105.1  
TestComment = 13:01  
NumberOfDrops = 3  
DropData_1 = 9120.00, 18.32, 12.43, 9.69, 6.95, 5.37, 3.32, 2.43  
DropData_2 = 9040.00, 17.98, 12.24, 9.57, 6.90, 5.42, 3.30, 2.43  
DropData_3 = 8990.00, 17.91, 12.18, 9.56, 6.92, 5.36, 3.31, 2.46  
    ↓  
    ↓  
*****
```

On the "Test Temperatures = 93.5,105.1" line, the first value "93.5" is the air temperature and the second value "105.1" is the pavement surface temperature.

The "Test Comment = 13:01" indicates that 1:01 PM is the time of the test. The time uses the 24-hr time format.

In order to process FWD data, many steps are required. These steps include gathering information on the pavement's surface condition, conducting a preliminary analysis on the deflection data, performing pavement coring and subgrade boring operations, processing of all the data collected, and analyzing, interpreting and reporting on the data results. Each one of these steps has numerous tasks associated with them. These steps are detailed in the following sections.

C.6.1 Pre-Analysis

Once FWD data are collected, it is important to perform a preliminary analysis on the deflection data. Please refer to the *MODTAG Users Manual* for further instruction on pre-analysis.

C.6.2 Pavement Surface Condition Survey

Prior to collecting any FWD data, the engineer should conduct a detailed pavement condition and patching survey. These surveys will help the engineer establish possible problem areas with the pavement and set-up the appropriate FWD testing plan. Testing could be concentrated in specific areas while other areas could be avoided completely. Refer to **Section 8.2.5 Non-Destructive Testing, Coring and Material Testing Program** and **Section 9.2.4 Non-Destructive Testing**. Once these data are collected, the engineer can plot the results on a straight-line diagram. This will be extremely beneficial when other data are collected and analyzed.

C.6.3 Pavement Coring and Subgrade Boring

In order to conduct an analysis of FWD data, the exact pavement structure must be known. For most roadways, the exact structure is not known; therefore, pavement coring is required. Coring provides thicknesses to be used as seed values for backcalculation analysis. Cores should be retained for further evaluation in the laboratory. Pavement cores identify layer types and conditions to help validate surface course moduli. In addition, while the engineer may know what type of subgrade soils exists in the project area, they cannot be sure without boring the subgrade and extracting samples. These materials collected in field can be analyzed in the lab, and the lab results used to validate FWD Data Analysis results.

The thickness of the existing pavement layers must be known. Cores must be taken at a minimum of one core per mile for pavement layer and base layer thickness measurements. When pavement length is less than one mile, a minimum of one core will be taken. If a review of the as built plans from previous projects indicates there are locations with varying thicknesses, more cores will be taken to verify the existing pavement thickness.

For the materials above the subgrade, the coring and boring crew should record:

- Layer Materials - Asphalt, PCC, Granular, Cement Treated, etc
- Layer Thickness - Thickness for each different layer
- Layer Condition - AC material stripped, PCC deteriorated, granular material contaminated, etc.
- Material Types - For AC Materials, identify various layer types

For the subgrade and base materials refer to **Section 4.2 - Soil Survey Investigation** for three steps that are necessary to conduct a subgrade and base investigation. Document findings and test results on CDOT Forms #554 (Soil Survey Field Report) and #555 (Preliminary Soil Survey). See **Figure C.9 Coring Log Example**.

COLORADO DEPARTMENT OF TRANSPORTATION											LOCATION					
PRELIMINARY PAVEMENT STRUCTURE INVESTIGATION											I-76, US 85 to Burlington Canal					
Date: 4/13/06 Page: 1 of 2 NOTE: If samples are submitted leave sieve analysis section blank.											SUBACCOUNT 15361					
STATION AND LOG	TEST NO.	DESCRIPTION	PERCENT PASSING								LIQUID LIMIT	PLASTIC INDEX	CLASSIFICATION AND GROUP INDEX	MOISTURE %	Mr P.S.I.	
			1"	3/4"	1/2"	3/8"	#4	#8	#16	#50						#200
I-76, US 85 to Burlington Canal																
Eastbnd. @ MP 12.5, Lane #2																
0-4.5"	1	HBP	Lift Thickness: 0-1.5", 1.5-2.5", 2.5-4.5" (New 1/2" mix)													
4.5-12"		PCCP	Lift Thickness: 4.5-12"													
12-28"		Roadbase	100	99	97	90	78	66	39	18.5			Class 3			
Eastbnd. @ MP 13, Lane #2																
0-4.5"	2	HBP	Lift Thickness: 0-1.5", 1.5-2", 2-4.5" (New 1/2" mix)													
4.5-12.75"		PCCP	Lift Thickness: 4.5-12.75"													
12.75+"		Roadbase similar as #1														
Eastbnd. @ MP 13.5, Lane #2																
0-4.25"	3	HBP	Lift Thickness: 0-1.5", 1.5-2", 2-4.25" (New 1/2" mix)													
4.25+"		PCCP	Did not core PCCP because of similar depths													
Eastbnd. @ MP 13.5, Shoulder																
0-6.75"	4	HBP	Lift Thickness: 0-1.5", 1.5-2.25", 2.25-3", 3-4.25" (New 1/2" mix), 4.25-6.75" (Old 1/2" mix) highly visible air voids													
6.75-12+"		Roadbase	100	96	92	77	58	38	15	6.2			Class 2			
Eastbnd. @ MP 14.5, Lane #2																
0-4"	5	HBP	Lift Thickness: 0-1", 1-1.75", 1.75-4" (New 1/2" mix)													
4-12.25"		PCCP	Lift Thickness: 4-12.25"													
12.25-16"		Roadbase	100	100	99	97	92	87	81	58	27.8					
16+"		Soil														
Eastbnd. @ MP 16, Lane #2																
0-4.5"	6	HBP	Lift Thickness: 0-2", 2-4.5" (New 1/2" mix)													
4.5+"		PCCP	Did not core PCCP because of similar depths													
Eastbnd. @ MP 16, Shoulder																
0-6.5"	7	HBP	Lift Thickness: 0-1.75" (New 1/2" mix), 1.75-2.5" (Chip Seal), 2.5-4.5", 4.5-6.5" (New 1/2" mix)													
6.5+"		Roadbase similar as #4														

REGION DESIGN
REGION MATERIALS ENGINEER

C.D.O.T. FORM #555
1/92

Figure C.9 Coring Log Example

C.6.4 Full Data Processing

Once pavement condition data and materials data are collected, then the engineer can perform the data processing. The type of data processing depends on 1) pavement type – flexible, rigid or composite, and 2) testing performed – basin, joint load transfer, or corner void. Please refer to the *MODTAG Users Manual* for further instructions.

C.6.5 Data Analysis, Interpretation and Reporting

Except for operating the FWD processing programs, the data analysis and interpretation is the most difficult portion. Once the analysis and interpretation is completed, then the results must be presented in such a manner to be used in the pavement design programs. Please refer to the *MODTAG Users Manual* for further information.

C.6.5.1 Results Reporting – Flexible Pavements

FWD Analysis results are used to report on the condition of the existing pavement and to provide Information for use in future pavement designs. For flexible pavements, the existing conditions and pavement design information should be reported. The following existing conditions should be noted in the report:

- Effective Structural Number (if designing with software prior to M-E Design).
- Subgrade Resilient Modulus.
- Remaining Life or Condition Factor.

C.6.5.2 Results Reporting – Jointed and Composite Pavements

FWD Analysis results are used to report on the condition of the existing pavement and to provide information for use in future pavement designs. For Jointed and Composite pavements, the existing conditions and pavement design information should be reported. The following existing conditions should be noted in the report:

- Elastic Modulus of the Concrete.
- Composite Modulus of Subgrade Reaction (k-value) (if designing with software prior to M-E Design).
- Load Transfer Efficiency and J-Factor.
- Corners with Possible Voids.

C.6.5.3 Data Analysis and Interpretation – Jointed and Composite Pavements

To minimize errors in interpretation, more than one analysis approach should be used. By using multiple approaches, the engineer can determine if the results correlate between programs or are vastly different. Once results are obtained, then engineering judgment must be employed to see if the results are reasonable or make sense.

References

1. *Chapter VI - Pavement Evaluation and Design*, Virginia Department of Transportation, 1401 Broad Street, Richmond, VA 23219, January 2004.
2. *MODTAG Users Manual Version 4*, Virginia Department of Transportation and Cornell University, Virginia Department of Transportation, 1401 Broad Street, Richmond, VA 23219, June 2006.
3. *Instructional Guide for Back-Calculation and the Use of MODCOMP3*, Version 3.6, CLRP Publication No. 94-10, by Dr. Lynne H. Irwin, Cornell University, Local Roads Program, March 1994.
4. ModTag Analyser, Version 4.0.6, Software.

APPENDIX D

THE NEW ECONOMY; MATERIALS AND PAVEMENT OPTIONS AND CONSIDERATIONS

D.1 Introduction

The New Economy: Materials and Pavement Options and Considerations is a finalized white paper, written by Colorado Department of Transportation (CDOT) Materials Advisory Committee on January 16, 2007. The white paper is important document and is included in this manual as guidance for the pavement engineer. The authors and members of the Materials Advisory Committee at the time of the issuance were:

Tim Aschenbrener, CDOT Materials and Geotechnical Branch
Bill Schiebel, Region 1 Materials
Richard Zamora, Region 2 Materials
Rex Goodrich, Region 3 Materials
Gary DeWitt, Region 4 Materials
Mike Coggins, Region 5 Materials
Masoud Ghaeli, Region 6 Materials
Glenn Frieler, Concrete Pavement Program Manager
Jay Goldbaum, Pavement Design Program Manager
Roy Guevara, Asphalt Pavement Program Manager
Corey Stewart, Pavement Management Program Manager

D.2 White Paper - The New Economy

Introduction

There is a new economy relative to petroleum products. National prices set records in 2006 for crude oil (over \$70 per barrel) and gasoline (over \$3 per gallon). In the Rocky Mountain West there has been an increase in the use of cokers at asphalt refineries which has provided an additional tightening of the supply of asphalt binder. The tighter supply has also had an impact on cost. Unmodified asphalt binder prices exceeded \$450 per ton. These economic changes have been behind the recently introduced term, “new economy.” CDOT’s surface treatment program relies heavily on petroleum products, and the new economy warrants a discussion on the relative impacts and options available to CDOT.

The National Asphalt Pavement Association (NAPA) and Colorado Asphalt Pavement Association (CAPA) have concerns regarding the new economy. They have published methods to encourage owners to be more cost effective. NAPA has focused on the hot-mix asphalt (HMA) materials and pavement design with recommendations on reclaimed asphalt pavement (RAP), appropriate use of polymers, large-stone aggregate mixtures, thin-lift overlays and roofing shingles. CAPA has focused some on HMA materials and pavement design areas (RAP, specification changes, etc) but has also included the project development process (partnering, constructability reviews, etc.). The

methods NAPA and CAPA have documented are valid and need to be considered. However, they do not necessarily represent a complete list of options the owner should consider.

The purpose of this white paper is to document seven strategies that should be considered by the owner in light of the new economy. Some of these are old, tried and true strategies that will now be cost effective more often than in the past. Other strategies are new ideas that can be investigated to get the most from the limited surface treatment program funds. We need to remember that the common strategies used in the past will still work and may still be cost effective; however, we need to be sure to look at a variety of options with the prices of the new economy. Automatically choosing the proven strategies of the past may not be the most cost effective solution.

Preventive Maintenance

Nationally, pavement preservation has been touted as a more cost effective process to maintain the surface condition. It represents a key component of a long-range plan to preserve and prolong the service life of the existing roadway system. Its goal is to keep the pavements that are in good and fair condition in that condition rather than let them deteriorate to a poor condition. When in a poor condition, more costly treatments are needed. States such as Georgia and Michigan have documented that for every \$1 spent on maintaining and preserving roads in good to fair condition, you can save approximately \$5 to \$8 on major rehabilitation and reconstruction. Treating the pavements at the right time with the right maintenance treatments is very cost effective. These cost analyses were for the “old economy” so the “new economy” analyses should be even more persuasive.

Colorado Policy Memo 18 dated October 15, 2003 has started Colorado in the direction of more preventive maintenance. CDOT has committed 5% of the surface treatment program budget to be dedicated to preventive maintenance. With the new economy, it may be time to increase the amount dedicated to preventive maintenance.

Strategy 1: Use more preventive maintenance treatments that have worked.

Standard preventive maintenance treatments that are frequently used by CDOT have been incorporated into the draft CDOT Preventive Maintenance Manual available on the Pavement Management website.

- Chip seals are a commonly used maintenance treatment. Sometimes they are used for corrective maintenance and other times they are used for preventive maintenance. When it comes to preventive maintenance, chip seals provide the biggest bang for the buck. They dramatically slow the deterioration of the underlying asphalt by sealing out water and preventing further oxidation of the underlying asphalt, caused in part by the damaging effects of the sun. An asphalt overlay achieves the same but at a much higher cost. When the structural capacity of the pavement is adequate, a chip seal is often the best value tool in our toolbox for increasing the pavement life. It is necessary to extend the life of HMA overlay treatments as anticipated Surface Treatment budgets may not be sufficient to sustain network conditions.

A recent Region 5 chip seal project was bid at around \$3/SY for 385,000 SY of roadway. A similar 3" HMA overlay project cost about \$12/SY for 241,000 SY of roadway. In this example, the chip seal was approximately 1/4 the cost of a 3" overlay. Chip seals will continue to be widely used by CDOT and, considering our limited funding, are an essential tool for preserving and maintaining our roads.

Regions 4 and 5 have started doing chip seals for preventive maintenance at the 3rd to 5th year of life of an overlay. The goal is to extend the time to the next overlay from 8 to 10 years to 12 to 15 years. By placing 2 or 3 chip seals, the need for the next overlay can be delayed. The chip seals are much less costly than overlays making this strategy cost effective.

Strategy 2: Examine new preventive maintenance techniques.

CDOT should continue to evaluate new treatment strategies and expand upon existing treatment options. Examples of additional treatment options are as follows:

- There are 2 types of Brazier mixes. Understanding the difference is important to a successful application. The original Brazier mix is similar to an asphalt sand mix. The new generation of Brazier mix is a milled asphalt mixed with emulsion in a pug mill prior to placement. A technique called Armor Cote from Nebraska DOT, consisting of small rounded river rock mixed with emulsion, is being studied for a possible treatment.
- Further, project selection is critical. When trying these new techniques, it is important to follow the experimental feature protocol. Region 4 is experimenting with the Brazier mix.
- Cape seals are another new and potentially effective preventive maintenance treatment. Region 4 is experimenting with it. Project selection guidelines and materials and construction specifications need to be followed. The performance will be monitored to see if this is a viable new alternative.

Rehabilitation Strategies

Strategy 3: Use more 100 percent recycling.

There are several different types of 100 percent recycling that have been used in Colorado for many years. These options have performed very well when appropriate project selection guidelines have been used and the projects were constructed properly.

- Hot-in-place recycling has been used for many years in Colorado. Regions 3 and 5 have used the three types of hot-in-place recycling on the appropriate projects and have had very good success to date. Some of the projects that have been placed have even won awards. It is interesting to note that the City and County of Denver focuses on the heater repaving option in the major metropolitan area. Using curb line milling, the heater repaving process provides 2 inches of treatment for the cost of 1 inch of new material. The heater-remixing process provides 2 inches of treatment for less than the cost of a 1-inch overlay. Even though the fuel costs of hot-in-place recycling have increased, it is only a fraction of the increase that has been experienced for HMA pavements.

- Full-depth reclamation (FDR) is relatively new to Colorado. This is a version of foamed asphalt that was identified on a recent European scanning tour. In some cases FDR includes an additive and in other cases it does not. Region 4 has used this treatment on many projects with low traffic in the eastern part of the State. This treatment allows for a full depth treatment of the existing pavement section with the addition of just 2-6 inches of new HMA. The feedback on construction and performance to date has been very positive. Test sections in service for several years have shown no reflective cracking.
- Cold-in-place recycling has also been used for many years in Colorado. This is a tried and true method that has worked in the past. The specifications and project selection guidelines are CDOT standards. Once again, the existing pavement can have a deep treatment of up to 8 inches if specialized emulsion and equipment are used. Typical cold-in-place recycling is typically 4 inches deep and then only need 2 to 6 inches of overlay. This method should still be considered.
- Additionally, consideration should be given to performing combinations of various treatments depending on distresses observed during a project level pavement analysis.

Strategy 4: Focus on cost effective wearing surfaces.

- Stone matrix asphalt (SMA) shows a lot of promise. After first being introduced to the United States from a European scanning tour, SMA has shown to be a highly effective wearing surface on the high volume roadways in Colorado. Although the initial costs are higher than conventional HMA, the performance data indicates it is a cost effective choice in those locations.
- Expanding on CDOT's successful implementation of SMA, thin-lift SMA is now being studied and may even be more cost effective than SMA when only a functional overlay is required. The use of a smaller nominal maximum aggregate size (3/8-inch) and a thinner lift (1-inch) will allow for this wearing surface to be more cost effective initially. Data from other states have shown that the thin SMA performs well as a wearing course. Colorado has limited data to date, but we have learned that compaction and aggregate size are critical. Colorado will use thin-lift SMAs on several projects during the 2007 construction season. This may also be a preventative maintenance treatment.
- Micro-surfacing has been used by CDOT to correct minor rutting and to restore the skid resistance of the pavement surface. It is composed of polymer modified asphalt with crushed aggregate, mineral fillers, and field control additives. Due to the quick reaction time, an experienced Contractor is desired. Colorado has had mixed results using micro-surfacing as a wearing surface.
- When using more expensive wearing surfaces, shoulders can be treated differently. When focusing on the wearing surface, it is not necessary to treat the wider shoulders with the same premium HMA pavement that is placed on the shoulders. Consideration should be given to a more economical mix.

Strategy 5: Use more portland cement concrete pavement.

- Thin white topping is a CDOT standard. After 10 years of experimentation, the specifications and project selection guidelines have been refined to provide a product that has proven success. When examining major rehabilitations, this option should be given strong consideration.

Strategy 6: Examine new rehabilitation strategies.

- An Ultra-thin Whitetopping Overlay (UTW) is a pavement rehabilitation technique that has been marketed by the American Concrete Pavement association (ACPA). UTW projects have provided durable wearing surfaces for pavements that are not subject to frequent heavy truck loadings, and where a substantial thickness of asphalt exists. Given its success in limited applications, UTW is now being considered for a range of other applications. In fact, a few states have pilot projects using UTW as an alternative to asphalt overlays for interstate roads. There are, however, still a lot of unknowns about the process. CDOT's Pavement Design Program and Region 6 have gathered design and construction information and would be glad to share that with anyone that wants to consider this experimental feature. When there is a need to place 4-inches of HMA pavement, ultra-thin white topping may be a cost-effective alternative for pavement rehabilitation.
- Cement-treated bases and roller-compacted concrete (RCC) have been used in the past as strong bases to build up the structural layer coefficient of the pavement section. Possibilities exist for utilization of lesser quality of rock and utilization of asphalt placement equipment. A reduced quantity of HMA overlay that results from a stronger base is one motivation for considering these treatments. Colorado has not used RCC in the past, but is considering potential applications in light of the new economy. There is minimal experience nationally at this time with using RCC for highway applications, but RCC may be evaluated as a finished driving surface. Detour pavements may be the ideal location to begin evaluation of RCC pavement.
- Some geotextiles can reduce the structural layer coefficient needed for rehabilitation with an HMA overlay. Some research has shown that the use of a geo-grid can provide a structural benefit. Region 3 is reviewing this literature and is giving consideration to this treatment. If the overlay can be reduced by a nominal amount, then the use of the geo-grid may be cost effective. Region 1 is evaluating the use of high-tensile strength paving geogrids to mitigate severe crack reflection. These products are specially designed for placement within the asphalt layers. Successful performance may yield an alternative to hot and cold in-place recycling prior to overlay. Considerations need to be made for future rehabilitations that may include milling or 100% recycling options.

New Products

Strategy 7: Examine new products.

- AggCote is a product of the American Gilsonite Company that is an additive for Hot Mix Asphalt pavement that may increase the material's resistance to stripping and subsequently increases resistance to rutting. The product is a mineral called Gilsonite that is mined in

Utah and works by “priming” the aggregates before the liquid asphalt is applied. The AggCote increases the bond strength between the aggregate and asphalt cement, increasing the resistance to stripping while still maintaining the flexural properties of the binder for thermal crack resistance.

Lab studies conducted by CDOT concluded that AggCote does work well in all areas that the manufacturer claims. The product consistently provides both increased durability and rut resistance over the current alternative of hydrated lime. This is all with lab mixed samples only. It is unknown if these same results can be produced with plant mixed material in the field.

AggCote is currently a more expensive alternative to lime but it is undetermined if the benefits are worth the additional costs when this product is applied in the field. Field testing may determine if AggCote’s benefits outweigh the additional costs. With the price of crude oil increasing, the benefits and cost savings of using AggCote may soon surpass that of lime. AggCote can replace some asphalt cement used in the mix and does not require the aggregates to be hydrated and dried, which is another area for fuel savings.

It would be worthwhile to pilot this product on a project and do extensive field testing and comparisons of this product versus hydrated lime.

- Asphalt membranes have been an effective way to protect our bridge decks. However, they often have performance issues due to their unique nature, placement, and environment. Alternate bridge deck protection should be considered. A membrane that shows promise is Dega-deck. Region 1 has experimented with this new product. Applications where short application times are necessary have given support to the Dega-deck process.

Closure

From this discussion it can be observed that every Region within CDOT is proactively evaluating additional options because of costs in the new economy. There are many old strategies being used at increasing levels, and new ideas that are being investigated to get the most from the limited surface treatment program funds. This information is provided to encourage the continued and expanded uses of CDOT’s standard products when cost effective and to encourage the exploration of innovative products.

In looking at these pavement rehabilitation and maintenance strategies, it is important to remember to do the right treatment at the right time. Be sure to use structural fixes when the structure needs it. A recently published document that provides guidance for identifying the right treatment at the right time is *Guidelines for Selection of Rehabilitation Strategies for Asphalt Pavement* report number CDOT-DTD-R-2000-08 written by Bud Brakey.

References

1. CDOT Policy Memo 18, Pavement Preventive Maintenance Initiatives, Oct.1, 2003.
2. Brakey, Bud, *Guidelines for Selection of Rehabilitation Strategies for Asphalt Pavement*, Report No. CDOT-DTD-R-2000-08, Colorado Department of Transportation, 2000.
3. American Concrete Pavement Association, Ultra Thin Whitetopping Calculator, http://www.pavement.com/Concrete_Pavement/Technical/UTW_Calculator/index.asp, (1/16/2007).

PAVEMENT TREATMENT GUIDE FOR HIGHWAY CATEGORIES

D.1 Introduction

This guide is intended to assist the Region Materials Engineers (RME) when making pavement design decisions in accordance with the hierarchical stratification of highway categories. The Transportation Commission, per Policy Directive 14, identified Interstates and NHS as having the highest standards and the highest priority when directing surface treatment funds. Other highways will have reduced funding and treatment priority in accordance with traffic volume. Surface Treatment Program investments on highways should be in accordance with the defined goals and objectives for each. This document identifies treatment parameters for each category of highway.

These guidelines do not apply to capacity related projects, realignment projects, pavement safety issues, or new construction; such projects will follow current CDOT Pavement Design Manual processes.

D.1 Definitions

D.1.1 Highway Categories

Interstate: Any highway on the Interstate Highway System. This is the most important highway category in the state of Colorado.

NHS: Any highway on the National Highway System, excluding Interstates.

Other Highways: Any highway not on the NHS or Interstate.

High Volume: A high volume highway includes segments with annual average daily traffic (AADT) greater than 4,000 or average annual daily truck traffic (AADTT) greater than 1,000.

Medium Volume: A medium volume facility includes segments with AADT between 2,000 and 4,000 or AADTT between 100 and 1,000.

Low Volume: A facility with Low Volume includes segments with AADT less than 2,000 and AADTT less than 100.

D.1.2 Treatment Categories

Reconstruction: Complete removal, redesign, and replacement of the pavement structure (asphalt or concrete) from subgrade to surface. A minimum design life of 20 years for asphalt pavements and 30 years for concrete pavements is used for these projects.

Major Rehabilitation: Heavy duty pavement treatments that improve the structural life to the highway. These are asphalt treatments typically thicker than 4 inches, and may include, but are not limited to, full depth reclamation, thin concrete overlays, deep cold-in-place recycles, and thick

overlays. Concrete treatments in this category may include, but are not limited to, asphalt overlays (thicker than 4 inches), extensive slab replacements, and rubblization.

Minor Rehabilitation: Moderate pavement treatments that improve the structural life to the highway. These are asphalt treatments between 2 and 4 inches thick, and may include mill and fills, shallow cold-in-place recycles, overlays, leveling courses with overlays. Concrete treatments in this category may include black toppings (thinner than 4 inches), dowel and tie bar repairs, and diamond grinding.

Pavement Maintenance: Thin functional treatments 1-1/2 inches in thickness or less, intended to extend the life of the highway by maintaining the driving surface.

D.2 Policy and Process

CDOT's most important highway facilities are Interstates. These national networks provide interconnectivity across the state and across the nation. Interstate projects shall be built, rehabilitated, and maintained in accordance with AASHTO Pavement Design Standards, ensuring that they meet Federal standards and provide reliable service to the traveling public.

The High Volume category includes NHS and other highways. These highways serve a large segment of the traveling public and provide critical routes for the transportation of goods and services across regional boundaries. These projects shall also follow AASHTO Pavement Design Standards.

Medium Volume category may contain segments on the NHS and Other Highways. These projects shall be treated primarily with minor rehabilitation and pavement maintenance treatments. Major rehabilitation can be considered when drivability is poor and project level analysis reveals a compromised pavement structure.

The Low Volume category may include segments on the NHS or other highways and are to be maintained above acceptable drivability standards with pavement maintenance treatments. Minor rehabilitation treatments can be considered when drivability is poor and project level analysis reveals a compromised pavement structure or safety issues are identified. When designing these treatments the RME will consider using reliability levels at the bottom of the range for the appropriate functional classification of the highway. The RME will also consider using lower reliability binders for thermal cracking, especially if reflective cracking is expected to occur. A pavement justification report (PJR) shall be performed for every project however; a life cycle cost analysis will not be required for these low volume projects. If the RME and the Program Engineer determines that more than a pavement maintenance treatment is needed, they will prepare a detailed PJR documenting why the selected treatment is cost effective and obtain concurrence from the Chief Engineer. The PJR will include the date that concurrence was obtained from the Chief Engineer. The Chief Engineer's decision will establish the typical remedial action for the project.

HMA MATERIALS INPUT LIBRARY

E.1 Introduction

This appendix presents the library of inputs for typical CDOT HMA mixtures. These inputs can be used in lieu of site-specific or mixture-specific data.

E.2 Mix Types and Properties

Table F.1 Properties of Typical CDOT HMA Mixtures presents the binder type, gradation and volumetric properties of typical CDOT HMA mixtures. Select one of these typical CDOT mixtures from the tables that is closer to the HMA mix to be used in the design. The following sections in this Appendix present their laboratory measured engineering properties including dynamic modulus, creep compliance and indirect tensile strength.

E.2.1 Dynamic Modulus

Table F.2 Dynamic Modulus Values of Typical CDOT HMA Mixtures presents Level 1 dynamic modulus values of typical CDOT HMA mixtures. The dynamic modulus values were measured in accordance with the *AASHTO TP 62 - Standard Method of Test for Determining Dynamic Modulus of Hot Mix Asphalt (HMA)* protocols. **Section S.1.5.2 Asphalt Dynamic Modulus |E*|** presents a discussion on HMA dynamic modulus properties.

E.2.2 Creep Compliance and Indirect Tensile Strength

Table F.3 Asphalt Binder Complex Shear Modulus (G*) and Phase Angle (δ) Values of Typical CDOT HMA Mixtures

Mix ID	Temperature (°F)	Binder G* (Pa)	Phase Angle (degree)
FS1918 (PG 58-28, Gradation SX)	136.4	2227.6	80
	147.2	1068.2	82
	158.0	540.1	84
FS1919 (PG 76-28, Gradation SMA)	158	1233	64
	168.8	673	66
	179.6	383	68
FS1920 (PG 58-28, Gradation SX)	136.4	2056	80
	147.2	985	82
	158	498	84

Mix ID	Temperature (°F)	Binder G* (Pa)	Phase Angle (degree)
FS1938 (PG 64-22, Gradation SX)	147.2	1857	81.6
	158	889	83.1
	168.8	451	85
FS1939 (PG 76-28, Gradation SX)	158	1559	64
	168.8	859	66
	179.6	493	68
FS1940 (PG 58-28, Gradation SX)	136.4	1758	80
	147.2	835	82
	158.0	419	84
FS1958 (PG 58-34, Gradation SX)	136.4	3093	80
	147.2	1519	82
	158.0	784	84
FS1959 (PG 64-28, Gradation SX)	147.2	3051	81.6
	158	1495	83.1
	168.8	772	85
FS1960 (PG 76-28, Gradation SMA)	158	1733	64
	168.8	959	66
	179.6	552	68

Table F.4 Indirect Tensile Strength Values of Typical CDOT HMA Mixtures and **Table F.5 Creep Compliance Values of Typical CDOT HMA Mixtures** present laboratory measured (Level 1) indirect tensile strength and creep compliance values of typical CDOT HMA mixtures, respectively. Testing was conducted in accordance with the *AASHTO T 322 - Standard Method of Test for Determining the Creep Compliance and Strength of Hot-Mix Asphalt (HMA) Using the Indirect Tensile Test Device*. **Section S.1.11 Tensile Creep and Strength for Hot Mix Asphalt** presents a discussion on HMA creep compliance and indirect tensile strength properties.

APPENDIX F HMA MATERIALS INPUT LIBRARY

F.1 Introduction

This appendix presents the library of inputs for typical CDOT HMA mixtures. These inputs can be used in lieu of site-specific or mixture-specific data.

F.2 Mix Types and Properties

Table F.1 Properties of Typical CDOT HMA Mixtures presents the binder type, gradation and volumetric properties of typical CDOT HMA mixtures. Select one of these typical CDOT mixtures from the tables that are closer to the HMA mix to be used in the design. The following sections in this Appendix present their laboratory measured engineering properties including dynamic modulus, creep compliance and indirect tensile strength.

F.2.1 Dynamic Modulus

Table F.2 Dynamic Modulus Values of Typical CDOT HMA Mixtures presents Level 1 dynamic modulus values of typical CDOT HMA mixtures. The dynamic modulus values were measured in accordance with the *AASHTO TP 62 - Standard Method of Test for Determining Dynamic Modulus of Hot Mix Asphalt (HMA)* protocols. **Section S.1.5.2 Asphalt Dynamic Modulus $|E^*|$** presents a discussion on HMA dynamic modulus properties.

F.2.2 Asphalt Binder

Table F.3 Asphalt Binder Complex Shear Modulus (G^*) and Phase Angle (δ) Values of Typical CDOT HMA Mixtures presents Level 1 complex shear modulus, G^* and phase angle, δ values of typical CDOT HMA mixtures. Under this effort, binder characterization tests were not performed to measure the rheology properties of the binders used in Superpave mixtures listed in Table F.2. To allow the use of lab measured E^* values in the Pavement M-E Design software, G^* and δ values were backcast using the estimated E^* shift factors and $G^*-\eta$ conversion relationships in the MEPDG. Chapter 6 presents a discussion on HMA binder properties.

F.2.3 Creep Compliance and Indirect Tensile Strength

Table F.3 Asphalt Binder Complex Shear Modulus (G^*) and Phase Angle (δ) Values of Typical CDOT HMA Mixtures

Mix ID	Temperature (°F)	Binder G^* (Pa)	Phase Angle (degree)
FS1918 (PG 58-28, Gradation SX)	136.4	2227.6	80
	147.2	1068.2	82
	158.0	540.1	84
FS1919 (PG 76-28, Gradation SMA)	158	1233	64
	168.8	673	66
	179.6	383	68
FS1920 (PG 58-28, Gradation SX)	136.4	2056	80
	147.2	985	82
	158	498	84
FS1938 (PG 64-22, Gradation SX)	147.2	1857	81.6
	158	889	83.1
	168.8	451	85
FS1939 (PG 76-28, Gradation SX)	158	1559	64
	168.8	859	66
	179.6	493	68
FS1940 (PG 58-28, Gradation SX)	136.4	1758	80
	147.2	835	82
	158.0	419	84
FS1958 (PG 58-34, Gradation SX)	136.4	3093	80
	147.2	1519	82
	158.0	784	84
FS1959 (PG 64-28, Gradation SX)	147.2	3051	81.6
	158	1495	83.1
	168.8	772	85
FS1960 (PG 76-28, Gradation SMA)	158	1733	64
	168.8	959	66
	179.6	552	68

Table F.4 Indirect Tensile Strength Values of Typical CDOT HMA Mixtures and **Table F.5 Creep Compliance Values of Typical CDOT HMA Mixtures** present laboratory measured (Level 1) indirect tensile strength and creep compliance values of typical CDOT HMA mixtures, respectively. Testing was conducted in accordance with the *AASHTO T 322 - Standard Method of Test for Determining the Creep Compliance and Strength of Hot-Mix Asphalt (HMA) Using the*

Indirect Tensile Test Device. **Section S.1.11 Tensile Creep and Strength for Hot Mix Asphalt** presents a discussion on HMA creep compliance and indirect tensile strength properties.

Table F.1 Properties of Typical CDOT HMA Mixtures

Mix ID	FS1918-9	FS1920-3	FS1938-1	FS1940-5
Sample No.	United 58-28-2	#183476	#16967C	#17144B
Binder Grade	PG 58-28	PG 58-28	PG 64-22	PG 58-28
Gradation	SX	SX	SX	SX
Passing ¾" sieve	100	100	100	100
Passing ⅜" sieve	83	88	89	82
Passing No 4 sieve	53	62	69	56
Passing No. 200 sieve	6.5	7.1	6.8	5.9
Mix AC Binder	5	5.6	5.4	5.5
VMA (%)	16.2	17	16.3	17.2
VFA (%)	65.9	64.1	68.5	68.2
Air Voids (%)	5.5	6.1	5.1	5.5
V _b eff (%)	10.7	10.9	11.2	11.7

Mix ID	FS1958-5	FS1959-8	FS1919-2	FS1939-5	FS1960-2
Sample No.	Wolf Creek Pass	I70 Gypsum to Eagle	#181603	#194140	I25 N of SH34
Binder Grade	PG 58-34	PG 64-28	PG 76-28	PG 76-28	PG 76-28
Gradation	SX	SX	SMA	SX	SMA
Passing ¾" sieve	100	95	95	100	100
Passing ⅜" sieve	81	87	46	87	69
Passing No 4 sieve	54	65	22	62	25
Passing No. 200 sieve	5	7.1	8	6.6	8.1
Mix AC Binder	7	5.4	6.2	5.4	6.5
VMA (%)	19.6	16.4	16.9	16.3	17.1
VFA (%)	73.4	65.5	72	68.2	76.8
Air Voids (%)	5.2	5.7	4.7	5.2	4.0
V _b eff (%)	14.4	10.7	12.2	11.1	13.1

Table F.2 Dynamic Modulus Values of Typical CDOT HMA Mixtures

Mix ID	Temperature (°F)	Testing Frequency			
		0.5 Hz	1 Hz	10 Hz	25 Hz
FS1918 (PG 58-28, Gradation SX)	14	2,067,099	2,488,999	2,785,899	2,873,299
	40	930,800	1,472,800	2,008,399	2,196,999
	70	207,600	439,600	838,700	1,039,200
	100	52,500	101,200	215,300	291,900
	130	24,100	35,400	60,900	78,900
FS1919 (PG 76-28, Gradation SMA)	14	1,875,400	2,299,039	2,624,309	2,726,019
	40	846,575	1,309,050	1,799,540	1,983,379
	70	230,100	427,271	753,122	918,360
	100	76,296	127,286	231,357	296,468
	130	40,803	55,308	84,229	102,895
FS1920 (PG 58-28, Gradation SX)	14	1,913,059	2,346,169	2,663,359	2,759,109
	40	820,000	1,323,520	1,846,660	2,037,379
	70	181,430	379,863	730,105	911,130
	100	47,935	89,742	185,976	250,629
	130	22,739	32,752	54,793	70,107
FS1938 (PG 64-22, Gradation SX)	14	2,333,549	2,642,179	2,861,449	2,927,779
	40	1,309,490	1,791,270	2,219,829	2,365,949
	70	379,514	695,090	1,127,310	1,318,450
	100	87,238	174,824	349,546	452,545
	130	29,326	49,265	92,795	122,034
FS1939 (PG 76-28, Gradation SX)	14	1,821,960	2,284,749	2,635,719	2,743,629
	40	761,414	1,245,330	1,773,800	1,972,669
	70	186,328	368,894	694,551	866,370
	100	59,960	102,426	195,476	256,712
	130	32,727	44,234	68,258	84,345
FS1940 (PG 58-28, Gradation SX)	14	1,989,039	2,422,519	2,730,149	2,820,819
	40	831,755	1,354,270	1,895,720	2,091,109
	70	177,386	367,904	716,158	900,206
	100	51,014	88,693	175,626	234,927
	130	27,500	36,567	56,022	69,361
FS1958 (PG 58-34, Gradation SX)	14	1,291,280	1,808,320	2,249,869	2,393,659
	40	424,726	794,978	1,289,510	1,499,050
	70	98,659	198,153	405,545	529,690
	100	37,405	59,422	109,288	143,776
	130	23,504	29,885	43,077	51,915

Mix ID	Temperature (°F)	Testing Frequency			
		0.5 Hz	1 Hz	10 Hz	25 Hz
FS1959 (PG 64-28, Gradation SX)	14	1,687,360	2,134,249	2,493,389	2,608,869
	40	697,463	1,127,680	1,612,900	1,802,220
	70	173,403	334,774	616,373	765,125
	100	54,259	93,163	175,106	227,742
	130	27,890	38,645	60,413	74,657
FS1960 (PG 76-28, Gradation SMA)	14	1,860,030	2,300,499	2,637,329	2,741,889
	40	850,728	1,324,800	1,828,840	2,017,009
	70	246,113	453,444	796,133	969,276
	100	88,308	145,258	261,320	333,687
	130	49,660	66,719	100,905	123,005

Table F.3 Asphalt Binder Complex Shear Modulus (G^*) and Phase Angle (δ) Values of Typical CDOT HMA Mixtures

Mix ID	Temperature (°F)	Binder G^* (Pa)	Phase Angle (degree)
FS1918 (PG 58-28, Gradation SX)	136.4	2227.6	80
	147.2	1068.2	82
	158.0	540.1	84
FS1919 (PG 76-28, Gradation SMA)	158	1233	64
	168.8	673	66
	179.6	383	68
FS1920 (PG 58-28, Gradation SX)	136.4	2056	80
	147.2	985	82
	158	498	84
FS1938 (PG 64-22, Gradation SX)	147.2	1857	81.6
	158	889	83.1
	168.8	451	85
FS1939 (PG 76-28, Gradation SX)	158	1559	64
	168.8	859	66
	179.6	493	68
FS1940 (PG 58-28, Gradation SX)	136.4	1758	80
	147.2	835	82
	158.0	419	84
FS1958 (PG 58-34, Gradation SX)	136.4	3093	80
	147.2	1519	82
	158.0	784	84

Mix ID	Temperature (°F)	Binder G* (Pa)	Phase Angle (degree)
FS1959 (PG 64-28, Gradation SX)	147.2	3051	81.6
	158	1495	83.1
	168.8	772	85
FS1960 (PG 76-28, Gradation SMA)	158	1733	64
	168.8	959	66
	179.6	552	68

Table F.4 Indirect Tensile Strength Values of Typical CDOT HMA Mixtures

Mix ID	Indirect Tensile Strength at 14°F
FS1918 (PG 58-28, Gradation SX)	555.9
FS1919 (PG 76-28, Gradation SMA)	515.0
FS1920 (PG 58-28, Gradation SX)	519.0
FS1938 (PG 64-22, Gradation SX)	451.0
FS1939 (PG 76-28, Gradation SX)	595.0
FS1940 (PG 58-28, Gradation SX)	451.0
FS1958 (PG 58-34, Gradation SX)	446.0
FS1959 (PG 64-28, Gradation SX)	519.0
FS1960 (PG 76-28, Gradation SMA)	566.0

Table F.5 Creep Compliance Values of Typical CDOT HMA Mixtures

Mix ID	Loading Time (s)	Testing Temperature		
		-4°F	14°F	32°F
FS1918 (PG 58-28, Gradation SX)	1	2.78E-07	3.91E-07	2.65E-07
	2	3.11E-07	4.79E-07	3.91E-07
	5	3.48E-07	5.57E-07	6.33E-07
	10	3.74E-07	6.94E-07	9.55E-07
	20	4.22E-07	8.31E-07	1.28E-06
	50	4.63E-07	1.08E-06	1.99E-06
	100	5.28E-07	1.35E-06	2.72E-06
FS1919 (PG 76-28, Gradation SMA)	1	4.01E-07	4.45E-07	6.88E-07
	2	4.28E-07	5.41E-07	8.96E-07
	5	4.98E-07	6.37E-07	1.27E-06
	10	5.51E-07	7.85E-07	1.69E-06
	20	6.17E-07	9.33E-07	2.23E-06
	50	7.19E-07	1.18E-06	3.14E-06
	100	7.96E-07	1.39E-06	4.01E-06
FS1920 (PG 58-28, Gradation SX)	1	3.38E-07	4.31E-07	5.28E-07
	2	3.66E-07	5.02E-07	7.44E-07
	5	4.1E-07	6.27E-07	1.12E-06
	10	4.53E-07	7.61E-07	1.51E-06
	20	4.92E-07	8.55E-07	1.98E-06
	50	5.53E-07	1.11E-06	3.03E-06
	100	6.02E-07	1.31E-06	4.05E-06
FS1938 (PG 64-22, Gradation SX)	1	3.34E-07	4.19E-07	4.99E-07
	2	3.53E-07	4.64E-07	6.19E-07
	5	3.79E-07	5.15E-07	7.49E-07
	10	4.05E-07	5.7E-07	9.08E-07
	20	4.31E-07	6.26E-07	1.08E-06
	50	4.87E-07	7.27E-07	1.43E-06
	100	5.05E-07	8.41E-07	1.79E-06
FS1939 (PG 76-28, Gradation SX)	1	3.46E-07	4.12E-07	7.13E-07
	2	3.83E-07	4.76E-07	9.57E-07
	5	4.34E-07	5.97E-07	1.33E-06
	10	4.85E-07	7.25E-07	1.8E-06
	20	5.29E-07	8.45E-07	2.29E-06
	50	5.99E-07	1.05E-06	3.25E-06
	100	6.87E-07	1.32E-06	4.24E-06

Mix ID	Loading Time (s)	Testing Temperature		
		-4°F	14°F	32°F
FS1940 (PG 58-28, Gradation SX)	1	3.53E-07	3.82E-07	6.92E-07
	2	3.81E-07	4.62E-07	8.61E-07
	5	4.21E-07	5.92E-07	1.23E-06
	10	4.64E-07	7.07E-07	1.69E-06
	20	5.11E-07	8.15E-07	2.21E-06
	50	5.9E-07	1.1E-06	3.22E-06
	100	6.35E-07	1.27E-06	4.47E-06
FS1958 (PG 58-34, Gradation SX)	1	4.82E-07	5.95E-07	9.61E-07
	2	5.30E-07	8.18E-07	1.48E-06
	5	6.05E-07	1.05E-06	2.18E-06
	10	6.85E-07	1.35E-06	3.14E-06
	20	7.71E-07	1.62E-06	4.19E-06
	50	8.72E-07	2.12E-06	6.23E-06
	100	1.00E-06	2.63E-06	8.74E-06
FS1959 (PG 64-28, Gradation SX)	1	3.61E-07	4.73E-07	7.12E-07
	2	4.04E-07	5.74E-07	9.97E-07
	5	4.51E-07	7.35E-07	1.52E-06
	10	5.11E-07	8.78E-07	1.99E-06
	20	5.67E-07	1.04E-06	2.59E-06
	50	6.57E-07	1.37E-06	3.75E-06
	100	7.68E-07	1.66E-06	4.66E-06
FS1960 (PG 76-28, Gradation SMA)	1	3.64E-07	4.64E-07	7.35E-07
	2	4.05E-07	5.70E-07	1.04E-06
	5	4.43E-07	7.15E-07	1.51E-06
	10	5.06E-07	8.79E-07	2.04E-06
	20	5.48E-07	1.03E-06	2.61E-06
	50	6.40E-07	1.31E-06	3.61E-06
	100	7.44E-07	1.70E-06	4.69E-06

APPENDIX G

PCC MATERIALS INPUT LIBRARY

G.1 Introduction

This appendix presents the library of inputs for typical CDOT PCC mixtures. These inputs can be used in lieu of site-specific or mixture-specific data.

G.2 Mix Types

Table G.1 Properties of Typical CDOT PCC Mixtures presents the mix proportions and fresh concrete properties of typical CDOT PCC mixtures. The fresh concrete properties include slump, air content and unit weight.

The slump was documented in accordance with *ASTM C143 Standard Test Method for Slump of Portland Cement Concrete*. The air content of the concrete was tested by the pressure method according to *ASTM C231 Standard Test Method for Air Content of Freshly Mixed Concrete by the Pressure Method*. Unit weight was determined in accordance with *ASTM C138 Standard Test Method for Unit Weight, Yield and Air Content (Gravimetric) of Concrete*.

Table G.2 Materials and Sources Used in Typical CDOT PCC Mixtures presents the sources of materials used in these mixtures. Select one of these typical CDOT mixtures from the tables that is closer to the concrete mix to be used in the design. The following sections in this Appendix present their laboratory measured engineering properties including compressive strength, flexural strength, static elastic modulus, coefficient of thermal expansion and Poisson's ratio.

G.2.1 Compressive and Flexural Strength

Table G.3 Compressive Strength of Typical CDOT PCC Mixtures presents Level 1 compressive strength values of typical CDOT PCC mixtures. Testing was conducted in accordance with the *ASTM C 39 Standard Test Method for Compressive Strength of Cylindrical Concrete Specimens*.

Table G. 4 Flexural Strength of Typical CDOT PCC Mixtures presents Level 1 flexural strength values of typical CDOT PCC mixtures. Testing was conducted in accordance with the *ASTM C 79 Standard Test Method for Flexural Strength of Concrete*.

G.2.2 Static Elastic Modulus and Poisson's Ratio

Table G.5 Static Elastic Modulus and Poisson's Ratio of Typical CDOT PCC Mixtures presents Level 1 static elastic modulus and Poisson's ratio of typical CDOT PCC mixtures. Testing was conducted in accordance with the *ASTM C 469 Standard Test Method for Static Modulus of Elasticity and Poisson's Ratio of Concrete in Compression*.

G.2.3 Coefficient of Thermal Expansion

Table G.6 CTE values of Typical CDOT PCC Mixtures presents laboratory measured (Level 1) coefficient of thermal expansion values of typical CDOT HMA mixtures, respectively. Standard 4" diameter by 8" high cylinders were tested in accordance with *AASHTO T336 Standard Method of Test for Coefficient of Thermal Expansion of Hydraulic Cement Concrete*.

Table G.1 Properties of Typical CDOT PCC Mixtures

Mix ID	Region	Cement Type	Cement Content (lbs/yd ³)	Fly ash Content (lbs/yd ³)	Water/Cement Ratio	Slump (in)	Air Content (%)	Unit Weight (pcf)
2008160	2	I/II	575	102	0.44	3.75	6.3	139.8
2009092	3	I/II	515	145	0.42	4.00	6.8	138.6
2009105	4, 1, 6	I/II	450	113	0.36	1.50	6.8	140.6
2008196	5	I/II	480	120	0.44	1.25	6.0	140.8

Table G.2 Materials and Sources Used in Typical CDOT PCC Mixtures

Mix ID	2008160	2009092	2009105	2008196
Region	2	3	4, 1, 6	5
Cement	GCC-Pueblo	Mountain	Cemex-Lyons	Holsim
Fly ash	Boral-Denver Terminal	SRMG – Four Corners	Headwaters-Jim Bridger	SRMG – Four Corners
Aggregates	RMMA Clevenger Pit	Soaring Eagle Pit	Aggregate Industries	SUSG Weaselskin Pit (Fine agg.) C&J Gravel Home Pit (Coarse agg.)
Water Reducer	BASF Pozzolith 200N BASF PolyHeed 1020 (mid-range)	BASF PolyHeed 997	BASF Masterpave	BASF PolyHeed 997
Air Entrainment	BASF MB AE 90	BASF Micro Air	BASF Pave-Air 90	BASF MB AE 90

Table G.3 Compressive Strength of Typical CDOT PCC Mixtures

Mix Design ID	Region	Compressive Strength, psi				
		7-day	14-day	28-day	90-day	365-day
2008160	2	4,290	4,720	5,300	6,590	6,820
2009092	3	3,740	4,250	5,020	5,960	7,140
2009105	4, 1, 6	3,780	4,330	5,370	5,560	6,390
2008196	5	4,110	4,440	5,340	5,730	5,990

Table G. 4 Flexural Strength of Typical CDOT PCC Mixtures

Mix Design ID	Region	Flexural Strength, psi				
		7-day	14-day	28-day	90-day	365-day
2008160	2	660	760	900	935	940
2009092	3	570	645	730	810	850
2009105	4, 1, 6	560	620	710	730	735
2008196	5	640	705	905	965	970

Table G.5 Static Elastic Modulus and Poisson's Ratio of Typical CDOT PCC Mixtures

Mix Design ID	Region	Elastic Modulus, ksi					Poisson's Ratio
		7-day	14-day	28-day	90-day	365-day	
2008160	2	3,140	3,260	3,550	3,970	4,240	0.21
2009092	3	3,560	3,860	4,300	4,550	4,980	0.2
2009105	4, 1, 6	3,230	3,500	4,030	4,240	4,970	0.2
2008196	5	3,280	3,510	3,930	4,170	4,210	0.21

Table G.6 CTE values of Typical CDOT PCC Mixtures

Mix ID	Sample	CTE in/in./°C	CTE in/in./°F*10 ⁻⁶
2008160	1	8.5	4.72
	2	8.5	4.72
2009092	1	8.8	4.89
	2	8.6	4.78
2009105	1	8.8	4.89
	2	8.7	4.83
2008196	1	8.8	4.89
	2	8.6	4.78

APPENDIX H

HISTORICAL CDOT 18,000-POUND EQUIVALENT AXLE LOAD CALCULATIONS

H.1 Introduction

The appendix documents how 18,000-pound Equivalent Single Axle Load (18-kip ESAL) calculations were defined for CDOT.

H.2 Traffic Projections

There are certain input requirements needed for 18-kip ESAL calculations. They are:

- Vehicle or Truck Volumes
 - Lane Distributions
 - Direction Distributions
 - Class Distributions
 - Growth Factors
- Vehicle or Truck Weights
 - Axle Weight
 - Axle Configuration (single, tandem)
- Traffic Equivalence Load Factors

This section describes the process on obtaining or calculating 18-kip ESAL numbers.

H.2.1 Volume Counts

Volume counts are expressed as Annual Average Daily Traffic (AADT) counts. AADT is the annual average two-way daily traffic volume. It represents the total traffic on a section of roadway for the year, divided by 365. It includes both weekday and weekend traffic volumes. The count is given in vehicles per day. This includes all CDOT (or FHWA) vehicle classification types.

H.2.2 Lane and Directional Distributions

The most heavily used lane is referred to as the design lane. Generally, the outside lanes are the design lanes. Traffic analysis determines a percent of all trucks traveling on the facility for the design lanes. This also referred to a lane distribution factor.

The percent of trucks in the design direction is applied to the two directional AADT to account for any differences to truck volumes by direction. The percent trucks in the design direction is referred to as the directional distribution factor. Generally, the directional distribution factor is a 50/50 percent split. If the number of lanes and volumes are not the same for each direction, it may be appropriate to design a different pavement structure for each direction of travel.

CDOT uses a design lane factor to account for the lane distribution and directional distribution. Both distributions are combined into one factor, the design lane factor.

Table H.1 Design Lane Factor shows the relationship of the design lane factor and the lane and directional distributions.

Table H.1 Design Lane Factor

Type of Facility	Number of Lanes in Design Direction	CDOT Method	DARWin™ Procedure	
		Design Lane Factor	Percent of Total Trucks in the Design Lane (Outside Lane)	Directional Split (Design Direction/Non-design Direction)
One Way	1	1.00	100	NA
2-lanes	1	0.60	100	60/40
4-lanes	2	0.45	90	50/50
6-lanes	3	0.30	60	50/50
8-lanes	4	0.25	50	50/50

Note 1: Highway Capacity Manual, 2000 (Exhibit 12-13) recommends using a default value for a directional split of 60/40 on a two-lane highway may it be rural or urban (3).

H.2.3 Vehicle Classification

CDOT uses a classification scheme of categorizing vehicles into three bins. CDOT 18-kip ESAL calculations were based on “generalized, averaged, and non-site-specific equivalency factors” using a 3-bin vehicle classification scheme. These vehicle classifications types are (1):

- Passenger vehicles, types 1-3 and 0-20 feet,
- Single unit trucks, types 4-7 and 20-40 feet, and
- Combination trucks, types 8-13 and greater than 40 feet long.

A fourth bin is sometimes used and may be shown as unclassified vehicles. These bins are further broken down into 13 classes. The 13-classification scheme follows FHWA vehicle type classification. Two additional classes may be used as a fourth bin. Class 14 is for unclassifiable vehicles and Class 15 is not used at the present time. The 13 classes of FHWA are separated into groupings of whether the vehicle carries passengers or commodities. Non-passenger vehicles are subdivided by number of axles and number of units, including both power and trailer units. Exceptions may be a large camping and recreational vehicles, which crosses over into the commodities grouping. **Note:** The addition of a light trailer to a vehicle does not change the classification of the vehicle. Refer to **Figure H.1 CDOT Vehicle Classifications**. Listed are FHWA vehicle classes with definitions (2):

Class 1 - Motorcycles - All two or three-wheeled motorized vehicles. Typical vehicles in this category have saddle type seats and are steered by handlebars rather than steering wheels. This category includes motorcycles, motor scooters, mopeds, motor-powered bicycles, and three-wheel motorcycles. This vehicle type may be reported at the option of the State.

Class 2 - Passenger Cars - All sedans, coupes, and station wagons manufactured primarily for the purpose of carrying passengers and including those passenger cars pulling recreational or other light trailers.

Class 3 - Other Two-Axle, Four-Tire Single Unit Vehicles - All two-axle, four-tire, vehicles, other than passenger cars. Included in this classification are pickups, panels, vans, and other vehicles such as campers, motor homes, ambulances, hearses, carryalls, and minibuses. Other two-axle, four-tire single-unit vehicles pulling recreational or other light trailers are included in this classification. Because automatic vehicle classifiers have difficulty distinguishing class 3 from class 2, these two classes may be combined into class 2.

Class 4 - Buses - All vehicles manufactured as traditional passenger-carrying buses with two axles and six tires or three or more axles. This category includes only traditional buses (including school buses) functioning as passenger-carrying vehicles. Modified buses should be considered to be a truck and should be appropriately classified.

Note: In reporting information on trucks the following criteria should be used:

- a. Truck tractor units traveling without a trailer will be considered single-unit trucks.
- b. A truck tractor unit pulling other such units in a "saddle mount" configuration will be considered one single-unit truck and will be defined only by the axles on the pulling unit.
- c. Vehicles are defined by the number of axles in contact with the road. Therefore, "floating" axles are counted only when in the down position.
- d. The term "trailer" includes both semi- and full trailers.

Class 5 - Two-Axle, Six-Tire, Single-Unit Trucks - All vehicles on a single frame including trucks, camping and recreational vehicles, motor homes, etc., with two axles and dual rear wheels.

Class 6 - Three-Axle Single-Unit Trucks - All vehicles on a single frame including trucks, camping and recreational vehicles, motor homes, etc., with three axles.

Class 7 - Four or More Axle Single-Unit Trucks - All trucks on a single frame with four or more axles.

Class 8 - Four or Fewer Axle Single-Trailer Trucks - All vehicles with four or fewer axles consisting of two units, one of which is a tractor or straight truck power unit.

Class 9 - Five-Axle Single-Trailer Trucks - All five-axle vehicles consisting of two units, one of which is a tractor or straight truck power unit.

Class 10 - Six or More Axle Single-Trailer Trucks - All vehicles with six or more axles consisting of two units, one of which is a tractor or straight truck power unit.

Class 11 - Five or fewer Axle Multi-Trailer Trucks - All vehicles with five or fewer axles consisting of three or more units, one of which is a tractor or straight truck power unit.

Class 12 - Six-Axle Multi-Trailer Trucks - All six-axle vehicles consisting of three or more units, one of which is a tractor or straight truck power unit.

Class 13 - Seven or More Axle Multi-Trailer Trucks - All vehicles with seven or more axles consisting of three or more units, one of which is a tractor or straight truck power unit.

	Class	Schema	Description
Light-weight Vehicles	1		all motorcycles plus two wheel axles
	2		all cars plus one/two axle trailers
	3		all pickups and vans single/dual wheels plus one/two/three axle trailers
Single Unit Vehicles	4		buses single/dual wheels
	5		two axle, single unit single/dual wheels
	6		three axle, single unit
	7		four axle, single unit
Combination Unit Vehicles	8		four or less axles, single trailers
	9		five axles, single trailers
	10		six or more axles, single trailers
	11		five or less axles, multi-trailers
	12		six axles, multi-trailers
	13		seven or more axles, multi-trailers
	14		Unclassifiable vehicle
15		Not used	

Figure H.1 CDOT Vehicle Classifications

H.2.4 Growth Factors

The number of vehicles using a pavement tends to increase with time. CDOT uses a 20-year growth factor. Each roadway segment has a growth factor assigned to that segment. The 20-year growth factor is applied to all of the vehicles.

A simple growth rate assumes that the AADT is increase by the same amount each year. A compound growth rate assumes that the AADT percent growth rate for any given year is applied to the volume during the preceding year. CDOT uses the compound growth rate. See **Eq. H.3**.

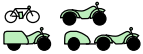
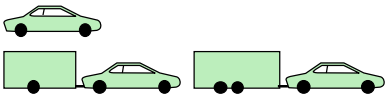
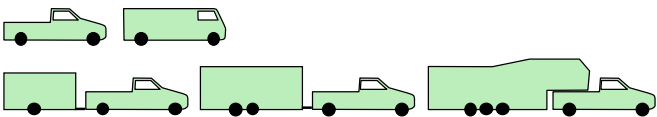
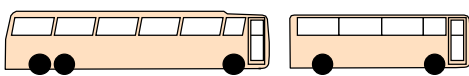
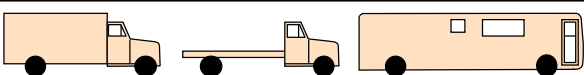
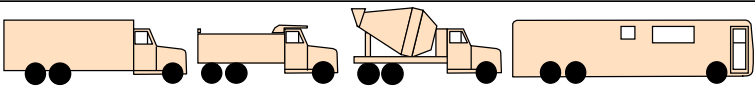
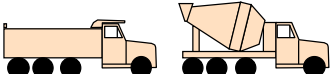
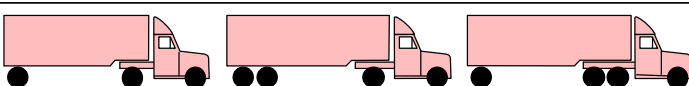
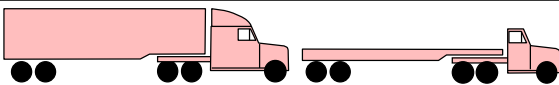
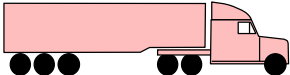
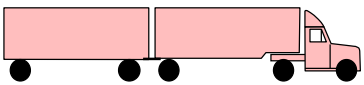
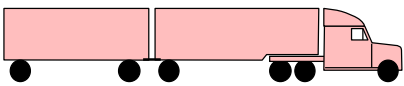
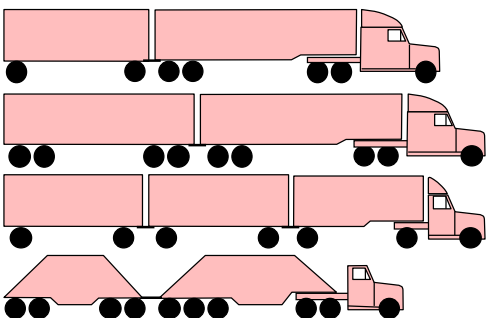
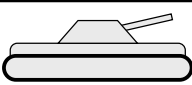
H.2.5 Vehicle or Truck Weights

The 18,000-pound Equivalent Single Axle Load (18-kip ESAL) is a concept of converting a mixed traffic stream of different axle loads and axle configurations into a design traffic number. The 18-kip ESAL is a conversion of each expected axle load into an equivalent number of 18,000-pound single axle loads and to sum these over the design period.

H.2.6 Traffic Equivalence Load Factors

The equivalence load factor is a numerical factor that expresses the relationship of a given axle load to another axle load in terms of their effect on the serviceability of a pavement structure. All axle loads are equated in terms of the equivalent number of repetitions of an 18,000-pound single axle. Using the 3-bin vehicle classification scheme, factors were assigned to each.

The damaging effect of an axle is different for a flexible pavement and a rigid pavement; therefore, there are different equivalency factors for the two types of pavement. **Table H.2 Colorado Equivalency Factors** shows the statewide equivalency factors that were determined by a study of Colorado traffic in 1987.

Table H.2 Colorado Equivalency Factors

3-Bin Vehicle Classification	Flexible Pavement	Rigid Pavement
Passenger cars & pickup trucks	0.003	0.003
Single unit trucks	0.249	0.285
Combination trucks	1.087	1.692

H.2.7 Discussion and Calculation of Traffic Load for Pavement Design

Traffic is one of the major factors influencing the loss of serviceability of a pavement. Traffic information required by the pavement designer includes axle loads, axle configurations and number of applications. The damaging effect of the passage of an axle of any load can be represented by a number of 18-kip ESAL. The load damage factor increases as a function of the ratio of any given axle load raised to the fourth power. For example, one application of a 12,000 pound single axle will cause a damage equal to 0.2 applications of an 18,000 pound single axle

load and about five applications of a 12,000-pound single axle will cause the same damage as one 18,000 pound single axle load thus, a 20,000 pound single axle load is 8 times as damaging as the 12,000 pound single axle load. The determination of design ESALs is an important consideration for the design of pavement structures. An approximate correlation exists between 18-kip ESAL computed using flexible pavement and rigid pavement equivalency factors. As a general rule of thumb, converting from rigid pavement 18-kip ESAL to flexible pavement 18-kip ESAL requires multiplying the rigid pavement 18-kip ESAL by 0.67. For example, 15 million rigid pavement 18-kip ESAL is approximately equal to 10 million flexible pavement 18-kip ESALs. Five million flexible pavement 18-kip ESAL equal 7.5 million rigid pavement 18-kip ESALs. Failure to utilize the correct type of 18-kip ESAL will result in significant errors in the designs. Conversions must be made, for example, when designing an asphaltic concrete overlay of a flexible pavement (flexible 18-kip ESAL required) and when designing an alternative portland cement concrete overlay of the same flexible pavement (rigid 18-kip ESAL required).

The Department has some sites on the highway system where instruments have been placed in the roadway to measure axle loads as a vehicle passes over the site. These stations, called Weigh-in-Motion (WIM) sites, can provide accurate information for the existing traffic load. An estimate of growth over the design period will be needed to calculate the traffic load during the design period. The link <http://dtdapps.coloradodot.info/Otis/TrafficData> is used to access traffic load information. Traffic analysis for pavement structure design is supplied by the Division of Transportation Development (DTD) Traffic Analysis Unit. The traffic data figures to be incorporated into the design procedure are in the form of 18 kip equivalent single axle load applications (18-kip ESALs). All vehicular traffic on the design roadway is projected for the design year in the categories of passenger cars, single unit trucks, and combination trucks with various axle configurations. The actual projected traffic volumes for each category are weighted by the appropriate load equivalence factors and converted to a cumulative total 18-kip ESAL number to be entered into the flexible or rigid pavement design equation. Adjustments for directional distribution and lane distribution will be made by the DTD Traffic Analysis Unit. The number supplied will be used directly in the pavement design calculation. Recall that this 18-kip ESAL number is the cumulative yearly ESAL for the design lane in one direction. This 18-kip cumulative number must be a 20-year ESAL to be used for the asphalt mix design for SuperPave™ gyratory compaction effort (revolutions). The designer must inform the DTD Traffic Analysis Unit that the intended use of the 18-kip ESAL is for flexible or rigid pavement design (see **Table H.2 Colorado Equivalency Factors**), since different load equivalence factors apply to different pavement types. If a comparison of flexible and rigid pavements is being made, 18-kip ESAL for each pavement type must be requested.

The procedure to predict the design ESALs is to convert each expected axle load into an equivalent number of 18-kip ESAL and to sum these over the design period. Thus, a mixed traffic stream of different axle loads and axle configurations is converted into a number of 18-kip ESALs. See 1993 AASHTO Guide for Design of Pavement Structure Appendix D, pages D1-28 for Conversion of Mixed Traffic to Equivalent Single Axle Loads for Pavement Design.

The DTD provides traffic projections Average Annual Daily Traffic (AADT) and ESAL. The designer must request 10, 20, and 30-year traffic projections for flexible pavements and 20 and 30-year traffic projections for rigid pavements from the Traffic Section of DTD. Requests for

traffic projections should be coordinated with the appropriate personnel of DTD. The pavement designer can help ensure that accurate traffic projections are provided by documenting local conditions and planned economic development that may affect future traffic loads and volumes.

DTD should be notified of special traffic situations when traffic data are requested. Some special situations may include:

- A street that is or will be a major arterial route for city buses;
- A roadway that will carry truck traffic to and from heavily used distribution or freight centers;
- A highway that will experience an increase in traffic due to a connecting major, high-traffic;
- A highway that will be constructed in the near future; and
- A roadway that will experience a decrease in traffic due to the future opening of a parallel roadway facility.

H.2.8 Traffic Projections

The following steps are used by CDOT to calculate ESALs:

Step 1. Determine the AADT and the number of vehicles of various classifications and sizes currently using the facility. The designer should make allowances for traffic growth, basing the growth rate on DTD information or other studies. Assuming a compound rate of growth, **Eq. H.1** is used by CDOT to calculate the 20-year growth factor. The future AADT is determined by:

$$T_f = (1 + r)^n \quad \text{Eq. H.1}$$

Where:

- T_f = CDOT 20-year growth factor
- r = rate of growth expressed as a fraction
- n = 20 (years)

$$T = \left(\frac{(T_1 * T_f) - T_1}{20} \right) * D + T_1 \quad \text{Eq. H.2}$$

Where:

- T = future AADT
- T_1 = current AADT
- D = design period (years)

Step 2. Determine the midpoint volume (Eq. H.3) by adding the current and future traffic and dividing by two.

$$T_m = (T_1 + T) / 2 \quad \text{Eq. H.3}$$

Where:

T_m = traffic volume at the midpoint of the design period.

Step 3. Multiply the midpoint traffic volume by the percentage of cars, single unit trucks, and combination trucks.

Step 4. Multiply the number of vehicles in each classification by the appropriate 18-kip equivalency factor. See **Table H.2 Colorado Equivalency Factors**. Then add the numbers from each classification to yield a daily ESAL value.

Step 5. Multiply the total 18-kip ESAL for the roadway by the design lane factor that correlates to the number of lanes for each direction shown in **Table H.2 Colorado Equivalency Factors**. This will be the 18-kip ESAL for the design lane over the design period.

Example: Determine the 20-year design period ESALs for a 4-lane flexible pavement (2 lanes per direction) if the current traffic volume is 16,500 with 85% cars, 10% single unit trucks, and 5% combination trucks. The traffic using the facility grows at an annual rate of 3.5%.

$$T_f = (1 + 0.035)^{20} = 1.99$$

$$T = (((16500 * 1.99) - 16500) / 20) * 20 + 16,500 = 32,835$$

$$T_m = (16,500 + 32,835) / 2 = 24,668$$

$$\text{Cars} = 24,668 * 0.85 = 20,968$$

$$\text{Single Unit Trucks} = 24,668 * 0.10 = 2,467$$

$$\text{Combination Trucks} = 24,668 * 0.05 = 1,233$$

$$\text{Daily ESALs for Cars} = 20,968 * 0.003 = 62.9$$

$$\text{Daily ESALs for Single Unit Trucks} = 2,467 * 0.249 = 614.3$$

$$\text{Daily ESALs for Combination Trucks} = 1,233 * 1.087 = 1,340.3$$

$$\text{Total Daily ESALs} = 2,017.5$$

$$\text{Total Design Period ESALs} = 2,017.5 * 365 * 20 = 14,727,750$$

$$\text{Design lane ESALs} = 14,727,750 * 0.45 = 6,627,500$$

References

1. *Development of Site-Specific ESAL, Final Report*, CDOT-DTD-R-2002-9, Project Manager, Ahmad Ardani, Colorado Department of Transportation and Principal Investigator, Sirous Alavi, Nichols Consulting Engineers, Chtd., July 1, 2002.
2. *Heavy Vehicle Travel Information System*, Field Manual, FHWA publication PDF version, May 2001 (revised), obtained at website, <http://www.fhwa.dot.gov/ohim/tvtw/hvtis.htm>
3. *Highway Capacity Manual*, Transportation Research Board, National Research Council, Washington, D.C., 2000.

SUPPLEMENT

MATERIAL PROPERTIES OF SUBGRADE, SUBBASE, BASE, FLEXIBLE AND RIGID LAYERS

S.1 Introduction

The designer needs to have a basic knowledge of soil properties. This appendix is to give such knowledge in the design of pavements. Basic knowledge of soil consistency, sieve analysis, unit weight, water content, specific gravity, elastic modulus, Poisson's ratio, unconfined compression strength, modulus of rupture, and indirect tensile strength. Resilient modulus and R-value needs to be understood. These soil properties have been for a long time have been in the Department's testing program. The Mechanistic-Empirical (M-E) Pavement Design Guide (24) will aggressively use these properties in the design of pavements.

The Resilient Modulus (M_R) was selected to replace the soil support value used in previous editions as noted when it first appeared in the *AASHTO Guide for Design of Pavement Structures 1986* (2). The AASHTO guide for the design of pavement structures, which was proposed in 1961 and then revised in 1972 (1), characterized the subgrade in terms of soil support value (SSV). SSV has a scale ranging from 1 to 10, with a value of 3 representing the natural soil at the Road Test. AASHTO Test Method T 274 determined the M_R that is referenced in the 1986 AASHTO Guide. The compacted layer of the roadbed soil was to be characterized by the M_R . Using correlations were suitable to obtain a M_R value. Procedures for assigning appropriate unbound granular base and subbase layer coefficients based on expected M_R values were also given in the 1986 Guide. The *1993 AASHTO Guide for Design of Pavement Structures* (3): Appendix L, lists four different approaches to determine a design resilient modulus value. The first approach is laboratory testing, another approach is by Non-Destructive Testing (NDT) backcalculation, the third approach consists of estimating resilient modulus from correlations with other properties, and the last is from original design and construction data (4).

S.1.1 Soil Consistency

Soil Consistency is defined as the amount of effort required to deform a soil. This level of effort allows the soil to be classified as either soft, firm, or hard. The forces that resist the deformation and rupture of soil are cohesion and adhesion. Cohesion is a water-to-water molecular bond, and adhesion is the water-to-solid bond (17). These bonds depend on water, so consistency directly relates to moisture content, which provides a further classification of soil as dry consistence, moist consistence, and wet consistence.

The Atterberg Limits takes this concept a step further, by labeling the different physical states of soil based on its water content as liquid, plastic, semi-solid, solid. The boundaries that define these states are known as the liquid limit (LL), plastic limit (PL), shrinkage limit (SL), and dry limit (DL). The liquid limit is the moisture content at which soil begins to behave like a liquid and flow. The plastic limit is the moisture content where soil begins to demonstrate plastic properties, such

as rolling a small mass of soil into a long thin thread. The plasticity index (PI) measures the range between LL and PL where soil is in a plastic state. The shrinkage limit is defined as the moisture content at which no further volume change occurs as the moisture content is continually reduced (18). The dry limit occurs when moisture no longer exists within the soil.

The Atterberg limits are typically used to differentiate between clays and silts. The test method for determining LL of soils is AASHTO T 89-02. AASHTO T90-00 presents the standard test method for determining PL and PI.

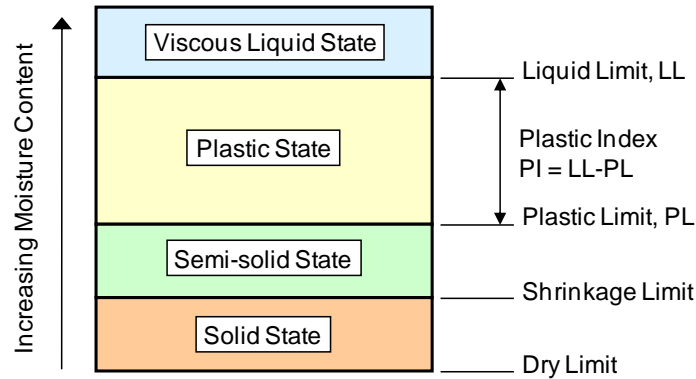

Figure S.1 Atterberg Limits

S.1.2 Sieve Analysis

The sieve analysis is performed to determine the particle size distribution of unbound granular and subgrade materials. In the M-E Design the required size distribution are the percentage of material passing the No. 4 sieve (P_4) and No. 200 sieve (P_{200}). D_{60} represents a grain diameter in inches for which 60% of the sample will be finer and passes through that sieve size. In other words, 60% of the sample by weight is smaller than diameter D_{60} . $D_{60} = 0.1097$ inches.

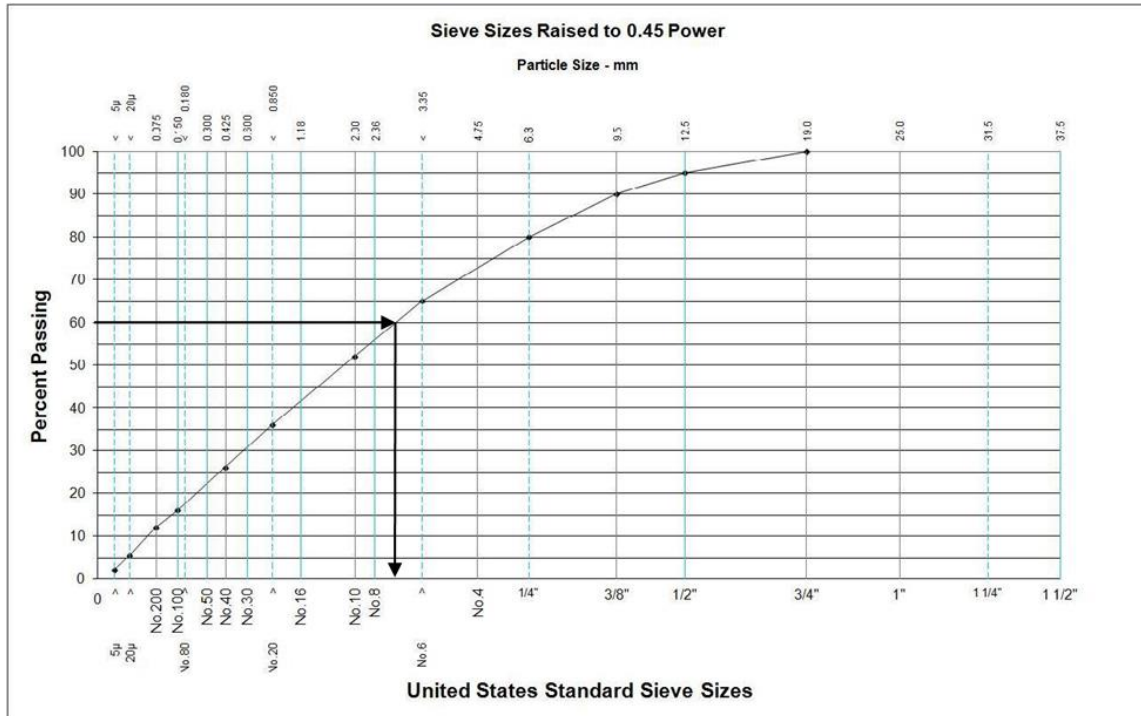

Figure S.2 Gradation Plot

Table S. 1 Nominal Dimensions of Common Sieves

US Nominal Sieve Size	Size (mm)	US Nominal Sieve Size	Size (mm)
2"	50.0	No. 8	2.36
1-1/2"	37.5	No. 10	2.00
1-1/4"	31.5	No. 16	1.18
1"	25.0	No. 20	850 µm
3/4"	19.0	No. 30	600 µm
1/2"	12.5	No. 40	425 µm
3/8"	9.5	No. 50	300 µm
1/4"	6.3	No. 80	180 µm
No. 4	4.75	No. 100	150 µm
No.6	3.35	No. 200	75 µm

S.1.3 Unit Weight, Water Content, and Specific Gravity

Maximum dry density ($\gamma_{dry\ max}$) and optimum gravimetric moisture content (w_{opt}) of the compacted unbound material is measured using AASHTO T 180 for bases or AASHTO T 99 for other layers. Specific gravity (G_s) is a direct measurement using AASHTO T 100 (performed in conjunction with consolidation tests - AASHTO T 180 for unbound bases or AASHTO T 99 for other unbound layers).

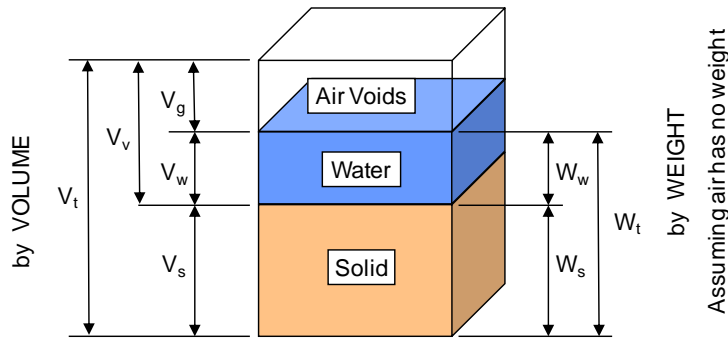

Figure S.3 Soil Sample Constituents

Unit Weight is:

$$\gamma = \frac{W_t}{V_t} = \frac{W_w + W_s}{V_g + V_w + V_s} \quad \text{Eq. S.1}$$

Dry Density (mass) is:

$$\gamma_{dry} = \frac{W_s}{V_t} = \frac{W_s}{V_g + V_w + V_s} \quad \text{Eq. S.2}$$

In the consolidation (compaction) test the dry density cannot be measured directly, what are measured are the bulk density and the moisture content for a given effort of compaction.

Bulk Density or oven-dry unit mass is:

$$\gamma_{bulk} = \frac{W_s + W_w}{V_t} = \frac{W_t}{V_t(1+w)} = \frac{\gamma}{1+w} = \frac{\frac{W_t}{V_t}}{\left(1 + \frac{W_w}{W_s}\right)} \quad \text{Eq. S.3}$$

The maximum dry unit weight and optimum water content are obtained by graphing as shown in **Figure S.4 Plot of Maximum Dry Unit Weight and Optimum Water Content**.

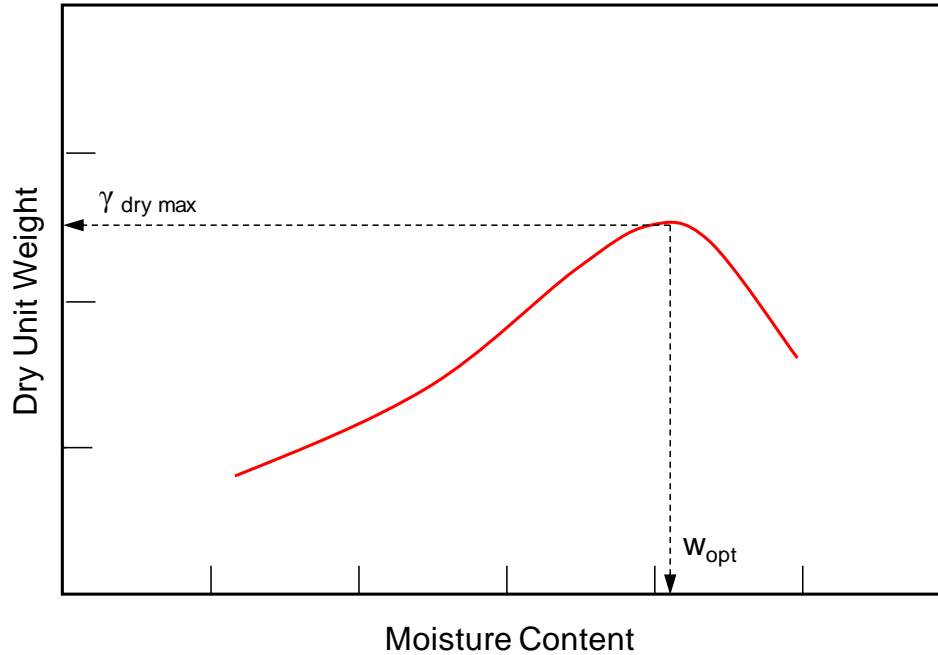

Figure S.4 Plot of Maximum Dry Unit Weight and Optimum Water Content

Specific Gravity is:

$$G_s = \frac{\gamma_s}{\gamma_w} = \frac{\frac{W_s}{V_s}}{\gamma_w} = \frac{\gamma_s}{62.4}$$

Eq. S.4

Where:

- γ = Unit Weight (density), pcf
- γ_{dry} = Dry Density, pcf
- γ_{bulk} = Bulk Density, pcf
- $\gamma_{dry\ max}$ = Maximum dry unit weight, pcf
- G_s = Specific Gravity (oven dry)
- W_t = total weight
- W_w = weight of water
- W_s = weight of solids
- V_t = total volume
- V_v = volume of voids
- V_g = volume of air (gas)
- V_w = volume of water
- V_s = volume of solids
- w = water content
- w_{opt} = optimum water content
- γ_s = density of solid constituents
- γ_w = 62.4 pcf at 4 °C

S.1.4 Pavement Materials Chemistry

S.1.4.1 Periodic Table

The periodic table is a tabular method of displaying the 118 chemical elements. Elements are listed from left to right as the atomic number increases. The atomic number identifies the number of protons in the nucleus of each element. Elements are grouped in columns, because they tend to show patterns in their atomic radius, ionization energy, and electronegativity. As you move down a group the atomic radii increases, because the additional electrons per element fill the energy levels and move farther from the nucleus. The increasing distance decreases the ionization energy, the energy required to remove an electron from the atom, as well as decreases the atom's electronegativity, which is the force exerted on the electrons by the nucleus. Elements in the same period or row show trends in atomic radius, ionization energy, electron affinity, and electronegativity. Within a period moving to the right, the atomic radii usually decreases, because each successive element adds a proton and electron, which creates a greater force drawing the electron closer to the nucleus. This decrease in atomic radius also causes the ionization energy and electronegativity to increase the more tightly bound an element becomes.

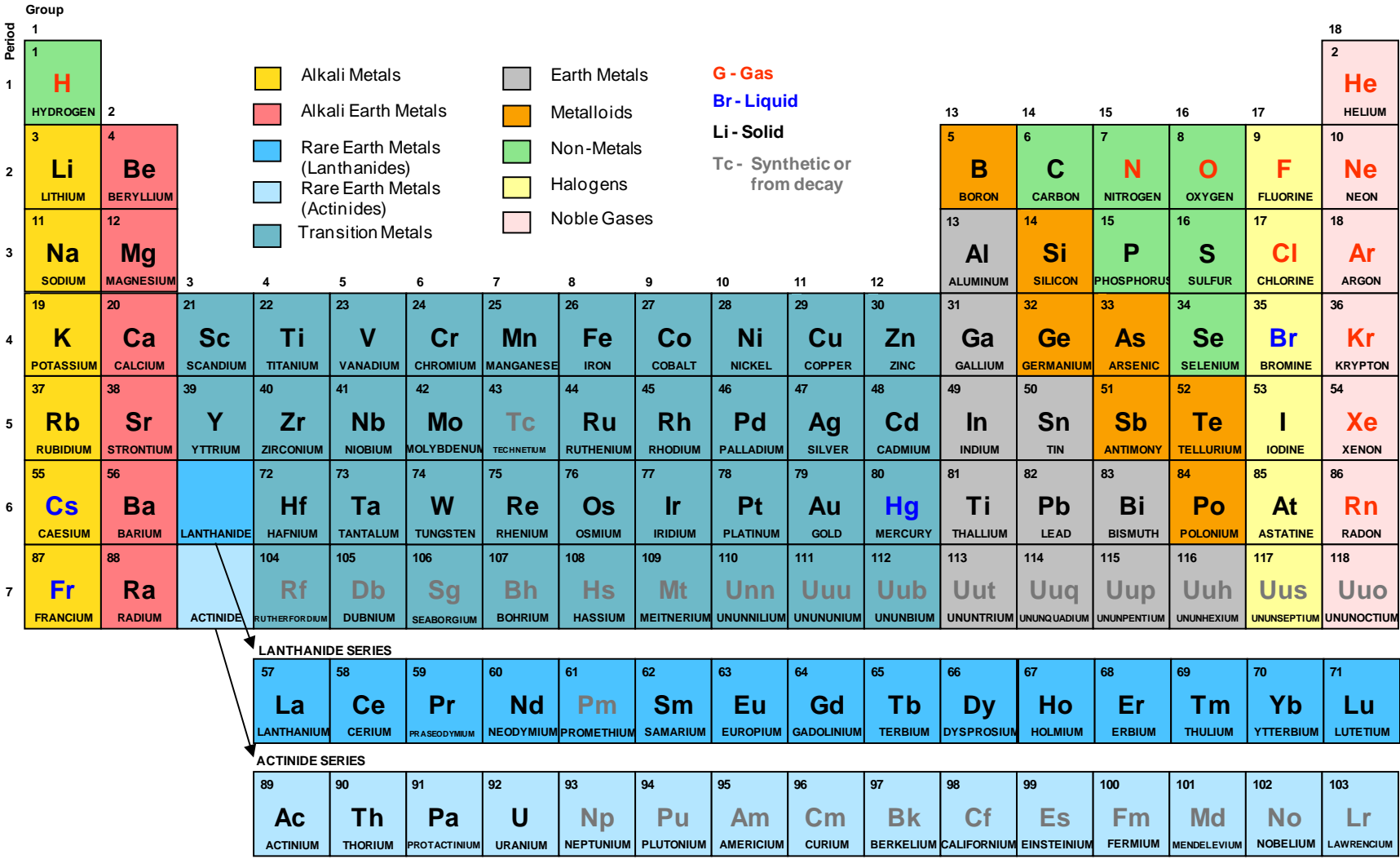

Figure S.5 Periodic Table

S.1.4.2 pH Scale

Water (H₂O) is a substance that can share hydrogen ions. The cohesive force that holds water together can also cause the exchange of hydrogen ions between molecules. The water molecule acts like a magnet with a positive and negative side, this charge can prove to be greater than the hydrogen bond between the oxygen and hydrogen atom causing the hydrogen to join the adjacent molecule (19). This process can be seen molecularly **Figure S.6 Dissociation of Water** and is expressed chemically in **Eq. S.5**.

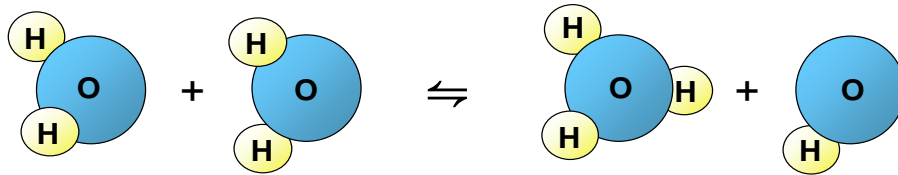
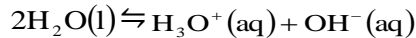

Figure S.6 Dissociation of Water



Eq. S.5

The pH of a solution is the negative logarithmic expression of the number of H⁺ ions in a solution. When this is applied to water with equal amounts of H⁺ and OH⁻ ions the concentration of H⁺ will be 0.00000001, the pH is then expressed as $-\log 10^{-7} = 7$. From the neutral water solution of 7 the pH scale ranges from 0 to 14, zero is the most acidic value and 14 is the most basic or alkaline.

An acid can be defined as a proton donor, a chemical that increases the concentration of hydronium ions [H₃O⁺] or [H⁺] in an aqueous solution. Conversely, we can define a base as a proton acceptor, a chemical that reduces the concentration of hydronium ions and increases the concentration of hydroxide ions [OH⁻] (18).

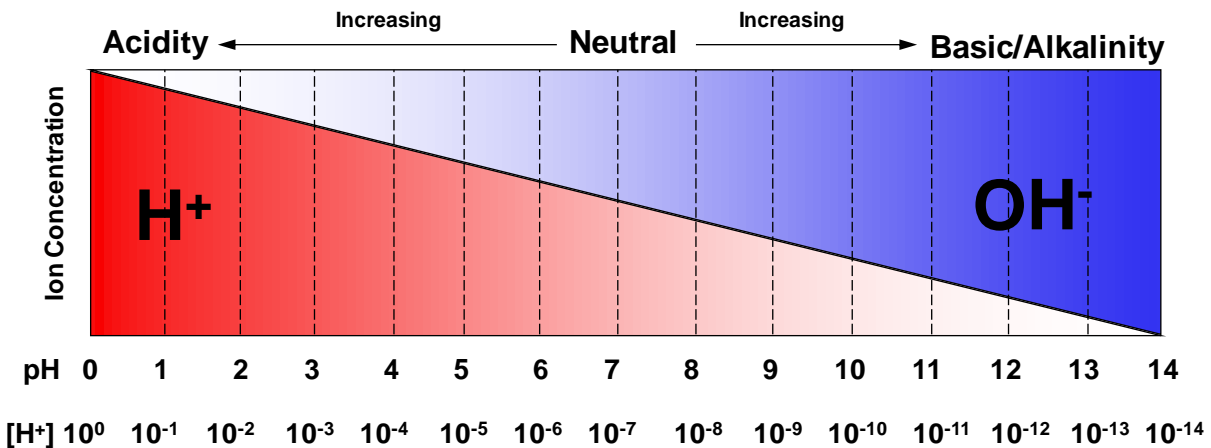

Figure S.7 pH Scale

S.1.5 Elastic Modulus

An Elastic Modulus (E) or Young's Modulus can be determined for any solid material and represents a constant ratio of stress over strain (a stiffness) below the proportional limit:

$$E = \frac{\sigma}{\epsilon} \quad \text{Eq. S.6}$$

Where:

E = Elastic Modulus

σ = stress =

$$\frac{\text{Load } P}{\text{Area } A} \quad \text{Eq. S.7}$$

ϵ = strain =

$$\frac{\text{Change in Length } \Delta L}{\text{Original Length } L_o} \quad \text{Eq. S.8}$$

A material is elastic if it is able to return to its original shape or size immediately after being stretched or squeezed. Almost all materials are elastic to some degree as long as the applied load does not cause it to deform permanently. The modulus of elasticity for a material is basically the slope of its stress-strain plot within the elastic range.

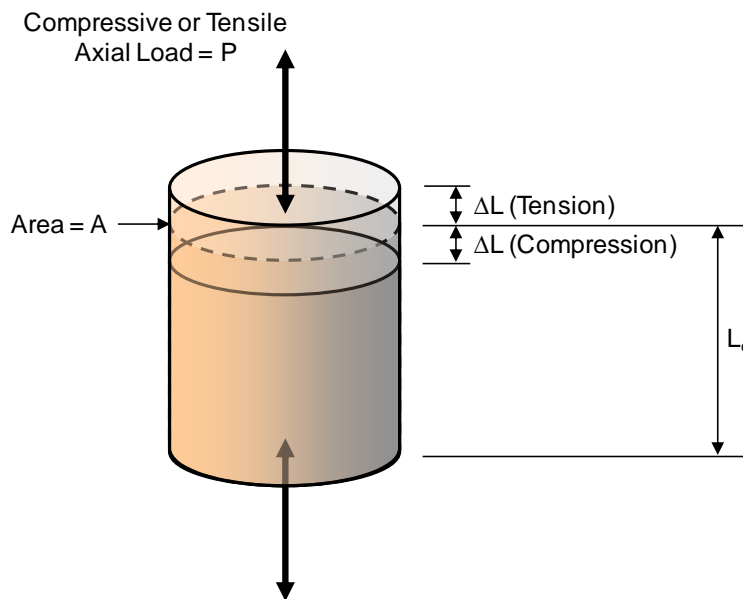

Figure S.8 Elastic Modulus

S.1.5.1 Concrete Modulus of Elasticity

The static Modulus of Elasticity (E_c) of concrete in compression is determined by ASTM C 469. The chord modulus is the slope of the chord drawn between any two specified points on the stress-strain curve below the elastic limit of the material.

$$E_c = \frac{(\sigma_2 - \sigma_1)}{(\varepsilon_2 - 0.000050)} \quad \text{Eq. S.9}$$

Where:

- E_c = Chord Modulus of Elasticity, psi
- σ_2 = stress corresponding to 40% of ultimate load
- σ_1 = stress corresponding to a longitudinal strain, ε_1 , of 50 millionths, psi
- ε_2 = longitudinal strain produced by stress σ_2

S.1.5.2 Asphalt Dynamic Modulus $|E^*|$

The complex Dynamic Modulus ($|E^*|$) of asphalt is a time-temperature dependent function. The $|E^*|$ properties are known to be a function of temperature, rate of loading, age, and mixture characteristics such as binder stiffness, aggregate gradation, binder content, and air voids. To account for temperature and rate of loading effects the analysis levels will be determined from a master curve constructed at a reference temperature of 20°C (70°F) (5). The description below is for developing the master curve and shift factors of the original condition without introducing aged binder viscosity and additional calculated shift factors using appropriate viscosity.

$|E^*|$ is the absolute value of the complex modulus calculated by dividing by the maximum (peak to peak) stress by the recoverable (peak to peak) axial strain for a material subjected to a sinusoidal loading.

A sinusoidal (Haversine) axial compressive stress is applied to a specimen of asphalt concrete at a given temperature and loading frequency. The applied stress and the resulting recoverable axial strain response of the specimen is measured and used to calculate the $|E^*|$ and phase angle. See **Eq. S.10** for $|E^*|$ general equation and **Eq. S.11** for phase angle equation. Dynamic modulus values are measured over a range of temperatures and load frequencies at each temperature. See **Table S.2 Recommended Testing Temperatures and Loading Frequencies**. Each test specimen is individually tested for each of the combinations. The table shows a reduced temperature and loading frequency as recommend. See **Figure S.9 Dynamic Modulus Stress-Strain Cycles** for time lag response. See **Figure S.10 $|E^*|$ vs. Log Loading Time Plot at Each Temperature**. To compare test results of various mixes, it is important to normalize one of these variables. 20°C (70°F) is the variable that is normalized. Test values for each test condition at different temperatures are plotted and shifted relative to the time of loading. See **Figure S.11 Shifting of Various Mixture Plots**. These shifted plots of various mixture curves can be aligned to form a single master curve (26). See **Figure S.12 Dynamic Modulus $|E^*|$ Master Curve**. The $|E^*|$ is determined by AASHTO PP 61-09 and PP 62-09 test methods (27 and 28).

Table S.2 Recommended Testing Temperatures and Loading Frequencies

PG 58-XX and Softer		PG 64-XX and PG 70-XX		PG 76-XX and Stiffer	
Temperature °C	Loading Frequencies Hz	Temperature °C	Loading Frequencies Hz	Temperature °C	Loading Frequencies Hz
4	10, 1, 0.1	4	10, 1, 0.1	4	10, 1, 0.1
20	10, 1, 0.1	20	10, 1, 0.1	20	10, 1, 0.1
35	10, 1,0.1,0.01	40	10, 1,0.1,0.01	45	10, 1,0.1,0.01

$$|E^*| = \frac{\sigma_o}{\epsilon_o}$$

Eq. S.10

Where:

$|E^*|$ = dynamic modulus

σ_o = average peak-to-peak stress amplitude, psi

ϵ_o = average peak-to-peak strain amplitude, in/in, that coincides with time lag (phase angle)

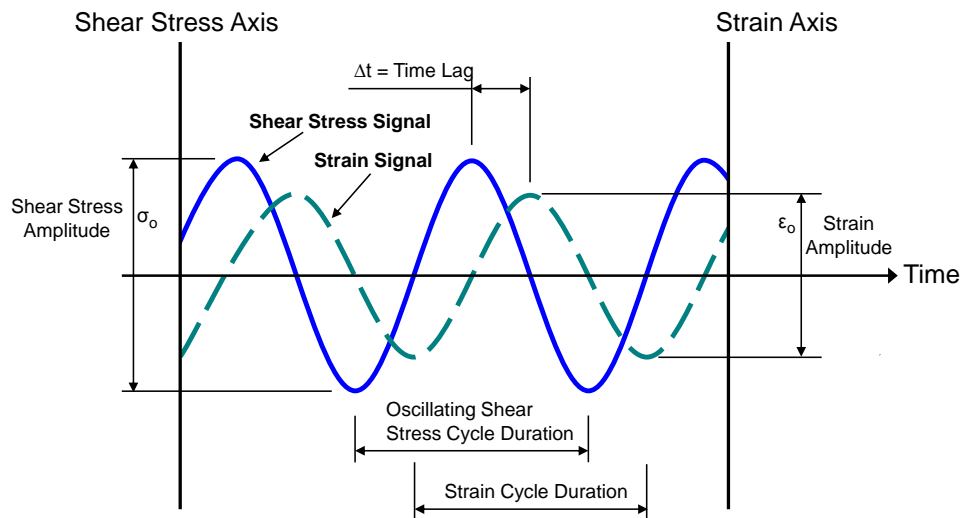

Figure S.9 Dynamic Modulus Stress-Strain Cycles

The phase angle \emptyset is calculated for each test condition and is:

$$\emptyset = 2\pi f \Delta t$$

Eq. S.11

Where:

\emptyset = phase angle, rad

f = frequency, Hz

Δt = time lag between stress and strain, sec.

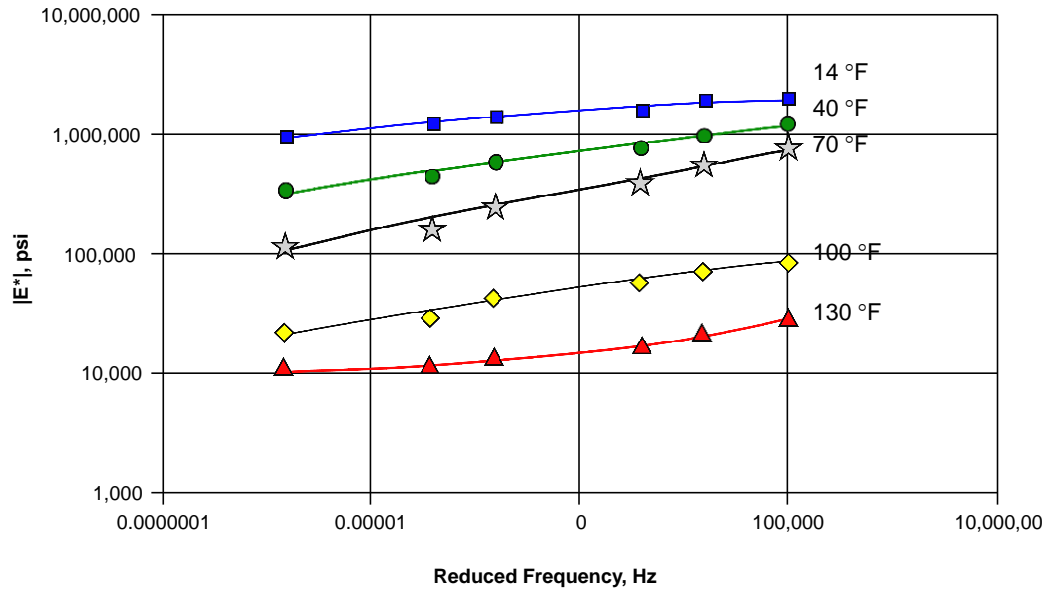

Figure S.10 |E*| vs. Log Loading Time Plot at Each Temperature

The $|E^*|$ master curve can be represented by a sigmoidal function as shown (27):

$$\log|E^*| = \delta + \frac{(\text{Max} - \delta)}{1 + e^{\beta + \gamma \left\{ \log f + \frac{\Delta E_a}{19.14714} \left[\left(\frac{1}{T} \right) - \left(\frac{1}{T_r} \right) \right] \right\}}}$$

Eq. S.12

Where:

$|E^*|$ = dynamic modulus, psi

δ , β , and γ = fitting parameters

Max = limiting maximum modulus, psi

F = loading frequency at the test temperature, Hz

E_a = energy (treated as a fitting parameter)

T = test temperature, °K

T_r = reference temperature, °K

Fitting parameters δ and α depend on aggregate gradation, binder content, and air void content. Fitting parameters β and γ depend on the characteristics of the asphalt binder and the magnitude of δ and α . The sigmoidal function describes the time dependency of the modulus at the reference temperature.

The maximum limiting modulus is estimated from HMA volumetric properties and limiting binder modulus.

$$|E^*|_{\max} = P_c \left[4,200,000 \left(1 - \frac{\text{VMA}}{100} \right) + 435,000 \left(\frac{\text{VFA} \times \text{VMA}}{10,000} \right) + \frac{1 - P_c}{\frac{1 - \text{VMA}}{4,200,000} + \frac{\text{VMA}}{435,000(\text{VFA})}} \right] \quad \text{Eq. S.13}$$

Where:

$$P_c = \frac{\left[20 + \frac{435,000(\text{VFA})}{\text{VMA}} \right]^{0.58}}{650 + \left[\frac{435,000(\text{VFA})}{\text{VMA}} \right]^{0.58}} \quad \text{Eq. S.14}$$

$|E^*|_{\max}$ = limiting maximum HMA dynamic modulus, psi
VMA = voids in the mineral aggregate, %
VFA = voids filled with asphalt, %

The shift factors describe the temperature dependency of the modulus.

Shift factors to align the various mixture curves to the master curve are shown in the general form as (27):

$$\log[\alpha(T)] = \frac{\Delta E_a}{19.14714} \left(\frac{1}{T} - \frac{1}{T_r} \right) \quad \text{Eq. S.15}$$

Where:

$\alpha(T)$ = shift factor at temperature (T)
 ΔE_a = the activation energy (treated as a fitting parameter)
T = the test temperature, °K
 T_r = the reference temperature, °K

A shift factor plot as a function of temperature for the mixtures is shown in **Figure S.13 Shift Factor Plot**.

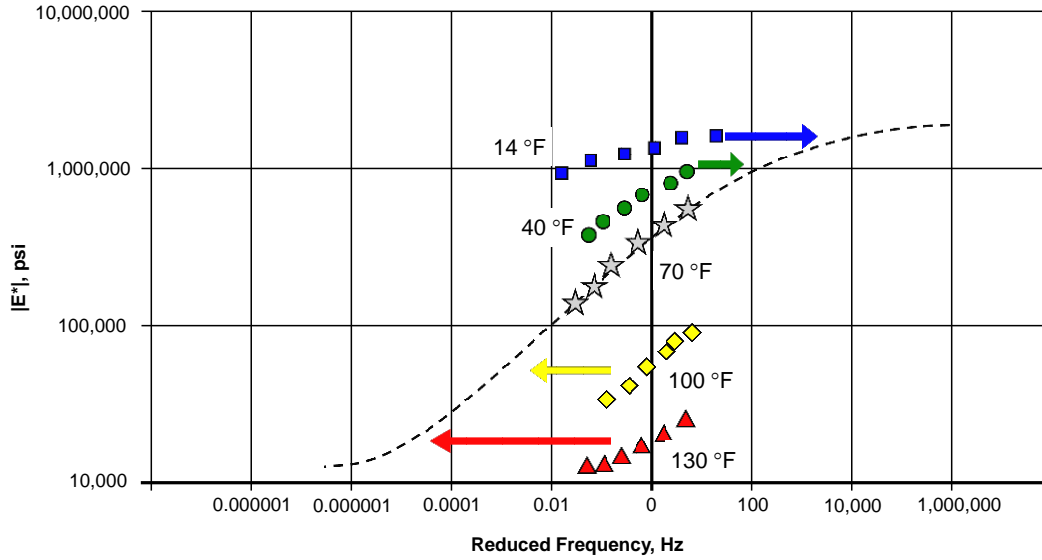

Figure S.11 Shifting of Various Mixture Plots

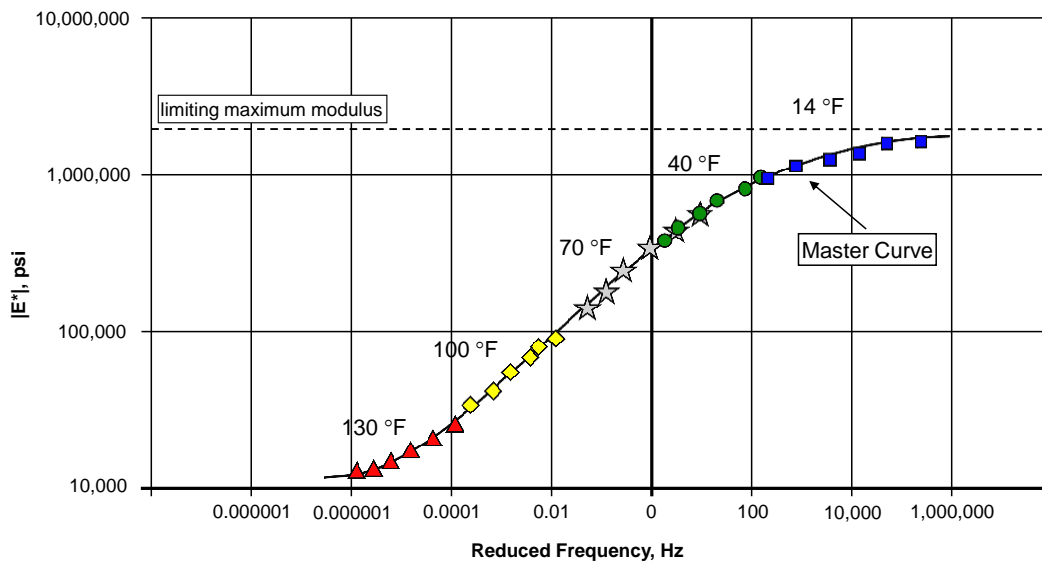

Figure S.12 Dynamic Modulus $|E^*|$ Master Curve

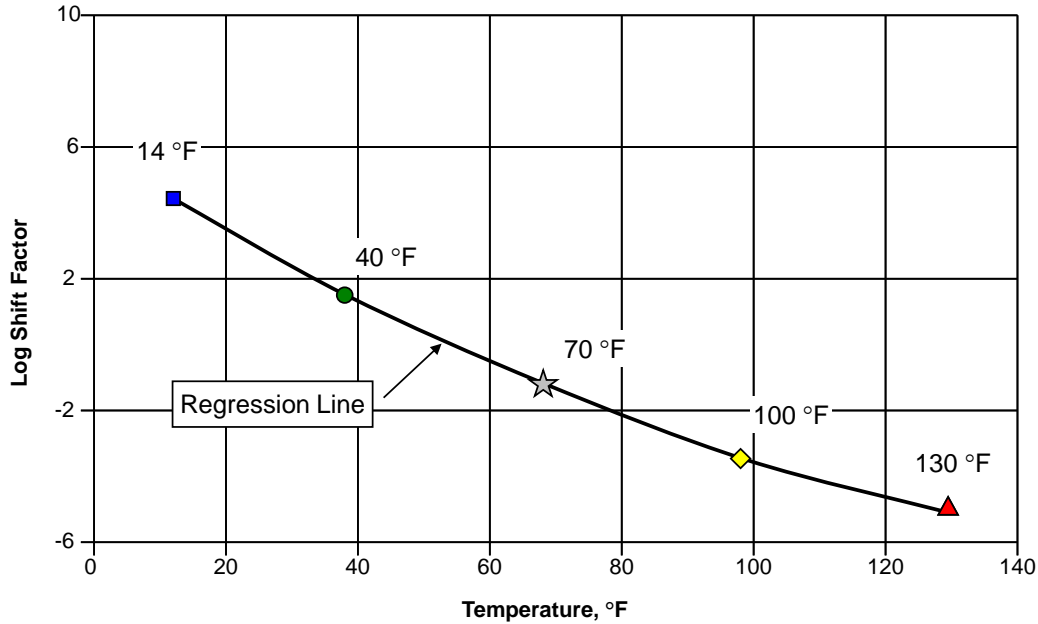

Figure S.13 Shift Factor Plot

S.1.6 Binder Complex Shear Modulus

The complex shear modulus, G^* is the ratio of peak shear stress to peak shear strain in dynamic (oscillatory) shear loading between a oscillating plate a fixed parallel plate. The test uses a sinusoidal waveform that operates at one cycle and is set at 10 radians/second or 1.59 Hz. The oscillating loading motion is a back and forth twisting motion with increasing and decreasing loading. Stress or strain imposed limits control the loading. The one cycle loading is a representative loading due to 55 mph traffic. If the material is elastic, then the phase lag is zero. G' represents this condition and is said to be the storage modulus. If the material is wholly viscous, then the phase lag is 90° out of phase. G'' represents the viscous modulus. G^* is the vector sum of G' and G'' . Various artificially aged specimens and/or in a series of temperature increments may be tested. The DSR test method is applicable to a temperature range of 40°F and above.

at peak angle in radians

$$G^* = \frac{\tau_{\max}}{\gamma_{\max}} \quad \text{Eq. S.16}$$

$$\tau_{\max} = \frac{2T_{\max}}{\pi r^3} \quad \text{Eq. S.17}$$

$$\gamma_{\max} = \frac{\theta_{\max}(r)}{h} \quad \text{Eq. S.18}$$

Where:

- G^* = Binder Complex Shear Modulus
- τ_{max} = maximum shear stress
- γ_{max} = maximum shear strain
- T_{max} = maximum applied torque
- r = radius of specimen
- θ_{max} = maximum rotation angle (radians)
- h = height of specimen

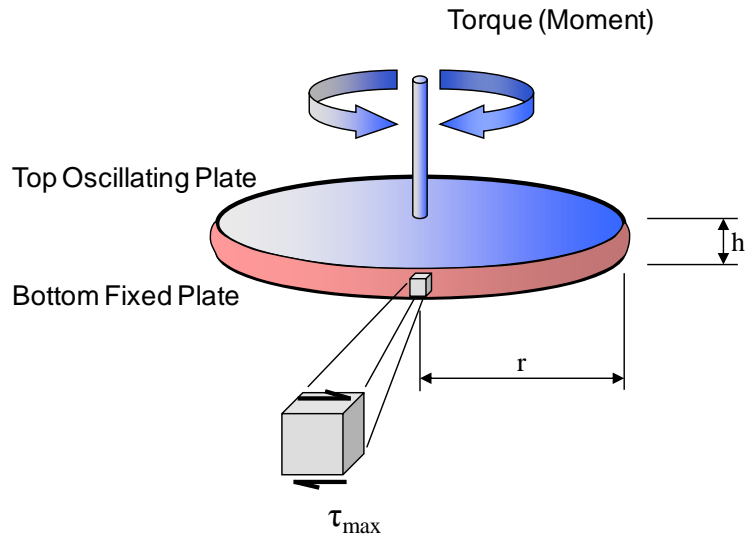

Figure S.14 Binder Complex Shear Modulus Specimen Loading

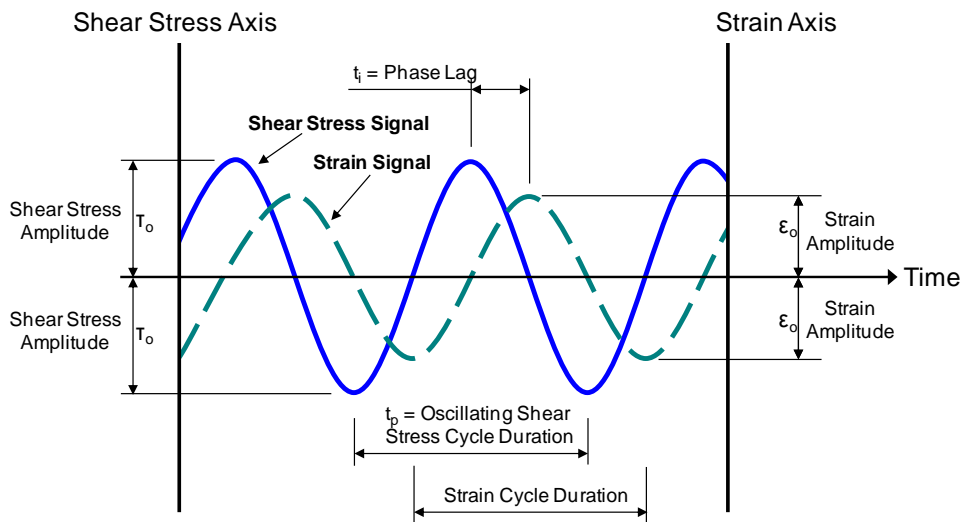

Figure S.15 Binder Complex Shear Modulus Shear-Strain Cycles

A relationship between binder viscosity and binder complex shear modulus (with binder phase angle) at each temperature increment of 40, 55, 70 (reference temperature), 85, 100, 115 and 130°F are obtained by:

$$\eta = \frac{G^*}{10} \left(\frac{1}{\sin \delta} \right)^{4.8628}$$

Eq. S.19

Where:

- η = viscosity
- G^* = binder complex shear modulus
- δ = binder phase angle

The regression parameters are found by using **Eq. S.20** by linear regression after log-log transformation of the viscosity data and log transformation of the temperature data:

$$\log \log \eta = A + VTS \log T_r$$

Eq. S.20

Where:

- η = binder viscosity
- A, VTS = regression parameters
- T_R = temperature, degrees Rankin

S.1.7 Poisson's Ratio

The ratio of the lateral strain to the axial strain is known as Poisson's ratio, μ .

$$\mu = \frac{\epsilon_{\text{lateral}}}{\epsilon_{\text{axial}}}$$

Eq. S.21

Where:

μ = Poisson's ratio

$\epsilon_{\text{lateral}}$ = strain in width or diameter =

$$\frac{\text{Change in Diameter}}{\text{Original Diameter}} = \frac{\Delta D}{D_o}$$

Eq. S.22

ϵ_{axial} = strain in length =

$$\frac{\text{Change in Length}}{\text{Original Length}} = \frac{\Delta L}{L_o}$$

Eq. S.23

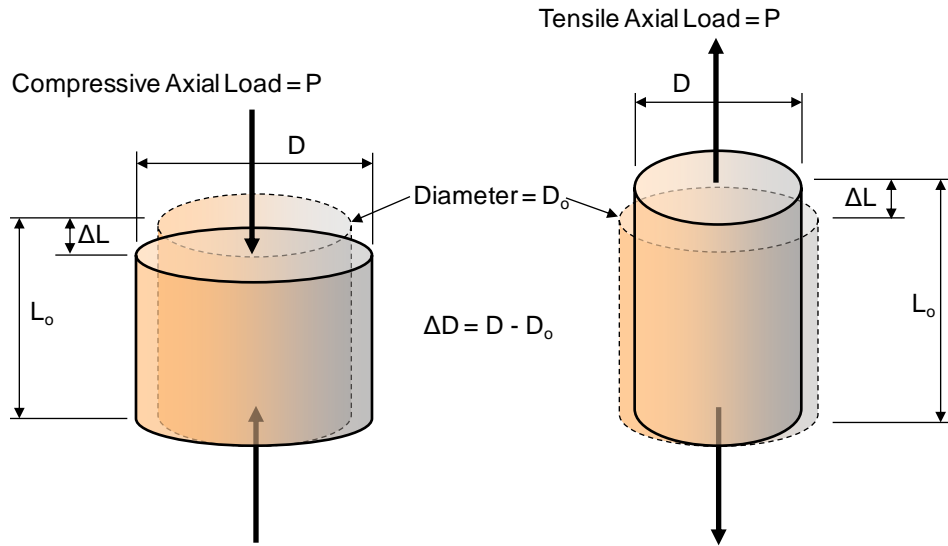

Figure S.16 Poisson's ratio

S.1.8 Coefficient of Lateral Pressure

The coefficient of lateral pressure, k_o , is the term used to express the ratio of the lateral earth pressure to the vertical earth pressure.

Cohesionless Materials:

$$k_o = \frac{\mu}{1 - \mu} \quad \text{Eq. S.24}$$

Cohesive Materials:

$$k_o = 1 - \sin \phi \quad \text{Eq. S.25}$$

Where:

- k_o = Coefficient of Lateral Pressure
- μ = Poisson's ratio
- ϕ = the effective angle of internal friction

S.1.9 Unconfined Compressive Strength

Unconfined compressive strength, f'_c is shown in **Eq. S.26**. The compressive strength of soil cement is determined by ASTM D 1633. The compressive strength for lean concrete and cement treated aggregate is determined by AASHTO T 22, lime stabilized soils are determined by ASTM D 5102, and lime-cement-fly ash is determined by ASTM C 593.

$$f'_c = \frac{P}{A}$$

Eq. S.26

Where:

f'_c = unconfined compressive strength, psi

P = maximum load

A = cross sectional area

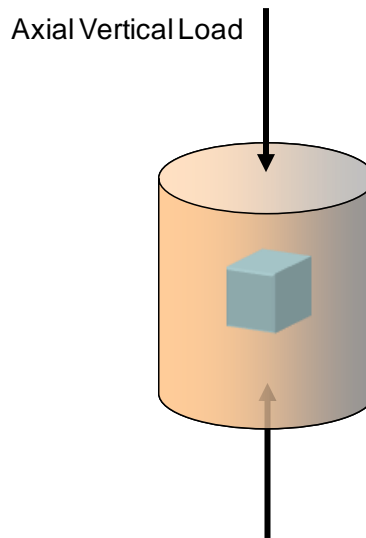

Figure S.17 Unconfined Compressive Strength

S.1.10 Modulus of Rupture

The Modulus of Rupture (M_r) is maximum bending tensile stress at the surface of a rectangular beam at the instant of failure using a simply supported beam, loaded at the third points. The M_r is a test conducted solely on portland cement concrete and similar chemically stabilized materials. The rupture point of a concrete beam is at the bottom. The classical formula is shown in **Eq. S.27**. The M_r for lean concrete, cement treated aggregate, and lime-cement-fly ash are determined by AASHTO T 97. Soil cement is determined by ASTM D 1635.

$$\sigma_{b,\max} = \frac{M_{\max} c}{I_c}$$

Eq. S.27

Where:

M_{\max} = maximum moment

c = distance from neutral axis to the extreme fiber

I_c = centroidal area moment of inertia

If the fracture occurs within the middle third of the span length then MR is calculated by:

$$S'_c = \frac{Pl}{bd^2} \quad \text{Eq. S.28}$$

If the fracture occurs outside the middle third of the span length by not more than 5% of the span length the MR is calculated by:

$$S'_c = \frac{3Pa}{bd^2} \quad \text{Eq. S.29}$$

Where:

S'_c = Modulus of Rupture, psi

P = maximum applied load

l = span length

b = average width of specimen

d = average depth of specimen

a = average distance between line of fracture and the nearest support on the tension surface of the beam

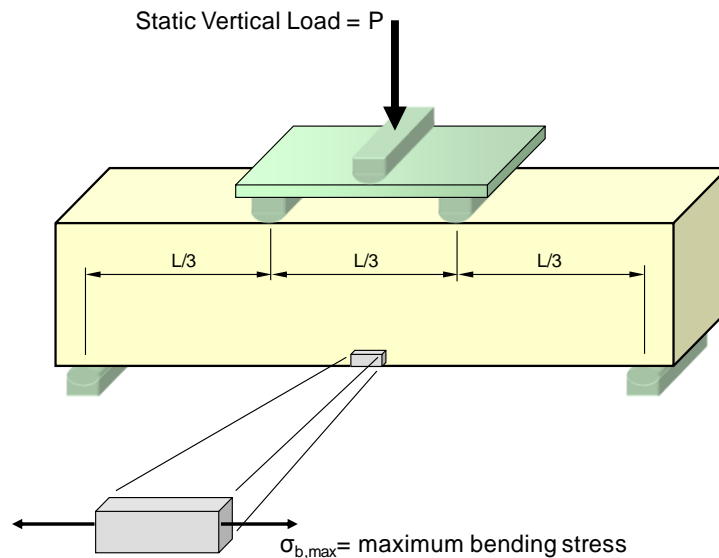

Figure S.18 3-Point Beam Loading for Flexural Strength

S.1.11 Tensile Creep and Strength for Hot Mix Asphalt

The tensile creep is determined by applying a static load along the diametral axis of a specimen. The horizontal and vertical deformations measured near the center of the specimen are used to calculate tensile creep compliance as a function of time. The Creep Compliance, $D(t)$ is a time-dependent strain divided by an applied stress. The Tensile Strength, S_t is determined immediately after the tensile creep (or separately) by applying a constant rate of vertical deformation (loading movement) to failure. AASHTO T 322 - *Determining the Creep Compliance and Strength of Hot-*

Mix Asphalt (HMA) Using the Indirect Tensile Test Device, using 6" diameter by 2" height molds, determines Creep Compliance and Tensile Strength. CDOT uses CP-L 5109 - *Resistance of Compacted Bituminous Mixture to Moisture Induced Damage* to determine the tensile strength using 4" diameter by 2.5" height molds for normal aggregate mixtures.

Creep Compliance is:

$$D(t) = \frac{\epsilon_t}{\sigma} \quad \text{Eq. S.30}$$

Where:

$D(t)$ = creep compliance at time, t
 ϵ_t = time-dependent strain
 σ = applied stress

Tensile Strength is:

$$S_t = \frac{2P}{\pi t D} \quad \text{Eq. S.31}$$

Where:

S_t = tensile strength, psi
 P = maximum load
 t = specimen height
 D = specimen diameter

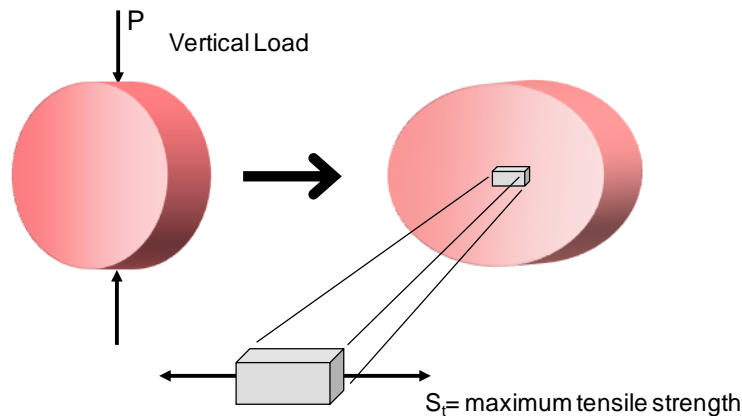
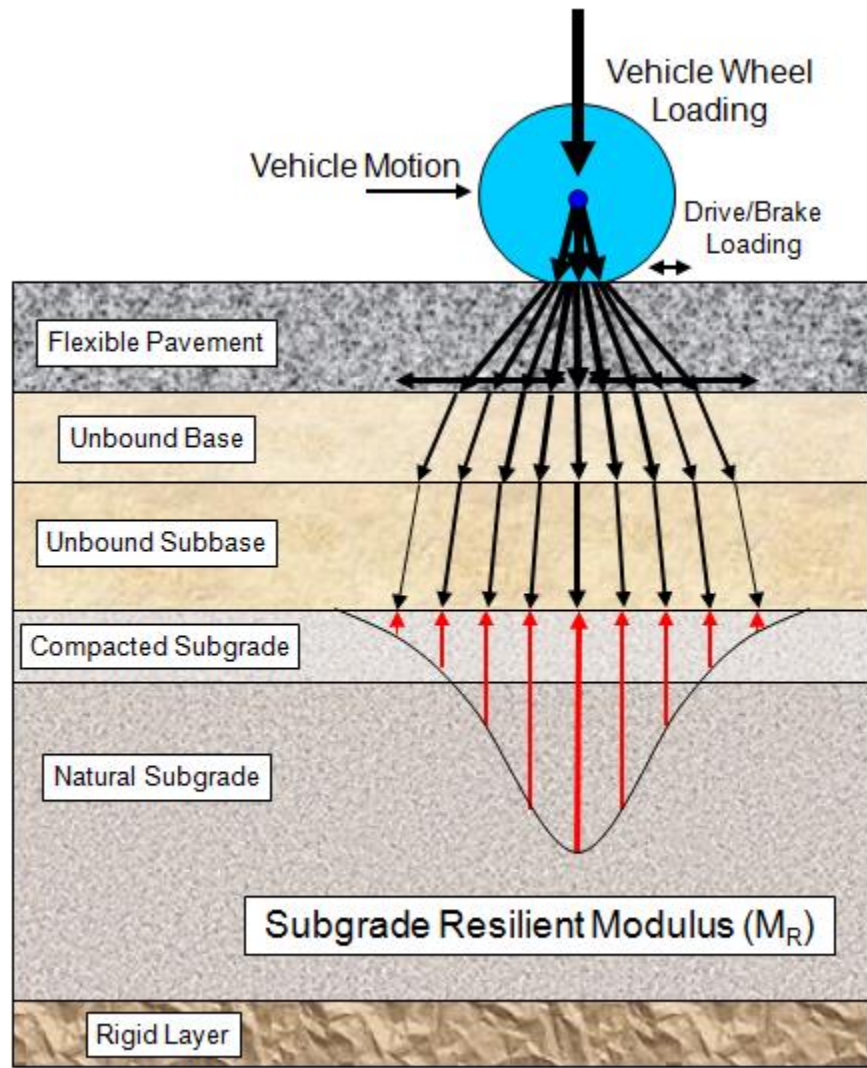

Figure S.19 Indirect Tensile Strength

S.2 Resilient Modulus of Conventional Unbound Aggregate Base, Subbase, Subgrade, and Rigid Layer

The subgrade resilient modulus is used for the support of pavement structure in flexible pavements. The graphical representation (**Figure S.20 Distribution of Wheel Load to Subgrade Soil (Mr)**)

is the traditional way to explain the interaction of subgrade reaction to a moving wheel load. As the wheel load moves toward an area of concern, the subgrade reacts with a larger reaction. When the wheel loading moves away the subgrade reaction is less. That variable reaction is the engineering property Resilient Modulus. Critical locations in the layers have been defined for the Mechanistic-Empirical Design. Refer to **Figure S.21 Critical Stress/Strain Locations for Bases, Subbases, Subgrade, and Rigid Layer**. CDOT has historically used the empirical design methodology using structural coefficients of base (a_2) and subbase (a_3) layers. The rigid layer was only accounted for when it was close to the pavement structure.



Conventional Flexible

Figure S.20 Distribution of Wheel Load to Subgrade Soil (M_R)

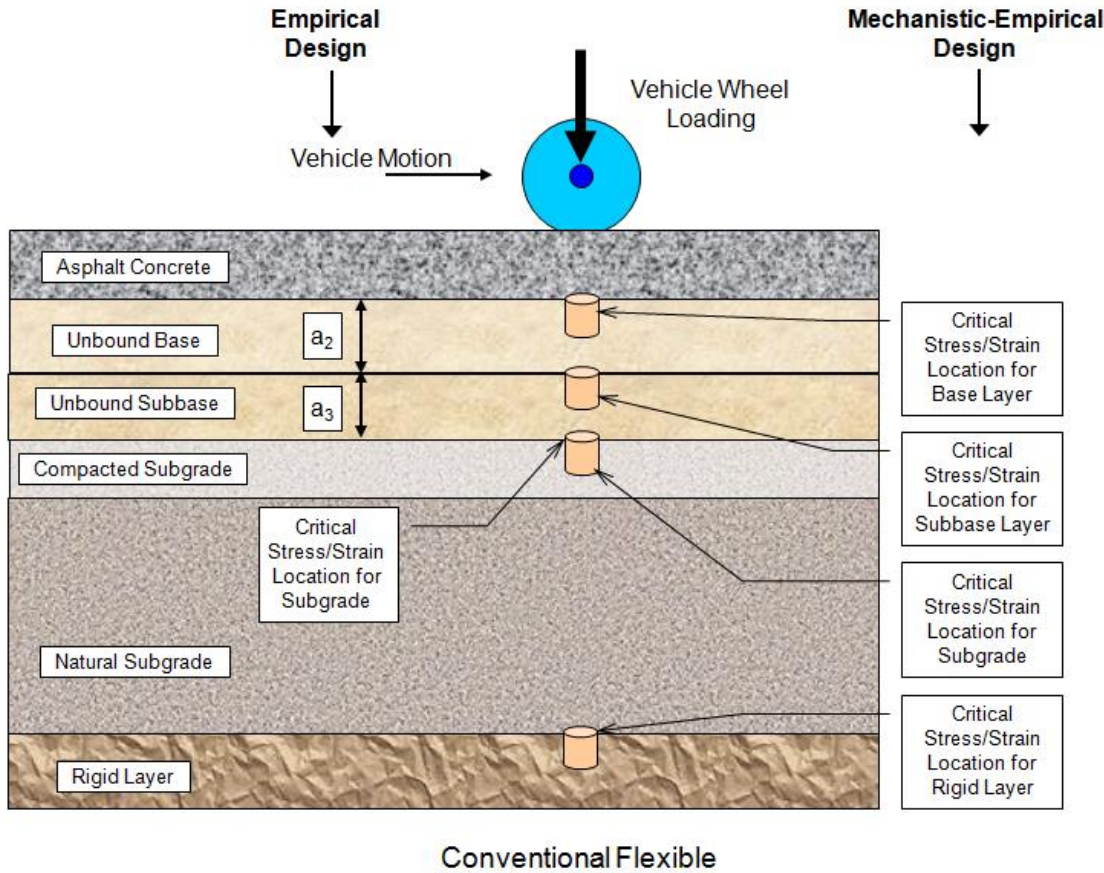

Figure S.21 Critical Stress/Strain Locations for Bases, Subbases, Subgrade, and Rigid Layer

S.2.1 Laboratory M_r Testing

The critical location for the subgrade is at the interface of the subbase and subgrade. The material subgrade element has the greatest loads at this location when the wheel loadings are directly above. Refer to **Figure S.30 Critical Stress Locations for Stabilized Subgrade**.

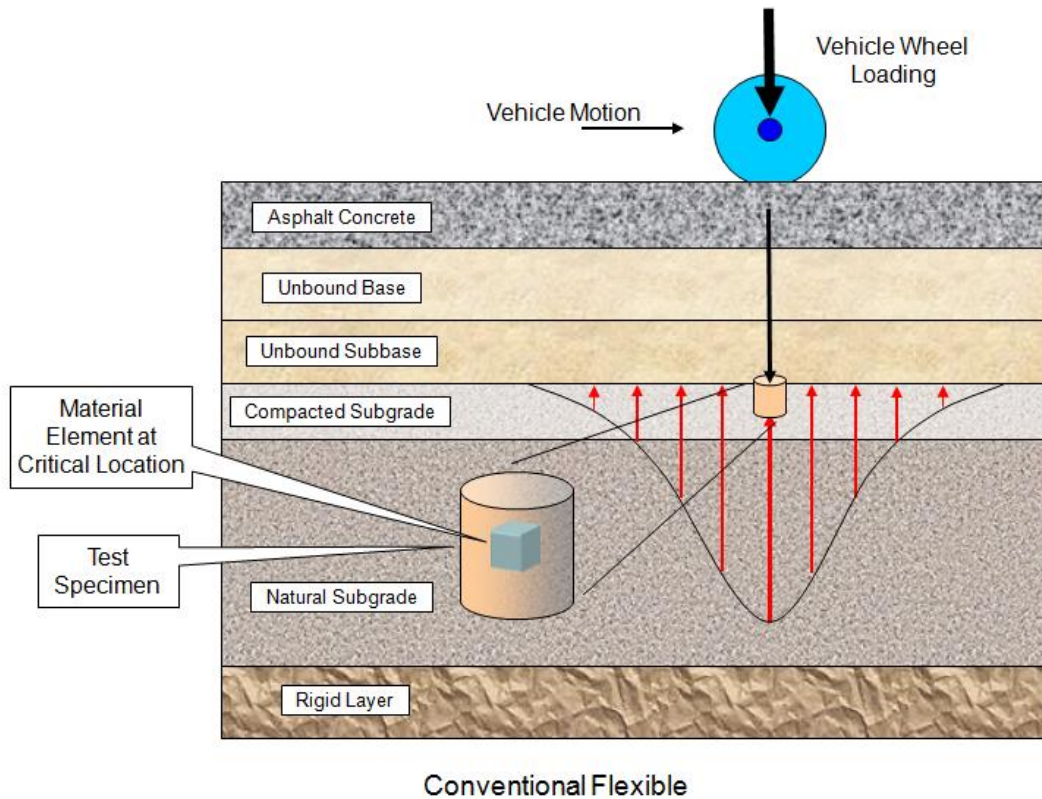

Figure S.22 Subgrade Material Element at Critical Location

While the modulus of elasticity is stress divided by strain for a slowly applied load, resilient modulus is stress divided by strain for rapidly applied loads – like those experienced by pavements.

Resilient Modulus is defined as the ratio of the amplitude of the repeated cyclical (resultant) axial stress to the amplitude of resultant (recoverable) axial strain.

$$M_r = \frac{\sigma_d}{\epsilon_r} \quad \text{Eq. S.32}$$

Where:

M_r = resilient modulus

σ_d = repeated wheel load stress (deviator stress) = applied load / cross sectional area

ϵ_r = recoverable strain = $\Delta L/L$ = recoverable deformation / gauge length

The test is similar to the standard triaxial compression test, except that the vertical stress is cycled at several levels to model wheel load intensity and duration typically encountered in pavements under a moving load. The confining pressure is also varied and sequenced through in conjunction with the varied axial loading to specified axial stresses. The purpose of this test procedure is to determine the elastic modulus value (stress-sensitive modulus) and by recognizing certain nonlinear characteristics for subgrade soils, untreated base and subbases, and rigid foundation materials. The stress levels used are based on type of material within the pavement structure. The

test specimen should be prepared to approximate the in situ density and moisture condition at or after construction (5). The test is to be performed in accordance with the latest version of AASHTO T 307. **Figure S.23 Resilient Modulus Test Specimen Stress State** and **Figure S.24 Resilient Modulus Test Specimen Loading** are graphical representations of applied stresses and concept of cyclical deformation applied deviator loading.

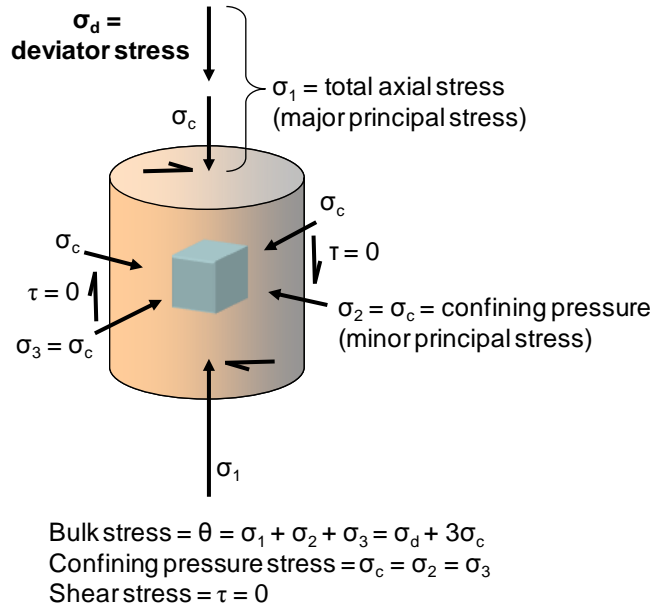

Figure S.23 Resilient Modulus Test Specimen Stress State

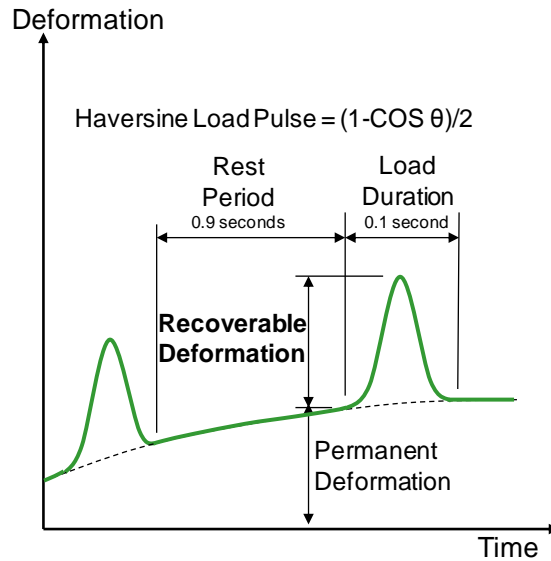

Figure S.24 Resilient Modulus Test Specimen Loading

Traditionally, the stress parameter used for sandy and gravelly materials, such as base courses, is the bulk stress.

$$\theta = \sigma_1 + \sigma_2 + \sigma_3 \quad \text{Eq. S.33}$$

For cohesive subgrade materials, the deviatoric stress is used.

$$\sigma_d = \sigma_1 - \sigma_3 \quad \text{Eq. S.34}$$

In recent years, the octahedral shear stress, which is a scalar invariant (it is essentially the root-mean-square deviatoric stress), has been used for cohesive materials instead of the deviatoric stress.

$$\tau_{\text{oct}} = \frac{1}{3} \sqrt{(\sigma_1 - \sigma_2)^2 + (\sigma_2 - \sigma_3)^2 + (\sigma_3 - \sigma_1)^2} \quad \text{Eq. S.35}$$

The major material characteristics associated with unbound materials are related to the fact that moduli of these materials may be highly influenced by the stress state (non-linear) and in-situ moisture content. As a general rule, coarse-grained materials have higher moduli as the state of confining stress is increased. In contrast, clayey materials tend to have a reduction in modulus as the deviatoric or octahedral stress component is increased. Thus, while both categories of unbound materials are stress dependent (non-linear), each behaves in an opposite direction as stress states are increased (5).

S.2.2 Field M_R Testing

An alternate procedure to determine the M_R value is to obtain a field value. Determination of an in-situ value is to backcalculate the M_R from deflection basins measured on the pavement's surface. The most widely used deflection testing devices are impulse loading devices. CDOT uses the Falling Weight Deflectometer (FWD) as a Nondestructive Test (NDT) method to obtain deflection measurements. The FWD device measures the pavement surface deflection and deflection basin of the loaded pavement, making it possible to obtain the pavement's response to load and the resulting curvature under load. A backcalculation software program analyzes the pavements response from the FWD data. Unfortunately, layered elastic moduli backcalculated from deflection basins and laboratory measured resilient modulus are not equal for a variety of reasons. The more important reason is that the uniform confining pressures and repeated vertical stresses used in the laboratory do not really simulate the actual confinement and stress state variation that occurs in a pavement layer under the FWD test load or wheel loading (9). Additional information on NDT is provided in **APPENDIX C**.

S.2.3 Adjustment to Laboratory and Field M_R Values for Climate

The M_R is dependent upon the seasonal variation or climate.

Figure S.25 Resilient Modulus Seasonal Variation is a graphical representation of the strength of unbound materials varies with the seasons. Pavement designers should select the M_R value that represents the average of the entire pavement foundation.

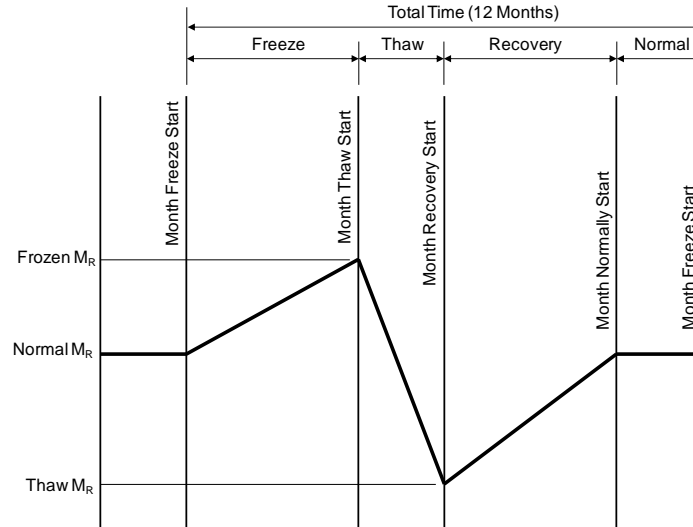

Figure S.25 Resilient Modulus Seasonal Variation

S.3 Resistance Value (R-value)

The Resistance Value (R-value) test is a material stiffness test. The test procedure expresses a material's resistance to deformation as a function of the ratio of transmitted lateral pressure to applied vertical pressure. The R-value is calculated from the ratio of the applied vertical pressure to the developed lateral pressure and is essentially a measure of the material's resistance to plastic flow. Another way the R-value may be expressed is it is a parameter representing the resistance to the horizontal deformation of a soil under compression at a given density and moisture content. The R-value test, while being time and cost effective, does not have a sound theoretical base and it does not reflect the dynamic behavior and properties of soils. The R-value test is static in nature and irrespective of the dynamic load repetition under actual traffic.

CDOT uses Hveem stabilometer equipment to measure strength properties of soils and bases. This equipment yields an index value called the R-value. The R-value to be used is determined in accordance with Colorado Procedure - Laboratory 3102, Determination of Resistance Value at Equilibrium, a modification of AASHTO T 190, Resistance Value and Expansion Pressure of Compacted Soils.

The inability of the Stabilometer R-value to realistically reflect the engineering properties of granular soils with less than 30 percent fines has contributed to its poor functional relationship to M_R in that range (7).

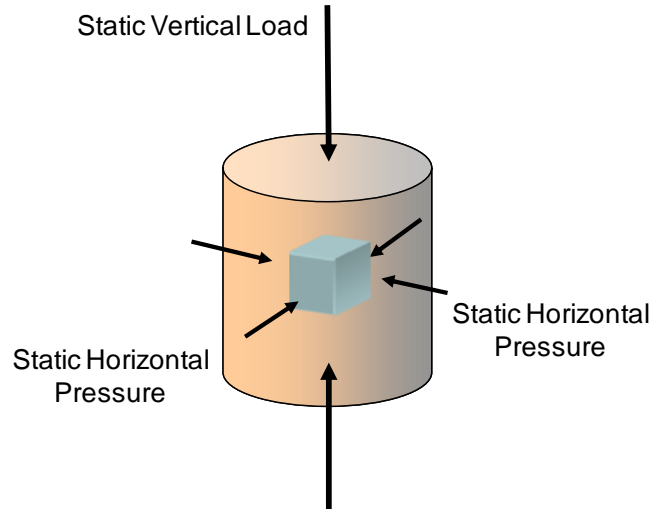

Figure S.26 Resistance R-value Test Specimen Loading State

S.4 M_r and R-value Correlation

A number of correlation equations have been developed. The Asphalt Institute (8) has related M_r to R-value repeated in the 1986 AASHTO Guide and expressed as follows (2)(5)(6):

$$M_r(\text{psi}) = A + B(\text{R-value}) \quad \text{Eq. S.36}$$

Where:

$$A = 772 \text{ to } 1,155.$$

$$B = 396 \text{ to } 555.$$

CDOT uses the correlation combining two equations:

$$S_1 = [(R-5)/11.29] + 3 \quad \text{Eq. S.37}$$

$$M_r = 10^{[(S_1 + 18.72) / 6.24]} \quad \text{Eq. S.38}$$

Where:

M_r = resilient modulus (psi).

S_1 = the soil support value.

R = the R-value obtained from the Hveem stabilometer.

Figure S.27 Correlation Plot between Resilient Modulus and R-value plots the correlations of roadbed soils. In the **Figure S.27 Correlation Plot between Resilient Modulus and R-value**, the CDOH/CDOT current design curve and the referenced 1986 AASHTO equations were based on the AASHTO Test Method T 274 to determine the M_R value. The plot is to show the relative relationship of each equation to each other.

Correlation between Resilient Modulus and R-values
(from 1986 AASHTO Design Guide and CDOH Current Design Curve)

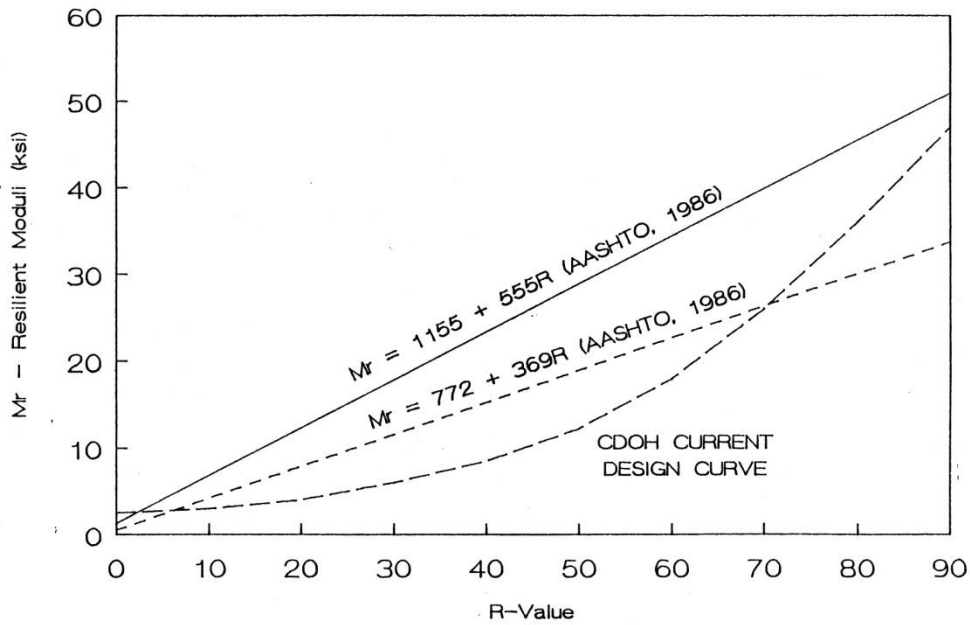

Figure S.27 Correlation Plot between Resilient Modulus and R-value
(*Resilient Properties of Colorado Soils*, pg 15, Figure 2.10, 1989 (6))

Table S.3 Comparisons of Mr between Suggested NCHRP 1-40D Values and Colorado Soils with R-values is a comparison of M_r values. The test procedure was in accordance to AASHTO 307, Type 2 Material with a loading sequence in accordance with SHRP TP 46, Type 2 Material. Additional testing of Colorado soils with 2 and 4 percent above optimum moisture were conducted to simulate greater moisture contents if the in-situ soils have an increase in moisture. Generally, the strengths decreased, but not always. Colorado soils exhibit a lower M_r than the recommended values from publication NCHRP 1-37A, Table 2.2.51.

Table S.3 Comparisons of M_r between Suggested NCHRP 1-40D Values and Colorado Soils with R-values

Research Results Digest of NCHRP Project 1-40D (July 2006)				Soil Classification	Colorado Soils (Unpublished Data 7/12/2002)			
Flexible Subgrades		Rigid Subgrades			R-value	Optimum M_r	2% Over Optimum M_r	4% Over Optimum M_r
Opt. M_r (mean)	Opt. M_r (std dev)	Opt. M_r (mean)	Opt. M_r (std dev)					
29,650	15,315	13,228	3,083	A-1-a	-	-	-	
26,646	12,953	14,760	8,817	A-1-b	32	10,181	9,235	
21,344	13,206	14,002	5,730	A-2-4	50	7,842	5,161	3,917
					37	11,532	5,811	4,706
					40	10,750	7,588	7,591
					38	7,801	7,671	-
-	-	-	-	A-2-5	-	-	-	
20,556	12,297	16,610	6,620	A-2-6	35	8,024	4,664	4,343
					19	7,600	5,271	5,009
					45	8,405	5,954	5,495
					42	8,162	7,262	-
					37	7,814	5,561	4800*
					24	7,932	5,846	5210*
16,250	4,598	-	-	A-2-7	49	10,425	9,698	8196*
					13	7,972	4,702	3,511
					18	7,790	5,427	4,003
					29	8,193	5,558	5,221
					29	8,351	6,604	6,248
					9	11,704	8,825	7,990
24,697	11,903	-	-	A-3	-	-	-	
16,429	12,296	17,763	8,889	A-4	19	6,413	5,233	4,736
					23	10,060	6,069	5,729
					49	7,583	7,087	6,311
					44	11,218	6,795	5794*
-	-	-	-	A-5	-	-	-	
14,508	9,106	14,109	5,935	A-6	21	7,463	3,428	2,665
					8	5,481	3,434	2,732
					12	5,162	3,960	2,953
					14	4,608	3,200	2,964
					10	13,367	4,491	3,007
					19	6,638	3,842	3,456
					10	7,663	4,244	3,515
					15	5,636	3,839	3,551
					17	7,135	4,631	3,821
					21	6,858	5,488	4,010
					14	6,378	4,817	4,234
					8	5,778	5,243	4,934
					40	17,436	7,438	5,870
					27	7,381	5,491	-
17	8,220	6,724	-					
13,004	13,065	7,984	3,132	A-7-5	26	11,229	9,406	5,238
11,666	7,868	13,218	322	A-7-6	6	4,256	2,730	1,785
					8	4,012	2,283	1,909
					10	5,282	2,646	1,960
					11	4,848	3,159	2,157
					5	6,450	3,922	2,331
					6	5,009	2,846	2,410
					6	5,411	3,745	2,577
					11	4,909	3,340	2,795
					15	9,699	4,861	3,018
					16	6,842	4,984	3,216
					29	8,873	4,516	3,308
					14	4,211	3,799	3,380
					7	7,740	5,956	4,107
					23	8,154	6,233	4,734
27	7,992	6,552	5,210					

S.5 Modulus of Subgrade Reaction (k-value)

The k-value is used for the support of rigid pavement structures. The graphical representation (Figure S.28 Distribution of Wheel Load to Subgrade Reaction (k-value)) is the traditional way to explain the interaction of subgrade reaction to a moving wheel load. As the wheel load moves toward an area of concern, the subgrade reacts with a slightly larger reaction and when the wheel loading moves away the subgrade reaction it is less. That variable reaction is the engineering property k-value. As an historical note, in the 1920's, Westergaard's work led to the concept of the modulus of subgrade reaction (k-value). Like elastic modulus, the k-value of a subgrade is an elastic constant which defines the material's stiffness or resistance to deformation. The value k actually represents the stiffness of an elastic spring.

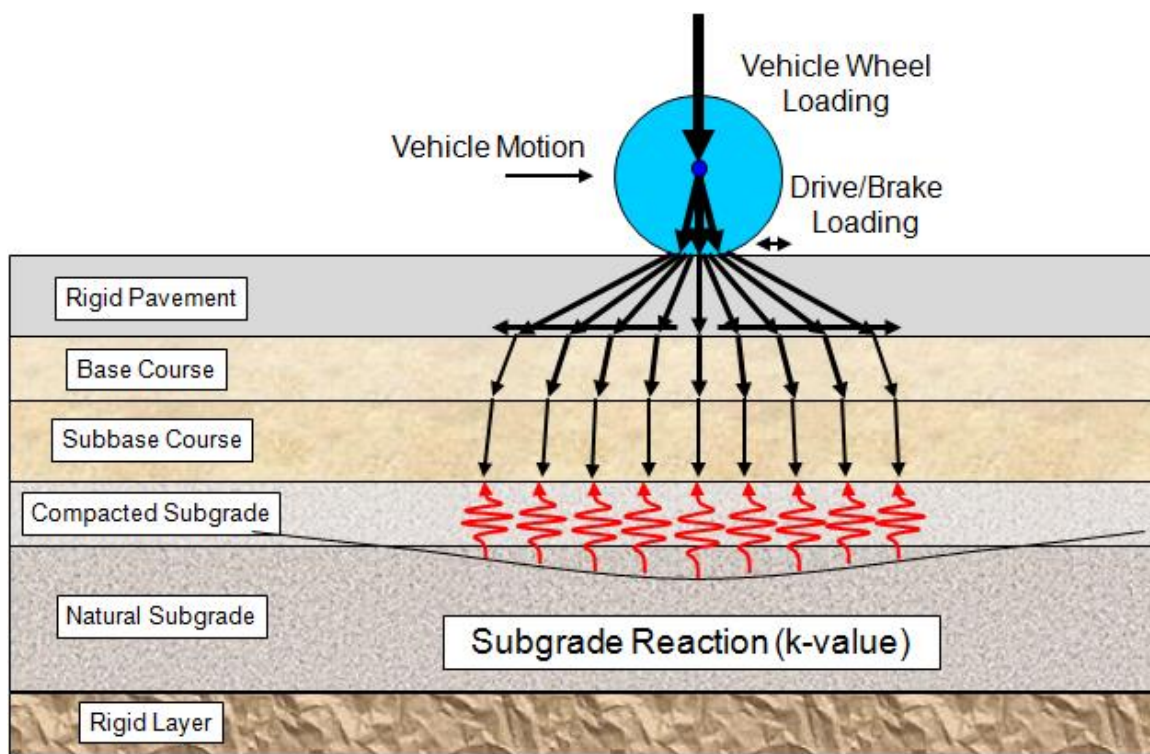

Conventional Rigid

Figure S.28 Distribution of Wheel Load to Subgrade Reaction (k-value)

S.5.1 Static Elastic k-value

The gross k-value was used in previous AASHTO pavement design guides. It not only represented the elastic deformation of the subgrade under a loading plate, but also substantial permanent deformation. The static elastic portion of the k-value is used as an input in the 1998 AASHTO Supplement guide. The k-value can be determined by field plate bearing tests (AASHTO T 221 or T 222) or correlation with other tests. There is no direct laboratory test procedure for determining k-value. The k-value is measured or estimated on top of the finished roadbed soil or

embankment upon which the base course and concrete slab is constructed. The classical equation for gross k-value is shown in **Eq. S.39**.

$$k\text{-value} = \frac{P}{\Delta} \quad \text{Eq. S.39}$$

Where:

k-value = modulus of subgrade reaction (spring constant)

p = applied pressure = $\frac{P \text{ (load)}}{\text{area of 30" diameter plate}}$

Δ = measured deflection

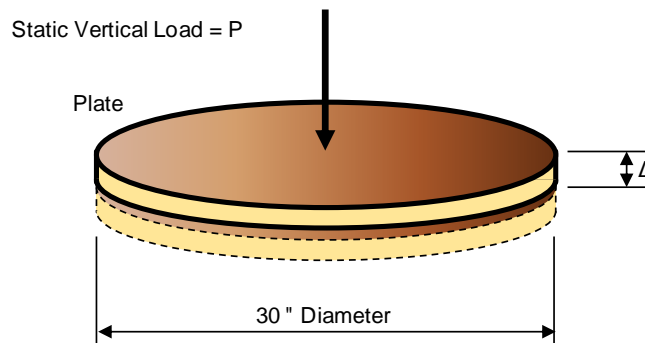

Figure S.29 Field Plate Load Test for k-value

S.5.2 Dynamic k-value

In the *AASHTO Guide for Mechanistic-Empirical Design, A Manual of Practice*, the effective k-value used is the effective dynamic k-value (24). Dynamic means a quick force is applied, such as a falling weight not an oscillating force. CDOT obtains the dynamic k-value from the Falling Weight Deflectometer (FWD) testing with a backcalculation procedure. There is an approximate relationship between static and dynamic k-value. The dynamic k-value may be converted to the initial static value by dividing the mean dynamic k-value by two to estimate the mean static k-value. CDOT uses this conversion because it does not perform the static plate bearing test.

FWD testing is normally performed on an existing surface course. In the Mechanistic-Empirical Design Guide software the dynamic k-value is used as an input for rehabilitation projects only. The dynamic k-value is not used as an input for new construction or reconstruction. One k-value is entered as an input in the rehabilitation calculation. The one k-value is the arithmetic mean of like backcalculated values. It is used as a foundation support value. The software then needs an additional value and that is the month the FWD is performed. The software uses an integrated climatic model to make seasonal adjustments to the support value. The software will backcalculate an effective single dynamic k-value for each month of the design analysis period for the existing unbound sublayers including the subgrade soil. The effective dynamic k-value is essentially the compressibility of underlying layers (i.e., unbound base, subbase, and subgrade layers) upon which the upper bound layers and existing HMA or PCC layer is constructed. The entered k-value will remain as an effective dynamic k-value for that month throughout the analysis period, but the

effective dynamic k-value for other months will vary according to moisture movement and frost depth in the pavement (24).

S.6 Bedrock

Table S.4 Poisson's Ratio for Bedrock

(Modified from Table 2.2.55. and Table 2.2.52., *Guide for Mechanistic-Empirical Design, Final Report*, NCHRP Project 1-37A, March 2004)

Material Description	μ (Range)	μ (Typical)
Solid, Massive, Continuous	0.10 to 0.25	0.15
Highly Fractured, Weathered	0.25 to 0.40	0.30
Rock fill	0.10 to 0.40	0.25

Table S.5 Elastic Modulus for Bedrock

(Modified from Table 2.2.54., *Guide for Mechanistic-Empirical Design, Final Report*, NCHRP Project 1-37A, March 2004)

Material Description	E (Range)	E (Typical)
Solid, Massive, Continuous	750,000 to 2,000,000	1,000,000
Highly Fractured, Weathered	250,000 to 1,000,000	50,000
Rock fill	Not Available	Not Available

S.7 Unbound Subgrade, Granular, and Subbase Materials

Table S.6 Poisson's Ratios for Subgrade, Unbound Granular and Subbase Materials
(Modified from Table 2.2.52., *Guide for Mechanistic-Empirical Design, Final Report*, NCHRP Project 1-37A, March 2004)

Material Description	μ (Range)	μ (Typical)
Clay (saturated)	0.4 to 0.5	0.45
Clay (unsaturated)	0.1 to 0.3	0.2
Sandy Clay	0.2 to 0.3	0.25
Silt	0.3 to 0.35	0.325
Dense Sand	0.2 to 0.4	0.3
Course-grained Sand	0.15	0.15
Fine-grained Sand	0.25	0.25
Clean gravel, gravel-sand mixtures	0.354 to 0.365	0.36

Table S.7 Coefficient of Lateral Pressure
(Table 2.2.53., *Guide for Mechanistic-Empirical Design, Final Report*, NCHRP Project 1-37A, March 2004)

Material Description	Angle of Internal Friction, ϕ	Coefficient of Lateral Pressure, k_o
Clean sound bedrock	35	0.495
Clean gravel, gravel-sand mixtures, and coarse sand	29 to 31	0.548 to 0.575
Clean fine to medium sand, silty medium to coarse sand, silty or clayey gravel	24 to 29	0.575 to 0.645
Clean fine sand, silty or clayey fine to medium sand	19 to 24	0.645 to 0.717
Fine sandy silt, non plastic silt	17 to 19	0.717 to 0.746
Very stiff and hard residual clay	22 to 26	0.617 to 0.673
Medium stiff and stiff clay and silty clay	19 to 19	0.717

S.8 Chemically Stabilized Subgrades and Bases

Critical locations in the layers have been defined for the Mechanistic-Empirical Design. Refer to **Figure S.30 Critical Stress Locations for Stabilized Subgrade** and **Figure S.31 Critical Stress/Strain Locations for Stabilized Bases**. CDOT has historically used the empirical design methodology using structural coefficients of stabilized subgrade and base layers and assigned a_2 for the structural coefficient. Lightly stabilized materials for construction expediency are not included. They could be considered as unbound materials for design purposes (5).

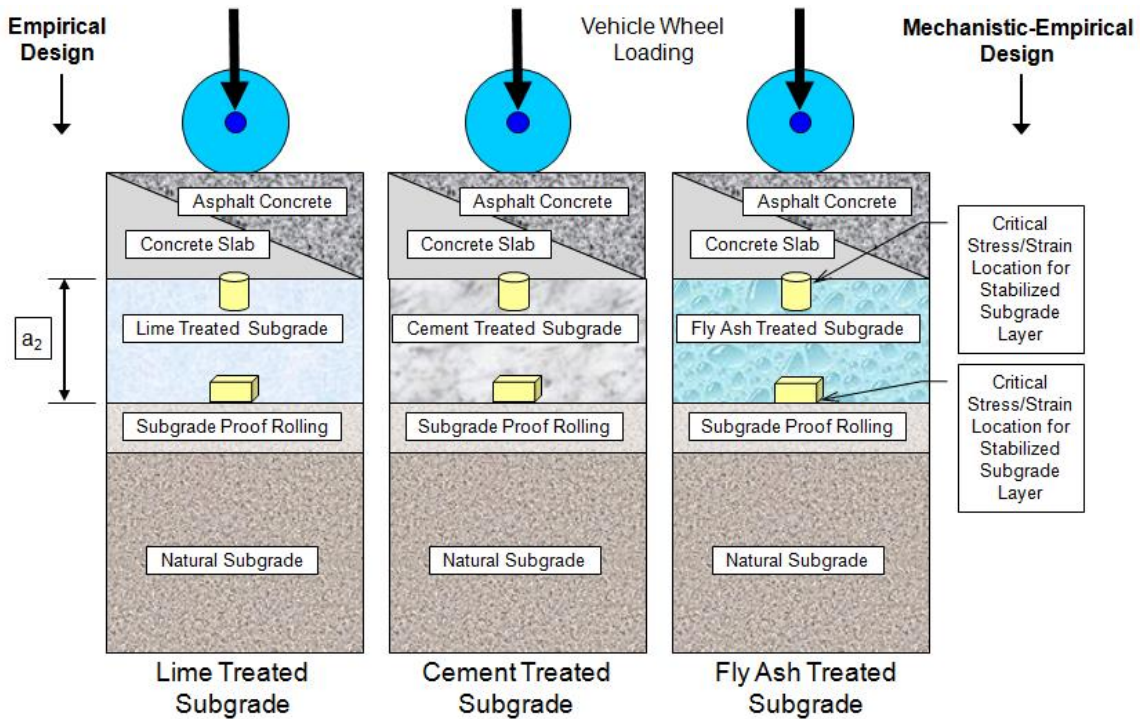

Figure S.30 Critical Stress Locations for Stabilized Subgrade

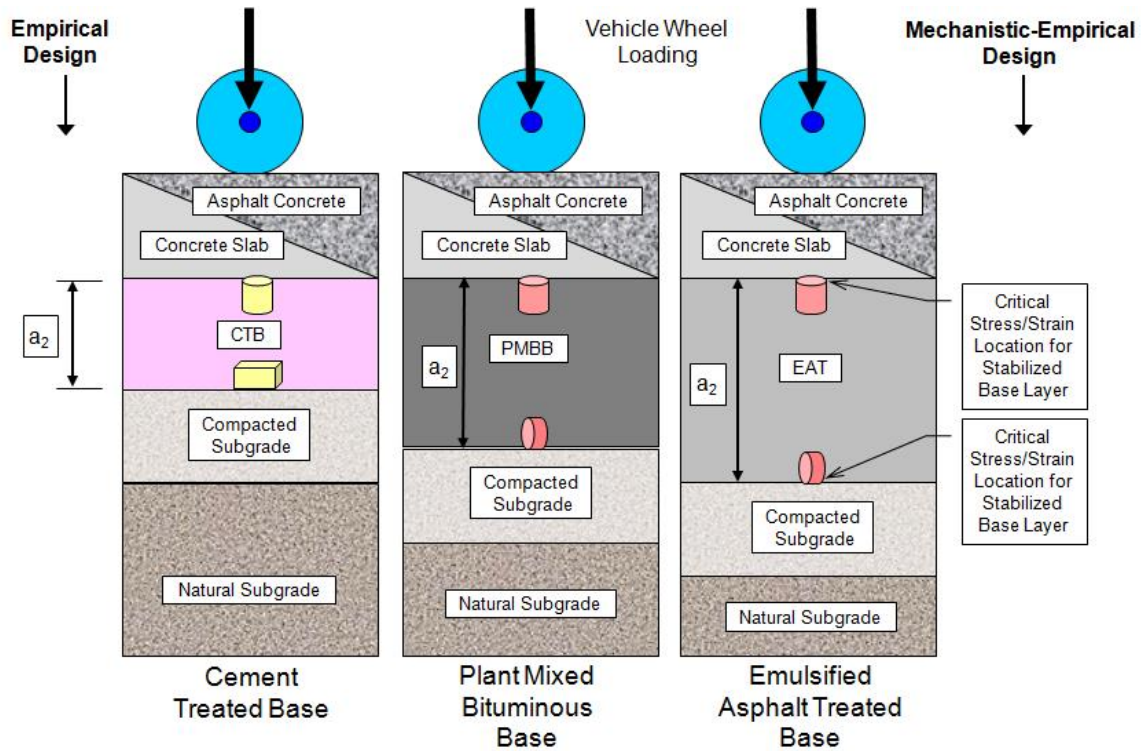

Figure S.31 Critical Stress/Strain Locations for Stabilized Bases

Table S.8 Poisson's Ratios for Chemically Stabilized Materials

(Table 2.2.48., *Guide for Mechanistic-Empirical Design, Final Report*, NCHRP Project 1-37A, March 2004)

Chemically Stabilized Materials	Poisson's ratio, μ
Cement Stabilized Aggregate (including lean concrete, cement treated, and permeable base)	0.1 to 0.2
Soil Cement	0.15 to 0.35
Lime-Fly Ash Materials	0.1 to 0.15
Lime Stabilized Soil	0.15 to 0.2

Table S.9 Poisson's Ratios for Asphalt Treated Permeable Base

(Table 2.2.16. and Table 2.2.17., *Guide for Mechanistic-Empirical Design, Final Report*, NCHRP Project 1-37A, March 2004)

Temperature, °F	μ (Range)	μ (Typical)
< 40 °F	0.30 to 0.40	0.35
40 °F to 100 °F	0.35 to 0.40	0.40
> 100 °F	0.40 to 0.48	0.45

Table S.10 Poisson's Ratios for Cold Mixed Asphalt and Cold Mixed Recycled Asphalt Materials

(Table 2.2.18. and Table 2.2.19., *Guide for Mechanistic-Empirical Design, Final Report*, NCHRP Project 1-37A, March 2004)

Temperature, °F	μ (Range)	μ (Typical)
< 40 °F	0.20 to 0.35	0.30
40 °F to 100 °F	0.30 to 0.45	0.35
> 100 °F	0.40 to 0.48	0.45

The critical location vertical loads for stabilized subgrades are at the interface of the surface course and stabilized subgrade or top of the stabilized subgrade. The material stabilized subgrade element has the greatest loads at this location when the wheel loadings are directly above. Strength testing may be performed to determine compressive strength (f'_c), unconfined compressive strength (q_u), modulus of elasticity (E), time-temperature dependent dynamic modulus (E^*), and resilient modulus (M_r).

The critical locations for flexural loading of stabilized subgrades are at the interface of the stabilized subgrade and non-stabilized subgrade or bottom of the stabilized subgrade. The material stabilized subgrade element has the greatest flexural loads at this location when the wheel loadings are directly above. Flexural testing may be performed to determine flexural strength (MR).

S.8.1 Top of Layer Properties for Stabilized Materials

Stabilized materials (chemically) are generally required to have some minimum compressive strength. Refer to **Table S.11 Minimum Unconfined Compressive Strengths for Stabilized Layers** for suggested minimum unconfined compressive strengths. 28-day values are used conservatively in design.

Table S.11 Minimum Unconfined Compressive Strengths for Stabilized Layers
(Modified from Table 2.2.40., *Guide for Mechanistic-Empirical Design, Final Report*, NCHRP Project 1-37A, March 2004)

Stabilized Layer	Minimum Unconfined Compressive Strength, psi ^{1,2}	
	Rigid Pavement	Flexible Pavement
Subgrade, Subbase, or Select Material	200	250
Base Course	500	750
Asphalt Treated Base	Not Available	Not Available
Plant Mix Bituminous Base	Not Available	Not Available
Cement Treated Base	Not Available	Not Available
1. Compressive strength determined at 7-days for cement stabilization and 28-days for lime and lime-cement fly ash stabilization.		
2. These values shown should be modified as needed for specific site conditions.		

E, E*, and M_r testing should be conducted on stabilized materials containing the target stabilizer content and molded and conditioned at optimum moisture and maximum density. Curing must also be as specified by the test protocol and must reflect field conditions (5).

Table S.12 Typical E, E*, or M_r Values for Stabilized Materials
(Modified from Table 2.2.43., *Guide for Mechanistic-Empirical Design, Final Report*, NCHRP Project 1-37A, March 2004)

Stabilized Material	E or M _r (Range), psi	E or M _r (Typical), psi
Soil cement, E	50,000 to 1,000,000	500,000
Cement stabilized aggregate, E	700,000 to 1,500,000	1,000,000
Lean concrete, E	1,500,000 to 2,500,000	2,000,000
Lime stabilized soils, M _r ¹	30,000 to 60,000	45,000
Lime-cement-fly ash, E	500,000 to 2,000,000	1,500,000
Permeable asphalt stabilized aggregate, E*	Not Available	Not Available
Permeable cement stabilized aggregate, E	Not Available	750,000
Cold mixed asphalt materials, E*	Not Available	Not Available
Hot mixed asphalt materials, E*	Not Available	Not Available
1. For reactive soils within 25% passing No. 200 sieve and PI of at least 10.		

Table S.13 Typical M_r Values for Deteriorated Stabilized Materials presents deteriorated semi-rigid materials stabilized showing the deterioration or damage of applied traffic loads and frequency of loading. The table values are required for HMA pavement design only.

Table S.13 Typical M_r Values for Deteriorated Stabilized Materials
(Modified from Table 2.2.44., *Guide for Mechanistic-Empirical Design, Final Report*, NCHRP Project 1-37A, March 2004)

Stabilized Material	Deteriorated M_r (Typical), psi
Soil cement	25,000
Cement stabilized aggregate	100,000
Lean concrete	300,000
Lime stabilized soils	15,000
Lime-cement-fly ash	40,000
Permeable asphalt stabilized aggregate	Not Available
Permeable cement stabilized aggregate	50,000
Cold mixed asphalt materials	Not Available
Hot mixed asphalt materials	Not Available

S.9.2 Bottom of Layer Properties for Stabilized Materials

Flexural strengths or modulus of rupture (M_r) should be estimated from laboratory testing of beam specimens of stabilized materials. M_r values may also be estimated from unconfined (q_u) testing of cured stabilized material samples. **Table S.14 Typical Modulus of Rupture (M_r) Values for Stabilized Materials** shows typical values. The table values are required for HMA pavement design only.

Table S.14 Typical Modulus of Rupture (M_r) Values for Stabilized Materials
(Modified from Table 2.2.47., *Guide for Mechanistic-Empirical Design, Final Report*, NCHRP Project 1-37A, March 2004)

Stabilized Material	Modulus of Rupture M_r (Typical), psi
Soil cement	100
Cement stabilized aggregate	200
Lean concrete	450
Lime stabilized soils	25
Lime-cement-fly ash	150

Permeable asphalt stabilized aggregate	None
Permeable cement stabilized aggregate	200
Cold mixed asphalt materials	None
Hot mixed asphalt materials	Not Available

Tensile strength for hot mix asphalt is determined by actual laboratory testing in accordance with CDOT CP-L 5109 or AASHTO T 322 at 14 °F. Creep Compliance is the time dependent strain divided by the applied stress. Creep Compliance is determined by actual laboratory testing in accordance with AASHTO T 332.

S.9.3 Other Properties of Stabilized Layers

S.9.3.1 Coefficient of Thermal Expansion of Aggregates

Thermal expansion is the characteristic property of a material to expand when heated and contract when cooled. The coefficient of thermal expansion is the factor that quantifies the effective change one degree will have on the given volume of a material. The type of course aggregate exerts the most significant influence on the thermal expansion of Portland cement concrete (3). National recommended values for the coefficient of thermal expansion in PCC are shown in **Table S.15 Recommended Values of PCC Coefficient of Thermal Expansion.**

Table S.15 Recommended Values of PCC Coefficient of Thermal Expansion
(Table 2.10., *AASHTO Guide for Design of Pavement Structures 1993*)

Type of Course Aggregate	Concrete Thermal Coefficient (10-6 inch/inch/°F)
Quartz	6.6
Sandstone	6.5
Gravel	6.0
Granite	5.3
Basalt	4.8
Limestone	3.8

The Long-Term Pavement Performance (LTPP) database shows a coefficient of thermal expansion of siliceous gravels in Colorado. Siliceous gravels are a group of sedimentary "sand gravel" aggregates that consist largely of silicon dioxide (SiO₂) makeup. Quartz a common mineral of the silicon dioxide makeup may be classified as such, and is a major constituent of most beach and river sands.

Table S.16 LTPP Values of PCC Coefficient of Thermal Expansion of Siliceous Gravel in Colorado

Range (10-6 inch/inch/°F)	Average (10-6 inch/inch/°F)	Standard Dev (10-6 inch/inch/°F)
4.2 - 6.2	5.3	0.4

S.9.3.2 Dry Thermal Conductivity (K) and Heat Capacity (Q)

Thermal Conductivity and Heat Capacity are material properties that control the heat flow through the pavement system and thereby influence the temperature and moisture regimes within it. Dry Thermal Conductivity (K) is the quantity of heat that flows normally across a surface of unit area per unit of time and per unit of temperature gradient. The thermal or Heat Capacity (Q) is the actual amount of heat energy necessary to change the temperature of a unit mass by one degree. Dry Thermal Conductivity may be measured direct by using ASTM E 1952 procedure. Heat Capacity may be measured direct by using ASTM D 2766 procedure.

Table S.17 Dry Thermal Conductivity (K) and Heat Capacity (Q) for Unbound Compacted Material

(Modified from Table 2.3.5., *Guide for Mechanistic-Empirical Design, Final Report*, NCHRP Project 1-37A, March 2004)

Material Property	Soil Type	(Range)	(Typical)
Dry Thermal Conductivity, K (Btu/hr-ft-°F)	A-1-a	0.22 to 0.44	0.30
	A-1-b	0.22 to 0.44	0.27
	A-2-4	0.22 to 0.24	0.23
	A-2-5	0.22 to 0.24	0.23
	A-2-6	0.20 to 0.23	0.22
	A-2-7	0.16 to 0.23	0.20
	A-3	0.25 to 0.40	0.30
	A-4	0.17 to 0.23	0.22
	A-5	0.17 to 0.23	0.19
	A-6	0.16 to 0.22	0.18

	A-7-5	0.09 to 0.17	0.13
	A-7-6	0.09 to 0.17	0.12
Dry Heat Capacity, Q (Btu/lb-°F)	All soil types	0.17 to 0.20	Not Available

Table S.18 Dry Thermal Conductivity (K) and Heat Capacity (Q) for Chemically Stabilized Material

(Modified from Table 2.2.49., *Guide for Mechanistic-Empirical Design, Final Report*, NCHRP Project 1-37A, March 2004)

Material Property	Chemically Stabilized Material	μ (Range)	μ (Typical)
Dry Thermal Conductivity, K (Btu/hr-ft-°F)	Lime	1.0 to 1.5	1.25
Dry Heat Capacity, Q (Btu/lb-°F)	Lime	0.2 to 0.4	0.28

Table S.19 Dry Thermal Conductivity (K) and Heat Capacity (Q) for Asphalt Concrete and PCC Material

(Modified from Table 2.2.21. and Table 2.2.39., *Guide for Mechanistic-Empirical Design, Final Report*, NCHRP Project 1-37A, March 2004)

Material Property	Chemically Stabilized Material	μ (Range)	μ (Typical)
Dry Thermal Conductivity, K (Btu/hr-ft-°F)	Asphalt Concrete	Not Available	0.44 to 0.81
	PCC	1.0 to 1.5	1.25
Dry Heat Capacity, Q (Btu/lb-°F)	Asphalt Concrete	Not Available	0.22 to 0.40
	PCC	0.2 to 0.28	0.28

S.9.3.3 Saturated Hydraulic Conductivity

Saturated Hydraulic Conductivity, k_{sat} is required to determine the transient moisture profiles in compacted unbound materials. Saturated Hydraulic Conductivity may be measured direct by using a permeability test AASHTO T 215.

S.10 Reclaimed Asphalt and Recycled Concrete Base Layer

The critical location vertical loads for reclaimed asphalt or recycled concrete bases are at the interface of the surface course and top of the recycled pavement. The recycled pavement element has the greatest loads at this location when the wheel loadings are directly above. Strength testing may be performed to determine modulus of elasticity (E) and/or resilient modulus (M_r). These bases are considered as unbound materials for design purposes. If the reclaimed asphalt base is stabilized and if an indirect tension (S_t) test can be performed then these bases may be considered as bound layers.

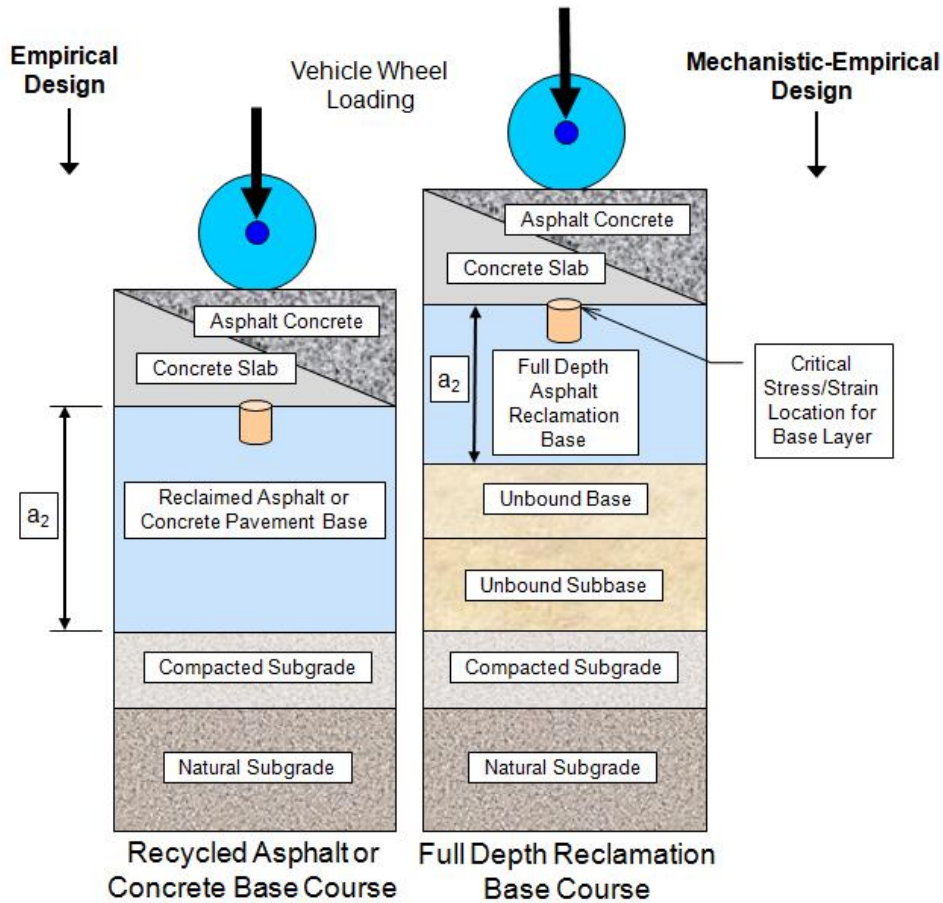

Figure S.32 Critical Stress Locations for Recycled Pavement Bases

Table S.20 Poisson's Ratios for Cold Mixed Asphalt and Cold Mixed Recycled Asphalt Materials

(Table 2.2.18. and Table 2.2.19., *Guide for Mechanistic-Empirical Design, Final Report*, NCHRP Project 1-37A, March 2004)
(A restatement of **Table S.10**)

Temperature (°F)	μ (Range)	μ (Typical)
< 40	0.20 to 0.35	0.30
40 to 100	0.30 to 0.45	0.35
> 100	0.40 to 0.48	0.45

Table S.21 Typical E, E*, or M_R Values for Stabilized Materials

(Modified from Table 2.2.43., *Guide for Mechanistic-Empirical Design, Final Report*, NCHRP Project 1-37A, March 2004)
(A restatement of **Table S.12**)

Stabilized Material	E or M _R (Range), psi	E or M _R (Typical), psi
Soil cement, E	50,000 to 1,000,000	500,000
Cement stabilized aggregate, E	700,000 to 1,500,000	1,000,000
Lean concrete, E	1,500,000 to 2,500,000	2,000,000
Lime stabilized soils, M _R ¹	30,000 to 60,000	45,000
Lime-cement-fly ash, E	500,000 to 2,000,000	1,500,000
Permeable asphalt stabilized aggregate, E*	Not Available	Not Available
Permeable cement stabilized aggregate, E	Not Available	750,000
Cold mixed asphalt materials, E*	Not Available	Not Available
Hot mixed asphalt materials, E*	Not Available	Not Available

1. For reactive soils within 25% passing No. 200 sieve and PI of at least 10.

S.11 Fractured Rigid Pavement

Rubblization is a fracturing of existing rigid pavement to be used as a base. The rubblized concrete responds as a high-density granular layer.

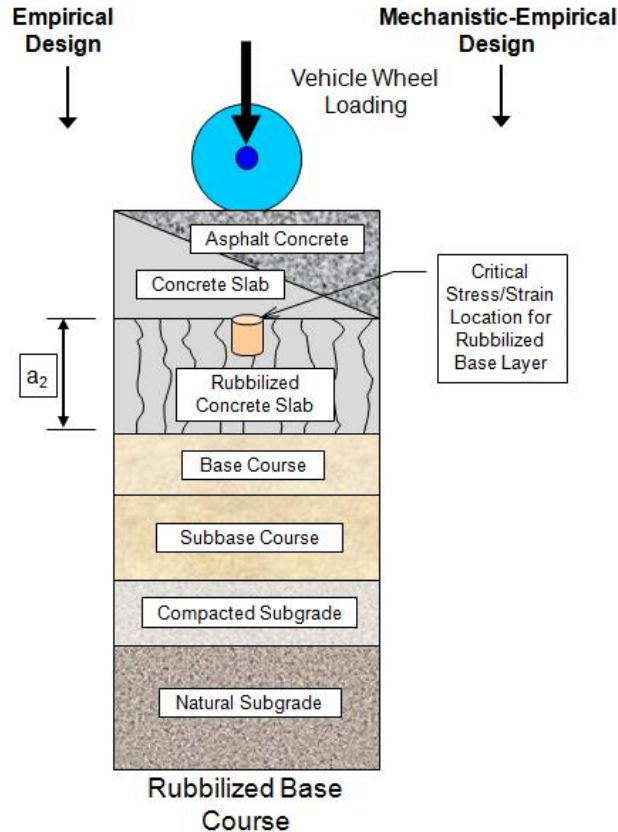

Figure S.33 Critical Stress Location for Rubblized Base

Table S.22 Poisson's Ratio for PCC Materials

(Table 2.2.29., *Guide for Mechanistic-Empirical Design, Final Report*, NCHRP Project 1-37A, March 2004)

PCC Materials		μ (Range)	μ (Typical)
PCC Slabs (newly constructed or existing)		0.15 to 0.25	0.20 (Use 0.15 for CDOT)
Fractured Slab	Crack/Seat	0.15 to 0.25	0.20
	Break/Seat	0.15 to 0.25	0.20
	Rubblized	0.25 to 0.40	0.30

Table S.23 Typical M_r Values for Fractured PCC Layers

(Table 2.2.28., *Guide for Mechanistic-Empirical Design, Final Report*, NCHRP Project 1-37A, March 2004)

Fractured PCC Layer Type	M_r (Ranges), psi
Crack and Seat or Break and Seat	300,000 to 1,000,000
Rubblized	50,000 to 150,000

S.12 Pavement Deicers

S.12.2 Magnesium Chloride

Magnesium Chloride ($MgCl_2$) is a commonly used roadway anti-icing/deicing agent in conjunction with, or in place of salts and sands. The $MgCl_2$ solution can be applied to traffic surfaces prior to precipitation and freezing temperatures in an anti-icing effort. The $MgCl_2$ effectively decreases the freezing point of precipitation to about 16° F. If ice has already formed on a roadway, $MgCl_2$ can aid in the deicing process.

Magnesium chloride is a proven deicer that has done a great deal for improving safe driving conditions during inclement weather, but many recent tests have shown that magnesium may have a negative impact on the life of concrete pavement. Iowa State University performed a series of experiments testing the effects of different deicers on concrete. Their experiment determined that the use of magnesium and/or calcium deicers may have unintended consequences in accelerating concrete deterioration (20). $MgCl_2$ was mentioned to cause discoloration, random fracturing and crumbling (20).

In 1999, a study was performed to identify the environmental hazards of $MgCl_2$. This study concluded that it was highly unlikely that the typical $MgCl_2$ deicer would have any environmental impact greater than 20 yards from the roadway. It is even possible that $MgCl_2$ may offer a positive net environmental impact if it limits the use of salts and sands. The study's critical finding was that any deicer must limit contaminants, as well as the use of rust inhibiting additives like phosphorus (21).

The 1999 study led to additional environmental studies in 2001. One study concluded that $MgCl_2$ could increase the salinity in nearby soil and water, which is more toxic to vegetation than fish (22). Another study identified that certain 30% $MgCl_2$ solutions deicers used in place of pure $MgCl_2$ had far higher levels of phosphorus and ammonia. These contaminants are both far more hazardous to aquatic life than $MgCl_2$ alone (23).

References

1. *AASHTO Interim Guide for Design of Pavement Structures 1972*, published by American Association of State Highway and Transportation Officials, Washington, DC, 1972.
2. *AASHTO Guide for Design of Pavement Structures 1986*, American Association of State Highway and Transportation Officials, Washington, DC, 1986.
3. *AASHTO Guide for Design of Pavement Structures 1993*, American Association of State Highway and Transportation Officials, Washington, DC, 1993.
4. George, K.P., *Resilient Modulus Prediction Employing Soil Index Properties*, Final Report Number FHWA/MS-DOT-RD-04-172, Federal Highway Administration and Mississippi Department of Transportation, Research Division, P O Box 1850, Jackson MS 39215-1850, report conducted by the Department of Civil Engineering, The University of Mississippi, Nov 2004.
5. *Guide for Mechanistic-Empirical Design*, Final Report, NCHRP Project 1-37A, National Cooperative Highway Research Program, Transportation Research Board, National Research Council, Submitted by ARA, INC., ERES Consultants Division, Champaign, IL, March 2004.
6. Yeh, Shan-Tai, and Su, Cheng-Kuang, *Resilient Properties of Colorado Soils*, Final Report CDOH-DH-SM-89-9, Colorado Department of Highways, December 1989.
7. Chang, Nien-Yin, Chiang, Hsien-Hsiang, and Jiang, Lieu-Ching, *Resilient Modulus of Granular Soils with Fines Contents*, Final Research Report CDOT 91-379, Colorado Department of Transportation, May 1994.
8. *Research and Development of the Asphalt Institute's Thickness Design Manual, Ninth Edition*, Research Report No. 82-2, pg. 60-, The Asphalt Institute, 1982.
9. *Design Pamphlet for the Determination of Layered Elastic Moduli for Flexible Pavement Design in Support of the 1993 AASHTO Guide for the Design of Pavement Structures*, Final Report FHWA-RD-97-077, U.S. Department of Transportation, Federal Highway Administration, Research and Development, Turner-Fairbank Highway Research Center, 6300 Georgetown Pike, Mclean VA 22101-2296, September 1997.
10. *Standard Method of Test for Determining Dynamic Modulus of Hot-Mix Asphalt Concrete Mixtures*, AASHTO Designation: TP 62-03 (2005), American Association of State Highway and Transportation Officials, 444 North Capital Street, N.W., Suite 249, Washington, DC 20001, 25th Edition 2005.
11. *Review of the New Mechanistic-Empirical Pavement Design Guide - A Material Characterization Perspective*, Morched Zeghal, National Research Council Canada, Yassin E., Adam, Carleton University, Osman Ali, Carleton University, Elhoussein H.

- Mohamed, National Research Council Canada, Paper prepared for presentation at the Investing in New Materials, Products and Processes Session of the 2005 Annual Conference of the Transportation Association of Canada, Calgary, Alberta.
12. *Changes to the Mechanistic-Empirical Pavement Design Guide Software Through Version 0.900*, July 2006, National Cooperative Highway Research Program (NCHRP).
 13. *Simple Performance Tests: Summary of Recommended Methods and Database*, NCHRP Report 547, Witczak, Matthew, Arizona State University, Transportation Research Board, Washington, D.C., 2005.
 14. *Development of a New Revised Version of the Witczak E* Predictive Models for Hot Mix Asphalt Mixtures*, Final Report, Prepared for NCHRP, Witczak, Dr. M.W., Project Principal Investigator, Arizona State University, October 2005. This report is an Appendix to NCHRP Report 547 *Simple Performance Tests and Advanced Materials Characterization Models* for NCHRP Project 9-19 in DVD format designated as CRP-CD-46.
 15. Use of the Dynamic Modulus (E*) Test as a Simple Performance Test for Asphalt Pavement Systems (AC Permanent Deformation Distress) Volume I of IV, Final Report, Prepared for NCHRP, Witczak, Dr. M.W., Project Principal Investigator, Arizona State University, October 2005. This report is an Appendix to NCHRP Report 547 *Simple Performance Tests and Advanced Materials Characterization Models* for NCHRP Project 9-19 in DVD format designated as CRP-CD-46.
 16. *Soil Mechanics & Foundations Lecture 3.1*, Prepared by Liu, Lanbo Referencing *Principles of Geotechnical Engineering 6th Edition*, London: Thomson Engineering. 2006
 17. *Atterberg Limits*, Wikipedia, 22 September 2007. 10 October 2007.
<http://en.wikipedia.org/wiki/Atterberg_limits>
 18. *Acids, Bases, and pH*, Carpi, Anthony 1998-1999, 24 Sept 2007.
<<http://www.visionlearning.com/en/library/Chemistry/1/Acids-and-Bases/58>>
 19. *Dissociation of Water and the pH Scale*, University of British Columbia Department of Chemistry, 24 September 2007. <http://www.chem.ubc.ca/courseware/pH/>
 20. Cody, Robert D., Cody, Anita M., Spry, Paul G., Guo-Liang Gan, *Concrete Deterioration by Deicing Salts: An Experimental Study*, Iowa State University, Center for Transportation Research and Education, Ames, Iowa, May 1996.
 21. Lewis, William M., *Study of Environmental Effects of Magnesium Chloride Deicers in Colorado*, Report No. CDOT-DTD-R-99-10, Colorado Department of Transportation, November 1999.

22. Fischel, Marion, *Evaluation of Selected Deicers Base on A Review of the Literature*, Report No. CDOT-DTD-R-2001-15, Colorado Department of Transportation, October 2001.
23. Lewis, William M., *Evaluation and Comparison of Three Chemical Deicers for Use in Colorado*, Report No. CDOT-DTD-R-2001-17, Colorado Department of Transportation, August 2001.
24. AASHTO *Mechanistic-Empirical Pavement Design Guide, A Manual of Practice*, July 2008, Interim Edition, American Association of State Highway and Transportation Officials, 444 North Capitol St. NW, Suite 249, Washington, DC 20001.
25. *Supplement to the AASHTO Guide for Design of Pavement Structures, Part II, - Rigid Pavement Design & Rigid Pavement Joint Design*, American Association of State Highway and Transportation Officials, Washington, DC, 1998.
26. *Refining the Simple Performance Tester for Use in Routine Practice*, NCHRP Report 614, National Cooperative Highway Research Program, Transportation Research Board, Washington, DC, 2008.
27. *Standard Practice for Developing Dynamic Modulus Master Curves for Hot Mix Asphalt (HMA) Using the Asphalt Mixture Performance Tester (AMPT)*, AASHTO Designation: PP 61-09, American Association of State Highway and Transportation Officials, 444 North Capital Street, N.W., Suite 249, Washington, DC 20001.
28. *Standard Practice for Developing Dynamic Modulus Master Curves for Hot Mix Asphalt (HMA)* AASHTO Designation: PP 62-09, American Association of State Highway and Transportation Officials, 444 North Capital Street, N.W., Suite 249, Washington, DC 20001.
29. *AASHTO Mechanistic-Empirical Pavement Design Guide, A Manual of Practice, Interim Edition, July 2008*, American Association of State Highway and Transportation Officials, Washington, DC, 2008.