



2011 Pavement Design Manual



INTRODUCTION

Purpose of Manual

The purpose of the 2011 Pavement Design Manual is to provide the Colorado Department of Transportation (CDOT) and consultant pavement designers with a uniform and detailed procedure for designing pavements on CDOT projects. This manual should be used after July 1, 2010.

Organization of the Manual

The manual is organized in a manner that affords the users with simple and methodical steps in the design of pavements for the Colorado state highway system. The contents are arranged carefully to provide users with sufficient flexibility in selecting and focusing on the appropriate topics and chapters that will suit their specific pavement design needs. There are four major pavement design categories presented in this manual. These categories include new construction/reconstruction, rehabilitation with overlays, rehabilitation without overlays, and intersection designs. Each category contains CDOT's current procedures utilized in the design of both flexible and rigid pavements. Also included are relevant and required input data provided in separate chapters on major topics including pavement design information, subgrade and base materials, pavement type selection and life cycle cost analysis, pavement justification report (PJR), and appendices. These chapters are provided to support and document the entire pavement design process. The Introduction Pavement Design Manual Organization Flow Chart depicts a general overview of how this manual is organized.

Importance of Pavement Design

CDOT spends more than 30 percent of its annual construction and maintenance budget on pavements. Therefore, pavements need to be properly designed using an analytical process with accurate design inputs. A pavement design needs to be performed during the early phase of project development. This step ensures that pavement design is used to estimate and establish the project cost rather than the project cost dictating the pavement design.

Training

This manual provides general and detailed information about pavement design processes and procedures applicable to various locations in the State of Colorado. Information on more comprehensive training courses entitled Pavement Design and Life Cycle Cost Analysis and other materials-related training classes is available through the CDOT Materials and Geotechnical Branch, Pavement Management and Design Program.

Approved Pavement Design Methods

The AASHTO design procedure using Design and Rehabilitation for Windows (DARWin™) software is the recommended method to determine pavement design thickness. The CDOT strongly recommends using the 1993 AASHTO Guide for Design of Pavement Structures along with the 1998 Supplement to the AASHTO design procedure for rigid pavements and the latest CDOT Pavement Design Manual.

Coordinating Designs with Other Agencies

Other agencies should contact either the Region Materials Engineer (RME) or the Pavement Design Program Manager (PDPM) concerning CDOT and Region policies relating to pavement issues.

Data Collection

The data collected for new construction and rehabilitation projects are somewhat different. The pavement rehabilitation project will take the largest data collection effort. In many instances, it may be necessary to design for both pavement reconstruction and pavement rehabilitation. The final selection between the two will involve a study of costs, traffic handling, and other related items

Pavement Justification Report (PJR) and Other Documentation

A PJR is a formal engineering document that presents all analyses, data, and other considerations used to design a pavement. Guidelines for the information that needs to be included in a pavement design report are contained in this manual. For the special cases identified below that do not require a pavement design report, the documentation should include a brief description of the criteria, engineering considerations, and/or Region policy used in the decision process. For other reporting requirements, contact the RME for guidance. The PJR shall be sent to the CDOT Region Materials Engineer. A copy of the PJR on all surface treatment projects and all new or reconstruction projects with Hot Mix Asphalt (HMA) or Portland Cement Concrete Pavement (PCCP) material costs greater than \$2,000,000 will be sent to the PDPM. Access and local agency project PJR's will not be required to be submitted to the PDPM.

Projects Needing a Pavement Justification

HMA overlays less than 2 inches are considered a preventive maintenance treatment, and therefore a PJR report may not be required. Nevertheless, considering the significant investment that thin overlays represent, these treatments should be considered in an overall pavement preservation program. For design categories not covered above, contact the RME or the PDPM for guidance about recommended design procedures and documentation requirements.

Responsibility, Approval, and Signature Authority

Pavement design and documentation is primarily the responsibility of the engineer of record and must be reviewed and approved by the RME. In the event that the RME position is vacant, the pavement designs shall be forwarded to the CDOT Materials and Geotechnical Branch Manager. For the pavement design work done by a consultant, the PJR report shall be stamped, signed, and dated by the consultant and shall include his/her Professional Engineer's License number. The development of pavement design in CDOT is done in English units, which is the standard.

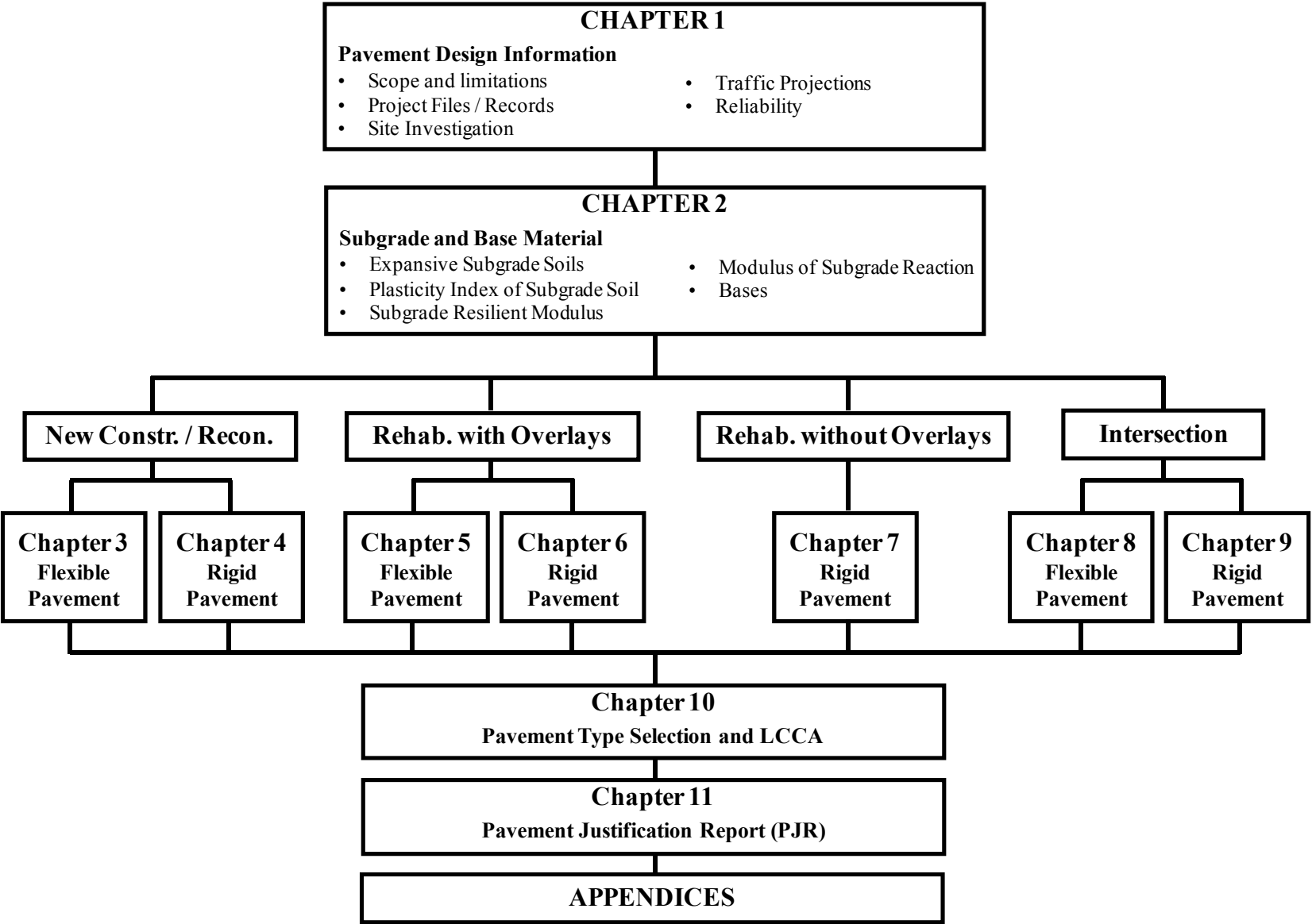

Figure Intro.1 Pavement Design Manual Organization Flow Chart

ACKNOWLEDGMENTS

The Materials and Geotechnical Branch of the Colorado Department of Transportation thanks the following individuals who contributed their expertise, knowledge, and time in the rewriting of the CDOT Pavement Design Manual.

PAVEMENT DESIGN TASK FORCE MEMBERS

Headquarters

Jim Zufall
Materials and Geotechnical Branch Manager
4670 Holly Street, Unit A
Denver, CO 80216
(303)398-6501
James.Zufall@dot.state.co.us

Roy Guevera
Asphalt Program Manager
4670 Holly Street, Unit A
Denver, CO 80216
(303)398-6526
Roy.E.Guevara@dot.state.co.us

Eric Prieve
Assistant Concrete and Physical Engineer
Properties Program Manager
4670 Holly Street, Unit A
Denver, CO 80216
(303)398-6542
Eric.Prieve@dot.state.co.us

CK Su
Soils and Rock Fall Program Manager
4670 Holly Street, Unit A
Denver, CO 80216
(303)398-6586
Cheng.Su@dot.state.co.us

Alan Hotchkiss
Soils and Rock Fall Scientist
4670 Holly Street, Unit A
Denver, CO 80216
(303)398-6587
Alan.Hotchkiss@dot.state.co.us

Dr. Liu
Geotechnical Program Manager
4670 Holly Street, Unit A
Denver, CO 80216
(303)398-6601
Hsing-Cheng.Liu@dot.state.co.us

Jay Goldbaum
Pavement Design Program Manager
4670 Holly Street, Unit A
Denver, CO 80216
(303)398-6561
Jay.Goldbaum@dot.state.co.us

Robert Locander
Pavement Design Engineer
4670 Holly Street, Unit A
Denver, CO 80216
(303)398-6562
Robert.Locander@dot.state.co.us

Special Assistance

Roberto DeDios
Research Engineer
4201 E. Arkansas Avenue
Shumate Building
Denver, CO 80222
(303)757-9975
Roberto.DeDios@dot.state.co.us

Matt Greer
FHWA Structural and Materials Engineer
12300 West Dakota Ave., Suite 180
Lakewood, Co 80228
(303)963-3008
Matt.Greer@fhwa.dot.gov

Donna Harmelink
FHWA Pavements/Operations Engineer
12300 West Dakota Ave., Suite 180
Lakewood, Co 80228
(720)963-3021
Donna.Harmelink@fhwa.dot.gov

Joan Pinamont
Research Branch Librarian
4201 East Arkansas Ave.
Shumate Building
Denver, CO 80222
(303)757-9972
Joan.Pinamont@dot.state.co.us

Region 1

Bill Schiebel
Region Materials Engineer
4670 Holly Street, Unit B
Denver, CO 80216
(303)398-6801
Bill.Schiebel@dot.state.co.us

Shamshad Hussain
Assistant Region Materials Engineer
4670 Holly Street, Unit B
Denver, CO 80216
(303)398-6802
Shamshad.Hussain@dot.state.co.us

Janet Minter
Assistant Region Materials Engineer
4670 Holly Street, Unit B
Denver, CO 80216
(303)398-6803
Janet.Minter@dot.state.co.us

Region 2

Richard Zamora
Region Materials Engineer
905 Erie Ave.
Pueblo, CO 81001
(719)546-5778
Richard.Zamora@dot.state.co.us

Craig Wieden
Assistant Region Materials Engineer
905 Erie Ave.
Pueblo, CO 81001
(719)546-5779
Craig.Wieden@dot.state.co.us

Region 3

Rex Goodrich
Region Materials Engineer
222 South 6th St, Room 317
Grand Jct. CO. 81501
(970)248-7228
Rex.Goodrich@dot.state.co.us

Jason C. Smith
Assistant Region Materials Engineer
222 South 6th St., Room 317
Grand Jct. CO 81501
(970)248-7239
Jason.C.Smith@dot.state.co.us

Region 4

Gary DeWitt
Region Materials Engineer
3971 W. Service Road
Evans, CO 80620
(970)350-2379
Gary.DeWitt@dot.state.co.us

Rick Chapman
Assistant Region Materials Engineer
3971 W. Service Road
Evans, CO 80620
(970)350-2380
Rick.Chapman@dot.state.co.us

Region 5

Michael Coggins
Region Materials Engineer
20581 Highway 160 West
Durango, CO 81301
(970)385-1625
Michael.Coggins@dot.state.co.us

Robert Shanks
Assistant Region Materials Engineer
20581 Highway 160 West
Durango, CO 81301
(970)385-1627
Robert.Shanks@dot.state.co.us

Region 6

Masoud Ghaeli
Region Materials Engineer
4670 Holly Street, Unit C
Denver, CO 80216
(303)398-6701
Masoud.Ghaeli@dot.state.co.us

Jan Chang
Assistant Region Materials Engineer
4670 Holly Street, Unit C
Denver, CO 80216
(303)398-6702
James.Chang@dot.state.co.us

Bob Mero
Assistant Region Materials Engineer
4670 Holly Street, Unit C
Denver, CO 80216
(303)398-6703
Bob.Mero@dot.state.co.us

TABLE OF CONTENTS

INTRODUCTION	i
ACKNOWLEDGMENTS	iv
TABLE OF CONTENTS	vii
LIST OF FIGURES	xviii
LIST OF TABLES	xxiv
LIST OF EQUATIONS	xxviii
ACRONYMS COMMON TO CDOT	xxxiii
DESIGN OF PAVEMENT STRUCTURES DEFINITIONS	xxxvii
ESTIMATING FORMULAS, CALCULATIONS, AND CONVERSION FACTORS	liv
SUMMARY OF MANUAL REVISIONS	lvi

CHAPTER 1

PAVEMENT DESIGN INFORMATION.....	1-1
1.1 Introduction.....	1-1
1.2 Scope and Limitations.....	1-1
1.3 Project Files/Records	1-1
1.3.1 Project Data Collection	1-2
1.3.2 Field Survey	1-2
1.3.3 Initial Selection	1-2
1.3.4 Physical Testing	1-2
1.3.5 Evaluation and selection	1-2
1.4 Site Investigation	1-2
1.4.1 Abutting Land Usage	1-3
1.4.2 Existing/Proposed Project Geometrics	1-3
1.4.3 Geotechnical Investigations	1-3
1.4.4 Drainage Characteristics	1-3
1.5 Traffic Projections	1-4
1.5.1 Volume Counts	1-4
1.5.2 Lane and Directional Distributions.....	1-4
1.5.3 Vehicle Classification	1-5
1.5.4 Growth Factors.....	1-8
1.5.5 Vehicle or Truck Weights.....	1-8
1.5.6 Traffic Equivalence Load Factors.....	1-8
1.5.7 Discussion and Calculation of Traffic Load for Pavement Design	1-8
1.5.8 Traffic Projections	1-10
1.5.9 Estimates of Traffic Load Using Land Use	1-11
1.6 Construction and Maintenance Experience	1-12
1.7 Pavement Management System (PMS) Condition Data.....	1-12
1.7.1 International Roughness Index (IRI)	1-13
1.8 Functional Class and Reliability	1-13
1.9 Serviceability	1-16
1.10 Drainage.....	1-17
1.11 Subdrainage Design	1-18
1.12 Drainage Survey and Evaluation	1-19

References..... 1-23

CHAPTER 2

SUBGRADE AND BASE MATERIALS..... 2-1

2.1 Introduction..... 2-1

2.1.1 Introduction to Mechanistic-Empirical Design Guide Material Categories 2-2

2.2 Soil Survey Investigation..... 2-3

2.2.1 Sulfate Subgrade Soils 2-4

2.3 Rigid Layer 2-5

2.4 Subgrade (Natural or Compacted) 2-5

2.5 Subgrade Resilient Modulus (M_R)..... 2-5

2.5.1 Laboratory Resilient Modulus 2-6

2.5.1.1 Development of Effective Roadbed Soil Moduli (Seasonal Adjustment) 2-7

2.5.2 Field Surface M_R Using Falling Weight Deflectometer 2-10

2.6 Modulus of Subgrade Reaction (k-value)..... 2-11

2.6.1 Estimating or Measuring the k-value..... 2-11

2.6.1.1 Correlations of Initial k-value using Soil Classifications 2-12

2.6.1.1.1 Cohesionless Soils (A-1 and A-3)..... 2-12

2.6.1.1.2 Granular Materials (A-2)..... 2-12

2.6.1.1.3 Cohesive Soils (A-4 through A-7) 2-14

2.6.1.2 Correlation of k-values using California Bearing Ratio (CBR)..... 2-16

2.6.1.3 Correlation of k-values using Penetration Rate by Dynamic Cone Penetrometer
..... 2-16

2.6.1.4 Plate Bearing Test Procedure..... 2-17

2.6.1.5 Deflection Testing and Backcalculation (Recommended) 2-17

2.6.2 Adjustments 2-18

2.6.2.1 Adjust the Initial k-value for the Seasons to Obtain an Effective k-value..... 2-18

2.6.2.2 Adjust the Effective k-value for Embankment and/or Shallow Rigid Layer. 2-18

2.6.3 Example 2-20

2.7 Compacted Subgrade Layer..... 2-21

2.7.1 Special Cases 2-22

2.7.1.1 Two Layer Embankment Fill..... 2-22

2.7.1.2 Frost Susceptible Soils..... 2-23

2.8 Expansive Subgrade Soils..... 2-28

2.9 Stabilizing Agents..... 2-32

2.9.1 Lime Treated Subgrade..... 2-33

2.9.2 Cement Treated Subgrade..... 2-35

2.9.3 Fly Ash and Lime/Fly Ash Treated Subgrade 2-36

2.10 Geosynthetic Fabrics and Mats..... 2-37

2.11 Bases 2-37

2.11.1 Aggregate Base Course (ABC)..... 2-38

2.11.2 Treated Base Course 2-40

2.11.3 Permeable Bases 2-42

2.11.4 Reclaimed Asphalt and Concrete Pavement..... 2-44

2.11.4.1 Reclaimed Asphalt Pavement Base 2-44

2.11.4.1.1 Reclaimed Asphalt Pavement (RAP) Base 2-44

2.11.4.1.2 Full Depth Asphalt Reclaimed Base (FDR).....	2-45
2.11.4.2 Reclaimed Concrete Pavement Base (RCP).....	2-46
2.11.5 Base Layer Made of Rubblized Rigid Pavement.....	2-46
2.12 Material Sampling and Testing.....	2-47
References.....	2-48

CHAPTER 3

PRINCIPLES OF DESIGN FOR FLEXIBLE PAVEMENT.....	3-1
3.1 Introduction.....	3-1
3.2 Design Considerations.....	3-2
3.3 Design Period.....	3-2
3.4 Design Methodology for Flexible Pavement.....	3-2
3.4.1 Use of Equation.....	3-2
3.4.2 Use of Computer Programs.....	3-3
3.4.3 Use of Nomograph.....	3-3
3.5 Structural Layer Coefficient.....	3-5
3.6 Determination of Layer Thicknesses.....	3-7
3.6.1 HMA Thickness with ABC.....	3-11
3.6.2 Required Minimum Thickness of Pavement Layer.....	3-11
3.7 Calculations for Flexible Pavement with a Variable Layer.....	3-12
3.8 Asphalt Materials Selection.....	3-13
3.8.1 Selection of SuperPave™ Gyratory Design.....	3-15
3.8.2 Binder Selection.....	3-16
3.8.3 Example 1.....	3-22
3.9 Asphalt Mix Design Criteria.....	3-27
3.9.1 Fractured Face Criteria.....	3-27
3.9.2 Air Void Criteria.....	3-28
3.9.3 Criteria for Stability.....	3-29
3.9.4 Moisture Damage Criteria.....	3-29
3.10 Rumble Strips.....	3-29
References.....	3-30

CHAPTER 4

PRINCIPLES OF DESIGN FOR RIGID PAVEMENT.....	4-1
4.1 Introduction.....	4-1
4.2 Design Considerations.....	4-2
4.3 Design Period.....	4-5
4.4 Modulus of Rupture (S'_c).....	4-5
4.5 Modulus of Elasticity (E_c).....	4-5
4.6 Joint Spacing (L).....	4-5
4.7 Base Modulus (E_b).....	4-6
4.8 Slab/Base Friction Coefficient (f).....	4-6
4.9 Base Thickness (H_b).....	4-7
4.10 Effective Temperature Differential (°F).....	4-7
4.10.1 Climatic Properties.....	4-9
4.11 Lane Edge Support Condition (E).....	4-16

4.12	Dowel Bars (Load Transfer Devices) and Tie Bars.....	4-17
4.13	Modified Drainage Coefficient (Cd).....	4-19
4.14	Design Methodology for PCCP	4-20
4.15	Concrete Pavement Minimum Thickness	4-24
4.16	Concrete Pavement Tining, Stationing, and Rumble Strips	4-24
4.17	Concrete Pavement Materials Selection	4-24
4.17.1	Understanding pH in Concrete Mixes.....	4-25
4.17.2	Alkali Aggregate Reactivity	4-25
4.17.3	Sulfate Resistant Concrete Pavement	4-26
	References.....	4-29

CHAPTER 5
PRINCIPLES OF DESIGN FOR PAVEMENT REHABILITATION WITH FLEXIBLE OVERLAYS **5-1**

5.1	Introduction.....	5-1
5.2	Design Considerations	5-1
5.3	Design Period.....	5-3
5.4	Traffic Analysis	5-3
5.5	Pavement Evaluation	5-3
5.6	Structural versus Functional Overlays.....	5-5
5.6.1	Functional Evaluation of Existing Pavement.....	5-5
5.7	Preventive Maintenance.....	5-6
5.8	Conventional Overlay	5-7
5.9	Pre-overlay Repair	5-8
5.9.1	Planing Flexible Pavement	5-9
5.9.2	Recycling the Existing Pavement	5-11
5.9.3	Reflection Crack Control	5-11
5.10	Pavement Widening.....	5-12
5.11	Determining Structural Number by Nondestructive Testing (NDT)	5-13
5.11.1	Structural Capacity Based on Visual Survey and Materials Testing	5-13
5.11.2	Structural Capacity Based on Fatigue Damage from Traffic.....	5-16
5.12	Coring and Material Testing Program	5-16
5.13	Asphalt Pavement Rehabilitation.....	5-17
5.14	Overlay Design by Component Analysis.....	5-18
5.14.1	Subgrade Analysis	5-19
5.14.2	Aggregate Base Course Analysis.....	5-19
5.14.3	Asphalt Layer Analysis.....	5-19
5.15	Existing Portland Cement Concrete Slab.....	5-22
5.15.1	Flexible Overlay On Rigid Pavement.....	5-22
5.16	Cold In-Place Recycling (CIP)	5-23
5.17	Hot In-Place Recycling (HIR)	5-24
5.17.1	Introduction.....	5-24
5.17.2	Pavement Evaluation	5-25
5.17.3	Project Selection	5-25
5.17.4	Types of Hot In-Place Recycling.....	5-25
5.17.5	Surface Recycling (Heating and Scarifying Treatment).....	5-26

5.17.5.1	Preliminary Engineering Job-Mix Formula	5-27
5.17.5.2	Contractor Job-Mix Formula	5-27
5.17.5.3	Structural Design	5-27
5.17.5.4	Construction Considerations	5-28
5.17.6	Remixing (Heating and Remixing Treatment)	5-28
5.17.6.1	Preliminary Engineering Job-Mix Formula	5-30
5.17.6.2	Contractor Job-Mix Formula	5-30
5.17.6.3	Structural Design	5-30
5.17.6.4	Construction Considerations	5-30
5.17.7	Repaving (Heating and Repaving Treatment)	5-30
5.17.7.1	Preliminary Engineering Job-Mix Formula	5-32
5.17.7.2	Contractor Job-Mix Formula	5-32
5.17.7.3	Structural Design	5-32
5.17.7.4	Construction Considerations	5-32
5.17.8	Selecting the Appropriate Hot In-Place Recycling Process	5-33
5.18	Overlay Using Micro-Surfacing	5-35
5.19	Full Depth Reclamation (FDR)	5-36
5.20	Rubblization and Flexible Pavement Overlay	5-37
5.21	Stone Matrix Asphalt Project and Material Selection Guidelines	5-39
5.21.1	Aggregate Gradation	5-39
5.21.2	Recommended Minimum Thickness Layers	5-41
References	5-42

CHAPTER 6

PRINCIPLES OF DESIGN FOR PAVEMENT REHABILITATION WITH RIGID

OVERLAY	6-1
6.1 Introduction.....	6-1
6.1.1 Benefits of Whitetopping.....	6-3
6.2 Design Period.....	6-3
6.3 Traffic Analysis	6-3
6.4 Existing Pavement Evaluation	6-4
6.4.1 Structural Evaluation of Existing Pavement	6-4
6.4.2 Surface Preparation.....	6-7
6.4.3 Effective Thickness of Existing Pavement for the AASHTO Method	6-8
6.5 Design Considerations	6-9
6.5.1 Unbonded and Bonded Concrete Overlay	6-11
6.6 The CDOT Thin Whitetopping Method for Thickness Design	6-11
6.6.1 Development of Design Equations	6-14
6.6.1.1 Corner Loading (1998)	6-14
6.6.1.2 Mid-Joint Loading (1998).....	6-14
6.6.1.3 Determination of Critical Load Location (1998).....	6-15
6.6.1.4 Interface Bond on Load-Induced Concrete Stress	6-15
6.6.1.5 Interface Bond on Load-Induced Asphalt Strain	6-15
6.6.1.6 Temperature Restraint Stress	6-16
6.6.1.7 Development of Prediction Equations for Design Stresses and Strains	6-16
6.6.1.8 PCCP and HMA Pavement Fatigue.....	6-18

6.6.1.9	Converting Estimated ESALs to Whitetopping ESALs	6-19
6.7	CDOT Thin Whitetopping Pavement Design Procedure.....	6-20
6.7.1	Procedure Steps.....	6-20
6.7.2	Bonding Condition.....	6-23
6.7.3	Joint Spacing.....	6-24
6.7.4	Example Project CDOT Thin Whitetopping Design	6-24
6.8	The AASHTO Method for Thickness Design	6-27
6.8.1	Portland Cement Concrete Overlay Joints.....	6-27
6.8.2	Rehabilitation Sample Problem	6-27
References	6-31

CHAPTER 7

REHABILITATION OF PORTLAND CEMENT CONCRETE PAVEMENT..... 7-1

7.1	Introduction.....	7-1
7.2	Scope and Limitations.....	7-1
7.3	Colorado Documented Design Methods.....	7-2
7.4	Project Information.....	7-7
7.5	Pavement Evaluation	7-8
7.5.1	Functional and Structural Condition.....	7-8
7.5.1.1	Structural Condition.....	7-8
7.5.1.2	Functional Condition	7-9
7.5.1.3	Problem Classifications between Structural and Functional Condition	7-9
7.5.2	Material Condition and Properties.....	7-10
7.5.2.1	Non-destructive Testing.....	7-10
7.5.2.2	Destructive Testing.....	7-11
7.5.3	Drainage Condition.....	7-15
7.5.4	Lane Condition Uniformity.....	7-15
7.6	Pavement Rehabilitation Techniques.....	7-16
7.6.1	Diamond Grinding	7-17
7.6.2	Concrete Crack Sealing.....	7-21
7.6.3	Concrete Joint Resealing.....	7-22
7.6.4	Partial Depth Repair.....	7-24
7.6.5	Full Depth Concrete Pavement Repair	7-26
7.6.6	Dowel Bar Retrofit.....	7-30
7.6.7	Cross Stitching.....	7-32
7.6.8	Slab Stabilization and Slabjacking.....	7-34
7.7	Selecting the Appropriate Pavement Rehabilitation Techniques.....	7-36
References	7-38

CHAPTER 8

PRINCIPLES OF DESIGN FOR FLEXIBLE PAVEMENT INTERSECTIONS..... 8-1

8.1	Introduction.....	8-1
8.2	Design Considerations	8-1
8.3	Design Period.....	8-2
8.4	Traffic Analysis	8-2
8.5	Design Methodology.....	8-3

8.6	Reconstruction Sample Problem.....	8-3
8.7	Assessing Problems with Existing Intersections.....	8-6
8.8	Performance Characteristics of Existing Intersections	8-6
8.9	Utilities.....	8-8
8.10	Rehabilitation Sample Problem	8-8

CHAPTER 9

PRINCIPLES OF DESIGN FOR RIGID PAVEMENT INTERSECTIONS 9-1

9.1	Introduction.....	9-1
9.2	Design Considerations	9-1
9.3	Design Period.....	9-2
9.4	Traffic Analysis	9-3
9.5	Design Methodology.....	9-3
9.6	Intersection Sample Problem	9-3
9.7	Rigid Pavement Joint Design for Intersections.....	9-8
9.8	Rigid Pavement Roundabout Joint Design	9-15
9.8.1	General Joint Layout.....	9-16
9.8.2	Details of Joints.....	9-17
9.8.3	Typical Section	9-20
9.9	Assessing Problems with Existing Intersections.....	9-22
9.10	Detail for Abutting Asphalt and Concrete	9-22
	References.....	9-24

CHAPTER 10

PAVEMENT TYPE SELECTION AND LIFE CYCLE COST ANALYSIS..... 10-1

10.1	Introduction.....	10-1
10.2	Implementation of a LCCA	10-2
10.2.1	Analysis Period.....	10-3
10.2.2	Performance Life	10-3
10.2.3	Rehabilitation Selection Process.....	10-3
10.3	Examples of the Rehabilitation Selection Process.....	10-4
10.3.1	Core Data Matches Historical Data	10-4
10.3.2	No Core Data and No Historical Data	10-5
10.3.3	Portland Cement Concrete Pavement	10-6
10.3.4	Restoration, Rehabilitation and Resurfacing Treatments	10-6
10.4	Discount Rate.....	10-7
10.5	Life Cycle Cost Factors	10-8
10.5.1	Initial Construction Costs	10-8
10.5.2	Maintenance Cost.....	10-10
10.5.3	Design Costs	10-10
10.5.4	Pavement Construction Engineering Costs.....	10-11
10.5.5	Traffic Control Costs	10-11
10.5.6	Salvage Value	10-11
10.5.7	User Costs.....	10-11
10.5.7.1	User Cost Program.....	10-12
10.6	Probabilistic Life Cycle Cost Analysis.....	10-22

10.7	FHWA RealCost Software.....	10-22
10.7.1	RealCost Switchboard.....	10-23
10.7.2	Real world example using the RealCost software	10-24
10.7.3	Project Details Options	10-25
10.7.4	Analysis Options.....	10-26
10.7.5	Traffic Data Options	10-28
10.7.6	Value of User Time.....	10-31
10.7.7	Traffic Hourly Distribution.....	10-32
10.7.8	Added Time and Vehicle Costs Options.....	10-33
10.7.9	Saving and Opening Project-Level Inputs	10-35
10.7.10	Alternative-Level Data Input Forms	10-50
10.7.11	Executing the Simulation.....	10-54
10.7.12	Analyzing Probabilistic Results.....	10-56
10.7.13	Analyzing Probabilistic Agency Costs	10-56
10.7.14	Analyzing Probabilistic User Cost.....	10-57
10.8	Comparing Probabilistic Results.....	10-58
10.9	Pavement Type Selection Committee (PTSC).....	10-60
10.9.1	Purpose.....	10-60
10.9.2	Scope.....	10-60
10.9.3	Membership	10-61
10.9.4	Roles of Membership.....	10-61
10.9.5	Process	10-61
	References.....	10-63

CHAPTER 11

PAVEMENT JUSTIFICATION REPORT..... 11-1

11.1	Introduction.....	11-1
11.2	Pavement Justification Report (PJR)	11-1
11.2.1	General Information in a PJR	11-1
11.2.2	Site Conditions.....	11-2
11.2.3	Subgrade Materials	11-2
11.2.4	Design Traffic	11-2
11.2.5	Pavement Materials Characteristics.....	11-2
11.2.6	Pavement Design and Selection Process.....	11-3
11.3	Guidelines for Data on Plan Sheets	11-3

APPENDIX A

PROCEDURES FOR FORENSIC STUDY OF DISTRESS OF HOT MIX ASPHALT AND PORTLAND CEMENT CONCRETE..... A-1

A.1	Introduction.....	A-1
A.2	Formation of an Evaluation Team	A-1
A.3	Levels of Investigation.....	A-1
A.3.1	Level I (CDOT Region).....	A-1
A.3.2	Level II (CDOT Statewide)	A-2
A.3.3	Level III (National Effort)	A-2
A.4	Site Investigation	A-3

A.4.1	Visual Analysis	A-3
A.4.2	Review of Construction Documents	A-6
A.4.3	Investigational Requirements.....	A-6
A.4.4	Required Core Samples and Testing.....	A-6
A.4.4.1	Core Samples from Hot Mix Asphalt and PCCP.....	A-6
A.4.4.2	Base and Subgrade Samples	A-7
A.5	Final Report	A-7
A.6	Funding Sources.....	A-8
Reference	A-9

**APPENDIX B
FORMS** **B-1**

**APPENDIX C
DEFLECTION TESTING AND BACKCALCULATION.....** **C-1**

C.1	Introduction.....	C-1
C.2	FWD Testing – Flexible Pavements	C-3
C.2.1	FWD Testing Pattern - Flexible Pavement	C-3
C.2.2	FWD Drop Sequence – Flexible Pavement	C-6
C.2.3	FWD Sensor Spacing – Flexible Pavement.....	C-6
C.2.4	Surface Temperature Measurement – Flexible Pavement	C-6
C.3	FWD Testing – Rigid Jointed Plain Concrete Pavements	C-7
C.3.1	FWD Testing Pattern – Rigid Pavement.....	C-7
C.3.2	FWD Drop Sequence – Rigid Pavement	C-9
C.3.3	FWD Sensor Spacing – Rigid Pavement	C-10
C.3.4	Surface Temperature Measurement – Rigid Pavement	C-11
C.4	FWD Testing – Composite Pavements.....	C-12
C.4.1	FWD Testing Pattern – Composite Pavement	C-12
C.4.2	FWD Drop Sequence – Composite Pavements	C-14
C.4.3	FWD Sensor Spacing – Composite Pavement.....	C-15
C.4.4	Pavement Temperature Readings – Composite Pavement	C-15
C.5	Field Test Report.....	C-16
C.6	FWD Data Processing.....	C-18
C.6.1	Pre-Analysis.....	C-18
C.6.2	Pavement Surface Condition Survey	C-19
C.6.3	Pavement Coring and Subgrade Boring.....	C-19
C.6.4	Full Data Processing.....	C-20
C.6.5	Data Analysis, Interpretation and Reporting	C-20
C.6.5.1	Results Reporting – Flexible Pavements	C-21
C.6.5.2	Results Reporting – Jointed and Composite Pavements.....	C-21
C.6.5.3	Data Analysis and Interpretation – Jointed and Composite Pavements	C-21
References	C-22

**APPENDIX D
THE NEW ECONOMY; MATERIALS AND PAVEMENT OPTIONS AND
CONSIDERATIONS** **D-1**

D.1	Introduction.....	D-1
D.2	White Paper - The New Economy	D-1
	References.....	D-7

APPENDIX E

Practical Design Guide for Pavements.....	E-1	
E.1	Introduction.....	E-1
E.2	Category I Pavement Designs.....	E-1
E.3	Category II Pavement Designs.....	E-1

SUPPLEMENT

MATERIAL PROPERTIES OF SUBGRADE, SUBBASE, BASE, FLEXIBLE AND RIGID LAYERS

		S-1
S.1	Introduction.....	S-1
S.2	Basic Definitions of Engineering Properties.....	S-1
S.2.1	Basic Definitions of the Roadway	S-1
S.2.1.1	Roadbed	S-1
S.2.1.2	Surface Course	S-1
S.2.1.3	Base.....	S-2
S.2.1.4	Subbase	S-3
S.2.1.5	Subgrade	S-3
S.2.1.6	Fabric Layers	S-3
S.2.2	Soil Consistency	S-4
S.2.3	Sieve Analysis.....	S-4
S.2.4	Unit Weight, Water Content, and Specific Gravity	S-6
S.2.5	Pavement Materials Chemistry	S-8
S.2.5.1	Periodic Table	S-8
S.2.5.2	pH Scale.....	S-10
S.2.6	Elastic Modulus	S-11
S.2.6.1	Concrete Modulus of Elasticity	S-12
S.2.6.2	Asphalt Dynamic Modulus E* 	S-12
S.2.7	Binder Complex Shear Modulus.....	S-17
S.2.8	Poisson's Ratio	S-19
S.2.9	Coefficient of Lateral Pressure	S-20
S.2.10	Unconfined Compressive Strength	S-20
S.2.11	Modulus of Rupture	S-21
S.2.12	Tensile Creep and Strength for Hot Mix Asphalt.....	S-22
S.3	Resilient Modulus of Conventional Unbound Aggregate Base, Subbase, Subgrade, and Rigid Layer	S-24
S.3.1	Laboratory M _R Testing	S-26
S.3.2	Field M _R Testing.....	S-29
S.3.3	Adjustment to Laboratory and Field M _R Values for Climate	S-29
S.4	Resistance Value (R-value).....	S-30
S.5	M _R and R-value Correlation.....	S-31
S.6	Modulus of Subgrade Reaction (k-value).....	S-34
S.6.1	Static Elastic k-value.....	S-34

S.6.2	Dynamic k-value.....	S-35
S.7	Bedrock.....	S-36
S.8	Unbound Subgrade, Granular, and Subbase Materials.....	S-37
S.9	Chemically Stabilized Subgrades and Bases.....	S-38
S.9.1	Top of Layer Properties for Stabilized Materials.....	S-41
S.9.2	Bottom of Layer Properties for Stabilized Materials.....	S-43
S.9.3	Other Properties of Stabilized Layers.....	S-43
S.9.3.1	Coefficient of Thermal Expansion of Aggregates.....	S-43
S.9.3.2	Dry Thermal Conductivity (K) and Heat Capacity (Q).....	S-44
S.9.3.3	Saturated Hydraulic Conductivity.....	S-46
S.10	Reclaimed Asphalt and Recycled Concrete Base Layer.....	S-46
S.11	Fractured Rigid Pavement.....	S-48
S.12	Pavement Deicers.....	S-50
S.12.1	Magnesium Chloride.....	S-50
References	S-51

LIST OF FIGURES

INTRODUCTION

Figure Intro.1 Pavement Design Manual Organization Flow Chart.....	iii
--	-----

CHAPTER 1

Figure 1.1 CDOT Vehicle Classifications	1-7
Figure 1.2 Highway Functional Classifications.....	1-15

CHAPTER 2

Figure 2.1 Conventional Structural Layered Flexible and Rigid Systems.....	2-1
Figure 2.2 Distribution of Wheel Load to Subgrade Soil (M_R)	2-6
Figure 2.3 Chart for Estimating Effective Roadbed Soil Resilient Modulus	2-9
Figure 2.4 DARWin™ Secondary Dialog Screen for effective resilient modulus.....	2-10
Figure 2.5 Distribution of Wheel Load to Subgrade Reaction (k-value).....	2-11
Figure 2.6 k-value vs. Soil Classification	2-13
Figure 2.7 k-values Versus Degree of Saturation for A-4 through A-7 Soils.....	2-14
Figure 2.8 Approximate k-value Range to CBR.....	2-16
Figure 2.9 k-value Range versus DCP Penetration Rate	2-17
Figure 2.10 k-value Adjustment for Fill and/or Rigid Layer.....	2-19
Figure 2.11 Embankment Fill and Cut Sections	2-22
Figure 2.12 Special Cases of Embankment Fill.....	2-23
Figure 2.13 Colorado Annual Freezing Index (degrees-Fahrenheit days).....	2-25
Figure 2.14 Frost Depth to FI	2-26
Figure 2.15 Frost Susceptible Soil Classifications	2-27
Figure 2.16 Subexcavated Subgrade Layers.....	2-29
Figure 2.17 Effective Depth of Moisture Treatment	2-31
Figure 2.18 Recommended Depth of Moisture Treatment	2-31
Figure 2.19 Lime/Cement Stabilization Flow Chart.....	2-33
Figure 2.20 Lime Treated Structural Subgrade Layer	2-34
Figure 2.21 Cross Section of Lime Treated Cut Section Subgrade	2-35
Figure 2.22 Cement Treated Structural Subgrade Layer	2-35
Figure 2.23 Fly Ash Treated Structural Subgrade Layer.....	2-36
Figure 2.24 Unbound Aggregate Base Course Layers.....	2-38
Figure 2.25 Stabilized Treated Structural Base Layers	2-41
Figure 2.26 Structural Permeable Aggregate Base Course Layers.....	2-43
Figure 2.27 Reclaimed Asphalt and Concrete Pavement Base Layers.....	2-44
Figure 2.28 Rubblized Base Course.....	2-46

CHAPTER 3

Figure 3.1 Design Nomograph for Flexible Pavements.....	3-4
Figure 3.2 Structural Layers	3-8
Figure 3.3 Simple Pavement Layer Systems	3-9
Figure 3.4 Correlation of Soil Support Indices to Structural Base Layer Coefficients	3-10
Figure 3.5 Flexible Pavement Field Design Worksheet (CDOT Form #585).....	3-13
Figure 3.6 PG Binder Grades.....	3-18

Figure 3.7 Colorado 98% Reliability LTPP High Pavement Temperature Weather Station Models	3-20
Figure 3.8 Colorado 98% Reliability LTPP Low Pavement Temperature Weather Station Models	3-21
Figure 3.9 LTPP Interface Form for Weather Station Selection (version 3.1)	3-23
Figure 3.10 LTPP Weather Station Output Data (version 3.1)	3-24
Figure 3.11 LTPP PG Binder Selection at 98% Reliability	3-25

CHAPTER 4

Figure 4.1 Simple Rigid Pavement Layers	4-2
Figure 4.2 Curling and Warping	4-8
Figure 4.3 Region 1 Weather Stations	4-11
Figure 4.4 Region 2 Weather Stations	4-12
Figure 4.5 Region 3 Weather Stations	4-13
Figure 4.6 Region 4 Weather Stations	4-14
Figure 4.7 Region 5 Weather Stations	4-15
Figure 4.8 Region 6 Weather Stations	4-16
Figure 4.9 Details of Dowel Bar Placement	4-18
Figure 4.10 1998 AASHTO Supplemental Input Screen	4-21
Figure 4.11 1998 AASHTO Supplemental Faulting Input Screen	4-22
Figure 4.12 1998 AASHTO Supplemental Corner Break Input Screen	4-23
Figure 4.13 Idealized Sketch of Cracking Pattern in Concrete Mass Caused By Internal Expansion	4-26
Figure 4.14 Sulfate Attack	4-27

CHAPTER 5

Figure 5.1 Rehabilitation Alternative Selection Process	5-1
Figure 5.2 Pavement Condition Evaluation Checklist (Flexible)	5-4
Figure 5.3 Thin Wearing Course Treatment Layer	5-7
Figure 5.4 Schematic of Thin Wearing Course Equipment	5-7
Figure 5.5 Conventional Hot Mix Asphalt (HMA) Layer	5-8
Figure 5.6 Schematic of Conventional HMA Paving Equipment	5-8
Figure 5.7 Cold Planing of Existing Flexible Pavement	5-10
Figure 5.8 Schematic of Cold Planing Equipment	5-10
Figure 5.9 Structural Layer Coefficients of Existing Pavements (CDOT Form #903 3/04) ...	5-20
Figure 5.10 Overlay Design by Component Analysis (CDOT Form #586 3/04)	5-21
Figure 5.11 Cold In-Place Recycling Layers	5-23
Figure 5.12 Schematic of Cold In-Place Recycling Equipment	5-24
Figure 5.13 Surface Recycling Layers	5-26
Figure 5.14 Schematic of Surface Recycling Equipment	5-27
Figure 5.15 Remixing Layers	5-29
Figure 5.16 Schematic of Remixing Equipment	5-29
Figure 5.17 Repaving Layers	5-31
Figure 5.18 Schematic of Repaving Equipment	5-31
Figure 5.19 Full Depth Reclamation (FDR) Layers	5-36
Figure 5.20 Schematic of Full Depth Reclamation Equipment	5-37

Figure 5.21 Rubblization and Overlay Layers	5-38
Figure 5.22 Schematic of Rubblization and Overlay Equipment	5-38

CHAPTER 6

Figure 6.1 Rehabilitation Alternative Selection Process	6-2
Figure 6.2 Pavement Condition Evaluation Checklist (Rigid)	6-6
Figure 6.3 Thin Whitetopping Overlay Layer	6-12
Figure 6.4 Schematic of Thin Whitetopping Overlay Equipment	6-12
Figure 6.5 Sample TWT Project Location Map.....	6-25
Figure 6.6 Input and Required Thickness Form for Thin Whitetopping Design.....	6-26
Figure 6.7 Input Form for Future Rigid Pavement Overlay Design Procedure.....	6-28
Figure 6.8 DARWin™ Selection of Rigid Pavement Overlay Design.....	6-29
Figure 6.9 DARWin™ Input Form for Effective Thickness-Condition Survey Method	6-29
Figure 6.10 DARWin™ Input Form for Rigid Pavement Overlay Design	6-30
Figure 6.11 DARWin™ Printout of Results for Rigid Pavement Overlay Design	6-30

CHAPTER 7

Figure 7.1 CPR Sequencing.....	7-17
Figure 7.2 Dimensions for Grinding and Grooving.....	7-20
Figure 7.3 Dimensional Grinding Texture for Hard and Soft Aggregate	7-20
Figure 7.4 Grout Retention Disk.....	7-28
Figure 7.5 Typical Dowel Bar Retrofit Installation	7-31
Figure 7.6 Typical Dowel Bar Retrofit Sequencing of the Installation	7-32
Figure 7.7 Typical Slab Stabilization Hole Layout	7-35
Figure 7.8 Typical Slab Raising in Slabjacking.....	7-36
Figure 7.9 Typical Slabjacking Hole Layout.....	7-36

CHAPTER 8

Figure 8.1 Rutting in Subgrade or Base.....	8-6
Figure 8.2 Plastic Flow	8-7
Figure 8.3 Rutting in Asphalt Layer	8-8

CHAPTER 9

Figure 9.1 Rigid Pavement Intersection Example Input/Output Values.....	9-6
Figure 9.2 Rigid Pavement Intersection Example Fault Check Values.....	9-7
Figure 9.3 Typical Joint Layout for a Rigid Pavement Intersection.....	9-11
Figure 9.4 Typical Joint Layout for a Rigid Pavement Intersection.....	9-11
Figure 9.5 Typical Joint Layout for a Rigid Pavement Intersection.....	9-12
Figure 9.6 Typical Joint Layout for a Rigid Pavement Intersection.....	9-12
Figure 9.7 Typical Joint Layout for a Rigid Pavement Intersection.....	9-13
Figure 9.8 Typical Joint Layout for a Rigid Pavement Intersection.....	9-13
Figure 9.9 Typical Joint Layout for a Rigid Pavement Intersection.....	9-14
Figure 9.10 Typical Urban Double-lane Roundabout.....	9-15
Figure 9.11 Isolating the Circle	9-16
Figure 9.12 Pave-through Layout	9-17
Figure 9.13 Six Step Jointing Layout	9-18

Figure 9.14 Dowel Bar Locations in the Transverse Joints	9-19
Figure 9.15 Tie-bar Locations in the Longitudinal Joints.....	9-19
Figure 9.16 Typical Section of an Urban Double-lane Roundabout	9-21
Figure 9.17 Detail of Asphalt and Concrete Slab Joint	9-23

CHAPTER 10

Figure 10.1 Pavement Selection Process Flow Chart.....	10-2
Figure 10.2 Unmodified HMA Cash Flow Diagram	10-5
Figure 10.3 Cold Plaining and Overlay with Polymer Modified HMA Cash Flow Diagram ...	10-5
Figure 10.4 PCCP Cash Flow Diagram	10-6
Figure 10.5 Input Screen for WorkZone Software SLC (HMA).....	10-13
Figure 10.6 Input Screen for WorkZone Software SLC (PCCP).....	10-14
Figure 10.7 Input Screen for WorkZone Software Cross-Over (PCCP)	10-15
Figure 10.8 Initial Construction Result Screen for WorkZone Software	10-17
Figure 10.9 Screens of User Costs and Traffic Distribution Factors for a HMA Project in a Single Lane Closure	10-18
Figure 10.10 Screens of User Costs and Traffic Distribution Factors for a PCCP Project in a Cross-Over Closure.....	10-19
Figure 10.11 Screens of User Costs and Traffic Distribution Factors for a PCCP Rehabilitation Project in a Single Lane Closure.....	10-19
Figure 10.12 User Cost Screen for Removal of PCCP in a Single Lane Closure.....	10-20
Figure 10.13 The RealCost Switchboard	10-24
Figure 10.14 Project Details Input Screen	10-25
Figure 10.15 Analysis Option Screen	10-27
Figure 10.16 Traffic Data Option Screen	10-30
Figure 10.17 Value of User Option Screen.....	10-31
Figure 10.18 Traffic Hourly Distribution Screen	10-33
Figure 10.19 Added Time and Vehicle Stopping Costs Screen.....	10-35
Figure 10.20 Saving and Opening Project-Level Inputs.....	10-36
Figure 10.21 PCCP Unit Costs (Region 1).....	10-37
Figure 10.22 Unmodified HMA Unit Costs (Region 1)	10-37
Figure 10.23 Polymer Modified HMA Unit Costs (Region 1)	10-38
Figure 10.24 PCCP Unit Costs (Region 2).....	10-39
Figure 10.25 Unmodified HMA Unit Costs (Region 2)	10-40
Figure 10.26 Polymer Modified HMA Unit Costs (Region 2).....	10-40
Figure 10.27 Unmodified HMA Unit Costs (Region 3)	10-41
Figure 10.28 Polymer Modified HMA Unit Costs (Region 3).....	10-41
Figure 10.29 PCCP Unit Costs (Region 4).....	10-42
Figure 10.30 Unmodified HMA Unit Costs (Region 4)	10-42
Figure 10.31 Polymer Modified HMA Unit Costs (Region 4).....	10-43
Figure 10.32 Unmodified HMA Unit Costs (Region 5)	10-44
Figure 10.33 Polymer Modified HMA Unit Costs (Region 5).....	10-44
Figure 10.34 PCC Unit Costs (Region 6)	10-45
Figure 10.35 Unmodified HMA Unit Costs (Region 6)	10-46
Figure 10.36 Polymer Modified HMA Unit Costs (Region 6).....	10-46
Figure 10.37 PCCP Unit Costs (Statewide).....	10-47

Figure 10.38 Unmodified HMA Unit Costs (Statewide).....	10-47
Figure 10.39 Polymer Modified HMA Unit Costs (Statewide).....	10-48
Figure 10.40 PCCP Unit Costs (Statewide).....	10-49
Figure 10.41 Unmodified HMA Unit Costs (Statewide).....	10-49
Figure 10.42 Polymer Modified HMA Unit Costs (Statewide).....	10-50
Figure 10.43 Alternative 1 (HMA) Screen.....	10-52
Figure 10.44 Alternative 2 (PCCP) Screen.....	10-53
Figure 10.45 Simulation Screen.....	10-55
Figure 10.46 Probabilistic Results Screen.....	10-56
Figure 10.47 Agency Cost Results Screen.....	10-57
Figure 10.48 User Cost Results Screen.....	10-58
Figure 10.49 Agency-User Cost Results Screens.....	10-59

APPENDIX A

Figure A.1 Pavement Condition Evaluation Checklist (Rigid).....	A-4
Figure A.2 Pavement Condition Evaluation Checklist (Flexible).....	A-5

APPENDIX B

Figure B.1 Design Data (Page 1 of 2) (CDOT Form 463 12/03).....	B-1
Figure B.2 Maintenance Project - Request Form (CDOT Form 463M 10/04).....	B-3
Figure B.3 Flexible Pavement Field Design Work Sheet (CDOT Form 585 3/05).....	B-4
Figure B.4 Overlay Design by Component Analysis (CDOT Form 586 3/04).....	B-5
Figure B.5 Structural Layer Coefficient of Existing Pavements (CDOT Form 903 3/04).....	B-6

APPENDIX C

Figure C.1 Depiction of FWD Load Distribution through Pavement.....	C-3
Figure C.2 Flexible Pavement Staggered Testing Pattern.....	C-5
Figure C.3 JPCP Testing Pattern.....	C-9
Figure C.4 Joint Load Transfer Testing Sensor Spacing.....	C-11
Figure C.5 Corner Testing Sensor Location.....	C-11
Figure C.6 Staggered Testing Pattern.....	C-13
Figure C.7 Joint Load Transfer Testing Sensor Spacing.....	C-15
Figure C.8 Field Test Report.....	C-17
Figure C.9 Coring Log Example.....	C-20

SUPPLEMENT

Figure S.1 Atterberg Limits.....	S-4
Figure S.2 Gradation Plot.....	S-5
Figure S.3 Soil Sample Constituents.....	S-6
Figure S.4 Plot of Maximum Dry Unit Weight and Optimum Water Content.....	S-7
Figure S.5 Periodic Table.....	S-9
Figure S.6 Dissociation of Water.....	S-10
Figure S.7 pH Scale.....	S-10
Figure S.8 Elastic Modulus.....	S-11
Figure S.9 Dynamic Modulus Stress-Strain Cycles.....	S-13
Figure S.10 $ E^* $ vs. Log Loading Time Plot at Each Temperature.....	S-14

Figure S.11 Shifting of Various Mixture Plots	S-16
Figure S.12 Dynamic Modulus $ E^* $ Master Curve	S-16
Figure S.13 Shift Factor Plot	S-17
Figure S.14 Binder Complex Shear Modulus Specimen Loading	S-18
Figure S.15 Binder Complex Shear Modulus Shear-Strain Cycles	S-18
Figure S.16 Poisson's ratio	S-20
Figure S.17 Unconfined Compressive Strength.....	S-21
Figure S.18 3-Point Beam Loading for Flexural Strength.....	S-22
Figure S.19 Indirect Tensile Strength	S-23
Figure S.20 Distribution of Wheel Load to Subgrade Soil (M_R).....	S-25
Figure S.21 Critical Stress/Strain Locations for Bases, Subbases, Subgrade, and Rigid Layer	S-26
Figure S.22 Subgrade Material Element at Critical Location.....	S-27
Figure S.23 Resilient Modulus Test Specimen Stress State	S-28
Figure S.24 Resilient Modulus Test Specimen Loading	S-28
Figure S.25 Resilient Modulus Seasonal Variation	S-30
Figure S.26 Resistance R-value Test Specimen Loading State	S-31
Figure S.27 Correlation Plot between Resilient Modulus and R-value	S-32
Figure S.28 Distribution of Wheel Load to Subgrade Reaction (k-value)	S-34
Figure S.29 Field Plate Load Test for k-value	S-35
Figure S.30 Critical Stress Locations for Stabilized Subgrade.....	S-39
Figure S.31 Critical Stress/Strain Locations for Stabilized Bases.....	S-39
Figure S.32 Critical Stress Locations for Recycled Pavement Bases.....	S-47
Figure S.33 Critical Stress Location for Rubblized Base	S-49

LIST OF TABLES

CHAPTER 1

Table 1.1 Design Lane Factor.....	1-5
Table 1.2 Colorado Equivalency Factors.....	1-8
Table 1.3 Reliability (Risk).....	1-14
Table 1.4 Reliability and Standard Normal Deviate.....	1-16
Table 1.5 Serviceability Index.....	1-16
Table 1.6 Drainage Quality.....	1-18
Table 1.7 Moisture-Related Distress in Flexible Pavements.....	1-21
Table 1.8 Moisture-Related Distress in Rigid Pavements.....	1-22

CHAPTER 2

Table 2.1 M-E Design Guide Major Material Categories of Subgrades and Bases.....	2-2
Table 2.2 k-value Ranges for Various Soil Types.....	2-15
Table 2.3 Season Adjusted Effective Subgrade k-value.....	2-18
Table 2.4 Example Project Soils.....	2-20
Table 2.5 Treatment of Expansive Soils.....	2-29
Table 2.6 Probable Swell Damage Risk.....	2-30
Table 2.7 CDOT Classification for Aggregate Base Course.....	2-40
Table 2.8 CDOT Classification for Reclaimed Asphalt Pavement.....	2-45

CHAPTER 3

Table 3.1 Flexible Pavement Thickness Design Factors.....	3-2
Table 3.2 Recommended a_i Values for the Structural Layer Coefficients.....	3-6
Table 3.3 Recommended a_i Values for the Base Layer Coefficients.....	3-6
Table 3.4 Recommended m_i Values* for Modifying Structural Layer Coefficients of Untreated Base and Subbase Materials in Flexible Pavements.....	3-7
Table 3.5 Minimum Total Pavement Thicknesses for Flexible Pavement Structures.....	3-11
Table 3.6 HMA Grading Size and Application.....	3-14
Table 3.7 HMA Grading Size and Application.....	3-14
Table 3.8 Environmental Categories.....	3-16
Table 3.9 Recommended SuperPave™ Gyratory Design Revolution (N_{DES}).....	3-16
Table 3.10 Available Asphalt Cement Grades in Colorado.....	3-17
Table 3.11 SuperPave™ Weather Data Summary.....	3-25
Table 3.12 Environmental Categories (Restated).....	3-26
Table 3.13 Recommended SuperPave™ Gyratory Design Revolution (N_{DES}).....	3-27
Table 3.14 Fractured Face Criteria.....	3-27
Table 3.15 Minimum VMA Requirements.....	3-28
Table 3.16 Criteria for Stability and Voids Filled with Asphalt (VFA).....	3-29
Table 3.17 Moisture Damage Criteria.....	3-29

CHAPTER 4

Table 4.1 Rigid Pavement Thickness Design Factors.....	4-3
Table 4.2 Rigid Pavement Doweled Faulting Design Factors.....	4-4
Table 4.3 Rigid Pavement Non-doweled Faulting Design Factors.....	4-4

Table 4.4 Rigid Pavement Non-doweled Corner Break Design Factors	4-5
Table 4.5 Friction Coefficient (f) Between Slab and Base	4-7
Table 4.6 Average WIND Speed (mph)	4-9
Table 4.7 Reinforcing Size Table	4-17
Table 4.8 Dowel Bar Placement Tolerances	4-18
Table 4.9 Modified AASHTO Drainage Coefficients	4-19
Table 4.10 Minimum Thicknesses for Highway and Bicycle Path	4-24
Table 4.11 Concrete Classification	4-25
Table 4.12 Requirements to Protect Against Damage to Concrete by Sulfate Attack from External Sources of Sulfates	4-28

CHAPTER 5

Table 5.1 Equivalency Factors for Overlay Design	5-3
Table 5.2 List of Recommended Overlay Solutions to Functional Problems	5-6
Table 5.3 Structural Layer Coefficients for Existing Asphalt Pavement Layers	5-15
Table 5.4 Hot In-Place Recycling Suitability in Pavement Distress Treatment	5-25
Table 5.5 Selection Guidelines for HIR Process Distress-Related Considerations	5-34
Table 5.6 Master Range Table for Stone Matrix Asphalt	5-40
Table 5.7 SMA Functional and Structural Recommended Minimum Thickness Layers	5-41

CHAPTER 6

Table 6.1 Required Whitetopping Procedure	6-1
Table 6.2 Guidelines for Whitetopping Preoverlay Repair (ACPA 1998)	6-7
Table 6.3 1998 AASHTO Supplemental Design Method Factors for Rigid Pavement	6-10
Table 6.4 Design Factors for Rigid Pavement	6-13
Table 6.5 Design Calculation Results	6-22
Table 6.6 Design Calculation Results (Continued)	6-23

CHAPTER 7

Table 7.1 Structural Adequacy for JPCP	7-9
Table 7.2 Functional Adequacy for JPCP	7-9
Table 7.3 Load Transfer Efficiency Quality	7-11
Table 7.4 Distress Levels for Durability of JPCP	7-13
Table 7.5 Strength Correlation Formulas	7-14
Table 7.6 Distress Levels for Assessing Drainage Adequacy of JPCP	7-15
Table 7.7 Trigger Values for Diamond Grinding	7-19
Table 7.8 Limit Values for Diamond Grinding	7-19
Table 7.9 Hot Poured Crack Sealant Estimated Quantities	7-22
Table 7.10 Sealant Severity Level	7-23
Table 7.11 Sealant Survey Sampling Frequency	7-24
Table 7.12 Minimum Cost Effective Distance between Two Patches	7-27
Table 7.13 Guidelines for PCC Treatment Selection	7-37

CHAPTER 8

Table 8.1 Design Factors for Flexible Pavement Intersections	8-2
--	-----

CHAPTER 9

Table 9.1 Rigid Pavement Intersection Thickness Design Factors..... 9-2

CHAPTER 10

Table 10.1 Default Input Values for Treatment Periods to be used in a LCCA 10-4
 Table 10.2 Present Worth Factors for 3.3% Discount Rates 10-7
 Table 10.3 Discount Factors for Discrete Compounding 10-8
 Table 10.4 Annual Maintenance Costs 10-10
 Table 10.5 Range in Capacity for Construction..... 10-16
 Table 10.6 Lane Width Adjustment Factors from the Highway Capacity Manual 10-21
 Table 10.7 Analysis Data Inputs and Analysis Options 10-26
 Table 10.8 Traffic Data Options 10-28
 Table 10.9 Value of User Time Data Options 10-31
 Table 10.10 Traffic Hourly Distribution Data Options 10-32
 Table 10.11 Added Time and Vehicle Costs Data Options 10-34
 Table 10.12 Alternative-Level Data Options..... 10-51
 Table 10.13 Simulation Data Options..... 10-55
 Table 10.14 Possible Elements for Pavement Type Selection Process 10-62

APPENDIX C

Table C.1 Flexible Pavement Test Spacing Guidelines..... C-4
 Table C.2 Jointed Plain Concrete Pavement Test Spacing Guidelines..... C-8
 Table C.3 Composite Pavement Test Spacing Guidelines..... C-13

SUPPLEMENT

Table S.1 Nominal Dimensions of Common Sieves S-5
 Table S.2 Recommended Testing Temperatures and Loading Frequencies..... S-13
 Table S.2 Comparisons of M_R between Suggested NCHRP 1-40D Values and Colorado Soils
 with R-values S-33
 Table S.3 Poisson's Ratio for Bedrock..... S-36
 Table S.4 Elastic Modulus for Bedrock..... S-36
 Table S.5 Poisson's Ratios for Subgrade, Unbound Granular and Subbase Materials S-37
 Table S.6 Coefficient of Lateral Pressure S-37
 Table S.7 Poisson's Ratios for Chemically Stabilized Materials S-40
 Table S.8 Poisson's Ratios for Asphalt Treated Permeable Base S-40
 Table S.9 Poisson's Ratios for Cold Mixed Asphalt and S-40
 Table S.10 Minimum Unconfined Compressive Strengths for Stabilized Layers..... S-41
 Table S.11 Typical E, E^* , or M_R Values for Stabilized Materials..... S-42
 Table S.12 Typical M_R Values for Deteriorated Stabilized Materials..... S-42
 Table S.13 Typical Modulus of Rupture (M_R) Values for Stabilized Materials..... S-43
 Table S.14 Recommended Values of PCC Coefficient of Thermal Expansion S-44
 Table S.15 LTPP Values of PCC Coefficient of Thermal Expansion of Siliceous Gravel in
 Colorado..... S-44
 Table S.16 Dry Thermal Conductivity (K) and Heat Capacity (Q) for Unbound Compacted
 Material..... S-45

Table S.17 Dry Thermal Conductivity (K) and Heat Capacity (Q) for Chemically Stabilized Material	S-45
Table S.18 Dry Thermal Conductivity (K) and Heat Capacity (Q) for Asphalt Concrete and PCC Material	S-46
Table S.19 Poisson's Ratios for Cold Mixed Asphalt and Cold Mixed Recycled Asphalt Materials	S-47
Table S.20 Typical E, E*, or M _R Values for Stabilized Materials.....	S-48
Table S.21 Poisson's Ratio for PCC Materials	S-49
Table S.22 Typical M _R Values for Fractured PCC Layers	S-49

LIST OF EQUATIONS

CHAPTER 1

$T_f = (1 + r)^n$	Eq. 1.1	1-10
$T = (((T_1 * T_f) - T_1) / 20) * D + T_1$	Eq. 1.2	1-10
$T_m = (T_1 + T) / 2$	Eq. 1.3	1-10
18 – kip ESAL(20years) = 62,000 + 80R	Eq. 1.4	1-11
18 – kip ESAI(20years) = 62,000 + 80R + 260,000C _A	Eq. 1.5	1-12
18 – kip ESAI(20years) = 62,000 + 80R + 260,000C _A + 400,000I _A	Eq. 1.6	1-12

CHAPTER 2

$S_1 = [(R - 5) / 11.29] + 3$	Eq. 2.1	2-7
$M_R = 10^{[(S_1 + 18.72) / 6.24]}$	Eq. 2.2	2-7
$(M_R)_{eff} = 3005(\bar{u}_f)^{-0.431}$	Eq. 2.3	2-8
$\bar{u}_f = \frac{\sum_{i=1}^n u_{fi}}{n}$	Eq. 2.4	2-8
$FI = \sum_{i=1}^n (0 - T_i)$	Eq. 2.5	2-24
$FI = \text{Annual Freezing Index} (^{\circ}\text{C days}) = (5/9) \text{Annual Freezing Index} (^{\circ}\text{F days})$	Eq. 2.6	2-24
$\text{Frost Depth (meters)} = 0.0014 \times FI$	Eq. 2.7	2-24
$D_{15B} \leq 5 \times D_{85S}$, and	Eq. 2.8	2-37
$D_{50B} \leq 25 \times D_{50S}$	Eq. 2.9	2-37

CHAPTER 3

$\log_{10}(18k \text{ ESAL}) = [Z_r \times S_0] + [9.36 \times \log_{10}(SN + 1)] - 0.20 + \frac{\log_{10}\left(\frac{\Delta PSI}{4.2 - 1.5}\right)}{0.40 + \left(\frac{1094}{(SN + 1)^{5.19}}\right)} + [2.32 \times \log_{10}(M_R)] - 8.07$	Eq. 3.1	3-3
$SN = a_1 D_1 + a_2 D_2 m_2 + a_3 D_3 m_3$	Eq. 3.2	3-7

CHAPTER 4

$\text{SiO}_2 + 2\text{NaOH} + \text{H}_2\text{O} \rightarrow \text{Na}_2\text{SiO}_3 \cdot 2\text{H}_2\text{O}$	Eq. 4.1	4-25
$\text{CaMg}(\text{CO}_3)_2 + 2\text{NaOH} \rightarrow \text{Mg}(\text{OH})_2 + \text{CaCO}_3 + \text{NaCO}_3$	Eq. 4.2	4-26

CHAPTER 5

$SN_{OL} = SN_2 - SN_1$	Eq. 5.1	5-19
-------------------------	---------	------

CHAPTER 6

$M_R = C(0.24P)/d_r$ Eq. 6.1 6-8

$k_{eff} = E_c [18.42(D^{0.75} - (u_r)(4.22 - 0.32 * P_t)^{-1})]^4$ Eq. 6.2 6-8

$\sigma_{FE} = 1.87x\sigma_{TE}$ Eq. 6.3 6-15

$\sigma_{ex} = 1.51 * \sigma_{th}$ Eq. 6.4 6-15

$\epsilon_{ac} = 0.897 * \epsilon_{pcc} - 0.776$ Eq. 6.5 6-16

$\sigma_{\%} = 3.85 * \Delta T$ Eq. 6.6 6-16

$(\sigma_{pcc})^{1/2} = 18.879 + 2.918 t_{pcc} / t_{ac} + 425.44 / l_e - 6.955x10^{-6} E_{ac} - 9.0366 \log k + 0.0133 L$ Eq. 6.7 .
6-17

$(\sigma_{pcc})^{1/2} = 17.669 + 2.668 t_{pcc} / t_{ac} + 408.52 / l_e - 6.455x10^{-6} E_{ac} - 8.3576 \log k + 0.00622 L$ Eq. 6.8
6-17

$(\epsilon_{ac})^{1/4} = 8.224 - 0.2590 t_{pcc} / t_{ac} - 0.04419 l_e - 6.898x10^{-7} E_{ac} - 1.1027 \log k$ Eq. 6.9 6-17

$(\epsilon_{ac})^{1/4} = 7.923 - 0.2503 t_{pcc} / t_{ac} - 0.04331 l_e - 6.746x10^{-7} E_{ac} - 1.0451 \log k$ Eq. 6.10 6-17

$\text{Log}10(N) = (0.97187 - SR) / 0.0828$ Eq. 6.11 6-18

$N = (4.2577 / (SR - 0.43248))^{3.268}$ Eq. 6.12 6-18

$N = \text{Unlimited}$ Eq. 6.13 6-18

$N = C * 18.4 * (4.32x10^{-3}) * (1 / \epsilon_{ac})^{3.29} * (1 / E_{ac})^{0.854}$ Eq. 6.14 6-18

Primary Highway: $F_{ESAL} = 0.985 + 10.057 * (t_{pcc})^{-3.456}$ Eq. 6.15 6-19

Secondary Highway: $F_{ESAL} = (1.286 - 2.138 / t_{pcc})^{-1}$ Eq. 6.16 6-19

CHAPTER 7

$LTE = \frac{\delta_u}{\delta_l} \times 100$ Eq. 7.1 7-10

Flexural Strength = $190 + 0.097 \times \text{Compressive Strength}$ Eq. 7.2 7-13

Flexural Strength = $247 + 0.068 \times \text{Compressive Strength}$ Eq. 7.3 7-13

Flexural Strength = $217 + 0.075 \times \text{Compressive Strength}, r^2 = 0.45$ Eq. 7.4 7-14

CHAPTER 8

$S_1 = [(R - 5) / 11.29] + 3$ $S_1 = 4.33$ Eq. 8.1 (Eq. 2.1 re-stated) 8-4

$M_R = 10^{[(S_1 + 18.72) / 6.24]}$ $M_R = 4942$ Eq. 8.2 (Eq. 2.2 re-stated) 8-4

$SN = a_1 D_1 + a_2 D_2 m_2 + a_3 D_3 m_3$ Eq. 8.3 (Eq. 3.2 restated) 8-5

$SN_{OL} = SN_f - SN_{eff}$ Eq. 8.4 (Similar to Eq. 5.1) 8-9

CHAPTER 10

$SV = (1 - (L_A / L_E)) * C$ Eq. 10.1 10-11

$$\frac{(\text{large NPV value} - \text{small NPV value}) \times 100}{(\text{small NPV value})} \quad \text{Eq. 10.2} \dots\dots\dots 10-59$$

SUPPLEMENT

$$\gamma = \frac{W_t}{V_t} = \frac{W_w + W_s}{V_g + V_w + V_s} \quad \text{Eq. S.1} \dots\dots\dots \text{S-6}$$

$$\gamma_{\text{dry}} = \frac{W_s}{V_t} = \frac{W_s}{V_g + V_w + V_s} \quad \text{Eq. S.2} \dots\dots\dots \text{S-6}$$

$$\gamma_{\text{bulk}} = \frac{W_s + W_w}{V_t} = \frac{W_t}{V_t(1+w)} = \frac{\gamma}{1+w} = \frac{\frac{W_t}{V_t}}{\left(1 + \frac{W_w}{W_s}\right)} \quad \text{Eq. S.3} \dots\dots\dots \text{S-6}$$

$$G_s = \frac{\gamma_s}{\gamma_w} = \frac{\frac{W_s}{V_s}}{\frac{W_w}{V_w}} = \frac{\gamma_s}{62.4} \quad \text{Eq. S.4} \dots\dots\dots \text{S-7}$$

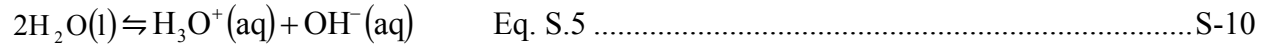

$$E = \frac{\sigma}{\epsilon} \quad \text{Eq. S.6} \dots\dots\dots \text{S-11}$$

$$\frac{\text{Load}}{\text{Area}} = \frac{P}{A} \quad \text{Eq. S.7} \dots\dots\dots \text{S-11}$$

$$\frac{\text{Change in Length}}{\text{Original Length}} = \frac{\Delta L}{L_o} \quad \text{Eq. S.8} \dots\dots\dots \text{S-11}$$

$$E_c = \frac{(\sigma_2 - \sigma_1)}{(\epsilon_2 - 0.000050)} \quad \text{Eq. S.9} \dots\dots\dots \text{S-12}$$

$$|E^*| = \frac{\sigma_o}{\epsilon_o} \quad \text{Eq. S.10} \dots\dots\dots \text{S-13}$$

$$\emptyset = 2\pi f \Delta t \quad \text{Eq. S.11} \dots\dots\dots \text{S-13}$$

$$\log|E^*| = \delta + \frac{(\text{Max} - \delta)}{1 + e^{\beta + \gamma \left\{ \log f + \frac{\Delta E_\alpha}{19.14714} \left[\left(\frac{1}{T} \right) - \left(\frac{1}{T_r} \right) \right] \right\}}} \quad \text{Eq. S.12} \dots\dots\dots \text{S-14}$$

$$|E^*|_{\text{max}} = P_c \left[4,200,000 \left(1 - \frac{\text{VMA}}{100} \right) + 435,000 \left(\frac{\text{VFA} \times \text{VMA}}{10,000} \right) + \frac{1 - P_c}{\frac{1 - \frac{\text{VMA}}{100}}{4,200,000} + \frac{\text{VMA}}{435,000(\text{VFA})}} \right] \quad \text{Eq. S.13} \dots\dots \text{S-15}$$

$$P_c = \frac{\left[20 + \frac{435,000(\text{VFA})}{\text{VMA}}\right]^{0.58}}{650 + \left[\frac{435,000(\text{VFA})}{\text{VMA}}\right]^{0.58}}$$

Eq. S.14.....S-15

$$\log[\alpha(T)] = \frac{\Delta E_\alpha}{19.14714} \left(\frac{1}{T} - \frac{1}{T_r} \right)$$

Eq. S.15.....S-15

$$G^* = \frac{\tau_{\max}}{\gamma_{\max}}$$

Eq. S.16.....S-17

$$\tau_{\max} = \frac{2T_{\max}}{\pi r^3}$$

Eq. S.17.....S-17

$$\gamma_{\max} = \frac{\theta_{\max}(r)}{h}$$

Eq. S.18.....S-17

$$\eta = \frac{G^*}{10} \left(\frac{1}{\sin \delta} \right)^{4.8628}$$

Eq. S.19.....S-19

$$\log \log \eta = A = VT S \log T_r$$

Eq. S.20.....S-19

$$\mu = \frac{\epsilon_{\text{lateral}}}{\epsilon_{\text{axial}}}$$

Eq. S.21.....S-19

$$\frac{\text{Change in Diameter}}{\text{Original Diameter}} = \frac{\Delta D}{D_o}$$

Eq. S.22.....S-19

$$\frac{\text{Change in Length}}{\text{Original Length}} = \frac{\Delta L}{L_o}$$

Eq. S.23.....S-19

$$k_o = \frac{\mu}{1-\mu}$$

Eq. S.24.....S-20

$$k_o = 1 - \sin \phi$$

Eq. S.25.....S-20

$$f'_c = \frac{P}{A}$$

Eq. S.26.....S-21

$$\sigma_{b,\max} = \frac{M_{\max} c}{I_c}$$

Eq. S.27.....S-21

$$S'_c = \frac{PI}{bd^2}$$

Eq. S.28.....S-22

$$S'_c = \frac{3Pa}{bd^2}$$

Eq. S.29.....S-22

$$D(t) = \frac{\epsilon_t}{\sigma}$$

Eq. S.30.....S-23

$S_t = \frac{2P}{\pi tD}$	Eq. S.31	S-23
$M_R = \frac{\sigma_d}{\epsilon_r}$	Eq. S.32	S-27
$\theta = \sigma_1 + \sigma_2 + \sigma_3$	Eq. S.33	S-29
$\sigma_d = \sigma_1 - \sigma_3$	Eq. S.34	S-29
$\tau_{oct} = \frac{1}{3} \sqrt{(\sigma_1 - \sigma_2)^2 + (\sigma_2 - \sigma_3)^2 + (\sigma_3 - \sigma_1)^2}$	Eq. S.35	S-29
$M_R(\text{psi}) = A + B(R\text{-value})^C$	Eq. S.36	S-31
$S_1 = [(R - 5)/11.29] + 3$	Eq. S.37	S-31
$M_R = 10^{[(S_1 + 18.72)/6.24]}$	Eq. S.38	S-31
k-value = $p\Delta$	Eq. S.39	S-35

ACRONYMS COMMON TO CDOT

AADT	Annual Average Daily Traffic
AASHO	American Association of State Highway Officials (1914 – 1949)
AASHTO	American Association of State Highway and Transportation Officials (1950 - Present)
ASTM	American Society for Testing and Materials
ABC	Aggregate Base Course
ACI	American Concrete Institute
ACPA	American Concrete Pavement Association
ADT	Average Daily Traffic
AMC	Annual Maintenance Cost
ARA	Asphalt Rejuvenating Agent
ASR	Alkali Silica Reactivity
CAPA	Colorado Asphalt Pavement Association
CBR	California Bearing Ratio
CDOT	Colorado Department of Transportation
CFR	Code of Federal Regulations
CIR	Cold In-Place Recycling
CP	Colorado Procedure
CTB	Cement Treated Base
CPPP	Concrete and Physical Properties Program
DARWin™	Design Analysis and Rehabilitation for Windows
DTD	Division of Transportation Development

EATB	Emulsified Asphalt Treated Base
ESAL	Equivalent Single Axle Load
FASB	Foamed Asphalt Stabilized Base
FDR	Full Depth Reclamation
FHWA	Federal Highway Administration
FIR	Field Inspection Review
FOR	Final Office Review
FMM	Field Materials Manual
FWD	Falling Weight Deflectometer
HBP	Hot Bituminous Pavement
HIR	Hot In-Place Recycling
HMA	Hot Mix Asphalt
HMAP	Hot Mix Asphalt Pavement
IRI	International Roughness Index
JPCP	Jointed Plain Concrete Pavement
LCCA	Life Cycle Cost Analysis
LL	Liquid Limit
LS	Loss of Support
LTB	Lime Treated Base
LTPP	Long Term Pavement Performance
MMS	Maintenance Management System
MGPEC	Metropolitan Government Pavement Engineering Council
M_R	Resilient Modulus

MUTCD	Manual on Uniform Traffic Control Devices
NMAS	Nominal Maximum Aggregate Size
N _{DES}	Recommended SuperPave™ Gyratory Design Revolution
NDT	Nondestructive Testing
NLPM	Network Level Pavement Manager
PCCP	Portland Cement Concrete Pavement
PDM	Pavement Design Manual
PG	Performance Grade
PI	Plasticity Index
PJR	Pavement Justification Report
PMBB	Plant Mix Bituminous Base
PMBP	Plant Mix Bituminous Pavement
PDPM	Pavement Design Program Manager
PM	Pavement Manager
PMS	Pavement Management System
PMSC	Plant Mix Seal Coat
PTSC	Pavement Type Selection Committee
PSI	Present Serviceability Index
PWF	Present Worth Factor
RAP	Reclaimed Asphalt Pavement
RCP	Reclaimed Concrete Pavement
RCC	Roller Compacted Concrete
RIC	Research Implementation Council

RME	Region Materials Engineer
RSL	Remaining Service Life
SHRP	Strategic Highway Research Program
SMA	Stone Matrix Asphalt
SN	Structural Number
TCP	Traffic Control Plan
VFA	Voids Filled With Asphalt
VMA	Voids in the Mineral Aggregate
WIMS	Weigh-In-Motion Station
WSN	Weighted Structural Number
WWF	Welded Wire Fabric

DESIGN OF PAVEMENT STRUCTURES DEFINITIONS

ADT (Current Year)

The average two-way daily traffic, in the number of vehicles, for the current year. The average 24-hour volume, being the total number during a stated period, divided by the number of days in that period. Unless otherwise stated, the period is a year. This term is commonly abbreviated as ADT.

ADT (Design Year)

The average two-way daily traffic for the future year used as a target in design.

AADT

The annual average two-way daily traffic volume. It represents the total traffic on a section of roadway for the year, divided by 365. It includes both weekday and weekend traffic volumes.

AAD-T

The annual average daily truck traffic volume. It represents the total truck traffic on a section of roadway for the year, divided by 365. It includes both weekday and weekend traffic volumes.

Analysis Period

The period of time for which the economic analysis is to be made. Ordinarily, the period will include at least one rehabilitation activity.

Approach Slab

Section of pavement just prior to joint, crack, or other significant roadway feature relative to the direction of traffic.

Arterial Highway

A highway primarily for through traffic, usually on a continuous route.

Asphalt Mix Design

The process and documentation of proportions of asphalt cement, mineral aggregate with the percentages of each component and size of particle that will result in a homogeneous mix and can be compacted into asphaltic concrete.

Asphalt Rejuvenating Agent (ARA)

A bituminous emulsion sprayed on new asphalt pavements to seal them from the adverse environmental effects of air and water. ARA is also used on dry, weathered asphalt pavements to give them new vitality and plasticity.

Asphalt Overlay

One or more courses of asphalt construction on an existing pavement. The overlay may include a leveling course, to correct the contour of the old pavement, followed by uniform course or courses to provide needed thickness.

At-Grade Intersection

An intersection where all roadways join or cross at the same level.

Axle Load

The total load transmitted by all wheels on a single axle extending across the full width of the vehicle. Tandem axles 40 inches or less apart will be considered as a single axle.

Base Course

The layer or layers of specified or selected material of designed thickness placed on a subbase or subgrade to support a surface course.

Bituminous

A term used to designate materials that are derived from petroleum, coal tar, etc.

Bituminous Surface Treatment

Alternate layers of bituminous binder material and stone chips.

Binder

Asphalt Cement used to hold stones together for paving.

Bleeding

A type of asphalt pavement distress identified by a film of bituminous material on the pavement surface that creates a shiny, glass-like, reflective surface that may be tacky to the touch in warm weather.

Block Cracking

The occurrence of cracks that divide the asphalt surface into approximately rectangular pieces, typically one square foot or more in size.

Blowup

The result of localized upward movement or shattering of a slab along a transverse joint or crack.

California Bearing Ratio (CBR) Test

An empirical measure of bearing capacity used for evaluating bases, subbases, and subgrades for pavement thickness design.

Cement Treated Base

A base consisting of a mixture of either mineral aggregate or granular soil and portland cement mixed and spread on a prepared subgrade to support a surface course.

Centerline

The painted line separating opposing traffic lanes.

Channels

A ditch or canal adjacent the roadway

Chipping

Breaking or cutting off small pieces from the surface.

Chip Seal

A seal coat consisting of the application of asphalt followed by a cover aggregate.

Cohesive Failure

The loss of a material's ability to bond to itself. Results in the material splitting or tearing apart from itself (i.e., joint sealant splitting).

Cold In-Place Recycled Pavement

A pavement rehabilitation process that consists of pulverizing the existing pavement to a depth of one inch or more, followed by reshaping and compaction. This operation may be performed with the addition of a stabilizer.

Composite Pavement

A pavement structure composed of an asphalt concrete wearing surface and portland cement concrete slab. An asphalt concrete overlay on a PCC slab is also called a composite pavement.

Control of Access

The condition where the right of owners or occupants of abutting land or other persons to access, light, air, or view in connection with a highway is controlled by a public authority.

Collector

A road of the intermediate functional category that collects traffic from the local roads to arterials or distributes traffic to local roads from arterials.

Constant Dollars

Un-inflated dollars that represent the prevailing prices for all elements at the base year for the analysis.

Corner Break

A portion of a jointed concrete pavement separated from the slab by a diagonal crack intersecting the transverse and longitudinal joint, which extends down through the slab, allowing the corner to move independently from the rest of the slab.

Cross-Stitching

A Repair technique for longitudinal cracks and joints that are in reasonably good condition. The purpose of cross-stitching is to maintain aggregate interlock and provide added reinforcement

and strength to the crack or joint. The technique uses deformed tie bars inserted into holes drilled across a crack at angles of 35-45 degrees depending upon the slab thickness.

DARWin™

A software that performs the complex calculations for design and analysis of pavement structures. DARWin™ is an acronym for Design, Analysis, and Rehabilitation for Windows. Please use the latest version of the software, which is version 3.1

Deflection Analysis

The procedure used to establish pavement strength indices based on pavement deflections induced by a force.

Deformed Bar

A reinforcing bar for rigid slabs. Most often used to tie slabs together in the longitudinal direction across lane lines including tying travel lanes and shoulders.

Design Period

The number of years from initial construction or rehabilitation until terminal service life. This term should not be confused with pavement life or analysis period. By adding asphalt overlays as required, pavement life may be extended indefinitely, or until geometric considerations or other factors make the pavement obsolete. The initial design period is the number of years for which the volume and type of traffic and the resultant wheel or axle load application are forecast, and on which the pavement designs are calculated.

Design Traffic (18k ESAL)

The design traffic will be the total number of equivalent 18,000-lb single-axle load (18k ESAL) applications expected during the Design Period. This can be calculated or obtained from CDOT personnel at the Traffic Analysis Unit of the Division of Transportation Development.

Deterministic Life Cycle Cost Analysis

A traditional cost comparison process, where each item of interest is assigned a fixed, discrete value, usually a value most likely to occur based on historical data and user judgment. This value includes all costs over the life of the project, such as construction, maintenance, and rehabilitation adjusted to a present value.

Diamond Grinding

A process of improving a pavements ride by creating a smooth, uniform profile by removing faulting, slab warping, studded tire wear, and patching unevenness.

Discount Rate

A value in percent used for comparing the alternative uses of funds over a time period. The discount rate may be defined as the difference between the market interest rate and inflation rate using constant dollars over the analysis period.

Dowel

A load transfer device in a rigid slab, usually consisting of a plain, epoxy coated round steel bar. Most often used to provide load transfer between slabs in the transverse direction that are within the same lane.

Drainage Coefficients

Factors used to modify structural layer coefficients in flexible pavements or stresses in rigid pavements as a function of how well the pavement structure can handle the adverse effect of water infiltration.

Durability Cracking

The breakup of concrete due to freeze-thaw expansive pressures within certain aggregates. Also called “D” cracking.

Economic Analysis

A justification of the expenditure required and the comparative worth of a proposed improvement as compared to other alternate plans.

Economic Life

Economic life is the total useful life of a pavement structure including the extended service life gained when the initial pavement is supplemented by the addition of structural layers. It also defines the period of time beyond which further use is not economical.

Edge Cracking

Fracture and materials loss in pavements without paved shoulders which occurs along the pavement perimeter. Caused by soil movement beneath the pavement.

Embankment (embankment soil)

The prepared or natural soil underlying the pavement structure.

Emulsified Asphalt Treated Base

A base consisting of a mixture of mineral aggregate and emulsified asphalt spread on a subgrade to support a surface course.

Equivalence Factor

A numerical factor that expresses the relationship of a given axle load to another axle load in terms of their effect on the serviceability of a pavement structure. All axle loads are equated in terms of the equivalent number of repetitions of an 18,000-pound single axle.

Equivalent Single Axle Loads (ESALs)

The effect on pavement performance of any combination of axle loads of varying magnitude expressed in terms of the number of 18,000-lb single-axle loads required to produce an equivalent effect. This is calculated by summing the equivalent 18,000-pound single axle loads (18k ESALs) used to combine mixed traffic to design traffic for the Design Period. The value of 18k ESALs is obtained as an accumulative total from the beginning of use until and including the

design year. The 18k ESAL is calculated by multiplying the annual design traffic volume by the Traffic Equivalence Factor (e) at a given terminal serviceability index (P_t)

Expansion Factor

A factor expressing the expected traffic growth trend on a particular section of highway.

Expressway

A divided arterial highway for through traffic with full or partial control of access and generally with grade separations at major intersections.

Fatigue Cracking

A series of small, jagged, interconnecting cracks caused by failure of the asphalt concrete surface under repeated traffic loading (also called alligator cracking).

Fault

Difference in elevation between opposing sides of a joint or crack.

Flexible Pavement

A pavement structure of which the surface course is made of asphaltic concrete, that maintains intimate contact with and distributes loads to the subbase or subgrade and depends upon aggregate interlock, particle friction, and cohesion for stability.

Foamed Asphalt Stabilized Base

A base consisting of wet unheated aggregates and asphalt cement mixed while the asphalt cement is in a foamed state.

Fog Seal

A seal coat consisting of the application of diluted asphalt emulsion without an aggregate cover.

Free Edge

Pavement border that is able to move freely.

Freeway

An expressway with full control of access and all at-grade intersections eliminated.

Full Depth Asphalt

A pavement structure consisting of one and only one layer that is asphaltic concrete. There is no base, subbase, or intermediary layer of gravel between the asphaltic concrete layer and the subgrade.

Full Depth Reclamation

A rehabilitation technique in which the full thickness of asphalt pavement and a predetermined portion of the underlying materials (base, subbase and/or subgrade) is uniformly pulverized and blended to provide an upgraded, homogeneous base material. This new stabilized base course may be used for an asphalt or concrete wearing surface.

Functional Deficiency

Any condition that adversely affects the roadway user. These include poor surface friction and texture, hydroplaning and splash from wheel path rutting, and excess surface distortion.

Grade Separation

A crossing of two highways, or a highway and a railroad, at different levels.

Granular Base

A base consisting of mineral aggregate laid and compacted on a subbase or subgrade to support a surface course.

Grooving

Grooving restores skid resistance to concrete pavements. It increases the surface friction and surface drainage capabilities of a pavement by creating small longitudinal or transverse channels that drain water from underneath the tire, reducing the hydroplaning potential.

Hairline Crack

A fracture that is very narrow in width, less than 0.125 in. (3 mm).

Hinged Joint

A joint between two rigid pavement slabs in which flexure is permitted but separation and vertical displacement of abutting rigid slabs are prevented by metal ties and mechanical or aggregate interlock.

Hot Mix Asphalt

High quality, thoroughly controlled hot mixture of AC (binder) and high quality aggregate, which can be compacted into a uniform mass, to act as a surface course and carry traffic. Stone Matrix Asphalt (SMA) and Polymer Modified Asphalt (PMA) are both types of HMA. In historic documents, HMA may also be referred to as Plant Mixed Bituminous Pavement and Hot Bituminous Pavement.

Hot Bituminous Pavement

A combination of mineral aggregate and bituminous material, mixed in a central plant, laid and compacted while hot, to act as a surface course and carry traffic. Hot Bituminous Pavement is an older designation usage. Also known as Plant Mixed Bituminous Pavement, see Hot Mix Asphalt for current designation.

Hot In-Place Recycled Pavement - Heater Remixing

A pavement rehabilitation process that consists of reworking the existing pavement with a heating device, reshaping, and compaction. This operation may be performed with or without the addition of a rejuvenating agent, aggregates, or new asphalt mix.

Hot In-Place Recycled Pavement – Heater Repaving

A pavement rehabilitation process that consists of reworking the existing pavement with a heating device. During the lay down process of the old rejuvenated material a virgin lift will be added reshaped and compacted.

Hot In-Place Recycled Pavement – Heater Scarifying

A pavement rehabilitation process that consists of reworking the existing pavement with a heating device. A rejuvenating agent will be added to the old mix reshaped and compacted.

Hveem Stabilometer

A device for the measurement of the lateral pressure transmitted by a soil or aggregate being subjected to a vertical load. The pressure obtained is used to compute the R-value, which is the internal resistance or the internal friction property of a bituminous pavement or a base. The data obtained is used to compute the relative stability.

Hydroplaning

To skid on wet pavement because water on the pavement causes the tires to lose contact with it.

Joint Seal Damage

Any distress associated with the joint sealant, or lack of joint sealant.

Keyway

A groove on either vertical or horizontal face of a concrete slab. A keyway is often molded in concrete structures. A keyway molded on a vertical face of a concrete slab will provide interlock and load transfer to an adjacent slab. A keyway molded on a horizontal face of a concrete structure will provide interlock and resist horizontal movement of a concrete structure molded over the keyway.

Lane Factor

Factors used to convert total 18k ESAL to Design Lane 18k ESAL given the number of lanes.

Lane to shoulder drop-off

The difference in elevation between the traffic lane and shoulder.

Lane to shoulder Separation

Widening of the joint between the traffic lane and the shoulder.

Lime-Treated Base

A base consisting of a mixture of soil, hydrated lime and water, usually mixed in place and placed to support a pavement structure, or the components thereof.

Load Transfer Device

A mechanical means designed to carry loads across a joint in a rigid slab.

Local Street or Local Road

A street or road primarily for access to residence, business, or other abutting property.

Longitudinal

Parallel to the pavement centerline.

Maintenance

The preservation of the entire roadway, including surface, shoulders, roadsides, structures, and such traffic control devices as are necessary for its safe and efficient utilization.

Map Cracking

A series of interconnected hairline cracks in portland cement concrete pavements that extend only into the upper surface of the concrete. Includes cracking typically associated with alkali-silica reactivity (ASR).

Mechanistic-Empirical Pavement Design Guide

The guide, and its accompanying software, provides a uniform basis for the design of flexible, rigid, and composite pavements, using mechanistic-empirical approaches that more realistically characterize in-service pavements and improve the reliability of designs.

Micro-surfacing

A seal coat consisting of the application of polymer modified emulsion followed by a cover of aggregates selected for properties of hardness and angularity.

Modulus of Elasticity (E)

A measure of the rigidity of a material and its ability to distribute loads defined by the ratio of strain to stress in a portland cement concrete pavement slab.

Modulus of Subgrade Reaction (k-value)

Westergard's modulus of subgrade reaction for use in rigid pavement design (the load in pounds per square inch on a loaded area of the roadbed soil or subbase divided by the deflection, in inches, of the roadbed soil or subbase), psi/in. The modulus of subgrade reaction is the supporting capability of a soil measured by its ability to resist penetration of a series of loaded stacked plates.

Modulus of Rupture (S'_c)

The modulus of rupture of portland cement concrete pavement is an index of the flexural strength of the portland cement concrete pavement. It is a measure of the extreme fiber stress developing under slab bending, the mode in which most concrete pavements are loaded. The modulus of rupture required by the design procedure is the mean value determined after 28 days using third-point loading (AASHTO T97).

Nominal Maximum Aggregate Size

One sieve size larger than the first sieve to retain more than 10 percent of the material" (Roberts et al., 1996).

Overlays

- a. **Leveling Course:** The layer of material placed on an existing paved surface to eliminate irregularities prior to placing an overlay or a surfacing course. Milling procedures are to be considered the primary method to address rutting and are to be used instead of a leveling course to remove ruts whenever possible.

- b. Overlaying Course:** Surfacing Course, either plant mixed or road mixed, placed over an existing pavement structure, after placement of a leveling course, as appropriate.

Partial Depth Reclamation

A rehabilitation technique, in which a portion of the asphalt pavement is pulverized, mixed with a stabilizing agent and then placed back on the remaining pavement surface. Partial depth reclamation is limited to correcting only those distresses that are surface problems in the asphalt layer.

Patch

An area where the pavement has been removed and replaced with a new material.

Patch Deterioration

Distress occurring within a previously repaired area.

Pavement

The part of roadway having a constructed surface for the facilitation of vehicular movement.

Pavement Design (design, structure design)

The specifications for materials and thickness of the pavement components.

Pavement Joints

The designed vertical planes of separation or weakness. Complete details of concrete pavement joints are given in the Standard Specifications and the Division's Standard Plans "M & S" Standards.

Joints used in portland cement concrete pavement are:

- a. Construction Joints:** Joints made necessary by a prolonged interruption in placing of concrete. They are formed by placing concrete up to one side of a planned joint and allowing it to set before the concrete is placed on the other side of the joint. They may be either longitudinal or transverse.
- b. Contraction Joints:** Joints placed either transversely at recurrent intervals or longitudinally between traffic lanes to control cracking.
- c. Expansion Joints:** Transverse joints located to provide for expansion without damage to themselves, adjacent slabs, or structures.
- d. Relief Joints at Bridges:** Joints placed between two PCCP slabs in bridge structure(s) to relieve stresses and strains.
- e. Weakened Plane Joints (Longitudinal and Transverse):** Weakened plane joints are placed both longitudinally and transversely in PCCP. CDOT specifies using a saw to cut the weakened planes at T/3 in PCCP.

Pavement Management

Pavement management is the evaluation, documentation, and analysis of the amount, quality and type of pavement under the responsibility of any given owner or agency. It is also the planning and budgeting for the upkeep and replacement of paved assets.

Pavement Performance

The trend of serviceability with load applications.

Pavement Rehabilitation

Work undertaken to extend the service life of an existing facility. This includes placement of additional surfacing material and/or completing any other work necessary to return an existing roadway, including shoulders, to a condition of structural or functional adequacy. This could include the complete removal and replacement of the pavement structure.

Pavement Structure

The combination of subbase, base course, and surface course placed on a prepared subgrade to support the traffic load and distribute it to the roadbed.

Pavement Section

A layered system designed to distribute concentrated traffic loads to the subgrade. Performance of the pavement structure is directly related to the physical properties of the subgrade soils and traffic loadings. Most soils can be adequately represented for pavement design purposes by means of the soil support value for flexible pavements and a modulus of subgrade reaction for rigid pavements.

Performance Period

The period of time that the initially constructed or rehabilitated pavement structure will last (perform) before reaching its terminal serviceability. This is also called the design period.

Permeability

The property of soils, which permits the passage of any fluid. Permeability depends on grain size, void ratio, shape, and arrangement of pores.

Plant Mixed Bituminous Base

A base consisting of mineral aggregate and bituminous material, mixed in a central plant, laid and compacted while hot, on a subbase or a subgrade, to support a surface course.

Plant Mixed Bituminous Pavement

A combination of mineral aggregate and bituminous material, mixed in a central plant, laid and compacted while hot, to act as a surface course and carry traffic. Plant Mixed Bituminous Pavement is an older designation usage. Also known as Hot Bituminous Pavement, see Hot Mix Asphalt for current designation.

Plant Mixed Seal Coat

A seal coat consisting of a combination of mineral aggregate and bituminous material mixed in a central plant, laid and compacted while hot.

Polished Aggregate

Surface mortar and texturing worn away to expose coarse aggregate in the concrete.

Popouts

Small pieces of pavement broken loose from the surface.

Pothole

A bowl-shaped depression in the pavement surface.

Prepared Roadbed

In place roadbed soils compacted or stabilized according to provisions of applicable specifications.

Present Serviceability Index (PSI)

A number derived by formula for estimating the serviceability rating from measurements of certain physical features of the pavement.

Prime Coat

Bituminous material used on aggregate base courses to provide good adhesion to the Hot Mix Asphalt layer placed above.

Probabilistic Life Cycle Cost Analysis

A process where probabilistic LCCA inputs are described by probability functions that convey both the range of likely inputs and the likelihood of their occurrence. Probabilistic LCCA also allows for the simultaneous computation of differing assumptions for many different variables. Probabilistic LCCA allow the value of individual data inputs to be defined by a frequency (probability) distribution.

Pumping

The ejection of foundation material, either wet or dry, through joints or cracks, or along edges of rigid slabs resulting from vertical movements of the slab.

Punchout

A localized area of a continuously reinforced concrete pavement bounded by two transverse cracks and a longitudinal crack. Aggregate interlock decreases over time and eventually is lost, which leads to steel rupture, and allows the pieces to be punched down into the subbase and subgrade.

Raveling

The wearing away of the pavement surface caused by the dislodging of aggregate particles.

Reflection Cracking

The fracture of asphalt concrete above joints in the underlying pavement layer(s).

Regional Factor

A numerical factor expressed as a summation of the values assigned for precipitation, elevation, and drainage. This factor is used to adjust the structural number.

Reinforcement

Steel embedded in a rigid slab to resist tensile stresses and detrimental opening of cracks.

Reliability

The probability, expressed as a percentage that a pavement structure will carry the traffic for which it is designed over the design or analysis period.

Remaining Service Life (RSL)

The remaining service life is the number of years a pavement is expected to last until maintenance and rehabilitation treatments no longer improve or maintain the surface condition.

Resilient Modulus (M_R)

A measure of the modulus of elasticity of roadbed soil or other pavement material.

Rigid Pavement

A pavement structure of which the surface course is made of portland cement concrete.

Rigid Slab

A section of portland cement concrete pavement bounded by joints and edges, designed for continuity of flexural stress.

Roadbed

The graded portion of a highway within top and side slopes, prepared as a foundation for the pavement structure and shoulder.

Roadbed Material

The material below the pavement structure in cuts and embankments, and in embankment foundations, extending to such depth as affects the support of the pavement structure.

Roadway

The portion of a highway, including shoulders, for vehicular use.

Roundabout

A circular intersection with yield control of all entering traffic, channelized approaches, counter-clockwise circulation, and appropriate geometric curvature to ensure that travel speeds on the circulatory roadway are typically less than (30 mph).

Rutting

Longitudinal surface depressions in the wheel paths.

Sand Seal

A seal coat consisting of the application of asphalt emulsion followed by a sand cover aggregate.

Scaling

The deterioration of the upper 0.125 to 0.5 in. of the concrete surface, resulting in the loss of surface mortar.

Seal Coat

A thin treatment consisting of bituminous material, usually with cover aggregate, applied to a surface as an armor coat or for delineation. The term includes but is not limited to sand seal, chip seal, slurry seal, and fog seal.

Service Life

The service life is the number of years a pavement is expected to last from completion of construction until pavement failure.

Serviceability

The ability, at the time of observation, of a pavement to serve traffic using the facility. Also, serviceability is a pavement's ability to provide adequate support and a satisfactory ride at any specific time.

Serviceability Index

The Serviceability Index is a number that is indicative of the pavement's ability to serve traffic at any specific time in its life.

Shoving

Permanent, longitudinal displacement of a localized area of the pavement surface caused by traffic pushing against the pavement.

Single Axle Load

The total load transmitted by all wheels whose centers may be included between two parallel transverse vertical planes 40 inches apart, extending across the full width of the vehicle.

Skid Hazard

Any condition that might contribute to making a pavement slippery when wet.

Slot Stitching

A technique for repairing longitudinal cracks or joints. Slot-stitching is an extension of the more recent dowel bar retrofit technique, which is used to add dowel bars to existing transverse joints. The purpose of slot-stitching is to provide positive mechanical interconnection between two slabs or segments. The deformed bars placed in the slots hold the segments together serving to maintain aggregate interlock and provide added reinforcement and strength to the crack or joint. These bars also prevent the crack or joint from vertical and horizontal movement or widening. Larger diameter bars (>25mm) (> 1.0 in.) also serve to provide long-term load transfer capabilities.

Slurry Seal

A seal coat consisting of a semi fluid mixture of asphaltic emulsion and fine aggregate. This type of seal is usually placed in very thin course of 1/8 to 1/4 inches.

Soil Support Value

A number that expresses the relative ability of a soil or aggregate mixture to support traffic loads through the pavement structure.

Spalling

Cracking, breaking, chipping, or fraying of the concrete slab surface within 2 feet of a joint or crack.

Squeegee Seal

A seal coat similar to a sand seal, consisting of the application of asphalt emulsion and sand. The application of a squeegee seal differs from that of a sand seal in that a surface drag is used to spread the emulsion to seal cracks.

Stabilometer R-Value

A numerical value expressing the measure of a soil's or aggregate's ability to resist the transmission of vertical load in a lateral or horizontal direction. A test for evaluating bases, subbases, and subgrades for pavement thickness design. Measured with a stabilometer.

Standard Normal Deviate (Z_R)

The standard normal deviate is a statistical value identical to Z-scale value used in the standard normal distribution. It is a measure of the deviation of any observations from the mean of all observations expressed in terms of the number of standard deviations. The standard normal deviate, Z can be calculated from the equation, $Z = (\text{observed value} - \text{mean of all observed values}) / \text{standard deviation of all observations}$. Each calculated Z value corresponds to a certain level of significance, confidence interval, certainty or reliability value in a standard normal distribution curve.

Stone Matrix Asphalt (SMA)

A mixture of crushed coarse aggregate, crushed fine aggregate, mineral filler, asphalt cement, and stabilizing agent typically used as a wearing course. A stabilizing agent is used to prevent drain down of the asphalt cement and typically consists of fibers, polymers, or limestone dust (powder).

Structural Deficiency

Any condition that adversely affects the load carrying capability of the pavement structure. These include inadequate thickness as well as cracking, distortion, and disintegration. Several types of distress (e.g., distress was caused by poor construction techniques, low temperature cracking) are not initially caused by traffic loads, but do become more severe under traffic, to the point that they also detract from the load carrying capability of the pavement.

Structural Layer Coefficient (a_1 , a_2 , a_3)

The empirical relationship between structural number (SN) and layer thickness that expresses the relative ability of a material to function as a structural component of the pavement and express the relative strength of a layer in a pavement structure.

Structural Number (SN)

An index derived from an analysis of traffic, roadbed soil conditions, and environment that may be converted to thickness of flexible pavement layers by using suitable structural layer coefficients related to the type of materials being used in each layer of the pavement structure.

Subbase

The layer or layers of specified or selected material of designed thickness placed on a subgrade to support a base course. Subgrade treated with lime, fly ash, cement kiln dust, or combination thereof stabilization will be considered subbase.

Subgrade

The top surface of a roadbed upon which the pavement structure and shoulders are constructed

Surface Course

The uppermost component of a pavement structure designed to accommodate the traffic load, the top layer of which resists skidding, traffic abrasion, and the disintegrating effects of climate. The top layer is also sometimes called the wearing course.

Surface Life

A period of time where treatments can be performed on a pavement that maintain or improve the surface condition.

Tack Coat

A light application of emulsified asphalt applied to an existing asphalt or portland cement concrete pavement surface. It is used to ensure a bond between the surface being paved and the overlaying course. Typically 0.10 gal/yd² of diluted CSS1h.

Tandem Axle Load

The total load transmitted to the road by two consecutive axles whose centers may be included between parallel vertical planes spaced more than 40 inches and not more than 96 inches apart, extending across the full width of the vehicle.

Tie Bar

A deformed steel bar or connector embedded across a longitudinal joint for a rigid slab to prevent separation of abutting slabs.

Tining

A process by which it is achieved by a mechanical device equipped with a tining head (metal rake) that moves laterally across the width of the paving surface.

Treated Base

A layer of base material stabilized with asphalt, Portland cement or other suitable stabilizers.

Traffic Equivalence Factor (e)

A numerical factor that expresses the relationship of a given axle load to another axle load in terms of their effect on the serviceability of a pavement structure. All axle loads are equated in terms of the equivalent number of repetitions of an 18k ESAL single axle.

Transverse

Perpendicular to the pavement centerline.

Triple Axle Load

The total load transmitted to the road by three consecutive axles whose centers may be included between parallel planes spaced more than 40 inches and no more than 96 inches apart, extending across the full width of the vehicle.

Water Bleeding

Seepage of water from joints or crack.

Weathering

The wearing away of the pavement surface caused by the loss of asphalt binder.

Weigh-In-Motion (WIM) Station

The process of measuring the dynamic tire forces of a moving vehicle and estimating the corresponding tire loads of the static vehicle.

Welded Wire Fabric (WWF)

A two-way reinforcement system for rigid slabs, fabricated from cold-drawn steel wire, having parallel longitudinal wires welded at regular intervals to parallel transverse wires. The wires may be either smooth or deformed.

Whitetopping

The procedure for placing Portland Cement Concrete (PCC) overlays over existing Hot Mix Asphalt (HMA) pavements. Whitetopping may be either conventional, thin, or ultra-thin depending on the required thickness of the PCC overlay. In general, conventional whitetopping uses 8 inches or greater:

- Thin Whitetopping uses greater than 4 but less than 8 inches.
- Ultra-Thin Whitetopping uses 4 inches or less thickness of PCC overlay.

ESTIMATING FORMULAS, CALCULATIONS, AND CONVERSION FACTORS

Diluted emulsified asphalt at 0.10 gal./sq. yd. (diluted) (slow setting)

Bituminous pavement at 110 lbs./sq. yd./1" thickness

Aggregate Base Course (Class 6) at 133 lbs./cu. ft.

Aggregate Base Course (Class 2) at 133 lbs./cu. ft.

Filter material at 110 lbs./cu. ft.

Hydrated lime at: 26.4 lbs./sq. yd./ 8 in. depth at 4% lime

39.6 lbs./sq. yd./12 in. depth at 4% lime = 4.4 lb/cu. ft.

59.4 lbs./sq. yd./12 in. depth at 6% lime

Asphalt Rejuvenating Agent at 0.15 gal./sq. yd. (diluted)

Asphalt Rejuvenating Agent at 0.15 gal./sq. yd. (Non-Diluted Asphalt Rejuvenating Agent for use with item 404- Heater and Scarifying Treatment)

Micro-Surfacing Seal Coat at 35 lbs./sq. yd. (Based on an average rut depth of $\frac{3}{4}$ ")

Quantities of crack sealant were estimated based on the level of cracking and the following ratios. The quantities shown here are for information only.

Heavy	2 tons per lane mile
Medium	1 ton per lane mile
Light	0.5 ton per lane mile
Very light	0.25 ton per lane mile

1 ton = 0.90718 metric ton

1 lb/cu. ft = 16.018 Kg/cu. meter

1 psi/in. = 0.271 kpa/mm

0.10 gal./sq. yd. = 0.453 L/sq. Meter

0.15 gal./sq. yd. = 0.70 L/sq. Meter

110 lbs/sq. yd./one inch = 2.34 kg/sq. meter/25.4 millimeter

110 lbs/cu. ft. = 1762 kg./cu. Meter

133 lbs/cu. ft. = 2130 kg/cu. meter

2 inches = 50.8 mm or 50 mm (rounded for pavement design)

4 inches = 101.6 mm or 100 mm (rounded for pavement design)

1/2 inch = 12.7 mm or 12.5 (rounded for pavement design)

A U.S. gallon (determined by fluid volume at 72 deg. F, at sea level) of fresh water weighs exactly 8.3452641 lbs.

Incentive/Disincentive

$$I/DP = (PF - 1)(QR)(UP)(W/100)$$

Where: I/DP = Incentive/Disincentive Payment
PF = Pay Factor
QR = Quantity in Tons of HMA Represented by the Process
UP = Unit Bid Price of Asphalt Mix
W = Element Factor from Table 105-2

When AC is paid for separately UP shall be:

$$UP = [(Ton_{HMA})(UP_{HMA}) + (Ton_{AC})(UP_{AC})]/Ton_{HMA}$$

Where: Ton_{HMA} = Tons of Asphalt Mix
 UP_{HMA} = Unit Bid Price of Asphalt Mix
 Ton_{AC} = Tons of Asphalt Cement
 UP_{AC} = Unit Bid Price of Asphalt Cement

For the joint density element:

$$UP = UPHMA$$

Where: UP_{HMA} is as defined above.

When AC is paid for separately UP shall be:

$$UP = [(BTon_{HMA})(BUP_{HMA}) + (BTon_{AC})(BUP_{AC})]/BTon_{HMA}$$

Where: $BTon_{HMA}$ = Bid Tons of Asphalt Mix
 BUP_{HMA} = Unit Bid Price of Asphalt Mix
 $BTon_{AC}$ = Bid Tons of Asphalt Cement
 BUP_{AC} = Unit Bid Price of Asphalt Cement

SUMMARY OF MANUAL REVISIONS

<u>SECTION</u>	<u>MAJOR REVISIONS</u>
Introduction Acronyms and Definitions	Added Definitions.
Chapter 1	Added missing parenthesis in Eq. 1.2.
Chapter 2	No revisions.
Chapter 3	Table 3.7, revised. PG 70-28 is available for CDOT use.
Chapter 4	No revisions.
Chapter 5	Text change of Section 5.9.1, patching pay item by ton. Section 5.11.1, delete explanation of percent transverse cracking.
Chapter 6	No revisions.
Chapter 7	No revisions.
Chapter 8	No revisions.
Chapter 9	No revisions.
Chapter 10	Section 10.2 and 10.3, revised analysis period and performance life.
Chapter 11	Corrected dollar amount for PJR. Clarified when PJRs are to be submitted.
Appendix A	No revisions.
Appendix B	Revised to latest Form 463 M.
Appendix C	No revisions.
Appendix D	No revisions.
Appendix E	Added Appendix E – Practical Design Guide for Pavements
Supplement	Section S.2.6.2, revised. Added Section on k-value. Added and revised references.

CHAPTER 1

PAVEMENT DESIGN INFORMATION

1.1 Introduction

Pavement structure sections, except for experimental construction for research, are to be designed using methods or standards described herein. This will assure adequate strength and durability to carry the predicted traffic loads for the design life of each project. Alternative designs (flexible and rigid) should be considered for each project, as appropriate, for the specific project conditions. The Colorado Department of Transportation (CDOT) has adopted the 1998 Supplement to the AASHTO Guide for Design of Pavement Structures to be used along with the 1993 edition of the American Association of State Highway and Transportation Officials (AASHTO) Guide for Design of Pavement Structures, and excerpts have been incorporated into the following chapters. The final design should be based on a thorough investigation of specific project conditions, projected traffic, life-cycle economics, and on the performance of comparable projects with similar structural sections under similar conditions.

1.2 Scope and Limitations

Design of the pavement structure includes the determination of the thickness of subbases, bases, and surfacing to be placed over subgrade soils. An important aspect of this design is the selection of available materials that are most suited to the intended use. Their grouping in horizontal layers under the pavement, from poor layers on the bottom to good layers on the top, should be such that the most benefit will be derived from the inherent qualities of each material. In establishing the depth of each layer, the objective is to provide a minimum thickness of overlying material that will reduce the unit stress on the next lower layer commensurate with the load-carrying capacity of the material within that layer.

The design of the roadbed cross-section is not an exact science. With many variables to be correlated, reducing the problem to exact mathematical terms so commonly applied to structures is extremely difficult. Present practice, as discussed herein, stems from mechanistic procedures and empirical relationships developed from test tracks and other pavement experiments as well as the observation of pavements under service throughout the state. Research continues on this subject, and current design methods may, therefore, be subject to frequent modification.

1.3 Project Files/Records

A review of project files and/or records will reveal to the pavement designer many things related to the current status of project development. Reviewing the project files and/or records will be the most beneficial to the pavement designer who has not been with the project since its original construction. In reviewing the project files and/or records, the pavement designer should especially be on the alert for any information relating to pavement design. The Regions should keep copies of the information in the original report between 5 to 8 years.

1.3.1 Project Data Collection

Information gathered should include such items as "As Built" plans from previous projects, pavement design data, materials and soil properties, climate conditions, determination of actual 18,000 pound Equivalent Single Axle Load (18-kip ESAL), and any information relevant to major maintenance.

1.3.2 Field Survey

A pavement evaluation should be conducted to determine the cause of the pavement deterioration. Information gathered in this survey includes review items such as distress, drainage conditions, roughness, traffic control options, safety considerations, and any other overall project conditions assessments including an estimate of remaining service life.

1.3.3 Initial Selection

Preliminary alternate designs are developed to repair the existing distress and prevent future problems. The first cuts, based on an evaluation of various candidate alternatives, are made at this time. A determination of additional data needs is made.

1.3.4 Physical Testing

Testing includes collection of additional information such as coring, deflection testing, resilient modulus, permeability, moisture content, etc.

1.3.5 Evaluation and selection

The selection of new construction and rehabilitation techniques includes identifying the various constraints associated with the project such as:

- Funding (first cost consideration);
- Traffic Control;
- Design Period;
- Geometric Problems;
- Right of Way;
- Utilities; and
- Vertical Clearance Problems (e.g. overhead clearance).

1.4 Site Investigation

It may be advantageous to visit the proposed project site a few times during the development of a pavement or rehabilitation design. Most likely, the pavement designer may find it desirable to make a brief visit to the project site as the first step in the scoping process. As the investigation proceeds, events may develop which will make it desirable to revisit the project site. During visits to the project site, the following are some of the items that should be determined:

1.4.1 Abutting Land Usage

The abutting land usage will be a needed item of design information. Land usage will have an effect on the selection of a pavement type or the selection of a rehabilitation design procedure. If the abutting land is rural, then a note should be made of its use such as farming, ranching, or other, with descriptive details as needed. If the property is urban, a record of usage in terms of residential or commercial is helpful. Additional details on type of residences or type of commercial usage are also helpful.

1.4.2 Existing/Proposed Project Geometrics

Notes should be made as to vertical and horizontal alignment characteristics and type of typical section. Data concerning the typical section should indicate the average and maximum "cut" and "fill" heights and the extent of these over the project. Items such as number of travel lanes and shoulders should be noted. Notes on type and extent of curb and gutter should be made. Vertical clearances at structures should be recorded.

1.4.3 Geotechnical Investigations

Geotechnical investigations are performed to determine the subgrade soil properties needed for pavement structural design considerations and to determine if subgrade stabilization/modification is needed. While pavement design is based on the response of the soil to short-term loads, long-term soil response may dramatically affect the roadway. For example, roadways constructed over soft soils may experience long-term settlements. Important subgrade parameters obtained through a geotechnical investigation not limited to the soil classification include the following: Atterberg Limits, sulfate content, stabilization requirements, test for expansive soils, and other design considerations. Geotechnical investigations are typically required for new construction and reconstruction projects. Contact the Regional Materials Engineer or CDOT Materials and Geotechnical Branch to request a geotechnical investigation. See Section **2.2 Soil Survey Investigation** of this manual for more information, as well as Chapter 200 of the Field Materials Manual.

1.4.4 Drainage Characteristics

Drainage characteristics should be noted during the visit to the project. Items such as the general terrain drainage, the highway drainage, and the existing pavement drainage need to be noted. Another drainage item is bridge drainage structures. The number of bridges and how the existing pavement terminates at the bridge ends is important to note. Also, note if the bridges have bridge approach slabs. The condition of the bridge end/approach slab and the approach slab/pavement interface conditions are of special interest when concrete pavement exists.

1.5 Traffic Projections

There are certain input requirements needed for 18,000-pound Equivalent Single Axle Load (18-kip ESAL) calculations. They are:

- Vehicle or Truck Volumes
 - Lane Distributions
 - Direction Distributions
 - Class Distributions
 - Growth Factors
- Vehicle or Truck Weights
 - Axle Weight
 - Axle Configuration (single, tandem)
- Traffic Equivalence Load Factors

This section describes the process on obtaining or calculating 18-kip ESAL numbers.

1.5.1 Volume Counts

Volume counts are expressed as Annual Average Daily Traffic (AADT) counts. AADT is the annual average two-way daily traffic volume. It represents the total traffic on a section of roadway for the year, divided by 365. It includes both weekday and weekend traffic volumes. The count is given in vehicles per day. This includes all CDOT (or FHWA) vehicle classification types.

1.5.2 Lane and Directional Distributions

The most heavily used lane is referred to as the design lane. Generally, the outside lanes are the design lanes. Traffic analysis determines a percent of all trucks traveling on the facility for the design lanes. This also referred to a lane distribution factor.

The percent of trucks in the design direction is applied to the two directional AADT to account for any differences to truck volumes by direction. The percent trucks in the design direction is referred to as the directional distribution factor. Generally, the directional distribution factor is a 50/50 percent split. If the number of lanes and volumes are not the same for each direction, it may be appropriate to design a different pavement structure for each direction of travel.

CDOT uses a design lane factor to account for the lane distribution and directional distribution. Both distributions are combined into one factor, the design lane factor.

Table 1.1 Design Lane Factor shows the relationship of the design lane factor and the lane and directional distributions.

Table 1.1 Design Lane Factor

Type of Facility	Number of Lanes in Design Direction	CDOT Method	DARWin™ Procedure	
		Design Lane Factor	Percent of Total Trucks in the Design Lane (Outside Lane)	Directional Split (Design Direction/Non-design Direction)
One Way	1	1.00	100	NA
2-lanes	1	0.60	100	60/40
4-lanes	2	0.45	90	50/50
6-lanes	3	0.30	60	50/50
8-lanes	4	0.25	50	50/50

Note 1: Highway Capacity Manual, 2000 (Exhibit 12-13) recommends using a default value for a directional split of 60/40 on a two-lane highway may it be rural or urban (3).

1.5.3 Vehicle Classification

CDOT uses a classification scheme of categorizing vehicles into three bins. CDOT 18-kip ESAL calculations were based on “generalized, averaged, and non-site-specific equivalency factors” using a 3-bin vehicle classification scheme. These vehicle classifications types are (1):

Passenger vehicles, types 1-3 and 0-20 feet,
Single unit trucks, types 4-7 and 20-40 feet, and
Combination trucks, types 8-13 and greater than 40 feet long.

A fourth bin is sometimes used and may be shown as unclassified vehicles. These bins are further broken down into 13 classes. The 13-classification scheme follows FHWA vehicle type classification. Two additional classes may be used as a fourth bin. Class 14 is for unclassifiable vehicles and Class 15 is not used at the present time. The 13 classes of FHWA are separated into groupings of whether the vehicle carries passengers or commodities. Non-passenger vehicles are subdivided by number of axles and number of units, including both power and trailer units. Exceptions may be a large camping and recreational vehicles, which crosses over into the commodities grouping. Note that the addition of a light trailer to a vehicle does not change the classification of the vehicle. Refer to **Figure 1.1 CDOT Vehicle Classifications**. Listed are FHWA vehicle classes with definitions (2):

Class 1 - Motorcycles - All two or three-wheeled motorized vehicles. Typical vehicles in this category have saddle type seats and are steered by handlebars rather than steering wheels. This category includes motorcycles, motor scooters, mopeds, motor-powered bicycles, and three-wheel motorcycles. This vehicle type may be reported at the option of the State.

Class 2 - Passenger Cars - All sedans, coupes, and station wagons manufactured primarily for the purpose of carrying passengers and including those passenger cars pulling recreational or other light trailers.

Class 3 - Other Two-Axle, Four-Tire Single Unit Vehicles - All two-axle, four-tire, vehicles, other than passenger cars. Included in this classification are pickups, panels, vans, and other vehicles such as campers, motor homes, ambulances, hearses, carryalls, and minibuses. Other two-axle, four-tire single-unit vehicles pulling recreational or other light trailers are included in this classification. Because automatic vehicle classifiers have difficulty distinguishing class 3 from class 2, these two classes may be combined into class 2.

Class 4 - Buses - All vehicles manufactured as traditional passenger-carrying buses with two axles and six tires or three or more axles. This category includes only traditional buses (including school buses) functioning as passenger-carrying vehicles. Modified buses should be considered to be a truck and should be appropriately classified.

NOTE: In reporting information on trucks the following criteria should be used:

- a. Truck tractor units traveling without a trailer will be considered single-unit trucks.
- b. A truck tractor unit pulling other such units in a "saddle mount" configuration will be considered one single-unit truck and will be defined only by the axles on the pulling unit.
- c. Vehicles are defined by the number of axles in contact with the road. Therefore, "floating" axles are counted only when in the down position.
- d. The term "trailer" includes both semi- and full trailers.

Class 5 - Two-Axle, Six-Tire, Single-Unit Trucks - All vehicles on a single frame including trucks, camping and recreational vehicles, motor homes, etc., with two axles and dual rear wheels.

Class 6 - Three-Axle Single-Unit Trucks - All vehicles on a single frame including trucks, camping and recreational vehicles, motor homes, etc., with three axles.

Class 7 - Four or More Axle Single-Unit Trucks - All trucks on a single frame with four or more axles.

Class 8 - Four or Fewer Axle Single-Trailer Trucks - All vehicles with four or fewer axles consisting of two units, one of which is a tractor or straight truck power unit.

Class 9 - Five-Axle Single-Trailer Trucks - All five-axle vehicles consisting of two units, one of which is a tractor or straight truck power unit.

Class 10 - Six or More Axle Single-Trailer Trucks - All vehicles with six or more axles consisting of two units, one of which is a tractor or straight truck power unit.

Class 11 - Five or fewer Axle Multi-Trailer Trucks - All vehicles with five or fewer axles consisting of three or more units, one of which is a tractor or straight truck power unit.

Class 12 - Six-Axle Multi-Trailer Trucks - All six-axle vehicles consisting of three or more units, one of which is a tractor or straight truck power unit.

Class 13 - Seven or More Axle Multi-Trailer Trucks - All vehicles with seven or more axles consisting of three or more units, one of which is a tractor or straight truck power unit.

	Class	Schema	Description
Light-weight Vehicles	1		all motorcycles plus two wheel axles
	2		all cars plus one/two axle trailers
	3		all pickups and vans single/dual wheels plus one/two/three axle trailers
Single Unit Vehicles	4		buses single/dual wheels
	5		two axle, single unit single/dual wheels
	6		three axle, single unit
	7		four axle, single unit
Combination Unit Vehicles	8		four or less axles, single trailers
	9		five axles, single trailers
	10		six or more axles, single trailers
	11		five or less axles, multi-trailers
	12		six axles, multi-trailers
	13		seven or more axles, multi-trailers
Unclassified Vehicles	14		Unclassifiable vehicle
	15		Not used

Figure 1.1 CDOT Vehicle Classifications

1.5.4 Growth Factors

The number of vehicles using a pavement tends to increase with time. CDOT uses a 20-year growth factor. Each roadway segment has a growth factor assigned to that segment. The 20-year growth factor is applied to all of the vehicles.

A simple growth rate assumes that the AADT is increase by the same amount each year. A compound growth rate assumes that the AADT percent growth rate for any given year is applied to the volume during the preceding year. CDOT uses the compound growth rate. See **Eq. 1.1**.

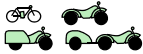
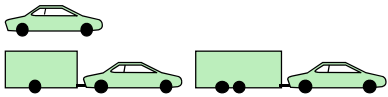
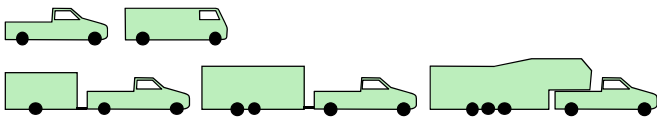
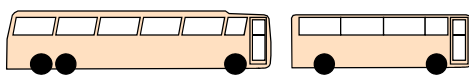
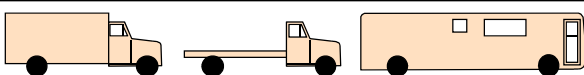
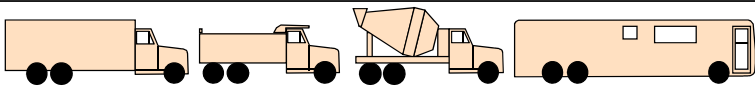
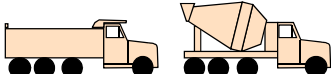
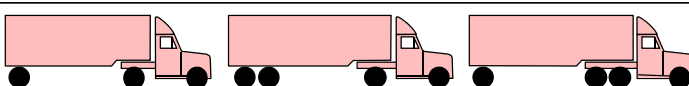
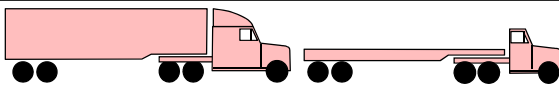
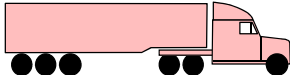
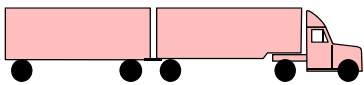
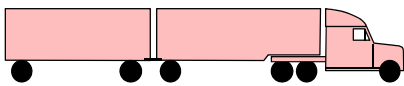
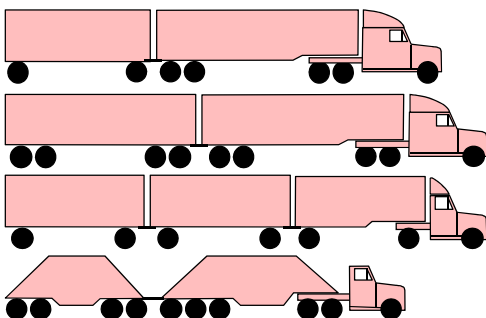
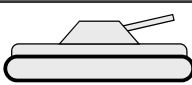
1.5.5 Vehicle or Truck Weights

The 18,000-pound Equivalent Single Axle Load (18-kip ESAL) is a concept of converting a mixed traffic stream of different axle loads and axle configurations into a design traffic number. The 18-kip ESAL is a conversion of each expected axle load into an equivalent number of 18,000-pound single axle loads and to sum these over the design period.

1.5.6 Traffic Equivalence Load Factors

The equivalence load factor is a numerical factor that expresses the relationship of a given axle load to another axle load in terms of their effect on the serviceability of a pavement structure. All axle loads are equated in terms of the equivalent number of repetitions of an 18,000-pound single axle. Using the 3-bin vehicle classification scheme, factors were assigned to each.

The damaging effect of an axle is different for a flexible pavement and a rigid pavement; therefore, there are different equivalency factors for the two types of pavement. **Table 1.2 Colorado Equivalency Factors** shows the statewide equivalency factors that were determined by a study of Colorado traffic in 1987.

Table 1.2 Colorado Equivalency Factors

3-Bin Vehicle Classification	Flexible Pavement	Rigid Pavement
Passenger cars & pickup trucks	0.003	0.003
Single unit trucks	0.249	0.285
Combination trucks	1.087	1.692

1.5.7 Discussion and Calculation of Traffic Load for Pavement Design

Traffic is one of the major factors influencing the loss of serviceability of a pavement. Traffic information required by the pavement designer includes axle loads, axle configurations and number of applications. The damaging effect of the passage of an axle of any load can be represented by a number of 18-kip ESAL. The load damage factor increases as a function of the ratio of any given axle load raised to the fourth power. For example, one application of a 12,000 pound single axle will cause a damage equal to 0.2 applications of an 18,000 pound single axle load and about five applications of a 12,000-pound single axle will cause the same damage as

one 18,000 pound single axle load thus, a 20,000 pound single axle load is 8 times as damaging as the 12,000 pound single axle load. The determination of design ESALs is an important consideration for the design of pavement structures. An approximate correlation exists between 18-kip ESAL computed using flexible pavement and rigid pavement equivalency factors. As a general rule of thumb, converting from rigid pavement 18-kip ESAL to flexible pavement 18-kip ESAL requires multiplying the rigid pavement 18-kip ESAL by 0.67. For example, 15 million rigid pavement 18-kip ESAL is approximately equal to 10 million flexible pavement 18-kip ESALs. Five million flexible pavement 18-kip ESAL equal 7.5 million rigid pavement 18-kip ESALs. Failure to utilize the correct type of 18-kip ESAL will result in significant errors in the designs. Conversions must be made, for example, when designing an asphaltic concrete overlay of a flexible pavement (flexible 18-kip ESAL required) and when designing an alternative portland cement concrete overlay of the same flexible pavement (rigid 18-kip ESAL required).

The Department has some sites on the highway system where instruments have been placed in the roadway to measure axle loads as a vehicle passes over the site. These stations, called Weigh-in-Motion (WIM) sites, can provide accurate information for the existing traffic load. An estimate of growth over the design period will be needed to calculate the traffic load during the design period. The link http://www.dot.state.co.us/App_DTD_DataAccess/index.cfm is used to access traffic load information. Traffic analysis for pavement structure design is supplied by the Division of Transportation Development (DTD) Traffic Analysis Unit. The traffic data figures to be incorporated into the design procedure are in the form of 18 kip equivalent single axle load applications (18-kip ESALs). All vehicular traffic on the design roadway is projected for the design year in the categories of passenger cars, single unit trucks, and combination trucks with various axle configurations. The actual projected traffic volumes for each category are weighted by the appropriate load equivalence factors and converted to a cumulative total 18-kip ESAL number to be entered into the flexible or rigid pavement design equation. Adjustments for directional distribution and lane distribution will be made by the DTD Traffic Analysis Unit. The number supplied will be used directly in the pavement design calculation. Recall that this 18-kip ESAL number is the cumulative yearly ESAL for the design lane in one direction. This 18-kip cumulative number must be a 20-year ESAL to be used in **CHAPTER 3** for the asphalt mix design for SuperPave™ gyratory compaction effort (revolutions). The designer must inform the DTD Traffic Analysis Unit that the intended use of the 18-kip ESAL is for flexible or rigid pavement design (see **Table 1.2 Colorado Equivalency Factors**), since different load equivalence factors apply to different pavement types. If a comparison of flexible and rigid pavements is being made, 18-kip ESAL for each pavement type must be requested.

The procedure to predict the design ESALs is to convert each expected axle load into an equivalent number of 18-kip ESAL and to sum these over the design period. Thus, a mixed traffic stream of different axle loads and axle configurations is converted into a number of 18-kip ESALs. See 1993 AASHTO Guide for Design of Pavement Structure Appendix D, pages D1-28 for Conversion of Mixed Traffic to Equivalent Single Axle Loads for Pavement Design.

The DTD provides traffic projections Average Annual Daily Traffic (AADT) and ESAL. The designer must request 10, 20, and 30-year traffic projections for flexible pavements and 20 and 30-year traffic projections for rigid pavements from the Traffic Section of DTD. Requests for traffic projections should be coordinated with the appropriate personnel of DTD. The pavement

designer can help ensure that accurate traffic projections are provided by documenting local conditions and planned economic development that may affect future traffic loads and volumes.

DTD should be notified of special traffic situations when traffic data are requested. Some special situations may include:

- A street that is or will be a major arterial route for city buses;
- A roadway that will carry truck traffic to and from heavily used distribution or freight centers;
- A highway that will experience an increase in traffic due to a connecting major, high-traffic;
- A highway that will be constructed in the near future; and
- A roadway that will experience a decrease in traffic due to the future opening of a parallel roadway facility.

1.5.8 Traffic Projections

The following steps are used by CDOT to calculate ESALs:

Step 1. Determine the AADT and the number of vehicles of various classifications and sizes currently using the facility. The designer should make allowances for traffic growth, basing the growth rate on DTD information or other studies. Assuming a compound rate of growth, **Eq. 1.1** is used by CDOT to calculate the 20-year growth factor. The future AADT is determined by **Eq. 1.2**.

$$T_f = (1 + r)^n \quad \text{Eq. 1.1}$$

Where:

$$\begin{aligned} T_f &= \text{CDOT 20-year growth factor} \\ r &= \text{rate of growth expressed as a fraction} \\ n &= 20 \text{ (years)} \end{aligned}$$

$$T = \left(\frac{(T_1 * T_f) - T_1}{20} \right) * D + T_1 \quad \text{Eq. 1.2}$$

Where:

$$\begin{aligned} T &= \text{future AADT} \\ T_1 &= \text{current AADT} \\ D &= \text{design period (years)} \end{aligned}$$

Step 2. Determine the midpoint volume (**Eq. 1.3**) by adding the current and future traffic and dividing by two.

$$T_m = (T_1 + T) / 2 \quad \text{Eq. 1.3}$$

Where:

$$T_m = \text{traffic volume at the midpoint of the design period.}$$

Step 3. Multiply the midpoint traffic volume by the percentage of cars, single unit trucks, and combination trucks.

Step 4. Multiply the number of vehicles in each classification by the appropriate 18-kip equivalency factor. See **Table 1.2 Colorado Equivalency Factors**. Then add the numbers from each classification to yield a daily ESAL value.

Step 5. Multiply the total 18-kip ESAL for the roadway by the design lane factor that correlates to the number of lanes for each direction shown in **Table 1.2 Colorado Equivalency Factors**. This will be the 18-kip ESAL for the design lane over the design period.

Example: Determine the 20-year design period ESALs for a 4-lane flexible pavement (2 lanes per direction) if the current traffic volume is 16,500 with 85% cars, 10% single unit trucks, and 5% combination trucks. The traffic using the facility grows at an annual rate of 3.5%.

$$T_f = (1 + 0.035)^{20} = 1.99$$

$$T = (((16500 * 1.99) - 16500) / 20) * 20 + 16,500 = 32,835$$

$$T_m = (16,500 + 32,835) / 2 = 24,668$$

$$\text{Cars} = 24,668 * 0.85 = 20,968$$

$$\text{Single Unit Trucks} = 24,668 * 0.10 = 2,467$$

$$\text{Combination Trucks} = 24,668 * 0.05 = 1,233$$

$$\text{Daily ESALs for Cars} = 20,968 * 0.003 = 62.9$$

$$\text{Daily ESALs for Single Unit Trucks} = 2,467 * 0.249 = 614.3$$

$$\text{Daily ESALs for Combination Trucks} = 1,233 * 1.087 = 1,340.3$$

$$\text{Total Daily ESALs} = 2,017.5$$

$$\text{Total Design Period ESALs} = 2,017.5 * 365 * 20 = 14,727,750$$

$$\text{Design lane ESALs} = 14,727,750 * 0.45 = 6,627,500$$

1.5.9 Estimates of Traffic Load Using Land Use

When designing for local roads and collectors, traffic data may not be available. If traffic data is not available, the following equations may be used to estimate the traffic load according to the surrounding land use of a roadway. Arterial roads should have traffic data collected.

Residential Areas:

$$18 - \text{kip ESAL}(20\text{years}) = 62,000 + 80R$$

Eq. 1.4

Where:

R = number of residential density units served by the roadway.

Commercial Areas:

Commercial roadways provide access to retail stores, businesses, office and other commercial areas. These roadways typically receive a large mix of residential traffic along with trash trucks and delivery trucks. **Eq. 1.5** can be used for roadways with both commercial and residential traffic. **Eq. 1.5** should not be used for commercial property larger than ten acres. If there are more than ten acres, a traffic study is required.

$$18\text{-kipESAI}(20\text{year}) = 62,000 + 80R + 260,000C_A \quad \text{Eq. 1.5}$$

Where:

C_A = acres of commercial property served by the roadway.

Industrial Areas:

Industrial roadways provide access to property zoned for industrial use, such as, manufacturing, distribution and warehousing. Industrial roadways, which are typically subjected to some heavy truckloads, will also serve some commercial areas and may serve some residential areas. **Eq. 1.6** should not be used for an area with commercial and industrial uses larger than ten acres. If there are more than ten acres, a traffic study is required.

$$18\text{-kipESAI}(20\text{year}) = 62,000 + 80R + 260,000C_A + 400,000IA \quad \text{Eq. 1.6}$$

Where:

IA = acres of industrial property served by the roadway.

1.6 Construction and Maintenance Experience

On any given project, there are always construction and maintenance experiences with pavement structures that were never entered into the permanent records relating to the project. Usually, it was not realized that information such as this would be useful in the future. The Program Engineers, Resident Engineers, Project Engineers, Construction Inspectors, and other personnel involved with the project may have useful information if interviewed. The Region Maintenance Superintendent and other maintenance personnel may have pavement performance data that do not appear elsewhere in the records. Frequently, maintenance forces have repaired substantial sections of the project and this information is not always readily available in the records.

1.7 Pavement Management System (PMS) Condition Data

The PMS provides network-level pavement condition information for planning and programming purposes. PMS data are used to help select reconstruction, rehabilitation, and preventive maintenance projects and evaluate performance trends. It also provides pavement condition

information that is useful for performing a preliminary evaluation of a project. For more information about PMS data, contact the PMS unit or the Region Pavement Manager.

1.7.1 International Roughness Index (IRI)

International Roughness Index (IRI) is a statistic used to determine the amount of roughness in a measured longitudinal profile. The IRI is computed from a single longitudinal profile using a quarter-car simulation as described in the report, *On the Calculation of IRI from Longitudinal Road Profile*, (Sayers 1995) see <http://www.umtri.umich.edu/erd/roughness/iri.html> for more information. Computer programs to calculate the IRI statistic from a longitudinal profile are referenced in AASHTO Designation PP 37-04, *Standard Practice for Determination of International Roughness Index (IRI) to Quantify Roughness of Pavements*. The mathematical filter for the IRI can be either a quarter-car or half-car model. The filter in the IRI is based on a mathematical model called a quarter-car. The quarter-car filter calculates the suspension deflection of a simulated mechanical system with a response similar to a passenger car. The simulated suspension motion is accumulated and divided by the distance traveled to give an index with units of slope (in/mi).

1.8 Functional Class and Reliability

The reliability component gives the designer the option of incorporating a risk reduction factor into the pavement design process. The reliability factor is determined based on the functional classification of the roadway and whether it is in an urban or a rural location. Reliability is not dependent on either type of pavement or type of project. Reliability is most closely related to traffic conditions and 18-kip ESALs. The selection of a reliability factor should be consistent throughout the design and analysis of a project. Once a reliability factor is selected for a project using **Table 1.3 Reliability (Risk)**, it should be used consistently throughout the pavement type selection and design calculations. The selection of reliability level is dependent on the functional classification of the proposed roadway. The appropriate functional classification for a certain roadway can be determined from the information on CDOT Form #463, *Design Data*, completed for the specific highway project being designed. A blank CDOT Form #463 is shown in the Appendix of the CDOT Project Development Manual and **APPENDIX B - FORMS** of this manual. As an example, CDOT Form #463 identifies a segment of SH 83 as a rural principal arterial; the reliability for this roadway can be obtained from **Table 1.3 Reliability (Risk)**. As the table shows, the reliability for this road may range from 70 to 95 percent. This is a high profile road, so the reliability is set 95%.

Table 1.3 Reliability (Risk)

Functional Classification	Urban	Rural
Interstate Freeway	85-95	80-95
Principal Arterials	80-95	70-95
Minor Arterial	70-95	60-90
Collectors	50-90	50-85
Local	50-80	50-75

CDOT has a map available designating highway functional classifications. See **Figure 1.2 Highway Functional Classifications**. The map may be downloaded from the website: http://alphainternal.dot.state.co.us/App_DTD_DataAccess/Downloads/StatewideMaps/func_classes.pdf

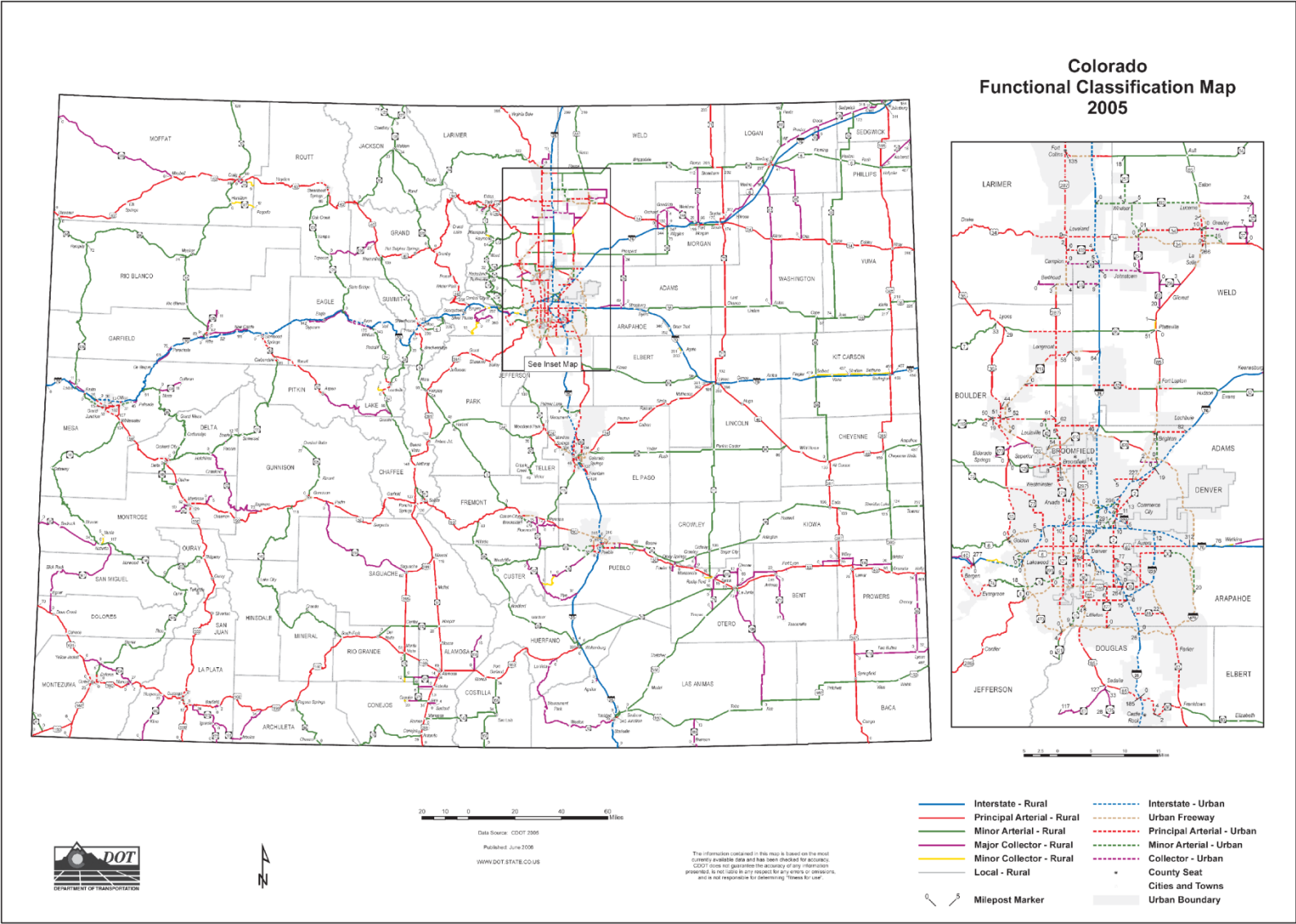

Figure 1.2 Highway Functional Classifications

The pavement design formulas use the standard normal deviate value that corresponds to a selected level of reliability factor. Levels of reliability and corresponding values of standard normal deviate are provided in **Table 1.4 Reliability and Standard Normal Deviate**. If the reliability is set to 95%, the table, shows a corresponding normal deviate (Z_R) value of (-)1.645.

Table 1.4 Reliability and Standard Normal Deviate

Reliability, R (percent)	Standard Normal Deviate (Z_R)
50	0.000
60	-0.253
70	-0.524
75	-0.674
80	-0.841
85	-1.037
90	-1.282
91	-1.340
92	-1.405
93	-1.476
94	-1.555
95	-1.645
98	-2.054

1.9 Serviceability

Serviceability of a pavement is based on the public's acceptance of ride and distress, e.g., cracking, patching and rut depth at any specific time. Serviceability Index (SI) is a number that is indicative of the pavement's ability to serve traffic at any specific time. This number is based on a combination of profilograph readings and visual inspection. Values of Serviceability Index (SI) range from 0 to 5 as shown in **Table 1.5 Serviceability Index**.

Table 1.5 Serviceability Index

Serviceability Index	Pavement Condition
0 - 1	Very Poor
1 - 2	Poor
2 - 3	Fair
3 - 4	Good
4 - 5	Very Good

Design serviceability loss (Δ PSI) is determined by subtracting the terminal SI at the end of design period from the initial SI at initial construction. The SI at initial construction will normally fall in the range from 4.2 to 4.6 and generally can be assumed to be 4.5. The SI at the end of the design period is the worst-case allowable condition that the pavement may reach. A terminal PSI of 2.5 is acceptable for roads with a current Average Daily Traffic (ADT) of 750 or more. ADT is a 24-hour, two-way daily traffic count. A terminal PSI of 2.0 is acceptable for roads with a current ADT of less than 750. Therefore, serviceability loss (Δ PSI) of 2.0 will be used for current ADT greater than 750 and serviceability loss (Δ PSI) of 2.5 will be used for current ADT less than 750. Design serviceability loss may be affected by components other than traffic; the roadbed soils may influence the loss if problems are anticipated such as frost heaving or moisture swelling. Serviceability loss is not unique to the pavement type or type of project.

1.10 Drainage

Water is a fundamental variable in most problems associated with pavement performance and is directly or indirectly responsible for many of the distresses found in pavement systems. A well-drained pavement section is required to maintain the strength coefficients assigned to individual components of a hot mix asphalt pavement section. Edge drains, cross drains, and drainage layers all must tie into a collection system or some means to carry collected water away from intersections and the pavement section. Installing drainage systems that collect and impound water rather than diverting it away from the pavement section should never be allowed.

There are provisions to modify the pavement design equations to take advantage of improvements in performance when good drainage is designed in the roadway. Strategies for combating the effects of water in a pavement system are:

- Prevent water from entering the pavement;
- Provide drainage to remove excess water quickly; and
- Build the pavement strong enough to resist the combined effect of load and water.

It is preferable to exclude water from the pavement and provide for rapid drainage. The cost of improving the drainage should be compared to the cost of building a stronger pavement. It is more likely that drainage improvements will outperform a stronger pavement. To obtain adequate pavement drainage, the designer should consider providing three types of drainage systems that may include surface drainage, groundwater drainage and structural drainage.

It is important to understand the roadway geometry, particularly the drainage gradients in the roadway prism, when selecting base type. As long as the base will be able to carry drainage away from the pavement structure, a gravel base will perform adequately. It is also important to note that these values apply only to the effects of drainage on untreated base and subbase layers. **Table 1.6 Drainage Quality** contains the general definitions corresponding to different drainage levels within the pavement structure. For comparison purposes, the drainage conditions at the original AASHTO Road Test were considered to be fair, i.e., free water was removed within one week.

Table 1.6 Drainage Quality

Quality of Drainage	Water Removed Within
Excellent	2 hours
Good	1 day
Fair	1 week
Poor	1 month
Very Poor	(water will not drain)

1.11 Subdrainage Design

Subdrainage is an important consideration in new construction or reconstruction and in the resurfacing, restoration, and rehabilitation of pavement systems. General types of pavement subsurface design criteria include:

Criterion for the time of drainage of the base or subbase beginning with the flooded condition and continuing to an established acceptable level; and

An inflow-outflow criterion, by which drainage occurs at a rate greater than or equal to the inflow rate, thus avoiding saturation.

Removal of the free water can be accomplished by draining the free water vertically into the subgrade, or laterally through a drainage layer into a system of pipe collectors. Generally, the actual process will be a combination of the above two criteria. Such systems, however, are only effective for “free water.” Water held by capillary forces in soils and in fine aggregates cannot be drained. The effects of the “bound” moisture must be considered in the design of pavement structures through its effect on the pavement material properties. Most existing pavements do not include drainage systems capable of quickly removing free water.

A drainage survey may indicate that a subdrainage system is required to control one or more sources of water in the pavement. Pavement construction and maintenance activities often require several types of subsurface drainage. The removal of water will increase the strength or stiffness of the pavement, thereby extending the life. Thus, considerable care is required when designing elaborate and complex drainage systems. The designer must reevaluate the material properties used in design.

Subsurface drainage systems should be designed and constructed with long-term performance and maintenance in mind, including periodic inspections to check performance. Outflow measurements taken at periodic intervals can be compared to those obtained immediately after construction to determine whether or not the drainage system is functioning properly. Substantial decreases may indicate a need for cleaning and/or maintenance activities. The adequacy of the subdrainage installations for an existing pavement can be evaluated by working a complete “new” drainage analysis of the pavement and assessing its capacity to drain the pavement.

The pavement designer should coordinate with the respective Region Hydraulics Engineer and/or Staff Hydraulics Engineer if necessary where a pavement drainage problem is anticipated. The pavement designer may consult the CDOT Drainage Design Manual, other AASHTO publications, and FHWA’s latest software DRIP can be accessed through the link (<http://www.fhwa.dot.gov/pavement/library.htm>) that are recommended drainage references for pavement design.

AASHTO’s Appendix AA - Guidelines for the Design of Highway Internal Drainage Systems, which is located in Volume 2 of the AASHTO Guide for Design of Pavement Structures, August 1986, should be referred to for guidance in developing a drainage system for rehabilitation.

1.12 Drainage Survey and Evaluation

Distresses can be related to particular moisture properties of the materials in the pavement. If the existence of these properties is not recognized and corrected where possible, the rehabilitation work will be wasted by allowing the same type of moisture-related distress to occur again. The recognition of the amount, severity, and cause of moisture damage also plays an important role in the selection of the rehabilitation scheme to be utilized on the pavement. This information will help in the structural evaluation of the pavement.

Moisture-related distresses develop from two major groupings of factors that influence the moisture condition in a pavement. These two major groups of factors include:

External factors such as the climatic factors in an area that regulates the supply of moisture to the pavement; and

Internal factors are those properties of the pavement materials whose interaction with moisture influences pavement performance.

The recognition of each distress and the mechanism causing that distress are necessary if the correct rehabilitation procedures are to be selected. Each distress type that develops within a pavement will be load or environment-related or a combination of the two. Moisture will serve to accelerate this deterioration when it is environment-related. To prevent future deterioration, the moisture problems must be recognized and corrected.

The fact that moisture problems may appear in any layer emphasizes the necessity of having a logical procedure for examining the pavement in order to determine the cause of the problem. Nondestructive testing (NDT) will indicate the overall structural level of the pavement. However, NDT alone cannot identify which component of the pavement is responsible for the strength loss. The distress analysis must be utilized in conjunction with the NDT analysis in order to identify potential moisture-related problems. If the subgrade has moisture problems that caused the distress, as determined in the distress survey, it may do no good to overlay the pavement, recycle it, or rework and stabilize the base without also addressing the subgrade. If the base or subbase has moisture problems, it will be wasteful to rehabilitate, restore, or overlay without addressing the moisture problems through reworking or stabilization of the base and/or consideration of drainage of the granular layer. **Table 1.7 Moisture-Related Distress in Flexible Pavements** and **Table 1.8 Moisture-Related Distress in Rigid Pavements** contain a breakdown of the more common moisture-related distresses for flexible and rigid pavements.

Table 1.7 Moisture-Related Distress in Flexible Pavements

Type	Distress Manifestation	Moisture Problem	Climatic Problem	Material Problem	Load Associated	Structural Defect Begins In		
						Asphalt	Base	Subgrade
Surface Defect	Bleeding	No	Accentuated by High Temp.	Bitumen	No	Yes	No	No
	Raveling	No	No	Aggregate	Slightly	Yes	No	No
	Weathering	No	Humidity and Light-dried Bitumen	Bitumen	No	Yes	No	No
Surface Deformation	Bump or Distortion	Excess Moisture	Frost Heave	Strength-Moisture	Yes	No	Yes	Yes
	Corrugation Or Rippling	Slight	Climatic & Suction Relations	Unstable Mix	Yes	Yes	Yes	Yes
	Shoving	No		Unstable Mix Loss of Bond	Yes	Yes	No	No
	Rutting	Excess in Granular Layers	Suction & Material	Compaction Properties	Yes	Yes	Yes	Yes
	Depression	Excess	Suction & Materials	Settlement, Fill Material	Yes	No	No	Yes
	Potholes	Excess	Frost Heave	Strength-Moisture	Yes	No	Yes	Yes
Cracking	Longitudinal	Yes	Spring-Thaw Strength Loss		Yes	Faulty Construction	Yes	Yes
	Alligator	Yes, Drainage		Possible Mix Problems	Yes	Yes, Mix	Yes	Yes
	Transverse	Yes	Low-Temp. F-T Cycles	Thermal Properties	No	Yes, Temp. Susceptible	Yes	Yes

Table 1.8 Moisture-Related Distress in Rigid Pavements

Type	Distress Manifestation	Moisture Problem	Climatic Problem	Material Problem	Load Associated	Structural Defect Begins In		
						Surface	Bases	Subgrade
Surface Defects	Spalling	Possible	No		No	Yes	No	No
	Crazing	No	No	Rich Mortar	No	Yes - weak surface	No	No
Surface	Blow-up	No	Temperature	Thermal Properties	No	Yes	No	No
	Pumping	Yes	Moisture	Fines in Base Moisture Sensitive	Yes	No	Yes	Yes
	Faulting	Yes	Moisture-Suction	Settlement Deformation	Yes	No	Yes	Yes
	Curling	Possible	Moisture and Temp.		No	Yes	No	No
Cracking	Corner	Yes	Yes	Follows Pumping	Yes	No	Yes	Yes
	Diagonal	Yes	Possible	Cracking Follows Moisture Buildup	Yes	No	Yes	Yes
	Transverse							
	Longitudinal							
	Punch Out	Yes	Yes	Deformation Following Cracking	Yes	No	Yes	Yes
Joint	Produces Damage Later	Possible	Proper Filler and Clean Joints	No	Joint	No	No	

References

1. Development of Site-Specific ESAL, Final Report CDOT-DTD-R-2002-9, Project Manager, Ahmad Ardani, Colorado Department of Transportation and Principal Investigator, Sirous Alavi, Nichols Consulting Engineers, Chtd., July 1, 2002.
2. Heavy Vehicle Travel Information System, Field Manual, FHWA publication PDF version, May 2001 (revised), obtained at website, <http://www.fhwa.dot.gov/ohim/tvtw/hvtis.htm>
3. Highway Capacity Manual, Transportation Research Board, National Research Council, Washington, D.C., 2000.

CHAPTER 2 SUBGRADE AND BASE MATERIALS

2.1 Introduction

The pavement structure may consist of layers of material placed on the subgrade. In establishing the thickness of each layer, it is necessary to provide proper thickness of overlying material so that the next lower layer is not stressed beyond its capacity. Consequently, in a layer system, lower quality materials may be used in the bottom courses of the pavement structure if sufficient cover of higher quality materials is provided as shown in **Table 2.1 M-E Design Guide Major Material Categories of Subgrades and Bases**. It is recommended to remove and replace any subgrade soils that are susceptible to the detrimental effects of frost or swelling. Pavement damage due to swelling or expansive soils may be extensive if not treated properly. See **Figure 2.1 Conventional Structural Layered Flexible and Rigid Systems**.

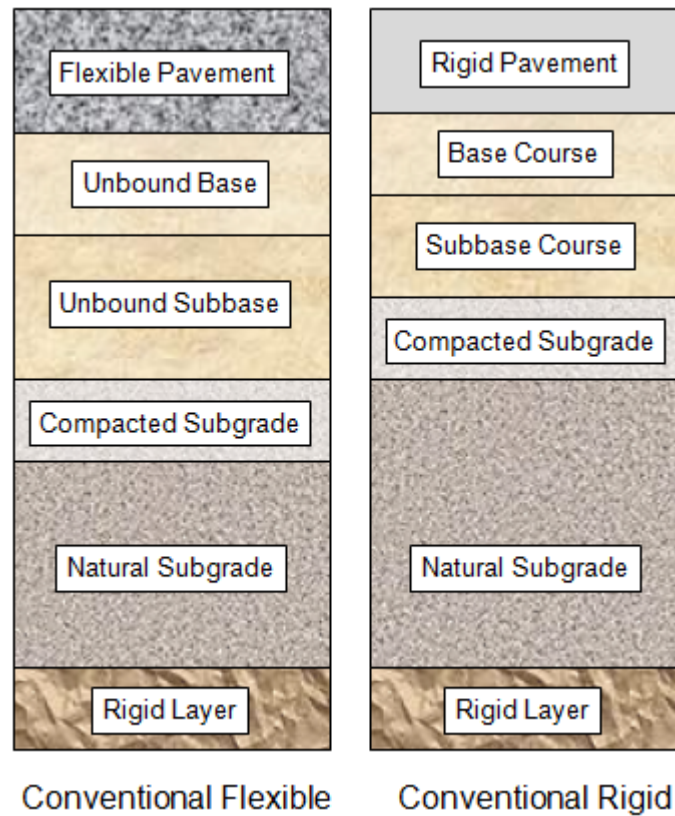

Figure 2.1 Conventional Structural Layered Flexible and Rigid Systems

2.1.1 Introduction to Mechanistic-Empirical Design Guide Material Categories

The Mechanistic-Empirical (M-E) Design Guide categorizes four major material groups in the broad generalization of subgrades and bases. **Table 2.1** shows the material categories the M-E Design Guide uses.

Table 2.1 M-E Design Guide Major Material Categories of Subgrades and Bases

Material Category	Sub-Category	Section
Rigid Foundation	Solid, Massive and Continuous Highly Fractured, Weathered	Section 2.3
Subgrade Soils	Gravelly Soils (A-1; A-2) Sandy Soils Loose Sands (A-3) Dense Sands (A-3) Silty Sands (A-2-4; A-2-5) Clayey Sands (A-2-6; A-2-7) Silty Soils (A-4; A-5) Clayey Soils Low Plasticity Clays (A-6) Dry-Hard Moist Stiff Wet/Sat-Soft High Plasticity Clays (A-7) Dry-Hard Moist Stiff Wet/Sat-Soft	Sections 2.4 through 2.8
Chemically Stabilized Materials	Lime Stabilized Soils Cement Treated Subgrade Fly Ash Lime/Fly Ash Treated Base Course Permeable Bases	Section 2.9.1 Section 2.9.2 Section 2.9.3 Section 2.9.3 Section 2.11.2 Section 2.11.3
Non-Stabilized Granular Base/Subbase	Granular Base/Subbase Cold Recycled Asphalt (used as aggregate) RAP (including millings) Pulverized In-Place Cold Recycled Asphalt Pavement (HMA plus aggregate base/subbase)	Section 2.11.1 Section 2.11.4.1 Section 2.11.4

The major material characteristics associated with unbound materials are related to the fact that moduli of these materials may be highly influenced by the stress state (non-linear) and in-situ moisture content. As a general rule, coarse-grained materials have higher moduli as the state of confining stress is increased. In contrast, clayey materials tend to have a reduction in modulus. Thus, while both categories of unbound materials are stress dependent (non-linear), each behaves in an opposite direction as stress states are increased (16).

2.2 Soil Survey Investigation

The purpose of the preliminary soil survey is to gather information for the design of the pavement rehabilitation, and the new pavement structure. The steps necessary to conduct the soil survey investigation include:

Step 1. Obtain clearance and locates. When required, provide for necessary landowner permission to trespass. Obtain necessary utility clearance or locates prior to the start of work.

Step 2. Determine sampling locations and methods. Test holes can be drilled, dug by hand, power augered, back hoed, or completed by any other practical method. The method used should ensure the attainment of representative, uncontaminated samples. Sampling and testing procedures should conform to the following requirements:

- Determine horizontal and vertical test hole locations for virgin alignment. Test holes should be no farther apart than approximately 500 ft. in continuous cut sections and no farther than approximately 1,000 ft. in other sections. In addition, test holes should be drilled whenever there is a variation in soil or geological conditions. Sampling locations and depths should be coordinated with the Region Materials Engineer (RME) in order to obtain sufficient number of test holes and materials to outline subsurface complexities.
- Determine coring locations for pavement rehabilitation of existing roadways and coordinate with the Region Materials Engineer. Coring should be spaced to provide sufficient data of pavement thickness and condition to perform pavement design. Researching as-constructed plans will help in determine coring locations. Cores should be retained for further evaluation in the laboratory. Refer to Section **C.6.3 Pavement Coring and Subgrade Boring** of **APPENDIX C - DEFLECTION TESTING AND BACKCALCULATION**.
- Collect subgrade soil samples and test for:
 - Classification per AASHTO M 145 and U.S. Army Corps of Engineers;
 - Soil moisture density relation per AASHTO T 99;
 - Resistance value, Colorado Procedure-L 3101 and L 3102 ; and
 - Swell consolidation test, ASTM D 4546 at 200-psf surcharge.
 - Determining the Sulfate Ion Content in Water or Water Soluble Sulfate Ion Content in Soil, Colorado Procedure-L 2103. Refer to Chapter 200 of the CDOT Field Materials Manual.
- Collect base and subbase samples for information and testing (pavement rehabilitation investigation):
 - Thickness;
 - Gradation CP 21, PI and LL (AASHTO T 89 and T 90); and
 - Resistance value, Colorado Procedure-L 3101 and L 3102.
 - Fill all sample holes. Provide and place patching material similar to the existing surface.
 - Combine similar soil and aggregate types encountered and note locations and depths.

Step 3. Provide documentation of sample locations and other details required in CDOT Forms #554 (Soil Survey Field Report) and #555 (Preliminary Soil Survey). More information on the preliminary soil survey can be referred to in Chapter 200 of the Field Materials Manual.

2.2.1 Sulfate Subgrade Soils

Sulfate induced problems in soils stabilized using calcium-based stabilizing agents such as lime and Portland cement has been documented since the late 1950's in the United States. A number of highly qualified cement chemists has studied the mechanism in an effort to understand and control sulfate attack on Portland cement concrete structures. It is very important for the designers to understand the fundamentals of sulfate-induced distress and the risk levels when sulfate soils are stabilized with lime or with other calcium-based stabilizing agents.

Sulfates typically are concentrated closer to the surface in the drier, western regions. Moving eastward into wetter and more humid climates, the general rule is that sulfates tend to concentrate at deeper depths if present. For preliminary soil information, two valuable tools can be used to assess the presence and significance of sulfates within an area. These are the United States Department of Agriculture's County Soils Report, and the "Web Soil Survey" developed by the Natural Resources Conservation Service (NRCS) of the United States Department of Agriculture.

The "Web Soil Survey" is located at <http://websoilsurvey.nrcs.usda.gov/app/>. This website allows the user to locate the construction job site of interest and identify where sulfates typically occur and at what depth to expect significant concentrations.

The County Soils Report provides agricultural and engineering data for each soil. It is conveniently tabulated and generally shows the presence of gypsum and other sulfate salts, as well as the depth of significant concentrations, if any. This is an extremely valuable reconnaissance tool. It is very important not only to identify the presence of sulfates but also the depth of occurrence. For example, a soil may be essentially sulfate free in the upper 2 or 3 feet but have sulfate concentrations at a depth of 6 feet. In this case, sulfates would not be of concern during normal surface stabilization operations but could be of concern in cut and fill areas.

If sulfates are present and identified in the Soils Report, a field testing plan should be established with the Geotechnical Engineer. The frequency of testing depends on the level of sulfates present and the geological information for the region. If initial testing confirms the presence of sulfates in concentrations that may present problems, additional testing for the concentration of water-soluble sulfates may be warranted prior to recommending lime stabilization of the subgrade. Refer to Chapter 200 of CDOT Field Materials Manual for more information on sulfates.

2.3 Rigid Layer

A rigid layer is generally thought of as bedrock. Bedrock is an unweathered rock layer. A rock layer may consist of igneous, metamorphic, and sedimentary material or combinations of each, which cannot be excavated without blasting or the use of large mechanical equipment used for ripping the bedrock. For example, a thick shale or claystone layer would be considered a rigid layer.

In pavement design, a rock fill would be a rigid layer. Rock fill is defined in Subsection 203.03 - Embankment of *CDOT Standard Specification for Road and Bridge Construction*, 2005 (13). Rock fill shall consist of sound, durable stones, boulders, or broken rock not less than six inches in least dimension. At least 50 percent of the rock used shall have a volume of 2 cubic feet or more, as determined by physical or visual measurement.

2.4 Subgrade (Natural or Compacted)

Natural subgrade is the top surface of a roadbed upon which the pavement structure and shoulders are constructed. The subgrade is further subdivided and described as a man-made compacted layer of the same soil as beneath it (natural subgrade) or imported soil. See **Figure 2.1 Conventional Structural Layered Flexible and Rigid Systems**. The compacted subgrade is further described in Section **2.7 Compacted Subgrade Layer**. The natural subgrade engineering values are obtained from the soil subgrade investigation. The critical location of the natural subgrade stress-strain relationship is at the top of the natural subgrade and bottom of the compacted subgrade. The critical location of the compacted subgrade stress-strain relationship is at the top of the layer and is the surface of the roadbed. If the compacted subgrade layer is thick, the engineering design values should represent that material in place. Test specimens representing the compacted subgrade should be prepared as if in place at the time of construction. If the compacted subgrade layer is similar to a pre-conditioning of the natural subgrade, the engineering design values of the natural soil is sufficient.

2.5 Subgrade Resilient Modulus (M_R)

Typical wheel loading distributions of flexible pavement structural layers are shown below in **Figure 2.2 Distribution of Wheel Load to Subgrade Soil (M_R)**. The loading distributions, in the layered system, spread out and become less intense the further from the wheel loading. The subgrade engineering property of support is the Subgrade Resilient Modulus (M_R).

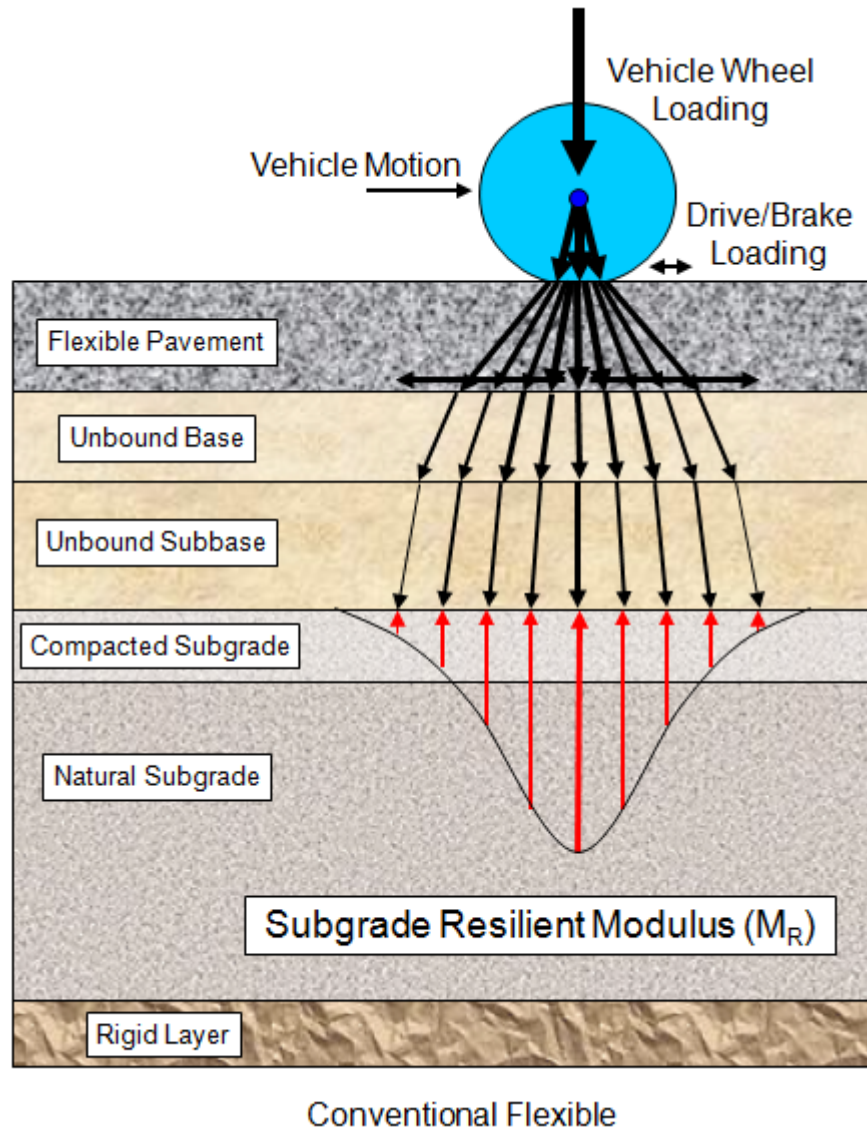

Figure 2.2 Distribution of Wheel Load to Subgrade Soil (M_R)

2.5.1 Laboratory Resilient Modulus

The performance of a flexible pavement structure is directly related to the physical properties and supporting strength of the roadbed soil. Increasing the thickness or the strength of the pavement structure can compensate for the effect of less satisfactory soils.

Thickness of the pavement structure required by soil conditions is governed by:

- Strength of the layers required protecting the soil from displacement due to traffic loads.
- Weight of the layers required to confine expansive forces that develop in the soil.

The dynamic Resilient Modulus (M_R) is defined as the ratio of the amplitude of the repeated cyclical (resultant) axial stress to the amplitude of resultant (recoverable) axial strain. Refer to

SUPPLEMENT - MATERIAL PROPERTIES OF SUBGRADE, SUBBASE, BASE, FLEXIBLE AND RIGID LAYERS for further discussion. The dynamic M_R value is an expensive and time-consuming test. The dynamic M_R is determined in accordance with AASHTO T 307, Determining the Resilient Modulus of Soils and Aggregate Materials.

M_R can be measured directly from the laboratory tests or obtained using correlations with other material strength properties. The Department uses **Eq. 2.1** and **Eq. 2.2** to give an approximate correlation of Resistance value (R-value) to the Resilient Modulus (M_R). The R-value is considered a static value and the M_R value is considered a dynamic value. CDOT uses Hveem stabilometer equipment to measure strength properties of soils and bases. This equipment yields an index value called the R-value. The R-value is determined in accordance with Colorado Procedure - Laboratory 3102, Determination of Resistance Value at Equilibrium, a modification of AASHTO T 190, Resistance Value and Expansion Pressure of Compacted Soils.

$$S_1 = [(R - 5)/11.29] + 3 \quad \text{Eq. 2.1}$$

$$M_R = 10^{[(S_1 + 18.72)/6.24]} \quad \text{Eq. 2.2}$$

Where:

M_R	=	resilient modulus (psi)
S_1	=	the soil support value
R	=	the R-value obtained from the Hveem stabilometer

Designers should note that although the Hveem equipment is used to gather input data for pavement design, the result of the Hveem test is not the resilient modulus. It is recommended that documentation of the pavement design show that when the Hveem test is used, the R-value is measured and the resilient modulus is an approximation from correlation formulas.

2.5.1.1 Development of Effective Roadbed Soil Moduli (Seasonal Adjustment)

The prescribed procedure to obtain an effective roadbed soil modulus is presented. This procedure may be used for the laboratory resilient modulus or the correlated resilient modulus using the R-value. The M_R value needs to be adjusted to an effective seasonal value. The effective resilient modulus (M_R)_{eff} may be calculated by three methods. This (M_R)_{eff} is used only in the design of flexible pavements using the serviceability criteria. Each method is the same but presented in different ways. The three methods are, by AASHTO 1993 Design Guide equation, by AASHTO 1993 Design Guide graphical chart, and by using the DARWin™ software. The (M_R)_{eff} is a unique resilient modulus value for the roadbed soil that produces the same overall damage as the combined effects of the modulus values during each season or month.

- Equation Method

Eq. 2.3 and **Eq. 2.4** are mathematical equations to adjust the resilient modulus for seasonal variations.

The equation for $(M_R)_{\text{eff}}$ is as follows:

$$(M_R)_{\text{eff}} = 3005(\bar{u}_f)^{-0.431} \quad \text{Eq. 2.3}$$

$$\bar{u}_f = \frac{\sum_{i=1}^n u_{fi}}{n} \quad \text{Eq. 2.4}$$

Where:

- $(M_R)_{\text{eff}}$ = effective roadbed soil resilient modulus
- \bar{u}_f = average relative damage
- u_{fi} = individual seasonally/monthly relative damage = $1.18 \times 10^8 \times M_{Ri}^{-2.32}$
- M_{Ri} = individual seasonally/monthly resilient modulus

- Graphical Chart

An explanation on how to use the graphical chart as shown **Figure 2.3 Chart for Estimating Effective Roadbed Soil Resilient Modulus** is documented in Chapter 2, Section 2.3 - Material Properties for Structural Design of the 1993 AASHTO Pavement Design Guide.

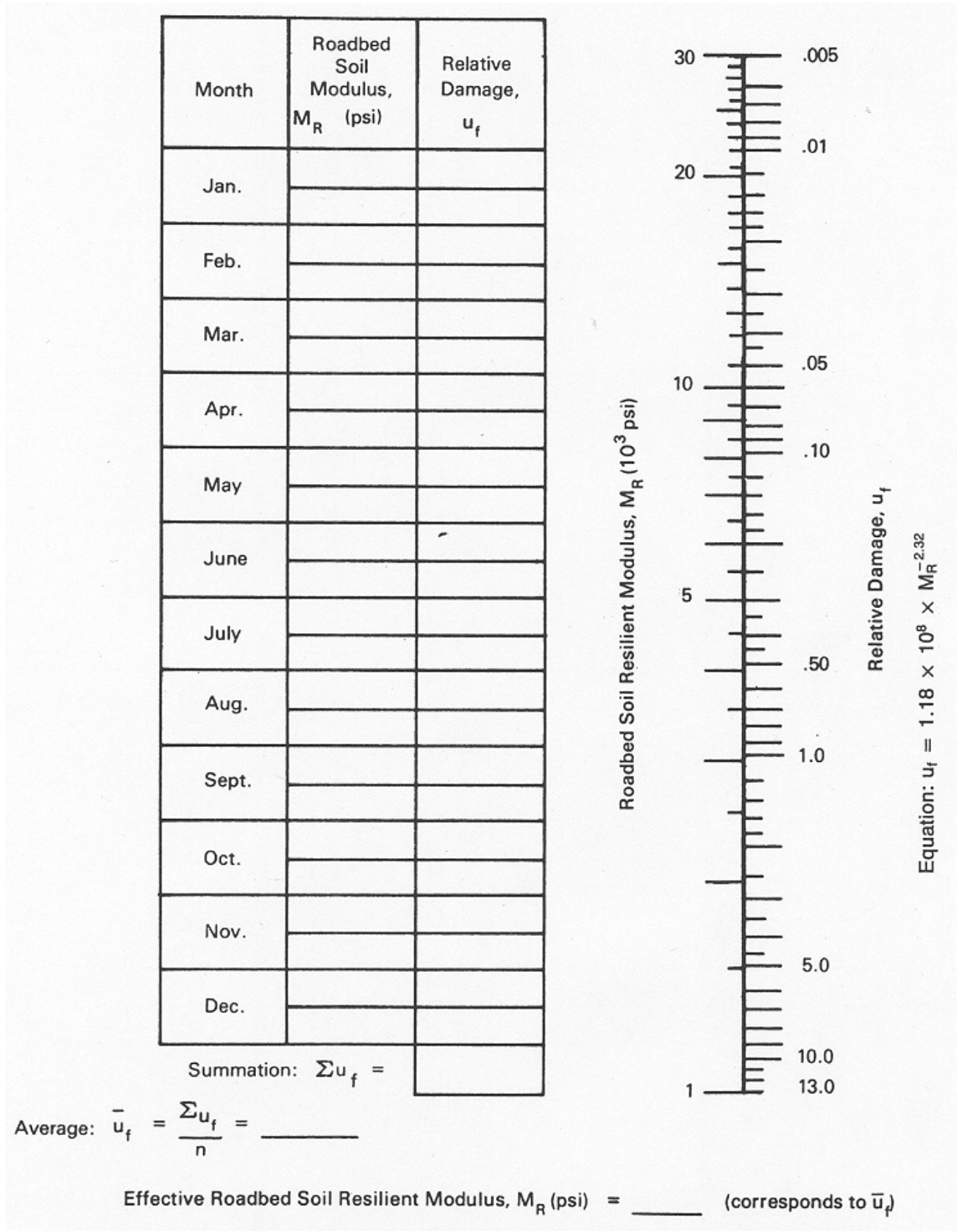

Figure 2.3 Chart for Estimating Effective Roadbed Soil Resilient Modulus

- DARWin™ Software

Calculate the $(M_R)_{eff}$ by clicking on the secondary dialog button that is located next to the resilient modulus input box. The secondary dialog screen is shown in **Figure 2.4 DARWin™ Secondary Dialog Screen for effective resilient modulus**.

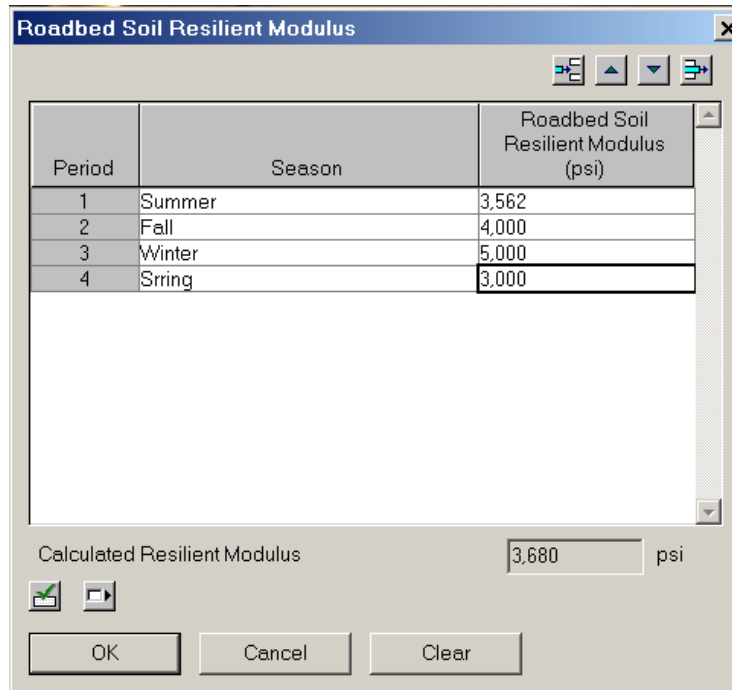

Figure 2.4 DARWin™ Secondary Dialog Screen for effective resilient modulus

2.5.2 Field Surface M_R Using Falling Weight Deflectometer

Another method to determine the M_R of a subgrade is to use a Falling Weight Deflectometer (FWD). Discussion and guidelines for FWD testing and analysis is presented in Appendix C - Deflection Testing and Backcalculation Method.

Adjustment to the field surface M_R is needed to account for the seasonal variation. The month or season the FWD was performed dictates the individual surface M_R . The effective resilient modulus $(M_R)_{eff}$ value uses the same procedures as outlined in Section 2.5.1.1. The $(M_R)_{eff}$ is the value used for the M_R value as discussed in **CHAPTER 3 - PRINCIPLES OF DESIGN FOR FLEXIBLE PAVEMENT**.

2.6 Modulus of Subgrade Reaction (k-value)

The modulus of subgrade reaction (k-value) is obtained by determining the soil classification by normal laboratory methods and then converting to the adjusted effective k-value. The adjusted effective modulus of subgrade reaction can be improved by use of a base layer between the portland cement concrete slab and the subgrade. The adjusted effective elastic k-value on top of the subgrade or embankment is the required design value; it does not represent the top of the base course (19). See **Figure 2.5 Distribution of Wheel Load to Subgrade Reaction (k-value)**. The adjusted effective elastic k-value for use as an input in the 1998 AASHTO Supplement is the static elastic k-value. Note, in the *Guide for Mechanistic-Empirical Design* the effective k-value used is the effective dynamic k-value (16).

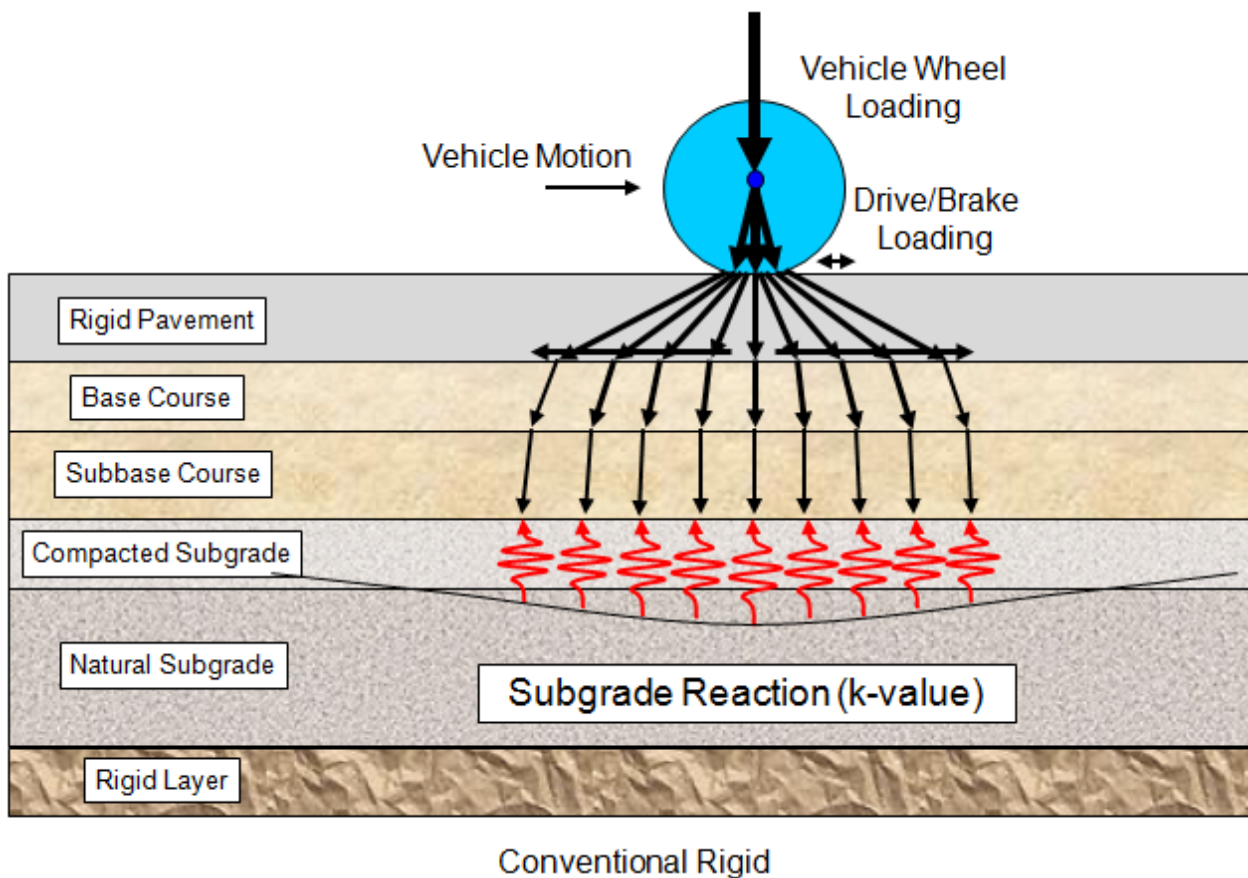

Figure 2.5 Distribution of Wheel Load to Subgrade Reaction (k-value)

2.6.1 Estimating or Measuring the k-value

The 1998 AASHTO Supplement outlines three procedures to estimate or measure the k-value. The Microsoft Excel™ Rigid Pavement Design software has the referenced charts and tables as in the 1998 AASHTO Supplement. There is no direct laboratory procedure for determining the initial k-value, however, there are three procedures for estimating the initial k-value. One of the

procedures uses correlations and has three methods of correlations to determine the initial k-value. The three procedures are:

- Correlations with soil type and other soil properties or tests.
- Correlation using soil classification
- Correlation to California Bearing Ratio
- Correlation by Dynamic Cone Penetrometer
- Plate bearing tests.
- Deflection testing and backcalculation (recommended).

A procedure not described in the 1998 AASHTO Supplement is to use an R-value correlated to the dynamic M_R and using a simplified older AASHTO relationship equation to obtain a k-value.

After selecting which procedure to use, the designer continues with steps to adjust the initial k-value. Two adjustment steps follow. The first step is to adjust the initial k-value to a seasonal effective k-value. The second step is to adjust the seasonal effective k-value for the effects of a shallow rigid layer, if present, and/or an embankment above the natural subgrade.

2.6.1.1 Correlations of Initial k-value using Soil Classifications

Initial k-values may be correlated to the soil type and basic physical properties. In general, the static k-value can be determined using a simplified graphical depiction of soil classification in **Figure 2.6 k-value vs. Soil Classification**. Greater detail can be found using **Table 2.2 k-value Ranges for Various Soil Types**.

2.6.1.1.1 Cohesionless Soils (A-1 and A-3)

Recommended k-values ranges for insensitive to moisture variation A-1 and A-3 soils are summarized in Table 11 of the 1998 AASHTO Supplement as shown in **Table 2.2 k-value Ranges for Various Soil Types**. Shown in **Table 2.2** are typical ranges of dry density and CBR for each soil type.

2.6.1.1.2 Granular Materials (A-2)

Recommended k-values for granular materials that fall between A-1 and A-3 soils are summarized in Table 11 of the 1998 AASHTO Supplement as shown in **Table 2.2 k-value Ranges for Various Soil Types**. Shown in **Table 2.2** are typical ranges of dry density and CBR for each soil type.

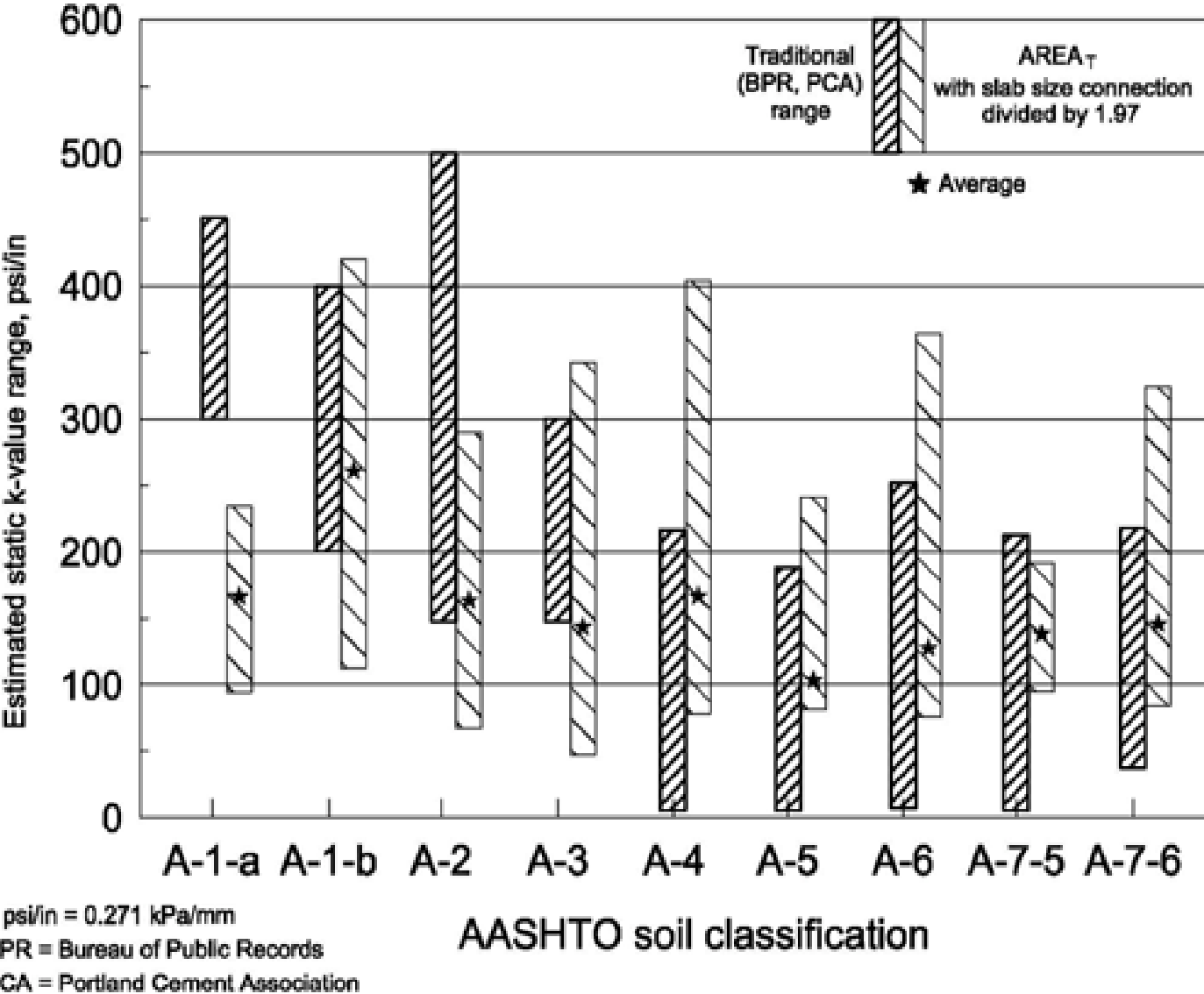

Figure 2.6 k-value vs. Soil Classification

2.6.1.1.3 Cohesive Soils (A-4 through A-7)

Recommended k-values for AASHTO classification of fine-grained A-4 through A-7 soils as a function of saturation are shown in the 1998 AASHTO Supplement and shown in **Figure 2.7 k-values Versus Degree of Saturation for A-4 through A-7 Soils**. Each line represents the middle range of reasonable values ± 40 psi/in.

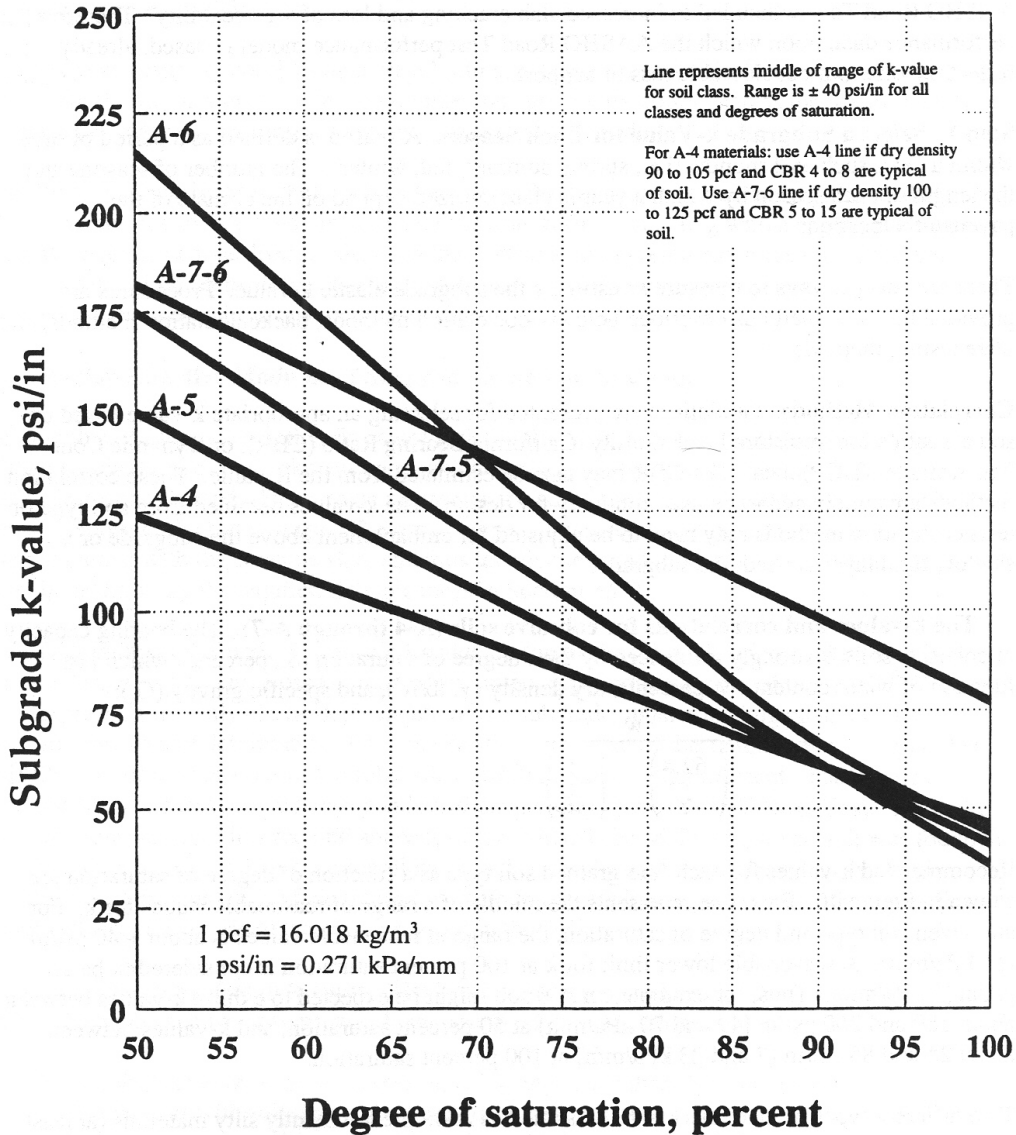

Figure 2.7 k-values Versus Degree of Saturation for A-4 through A-7 Soils

Table 2.2 k-value Ranges for Various Soil Types

AASHTO class	Description	Unified class	Dry density (lb/ft ³)	CBR (percent)	k-value (psi/in)
Coarse-grained soils:					
A-1-a, well graded	gravel	GW, GP	125 - 140	60 - 80	300 - 450
A-1-a, poorly graded			120 - 130	35 - 60	300 - 400
A-1-b	coarse sand	SW	110 - 130	20 - 40	200 - 400
A-3	fine sand	SP	105 - 120	15 - 25	150 - 300
A-2 soils (granular materials with high fines):					
A-2-4, gravelly	silty gravel	GM	130 - 145	40 - 80	300 - 500
A-2-5, gravelly	silty sandy gravel				
A-2-4, sandy	silty sand	SM	120 - 135	20 - 40	300 - 400
A-2-5, sandy	silty gravelly sand				
A-2-6, gravelly	clayey gravel	GC	120 - 140	20 - 40	200 - 450
A-2-7, gravelly	clayey sandy gravel				
A-2-6, sandy	clayey sand	SC	105 - 130	10 - 20	150 - 350
A-2-7, sandy	clayey gravelly sand				
Fine-grained soils:					
A-4	silt	ML, OL	90 - 105	4 - 8	25 - 165 *
	silt/sand/ gravel mixture		100 - 125	5 - 15	40 - 220 *
A-5	poorly graded silt	MH	80 - 100	4 - 8	25 - 190 *
A-6	plastic clay	CL	100 - 125	5 - 15	25 - 255 *
A-7-5	moderately plastic elastic clay	CL, OL	90 - 125	4 - 15	25 - 215 *
A-7-6	highly plastic elastic clay	CH, OH	80 - 110	3 - 5	40 - 220 *

* k-value of fine-grained soil is highly dependent on degree of saturation. See Figure 40.

These recommended k-value ranges apply to a homogeneous soil layer at least 10 ft [3 m] thick. If an embankment layer less than 10 ft [3 m] thick exists over a softer subgrade, the k-value for the underlying soil should be estimated from this table and adjusted for the type and thickness of embankment material using Figure 43. If a layer of bedrock exists within 10 ft [3 m] of the top of the soil, the k should be adjusted using Figure 43.

The notes refer to figures in the 1998 AASHTO Supplement.

2.6.1.2 Correlation of k-values using California Bearing Ratio (CBR)

Figure 41 of the 1998 AASHTO Supplement as shown in **Figure 2.8 Approximate k-value Range to CBR** graphs the approximate initial k-value range versus CBR.

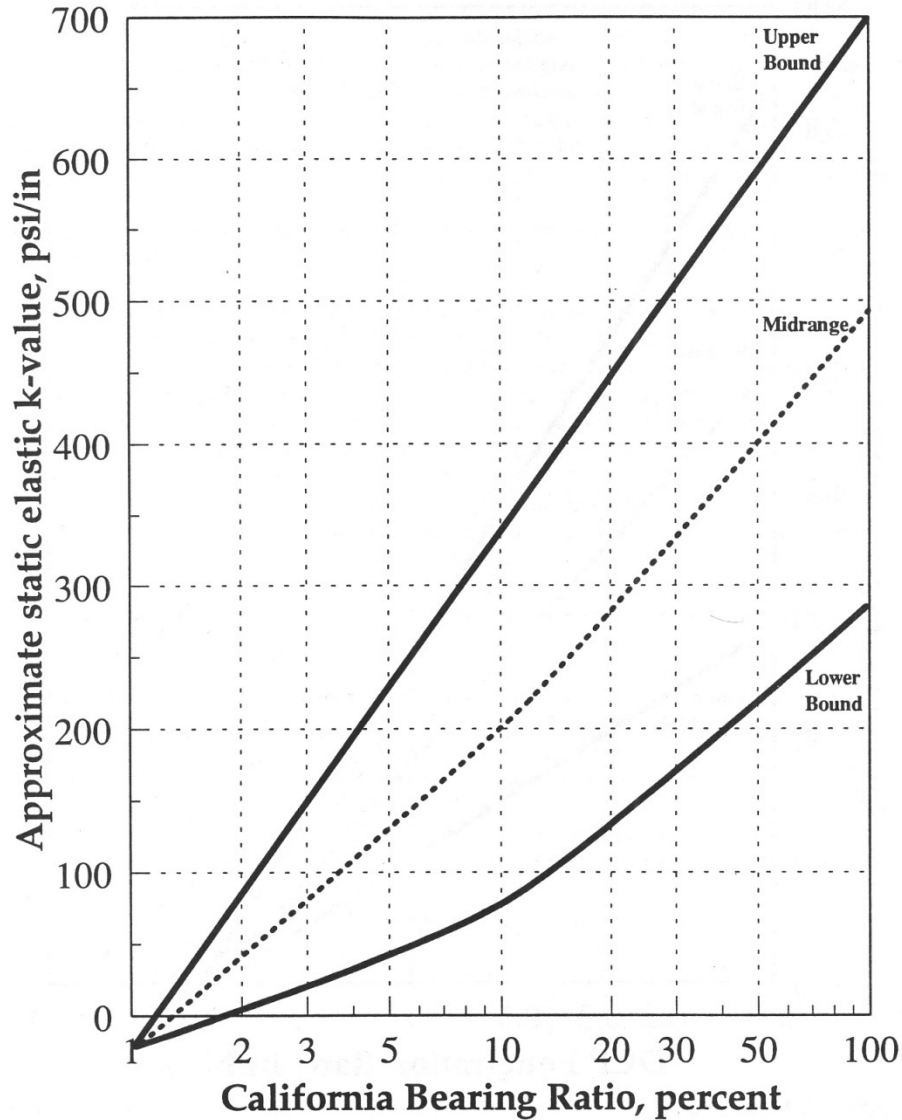

Figure 2.8 Approximate k-value Range to CBR

2.6.1.3 Correlation of k-values using Penetration Rate by Dynamic Cone Penetrometer

The Dynamic Cone Penetrometer (DCP) is a hand held testing device that gives a penetration rate (inches per blow). Figure 42 of the 1998 AASHTO Supplement as shown in **Figure 2.9 k-value Range versus DCP Penetration Rate** graphs the initial k-value versus penetration rate.

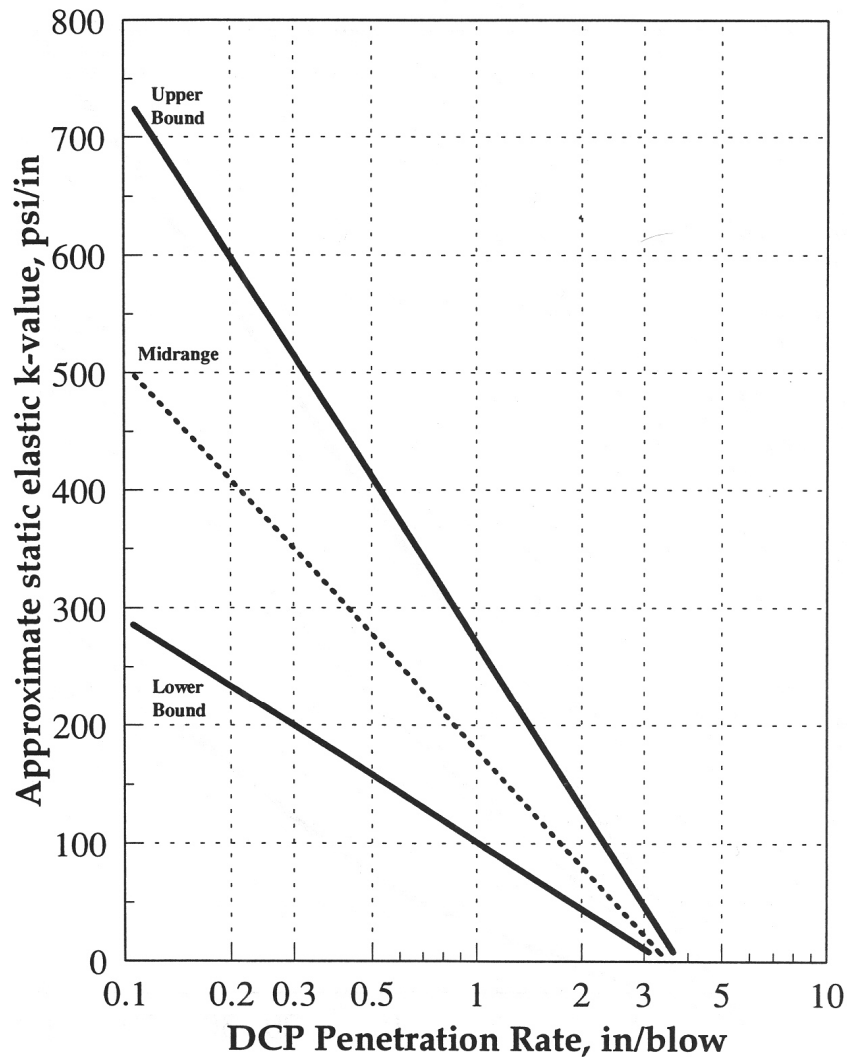

Figure 2.9 k-value Range versus DCP Penetration Rate

2.6.1.4 Plate Bearing Test Procedure

CDOT does not use the plate bearing procedure. It is presented here as an alternative. A plate 30 inches in diameter is to be used. There are two types of plate bearing tests: repetitive static plate loading or nonrepetitive static plate loading. For more information, see the 1998 AASHTO Supplement.

2.6.1.5 Deflection Testing and Backcalculation (Recommended)

Another procedure to determine the initial k-value is to use a Falling Weight Deflectometer (FWD). Discussion and guidelines for FWD testing and analysis is presented in **APPENDIX C - DEFLECTION TESTING AND BACKCALCULATION**. FWD testing and backcalculation computes a dynamic k-value. The dynamic k-value must then be converted to

the initial static k-value. Divide the mean dynamic k-value by two (2) to estimate the mean static k-value for further adjustments.

2.6.2 Adjustments

Each of the procedures and correlation methods to obtain the k-value stated above need to be adjusted. Adjustment to the k-value is needed to account for the seasonal variation. The initial individual k-values are associated with the seasonal variations and should represent such. The effective k-value uses a similar procedures as outlined in Section 2.5.1.1. The k-value used and discussed in Chapter 4 Principles of Design for Rigid Pavement uses the effective k-value as adjusted in the following sections.

2.6.2.1 Adjust the Initial k-value for the Seasons to Obtain an Effective k-value

The effective k-value is obtained by combining the each initial individual seasonal k-value into a single value. The effective k-value is a weighted average based on fatigue damage. A worksheet is presented in the 1998 AASHTO Supplement and the rigid pavement design software. The worksheet is shown in **Table 2.3 Season Adjusted Effective Subgrade k-value**.

Table 2.3 Season Adjusted Effective Subgrade k-value

Season	k-value (psi/in)	W ₁₈ (millions)	Relative Damage (1 / W ₁₈)
Mean Damage			
W ₁₈			million
Effective k-value			psi/in

2.6.2.2 Adjust the Effective k-value for Embankment and/or Shallow Rigid Layer

An adjustment of the effective k-value is needed if a fill embankment is placed above the natural subgrade and/or a rigid layer is present at a depth of 10 feet or less beneath the existing subgrade surface. The 1998 AASHTO Supplement as shown in **Figure 2.10 k-value Adjustment for Fill and/or Rigid Layer** is a nomograph to be used. This adjustment to the effective k-value is only applied if the initial k-values were determined based on soil type or similar correlations.

Note: If nondestructive deflection testing or field plate bearing tests determined the k-values, the adjustments to the effective k-value for embankment and/or shallow rigid layer have already been represented in the k-value.

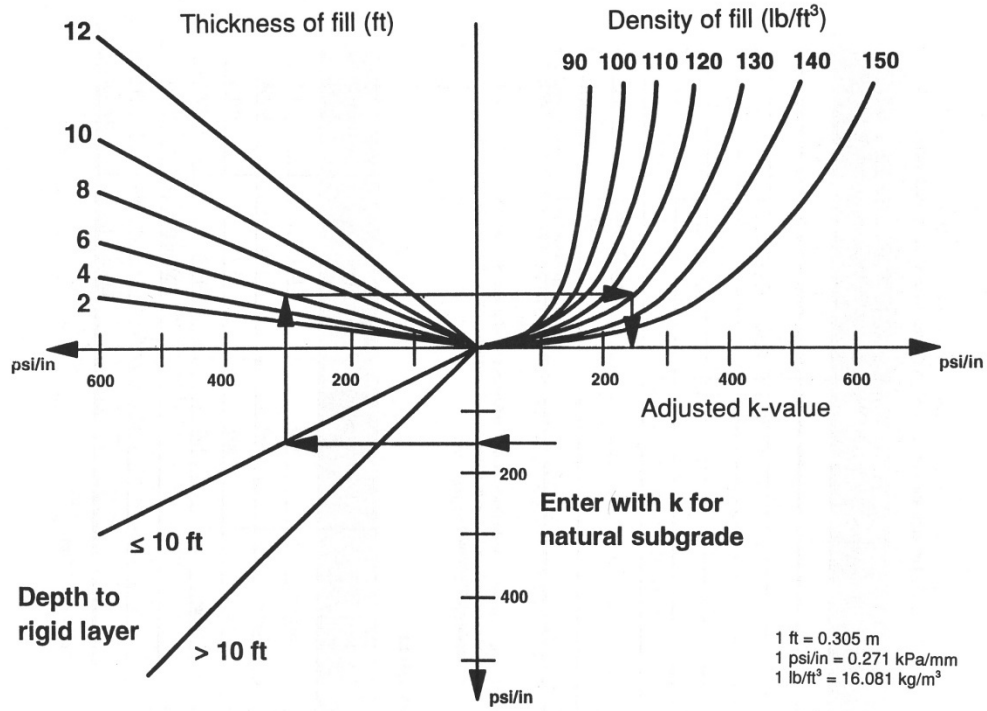

Figure 2.10 k-value Adjustment for Fill and/or Rigid Layer

2.6.3 Example

Given: A new 2.0 mile section of two-lane roadway is to be constructed. Soil samples were obtained every 1,000 feet from 0 to 2 feet below the proposed grade. The soils have an approximate degree of saturation of 80%. The depth to bedrock is 20.0 feet. The soil has the following soils characteristics.

Find: The k-value of the subgrade.

Table 2.4 Example Project Soils

Station	AASHTO Soil Classification	Liquid Limit	Plasticity Index	% Passing #200
2505+50	A-6(7)	32	14	64
2515+50	A-6(4)	27	11	62
2525+50	A-6(4)	27	11	63
2535+50	A-4(5)	27	9	75
2545+50	A-4(4)	27	9	69
2555+50	A-6(9)	32	14	75
2565+50	A-6(6)	29	12	68
2575+50	A-6(11)	40	20	88
2585+50	A-7-6(23)	44	25	84
2595+50	A-7-6(22)	45	26	84
2605+50	A-6(10)	31	11	94
2611+10	A-6(14)	35	16	88

Solution: From **Figure 2.7 k-values Versus Degree of Saturation for A-4 through A-7 Soils**, the k-value of the A-6 soil is between 60 psi/in and 140 psi/in and the A-7-6 soil is between 80 and 160 psi/in. **Figure 2.6 k-value vs. Soil Classification**, the average k-value of the A-6 soil is about 120 psi/in and the A-7-6 soil is about 100 psi/in. Since most of the soil samples are classified as an A-6, we would choose an average k-value of 120 psi/in. In accordance with **Table 2.5 Treatment of Expansive Soils**, the A-7-6 soils would require some treatment of the top 3 feet such as removal and replacement or lime stabilization. For this example, we will specify the removal of 3 feet of the A-7-6 soil and replacement with an A-6 soil or better.

2.7 Compacted Subgrade Layer

Compacted subgrades may take the form of three applied layer systems. The first and simplest is a pre-reconditioning of the finished subgrade. In some instances, the compacted subgrade may be designated as needing proof rolling only, usually before paving or placement of other engineered layers.

The second is the compacted subgrade layer in a fill section of compacted embankment. Embankment material will be contingent on having a resistance value (R-value), or equivalent resilient modulus value (M_R), of at least what is required by the pavement design and specified in the contract plans and specifications, and the material must have a maximum dry density of not less than 90 pounds per cubic foot. Refer to **Eq. 2.1** and **Eq. 2.2** for the correlation of R-value to M_R . Refer to the embankment fill (subgrade) section **Figure 2.11 Embankment Fill and Cut Sections** Embankments can be defined as the following two types:

- Soil Embankment shall consist predominantly of materials smaller than 4.75mm (No. 4) sieve in diameter. Soil embankment is constructed with moisture density control in accordance with the requirements of Subsection 203.07 - Construction of Embankment and Treatment of Cut Areas with Moisture and Density Control of *CDOT Standard Specification for Road and Bridge Construction*.
- Rock embankment shall consist of materials with 50 percent or more by weight, at field moisture content, of particles with least dimension diameters larger than 4.75 mm (No. 4) sieve and smaller than 6 inches. Rock embankment is constructed without moisture density control in accordance with the requirements of Subsection 203.08 - Construction of Embankments without Moisture and Density Control of *CDOT Standard Specification for Road and Bridge Construction*.

The pavement design subgrade thickness layer varies with embankment height. Refer to Section **2.6.2.2 Adjust the Effective k-value for Embankment and/or Shallow Rigid Layer** for adjustment to the effective k-value under rigid pavements.

The third is cut sections, the finished subgrade cut section is to be scarified to a depth of 6 inches, and moisture applied or removed as necessary and compacted to a specified relative compaction. Refer to the cut section in **Figure 2.11 Embankment Fill and Cut Sections**.

The designer needs to be aware of a few fill embankment requirements. Claystone or soil-like nondurable shale, as defined by Colorado Procedure 26, shall not be treated as sound rock and shall be pulverized, placed, and compacted as soil embankment. Claystone or soil-like nondurable shale particles greater than 12 inches in diameter shall not be placed in the embankment (17).

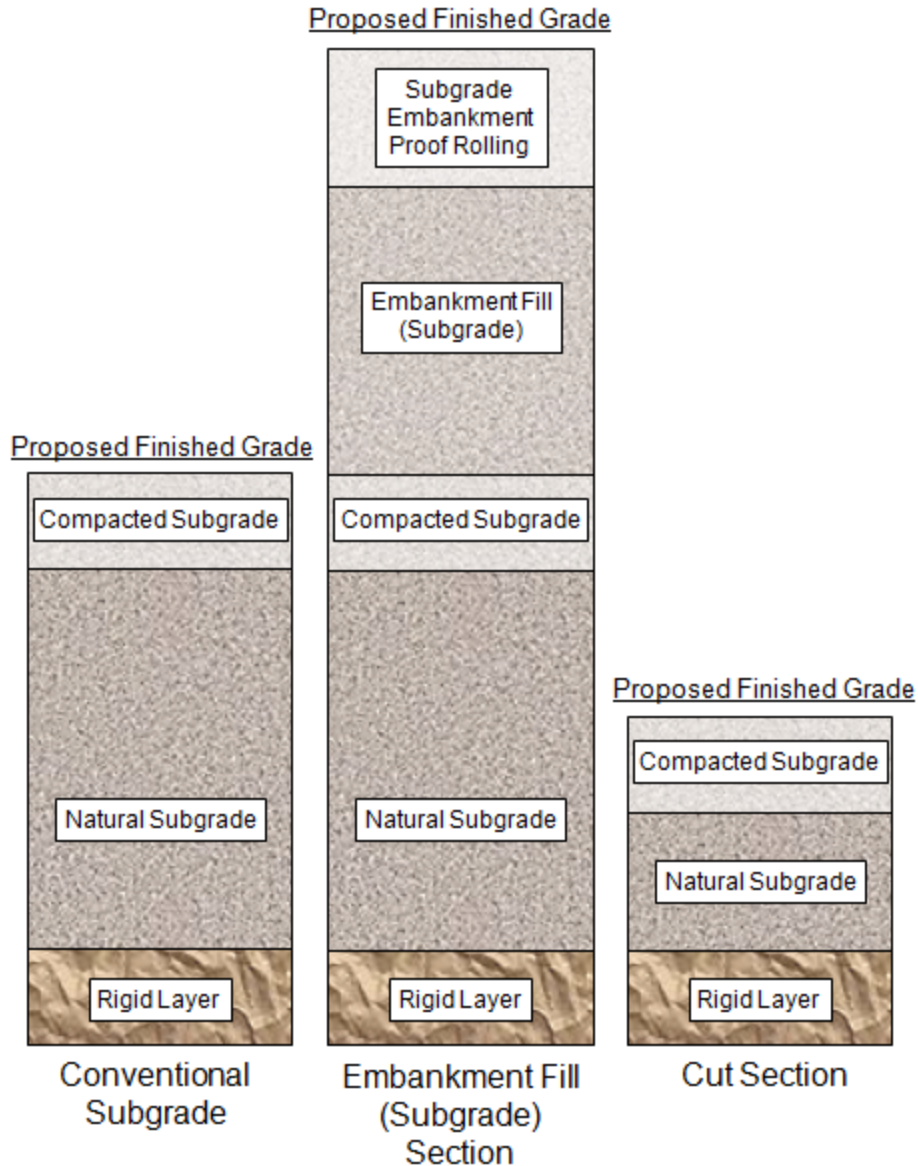

Figure 2.11 Embankment Fill and Cut Sections

2.7.1 Special Cases

2.7.1.1 Two Layer Embankment Fill

A special case of compacted subgrade is a fill section where the fill is comprised of two layers of subgrades with different engineering properties for each. The lower fill may comprise of a lesser R-value or resilient modulus than the upper layer. For illustration purposes, the upper embankment fill layer is shown here as special subgrade. The upper layer may require a higher engineered material R-value than the lower layer such as a R-value of 40 in the top 2 feet of subgrade, and the lower layer may have an R-value of 10. See **Figure 2.12 Special Cases of Embankment Fill**.

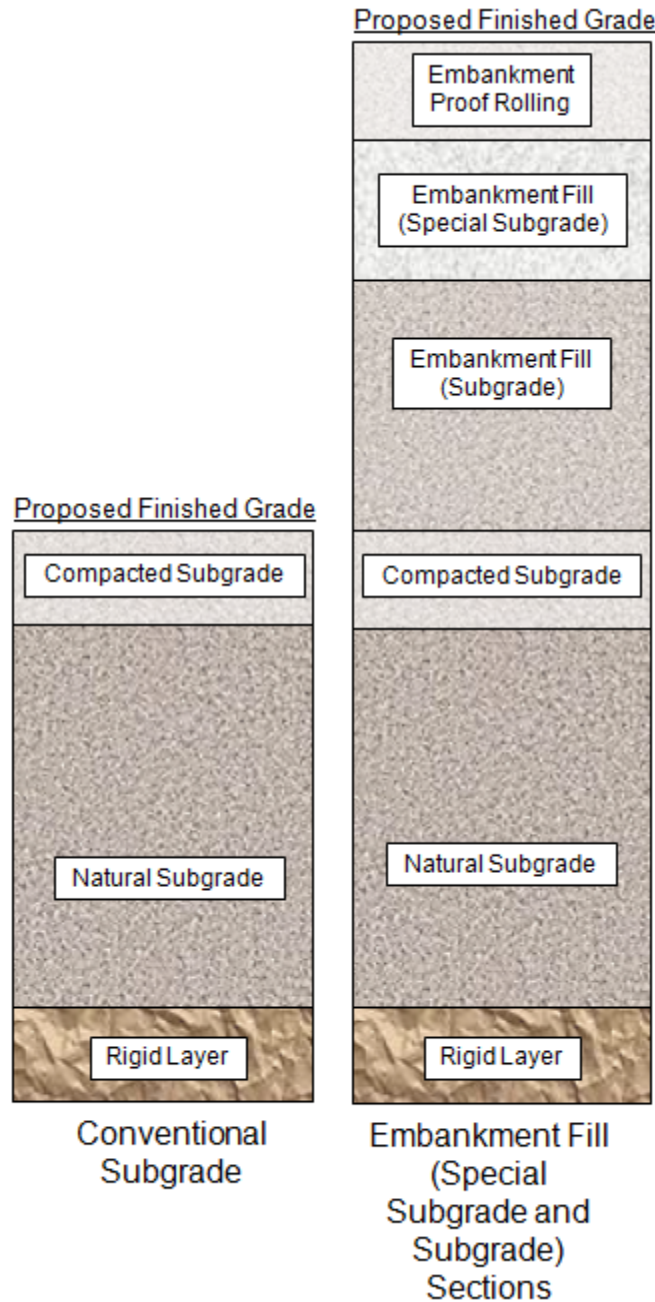

Figure 2.12 Special Cases of Embankment Fill

2.7.1.2 Frost Susceptible Soils

In areas subject to frost, soils may be removed and replaced with selected, nonsusceptible material. Where such soils are too extensive for economical removal, they may be covered with a sufficient depth of suitable material to overcome the detrimental effects of freezing and thawing. The need for such measures and the type and thickness of material required must be determined on the basis of local experience and types of materials (20). Frost heaving may be caused by crystallization of ice lenses in voids of soils containing fine particles. Bearing

capacity may be reduced substantially during thawing periods. Frost heaving can be more severe during freeze-thaw periods because water is more readily available. Several cycles of freeze and thaw may occur during a winter season and cause more damage than one longer period of freezing in more northerly areas of the state.

To compute the monthly or annual freezing index and estimate frost heave depth, the following equation is used:

$$FI = \sum_{i=1}^n (0 - T_i) \quad \text{Eq. 2.5}$$

Where:

- FI = freezing index, degrees Celsius (°C) degree-days
- T_i = average daily air temperature on day i, °C
- n = days in the specified period when average daily temperature is below freezing
- i = number of days below freezing

When using this equation, only the days where the average daily temperature is below freezing are used. Therefore, the freezing index is the negative of the sum of all average daily temperatures below 0 °C within the given period (29).

See **Figure 2.13 Colorado Annual Freezing Index (degrees-Fahrenheit days)** for a map of Colorado showing isopieth lines for the annual freezing index. The isopieth lines are in units of degree-Fahrenheit days. The highest Freezing Index values are in the mountains, Berthoud Pass, Taylor Park, and Climax. The lowest values are on the western side of the state, Gateway, Uravan, and Palisade. Note that the Freezing Index values do not necessarily follow elevations.

See **Eq. 2.6** to convert Annual Freezing Index (degrees-Fahrenheit days) to (degrees-Celsius days). The conventional conversion formula has the term 32°F and is all ready accounted for in the number of days below freezing.

$$FI = \text{Annual Freezing Index} (^{\circ}\text{C days}) = (5/9) \text{Annual Freezing Index} (^{\circ}\text{F days}) \quad \text{Eq. 2.6}$$

There is a relationship between Annual Freezing Index (FI) and frost depth. The seasonal monitoring program with FHWA Long-Term Pavement Performance sites analyzed this relationship (30). See **Eq. 2.7**.

$$\text{Frost Depth (meters)} = 0.0014 \times FI \quad \text{Eq. 2.7}$$

Where:

Frost Depth in meters

FI = Annual Freezing Index (degrees-Celsius days)

A graph was developed to show the relationship. See **Figure 2.14 Frost Depth to FI**. The scattered is influenced by local conditions at the sites. Refer to **Figure 2.15 Frost Susceptible Soil Classifications** for possible scatter.

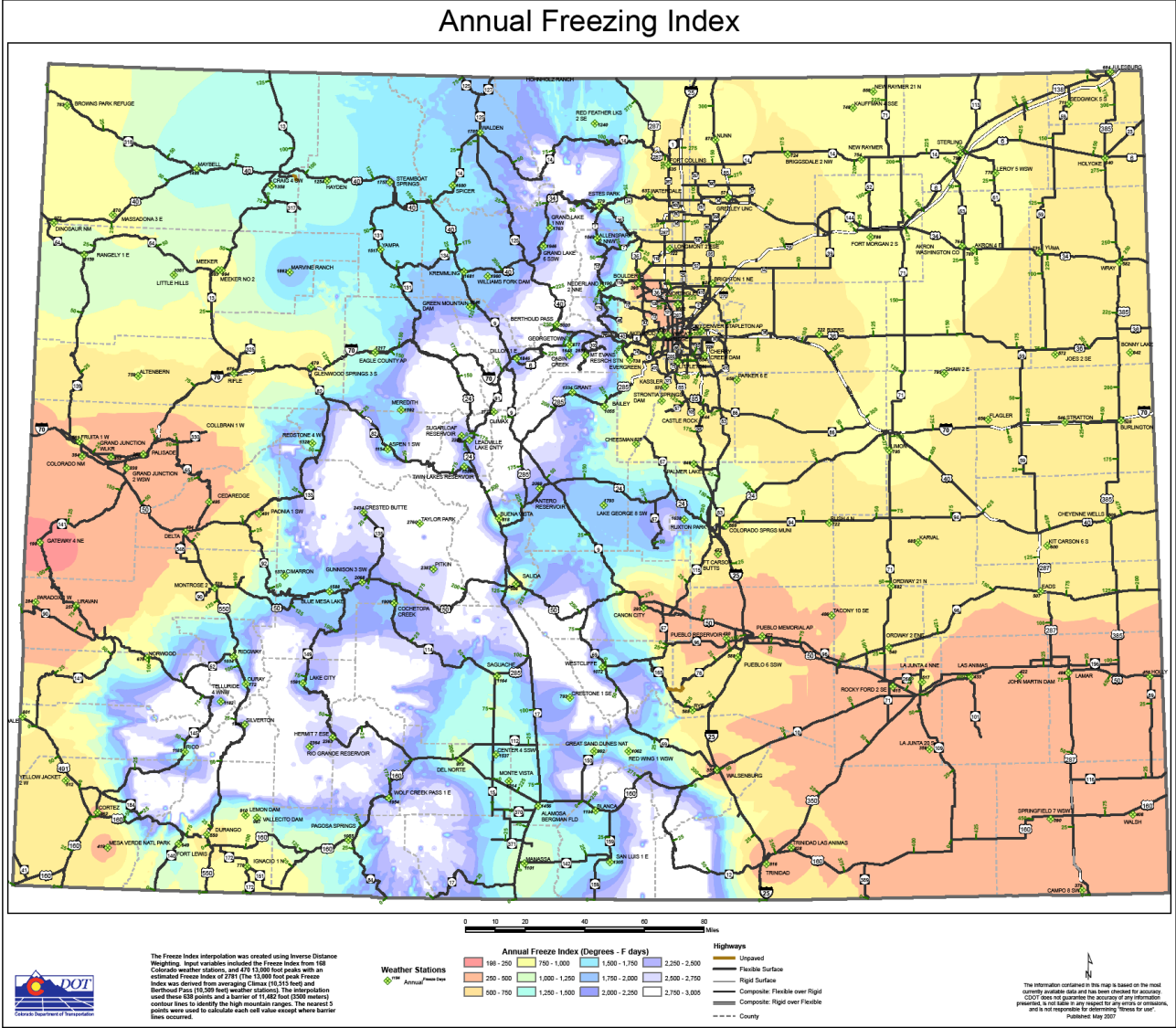

Figure 2.13 Colorado Annual Freezing Index (degrees-Fahrenheit days)

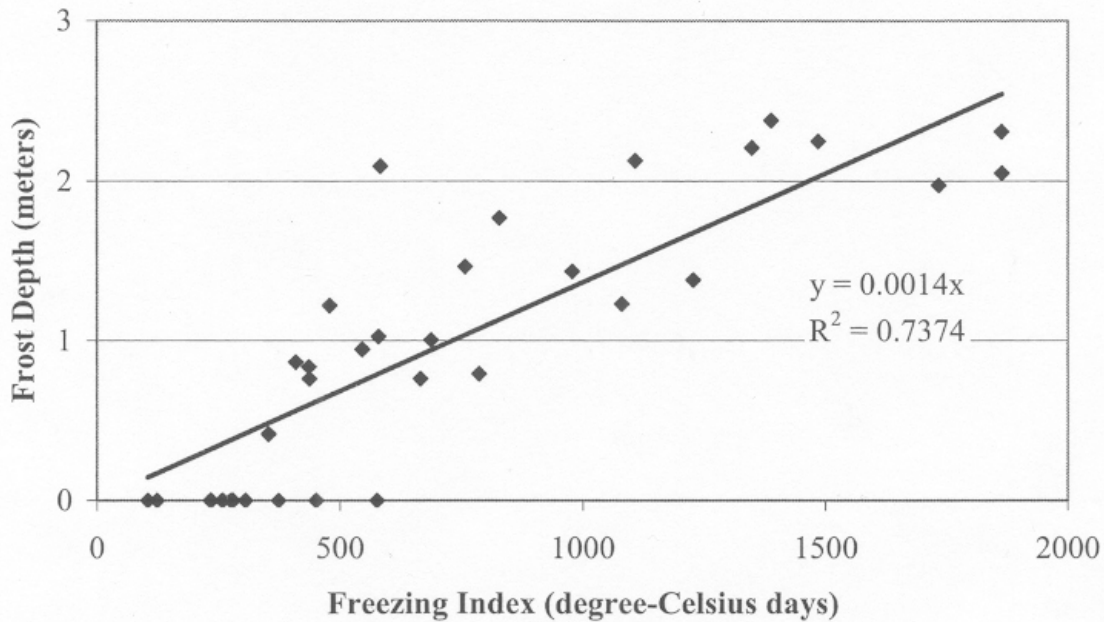
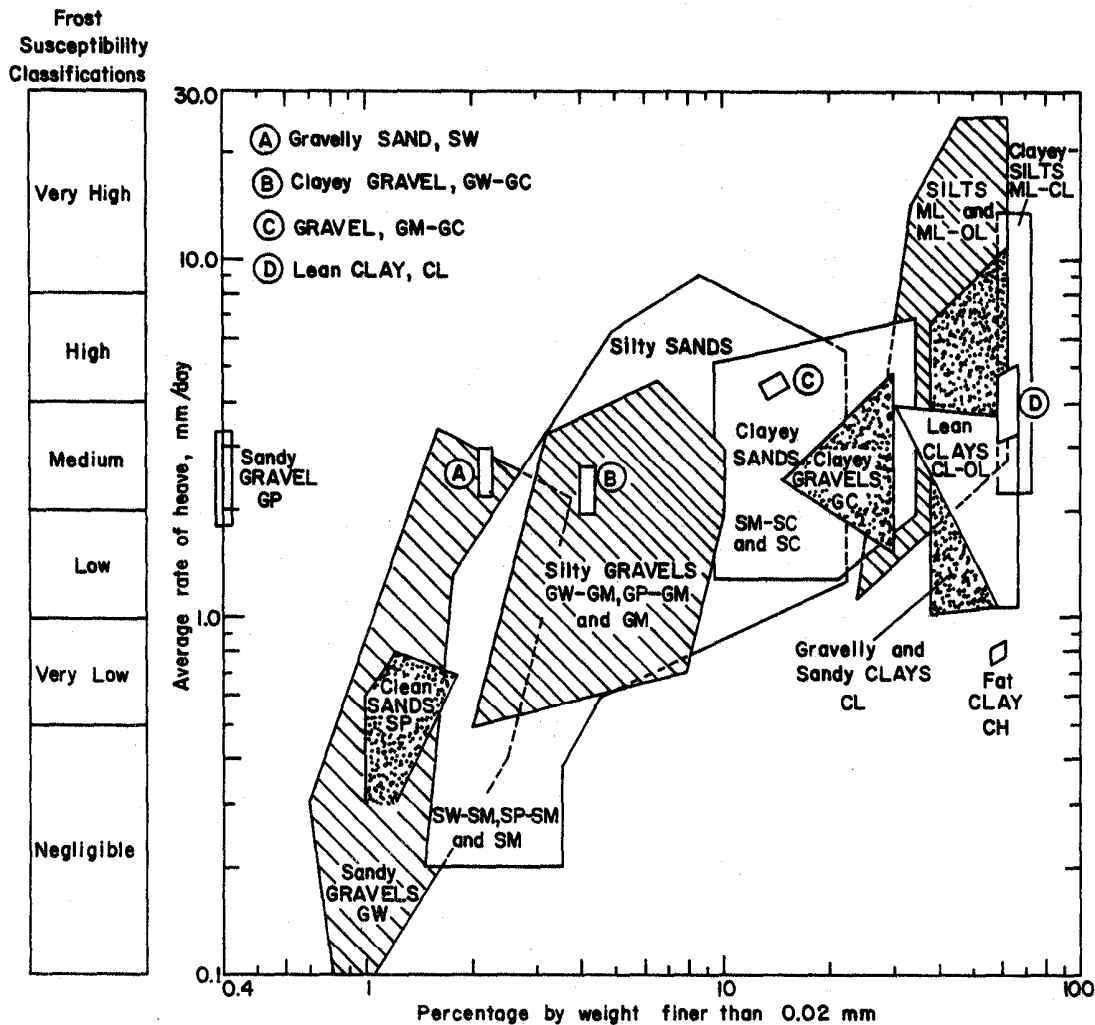

Figure 2.14 Frost Depth to FI

Frost susceptible soils have been classified into general groups (16):

- Gravels, crushed rock, sands, and similar materials exhibit little or no frost action when clean and free draining under normal freezing conditions.
- Silts are highly frost susceptible. The relatively small voids, high capillary potential/action, and relatively good permeability accounts for this characteristic.
- Clays are cohesive and, although their potential capillary action is high, their capillary rate is low. Although frost heaving can occur in clay soils, it is not as severe as for silts, since the impervious nature of clays makes passage of water slow. The supporting capacity of clays must be reduced greatly during thaws, although significant heave has not occurred.

Figure 2.15 Frost Susceptible Soil Classifications shows frost susceptibility for various soil classifications (31). The figure shows rates of heave in laboratory freezing tests on remolded soils. Because of the severity of the remolded laboratory test, the rates of heave shown in the figure are generally greater than may be expected under normal field conditions.



E. Summary Envelopes

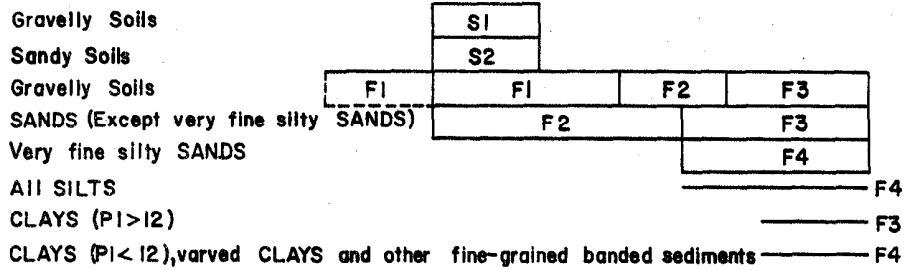

U.S. Army Corps of Engineers

Figure 2.15 Frost Susceptible Soil Classifications

Muck is an unsuitable material with a minimum of 15% organic material, in either natural subgrade, fill embankment or cut sections and should be disposed of. Muck may be soil made from decaying plant materials. Problems with highly organic soils are related to their extremely

compressible nature. Those of relatively shallow depth, are often most economically excavated and replaced with suitable select material. Deeper deposits have been alleviated by placing surcharge embankments for preconsolidation with provisions on removal of water (20).

In using the pavement design procedures, it is understood to use the final material properties of the soils in final construction. The design procedures use the proposed final properties as inputs to the design analysis. Therefore, the calculation of depth of frost penetration and suitable low frost susceptible soils must be performed prior to pavement design.

2.8 Expansive Subgrade Soils

Soils that are excessively expansive should receive special consideration. One solution is to cover these soils with a sufficient depth of select material to overcome the detrimental effects of expansion. Expansive soils may often be improved by compaction at water contents over the optimum. In other cases, it may be more economical to treat expansive soils by stabilizing with a suitable stabilizing agent, such as lime (20).

One treatment of expansive soils is done by performing the following subexcavation method. Subexcavate the expansive soil (dry dense unweathered shales and dry dense clays) and backfill with impermeable soil at 95 percent of maximum dry density at or above optimum moisture, in accordance with AASHTO Designation T 99. This treatment should carry through the cut area and transitions from cut to fill until the depth of fill is approximately equal to the depth of treatment.

Table 2.5 Treatment of Expansive Soils is to be used as a guide to determine the depth of treatment as Revised from Colorado Department of Highways Memo #323, (Construction) Swelling Soils, 1/5/1966. Projects on the Interstate and National Highway System will require treatment of expansive soils. Treatment may take the form of subexcavation and replace with impermeable soil or subexcavate and recompact with moisture control of the same soil. Refer to **Figure 2.16 Subexcavated Subgrade Layers**. Granular soils should not be used as backfill for subexcavation or replacement of expansive subgrade soils without a filter separator layer and edge drains to collect and divert the water from the pavement structure (26).

Table 2.5 Treatment of Expansive Soils

Plasticity Index	Depth of Treatment Below Normal Subgrade Elevation
10 – 20	2 feet
20 – 30	3 feet
30 – 40	4 feet
40 – 50	5 feet
More than 50	Placed in the bottom of the fills of less than 50 feet or greater than 6 feet in height, or wasted

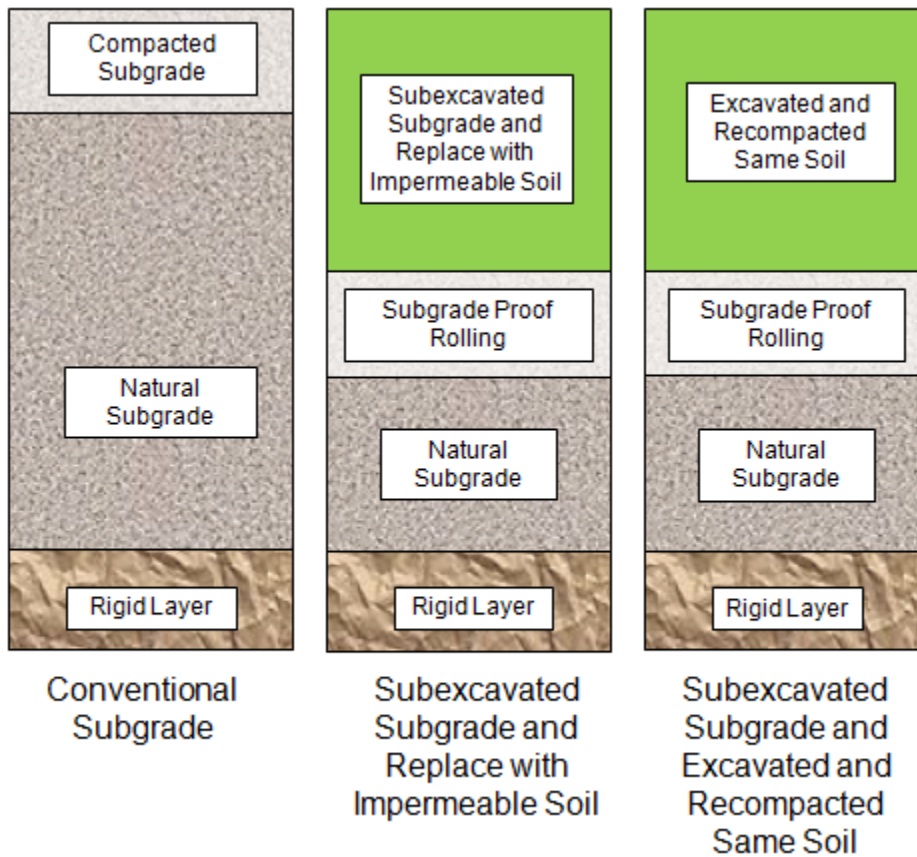

Figure 2.16 Subexcavated Subgrade Layers

Risk of swell potential is always a concern to the designer. A categorized of the "swell damage risk" is shown in **Table 2.6 Probable Swell Damage Risk**. The designer should use **Table 2.6 Probable Swell Damage Risk** and **Table 2.5 Treatment of Expansive Soils** to decide the risk.

Table 2.6 Probable Swell Damage Risk

Swell (%)	Swell Pressure (psf) (at 200 psf surcharge)	Probable Swell Damage Risk
0	0	None
0 - 1	0 - 1,000	Low
1 - 5	1,000 - 5,000	Medium
5 - 20	5,000 - 10,000	High
Over 20	Over 10,000	Very High

Potential swell risk characterized by the driver's perception has been published by the Metropolitan Government Pavement Engineers Council (MGPEC). Under the Section - Swelling Soils of the publication *Development of Pavement Design Concepts*, April 1998 (24) documents the driver's perception concept. A driver's perception of a bump is directly related to the slope of the bump. A driver's perception of pavement roughness is related to the vehicle speed. A design criteria separation of below and above 35 mph was found to be an appropriate separation. Slopes representing the maximum allowable movement before causing discomfort to the driving public have been analyzed relating to the vehicle speed. Streets with speeds less than 35 mph have a discomfort level of a 2% change. Higher speed streets and highways have a discomfort level of a 1% change. The slope of the heave is also related to the depth of the moisture treatment (subexcavation by means of excavate and recompact). **Figure 2.17 Effective Depth of Moisture Treatment** and **Figure 2.18 Recommended Depth of Moisture Treatment** graph the concept of slope of the bump and depth of recommended moisture treatment.

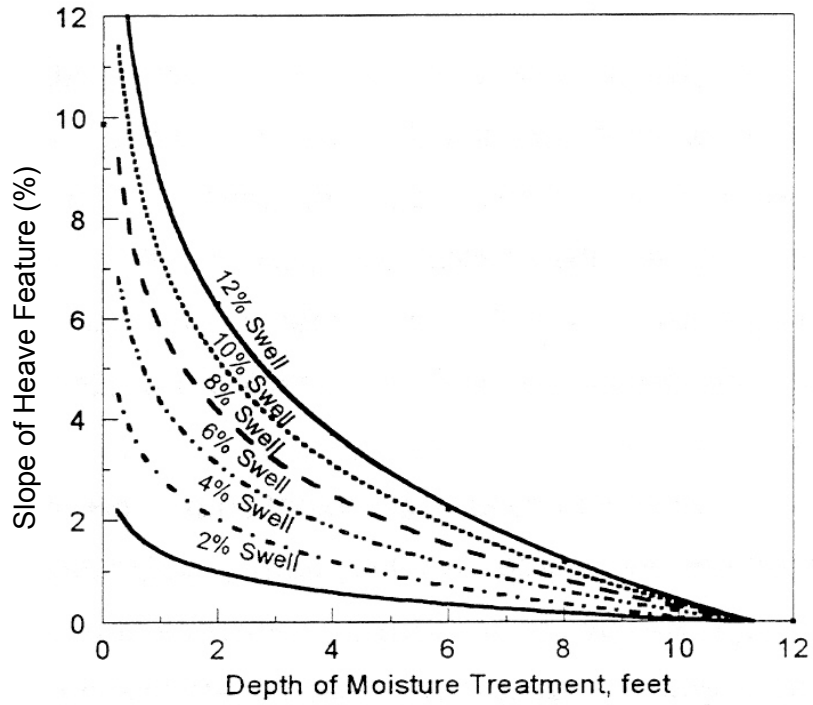

Figure 2.17 Effective Depth of Moisture Treatment

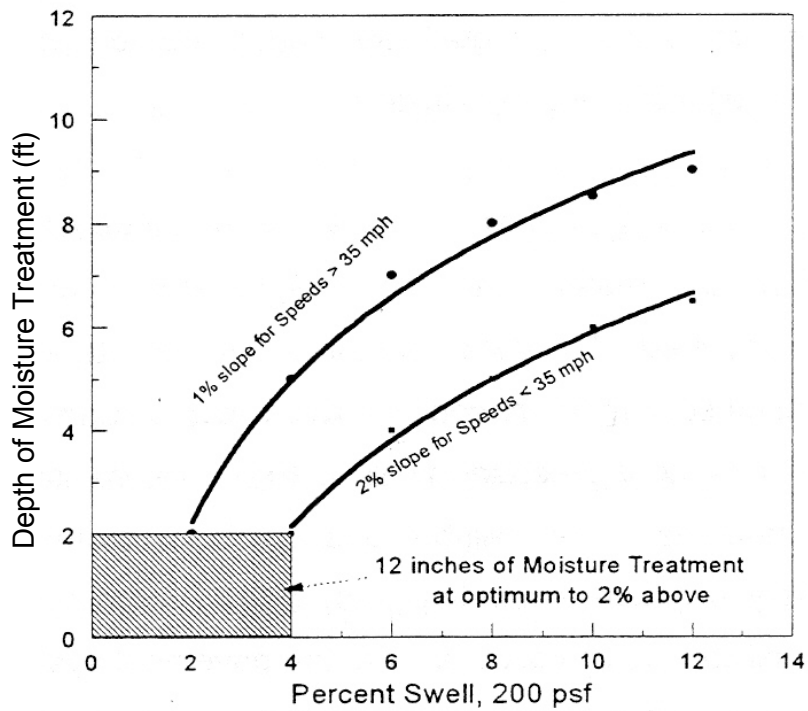

Figure 2.18 Recommended Depth of Moisture Treatment

Table 2.6, Figure 2.17 and Figure 2.18 use the percent swell to determine the depth of subgrade treatment. **Table 2.5** uses the Plasticity Index to determine the depth of subgrade treatment. The designer should consider each of the methods and know the field conditions to make a reasonable decision.

2.9 Stabilizing Agents

The strength and stability of all subgrade soils improve on compaction. For certain subgrade soils, the strength gained, even after compaction may not be adequate. Similarly, silty and clayey subgrade soils may be collapsible or expansive in nature, and thus not suitable for pavement construction. Stabilization of soils is an effective method for improving the properties of soil and pavement system performance. Mechanical stabilization is the process in which the properties of subgrade soils are improved by blending and compacting the subgrade soils without the use of admixtures or stabilizing agents. However, unstable and expansive subgrade soils may be stabilized through chemical stabilization. For many soils, many stabilizing agents may be effective by improving soil properties in-place rather than removing and replacing material or increasing base thickness. Availability or financial considerations may be the determining factor on which a stabilizing agent is used. The objective of stabilizing agents is to increase the strength and stiffness of soil, improve workability and constructability of the soil, and reduce the Plasticity Index (PI) and swell potential for expansive clays. The following are the various stabilizing agents used for chemical stabilization.

Approved stabilizing agents are asphalt, lime, lime/fly ash, fly ash, portland cement, and approved chemical stabilizers. Other agents may be used with the prior approval of the Department. The approved stabilizing agents are combined with selected aggregate or soils or with native materials to improve their stability and strength as load carrying elements of structural sections. The type and amount of stabilizing agent should be developed from tests of available materials and then cost comparisons made against untreated materials.

Lime generally performed better on fine-grained materials, cement on coarse-grained soils, and fly ash performed well mostly on silty sands. Cement also provides highly effective clay stabilization, usually with the added benefit of higher strength gain but quality control may be difficult. However, the following chart, **Figure 2.19 Lime/Cement Stabilization Flow Chart**, provides a good estimate of the lime and cement for a certain soil type dependent upon gradation and PI.

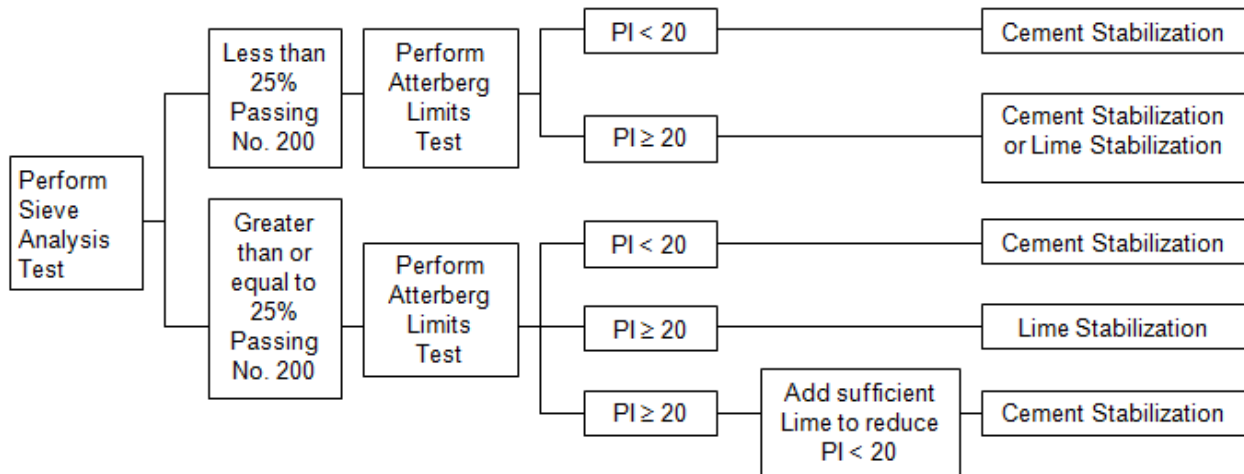

Figure 2.19 Lime/Cement Stabilization Flow Chart

2.9.1 Lime Treated Subgrade

When swell potential as determined by ASTM D 4546 is found to be greater than 0.5% using a 200 psf surcharge then stabilization should be used, as per *CDOT Standard Specification for Road and Bridge Construction, 2005* specification book, Table 307-1. If the R-value of the subgrade soil is greater than 40, the use of a base layer is not recommended in the structural layering of a potential swelling soil. Soil with a PI of more than 50 should be placed in the bottom of the fills of less than 50 feet in height, or wasted. The backfill soil should be uniform and all lenses or pockets of very high swelling soil should be removed and replaced with the predominant type of soil that has a PI less than 50. If removal is not practical or subgrade soils were determined to have a PI greater than 10, in-place treatment such as a lime-treated subgrade is recommended. However, a subgrade proposed for lime treatment should be investigated for sulfates. In some cases, such as construction over a rocky subgrade or when having to maintain traffic over a widened section, an aggregate base may be desirable.

Lime treated subgrade consists of blending the existing subgrade material with a minimum of 3 percent lime, by weight, per design, to the specified depth and compaction. Refer to **Figure 2.20 Lime Treated Structural Subgrade Layer**. Lime may be either quicklime or hydrated lime, shall conform to the requirements of ASTM C 977 along with a rate of slaking test for quicklime in accordance with ASTM C 110, and shall be the product of a high-calcium limestone as defined by ASTM C 51. The use of dolomitic quicklime or magnesia quicklime with magnesium oxide contents in excess of 4 percent, carbonated hydrated lime, and lime kiln dust or cement kiln dust shall not be allowed unless approved by the RME.

Some soils, when treated with lime, will form cementitious compounds resulting in a relatively high strength material. Lime reduces the ability of clays to absorb water thus increasing internal friction and shear strength. Lime provides greater workability by changing the clays into friable sand-like material and reduces the Plasticity Index (PI) and swell potential.

The designer should test the soil for the concentration of water-soluble sulfates prior to recommending lime stabilization of the subgrade. Water-soluble sulfate content should be less

than 0.2% by mass. Sulfate content greater than 0.2% can cause an adverse reaction among the lime, soil, sulfate ions, and water. This can lead to loss of stability and cause swelling or heave. Additionally, excessive lime in the subgrade can create leaching of calcium into the ground water. For more information, see Chapter 200 of the CDOT Field Materials Manual.

Additional treatment of the natural subgrade may be needed. If lime treatment depth seems to be too thick to be practical, the swell potential subgrade may need to be excavated and recompacted to a depth as shown in **Table 2.5 Treatment of Expansive Soils**. The recompaction shall be at $2\% \pm 1\%$ above optimum moisture control. Refer to **Figure 2.20 Lime Treated Structural Subgrade Layer**.

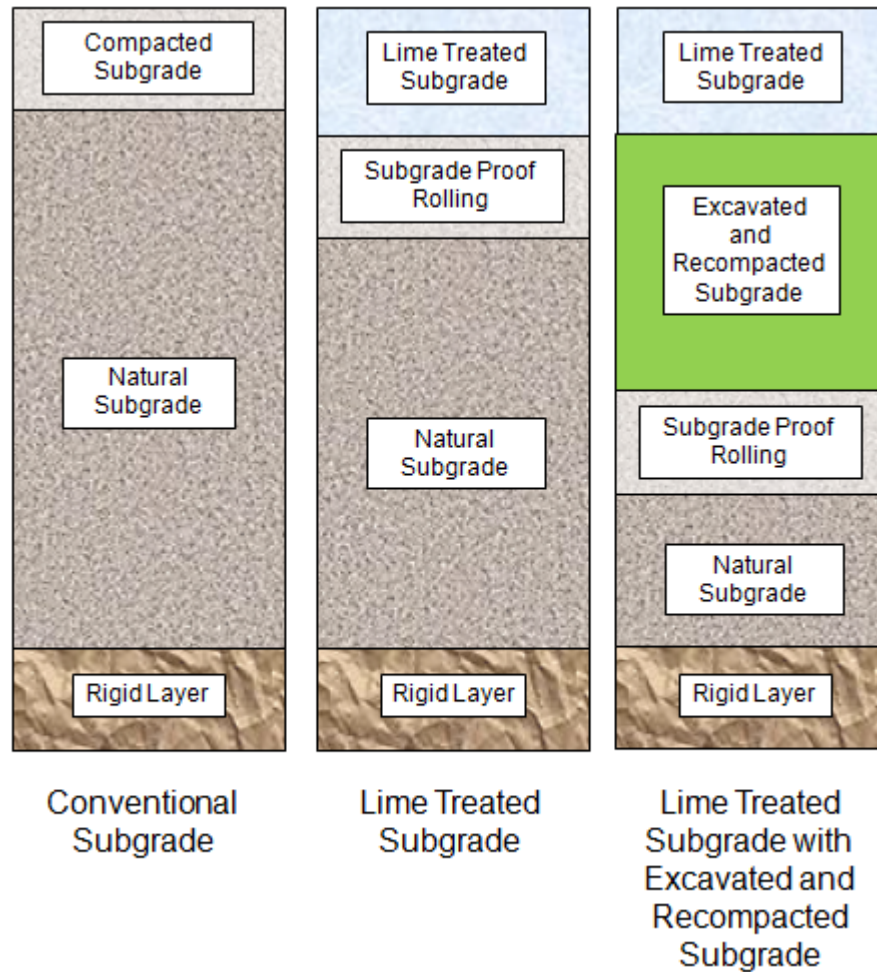

Figure 2.20 Lime Treated Structural Subgrade Layer

Figure 2.21 Cross Section of Lime Treated Cut Section Subgrade shows the extent of the subexcavation, excavated and recompacted treatment, or moisture treatment in cross sectional view.

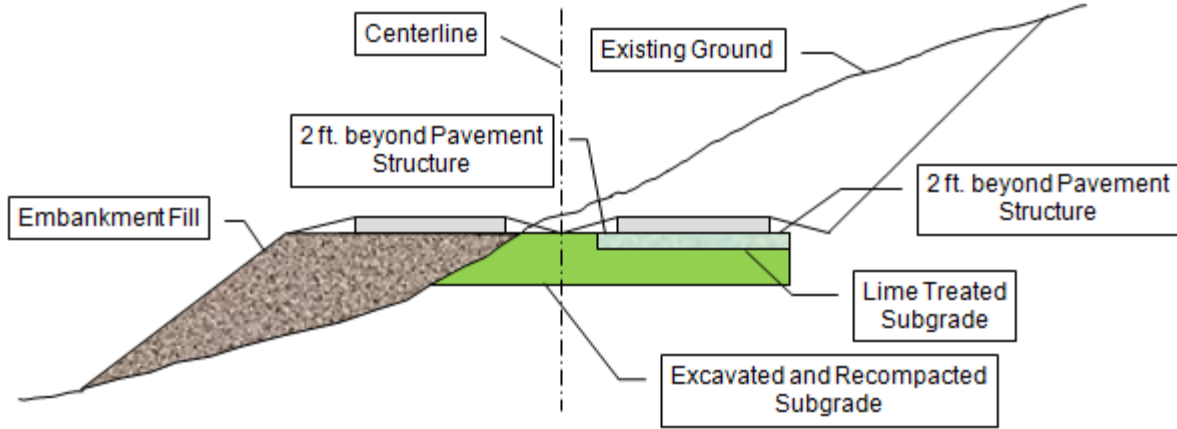

Figure 2.21 Cross Section of Lime Treated Cut Section Subgrade

2.9.2 Cement Treated Subgrade

Cement is typically used to stabilize fine and coarse sands and low PI clays where the PI is less than 20. Refer to **Figure 2.22 Cement Treated Structural Subgrade Layer**. Cement treated subgrade will have higher unconfined strengths, low permeability, and inhibits leaching. Cement treated subgrade reduces permeability of the soil and can rapid set within 2 hours of the subgrade treated being treated. Normal percentages used in cement treated subgrade are from 2% up to 15% by weight.

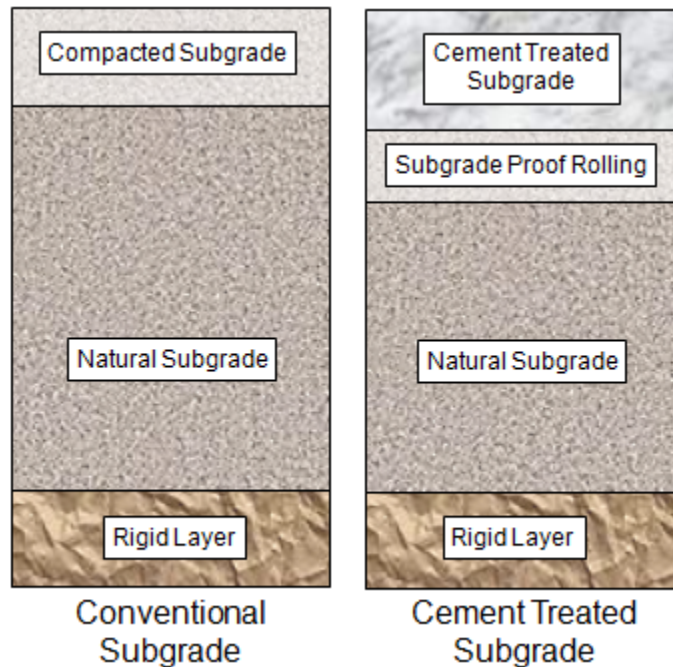

Figure 2.22 Cement Treated Structural Subgrade Layer

2.9.3 Fly Ash and Lime/Fly Ash Treated Subgrade

CDOT recommends the use of Class C fly ash as a stabilizing agent due to its calcium content. It can be used in sands and clays with low PI's and at percentages of up to 25%. Fly ash percentages in the subgrade of greater than 25% can lead to a decrease in density and durability issues. Fly ash treated subgrade will typically see increased unconfined compressive strengths similar to lime and increased sand maximum densities. Refer to **Figure 2.23 Fly Ash Treated Structural Subgrade Layer**.

When used, the typical lime/fly ash content of a mixture ranges from 12% to 30% with lime to fly ash ratios of 1:3 to 1:4 being common. Class C fly ash is recommended for these mixtures. The designer may use high carbon Class C fly ash for soil stabilization.

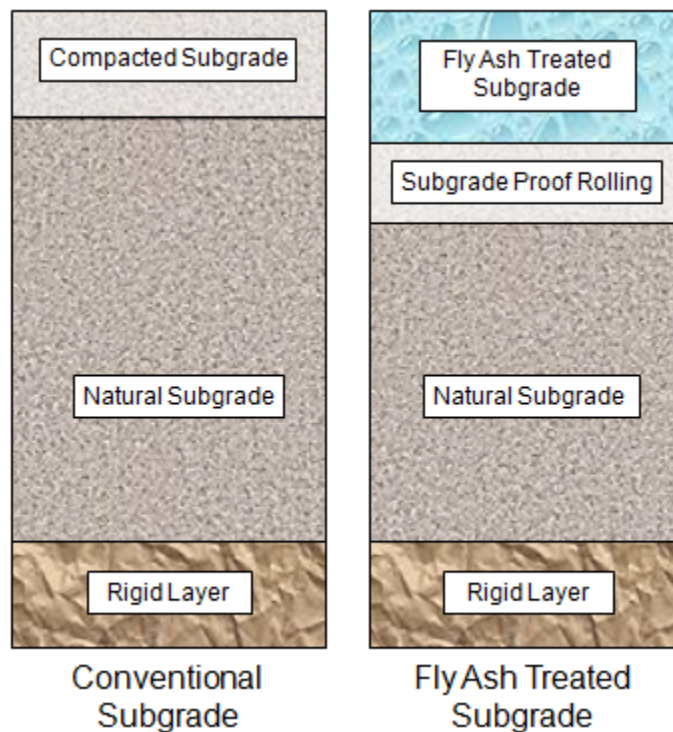

Figure 2.23 Fly Ash Treated Structural Subgrade Layer

2.10 Geosynthetic Fabrics and Mats

If coarse, open-graded base or subbase courses are used, it may be necessary to provide a means for preventing the intrusion of the underlying fine-grained roadbed soils. Historically preventive measures usually consist of providing a layer of suitable material to act as a barrier between the roadbed soils and the susceptible subbase or base. An engineered aggregate layer serves this purpose. To ensure that the gradation of the separator layer will prevent subgrade fines from migrating up, the following criteria are imposed (20, 22). **Eq. 2.8** may be referred to as the piping ratio.

$$D_{15B} \leq 5 \times D_{85S}, \text{ and} \quad \text{Eq. 2.8}$$

$$D_{50B} \leq 25 \times D_{50S} \quad \text{Eq. 2.9}$$

Where:

D_{15B} = particle size wherein 15 percent of the base or subbase course particles are smaller than this size.

D_{85S} = particle size wherein 85 percent of the roadbed soil particles are smaller than this size.

D_{50B} = particle size wherein 50 percent of the base or subbase course particles are smaller than this size.

D_{50S} = particle size wherein 85 percent of the roadbed soil particles are smaller than this size.

Separation fabrics used to separate fine grain silts and clays from open-graded drainage mats and subbase/base materials are an especially valuable and cost-effective application. Without them, a soft subgrade could inundate the more open void spaces of drainage mats and base courses, thereby decreasing their strength and ability to drain.

Geosynthetic fabrics and mats can be used as reinforcement in a variety of ways within and below the pavement section. Any time poor or marginally acceptable in-situ soils are encountered, geosynthetic fabrics and mats should be considered. CDOT Soils and Rockfall Program personnel are available to help in the selection of the most appropriate product. Technical representatives for individual brand materials are also available.

For additional information on material use and approved products, the CDOT Materials Bulletin dated 25 January 2008, clarifies the terminology and application of geosynthetics, as specified in the Standard Specifications and the standard special provision (SSP), *Revision of Sections 208, 420, 605, and 712 – Geosynthetics and Geotextiles* (32).

2.11 Bases

A base course is a layer of material beneath the surface course pavement. The design and construction of a pavement structure may include one or more base courses. It is constructed on the subbase course, or, if no subbase is used, directly on the natural subgrade. Bases may be used in various combinations to design the most economical structural section for the specific project. Bases should be non-erodible, especially under rigid pavements. Bases may be constructed of gravels, mixtures of soil and aggregate, mixtures of asphalt and aggregate,

mixtures of cement and aggregate or soil, or other innovative materials. Bases may be made of unbound materials, such as gravel, or bound materials, such as lime treated subgrade (17).

2.11.1 Aggregate Base Course (ABC)

Aggregate base is normally specified as the lowest element of any structural section because it generally results in the most economical design. It may consist of more than one layer. Refer to **Figure 2.24 Unbound Aggregate Base Course Layers**.

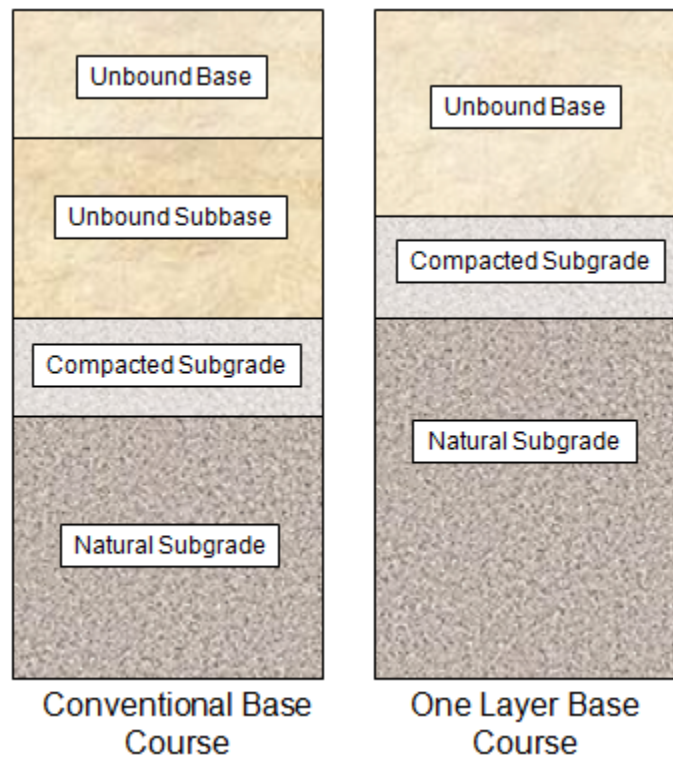

Figure 2.24 Unbound Aggregate Base Course Layers

Aggregate base courses under flexible pavements provide a significant increase in structural capacity. Pavement design of flexible pavement depends on the wheel loads being distributed over a greater area as the depth of the pavement structure increases. Thick granular layers aim to improve the natural soil subgrade foundation of weak, fine-grained subgrades. Thick granular bases are generally greater than 18 inches thick (16). Added benefits include improved drainage by preventing the accumulation of free water, protection against frost damage, prevent intrusion of fine-grained roadbed soils in base layers, provide a uniform underlying surface course support, and to provide a construction platform.

Subbase layers are usually distinguished from the base course layers by less stringent specification requirements for strength, plasticity, and gradation. Because it is obvious that the subbase course must be of significantly better quality than the roadbed soil, the subbase is often omitted if roadbed soils are of high quality. When the roadbed soils are of relatively poor quality and the design procedure indicates the requirement for substantial thickness of pavement,

alternate designs should be prepared for structural sections with and without subbase. A selection may be made based on availability and relative costs suitable for base and subbase (20). Unbound subbase layers may be of pit-run gravels. The pit-run gravels are comprised of rounded rock, sand, and soil mixture. Typically, sand or granular materials, or course grained materials with limited fines, corresponding to AASHTO A-1 and A-2 soils may be used. California Bearing Ratio (CBR) and/or resilient modulus testing may measure strength and stiffness of the subbase. Subbases having strengths and stiffness of CBR values 6% or greater, corresponding resilient moduli (M_R) of approximately 8,000 psi, R-value of 50, or structural coefficient (a_3) of 0.06 would be designated as an aggregate subbase material.

CDOT bases may range from R-value from 69 to 83, M_R from 20,000 to 48,675 psi, with a structural layer coefficient (a_2) from 0.10 to 0.19. Refer to **Table 3.2 Recommended a_i Values for the Structural Layer Coefficients**, **Table 3.3 Recommended a_i Values for the Base Layer Coefficients**, and **Figure 3.4 Correlation of Soil Support Indices to Structural Base Layer Coefficients** for the above approximate values. Slight differences of the suggested values can be found in charts, graphs, and correlation tables of other publications. CDOT Aggregate Base Course Class 1, 2 or 3 would be classified as a subbase. Class 1 and 2 are more restrictive because of the sieve sizing than Class 3 (pit-run). Aggregate base courses Class 4 and Class 6 limit the fines to 3-12% percent passing the # 200 sieve. When the gradation approaches the 12% passing, the base becomes impermeable. When the gradation approaches the 3% limit they tend to be more permeable.

Aggregate base courses under rigid pavements provide a drainage layer, reduce pumping, provide protection against frost damage, provide uniform, stable, permanent support, and provide support for the heavy equipment usually used for placing rigid pavement. There is some increase in structural capacity when a base is placed under a rigid pavement, but typically not a significant amount (17). Bases provide uniform support of rigid pavements across the joints and under the entire slab. A non-erodable base is most desirable. To limit pumping of fines through the joints, a good base course gradation such as an Aggregate Base Course (Class 6) limits the fines to 3-12% percent passing the # 200 sieve. The base course is considered a structural layer of the pavement along with the concrete slab, thus its thickness and modulus are important design values (19).

Aggregates for bases should be crushed stone, crushed slag, or crushed reclaimed concrete and shall conform to the requirements of Section 703.03 and **Table 2.7 CDOT Classification for Aggregate Base Course** and **Table 2.8 CDOT Classification for Reclaimed Asphalt Pavement** and quality requirements of AASHTO M 147. Placement and compaction of each lift layer shall continue until a density of not less than 95 percent on the maximum density determined in accordance with AASHTO T 180 has been achieved (13). FHWA also recommends using only crushed aggregates in the unbound base layer to maintain good mechanical interlock.

Table 2.7 CDOT Classification for Aggregate Base Course

Sieve Size	Mass Percent Passing Square Mesh Sieves						
	LL not greater than 35			LL not greater than 30			
	Class 1	Class 2	Class 3	Class 4	Class 5	Class 6	Class 7
6"			100				
4" (100 mm)		100					
3" (75 mm)		95-100					
2-1/2" (60 mm)	100						
2" (50 mm)	95-100			100			
1-1/2" (37.5 mm)				90-100	100		
1" (25 mm)					95-100		100
3/4" (19 mm)				50-90		100	
#4 (4.75 mm)	30-65			30-50	30-70	30-65	
#8 (2.36 mm)						25-55	20-85
#200 (75 µm)	3-15	3-15	20 max.	3-12	3-15	3-12	5-15

NOTE: Class 3 material shall consist of bank or pit-run material.

The design thickness should be rounded up to the next 1.0-inch increment.

2.11.2 Treated Base Course

The use of bases in the design of rigid pavements is a function of the structural quality of the pavement material characterized by the modulus of rupture and elastic modulus. In comparison to the strength of the concrete slab, the structural contributions of the underlying layers are relatively small. Treated or untreated bases can be used under rigid pavements, but their use is not mandatory. **Figure 2.25 Stabilized Treated Structural Base Layers** shows several materials historically used by CDOT as bases on the effective modulus of subgrade reaction.

Treated bases under flexible pavements are similar to rigid pavements. The structural capacity is increased while decreasing the flexible pavement thickness. They are used to strengthen a weak subgrade. The treated bases are another design tool to be used in the layering system to place lower quality materials in the bottom courses.

Plant Mix Bituminous Base (PMBB) is composed of a mixture of aggregate, filler if required, hydrated lime, and bituminous material. The aggregate and bituminous materials are mixed in a central batch plant. Several aggregate fractions are sized, uniformly graded and combined in such proportions that the resulting composite blend meets the job-mix formula. PMBB is a very good non-erodable base.

Emulsified Asphalt Treated Base (EATB) is composed of a mixture of aggregate, water if required, and emulsified asphalt. The aggregate and emulsified asphalt is mixed in a central batch plant. Aggregates are specified by meeting the classification of aggregate base course. In certain instances subgrades may be used if, they are sandy and do not have an excessive amount of material finer than the No. 200 sieve. Placement and spreading is by approved spreading devices capable of achieving specified surface tolerances. Compaction is to not less than 95% of AASHTO T 180.

Cement Treated Base (CTB) is a mixture of aggregate and portland cement. The aggregate is obtained from scarifying the existing roadway and shall meet specified gradation. Mixing is accomplished by means of a mixer that will thoroughly blend the aggregate with the cement. The mixer is equipped with a metering device that will introduce the required quantity of water during the mixing cycle. Another option is to have the aggregate proportioned and mixed with cement and water in a central batch plant. Compaction is to at least 95% of AASHTO T 134 - Moisture-Density Relations of Soil-Cement Mixtures.

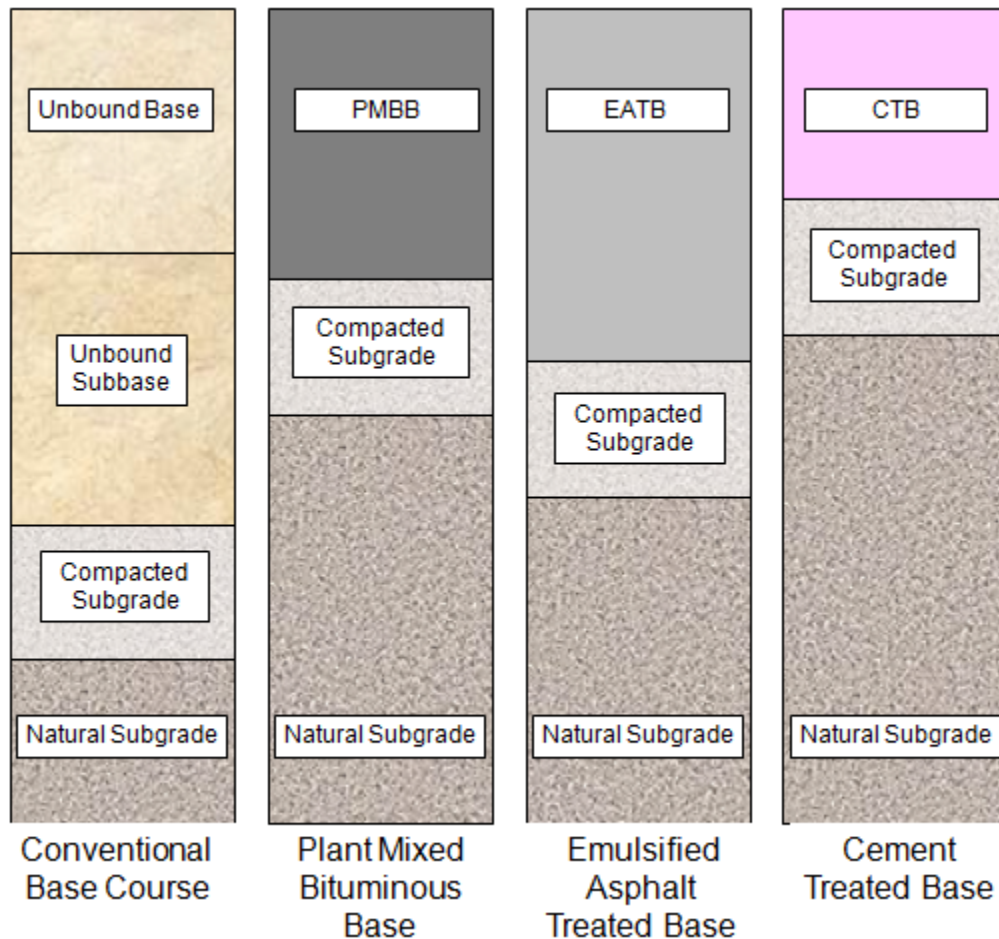

Figure 2.25 Stabilized Treated Structural Base Layers

2.11.3 Permeable Bases

Open-graded aggregate bases are becoming popular. Permeable bases may be unstabilized or stabilized and should be placed at least 4 inches thick. Care must be taken when designing with permeable bases, as they are subject to freeze-thaw cycles.

Unstabilized permeable bases contain smaller size aggregates to provide interlock, but have lower permeability. Typically, the coefficient of permeability is 1,000 to 3,000 feet/day. Unstabilized bases are difficult to compact and density is difficult to measure. CDOT does not recommend using an unstabilized permeable base.

Stabilized permeable bases are open-graded aggregates that have been stabilized with asphalt cement or portland cement. Stabilized bases provide a stable working platform for construction equipment. Stabilization of the base does not appreciably affect the permeability of the material and provides a very stable base during the construction phase. The coefficient of permeability is > 3000 feet/day.

Asphalt stabilized permeable bases contain 2% to 2.5% asphalt by weight. Care must be used in construction to prevent over rolling of the base. Over rolling can lead to degradation of the aggregate and loss of permeability. The base should be laid at 200°F to 250°F and compacted between 100°F and 150°F.

Cement stabilized bases have 2 to 3 bags of portland cement /cubic yard. This provides a very strong base that is easily compacted with a vibratory screed and plate. Curing can be done by covering the base with polyethylene sheeting for 3 to 5 days or with a fine water mist sprayed several times the day after the base is placed.

The designer is suggested to use FHWA's software DRIP 2.0. The software has capabilities to perform roadway geometry calculations for the drainage path, sieve analysis calculations, inflow calculations, permeable base design, separator design (geotextile or aggregate layer), and edgedrain design. Refer to **Figure 2.26 Structural Permeable Aggregate Base Course Layers**. The software may be obtained from the website:

<http://www.fhwa.dot.gov/pavement/software.cfm>.

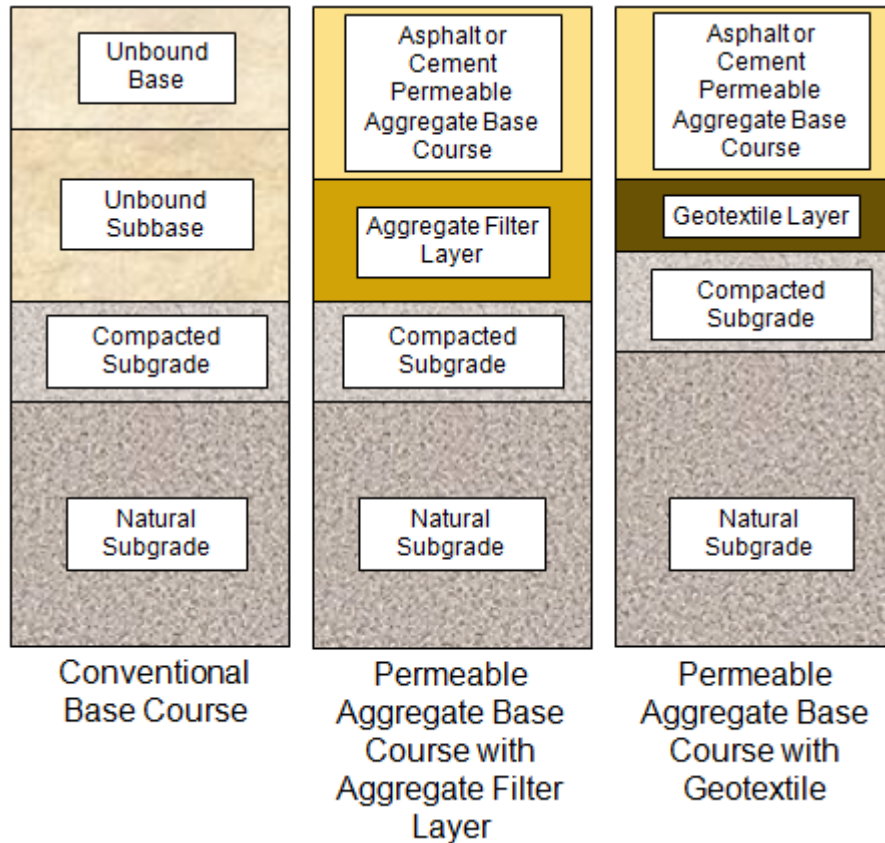

Figure 2.26 Structural Permeable Aggregate Base Course Layers

Drainage is particularly important where heavy flows of water are encountered (i.e., springs or seeps); where detrimental frost conditions are present; or where soils are particularly susceptible to expansion with increase in water content. Special subsurface drainage may include provisions of a permeable material beneath the pavement for interception and collection of water, and pipe drains for collection and transmission of water. Special surface drainage may require such facilities as dikes, paved ditches, and catch basins(20).

2.11.4 Reclaimed Asphalt and Concrete Pavement

Refer to **Figure 2.27 Reclaimed Asphalt and Concrete Pavement Base Layers** for using reclaimed asphalt or concrete for a base layer.

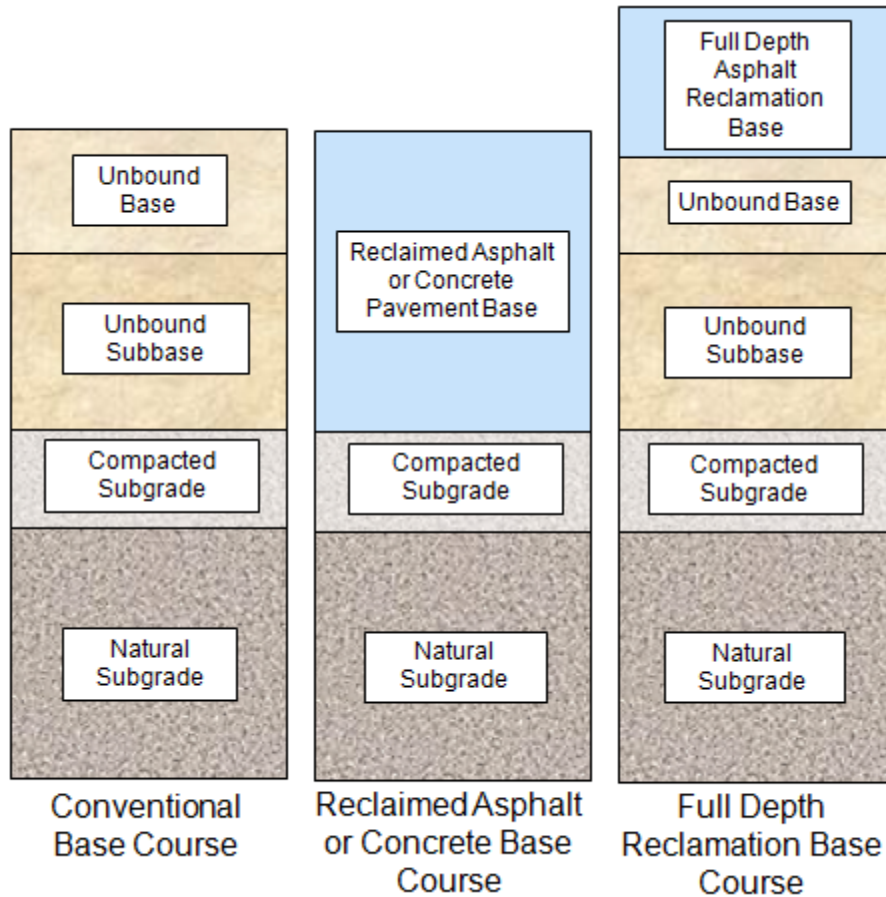

Figure 2.27 Reclaimed Asphalt and Concrete Pavement Base Layers

2.11.4.1 Reclaimed Asphalt Pavement Base

Recycled asphalt pavement may be used as a granular base or subbase provided it meets gradation and minimum R-values specified in contract documents. Recycled asphalt used as an aggregate base is discussed in this section as a cold recycling process compared to a hot process. Refer to Section **5.17 Hot In-Place Recycling (HIR)** in **CHAPTER 5** for explanation on the hot recycling process. The cold recycling process of asphalt is recovered, crushed, screened, and blended with conventional aggregates, and is placed as a conventional granular material.

2.11.4.1.1 Reclaimed Asphalt Pavement (RAP) Base

Aggregate for Reclaimed Asphalt Pavement (RAP) base shall meet the grading requirements of **Table 2.8 CDOT Classification for Reclaimed Asphalt Pavement**. The aggregate shall have a liquid limit of non-viscous (NV), plasticity index of non-plastic (NP), and a Los Angeles

percentage of wear of 45 or less. Placement and compaction of each lift layer shall continue until a density of at least 100 percent on the maximum wet density determined in accordance with Colorado Procedure 53 has been achieved (13).

**Table 2.8 CDOT Classification for Reclaimed Asphalt Pavement
Aggregate Base Course**

Sieve Size	Mass Percent Passing Square Mesh Sieves	
	ABC (RAP)	
	Lower Limit	Upper Limit
2" (50 mm)	100	
1-1/2" (37.5 mm)		
1" (25 mm)	85	100
3/4" (19 mm)	75	100
1/2" (12.5 mm)	55	90
3/8" (9.5 mm)	45	80
#4 (4.75 mm)	25	55
#8 (2.36 mm)		
#16 (1.18 mm)	5	25
#30 (600 µm)		
#50 (300 µm)		
#100 (150 µm)		
#200 (75 µm)	0	5

2.11.4.1.2 Full Depth Asphalt Reclaimed Base (FDR)

A full depth asphalt reclaimed base is an in-place process that pulverizes the existing pavement and thoroughly mixes the individual surface and granular base course layers into a relatively homogeneous mixture and recompacted as a granular base (25). Stabilizing agents may be added with a laboratory mix design to optimize the quantity of stabilizing agent and other properties of the reclaim mix. Pavement distresses that can be treated by full depth asphalt reclamation are (28):

- Cracking from age, fatigue, slippage, edge, block, longitudinal, reflection, and discontinuity.
- Reduced ride quality due to swell, bumps, sags, and depressions, which are not contributed to swelling soils.
- Permanent deformations in the form of rutting, corrugation, and shoving.

- Loss of bonding between layers and stripping.
- Loss of surface integrity due to raveling, potholes, and bleeding.
- Inadequate structural capacity.

2.11.4.2 Reclaimed Concrete Pavement Base (RCP)

Reclaimed concrete pavement (RCP) may be used as a granular base or subbase, similar to recycled asphalt. RCP is a recycling of recovered, crushed, and screened concrete pavement that is placed as a conventional granular material. RCP shall meet all conventional granular material requirements. RCP has all the steel removed in the recovering process.

2.11.5 Base Layer Made of Rubblized Rigid Pavement

Rubblization is a fracturing of existing rigid pavement. The rubblized concrete responds as a high-density granular material. The rough, hard particles provide an internal friction to resist rutting while the lack of tension prevents cracking in the surface layer. The reasoning is the more concrete there is to expand and contract as the temperature changes, the greater the movement of the slab, and the greater the opening of joints and cracks. Rubblization reduces the size of concrete pieces so that the expansion and contraction causes a minimum of movement. The space between the fractured pieces moves less so that the cracks are not reflected through the surface course. An edge drain system needs to be installed to remove the water that is captured between the fractured concrete slabs. The fractured concrete pavement has been found to be more permeable than a dense graded compacted base layer **Figure 2.28 Rubblized Base Course**.

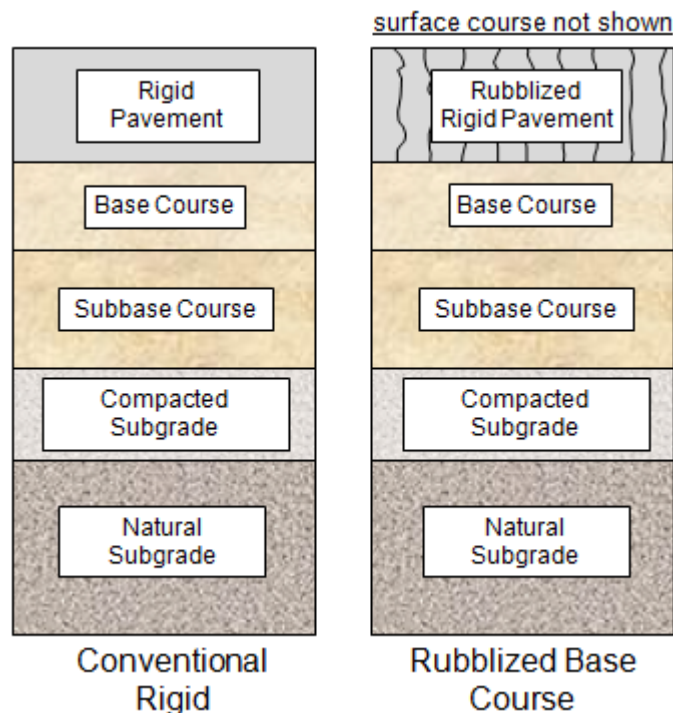

Figure 2.28 Rubblized Base Course

2.12 Material Sampling and Testing

Sampling involves coring the existing pavement to determine layer thicknesses, to permit visual inspection of the subsurface condition, and to obtain material samples of unbound layers for further testing. For an existing pavement, the types of tests performed on the extracted materials should depend on the type of distress observed. Contact the Region Materials Engineer and see Chapter 200 of the Field Materials Manual for information on recommended sampling intervals and further guidance on available material test methods.

References

1. *Guidelines for Stabilization of Soils Containing Sulfates*, Technical Memorandum, by Austin White Lime, Chemical Lime, Texas Lime, distributed by National Lime Association, Arlington, VA, August 2000.
2. Hunter, D., *Lime-Induced Heave in Sulfate-Bearing Clay Soil*, ASCE Journal of Geotechnical Engineering Vol. 114 Issue 2, 1988 pp. 150-167.
3. Little, D. N., *Handbook for Stabilization of Pavement Subgrades and Base Courses with Lime*, National Lime Association, Kendall/Hunt Publishing Company, Dubuque, Iowa, 1995.
4. Hopkins, T. C., T. L. Beckham, L. Sun, B. Ni and B. Butcher, *Long-Term Benefits of Stabilizing Soil Subgrades*, Kentucky Transportation Center, College of Engineering, University of Kentucky, Lexington, Kentucky, 2002.
5. Copas, T. L. and H. A. Pennock, *Lime- Fly Ash-Stabilized Bases and Subbases*, NCHRP Synthesis of Highway Practice 37, TRB, National Research Council, Washington, D.C., 1976.
6. McManis, K. L. and A. Arman, *Class C Fly Ash as a Full or Partial Replacement for Portland Cement or Lime*, Transportation Research Record 1219, TRB, National Research Council, Washington, D.C., 1989, pp. 68-81.
7. Nicholson, P. G., V. Kashyap, and C.F. Fujii, *Lime and Fly Ash Admixture Improvement of Tropical Hawaiian Soils*, Transportation Research Record 1440, TRB, National Research Council, Washington, D.C., 1994, pp. 71-78.
8. Petry, T. M., *Performance-Based Testing of Chemical Stabilizers*, Transportation Research Record 1589, TRB, National Research Council, Washington, D.C., 1997, pp. 36-41.
9. Prusinski, J. R., and S. Bhattacharja, *Effectiveness of Portland Cement and Lime in Stabilizing Clay Soils*, Transportation Research Record 1652, TRB, National Research Council, Washington, D.C., 1999, pp. 215-227.
10. Parsons, R. L., and J. P. Milburn, *Engineering Behavior of Stabilized Soils*, Transportation Research Record 1837, TRB, National Research Council, Washington, D.C., 2003, pp. 20-29.
11. *1972 Roadway Design Manual*, Colorado Department of Transportation.
12. *1980 Roadway Design Manual*, Colorado Department of Transportation.

13. *Standard Specifications for Road and Bridge Construction*, Colorado Department of Transportation, Denver, Co, 2005.
<http://www.dot.state.co.us/DesignSupport/Construction/2005SpecsBook/2005index.htm>
14. Yeh, Shan-Tai, and Su, Cheng-Kuang, *Resilient Properties of Colorado Soils*, Final Report CDOH-DH-SM-89-9, Colorado Department of Highways, December 1989.
15. Chang, Nien-Yin, Chiang, Hsien-Hsiang, and Jiang, Lieu-Ching, *Resilient Modulus of Granular Soils with Fines Contents*, Final Research Report CDOT 91-379, Colorado Department of Transportation, May 1994.
16. *Guide for Mechanistic-Empirical Design*, Final Report, NCHRP Project 1-37A, National Cooperative Highway Research Program, Transportation Research Board, National Research Council, Submitted by ARA, INC., ERES Consultants Division, Champaign, IL, March 2004.
17. *CDOT Field Materials Manual*, Colorado Department of Transportation, 2004.
18. *AASHTO Guide for Design of Pavement Structures*, American Association of State Highway and Transportation Officials, Washington, DC, 1993.
19. Supplement to the AASHTO Guide for Design of Pavement Structures, Part II, - Rigid Pavement Design & Rigid Pavement Joint Design, American Association of State Highway and Transportation Officials, Washington, DC, 1998.
20. *AASHTO Interim Guide for Design of Pavement Structures 1972*, published by American Association of State Highway and Transportation Officials, Washington, DC, 1972.
21. DRIP 2.0 Software Program <<http://www.fhwa.dot.gov/pavement/software.cfm>>
22. Mallela, Jagannath, Larson, Gregg, Wyatt, Tim, Hall, Jim, and Barker, Walter, *User's Guide for Drainage Requirement In Pavements- Drip 2.0 Microcomputer Program*, ERES Consultants, Division of Applied Research Associates, Inc., 505 W. University Avenue, Champaign, IL 61820 and prepared for Federal Highway Administration, 400 Seventh Street, SW, Washington, DC 20590, July 2002.
23. *LTPP Data Analysis Phase I: Validation of Guidelines for k-Value Selection and Concrete Pavement Performance Prediction*, Publication FHWA-RD-96-198, Federal Highway Administration, Research and Development, Turner-Fairbank Highway Research Center, 6300 Georgetown Pike, McLean, VA 22101-2296, January 1997.
24. *Development of Pavement Design Concepts*, prepared by CTL/Thompson, Inc., Consulting Engineers, 1971 West 12th Ave, Denver, CO 80204 and prepared for the Metropolitan Government Pavement Engineers Council, April 1998.

25. *FHWA Reclaimed Asphalt Concrete - User Guideline - Granular Base*, <<http://www.tfhrc.gov/hnr20/recycle/waste/rap134.htm>> (1/25/2006).
26. Ardani, Ahmad, *Expansive Soil Treatment Methods in Colorado*, Final Report CDOT-DTD-R-92-2, Colorado Department of Transportation, March 1992.
27. Colorado Department of Highways Memo #323, (Construction) Swelling Soils, 1/5/1966.
28. *Basic Asphalt Recycling Manual*, Federal Highway Administration, 400 Seventh Street, SW, Washington, DC 20590 and Asphalt Recycling and Reclaiming Association, #3 Church Circle, PMB 250, Annapolis, MD 21401, 2001.
29. *Long-Term Pavement Performance Information Management System: Pavement Performance Database User Reference Guide*, Publication No. FHWA-RD-03-088 (Interim Update), Federal Highway Administration, Research, Development and Technology, Turner-Fairbank Highway Research Center, 6300 Georgetown Pike, McLean, VA 22101-2296, September 2005.
30. Long-Term Pavement Performance (LTPP) Data Analysis Support: National Pooled Fund Study TPF-5(013), Effects of Multiple Freeze Cycles and Deep Frost Penetration on Pavement Performance and Cost, Publication No. FHWA-HRT-06-121, Federal Highway Administration, Research and Development, Turner-Fairbank Highway Research Center, 6300 Georgetown Pike, McLean, VA 22101-2296, November 2006.
31. *Engineering and Design Pavement Criteria for Seasonal Frost Conditions, Mobilization Construction*, Engineering Manual EM1110-3-138, Department of the Army, Corps of Engineers, Office of the Chief of Engineers, Washington, D.C. 20314, April 9, 1984.
32. CDOT Materials Bulletin, 2008 Number 1, Geosynthetics and Geotextiles, Project Development Branch (for Materials and Geotechnical Branch), January 25, 2008.

CHAPTER 3

PRINCIPLES OF DESIGN FOR FLEXIBLE PAVEMENT

3.1 Introduction

Hot Mix Asphalt (HMA) is composed of aggregates with an asphalt binder and certain anti-stripping additives. Stone Matrix Asphalt (SMA) is a gap-graded HMA that maximizes rutting resistance and durability with a stable stone-on-stone skeleton held together by a rich mixture of AC, filler, and stabilizing agents. The final product of the Strategic Highway Research Program (SHRP) asphalt research program is a system referred to as SuperPave™, which stands for Superior Performing Asphalt Pavements. SuperPave™ binders are classified based on their performance at both hot and cold temperatures. By carefully selecting quality aggregates and the correct SuperPave™ Performance Graded (PG) asphalt binder, it is possible to produce high quality hot mix asphalt for a wide variety of climatic conditions in Colorado.

The design procedure for flexible pavements is based on the concepts originally developed at the AASHO Road Test at Ottawa, Illinois, in the late 1950s, and modified according to the most recent formulation of a design procedure by AASHTO in the *1993 AASHTO Guide for Design of Pavement Structures*.

Design of the pavement structure involves the consideration of numerous factors, of which the most important are: speed, volume, weight and distribution of traffic loads, quality of the materials used, supporting capacity of the subgrade soils, the resistance of the surface to wear, expansion and contraction, and climatic and other environmental conditions.

Methods are presented in this section for the design of the pavement structure with respect to total overall thickness, and for thickness of the subbase, base course, and surface course. It can also be used in evaluating the quality and strength of the material in place.

3.2 Design Considerations

The definitions and design factors necessary for flexible pavement design were introduced in previous sections. The design factors and their sources are summarized in **Table 3.1 Flexible Pavement Thickness Design Factors**.

Table 3.1 Flexible Pavement Thickness Design Factors

Factor	Source
18k ESAL	Division of Transportation Development, requested by the designer specifically for flexible pavement. http://www.dot.state.co.us/App_DTD_DataAccess/index.cfm
Reliability, R	Table 1.3, CHAPTER 1
Standard Normal Deviate, Z_R	Table 1.4, CHAPTER 1
Overall Deviation, S_o	CDOT flexible default value = 0.44
Serviceability Loss, ΔPSI	Derived from traffic volumes, Section 1.9 of CHAPTER 1
M_R Value of the Subgrade	Soil profile report from laboratory and correlation equations.
Structural Layer Coefficients (a_i)	Table 3.2 Recommended a_i Values for the Structural Layer Coefficients and Table 3.3 Recommended a_i Values for the Base Layer Coefficients

3.3 Design Period

The destructive effect of repeated wheel loads is the major factor that contributes to the failure of highway pavement. Since both the magnitude of the load and the number of its repetitions are important, provision is made in the design procedure to allow for the effects of the number and weight of all axle loads expected during the design period. The design period for new flexible pavement construction and reconstruction is at least 20 years. The design period for restoration, rehabilitation, and resurfacing is 10 years. Selection of less than 10-year design period projects needs to be supported by a Life Cycle Cost Analysis (LCCA) or other overriding considerations.

3.4 Design Methodology for Flexible Pavement

Any of the following methods may be used to calculate the structural number for flexible pavements.

3.4.1 Use of Equation

The factors from **Table 3.1 Flexible Pavement Thickness Design Factors** are all combined and shown in **Eq. 3.1**.

$$\log_{10}(18k \text{ ESAL}) = [Z_r \times S_0] + [9.36 \times \log_{10}(SN + 1)] - 0.20 + \frac{\log_{10}\left(\frac{\Delta PSI}{4.2 - 1.5}\right)}{0.40 + \left(\frac{1094}{(SN + 1)^{5.19}}\right)} + [2.32 \times \log_{10}(M_R)] - 8.07$$

Eq. 3.1

Once the Structural Number (SN) has been determined, the design thicknesses of the pavement structure can be calculated by **Eq. 3.2** given in Section **3.6**.

3.4.2 Use of Computer Programs

With the availability and power of desktop personal computers in the workplace, it is preferred that the flexible pavement design equations be performed by computers. **Eq. 3.1** may be used by the designer who has access to a programmable calculator or microcomputer. The Department recommends the use of the most current version of the AASHTO pavement design software, DARWin™.

3.4.3 Use of Nomograph

The basis of the design nomograph for flexible pavement has been in **Figure 3.1 Design Nomograph for Flexible Pavements** with the AASHTO equation. **Figure 3.1 Design Nomograph for Flexible Pavements** used as explained in the following steps:

Step 1. Select the level of Reliability required. Enter the nomograph at the left scale using the Reliability level value. Connect the Reliability component with a Standard Deviation value (0.44 is to be used in all CDOT flexible designs). Extend this line to the first turning line (TL).

Step 2. From the TL intercept, draw a line through the appropriate value for estimated traffic, the 18k ESAL. Extend the line to the second TL.

Step 3. From this TL intercept, draw a line through the appropriate soil support value (roadbed soil resilient modulus, M_R) and extend it to left edge of the Design Serviceability Loss portion of **Figure 3.1 Design Nomograph for Flexible Pavements**.

Step 4. Plot the horizontal line intercepting the selected PSI value. From this turning point, plot a vertical line down to the resultant Design Structural Number, SN.

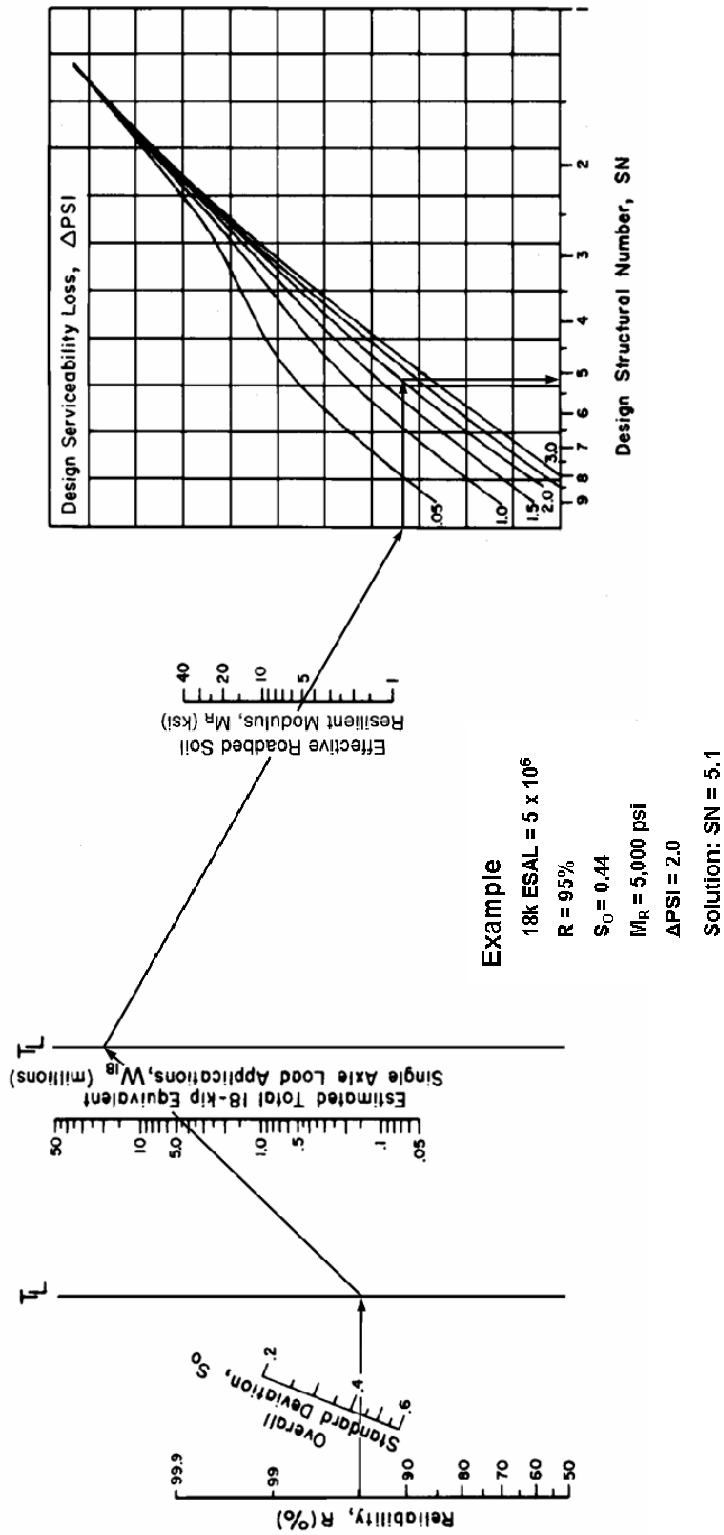

Figure 3.1 Design Nomograph for Flexible Pavements
 (Modified from 1993 AASHTO Guide for Design of Pavement Structures, pg. II-32, Fig. 3.1)

3.5 Structural Layer Coefficient

The treatment for the expected level of drainage for a flexible pavement is through the use of modified structural layer coefficients. A higher effective structural layer coefficient would be used for improved drainage conditions. The factor for modifying the structural layer coefficient is called an m_i value and has been integrated into the structural number (SN) **Eq. 3.2** along with structural layer coefficient (a_i) and thickness (D_i). **Table 3.2 Recommended a_i Values for the Structural Layer Coefficients** indicates the recommended a_i values. **Table 3.3 Recommended a_i Values for the Base Layer Coefficients** are recommended a_i values for unbound aggregate bases and reclaimed asphalt pavement (RAP) aggregates (5).

The moisture holding ability of an asphalt surface course is considered to be close to nonexistent and the possible effect of drainage on the asphalt concrete surface course is not considered. The conversion of the structural number into actual pavement layer thicknesses is discussed in more detail in Section 3.6.

Table 3.4 Recommended m_i Values* for Modifying Structural Layer Coefficients of Untreated Base and Subbase Materials in Flexible Pavements presents the recommended m_i values, as a function of the quality of drainage and the percent of time during the year the pavement structure would normally be exposed to moisture levels approaching saturation. Obviously, the latter are dependent on the average yearly rainfall and the prevailing drainage conditions. As a basis for comparison, the m_i value for conditions at the AASHO Road Test was 1.0, regardless of the type of material.

Table 3.2 Recommended a_i Values for the Structural Layer Coefficients

Component	Coefficient
Stone Matrix Asphalt (SMA)	0.44
Hot Mix Asphalt (HMA)	0.44
Hot Mix Asphalt Grading Fines (for maintenance)	0.34
Plant Mix Bituminous Base	0.34
Treated Subgrade with compressive strength, unconfined 7 day cure: 425 psi or higher	0.15
Treated Subgrade with compressive strength, unconfined 7 day cure: 350 psi to 424 psi	0.14
Treated Subgrade with compressive strength, unconfined 7 day cure: 275 psi to 349 psi	0.13
Treated Subgrade with compressive strength, unconfined 7-day cure: 200 psi to 274 psi	0.12
Treated Subgrade with compressive strength, unconfined 7-day cure: 125 psi to 199 psi	0.11

Table 3.3 Recommended a_i Values for the Base Layer Coefficients

Component	Design M_R (psi)	Design Coefficient
100% RAP with R-value ≥ 90	48,675	0.19
100% RAP with $78 \leq$ R-value < 90	32,883	0.15
Aggregate Base Course (Class 6) with R-value ≥ 78	32,883	0.15
Aggregate Base with R-value ≥ 83	38,721	0.14
Aggregate Base with $77 \leq$ R-value < 83	31,826	0.12
Aggregate Base with $69 \leq$ R-value < 77	24,503	0.11
Aggregate Base with $59 \leq$ R-value < 69	21,500	0.10

Table 3.4 Recommended m_i Values* for Modifying Structural Layer Coefficients of Untreated Base and Subbase Materials in Flexible Pavements

Quality of Drainage	Percent of Time Pavement Structure Is Exposed to Moisture Levels Approaching Saturation			
	Less Than 1%	1 - 5%	5 - 25%	Greater Than 25%
Excellent	1.40 - 1.35	1.35 - 1.30	1.30 - 1.20	1.20
Good	1.35 - 1.25	1.25 - 1.15	1.15 - 1.00	1.00
Fair	1.25 - 1.15	1.15 - 1.05	1.05 - 0.80	0.80
Poor	1.15 - 1.05	1.05 - 0.80	0.80 - 0.60	0.60
Very Poor	1.05 - 0.95	0.95 - 0.75	0.75 - 0.40	0.40

*Note: Designer shall use a value of $m_i = 1.0$ unless specific drainage information indicates otherwise.

3.6 Determination of Layer Thicknesses

The design thicknesses of the pavement structure can be determined by considering the relationship between the thickness of a component layer in a pavement structure and the type of material used in the layer. Coefficients for hot mix asphalt pavement, plant mix bituminous base course, and aggregate base course are based on AASHTO Road Test recommendations, adjusted for Colorado conditions. Other coefficients are based on laboratory tests and actual performance. Correlations of soil support indices to structural base layer coefficients are shown in **Figure 3.4 Correlation of Soil Support Indices to Structural Base Layer Coefficients**. **Figure 3.2 Structural Layers** is a graphical representation of the equation **Eq. 3.2** relationships.

$$SN = a_1 D_1 + a_2 D_2 m_2 + a_3 D_3 m_3 \quad \text{Eq. 3.2}$$

Where:

- a_1, a_2, a_3 = structural layer coefficients
- D_1 = thickness of bituminous surface course (inches)
- D_2 = thickness of base course (inches)
- D_3 = thickness of subbase (inches)
- m_2 = drainage coefficient of base course
- m_3 = drainage coefficient of subbase

The design thickness of HMA will be rounded up to the next 1/4-inch increment.

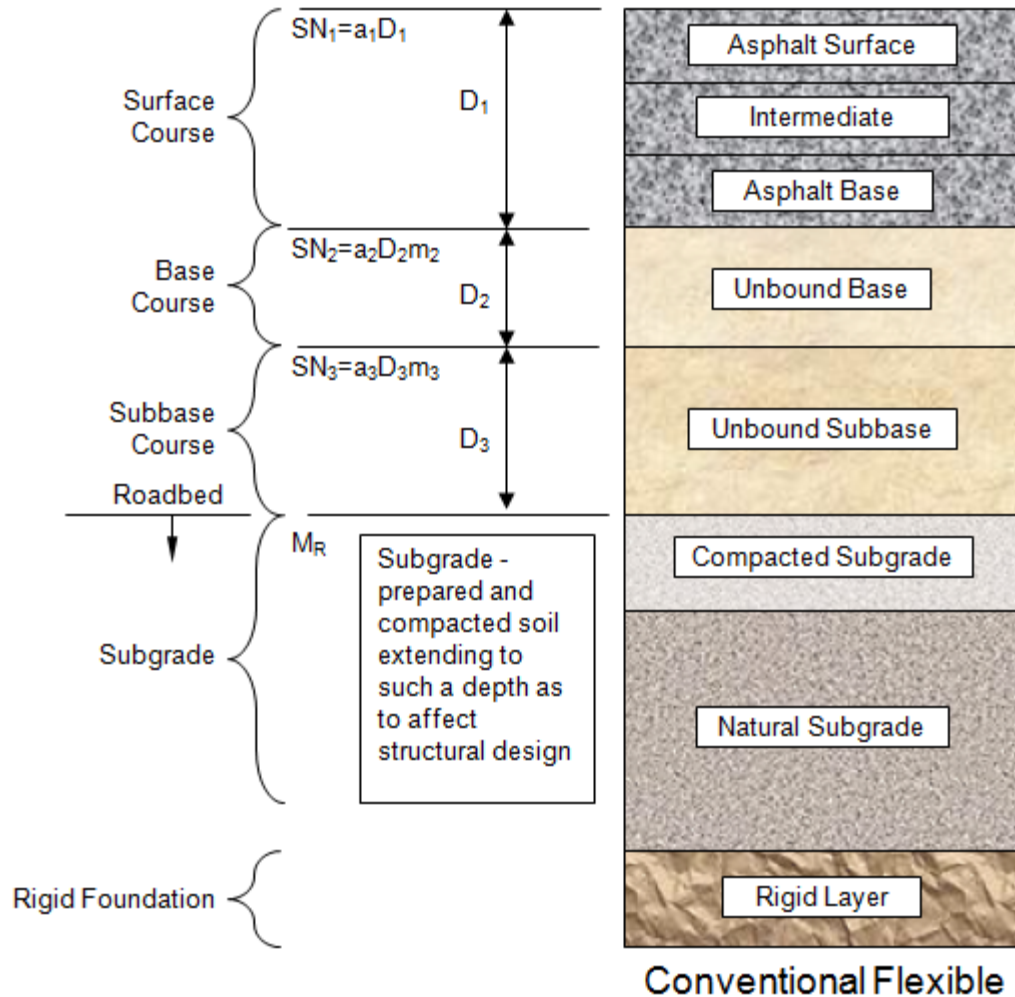

Figure 3.2 Structural Layers

(Modified from 1993 AASHTO Guide for Design of Pavement Structures, pg. II-36, Fig. 3.2)

In the 1993 AASHTO Guide for Design of Pavement Structures the material characteristics are denoted by the structural layer coefficients. The materials characteristics are generalized for the whole layer. As shown in **Figure 3.2 Structural Layers** historically the surface course was of one type of asphalt mix.

Figure 3.3 Simple Pavement Layer Systems illustrates several other well-known CDOT combinations of structural pavement layers. Two common methods, Deep Strength HMA over Unbound Aggregate Base and Full Depth HMA are illustrated. The asphalt concrete layer may be made up of any combination of layers to satisfy the traffic loadings and climate of the project site conditions. The compacted and natural subgrades are equivalent to the roadbed course.

The surface course in **Figure 3.2 Structural Layers** may be made up of layers of asphalt pavement courses. The pavement layers are generally divided into a surface course, intermediate or binder course, and a base course. The surface, binder, and base courses are typically different in composition and are placed in separate construction operations (3).

- Surface Layer - The surface layer normally contains the highest quality materials. It provides characteristics such as friction, smoothness, noise control, rut and shoving resistance, and drainage. In addition, it serves to prevent the entrance of excessive quantities of surface water into the underlying HMA layers, bases, and subgrade.
- Intermediate/Binder Layer - The intermediate layer, sometimes called binder course, consists of one or more lifts of structural HMA placed below the surface layer. Its purpose is to distribute traffic loads so that stresses transmitted to the pavement foundation will not result in permanent deformation of that layer. Additionally, it facilitates the construction of the surface layer.
- Base Layer - The base layer consists of one or more HMA lifts located at the bottom of the structural HMA layer. Its major function is to provide the principal support of the pavement structure. It should contain durable aggregates, which would not be damaged by moisture or frost action.

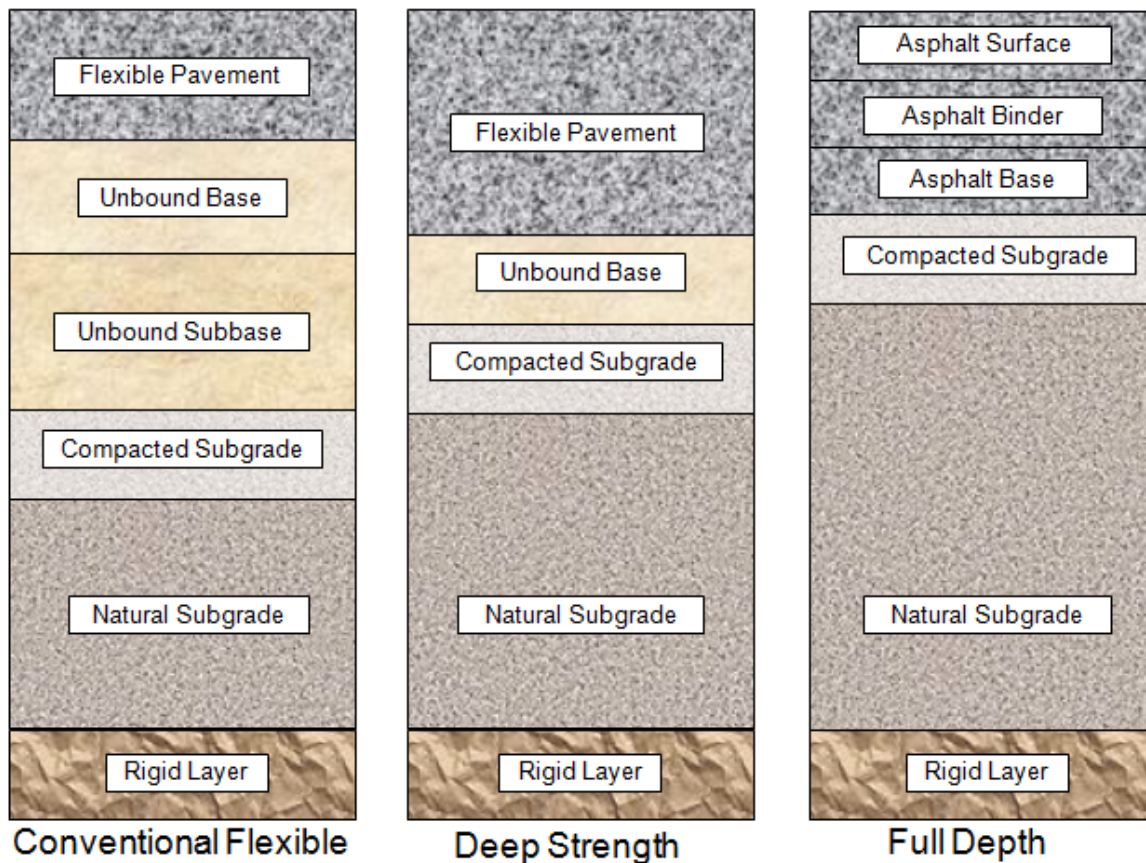
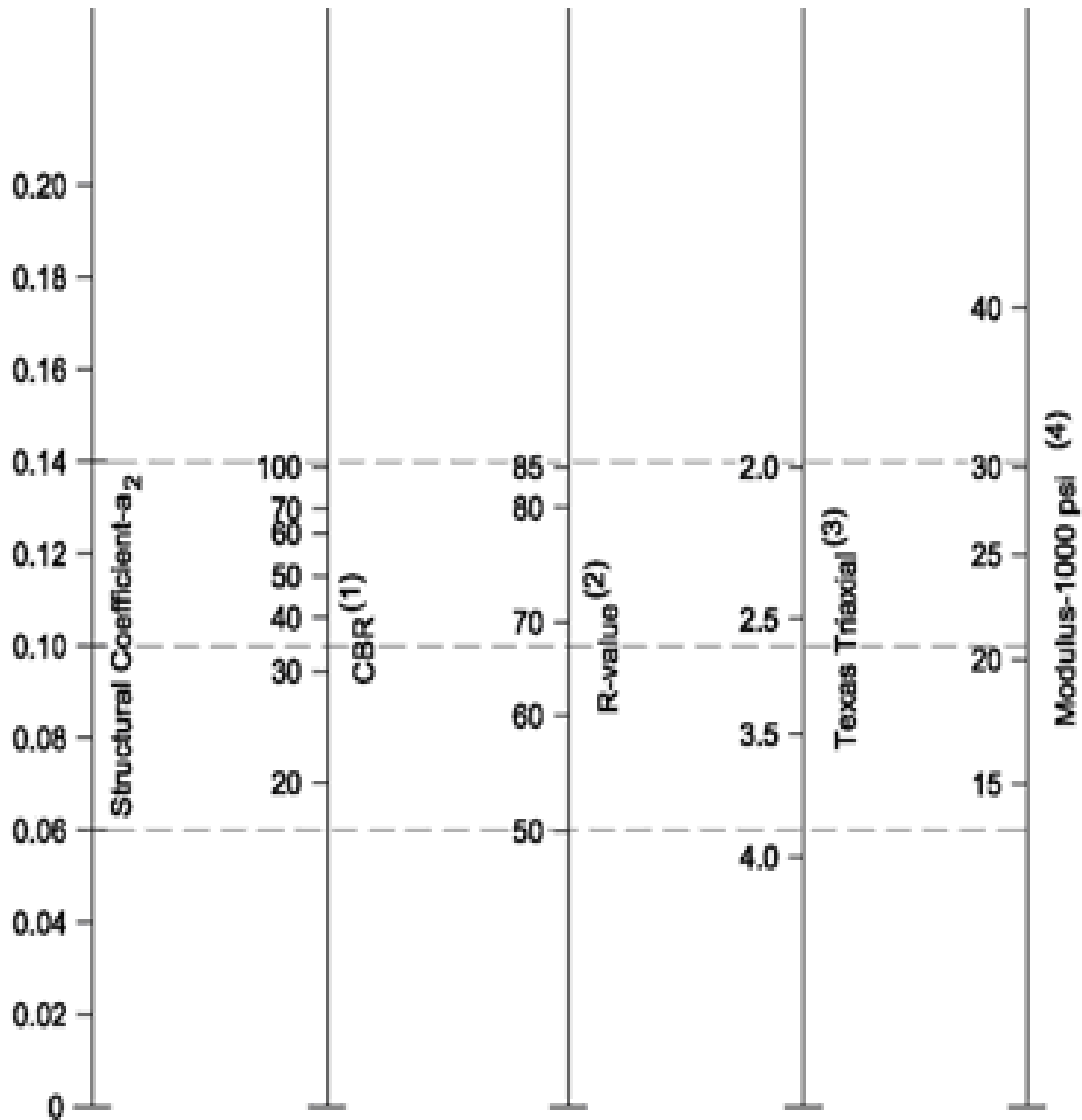

Figure 3.3 Simple Pavement Layer Systems

(Modified from *Guide for Mechanistic-Empirical Design*, pg. 3.3.4, Figure 3.3.2 Illustration of possible asphalt pavement layered systems)

Structural Base Layer Coefficient



- (1) Scale derived by averaging correlations obtained from Illinois.
- (2) Scale derived by averaging correlations obtained from California, New Mexico, and Wyoming.
- (3) Scale derived by averaging correlations obtained from Texas.
- (4) Scale derived on NCHRP project (3).

Figure 3.4 Correlation of Soil Support Indices to Structural Base Layer Coefficients
(1993 AASHTO Guide for Design of Pavement Structures, pg. II-19, Fig. 2.6)

3.6.1 HMA Thickness with ABC

Once a SN is determined, thicknesses of HMA subbase and/or base course can be calculated. If HMA is placed directly on subgrade, the thickness of the HMA is determined by inserting the structural layer coefficient of HMA into **Eq. 3.2**. If HMA is placed on subbase and/or base course, the thickness of the layers is determined by the engineer assigning appropriate layer and drainage coefficients while solving for the most cost-effective thicknesses. The design is determined to be adequate when the calculated structural number from **Eq. 3.2** exceeds the required SN from the selected method described in Section 3.4. If an aggregate base course (ABC) is included for structural enhancement of the pavement, the designer should rerun the design. As a minimum, the designer should include 4 inches of ABC for any thickness of HMA when the design 18k ESAL is less than or equal to 500,000 and 6 inches of ABC for any thickness of HMA when the design 18k ESAL is greater than 500,000, as shown in **Table 3.5 Minimum Total Pavement Thicknesses for Flexible Pavement Structures**.

3.6.2 Required Minimum Thickness of Pavement Layer

Compaction of a hot mix asphalt pavement during its construction is the single most important factor that affects the ultimate performance of the pavement. Achieving adequate compaction increases pavement performance by decreasing rutting, reducing damage due to moisture and oxidation, and increasing the stability of the mix. Factors affecting the cooling rate of the mat include the layer thickness, the temperature of the mix when placed, ambient temperature, temperature of the base, and wind conditions. Layer thickness is the single most important variable in the cooling rate of an asphalt mat, especially for thin layers. This is especially true in cool weather because thin layers of asphalt mat have less capacity to retain heat than thicker lifts of pavement. The thicker layers of asphalt mat help to maintain the temperature at a workable level thus increasing the time available for compaction. Because of the increased difficulty in achieving density and the importance of achieving compaction, a minimum layer thickness for construction of HMA pavement is two inches. A designer of special mixes, such as stone matrix asphalt, should look at minimum thickness requirements of the particular product. The minimum thickness of these special mixes is likely to be a dimension other than two inches. **Table 3.5 Minimum Total Pavement Thicknesses for Flexible Pavement Structures** shows the minimum total required pavement thicknesses for a new or reconstructed flexible pavement structure based on traffic ESALs.

Table 3.5 Minimum Total Pavement Thicknesses for Flexible Pavement Structures

Traffic, 18k ESALs	HMA Thickness	ABC Thickness
≤ 150,000	2.0"	4"
150,001 to 500,000	2.5"	4"
500,001 to 2,000,000	3.0"	6"
> 2,000,000	4.0"	6"

3.7 Calculations for Flexible Pavement with a Variable Layer

On many projects, by the time the soil survey of the completed roadbed has begun, the thicknesses of all layers in the pavement structure, except one, have been determined from preliminary design information. The thickness of the remaining layer is based on the R-value of the subgrade soil. The R-value may vary along the length of a project. By using **Eq. 3.2** with a required SN found from using one of the methods in Section 3.4, known structural layer coefficients (a_1 , a_2 , etc.) from **Table 3.2 Recommended a_i Values for the Structural Layer Coefficients** and known thicknesses (D_1 , D_2 , etc.) of all but one layer, the designer or field engineer can calculate the thickness of a base layer that varies. This layer will vary with the required SN. The required SN of a roadway segment will vary with the R-value that represents the subgrade of that roadway segment. CDOT Form #585, Flexible Pavement Field Design Worksheet, is a worksheet designed to aid in calculating the thickness of the variable layer of the pavement structure. **Figure 3.5 Flexible Pavement Field Design Worksheet (CDOT Form #585)** is an example of CDOT Form #585.

The top half of CDOT Form #585 is used to calculate a Thickness Index (TI). The Thickness Index is the sum of the thickness times the structural layer coefficient from **Table 3.2 Recommended a_i Values for the Structural Layer Coefficients** of each known layer of the pavement structure. The bottom half of CDOT Form #585 is used to calculate the thickness of the variable layer as needed to meet the required SN as determined for each R-value.

Within a project, there may be roadway segments with different traffic loads. CDOT Form #585 uses one value for the traffic load (Design 18k ESAL), so a new form should be completed for each roadway segment with a different traffic load.

The example in **Figure 3.5 Flexible Pavement Field Design Worksheet (CDOT Form #585)** is for a project with the following predetermined layer thicknesses:

Hot Mix Asphalt (Grading S) =	5.0 inches
Aggregate Base Course (Class 6) =	4.0 inches

The variable thickness layer is Aggregate Base Course (Class 1). The Thickness Index is determined to be 2.68 in this example. The Thickness Index is subtracted from each of the three SN determined by each of the three R-values in this example. The difference is then divided by the structural layer coefficient (0.11 in this example) to yield three different thicknesses for the Aggregate Base Course (Class 1). In this example, the thickness for Aggregate Base Course (Class 1) is rounded up to the nearest whole inch. The example in **Figure 3.5 Flexible Pavement Field Design Worksheet (CDOT Form #585)** shows that a required thickness of 18.2 inches was rounded up to 19 inches.

COLORADO DEPARTMENT OF TRANSPORTATION FLEXIBLE PAVEMENT FIELD DESIGN WORK SHEET Design Data from Plans and Reports				Project No.: I 70 4(23)						
				Proj. location: I 70 East						
				Project code (SA#): 11423	Date: 1/1/04	Sheet No.: 1 of 1				
Δ PSI: 2.0		Reliability: 95		Design ESAL: 3,631,00		Design period (years)				
Item	Layer identification			R value	Inches	X	Strength Coefficient	=	Thickness Index	
403	Hot Bituminous Pavement Grading: S				5		.44		2.20	
403	Hot Bituminous Pavement Grading									
	Class: 6			80	4		.12		.48	
	Class:									
	Class:									
Project Thickness Index (TI) constant total = 2.68										
Variable layer identification: 304 Aggregate Base Course CL 1		Strength coefficient: 0.11		Minimum required 4 inches		NOTE: Do not include variable layer thickness in above calculations.				
Test numbers	Station to station	Soil class.	R value	SN	- TI constant	Diff. (1)	+ Strength coeff.(2)	Thickness req'd	Thickness used	
1,2,3	0+00 To 25+00	A-7-6 (22)	17	5.09	2.68	2.41	.11	22.0	22.0"	
4,5	25+50 To 40+00	A-6 (15)	25	4.68	2.68	2.00	0.11	18.2	19"	
6,7,8,9	40+00 To 70+75	A-4 (2)	42	3.89	2.68	1.21	0.11	11.0	11"	
(1) If difference is a minus quantity do not fill out the next two columns. (2) Strength coefficient of variable layer.										
Calculations by: Joe Pavement		Title: PE I		Date:		Checked by: Project Engineer		Title: PE II		Date:

CDOT Form #585 3/04

Figure 3.5 Flexible Pavement Field Design Worksheet (CDOT Form #585)

3.8 Asphalt Materials Selection

The flexible pavement usually consists of 3/4-inch nominal maximum aggregate size (NMAS) in the lower layers, hot mix asphalt (HMA) Grading S. The top layer, which is the surface layer, should be stone matrix asphalt (SMA). SMA mixes are often used in areas that are expected to experience extreme traffic loading. Refer to Section 5.21 Stone Matrix Asphalt Project and Material Selection Guidelines for more information. When low to high traffic load are expected, a 1/2-inch NMAS, Grading SX, should be used.

A CDOT study (1) found less thermal segregation in the top lift when Grading SX mixes were used. HMA Grading SX can also be used where layers are very thin or where the pavement must taper into an existing pavement. A study from Auburn University (2) found little difference in the stability or rutting of 3/4-inch and 1/2-inch NMA mixes. CDOT cost data for 2005 showed a slight increase in the cost per ton of Grading SX mixes as compared to Grading S mixes with the same bid quantities.

HMA with a 1-inch NMA, Grading SG, should not be used in the surface layer. Although Grading SG mixes have been used in specialized situations, they are not currently used or accepted on a regular basis for pavement mixes. CDOT has found that the production and placement of Grading SG mixes are prone to segregation and the use should be discouraged.

To provide maximum density, HMA thickness three inches or less should be placed and compacted in one lift. For structural overlays, the minimum allowed layer thickness will be two inches.

Table 3.6 and **Table 3.7** give guidance for mix selection and recommended layer thicknesses for various layers and nominal maximum aggregate sizes.

Table 3.6 HMA Grading Size and Application

CDOT HMA Grade	Nominal Maximum Aggregate Size (NMA)	Application
SX	1/2"	Top Layer (Preferred), Thin Patch
S	3/4"	Top Layer, Layers Below the Surface, Patching
SG	1"	Layers Below the Surface, Deep Patching

Table 3.7 HMA Grading Size and Application

CDOT HMA Grade	Nominal Maximum Aggregate Size (NMA)	Layer Thickness (Inches)	
		Minimum	Maximum
SX	1/2"	2.00	3.00
S	3/4"	2.25	3.50
SG	1"	3.00	4.00

3.8.1 Selection of SuperPave™ Gyratory Design

To choose the appropriate number of revolutions of a SuperPave™ gyratory asphalt mix design on a particular project, determining the design 18k ESALs and the high temperature environment for the project is necessary. The following steps should be followed to determine the proper SuperPave™ gyratory design revolutions for a given project:

Step 1. Determine 18k ESALs.

To obtain the correct SuperPave™ gyratory compaction effort (revolutions), the 18k ESALs must be a 20-year cumulative 18k ESAL of the design lane in one direction. The compaction effort simulates the construction compaction roller to obtain the correct voids properties to resist the intended traffic in the design lane. The department's traffic analysis unit of the Division of Transportation Development (DTD) automatically provides on their website an ESAL calculator. One must use a 20-year design with the appropriate number of lanes with flexible pavement specified. Even a 10-year asphalt overlay must use a 20-year cumulative 18k ESAL number of the design lane to be able to continue with this procedure. If 18k ESAL calculations are calculated using a spreadsheet or manually, one must use the 20 year 18k ESAL of the design lane.

Step 2. Reliability for the 7-day Average Maximum Air Temperature.

The next decision is to determine what type of project is being designed. For new construction or reconstruction, asphalt cement with 98% reliability for both low and high temperature properties is recommended. For overlays, asphalt cement with 98% reliability for high temperature properties (rutting resistance) and 50% reliability for low temperature properties (cracking resistance) is recommended. Asphalt cements with lower than 98% reliability against rut resistance should not be specified. In the SuperPave™ system, anything between 50% and 98% reliability is considered 50% reliability for the purpose of binder selection. The low temperatures are specified at a lower reliability for overlays because of reflection cracking.

Step 3. Determine weather data for the project.

Obtain the highest 7-day average maximum air temperature, based on weather data in the project area from the computer program LTPPBIND 3.1 (beta). Refer to Section **3.8.2 Binder Selection** for a further explanation of LTPPBIND 3.1 (beta). From the appropriate high temperature, find the environmental category for the project from **Table 3.8 Environmental Categories**. The Environmental Categories are from CDOT Pavement Management Program, Environmental Zones. The Environmental Zones (Categories) are one of four pavement groupings to group pavements into families that have similar characteristics.

Table 3.8 Environmental Categories

Highest 7-Day Average Air Temperature	High Temperature Category
>97°F (>36°C)	Hot (SE and West)
>88° to 97°F (>31° to 36°C)	Moderate (Denver, Plains and West)
81° to 88°F (27° to 31°C)	Cool (Mountains)
<81°F (<27°C)	Very Cool (High Mountains)

Step 4. Selection of the number of design gyrations (N_{DES}).

Select the N_{DES} from **Table 3.9 Recommended SuperPave™ Gyrotory Design Revolution (N_{DES})**. For example, **Table 3.9** shows that for 5,000,000 18k ESALs and a high temperature category of “Cool”, the design revolutions should be 75.

Table 3.9 Recommended SuperPave™ Gyrotory Design Revolution (N_{DES})

CDOT Pavement Management System Traffic Classification (20 year Design ESAL)	20 Year Total 18k ESAL in the Design Lane	High Temperature Category			
		Very Cool	Cool	Moderate	Hot
Low	< 100,000	50	50	50	50
	100,000 to < 300,000	50	75	75	75
Medium	300,000 to < 1,000,000	75	75	75	75
	1,000,000 to < 3,000,000	75	75	75	100
High	3,000,000 to < 10,000,000	75	75	100	100
Very High	10,000,000 to < 30,000,000	---	---	100	---
Very Very High	≥ 30,000,000	---	---	125	---

Based on Standard Practice for SuperPave™ Volumetric Design for Hot-Mix Asphalt (HMA), AASHTO Designation R 35-04.

3.8.2 Binder Selection

Performance graded (PG) binders have two numbers in their designation, such as PG 58-34. Both numbers describe the pavement temperatures in degrees Celsius at which the pavement must perform. The first number (58 in the example) is the high temperature standard grade for

the pavement, and the second number (minus 34 in the example) is the low temperature standard grade. PG 64-28 (rubberized) or PG 76-28 (polymerized) or bituminous mixtures should only be placed directly on an existing pavement or milled surface that does not show signs of stripping or severe raveling. Cores should be taken to determine if stripping is present. Colorado local suppliers only have the capacity to supply a limited number of asphalt cement grades, because of a limited number of tanks. **Table 3.10 Available Asphalt Cement Grades in Colorado** show available grades that maybe used on CDOT projects or that are available for use on CDOT projects.

Table 3.10 Available Asphalt Cement Grades in Colorado

Polymer Modified	Unmodified
PG 76-28 PG 70-28 PG 64-28 PG 58-34	PG 64-22 PG 58-28

LTPPBind 3.1 (beta) is a working version, dated September 15, 2005. Beta only means that it is going through the 508-compliance process for the visually disabled users as required by the Federal Government. The computer program may be obtained from the following web address: <http://www.fhwa.dot.gov/pavement/ltp/ltpbind.cfm>

The program allows the user to select the asphalt binder grade for the appropriate project site conditions. In the "Preferences" under the "File" menu, use 12.5mm (1/2 inch) for the target rut depth for a CDOT default value. The computer program has a help menu to assist the user and supporting technical information regarding the computation of design temperatures required for the selection of the asphalt binder grade as provided in the "Climatic Data" and "Algorithms" sections. The algorithms are broken down under four subsections. Each algorithm equation is shown and briefly explained for high temperature, low temperature, PG with depth, and PG grade bumping.

- High Temperature - The high temperature is based on a rutting damage model. The LTPP high temperature model was not used in this version since it provided very similar results to the SHRP model at 98% reliability. Initially the user must select a preference for a target rut depth. The default is 12.5 mm (0.5 inches). The user has the option to change the target rut depth.
- Low Temperature - The low temperature is based on LTPP climatic data using air temperature, latitude and depth to surface.
- PG with depth - LTPP pavement temperature algorithms were used to adjust PG for a depth into the pavement. The LTPP algorithms are empirical models developed from seasonal monitoring data.

- PG Grade Bumping - PG grade bumping was based on the rutting damage concept for high temperature adjustments. Adjustments were developed as the difference between PG for standard traffic conditions (ESAL of 3 million and high speed) and PG site conditions. 187 sites throughout the U.S. and for five different target rut depths. The PG adjustments were then averaged by different ESAL ranges, traffic speeds and base PG.

The following steps should be followed to determine the proper SuperPave™ asphalt cement grade for a given project:

Step 1. Determine proper reliability to satisfy pavement temperature property requirements.

The first decision is to determine what type of project is being designed. For new construction or reconstruction, asphalt cement with 98% reliability for both low and high pavement temperature properties is recommended. For overlays, asphalt cement with 98% reliability for high pavement temperature properties (rutting resistance) and 50% reliability for low pavement temperature properties (cracking resistance) are recommended. Asphalt cements with lower than 98% reliability against rut resistance should not be specified. In the SuperPave™ system, anything between 50% and 98% reliability is considered 50% reliability for the purpose of binder selection. The low pavement temperatures are specified at a lower reliability for overlays because of reflection cracking. See **Figure 3.6 PG Binder Grades** for a graphical representation of reliability.

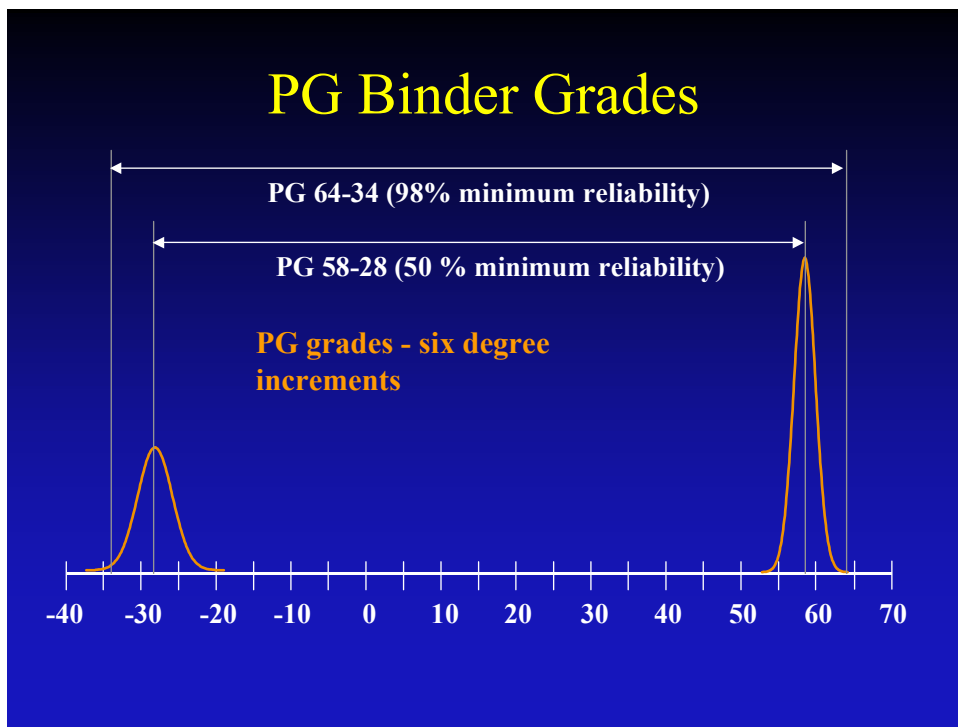

Figure 3.6 PG Binder Grades

Step 2. Determine weather data for the project.

Obtain the SuperPave™ recommended asphalt cement grade, based on weather data and traffic in the project area. Recommendations on 98% reliability high and low pavement temperature weather stations are found in **Figure 3.7 Colorado 98% Reliability LTPP High Pavement Temperature Weather Station Models** and **Figure 3.8 Colorado 98% Reliability LTPP Low Pavement Temperature Weather Station Models**, neither of which accounts for grade bumping. The program also calculates the reliability of various asphalt cements for a given location. Each RME has a copy of this program. This source will yield the 98% and 50% reliability asphalt cement for a project area for a free flowing traffic condition, which is described in Step 3. For example, when the recommendations call for a PG 58-22 for a given project, due to the available binder grades in Colorado, a PG 64-22 would be specified. This selection provides for rut resistance while preserving the same level of resistance to cracking. Because of the danger of rutting, in no case should the recommended high temperature requirements be lowered based on availability.

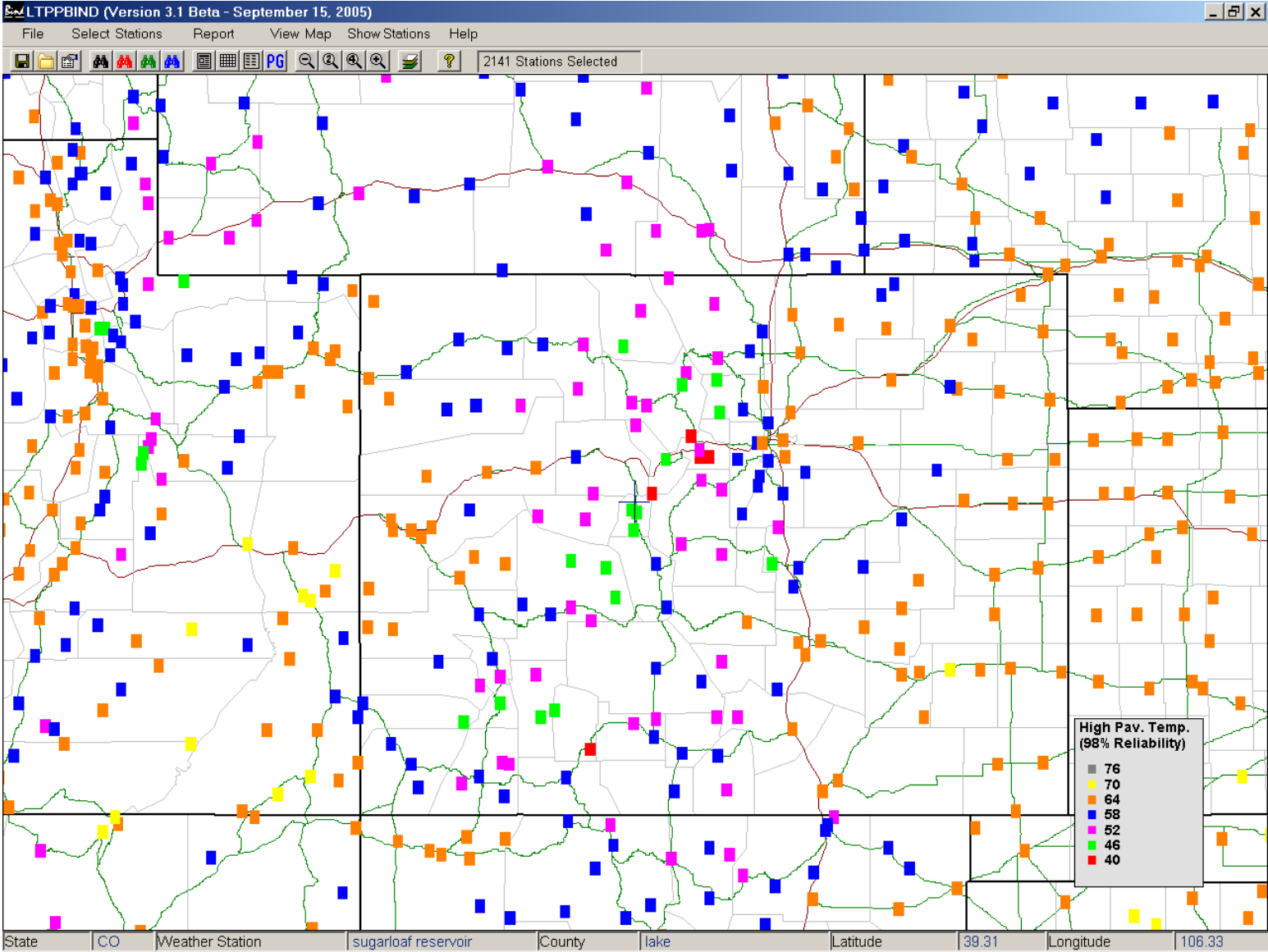

Figure 3.7 Colorado 98% Reliability LTPP High Pavement Temperature Weather Station Models

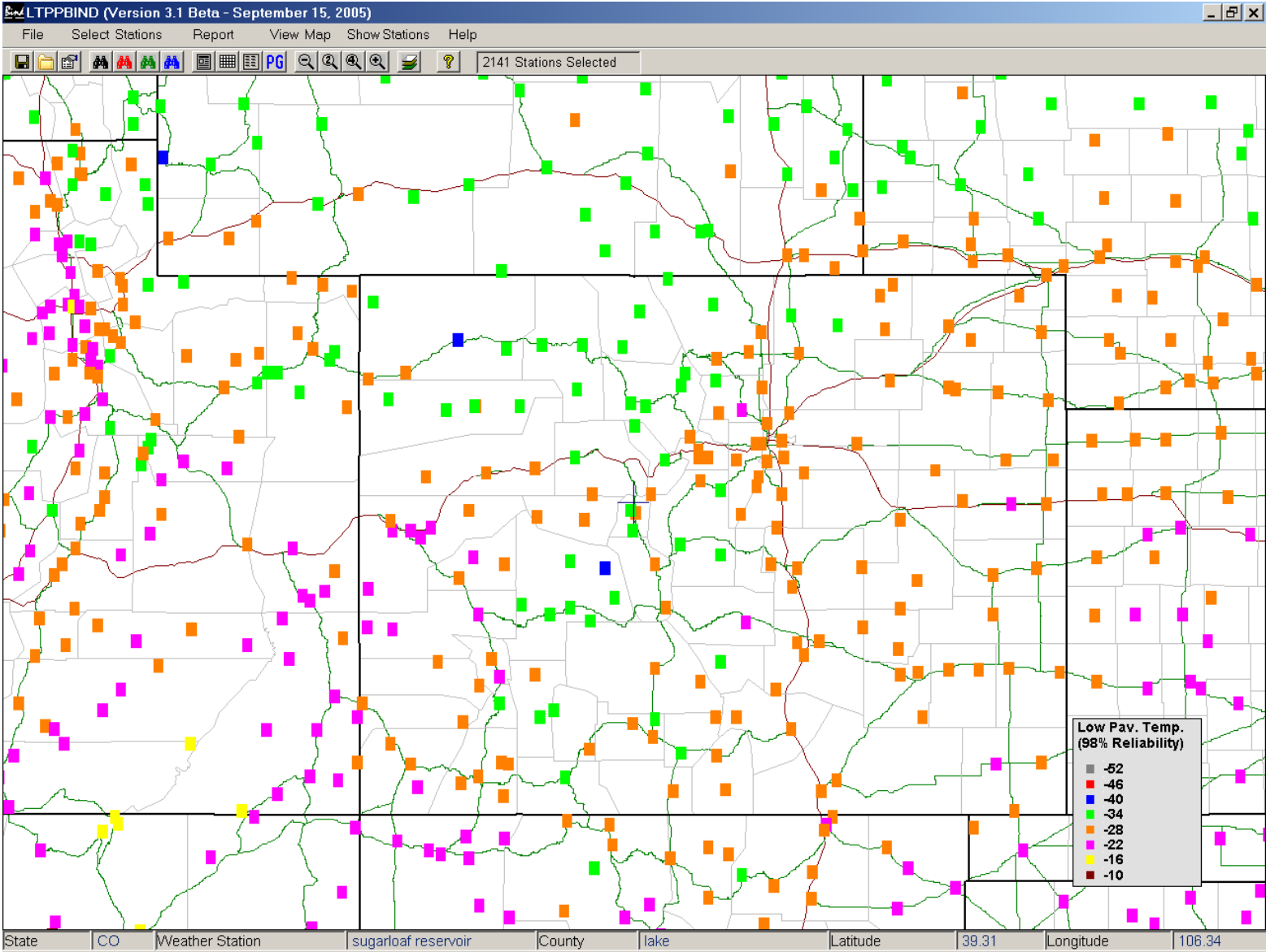

Figure 3.8 Colorado 98% Reliability LTPP Low Pavement Temperature Weather Station Models

Step 3. Select Location of Roadway.

Place the cross hair on the location of area of interest in the weather data program LTPPBind. The program selects five weather stations surrounding the area of interest. The designer has the option to use any number of weather stations that are representative of the climate at the area of interest.

Step 4. Adjust HMA Performance Grade Binder to meet layer depth, traffic flow and loading requirements.

SuperPave™ high temperature reliability factors are based on historical weather data and algorithms to predict pavement temperature. At a depth layer of one inch or more below the surface, high temperature recommendations are changed because of their depth and the temperatures at that pavement depth.

For pavements with multiple layers, a lesser grade may be specified for lower layers based on the amount of material needed and other economical design decisions. In many cases, the requirements for lower layers might be obtained with an unmodified or more economical grade of asphalt cement. It is recommended that at least 10,000 tons of mix in the lower layer is needed before a separate asphalt cement is specified for the lower layer.

Adjustments can be made to the base high temperature binder through the PG Binder Selection screen. Adjustments to reliability, depth of layer, traffic loading, and traffic speed (fast and slow) will be required. These adjustments are called grade bumping. Additional grade bumping may be performed for stop and go traffic characteristics, such as in intersections. This extra grade bump may be applied and is suggested to have prior regional experience on doing such.

3.8.3 Example 1

A new roadway project will be constructed near Sugarloaf Reservoir. It will have two lanes per direction. It will have a traffic characteristic of slow moving because of winding mountain road. Find the appropriate binder grade. N_{DES} for the surface layer is obtained in the same manner as the previous example and has a design revolution of 75.

Step 1. Determine 18k ESAL.

Design Lane ESALs = 4,504,504 from DTD web site

This is a 20 year 18k ESAL in the design lane.

Step 2. Use LTPP software database.

Use LTPPBind software database to obtain the data from the nearest weather station. Sugarloaf Reservoir has a weather station. Appropriate weather stations can be determined from information on state, county, coordinates, location, and/or station ID. **Figure 3.9 LTPP Interface Form for Weather Station Selection (version 3.1)** is where the cross hair is placed

for the new roadway project. **Figure 3.10 LTPP Weather Station Output Data (version 3.1)** shows the data at the weather station Sugarloaf Reservoir.

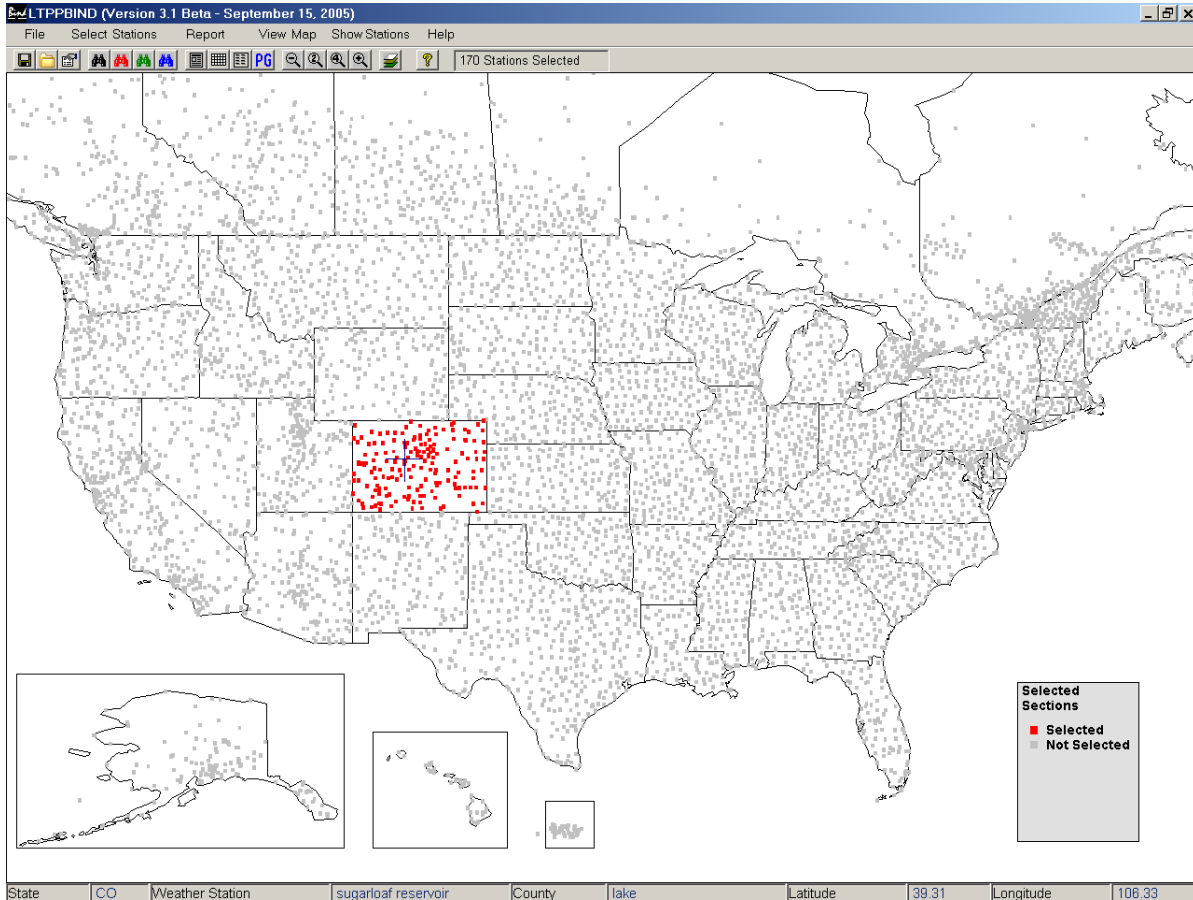

Figure 3.9 LTPP Interface Form for Weather Station Selection (version 3.1)

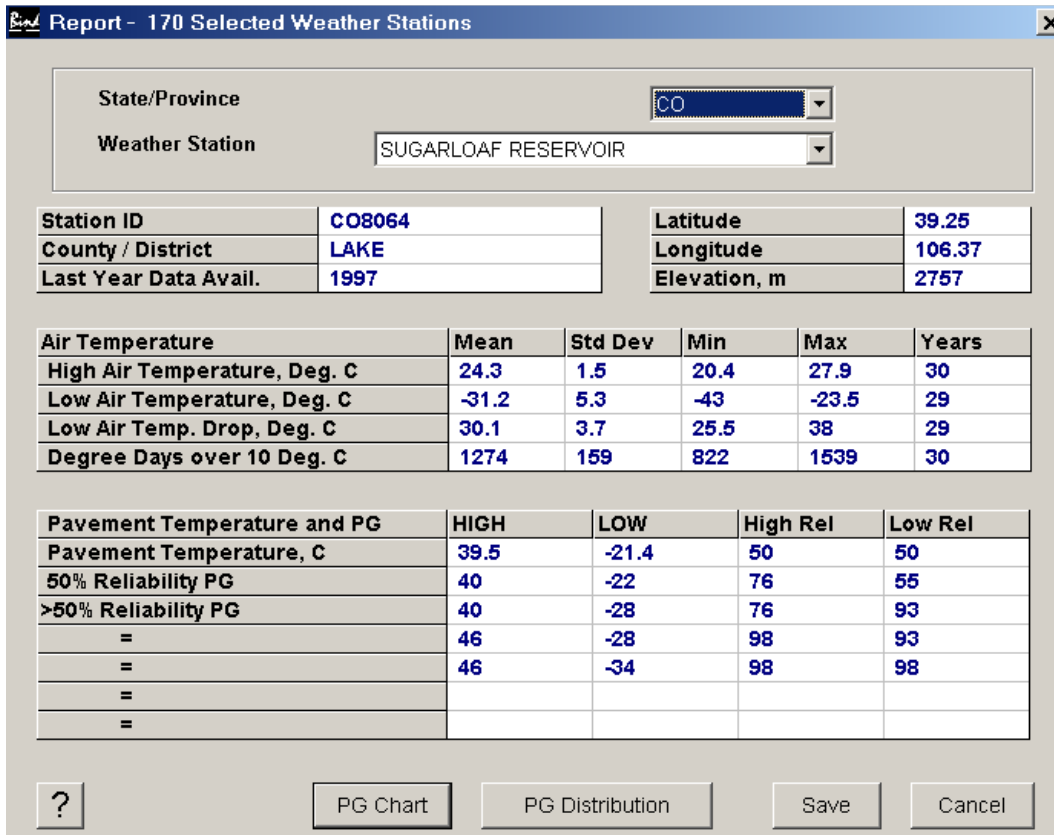

Figure 3.10 LTPP Weather Station Output Data (version 3.1)

Step 3. Select the desired weather stations.

The LTPPBind software gives the option to select the weather stations that provide the best weather data at the project location. See the upper table in **Figure 3.11 LTPP PG Binder Selection at 98% Reliability**. Check the first three weather stations. Uncheck the two weather stations that are furthest from the project. The two weather stations are too far from the site and not representative of site conditions.

Step 4. Select the Temperature Adjustments.

Because this is a principal arterial and because this is a new construction project, 98% reliability is chosen with a layer depth of zero (0) for the surface layer. Again, see **Figure 3.11 LTPP PG Binder Selection at 98% Reliability** for the selection.

Step 5. Select the Traffic Adjustments for High Temperature.

Select the appropriate traffic loading and traffic speed. The design lane ESALs are 4,504,504 and the traffic speed is slow. Grade bumping is automatic and is demonstrated by toggling in appropriate cells.

Parameter	A=8 km	B=10 km	C=16 km	D=25 km	E=35 km
Station ID	✓ CO8064	✓ CO4885	✓ CO1660	✗ CO8501	✗ CO5507
Elevation, m	9046	9229	10516	8542	7269
Degree-Days >10 C	1274	1328	761	1442	2083
Low Air Temperature, C	-31.2	-30.5	-30.4	-31.4	-29.9
Low Air Temp. Std Dev	5.3	3.5	2.9	4.3	3.4

Input Data

Latitude, Degree: 39.31 Lowest Yearly Air Temperature, C: -30.7
 Yearly Degree-Days >10 Deg.C: 1121 Low Air Temp. Standard Dev., Deg: 3.9

Temperature Adjustments

Base HT PG: 52
 Desired Reliability, %: 98
 Depth of Layer, mm: 0

Traffic Adjustments for HT

Traffic Loading	Fast	Slow
Up to 2 M. ESAL	0.0	0.0
3 to 10 M. ESAL	7.8	10.3
10 to 30 M. ESAL	13.2	15.5
Above 30 M. ESAL	15.5	17.7

PG Temperature

	HIGH	LOW
PG Temp. at 50% Reliability	37.7	-21.1
PG Temp. at Desired Reliability	39.2	-28.3
Adjustments for Traffic	10.3	
Adjustments for Depth	0.0	0.0
Adjusted PG Temperature	49.5	-28.3
Selected PG Binder Grade	52	-34

Buttons: ? Recalculate PG Save Cancel

Figure 3.11 LTPP PG Binder Selection at 98% Reliability

The following data summarized in **Table 3.11 SuperPave™ Weather Data Summary** are obtained from three out of five weather stations.

Table 3.11 SuperPave™ Weather Data Summary

98% Reliability	
Depth of Layer	0 mm
Traffic Loading and Speed Adjustment	10.3°C (Slow)
PG Binder Grade	52 -34

Step 6. Select Final Binder

Table 3.10 Available Asphalt Cement Grades in Colorado, lists the binder grades that are available in Colorado. A PG 58-28 (Unmodified) is available, but it does not meet the low temperature requirement. The lowest temperature that binders available in Colorado can meet is -34° C. This is available in PG 58-34 (Polymer Modified). Therefore, at 98% reliability use PG 58-34.

Step 7. Find that temperature that falls into the environmental category.

Use **Table 3.12 Environmental Categories (Restated)** to obtain the Highest 7-Day Average Air Temperature, 24.3°C. Go to **Table 3.12 Environmental Categories (Restated)**, and find that this temperature falls into the category Very Cool (High Mountains).

Table 3.12 Environmental Categories (Restated)

Highest 7-Day Average Air Temperature	High Temperature Category
> 36°C (> 97°F)	Hot (SE and West)
>31° to 36°C (>88° to 97°F)	Moderate (Denver, Plains & West)
27° to 31°C (81° to 88°F)	Cool (Mountains)
< 27°C (< 81°F)	Very Cool (High Mountains)

Step 8. Select the Gyratory Design Revolution (N_{DES}).

Table 3.13 Recommended SuperPave™ Gyratory Design Revolution (N_{DES}), shows that for 4,504,504 18k ESAL and a high temperature category of “Very Cool,” the design revolutions should be 75.

**Table 3.13 Recommended SuperPave™ Gyratory Design Revolution (N_{DES})
(Table 3.9 Restated)**

CDOT Pavement Management System Traffic Classification (20 year Design ESAL)	20 Year Total 18k ESAL in the Design Lane	High Temperature Category			
		Very Cool	Cool	Moderate	Hot
Low	< 100,000	50	50	50	50
	100,000 to < 300,000	50	75	75	75
Medium	300,000 to < 1,000,000	75	75	75	75
	1,000,000 to < 3,000,000	75	75	75	100
High	3,000,000 to < 10,000,000	75	75	100	100
Very High	10,000,000 to < 30,000,000	---	---	100	---
Very Very High	≥ 30,000,000	---	---	125	---

Based on Standard Practice for SuperPave™ Volumetric Design for Hot-Mix Asphalt (HMA), AASHTO Designation R 35-04.

3.9 Asphalt Mix Design Criteria

3.9.1 Fractured Face Criteria

For an aggregate to meet CDOT’s fractured face criteria, the aggregate retained on the No. 4 sieve must have at least two mechanically induced fractured faces (2).

Table 3.14 Fractured Face Criteria

% Fractured Faces of 20 Year 18k ESAL in Design Lane	SX	S	SG	SMA
Non-Interstate Highways or Pavements With < 10,000,000 Total 18K ESALs	60%	60%	90%	90%
Interstate Highways or Pavements With > 10,000,000 Total 18K ESALs	70%	70%	90%	90%

3.9.2 Air Void Criteria

A design air void range of 3.5% to 4.5% with a target of 4.0% will be used on all mixes. See **Table 3.15 Minimum VMA Requirements** for design air voids and minimum VMA requirements. The air void criteria will be applied to the approved design mix. The nominal maximum size is defined as one size larger than the first sieve to retain more than 10%. Interpolate specified VMA values for Design air voids between those listed. All mix designs shall be run with a gyratory compactor angle of 1.25 degrees. CDOT Form #43 will establish construction targets for asphalt cement and all mix properties at Air Voids up to 1.0% below the mix design optimum. Extrapolate VMA values for production (Form 43) air voids beyond those listed in **Table 3.15 Minimum VMA Requirements**.

Table 3.15 Minimum VMA Requirements

Nominal Maximum Size ¹ mm (in)	Design Air Voids ^{2,3}		
	3.5%	4.0%	4.5%
37.5 (1-1/2)	11.6	11.7	11.8
25.0 (1)	12.6	12.7	12.8
19.0 (3/4)	13.6	13.7	13.8
12.5 (1/2)	14.6	14.7	14.8
9.5 (3/8)	15.6	15.7	15.8

¹ The Nominal Maximum Size is defined as one size larger than the first sieve to retain more than 10%

² Interpolate specified VMA values for design air voids between those listed.

³ Extrapolate specified VMA values for production air voids between those listed.

Criteria for voids at (N_{DES}) are listed in **Table 3.15 Minimum VMA Requirements**.

3.9.3 Criteria for Stability

Criteria for stability and voids filled with asphalt (VFA) are shown in **Table 3.16 Criteria for Stability and Voids Filled with Asphalt (VFA)**.

Table 3.16 Criteria for Stability and Voids Filled with Asphalt (VFA)

SuperPave™ Gyratory Revolutions (N _{DES})	Hveem Minimum Stability*	VFA (%)
125	30	65-75
100	30	65-75
75	28	65-80
50	**	70-80

* Hveem Stability criteria for mix design approval and for field verification.

** Hveem Stability is not a criterion for mixes with a (N_{DES}) of 50.

Note: 1-inch mix (CDOT Grade SG) has no stability requirements.

3.9.4 Moisture Damage Criteria

Moisture damage criteria are shown in **Table 3.17 Moisture Damage Criteria**.

Table 3.17 Moisture Damage Criteria

Characteristic	Value
Minimum dry split tensile strength, psi	30
Minimum tensile strength ratio, CP-L 5109, (%)	80
Minimum tensile strength ratio, CP-L 5109, Stone Matrix Asphalt, (%)	70

3.10 Rumble Strips

When Rumble Strips are installed, they shall be of the style and location as shown on Standard Plan Sheet No. M-614-1, Rumble Strips.

References

1. Gilbert, K., *Thermal Segregation*, 2005, CDOT Report No. CDOT-DTD-R-2005-16. <http://www.dot.state.co.us/publications/PDFFiles/thermalesegregation.pdf>.
2. Brown, E.R. and Bassett, C.E. *Effects of Maximum Aggregate Size on Rutting Potential and Other Properties of Asphalt-Aggregate Mixtures 1990*. Transportation Research Record 1259, TRB, National Research Council, Washington, D.C., 1990, pp. 107-119.
3. *HMA Pavement Mix Type Selection Guide*, FHWA Information Series 128, Federal Highway Administration, 400 7th Street S.W., Washington, DC 20590 and National Asphalt Pavement Association (NAPA), 5100 Forbes Blvd, Lanham, MD 20706, January 2001.
4. *Guide for Mechanistic-Empirical Design, Final Report*, NCHRP Project 1-37A, National Cooperative Highway Research Program, Transportation Research Board, National Research Council, Submitted by ARA, INC., ERES Consultants Division, Champaign, IL, March 2004.
5. Locander, Robert, *Analysis of Using Reclaimed Asphalt Pavement (RAP) as a Base Material*, Final Report, CDOT Report No. CDOT-2009-5, Colorado Department of Transportation, February 2009.

CHAPTER 4

PRINCIPLES OF DESIGN FOR RIGID PAVEMENT

4.1 Introduction

Rigid pavement design is based in part on data obtained in the AASHO Road Test data at Ottawa, Illinois, reported in 1962 and as modified by AASHTO in the 1993 *AASHTO Guide for Design of Pavement Structures*. The 1998 *Supplement to the AASHTO Guide for Design of Pavement Structures* is to be used along with the 1993 guide. The 1998 AASHTO Supplement was based on the results of the verification study conducted using the Long Term Pavement Performance (LTPP) database. The design of rigid pavements is to follow the 1998 Supplement as the primary method of design. The 1998 Supplement replaces the Section 3.2 - Rigid Pavement Design for Design of Pavement Structures and Section 3.3 - Rigid Pavement Joint Design in Part II of the 1993 AASHTO Guide. Refer to **CHAPTER 6** when rehabilitation designs are necessary with rigid overlays or whitetopping projects. Under current procedures truck traffic and soil conditions are the principle factors considered in selecting a structural section. The design of rigid pavements is a function of the structural quality of the pavement material characterized by the modulus of rupture. In comparison to the strength of the concrete slab, the structural contributions of underlying layers to the capacity of the pavement are relatively insignificant. While the use of thick bases under concrete pavement to achieve greater structural capacity is considered uneconomical, bases are useful in the prevention of pumping.

An overview of the proven concrete pavement practices that the Colorado Department of Transportation (CDOT) has implemented over the last several years is document in the Final Research Report CDOT-DTD-R-2006-9, *Implementation of Proven PCCP Practices in Colorado*, dated April 2006 (8).

4.2 Design Considerations

Figure 4.1 shows a conventional rigid layered system.

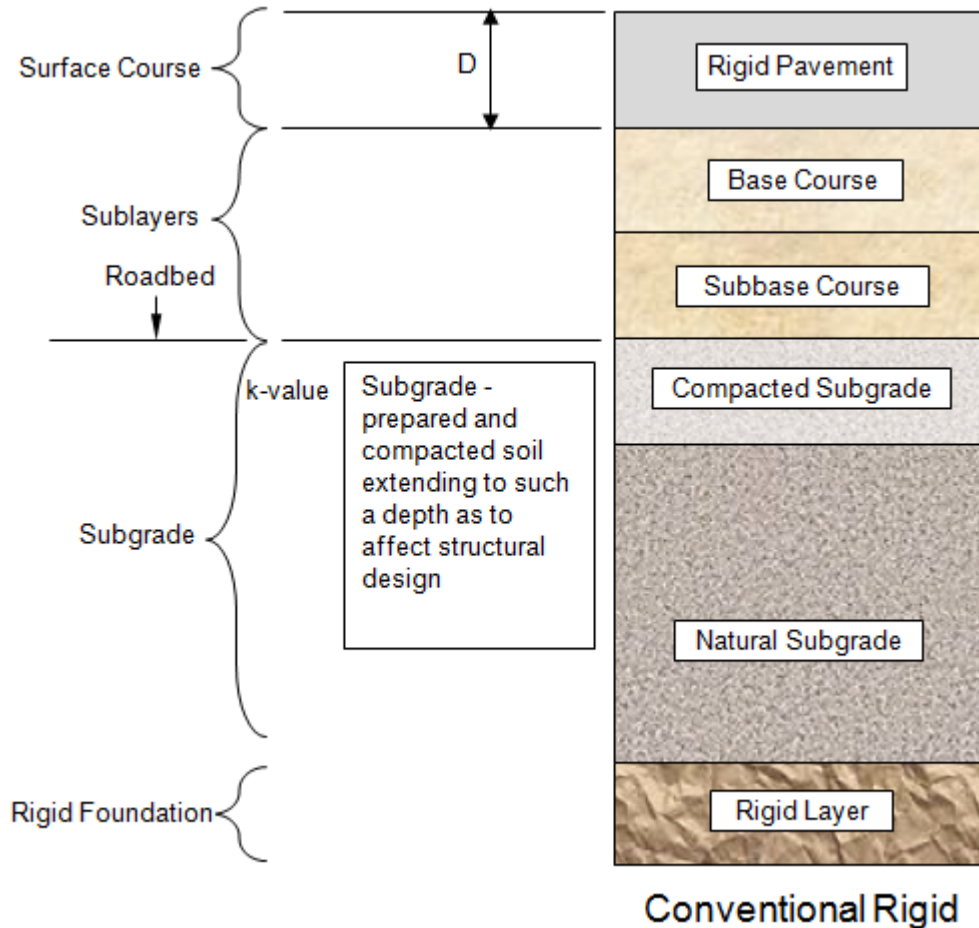

Figure 4.1 Simple Rigid Pavement Layers

Some of the definitions and design factors necessary for rigid pavement design were introduced in Chapters 1 and 2. The required thickness design factors of a rigid pavement and their sources are summarized in **Table 4.1 Rigid Pavement Thickness Design Factors**, **Table 4.2 Rigid Pavement Doweled Faulting Design Factors**, **Table 4.3 Rigid Pavement Non-doweled Faulting Design Factors** and **Table 4.4 Rigid Pavement Non-doweled Corner Break Design Factors**.

Table 4.1 Rigid Pavement Thickness Design Factors
(1998 AASHTO Supplement Inputs)

Factor	Source
18k ESAL, W18	Division of Transportation Development, requested by the designer specifically for rigid pavement http://www.dot.state.co.us/App_DTD_DataAccess/index.cfm
Reliability Level (%)	Table 1.3, CHAPTER 1
Overall Standard Deviation, S_o	0.34
Initial Serviceability, P_o	Table 1.5, CHAPTER 1
Terminal Serviceability, P_t	Table 1.5, CHAPTER 1
Serviceability Loss, ΔPSI	Table 1.5, CHAPTER 1
Modulus of Subgrade Reaction, k	See CHAPTER 2
Modulus of Rupture, S'_c	Use 650 psi
Modulus of Elasticity, E_c	Use 3,400,000 psi
Poisson's Ratio for Concrete, μ	Use 0.15
Joint Spacing, L	Section 4.6
Base Modulus, E_b	Section 4.7
Slab/Base Friction Coefficient, f	Section 4.8
Base Thickness, H_b	Section 4.9
Effective Temperature Differential, °F a) Mean Annual Wind Speed, WIND b) Mean Annual Temperature, TEMP c) Mean Annual Precipitation, PRECIP	Section 4.10
Lane Edge Support Condition, E	Section 4.11

Table 4.2 Rigid Pavement Doweled Faulting Design Factors
(1998 AASHTO Supplement Inputs)

Factor	Source
Dowel Diameter	Section 4.12
Modulus of Dowel Support, K_d	Use 1,500,000 psi/in
Modulus of Elasticity of Dowel Bar, E_s	Use 29,000,000 psi
PCC Thermal Expansion Coefficient, ALPHA	Use 0.000,006/°F
Annual Temperature Range, TRANGE	Section 4.10 Annual Difference = TEMPmax - TEMPmin
PCC Drying Shrinkage Coefficient, e	Use 0.00015 strain
Thickness of PCC Slab, D	Use Calculated Slab Thickness
Applied Wheel Load, P	Use 9,000 lbf
Percent Load Transfer, T or LTE	Use 0.45
Mean Annual Freezing Index, FI	Section 4.10.1
Cumulative Equivalent 18k ESAL, CESAL	Use same as from Thickness Design
Age to First Rehabilitation, AGE	Use 22 years
Modified AASHTO Drainage Coefficient, C_d	Section 4.134.13
Recommended Critical Mean Faulting a) Less than 25 feet Joint Spacing b) Greater than 25 feet Joint Spacing	0.08 inches from CHAPTER 7, Table 7.7 (Recommend 0.06 in) 0.13 inches (CDOT does not use)

Table 4.3 Rigid Pavement Non-doweled Faulting Design Factors
(1998 AASHTO Supplement Inputs)

Factor	Source
Number of days with maximum temperature above 90°F, Days90	Section 4.10.1
Thickness of PCC Slab, D	Use Calculated Slab Thickness
Mean Annual Freezing Index, FI	Section 4.10.1
Cumulative Equivalent 18k ESAL, CESAL	Use same as from Thickness Design
Age to First Rehabilitation, AGE	Use 22 years
Modified AASHTO Drainage Coefficient, C_d	Section 4.13
Recommended Critical Mean Faulting a) Less than 25 feet Joint Spacing b) Greater than 25 feet Joint Spacing	0.08 inches from CHAPTER 7, Table 7.7 (Recommend 0.06 in) 0.13 inches (CDOT does not use)

Table 4.4 Rigid Pavement Non-doweled Corner Break Design Factors
(1998 AASHTO Supplement Inputs)

Factor	Source
Temperature Gradient	Use table in Corner Break Check tab of MS® Excel 1998 AASHTO Supplement
Tensile Stress at Top of Slab	Use table in Corner Break Check tab of MS® Excel 1998 AASHTO Supplement

4.3 Design Period

The destructive effect of repeated wheel loads is the major factor that contributes to the failure of highway pavement. Since both the magnitude of the load and the number of its repetitions are important, provision is made in the design procedure to allow for the effects of the number and weight of all axle loads expected during the design period. The design period for new rigid pavement construction and reconstruction is 20 or 30 years. It is recommended that a 30-year design period be used for rigid pavements. The design period for restoration, rehabilitation and resurfacing is 10 years. Selection of a design period other than 10, 20, or 30 years needs to be supported by a LCCA or other overriding considerations.

4.4 Modulus of Rupture (S'_c)

The modulus of rupture (flexural strength) of Portland cement concrete to be used by CDOT in the design will be $S'_c = 650$ psi. This is an average value of as constructed pavements.

4.5 Modulus of Elasticity (E_c)

Although the modulus of elasticity (E_c) can be evaluated (ASTM Test Method C 469), in practice this is rarely done. The range of values for E_c that is reasonable depends largely on the strength of the concrete. Typical values are from 2 to 6 million psi. A value of $E_c = 3,400,000$ psi is the default value used by CDOT.

4.6 Joint Spacing (L)

In general, the spacing of both transverse and longitudinal contraction joints depends on local conditions of materials and environment, whereas expansion and contraction joints are primarily dependent on layout and construction capabilities. For contraction joints, positive temperature gradient, or base frictional resistance increases, and the spacing increases as the concrete tensile strength increases. Spacing is also related to the slab thickness and the joint sealant capabilities.

Determination of the required slab thickness includes an input for joint spacing. As joint spacing increases, stresses due to thermal curling and moisture warping increase. CDOT designs their

PCCP using the Jointed Plain Concrete Pavement (JPCP) method. For a detailed illustration, see CDOT's current Standard Plan Sheet M-412-1. CDOT uses a joint spacing of 15 feet maximum for concrete pavement thicknesses over 6 inches, 12 feet maximum for concrete thicknesses of 6 inches or less, and a minimum of 8 feet for any full depth pavement.

4.7 Base Modulus (E_b)

The required inputs are layer thickness, mean modulus of elasticity, unit weight of the material, Poisson's ratio, etc. CDOT also utilizes the Falling Weight Deflectometer (FWD) to collect pertinent data for calculating E_b . Laboratory testing is described as follows. A cyclic stress of fixed amplitude, with duration of 0.1 seconds followed by a rest period of 0.9 seconds, is applied to the test specimen. During testing, the specimen is subjected to a dynamic cyclic stress and a constant stress (seating load). AASHTO road test research discovered that loads are selected to keep horizontal deformations between 0.038 and 0.089 mm (0.0015 and 0.0035 in). The deformation responses of the specimen are measured near the center of the specimen and used to calculate both an instantaneous and total resilient modulus (M_{Ri} and M_{Rt} respectively). Instantaneous resilient modulus is calculated using the recoverable horizontal deformation that occurs during the unloading portion of one load-unload cycle. Total resilient modulus is calculated using the total recoverable deformation, which includes both the instantaneous recoverable and the time-dependent continuing recoverable deformation during the unload or rest-period portion of one cycle. The resilient modulus test is performed on each specimen at temperatures of 5, 25, and 40 °C (41, 77 and 104 °F).

The value of resilient modulus determined from this protocol procedure is a measure of the elastic modulus of HMA materials recognizing certain non-linear characteristics. Resilient modulus values can be used with structural response analysis models to calculate the pavement structural response to wheel loads, and with pavement design procedures to design pavement structures. The resilient modulus test provides a means of characterizing pavement construction materials including surface, base, and subbase HMA materials under a variety of temperatures and stress states that simulate the conditions in a pavement subjected to moving wheel loads.

4.8 Slab/Base Friction Coefficient (f)

A ratio between slab stress at a given coefficient of friction between the slab and base and slab stress at full friction, see **Table 4.5 Friction Coefficient (f) Between Slab and Base** below.

Table 4.5 Friction Coefficient (f) Between Slab and Base

(Phase I: Validation of Guidelines for k-value Selection and Concrete Pavement Performance Prediction, FHWA-RD-96-198 Jan 1997, Pg. 95, Table 14)

Base Type or Interface Treatment	Modulus of Elasticity (psi)	Peak Friction Coefficient		
		low	mean	high
Fine-grained soil	3,000 - 40,000	0.5	1.3	2.0
Sand	10,000 - 25,000	0.5	0.8	1.0
Aggregate	15,000 - 45,000	0.7	1.4	2.0
Polyethylene sheeting	NA	0.5	0.6	1.0
Lime-stabilized clay	20,000 - 70,000	3.0	NA	5.3
Cement-treated gravel	(500 + CS) * 1000	8.0	34	63
Asphalt-treated gravel	300,000 - 600,000	3.7	5.8	10
Lean concrete without curing compound	(500 + CS) * 1000		> 36	
Lean concrete with single or double wax curing compound	(500 + CS) * 1000	3.5		4.5

Notes: CS = compressive strength, psi
Low, mean, and high measured peak coefficients of friction summarized from various references are shown above.
1 psi = 6.89 kPa

4.9 Base Thickness (H_b)

Is the thickness of base H_b . Table 4.5 Friction Coefficient (f) Between Slab and Base shows common base types.

4.10 Effective Temperature Differential ($^{\circ}F$)

An effective temperature differential includes the effects of temperature, precipitation, and wind. Wind is considered because it has an influence on the surface if it is moist. It may be drier at the surface of the slab and creates a larger differential. The same concept may be applied to the temperature differences.

Curling is slab curvature produced by a temperature gradient throughout the depth of the slab and warping is moisture-induced slab curvature. As shown in Figure 4.2 Curling and Warping, a positive gradient occurs when temperature and/or moisture levels at the top of a PCC slab are higher than that at the bottom of the PCC slab, resulting in downward curvature. In contrast, negative gradients occur when the temperature and moisture in the slab are greater at the bottom, resulting in upward slab curvature. Curling and warping actions may offset each other or augment each other. During summer days, curling may counteracted by warping.

During summer nights, the curling and warping actions may compound each other. Gradients, as shown in **Figure 4.2 Curling and Warping**, are primarily non-linear in nature (5).

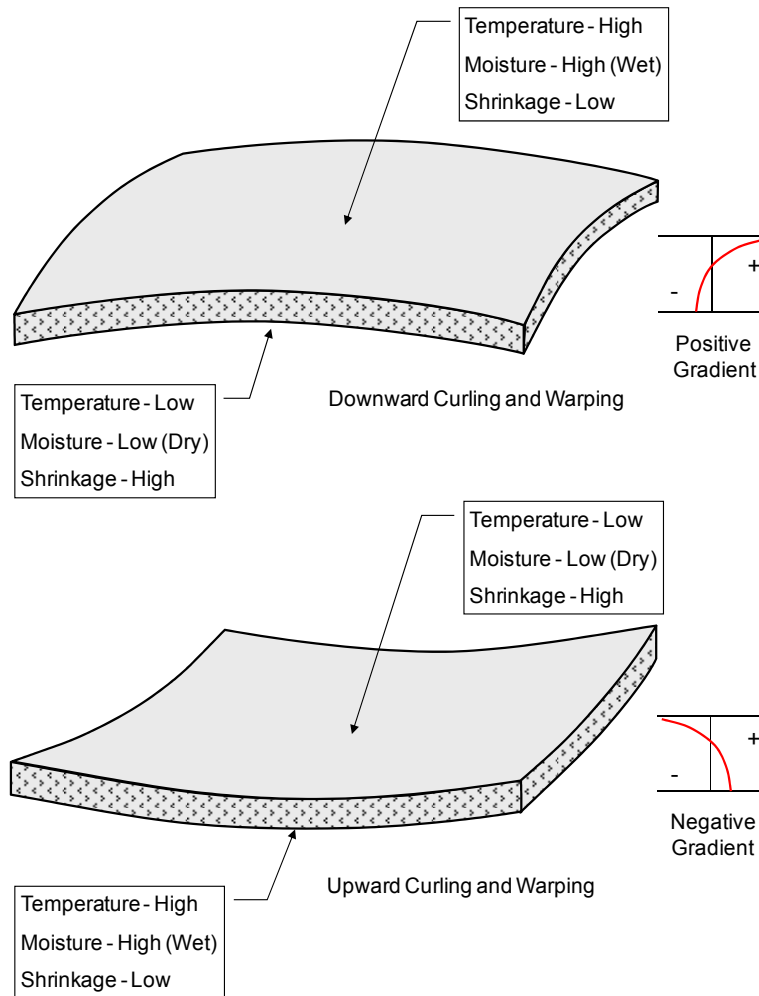

Figure 4.2 Curling and Warping

The magnitude of thermal and moisture gradients within a pavement are influenced by factors of daily temperature and relative humidity conditions, base layer type, slab geometry with constraints, shrinkage characteristics, and concrete mixture characteristics. The key characteristics of concrete mixtures that influence pavement response to thermal gradients are coefficient of thermal expansion, thermal conductivity, and specific heat (5).

Paving operations are often performed during the mornings and daytime of hot sunny days, a condition that tends to expose the newly paved slabs to a high temperature difference from the intense solar radiation plus the heat of hydration. Depending on the exposure conditions, a significant amount of positive temperature gradient may be present at the time of hardening. On the other hand, shrinkage occurs with the surface drying and bottom moisture wicking into the base/subbase. This resultant condition has been termed the "zero-stress temperature gradient" and is permanently locked into the slab at the time of construction. The permanent components

of curling and warping are considered together and are indistinguishable. Creep occurs over time and negates the effects of the permanent curvature but only a portion of the permanent curling and warping actually affects the long term pavement response(7). Refer to CDOT Final Research Report CDOT-DTD-R-2006-9, *Implementation of Proven PCCP Practices in Colorado*, dated April 2006 (8) for additional discussion on curling.

4.10.1 Climatic Properties

The values to be used are mean values at the location of the project. Use of weather station data is advisable.

- WIND = mean annual wind speed, mph
- TEMP = mean annual temperature, °F
- PRECIP = mean annual precipitation, inches
- TRANGE = annual temperature range, °F
- FI = mean annual Freezing Index, degree-Fahrenheit days
- Days90 = number of days with maximum temperature above 90°F, days

Wind speeds are generally documented in real time. **Table 4.6 Average WIND Speed (mph)** shows five cities in Colorado and other cities adjacent to Colorado with their monthly and annual wind speeds. These wind speeds were obtained from website:

<http://lwf.ncdc.noaa.gov/oa/climate/online/ccd/avgwind.html>

Table 4.6 Average WIND Speed (mph)

Data through 2002	YRS	Jan	Feb	Mar	Apr	May	Jun	Jul	Aug	Sep	Oct	Nov	Dec	Annual
Alamosa, CO	11	5.6	6.6	8.4	10.3	9.7	9.0	7.0	6.2	6.5	6.4	5.6	4.9	7.2
Colorado Springs, CO	54	9.4	10.0	11.1	11.6	11.2	10.4	9.3	8.9	9.4	9.6	9.5	9.4	10.0
Denver, CO	47	8.6	8.7	9.6	10.0	9.3	8.8	8.3	8.0	7.9	7.8	8.2	8.4	8.6
Grand Junction, CO	56	5.7	6.7	8.4	9.4	9.6	9.8	9.4	9.1	9.0	7.9	6.8	6.0	8.2
Pueblo, CO	47	7.8	8.5	9.6	10.3	9.7	9.3	8.7	7.9	7.9	7.4	7.5	7.7	8.5
Cheyenne, WY	45	15.2	14.6	14.4	14.1	12.6	11.4	10.4	10.4	11.2	12.3	13.5	14.7	12.9
Clayton, NM	10	11.9	12.4	13.1	14.4	13.2	12.9	11.2	10.2	11.3	11.8	11.8	12.1	12.2
Goodland, KS	54	12.4	12.4	14.0	14.4	13.5	12.7	11.9	11.5	12.0	11.9	11.9	11.9	12.5
North Platte, NE	50	9.2	9.8	11.5	12.6	11.5	10.4	9.5	9.2	9.7	9.6	9.5	9.0	10.1
Scottsbluff, NE	51	10.6	11.1	12.0	12.5	11.8	10.5	9.3	8.9	9.4	9.7	10.2	10.4	10.5

TEMP, PRECIP, TRANGE, FI, and Days90 are obtained for local weather stations. **Figure 4.3** through **Figure 4.8** show weather stations for each Engineering Region. The Engineer should select the closest or average the closest weather station data. **Figure 4.3** through **Figure 4.8** has a database for the in state annual weather stations shown. Each of the six Region Material

Engineers has the database. 168 weather stations in Colorado are in the database for rigid pavement design.

See Section **2.7.1.2 Frost Susceptible Soils** in **CHAPTER 2** for additional information on how the Freezing Index is used in bases, subbases, and soils.

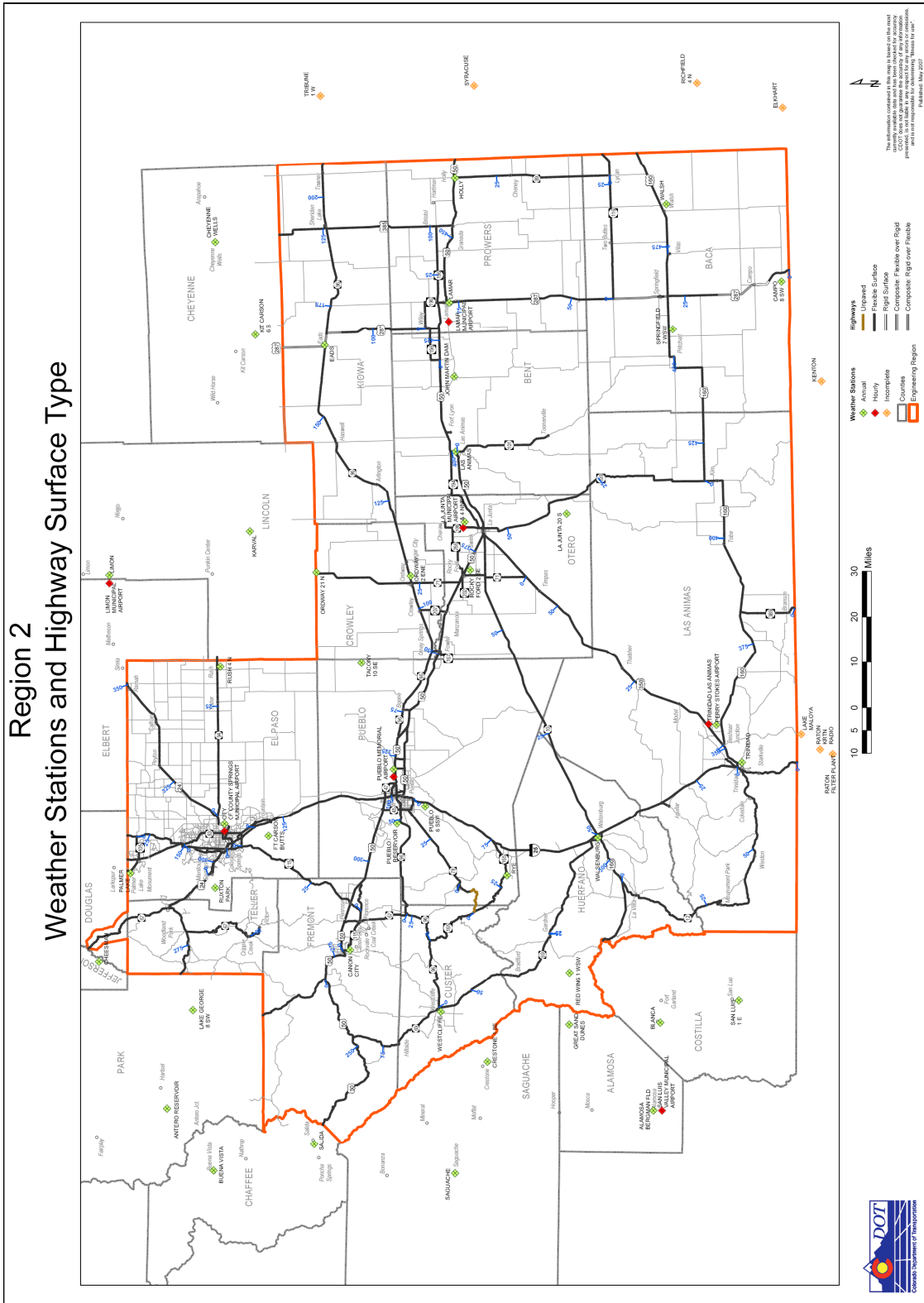

Figure 4.4 Region 2 Weather Stations

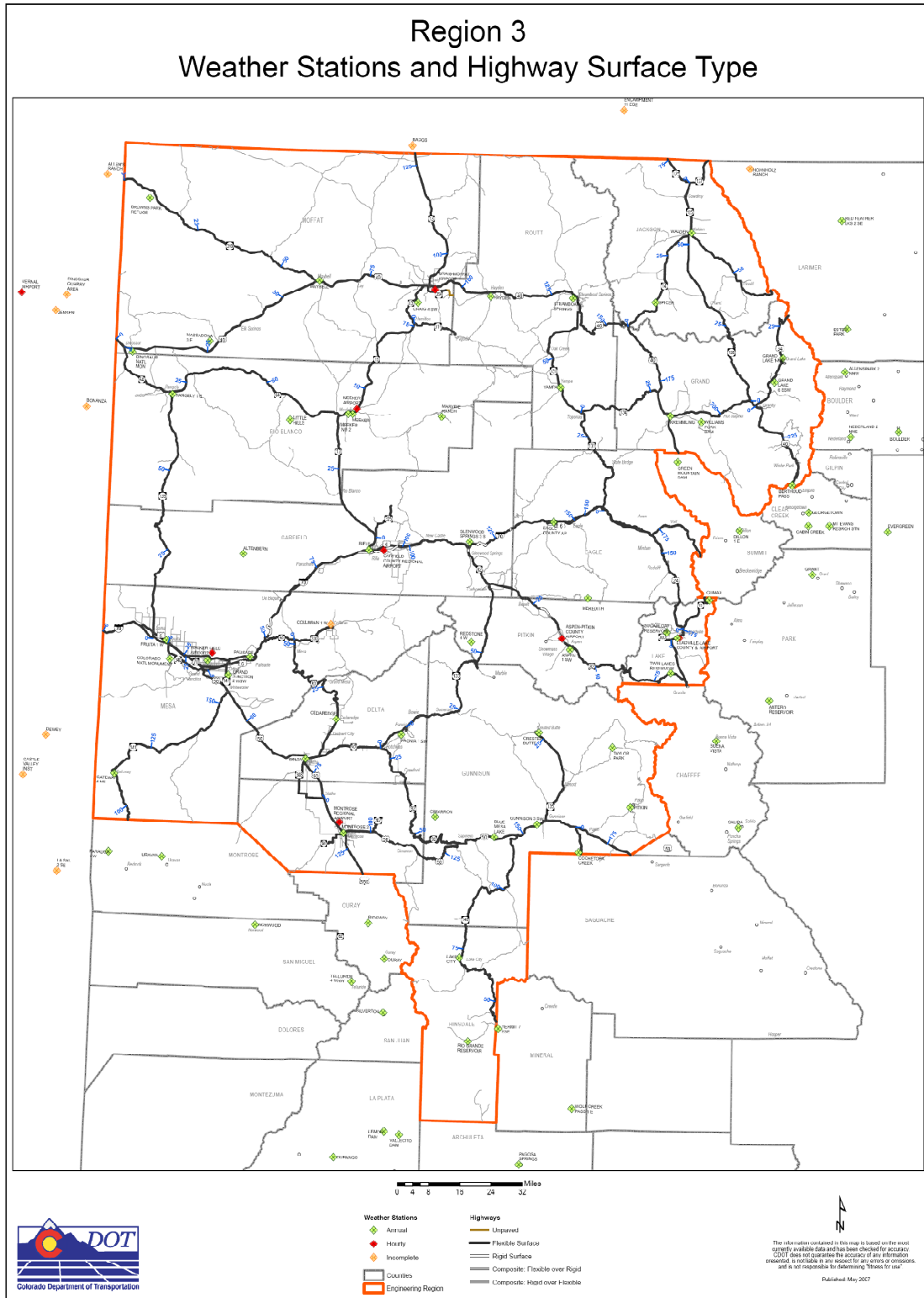

Figure 4.5 Region 3 Weather Stations

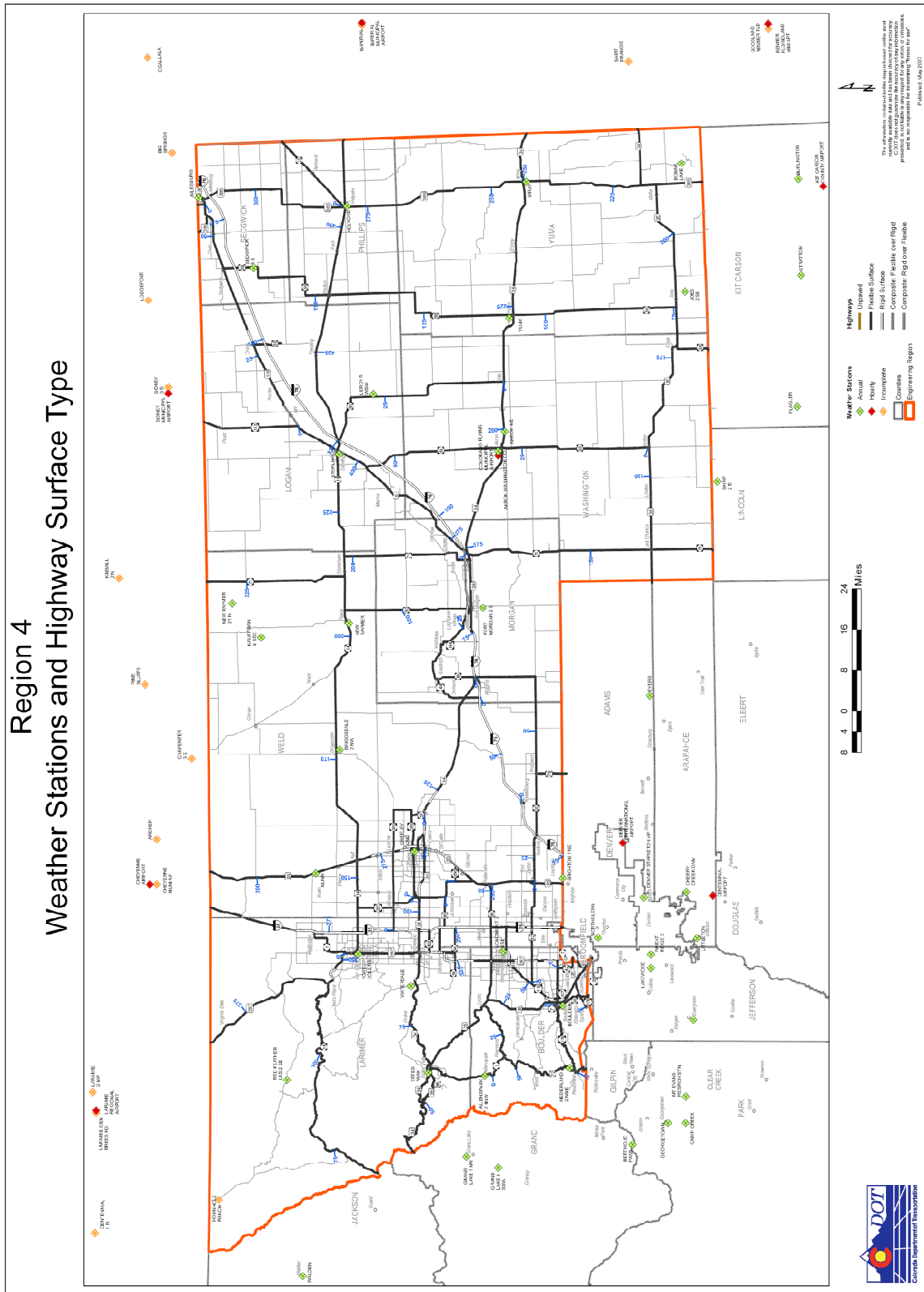

Figure 4.6 Region 4 Weather Stations

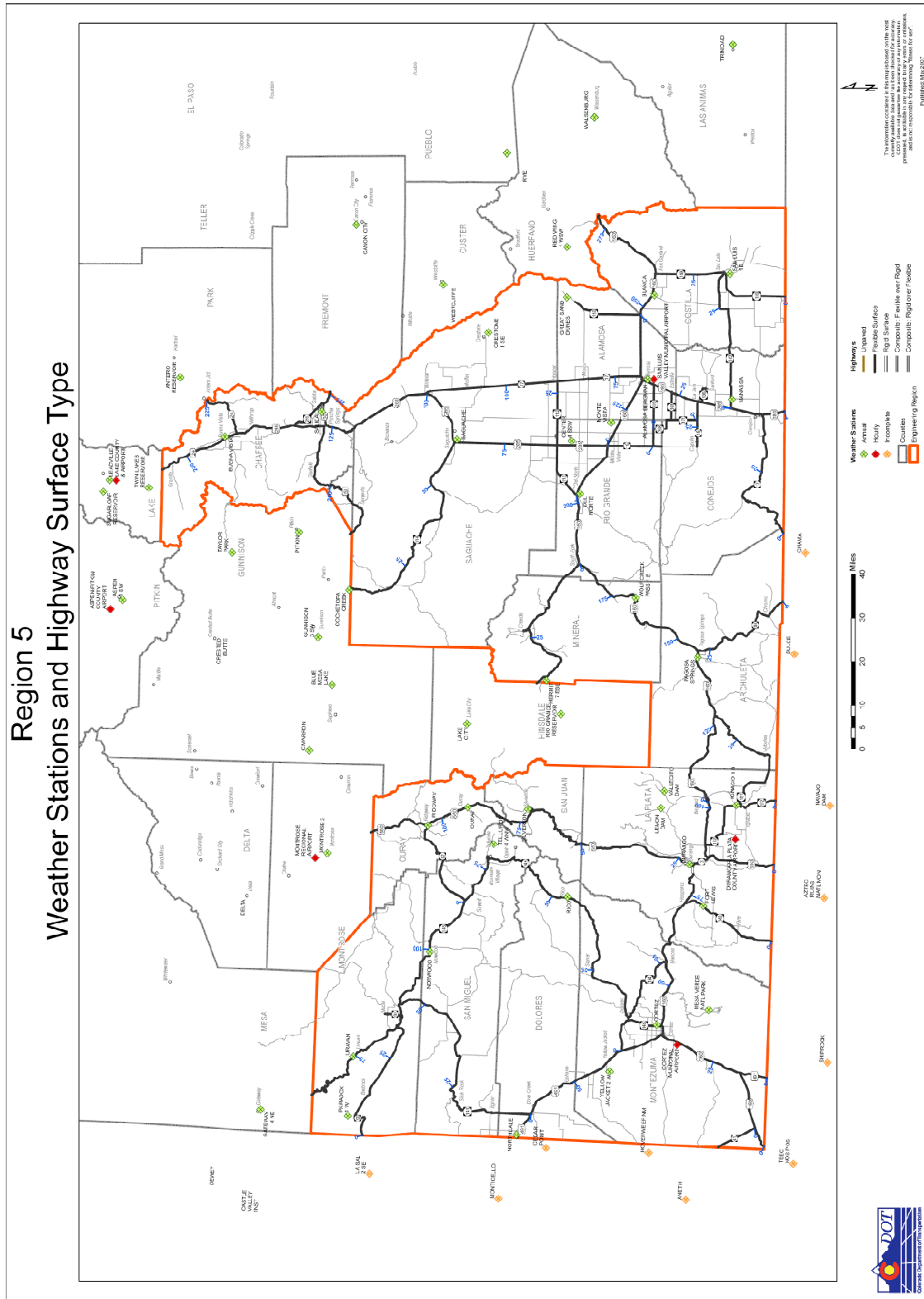

Figure 4.7 Region 5 Weather Stations

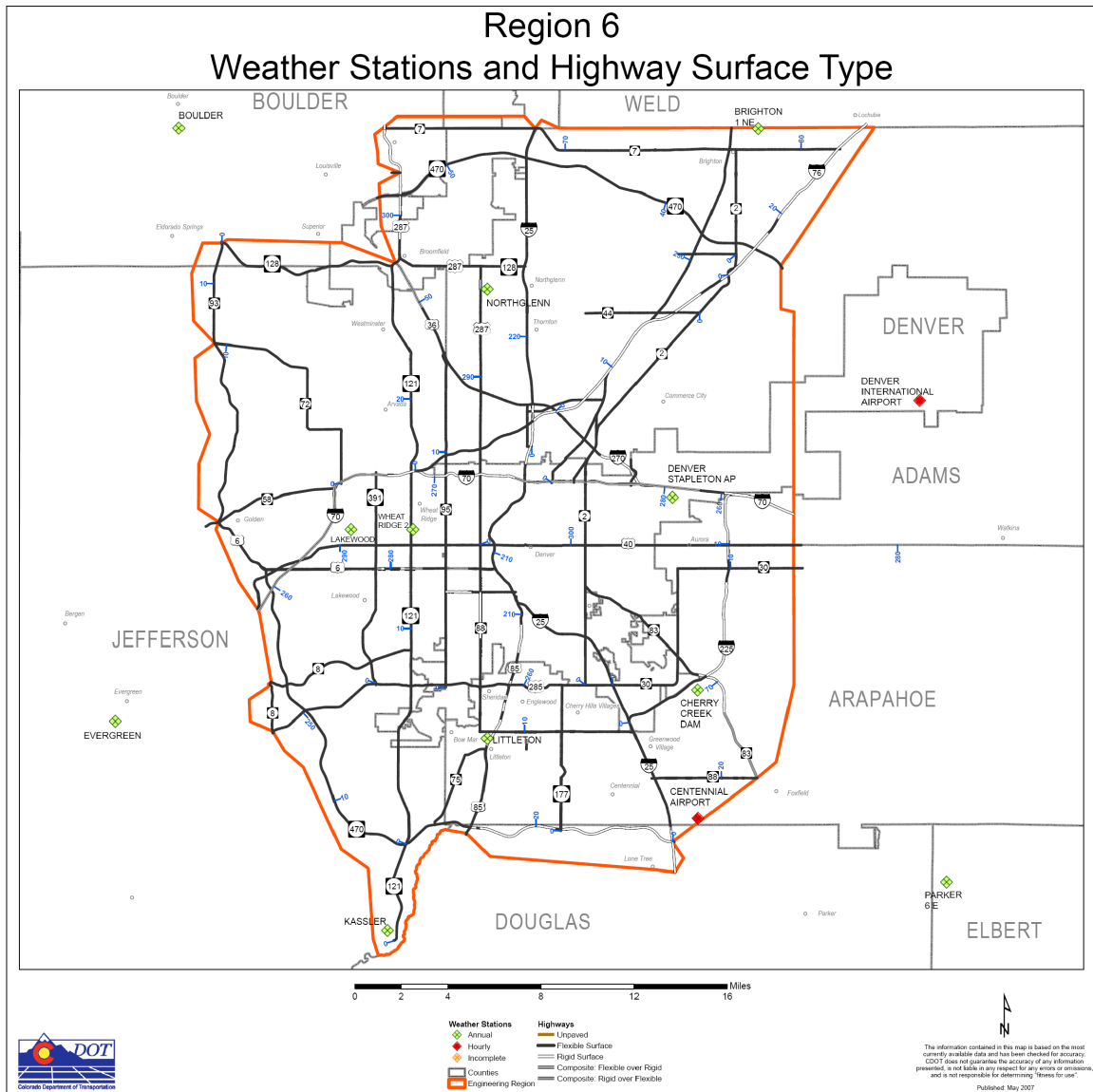

Figure 4.8 Region 6 Weather Stations

4.11 Lane Edge Support Condition (E)

- Conventional lane width (12 ft) with free edge
- Conventional lane width (12 ft) with tied concrete shoulder
- Wide slab (e.g., 14 ft) with conventional traffic lane width (12ft).

Refer to CDOT Final Research Report CDOT-DTD-R-2006-9, *Implementation of Proven PCCP Practices in Colorado*, dated April 2006 (8) and Refer to *Evaluation of Premature PCCP Longitudinal Cracking in Colorado*, Final Research Report CDOT-DTD-R-2003-1, dated January 2003 (11) for additional discussion on widen slabs.

4.12 Dowel Bars (Load Transfer Devices) and Tie Bars

Load transfer is used to account for the ability of a concrete pavement structure to transfer (distribute) load across discontinuities, such as joints or cracks. Load transfer devices, aggregate interlock, and the presence of tied longitudinal joints along with tied shoulders all have an effect.

All new rigid pavements construction and reconstruction, including ramps, auxiliary lanes, acceleration/deceleration lanes, and urban streets that have design ESALs ≥ 1 million will require epoxy coated smooth dowel bars in the transverse joints for load transfer. Smooth dowel bars aid the transfer of load across joints and allow thermal contraction in the PCCP. Since these transverse joints must be allowed to expand and contract, deformed tie bars should never be used as load transfer devices in the transverse direction. Most pavements should be dowelled.

If the pavement has shoulders, the shoulders must be portland cement concrete and tied to the travel lanes. One major advantage of using tied portland cement concrete shoulders is the reduction of slab stress and increased service life they provide. Concrete shoulders of three feet or greater may be considered a tied shoulder. Pavements with monolithic or tied curb and gutter that provide additional stiffness and keep traffic away from the edge may be treated as a tied shoulder. Studies have shown that on interstate projects, increasing the outside slab an additional two feet is equivalent to a tied shoulder. In a typical situation with 12-foot lane widths, the paint stripe is placed at 12 feet and the longitudinal joint is sawed and tied at 14 feet. Requiring the longitudinal joint to coincide with the lane line is recommended in urban locations. 14-foot longitudinal joints may not be appropriate for ramps, given that for the most part ramps are much thinner in comparison to the main line pavement.

Dowel bar diameter and tie bar size vs. for thickness of concrete pavement is tabulated in CDOT Standard Drawing M-412-1, Sheet 5, Reinforcing Size Table (9). The table is reproduced in **Table 4.7 Reinforcing Size Table**.

Table 4.7 Reinforcing Size Table

Pavement Thickness (T) inches	Tie Bar Size nominal size	Dowel Bar Diameter inches
T < 8	No. 4	1
$8 \geq T \leq 10$	No. 5	1.25
$10 > T \leq 15$	No.6	1.50

Details illustrating dowel placement tolerances are shown on CDOT Standard Drawing M-412-1, Sheet 1 (9). Dowel bar placement is at T/2 depth. Refer to **Figure 4.9 Details of Dowel Bar Placement**.

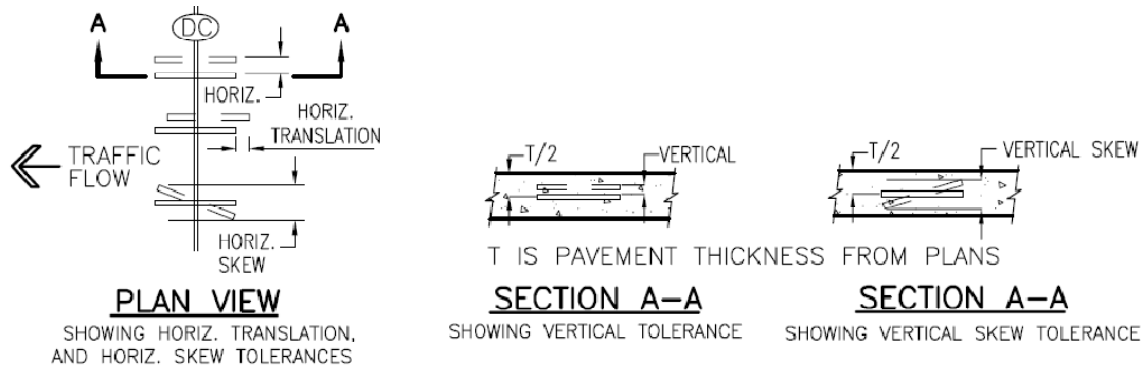

Figure 4.9 Details of Dowel Bar Placement

The tolerances are referenced in Subsection 412.13(b)2 of the *CDOT Standard Specification for Road and Bridge Construction* (10). The tolerance table is reproduced in **Table 4.8 Dowel Bar Placement Tolerances**.

Table 4.8 Dowel Bar Placement Tolerances

Position	Tolerance inches
Horizontal	1
Horizontal Translation	2
Horizontal Skew	0.375
Vertical	0.25
Vertical Skew	0.375

4.13 Modified Drainage Coefficient (C_d)

The treatment for the expected level of drainage for a rigid pavement is through the use of a drainage coefficient (C_d). Because drainage conditions influence slab support and, therefore, the overall stress condition in the slab, C_d is incorporated in the design equation for pavement depth. As a basis for comparison, the value for C_d for the conditions at the AASHTO Road Test was the value 1. The drainage coefficient value, C_d, depends on the quality of drainage and the percent of time during the year the pavement structure would normally be exposed to moisture levels approaching saturation. To obtain adequate pavement drainage the designer should consider various types of drainage systems, such as surface drainage, groundwater drainage, and drainage of pavement structure layers. Removal of free water can be accomplished by draining the free water vertically into the subgrade, or laterally through a drainage layer into a pipe collector, or edge drain. Such systems are only effective for free water; water held by capillary forces in soils and fine aggregates cannot be drained. The drainage coefficient values have been modified in the 1998 Supplement. **Table 4.9 Modified AASHTO Drainage Coefficients** shows recommended values of the drainage coefficient for various conditions.

Table 4.9 Modified AASHTO Drainage Coefficients

Edge Drains	Precipitation Level	Fine-Grained Subgrade		Course-Grained Subgrade	
		Non-permeable Base	Permeable Base	Non-permeable Base	Permeable Base
No	Wet	0.70-0.90	0.85-0.95	0.75-0.95	0.90-1.00
	Dry	0.90-1.10	0.95-1.10	0.90-1.15	1.00-1.15
Yes	Wet	0.75-0.95	1.00-1.10	0.90-1.10	1.05-1.15
	Dry	0.95-1.15	1.10-1.20	1.10-1.20	1.15-1.20

Notes:

1. Course subgrade = A-1 through A-3 classes;
Fine subgrade = A-4 through A-7 classes.
2. Permeable Base = $k = 1000$ ft/day or uniform coefficient (C_u) ≤ 6 .
3. Wet climate = Precipitation > 25 in/year;
Dry climate = Precipitation ≤ 25 in/year.
4. Select midpoint of range and use other drainage features (adequacy of cross slopes, depth of ditches, presence of daylighting, relative drainability of base course, bathtub design, etc.) to adjust upward or downward.

4.14 Design Methodology for PCCP

With the availability and power of desktop personal computers in the workplace, it is preferred that the rigid pavement design equations be performed by computers. The Department recommends use of the most current version of the NCHRP rigid pavement design supplemental spreadsheet software. The rigid pavement design software is a Microsoft Excel spreadsheet that automates the design and analysis procedures. A FHWA website contains information on the software, which may be downloaded at: <http://www.fhwa.dot.gov/pavement/ltp/rigid.cfm>.

In those cases where expansive subgrade soils are encountered, their treatment should be subject to a separate analysis. In all cases, the pavement design will be based on the support value of the subgrade soil after any swell has been eliminated or reduced to acceptable values. Add 1/4 inch to the design thickness in new construction and reconstruction to account for grinding of the surface for the first rehabilitation.

Thicknesses designated on plans are rounded up to the next 1/2 inch.

AASHTO has developed a supplemental to the 1993 Design Guide. This supplement has been prepared as the method for rigid pavement design, in the form of an addendum to the current AASHTO Guide. It contains the recommendations from NCHRP I-30, modified based on the results of the verification study conducted using the LTPP database. **Figure 4.10 1998 AASHTO Supplemental Input Screen** and **Figure 4.11 1998 AASHTO Supplemental Faulting Input Screen** are 1998 AASHTO Supplemental input screens.

Rigid Pavement Design - Based on AASHTO Supplemental Guide	
II. Design	
<p>Serviceability</p> <p>Initial Serviceability, P1: <input type="text" value="4.5"/></p> <p>Terminal Serviceability, P2: <input type="text" value="2.5"/></p>	
<p>PCC Properties</p> <p>28-day Mean Modulus of Rupture, (S'_c): <input type="text" value="650"/> psi</p> <p>Elastic Modulus of Slab, E_c: <input type="text" value="3,400,000"/> psi</p> <p>Poisson's Ratio for Concrete, m: <input type="text" value="0.15"/></p>	
<p>Table 14</p>	<p>Base Properties</p> <p>Elastic Modulus of Base, E_b: <input type="text" value="15,000"/> psi</p> <p>Design Thickness of Base, H_b: <input type="text" value="6.0"/> in</p> <p>Slab-Base Friction Factor, f: <input type="text" value="1.4"/></p>
<p>Reliability and Standard Deviation</p> <p>Reliability Level (R): <input type="text" value="95.0"/> %</p> <p>Overall Standard Deviation, S_o: <input type="text" value="0.34"/></p>	
<p>Table 15</p>	<p>Climatic Properties</p> <p>Mean Annual Wind Speed, WIND: <input type="text" value="9.0"/> mph</p> <p>Mean Annual Air Temperature, TEMP: <input type="text" value="50.0"/> °F</p> <p>Mean Annual Precipitation, PRECIP: <input type="text" value="15.0"/> in</p>
<p>Subgrade k-Value</p> <p>Calculate Seasonal k-Value: <input type="text" value="62"/> psi/in</p>	
<p>Design ESALs</p> <p>Calculate Traffic: <input type="text" value="42.7"/> million</p>	
<p>Pavement Type, Joint Spacing (L)</p> <p><input checked="" type="radio"/> JPCP Joint Spacing: <input type="text" value="15.0"/> ft</p> <p><input type="radio"/> JRCP</p> <p><input type="radio"/> CRCP</p> <p style="text-align: right;">JPCP</p> <hr/> <p>Effective Joint Spacing: <input type="text" value="180"/> in</p>	
<p>Edge Support</p> <p><input checked="" type="radio"/> Conventional 12-ft wide traffic lane</p> <p><input type="radio"/> Conventional 12-ft wide traffic lane + tied PCC</p> <p><input type="radio"/> 2-ft widened slab w/conventional 12-ft traffic lane</p> <hr/> <p>Edge Support Factor: <input type="text" value="1.00"/></p>	
<p>Sensitivity Analysis</p> <p>Slab Thickness used for Sensitivity Analysis: <input type="text" value="12.84"/> in Slab Thickness Sensitivity</p> <p><input type="radio"/> Modulus of Rupture <input type="radio"/> Elastic Modulus (Slab)</p> <p><input type="radio"/> Elastic Modulus (Base) <input type="radio"/> Base Thickness</p> <p><input checked="" type="radio"/> k-Value <input type="radio"/> Joint Spacing</p> <p><input type="radio"/> Reliability <input type="radio"/> Standard Deviation</p>	
<p>Calculated Slab Thickness for Above Inputs: 12.84 in <input type="button" value="Calculate"/></p> <p style="text-align: right;"><input type="button" value="Faulting Check"/></p>	

Figure 4.10 1998 AASHTO Supplemental Input Screen

Table 28 on the bottom of **Figure 4.11 1998 AASHTO Supplemental Faulting Input Screen** compares the Predicted Mean Faulting with the Recommended Maximum Critical Levels. If the predicted faulting is greater than the recommended level, an adjustment to the joint load transfer design should be made. Potential adjustments include use of dowels, or, if dowels already exist, an increase in the diameter; selection of a different base type and permeability; and/or a decrease in the joint spacing (for undoweled joints). Slab thickness should not be increased in an effort to improve the joint load transfer design, because slab thickness has only a minimal effect on joint faulting. However, the slab design may need adjustment after the joint design is completed, especially if the joint spacing is reduced or the base type is changed to reduce expected faulting.

Faulting

DOWELED PAVEMENT	NONDOWELED PAVEMENT						
<p>Dowel Diameter: <input type="text" value="1.50"/> in K_d: <input type="text" value="1,500,000"/> psi/in E_s: <input type="text" value="29,000,000"/> psi</p> <p>Base/Slab Frictional Restraint <input checked="" type="radio"/> Stabilized Base <input type="radio"/> Aggregate Base or LCB w/ bond breaker</p> <p>ALPHA: <input type="text" value="0.000006"/> /°F TRANGE: <input type="text" value="120.0"/> °F e: <input type="text" value="0.00015"/> strain D: <input type="text" value="12.84"/> in P: <input type="text" value="9,000"/> lbf T: <input type="text" value="0.45"/></p> <p>Base Type: <input checked="" type="radio"/> Stabilized Base <input type="radio"/> Unstabilized Base</p> <p><input type="button" value="FITable"/> F_i: <input type="text" value="400"/> °F-days CESAL: <input type="text" value="42.70"/> million Age: <input type="text" value="22.0"/> years C_d: <input type="text" value="1.00"/> <input type="button" value="Drainage Coeff. Table"/></p> <p>Faulting (doweled)</p> <p><input type="button" value="Calculate"/> 0.04 in</p> <p>Faulting Check - PASS</p> <p><input type="button" value="Input Form"/> <input type="button" value="Results"/></p>	<p><input type="button" value="Days90 Table"/> Days90: <input type="text" value="30"/> days D: <input type="text" value="12.84"/> in</p> <p>Base Type: <input checked="" type="radio"/> Stabilized Base <input type="radio"/> Unstabilized Base</p> <p><input type="button" value="FITable"/> F_i: <input type="text" value="550"/> °F-days CESAL: <input type="text" value="42.70"/> million Age: <input type="text" value="22.0"/> years C_d: <input type="text" value="1.00"/> <input type="button" value="Drainage Coeff. Table"/></p> <p>Faulting (nondoweled)</p> <p><input type="button" value="Calculate"/> 0.09 in</p> <p>Faulting Check - FAIL</p> <p><input type="button" value="Input Form"/> <input type="button" value="Corner Break Check"/></p>						
Recommended critical mean joint faulting levels for design (Table 28)							
<table border="1" style="margin: auto; border-collapse: collapse;"> <thead> <tr> <th style="width: 30%;">Joint Spacing</th> <th style="width: 70%;">Critical Mean Joint Faulting</th> </tr> </thead> <tbody> <tr> <td>< 25 ft</td> <td style="text-align: center;">0.06 in</td> </tr> <tr> <td>> 25 ft</td> <td style="text-align: center;">0.13 in</td> </tr> </tbody> </table>		Joint Spacing	Critical Mean Joint Faulting	< 25 ft	0.06 in	> 25 ft	0.13 in
Joint Spacing	Critical Mean Joint Faulting						
< 25 ft	0.06 in						
> 25 ft	0.13 in						

Figure 4.11 1998 AASHTO Supplemental Faulting Input Screen

Figure 4.12 1998 AASHTO Supplemental Corner Break Input Screen shows the input values and the results, pass/fail for the corner break check. This screen is used if the design is for non-doweled pavements as a check for corner breaks. The faulting check must pass to continue with the corner break check.

Note: Joint load position stress checks need to be performed only for nondoweled pavements

Only two numbers need to be entered in this sheet:
Temperature gradient
Tensile stress at top of slab

Step 1:

Total Negative Temperature Differential

Slab Thickness: 12.84 in
Total Negative Temperature Differential: -7.0 °F

Construction Curling and Moisture Gradient Temperature Differential

Enter temperature gradient: °F/in (enter positive value from below)

For temperature gradient use:

Wet Climate: 0 to 2 °F/in (Annual Precipitation >= 30 in or Thornthwaite Moisture Index > 0)
Dry Climate: 1 to 3 °F/in (Annual Precipitation < 30 in or Thornthwaite Moisture Index < 0)

Total Effective Negative Temp. Differential: °F

Step 2:

Use one or more of the following charts to estimate the tensile stress at top of slab. Note that the charts show the variation of tensile stress with negative temperature differential for slab thicknesses ranging from 7 to 13 in. These are plotted for a base course thickness of 6 in. The six charts represent three k-values (100, 250 and 500 psi/in) and two values for the elastic modulus of the base (25,000 psi and 1,000,000 psi). Use judgment to extrapolate the value of the tensile stress at the top of the slab from these charts.

Enter Tensile Stress at Top of Slab: psi (use charts below)

Step 3:

Compare the above tensile stress with the maximum tensile stress at the bottom of the slab for which the slab is designed. For the given inputs and the above thickness, this value is

psi

The slab is designed for a tensile stress of 151 psi.
If the tensile stress at the top of the slab (obtained from the charts below and entered above) is less than the design stress, the design is acceptable. If the check fails, new inputs have to be provided.

Corner Break Check:

Figure 4.12 1998 AASHTO Supplemental Corner Break Input Screen

4.15 Concrete Pavement Minimum Thickness

Table 4.10 Minimum Thicknesses for Highway and Bicycle Path

Traffic, 18k ESALs	Portland Cement Concrete Pavement
Greater than 1,000,000	8.0”
Less than or equal to 1,000,000 or Driveway, Sidewalk, Bicycle Path, and Maintenance Pavement	6.0”

The minimum thickness requirement may be changed on a project-to-project basis depending upon traffic, soil conditions, bases, etc.

4.16 Concrete Pavement Tining, Stationing, and Rumble Strips

Where posted speeds are 40 mph or higher, the surface shall be given a longitudinal metal tine finish immediately following turf drag, or it may be diamond grooved. Tining is not required where posted speeds are less than 40 mph. Tining shall produce grooves of 1/8 inch by 1/8 inch spaced 3/4 inch apart and parallel to the longitudinal joint. Longitudinal tining shall stop at the edge of travel lanes. Refer to Subsection 412.12(d) - Tining and Stationing, of *CDOT Standard Specification for Road and Bridge Construction*, 2005(10).

Refer to the Construction Bulletin Tining, dated February 4, 2002, at CDOT website for additional information:

<http://www.dot.state.co.us/DesignSupport/Construction%20Bulletins/Current/Current%20Construction%20Bulletins.htm>

Also, refer to CDOT Final Research Report CDOT-DTD-R-2005-22, *PCCP Texturing Methods*, dated January 2005 (12).

Stationing shall be stamped into the outside edge of the pavement, as shown on the plans. The stationing shall be stamped at 500-foot interval on each outside mainline shoulder as shown on Standard Plan No. M-412-1, *Concrete Pavement Joints*.

When Rumble Strips are installed, they shall be of the style and location as shown on Standard Plan Sheet No. M-614-1, Rumble Strips.

4.17 Concrete Pavement Materials Selection

Concrete pavement is a construction paving material that consists of cement (commonly Portland cement), other cementitious materials (fly ash), aggregate (gravel and sand), and water along with chemical admixtures. The concrete solidifies and hardens after mixing and placement due

to a chemical process known as hydration. The water reacts with cement, which bonds the other components together, eventually creating a hard stone-like material.

CDOT designates a concrete pavement mix as a Class P. **Table 4.1 Rigid Pavement Thickness Design Factors** shows the specified mix properties. Class E is a fast track mix that may be substituted for Class P.

Table 4.11 Concrete Classification

Concrete Class	Required Field Compressive Strength (psi)	Cementitious Content: Minimum (lbs/yd ³)	Air Content: % Range (Total)	Water Cement Ratio: Maximum
P	4200 at 28 days	660	4-8	0.44
E	4200 at 28 days	660	4-8	0.44

Class P and E are defined in Section 601 Structural Concrete and 701 Hydraulic Cement of *CDOT Standard Specification for Road and Bridge Construction*, 2005 (10) and as revised.

4.17.1 Understanding pH in Concrete Mixes

A brief explanation of pH is presented in Section **S.2.5.2 pH Scale** in the **SUPPLEMENT** Chapter. When applied to pavement design, freshly poured concrete can have a pH of 11 to 13 making it very alkaline. This high initial alkalinity helps resist corrosion, but as concrete ages, the pH can drop to around 8 increasing the degradation of steel reinforcement and load transfer devices. The high alkalinity of concrete can also affect the performance of fresh and hardened concrete when admixtures are used.

4.17.2 Alkali Aggregate Reactivity

The high alkalinity of concrete can cause serious problems when interacting with different parts of the mix, namely alkali-silica and alkali-carbonate reactions. Alkali-silica reactivity (ASR) is the process in which certain minerals in the aggregate along with the presence of moisture are broken down by the highly alkaline environment of concrete. This process produces a gel-like substance that expands adding tensile forces to the concrete matrix, which then leads to external cracking of the concrete slab (13). The cracking then allows more water to infiltrate into the concrete creating more gel and more expansion. Ultimately, the concrete destroys itself. The ASR chemical reaction is expressed in equation **Eq. 4.1** (15) below.

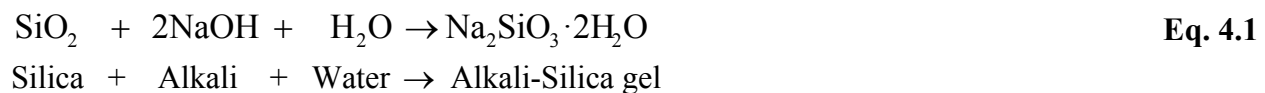

Alkali-carbonate reactivity (ACR) is much less common than ASR, but it does have similar expansive properties that occur within the aggregate and deteriorate concrete pavement. The

ACR reaction is dependent on certain types of clay rich, or impure, dolomitic limestones that are rarely used in concrete, because of their inherently weak structure (14). The ACR chemical reaction known as dedolomitization is represented in equation **Eq. 4.2** (15).

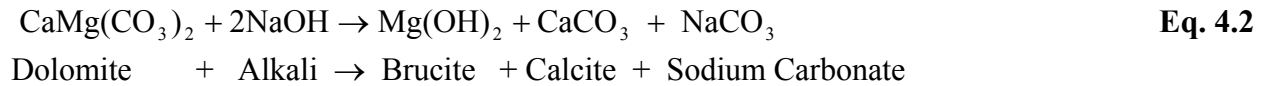

The cracking pattern is shown in **Figure 4.13 Idealized Sketch of Cracking Pattern in Concrete Mass Caused By Internal Expansion.**

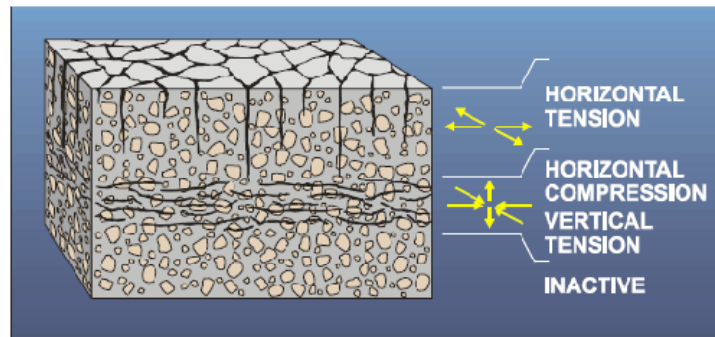

Figure 4.13 Idealized Sketch of Cracking Pattern in Concrete Mass Caused By Internal Expansion

(Figure 93, Petrographic Methods of Examining Hardened Concrete: A Petrographic Manual, July 2006)

"Sandgravel" aggregates in parts of Kansas, Nebraska, Colorado, Wyoming, especially those from the Platte, Republican, and Laramie Rivers, have been involved in the deterioration of concrete (17). In 1983 a team was formed to evaluate the concrete pavement condition in Colorado and to recommend rehabilitation methods for these pavements. This team identified that one-third of the pavements inspected suffered from ASR (19). A follow up study conducted in 1987 focused on the cause of ASR in Colorado. The study concluded that aggregates in the Denver Metro area showed no signs of ASR reaction, but aggregate from the Three Bells pit near Windsor demonstrated rapid signs of expansion. This study led CDOT to modify its specifications and require low alkali cement for all concrete pavement, it also identified the need for class F fly ash in areas where reactive aggregates have been a problem (20).

4.17.3 Sulfate Resistant Concrete Pavement

Sulfates may be found in soil and water. These sulfates may also be referred to as "alkali". The sulfates in soils and water are the main source of external sulfate attack on concrete pavement. Although the mechanism of sulfate attack is complex, it is primarily thought to be caused by two chemical reactions: 1) the formation of gypsum through the combination of sulfate and calcium ions, and/or 2) the formation of ettringite through the combination of sulfate ions and hydrated calcium aluminate (18). Ettringite is a high-sulfate, calcium sulfoaluminate mineral: $\text{Ca}_6[\text{Al}(\text{OH})_6]_2(\text{SO}_4)_3 \cdot 26\text{H}_2\text{O}$, which naturally occurs in curing concrete. The problem appears when ettringite forms after the concrete has set, this is known as Delayed Ettringite Formation

(DEF). This process is extremely harmful, because as ettringite crystals form they expand and that creates internal tensile stresses in the cement matrix (21). These stresses will cause the concrete to crack, but may not be apparent for 3-10 years (18).

The sulfate attack is a chemical reaction between sulfates and the calcium aluminate (C3A) in cement, resulting in surface softening (22). See **Figure 4.14 Sulfate Attack**.

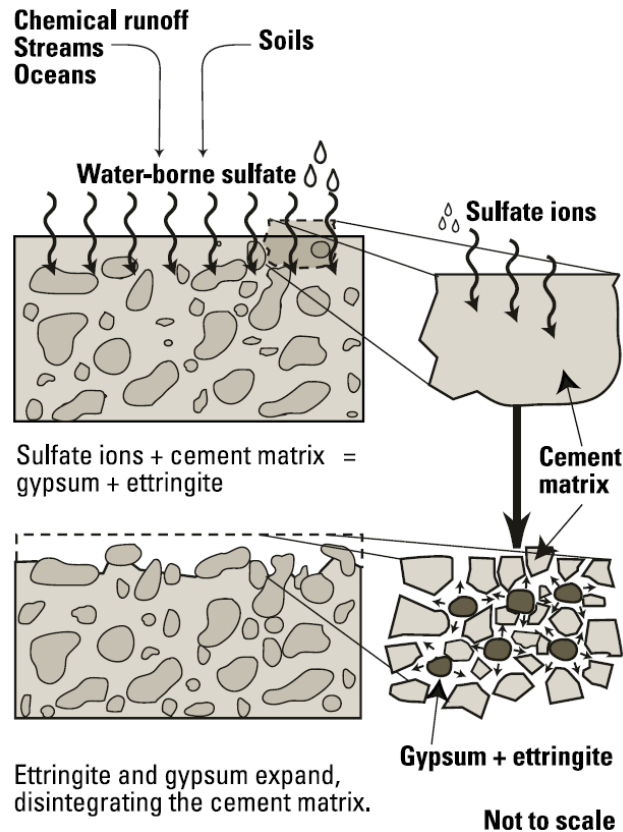

Figure 4.14 Sulfate Attack

(Figure 5-18: *Integrated Materials and Construction Practices for Concrete Pavement: State-of-the-Practice Manual*)

Steps taken to prevent the development of distress due to external sulfate attack include minimizing the tricalcium aluminate content in the cement or reducing the quantity of calcium hydroxide in the hydrated cement paste through the use of pozzolanic materials. It is also recommended that a w/c ratio less than 0.45 will help mitigate external sulfate attack (18).

Severity levels of potential exposure to sulfate attack have been developed. **Table 4.12 Requirements to Protect Against Damage to Concrete by Sulfate Attack from External Sources of Sulfates** shows the classification levels of potential exposure. Concrete pavement mix designs must provide protection against the sulfate attack. Cementitious material requirements are therefore modified. As the severity of potential exposure increases, the cementitious material requirements also become more stringent and water cement ratio becomes less stringent. Refer to Section 601 Structural Concrete of *CDOT Standard Specification for*

Road and Bridge Construction, 2005 (10) and as revised for additional cementitious material requirements.

Table 4.12 Requirements to Protect Against Damage to Concrete by Sulfate Attack from External Sources of Sulfates

Severity of Potential Exposure	Water-soluble Sulfate (SO₄), % Dry Soil	Sulfate (SO₄) in water, ppm	Water Cement Ratio, Maximum	Cementitious Material Requirements
Class 0 exposure	0.00 to 0.10	0 to 150	0.50	Class 0 requirements
Class 1 exposure	0.11 to 0.20	150 to 1500	0.50	Class 1 requirements
Class 2 exposure	0.21 to 2.00	1501 to 10,000	0.45	Class 2 requirements
Class 3 exposure	2.01 or greater	10,001 or greater	0.40	Class 3 requirements

References

1. *AASHTO Guide for Design of Pavement Structures*, American Association of State Highway and Transportation Officials, Washington, DC, 1993.
2. *Supplement AASHTO Guide for Design of Pavement Structures, Part II, - Rigid Pavement Design & Rigid Pavement Joint Design*, American Association of State Highway and Transportation Officials, Washington, DC, 1998.
3. *Techniques for Pavement Rehabilitation*, Nichols Consulting Engineers, Chtd., U.S. Department of Transportation, Federal Highway Administration and National Highway Institute, Arlington, Virginia, Sixth Edition, January 1998.
<http://www.nhi.fhwa.dot.gov/crsmaterial.asp?courseno=131008>
4. *LTPP Data Analysis Phase I: Validation of Guidelines for k-Value Selection and Concrete Pavement Performance Prediction*, Publication FHWA-RD-96-198, Federal Highway Administration, Research and Development, Turner-Fairbank Highway Research Center, 6300 Georgetown Pike, McLean, VA 22101-2296, January 1997.
5. Wells, Steven A., *Early Age Response of Jointed Plain Concrete Pavements to Environmental Loads*, thesis was presented and defended on July 27, 2005, University of Pittsburgh, School of Engineering, 2005.
6. *Computer-Based Guidelines for Concrete Pavements, Volume II: Design and Construction Guidelines and HIPERPAV[®] II User's Manual*, Publication No. FHWA-HRT-04-122, U.S. Department of Transportation, Federal Highway Administration, Research and Development, Turner-Fairbank Highway Research Center, 6300 Georgetown Pike, Mclean VA 22101-2296, February 2005.
7. *Guide for Mechanistic-Empirical Design*, Final Report, NCHRP Project 1-37A, National Cooperative Highway Research Program, Transportation Research Board, National Research Council, Submitted by ARA, INC., ERES Consultants Division, Champaign, IL, March 2004.
8. Ardani, Ahmad, *Implementation of Proven PCCP Practices in Colorado*, Final Report, Report No. CDOT-DTD-R-2006-9, Colorado Department of Transportation, Research Branch, April 2006.
9. CDOT Standard Plans, Concrete Pavement Joints M-412-1, July 2006.
10. *Standard Specifications for Road and Bridge Construction*, Colorado Department of Transportation, Denver, Co, 2005.
<http://www.dot.state.co.us/DesignSupport/Construction/2005SpecsBook/2005index.htm>

11. Ardani, Ahmad, Hussain, Shamshad, and LaForce, Robert, *Evaluation of Premature PCCP Longitudinal Cracking in Colorado*, Final Report, Report No. CDOT-DTD-R-2003-1, Colorado Department of Transportation, Research Branch, January 2003.
12. Ardani, Ahmad and Outcalt, William (Skip), *PCCP Texturing Methods*, Final Report, Report No. CDOT-DTD-R-2005-22, Colorado Department of Transportation, Research Branch, January 2005.
13. *Alkali Silica Reactivity*, Canadian Strategic Highway Research Program, Transportation Association of Canada, Technical Brief #13, April 1996, 1 October 2007. <http://www.cshrp.org/products/csbf-e13.pdf>
14. *Alkali Aggregate Reaction*, Concrete Technology, Portland Cement Association, 2007, 2 October 2007. http://www.cement.org/tech/cct_dur_AAR.asp
15. *Alkali-Aggregate Reaction in Roads & Bridges*, West, Graham, London: Thomas Telford Ltd. 1996 pp. 10-12.
16. *Petrographic Methods of Examining Hardened Concrete: A Petrographic Manual*, Publication No. FHWA-HRT-04-150, 1401 East Broad Street, Richmond, VA 23219 and Federal Highway Administration, Office of Infrastructure R&D, 6300 Georgetown Pike, McLean, VA 22101, July 2006.
17. *Standard Practice for Concrete for Civil Works Structures*, Publication No. EM 1110-2-2000, Department of the Army, US Army Corps of Engineers, Washington, DC 20314-1000, 1 February 1994.
18. *Guidelines for Detection, Analysis, and Treatment of Materials-Related Distress in Concrete Pavements - Volume 1: Final Report*, Report No. FHWA-RD-01-163, U.S. Department of Transportation, Federal Highway Administration, Research, Development and Technology, Turner-Fairbank Highway Research Center, 6300 Georgetown Pike, Mclean VA 22101-2296, August 2002.
19. *Rehabilitation of Concrete Pavements*, Report No. CDOH-83-1, Colorado Department of Highways, U.S. Department of Transportation, Federal Highway Administration, January 1983.
20. *Colorado Reactive Aggregate*, Report No. CDOH-DH-DML-87-5, Colorado Department of Highways, U.S. Department of Transportation, Federal Highway Administration, June 1987.
21. *Integrated Materials and Construction Practices for Concrete Pavement: State-of-the-Practice Manual*, FHWA Publication No. HIF-07-004, U.S. Department of Transportation, Federal Highway Administration, October 2007.

CHAPTER 5

PRINCIPLES OF DESIGN FOR PAVEMENT REHABILITATION WITH FLEXIBLE OVERLAYS

5.1 Introduction

Overlays are used to remedy structural or functional deficiencies of existing pavements. It is important that the designer consider the type of deterioration present when determining whether the pavement has a structural or functional deficiency, so that an appropriate overlay type and design can be developed. See **Figure 5.1 Rehabilitation Alternative Selection Process** for the flowchart of rehabilitation alternative selection process.

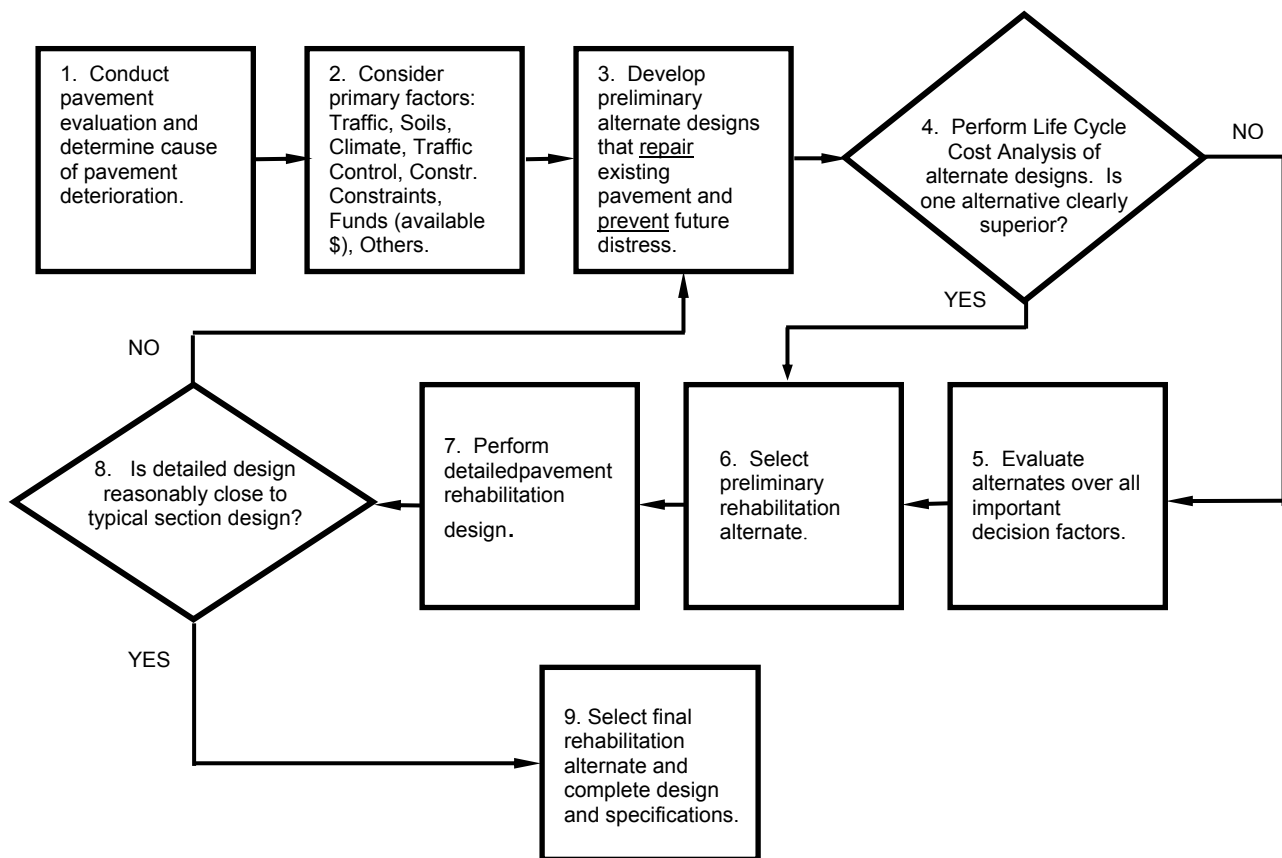

Figure 5.1 Rehabilitation Alternative Selection Process

5.2 Design Considerations

The feasibility of any type of overlay depends on the following major considerations:

- Construction feasibility of the overlay;
- Traffic control;
- Materials and equipment availability;

- Climatic conditions;
- Construction problems such as noise, air and/water pollution, hazardous materials/waste, subsurface utilities, overhead bridge clearance, shoulder thickness and side slope extensions in the case of limited right-of-way, etc; and
- Traffic disruptions.

All of the following and other considerations specific to the site need to be considered to determine whether the overlay should be placed or to rehabilitate/reconstruct the project.

- Existing pavement deterioration, specific distress types, severities, and quantities;
- Existing pavement design, condition of pavement materials, especially durability problems and subgrade soil;
- Future traffic loadings;
- Climate; and
- Existing subdrainage situation.

When a pavement surface evaluation indicates adequate structural strength, but the condition of the surface needs correction, a functional overlay may be used. Surface conditions that may require correction include excessive permeability, surface raveling, surface roughness, rutting, and low skid resistance.

When a pavement surface evaluation indicates possible structural deficiencies, a more detailed analysis should be undertaken. If the pavement shows deep rutting or distortion or is badly cracked, total reconstruction may be warranted. Reflective cracking potential should be considered in making a determination whether to reconstruct or overlay the roadway. Thick overlays are used to correct base or subgrade deficiencies or to correct structural deficiencies. For a complete reconstruction, a soil profile should be taken and drainage assessment made in order to design a new pavement structure. When structural deficiencies exist, which may be corrected by overlay, the thickness of the overlay should be sufficient to accommodate predicted traffic for the selected design period.

The following strategies will not be allowed:

- The use of thick flexible pavement overlays that do not satisfy the structural requirements of the pavement structure; and
- The use of thin overlays over severely cracked or rutted pavements for which remedial measures were not taken to prevent or retard the recurrence of the cracking or rutting.

Refer to Section **3.2** of **CHAPTER 3** for additional information on design considerations for flexible pavements.

Refer to **Table 3.1** of **CHAPTER 3** for the applicable design factors used in determining the thicknesses of flexible pavement overlays.

5.3 Design Period

The destructive effect of repeated wheel loads is the major factor that contributes to the failure of highway pavement. Since both the magnitude of the load and the number of its repetitions are important, provision is made in the design procedure to allow for the effects of the number and weight of all axle loads expected during the design period. The design period for new flexible pavement construction and reconstruction is at least 20 years. The design period for restoration, rehabilitation and resurfacing is 10 years. Selection of less than 10-year design periods needs to be documented and supported by a LCCA or other overriding considerations.

5.4 Traffic Analysis

The overlay design procedures require the 18k ESALs expected over the design period of the overlay in the design lane. The estimated 18k ESALs must be calculated using the appropriate flexible pavement or rigid pavement equivalency factors. The appropriate type of equivalency factors for each overlay type and existing pavement type are given in **Table 5.1 Equivalency Factors for Overlay Design**.

Table 5.1 Equivalency Factors for Overlay Design

Existing Pavement	Overlay Type	ESAL Equivalency Factors Type
Flexible Pavement	Flexible Pavement	Flexible Pavement
Rigid Pavement	Flexible Pavement	Rigid Pavement
Composite Flexible Pavement over Portland Cement Concrete Pavement	Flexible Pavement	Rigid Pavement

5.5 Pavement Evaluation

It is important that an evaluation of the existing pavement be conducted to identify any functional and structural deficiencies, and to select appropriate preoverlay repair, reflection crack treatments and overlay designs to correct these deficiencies. This section provides guidance in pavement evaluation for overlay design. See **Figure 5.2 Pavement Condition Evaluation Checklist (Flexible)** for the pavement condition evaluation checklist. When selecting an appropriate rehabilitation design, the most cost effective rehabilitation technique tends to be overlays. Flexible pavement overlays are used to correct both pavement and structural deficiencies. The type and thickness of the required overlay are based on an evaluation of present pavement conditions and estimates of future traffic. For information on how to conduct the distress survey, refer to **APPENDIX A, Section A.4 Site Investigation**.

PAVEMENT EVALUATION CHECKLIST (FLEXIBLE)

PROJECT NO.: _____ LOCATION: _____
 PROJECT CODE (SA #): _____ DIRECTION: _____ MP _____ TO MP _____
 DATE: _____ BY: _____
 TITLE: _____

TRAFFIC
 - Existing 18k ESAL/YR
 - Design 18k ESAL

EXISTING PAVEMENT DATA

- Subgrade (AASHTO)	- Roadway Drainage Condition
- Base (type/thickness)	(good, fair, poor)
- Soil Strength (R/M _R)	- Shoulder Condition
	(good, fair, poor)

DISTRESS EVALUATION SURVEY

Type	Distress Severity*	Distress Amount*
Alligator (Fatigue) Cracking		
Bleeding		
Block Cracking		
Corrugation		
Depression		
Joint Reflection Cracking (from PCC Slab)		
Lane/Shoulder Joint Separation		
Longitudinal Cracking		
Transverse Cracking		
Patch Deterioration		
Polished Aggregate		
Potholes		
Raveling/Weathering		
Rutting		
Slippage Cracking		
OTHER		

* Distress Identification Manual for the Long-Term Pavement Performance Program, U.S. Department of Transportation, Federal Highway Administration, Publication No. FHWA-RD-03-031, June 2003.

Figure 5.2 Pavement Condition Evaluation Checklist (Flexible)
(A restatement of Figure A.2)

5.6 Structural versus Functional Overlays

The overlay design procedures in this section provide an overlay thickness to correct a structural deficiency. If no structural deficiency exists, an overlay thickness equal to zero will be obtained. Leveling courses are such that they could be part of a rehabilitation strategy as a functional overlay. Because the thickness varies throughout, they do not improve the structural value. This does not mean, however, that the pavement does not need an overlay to correct a functional deficiency. If the deficiency is primarily functional, then a minimal overlay should remedy the functional problem. If the pavement has a structural deficiency as well, a structural overlay thickness that is adequate to carry future traffic over the design period is needed. Structural deficiency arises from any condition that adversely affects the load carrying capability of the pavement structure. These include inadequate thickness as well as cracking, distortion, and disintegration. It should be noted that several types of distress, e.g., distresses caused by poor construction techniques, are not initially caused by traffic loads, but do become more severe under traffic to the point that they also detract from the load carrying capability of the pavement. An overlay lift thickness should be at least 2 inches when correcting structural deficiencies.

5.6.1 Functional Evaluation of Existing Pavement

Functional deterioration is defined as any condition that adversely affects the highway user. Overlay designs, including thickness, preoverlay repairs and reflection crack treatments, must address the causes of functional problems and prevent their recurrence. This can only be done through sound engineering, and requires experience in solving the specific problems involved. The overlay design required to correct functional problems should be coordinated with that required to correct any structural deficiencies.

Functional deficiency arises from any conditions that adversely affect the highway user. These include poor surface friction and texture, hydroplaning and splash from wheel path rutting, and excess surface distortion. If a pavement has only a functional deficiency, it would not be appropriate to develop an overlay design using a structural deficiency design procedure. See **Table 5.2 List of Recommended Overlay Solutions to Functional Problems** for a list of recommended overlay solutions to functional problems.

Table 5.2 List of Recommended Overlay Solutions to Functional Problems

Functional Problem	Cause	Possible Solution
Surface Friction	Polishing or Bleeding of Surface	Thin overlay or micro-surfacing, milling maybe required.
Hydroplaning	Wheel Path Rutting	Thin overlay or micro-surfacing, milling may be required.
Surface Roughness	Distortion Due to Swells and Heaves	Leveling overlay with varying thickness.
Transverse and Longitudinal Cracking	Traffic Load, Climate and Materials	Conventional overlay and full depth repair may remedy this problem.
Potholes	Traffic Load	Conventional overlay and full depth repair may remedy this problem.
Raveling of the Surface	Climate and Materials	Thin overlay or micro-surfacing or HIR.
Raveling from Stripping	Inadequate Freeze Thaw Resistance	Removal of entire layer affected by stripping.

5.7 Preventive Maintenance

Preventive maintenance overlays and surface treatments are sometimes placed to slow the rate of deterioration of pavements which show initial cracking, but which do not exhibit any immediate structural or functional deficiency. Generally, preventive maintenance overlays should be done only on pavements with no obvious signs of major distress and have a Remaining Service Life (RSL) of 6 years or more. This type of overlay includes thin flexible pavement and various surface treatments that help keep out moisture. Preventive maintenance overlays are generally single operations. The overlays may be a thin wearing course over existing flexible pavements or rigid pavements as shown in **Figure 5.3 Thin Wearing Course Treatment Layer**. Equipment of a slurry type operation is shown in **Figure 5.4 Schematic of Thin Wearing Course Equipment**. The types of rollers depend on the surface course being laid.

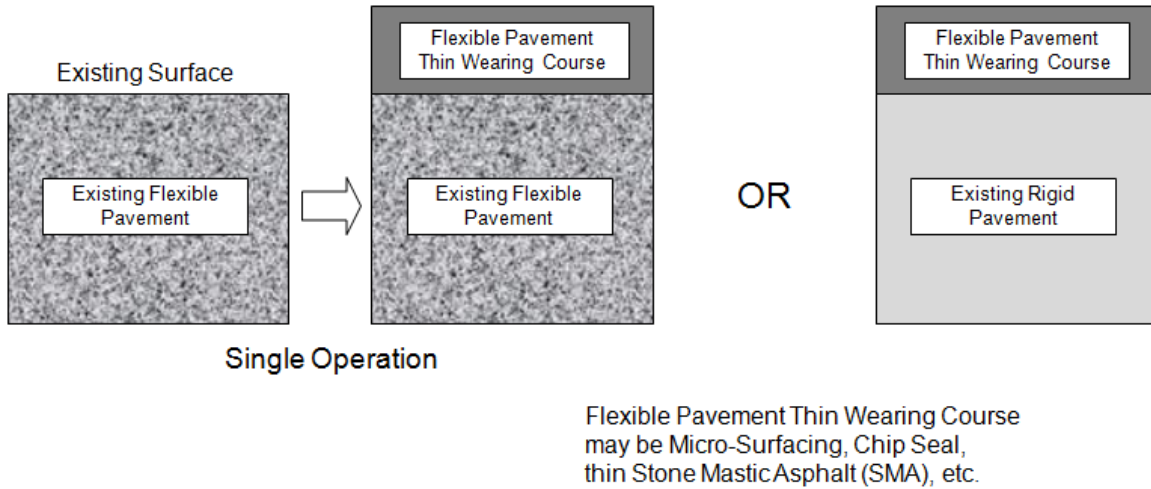

Figure 5.3 Thin Wearing Course Treatment Layer

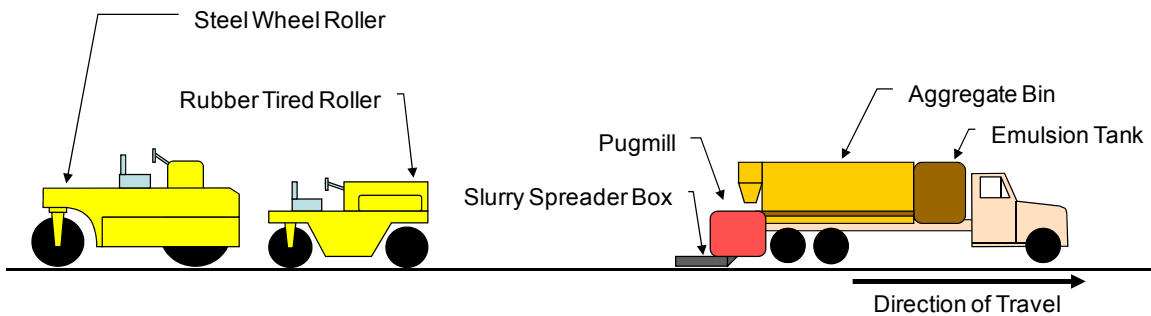

Figure 5.4 Schematic of Thin Wearing Course Equipment

5.8 Conventional Overlay

Conventional Hot Mix Asphalt (HMA) or Stone Matrix Asphalt (SMA) overlays are similar to the thin wearing course overlays. Again, they are a single operation of placing flexible pavement over existing flexible pavements or rigid pavements. Generally, they are a thicker overlay than the thin wearing courses. **Figure 5.5 Conventional Hot Mix Asphalt (HMA) Layer** and **Figure 5.6 Schematic of Conventional HMA Paving Equipment** shows the layers and equipment used. The type and number of rollers depends on the type of mix being placed.

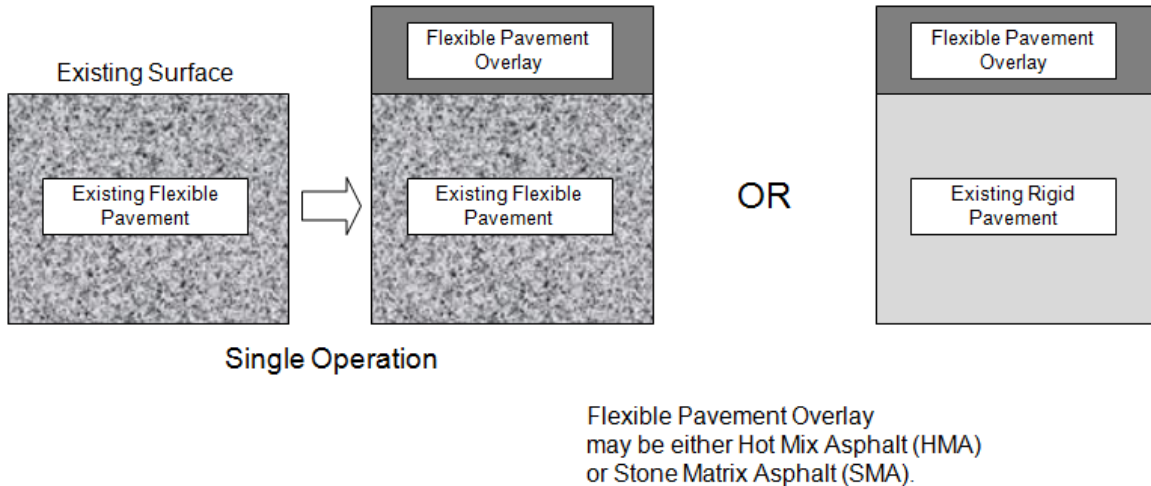

Figure 5.5 Conventional Hot Mix Asphalt (HMA) Layer

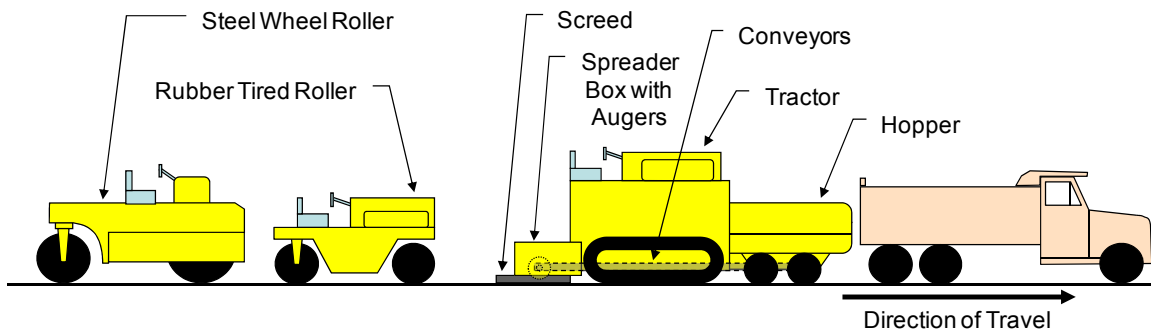

Figure 5.6 Schematic of Conventional HMA Paving Equipment

5.9 Pre-overlay Repair

Deterioration in the existing pavement includes visible distress as well as damage which is not visible at the surface, but which may be detected by other means. This distress should be repaired before an overlay is placed. The amount of preoverlay repair needed is related to the type of overlay selected. If distress in the existing pavement is likely to adversely affect the performance of the overlay, the overlay would not contribute much to the overall design life of the pavement structure. It should be repaired prior to placement of the overlay. Much of the deterioration that occurs in any overlay results from deterioration that was not repaired in the existing pavements. The designer should also consider the cost tradeoffs of preoverlay repair and overlay type. If the existing pavement is severely deteriorated, selecting an overlay type, which is less sensitive to existing pavement condition, may be more cost effective than doing extensive preoverlay repair. Nondestructive testing (NDT) is normally used to evaluate the existing pavement. Nondestructive testing using the deflection method is detailed in Section 5.11 under NDT. The designer should use a single or combination of several corrective techniques that will provide the best overall solution to extend the pavement life.

The following types of distress should be repaired prior to the overlay of flexible pavements. If they are not repaired, the service life of the overlay will be greatly reduced.

- Alligator (Fatigue) Cracking: All areas of high severity alligator cracking must be patched. Localized areas of medium severity alligator cracking should be patched unless a paving fabric or other means of reflective crack control is used. The patching must include removal of any soft subsurface material.
- Linear Cracks: High severity linear cracks should be patched. Linear cracks that are open greater than $\frac{1}{4}$ inch should be filled with a sand-asphalt mixture or other suitable crack filler. Some method of reflective crack control is recommended for transverse cracks that experience significant opening and closing. Crack filling should be performed independently and at least one year in advance of an overlay operation to allow sufficient curing time for the sealant. This is particularly important on overlays with thicknesses of two inches or less where tearing, shoving and wash boarding can occur during the rolling operation due to the influence of crack filler material expanding up into the fresh hot bituminous pavement.
- Rutting: Remove ruts by milling or placement of a leveling course. If rutting is severe, an investigation into which layer is causing the rutting should be conducted to determine whether an overlay is feasible.
- Surface Irregularities: Depressions, humps, and corrugations require investigation and treatment of their cause. In most cases, removal and replacement will be required.

5.9.1 Planing Flexible Pavement

Cold planing or milling has been widely used for removing existing hot mix asphalt pavement in order to restore the surface to a specified grade and cross-slope free of imperfections. A decision to remove a portion of the present HMA should be based on sound economic and engineering principles. The need to remove all or part of the existing pavement should be evaluated for every project.

Widths of the cold planers vary. A number of passes may be needed for a lane full width planed surface. The operation is considered a single operation. The milled material is hauled away and stockpiled. Traffic may be run on the exposed surface. It is recommended to keep the surface exposed only for a short period. The duration of exposed surface depends on the traffic, location, and type of project. **Figure 5.7 Cold Planing of Existing Flexible Pavement** and **Figure 5.8 Schematic of Cold Planing Equipment** shows the layers and equipment used.

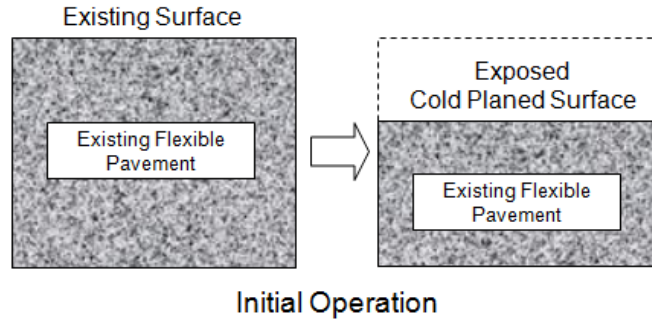

Cold planing is the removal of the top portion of existing flexible pavement. The material is removed and stockpiled.

Figure 5.7 Cold Planing of Existing Flexible Pavement

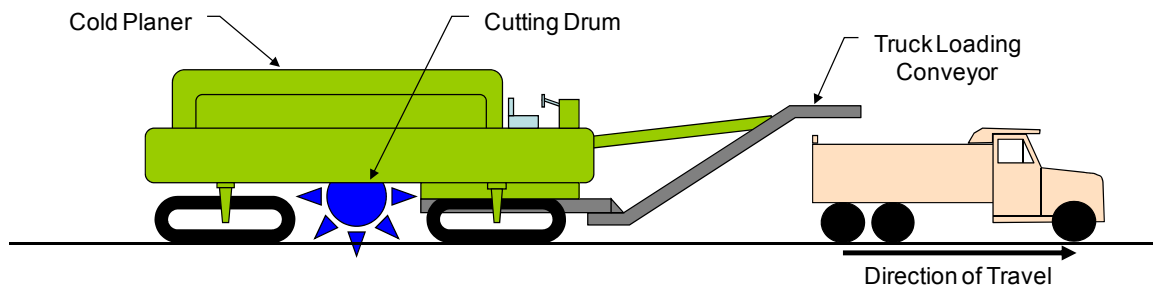

Figure 5.8 Schematic of Cold Planing Equipment

The evaluation process should include:

- A review of the historical construction data.
- Inspecting the surface for severe distresses.
- Checking the crown or cross slope for any drainage problems.
- Taking cores at an approximate frequency of 2 per lane mile from the existing pavement across the full width of the driving lanes to determine;
 - 1) Rut depth prior to coring,
 - 2) Total thickness of HMA,
 - 3) In-place air voids,
 - 4) Moisture susceptibility,
 - 5) Depth to any paving fabric, and
 - 6) Depth to next layer.

If the existing pavement has low to moderate distress, less than 1/2" rut depth, good drainage, and physical characteristics other cost effective treatments may be appropriate such as heater scarification. If the existing pavement has low to moderate distress, rut depth between 1/2" and 1", good drainage, and physical characteristics, a hot mix asphalt leveling course consisting of Grading SX or HMA with smaller nominal aggregate size prior to the overlay may be a cost effective alternative.

Planing should be used for the following reasons:

- To correct severe rutting in asphalt pavement due to low air voids;
- To avoid areas where the existing pavement grade cannot be raised;
- To remove moisture or rut susceptible mixes;
- To eliminate a pavement mix problem, such as severe raveling, that should be removed rather than overlaid.
- To create a butt joint to match the existing grade.

The planing depth should be uniform throughout the project and should go at least ½ inch into the underlying pavement layer. Circumstances have occurred when a layer was not completely removed by planing which lead to delaminating under traffic and a rough ride quality prior to the overlay. Under some conditions, variable depth planing may be appropriate. As an example, when planing is used to correct a crown or cross-slope problem. Proper pavement crown or cross-slope is essential to provide adequate drainage. The Region Materials Engineer should work closely with the designer to ensure that the crown or cross-slope is addressed in the design.

The rut depth and the HMA thickness information should be included on the Plan and Profile sheets or in tabular form to ensure proper planing depth throughout the project. Planing adjacent to vertical obstructions such as a guardrail and barrier wall is difficult with most equipment therefore; it is recommended that the designer specify a maximum clearance for the planing equipment. During the planing process, irregularities may occur before the area is overlaid with HMA therefore it is recommended that the designer include a separate HMA patching pay item for about 5% of the planing square yards. This HMA patching item should be paid by the ton. The designer should work closely with the Region Materials Engineer to specify the proper HMA patching material.

5.9.2 Recycling the Existing Pavement

Recycling a portion of an existing flexible pavement layer may be considered as an option in the design of an overlay. This is becoming a common practice. Complete recycling of the flexible pavement layer may also be done sometimes in conjunction with the removal of a deteriorated base course.

5.9.3 Reflection Crack Control

The basic mechanism of reflection cracking is strain concentration in the overlay due to movement in the vicinity of cracks in the existing surface. This movement may be bending or shear induced by loads, or may be horizontal contraction induced by temperature changes. Load induced movements are influenced by the thickness of the overlay and the thickness and stiffness of the existing pavement. Temperature induced movements are influenced by daily and seasonal temperature variations, the coefficient of thermal expansion of the existing pavement, and the spacing of cracks.

Reflection cracks are a frequent cause of the overlay deterioration. Additional steps must be taken to reduce the occurrence and severity of reflection cracking. Some overlays are less susceptible to reflection cracking than others because of their materials and design. Similarly, some reflection crack control measures are more effective with some pavement and overlay types than with others.

Pre-overlay repair, i.e., patching and crack filling, heater scarifying, may help delay the occurrence and deterioration of reflection cracks. Additional reflection crack control measures that have been beneficial in some cases include the following:

- Removal of the pavement by milling or planing. Specific distresses are reduced or eliminated by removal of the pavement. Please refer to Section 5.9.1 for information regarding the effects of pavement removal.
- Crack relief layers greater than 3 inches thick have been effective in controlling reflection of cracks subject to large movements. These crack relief layers can be achieved with cold recycling techniques.
- Crack filling at least one year prior to the overlay. Please refer to Section 5.9 for more information.

The long term benefits of non-woven synthetic fabrics have been shown to be ineffectual as a crack resistance interlayer between the old pavement and the new overlay. They generally retard the cracks from propagating into the new overlay; however, the cracks reappear within a few years. Encountering the non-woven synthetic fabric interlayer has caused production problems in most subsequent rehabilitation strategies (e.g. cold planing, hot-in-place recycling processes, etc.). Due to these adverse effects, it is not recommended to use non-woven synthetic fabrics as a pre-overlay repair method.

5.10 Pavement Widening

Many overlays are placed in conjunction with pavement widening, either adding lanes or adding width to a narrow lane. This situation requires coordination between the design of the widened pavement section and the overlay, not only so that the surface will be functionally adequate, but also so that both the existing and widening sections will be structurally adequate. Many lane-widening projects have developed serious deterioration along the longitudinal joint due to improper design.

The key design recommendations are as follows:

- The design lives of both the overlay and the new widening construction should be the same to avoid the need for future rehabilitation at significantly different ages.
- The widened cross section should generally closely match the existing pavement or cross section in material type and thickness. Widening which will carry traffic will be fully stabilized in accordance with standard procedures for new construction.

- The overlay should generally be the same thickness over the widening section as over the rest of the traffic lane.
- Longitudinal subdrainage may be placed along the outer edge of the widened section if needed.
- When a pavement is widened to the outside, the designer must be careful when placing a deeper pavement section outside the existing pavement section. By placing a deeper pavement section outside of the existing section, drainage under the pavement may be impeded and a bathtub section results.
- Many times in an urban setting, a widened outside lane becomes a through lane in some future time. The designer must balance the immediate needs with possible future usage of that lane becoming a through lane. The through lane may extend for a couple of blocks to a full corridor length. In either case, it is likely it will need to handle heavy loads such as busses.
- Design subgrade resilient modulus value should be reviewed. Specifically, a resilient modulus that is consistent with that incorporated into the flexible pavement design equation must be used.

5.11 Determining Structural Number by Nondestructive Testing (NDT)

For flexible pavement evaluation, NDT serves two functions:

- To estimate the roadbed soil resilient modulus, M_R , for design purposes; and
- To provide a direct estimate of the structural number of the existing pavement structure.

Refer to Section **2.5.2 Field Surface MR Using Falling Weight Deflectometer** and **APPENDIX C - DEFLECTION TESTING AND BACKCALCULATION**.

5.11.1 Structural Capacity Based on Visual Survey and Materials Testing

This involves the assessment of current conditions based on distress and drainage surveys, and usually some coring and testing of materials. A key component in the determination of effective structural capacity is the observation of existing pavement conditions. The observation should begin with a review of all information available regarding the design, construction, and maintenance history of the pavement. This should be followed by a detailed survey to identify the type, amount, severity, and location of surface distresses. Some of the key distress types that are indicators of structural deficiencies are listed below. Some of these are not initially caused by loading, but their severity is increased by loading and thus load carrying capacity is reduced. Some key distress type indicators include the following:

- Fatigue or alligator cracking in the wheel paths. Patching and a structural overlay are required to prevent this distress from recurring.
- Rutting in the wheel paths.

- Transverse or longitudinal cracks that develop into potholes.
- Localized failing areas where the underlying layers are disintegrating and causing a collapse of the asphaltic concrete surface, e.g., major shear failure of base course or subgrade, stripping of bituminous base course. This is a very difficult problem to repair and an investigation should be carried out to determine its extent. If it is not extensive, full depth patching and a structural overlay should remedy the problem. If the problem is too extensive for full depth patching, reconstruction or a structural overlay designed for the weakest area is required.
- There may be other types of distress that, in the opinion of the engineer, would detract from the performance of an overlay. These should be considered through an appropriate decrease of the structural coefficient of the layer exhibiting the distress, e.g., surface raveling of the flexible pavement, stripping of the flexible pavement, and freeze thaw damage to the base.

Depending on the types and amounts of deterioration present, the structural layer coefficient values assigned to materials in-service pavement should in most cases be less than the values that would be assigned to the same materials for new construction. Limited guidance is presently available for the selection of structural layer coefficients for in-service pavement materials. Some suggested structural layer coefficients for existing materials are provided in **Table 5.3 Structural Layer Coefficients for Existing Asphalt Pavement Layers**.

Table 5.3 Structural Layer Coefficients for Existing Asphalt Pavement Layers

	Surface Condition	Coefficient
Full Depth Flexible Pavement		AC Layer
	Little or no alligator cracking and low severity transverse cracking	0.35 to 0.40
	Low severity alligator cracking<10% and/or medium and high severity transverse cracking<5%	0.25 to 0.35
	Low severity alligator cracking>10% and/or medium severity alligator cracking<10% and/or 5%<medium and high severity transverse cracking<10%	0.20 to 0.30
	Medium severity alligator cracking>10% and/or high severity alligator cracking<10% and/or medium and high severity transverse cracking>10%	0.14 to 0.20
	High severity alligator cracking>10% and/or high severity transverse cracking>10%	0.08 to 0.15
Flexible Pavement with Stabilized Base		Stabilized Base Layer
	Little or no alligator cracking and low severity transverse cracking	0.20 to 0.35
	Low severity alligator cracking<10% and/or medium and high severity transverse cracking<5%	0.15 to 0.25
	Low severity alligator cracking>10% and/or medium severity alligator cracking<10% and/or 5%<medium and high severity transverse cracking<10%	0.15 to 0.20
	Medium severity alligator cracking>10% and/or high severity alligator cracking<10% and/or medium and high severity transverse cracking>10%	0.10 to 0.20
	High severity alligator cracking>10% and/or high severity transverse cracking>10%	0.08 to 0.15
Flexible Pavement with Granular Base		Granular Base Layer
	No evidence of pumping, degradation or contamination by fines.	0.10 to 0.14
	Some evidence of pumping, degradation or contamination by fines.	0.00 to 0.10

The following notes apply to the suggested structural layer coefficients shown in **Table 5.3 Structural Layer Coefficients for Existing Asphalt Pavement Layers**:

- All of the distress is as observed at the pavement surface.
- Patching all high severity alligator cracking is recommended. The asphaltic concrete surface and stabilized base structural layer coefficients selected should reflect the amount of high severity cracking remaining after patching.
- In addition to any evidence of pumping noted during the condition survey, samples of base material should be obtained and examined for evidence of erosion, degradation and contamination by fines, as well as evaluated for drainage ability, and structural layer coefficients reduced accordingly.

Coring and testing are recommended for evaluation of all materials and are strongly recommended for evaluation of stabilized layers.

5.11.2 Structural Capacity Based on Fatigue Damage from Traffic

Knowledge of past traffic is used to assess the existing fatigue damage in the pavement. The pavement's future remaining fatigue life can then be estimated. The remaining life procedure is most applicable to pavements, which have very little visible deterioration.

5.12 Coring and Material Testing Program

In addition to a survey of the surface distress, a coring and testing program is recommended to verify or identify the cause of the observed surface distress. The locations for coring should be selected following the distress survey to assure that all significant pavement conditions are represented. The appropriate core diameter will be as determined by the RME. If NDT is used, the data from that testing should also be used to help select the appropriate sites for additional coring.

The objective of the coring is to determine material thicknesses and conditions. A great deal of information will be gained simply by a visual inspection of the cored material. However, it should be kept in mind that the coring operation causes a disturbance of the material especially along the cut face of asphaltic concrete material. For example, in some cases coring has been known to disguise the presence of stripping. Consequently, at least some of the asphalt cores should be split apart to check for stripping.

The testing program should be directed toward determining how the existing materials compare with similar materials that would be used in a new pavement, how the materials may have changed since the pavement was constructed, and whether or not the materials are functioning as expected. The types of tests to be performed will depend on the material types and the types of distress observed. A typical testing program might include strength tests for asphaltic concrete and portland cement concrete cores, gradation tests to look for evidence of degradation and/or contamination of granular materials, and extraction tests to determine binder contents and

gradations of asphaltic concrete mixes. Portland cement concrete cores exhibiting durability problems may be examined by a petrographer to identify the cause of the problem.

5.13 Asphalt Pavement Rehabilitation

Asphalt pavement rehabilitation includes the removal and replacement of a portion of the existing pavement, e.g., removal by milling the wheel rutting in the driving lane. The removed material may be recycled. Rehabilitation techniques may also include rejuvenation of the existing pavement prior to overlay, e.g., heater-scarify or cold recycle of the existing pavement to remove irregularities and to rejuvenate an oxidized pavement. Other techniques including full depth patching, base removal and replacement, use of fabric, etc., should all be analyzed. Corrective action for rutted pavements should consist of removal by milling. This process should be used instead of a leveling course whenever possible. The use of a leveling course should be restricted to applications where rut depths are minimal, or rutting is not a result of low stability. In-place recycling can be an acceptable alternative as part of a comprehensive rehabilitation action when addressing rutting. The reasons for milling a rutted pavement before placing an overlay include the following:

- Milling removes the low void materials from the wheel path. The minimum depth for milling should be a half-inch below the bottom of the wheel path. When the existing ruts are greater than a half inch it is recommended that cores be taken during the design phase to establish the required removal depth. Milling should extend to a depth where the existing material has air voids in the range of 3% to 5%.
- Milling leaves a roughened surface that provides an excellent bond with the overlay. Milling machines with automatic grade control restore both longitudinal grade and transverse grade, thus improving the smoothness of the final overlay.
- Milling eliminates the need for leveling courses and therefore the problems associated with compacting material of varying width and thickness is eliminated.

As a result of the grooves produced during milling, the pavement will have an increased surface area and additional tack coat is required to assure adequate bond.

It is important to remember that when milling, the designer must take into account the loss of structural value when material is removed. A structural replacement depth must be included to account for the removed material. This is in addition to the design depth required to satisfy traffic loadings. For example, if one inch of existing material with an assumed structural layer coefficient of 0.22 is removed, then one half inch of new material with an assumed structural layer coefficient of 0.44 is required as an equivalent structural replacement for the removed material. When preparing pavement rehabilitation that includes milling, the designer must determine the appropriate depth for milling, show the appropriate depth on the plans and allow enough quantity for the structural replacement of the milled material in the surfacing requirements.

The following construction tasks are involved in the placement of a hot mix asphalt overlay on an existing flexible pavement:

- Repairing deteriorated areas and making subdrainage improvements, if needed;
- Correcting surface rutting by milling or placing a leveling course;
- Widening roadway pavement, if needed;
- Applying a tack coat; and
- Placing the flexible pavement overlay, including a reflective crack control treatment if needed.

Because of the increased difficulty in achieving density in thin layers of hot mix asphalt and the importance in achieving compaction, the minimum thickness for a hot mix asphalt mix used to overlay existing pavements is two inches. On such overlay projects the designer will still determine the minimum thickness based on traffic loadings and pavement condition, however, design thickness calculations less than two inches must be increased to the minimum two-inch requirement. If the overlay is being placed for the purpose of structural improvement, the required thickness of the overlay is a function of the structural capacity required to meet future traffic demands and the structural capacity of the existing pavement. Normally, a design period of 10 years will be used for overlay designs.

Thickness requirements will be determined by either pavement deflection analysis or component analysis. A hot mix asphalt overlay is a feasible rehabilitation alternative for an overlay except when the condition of the existing pavement dictates substantial removal and replacement.

Conditions under which a flexible pavement overlay would not be feasible include the following:

- The amount of high severity alligator cracking is so great that complete removal and replacement of the existing surface is required;
- Excessive surface rutting indicates that the existing materials lack sufficient stability to prevent recurrence of severe rutting;
- An existing stabilized base shows signs of serious deterioration and would require an inordinate amount of repair to provide uniform support for the overlay;
- An existing granular base must be removed and replaced due to infiltration of and contamination by a soft subgrade; and
- Stripping in the existing flexible pavement surface dictates that it should be removed and replaced.

5.14 Overlay Design by Component Analysis

The designer should use the component analysis with caution. This method provides a way of estimating the structural layer coefficient of an existing pavement. It does not necessarily take into account the structural inadequacy of the pavement section. For this reason, the designer needs to analyze the distress condition information carefully. Values produced by the component analysis may not provide sufficient cover, and engineering judgment may be needed to provide additional cover.

5.14.1 Subgrade Analysis

The R-value of the top two feet of the subgrade can be obtained from the soil survey of the completed roadbed. Field verification of the soil survey is required. In areas where this information is not available, obtaining samples of the major soil types for R-value determination will be necessary.

5.14.2 Aggregate Base Course Analysis

The thickness and structural layer coefficient of the base and subbase can be determined from plans or the soil survey of the completed roadbed. This information should be verified by field samples. When this information is not available, samples will be taken to determine the thickness R-value and structural layer coefficients. Samples will be taken at the locations where the soil samples are taken. A minimum of one sample per mile will be obtained.

5.14.3 Asphalt Layer Analysis

The thickness of the asphalt layers can be determined from plans or the soil survey of the completed roadbed; however, this information should be verified by field samples. If this information is not available, the thickness will be checked in the field at the time the soil and aggregate base course are sampled. Pavement type, age, and condition must be evaluated in accordance with **Figure 5.9 Structural Layer Coefficients of Existing Pavements (CDOT Form #903 3/04)**, in order to assign a structural layer coefficient to the existing pavement.

Obtain the 18k ESAL for a flexible pavement over the design period. This can be obtained from the Traffic Analysis Unit of the Division of Transportation Development.

http://internal/App_DTD_DataAccess/Traffic/.

The structural number of the old pavement (SN_1) will be determined from the structural layer coefficients and thicknesses of components of the existing pavement structure using data from the pavement condition evaluation, **Table 5.3 Structural Layer Coefficients for Existing Asphalt Pavement Layers**. The structural number of the new pavement (SN_2) will be determined using the procedures as outlined in Section **3.4 Design Methodology for Flexible Pavement** Design Methodology for Flexible Pavement using **Eq. 3.1** in **CHAPTER 3**, the R-value of the subgrade, the serviceability index, and the 18k ESAL loading for the design period.

Use **Eq. 5.1** to calculate the structure number of the overlay (SN_{OL}):

$$SN_{OL} = SN_2 - SN_1 \quad \text{Eq. 5.1}$$

Use **Eq. 3.2** in Section **3.6** of **CHAPTER 3** to calculate the design thickness. Design thickness will be rounded up to the next $\frac{1}{4}$ inch increment. **Figure 5.10 Overlay Design by Component Analysis (CDOT Form #586 3/04)** shows CDOT Form #586 used for overlay design by component analysis.

COLORADO DEPARTMENT OF TRANSPORTATION STRUCTURAL LAYER COEFFICIENTS OF EXISTING PAVEMENTS <small>This is a combination table and worksheet to be used for estimating and documenting the structural layer coefficients of existing pavement layers.</small>		Project code (SA#): 14149	Project No.: STA 0853-051
		Location: US 85 22nd St to 5th St	
		Date: 03/31/2003	Region: 4
		Asphalt Surface Course	
Factor Description	Factor	Mile or station representation	
Load associated cracking:	0.12	From: 1.1 to 1.3	To: From 1.3 to 1.6
Virtually none:			
More than 6ft. blocks:			
2 ft. to 5 ft. blocks:	0.08		0.08
less than 2 ft blocks:	0.06	0.06	
Average age of layer combination:			
less than 8 years:	0.12		
9 to 15 years:	0.09		
more than 16 years:	0.06	0.06	0.06
Estimated air voids ¹ :			
0 - 2%	0.09	0.09	0.09
3 - 6%	0.12		
7 - 10%	0.09		
more than 10%	0.06		
TOTAL = Structural layer coefficient: (except for pre 1990's Grading F)		0.21	0.23
For pre 1990's Grading F, multiply TOTAL by 0.70:			
Base layers			
Factor Description	Factor	Mile or station representation	
Untreated aggregate base (except as noted ²)	0.11	From: 1.1 to 1.3	To: From 1.3 to 1.6
Classes 1,2,3,4,&5			
Classes 3 & 7		0.10	0.10
Class 6	0.06		
Emulsion asphalt treated base	0.16		
¹ Air voids may be determined from old project test reports, estimated (based on judgment and experience), or determined from core samples. Generally, under-asphalted pavements are high in voids, and over-asphalted pavements are rutted and low in voids ² Use the listed structural layers unless actual test have been run (either during previous construction or just prior to overlaying) to confirm otherwise. Document below under REMARKS.			
Remarks: R value for agg. base indicates a structural layer coeff. of 0.10			
<small>Note: This form is to be completed in the Region and submitted, along with Proposed Log, to Soils Engineer for "component analysis" of overlay projects.</small>		By: Joe Pavement	
		Title: PE I	

Figure 5.9 Structural Layer Coefficients of Existing Pavements (CDOT Form #903 3/04)

COLORADO DEPARTMENT OF TRANSPORTATION OVERLAY DESIGN BY COMPONENT ANALYSIS	Project code (SA#): 12345	Project No.: 12345	Sheet No.: 1
	Proj. location: Colorado/Evan		Date: 01/01/2005

Station or Mile	Subgrade R-value	Calculated Subgrade Resilient Modulus	SN ₂ from Design	Existing pavement structure										SN ₂ = SN ₁ - SN ₃	Minimum design thickness (inches)*	Recommended thickness (inches)
				Strength Coefficient of existing pavement structure from CDOT Form #903												
				Pavement			Base			Subbase			SN ₁ = 0.14 * D ₁ ^{1.5} * a ₁ ^{1.5} * D ₂ ^{1.5} * a ₂ ^{1.5}			
				Thickness (D ₁)	Coefficient (a ₁)	(D ₁)(a ₁)	Thickness (D ₂)	Coefficient (a ₂)	(D ₂)(a ₂)	Thickness (D ₃)	Coefficient (a ₃)	(D ₃)(a ₃)				
654470	43	22.53	3.55	8	.35	3.0	12	.20	2.4	-----	-----	-----	3.4	1.0	2.0	2.0

*Minimum design thickness (inches) = $\frac{SN_2 - SN_1}{\text{Structural layer coefficient (overlay)}}$

Existing pavement condition: Alligator cracking in wheel path. Severe alligator cracking to patched. Minimal rutting. Str. Coeff. of New Overlay = .44	18k ESAL: 1,650,000
	Design period (years): 20
	Δ PSI: 2.0
Existing drainage: Good	Reliability: 80
	Overall standard deviation (σ): .44
Calculations by: Joe Pavement	Title: PE I
Date: 01/01/2005	

CDOT Form #688 3/04

Figure 5.10 Overlay Design by Component Analysis (CDOT Form #586 3/04)

5.15 Existing Portland Cement Concrete Slab

The durability of an existing portland cement concrete slab greatly influences the performance of asphaltic concrete overlays. If reactive aggregate exists, the deterioration of the existing slab can be expected to continue after an overlay. The overlay must be designed with this progressive deterioration of the underlying slab in mind.

5.15.1 Flexible Overlay On Rigid Pavement

A flexible overlay over an existing rigid pavement (also known as "blacktopping") is a significant and often used rehabilitation overlay strategy. It also represents the category in which state of the art concerning overlay requirements is least known. Since the existing portland cement concrete pavement is usually cracked when an asphalt overlay is considered, the pavement structure is neither "rigid" nor "flexible" but in a "semi-rigid" condition. Even after the overlay is placed, cracking of the portland cement concrete pavement layer may increase, causing the rigidity of the overall pavement to approach a more flexible condition with time and traffic.

See **Figure 5.5 Conventional Hot Mix Asphalt (HMA) Layer** and **Figure 5.6 Schematic of Conventional HMA Paving Equipment** for graphical representation of a flexible overlay over a rigid pavement.

Thin asphalt overlays are used primarily to correct surface distress such as rutting, reactive aggregate, etc. These overlays can range in thickness from the minimum 2-inch HMA overlay to a 3-inch HMA overlay. In some cases, a leveling course may be required. Thin asphalt overlays are not to be placed over severely cracked, step faulted, shattered, or broken pavements. An advantage of thin (< 2 inches) overlays is that the clearance and roadside improvements associated with thick overlays are usually not necessary.

Thicker asphalt overlays are used to provide additional structural capacity for the existing pavement. Since the principal causes of cracking in an overlay are thermal contractions and expansions, and vertical differential deflections of the underlying slabs, some effort must be made to mitigate these stresses. Differential deflections at cracks or joints are considered to be more critical due to the quicker loading rate. The designer must consider the reflective cracking potential of the asphalt overlay over the existing rigid pavement.

At present, there are several techniques, which minimize or eliminate reflective cracking distress. They are:

- Use of thick (≥ 2 inches) asphalt overlays;
- Crack and seat the existing pavement followed by an overlay;
- Saw cutting matching transverse joints in overlay;
- Use of crack relief layers;
- Stress-absorbing membrane interlayer with an overlay;
- Fabric/membrane interlayers with an overlay; and

- Rubblization – Experimental at this time, any questions should be directed to CDOT Region Materials Engineers.

Additional design and cost considerations such as vertical clearance at structures, drainage modifications, and the need to increase the height of railings and barriers need to be considered when evaluating thick asphalt overlays.

Design thickness will be rounded up to the next ¼ inch increment.

5.16 Cold In-Place Recycling (CIP)

Cold In-Place Recycling consists of recycling existing flexible pavement without the application of heat during the recycling process. The CIP process uses a number of pieces of equipment including tanker trucks, milling machines, crushing and screening units, mixers, pavers, and rollers. **Figure 5.12 Schematic of Cold In-Place Recycling Equipment** shows a "train". The equipment is spread out over a considerable distance and so named. The schematic is just one train configuration. Other combinations may be used to address specific needs of a project. CIP is undertaken on the roadway and generally uses 100 percent of the RAP generated during the process. The CIP treatment depth is typically within the 2 to 4 inches range when the recycling agent is only an asphalt emulsion or recycling agent. Lime may be added to improve strength and resistance to moisture damage (1). Other chemical additives may also be used, such as Portland cement, kiln dust or fly ash. Typical section layering is shown in **Figure 5.11 Cold In-Place Recycling Layers**. One type of a "train" configuration is shown in **Figure 5.12 Schematic of Cold In-Place Recycling Equipment**.

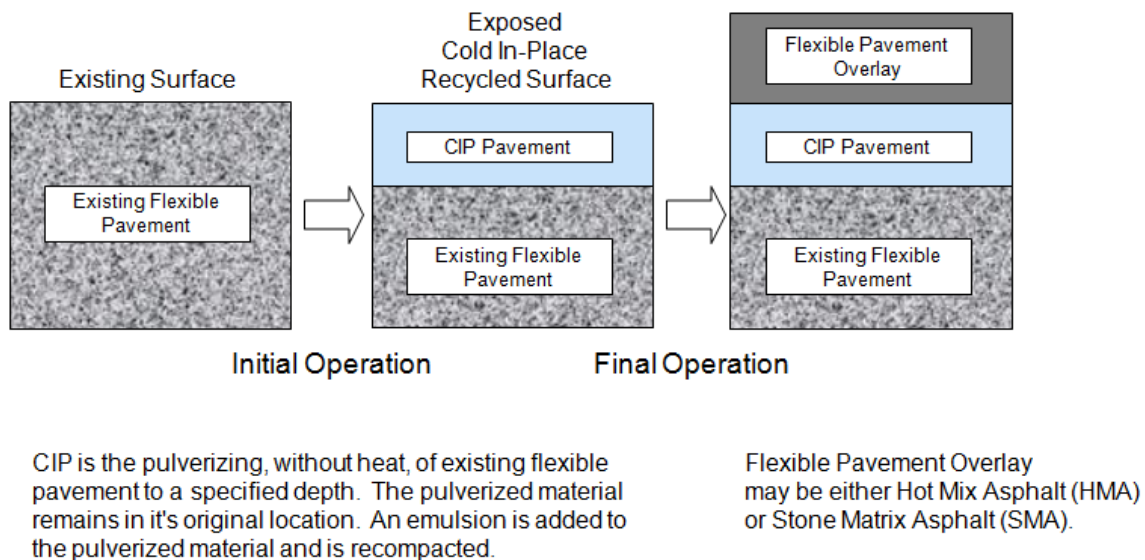

Figure 5.11 Cold In-Place Recycling Layers

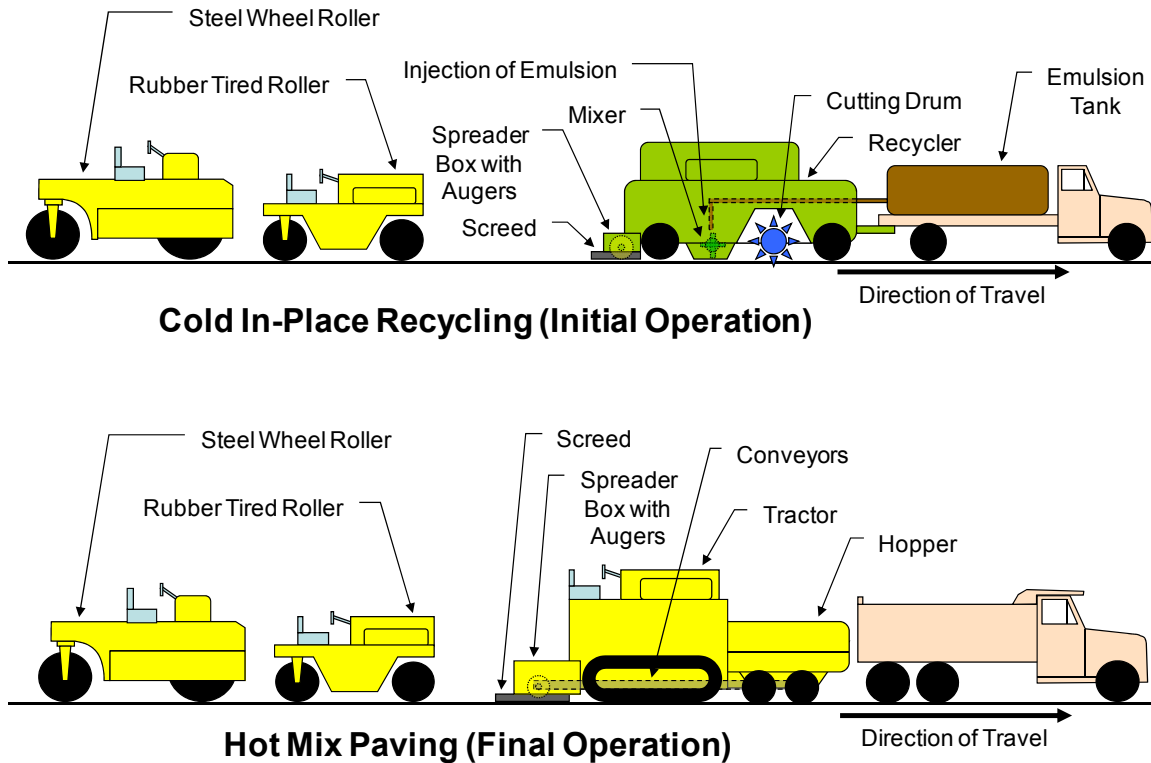

Figure 5.12 Schematic of Cold In-Place Recycling Equipment

5.17 Hot In-Place Recycling (HIR)

With HIR, recycling of all existing asphalt pavement materials is completed on site. The HIR process uses a number of pieces of equipment including pre-heaters, heaters, heater/scarifiers, mixers, pavers, and rollers.

5.17.1 Introduction

HIR is a four-step process that is used to fix surface distresses that are not caused by structural inadequacies. The four steps of the process are:

- Step 1.** Soften the asphalt pavement with heat;
- Step 2.** Scarify or hot mill the surface material;
- Step 3.** Mix the material with any or a combination of rejuvenating agent, asphalt binder, aggregate, or new mix; and
- Step 4.** Lay down and pave with the recycled material.

The mixture is produced at the paving site by use of special in-place heating and mixing equipment. HIR is often used to fix cracking, minor rutting, and oxidation (hardening) of the asphalt pavement. HIR is a good choice for treatment of the old pavement prior to an overlay and should be considered a better alternative than a leveling course. The primary benefit of HIR

techniques is the complete on-site recycling of the existing asphalt pavement thereby conserving both material and energy resources.

5.17.2 Pavement Evaluation

Evaluation of the existing pavement is an important step in the rehabilitation process and should be given a high priority. The existing pavement to be rehabilitated should have homogeneous plan and cross-sectional material properties. A minimum existing pavement thickness of 3 inches of HMA should be available before any hot-in-place recycled material is placed. If surface defects such as rutting, cracking, and/or deficient friction exist, the source of the problem needs to be identified before HIR or any other type of rehabilitation process is initiated. If a mixture problem such as excess asphalt, inadequate aggregate interlock, and too hard or too soft asphalt can be identified successfully, it may be possible to eliminate the problem using HIR. If the source of the problem is not identified and corrected, then the problem is likely to manifest itself again after rehabilitation.

5.17.3 Project Selection

Selecting an ideal project for hot in-place recycling is critical to the success of the project. **Table 5.4 Hot In-Place Recycling Suitability in Pavement Distress Treatment** below provides general guidelines whether or not to use hot-in-place recycling:

Table 5.4 Hot In-Place Recycling Suitability in Pavement Distress Treatment

Suitable Candidate	Non-Suitable Candidate
<ol style="list-style-type: none"> 1. Rutting 2. Wearing 3. Cracking 4. Aging 5. Poor frictional characteristics, etc. 	<ol style="list-style-type: none"> 1. Unstable subgrade 2. Wide transverse thermal cracks (Greater than 1 inch) 3. Asphalt stripping from aggregates 4. Structural defects, and lack of structural capacity and/or inadequate base. 5. The presence or placement of geotextile fabric within the top 2 inches of the existing pavement.

Two types of applications have been identified for the use of this process: maintenance and engineering. Maintenance applications being defined as those, which are used to maintain the existing roadway in a usable condition, and engineering applications are defined as hot in-place recycling being part of the structural rehabilitation or reconstruction of the pavement. Hot in-place recycling has not been shown to improve moisture resistance of the recycled pavement.

5.17.4 Types of Hot In-Place Recycling

CDOT uses three HIR processes to correct surface distresses of structurally adequate flexible pavements. These HIR processes include Heating and Scarifying Treatment, Heating and

Remixing Treatment, and Heating and Repaving Treatment. To date, Heating and Scarifying Treatment is a standard specification and the other two processes are project special provisions.

5.17.5 Surface Recycling (Heating and Scarifying Treatment)

The existing pavement is heated, scarified, sprayed with rejuvenating agent, mixed with an auger, leveled off with a screed and rolled with a rubber-tired roller. The depth of scarification usually specified for the surfacing recycling process is between $\frac{3}{4}$ and $1\frac{1}{2}$ inches with 1 inch being most common. A tack coat may be required if another layer of HMA will be added after surface recycling. This process normally requires a wearing course. A wearing course must be calculated separately from the surface recycling process. Normally, the wearing course is placed by a paving supplier/contractor. See **Figure 5.13 Surface Recycling Layers** and **Figure 5.14 Schematic of Surface Recycling Equipment**.

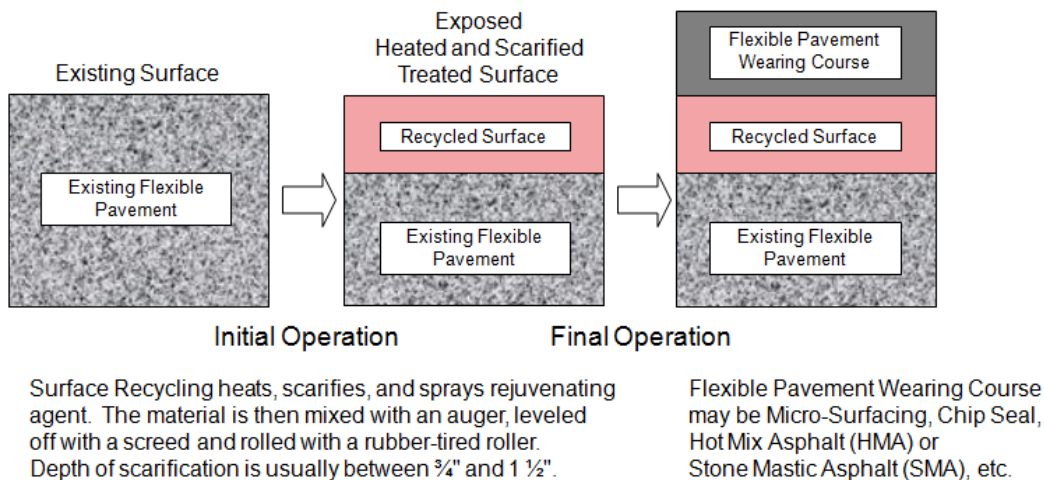

Figure 5.13 Surface Recycling Layers

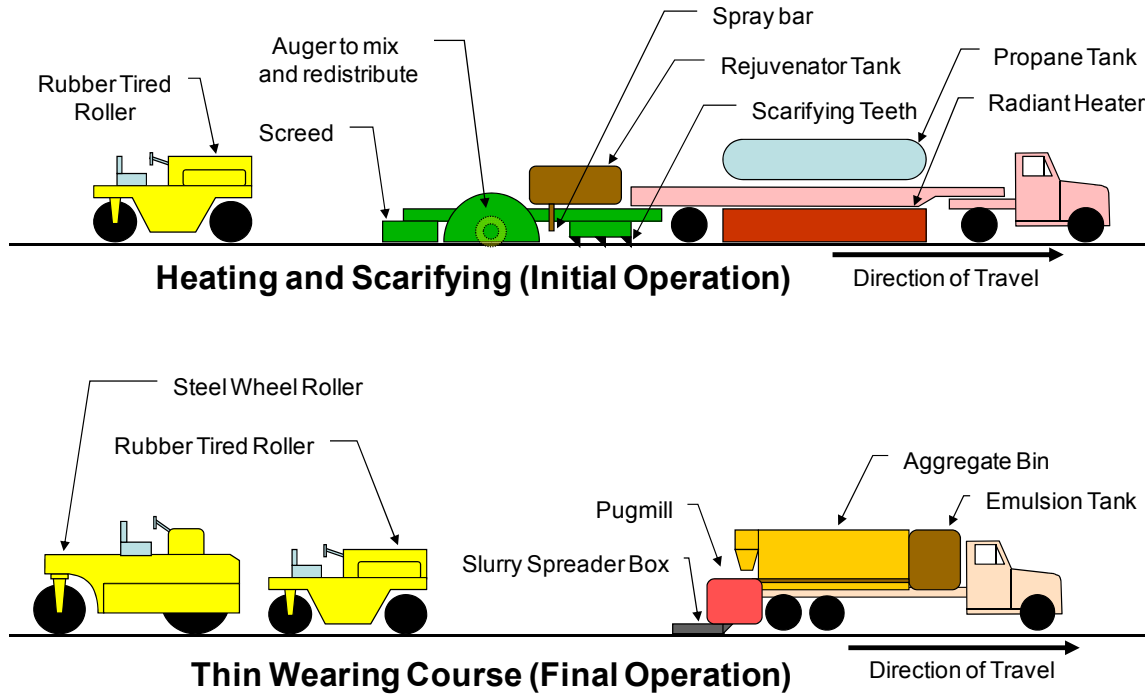

Figure 5.14 Schematic of Surface Recycling Equipment

Note: Grinding may be required since the surface smoothness is not controlled and this treatment may make the surface rough and may vary the cross-slope. Projects with tight curves may require grinding.

5.17.5.1 Preliminary Engineering Job-Mix Formula

CDOT will perform a preliminary engineering job-mix formula for estimating purposes. Cores will be obtained to verify the mat thickness and materials to be surface recycled. Cores can be categorized into like pavement materials, and a design should be performed on each set of similar samples. It is necessary to obtain 50 pounds of sample material per mix design. The mix design will be performed as per CP-L 5140.

5.17.5.2 Contractor Job-Mix Formula

The contractor must submit a job-mix formula as per CP 52, a list of materials, and target values to be used on the project to the Region Materials Engineer at least one week prior to the start of construction. A duplicate copy of the job-mix formula, list of materials, and target values to be used should be sent to the Materials and Geotechnical Branch.

5.17.5.3 Structural Design

The structural layer coefficient will be a minimum of 0.35 and a maximum of 0.44. For engineering applications, design structural requirements will be met, and a minimum 2-inch overlay thickness will be used in conjunction with the surface recycling that may require an

overlay. For maintenance applications, a minimum of 55 pounds per square yard of additional HMA is recommended or a chip seal coat may be used as a wearing surface, if needed.

5.17.5.4 Construction Considerations

The surface recycling is generally not performed through more than one lift of the existing mat. Geotextile fabrics should not be present within the top 2 inches of the existing pavement structure prior to the remixing process. In addition, geotextile fabrics should not be installed within the top 2 inches of the new pavement structure. Surface recycling can be performed either full width or in the driving lanes only. Traffic control for the paving trains must be taken into consideration. Surface recycling usually requires two separate paving operations, one for the recycling and the other for the wearing course. It is recommended that the wearing course be placed within 7 days after surface recycling. For engineering applications, the type and the amount of rejuvenating agent will be determined as per CP-L 5140. Controlling the application rate is very important to the success of this treatment, so education of project personnel on the use of the data is very important.

5.17.6 Remixing (Heating and Remixing Treatment)

The process heats, mills and removes 1½ to 2 inches of the existing pavement, then adds in rejuvenating agent, virgin aggregate or new HMA. All materials are mixed in a pug mill to form a single, homogenous mix. A remixing process is sometimes done when additional aggregates are needed for strength and stability. Treatment depths for the single stage method are generally between 1 and 2 inches with 1½ inches being most common. Treatment depths for the multiple stage method are between 1½ and 3 inches with 2 inches usually being the most common. Each succeeding multiple stage operation remixes the layer below the previously worked layer that has been stockpiled into a windrow. No tack coat is required for the single operation. See **Figure 5.15 Remixing Layers** and **Figure 5.16 Schematic of Remixing Equipment**.

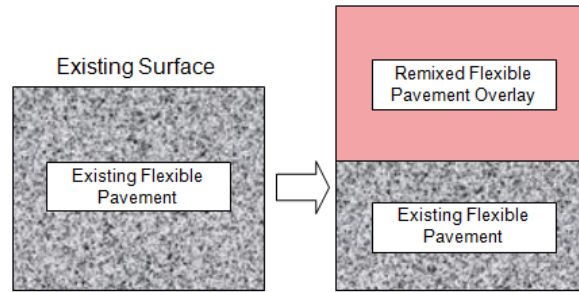

Single Operation

Remixing is a process that heats, plans (mills) and removes 1 ½" to 2" of the existing pavement, then adds in rejuvenating agent, virgin aggregate or new hot mix asphalt (HMA). All materials are mixed in a small mobile pug mill to form a single, homogenous mixture. The operation is simultaneously performed in a paving train operation. The overlay mixture is compacted with a roller.

Figure 5.15 Remixing Layers

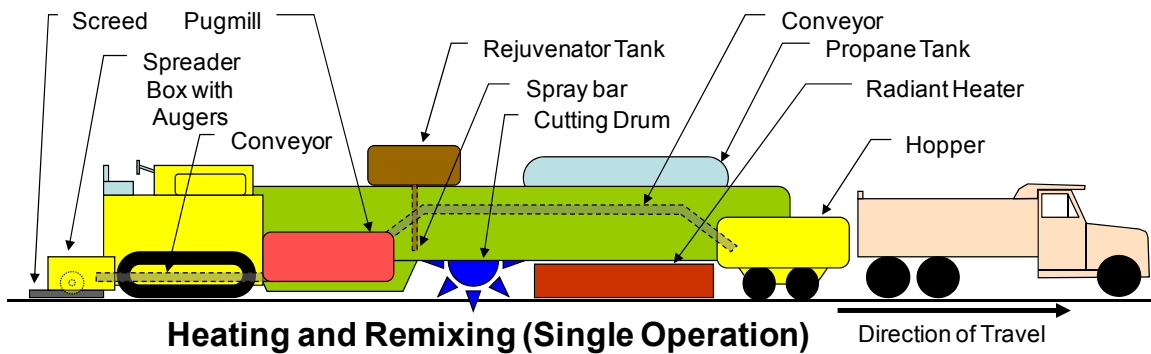

Heating and Remixing (Single Operation)

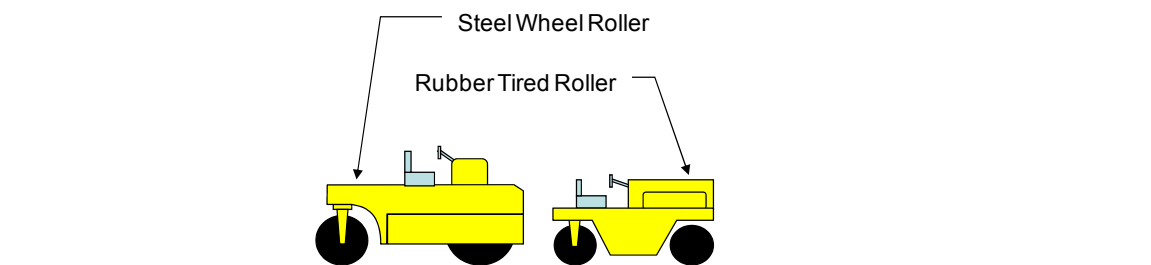

Heating and Remixing (Single Operation)
(Continued)

Figure 5.16 Schematic of Remixing Equipment

Note: This process requires grade control on the laydown machine.

5.17.6.1 Preliminary Engineering Job-Mix Formula

CDOT will perform a preliminary engineering job-mix formula for estimating purposes. Cores will be obtained to verify the mat thickness and materials to be recycled. Cores can be categorized into like pavement materials, and a design should be performed on each set of similar samples. It is necessary to obtain 50 pounds of sample material per mix design. The mix design will be performed as per CP-L 5140.

5.17.6.2 Contractor Job-Mix Formula

A CDOT Form #43, per CP 52, reviewed and approved by the Region Materials Engineer will be executed between the Engineer and the Contractor to establish the job-mix formula one week prior to construction. The Contractor must send a duplicate copy of the executed Form #43 to the Materials and Geotechnical Branch.

5.17.6.3 Structural Design

The structural layer coefficient will be a minimum of 0.35 and a maximum of 0.44. For engineering and maintenance applications, the design structural requirements will be met. The remixing process is generally followed by a 2-inch overlay.

5.17.6.4 Construction Considerations

Geotextile fabrics should not be present within the top 2 inches of the existing pavement structure prior to the remixing process. In addition, geotextile fabrics should not be installed within the top 2 inches of the new pavement structure. The remixing process can be performed either full width or in the driving lanes only. If only the driving lanes are remixed and the resulting lane/shoulder drop off is 1 inch or less, the drop off may be tapered for safety consideration. Traffic control for a long paving train must be taken into consideration. The process of remixing requires only one paving operation. The remixing process may be performed through multiple layers by using multiple stages. For engineering applications, the type and the amount of virgin aggregate, asphalt cement, and rejuvenating agent will be determined as per CP-L 5140. The typical additional mix rates are 30 to 70 pounds per square yard of HMA, with 50 pounds per square yard being most common. Controlling the application rate and grade is very important to the success of this treatment, so education of project personnel on the use of the data is very important. The job-mix formula for the complete mix will be as per the Contractor Mix Design Approval Procedures (CP 52). The amount of virgin aggregate, and/or HMA added should only be that amount required to offset longitudinal and transverse surface irregularities and surface inundations to provide a rideable surface. A chip seal may be supplied as a wearing surface for maintenance applications, and an overlay for engineering applications.

5.17.7 Repaving (Heating and Repaving Treatment)

This process combines surface recycling with a simultaneous thin overlay of new hot mix asphalt. When placed simultaneously, a strong thermal bond is formed between the two layers.

The depth of scarification usually specified for the surfacing recycling process is between $\frac{3}{4}$ and $1\frac{1}{2}$ inches with 1 inch being most common and a 1 to 2-inch integral overlay thickness is used. No tack coat is required for this single operation. See **Figure 5.17 Repaving Layers** and **Figure 5.18 Schematic of Repaving Equipment**.

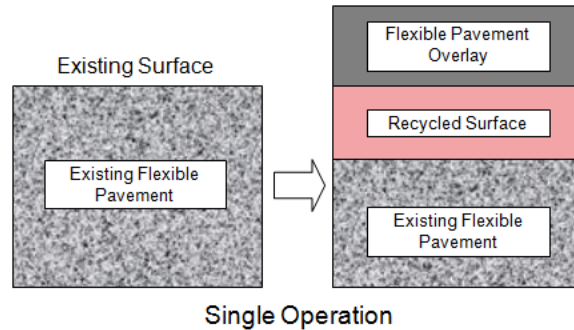

Repaving is the process of heating, scarifying, adding rejuvenating agent and mixing of the surface. A new hot mix asphalt overlay is placed over the heated recycled surface. These two operations are done simultaneously in a paving train operation. A strong thermal bond is formed between the two layers. The overlay is compacted with a roller. Depth of scarification is usually between $\frac{3}{4}$ " and $1\frac{1}{2}$ ".

Figure 5.17 Repaving Layers

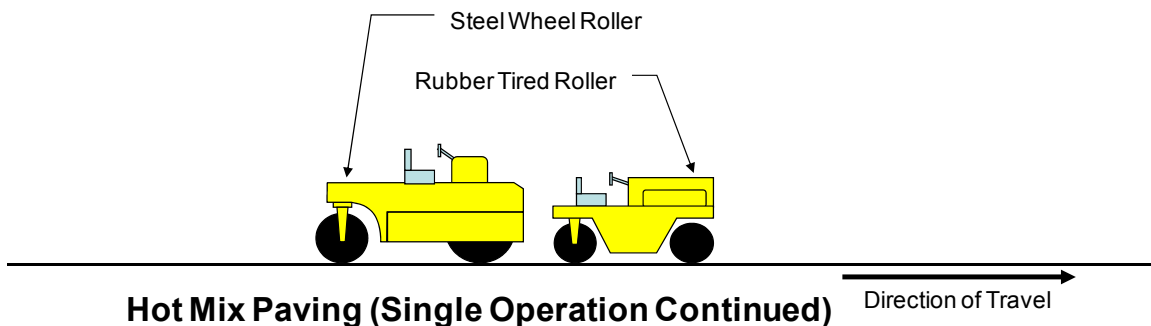
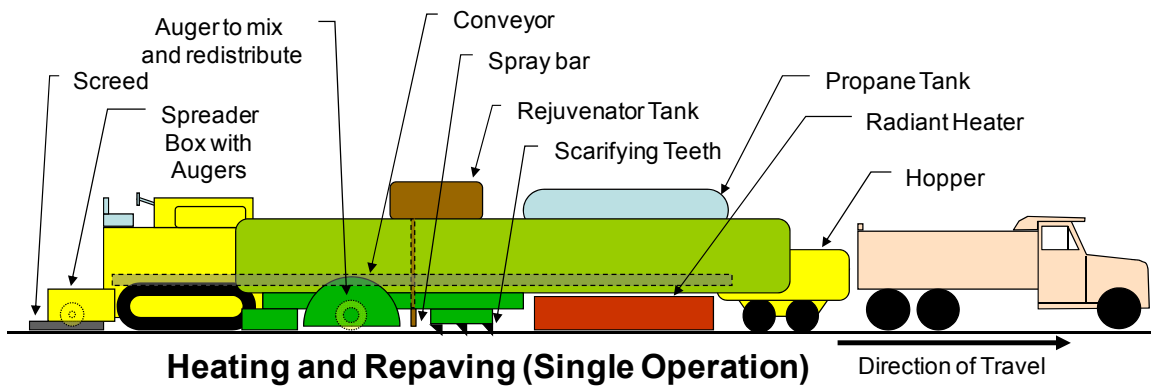

Figure 5.18 Schematic of Repaving Equipment

Note: This process requires grade control on the laydown machine.

5.17.7.1 Preliminary Engineering Job-Mix Formula

CDOT will perform a preliminary engineering job-mix formula for estimating purposes. Cores will be obtained to verify the mat thickness and materials to be surface recycled. Cores can be categorized into like pavement materials, and a design should be performed on each set of similar samples. It is necessary to obtain 50 pounds of sample material per mix design. The mix design will be performed as per CP-L 5140.

5.17.7.2 Contractor Job-Mix Formula

A CDOT Form #43, per CP 52, reviewed and approved by the Region Materials Engineer will be executed between the Engineer and the Contractor to establish the job-mix formula one week prior to construction. The Contractor must send a duplicate copy of the executed Form #43 to the Materials and Geotechnical Branch.

5.17.7.3 Structural Design

The structural layer coefficient will be a minimum of 0.35 and a maximum of 0.44. For engineering and maintenance applications, the design structural requirements will be met. This is to take advantage of the thermal bond that this process creates. For maintenance applications, a minimum of 110 pounds per square yard of additional HMA is recommended. For engineering applications, a minimum of 165 pounds per square yard of additional HMA is recommended. An engineering application would consist of increasing the structural coefficient, and the minimum for this procedure should be 1½ inches.

5.17.7.4 Construction Considerations

The repaving method is generally not performed through more than one lift of the existing mat. Geotextile fabrics should not be present within the top 2 inches of the existing pavement structure prior to the repaving process. In addition, geotextile fabrics should not be installed within the top 2 inches of the new pavement structure. Repaving can be performed either full width or in the driving lanes only. If only the driving lanes are repaved and the resulting lane/shoulder drop off is 1 inch or less, the drop off may be tapered for safety consideration. Traffic control for a long paving train must be taken into consideration. The process of repaving requires only one paving operation. The recycling and paving operation is done simultaneously. The maximum repaving and overlay thickness should not exceed a total of 3 inches. For engineering applications, the type and the amount of rejuvenating agent will be determined as per CP-L 5140. Controlling the application rate and grade is very important to the success of this treatment, so education of project personnel on the use of the data is very important.

Job-mix formula for the virgin mix will be as per the Contractor Mix Design Approval Procedures (CP 52). It should be noted that when 220 pounds per square yard are added to the recycled mix, the driving lane would be approximately two inches higher than the shoulder. For safety consideration, the grade of the shoulder should be raised to match the repaved areas.

5.17.8 Selecting the Appropriate Hot In-Place Recycling Process

Table 5.5 Selection Guidelines for HIR Process Distress-Related Considerations below provides a general guideline for the preliminary selection of candidate recycling or reclamation methods for the rehabilitation of asphalt pavements.

Table 5.5 Selection Guidelines for HIR Process Distress-Related Considerations

Pavement Distress Mode	Candidate HIR Process		
	Remixing	Repaving	Surface Recycling
Raveling			
Potholes			
Bleeding			
Skid Resistance			
Rutting			
Corrugations			
Shoving			
Fatigue Cracking			
Edge Cracking			
Slippage Cracking Block Cracking Long. /Trans. /Reflect. Cracking			
Swells, Bumps, Sags, Depressions			
Marginal Existing Pavement Strength			

Appropriate \longrightarrow Not Appropriate

Non-Distress-Related Considerations

Initial Cost ¹	\$3.75 - \$4.75 SY	\$1.25 - \$2.00 SY	\$1.00 - \$2.00 SY
User Costs	See Section 10.5.7	See Section 10.5.7	See Section 10.5.7
Min. turning radius greater than 500'			
Min. turning radius less than 500'			

Appropriate \longrightarrow Not Appropriate

¹The initial cost does not include the cost of any succeeding pavement layer that will be required to complete the work. The cost of any additional pavement overlay to be installed after each hot in-place recycling process should be considered in the cost evaluation step.

5.18 Overlay Using Micro-Surfacing

Micro-surfacing is a thin surface pavement system composed of polymer modified asphalt emulsion, 100% crushed aggregate, mineral filler, water, and field control additives. It is applied at a thickness of (0.4 to 0.5-inch) as a thin surface treatment primarily to improve the surface friction characteristics while producing a smooth wearing surface. Its other major use is to level wheel ruts on both moderate and high volume roads. The treatment has also been used to address pavement distresses such as flushing, raveling, and oxidation. Micro-surfacing is used to improve the functional condition, not the structural condition (load carrying capacity) of a roadway. Micro-surfacing has shown promising results in protecting the existing pavement and is estimated to extend the service life 4 to 7 years. It is particularly useful where a significant increase in thickness is not desired, such as curb and gutter sections. Micro-surfacing can be feathered out to the maximum mix aggregate size without edge raveling, and can generally be opened to traffic within one hour of placement. It is particularly suitable for high volume roads and urban areas. See revision of Section 409 and 702 - Micro-Surfacing of the Sample Project Special Provision for complete specifications related to Micro-Surfacing.

<http://www.dot.state.co.us/DesignSupport/Construction/2005SpecsBook/2005PSP/2005psp.htm>

See **Figure 5.3 Thin Wearing Course Treatment Layer** and **Figure 5.4 Schematic of Thin Wearing Course Equipment** for graphical representation.

Use Micro-Surfacing where the following distresses need to be addressed:

When rutting is less than 1-inch depth, where no plastic flow is occurring, and for rutting caused by compaction of the existing mat, inadequate subgrade or an unstable asphalt mat, use a rut box followed by a wearing course.

When filling ruts prior to an overlay, fill ruts up to 3 inches deep on asphalt or concrete pavements. Fill ruts with multiple passes using rut box with maximum 0.75-inch layers. A 0.125-inch to 0.25-inch crown is recommended for ruts over 1-inch to compensate for initial compaction.

Micro-surfacing can be used to address the following types of conditions as described in the Distress Identification Manual for the Long Term Pavement Performance Project (SHRP-P-38) published by the Strategic Highway Research Program (SHRP), National Research Council:

- Cracking - Low severity cracking of any form, including longitudinal, transverse or alligator. Micro-Surfacing will not stop reflective cracking.
- Raveling/Abrasion - Low to moderate severity levels. (Check existing pavement moisture resistance before specifying micro-surfacing.)
- Bleeding/Flushing - Low to moderate severity levels. (Check existing pavement moisture resistance before specifying Micro-Surfacing.)

5.19 Full Depth Reclamation (FDR)

Full Depth Reclamation is a rehabilitation technique in which the full thickness of asphalt pavement and a predetermined portion of the underlying materials (base, subbase, and/or subgrade) are, without heat, uniformly pulverized and blended to provide an upgraded, homogeneous material (1). FDR is a two-phase operation. The first operation is to create the base material. No traffic is placed on the roadway after this operation. The final operation is to place a flexible overlay on top of the base material. For pavement design, the full depth reclaimed material is considered a base material. See **Figure 5.19 Full Depth Reclamation (FDR) Layers** and **Figure 5.20 Schematic of Full Depth Reclamation Equipment**.

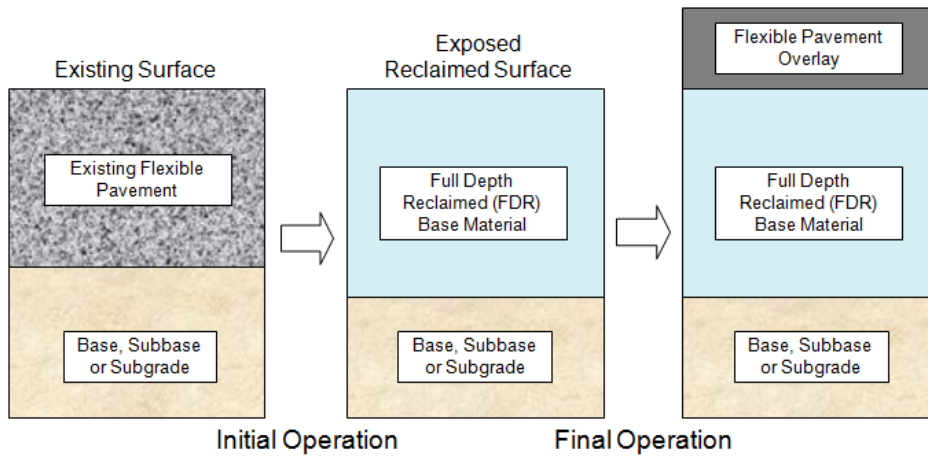

FDR is the pulverizing, without heat, of existing flexible pavement to produce an aggregate base material by mixing of some or all of the underlying granular base, subbase or subgrade material.

Flexible Pavement Overlay may be either Hot Mix Asphalt (HMA) or Stone Matrix Asphalt (SMA).

Figure 5.19 Full Depth Reclamation (FDR) Layers

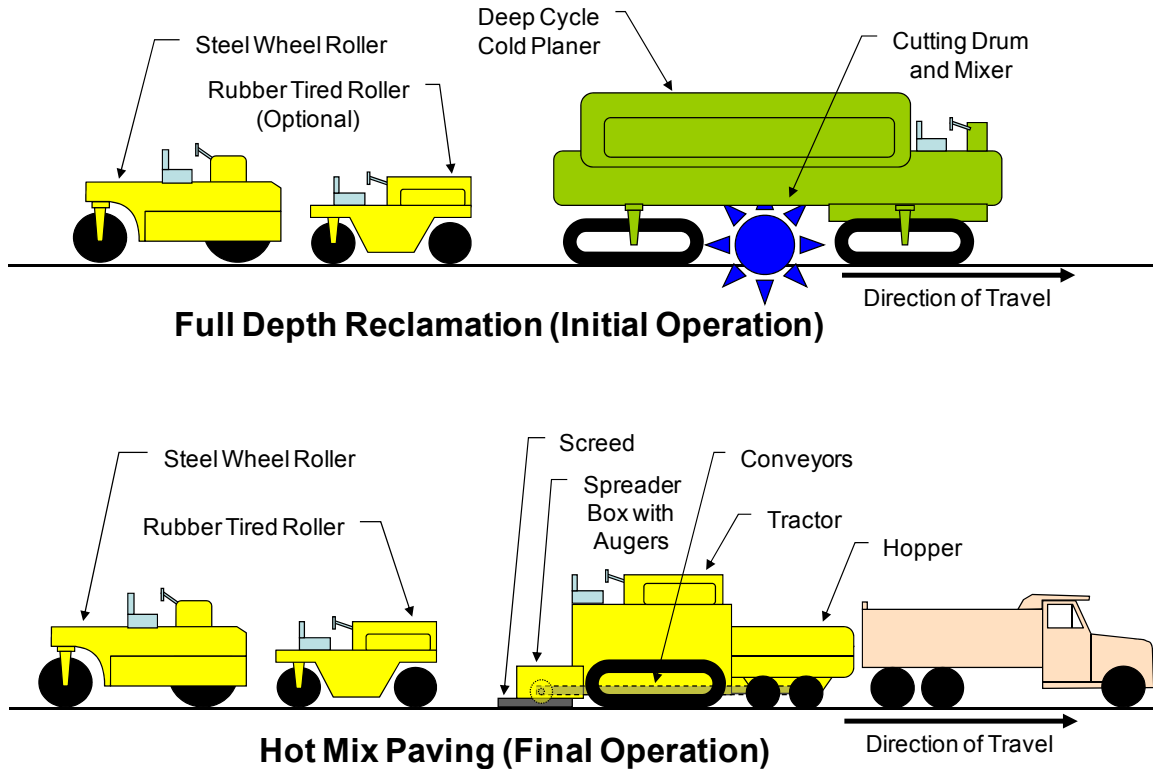

Figure 5.20 Schematic of Full Depth Reclamation Equipment

5.20 Rubblization and Flexible Pavement Overlay

Existing, worn-out PCC pavements present a particular problem for rehabilitation due to the likelihood of reflection cracking when an HMA overlay is placed. Horizontal and vertical movements occurring within the underlying PCC layer cause reflection cracking. Reflection cracking can occur at any PCC joint or crack. The reflection cracking problem must be addressed in the HMA overlay design phase if long-term performance of the overlay is to be achieved (2).

The objective of rubblization is to eliminate reflection cracking in the HMA overlay by the total destruction of the existing slab action of the PCC pavement. This process is normally achieved by rubblizing the slab into fragments (2). Rubblization and overlay is a two-phase operation. The first operation is to create the rubblized base material. No traffic is placed on the roadway after this operation. The final operation is to place a flexible overlay on top of the rubblized base material. For pavement design, the rubblized material is considered a base material. See **Figure 5.21 Rubblization and Overlay Layers** and **Figure 5.22 Schematic of Rubblization and Overlay Equipment**. Refer to Section 2.11.5 **Base Layer Made of Rubblized Rigid Pavement** in CHAPTER 2 for additional information.

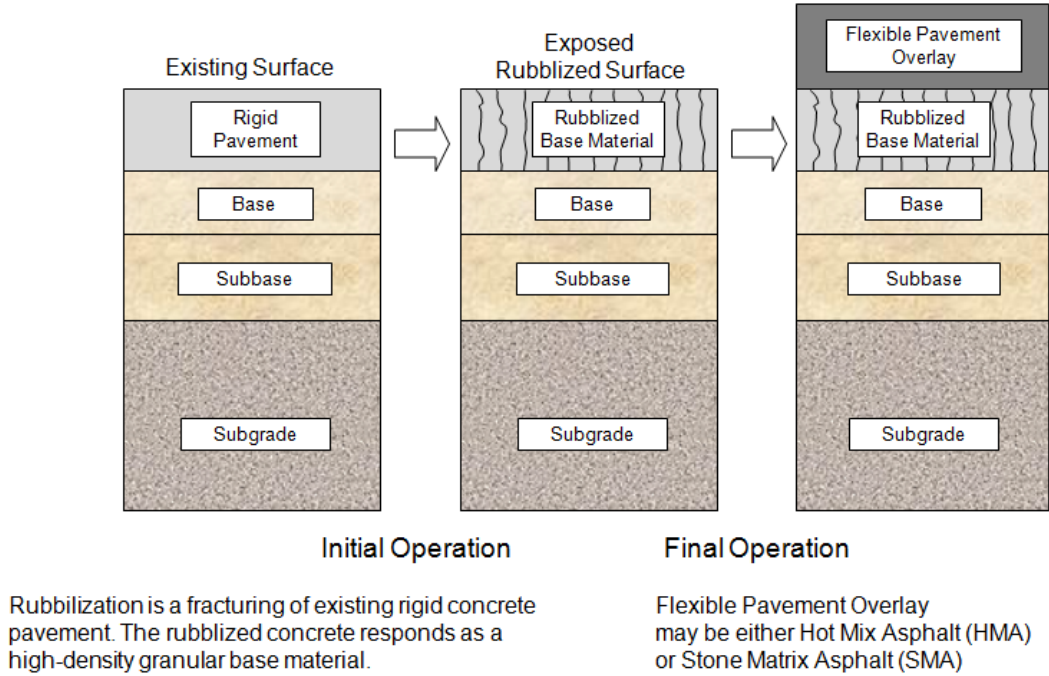

Figure 5.21 Rubblization and Overlay Layers

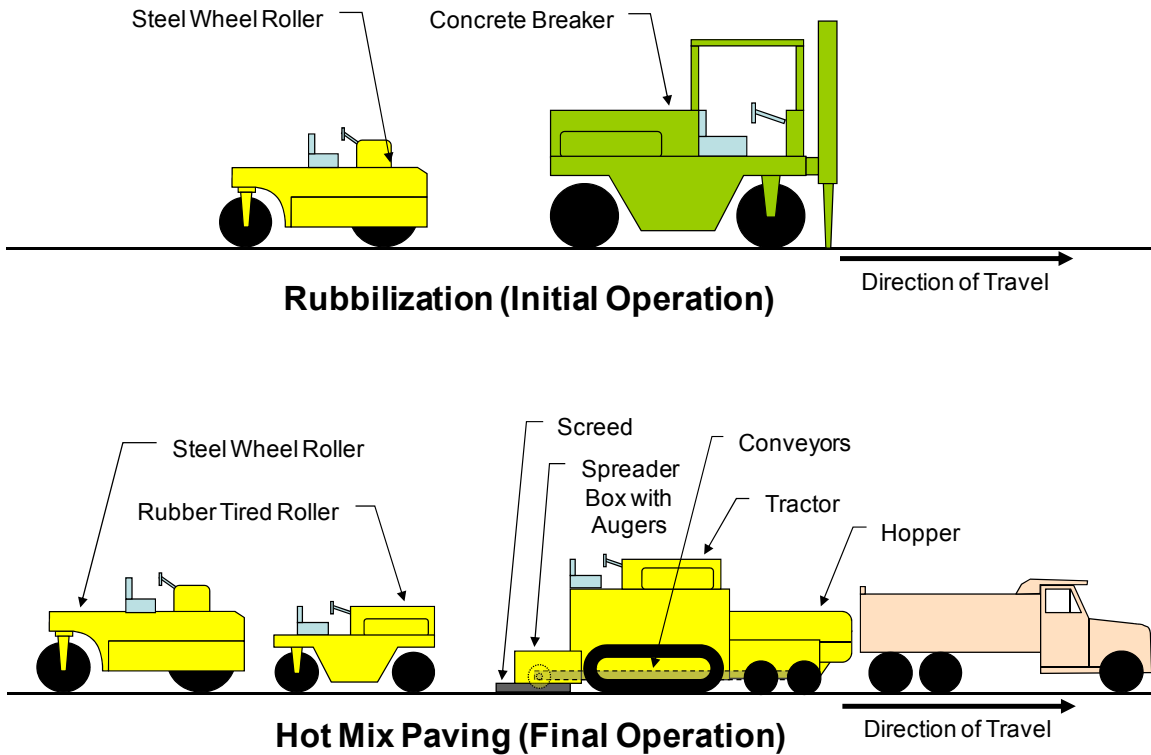

Figure 5.22 Schematic of Rubblization and Overlay Equipment

5.21 Stone Matrix Asphalt Project and Material Selection Guidelines

Stone Matrix Asphalt (SMA) is a gap-graded Hot Mix Asphalt (HMA) that maximizes rutting resistance and durability with a stable stone-on-stone skeleton held together by a rich mixture of AC, filler, and stabilizing agents. SMA is often considered a premium mix because of higher initial costs due to increased asphalt contents and the use of more durable aggregates. These mixes are almost exclusively used for surface courses on high volume interstates and highways. For a national perspective on designing SMA mixtures, refer to the National Cooperative Highway Research Program (NCHRP) Report 425, *Designing Stone Matrix Asphalt Mixtures for Rut-Resistant Pavements*.

The selection of a SMA mix on CDOT projects should be discussed with your Region Materials Engineer when the criterion for selecting a SMA mix is met. The following conditions need to be present prior to considering the selection of a SMA mix for the wearing surface on the project.

- Total Average Annual Daily Traffic (AADT) greater than 20,000 in the design year;
- The functional class of the roadway should be either a Principal Arterial, Freeway, or Interstate; and
- The underlying pavement should have a Lottman greater than 50 % (Lottman to be tracked) with Air Voids greater than 3.0 %.

Once the appropriate SMA project has been selected, in order to reduce the possibility of asphalt cement drain down or bleed spots, the SMA should contain cellulose fibers.

For ease of construction, it is recommended that the SMA extend full width of the pavement.

5.21.1 Aggregate Gradation

Definitions of aggregate size:

Nominal Maximum Aggregate Size (NMAS) - The size of aggregate of the smallest sieve opening through which the entire amount of aggregate is permitted to pass.

Note: For Item 403 - HMA and SMA, the Nominal Maximum Size is defined as one sieve size larger than the first sieve to retain more than ten percent of the aggregate.

Maximum Aggregate Size is defined as one size larger than nominal maximum size.

SMA Gradation Nomenclature Example:

The 19.0 mm (3/4") gradation is named the 3/4" Nominal Maximum Aggregate Size gradation because the first sieve that retains more than 10 % is the 1/2" sieve, and the next sieve larger is the 3/4" sieve.

Table 703-1 - Definition of Nominal Aggregates of CDOT 2005 *Standard Specifications for Road And Bridge Construction* book tabulates the above.

CDOT uses the No. 30 sieve as one of the job-mix formula tolerance sieves. **Table 5.6 Master Range Table for Stone Matrix Asphalt** is based (with some exceptions) on NCHRP No. 4 and 3/8" and AASHTO 1/2" and 3/4" SMA gradations ranges, where the No. 30 sieve range is included in the 1/2" and 3/4" gradations.

Table 5.6 Master Range Table for Stone Matrix Asphalt
(Revision of Section 703 - Aggregate for Stone Matrix Asphalt, TABLE 703-5)

Sieve Size	Percent by Weight Passing Square Mesh Sieves			
	4.75 mm (#4) Nominal Maximum	9.5 mm (3/8") Nominal Maximum	12.5 mm (1/2") Nominal Maximum	19.0 mm (3/4") Nominal Maximum
25 mm (1")				100
19.0 mm (3/4")			100	90-100
12.5 mm (1/2")	100	100	90-100	50-88
9.5 mm (3/8")	100	90-100	50-80	25-60
4.75 mm (#4)	90-100	26-60	20-35	20-28
2.36 mm (#8)	28-65	20-28	16-24	16-24
1.18mm (#16)	22-36			
600 µm (#30)	18-28	12-18	12-18	12-18
300 µm (#50)	15-22	10-15		
150 µm (#100)				
75 µm (#200)	12-15	8-12	8-11	8-11

5.21.2 Recommended Minimum Thickness Layers

If no structural deficiency exists and a preventative maintenance treatment is desired, the structural number will be less than or equal to zero. This does not mean, however, that the pavement does not need an overlay to correct a functional deficiency. If the deficiency is primarily functional, the minimum SMA thickness will be 4 times the nominal maximum aggregate size. In this case, a fine-grained (3/8" or No. 4) aggregate size is suggested. See **Table 5.7 SMA Functional and Structural Recommended Minimum Thickness Layers**.

If the pavement has a structural deficiency, the required minimum SMA thickness will be 2.0 inches. As a general construction practice, the lift thickness should be at least 4 times the nominal maximum aggregate size.

The Pavement Designer should be aware when specifying thin lifts (1-1/2" and less) the verification of compaction density by nuclear density devices and coring is suspect and may be unattainable in providing reasonable results. Revisions to the Specifications may be needed for the elements of In-place Density and Joint Density pay factors.

Table 5.7 SMA Functional and Structural Recommended Minimum Thickness Layers

Nominal Maximum Aggregate Size	Functional Minimum Thickness	Structural Minimum Thickness
3/4"	3"	3"
1/2"	2"	2"
3/8"	1 1/2"	2"
No. 4	3/4"	2"

References

1. *Basic Asphalt Recycling Manual*, Federal Highway Administration, 400 Seventh Street, SW, Washington, DC 20590 and Asphalt Recycling and Reclaiming Association, #3 Church Circle, PMB 250, Annapolis, MD 21401, 2001.
2. *Rubblization of Portland Cement Concrete Pavements*, Transportation Research Circular Number E-C087, Transportation Research Board, 500 Fifth Street, NW, Washington, DC 20001, January 2006.
3. *Distress Identification Manual for the Long-Term Pavement Performance Program*, U.S. Department of Transportation, Federal Highway Administration, Publication No. FHWA-RD-03-031, June 2003.

CHAPTER 6

PRINCIPLES OF DESIGN FOR PAVEMENT REHABILITATION WITH RIGID OVERLAY

6.1 Introduction

Whitetopping is quickly becoming a popular method used nationwide to rehabilitate deteriorated asphalt pavements. Since the flexible asphalt surface is replaced by rigid concrete, the technique offers superior service, long life, low maintenance, low life-cycle cost, improved safety, and environmental benefits. The critical stress and strain prediction equations developed of an initial research report are part of a first-generation design procedure. It was issued December 1998 *Guidelines for the Thickness Design of Bonded Whitetopping Pavement in the State of Colorado*, CDOT-DTD-R-98-10. An initial MS Excel worksheet was developed along with the report. The equations were verified and/or modified with the collection of additional data and is reported under August 2004, *Instrumentation and Field Testing of Thin Whitetopping Pavement in Colorado and Revision of the Existing Colorado Thin Whitetopping Procedure*, CDOT-DTD-R-2004-12. A revised MS Excel worksheet goes along with the report.

Whitetopping is the construction of a new PCCP over an existing HMA pavement. It is considered an advantageous rehabilitation alternative for badly deteriorated HMA pavements, especially those that exhibit such distress as rutting, shoving, and alligator cracking (ACPA 1998).

The primary concerns with whitetopping are:

- The thickness design procedure;
- Joint spacing; and
- The use and spacing of dowels and tie bars.

In general, CDOT does not recommend thin whitetopping thickness less than 5 inches. Conventional whitetopping uses 8 inches or greater thickness of concrete overlays. Ultra-thin whitetopping, which uses 5 inches or less of PCCP, should not be used on Colorado's state highways. See **Table 6.1 Required Whitetopping Procedure** for required Whitetopping Thickness Procedure.

Table 6.1 Required Whitetopping Procedure

Required Thickness	
< 5.0"	Do not use
≥ 5.0" to < 8.0"	Use CDOT Thin Whitetopping Procedure
≥ 8.0"	Use AASHTO Overlay Design (DARWin™)

Using the AASHTO overlay design, an unbonded overlay must be adequately isolated from the underlying deterioration and allowed unrestricted horizontal movement; however, a certain amount of bonding or friction between the overlay and the separator layer, and between the separator layer and the underlying pavement is also important to achieve good performance. With PCCP, the widened Portland cement concrete slab section must be tied with deformed bars to the existing Portland cement concrete slab face. The tie bars should be securely anchored and consistent with ties used in new pavement construction. The bonding or separation of PCCP overlays must be fully considered. Bonded overlays must be constructed to ensure that the overlay remains bonded to the existing slab. Unbonded overlays must be constructed to ensure that the separation layer prevents any reflection cracks in the overlay.

It is important that the designer consider the type of deterioration present when determining whether the pavement has a structural or functional deficiency, so that an appropriate overlay type and design can be developed. See **Figure 6.1 Rehabilitation Alternative Selection Process** for the flowchart of rehabilitation alternative selection process.

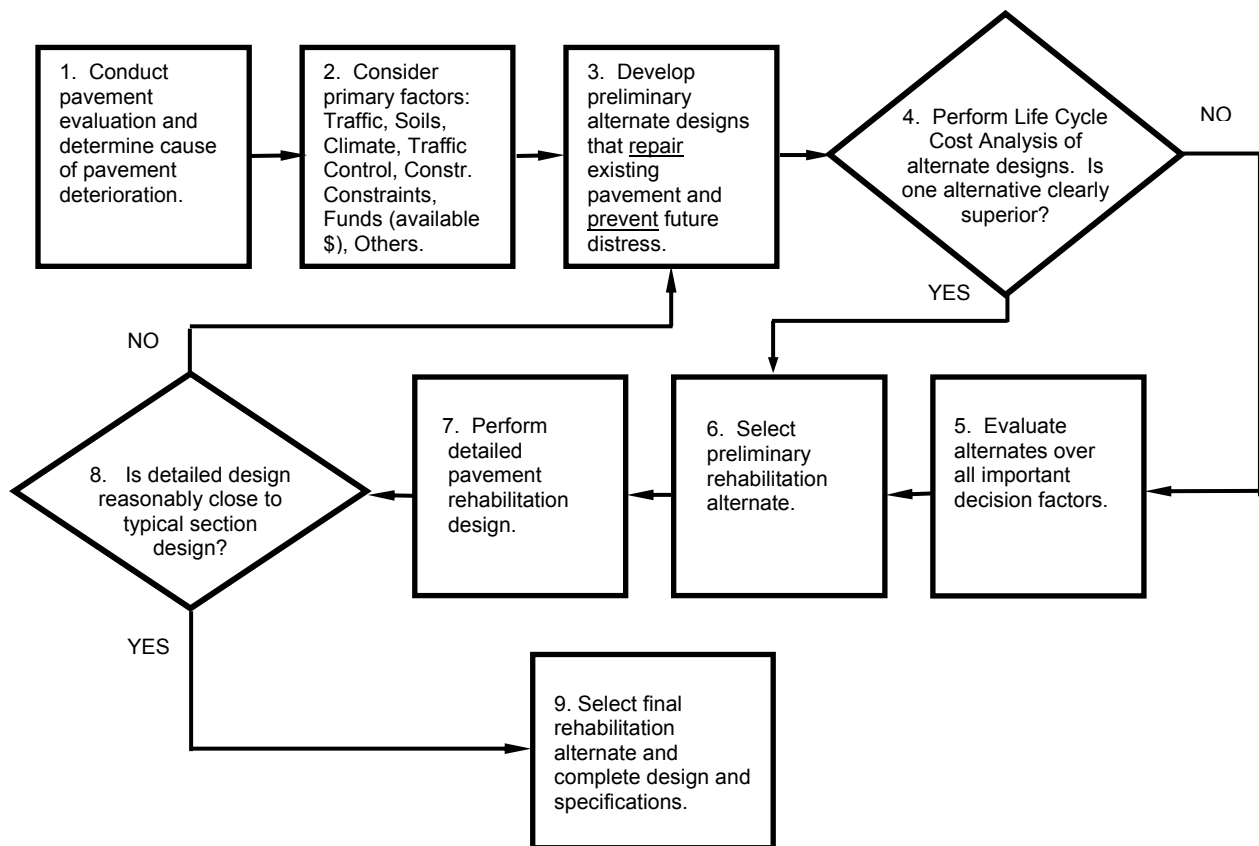

Figure 6.1 Rehabilitation Alternative Selection Process

6.1.1 Benefits of Whitetopping

The benefits for using whitetopping include the following:

- Can be cost-effective in comparison with other rehabilitation techniques;
- Long-term benefit to the traveling public as well as the highway or airport agency;
- Can reduce the user delays associated with maintenance of HMA pavement;
- Can perform well and be durable if properly designed and constructed;
- Can provide improved skid resistance and safety;
- Can strengthen the deteriorated HMA pavement, extending the service life of the highway or airport pavement; and
- Can provide a smooth ride that can significantly improve the functional life of the pavement. As opposed to full reconstruction with a new base course, whitetopping utilizes the existing HMA pavement as a solid base course, providing additional stability. This, in turn, reduces the potential for pumping, faulting, and loss of pavement support.

Whitetopping overlays are not recommended when the existing HMA pavement is badly deteriorated or when substantial amounts of the existing pavement have to be removed during rehabilitation. It is not recommended that whitetopping be placed over HMA pavements with material problems, such as asphalt stripping, either.

- Pavements with very little deterioration are excellent candidates for whitetopping overlays; and
- Intersections are also ideal for whitetopping placement, if rutting and “washboarding” of the HMA pavement is a common problem.

6.2 Design Period

The destructive effect of repeated wheel loads is the major factor that contributes to the failure of highway pavement. Since both the magnitude of the load and the number of its repetitions are important, provision is made in the design procedure to allow for the effects of the number and weight of all axle loads expected during the design period. The design period for restoration, rehabilitation, and resurfacing using whitetopping is usually 20 or 30 years. A 10-year design period may be used as a short-term alternative for CDOT whitetopping design procedure. Selection of a 10-year project needs to be supported by a LCCA or other overriding considerations.

6.3 Traffic Analysis

The overlay design procedures require the 18k ESALs expected over the design period of the overlay in the design lane. For rigid overlay design, use the ESAL equivalency factors (**Table 1.2 of CHAPTER 1**) for rigid pavement, regardless of the existing type of pavement to be overlaid.

6.4 Existing Pavement Evaluation

The evaluation of the existing pavement is an essential part of a whitetopping design. Field evaluation typically consists of a visual distress survey, deflection testing using a falling weight deflectometer (FWD), and coring of existing pavement thickness.

For rigid pavement evaluation, Nondestructive Testing (NDT) serves two functions:

- To estimate the roadbed composite modulus of subgrade reaction, k-value; and
- To estimate the elastic modulus of the concrete, E_c , of the existing pavement structure.

Refer to Section **2.6.1.5 Deflection Testing and Backcalculation (Recommended)**, Section **2.6.2 Adjustments**, and **APPENDIX C - DEFLECTION TESTING AND BACKCALCULATION**.

As with any pavement rehabilitation project, variability in the existing pavement condition and in the subgrade is important considerations. CDOT recommends breaking out any portion of the project with significantly different conditions as separate section and design.

A determination as to the cause of the pavement distress is important before the appropriate rehabilitation strategies can be evaluated. A Pavement Condition Evaluation Checklist is to be completed before the appropriate rehabilitation strategies can be selected. **Figure 6.2 Pavement Condition Evaluation Checklist (Rigid)** is the checklist used for a PCCP (in **CHAPTER 5**, a similar checklist is available in **Figure 5.2 Pavement Condition Evaluation Checklist (Flexible)** for flexible pavement). This information will help identify the cause of the pavement distresses. In addition to surface distress evaluation, available information from the Department's Pavement Management System should also be considered during data analysis and probable cause determination. This should include information such as roughness, deflections, skid resistance, drainage condition, etc. when appropriate. For information on how to conduct the distress survey, refer to **APPENDIX A**, Section **A.4 Site Investigation**.

A PCCP surface condition can deteriorate rapidly due to roughness from spalling, including potholes, and faulting of transverse and longitudinal joints and cracks. Full or partial depth repairs consisting of rigid materials can repair spalling. Faulting can be alleviated by an overlay of adequate thickness; however, faulting indicates poor load transfer and poor drainage. Drainage improvements may be needed.

6.4.1 Structural Evaluation of Existing Pavement

Structural deterioration is defined as any condition that reduces the load-carrying capacity of the pavement. The overlay design procedures presented here are based on the concept that time and traffic loadings reduce a pavement's ability to carry loads and an overlay can be designed to increase the pavement's ability to carry loads over a future design period. The required overlay structural capacity can be correctly determined only if the evaluation of existing structural capacity is correct. The primary objective of the structural evaluation is to determine the effective structural capacity of the existing pavement.

The evaluation of effective structural capacity must consider the current condition of the existing pavement materials, and consider how those materials will behave in the future. The following four alternative evaluation methods are recommended to determine effective structural capacity:

- Structural capacity based on nondestructive deflection testing (NDT);
- Structural capacity based on visual survey and materials testing;
- Structural capacity based on fatigue damage from traffic; and
- Structural capacity based on Remaining Service Life (RSL).

Because of the uncertainties associated with the determination of effective structural capacity, the four methods cannot be expected to provide equivalent estimates. The designer should consider all four methods whenever possible and select the best estimate based on judgment. There is no substitute for solid experience and judgment in this selection.

PAVEMENT EVALUATION CHECKLIST (RIGID)

PROJECT NO.: _____ LOCATION: _____
 PROJECT CODE (SA #): _____ DIRECTION: _____ MP _____ TO MP _____
 DATE: _____ BY: _____
 TITLE: _____

TRAFFIC

- Existing _____ 18k ESAL/YR
- Design _____ 18k ESAL

EXISTING PAVEMENT DATA

- | | |
|--|--|
| - Subgrade (AASHTO) | - Shoulder Condition
(good, fair, poor) |
| - Base (type/thickness) | - Joint Sealant Condition
(good, fair, poor) |
| - Pavement Thickness | - Lane Shoulder Separation
(good, fair, poor) |
| - Soil Strength (R/M _R) | |
| - Swelling Soil (yes/no) | |
| - Roadway Drainage Condition
(good, fair, poor) | |

DISTRESS EVALUATION SURVEY

Type	Distress Severity*	Distress Amount*
Blowup		
Corner Break		
Depression		
Faulting		
Longitudinal Cracking		
Pumping		
Reactive Aggregate		
Rutting		
Spalling		
Transverse and Diagonal Cracks		
OTHER		

* Distress Identification Manual for the Long-Term Pavement Performance Program, U.S. Department of Transportation, Federal Highway Administration, Publication No. FHWA-RD-03-031, June 2003.

Figure 6.2 Pavement Condition Evaluation Checklist (Rigid)
(A restatement of Figure A.1)

6.4.2 Surface Preparation

Conventional whitetopping of rigid pavement over existing flexible pavement requires minimal preoverlay repairs. The American Concrete Pavement Association (ACPA) guidelines for preoverlay repairs for conventional whitetopping are given **Table 6.2 Guidelines for Whitetopping Preoverlay Repair (ACPA 1998)** (3). Conventional whitetopping include the following:

- Removal and replacement of areas of subgrade or base failure;
- Repair or removal of severe rutting, shoving, or other distortions; and
- Repair of potholes.

Table 6.2 Guidelines for Whitetopping Preoverlay Repair (ACPA 1998)

General Pavement Condition	Recommended Repair*
Rutting (< 2 inches)	None or cold planing**
Rutting (> 2 inches)	Cold Planing or leveling
Shoving	Cold Planing
Potholes	Fill with crushed stone cold mix or hot mix
Subgrade failure	Remove and replace or repair
Alligator cracking	None
Block cracking	None
Transverse cracking	None
Longitudinal cracking	None
Reveling	None
Bleeding	None

*Other factors to consider: adding edge drains; costs of direct placement vs. cold planing or leveling.

** Consider increasing the joint sawing depth. For conventional whitetopping, no special efforts are made to encourage bonding between the overlay and the underlying HMA surface; however, a surface preparation step may be required to address distortions in the existing HMA pavement surface or to correct the surface profile.

The following are some common methods of surface preparation are used for whitetopping:

- Direct placement;
- Cold planing; and
- Placement of leveling course.

A minimum existing HMA thickness of 5 inches after cold planing or other rehabilitation processes is recommended for thin whitetopping overlays. A minimum 2-inch thickness of new HMA is also recommended on top of milled surface for AASHTO conventional overlay design.

6.4.3 Effective Thickness of Existing Pavement for the AASHTO Method

Design methods for this type of strategy have existed since the *1986 AASHTO Guide for Design of Pavement Structures* was published. This section uses the methods shown in the 1993 AASHTO Guide for Design of Pavement Structures. The procedure consists of the following:

For HMA pavements, refer to FWD analysis found in Section 5.11 of CHAPTER 5.

For PCC pavements, obtain the 18k ESAL for a rigid pavement over the design period from the DTD Traffic Analysis Unit. The subgrade resilient modulus (M_R) is calculated using an average value from Eq. 6.1 as performed with values from two deflection readings farthest from the load plate. The adjustment factor (C) used in the backcalculation method for placing an asphalt overlay over an existing asphalt pavement is not used in the design of a PCC overlay placed over an existing asphalt pavement. Since the thickness design will use the rigid pavement formulas, the value for C is 1.00, thus C may be ignored in the calculations.

$$M_R = C(0.24P)/d_r \quad \text{Eq. 6.1}$$

Where:

M_R = backcalculated subgrade resilient modulus, psi

C = correction factor for correlating field measured M_R to laboratory measured M_R and the AASHTO road test M_R . The default value is 0.33 for an overlay using the flexible pavement formula

P = applied load, pounds

d_r = deflection at a distance r from the center of the load, inches

r = distance from the center of load, inches

Calculate the required slab thickness for the design traffic using Equation (1.2.2) as documented in the *1993 AASHTO Guide for Design of Pavement Structures* with the 18k ESAL from Chapter 4 and the k_{eff} from Eq. 6.2.

$$k_{\text{eff}} = E_c [18.42(D^{0.75} - (u_r)(4.22 - 0.32 * P_t)^{-1})]^4 \quad \text{Eq. 6.2}$$

Where:

k_{eff} = effective modulus of subgrade reaction M_R calculated from Eq. 6.2 using the subgrade resilient modulus from Eq. 6.1

E_c = mean 28-day elastic modulus of slab, psi

D = thickness of pavement slab, inches

u_r = relative drainage

P_t = percent transverse steel

The loss of support for a PCCP constructed with normal good workmanship over an existing asphalt pavement may be assumed to be zero (0). Use the reliability, overall deviation, serviceability loss, drainage coefficient, modulus of rupture, load transfer coefficient, and modulus of elasticity according to the procedures in **CHAPTER 4 - PRINCIPLES OF DESIGN FOR RIGID PAVEMENT**.

6.5 Design Considerations

The design of whitetopping overlays involves the consideration of factors that are common to pavement rehabilitation projects including the following:

- Existing pavement evaluation;
- Functional classification;
- Preoverlay repair; and
- Subgrade soil.

Assessing the feasibility of whitetopping as a rehabilitation alternative, the following location factors should be considered:

- Future traffic loading;
- Existing curb and gutter; and
- Overhead clearance.

Table 6.3 1998 AASHTO Supplemental Design Method Factors for Rigid Pavement shows the design factors used for 1998 AASHTO Supplemental Design Method for rigid pavement overlay. Use the future design thickness of the 1998 Supplement calculation in the overlay design.

Table 6.3 1998 AASHTO Supplemental Design Method Factors for Rigid Pavement
(A restatement of **Table 4.1**)

Factor	Source
18k ESAL, W18	Division of Transportation Development, requested by the designer specifically for rigid pavement http://www.dot.state.co.us/App_DTD_DataAccess/index.cfm
Reliability Level (%)	Table 1.3, CHAPTER 1
Overall Standard Deviation, S_o	0.34
Initial Serviceability, P_o	Table 1.5, CHAPTER 1
Terminal Serviceability, P_t	Table 1.5, CHAPTER 1
Serviceability Loss, ΔPSI	Table 1.5, CHAPTER 1
Modulus of Subgrade Reaction, k	See CHAPTER 2
Modulus of Rupture, S'_c	Use 650 psi
Modulus of Elasticity, E_c	Use 3,400,000 psi
Joint Spacing, L	See CHAPTER 4
Base Modulus, E_b	See CHAPTER 4
Slab/Base Friction Coefficient, f	See CHAPTER 4
Base Thickness, H_b	See CHAPTER 4
Effective Positive Temperature Differential, °F a) Mean Annual Wind Speed, WIND b) Mean Annual Temperature, TEMP c) Mean Annual Precipitation, PRECIP	See CHAPTER 4 See CHAPTER 4 See CHAPTER 4
Lane Edge Support Condition, E	See CHAPTER 4

6.5.1 Unbonded and Bonded Concrete Overlay

Unbonded concrete overlays on rigid pavements provide additional structural capacity to the roadway. A bond breaker is placed between the old pavement and the new overlay to prevent reflective cracking. Slabs that are rocking, pumping or faulted should be stabilized prior to overlaying. Since there will be a considerable vertical height increase, additional design and cost considerations similar to the thick asphalt overlay must be addressed. If the existing shoulders are asphaltic and are to be removed, recycled, or replaced, they must be replaced with portland cement concrete shoulders and tied to the driving lanes. The replacement of asphalt shoulders with asphalt shoulders is not allowed for the rehabilitation of portland cement concrete pavements.

A thin bonded concrete overlay, no less than two inches, must be bonded to the existing portland cement concrete pavement. Consult Region Materials Engineer for additional information. To ensure an adequate bond, the existing surface should be cleaned of all surface contaminants including oil, paint, and unsound concrete. Cold planing, sand blasting, water blasting or a combination of the above can accomplish this. A grout made from sand and cement should be placed on the cleaned surface just in front of the paver and broomed in. The grout should not be allowed to dry before the overlay is placed. Since all cracks in the old surface will reflect through the overlay, all joints in the original pavement must be reproduced in the overlay. For this reason, thin concrete overlays are restricted to pavements that are not heavily cracked. Thin concrete overlays should be used only when the existing concrete is in good condition and only surface corrections are necessary.

6.6 The CDOT Thin Whitetopping Method for Thickness Design

A mechanistic pavement design procedure for whitetopping pavement was developed through a comprehensive study involving extensive field load testing and theoretical analysis of whitetopping responses. Two types of pavement failure were considered in this procedure; portland cement concrete fatigue under joint or corner loading and asphalt concrete fatigue under joint loading. Temperature induced stresses and strains were not included in the design procedure. The developed procedure was also modified to incorporate the number of expected Equivalent 18-kip Single Axle Loads (ESALs) currently used by the State of Colorado for the design of concrete pavements.

Thin whitetopping is a two-phase operation. The first operation is to cold mill the existing flexible pavement. The milled material is hauled away and stockpiled. No traffic is placed on the roadway. Surface defects are corrected to provide an acceptable relatively smooth cold milled surface. The surface needs to be roughened to create a good interlock bond for the thin whitetopping. Also, grade control is set up at this time. The final operation is to pave the thin whitetopping overlay with a conventional concrete paver. **Figure 6.3 Thin Whitetopping Overlay Layer** and **Figure 6.4 Schematic of Thin Whitetopping Overlay Equipment** shows the layers and equipment of a thin whitetopping overlay.

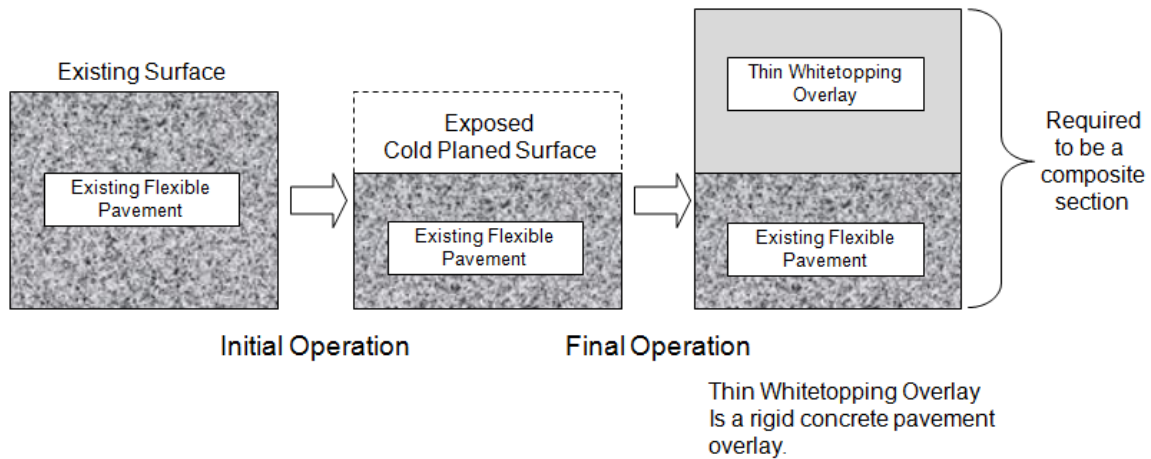

Figure 6.3 Thin Whitetopping Overlay Layer

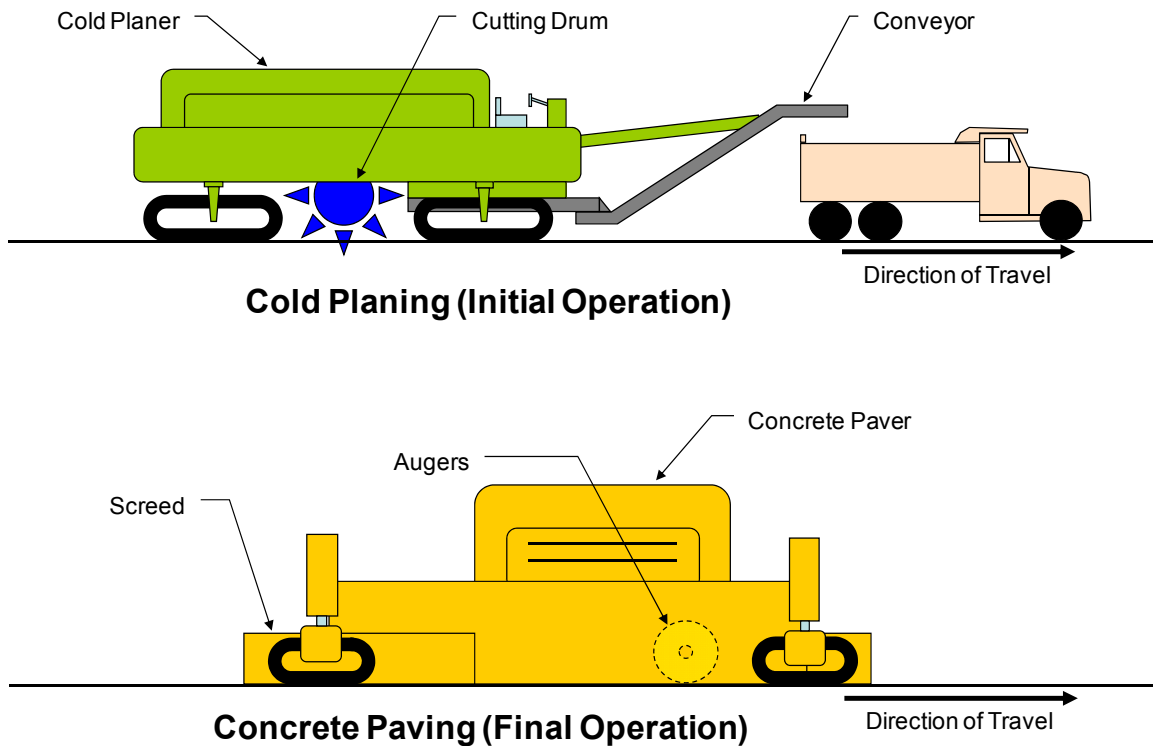

Figure 6.4 Schematic of Thin Whitetopping Overlay Equipment

Based on the field and theoretical analyses conducted during the study, the following construction practices should be used:

- A good bond within the concrete/asphalt interface is essential for successful whitetopping performance.
- For existing asphalt pavement being rehabilitated, the strain (and corresponding stress) in the whitetopping is reduced by approximately 25 percent when the asphalt is milled prior to

concrete placement. The opposite was found for new asphalt placed as a whitetopping base. The strain (and corresponding stress) in whitetopping on new asphalt is increased by approximately 50 percent when the asphalt is milled prior to concrete placement.

A minimum asphalt thickness of 5 in. (after cold planing) is recommended for the thin whitetopping pavement.

Table 6.4 Design Factors for Rigid Pavement contains the various design factors to be used in whitetopping design.

Table 6.4 Design Factors for Rigid Pavement

Factor	Source
Primary or Secondary	User Input
Joint Spacing	Section 6.7.3
Concrete Poisson's Ratio	0.15 (CDOT default value)
Concrete Elastic Modulus	Section 4.5, CHAPTER 4 or FWD data
Asphalt fatigue life consumed	FWD asphalt modulus data
k-value of the Subgrade	Soil profile report from laboratory and correlation equations.
Design ESALs	DTD Traffic Analysis Unit

For more information, please see: CDOT Research Report No. CDOT-DTD-R-98-10, *Guidelines for the Thickness Design of Bonded Whitetopping Pavement in the State of Colorado, December 1998*, CDOT-DTD-R-2002-3, *Instrumentation and Field Testing of Whitetopping Pavements in Colorado and Revision of the TWT Design Procedure*, March 2002 and CDOT-DTD-R-2004-12, *Instrumentation and Field Testing of Thin Whitetopping Pavement in Colorado and Revision of the Existing Colorado Thin Whitetopping Procedure, August 2004*. The last two research reports can be found on web page <http://www.dot.state.co.us/publications/researchreports.htm#White>. A revised MS Excel worksheet was developed in conjunction with report CDOT-DTD-R-2004-12. The worksheet may be obtained from CDOT Materials and Geotechnical Branch, Pavement Design Unit 303-398-6561 or CDOT Research Branch 303-757-9506.

The proper selection of candidate projects for CDOT thin whitetopping is of paramount importance to its continued use as a viable rehabilitation alternative. Listed are guidelines for the pavement designer on when to consider a project candidate for thin whitetopping. The list was compiled from past good performing whitetopping projects that had these characteristics.

- Determine adequate structural strength of existing asphalt by an analysis using Falling Weight Deflectometer (FWD) data.
- Cold mill 1/2 inch below wheel ruts to improve mechanical bond.
- The condition of the existing asphalt pavement must be good. The existing pavement must be in a good condition for an overlay and not a candidate for reconstruction.

- An existing roadway having a good aggregate base is preferred.
- Curb and gutter replacement should be at a minimum. The cost of removing and replacing extensive curb and gutter will reduce the cost benefit and may make a mill and fill asphalt pavement overlay more cost effective.
- Whitetopping works well with a divided roadway. The median serves as a non-tied longitudinal joint.
- Cross street traffic intersections, such as residential accesses should be light. Full depth pavement is necessary when major arterial intersections are encountered. The cross traffic must be accounted for in the pavement design at these intersection locations.
- A roadway with a minimal amount of truck traffic is ideal. Commuter roadways are better candidates than industrial access roadways.

A Project Special Provision has been developed and is to be used on thin whitetopping projects. The Project Special Provision is on web page <http://www.dot.state.co.us/DesignSupport/Construction/2005SpecsBook/2005PSP/2005psp.htm> titled Revision of Section 412, Portland Cement Concrete Pavement Thin Whitetopping. Additionally a thin whitetopping typical joint layout plan sheet has been developed to go along with the project special provision. It is found on web page http://www.dot.state.co.us/DesignSupport/MStandards/2000_MStandards/2000%20Project%20Details/ProjectDetails.htm and is titled D-412-2, Thin Whitetopping Typical Joint Layout.

6.6.1 Development of Design Equations

Two different modes of distress may exist in whitetopping pavements, corner cracking caused by corner loading and mid-slab cracking caused by joint loading. Both of these types of failure were considered in developing the original design equations (1998).

6.6.1.1 Corner Loading (1998)

Both a 20-kip Single Axle Load (SAL) and a 40-kip Tandem Axle Load (TAL) were applied to whitetopping slab corners. The corner loading case was found to produce the maximum concrete stress for relatively few conditions. In general, the corner loading case governed at higher values of the effective radius of relative stiffness. As the stiffness increases, the load-induced stress decreases. When the corner load case governed, relatively lower stresses resulted. The maximum stress, whether edge or corner, was used in the derivation of the concrete stress prediction equations.

6.6.1.2 Mid-Joint Loading (1998)

Load-induced longitudinal joint stresses for a 20-kip single axle load (SAL) and a 40-kip tandem axle load (TAL) were computed. Maximum tensile stresses at the bottom of each layer were calculated for both the concrete and asphalt. Maximum asphalt strains used in generating the design equations occurred for the joint loading condition. In most cases, the joint loading condition also produced the maximum stress at the bottom of the concrete layer.

6.6.1.3 Determination of Critical Load Location (1998)

The critical load location for the design of whitetopping pavement was determined during the original 1998 study by comparing the stress and strain data collected for each load position. The critical load location inducing the highest tensile stress in the concrete layer was when the load was centered along a longitudinal free edge joint. For whitetopping pavement, a free edge joint occurs when both the asphalt and concrete are formed against a smooth vertical surface such as a formed concrete curb and gutter. It is reasonable that free edge loading produces the highest stress, but it is likely more common that the joints loaded by traffic will not be free edges. The equation for original data is shown and could not be verified but is used in the 2004 procedure.

Original Critical Joint Stresses:

$$\sigma_{FE} = 1.87x\sigma_{TE} \quad \text{Eq. 6.3}$$

Where:

σ_{FE} = load-induced stress at a longitudinal free joint, psi

σ_{TE} = load-induced stress at a longitudinal tied joint, psi

6.6.1.4 Interface Bond on Load-Induced Concrete Stress

The effect of interface bonding was evaluated by comparing measured stresses for zero temperature gradient conditions to the computed stresses for fully bonded pavement systems. Stresses caused by loads at mid-joint and slab corner were computed using the finite element computer program ILLISLAB (ILSL2), assuming fully bonded concrete-asphalt interface. The program is based on plate bending theory for a medium-thick plate placed on a Winkler or spring foundation. All the test sections were existing asphalt milled prior to concrete placement, and based on the previous study (1998) this is the best approach for promoting bond for existing asphalt substrate conditions.

2004 Interface Bond on Load-Induced Concrete Stresses:

$$\sigma_{ex} = 1.51 * \sigma_{th} \quad \text{Eq. 6.4}$$

Where:

σ_{ex} = measured experimental partially bonded stress, psi

σ_{th} = calculated fully bonded stress, psi

6.6.1.5 Interface Bond on Load-Induced Asphalt Strain

The effect of interface bond on the load-induced asphalt surface strain was also studied using field-collected data. If slabs were fully bonded, the concrete bottom strain would equal the asphalt surface strain. Asphalt strains are generally less than the concrete strains, which is the result of slippage between the layers. There is approximately a 10 percent loss of strain transfer from the concrete to the asphalt due to the partial bond between the layers.

2004 Interface Bond on Load-Induced Asphalt Strain:

$$\varepsilon_{ac} = 0.897 * \varepsilon_{pcc} - 0.776 \quad \text{Eq. 6.5}$$

Where:

ε_{ac} = measured asphalt surface strain, microstrain

ε_{pcc} = measured concrete bottom strain, microstrain

Stresses and strains at the bottom of the asphalt layer decrease with loss of bond. The design procedure assumes that average strain reductions reflecting partial bond at the interface are equally reflected at the bottom of the asphalt layer.

6.6.1.6 Temperature Restraint Stress

Temperature gradients throughout load testing ranged from -2°F/in. to 6°F/in. Measurable stress changes occurred with changing temperature gradient, which indicates that restraint stresses are present and raises concern that there could be loss of support conditions. However, minimizing the whitetopping joint spacings is recommended (typically using 6 ft by 6 ft panels) for minimizing the effects of curling and warping restraint stresses and possible loss of support.

2004 Temperature Effects on Load-Induced Stresses:

$$\sigma_{\%} = 3.85 * \Delta T \quad \text{Eq. 6.6}$$

Where:

$\sigma_{\%}$ = percent change in stress from zero gradient

ΔT = temperature gradient, °F/in.

This relationship is applied to the partial bond stresses to account for the effect of temperature induced slab curling and loss of support effects on the load-induced concrete stresses. For CDOT projects, a default temperature gradient of 3°F/in. will be used.

6.6.1.7 Development of Prediction Equations for Design Stresses and Strains

Prediction equations were derived for computing design concrete flexural stresses and asphalt flexural strains. The 2004 equations have an increase in concrete flexural stress of 51 percent from fully bonded pavements would be required to account for the loss of bonding at the 95 percent confidence level. Asphalt strains are decreased by approximately 10 percent to account for the partial bonding condition at the 95 percent confidence level. Effects of temperature-induced slab curling on load-induced stresses were also included in the thickness design procedure, and all of the original 1998 adjustments for these stresses and strains were revised. The revised four equations are as follows:

2004 Concrete Stress For 20-kip SAL

$$(\sigma_{pcc})^{1/2} = 18.879 + 2.918 t_{pcc} / t_{ac} + 425.44 / l_e - 6.955 \times 10^{-6} E_{ac} - 9.0366 \log k + 0.0133 L \quad \text{Eq. 6.7}$$

$$R^2_{adj} = 0.91$$

2004 Concrete Stress For 40-kip TAL

$$(\sigma_{pcc})^{1/2} = 17.669 + 2.668 t_{pcc} / t_{ac} + 408.52 / l_e - 6.455 \times 10^{-6} E_{ac} - 8.3576 \log k + 0.00622 L \quad \text{Eq. 6.8}$$

$$R^2_{adj} = 0.92$$

2004 Asphalt Strain For 20-kip SAL

$$(\epsilon_{ac})^{1/4} = 8.224 - 0.2590 t_{pcc} / t_{ac} - 0.04419 l_e - 6.898 \times 10^{-7} E_{ac} - 1.1027 \log k \quad \text{Eq. 6.9}$$

$$R^2_{adj} = 0.81$$

2004 Asphalt Strain For 40-kip TAL

$$(\epsilon_{ac})^{1/4} = 7.923 - 0.2503 t_{pcc} / t_{ac} - 0.04331 l_e - 6.746 \times 10^{-7} E_{ac} - 1.0451 \log k \quad \text{Eq. 6.10}$$

$$R^2_{adj} = 0.82$$

Where:

- σ_{pcc} = maximum stress in the concrete slab, psi
- ϵ_{ac} = maximum strains at bottom of asphalt layer, microstrain
- E_{pcc} = concrete modulus of elasticity, assumed 4 million psi
- E_{ac} = asphalt modulus of elasticity, psi
- t_{pcc} = thickness of the concrete layer, in.
- t_{ac} = thickness of the asphalt layer, in.
- μ_{pcc} = Poisson's ratio for the concrete, assumed 0.15
- μ_{ac} = Poisson's ratio for the asphalt, assumed 0.35
- k = modulus of subgrade reaction, pci
- l_e = effective radius of relative stiffness for fully bonded slabs, in.

$$= \{E_{pcc} * [t_{pcc}^3 / 12 + t_{pcc} * (NA - t_{pcc} / 2)^2] / [k * (1 - \mu_{pcc}^2)] + E_{ac} * [t_{ac}^3 / 12 + t_{ac} * (t_{pcc} - NA + t_{ac} / 2)^2] / [k * (1 - \mu_{pcc}^2)]\}^{1/4}$$
- NA = neutral axis from top of concrete slab, in.

$$= [E_{pcc} * t_{pcc}^2 / 2 + E_{ac} * t_{ac} * (t_{pcc} + t_{ac} / 2)] / [E_{pcc} * t_{pcc} + E_{ac} * t_{ac}]$$
- L = joint spacing, in.

Each of the equations developed to calculate the critical stresses and strains in a whitetopping pavement is dependent on the effective radius of relative stiffness of the layered system. The radius of relative stiffness appears in many of the equations dealing with stresses and deflections of concrete pavements. Whitetopping pavements include an additional structural layer of asphalt concrete. The stiffness contribution of the asphalt layer is incorporated into the effective radius of relative stiffness equation shown above.

6.6.1.8 PCCP and HMA Pavement Fatigue

The Portland Cement Association (PCA) developed a fatigue criterion based on Miner's hypothesis that fatigue resistance not consumed by repetitions of one load is available for repetitions of other loads. In a design, the total fatigue should not exceed 100%. The concrete fatigue criterion was incorporated as follows:

For $SR > 0.55$

$$\text{Log}_{10}(N) = (0.97187 - SR) / 0.0828 \quad \text{Eq. 6.11}$$

For $0.45 \leq SR \leq 0.55$

$$N = (4.2577 / (SR - 0.43248))^{3.268} \quad \text{Eq. 6.12}$$

For $SR < 0.45$

$$N = \text{Unlimited} \quad \text{Eq. 6.13}$$

Where:

SR = flexural stress to strength ratio

N = number of allowable load repetitions

Asphalt pavements are generally designed based on two criteria, asphalt concrete fatigue and subgrade compressive strain. Subgrade compressive strain criterion was intended to control pavement rutting for conventional asphalt pavements. For whitetopping pavements, when the asphalt layer is covered by concrete slabs, pavement rutting will not be the governing distress. The asphalt concrete fatigue equation developed by the Asphalt Institute was employed in the development of the whitetopping design procedure. The asphalt concrete fatigue equation is as follows:

$$N = C * 18.4 * (4.32 \times 10^{-3}) * (1 / \epsilon_{ac})^{3.29} * (1 / E_{ac})^{0.854} \quad \text{Eq. 6.14}$$

Where:

N = number of load repetitions for 20% or greater AC fatigue cracking

ϵ_{ac} = maximum tensile strain in the asphalt layer

E_{ac} = asphalt modulus of elasticity, psi

C = correction factor = 10M

M = $4.84 * [(V_b / (V_v + V_b)) - 0.69]$

V_b = volume of asphalt, percent

V_v = volume of air voids, percent

For typical asphalt concrete mixtures, M would be equal to zero. The correction factor, C, would become one, and was omitted from the equation. However, since whitetopping is designed to rehabilitate deteriorated asphalt pavement, the allowable number of load repetitions (N) needs to be modified to account for the amount of fatigue life consumed prior to whitetopping construction. Therefore, the calculated repetitions must be multiplied by the fractional percentage representing the amount of fatigue life remaining in the asphalt concrete. For

example, if it is determined that 25 percent of the asphalt fatigue life has been consumed prior to whitetopping; the calculated allowable repetitions remaining must be multiplied by 0.75.

The whitetopping pavement thickness design involves the selection of the proper concrete slab dimensions and thickness. Two criteria were used in governing the pavement design; asphalt and concrete fatigue under joint or corner loading. Temperature and loss of support effects were also considered in the design procedure. A design example is presented in next section to illustrate how to use the developed procedure to calculate the required whitetopping concrete thickness.

6.6.1.9 Converting Estimated ESALs to Whitetopping ESALs

CDOT currently designs pavements using the procedure developed by the American Association of State Highway and Transportation Officials (AASHTO). This empirical procedure is based on pavement performance data collected during the AASHTO Road Test in Ottawa, in the late 1950's and early 1960's. Traffic (frequency of axle loadings) is represented by the concept of the 18-kip Equivalent Single Axle Load (ESAL). Factors are used to convert the damage caused by repetitions of all axles in the traffic mix (single and tandem) to an equivalent damage due to 18-kip ESALs alone. Because the relative damage caused by ESALs is a function of the pavement thickness, a series of ESAL conversion factors have been developed for a range of concrete thicknesses. However, the minimum concrete thickness included in the AASHTO design manual is 6 inches. Since whitetopping thicknesses below 6 inches are anticipated, it was necessary to develop correction factors to convert ESAL estimations based on thicker concrete sections. Also, because the ESAL method of design appears to overestimate the required PCC thickness, it was necessary to develop a conversion factor, which would make the empirical and mechanistic procedures more compatible.

CDOT provided axle distributions for two highway categories (Primary and Secondary) anticipated as typical whitetopping traffic loading. The ESAL conversion factors were for an 8-in.-thick concrete pavement and a terminal serviceability of 2.5. The conversion factors were extrapolated for pavement thicknesses as low as 4 inches and the total ESALs were computed for a range of possible whitetopping thicknesses. For each highway category, ESAL conversions were developed as a percentage of the total ESALs computed for an 8-in.-thick concrete pavement. With these conversions, the designer only needs to obtain the design ESALs based on an assumed concrete thickness of 8 inches. For each trial whitetopping thickness, the total ESAL estimation is adjusted based on the following conversion equations:

$$\text{Primary Highway: } F_{\text{ESAL}} = 0.985 + 10.057 * (t_{\text{pcc}})^{-3.456} \quad \text{Eq. 6.15}$$

$$\text{Secondary Highway: } F_{\text{ESAL}} = (1.286 - 2.138 / t_{\text{pcc}})^{-1} \quad \text{Eq. 6.16}$$

Where:

F_{ESAL} = Conversion factor from ESAL estimation based on assumed; 8-in.-thick concrete pavement

t_{pcc} = thickness of the concrete layer, in.

For example, in the design of a 4.5-inch thick whitetopping on a secondary highway, the estimated ESALs based on an assumed 8-in.-thick pavement, say 750,000, and should be converted to 925,000 using the secondary highway conversion equation **Eq. 6.16**.

6.7 CDOT Thin Whitetopping Pavement Design Procedure

An example problem is presented to illustrate the steps involved in the design procedure. The example represents the design of a whitetopping project for a secondary roadway. It was determined that approximately 25 percent of the asphalt concrete fatigue life has been consumed to date. Visual inspection of the existing pavement indicates that asphalt fatigue cracking is not too severe (magnitude and quantity) and supports the decision to use whitetopping rehabilitation. Results are presented in **Table 6.5 Design Calculation Results** for the expected loads (Column 1 in **Table 6.5**) and expected number of repetitions (Column 8 in **Table 6.6**). Parameters and material properties used in the design include the following:

Asphalt modulus of elasticity, $E_{ac} = 350,000$ psi;
Asphalt thickness, $t_{ac} = 5.5$ in.;
Existing modulus of sub grade reaction, $k = 200$ pci;
Concrete modulus of elasticity, $E_{pcc} = 4,000,000$ psi;
Concrete modulus of rupture, $M_R = 650$ psi;
Concrete Poisson's ratio, $\mu_{pcc} = 0.15$;
Asphalt Poisson's ratio, $\mu_{ac} = 0.35$;
Temperature differential, $\Delta T = 3^\circ$ F/in throughout the day;
Trial concrete thickness = 4 in.;
Joint spacing, $L = 72$ in.; and
Existing asphalt fatigue = 25 percent.

6.7.1 Procedure Steps

The following steps are used in the design procedure:

Step 1. Determine l_e and L/l_e for the set of design parameters given in Subsection **6.6.1.7**.

$l_e = 24.41$ (Calculated from **Eq. 6.10** input variable);
 $L = 72$ in. (Joint spacing for the design example);
 $L/l_e = 72/24.41 = 2.95$

Step 2. Using the calculated l_e and L/l_e along with the modulus of subgrade reaction, k , **Eq. 6.7** is used to compute the load-induced critical concrete stresses (Col. 2 in **Table 6.5**) and **Eq. 6.9** is used to compute the load-induced critical asphalt strains (Col. 3 in **Table 6.5**) for anticipated 20-kip single axle loads (SAL). Stresses and strains for the remaining axle loads are computed as ratios of the 20-kip SAL load. Results are presented in the upper portion of **Table 6.5**.

Step 3. Repeat step 2 for the anticipated tandem axle loads (TAL). Use **Eq. 6.8** to compute the concrete stresses and **Eq. 6.10** to compute the asphalt strains for a 40-kip TAL shown in the lower portion of Columns 2 and 3 in **Table 6.5**.

Step 4. Using **Eq. 6.4** and **Eq. 6.5** compute the partial bond adjustment to the computed fully bonded concrete stresses and asphalt strains. Adjust the stresses and strains accordingly as shown in Columns 4 and 5 of **Table 6.5**, respectively.

Step 5. Use **Eq. 6.6** to adjust the concrete stress to account for the loss of support due to temperature-induced concrete slab curling. There is no adjustment for the asphalt strains. Therefore, Columns 6 and 7 of **Table 6.5** reflect the total concrete stresses and asphalt strains due to the anticipated loading and temperature gradient.

Step 6. With the total concrete stresses and asphalt strains known, the fatigue analyses are conducted. Separate fatigue analyses must be done for the concrete and asphalt layers. For a given set of parameters, one of the two analyses will govern and determine the required concrete thickness for the selected joint spacing.

Step 7. Compute the concrete stress ratio, SR, in Column 9 of **Table 6.6**, by dividing the total concrete stresses in Column 6 of **Table 6.5** by the design concrete modulus of rupture.

Step 8. Using the stress ratio and **Eq. 6.11** to **Eq. 6.13**, determine the allowable repetitions for the concrete layer in Column 10.

Step 9. Compute the percent fatigue in Column 11 by dividing Column 8 by Column 10 in **Table 6.6** multiplying by 100, and totaling the concrete fatigue damage for all axle loadings.

Step 10. Enter the maximum asphalt microstrain from Column 7 of **Table 6.6** into Column 12.

Step 11. Using the existing asphalt modulus of elasticity and the microstrains in Column 12 of **Table 6.6**, compute the allowable load repetitions for the asphalt layer from **Eq. 6.14** and enter these values into Column 13.

Step 12. The percent fatigue for the asphalt layer and the total asphalt fatigue damage is computed the same way as used for the concrete fatigue computation in Step 9 except there is the addition of the fatigue damage consumed prior to whitetopping construction. Sum the percent fatigue for the given load cases as well as the percentage previously consumed to compute the total asphalt fatigue damage at the bottom of Column 14 of **Table 6.6**.

In this case, both the concrete and asphalt fatigue analyses dictated the required whitetopping thickness. For the existing asphalt and subgrade conditions, a concrete whitetopping thickness of 4 in. with a joint spacing of 72 in. is determined to be sufficient to carry the anticipated traffic loading.

Table 6.5 Design Calculation Results

Axle Load, kips	Critical Concrete Stresses and Asphalt Strains					
	Loads Induced		Bond Adjustment		Loss of Support Adjustment	
	Stress, psi	Microstrain	Stress, psi	Microstrain	Stress, psi	Microstrain
1	2	3	4	5	6	7

Single Axles

$l_e = 24.41$

$L/l_e = 2.95$

22	287	372	434	333	484	333
20	261	305	394	273	440	273
18	235	305	355	273	396	273
16	209	271	315	242	352	242
14	183	237	276	212	308	212
12	157	203	237	181	264	181
10	131	169	197	151	220	151
8	104	135	158	121	176	121
6	78	102	118	90	132	90
4	52	68	79	60	88	60
2	26	34	39	30	44	30

Tandem Axles

44	258	326	389	292	434	292
40	234	267	353	239	394	239
36	211	267	318	239	355	239
32	187	237	283	212	315	212
28	164	208	247	186	276	186
24	140	178	212	159	237	159
20	117	148	177	132	197	132
16	94	119	141	106	158	106
12	70	89	106	79	118	79
8	47	59	71	52	79	52
4	23	30	35	26	39	26

Table 6.6 Design Calculation Results (Continued)

Axle Load, kips	Expected Repetitions	Concrete Fatigue Analysis			Asphalt Fatigue Analysis		
		Concrete Stress Ratio	Allowable Repetitions, N	Fatigue Percent, %	Asphalt Microstrain	Allowable Repetitions, N	Fatigue Percent, %
1	8	9	10	11	12	13	14

Single Axles Percent HMA Pavement Fatigue Life Previously Consumed: 25

22	200	0.744	563	35.6	333	302,460	0.1
20	600	0.677	3,691	16.3	273	586,315	0.1
18	2,500	0.609	24,222	10.3	273	586,315	0.4
16	5,000	0.541	160,469	3.1	242	864,831	0.6
14	7,500	0.474	3,863,057	0.2	212	1,343,938	0.6
12	25,000	0.406	unlimited	0.0	181	2,236,180	1.1
10	550,000	0.338	unlimited	0.0	151	4,085,411	13.5
8	875,000	0.271	unlimited	0.0	121	8,548,812	10.2
6	1,250,000	0.203	unlimited	0.0	90	22,182,962	5.6
4	1,750,000	0.135	unlimited	0.0	60	85,410,299	2.0
2	5,000,000	0.068	unlimited	0.0	30	871,988,534	0.6

Tandem Axles

44	5	0.667	4,770	0.1	292	467,008	0.0
40	50	0.607	25,771	0.2	239	905,507	0.0
36	500	0.546	139,508	0.4	239	905,507	0.1
32	1,500	0.485	1,698,113	0.1	212	1,335,870	0.1
28	5,000	0.425	unlimited	0.0	186	2,076,368	0.2
24	50,000	0.364	unlimited	0.0	159	3,455,854	1.4
20	75,000	0.303	unlimited	0.0	132	6,316,223	1.2
16	500,000	0.243	unlimited	0.0	106	13,224,754	3.8
12	750,000	0.182	unlimited	0.0	79	34,350,779	2.2
8	1,000,000	0.121	unlimited	0.0	52	132,526,818	0.8
4	1,250,000	0.061	unlimited	0.0	26	1,361,391,514	0.1
Total Concrete Fatigue, % = 66.2				Total Asphalt Fatigue, % = 69.7			

6.7.2 Bonding Condition

In the design of thin whitetopping overlays, the effects of any bonding between the PCC overlay and the underlying HMA layer is critical. The effects of layer interaction have been included in the thickness design calculations. A good bond within concrete/asphalt interface is essential for proper thin whitetopping performance.

6.7.3 Joint Spacing

Transverse joint spacing directly affects the magnitude of critical stresses in thin whitetopping. Depending on the pavement design, the climate, season, and time of the day, curling stresses in whitetopping can equal or exceed the load stresses. Joint spacing is, however, directly considered as an input in the CDOT design. It has been determined that in whitetopping design, minimal benefit is gained for doweled pavements when the panel size is 6 ft. x 6 ft. or less.

CDOT does not recommend dowels for transverse joints in whitetopping design, however, it recommends the use of tie bars in longitudinal joints. The 2004 equations are based on using tie bars in the longitudinal joints. The analysis was with all wheel loadings next to tied longitudinal joints. CDOT project design drawing D-412-2, Thin Whitetopping Typical Joint Layout provides for this requirement.

6.7.4 Example Project CDOT Thin Whitetopping Design

This example is a two-lane highway, designated State Highway 287 (SH 287) in Colorado. We will study cost for a typical project, 6 miles in length. The cross section has 2 lanes, each 12 ft. wide and a 10 ft. shoulder on each side. Thus, the pavement is 44 ft. wide and the total pavement area is 154,880 square yards. The existing pavement structure is 5.5 in. Hot Mix Asphalt after cold planing over 12 in. gravel base from the outside of one shoulder to the other shoulder. See **Figure 6.5 Sample TWT Project Location Map** for a map. The 2004 revised MS Excel worksheet is shown in **Figure 6.6 Input and Required Thickness Form for Thin Whitetopping Design** with the required whitetopping thickness.

CDOT 2004 Thin Whitetopping Design Procedure

Whitetopping Input Parameters

Highway Category (Primary or Secondary)*	Secondary
Joint Spacing, in.	72
Trial Concrete Thickness, in.	4.1
Concrete Flexural Strength, psi	650
Concrete Elastic Modulus, psi	4,000,000
Concrete Poisson's Ratio	0.15
Asphalt Thickness, in.	5.5
Asphalt Elastic Modulus, psi	350,000
Asphalt Poisson's Ratio	0.35
Asphalt Fatigue Life Previously Consumed, %	25
Subgrade Modulus, pci	200
Temperature Gradient, °F/in.	3
Design ESALs	245,544
Converted Concrete Thickness, in. =	5.24
ESAL Conversion Factor =	1.3072
Neutral Axis =	3.07
le =	27.36
L/le =	2.63

Critical Concrete Stresses and Asphalt Strains					
Load Induced		Bond Adjustment		Support Adjustment	
Stress, psi	μstrain	Stress, psi	μstrain	Stress, psi	μstrain
1	2	3	4	5	6
201	228	303	204	338	204

ESAL Fatigue Analysis						
No. of 18-kip ESALs	Concrete Fatigue Analysis			Asphalt Fatigue Analysis		
	Stress Ratio	Allowable ESALs	Fatigue, %	Asphalt μstrain	Allowable ESALs	Fatigue, %
7	8	9	10	11	12	13
3.2E+05	0.520	3.2E+05	99.9	204	1.5E+06	21.0

Concrete Fatigue, % = 99.9 Asphalt Fatigue, % = 46.0

Required Whitetopping Thickness = 4.25 in.

Figure 6.6 Input and Required Thickness Form for Thin Whitetopping Design

6.8 The AASHTO Method for Thickness Design

The design methodology for rigid pavements with design thickness equal or greater than 8 inches is similar to those found in Chapter 4.

6.8.1 Portland Cement Concrete Overlay Joints

Jointed Portland cement concrete overlays require special joint design that considers the characteristics of the underlying pavement. Factors to be considered include joint spacing, depth of saw cut, sealant reservoir shape and load transfer requirements. CDOT has developed a standard layout for concrete pavement joints. Refer to M & S Standard Plan No. M-412-1.

6.8.2 Rehabilitation Sample Problem

When appropriate, use the rigid 1998 Supplemental thickness design procedure for the future slab thickness. See **Figure 6.7 Input Form for Future Rigid Pavement Overlay Design Procedure**. Otherwise, use the DARWin™ method to calculate the future slab thickness. **Figure 6.8** thru **Figure 6.11** shows a DARWin™ form with typical input/output data for the conventional rigid pavement overlay thickness design of a rehabilitation sample problem.

Rigid Pavement Design - Based on AASHTO Supplemental Guide	
II. Design	
Serviceability	
Initial Serviceability, P1:	<input type="text" value="4.5"/>
Terminal Serviceability, P2:	<input type="text" value="2.5"/>
PCC Properties	
28-day Mean Modulus of Rupture, (S' _r):	<input type="text" value="650"/> psi
Elastic Modulus of Slab, E _s :	<input type="text" value="3,400,000"/> psi
Poisson's Ratio for Concrete, m:	<input type="text" value="0.15"/>
Table 14	Base Properties
Elastic Modulus of Base, E _b :	<input type="text" value="15,000"/> psi
Design Thickness of Base, H _b :	<input type="text" value="6.0"/> in
Slab-Base Friction Factor, f:	<input type="text" value="1.0"/>
Reliability and Standard Deviation	
Reliability Level (R):	<input type="text" value="95.0"/> %
Overall Standard Deviation, S _v :	<input type="text" value="0.34"/>
Table 15	Climatic Properties
Mean Annual Wind Speed, WIND:	<input type="text" value="9.0"/> mph
Mean Annual Air Temperature, TEMP:	<input type="text" value="50.0"/> °F
Mean Annual Precipitation, PRECIP:	<input type="text" value="15.0"/> in
Subgrade k-Value	
Calculate Seasonal k-Value	<input type="text" value="62"/> psi/in
Design ESALs	
Calculate Traffic	<input type="text" value="34.8"/> million
Pavement Type, Joint Spacing	
<input checked="" type="radio"/> JPCP	Joint Spacing: <input type="text" value="15.0"/> ft
<input type="radio"/> JRCP	
<input type="radio"/> CRCP	
Effective Joint Spacing: <input type="text" value="180"/> in	
Edge Support	
<input type="radio"/> Conventional 12-ft wide traffic lane	
<input checked="" type="radio"/> Conventional 12-ft wide traffic lane + tied PCC	
<input type="radio"/> 2-ft widened slab w/conventional 12-ft traffic lane	
Edge Support Factor: <input type="text" value="0.94"/>	
Sensitivity Analysis	
Slab Thickness used for Sensitivity Analysis:	<input type="text" value="11.97"/> in
<input type="radio"/> Modulus of Rupture	<input type="radio"/> Elastic Modulus (Slab)
<input type="radio"/> Elastic Modulus (Base)	<input checked="" type="radio"/> Base Thickness
<input type="radio"/> k-Value	<input type="radio"/> Joint Spacing
<input type="radio"/> Reliability	<input type="radio"/> Standard Deviation
Calculated Slab Thickness for Above Inputs: 11.97 in	
<input type="button" value="Calculate"/>	
<input type="button" value="Faulting Check"/>	

Figure 6.7 Input Form for Future Rigid Pavement Overlay Design Procedure

New DARWin Module

Module Name
Rigid Rehab. OK

Module Type
Flexible Structural Design
Rigid Structural Design
Overlay Design Cancel
Life Cycle Cost Analysis

Overlay Types
AC Overlay of AC Pavement
AC Overlay of Fractured PCC Slab
AC Overlay of PCC Pavement
AC Overlay of AC/PCC Pavement
Bonded PCC Overlay of PCC Pavement
Unbonded PCC Overlay of PCC or AC/PCC Pavement
PCC Overlay of AC Pavement

Figure 6.8 DARWin™ Selection of Rigid Pavement Overlay Design

Effective Thickness--Condition Survey Method ✖

Existing PCC Thickness in

Existing AC Thickness in

Milling Thickness in

Durability Adjustment Factor (Fdur)

Fatigue Damage Adjustment Factor (Ffat)

AC Quality Adjustment Factor (Fac)

No. of Unrepaired Deteriorated Joints per mi

No. of Unrepaired Deteriorated Cracks per mi

No. of Unrepaired Punchouts per mi

No. of Expansion Joints, Exceptionally Wide Joints or AC Full Depth Patches per mi

Calculated Results

Joints and Cracks Adjustment Factor

Effective Existing Pavement Thickness in

OK Cancel Clear

Figure 6.9 DARWin™ Input Form for Effective Thickness-Condition Survey Method

Figure 6.10 DARWin™ Input Form for Rigid Pavement Overlay Design

1993 AASHTO Pavement Design

DARWin Pavement Design and Analysis System

A Proprietary AASHTOWare
Computer Software Product
Colorado DOT

Overlay Design Module

Bonded PCC Overlay of PCC Pavement

Pavement Thickness for Future Traffic	11.97 in	
	<u>Effective Existing</u>	<u>Overlay</u>
<u>Design Method</u>	<u>Overlay Thickness (in)</u>	<u>Thickness (in)</u>
Condition Survey	7.48	4.49
Remaining Life	-	-

Effective Pavement Thickness - Condition Survey Method

Existing PCC Thickness	8 in	
Existing AC Thickness	- in	
AC Milling Thickness	- in	
Rut Depth	- in	
Durability Adjustment Factor	1	
Fatigue Damage Adjustment Factor	0.97	
AC Quality Adjustment Factor	-	
Number of Deteriorated Joints	4 per mi	
Number of Deteriorated Cracks	3 per mi	
Number of Unrepaired Punchouts	2 per mi	
Number of Expansion Joints,	-	
Exceptionally Wide Joints, or AC Full Depth Patches	3 per mi	

Calculated Results

Calculated Joints and Cracks Adjustment Factor	0.96	
Calculated Effective Pavement Thickness	7.48 in	

Figure 6.11 DARWin™ Printout of Results for Rigid Pavement Overlay Design

References

1. *AASHTO Guide for Design of Pavement Structures*, American Association of State Highway and Transportation Officials, Washington, DC, 1993.
2. *Supplement AASHTO Guide for Design of Pavement Structures, Part II, - Rigid Pavement Design & Rigid Pavement Joint Design*, American Association of State Highway and Transportation Officials, Washington, DC, 1998.
3. *Whitetopping - State of the Practice*, Publication EB210.02P, American Concrete Pavement Association, 5420 Old Orchard Road, Suite A100, Skokie, IL, 1998.
4. *Guidelines for the Thickness Design of Bonded Whitetopping Pavement in the State of Colorado*, CDOT-DTD-R-98-10, Final Report, Scott M. Tarr, Mathew J. Sheehan, and Paul A. Okamoto, Colorado Department of Transportation, 4201 E. Arkansas Ave., Denver, CO, 80222, December 1998.
5. *Instrumentation and Field Testing of Thin Whitetopping Pavement in Colorado and Revision of the Existing Colorado Thin Whitetopping Procedure*, CDOT-DTD-R-2004-12, Final Report, Matthew J. Sheehan, Scott M. Tarr, and Shiraz Tayabji, Colorado Department of Transportation, 4201 E. Arkansas Ave., Denver, CO, 80222, August 2004.
6. *Distress Identification Manual for the Long-Term Pavement Performance Program*, U.S. Department of Transportation, Federal Highway Administration, Publication No. FHWA-RD-03-031, June 2003.

CHAPTER 7

REHABILITATION OF PORTLAND CEMENT CONCRETE PAVEMENT

7.1 Introduction

Prior to 1976, Federal-Aid Interstate funds could be used only for the initial construction of the system. All other non-maintenance work on the Interstate System was funded with Federal-Aid Primary or State funds. The Federal-Aid Highway Act of 1976 established the Interstate 3R program, which placed emphasis on the use of Federal funds for Resurfacing, Rehabilitation, and Restoration. The Federal-Aid Highway Act of 1978 required that 20 percent of each State's primary, secondary, and urban Federal-Aid funds be spent on 3R projects. The Federal-Aid Highway Act of 1981 added the fourth R, Reconstruction, so that existing facilities could be eligible for Federal funding. The Intermodal Surface Transportation Efficiency Act of 1991 (ISTEA) reclassifies the four Federal-Aid systems (Interstate, Primary, Secondary and Urban) into two Federal-Aid systems: the National Highway System (NHS) and the Non-NHS. Although the Interstate System is a part of the NHS, it retains its own identity and will receive separate funding. Due to the passage of 1998 TEA-21, funding is not available for surface transportation improvements but Federal funds are available for matching State and local funds to construct 4R projects (6). The above legislation and funding is the driving force behind the restoration of pavements and specifically this chapter.

This chapter provides a framework and describes the information needed to create a cost effective rehabilitation strategies for Portland Cement Concrete Pavement (PCCP). Policy decision making that advocates applying the same standard fixes to every pavement does not produce successful pavement rehabilitation. Successful rehabilitation depends on decisions that are based on the specific condition and design of the individual pavement. Five basic types of detailed project information are necessary: design, construction, traffic, environmental, and pavement condition (1). Once the data is gathered, an evaluation is in order to determine the cause of the pavement distress. Finally, a choice needs to be made to select an engineered rehabilitation technique(s) that will correct the distresses.

7.2 Scope and Limitations

Pavement rehabilitation projects should substantially increase the service life of a significant length of roadway. The guidelines presented in this chapter will focus on restoration. The restoration presented refers to the pavement rehabilitation before an overlay or not needing one after the restoration. In this chapter, the words rehabilitation and restoration are pretty much interchangeable; one needs to understand the contents as presented. Resurfacing with an overlay is covered in **CHAPTER 5** and **CHAPTER 6** of this manual. **CHAPTER 5** is the design of flexible overlays. Most of the chapter deals with flexible overlays over flexible pavement. But, the same principles apply to flexible overlays over rigid pavements. **CHAPTER 6** mostly deals with rigid overlays over rigid pavement and the design of whitetopping. Reconstruction involves complete removal of the pavement structure. Reconstruction would be the using the same design procedures as in **CHAPTER 4 - PRINCIPLES OF DESIGN FOR RIGID PAVEMENT**.

Reconstruction techniques offer the choice of selecting virgin or recycled materials. Use of recycled material can often lower project costs (1)(3).

The pavement designer will encounter other definitions relating to rehabilitation. Both of these definitions will refer to functional and structural conditions. The intent is to show how encompassing rehabilitation is.

- AASHTO defines Preventive Maintenance (PM) as a "planned strategy of cost-effective treatments to an existing roadway system and its appurtenances that preserves the system, retards future deterioration, and maintains or improves the functional condition of the system (without substantially increasing structural capacity)" (8).
- The publication *Development of a Pavement Maintenance Program for the Colorado Department of Transportation, Final Report*, CDOT-DTD-R-2004-17, August 2004 suggests this definition for Preventive Maintenance (22).

“Preventive Maintenance: Work undertaken that preserves the existing pavement, retards future deterioration, and improves the functional life without substantially increasing the structural capacity.”

- An AASHTO sponsored working group defined Pavement Preservation as "the planned strategy of cost-effective pavement treatments to an existing roadway to extend the life or improve the serviceability of the pavement. It is a program strategy intended to maintain the functional or structural condition of the pavement. It is the strategy for individual pavements and for optimizing the performance of a pavement network" (8).

The above definitions stress the point that pavement maintenance and preservation are planned strategies and are to be cost-effective. The gathering of information, evaluation, and selections of treatments as outlined below are the same if the strategies were planned or not.

7.3 Colorado Documented Design Methods

By June 1952, 8 inches concrete pavement over 6 inches granular subbase was placed on the now northbound lanes only of Interstate 25 from Evans Avenue southward through a rural area to Castle Rock. In 1951 the grading project in preparation for the concrete pavement had a requirement of 90% AASHTO T-180 Modified Compaction on A-6 and A-7 soils with a swell that ranged from 4.3% to 9.9%. Shortly after the PCCP was placed, Colorado Department of Highways (CDOH) noticed cracking and warping of the slabs in certain areas. By the following summer, the cracking and rising of the slabs had become severe in these areas. The cracking increased throughout the project from October 1952 of 1,802 linear feet to 13,959 linear feet by September 1958. What followed in 1956/1957 was not a restoration of the existing concrete pavement, but constructing experiential sections investigating alternatives mitigating the swell potential on the new future southbound lanes. A number of design philosophies in place now are a result of these experiential sections. The final report was published in 1966 titled, *Pavement Study - Project I 092-2(4)* in cooperation with U.S. Bureau of Public Roads (16). The grading project for the experiential sections required 95% AASHTO T-99 Standard Compaction as much

on the wet side as feasible. Laboratory tests showed that the A-7-5(20) soils that swelled 9.9% at 90% Modified compaction swelled to only 2.8% at 95% Standard compaction. At this time, the Department felt that if the swell of the subgrade soils was less than 3%, four inches of subbase material plus eight inches of PCCP would provide sufficient surcharge to nullify the detrimental effect of this small amount of swell. Five test sections were constructed from late 1957 to spring of 1958.

- Section A - 1/2 mile of 8 inch concrete pavement encasing a light welded wire reinforcing fabric placed 2 inches below the concrete surface with a joint spacing of 61.5 feet, concrete pavement was placed over 4 inches sand subbase treated with 2% cement.
- Section B - 1/2 mile of 8-inch concrete pavement encasing a heavy welded wire reinforcing fabric with a joint spacing of 106.5 feet, concrete pavement placed over 4 inches of sand subbase treated with 2% cement.
- Section C, "Control Section" - one mile of 8-inch non-reinforced concrete pavement with a joint spacing of 20 feet, placed on 4 inches cement-treated base.
- Section D - 1/2 mile of 10-inch non-reinforced concrete pavement with a joint spacing of 20 feet, placed on 4 inches cement-treated base.
- Section E - 1/2 mile of 8-inch concrete pavement with a joint spacing of 20 feet, placed on 20 inches of cement-treated base.

1966 results showed that the Section C "Control Section" had less cracking per mile than any other section; Section B - 718 ft/mile, Section D - 502 ft/mile, Section A - 396 ft/mile, Section E - 384 f/mile, and Section C - 85 ft/mile. The tests sections would never be classified as severe when compared to the cracking of 1952-1957.

A number of important conclusions were presented. Remedial measures are necessary for high swelling soils as the 1966 report concluded. High swelling soils could be mitigated by applying moisture contents at or near optimum using standard 95% AASHTO T-99 Standard Compaction. If the subgrade soils had a swell less than 3% than no mitigation was necessary. DOH Memo #323, 1/5/66, (Construction) Swelling Soils was issued to address the depth of treatments in cuts sections. Refer to Chapter 2 of this Manual and Chapter 200 of the Field Materials Manual for additional information. Both manuals basically follow Memo #323. Current thinking is to use a moisture content of optimum plus 2%. Another important conclusion was not to use continuously reinforced concrete pavement. Two reasons were presented. First, was that joint maintenance as a whole, cost was about the same for all sections. Second, the extra cost of wire mesh reinforcement was not justified considering rideability. The difference between a present service index of 4.0 and one of 3.4 were both considered acceptable. A practical remedial rehabilitation is what the maintenance forces did and that was to place a thin overlay to improve the appearance and ride. Currently this is a viable option and probably the most often used treatment.

In 1983 the Colorado Department of Highways (now referred to as the Colorado Department of Transportation, CDOT) prepared a research report titled *Rehabilitation of Concrete Pavements*, Report No. CDOH-83-1 (9). In 1983, the Colorado Department of Highways conducted an in-depth evaluation of concrete pavements on the interstate system. The purpose of the evaluation was to determine the condition of the pavements and develop rehabilitation strategies for these

concrete pavements in anticipation of increased 4R funds from the Federal Government. The rehabilitation philosophy used in 1983 was to restore all of the concrete pavements to "Like New" condition with a 20-year design life. Design procedures presented at the end of the study were developed at that time which utilized thick concrete and thick asphalt as a means of achieving the 20-year design life. Nine types of distress were identified and thought to be the most frequently observed on interstate roadways in Colorado. The pavements ages ranged from 4 to 24 years with the average age being 18 years. The nine distresses were:

1. Reactive Aggregate
2. Longitudinal Cracking
3. Transverse Cracking
4. Rutting
5. Depression
6. Pumping
7. Spalling
8. Faulting
9. Corner Breaks

Reactive aggregates were found to be the most devastating in terms of cost and effective corrective methods. The study recommended fly ash to be use on a routine basis where reactive aggregates problems are known to exist. Currently fly ash is used in CDOT Class P concrete. Rutting was found to be the most prominent in the areas where studded tire traffic volume is higher. Currently the use of studded snow tires is waning; chemical de-icing products are taking their place such as magnesium chloride and potassium acetate. Pumping was observed only in areas with relatively poor drainage and untreated granular base materials. In these areas the first stage of distress was found to be pumping followed by corner breaks, faulting, and ultimately slab block cracking. Currently pumping and faulting have been reduced by the use of load transfer devices. Dowel bar diameter significantly affects faulting per Long-Term Pavement Performance (LTPP) Tech Brief *LTPP Data Analysis: Frequently Asked Questions About Joint Faulting With Answers From LTPP*, FHWA-RD-97-101 (11). Presently untreated granular bases are still being used and bases are not being specified with concrete pavement being placed on natural soils. As a reference, refer to AASHTO M155-87(2000) - Standard Specification for Granular Material to Control Pumping Under Concrete Pavement for aggregate base requirements. In other instances treated soils are being specified such as lime treated subgrade in swelling soil conditions. Spalling at the joints was observed under two types of conditions. Plastic parting strip ribbons created spalling and where joint filler material was not replaced. Currently plastic parting strips have been eliminated and the standard for joint saw cutting has been revised using only a narrow single cut instead of two saw cuts with a wider top cut. Longitudinal cracking is still prominent. One apparent reason is the slab widths are too wide for the design thickness and serious construction problems create longitudinal cracking, *Structural Factors of Jointed Plain Concrete Pavements: SPS-2 -- Initial Evaluation and Analysis*, FHWA-RD-01-167. CDOT published a research report *Evaluation of Premature PCCP Longitudinal Cracking in Colorado*, Final Report, Report No. CDOT-DTD-R-2003-1, concluding swelling soils, shallow saw cut depth, and malfunctioning or improperly adjusted paver vibrators that created vibrator trails produces the longitudinal cracking (13). The 14-foot wide slabs on rural interstates did not contribute to the cracking. A regional investigation is looking at the ends of

the tie-bars where voids may be, where a longitudinal crack appeared. Other possible reasons may be wheel loadings applied before the concrete cures or thermal flash could create the crack.

Other conclusions were presented in the Report No. CDOH-83-1, 1983. First, rutting of low severity accounted for most of the distressed mileage. Second, reactive aggregates and faulting were most frequently occurring as high severity. Thirdly, medium severity of longitudinal cracking was observed.

The standard concrete pavement joint detail before 1983 required skewed and variable 13-19-18-12 transverse joint spacing and older standards of skewed or non-skewed equal 15 or 20-foot spacings depending on aggregate size. The transverse joints were not doweled except for first 3 joints after expansion joint. The saw depth was T/4 or older standards of 2 inches minimum. The longitudinal joints had tie-bars at 30 inch centers and size No. 4 for 8 inch thick pavement and No. 5 for thickness greater than 8 inches or older standards of No. 4 at 36 inch spacings. Most of the interstate pavement at that time was 8 inches thick. The design procedure was to obtain design traffic, soil support, concrete strength, and an applied load safety factor. The load safety factor was directly related to high predicted truck traffic.

In 1988, the report titled *Rehabilitation of Concrete Pavements Follow-Up Study*, Report No. CDOH-88-8 was released (10). The Colorado Department of Highways had been working under the guidelines of the previous study for 5 years. The intent was to review the effectiveness and suitability of the concepts developed in 1983. In 1983, approximately 81 miles of concrete were rated in the poor category. Over the period from 1983 to 1988 nearly 64 miles of concrete roadway were rehabilitated; however, the 1988 survey determined that approximately 98 miles of pavement were in the poor category. The rehabilitation philosophy used in 1983 to restore all of the concrete pavements to "Like New" condition with a 20-year design life was modified under this study. With the issuance of the *1986 AASHTO Design Guide*, FHWA allowed the states to use a design life as low as 8 years for rehabilitation. A section of roadway can now be analyzed using both an 8-year and 20-year design life to optimize the expenditure of resources to achieve acceptable levels of service. Examples of the new design procedures were included in the report. A rehabilitation plan was provided for a 10-year effort. Highlights were to start rehabilitating the worst sections first, use the 8 year design concept wherever it was possible and concentrating on sections having the highest levels of traffic. The focus of the study was to bring forth the rehabilitation by overlay design and not repair the nine distresses individually by restoration techniques.

Following the first report above, the need to showcase the latest state-of-the-art Concrete Pavement Restoration (CPR), a seminar and demonstration project was organized (Demonstration Project No. 69). It was a cooperative effort between CDOH, ACPA and FHWA. It was held a day after the AASHTO meeting on October 5, 1983 with approximately 200 state and highway officials and engineers along with industry representatives in attendance. The results of the seminar and notes in the construction of the demonstration were reported in *Evaluation of Concrete Pavement Restoration Procedures and Techniques*, Initial Report, Report No. CDOH-DTP-R-84-5 (14). The demonstration showcased the techniques of full depth repair, partial depth repair, undersealing, grinding, installing load transfer devices, joint sealing and crack sealing. The site was on eastbound Interstate 70 between Chambers Road and Tower

Road. The pavement was 19 years old, 8 inches of concrete pavement over 6 inches of base course surfacing, 20 foot joint spacing, skewed, with tie bars in the centerline longitudinal joint, no load transfer devices or steel in the transverse joints and with asphalt shoulders. *Concrete Pavement Restoration Demonstration*, Final Report, Report No. CDOH-DTD-R-88-6 (15) reports the subsequent evaluations for a period of three years after construction repair. Generally, most of the restoration techniques did not perform well in this demonstration project.

- Full-Depth Repair - 8 out of 13 replacement slabs cracked.
- Partial-Depth Repair - All 6 patches showed distress or have failed.
- Undersealing - Inconsistent data in slab deflections of grouted and non-grouted slabs and how well uniform support was obtained.
- Faulting and Grinding - Typically slabs faulted a third of unground sections.
- Load Transfer Device - Obsolete device worked well especially in conjunction with undersealing.
- Joint Sealing - 12 different types of joint sealer were applied, some worked some failed.
- Crack Sealing - Routed and sealed with same sealants used above, overall was not very successful, continued to crack and spall.

The Pavement Design Manual generally uses the 1993 edition of the American Association of State Highway and Transportation Officials (AASHTO) *Guide for Design of Pavement Structures* and the 1998 *Supplement AASHTO Guide for Design of Pavement Structures, Part II, - Rigid Pavement Design & Rigid Pavement Joint Design* (18). In anticipation for the new AASHTO guidelines for mechanistic-empirical design method a hierarchical design of inputs are hereby presented to ease the entry into the new design method. One must use the software to analyze the pavement damage. The pavement thickness is an input value. The software allows the mixing of input levels. It is important to realize that no matter what input design levels are used, the computational algorithm for damage is exactly the same. There are 3 levels of inputs (17).

Level 1 inputs provide for the highest level of accuracy and, thus, would have the lowest level of uncertainty or error. This level would be used for designing heavily trafficked pavements or wherever there is dire safety or economic consequences of early failure. The traffic data includes counting and classifying the number of trucks, along with the breakdown by lane and direction, and measuring the axle loads for each truck class (site specific axle load spectra data collections). Material data requires laboratory, field testing and non-destructive deflection testing. Level 1 inputs extensively use the back calculations of Falling Weight Deflectometer (FWD) deflections where the existing intact concrete slab is considered the base and the deflections are also used to obtain the modulus of subgrade reaction.

Level 2 inputs provide an intermediate level of accuracy and would be closest to the typical procedures used with earlier editions of the AASHTO Guides. Traffic data account for any weekday/weekend volume variation, significant seasonal trends, and vehicle weights taken from regional weight summaries used to differentiate routes with heavy versus light weights. Material data could possibly come from a database, limited testing program or estimated through correlations.

Level 3 inputs provide the lowest level of accuracy. Traffic data would be available from Average Annual Daily Traffic (AADT) counts with percent trucks, simple truck volume counts or lack of load knowledge and based on a regional or statewide average load distribution. Material data would be using typical averages for the region or default values.

The pre-overlay design methods and techniques suggested in this Chapter are based on these reports as well as *Factors for Pavement Rehabilitation Strategy Selection* by American Concrete Pavement Association (ACPA) (1). The following sections are based on the ACPA publications.

7.4 Project Information

Obtaining specific project information is the first step in the process of rehabilitation. Five basic types of detailed project information are necessary before an evaluation can be made:

- Design Data - data includes the pavement type and thickness. The components of the pavement are layer materials, layer strengths, joint design, shoulder design, drainage system and previous repair or maintenance.
- Construction Data - if possible obtain original construction conditions. Field books, daily logs and weather conditions are helpful. Concrete mix designs would show aggregate size and additives that may influence the existing concrete conditions.
- Traffic Data - strategy selection requires past, current and expected traffic growth. This helps determine the remaining effective structural capacity of the existing pavement. Section 1.5 Traffic Projections in Chapter 1 outlines the methods and procedures to calculate traffic loads.
- Environmental Data - important factors are temperature, precipitation, and freeze-thaw conditions. These factors influence material integrity, structural capacity, and rideability.

Distress and/or Condition Data - a distress survey should report the type, severity and quantity of each distress. A detailed concrete pavement distress/condition survey is required before a rehabilitation project can be evaluated and designed. The types of distress in concrete pavements have to be identified and documented prior to the selection of corrective measures. The cause of distresses is not always easily identified and may consist of a combination of problems. The following types of distress are common to deteriorating concrete pavements: excessive deflection, differential deflection at joints, moisture related distress at cracks and joints, cracking due to reactive aggregate, longitudinal and transverse cracking, spalling, faulting, pumping, rutting, and movement of slabs due to swelling soils. The condition survey should identify and document the types, location, and amount of distress encountered in the design selected for rehabilitation. Photographs are a good way to document many of the distresses mentioned above. Figure 6.1 Pavement Condition Evaluation Checklist (Rigid) should be used and placed in the pavement design report. To help determine the type of distress the pavement is exhibiting refer to FHWA *Distress Identification Manual* (4). This manual may be downloaded in pdf format by going to web page <http://www.tfrc.gov/pavement/ltpa/resource.htm>. CDOT has a distress manual documenting pavement distress, description, severity levels and additional notes

(22). The distress manual is presented in Appendix B - Colorado DOT Distress Manual for HMA and PCC Pavements in the publication *Development of a Pavement Maintenance Program for the Colorado Department of Transportation*, Final Report, CDOT-DTD-R-2004-17, August 2004. The report is in pdf format and can be downloaded from the web page <http://www.dot.state.co.us/publications/PDFFiles/preventivemaintenance.pdf>. In order to determine the pavement distress and condition a field inspection is mandatory. Isolating areas of distress can pinpoint different solutions for different sections along a project. Non-destructive testing (NDT) and destructive testing (i.e. coring and boring) can determine the structural condition and material properties below the surface.

7.5 Pavement Evaluation

The second step is to analyze and evaluate the gathered project information. Pavement evaluation requires a systematic approach to quantify adequately and analyze the many variables that influence the selection of the appropriate rehabilitation technique. More engineering effort may be required for pavement rehabilitation than for new construction because of the additional elements of evaluating the existing pavement. An engineering evaluation must address several key issues such as functional and structural condition, materials condition, drainage conditions, and lane condition uniformity (1)(5)(6).

7.5.1 Functional and Structural Condition

CDOT Pavement Management System triggers the need for rehabilitation work on automated visual surface distresses in a single lane. The distresses are rated and weighted in an index equation. The equation is weighted heavily to ride, then rut and then cracking. That index equation is then converted into remaining service life (RSL). Lost in the RSL values is the distinction between functional and structural distress. Be careful on just relying on the rating obtained from pavement management. As of this date the observed surface distresses are limited to a few of the major pavement distresses. Pavement management will not pick up on Alkali Silica Reactivity (ASR) until into the severe stage, showing up as surface cracking. Knowing that ASR exists may influence the restoration technique the designer may select. Each distress condition will have its own set of repair techniques. The project pavement design engineer must determine if the pavement condition is in a functional or structural distress.

7.5.1.1 Structural Condition

Structural deterioration is any condition that reduces the load carrying capacity of a pavement (6)(7). Corner breaks, pumping, faulted joints and shattered slabs are some examples of structural related distresses. Evaluating the level of structural capacity requires thorough visual survey and materials testing (7). Non-destructive testing is important to characterize both pavement stiffness and subgrade support. Restoration is applicable only for pavements with substantial remaining structural capacity. Pavements that have lost much of their structural capacity require either a thick overlay or reconstruction. To help assess the current structural adequacy of Jointed Plain Concrete Pavement (JPCP), the extent and severity distresses can be compared with value ranges provided in **Table 7.1 Structural Adequacy for JPCP**.

Table 7.1 Structural Adequacy for JPCP
(Extracted from March 2004, Guide for Mechanistic-Empirical Design,
Part 2 Design Inputs, Table 2.5.15, pg. 2.5.61 (17))

Load-Related Distress	Highway Classification	Current Distress Level		
		Inadequate	Marginal	Adequate
Deteriorated Cracked Slabs (medium and high severity transverse and longitudinal cracks and corner breaks), % slabs	Interstate/Freeway	>10	5 to 10	<5
	Primary	>15	8 to 15	<8
	Secondary	>20	10 to 20	<10
Mean Transverse Joint/Crack Faulting, inches	Interstate/Freeway	> 0.15	0.1 to 0.15	< 0.1
	Primary	>0.20	0.125 to 0.20	< 0.125
	Secondary	> 0.3	0.15 to 0.3	< 0.15

7.5.1.2 Functional Condition

Functional deterioration is defined as a condition that adversely affects the highway user. Functional distresses include problems which influence the ride quality, but are not necessarily signs of reduced structural capacity. These may include poor surface friction and texture, hydroplaning and splash from wheel path rutting, and excess surface distortion. Cracking and faulting affect ride quality but are not classified under functional distress. These conditions reduce load carrying capacity as stated above. The integrity of the base, concrete slab and joint system is compromised under cracking and faulting. To help assess the current functional adequacy of Jointed Plain Concrete Pavement (JPCP), International Roughness Index (IRI) is compared with value ranges provided in **Table 7.2 Functional Adequacy for JPCP**.

Table 7.2 Functional Adequacy for JPCP
(Extracted from March 2004, Guide for Mechanistic-Empirical Design,
Part 2 Design Inputs, Table 2.5.19, pg. 2.5.65 (17))

Pavement Type	Highway Classification	IRI (in/mile) Level		
		Inadequate (Not smooth)	Marginal (Moderately Smooth)	Adequate (Smooth)
Rigid (JPCP) and Flexible	Interstate/Freeway	>175	100 to 175	<100
	Primary	>200	110 to 200	<110
	Secondary	>250	125 to 250	<125

7.5.1.3 Problem Classifications between Structural and Functional Condition

How would the pavement designer classify lane separation? It could be classified under a functional condition if the lane separation (longitudinal joint width) becomes too excessive where the handling of a motorcycle becomes dangerous would adversely affect the highway user.

It becomes a structural condition when the lane separation starts to manifest itself when water infiltrates the base by cross slope sheet flow during rain storms. Also edge wheel loading next to the lane separation will eventually accumulate stress damage and finally over-stress the allowable limit. Even though no cracked slabs are present at the time of the investigation it will eventually be classified as a structural condition. The pavement designer could then say the integrity of the base, slab and joint system is compromised.

7.5.2 Material Condition and Properties

An evaluation of material condition should not be done using assumed conditions or unknown material strengths. These factors are measurable from actual response to non-destructive and destructive testing methods.

7.5.2.1 Non-destructive Testing

Non-destructive testing may use three methods of testing to determine structural adequacy (17).

- Deflection testing - to determine high deflections, layer moduli, and joint load transfer efficiencies.
- Profile testing - to determine joint/crack faulting.
- Ground Penetrating Radar - to determine layer thickness.

The data obtained from these methods would be a Level 1. The data would be project site-specific. Deflection testing results are used to determine the following:

- Concrete elastic modulus and subgrade modulus of reaction (center of slab).
- Load transfer across joints/cracks (across transverse joints/cracks in wheelpath).
- Void detection (at corners).
- Structural adequacy (at non-distressed locations).

In addition to backcalculation of pavement layer and subgrade properties and void detection, deflection testing can also be used to evaluate the load transfer efficiency (LTE) of joints and cracks in rigid pavements (18). *Evaluation of Joint and Crack Load Transfer*, Final Report, FHWA-RD-02-088 (19) is a study presenting the first systematic analysis of the deflection data under the LTPP program related to LTE.

$$LTE = \frac{\delta_u}{\delta_l} \times 100 \qquad \text{Eq. 7.1}$$

Where:

LTE = load transfer efficiency, percent

δ_u = deflection on unloaded side of joint or crack measured 6 inches from the joint/crack

δ_l = deflection on loaded side of joint or crack measured beneath the load plate the center of which is placed 6 inches from the joint/crack

Visual distresses present at the joint or crack should be recorded and quantified. Joint (and crack) distress information is useful in analyzing and filtering the results obtained from the LTE calculation. The load transfer rating as related to the load transfer efficiency is shown in **Table 7.3 Load Transfer Efficiency Quality**.

Table 7.3 Load Transfer Efficiency Quality
(From March 2004, Guide for Mechanistic-Empirical Design,
Part 2 Design Inputs, Table 2.5.9, pg. 2.5.49 (17))

Load Transfer Rating	Load Transfer Efficiency (percent)
Excellent	90 to 100
Good	75 to 89
Fair	50 to 74
Poor	25 to 49
Very Poor	0 to 24

Crack LTE is critical measure of pavement condition because it is an indicator of whether the existing cracks will deteriorate further. LTE tests are usually performed in the outer wheelpath of the outside lane. For JPCP, cracks are held together by aggregate interlock, joints designed with load transfer devices have steel and aggregate interlock. In general, cracks with a good load transfer (LTE greater than 75%) hold together quite well and do not significantly contribute to pavement deterioration. Cracks with poor load transfer (LTE less than 50%) are working cracks and can be expected to deteriorate to medium and high severity levels and will exhibit faulting over time. These cracks are candidates for rehabilitation.

7.5.2.2 Destructive Testing

Experience has shown that non-destructive testing techniques alone may not always provide a reasonable or accurate characterization of the in-situ properties, particularly for those of the top pavement layer (17). The determination of pavement layer type cannot be made through non-destructive testing. While historic information may be available, the extreme importance and sensitivity calls for a limited amount of coring at randomly selected locations to be used to verify the historic information. Pavement coring, base and subbase thicknesses and samples are recommended to be collected at an approximate frequency of one sample per one-half mile of roadway. Several major parameters are needed in the data collection process. They are as follows:

- Layer thickness.
- Layer material type.
- Examination of cores to observe general condition and material durability.
- In-situ material properties (e.g., modulus and strength).

Concrete slab durability may have a possible condition of severe "D" cracking and reactive aggregate. Petrographic analysis helps identify the severity of the concrete distresses when their cause is not obvious. Material durability problems are the result of adverse chemical or physical

interactions between a paving material and the environment (17). The field condition survey and examination of cores for material durability reinforce each other. See **Table 7.4 Distress Levels for Durability of JPCP**. Listed are durability problems and causes.

D-cracking - the fracture of layer aggregates particles, and subsequently the PCC mortar, as a result of water freezing (and expanding) in the pores of moisture-susceptible course aggregate.

- Freeze-thaw damage - spalling and scaling in freeze-thaw climates due to inadequate entrained air voids. The lack of entrained air restricts the internal expansion of water in concrete during periods of freezing and thawing.
- Alkali-Silica reactivity - map cracking and joint deterioration resulting from the reaction of high silica or high carbonate aggregates and alkalis (sodium and potassium) in portland cement. The reaction produces a gel that absorbs water and swells, thus fracturing the cement matrix.
- Steel corrosion - pavements located in regions where de-icing salts are used.
- Treated base/subbase disintegration - stripping of asphalt cement by water in asphalt-treated materials, or the disintegration of cement-treated materials due to freeze thaw cycles.
- Unbound base/subbase contamination by fines from subgrade.

Table 7.4 Distress Levels for Durability of JPCP
(From March 2004, Guide for Mechanistic-Empirical Design,
Part 2 Design Inputs, Table 2.5.22, pg. 2.5.70 (17))

Load-Related Distress	Highway Classification	Current Distress Level		
		Inadequate	Marginal	Adequate
Patch Deterioration (medium and high severity), % surface area	Interstate/Freeway	>10	5 to 10	<5
	Primary	>15	8 to 15	<8
	Secondary	>20	10 to 20	<10
D-cracking and ASR	All	Predominantly medium and high severity	Predominantly low and medium severity	None or predominantly low severity
Longitudinal Joint Spall (medium and high severity), % length	Interstate/Freeway	>50	20 to 50	<20
	Primary	>60	25 to 60	<25
	Secondary	>75	30 to 75	<30
Transverse Joint Spalling (medium and high severity), joints /mile	Interstate/Freeway	>50	20 to 50	<20
	Primary	>60	25 to 60	<25
	Secondary	>75	30 to 75	<30
Stripping (treated base/subbase)	All	Unable to recover majority of cores due to disintegration or stripping	Unable to recover some cores due to disintegration or stripping	Cores are predominantly intact
Unbound granular base contamination	All	Contamination of unbound granular base/subbase with fines from subgrade		

For rigid pavements, one of the more significant properties influencing performance is the flexural strength (modulus of rupture) of the concrete. General correlations between splitting tensile strength and flexural strength may be used as a source of input since cores can be obtained from the pavement.

Three correlation formulas may be used. The reports cannot be found but the formulas were kept. All are straight line relationships.

1971, Deville

$$\text{Flexural Strength} = 190 + 0.097 \times \text{Compressive Strength}$$

Eq. 7.2

1979, Mirza

$$\text{Flexural Strength} = 247 + 0.068 \times \text{Compressive Strength}$$

Eq. 7.3

1996, Lollar - using CDOT Region 1 data for masters degree
Flexural Strength = $217 + 0.075 \times \text{Compressive Strength}$, $r^2 = 0.45$

Eq. 7.4

There are many papers, articles, and opinions on the correlation between the different strength test types, and ACPA does not recommend any one test in particular. The listed national correlations are from ACPA website (20) <http://www.pavement.com/PavTech/Tech/FATQ/fatq-strengthtests.html>. See **Table 7.5 Strength Correlation Formulas**.

Table 7.5 Strength Correlation Formulas

Source/Author	Equation in psi (pounds per square inch)
ACI Journal / Raphael, J.M.	MR = 2.3 * [Fc ^ (2/3)]
	Fst = 1.7 * [Fc ^ (2/3)]
ACI Code	MR = 7.5 * [Fc ^ (0.5)]
	Fst = 6.7 * [Fc ^ (0.5)]
Center for Transportation Research / Fowler, D.W.	Fst = 0.72 x MR
Center for Transportation Research / Carrasquillo, R.	MR (3rd Point) = 0.86 x MR (Center Point)
Greer	MR = 21 + 1.254 Fst
	MR = 1.296 Fst
	MR = Fst + 150
Hammit	MR = 1.02 Fst + 210.5
Narrow & Ulbrig	MR = Fst + 250
Grieb & Werner	Fst = 5/8 MR (river gravel)
	Fst = 2/3 MR (crushed limestone)

NOTE: When High-Performance Concrete (HPC) is used, the above relationships will not necessarily hold true. The HPC mixes with very low w/c ratios tend to be more brittle and show different behaviors.

Where:

Fst = Splitting Tensile Strength

Fc = Compressive Strength

MR (Modulus of Rupture) = Flexural Strength, third-point loading (unless otherwise noted)

In-situ material properties of bases, subbases and soils may be obtained using the Dynamic Cone Penetrometer (DCP). It is typically used to measure soil strength. The proposed mechanistic-empirical design guide software allows users to input DCP test results directly or indirectly depending on the models of choice. The pavement design engineer uses the above material properties to obtain a resilient modulus of each layer. The field and laboratory testing would have a hierarchical level 2 for inputs in the mechanistic-empirical design method. Level 3 would use similar values but were obtained through regional or typical default values.

7.5.3 Drainage Condition

Condition of drainage structures and systems such as ditches, longitudinal edge drains, transverse drains, joint and crack sealant, culverts, storm drains, inlets and curb and gutters are all important to convey water away from the pavement structure. Visual distress will reveal the types and extents of distresses present in the pavement that are either caused by or accelerated by moisture. Drainage assessment can also be benefited by data obtained from coring and material testing. The permeability and effective porosity of base/subbase materials, as determined through laboratory tests or calculated from gradations, can be used to quantify drainability (17). See **Table 7.6 Distress Levels for Assessing Drainage Adequacy of JPCP**.

Table 7.6 Distress Levels for Assessing Drainage Adequacy of JPCP
(From March 2004, Guide for Mechanistic-Empirical Design,
Part 2 Design Inputs, Table 2.5.20, pg. 2.5.67 (17))

Load-Related Distress	Highway Classification	Current Distress Level		
		Inadequate	Marginal	Adequate
Pumping (all severities), % joints	Interstate/Freeway	>25	10 to 25	<10
	Primary	>30	15 to 30	<15
	Secondary	>40	20 to 40	<20
Mean Transverse Joint/Crack Faulting, inches	Interstate/Freeway	>0.15	0.1 to 0.15	<0.1
	Primary	>0.20	0.125 to 0.20	<0.125
	Secondary	>0.3	0.15 to 0.3	<0.15
Durability (All severity levels of D-cracking and reactive aggregate)	All	Predominantly medium and high severity	Predominantly low and medium severity	None or predominantly low severity
Corner Breaks (all severities), number/mile	Interstate/Freeway	>25	10 to 25	<10
	Primary	>30	15 to 30	<15
	Secondary	>40	20 to 40	<20

7.5.4 Lane Condition Uniformity

On many four lane roadways, the outer truck lane deteriorates at more rapid pace than the inner lane of shoulders. The actual distribution of truck traffic across lanes varies with the roadway type, roadway location (urban or rural), the number of lanes in each direction, and the traffic volume. Because of these many factors, it is suggested that lane distribution be measured for the project under consideration (6). Obtaining the actual truck lane distributions will determine the actual remaining life of the lane under consideration. Significant savings may result by repairing only the pavement lane that requires treatment.

7.6 Pavement Rehabilitation Techniques

Rehabilitation or restoration techniques are methods to preserve the integrity of the concrete pavement system or to bring the pavement system up to an acceptable level for future performance. Concrete pavement restoration (CPR) is a series of engineered techniques to manage the rate of pavement deterioration in concrete roadways. Ideally, CPR is the first rehabilitation procedure applied to the concrete pavement. CPR is a non-overlay option used to repair isolated areas of distress, or to prevent or slow overall deterioration, as well as to reduce the impact loadings on the concrete pavement without changing its grade (21). If the pavement needs more load carrying capacity or has deteriorated to poorer conditions, other procedures, such as bonded concrete overlay, unbonded concrete overlay, or asphalt overlay may be applied in conjunction with the restoration. Pavement rehabilitation work shall not include normal periodic maintenance activities (2). Cleaning of cross culverts, inlets and underdrain outlets would be considered normal periodic maintenance activities. CPR may be a maintenance activity or contract work by maintenance purchase order or contract low bid. Either way the work performed is identical. A report was published in August 2004 to assist staff maintenance in developing a pavement maintenance program. Refer to Appendix A - Preventive Maintenance Program Guidelines in the publication *Development of a Pavement Maintenance Program for the Colorado Department of Transportation*, Final Report, CDOT-DTD-R-2004-17, August 2004 (22). The report is in pdf format and can be downloaded from the web page <http://www.dot.state.co.us/publications/PDFFiles/preventivemaintenance.pdf>. Specific maintenance treatments were documented. These same concrete pavement treatments are described in this chapter. See **Figure 7.1 CPR Sequencing**.

- Diamond Grinding
- Concrete Crack Sealing
- Concrete Joint Resealing
- Partial Depth Repair
- Full Depth Concrete Pavement Repair
- Dowel Bar Retrofit

Two additional treatments will also be described.

- Cross Stitching
- Slab Stabilization

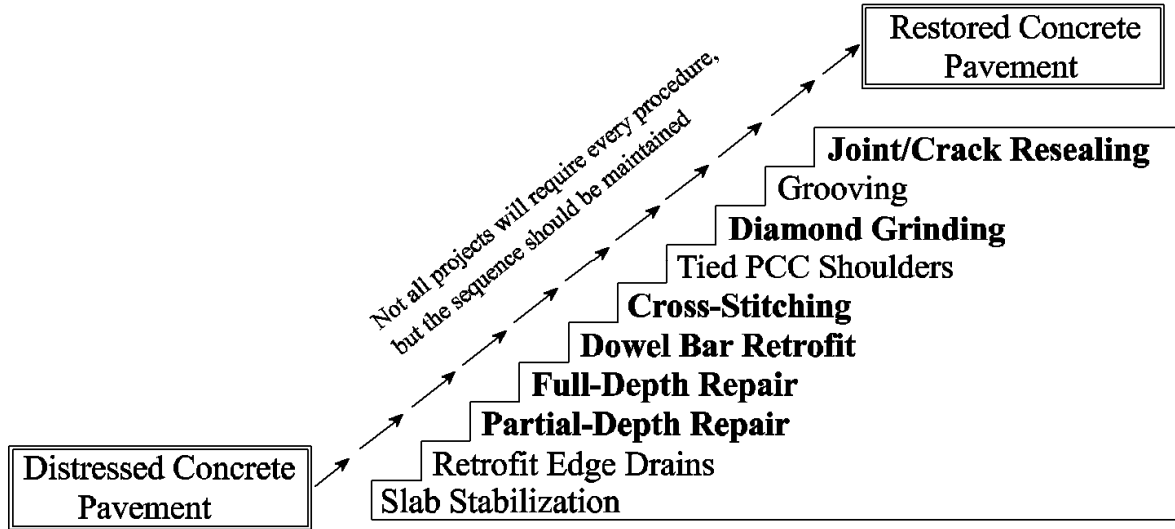

Figure 7.1 CPR Sequencing
Recommended Sequence of Restoration Activities (ACPA 2006)

7.6.1 Diamond Grinding

Diamond grinding and grooving are used to restore the surface of the PCCP. Diamond grinding is the removal of a thin layer of concrete generally about 0.25 inches (6 mm) from the surface of the pavement (36). Diamond grinding utilizes closely spaced diamond saw blades and corrects surface irregularities, such as cracking, rutting, warping, polishing, and joint faulting. Diamond grooving is the establishment of discrete grooves in the concrete pavement using diamond saw blades. The grooving is to break up the flow of water across the surface. Grooving may be performed longitudinally or transversely (36). CDOT's standard is to groove longitudinally. Grooving places the diamond blades 3/4 inch apart and is used to prevent hydroplaning on wet pavements. Grinding and grooving operations produce a slurry consisting of ground concrete and water. Local environmental regulations should be consulted to determine acceptable disposal solutions. After the diamond grinding or grooving, all concrete joints and major cracks must be resealed.

Tining is a term CDOT uses to describe the grooving of plastic concrete pavement. Refer to Subsection 412.12(d) Tining and Stationing of CDOT Standard Specification for Road and Bridge Construction, 2005 of tining dimensions. Also, refer to Section 4.16 Concrete Pavement Tining, Stationing, and Rumble Strips in CHAPTER 4.

Cold milling may be done on PCCP, although it is more commonly used on asphalt pavements. Cold milling uses carbide tips to chip off the distressed surface. Cold milling can cause damage to transverse and longitudinal joints. Figure 3 in the publication *Diamond Grinding and Concrete Pavement Restoration* by ACPA (23) shows photographs of the difference between a diamond ground surface and a milled surface. Unless surface unevenness, aggregate fracturing, and joint spalling are tolerable, cold milling should not be allowed as a final surface.

When to use diamond grinding:

- Faulting at joints and cracks - Removal of roughness caused by excessive faulting has been the most common need for surface restoration. Trigger values indicate when a highway agency should consider diamond grinding and CPR to restore rideability. See **Table 7.7 Trigger Values for Diamond Grinding**. Limit values for diamond grinding define the point when the pavement has deteriorated so much that it is no longer cost effective to grind. See **Table 7.8 Limit Values for Diamond Grinding**. The two tables below show when it is appropriate and how much to diamond grind. The two tables are presented in FHWA technical report titled *Concrete Pavement Rehabilitation Guide for Diamond Grinding*, dated June 2001 (29). The report can be found on website
- <http://www.fhwa.dot.gov/pavement/concrete/diamond.cfm>.
- Smoothing out rehabilitation roughness - Partial-depth and full-depth repairs created differences in elevation between the repair and existing pavement. Diamond grinding smoothes out the repair.
- Wheelpath rutting - Diamond grinding removes wheelpath ruts caused by studded tires, improves drainage in wet weather by eliminating pooling of water, and reduces the possibility of hydroplaning.
- Reestablish macrotexture - Restores a polished surface to provide increased skid resistance, improves cornering friction numbers, and provides directional stability by tire tread-pavement-groove interlock.
- Reduce noise level - Retextures worn and tined surfaces with a longitudinal texture and provides a quieter ride. Also removes the faults by leveling the surface, thus eliminating the thumping and slapping sound created by the faulted joints.
- Removes slab warping and curling - Long joint spacing and stiff base support may result in curled slabs that are higher at the joints than at mid-panel. Warped slabs are higher at the mid-panel. Diamond grinding smoothes out the curled and warped slabs.
- Minor cross slope changes - Minor cross slope changes helps transverse drainage and reduces the potential for hydroplaning.
- Pre-overlay treatment - Creates a smooth base surface for thin micro-surfacing overlays.

Table 7.7 Trigger Values for Diamond Grinding

(From Table 1 Trigger Values for Diamond Grinding, Concrete Pavement Rehabilitation - Guide for Diamond Grinding June 2001 (29))

Traffic Volumes*	JPCP			JRCP			CRCP		
	High	Med	Low	High	Med	Low	High	Med	Low
Faulting mm-avg (inches avg)	2.0 (0.08)	2.0 (0.08)	2.0 (0.08)	4.0 (0.16)	4.0 (0.16)	4.0 (0.16)	N.A.		
Skid Resistance	Minimum Local Acceptable Levels								
PSR	3.8	3.6	3.4	3.8	3.6	3.4	3.8	3.6	3.4
IRI m/km (in/mi)	1.0 (63)	1.2 (76)	1.4 (90)	1.0 (63)	1.2 (76)	1.4 (90)	1.0 (63)	1.2 (76)	1.4 (90)

*Volumes: High ADT>10,000; Med 3000<ADT<10,000; Low ADT <3,000

Table 7.8 Limit Values for Diamond Grinding

(From Table 2 Limit Values for Diamond Grinding, Concrete Pavement Rehabilitation - Guide for Diamond Grinding June 2001 (29))

Traffic Volumes*	JPCP			JRCP			CRCP		
	High	Med	Low	High	Med	Low	High	Med	Low
Faulting mm-avg (inches avg)	9.0 (0.35)	12.0 (0.5)	15.0 (0.6)	9.0 (0.35)	12.0 (0.5)	15.0 (0.6)	N.A.		
Skid Resistance	Minimum Local Acceptable Levels								
PSR	3.0	2.5	2.0	3.0	2.5	2.0	3.0	2.5	2.0
IRI m/km (in/mi)	2.5 (160)	3.0 (190)	3.5 (222)	2.5 (160)	3.0 (190)	3.5 (222)	2.5 (160)	3.0 (190)	3.5 (222)

*Volumes: High ADT>10,000; Med 3000<ADT<10,000; Low ADT <3,000

For both diamond grinding and diamond grooving, the most important design element is the spacing of the blades on the grinding head. Grinding is made by using 50 to 60 circular saw blades per foot on a shaft to produce the desired texture. Grooving has a different cutting pattern. It has a uniform spacing of 0.75 inches (19 mm) between grooves. See **Figure 7.2 Dimensions for Grinding and Grooving**. See **Figure 7.3 Dimensional Grinding Texture for Hard and Soft Aggregate** for an earlier publications suggested dimensions for hard and soft aggregates.

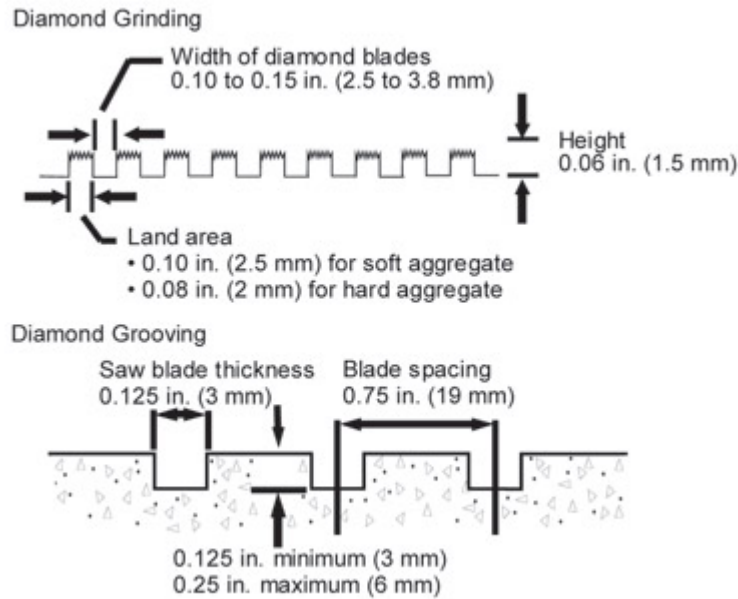

Figure 7.2 Dimensions for Grinding and Grooving
(From Figure 7, Concrete Pavement Rehabilitation and Preservation Treatment, November 2005 (36))

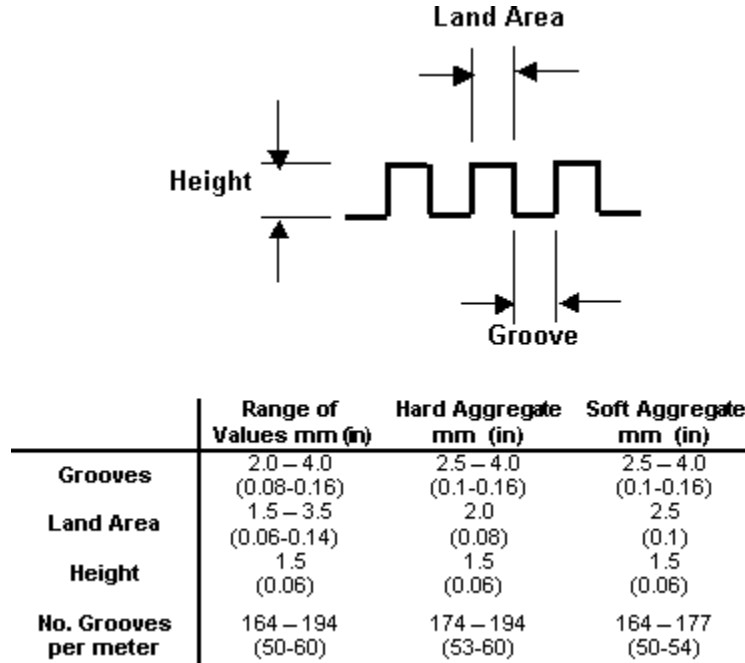

Figure 7.3 Dimensional Grinding Texture for Hard and Soft Aggregate
(From Figure 7, Concrete Pavement Rehabilitation - Guide for Diamond Grinding, June 2001 (29))

CDOT has published research reports on textures of new pavements. Refer to CDOT Final Report CDOT-DTD-R-2005-22 *PCCP Texturing Methods*, dated January 2005 (37) and Final Report CDOT-DTD-R-2006-9, *Implementation of Proven PCCP Practices in Colorado*, dated April 2006 (38).

7.6.2 Concrete Crack Sealing

Crack sealing is a commonly performed pavement maintenance activity that serves two primary purposes. One objective is to reduce the amount of moisture that can infiltrate a pavement structure, thereby reducing moisture-related distresses such as pumping. A second objective is to prevent the intrusion of incompressible materials into cracks so that pressure-related distresses (such as spalling) are prevented (6).

Sealants may become ineffective anywhere from 1 to 4 years after placement. However, improvements in sealant materials, an increased recognition of the importance of a proper reservoir design, and an emphasis on effective crack/joint preparation procedures are expected to increase the expected life of sealant installations. At the same time, there is a persistent controversy over whether joint/crack sealing is needed at all (6). CDOT policy is to seal the cracks and not take the position that joint/crack sealing is not necessary.

What to crack seal:

- Plastic shrinkage and working cracks - Cracks that remain tight usually do not require sealing. These cracks are typically very narrow (hairline) cracks. These are plastic shrinkage cracks and only penetrate to a partial depth. Once started, any crack may develop full depth through a slab. The crack may begin moving and functioning as a joint. Cracks which function as a joint are "working" cracks. Working cracks are subject to nearly the same range of movement as transverse and longitudinal joints and therefore require sealing (24). If significant pavement integrity is being lost then other remedial repairs are needed in conjunction with the crack sealing.
- Number of cracks in a slab - Section 412.16 of CDOT *2005 Standard Specification for Road and Bridge Construction* (25) book specifies when cracks penetrate partial depth they may be epoxy injected with the written approval of the Engineer. New construction and reconstruction that have full depth cracks that separate the slab into two or more parts will not be sealed but the slab will be removed and replaced. Rehabilitation treatments are generally designed with a shorter design life than new construction. Thus, when cracks are full depth and the slab is separated into three or more parts the slab should be removed and replaced or repaired. Slabs remaining in place that are cracked will require sealing as well as the repaired slabs if appropriate.
- Crack load transfer rating - Refer to Section **7.5.2.1 Non-destructive Testing** for guidance on LTE and when to remove and replace or repair the slab parts or when to crack seal a good LTE crack.

Cracks are not straight and are therefore more difficult to shape and seal. Special crack saws are now available to help the operator follow crack wander. The saws have special blades with 7-8 inch diameters and are more flexible. The saws are supported by three wheels and the pivot

wheel allows the saw to follow the crack. The desire is to obtain the same shape factor at the working cracks that is developed at the joints. Routers were used extensively in the past to create the seal reservoir. The trend now is to use the special crack saws. It is believed better reservoir results and increased productivity are obtained with these special crack saws. Crack sealing requires all of the cleaning steps used in joint resealing. That includes the use of a backer rod and uniform sealant installation (24). This treatment procedure follows the concept of the joint details and sealants as specified in CDOT Standard Plan *M-412-1 Concrete Pavement Joints*, sheet 5 of 5. CDOT publication *Development of a Pavement Preventive Maintenance Program for the Colorado Department of Transportation* (22) follows the Standard Plan M-412-1 concept as well. This treatment using silicone sealant is recommended when the existing concrete surface is the new riding surface. A project special provision is required to outline the method of construction and payment. Section 408, Joint and Crack Sealant in the *2005 Standard Specification for Road and Bridge Construction* (25) book consists of work with hot poured joint and crack sealant. Section 408 does not require routing or sawing to develop a seal reservoir. This treatment is recommended when an overlay is required. When routed or sawed cracks with backer rod is required, use Colorado Procedure (CP) 67-02 Standard Method of Test for Determining Adhesion of Joint Sealant to Concrete Pavement as the test method for crack sealing adequacy.

Estimating crack sealant is based on the severity level of cracking. These are estimated quantities only and were used in HMA crack sealing projects. The quantities shown are for information only and are only listed as an aid to the pavement designer for comparisons purposes. See **Table 7.9 Hot Poured Crack Sealant Estimated Quantities**.

Table 7.9 Hot Poured Crack Sealant Estimated Quantities

Cracking Severity Level	Crack Sealant (tons) per lane mile
Heavy	2
Medium	1
Light	0.5
Very Light	0.25

7.6.3 Concrete Joint Resealing

Joint resealing is a commonly performed pavement maintenance activity that serves two primary purposes. One objective is to reduce the amount of moisture that can infiltrate a pavement structure, thereby reducing moisture-related distresses such as pumping. A second objective is to prevent the intrusion of incompressible materials into joints so that pressure-related distresses (such as spalling) are prevented (6).

Sealants may become ineffective anywhere from 1 to 4 years after placement. However, improvements in sealant materials, an increased recognition of the importance of a proper reservoir design, and an emphasis on effective crack/joint preparation procedures are expected to increase the expected life of sealant installations. At the same time, there is a persistent

controversy over whether joint/crack sealing is needed at all (6). CDOT policy is to seal the joints/cracks and not take the position that joint/crack sealing is not necessary. The above objectives and effectiveness are the same as stated in the section of concrete crack sealing. It was reiterated here for emphases.

What to joint seal:

- Joint load transfer rating - Refer to Section **7.5.2.1 Non-destructive Testing** for guidance on LTE and when to improve the LTE or when to reseal the joint.
- Joint spalling - Studies show joint sealing and resealing reduces joint spalling by keeping out incompressibles even on short-panel pavements (24). Joint resealing is still recommended, even on pavements supported by permeable base layers.
- Type of joints - Joint resealing is to be done on transverse and longitudinal joints. If the shoulder is of HMA that interface joint should also be resealed.

Existing sealant distresses (24):

- Adhesion loss - The loss of bond between the sealant material and the concrete joint face.
- Cohesion loss - The loss of internal bond within the sealant material.
- Oxidation/Hardening - The degradation of the sealant as a result of natural aging, long-term exposure to oxygen, ozone, ultra-violet radiation and/or the embedment of incompressibles into the sealant material.

Resealing is necessary when sealant distress affects average sealant condition and results in significant water and incompressible infiltration. The basis of this determination is typically engineering judgment. ACPA has suggested guidelines to assist in the engineering judgment. See **Table 7.10 Sealant Severity Level**. The length of the deterioration defines the severity level of deterioration along each surveyed joint.

Table 7.10 Sealant Severity Level

Severity Level	Length in Percent
Low	< 25%
Moderate	≥ 25% to < 50%
High	≥ 50%

Every joint need not be surveyed to determine the average sealant condition. A statistical sampling can be done. Random and area sampling frequencies are provided for a statistical significant survey. The area sampling represents the average condition of the joints and therefore the selected area should be represented of the total length of the roadway in question. Longitudinal joints should be sampled at the same time the transverse joints are surveyed. See **Table 7.11 Sealant Survey Sampling Frequency**.

Table 7.11 Sealant Survey Sampling Frequency

Joint Spacing (ft)	Measurement Interval	Number of Joints per mile	Area in percent
< 12	every 9th joint	+85	20
12 - 15	every 7th joint	85 - 70	20
15 - 20	every 5th joint	70 - 50	20
20 - 30	every 4th joint	50 - 35	20
30 +	every 4th joint	35	20

Joint resealing requires removing the old sealant, reshaping the reservoir and cleaning the reservoir. Removal of the old sealant may be done manually, use of a small plow, cutting with a knife or sawing method. Shaping the reservoir may be done using saw blades. Cleaning must remove dust, dirt or visible traces of old sealant. A backer rod is required followed by a uniform sealant installation process (24). The joint resealing procedure follows the concept of the joint details and sealants as specified in CDOT Standard Plan *M-412-1 Concrete Pavement Joints*, sheet 5 of 5. CDOT publication *Development of a Pavement Preventive Maintenance Program for the Colorado Department of Transportation* (22) follows the Standard Plan M-412-1 concept as well. The joint resealing treatment using silicone sealant is recommended when the existing concrete surface is the new riding surface. A project special provision is required to outline the method of construction and payment for joint resealing. Section 408, Joint and Crack Sealant in the *2005 Standard Specification for Road and Bridge Construction* (25) book consists of work with hot poured joint and crack sealant. This treatment is recommended when an overlay is required. Use Colorado Procedure (CP) 67-02 Standard Method of Test for Determining Adhesion of Joint Sealant to Concrete Pavement as the test method for joint resealing adequacy. The frequency of the test is documented in the Frequency Guide Schedule for Minimum Material Sampling, Testing, and Inspection chapter of the current *CDOT Field Materials Manual*.

7.6.4 Partial Depth Repair

Partial-depth repair restores localized surface distress, such as spalling at joints and/or cracks in the upper one third to one half of a concrete pavement. Spalling is the breaking, cracking, chipping, or fraying of the slab edges that occurs within 2 inches of joints and cracks or their corners. Spalls that are smaller than 2 inches by 6 inches do not affect ride quality and do not need partial depth repair. Another localized surface distress may be severe scaling. A partial depth repair patch is usually very small (26). Partial depth repairs should be done after slab stabilization.

When not to use partial depth repairs (26):

- When spalls extend more than 6 to 10 inches from the joint and are moderately severe these spalls indicate more deterioration is taking place below the surface. Full depth repair is more appropriate for these types of distresses.

- A partial depth repair cannot correct a crack through the full thickness of the slab. Partial depth repair is not recommended when the deterioration is greater than 1/3 to 1/2 the slab depth.
- A partial depth repair is not appropriate for distresses such as D-cracking. These distresses are not confined to the surface.
- Partial depth repairs should not be used when spalls are caused by corrosion of metal.
- Pavements with little remaining structural life are not good candidates for partial depth repairs.

Guidelines on repair sizes (26):

- A patch typically covers an area less than 1-1/4 square yards and is only 2 to 3 inches deep.
- Patch boundaries should be square or rectangular and are easily shaped by saw cutting.
- Use a minimum length of 12 inches.
- Use a minimum width of 4 inches.
- Extend the patch limits beyond the distress by 3 to 4 inches.
- Do not patch if the spall is less than 6 inches long and less than 1-1/2 inches wide.
- If two patches will be less than 2 feet apart, then combine them into one large patch.
- Repair the entire joint length if there are more than two spalls along a transverse joint.
- During removal of the concrete, the patch depth is determined.

The recommended concrete removal method is by sawing and chipping. First saw cuts are made around the perimeter of the repair area. The vertical faces provide a sufficient depth to prevent spalling of the repair material. Saw cuts should be at least 1-1/2 inches deep preferably more. Then chipping can be done with light (less than 30 lb.) pneumatic hammers until sound and clean concrete is exposed. For best results, use 15 lb. hammers or lighter. Spade bits are preferred. Light hammers with gouge bits can damage sound concrete. However, if the depth of the patch exceeds about 1/2 of the slab thickness or exposes any dowel bars, switch to a full depth repair. Chipping without sawing the perimeter has shown that when a thin or feathered concrete edge is along the perimeter it is prone to spalling and debonding. All loose particles, oil (from pneumatic tools), dust and joint sealant materials must be thoroughly removed to create a good bond. Patches that cross or abut a working joint/crack require a compressible insert. The primary function is to keep the adjacent concrete from bearing against the new patch. The compressible insert provides space for when the slabs thermally expand. This is the primary reason for failure of partial depth repairs. The compressible insert should extend about one inch below and three inches beyond each patch area. At no time should the patch material be permitted to flow into or across the joint or crack. Curing is very important because of the partial depth repair's large surface-area-to-volume ratio makes them susceptible to rapid heat and moisture loss. After the patch material has hardened the reservoir may need to be reformed by saw cutting and resealed. Patch material may be found in CDOT's Approved Products List website under Concrete; Repair/Patching; Rapid Set, Horizontal. It is best to use the patch material manufacturers recommended bonding agent and follow their instructions. Depending on the specified patch material opening to traffic may be specified by minimum strength or minimum time after completing the patch repair. Care should be taken to ensure manufacturers w/c ratios are achieved, as additional water will result in dramatically reduced strength and durability.

7.6.5 Full Depth Concrete Pavement Repair

Full depth repair or full depth patching entails removing and replacing portions of (full depth patching) or the complete slab repair to the bottom of the concrete (27). Sometimes the repair must go into the base and subbase layers. Full depth repairs improve pavement rideability and structural integrity. The most common distress for using full depth repair is joint deterioration that includes any cracking, breaking or spalling of the slab edges. Below surface cracking and spalling requires full depth repairs. Below surface spalling exists where D-cracking is present. Any crack may develop full depth through a slab. The crack may begin moving and functioning as a joint. Cracks which function as joints are "working" cracks. Working cracks are subject to nearly the same range of movement as transverse and longitudinal joints and therefore require sealing (24). However, once the cracks develop severe spalling, pumping or faulting it would be necessary to restore the pavement structural integrity. Corner breaks and intersecting cracks in slabs are also candidates for full depth repairs. Refer to **Figure 7.1 CPR Sequencing** when other techniques are applied in conjunction with full depth repairs. The other techniques are cross stitching, retrofit dowel bars and tied PCC shoulders or curb and gutter. Full depth repair should be done after partial depth repair and slab stabilization. If during a partial depth repair the distress is more extensive than originally thought then a full depth repair may be substituted.

When to use full depth repair (27):

- When spalls extend more than 6 to 10 inches from the joint and are moderately severe these spalls indicate more deterioration is taking place below the surface. Full depth repair is more appropriate for these types of distresses.
- When transverse joints or transverse cracks deteriorate with a moderate severity level of faulting equal to or greater than 0.25 inches other techniques and full depth repair is appropriate.
- When longitudinal joints or cracks deteriorate with high severity level of faulting of 0.5 inches or may be wider than 0.5 inches full depth repair and other techniques are to be used.
- New construction and reconstruction that have full depth cracks that separate the slab into two or more parts will not be sealed but the slab will be removed and replaced. Rehabilitation treatments are generally designed with a shorter design life than new construction. Thus, when cracks are full depth and the slab is separated into three or more parts the slab should be removed and replaced or repaired.

To size the repair the pavement designer must know the mechanisms of the observed distresses. Generally the visible surface distresses show the minimum amount of repair area affected.

Guidelines on patch repair sizes (27):

- When the erosion action of pumping is present than the repair size should go beyond the limits of any base/subbase voids.
- In freeze-thaw climates the below slab deterioration may have to extend 3 feet beyond the visible distress.
- Parallel full lane width patching has been found to perform better than having interior corners of a partial width patch.

- If dowels (load transfer devices) are present a minimum longitudinal patch length of 6 feet from the joint is acceptable to prevent slab patch rocking and to provide room for equipment such as dowel hole drill rigs. If the other side of the transverse joint does not need repair with a minimum patch width, extend the patch beyond the joint about 12 to 15 inches to remove the existing dowels and install new dowels.
- If no dowels are present a minimum longitudinal patch length of 8 to 10 feet may be used. The extra length will provide more load distributing stability on the base/subgrade. If the minimum width patch falls within 6 feet of a joint that does not need repair, extend the patch to the transverse joint.
- Combining two smaller patches into one large patch often can reduce repair costs. When costs of the additional removal and patch material of a large patch is equivalent to the increased costs for additional sawing, sealing, drilling and grouting dowels and/or chipping the patch thickness face of two smaller patches a minimum cost effective distance has been calculated. When two patches will be closer than the distances as shown in **Table 7.12 Minimum Cost Effective Distance between Two Patches**, it is probably more effective to combine them.

Table 7.12 Minimum Cost Effective Distance between Two Patches

(Extracted from Table 2 Minimum cost-effective distance between two patches, *Guidelines for Full-Depth Repair*, Publication TB002.02P, American Concrete Pavement Association, 1995)

Slab Thickness inches	Patch (Lane) Width feet			
	9	10	11	12
8	15	13	12	11
9	13	12	11	10
10	12	11	10	9
11	11	10	9	8
12	10	9	8	8
15	8	8	7	6

- The above table does not apply to longitudinal patches. Longitudinal patches should be wide enough to remove the crack and any accompanying distress. Locate the longitudinal joint beyond the wheelpaths to avoid edge loading.

Slab Removal: Full depth saw cuts are to be made on all four sides to create a smooth, straight, vertical face. The saw cuts may require a full depth cut through the existing joint reservoir. These cuts may have to sever the existing tie bars for longitudinal cuts and dowel bars in the transverse cuts. The smooth faces improve the accuracy of new tie bar and dowel bar placement. Carbide tooth wheel saws can cause micro cracks in the surrounding concrete. It is recommended to use diamond bladed wheel saws. The preferred method to remove the existing deteriorated slab is to lift it out. A number of means to lift the slab out by the contractor is available. It may be necessary to provide additional saw cuts to facilitate the slab removal. Another method to remove the slabs after saw cutting is to break the deteriorated concrete into small fragments by drop hammers, hydraulic rams or jackhammers. The drawback to the break

up method is it often damages the base/subbase and requires more patch preparation. Generally buffer cuts minimize the potential of damaging the surrounding concrete. These buffer cuts help absorb the energy and reduce spalling from the pavement breakers.

Patch Preparation: Sometimes it is necessary to remove and replace soft areas in the base/subbase. Good compaction is often difficult to achieve in the patch areas. It may be advantageous to fill the disturbed base/subbase areas with the patching concrete. Flow-fill is ideal for utility excavations. Flow-fill mix design properties are documented in Section 206.02 of *CDOT Standard Specifications for Road and Bridge Construction* specifications (25).

Install Load Transfer: Load transfer devices (dowel bars) should conform to the size and placement as specified on CDOT Standard Plan *M-412-1 Concrete Pavement Joints*. Dowel bars slip into holes drilled into the transverse edge of the existing slabs. Dowel drill rigs with gangs of drills are preferred to control drill alignment and wandering. Either standard pneumatic or hydraulic percussion drills are acceptable. Both can drill a typical dowel hole in about 30 seconds. Standard pneumatic drills may cause slightly more spalling on the existing slab face. Hole diameter is dependent on what anchoring material is used. Cement type grouts requires about 1/4 inch larger hole and epoxy materials should be 1/16 inch larger than the nominal dowel diameter. A grout retention disk made of nylon or plastic shall be used for all dowel bars placed in the existing pavement. See **Figure 7.4 Grout Retention Disk**. An anchoring material should be used and not a compression fit. Adhesive anchoring materials are listed on CDOT's website for approved products conforming to AASHTO M235. After drilling the dowel holes the holes should be cleaned with compressed air. Apply the anchoring material as per manufacturer's directions. Do not use any method that pours or pushes the material into the hole. Insert the dowel with a twisting motion about one revolution to evenly distribute the material around the circumference of the dowel to provide a good bearing surface and bond. Apply a bond breaker coating onto the other half of the dowel bar that is to be imbedded into the fresh concrete.

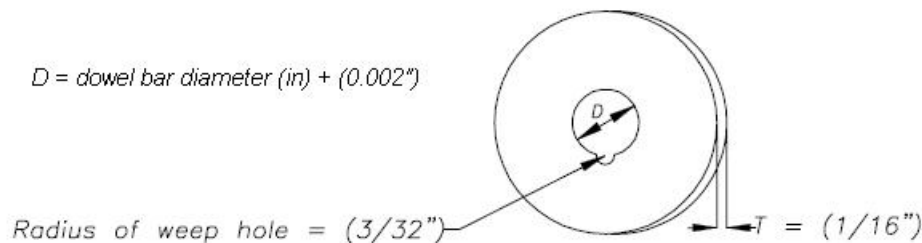

Figure 7.4 Grout Retention Disk

Install Tie Bars: Tie bar installation is similar to the load transfer devices. The size and placement is specified on CDOT Standard Plan *M-412-1 Concrete Pavement Joints*. Tie bars are placed in the longitudinal joint face of existing slabs. Full slab replacements and repairs greater than 15 feet require tie bars where previous tie bars existed. Hand held drills are acceptable because alignment is not critical. Tie bar requirements and pull out testing is specified in Section 412.13 of *CDOT Standard Specifications for Road and Bridge Construction* specifications (25). For repairs less than 15 feet long a bond breaker board (1/4 inch fiberboard) may be placed along

the longitudinal face. For urban area repairs around maintenance access units (manholes) do not install tie bars but place a bond breaker board around the perimeter. Tie bars are used to tie the curb and gutter to the travel lanes. The curb and gutter acts as lateral support such as widened and tied shoulders.

Concrete Material: All concrete pavement full depth patch repairs are to use a concrete material and not asphaltic materials (HMA). Asphalt patches heave and compress during warm weather when the existing concrete slabs expand. Generally, full depth repairs are done under traffic conditions. Time is of essence. Class E concrete is used for fast track pavements. Class E concrete is specified in Section 601.02 of *CDOT Standard Specifications for Road and Bridge Construction* specifications (25) and has been revised in Standard Project Special Provision, Revision of Sections 601 and 701 - Structural Concrete.

Finishing: Strike-off, consolidation, floating and final surface finish is specified in Section 412.12 of *CDOT Standard Specifications for Road and Bridge Construction* specifications (25). The surface texture should be similar to the surrounding pavement.

Curing: The type and method of placement of membrane curing compounds and/or curing blankets for Class P and Class E concretes are specified in Section 412.14 of *CDOT Standard Specifications for Road and Bridge Construction* specifications (25).

Smoothness: If many closely spaced patches are required then consider specifying the pavement smoothness specification. The requirements are specified in Section 105.07 of *CDOT Standard Specifications for Road and Bridge Construction* specifications (25). If diamond grinding is required, the grinding should precede the joint sealing.

Joint Sealing: The final step is to saw the joint sealant reservoirs of the transverse and longitudinal joints, clean and then apply the joint sealant. Refer to Section **7.6.3 Concrete Joint Resealing**.

Strength or Time Method on Opening to Traffic: CDOT utilizes strength requirements or maturity relationships to determine the when to open the roadway repair to traffic. Both methods are specified in Section 412.12 of *CDOT Standard Specifications for Road and Bridge Construction* specifications (25).

Precast Panels: CDOT has been utilizing precast panels for the use in full depth repairs. Each panel is custom cast to fit the patch repair dimensions. The removal of the existing slabs is the same as above. The advantage of this method is being able to open the roadway to traffic in a shorter length of time than the above conventional method. This operation is well suited for night time work on busy day time highways. Refer to CDOT Final Report CDOT-DTD-R-2006-8 *Precast Concrete Paving Panels: The Colorado Department of Transportation Region 4 Experience*, 2000 to 2006, dated August 2006 (39). An example of a project's complete plans and specifications utilizing precast panels is available. The project was in Region 4, Project Number MTCE 04-061R, Region 4 FY06 I-25 MP 244 to MP 270 Concrete Slab Replacement, Subaccount Number M4061R.

7.6.6 Dowel Bar Retrofit

Dowel bar (load transfer devices) retrofit is a technique that increases the load transfer capability from one slab to the next through shear action (28). Slots are cut into the existing pavement at transverse joints/cracks with diamond-saw slot cutting (preferred method). Generally, three slots per wheel path are cut to a depth that allows the dowel bar to sit half way down in the slab with a half-inch of clearance to the bottom of the slot. Epoxy coated dowels must be a minimum of 14 inches long so that at least six inches will extend on each side of the joint or crack. A non-metallic expansion cap is placed on one end of the dowel and the dowel is placed on non-metallic chairs for clearance beneath the dowel. Horizontal and vertical alignments are critical. Refer to the Details Illustrating Dowel Placement Tolerances in CDOT *Standard Plan M-412-1 Concrete Pavement Joints* drawings. The slots are then backfilled using the same materials that would be used for partial depth repairs. The retrofit should last the remaining life of the pavement. Refer to **Figure 7.1 CPR Sequencing** when other techniques are applied in conjunction with dowel bar retrofit. The other techniques are cross stitching and tied PCC shoulders or curb and gutter. Dowel bar retrofit should be done after full or partial depth repair and slab stabilization and before diamond grinding.

When to use dowel bar retrofit (28):

- Generally load transfer devices should be installed at transverse joints and transverse working cracks with poor load transfer but otherwise little or no deterioration,
- Pavements exhibiting D-cracking are not good candidates for load transfer restoration because the concrete in the vicinity of the joints and cracks is likely to be weakened and thus retrofit load transfer devices would not have sound concrete on which to bear. For D-Cracked pavements with concrete deterioration only in the vicinity of joints and cracks, full depth repair is more appropriate,
- Pavements with distress caused by alkali-silica reaction (ASR) or alkali-carbonate reaction (ACR) are not good candidates for load transfer restoration either.

Refer to Section **7.5.2.1 Non-destructive Testing** for the definition and meaning of Load Transfer Efficiency. The load transfer rating as related to the load transfer efficiency is shown in **Table 7.3 Load Transfer Efficiency Quality**.

Dowel bars are either 1.25 or 1.5 inches in diameter. The larger diameter dowel bars are used in thicker pavements (> 10 inches). Dowel bars are spaced 12 inches on center in sets of three or four per wheelpath. Edge spacing from the longitudinal joint to the first dowel bar varies. The edge distance is dependent on whether tie bars are located at the longitudinal joint. Use 12 inches if tie bars are not present and 18 inches if they are.

Refer to **Figure 7.5 Typical Dowel Bar Retrofit Installation** for a conceptual drawing of the retrofit installation. See **Figure 7.6 Typical Dowel Bar Retrofit Sequencing of the Installation** for the installation procedure. Apply a bond breaker coating (e.g. a light coating of grease or oil) to the dowel bars along their full length to facilitate joint movement. Bond breaker application is specified in Section 709.03 of *CDOT Standard Specifications for Road and Bridge Construction* specifications (25).

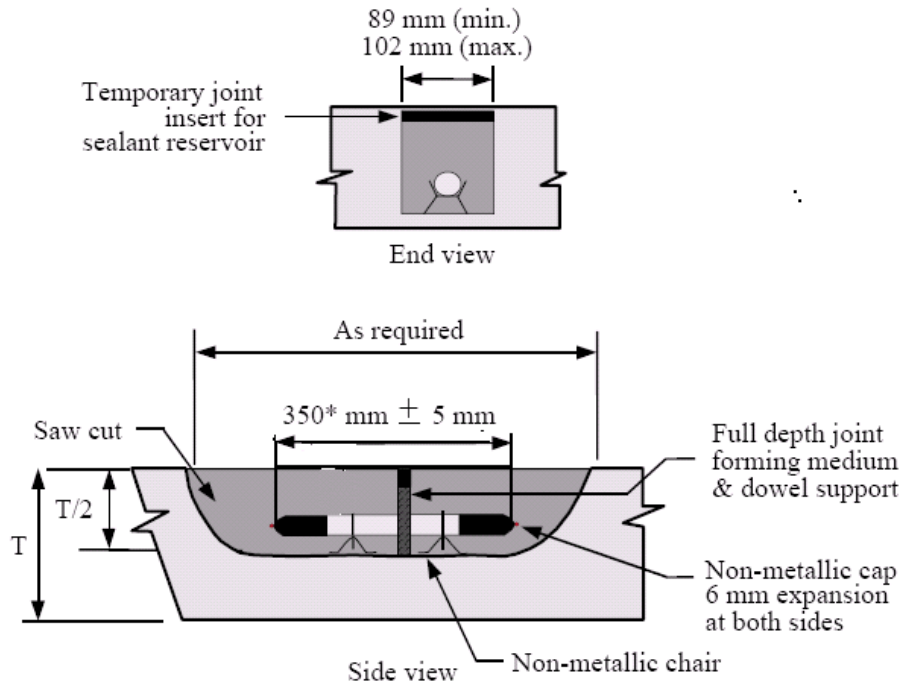

* For pavements with poor support conditions slightly longer bars should be considered.

Figure 7.5 Typical Dowel Bar Retrofit Installation
(Modified from Figure 4-9.3 Dowel Bar Load Transfer Device
Techniques for Pavement Rehabilitation, 1998 (6))

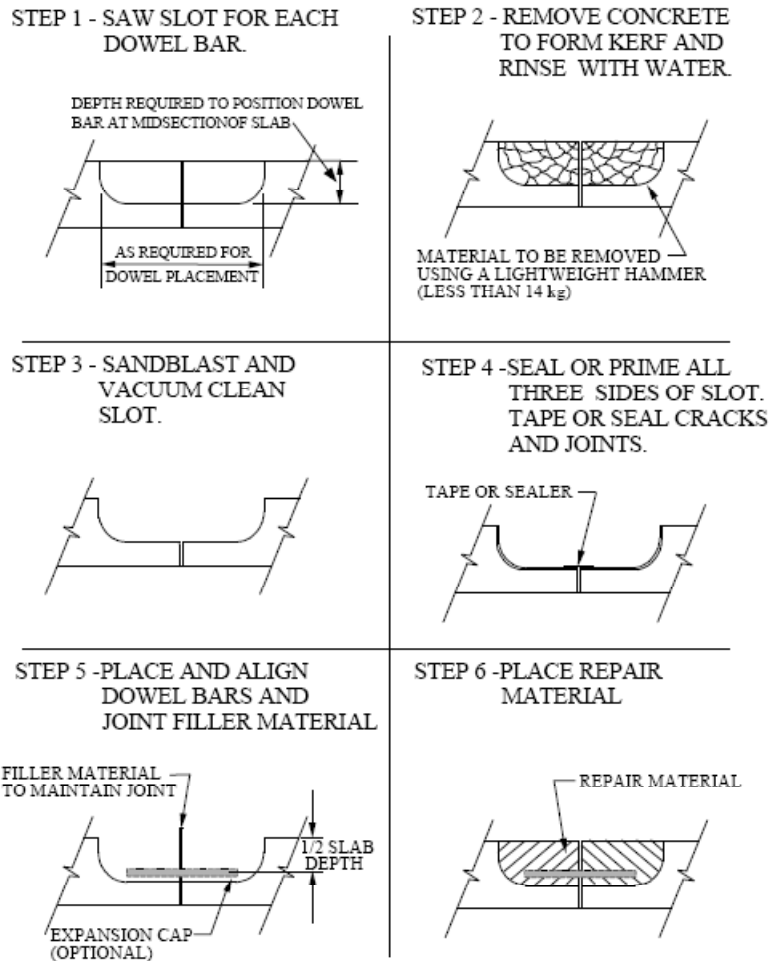

Figure 7.6 Typical Dowel Bar Retrofit Sequencing of the Installation
(From Figure 4-9.7 Construction Procedures for Retrofitted Dowel Bar Installation
Techniques for Pavement Rehabilitation 1998 (6))

7.6.7 Cross Stitching

Cross stitching longitudinal discontinuities, such as joints and cracks is a repair technique to facilitate in the lateral load transfer of an otherwise unsupported free edge. The free edge is where the most critical loadings occur in the slab. This free edge condition may exist at a lane-to-lane or lane-to-shoulder joint. Working longitudinal cracks may also develop and create an unsupported free edge condition. The cross stitching will help maintain the aggregate interlock in this situation if the crack doesn't widen too much. Cross stitching uses deformed tie bars inserted into holes drilled across a joint/crack at an angle. If the angle is less than 35° from the horizontal the Contractor has problems drilling the holes. This was observed on a CDOT project. The tie bars are placed and staggered with each other on each side of the joint/crack for the length of the discontinuity. The tie bars prevent joints and cracks from vertical and especially horizontal movement or widening. In new construction tie bars are placed in plastic concrete and keep the joints tight in the hardened state and to keep incompressibles and sheet

flow of water into the base. The cross stitching repair technique for joints is to prevent further lane or shoulder separation and minimize the settlement of the slabs. Generally this technique is used where the overall pavement condition as well as where the joints and cracks are in good condition. If the joints and cracks are spalled too much other rehabilitation repair methods may be appropriate.

Another similar technique is slot stitching. Slot stitching uses a modified dowel bar retrofit method. Slots are cut across the joints/cracks, deformed bars are placed in the slots and are backfill similarly to dowel bar retrofit. If an overlay will be placed either method is acceptable. If an overlay is not being placed after this repair then the cross stitching has a more pleasing appearance than the slot stitching.

Both rehabilitation techniques are detailed and discussed in *Stitching Concrete Pavement Cracks and Joints*, Publication Special Report SR903P, ACPA and IGGA, 2001 (30). The publication illustrates the cross stitching bar dimensions and locations of drilled holes and slots layouts. Be aware that if diamond grinding is performed after cross stitching, then the placement of the bars should be deep enough so they are not impacted by the grinding machining. The amount of anchor adhesive cover over the bars should be sufficient to protect the bars from the elements. The project plans should detail the appropriate stitching method.

Refer to **Figure 7.1 CPR Sequencing** when other techniques are applied in conjunction with the cross/slot stitching. Cross/slot stitching should be done after full/partial depth repair and slab stabilization and before diamond grinding and crack/joint sealing. Cross/slot stitching should last the remaining life of the pavement.

A special note is in order to understand the significance of tying the longitudinal joints and cracks. In the Section 3.4.3.8 Pavement Design Features, subheading Edge Support of the *Guide for Mechanistic-Empirical Design*, Final Report, NCHRP Project 1-37A (17) explains the structural effects of the edge support features are directly considered in the design process. The Design Guide evaluates the adequacy of the trial design through the prediction of key distresses and smoothness. The design process uses the Load Transfer Efficiency (LTE) equation for transverse joints related to shoulder type (HMA vs. PCC), tied PCC shoulders or widen slabs. The distresses are percent slabs cracked and faulted joints vs. time and are compared to the user defined allowable reliability limits. It appears that the Design Guide assumes all lane-to-lane joints are tied, but the designer has a choice on lane-to-shoulder jointing. LTE design inputs features are as follows:

- Tied PCC Shoulder – for tied concrete shoulders the long-term LTE between the lane and shoulder must to be provided. The LTE is defined as the ratio of deflections of the unloaded and loaded slabs. The higher the LTE, the greater the support provided by the shoulder to reduce critical responses of the mainline slabs. Typical long-term deflection LTE are:
 - 50 to 70 percent for monolithically constructed and tied PCC shoulder.
 - 30 to 50 percent for separately constructed tied PCC shoulder.
- Untied concrete shoulders or other shoulder types do not provide significant support; therefore, a low LTE value should be used (e.g., 10 percent due to the support from extended base course).

- Widened Slab – widened slabs improve JPCP performance by effectively moving the mean wheelpath well away from the pavement edges where the critical loadings occur. The design input for widened slab is the slab width which can range from 12 to 14 ft.

7.6.8 Slab Stabilization and Slabjacking

The purpose of slab stabilization also called subsealing, undersealing or pavement grouting is to stabilize the pavement slab by the pressurized injection of a cement grout, pozzolan-cement grout, bituminous materials or polyurethane mixture through holes drilled in the slab. The cement grout will, without raising the slab, fill the voids under it, displace water from the voids, and reduce the damaging pumping action caused by excessive pavement deflections. Slab stabilization should be accomplished as soon as significant loss of support is detected at slab corners. Symptoms of loss of support include increased deflections, transverse joint faulting, corner breaks, and the accumulation of fines in or near joints or cracks on traffic lanes or shoulders (31)(32).

When to use slab stabilization (33):

- Slab stabilization should be performed only at joints and working cracks where loss of support is known to exist. Symptoms of loss of support include:
 - Increased deflections.
 - Transverse joint faulting.
 - Corner breaks.
 - Accumulation of underlying fine materials in or near joints or cracks on the traffic lane or shoulder.
- Slab stabilization should be performed before the voids become so large in area that they cause pavement failure. The only exception is when the pavement is to be overlaid with asphalt or concrete. In this case, slab stabilization is necessary, regardless of pavement condition. Slab stabilization is particularly important for asphalt overlays which have little resistance to shearing forces and reflect the underlying foundation problems.

Refer to **Figure 7.7 Typical Slab Stabilization Hole Layout** for a typical application and hole layout. Refer to **Figure 7.1 CPR Sequencing** when other techniques are applied in conjunction with slab stabilization. Slab stabilization should be before partial depth repair and other repairs.

The slab stabilization technique is detailed and discussed in *Slab Stabilization Guidelines for Concrete Pavements*, Publication TB018P, ACPA, 1994 (32). The 20 page publication discusses void detection, materials, equipment, installation, post-testing, and opening to traffic.

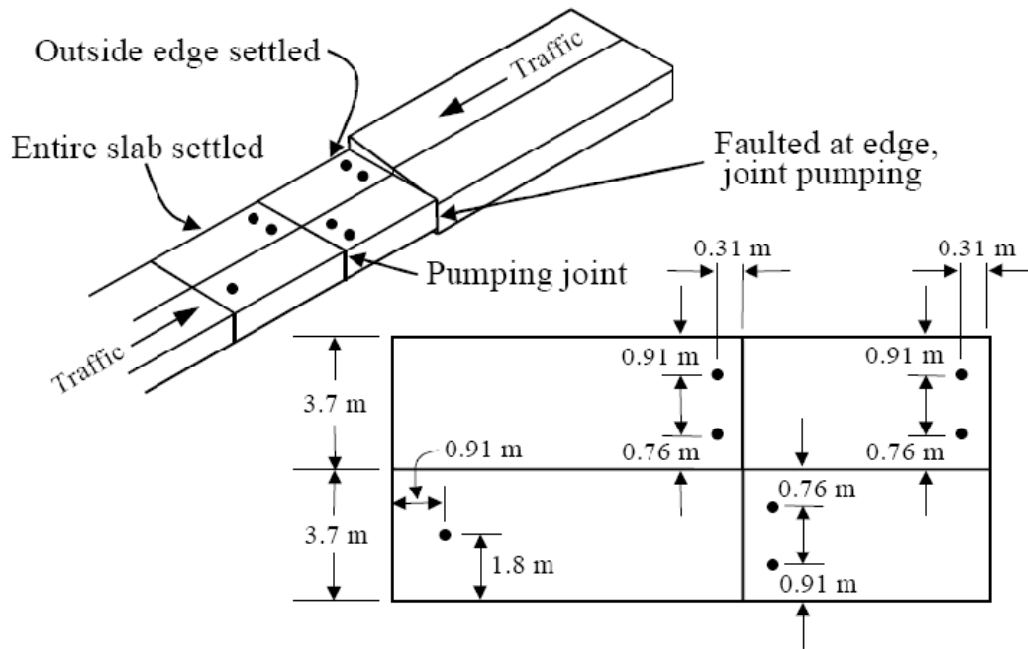

Figure 7.7 Typical Slab Stabilization Hole Layout

(From Figure 4-7.6 Location of holes depending on defect to be corrected
Techniques for Pavement Rehabilitation 1998 (6))

The purpose of slabjacking is to raise a slab in place permanently, prevent impact loading, correct faulty drainage, and prevent pumping at transverse joints by injection of a grout, pozzolan-cement grout or polyurethane mixture under the slab. The grout fills voids under the slab, thereby restoring uniform support. Slabjacking should be considered for any condition that causes nonuniform slab support, such as embankment settlement, settlement of approach slabs, settlement over culverts or utility cuts, voids under the pavements, differences in elevation of adjacent pavements, joints in concrete pavements that are moving or expelling water or soil fines, and pavement slabs that rock or teeter under traffic (31)(32). The performance of pavements subjected to slabjacking is somewhat dependent upon the origin of the corrected defect. For example, an embankment that slowly continues to settle will require periodic slabjacking. Periodic slabjacking may also be required on bridge approach slabs due to poor drainage design and improper embankment compaction (34). An example of a suggested slab jacking pumping sequence that provides a general guideline for obtaining satisfactory results is presented in manual *Techniques for Pavement Rehabilitation 1998 (6)*. It must be remembered that the sequence must be modified to meet the specific needs of a given project.

Refer to **Figure 7.8 Typical Slab Raising in Slabjacking** and **Figure 7.9 Typical Slabjacking Hole Layout** for a typical application using a stringline and hole layout.

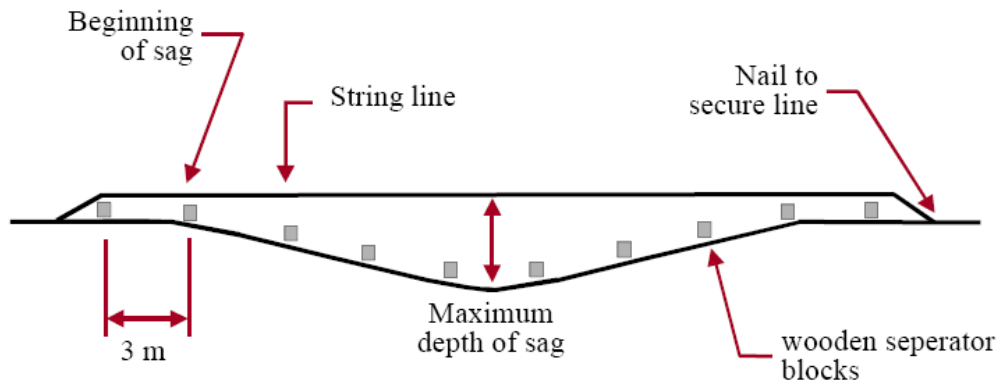

Figure 7.8 Typical Slab Raising in Slabjacking
(From Figure 4-7.9 Stringline method of slab jacking
Techniques for Pavement Rehabilitation 1998 (6))

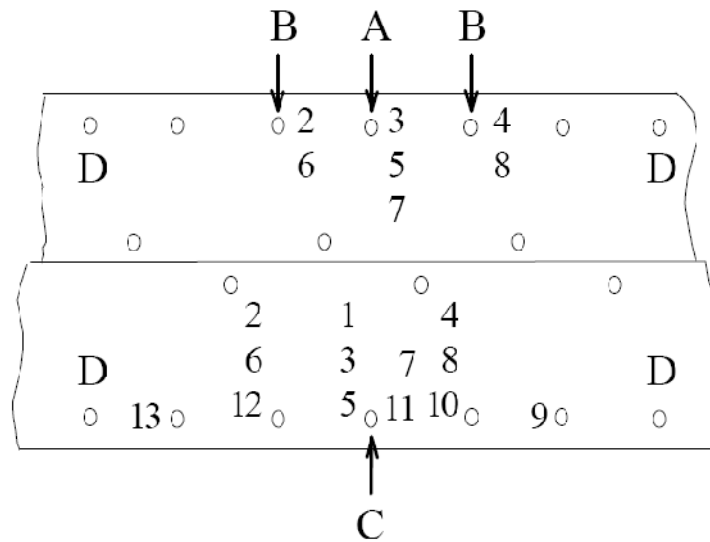

Figure 7.9 Typical Slabjacking Hole Layout
(From Figure 4-7.7 Location of holes and the order of grout pumping to correct settlement
Techniques for Pavement Rehabilitation 1998 (6))

An example of a project's complete plans and specifications utilizing Slabjacking is available. The project used water blown formulation of high density polyurethane. The project was in Region 4, Project Number MTCE 04-061R, Region 4 FY06 I-25 MP 244 to MP 270 Concrete Slab Replacement, Subaccount Number M4061R

7.7 Selecting the Appropriate Pavement Rehabilitation Techniques

Table 7.13 Guidelines for PCC Treatment Selection is from a complete bound report titled *Development of a Pavement Preventive Maintenance Program for the Colorado Department of Transportation*, October 2004, by Larry Galehouse (35). Note that the Final Report CDOT-

DTD-R-2004-17, August 2004 (22) is not as complete as the October 2004 bound report. The tabular guidelines only include CDOT's treatments as reported in the bound report. Refer also to **Table 7.13 Guidelines for PCC Treatment Selection** for additional treatments and repairs.

Table 7.13 Guidelines for PCC Treatment Selection

(From Table Guidelines for Pavement Treatment Selection, *CDOT Preventive Maintenance Program Guidelines*, October 2004 (35))

Pavement Distresses		Rigid Treatments					
		Diamond Grinding	Concrete Crack Sealing	Concrete Joint Resealing	Partial Depth Repair	Dowel Bar Retrofit	Full Depth Concrete Pavement Repair
Corner Breaks	Low	⊙	P	⊙	✓	⊙	✓
	Moderate	⊙	P	⊙	✓	⊙	✓
	High	✓	✓	⊙	✓	⊙	P
Durability Cracking ("D" Cracking)	Low	⊙	✓	⊙	✓	⊙	✓
	Moderate	⊙	✓	⊙	✓	⊙	✓
	High	⊙	⊙	⊙	⊙	⊙	P
Longitudinal Cracking	Low	⊙	P	⊙	⊙	⊙	✓
	Moderate	✓	P	⊙	P	⊙	✓
	High	P	P	⊙	P	⊙	✓
Transverse Cracking	Low	⊙	P	⊙	✓	✓	✓
	Moderate	✓	P	⊙	P	✓	✓
	High	P	P	⊙	P	✓	✓
Joint Seal Damage	Low	⊙	⊙	✓	⊙	⊙	⊙
	Moderate	⊙	⊙	P	⊙	⊙	⊙
	High	⊙	⊙	P	⊙	⊙	⊙
Longitudinal Joint Spalling	Low	⊙	⊙	P	⊙	⊙	⊙
	Moderate	⊙	⊙	P	P	⊙	✓
	High	⊙	⊙	P	P	⊙	✓
Transverse Joint Spalling	Low	⊙	⊙	P	P	⊙	✓
	Moderate	⊙	⊙	P	P	⊙	✓
	High	⊙	⊙	P	P	⊙	P
Map Cracking and Scaling	Low	⊙	⊙	⊙	✓	⊙	✓
	Moderate	⊙	⊙	⊙	P	⊙	✓
	High	⊙	⊙	⊙	⊙	⊙	⊙
Polished Aggregate	Significant	P	⊙	⊙	⊙	⊙	⊙
Condition Factors							
Traffic AADT-T	<400	✓	✓	✓	✓	✓	✓
	400-6000	✓	✓	✓	✓	✓	✓
	>6000	✓	✓	✓	✓	✓	✓
Ride	Poor	P	⊙	⊙	✓	⊙	
Rural	Min	✓	✓	✓	✓	✓	✓
	Turning						
Urban	Max	✓	✓	✓	✓	✓	✓
	Turning						
Drainage	Poor	⊙	⊙	⊙	⊙	⊙	⊙

P – Preferred Treatment Option

✓ - Acceptable Treatment Option

⊙ - Not Recommended

References

1. *Factors for Pavement Rehabilitation Strategy Selection*, Number 3.02, R & T Update, Concrete Pavement Research & Technology, American Concrete Pavement Association, Skokie, IL, February 2002.
2. *AASHTO Guide for Design of Pavement Structures*, American Association of State Highway and Transportation Officials, Washington, DC, 1993.
3. *Recycling Concrete Pavements*, TB014P, American Concrete Pavement Association, Skokie, IL, 1993.
4. *Distress Identification Manual for the Long-Term Pavement Performance Program*, Publication Number FHWA-RD-03-031, U.S. Department of Transportation, Federal Highway Administration, Washington, DC, March 2003.
<<http://www.tfhr.gov/pavement/ltp/resource.htm>>
5. *Techniques for Pavement Rehabilitation*, ERES Consultants, Inc., U.S. Department of Transportation, Federal Highway Administration, Washington, DC, 1992.
6. *Techniques for Pavement Rehabilitation*, Nichols Consulting Engineers, Chtd., U.S. Department of Transportation, Federal Highway Administration and National Highway Institute, Arlington, Virginia, Sixth Edition, January 1998.
<<http://www.nhi.fhwa.dot.gov/crsmaterial.asp?courseo=131008>>
7. *Revision of AASHTO Pavement Overlay Design Procedures*, Final Report, Darter, M., Elliott, R., Hall, K., National Cooperative Highway Research Program, Transportation Research Board, Washington, DC, April 1992.
8. *Public Benefits of Highway System Preservation and Maintenance*, A Synthesis of Highway Practice, NCHRP Synthesis 330, National Cooperative Highway Research Program, Transportation Research Board, Washington, DC, 2004.
9. *Rehabilitation of Concrete Pavements*, Final Report, Report No. CDOH-83-1, Colorado Department of Highways, January, 1983.
10. *Rehabilitation of Concrete Pavements Follow-Up Study*, Follow-Up Report, Report No. CDOH-88-8, Colorado Department of Highways, April 1988.
11. *LTPP Data Analysis: Frequently Asked Questions About Joint Faulting With Answers From LTPP*, Publication No. FHWA-RD-97-101, U.S. Department of Transportation, Federal Highway Administration, Research and Development Turner-Fairbank Highway Research Center, McLean, VA, August 1997.
12. *Structural Factors of Jointed Plain Concrete Pavements: SPS-2 -- Initial Evaluation and Analysis*, Publication No. FHWA-RD-01-167, U.S. Department of Transportation,

- Federal Highway Administration, Research and Development Turner-Fairbank Highway Research Center, McLean, VA, April 2005.
13. Ardani, Ahmad, Hussain, Shamshad, and LaForce, Robert, *Evaluation of Premature PCCP Longitudinal Cracking in Colorado*, Final Report, Report No. CDOT-DTD-R-2003-1, Colorado Department of Transportation, Research Branch, January 2003.
 14. Wood, K. L., *Evaluation of Concrete Pavement Restoration Procedures and Techniques*, Initial Report, Report No. CDOH-DTP-R-84-5, Colorado Department of Highways, March 1984.
 15. Killian, John, *Concrete Pavement Restoration Demonstration*, Final Report, Report No. CDOH-DTD-R-88-6, Colorado Department of Highways, February 1988.
 16. *Pavement Study - Project I 092-2(4)*, Final Report, Colorado Department of Highways, Planning & Research Division, Research and Special Studies Section, 1966.
 17. *Guide for Mechanistic-Empirical Design*, Final Report, NCHRP Project 1-37A, National Cooperative Highway Research Program, Transportation Research Board, National Research Council, Submitted by ARA, INC., ERES Consultants Division, Champaign, IL, March 2004.
 18. *Supplement to the AASHTO Guide for Design of Pavement Structures, Part II, - Rigid Pavement Design & Rigid Pavement Joint Design*, American Association of State Highway and Transportation Officials, Washington, DC, 1998.
 19. *Evaluation of Joint and Crack Load Transfer*, Final Report, FHWA-RD-02-088, U.S. Department of Transportation, Federal Highway Administration, Research and Development Turner-Fairbank Highway Research Center, McLean, VA, October 2003.
 20. *ACPA Pavement Technology Construction-Related FATQ*, (23, June 2005).
<<http://www.pavement.com/PavTech/Tech/FATQ/fatq-strengthtests.html>>
 21. *The Concrete Pavement Restoration Guide*, Publication TB020.02P, American Concrete Pavement Association, Concrete Paving Technology, Skokie, IL, 1998.
 22. *Development of a Pavement Preventive Maintenance Program for the Colorado Department of Transportation*, Final Report, CDOT-DTD-R-2004-17, Colorado Department of Transportation, Research Branch, prepared by National Center for Pavement Preservation, Okemos, MI, August 2004.
 23. *Diamond Grinding and Concrete Pavement Restoration*, Publication TB008.01P, American Concrete Pavement Association, Concrete Paving Technology, Skokie, IL, 2000.

24. *Joint and Crack Sealing and Repair for Concrete Pavements*, Publication TB012P, American Concrete Pavement Association, Concrete Paving Technology, Skokie, IL, 1995.
25. *Standard Specifications for Road and Bridge Construction*, Colorado Department of Transportation, Denver, Co, 2005.
<http://www.dot.state.co.us/DesignSupport/Construction/2005SpecsBook/2005index.htm>
26. *Guidelines for Partial-Depth Spall Repair*, Publication TB003.02P, American Concrete Pavement Association, Concrete Paving Technology, Skokie, IL, 1998.
27. *Guidelines for Full-Depth Repair*, Publication TB002.02P, American Concrete Pavement Association, Concrete Paving Technology, Skokie, IL, 1995.
28. *Concrete Pavement Rehabilitation: Guide for Load Transfer Restoration*, Publication FHWA-SA-97-103, Federal Highway Administration, Washington, D.C., and Publication ACPA JP001P, American Concrete Pavement Association, Skokie, IL, 1997.
29. *Concrete Pavement Rehabilitation - Guide for Diamond Grinding*, FHWA Technical Report, Correa, Angel L. and Wong, Bing, Federal Highway Administration, 400 7th Street S.W., Washington, DC 20590, June 2001.
<<http://www.fhwa.dot.gov/pavement/concrete/diamond.cfm>>
30. *Stitching Concrete Pavement Cracks and Joints*, Publication Special Report SR903P, American Concrete Pavement Association, Concrete Paving Technology and Research, Skokie, IL and International Grooving & Grinding Association, Coxsackie, NY, 2001.
31. *O&M: Concrete Repair*, Publication UFC 3-270-04, Unified Facilities Criteria, U.S. Army Corps of Engineers, March 15, 2001.
32. *Slab Stabilization Guidelines for Concrete Pavements*, Publication TB018P, American Concrete Pavement Association, Concrete Paving Technology, Skokie, IL, 1994.
33. *Slab Stabilization*, Factsheet from Military Tri-Service Transportation Website, (03, January 2006).
<<https://transportation.wes.army.mil/factsheets/>>
34. *Slabjacking*, Factsheet from Military Tri-Service Transportation Website, (03, January 2006).
<<https://transportation.wes.army.mil/factsheets/>>
35. *CDOT Preventive Maintenance Program Guidelines*, prepared by National Center for Pavement Preservation, Okemos, MI, October 2004.
36. *Concrete Pavement Rehabilitation and Preservation Treatment*, Report FHWA-IF-06-005, CPTP TechBrief, November 2005.

37. Ardani Ahmad and Outcalt William (Skip), *PCCP Texturing Methods*, Final Report, Report No. CDOT-DTD-R-2005-22, Colorado Department of Transportation, Research Branch, January 2005.
38. Ardani Ahmad, *Implementation of Proven PCCP Practices in Colorado*, Final Report, Report No. CDOT-DTD-R-2006-9, Colorado Department of Transportation, Research Branch, April 2006.
39. DeWitt, Gary L., P.E., *Precast Concrete Paving Panels: The Colorado Department of Transportation Region 4 Experience, 2000 to 2006*, Final Report, Report No. CDOT-DTD-R-2006-8, Colorado Department of Transportation, Research Branch, August 2006.

CHAPTER 8

PRINCIPLES OF DESIGN FOR FLEXIBLE PAVEMENT INTERSECTIONS

8.1 Introduction

A standard pavement design is based on fast-moving traffic traveling one direction on long stretches of roadway where drainage is usually easy to handle. This is not the situation with intersections. ESALs are greater at intersections because of compounding traffic directions. Also, it's necessary to design for slower stop-and-go traffic, which induces much heavier stresses on the pavement section. In addition, drainage is often compromised within intersections, leading to saturation of the pavement section and the underlying subgrade. Some mixes that have a history of good performance may not perform well in intersections, climbing lanes, truck weigh stations and other slow-speed areas. Special attention should be focused on high traffic volume intersections to ensure the same outstanding performance.

The key to achieving this desired performance is recognizing that these pavements may need to be treated differently than conventional roadways. Specifically, the pavement must be designed and constructed to withstand the more severe conditions. Well-designed, properly constructed HMA intersections provide an economical and long-lasting pavement.

8.2 Design Considerations

Determining whether to use a high performance HMA intersection design versus a conventional HMA design should be assessed on a project-by-project basis. Some general rules to consider are:

Special consideration needs to be given to intersections with heavy truck traffic and high traffic volumes. If the traffic loading for a 20-year design is one to three million ESALs or greater, a high performance asphalt intersection should be considered. When 20-year traffic loading of the two traffic streams are one million ESALs or greater within an intersection, a high performance intersection design should be considered. If high traffic volume intersections are within $\frac{1}{4}$ mile of each other, the entire roadway should be designed using a high performance intersection design. Acceleration and deceleration lanes should be included as part of the intersection design.

Sharp turns with slow-moving traffic should be included as part of the intersection design. If there are not enough high performance intersections within a project to warrant a high traffic volume intersection design throughout, but the intersections that are within the project are potentially subject to moderate to heavy traffic (one million ESALs or greater), they should be blocked out and a high traffic volume intersection design used. When there is two-way traffic, the transition should extend at least 300 linear feet on either side of the intersection. When there is one-way traffic, the transition should be at least 300 linear feet on the deceleration side and 100 linear feet on the acceleration side of the intersection. The definitions and design factors necessary for flexible pavement design were introduced in previous sections. The design factors

and their sources are summarized in **Table 8.1 Design Factors for Flexible Pavement Intersections**.

It is suggested that a PG 76-28 binder be selected for use in asphalt intersections, providing it is available. Bumping grades, as suggested in Section 3.8.2 **Binder Selection** of **CHAPTER 3**, would also provide improved performance in asphalt intersections. In general, it is suggested that the Superpave™ procedure be followed to select appropriate binder grade for asphalt intersection design.

In designing the pavement, the following factors as shown in **Table 8.1 Design Factors for Flexible Pavement Intersections** will be needed.

Table 8.1 Design Factors for Flexible Pavement Intersections

Factor	Source
18k ESAL	Be sure to add the ESALs from both directions. Division of Transportation Development, requested by the designer specifically for flexible pavement. http://internal/App_DTD_DataAccess/Traffic/
Reliability, R	Table 1.3, CHAPTER 1
Standard Normal Deviate, Z_R	Table 1.4, CHAPTER 1
Overall Deviation, S_o	CDOT flexible default value = 0.44
Serviceability Loss, ΔPSI	Derived from traffic volumes, Section 1.9 of CHAPTER 1
M_R Value of the Subgrade	Soil profile report from laboratory and correlation equations, Section 2.5, CHAPTER 2
Structural Layer Coefficients (a_i)	Table 3.2 and Table 3.3, CHAPTER 3

8.3 Design Period

The destructive effect of repeated wheel loads is the major factor that contributes to the failure of highway pavement. Since both the magnitude of the load and the number of its repetitions are important, provision is made in the design procedure to allow for the effects of the number and weight of all axle loads expected during the design period. The design period for new flexible pavement construction and reconstruction is at least 20 years. The design period for restoration, rehabilitation and resurfacing is 10 years. Selection of less than 10-year design period needs to be supported by a LCCA or other overriding considerations.

8.4 Traffic Analysis

In any pavement type, the destructive effect of repeated wheel loads is the major factor that contributes to the failure of highway pavement. Design traffic will be the 18,000-pound equivalent single axle load (18k ESAL) and will be obtained from the CDOT's Traffic Analysis

Unit of the Division of Transportation Development, the following website assist the user in calculating an ESAL value http://internal/App_DTD_DataAccess/Traffic/. The actual projected traffic volumes for each category are weighted by the appropriate load equivalence factors and converted to a cumulative total 18k ESAL number to be entered into the flexible pavement design equation. The designer must inform the DTD Traffic Analysis Section that the intended use of the 18k ESAL is for flexible pavement design since different load equivalence factors apply to different pavement types. Cross traffic at intersections needs to be accounted for as part of the traffic count projection. Use only high quality aggregates. Select the SuperPave™ Gyrotory design compaction effort one level higher than would be selected for normal roadway design. If a comparison of flexible and rigid pavements is being made, 18k ESALs for each pavement type must be requested. Another source of traffic load data can be weigh-in-motion data. Although these devices are not as plentiful, they are usually more accurate for measurements of traffic load in the present year. Projections for future traffic loads can be calculated similarly using growth factors provided by the DTD Traffic Analysis Unit.

8.5 Design Methodology

Design methodology for flexible intersections are similar to those found in Sections 3.4 through 3.7 of CHAPTER 3.

8.6 Reconstruction Sample Problem

This problem will reconstruct a Sugarloaf Reservoir intersection using the same temperatures and ESALs that have previously been stated in Section 3.8.3 Example 1 of CHAPTER 3. Remember that the ESALs were found using traffic counts from **both** roads leading to the intersection. The various factors to design the pavement will be obtained from **Table 8.1 Design Factors for Flexible Pavement Intersections**. The following steps determine the required design thicknesses for a pavement structure in addition to the information presented above. ADT is greater than 750.

Step 1. Determine the Intersection Design Traffic Loading (18k ESALs).

See Sections 8.3, 8.4, and 8.5 above.

Step 2. Determine the Reliability Factor.

This road is a rural principal arterial. **Table 1.3 (CHAPTER 1)**, Reliability (Risk), shows the reliability for this road should be chosen from 70% – 95%. This is a high profile road, so the reliability is set to 95%.

Step 3. Determine the Standard Normal Deviate (Z_R).

Table 1.4 (CHAPTER 1), Reliability and Standard Normal Deviate, shows that the standard normal deviate, Z_R , equals -1.645 .

Step 4. Determine the Overall Deviation (So).

This is always set to 0.44 for CDOT flexible pavements.

Step 5. Calculate the Serviceability Loss (Δ PSI).

The Serviceability Section 1.9 in CHAPTER 1 tells us to set the terminal serviceability of this volume road to 2.5. The initial serviceability is usually set at 4.5. The serviceability loss is the difference of these two, which equals 2.0.

Step 6. Calculate the M_R Value of the Subgrade.

Figure 3.4 in CHAPTER 3, Correlation of Soil Support Indices to Structural Base Layer Coefficients, shows the correlation between CBR and R-value. This example will precede using R-value. If you normally work with CBR, please use Figure 3.4 in CHAPTER 3 to see the correlation. The soil at this intersection has an R-value of 20. Eq. 2.1 and Eq. 2.2 in Section 2.5.1 Laboratory Resilient Modulus, are used to find the resilient modulus from a known R-value.

$$S_1 = [(R - 5) / 11.29] + 3 \quad S_1 = 4.33 \quad \text{Eq. 8.1 (Eq. 2.1 re-stated)}$$

$$M_R = 10^{[(S_1 + 18.72) / 6.24]} \quad M_R = 4942 \quad \text{Eq. 8.2 (Eq. 2.2 re-stated)}$$

Where:

M_R = resilient modulus (psi).

S_1 = the soil support value.

R = the R-value obtained from the Hveem stabilometer.

Step 7. Calculate the Structural Number (SN).

All of the values obtained from the previous steps are used to find the structural number. The manual procedure, Eq. 3.1 or the nomograph in Figure 3.1 Design Nomograph for Flexible Pavements in CHAPTER 3, can be used to determine the structural number. These procedures should yield a SN value equal to 5.1. Using DARWin™ software, values obtained from previous steps are input into the computer program and a SN of 5.1 is calculated.

Step 8. Find the Asphalt Thickness.

Assuming a full-depth asphalt design, Table 3.2 Recommended a_i Values for the Structural Layer Coefficients in CHAPTER 3, shows that the structural layer coefficient for HMA is 0.44. The moisture holding ability of an asphalt surface course is considered to be close to nonexistent, so the possible effect of drainage on the asphalt concrete surface course is not considered.

Eq. 3.2 (re-stated) in CHAPTER 3 is used to solve for the thickness.

$$SN = a_1 D_1 + a_2 D_2 m_2 + a_3 D_3 m_3$$

Eq. 8.3 (Eq. 3.2 restated)

Where:

- a_1, a_2, a_3 = structural layer coefficients
- D_1 = thickness of bituminous surface course (inches)
- D_2 = thickness of base course (inches)
- D_3 = thickness of subbase (inches)
- m_2 = drainage coefficient of base course
- m_3 = drainage coefficient of subbase

$$5.1 = (0.44)(D_1) + a_2 D_2 m_2 + a_3 D_3 m_3$$

Being full-depth asphalt, only a_1 and D_1 are needed.

$$D_1 = 11.59 \text{ inches HMA}$$

This should be rounded up to the next $\frac{1}{4}$ inch.

The intersection will need 11.75 inches of HMA.

Assuming the asphalt pavement **will not be full-depth**, the designer wants to use 9 inches of aggregate base course with an R-Value of 86. **Table 3.3 Recommended ai Values for the Base Layer Coefficients** in **CHAPTER 3**, tells the designer to use a coefficient of 0.14 for this aggregate base course. **Eq. 8.3** is used again with a $SN = 5.1$.

$$5.1 = (0.44)(D_1) + (0.14)(9)(1) + a_3 D_3 m_3 \quad D_1 = 8.73 \text{ inches HMA}$$

This should be rounded up to the next $\frac{1}{4}$ inch, which is 8.75 inches of HMA.

To verify the design thicknesses of the pavement structure including the aggregate base course (ABC), the following calculation is performed.

$$5.1 = (0.44)(8.75) + (0.14)(D_2)(1) \quad D_2 = 8.93 \text{ inches of ABC}$$

Again, round up to the nearest whole inch, which is 9.0 inches of ABC.

The intersection will need 8.75 inches of HMA and 9.0 inches of the selected ABC. Ensuring structural adequacy, to ensure long life performance, the pavement section for intersections must have adequate thickness to support the slow moving or stopped traffic- induced loads. Whether new or existing, the thickness of each component of the section must provide structural integrity and be sufficient so that it will carry the anticipated loads and higher stresses resulting from slower-moving traffic. Key factors to consider when ensuring structural adequacy: Subgrade strength, frost depth, subbase and base thickness, asphalt thickness, traffic type, loading and drainage.

8.7 Assessing Problems with Existing Intersections

A successful intersection rehabilitation project is dependent on proper project scoping. The keys to proper scoping are the following:

- Identifying the problem with the existing intersection;
- Removing enough of the pavement section to encompass the entire problem; and
- Designing and reconstructing with a high performance hot mix asphalt mix design especially formulated for high traffic volume intersections.

8.8 Performance Characteristics of Existing Intersections

The AASHTO Joint Task Force on Rutting (1987) identified three types of rutting:

- Rutting in Base, See **Figure 8.1 Rutting in Subgrade or Base**
- Plastic Flow Rutting, See **Figure 8.2 Plastic Flow**
- Rutting in Asphalt Layer, See **Figure 8.3 Rutting in Asphalt Layer**

Figure 8.1 Rutting in Subgrade or Base shows a weak subgrade or base will expedite damage in all pavements.

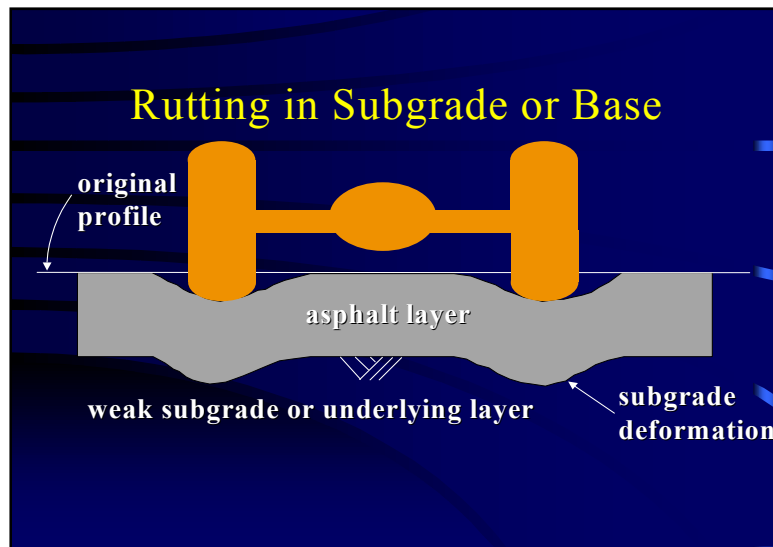

Figure 8.1 Rutting in Subgrade or Base

Figure 8.2 Plastic Flow shows plastic flow can result for various reasons that include the following:

- High pavement temperatures;
- Improper materials and mixture design;
- Rounded aggregate;
- Too much binder and/or filler; and

- Insufficient or too high of VMA

Plastic flow or deformation in the asphalt layer occurs during warm summer months when pavement temperatures are high. At intersections, stopped and slow moving traffic allow exhaust to elevate asphalt surface temperatures even higher. Dripping engine oil and other vehicle fluids are also concentrated at intersections and tend to soften the asphalt. A properly designed mixture with a stiffer asphalt binder and strong aggregate structure will resist plastic deformation of the hot mix asphalt pavement.

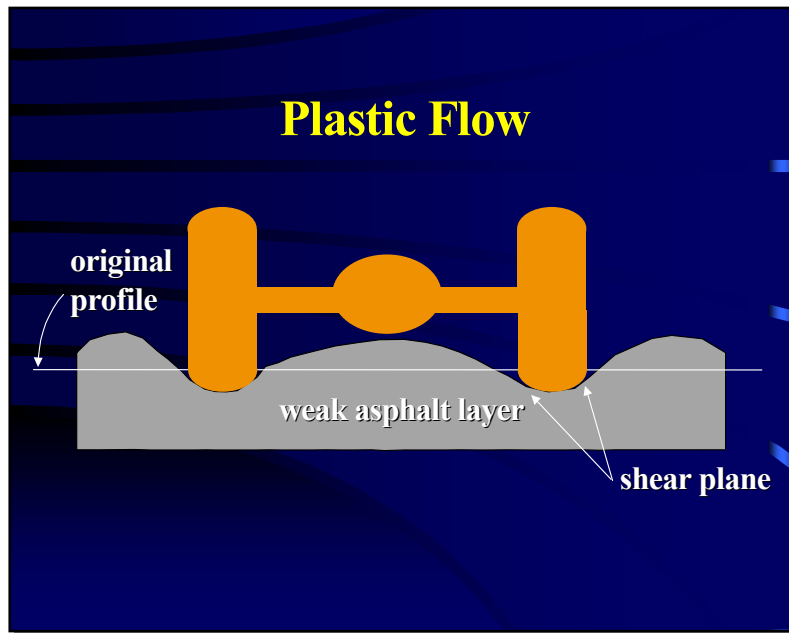

Figure 8.2 Plastic Flow

Figure 8.3 Rutting in Asphalt Layer shows HMA consolidation in the wheel paths. Proper compaction procedures and techniques will ensure that the target density is achieved. To prevent rutting in the asphalt layer, good quality control in the design and production of asphalt mixtures is crucial. Consolidation occurs in the wheel paths because of insufficient compaction of the pavement section.

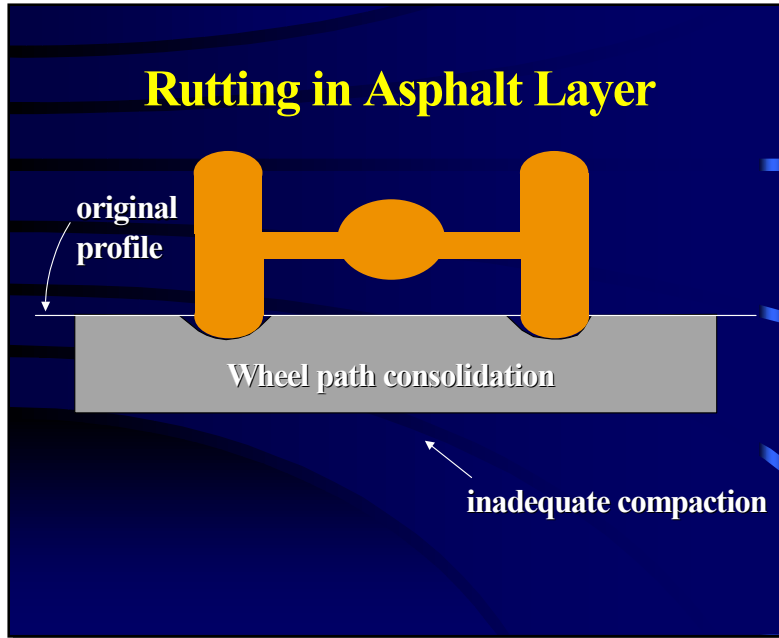

Figure 8.3 Rutting in Asphalt Layer

The following factors can contribute to lack of compaction:

- Insufficient compaction effort within the lower base layers of the pavement section;
- Too few roller passes during paving;
- Hot mix asphalt material cooling prior to achieving target density;
- High fluid content (asphalt moisture, dust);
- Too low of an asphalt content; and
- Lack of cohesion in the mix, tender mix, and gradation problem with the mix can make it hard to compact.

Surface wear is the result of chains and studded tires wearing away the road surface in winter.

8.9 Utilities

Whether it be intersection rehabilitation or new construction, a utility study should be performed to determine if utilities being proposed, or that are already installed, are adequate in size to handle the projected growth within their service area. It should be verified that they are adequately sized and that they have been installed properly, and that utility trenches have been backfilled and compacted properly.

8.10 Rehabilitation Sample Problem

This problem will rehabilitate the Sugarloaf Reservoir intersection using the same temperatures and ESALs that have previously been stated Section **8.6 Reconstruction Sample Problem**. Remember that the ESALs were found using traffic counts from **both** roads leading to the intersection. The intersection has experienced rutting. Coring was done and it was found that

the top two inches of existing pavement have less than 3% air voids. We want to mill off all existing material where the air voids are less than 3%. Therefore, 2 inches of milling will be done.

Nondestructive testing (NDT) is done to find the effective structural number of the existing pavement. Similar to **Eq. 5.1** in **CHAPTER 5**, **Eq. 8.4** was modified to calculate the SN_{ol} :

$$SN_{OL} = SN_f - SN_{eff} \quad \text{Eq. 8.4 (Similar to Eq. 5.1)}$$

For example:

$$SN_f = 5.10$$

$$SN_{eff} = 4.21$$

Where:

SN_{ol} = structural number of the overlay (new construction)

SN_f = structural number needed for the ESALs

SN_{eff} = structural number of the existing pavement (value determined by engineer through NDT)

$$SN_{ol} = 5.10 - 4.21$$

$$SN_{ol} = 0.89$$

Table 3.2 Recommended ai Values for the Structural Layer Coefficients and **Table 3.3 Recommended ai Values for the Base Layer Coefficients**, gives us a guide to do this. The existing asphalt pavement is judged to have a coefficient of 0.22. New HMA will have a coefficient of 0.44. Therefore, 1 inch of new HMA will need to be added after milling just to restore the old pavement structural number of 4.21.

Using **Eq. 3.2** (restated) in **CHAPTER 3**:

$$SN_{ol} = 0.89 = (0.44)(D_1) + a_2D_2m_2 + a_3D_3m_3$$

Solve for D_1

$$D_1 = 2.02 \text{ inches HMA}$$

This should be rounded up to the next closest ¼ inch; therefore, 2.25 inches of new HMA will be required. This is added to what must be put down due to 2" of milling, which is 1 inch of new HMA. The intersection will need 3.25 inches of HMA. The default binder is PG 76-28 for intersection.

CHAPTER 9

PRINCIPLES OF DESIGN FOR RIGID PAVEMENT INTERSECTIONS

9.1 Introduction

The construction and reconstruction of urban intersections utilizing Portland Cement Concrete Pavement (PCCP) need to be given serious consideration by the designer. Portland cement concrete pavement in an intersection offers many advantages, such as long life, reduction in maintenance costs, and elimination of wash boarding and rutting caused by the braking action of all types of traffic especially heavy buses and trucks. Portland cement concrete pavement in an intersection will eliminate the distress caused in asphalt pavements due to rolling traffic loads plus the deceleration and acceleration forces. The *1998 Supplement to the AASHTO Guide for Design of Pavement Structures* is to be used along with the 1993 guide.

9.2 Design Considerations

The distance from the intersection where this deformation such as rutting and shoving occurs varies depending on the traffic situation, types of traffic, speed and stopping distance, and the number of vehicles per lane stopped at the intersection. Several approaches can be used. In some applications, PCCP can extend full width several hundred feet on each side of the intersection. In other situations, the concrete lanes approaching the intersection extend two hundred fifty feet (deceleration lane), while those going away terminate about 60 feet (acceleration lane) beyond the curb return. These approaches can be used for both high volume streets and bus stops. For more moderate traffic, 50 feet to 100 feet on each side is likely to be adequate. This distance can be based on an evaluation of the existing traffic and pavement conditions.

Dowels should be placed in the transverse joints of the dominant traffic stream as well as the cross street transverse joints. Tie bars should be placed in the longitudinal joints of the dominant traffic stream and cross street sections past the intersection.

Class P concrete is recommended for rigid pavements. If it is desirable to fast track an intersection reconstruction, Class E concrete can be used, Class E concrete is designed to achieve minimum of 2500 psi in 12 hours or as required. It is possible to remove existing pavement, recondition the base materials, place Class E concrete and have the roadway open for use in 24 hours.

Table 9.1 Rigid Pavement Intersection Thickness Design Factors
(Table 4.1 Restated)
(1998 AASHTO Supplement Inputs)

Factor	Source
18k ESAL, W18	Division of Transportation Development, requested by the designer specifically for rigid pavement http://www.dot.state.co.us/App_DTD_DataAccess/index.cfm
Reliability Level (%)	Table 1.3, CHAPTER 1
Overall Standard Deviation, S_o	0.34
Initial Serviceability, P_o	Table 1.5, CHAPTER 1
Terminal Serviceability, P_t	Table 1.5, CHAPTER 1
Serviceability Loss, ΔPSI	Table 1.5, CHAPTER 1
Modulus of Subgrade Reaction, k	See CHAPTER 2
Modulus of Rupture, S'_c	Use 650 psi
Modulus of Elasticity, E_c	Use 3,400,000 psi
Poisson's Ratio for Concrete, μ	Use 0.15
Joint Spacing, L	Section 4.6, CHAPTER 4
Base Modulus, E_b	Section 4.7, CHAPTER 4
Slab/Base Friction Coefficient, f	Section 4.8, CHAPTER 4
Base Thickness, H_b	Section 4.9, CHAPTER 4
Effective Temperature Differential, °F a) Mean Annual Wind Speed, WIND b) Mean Annual Temperature, TEMP c) Mean Annual Precipitation, PRECIP	Section 4.10, CHAPTER 4
Lane Edge Support Condition, E	Section 4.11, CHAPTER 4

9.3 Design Period

The destructive effect of repeated wheel loads and the impacts of braking action are the major factors that contribute to the failure of highway pavement in the intersections. Since both the magnitude of the load, the number of its repetitions and the braking actions are important, provision is made in the design procedure to allow for the effects of braking actions, the number and weight of all axle loads expected during the design period. The design period for new rigid pavement construction and reconstruction is 30 years.

9.4 Traffic Analysis

When two roadways intersect there are two streams of traffic that exert loads on the pavement. The total of the design 18k ESALs for each stream of traffic should be used in the calculation for pavement thickness in the intersection. In any pavement, the destructive effect of repeated wheel loads is the major factor that contributes to the failure of highway pavement. Design traffic will be the 18,000-pound equivalent single axle loads (18k ESAL) and can be obtained from the Traffic Analysis Unit of the Division of Transportation Development, http://www.dot.state.co.us/App_DTD_DataAccess/Traffic/index.cfm?fuseaction=TrafficMain&MenuType=Traffic. The actual projected traffic volumes for each category are weighted by the appropriate load equivalence factors and converted to a cumulative total 18k ESAL number to be entered into the rigid pavement design equation. The designer must inform the Traffic Analysis Section that the intended use of the 18k ESAL is for rigid pavement design since different load equivalence factors apply to different pavement types.

Another source of traffic load data can be weigh-in-motion data. Although these devices are not as plentiful, they are usually more accurate for measurements of traffic load in the present year. Projections for future traffic loads can be calculated similarly using growth factors provided by the DTD Traffic Analysis Unit.

9.5 Design Methodology

Design methodologies for rigid intersections are similar to those found in Section 4.14 **Design Methodology for PCCP** in CHAPTER 4.

9.6 Intersection Sample Problem

This example uses the intersection of two fictitious arterial streets, Sugarloaf Boulevard and Sourdough Avenue. The intersection will be in the Denver area. The 20-year design 18k ESAL for Sugarloaf Boulevard is 3,095,415 and 1,409,089 for Sourdough Avenue for flexible pavement. For rigid pavement, the 30-year 18k ESAL values are 3,999,437 and 1,820,617 respectively. Thus for this example the intersection will be designed for 5,820,054 18k ESAL. A preliminary soil survey characterized the subgrade soil as A-7-5(23) according to AASHTO M 145. To provide adequate drainage, the intersection will have a six-inch base of good quality aggregate base course, storm water sewers, curb and gutters. Dowels will be placed in the transverse joints and tie bars will be placed in the longitudinal joints.

The following steps determine the required design thickness for a rigid pavement structure in addition to the information presented above:

Step 1. Determine the Intersection Design Traffic Loading (18k ESALs).

See Sections 9.4 and 9.6 for traffic load information. From the given data, the 30-year ESAL value is 5,820,054.

Step 2. Determine the Reliability Factor (%).

This road is a rural principal arterial. **Table 1.3 Reliability (Risk)**, shows the reliability for this road should be chosen from 70% – 95%. This is a high profile road, so the reliability is set to 95%.

Step 3. Determine the Overall Deviation (S_o).

This is always set to 0.34 for CDOT rigid pavement designs.

Step 4. Calculate the Serviceability Loss (ΔPSI).

The Serviceability Section in **CHAPTER 1** of this Pavement Design Manual guides us to set the terminal serviceability of this volume road to 2.5. The initial serviceability is usually set at 4.5. The serviceability loss is the difference between the initial and final serviceability that is equal to $4.5 - 2.5 = 2.0$.

Step 5. Determine the Modulus of Subgrade Reaction, k and the effective k -value of the Subgrade.

See **Figure 2.6 k-value vs. Soil Classification** and adjust accordingly to obtain an effective k -value as shown in **CHAPTER 2**. An alternative is to use the tab "K-value Information" of the 1998 Supplement software.

Step 6. Determine the Modulus of Rupture (S'_c).

This is a CDOT default value set at 650 psi.

Step 7. Determine the Modulus of Elasticity (E_c).

This is a CDOT default value set at 3,400,000 psi.

Step 8. Joint Spacing (L).

A CDOT default value length of 15 feet will be set as per the Standard Plan *M-412-1 Concrete Pavement Joints*.

Step 9. Base Modulus (E_b).

The intersection will have a six-inch base of good quality aggregate base course. The "Information" tab of the 1998 Supplement software has a range of 15,000 to 45,000 psi aggregate base modulus of elasticity tabulated in Table 14. In this example, a value of 30,000 psi will be set.

Step 10. Slab/Base Friction Coefficient (f).

Using the same Table 14, a mean peak friction coefficient of 1.4 will be set.

Step 11. Base Thickness (H_b).

The sample problem stated six-inches will be constructed as the base thickness.

Step 12. Effective Positive Temperature Differential ($^{\circ}\text{F}$).

Table 15 of the 1998 Supplement software lists the mean annual wind speed, temperature, and precipitation for the Denver area. The values are WIND = 8.8 mph, TEMP = 50.3 $^{\circ}\text{F}$, and PRECIP = 15.3 inches. 8.73 $^{\circ}\text{F}$ is the calculated positive temperature differential.

Step 13. Lane Edge Support Condition (E).

The curb and gutter acts as a tied shoulder. Therefore, a value of 0.94 is set for a conventional 12 wide traffic lane with the tied shoulder.

Step 14. Calculate the thickness of PCCP (D).

These values can also be input into the 1998 Supplement software to calculate the PCCP thickness.

Rigid Pavement Design - Based on AASHTO Supplemental Guide	
II. Design	
<p>Serviceability</p> <p>Initial Serviceability, P1: <input style="width: 50px;" type="text" value="4.5"/></p> <p>Terminal Serviceability, P2: <input style="width: 50px;" type="text" value="2.5"/></p> <p>PCC Properties</p> <p>28-day Mean Modulus of Rupture, (S_r): <input style="width: 50px;" type="text" value="650"/> psi</p> <p>Elastic Modulus of Slab, E_s: <input style="width: 50px;" type="text" value="3,400,000"/> psi</p> <p>Poisson's Ratio for Concrete, m: <input style="width: 50px;" type="text" value="0.15"/></p>	<p>Pavement Type, Joint Spacing</p> <p><input checked="" type="radio"/> JPCP</p> <p><input type="radio"/> JRCP</p> <p><input type="radio"/> CRCP</p> <p style="text-align: right;">Joint Spacing:</p> <p style="text-align: right;"><input style="width: 50px;" type="text" value="15.0"/> ft</p> <hr/> <p style="text-align: right;">Effective Joint Spacing: <input style="width: 50px;" type="text" value="180"/> in</p>
<p>Table 14</p> <p>Base Properties</p> <p>Elastic Modulus of Base, E_b: <input style="width: 50px;" type="text" value="30,000"/> psi</p> <p>Design Thickness of Base, H_b: <input style="width: 50px;" type="text" value="6.0"/> in</p> <p>Slab-Base Friction Factor, f: <input style="width: 50px;" type="text" value="1.4"/></p> <p>Reliability and Standard Deviation</p> <p>Reliability Level (R): <input style="width: 50px;" type="text" value="95.0"/> %</p> <p>Overall Standard Deviation, S_o: <input style="width: 50px;" type="text" value="0.34"/></p>	<p>Edge Support</p> <p><input type="radio"/> Conventional 12-ft wide traffic lane</p> <p><input checked="" type="radio"/> Conventional 12-ft wide traffic lane + tied PCC</p> <p><input type="radio"/> 2-ft widened slab w/conventional 12-ft traffic lane</p> <hr/> <p style="text-align: right;">Edge Support Factor: <input style="width: 50px;" type="text" value="0.94"/></p>
<p>Table 15</p> <p>Climatic Properties</p> <p>Mean Annual Wind Speed, WIND: <input style="width: 50px;" type="text" value="8.8"/> mph</p> <p>Mean Annual Air Temperature, TEMP: <input style="width: 50px;" type="text" value="50.3"/> °F</p> <p>Mean Annual Precipitation, PRECIP: <input style="width: 50px;" type="text" value="15.3"/> in</p> <p>Subgrade k-Value</p> <p>Calculate Seasonal k-Value: <input style="width: 50px;" type="text" value="62"/> psif/in</p> <p>Design ESALs</p> <p>Calculate Traffic: <input style="width: 50px;" type="text" value="5.8"/> million</p>	<p>Sensitivity Analysis</p> <p>Slab Thickness used for Sensitivity Analysis: <input style="width: 50px;" type="text" value="9.14"/> in</p> <div style="border: 1px solid gray; padding: 2px; width: fit-content; float: right; font-size: 8px;">Slab Thickness Sensitivity</div> <p><input type="radio"/> Modulus of Rupture</p> <p><input type="radio"/> Elastic Modulus (Slab)</p> <p><input type="radio"/> Elastic Modulus (Base)</p> <p><input type="radio"/> Base Thickness</p> <p><input type="radio"/> k-Value</p> <p><input type="radio"/> Joint Spacing</p> <p><input checked="" type="radio"/> Reliability</p> <p><input type="radio"/> Standard Deviation</p>
<p>Calculated Slab Thickness for Above Inputs: 9.14 in</p> <p style="text-align: right; margin-top: 10px;"><input type="button" value="Calculate"/></p> <p style="text-align: right; margin-top: 10px;"><input type="button" value="Faulting Check"/></p>	

Figure 9.1 Rigid Pavement Intersection Example Input/Output Values

Faulting							
<p style="text-align: center;">DOWELED PAVEMENT</p> <p>Dowel Diameter: <input type="text" value="1.25"/> in K_d: <input type="text" value="1,500,000"/> psif/in E_s: <input type="text" value="29,000,000"/> psi</p> <p>Base/Slab Frictional Restraint <input type="radio"/> Stabilized Base <input checked="" type="radio"/> Aggregate Base or LCB w/ bond breaker</p> <p>ALPHA: <input type="text" value="0.000006"/> /°F TRANGE: <input type="text" value="130.0"/> °F e_s: <input type="text" value="0.00015"/> strain D: <input type="text" value="9.14"/> in P: <input type="text" value="9,000"/> lbf T: <input type="text" value="0.45"/></p> <p>Base Type: <input type="radio"/> Stabilized Base <input checked="" type="radio"/> Unstabilized Base</p> <p><input type="button" value="FI Table"/> FI: <input type="text" value="550"/> °F-days CESAL: <input type="text" value="5.82"/> million Age: <input type="text" value="22.0"/> years C_d: <input type="text" value="1.00"/> <input type="button" value="Drainage Coeff. Table"/></p> <p>Faulting (doweled)</p> <p><input type="button" value="Calculate"/> <input style="background-color: yellow;" type="text" value="0.05"/> in</p> <p>Faulting Check - PASS</p> <p><input type="button" value="Input Form"/> <input type="button" value="Results"/></p>	<p style="text-align: center;">NONDOWELED PAVEMENT</p> <p><input type="button" value="Days90 Table"/> Days90: <input type="text" value="30"/> days D: <input type="text" value="9.14"/> in</p> <p>Base Type: <input type="radio"/> Stabilized Base <input checked="" type="radio"/> Unstabilized Base</p> <p><input type="button" value="FI Table"/> FI: <input type="text" value="550"/> °F-days CESAL: <input type="text" value="5.82"/> million Age: <input type="text" value="22.0"/> years C_d: <input type="text" value="1.00"/> <input type="button" value="Drainage Coeff. Table"/></p> <p>Faulting (nondoweled)</p> <p><input type="button" value="Calculate"/> <input style="background-color: yellow;" type="text" value="0.10"/> in</p> <p>Faulting Check - FAIL</p> <p><input type="button" value="Input Form"/> <input type="button" value="Corner Break Check"/></p>						
Recommended critical mean joint faulting levels for design (Table 28)							
<table border="1" style="margin: auto; border-collapse: collapse;"> <thead> <tr> <th style="padding: 5px;">Joint Spacing</th> <th style="padding: 5px;">Critical Mean Joint Faulting</th> </tr> </thead> <tbody> <tr> <td style="padding: 5px;">< 25 ft</td> <td style="padding: 5px;">0.06 in</td> </tr> <tr> <td style="padding: 5px;">> 25 ft</td> <td style="padding: 5px;">0.13 in</td> </tr> </tbody> </table>		Joint Spacing	Critical Mean Joint Faulting	< 25 ft	0.06 in	> 25 ft	0.13 in
Joint Spacing	Critical Mean Joint Faulting						
< 25 ft	0.06 in						
> 25 ft	0.13 in						

Figure 9.2 Rigid Pavement Intersection Example Fault Check Values

With this information, a designer would typically choose to require 9-1/2 inches throughout the length of Sugarloaf Boulevard and 8 inches on Sourdough Avenue. Dowels and tie-bars for Sourdough Avenue past intersection will be used.

9.7 Rigid Pavement Joint Design for Intersections

Joints are used in portland cement concrete pavement to aid construction and to eliminate random cracking. There are two types of longitudinal joints. Longitudinal weakened plane joints relieve stresses and control longitudinal cracking. Longitudinal construction joints perform the same functions and also divide the pavement into suitable paving lanes.

Longitudinal weakened plane joints are spaced to coincide with lane markings, these joints are formed by sawing the hardened concrete. The joint should be sawed to a depth of $\frac{1}{3}$ the pavement thickness.

Longitudinal construction joints should be tied with deformed reinforcing steel bars to hold the slabs in vertical alignment. Stresses in a slab are reduced when the slab is tied to adjacent slabs. Keyed joints may be used in a longitudinal construction joint, but tying the slabs is preferable.

The key may be formed by attaching a keyway at the mid-depth of a side form. With a slip form paver, the keyway can be formed as the paver advances. For detailed layout refer to the CDOT M&S Standards.

Transverse joints are spaced at short intervals in the slab. A maximum of 15 feet is recommended to insure crack control, or 2 to 2.5 times the slab thickness in inches and reading the calculation in feet. For example, a 6-inch slab or less will require a maximum of 12-foot transverse joint spacing (2×6 inches = 12 feet) and a 6-inch slab or greater will require a maximum of 15-foot transverse joint spacing (2.5×6 inches = 15 feet). The joint should be sawed to a depth of at least $\frac{1}{3}$ the pavement thickness.

Dowell bars in the first three transverse joints where portland cement concrete pavement abuts asphalt pavement can prevent progressive slab movement.

Expansion joints are not required except at intersections.

The following summarizes the general design guides and information for constructing rigid pavement joints:

Joints are used in portland cement concrete pavement to aid construction and to minimize random cracking. Odd shaped slabs should be avoided. Acute angles of less than 60 degrees should be avoided. Longitudinal joint spacing should not exceed 14 feet. Transverse joint spacing should be at regular intervals no more than 15 feet. Thinner slabs tend to crack at closer intervals than thicker slabs. Long narrow slabs tend to crack more than square slabs. All contraction joints must be continuous through the curb and have a depth equal to $\frac{1}{3}$ of the pavement thickness. Transverse joints should be carried through the curb. Expansion joint filler must be full-depth and extend through the curb. Longitudinal joints should be tied to hold adjacent slabs in vertical alignment as well as curb and gutter.

The normal backfill behind the curb constrains the slabs and holds them together. Offsets at radius points should be at least 18 inches wide. Minor adjustments in joint location made by

skewing or shifting to meet inlets and manholes will improve pavement performance. When pavement areas have many drainage structures, particularly at intersections, place joints to meet the structures, if possible. Depending on the type of castings, manhole and inlet frames may be boxed out and isolated using expansion joint filler. The frames may be wrapped with expansion joint filler or the frames may be cast rigidly into the concrete.

CDOT designs their PCCP using the JPCP (Jointed Plain Concrete Pavement) method. For a detailed illustration, see *CDOT's Standard Plans (M & S) Standards July 2006, M-412-1*.

Following the previous design of a new intersection near Sugarloaf Reservoir, the following steps and points should be followed to design slabs and location of joints:

Step 1. Draw all edge of pavement lines on a plan view. Plot all utility manholes, catch basins, water valves, etc. on the plan view. See **Figure 9.3**.

Step 2. Draw lines, which define the median, travel lanes and turning lanes. These lines define the longitudinal joints. See **Figure 9.4**.

Step 3. Determine locations in which the pavement changes width, such as channelization tapers, turning lane tapers, intersection radius returns, etc. Joints at these locations are necessary to isolate irregular shapes. Triangles or circles, which are left intact with a rectangular portion of a slab, will create a plane of weakness that will break during temperature movements of the slab. Concrete simply likes to be square. See **Figure 9.5**.

Step 4. Draw transverse lines through each manhole or other utility. Joints need to be placed through utility structures in the pavement, or movement of the pavement will be restricted and cracking will result. When structures are located near a joint placed according to the steps above, isolation can be provided by adjusting the joint to meet the structure. By doing this, numerous short joints will be avoided. Add transverse joints at all locations where the pavement changes width, extending the joints through the curb and gutter. Create an "intersection box". Do not extend joints that intercept a circumference-return-return line, except at the tangent points. The joints at the tangent point farthest from the mainline becomes an isolation joint in the cross road for T- and unsymmetrical intersections. See **Figure 9.6**.

Step 5. The intermediate areas between the transverse joints placed in steps 3 through 4 may also require transverse joints. These joints are placed using a standard joint spacing. There is an old rule of thumb for joint placement in plain concrete pavements that says that the joint spacing, in feet, should be no greater than two to two and a half times the slab thickness, in inches. However, in no case should the joint spacing exceed 15 feet. See **Figure 9.7**.

Step 6. Where an intersection is encountered, intermediate joints must be placed. This is done by extending the radius line of each turning radius three feet beyond the back of curb. The extension is made at approximately the 45° line for small radii and at approximately the 30° and 60° lines for larger radii. Joints are then connected to each of these points.

Step 7. Expansion joints are needed adjacent to any structure, i.e., bridges, buildings, etc., and at T intersections. T intersections are isolated at the radius return to the intersecting street. The same layout discussed in Step 6 is used out to that location.

Step 8. If there are manholes or other structures, which cannot be intersected by a joint, they must be isolated. These structures can be isolated by boxing out the structure during paving. Manholes can also be isolated by using a telescoping manhole, which can be poured integral with the pavement. The area around the structure should be reinforced to control cracking. The joints that form a box out should be expansion joints to allow some movement.

Step 9. Check the distances between the “intersection box” and the surrounding joints. See **Figure 9.8**.

Step 10. Lightly extend lines from the center of the curves) to the points defined by the “intersection box” and point(s) along any island. Add joints along these radius lines. Finally, make slight adjustments to eliminate doglegs in mainline edges. See **Figure 9.9**.

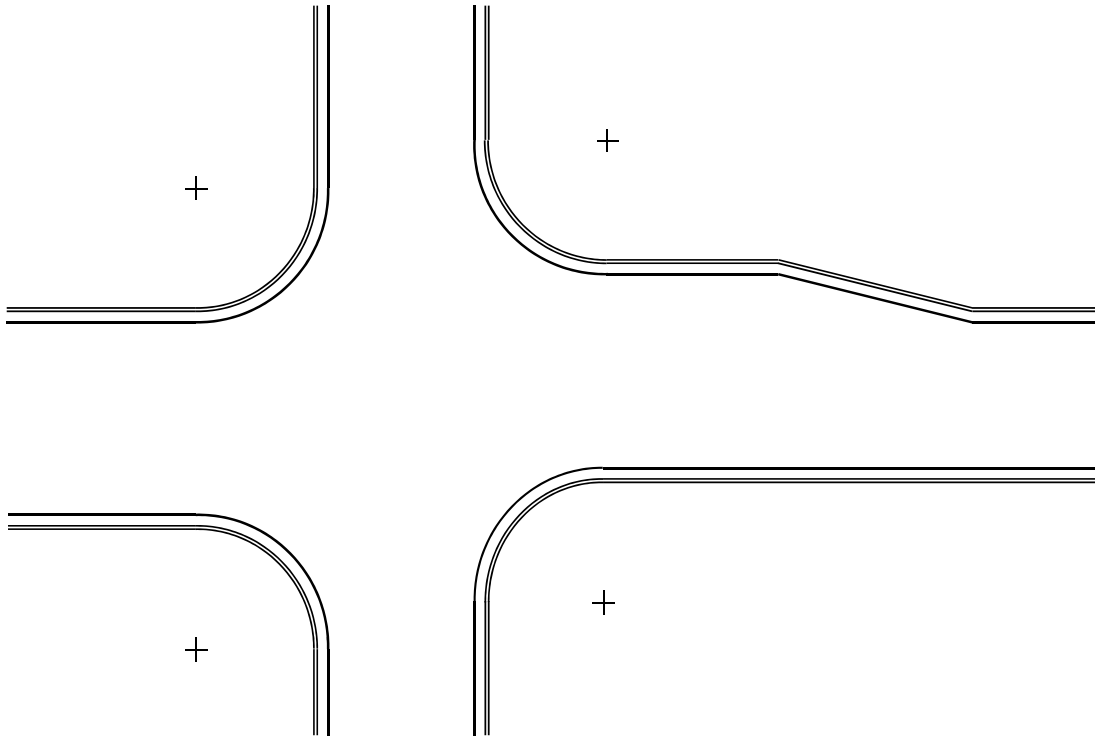

Figure 9.3 Typical Joint Layout for a Rigid Pavement Intersection
(Shows lane configuration, Step 1)

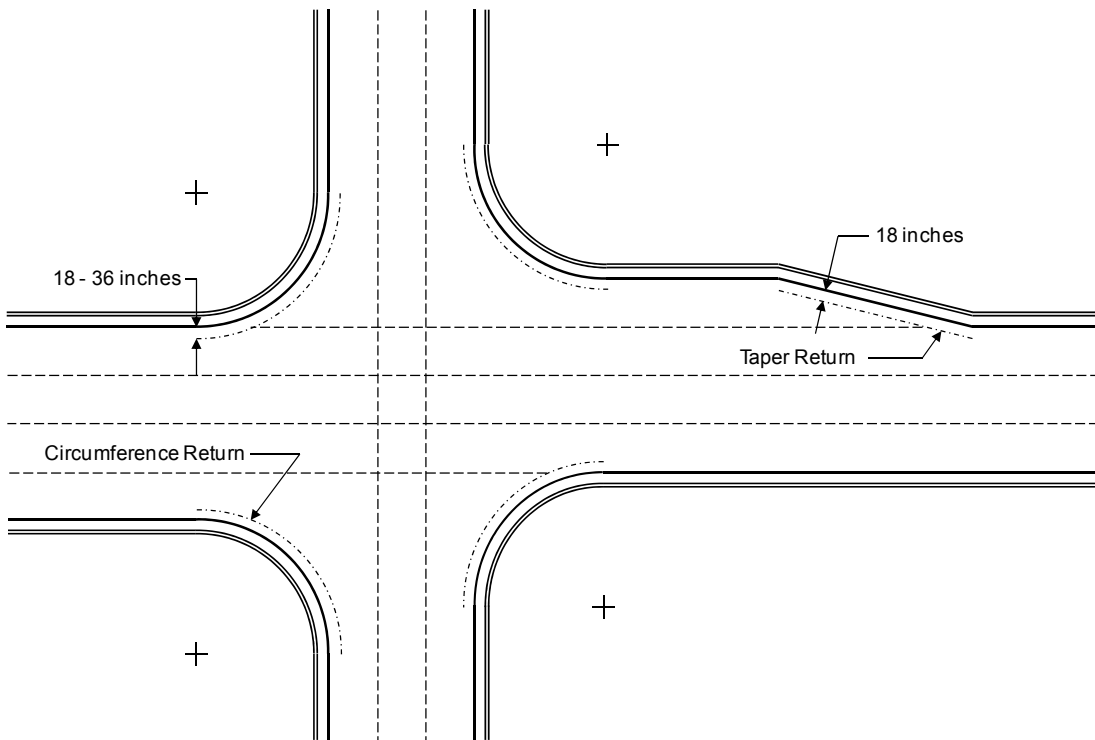

Figure 9.4 Typical Joint Layout for a Rigid Pavement Intersection
(Shows lane configuration, Step 2)

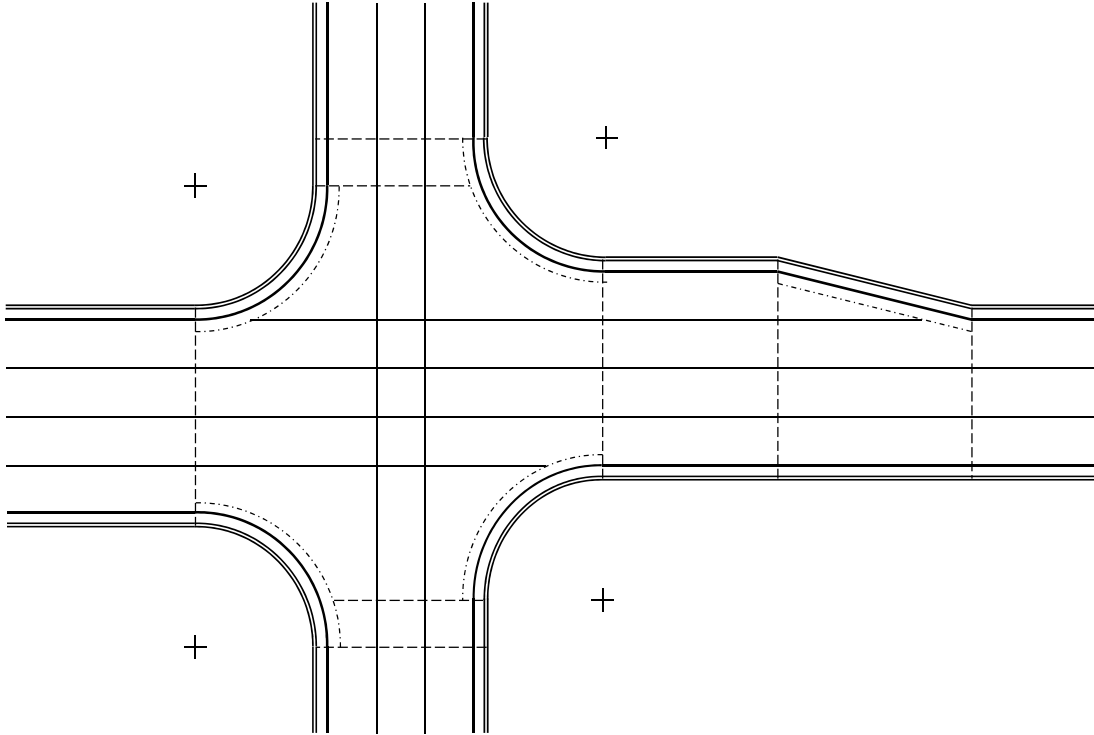

Figure 9.5 Typical Joint Layout for a Rigid Pavement Intersection
(Shows lane configuration, Step 3)

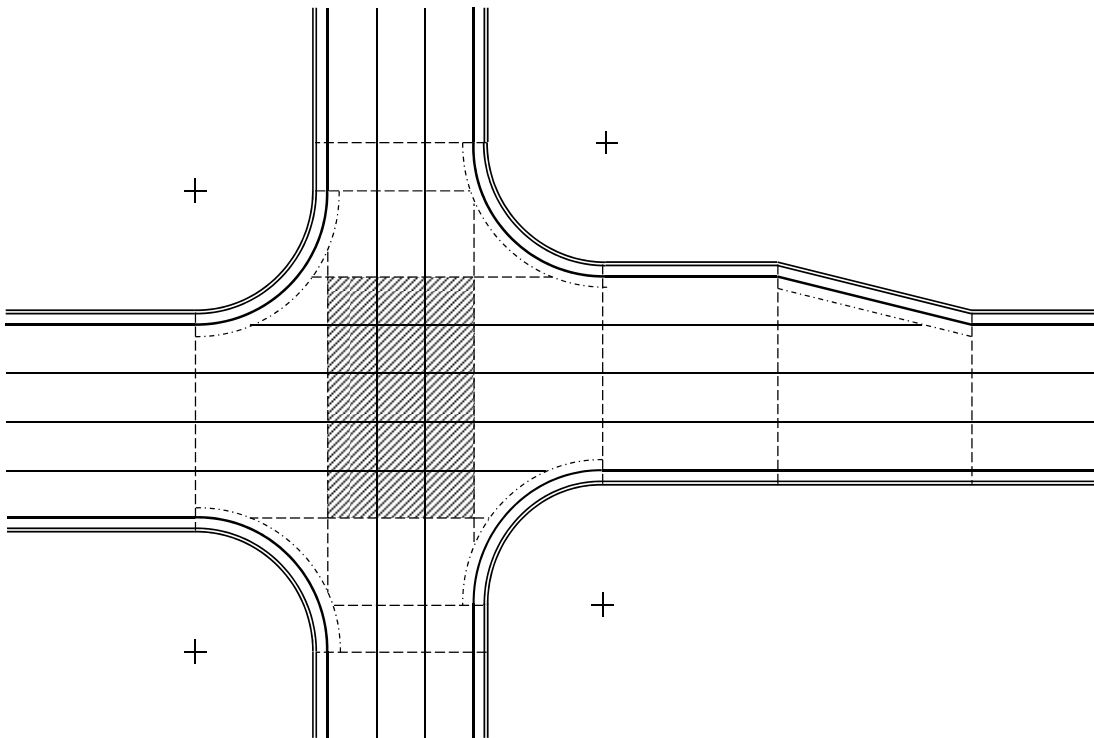

Figure 9.6 Typical Joint Layout for a Rigid Pavement Intersection
(Shows lane configuration, Step 4)

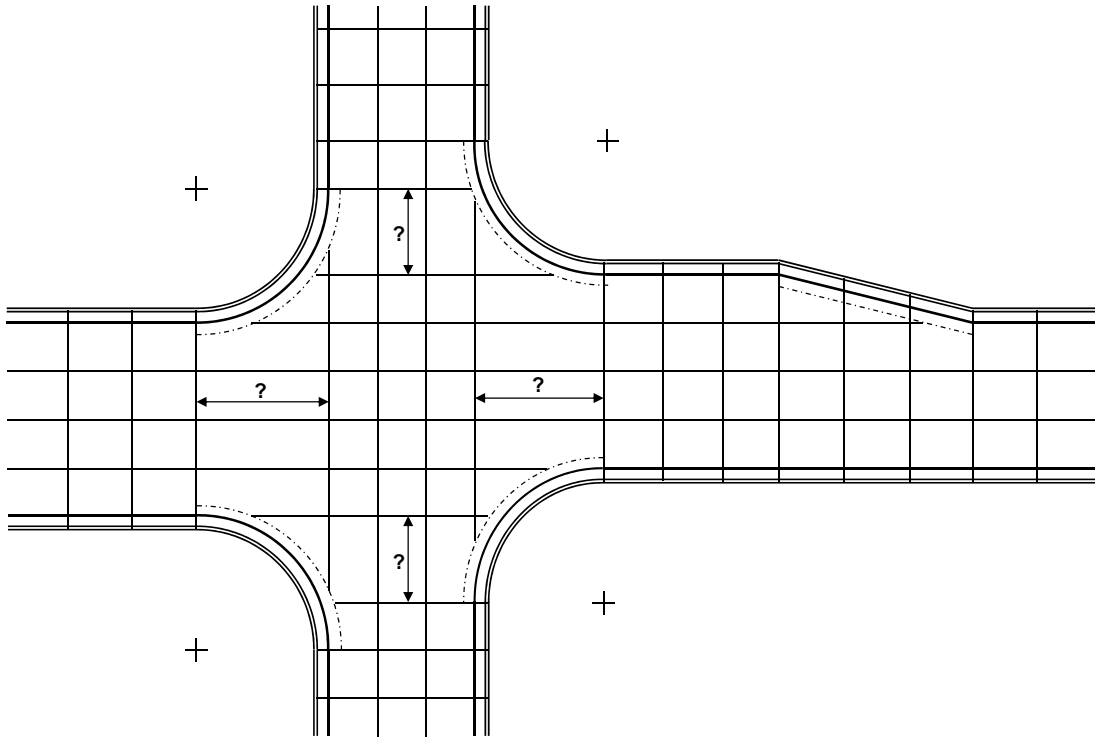

Figure 9.7 Typical Joint Layout for a Rigid Pavement Intersection
(Shows lane configuration, Steps 5 thru 8)

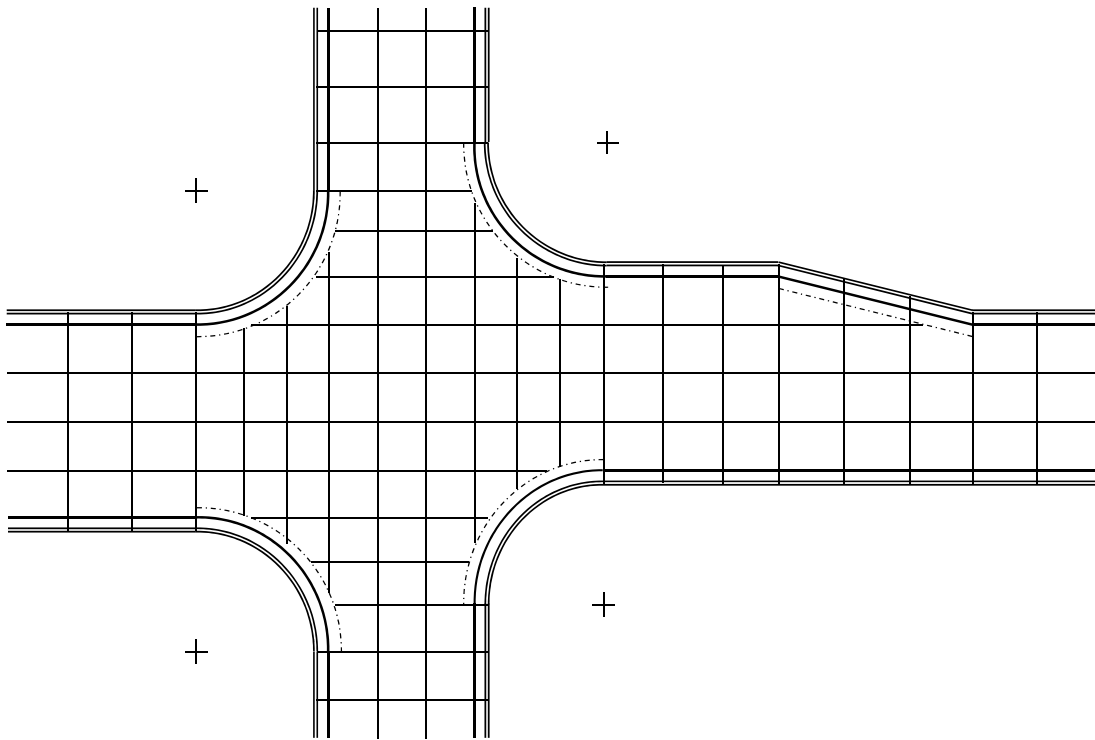

Figure 9.8 Typical Joint Layout for a Rigid Pavement Intersection
(Shows lane configuration, Step 9)

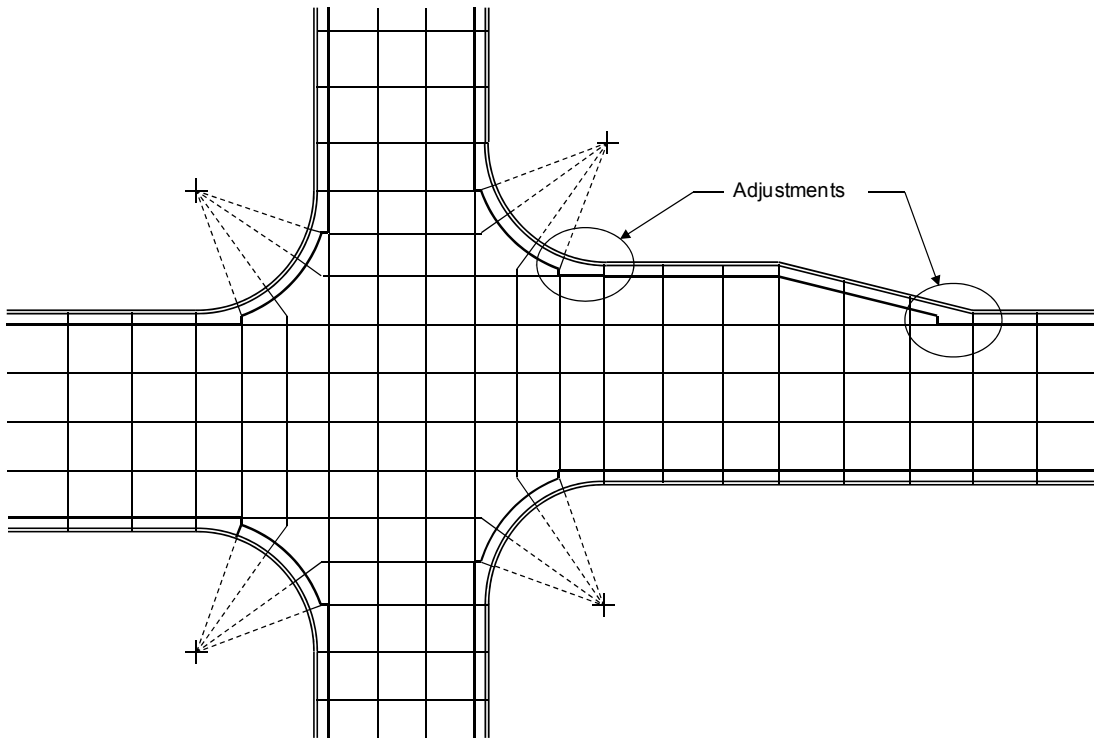

Figure 9.9 Typical Joint Layout for a Rigid Pavement Intersection
(Shows lane configuration, Steps 10)

9.8 Rigid Pavement Roundabout Joint Design

Roundabouts are circular intersections with specific design and traffic control features. These features include yield control of all entering traffic, channelized approaches, and appropriate geometric curvature to ensure that travel speeds on the circulatory roadway are typically less than 30 mph. Thus, roundabouts are a subset of a wide range of circular intersection forms. Circular intersections that do not conform to the characteristics of modern roundabouts are called “traffic circles” (1).

Roundabouts have been categorized according to size and environment to facilitate discussion of specific performance or design issues. There are six basic categories based on environment, number of lanes, and size:

- Mini-roundabouts
- Urban compact roundabouts
- Urban single-lane roundabouts
- Urban double-lane roundabouts
- Rural single-lane roundabouts
- Rural double-lane roundabouts

The most likely categories CDOT will use are the Urban and Rural double-lane roundabouts. The double-lane roundabouts can be expected to handle the increased traffic volumes of a state highway. The following chapter sections will address the double-lane categories.

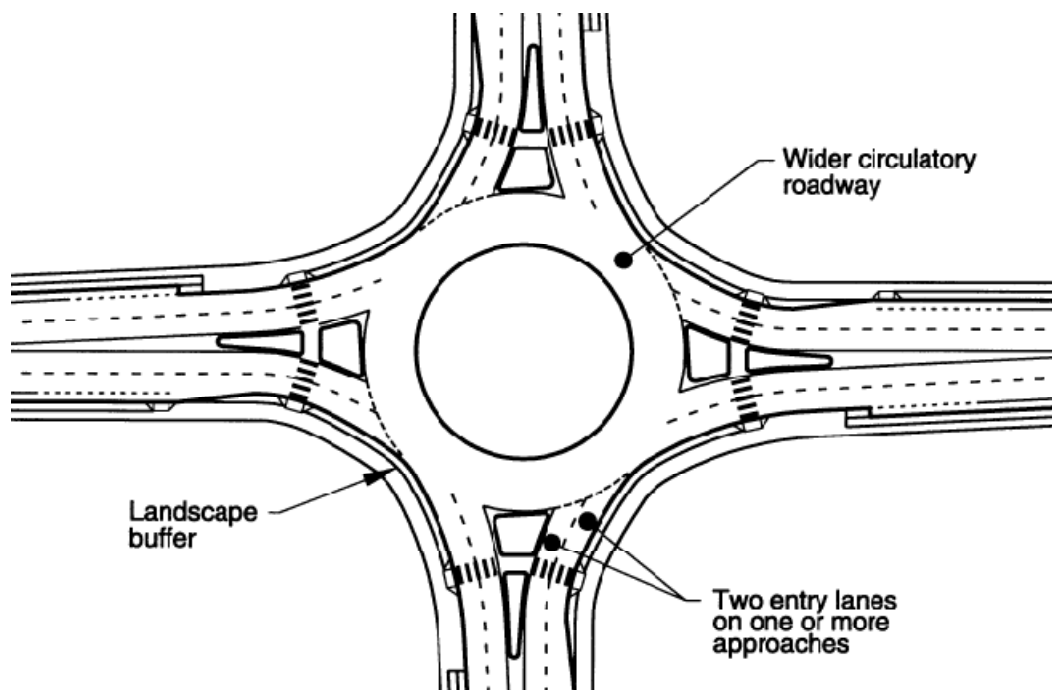

Figure 9.10 Typical Urban Double-lane Roundabout
(From Exhibit 1-11 typical urban double-lane roundabout,
Roundabouts: An Informal Guide, FHWA-RD-00-067 (1))

9.8.1 General Joint Layout

The pavement designer may choose from two layout approaches. One is to isolate the circle from the legs and the other is to use a pave through layout. Once the approach layout is decided on, a sequencing of step-by-step procedure is utilized. The sequencing is similar to the traditional intersection layout as outlined in **Figure 9.10 Typical Urban Double-lane Roundabout**.

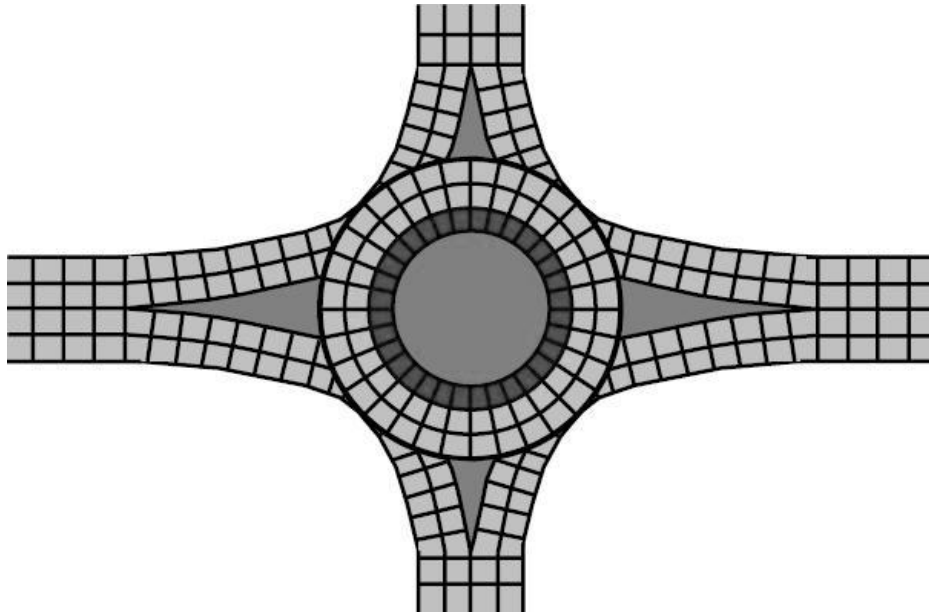

Figure 9.11 Isolating the Circle

(From Figure 1, Joint Layout for Roundabout, Isolating Circle from Legs,
Concrete Roundabouts: Rigid Pavement Well-Suited for Increasing Popular Intersection Type, ACPA,
June 2005 (2))

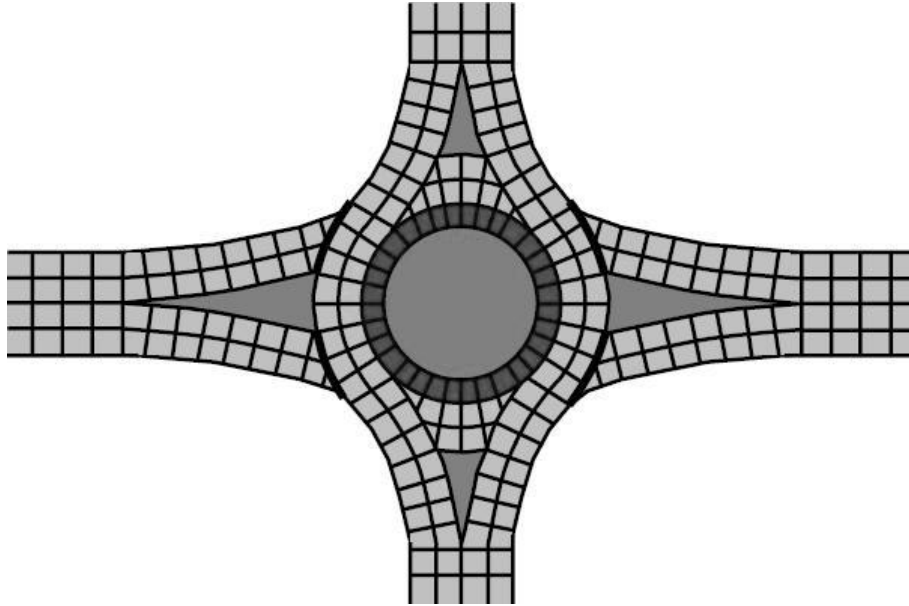

Figure 9.12 Pavement Joint Layout

(From Figure 2, Joint Layout for Roundabout, "Pave-Through" Option,
Concrete Roundabouts: Rigid Pavement Well-Suited for Increasing Popular Intersection Type, ACPA,
June 2005 (2))

ACPA recommends a six-step process on constructing joint layouts. **Figure 9.13 Six Step Jointing Layout** is an example illustrating an isolating circle for the general layout.

9.8.2 Details of Joints

Additional detailing of the joints is necessary to achieve long lasting, crack free pavements. Slab shapes should be square or in roundabouts pie shaped. Keep angles greater than 60° by using doglegs through curve radius points. The width of slabs should be a maximum of 14 feet and their lengths a maximum of 15 feet. Typically, on state highway projects, load transfer devices (dowel bars) and tie-bars are used. Their use must be detailed throughout the roundabout intersection as well. Refer to **Figure 9.14 Dowel Bar Locations in the Transverse Joints** for shape, size and dowel bar locations in the transverse joints. The dowel bars should be evenly distributed across the lane width. The tie-bars are located in the longitudinal joints as shown in **Figure 9.15 Tie-bar Locations in the Longitudinal Joints**. Tie bar requirements and pull out testing is specified in Section 412.13 of *CDOT Standard Specifications for Road and Bridge Construction* specifications (3). Dowel bar and tie-bar joints to be used in the roundabouts are detailed in *CDOT Standard Plan M-412-1, Concrete Pavement Joints*. The transverse joints are extended through the curb and gutter sections. Normally the curb and gutter sections are jointed at 10 feet. Because the curb and gutter sections are tied or poured monolithically and the thickness is the same as the pavement thickness, the jointing can be increased to match the slab joint spacing.

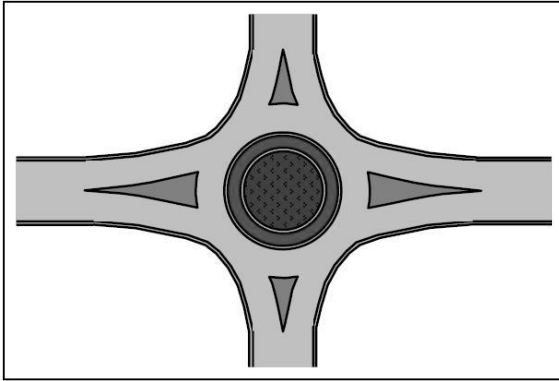

Step 1. Draw all pavement edge and back-of-curb lines in the plan view. Draw locations of all manholes, drainage inlets, and valve covers so that joints can intersect these.

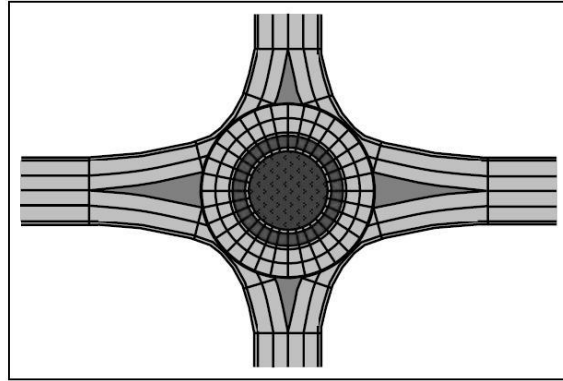

Step 4. On the legs, add transverse joints at all locations where a width change occurs in the pavement (at bullnose of median islands, begin & end of curves, tapers, tangents, curb returns, etc.). Extend these joints through the back of the curb & gutter.

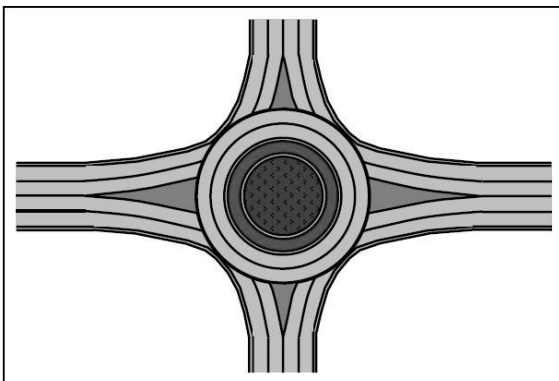

Step 2. Draw all lane lines on the legs and in the circular portion. If isolating circle from legs, do not extend these through the circle. If using "pave-through" method, determine which roadway will be paved through. Make sure no distance is greater than the maximum recommended width.

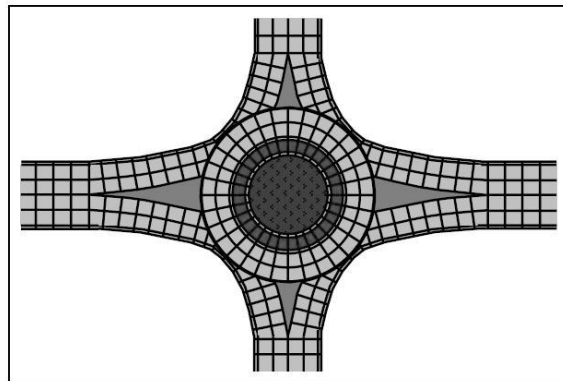

Step 5. Add transverse joints beyond & between those added in Step 4. Space joints out evenly between other joints, making sure to not violate maximum joint spacing.

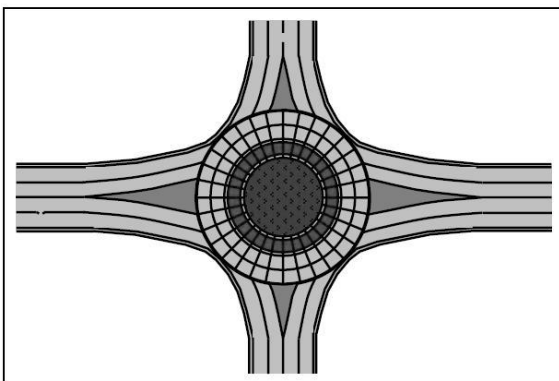

Step 3. In the circle, add "transverse" joints radiating out from the center of the circle. Make sure that the largest dimension of a pie-shaped slab is smaller than the maximum recommended. Extend these joints through the back of the curb & gutter.

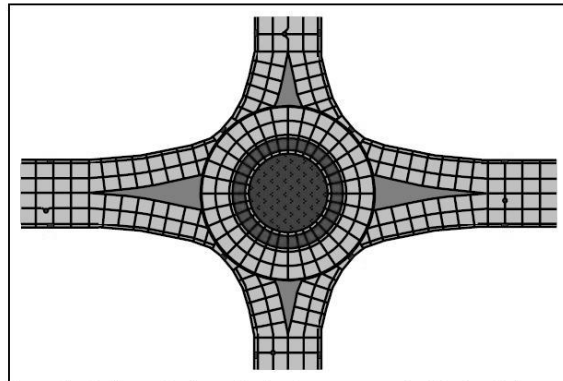

Step 6. Make adjustments for in-pavement objects, fixtures, and to eliminate L-shapes, small triangular slabs, etc.

Figure 9.13 Six Step Jointing Layout

(From Page 3, Six Steps, *Concrete Roundabouts: Rigid Pavement Well-Suited for Increasing Popular Intersection Type*, ACPA, June 2005 (2))

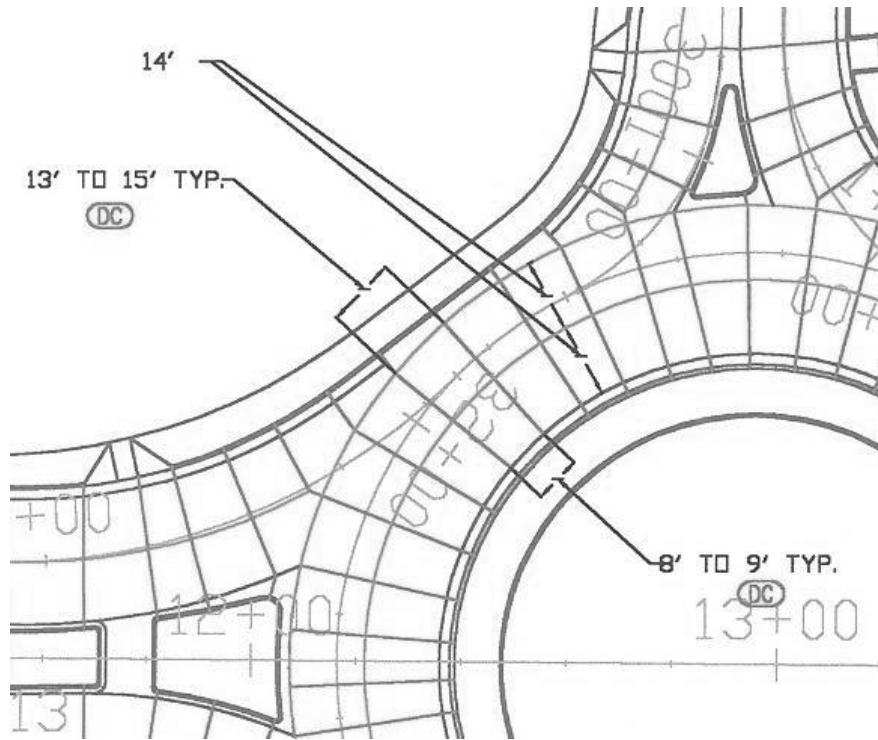

Figure 9.14 Dowel Bar Locations in the Transverse Joints

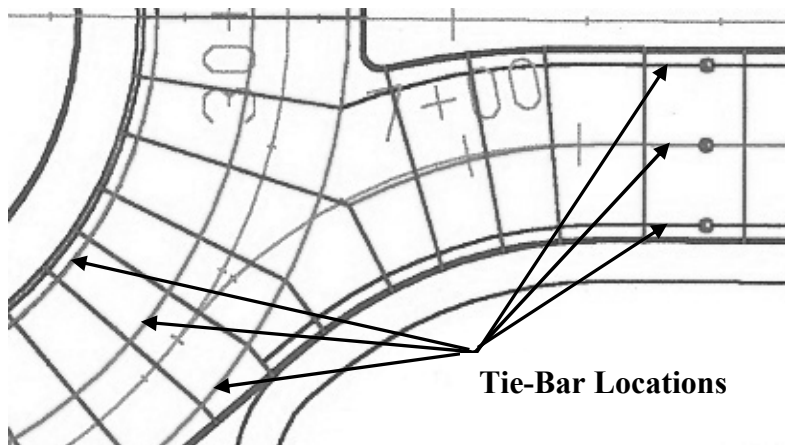

Figure 9.15 Tie-bar Locations in the Longitudinal Joints

9.8.3 Typical Section

Figure 9.16 Typical Section of an Urban Double-lane Roundabout shows the structural components of the pavement system. The concrete pavement thickness is calculated by adding the 18 k ESALs for each stream of traffic going through the roundabout intersection. Parts of the structural components are the curb and gutter sections. The curb and gutter sections are detailed in CDOT *Standard Plan M-609-1, Curb, Gutters, and Sidewalks*. It is recommended to use Curb Type 2 (6" Barrier)(Section B) for the inner most ring curb barrier adjacent to the in-field, Curb and Gutter Type 2 (Section IIM)(6" Mountable - 2' Gutter) for the middle ring curb barrier, and Curb and Gutter Type 2 (Section IIB)(6" Barrier - 2' Gutter) for the outer ring barrier. The gutter thickness has been increased to the thickness of the pavement and tie-bars are used to tie the gutters to the pavement. This mimics a monolith pour. See Section **4.11 Lane Edge Support Condition (E)** in **CHAPTER 4**. In this example, the coefficient used is with dowels and tied shoulders. The pavement designer, starting with the calculated thickness design calculations must follow up to make sure the design drawings conform to the design assumptions.

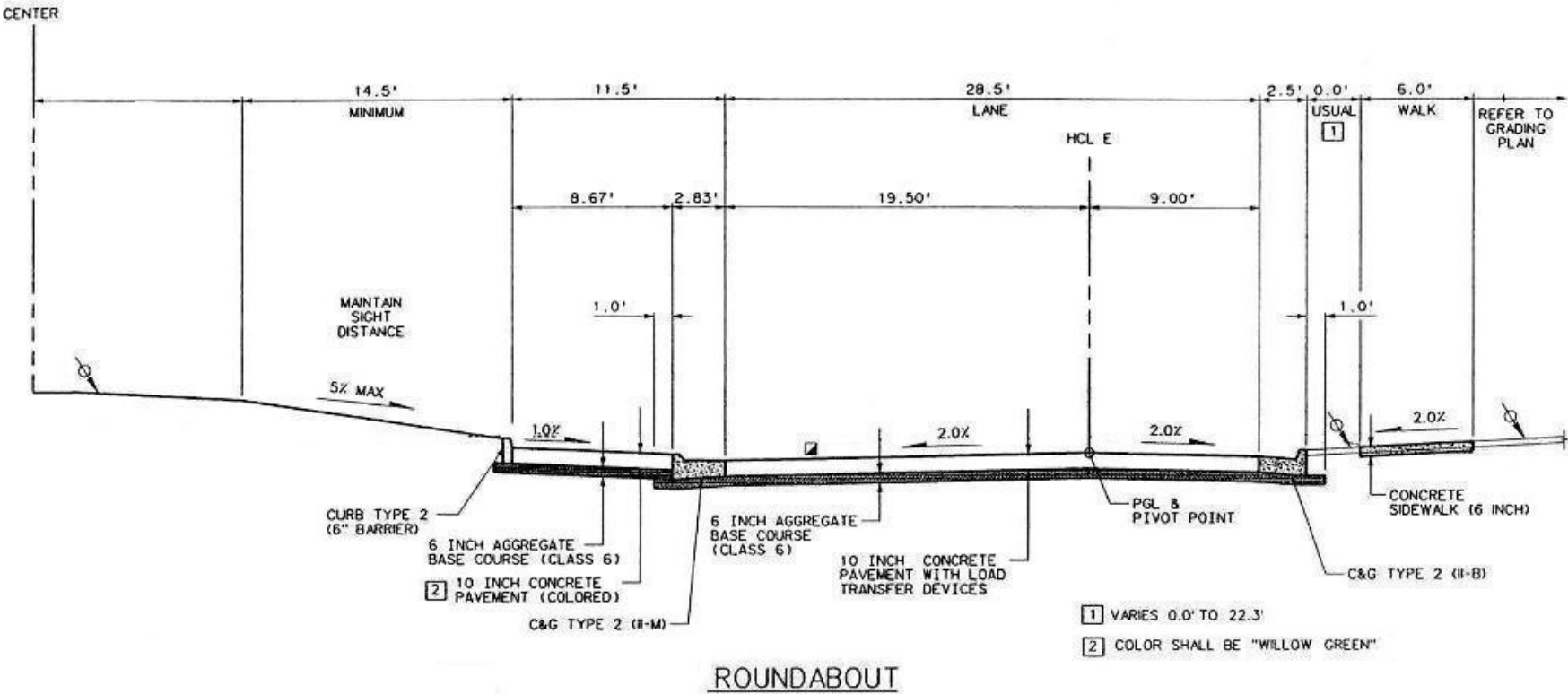

Figure 9.16 Typical Section of an Urban Double-lane Roundabout

9.9 Assessing Problems with Existing Intersections

A successful rigid pavement intersection rehabilitation project is dependent on proper project scoping. The keys to proper scoping include the following:

- Identifying the problem with the existing intersection;
- Removing enough of the pavement section to encompass the entire problem; and
- Designing and reconstructing with a full depth portland cement concrete pavement especially formulated for high traffic volume intersections. Special caution should be exercised in whitetopping intersections (using PCCP overlay and not a full depth PCCP design).

9.10 Detail for Abutting Asphalt and Concrete

To join asphalt and concrete slabs, refer to the schematic layout given in **Figure 9.17 Detail of Asphalt and Concrete Slab Joint**. In this detail, at least three consecutive machine-laid concrete slabs will be constructed and doweled at the transverse construction joints to prevent creeping or curling. The size of the dowels will conform to *CDOT Standard Plan M-412-1 - Concrete Pavement Joints* (use the larger required dowel diameter in joining 2 different pavement thicknesses) and will be 18" long, and spaced under the wheel paths as shown on *Standard Plan M-412-1*. A hand-poured concrete slab with a rough surface finish and with a depth equal to the design thickness will be constructed and joined to the first of the three machine-laid concrete slabs numbered 1, 2 and 3. Concrete slab 1 will have a depth of design thickness plus 2 inches. Concrete slabs 2 and 3 will be constructed with a depth equal to the design thickness.

The bottom of the hand-poured concrete slab will be flushed with the bottom elevation of concrete slab 1 leaving a 2-inch vertical drop from the adjacent concrete slab finish elevation. The HMA paving operation will terminate in the area of the hand-poured concrete slab that will be overlaid with a HMA overlay to fill the 2-inch vertical drop.

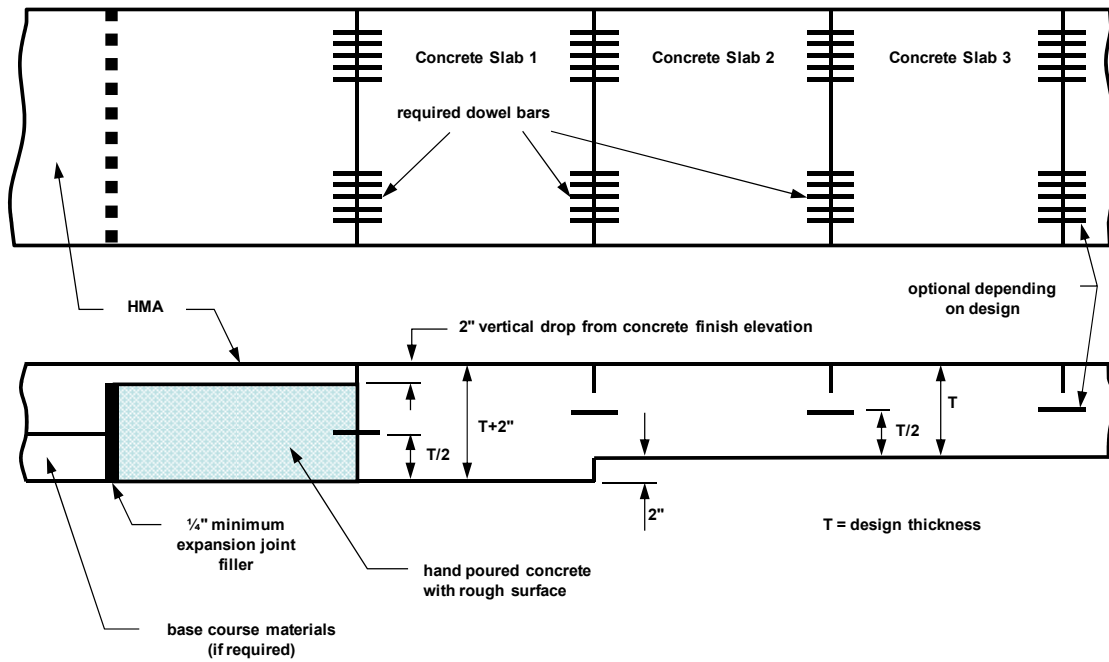

Figure 9.17 Detail of Asphalt and Concrete Slab Joint

References

1. *Roundabouts: An Informal Guide*, FHWA-RD-00-067, Federal Highway Administration, Turner-Fairbanks Highway Research Center, June 2000.
2. *Concrete Roundabouts: Rigid Pavement Well-Suited for Increasing Popular Intersection Type*, Number 6.03, R & T Update, Concrete Pavement Research & Technology, American Concrete Pavement Association, Skokie, IL, June 2005.
3. *Standard Specifications for Road and Bridge Construction*, Colorado Department of Transportation, Denver, Co, 2005.
<http://www.dot.state.co.us/DesignSupport/Construction/2005SpecsBook/2005index.htm>
4. *Intersection Joint Layout*, Publication IS006.01P, American Concrete Pavement Association, Skokie, IL, 1996.
5. *Design and Construction of Joint for Concrete Street*, Publication IS06101P, American Concrete Pavement Association, Skokie, IL, 1992.

CHAPTER 10

PAVEMENT TYPE SELECTION AND LIFE CYCLE COST ANALYSIS

10.1 Introduction

Some of the principal factors to be considered in choosing pavement type are soils characteristics, traffic volume and types, climate, life cycle costs, and construction considerations. All of the above factors should be considered in any pavement design, whether it is for new construction or rehabilitation.

Life cycle cost comparisons must be made between properly designed structural sections that would be approved for construction. The various costs of the design alternatives over a selected analysis period are the major consideration in selecting the preferred alternative. A Life Cycle Cost Analysis (LCCA) includes costs of initial design and construction, future maintenance, rehabilitation, and user costs. Colorado Department of Transportation (CDOT) uses the AASHTOWare™ DARWin™ program version 3.1 for designing flexible pavements. CDOT design of rigid pavements is to follow the 1998 Supplement as the primary method of design. Federal Highway Administration (FHWA) RealCost software is to be used for probabilistic LCCA. It is imperative that careful attention should be given to the calculations involved and the data used in the calculations to ensure the most realistic and factual comparison between pavement types and rehabilitation strategies.

Several design variations are possible within each rehabilitation strategy. A suggested flowchart illustrating the selection process for new pavement construction is shown in **Figure 10.1 Pavement Selection Process Flow Chart**.

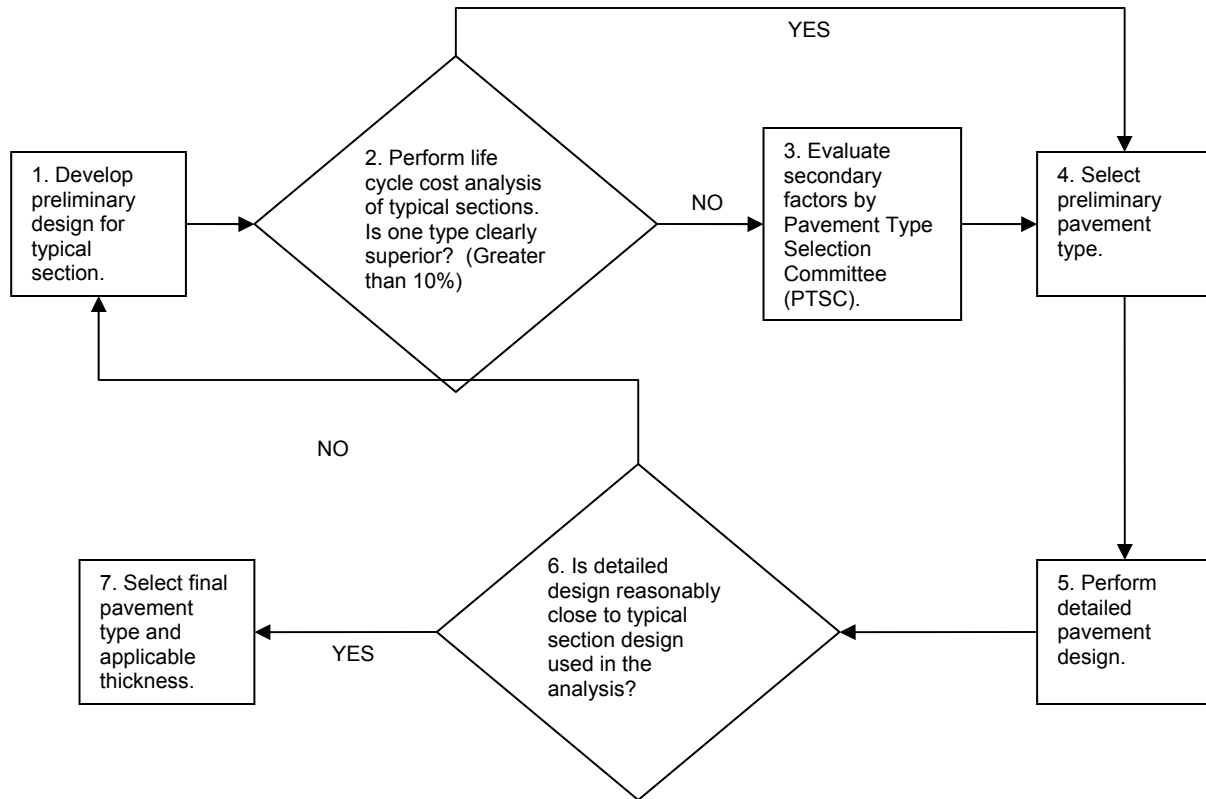

Figure 10.1 Pavement Selection Process Flow Chart

10.2 Implementation of a LCCA

A LCCA comparing concrete to asphalt pavements will be prepared for all new or reconstruction projects with more than \$2,000,000 initial pavement material cost. A LCCA comparing asphalt and concrete should also be prepared for all surface treatment projects with more than \$2,000,000 initial pavement cost where both pavement types are considered feasible alternatives as determined by the RME. If the RME determines one pavement type is not a feasible alternative for a surface treatment project, they will include information supporting their decision in the Pavement Justification Report. Some examples of why alternatives may not be considered feasible are constructability of the alternative, lane closure limitations set by Regional traffic policies, geometric constraints, and minimum required pavement thicknesses for various alternatives. It may be helpful to discuss constructability concerns with industry to ensure that CDOT does not overlook recent innovations in the paving industry. For CDOT projects, the net present value economic analysis will be used. Refer to the references at the end of this chapter for documents published that explain LCCA.

Examples of projects where a LCCA may not be necessary are:

- A concrete pavement, which is structurally sound and requires only resealing and/or minor rehabilitation work;

- A concrete or asphalt pavement, which is structurally sound but may need skid properties restored or ride improved;
- Minor safety improvements such as channelization, shoulder work, etc.;
- Bridge replacement projects with minimal pavement work; and
- Locations where curb and gutter or barrier prohibit the use of alternative thicker treatments.

10.2.1 Analysis Period

The analysis period to be used is the period of time selected for making an LCCA of pavement costs. CDOT will be using a 40-year period for their LCCA. All alternatives being considered should be evaluated over this same period. If the service life of an alternative were 20 years, another rehabilitation project would have to be applied at the 20th year, and into the future, until the analysis period is covered.

10.2.2 Performance Life

Besides initial costs and discount rate, the performance life of the rehabilitation strategy is a major component of LCCA. Total economic life of the alternative is used to compare initial designs along with the performance lives gained from the future rehabilitation of the pavement.

CDOT uses an assortment of rehabilitation strategies for pavements. Potential pavement alternatives include, but are not limited to: Mill and fill, hot or cold in-place recycling, overlay, rubblization, and whitetopping. Every approach to rehabilitation will include a type of treatment and the life of that treatment. Planned rehabilitation is used in the pavement analysis to make engineering comparisons of candidate strategies and is not used for future funding eligibility determinations.

To select a future strategy, the pavement designer will review the data from the Pavement Management System to determine what was done in the past. Each section of pavement could have its own unique rate of deterioration and performance life. The decision of using the same tactic or modifying the treatment will be determined by analyzing past treatments and the lives of those methods.

10.2.3 Rehabilitation Selection Process

CDOT has developed this selection process that takes full advantage of available pavement management performance data. It is believed the following guide will provide recommendations that are more representative of actual pavement performance on Colorado highways. The selection of the appropriate treatment should be based on an engineering analysis for the project. The following precedence is recommended for the selecting a rehabilitation strategy to be used in the LCCA:

The pavement designer should use the historical treatments on the same roadway with their associated service life. Past strategies could be determined by coring the pavement as well as historical plan investigations. The coring program is outlined in Section 5.12. Typically, discrepancies arise in the pavement management data and the

thickness of cores. The pavement designer may have to categorize a lift thickness as being a structural or a functional (preventive maintenance) overlay. See Section 5.6 for more information. The service life of a structural overlay is determined as the number of years between two structural overlays. If a functional overlay was performed, a service life is not established and no adjustment is done on the expected service life.. The cost of the functional treatment should be included as part of the maintenance cost and the cost shown in **Table 10.4** will need to be reevaluated.

If the core and historical information is unknown, then refer to **Table 10.1** and estimate the performance life for various alternative treatments. The performance lives shown in **Table 10.1** are based on projects constructed throughout Colorado therefore, regional or local adjustments could be made.

Table 10.1 Default Input Values for Treatment Periods to be used in a LCCA Using Unmodified Binders

Type of Treatment ⁽¹⁾	Performance in Years		
	Minimum	Most Likely	Maximum
Cold Planing and Overlay ⁽²⁾	6	12	21
2 to 4-Inch Overlay ⁽²⁾	5	11	39
Stone Matrix Asphalt Overlay	5	9	17
Full Depth Reclamation and Overlay ⁽²⁾	10	12	15
Heating and Remixing and Overlay ⁽²⁾	4	7	14
Heating and Scarifying and Overlay ⁽²⁾	6	9	23
Cold In-Place Recycling and Overlay ⁽²⁾	3	8	16
Overall Weighted Statewide Average	5	10	26

- (1) This table will not be used to select project-specific rehabilitation strategies. The performance years are not intended to be a comparative tool between different treatment types. They are default values to be entered into the LCCA after the appropriate treatment has been selected based on project specific design criteria.
- (2) If modified asphalt cement is used, add 1 year from the most likely value.

10.3 Examples of the Rehabilitation Selection Process

10.3.1 Core Data Matches Historical Data

A reconstruction project is planned for 2010 and unmodified HMA is anticipated. Cores taken from the roadway indicated that the existing HMA thickness is 8.5 inches thick. The historical information from the Pavement Management System indicated the original construction project

was built in 1976 with a total of 6 inches of unmodified HMA. In 1998, the second project milled 2 inches off the existing HMA and overlaid it with 4 inches of unmodified HMA. Since the core thickness is reasonably close to the historical data, the average service life of 17 $((1998-1976) + (2010-1998))/2$ should be used. The cash flow diagram is shown in **Figure 10.2**.

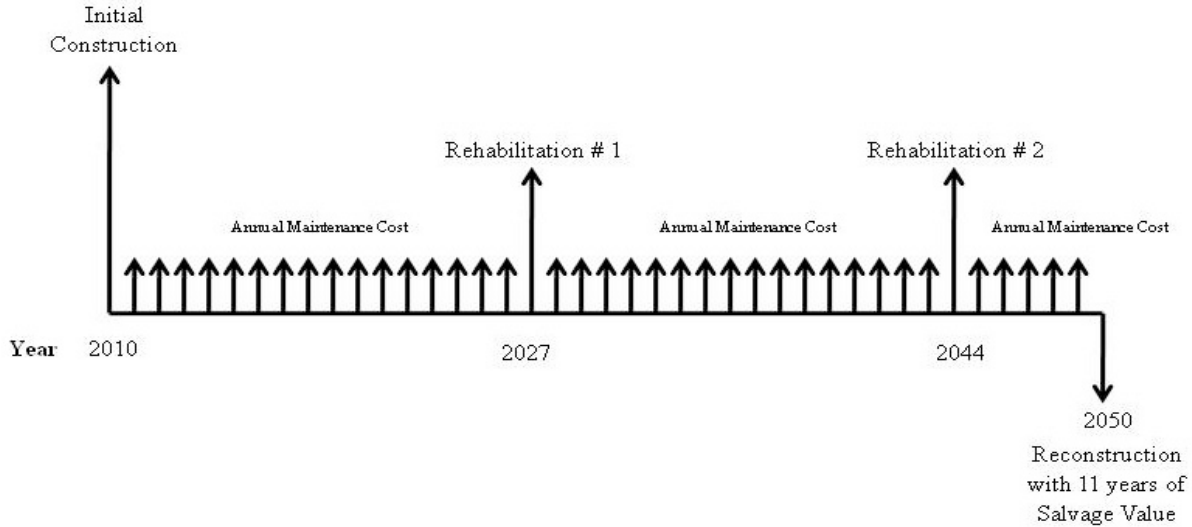

Figure 10.2 Unmodified HMA Cash Flow Diagram

10.3.2 No Core Data and No Historical Data

A reconstruction project is planned for 2010 and modified HMA is anticipated. Discernable lifts of HMA could not be found in the roadway cores and no historical information is available for this area. Since a curb and gutter will be constructed, future rehabilitation work will require cold planing and overlays. Based on **Table 10.1**, the most likely life expectancy for this rehabilitation strategy is 13 years (12 + 1 year for modified HMA). The cash flow diagram is shown in **Figure 10.3**.

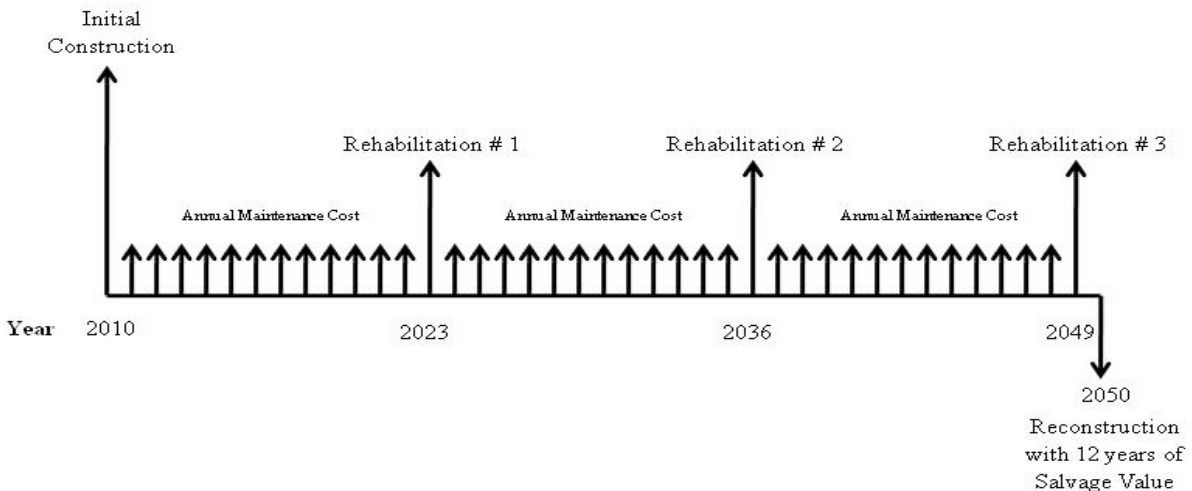

Figure 10.3 Cold Planing and Overlay with Polymer Modified HMA Cash Flow Diagram

10.3.3 Portland Cement Concrete Pavement

The LCCA of a PCCP may be analyzed with either a 30-year initial design period or a 20-year initial design period:

Analysis Period: 40 years

Initial Design Period: 30 years, Note, Add ¼ inch to thickness for future diamond grinding.

Rehabilitation (Travel Lanes Only, No Shoulders):

- PCCP with dowel and tie bars will require 50 percent full width diamond grinding of ¼ inch to restore rideability at 22 years with joint resealing and ½ percent slab replacement in the travel lanes.
- PCCP without dowel or tie bars will still require full width diamond grinding of ¼ inch with joint resealing and 1 percent slab replacement in the travel lanes.

Or

Analysis Period: 40 years

Initial Design Period: 20 years

Rehabilitation: 2-inch HMA overlay at 20 and 30 years or 3-inch overlay at 20 and 30 years in a high volume urban area.

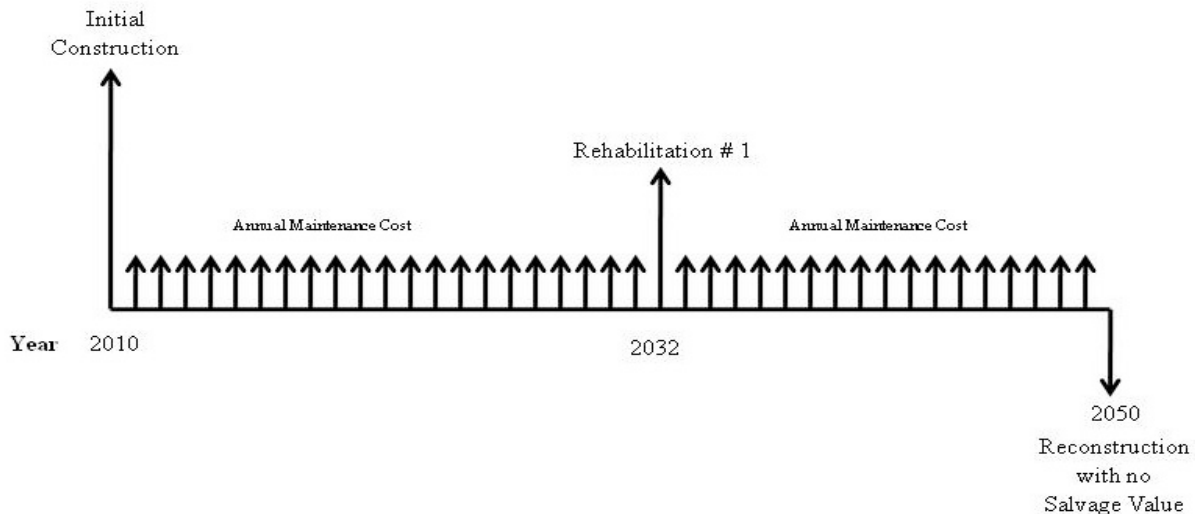

Figure 10.4 PCCP Cash Flow Diagram

10.3.4 Restoration, Rehabilitation and Resurfacing Treatments

The economic cost of these surface treatments are performed with the following parameters:

Analysis Period: 40 years

Design Period: 10, 20 or 30 years

10.4 Discout Rate

All future costs are adjusted according to a discount rate to a present worth. Costs incurred at any time into the future can be combined with initial construction costs to give a total cost over the life cycle. See **Table 10.2 Present Worth Factors for 3.3% Discount Rates** for present worth factors (for a single deposit at the n^{th} year, PWF_n and for a uniform series of deposits, S_n). The current discount rate is 3.3% with a standard deviation 0.18% (6).

The discount rate and standard deviation will be calculated annually. If the new 10-year average discount rate varies more than two standard deviations from the original discount rate used at the time of the design, in this case 0.36%, a new LCCA should be performed for all those applicable projects that have not yet been awarded. The Pavement Designer is responsible for checking previous pavement designs to ensure that an appropriate discount rate was used and the pavement choice is still valid.

Table 10.2 Present Worth Factors for 3.3% Discount Rates

n	Discount Rate	
	3.30%	
	PWF_n	S_n
5	0.8502	4.541
6	0.8231	5.364
7	0.7968	6.161
8	0.7714	6.932
9	0.7468	7.679
10	0.7230	8.402
11	0.6999	9.102
12	0.6776	9.779
13	0.6560	10.436
14	0.6351	11.071
15	0.6149	11.685
16	0.5953	12.281
17	0.5763	12.857
18	0.5580	13.416
19	0.5402	13.956
20	0.5230	14.478
21	0.5064	14.985
22	0.4903	15.475
23	0.4747	15.950
24	0.4596	16.409
25	0.4449	16.854
30	0.3786	18.875
35	0.3222	20.595
40	0.2742	22.059

The discounting factors are listed in **Table 10.3 Discount Factors for Discrete Compounding** in symbolic and formula form and a brief interpretation of the notation. Normally, it will not be necessary to calculate factors from these formulas. For intermediate values, computing the factors from the formulas may be necessary, or linear interpolation can be used as an approximation.

Table 10.3 Discount Factors for Discrete Compounding

Factor Name	Converts	Symbol	Formula	Interpretation of Notation
Single Payment Present Worth	F to P (Future single payment to present worth)	$(P/F, i\%, n)$	$(1+i)^{-n}$	Find P, given F, using an interest rate of $i\%$ over n years
Uniform Series Present Worth	A to P (Annual payment to present worth)	$(P/A, i\%, n)$	$(1+i)^n - 1$ $i(1+i)^n$	Find P, given A, using an interest rate of $i\%$ over n years

The single payment present worth $P=F(P/F, i\%, n)$ notation is interpreted as, “Find P, given F, using an interest rate of $i\%$ over n years. Thus, an annuity is a series of equal payments, A, made over a period of time. In the case of an annuity that starts at the end of the first year and continues for n years, the purchase price, P, would be $P=A(P/A, i\%, n)$. See

Table 10.2 Present Worth Factors for 3.3% Discount Rates.

10.5 Life Cycle Cost Factors

The cost factors are values associated with the LCCA that cover the full cycle from initial design to the end of the analysis period. Any item that impacts the initial cost should be analyzed, and a determination made as to whether it should be included in the cost analysis. Such items would include shoulder construction, major utility considerations, mobilization, temporary access, traffic crossovers, etc... Some of the factors the designer should consider are as follows:

10.5.1 Initial Construction Costs

Pavement construction costs are the expenses incurred to build a section of pavement in accordance with the plans and specifications. The pavement construction cost is one of the most important factors in the LCCA and should be as accurate as possible. The current version of CDOT’s Cost Data manual should be used unless up-to-date bid prices are available for similar work in the same general area. Initial cost of PCCP and HMA should be based on the best available information. The designer should take into consideration project specific information, such as; special mixes, fast track mixes, pavement constructability, special binders, construction phasing, project location, and other pertinent information. These project details may alter the unit costs shown in the figures. The designer should exercise good judgment in the application of the PCCP and HMA unit costs. If there is a wide range of prices for a certain item, then it is

best to run a sensitivity analysis to determine the effect of cost variation on the end result. Computing the initial cost of a design alternative involves not only the material quantity calculations, but also the other direct costs associated with the pavement alternative being considered. Difference in grading quantities required by different pavement alternatives should be considered where appropriate. For example, the comparison of a thick overlay alternative versus a removal and replacement alternative should include the required shoulder quantity for the overlay. If traffic control costs vary from one alternative to another, this cost should be estimated and included as an initial cost. The different construction techniques, curing time, and duration of lane closures associated with PCCP or HMA have a significant impact on the user costs. For example, a HMA overlay could involve the closure of one lane of traffic at a time, while a concrete pavement overlay might necessitate complete roadway closure and detour construction. This will impact traffic control and user costs. The designer should utilize the resources of the Engineering Estimates Unit as necessary to supplement information used in the calculation of the unit cost. The supporting information and any worksheets for the unit cost should be included in the Pavement Justification Report.

10.5.2 Maintenance Cost

Maintenance costs should be based on the best available information. The CDOT Maintenance Management System compiled data on State Highway maintenance costs. The annual maintenance cost per lane mile is shown in **Table 10.4 Annual Maintenance Costs**. This data was collected from January 1, 2002 to January 1, 2007.

Table 10.4 Annual Maintenance Costs

Region	Type of Pavement	Average Annual Cost Per Lane Mile	Standard Deviation	Lane Miles Surveyed
1	HMA	1057	1494	605
	PCCP	395	673	384
2	HMA	812	557	508
	PCCP	449	378	158
3	HMA	891	835	714
	PCCP	664	N/A	2
4	HMA	791	839	632
	PCCP	468	412	106
5	HMA	1474	1670	268
	PCCP	1478	N/A	7
6	HMA	2520	4562	245
	PCCP	643	349	25
Statewide	HMA	1270	2377	2972
	PCCP	499	553	682

The designer should exercise good judgment in the application of maintenance costs. Inappropriate selection can adversely influence the selection of alternatives to be constructed. If actual cost cannot be provided, use the following default values for average annual cost:

- \$1270/lane-mile for asphalt pavements.
- \$499/lane-mile for portland cement concrete pavements.

10.5.3 Design Costs

The expected preliminary engineering (PE) costs for designing a new or rehabilitated pavement including materials, site investigation, traffic analysis, pavement design, and preparing plans with specifications vary from region to region and are in the range of 8% to 12% with the average being 10% of the total pavement construction cost.

10.5.4 Pavement Construction Engineering Costs

Included in the pavement construction cost should be the cost of engineering (CE). The CE and indirect costs vary from Region to Region and are in the range of 8% to 20% with the average being 18.1% of the total pavement construction cost.

10.5.5 Traffic Control Costs

Traffic control costs are the cost to place and maintain signs, signals, and markings and devices placed on the roadway to regulate, warn, or guide traffic. The traffic control costs vary from Region to Region and from day to night. The range is from 10% to 18% with the average being 15% of the total pavement construction cost. In some designs, the construction traffic control costs may be the same in both alternatives and excluded from the LCCA.

10.5.6 Salvage Value

Salvage value represents the value of an investment alternative at the end of the analysis period. The method CDOT uses to account for salvage value is prorated - based on the cost of the final rehabilitation activity, design life of the rehabilitation strategy, and the time since the last rehabilitation. For example, over a 40-year analysis, alternative A requires a 10-year design life rehabilitation to be placed at year 31. In this case, alternative A will have 1 year of residual design life remaining at the end of the analysis. The salvage value is 1/10 of the rehabilitation cost, as shown in equation.

$$SV = (1 - (L_A/L_E)) * C \qquad \text{Eq. 10.1}$$

Where:

- SV = salvage value
- L_A = the portion of the design life consumed
- L_E = the design life of the rehabilitation
- C = the cost of the rehabilitation

10.5.7 User Costs

These costs are considered to be indirect “soft” costs accumulated by the facility user in the work zone as they relate to roadway condition, maintenance activity, and rehabilitation work over the analysis period. For example, these costs include user travel time, increased vehicle operating costs (VOC), and crashes. Though these “soft” costs are not part of the actual spending for CDOT, they are costs borne by the road user and should be included in the LCCA. Due to the lack of crash cost data, for certain types of work zone activities, CDOT will not consider the costs due to crashes.

10.5.7.1 User Cost Program

CDOT uses a software program called WorkZone to calculate user costs. WorkZone with a help document may be downloaded from CDOT's website:

<http://www.dot.state.co.us/ECSU/Download.asp>

Instructions on Using the Program:

Once the data entry main screen has been brought up, the project specific data (generally speaking, any white cell will accept data) is ready to be entered. Accessing the data cells can be done by pointing and clicking or by using the tab key on the keyboard.

Enter the name of the project, freeway (State Highway) name, design speed, speed limit, length of closure, and work zone speed limit.

According to the Highway Capacity Manual, grades less than 2% (including going downhill) will not need adjustments to the highway capacity (CDOT has a default value of 2%). Any grade less than 3% and longer than 1 mile, or any grade greater than 3% and longer than ½ mile should be analyzed separately. The average grade of the project may be used.

Single clicking on the type of work zone tab yields two options:

Cross over = shutting down one side of a divided highway; and

SLC = Single Lane Closure

Figure 10.5 and **Figure 10.6**, for the layout of the general input screens.

Single Lane Closure: For a single-lane closure (SLC), enter the total number of lanes in each direction, the number of open lanes, and the number of temporary lanes. The temporary lanes are like temporary detours in the work zone. Use of the shoulder is counted as a temporary lane. Enter the percent single and combination unit trucks along with the Average Annual Daily Traffic (AADT) for the direction of the inbound or outbound lanes. (Use the same percent trucks as shown in the Traffic Volume Report and 50 or 60 percent the AADT for each direction.). **Do not** use commas in entering the AADT. The program will only recognize the last three digits of the input data if commas are used. If better directional AADT is available, then use it. If the work is in only one direction at a time, the check mark should be removed. To remove the check mark, just point and click in the cell. See **Figure 10.5 Input Screen for WorkZone Software SLC (HMA)** and **Figure 10.6 Input Screen for WorkZone Software SLC (PCCP)** for the layout of a single lane closure.

Cross-over work zone: In a cross over, the traffic volumes are the same as described in the SLC. It gets a little tricky for the inputs for the lanes. It is probably easier if an example is given instead of trying to explain it. See **Figure 10.7 Input Screen for WorkZone Software Cross-Over (PCCP)** for the layout of a cross over closure.

NOTE: The sum of open and temporary lanes must be less than or equal to (\leq) the total number of lanes in each direction. If there are no temporary lanes, enter a zero (0) in the cell, otherwise an error message will appear.

CDOT : WorkZone-RUC - New File

File Edit Analyze Reports About

Name of the Project Freeway Name Percent Grade

Design Speed mph Speed Limit mph Type of Closure
 SLC
 Cross Over

Length of Closure miles Work Zone Speed Limit mph

Enter The Following Data Per Direction

Total Number of Lanes Number of Open Lanes

Single Unit Trucks (%) Number of Temporary Lanes

Combination Trucks (%) Average Annual Daily Traffic

Work on Both Directions

Type of Work
 403-Stone Mastic Asphalt
 403-HBP (Patching)
 403-HBP (Asphalt) <= 1.0 inch
 403-HBP (Asphalt) <= 2.0 inch
 403-HBP (Asphalt) <= 3.0 inch

Func. Class

Total Duration days

Type of Selected Work	Duration	Depth	Work Zone Capacity per Lane
403-HBP (Asphalt) <= 3.0 inch	108	N/A	1122

Enter the Grade Near the Work Zone

Normal Capacity per Lane MODIFIED

Figure 10.5 Input Screen for WorkZone Software SLC (HMA)

CDOT : WorkZone-RUC - New File
File Edit Analyze Reports About

Name of the Project Freeway Name Percent Grade

Design Speed mph Speed Limit mph
Length of Closure miles Work Zone Speed Limit mph

Type of Closure
 SLC
 Cross Over

Enter The Following Data Per Direction

Total Number of Lanes Number of Open Lanes
Single Unit Trucks (%) Number of Temporary Lanes
Combination Trucks (%) Average Annual Daily Traffic

Work on Both Directions

Type of Work
202-Removal of Concrete
202-Removal of Concrete (Diamond Grinding)
202-Removal of Asphalt
202-Removal of Asphalt (Planing)
203-Unclassified Excavation

Func. Class

Total Duration days

Type of Selected Work	Duration	Depth	Work Zone Capacity per Lane
202-Removal of Concrete (Diamond Grinding)	10	N/A	1186
202-Removal of Concrete	20	N/A	1053

Enter the Grade Near the Work Zone Normal Capacity per Lane MODIFIED

Figure 10.6 Input Screen for WorkZone Software SLC (PCCP)

Example: A divided 4-lane (2 inbound lanes and 2 outbound lanes) of I-70 will be reconstructed using a cross over. The phasing is such that the outbound direction is closed first. The input for the cell for the outbound total number of lanes is 2, the number of open outbound lanes is 1, and the number of temporary lanes is 0. The input for the inbound direction is then 2 for the total number of lanes, 1 for the number of open lanes and 0 for the number of temporary lanes. **Figure 10.7 Input Screen for WorkZone Software Cross-Over (PCCP)** shows the input screen for this example.

CDOT : WorkZone-RUC - New File
File Edit Analyze Reports About

Name of the Project Freeway Name Percent Grade

Design Speed mph Speed Limit mph
Length of Closure miles Work Zone Speed Limit mph

Type of Closure
 SLC
 Cross Over

Inbound Direction				Outbound Direction			
Total Number of Lanes	<input type="text" value="2"/>	Number of Temporary Lanes	<input type="text" value="0"/>	Total Number of Lanes	<input type="text" value="2"/>	Number of Temporary Lanes	<input type="text" value="0"/>
Number of Open Lanes	<input type="text" value="1"/>	Single Unit Trucks (%)	<input type="text" value="6.3"/>	Number of Open Lanes	<input type="text" value="1"/>	Single Unit Trucks (%)	<input type="text" value="6.3"/>
	<input type="text" value="22.5"/>	Combination Trucks (%)	<input type="text" value="22.5"/>		<input type="text" value="22.5"/>	Combination Trucks (%)	<input type="text" value="22.5"/>
AADT		<input type="text" value="5186"/>		AADT		<input type="text" value="5186"/>	

Type of Work

Func. Class

Total Duration days

Type of Selected Work	Duration	Depth	Inbound Capacity per Lane	Outbound Capacity per Lane
412-Concrete Pavement <= 14.0 inch	100	N/A	1158	1158

Enter Number of Temporary Lanes in the Outbound Direction

Normal Capacity per Lane MODIFIED

Figure 10.7 Input Screen for WorkZone Software Cross-Over (PCCP)

Type of work: There are 34 different types of work listed according to CDOT’s Items. To select a “type of work” just point and single click on the Item. Arrow down (right side of the type of work box) to scroll to more Items. After pointing and clicking on an Item, the type of work moves down into the selected area on the page. After the Item has been selected, it can be deselected by single clicking on the highlighted item in the “type of work” box to remove it from the selected area. Once a type of work is selected, default values have been assigned in order to determine the duration of the work and the capacities of the lanes. If the duration or capacity is different, double click on the Item in the Type of Selected Work box and a new screen will appear so that entered values can be modified. Normally, pick only the major item of work to be constructed. (Generally speaking the other items are concurrent with your major item.) The capacity adjustment factor has a set default value based on data from the Highway Capacity Manual, if equipment is very close to the traveling public, the default value should be decreased. **Table 10.5 Range in Capacity for Construction** in the WorkZone program provides the range in capacity that can be used to modify any particular type of construction.

Table 10.5 Range in Capacity for Construction

Item	Description	Int. Adj. Factor	Item	Description	Int. Adj. Factor
202	Removal of Concrete	-160 to +50	403	Stone Mastic (Matrix) Asphalt	-100 to +160
202	Removal of Concrete (Planing)	+120 to +160	403	HMA (Patching)	0 to +160
202	Removal of Asphalt	-160 to + 50	403	HMA (Asphalt) ≤ 1.0”	-100 to +160
202	Removal of Asphalt (Planing)	+120 to +160	403	HMA (Asphalt) ≤ 2.0”	-100 to +160
203	Unclassified Excavation	-100 to +100	403	HMA (Asphalt) ≤ 3.0”	-100 to +160
203	Uncl. Excavation (C.I.P.)	-50 to + 100	405	Heating and Scarifying	-50 to +100
203	Embankment Material	-100 to +100	406	Cold Recycle	-50 to +100
203	Emb. Material (C.I.P.)	-50 to +100	408	Hot Poured Joint & Crack Sealant	-100 to +160
203	Muck Excavation	-50 to +50	409	Microsurfacing	-100 to +160
203	Rolling	+100 to +160	412	Concrete Pavement System	-160 to +160
203	Blading	+50 to +160	412	Concrete Pavement ≤ 6.0”	-160 to +160
203	Dozing	-50 to +100	412	Concrete Pavement ≤ 10.0”	-160 to +160
210	Adjust Guardrail	-50 to +50	412	Concrete Pavement ≤ 14.0”	-160 to +160
210	Replace Concrete Pavement	0 to +50	412	Routing & Sealing PCCP Cracks	-100 to +160
304	Aggregate Base Course	-50 to +50	412	Cross Stitching	-100 to +100
306	Reconditioning	-50 to +160	412	Rubblization of PCCP	-120 to -160
310	Process Asphalt Mat for Base	-50 to +100	***	Misc. Other Roadway Constr.	-160 to +160

Software is a good example of the WorkZone output. It provides a summary of the inputs and identifies the user cost based on the duration of each construction item. For this example the total additional user cost is \$2,317,788.

<u>INPUT DATA</u>			
Project Name	Bethune		
Freeway Name	I-70		
Input File	...~1\FIG_9_25.WZM		
Project Start Date			
Project End Date			
Design Speed	75 mph		
Speed Limit	65 mph		
Workzone Speed Limit	55 mph		
Grade	2.0 %		
Work Zone Length	10.00 miles		
Functional Class	Rural Interstate (Weekday)		
<u>INBOUND</u>		<u>OUTBOUND</u>	
Total Number of Lanes	2	Total Number of Lanes	2
Number of Open Lanes	1	Number of Open Lanes	1
Number of Temporary Lanes	0	Number of Temporary Lanes	0
AADT	11573	AADT	11573
Percentage of Single Unit Trucks	6.3 %	Single Unit Trucks(%)	6.3 %
Percentage of Combination Trucks	22.8 %	CombinationTrucks(%)	22.8 %
<u>OUTPUT SUMMARY</u>			
<u>ADDITIONAL USER COST DUE TO WORKZONE</u>			
<u>TYPE OF WORK</u>	<u>INBOUND COST</u>	<u>OUTBOUND COST</u>	<u>DURATION</u>
412-Concrete Pavement <= 14.0 inc	\$2,317,788.27	\$2,317,788.27	100
TOTAL ADDL. USER COST	\$2,317,788.27	\$2,317,788.27	100
NO WORKZONE)			
FOR A DURATION OF 100 DAYS : INBOUND = \$9,544,395.02 OUTBOUND = \$9,544,395.02			
Disclaimer:			
The values presented in this program are intended to provide guidelines only.			
Engineering judgement must be applied to use these values.			
No one but the user can assure that these results are properly applied.			

Figure 10.8 Initial Construction Result Screen for WorkZone Software

The functional class is a scroll down menu used to find the functional class that best fits the user's needs. (Note that weekend and weekday options are provided for each functional class. For lane closures spanning weekdays and weekends both scenarios should be run and a weighted average user cost calculated.) Point and single click on the item to select it. The next step is to run the program. The program will run once (top tool bar) the data is analyzed. The data should be checked first and if it is correct, run the analysis. If everything seems to be in order, then in the top tool bar under reports, the resulting price (work zone user cost information) will be shown. The edit tool bar contains 4 items to customize the work zone program to a specific project. The first one (edit-input data) will allow user to change the main screen. The second (hourly traffic distribution) will allow the user to change the values for the project. Traffic has an internal web site http://www.dot.state.co.us/App_DTD_DataAccess/index.cfm that can be used to determine traffic counts. Finding the traffic distribution for some projects at the DTD site may not always be easy because not all the data is available at this time.

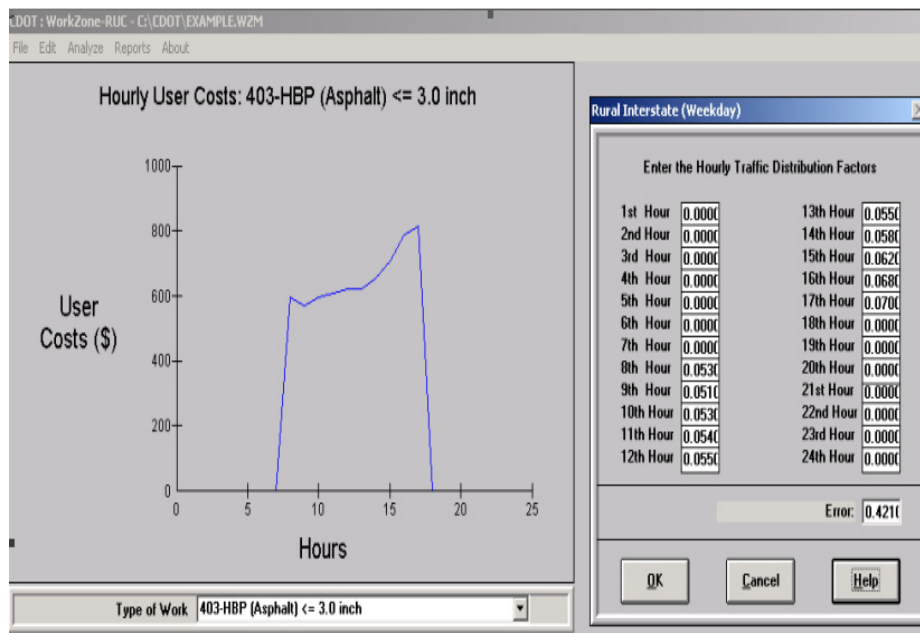

Figure 10.9 Screens of User Costs and Traffic Distribution Factors for a HMA Project in a Single Lane Closure

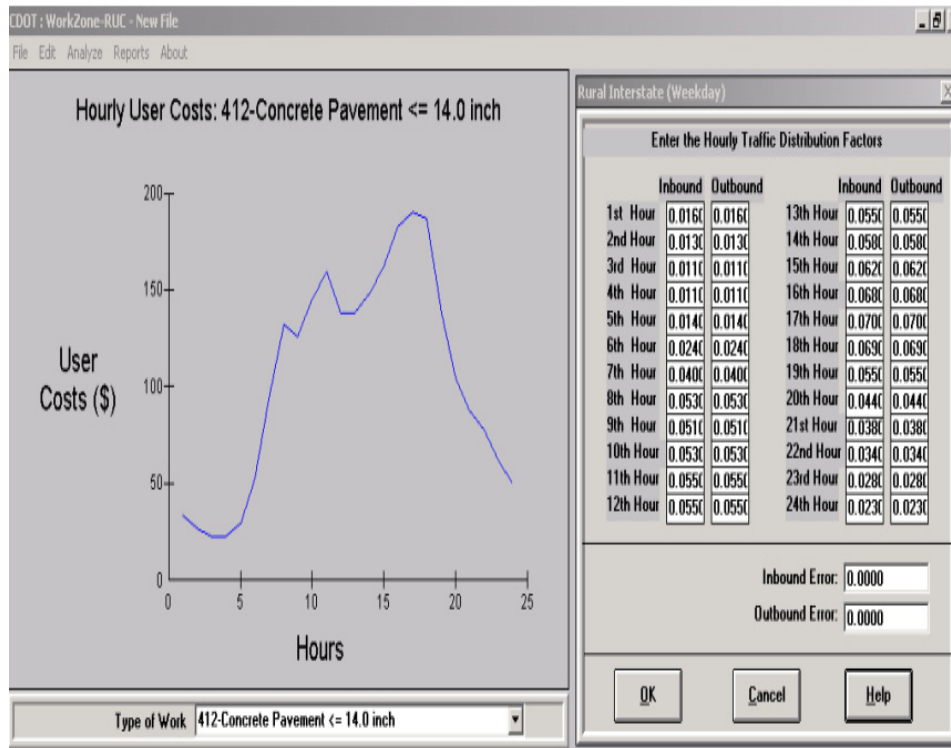

Figure 10.10 Screens of User Costs and Traffic Distribution Factors for a PCCP Project in a Cross-Over Closure

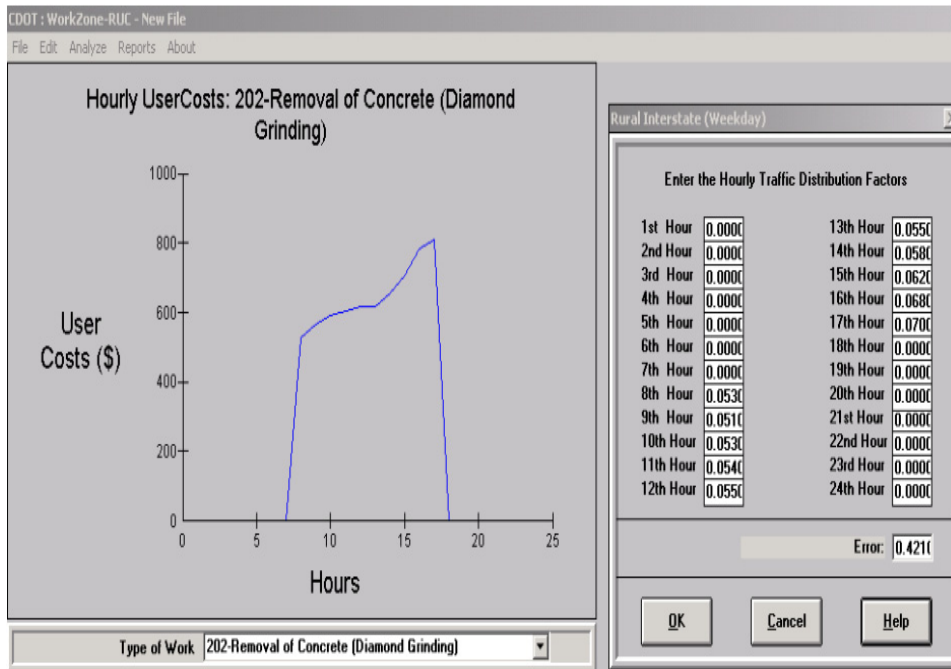

Figure 10.11 Screens of User Costs and Traffic Distribution Factors for a PCCP Rehabilitation Project in a Single Lane Closure

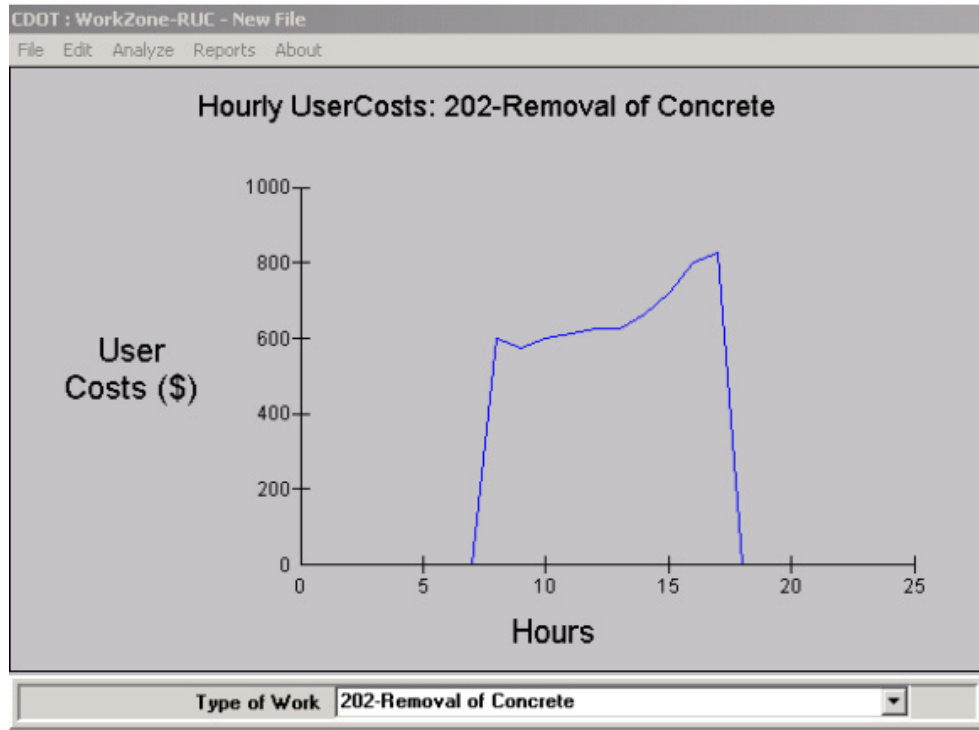

Figure 10.12 User Cost Screen for Removal of PCCP in a Single Lane Closure

IMPORTANT NOTE: A queue greater than 5 Miles or a delay greater than ½ hour should not be allowed to form. The main focus is on the user cost when a work zone is in place; therefore, if the contractor only works from 9:00 am to 5:00 p.m. on a SLC then all the hourly traffic distribution values **outside** the working time should be changed to zero (0).

ANOTHER IMPORTANT NOTE: Once this table has been changed, it must be saved (File tool bar) prior to running the program. If the values are not saved and the program is rerun (analyze tool bar), the program will revert back to the default values and the hourly distribution data has to be reentered again. The third item that can be edited is the type of work parameters. If the intensity value is changed, (how close the contractor is working to the traveling public) the lane capacity will change. If the productivity is changed, the duration will also change. The PSI is the present serviceability index and a lower value means that the road is rougher and it slightly increases the user cost due to wear and tear on the vehicles. **Table 10.6 Lane Width Adjustment Factors from the Highway Capacity Manual** provides the lane width adjustment factors from the Highway Capacity Manual.

Table 10.6 Lane Width Adjustment Factors from the Highway Capacity Manual

Obstruction Distance From Traveled Pavement (ft)	Obstruction on One Side of the Roadway				Obstruction on Both Sides of the Roadway			
	Lane Width (ft)							
	12	11	10	9	12	11	10	9
4-Lane Freeway (2-lanes each direction)								
≥ 6	1.00	0.97	0.91	0.81	1.00	0.97	0.91	0.81
5	0.99	0.96	0.90	0.80	0.99	0.96	0.90	0.80
4	0.99	0.96	0.90	0.80	0.98	0.95	0.89	0.79
3	0.98	0.95	0.89	0.79	0.96	0.93	0.87	0.77
2	0.97	0.94	0.88	0.79	0.94	0.91	0.86	0.76
1	0.93	0.90	0.85	0.76	0.87	0.85	0.80	0.71
0	0.90	0.87	0.82	0.73	0.81	0.79	0.74	0.66
6- or 8- Lane Freeway (3 or 4 Lanes each direction)								
≥ 6	1.00	0.96	0.89	0.78	1.00	0.96	0.89	0.78
5	0.99	0.95	0.88	0.77	0.99	0.95	0.88	0.77
4	0.99	0.95	0.88	0.77	0.98	0.94	0.87	0.77
3	0.98	0.94	0.87	0.76	0.97	0.93	0.86	0.76
2	0.97	0.93	0.87	0.76	0.96	0.92	0.85	0.75
1	0.95	0.92	0.86	0.75	0.93	0.89	0.83	0.72
0	0.94	0.91	0.85	0.74	0.91	0.87	0.81	0.70

If there are ramps that are not metered in a project, the traffic accelerating and slowing down will affect the capacity in the work zone, therefore, the increased volume from the ramps must be included.

See the above ANOTHER IMPORTANT NOTE before running the program.

The fourth item that should be performed is to edit the value of time. If a project is outside the Denver metro area, the designer may want to change this value. If users have any problems or comments on the program, please contact the Pavement Design Program Manager at (303) 398-6561.

10.6 Probabilistic Life Cycle Cost Analysis

Two different computational approaches can be used in LCCA, deterministic and probabilistic. The methods differ in the way they address the variability associated with the LCCA input values. In the deterministic approach, the analyst assigns each LCCA input variable a fixed, discrete value. The analyst determines the value most likely to occur for each parameter, usually basing the determination on historical evidence or professional judgment. Collectively, the input values are used to compute a single life-cycle cost estimate for the alternative under consideration. Traditionally, applications of LCCA have been deterministic. A deterministic life-cycle cost computation is straightforward and can be conducted manually with a calculator or automatically with a spreadsheet. Sensitivity analyses may be conducted to test input assumptions by varying one input, holding other inputs constant, and determining the effect of the variation on the outputs. The deterministic approach, however, fails to address simultaneous variation in multiple inputs, and it fails to convey the degree of uncertainty associated with the life-cycle cost estimates. Probabilistic LCCA inputs are described by probability functions that convey both the range of likely inputs and the likelihood of their occurrence. Probabilistic LCCA also allows for the simultaneous computation of differing assumptions for many different variables. Outputs, like inputs, express the likelihood that a particular life-cycle cost will actually occur. Because of the dramatic increases in computer processing capabilities of the last two decades, the process of probabilistic analysis has become more practical. Simulating and accounting for simultaneous changes in LCCA input parameters can now be accomplished easily and quickly.

10.7 FHWA RealCost Software

The RealCost software was created with two distinct purposes. The first is to provide an instructional tool for pavement design decision-makers who want to learn about LCCA. The software allows the student of LCCA to investigate the effects of cost, service life, and economic inputs on life-cycle cost. For this purpose, a graphical user interface (GUI) was designed to make the software easy to use. The second purpose is to provide an actual tool for pavement designers, which they can use to incorporate life-cycle costs into their pavement investment decisions.

RealCost automates FHWA's LCCA methodology as it applies to pavements. The software calculates life-cycle values for both agency and user costs associated with construction and rehabilitation. The software can perform both deterministic and probabilistic modeling of pavement LCCA problems. Outputs are provided in tabular and graphic format. Additionally, RealCost supports deterministic sensitivity analyses and probabilistic risk analyses. While RealCost compares two alternatives at a time, it has been designed to give the pavement engineer the ability to compare an unlimited number of alternatives. By saving the input files of all alternatives being considered, the analyst can compare any number of alternatives. Furthermore, the software has been designed so that an understanding of the LCCA process is sufficient to operate the software. The software automates FHWA's work zone user cost calculation method. This method for calculating user costs compares traffic demand to roadway capacity on an hour-by-hour basis, revealing the resulting traffic conditions. The method is computation intensive and ideally suited to a spreadsheet application. The software does not calculate agency costs or

service lives for individual construction or rehabilitation activities. These values must be input by the analyst and should reflect the construction and rehabilitation practices of the agency. While RealCost compares the agency and user life-cycle costs of alternatives, its analysis outputs alone do not identify which alternative is the best choice for implementing a project. The lowest life-cycle cost option may not be implemented when other considerations such as risk, available budgets, and political and environmental concerns are taken into account. As with any economic tool, LCCA provides critical information to the overall decision-making process, but not the answer itself. FHWA's RealCost software may be obtained at:

<http://www.fhwa.dot.gov/infrastructure/asstmgmt/lcca.htm>

10.7.1 RealCost Switchboard

RealCost opens to the main menu form, called the “Switchboard,” a form superimposed on an Excel worksheet. The switchboard buttons, shown in **Figure 10.13 The RealCost Switchboard**, provide access to almost all of the functionality of the software- data entry, analysis, reports, and utilities.

The Switchboard, shown in **Figure 10.13**, has five sections:

Project-Level Inputs

Data that will be used for all alternatives. These data document the project characteristics, define the common benefits that all alternatives will provide, and specify the common values (e.g., discount rate) that will be applied with each alternative.

Alternative-Level Inputs

Data that will be used for a specific design alternative. These data differentiate alternatives from each other.

Input Warnings

List of missing or potentially erroneous data. The software identifies and displays a list.

Simulation and Output

Forms used to view deterministic results, run Monte Carlo simulation of probabilistic inputs, view probabilistic results, and print reports.

Administrative Functions

Forms used to save, clear, and retrieve data and to close the Switchboard or RealCost.

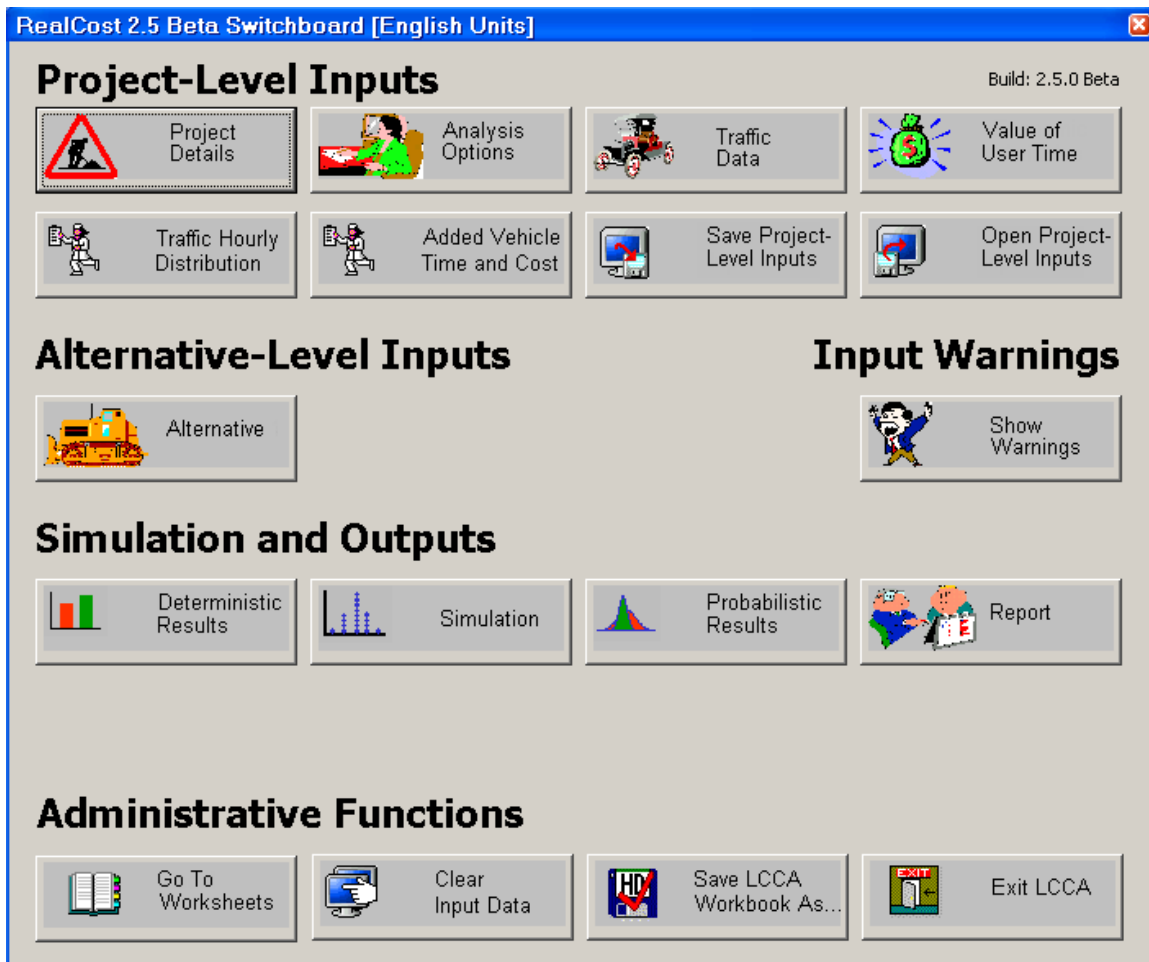

Figure 10.13 The RealCost Switchboard

10.7.2 Real world example using the RealCost software

Compare 9.0” HMA alternative to a 12” PCCP alternative on a 4-lane section of I-70 (2-lanes per direction) near Bethune Colorado from MP 417 to MP 427, which is located in Region 1. It is estimated that the HMA alternative will take 54 construction days working from 8:00 a.m. to 5:00 p.m. of a single lane closure per direction. The 12” PCCP alternative will take 100 construction days per direction using a cross over. Each of the HMA rehabilitation cycles will take approximately 20 construction days and the PCCP rehabilitation will take approximately 30 construction days each working from 8:00 a.m. to 5:00 p.m. detailed information on this example can be found below.

10.7.3 Project Details Options

The Project Details, **Figure 10.14 Project Details Input Screen** is used to identify and document the project. Data entered into this form are not used in the analysis. The analyst may enter data according to the field names on the form or may use the fields to include other project documentation details.

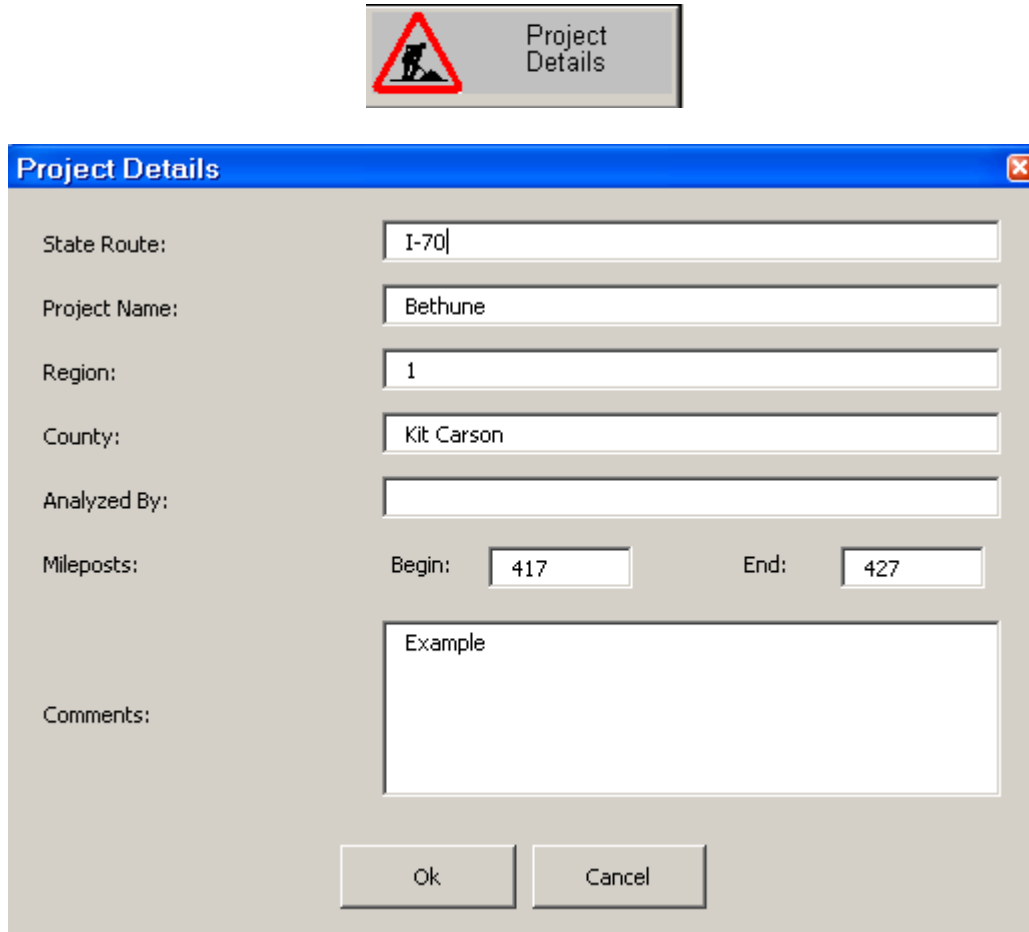

The image shows a software interface for entering project details. At the top, there is a button with a red triangle warning icon and the text "Project Details". Below this is a dialog box titled "Project Details" with a close button in the top right corner. The dialog box contains several input fields:

- State Route: I-70
- Project Name: Bethune
- Region: 1
- County: Kit Carson
- Analyzed By: (empty field)
- Mileposts: Begin: 417, End: 427
- Comments: Example

At the bottom of the dialog box are two buttons: "Ok" and "Cancel".

Figure 10.14 Project Details Input Screen

10.7.4 Analysis Options

Generally, analysis options are decided by agency policy rather than the pavement design decision maker. Options defined in the Analysis Options form include the analysis period, discount rate, beginning year, inclusion of residual service life, and the treatment of user costs in the LCCA (see **Figure 10.15 Analysis Option Screen**). A checked box equals “yes,” an unchecked box equals “no.” The data inputs and analysis options available on this form are discussed in **Table 10.7 Analysis Data Inputs and Analysis Options**, with CDOT and FHWA’s recommendations.

Table 10.7 Analysis Data Inputs and Analysis Options

Variable Name	Probability Distribution (CDOT Default)	Value (CDOT Default)	Source
Analysis Units	Select Option English/Metric	English	CDOT
Analysis Period (Years)	User Specified	40	Sections 10.3.1 , 10.3.2 , and 10.3.4
Discount Rate (%)	Log Normal	Mean 3.3, Standard Deviation 0.18	T-bill and inflation rate, 10 year analysis
Beginning of Analysis Period	User Specified	Date (year)	Project start date
Included Agency Cost Remaining Service Life Value	Select Option	Yes	Section 10.5.6 (Salvage value)
Include User Costs in Analysis	Select Option	Yes	Section 10.5.7
User Cost Computation Method	Select Option Specified/Calculated	Specified	Section 10.5.7 Use predetermined user costs from CDOT WorkZone software*
Traffic Direction	Select Option Both/Inbound/Outbound	Both	Site specific
Include User Cost RSL	Select Option	Yes	Section 10.5.7

* When "Specified" is selected the manual calculated user cost from the WorkZone program will be used in the RealCost program.



The image shows a software dialog box titled "Analysis Options" with a blue header bar and a close button in the top right corner. The dialog box has a light grey background and contains the following settings:

- Analysis Units: English (dropdown menu)
- Analysis Period (years): 40 (text input)
- Discount Rate (%): 3.3 (text input with a small menu icon to the right)
- Beginning of Analysis Period: 2004 (text input)
- Include Agency Cost Remaining Service Life Value:
- Include User Costs in Analysis:
- User Cost Computation Method: Specified (dropdown menu)
- Traffic Direction: Both (dropdown menu)
- Include User Cost Remaining Service Life Value:
- Number of Alternatives: 2 (dropdown menu)

At the bottom of the dialog box, there are two buttons: "Ok" and "Cancel".

Figure 10.15 Analysis Option Screen

10.7.5 Traffic Data Options

Pavement engineers use traffic data to determine their design parameters. In RealCost, traffic (Figure 10.16 Traffic Data Option Screen) are used exclusively to calculate work zone.

Table 10.8 Traffic Data Options

Variable Name	Probability Distribution (CDOT Default)	Value (CDOT Default)	Source
AADT Construction Year (total for both directions)	Deterministic	User Input	Section 1.5, CHAPTER 1
Single Unit Trucks as Percentage of AADT (%)	Deterministic	User Input	Section 1.5, CHAPTER 1
Combination Trucks as Percentage of AADT (%)	Deterministic	User Input	Section 1.5, CHAPTER 1
Annual Growth Rate of Traffic (%)	Triangular	Min. 0.34 Most Likely 1.34 Max. 2.34	Section 1.5.4, CHAPTER 1
Speed Limit Under Normal Operating Conditions (mph)	Deterministic	User Input	Site specific
Lanes Open in Each Direction Under Normal Conditions	Deterministic	User Input	Site specific
Free Flow Capacity (vphpl)	Deterministic	User Input	CDOT WorkZone software (Normal capacity per lane)
Queue Dissipation Capacity (vphpl)	Deterministic	User Input	CDOT WorkZone software (Work zone capacity per lane)
Maximum AADT (total for both directions)	Deterministic	User Input	Site specific
Maximum Queue Length (miles)	Deterministic	5 miles	CDOT
Rural or Urban Hourly Traffic Distribution	Select Option Urban/Rural	User Input	CDOT WorkZone software (Functional class)

Free Flow Capacity (vphpl) is obtained from CDOT WorkZone software and is labeled "Normal Capacity per Lane" on the input screen. Queue Dissipation Capacity (vphpl) must be equal to or greater than the largest value of work zone capacity per lane under the alternatives input screens, otherwise an error is detected under the input error warnings check. An explanation is in order. The queue dissipation capacity is on a roadway when there is no work zone. The traffic comes to a complete stop or almost to a complete stop and the traffic starts and dissipates. This is

similar to a traffic light or some object in the roadway. The queue dissipation capacity is then how much traffic the roadway will carry under these conditions. This is different than free flow and different than during a work zone normal traffic flow. The work zone normal traffic slows down but does not come to a complete stop or near stop. Therefore, the Queue Dissipation Capacity must be larger for the same roadway to be able to disperse more volume of traffic than a work zone condition.

Only a deterministic value is needed for the maximum AADT (both direction). In the Highway Capacity Manual (2000) (HCM (2000)) lists various volumes of freeways with 4, 6, and 8 lanes and 4 lane arterial. It is fortunate that Denver, Colorado is listed in the tables and exhibits.

Exhibit 8-13 – Reported Maximum Directional Volumes on Selected Urban Streets in the HCM (2000) is shown as.

6-lane

Colorado State

Highway 2: 3,435 vehicles/hour

$3,435 \text{ vehicles/hour} \times 2 \text{ directions} = 6,870 \text{ vehicles/hour both directions}$

$6,870 \text{ vehicles/hour both directions} \times 24 \text{ hours} = 164,880 \text{ Maximum AADT both directions}$

Exhibit 8-19 – Reported Maximum Hourly One-Way Volumes On Selected Freeways in the Highway Capacity Manual (2000) (HCM (2000)) lists various volumes of freeways with 4, 6, and 8 lanes.

4-lane I-225: 4,672 vehicles/hour

$4,672 \text{ vehicles/hour} \times 2 \text{ directions} = 9,344 \text{ vehicles/hour both directions}$

$9,344 \text{ vehicles/hour both directions} \times 24 \text{ hours} = 224,256 \text{ Maximum AADT both directions}$

6-lane US 6: 7,378 vehicles/hour

$7,378 \text{ vehicles/hour} \times 2 \text{ directions} = 14,756 \text{ vehicles/hour both directions}$

$14,756 \text{ vehicles/hour both directions} \times 24 \text{ hours} = 354,144 \text{ Maximum AADT both directions}$

8-lane I-25: 8,702 vehicles/hour

$8,702 \text{ vehicles/hour} \times 2 \text{ directions} = 17,404 \text{ vehicles/hour both directions}$

$17,404 \text{ vehicles/hour both directions} \times 24 \text{ hours} = 417,696 \text{ Maximum AADT both directions}$

The pavement designer may select a reasonable Maximum AADT. If need be an interpolation may be in order to fit the project specifics. An alternate method is to use the Free Flow Capacity (vphpl) times the number of lanes times the 2 directions times 24 hours.

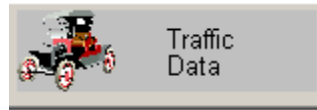

Traffic Data [Close]

AADT Construction Year (total for both directions):	<input type="text" value="10372"/>
Single Unit Trucks as Percentage of AADT (%):	<input type="text" value="6.3"/>
Combination Trucks as Percentage of AADT (%):	<input type="text" value="22.9"/>
Annual Growth Rate of Traffic (%):	<input type="text" value="1.34000003"/>
Speed Limit Under Normal Operating Conditions (mph):	<input type="text" value="75"/>
Lanes Open in Each Direction Under Normal Conditions:	<input type="text" value="2"/>
Free Flow Capacity (vphpl):	<input type="text" value="1942"/>
Free Flow Capacity Calculator	
Queue Dissipation Capacity (vphpl):	<input type="text" value="1140"/>
Maximum AADT (total for both directions):	<input type="text" value="150000"/>
Maximum Queue Length (miles):	<input type="text" value="5"/>
Rural or Urban Hourly Traffic Distribution:	<input type="text" value="Rural"/>

Figure 10.16 Traffic Data Option Screen

10.7.6 Value of User Time

The Value of User Time form, shown in **Figure 10.17 Value of User Option Screen**, allows editing of the values applied to an hour of user time. The dollar value of user time is different for each vehicle type and is used to calculate user costs associated with delay during work zone operations.

Table 10.9 Value of User Time Data Options

Variable Name	Probability Distribution (CDOT Default)	Value (CDOT Default)	Source
Value of Time for Passenger Cars (\$/hour)	Deterministic	17	CDOT Work Zone Software Section 10.5.7
Value of Time for Single Unit Trucks (\$/hours)	Deterministic	35	CDOT Work Zone Software Section 10.5.7
Value of Time for Combination Trucks (\$/hour)	Deterministic	36.50	CDOT Work Zone Software Section 10.5.7

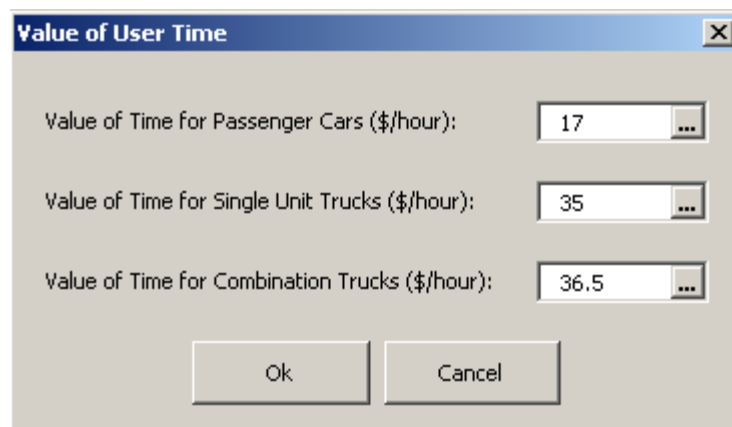

Figure 10.17 Value of User Option Screen

10.7.7 Traffic Hourly Distribution

To transform Annual Average Daily Traffic (AADT) to an hourly traffic distribution, default Rural and Urban Traffic hourly distributions from MicroBENCOST are provided with RealCost. The Traffic Hourly Distribution (**Figure 10.18**) form is used to adjust (or restore) these settings. Distributions are required to sum to 100 percent.

Table 10.10 Traffic Hourly Distribution Data Options

Variable Name	Probability Distribution (CDOT Default)	Value (CDOT Default)	Source
AADT Rural (%)	Real Cost Default	Real Cost Default	Real Cost Software
Inbound Rural (%)	Real Cost Default	Real Cost Default	Real Cost Software
AADT Urban (%)	Real Cost Default	Real Cost Default	Real Cost Software
Inbound Urban (%)	Real Cost Default	Real Cost Default	Real Cost Software



Traffic Hourly Distribution - Distribution 1

Distribution Name: Week Day 1

Hour	AADT Rural (%)	Inbound Rural (%)	Outbound Rural (%)	AADT Urban (%)	Inbound Urban (%)	Outbound Urban (%)
0 - 1	1.8	48	52	1.2	47	53
1 - 2	1.5	48	52	0.8	43	57
2 - 3	1.3	45	55	0.7	46	54
3 - 4	1.3	53	47	0.5	48	52
4 - 5	1.5	53	47	0.7	57	43
5 - 6	1.8	53	47	1.7	58	42
6 - 7	2.5	57	43	5.1	63	37
7 - 8	3.5	56	44	7.8	60	40
8 - 9	4.2	56	44	6.3	59	41
9 - 10	5	54	46	5.2	55	45
10 - 11	5.4	51	49	4.7	46	54
11 - 12	5.6	51	49	5.3	49	51
12 - 13	5.7	50	50	5.6	50	50
13 - 14	6.4	52	48	5.7	50	50
14 - 15	6.8	51	49	5.9	49	51
15 - 16	7.3	53	47	6.5	46	54
16 - 17	9.3	49	51	7.9	45	55
17 - 18	7	43	57	8.5	40	60
18 - 19	5.5	47	53	5.9	46	54
19 - 20	4.7	47	53	3.9	48	52
20 - 21	3.8	46	54	3.3	47	53
21 - 22	3.2	48	52	2.8	47	53
22 - 23	2.6	48	52	2.3	48	52
23 - 24	2.3	47	53	1.7	45	55
Total	100			100		

Restore Defaults Ok

Figure 10.18 Traffic Hourly Distribution Screen

10.7.8 Added Time and Vehicle Costs Options

“Added Time per 1,000 Stops (Hours)” and “Added Cost per 1,000 Stops (\$)” values are used to calculate user delay and vehicle costs due to speed changes that occur during work zone operations. This form (Figure 10.19) is used to adjust the default values for added time and added cost per 1,000 stops. The “Idling Cost per Veh-Hr (\$)” is used to calculate the additional vehicle operating costs that result from traversing a traffic queue under stop and go conditions. The costs and times are different for each vehicle type.

The Restore Defaults button functions much the same as it does on the Traffic Hourly Distribution form. The default values are drawn from NCHRP Study 133, Procedures for Estimating Highway User Costs, Air Pollution, and Noise Effects.

Table 10.11 Added Time and Vehicle Costs Data Options

Variable Name	Probability Distribution (CDOT Default)	Value (CDOT Default)	Source
Added Time Passenger Cars	Real Cost Default	Real Cost Default	Real Cost Software
Added Time Single Unit Trucks	Real Cost Default	Real Cost Default	Real Cost Software
Added Time Combination Trucks	Real Cost Default	Real Cost Default	Real Cost Software
Added Cost Passenger Cars	Real Cost Default	Real Cost Default	Real Cost Software
Added Cost Single Unit Trucks	Real Cost Default	Real Cost Default	Real Cost Software
Added Cost Combination Trucks	Real Cost Default	Real Cost Default	Real Cost Software
Base Transportation Component CPI	Deterministic	142.8	Real Cost Software
Base Year	Deterministic	1996	Real Cost Software
Current Transportation Component CPI	Deterministic	User Input	CDOT
Current Year	Deterministic	User Input	CDOT
Idling Cost Per Veh-HR (\$) Passenger Cars	Real Cost Default	Real Cost Default	Real Cost Software
Idling Cost Per Veh-HR (\$) Single Unit Trucks	Real Cost Default	Real Cost Default	Real Cost Software
Idling Cost Per Veh-HR (\$) Combination Trucks	Real Cost Default	Real Cost Default	Real Cost Software

The Colorado Construction Cost Index may be obtained from the Agreements and Market Analysis Branch, Engineering Estimates and Market Analysis Unit. The unit publishes a quarterly report and is in Acrobat file format. The website is http://www.dot.state.co.us/app_eema_cdb/ and is under the title Colorado Construction Cost Index (CCI).

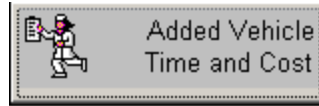

Added Time and Vehicle Stopping Costs

Initial Speed (mph)	Added Time per 1,000 Stops (Hours)			Added Cost per 1,000 Stops (\$)		
	Passenger Cars	Single Unit Trucks	Combination Trucks	Passenger Cars	Single Unit Trucks	Combination Trucks
0	0	0	0	0	0	0
5	1.02	0.73	1.1	2.7	9.25	33.62
10	1.51	1.47	2.27	8.83	20.72	77.49
15	2	2.2	3.48	15.16	33.89	129.97
20	2.49	2.93	4.76	21.74	48.4	190.06
25	2.98	3.67	6.1	28.67	63.97	256.54
30	3.46	4.4	7.56	36.1	80.23	328.21
35	3.94	5.13	9.19	44.06	96.88	403.84
40	4.42	5.87	11.09	52.7	113.97	482.21
45	4.9	6.6	13.39	62.07	130.08	562.14
50	5.37	7.33	16.37	72.31	145.96	642.41
55	5.84	8.07	20.72	83.47	160.89	721.77
60	6.31	8.8	27.94	95.7	178.98	798.99
65	6.78	9.53	31.605	109.02	195.84	849.64
70	7.25	10.27	39.48	123.61	209.06	921.03
75	7.71	11	47.9	139.53	224.87	992.42
80	8.17	11.73	57.68	156.85	240.68	1063.82

Cost Escalation

Base Transp. Component CPI: 142.8

Base Year: 1996

Current Transp. Component CPI: 142.8

Current Year: 1996

Escalation Factor: 1.00

Escalate

Idling Cost per Veh-Hr (\$): 0.6927 0.7681 0.8248

Restore Defaults Ok

Figure 10.19 Added Time and Vehicle Stopping Costs Screen

10.7.9 Saving and Opening Project-Level Inputs

The last two buttons in the project-level input section of the Switchboard (see **Figure 10.20**) are used to save and to retrieve (load) project-level inputs. NOTE: Alternative-level inputs are saved separately from project-level inputs. The mechanism to save and open alternative-level inputs is found on the Alternative 1 and Alternative 2 forms.

Project-level inputs are saved in a small, comma-delimited file. This file may be named via ordinary Windows conventions and is automatically saved with the *.LCC extension. Changing the file extension will prevent RealCost from recognizing the file.

Warning: Opening an *.LCC file will overwrite data in the Project-Level Inputs section.

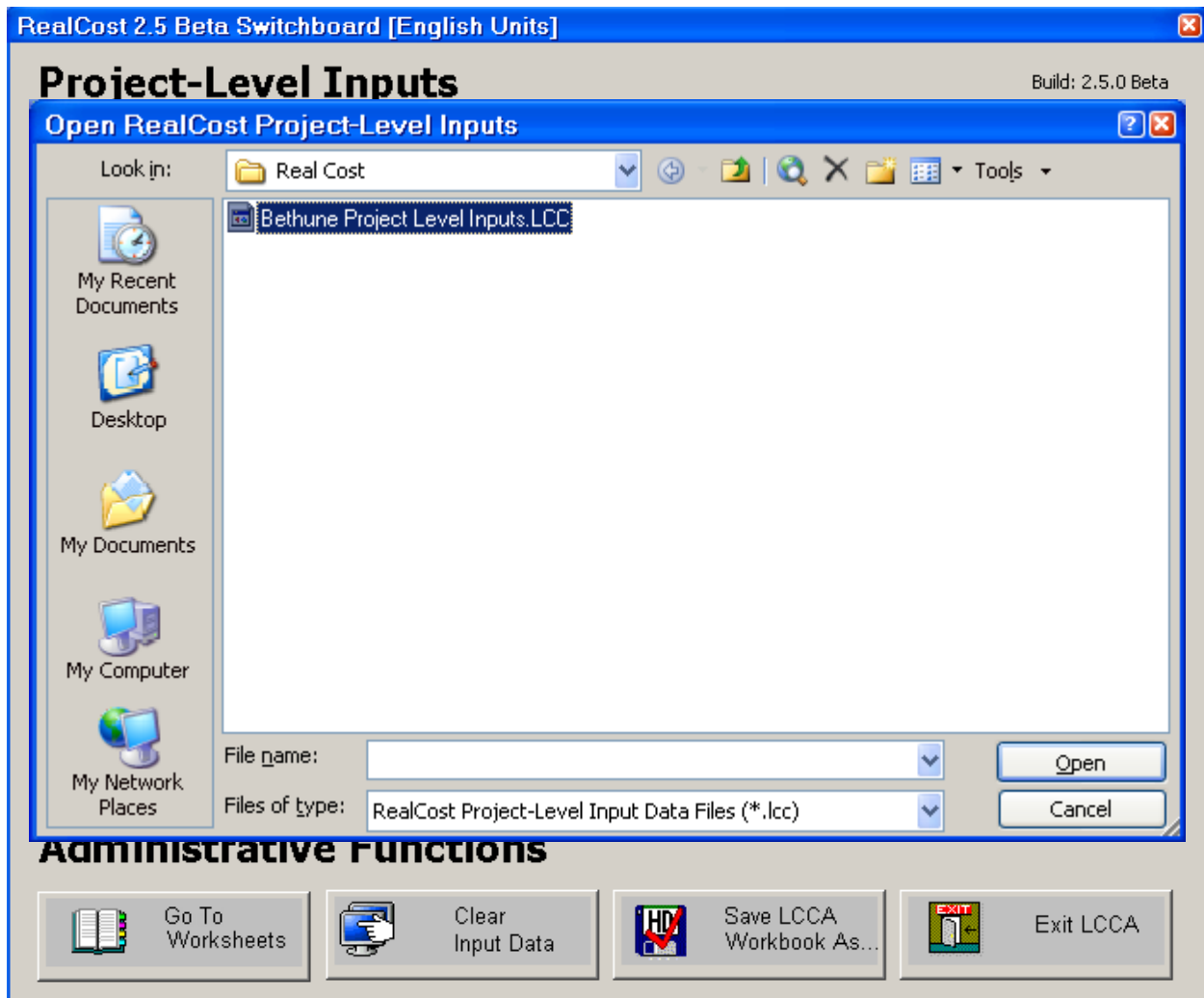

Figure 10.20 Saving and Opening Project-Level Inputs

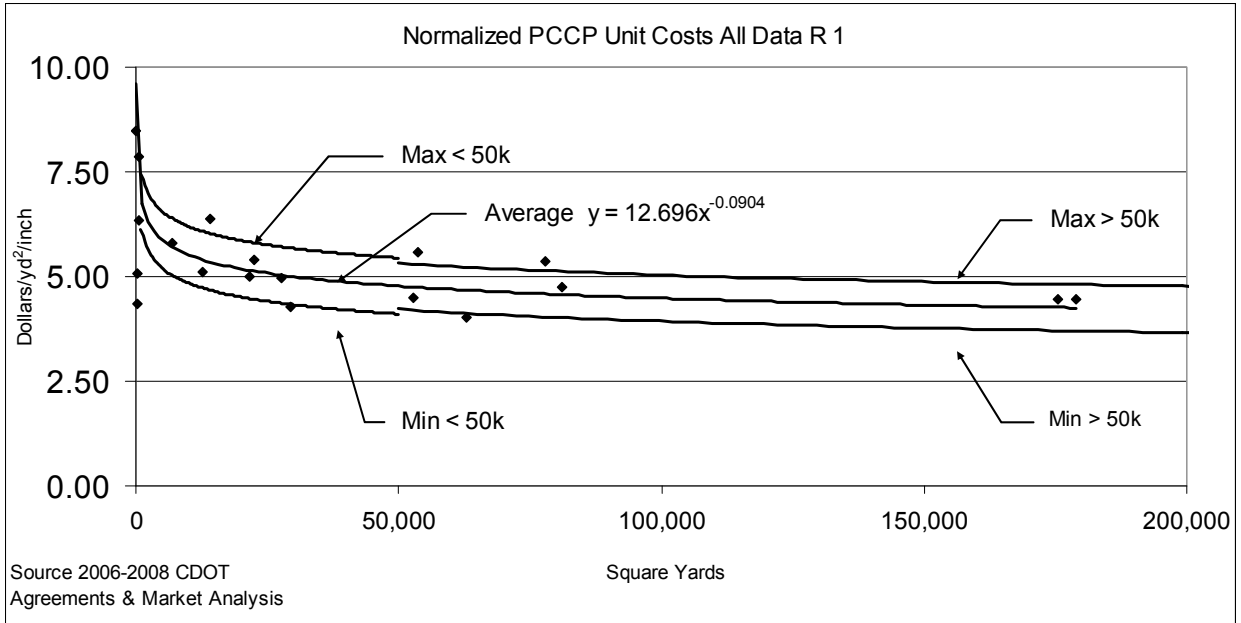

Figure 10.21 PCCP Unit Costs (Region 1)

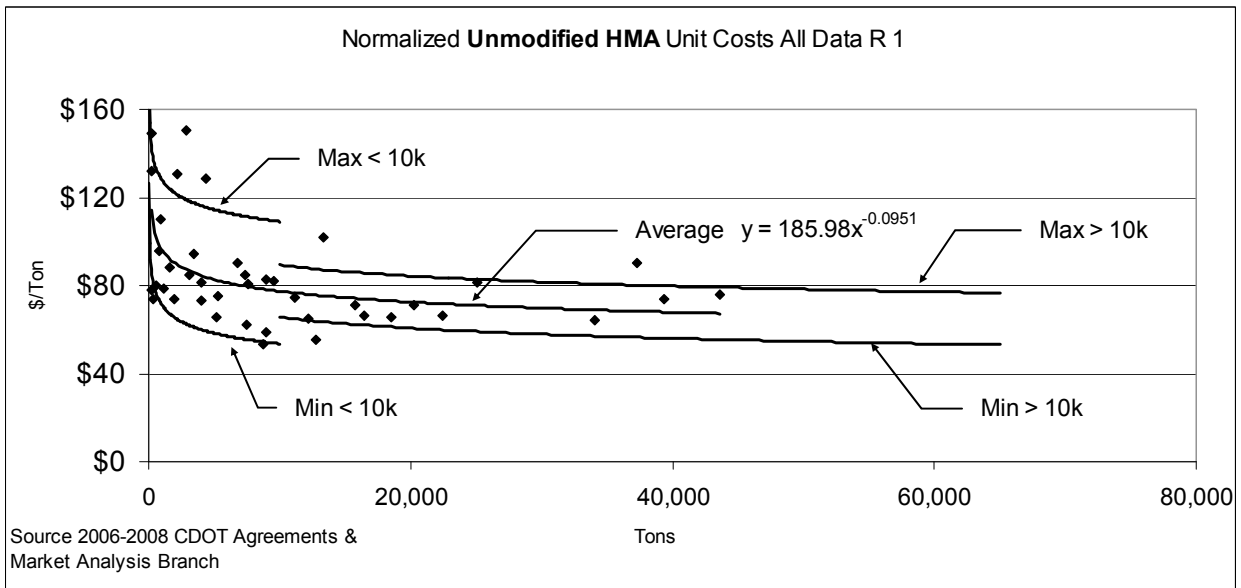

Figure 10.22 Unmodified HMA Unit Costs (Region 1)

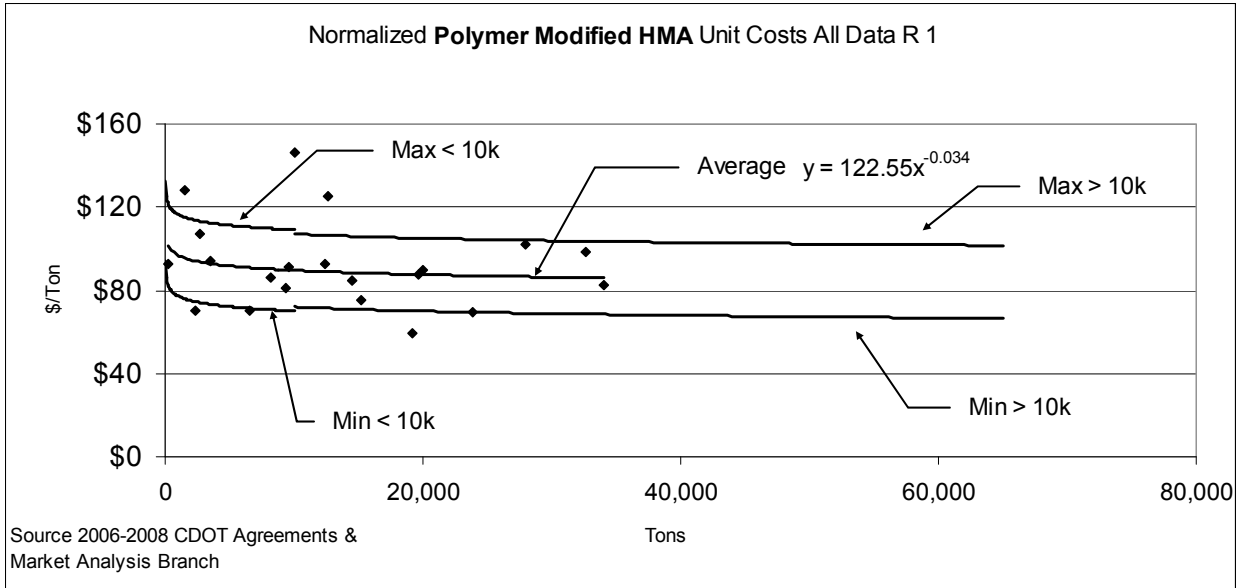

Figure 10.23 Polymer Modified HMA Unit Costs (Region 1)

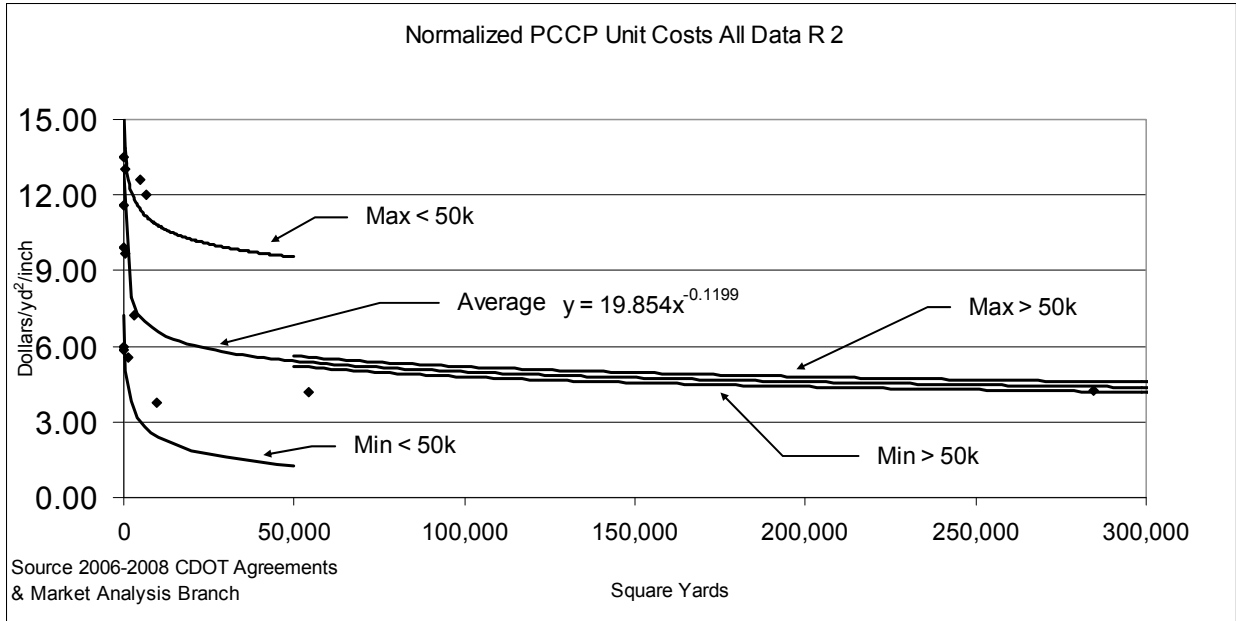

Figure 10.24 PCCP Unit Costs (Region 2)

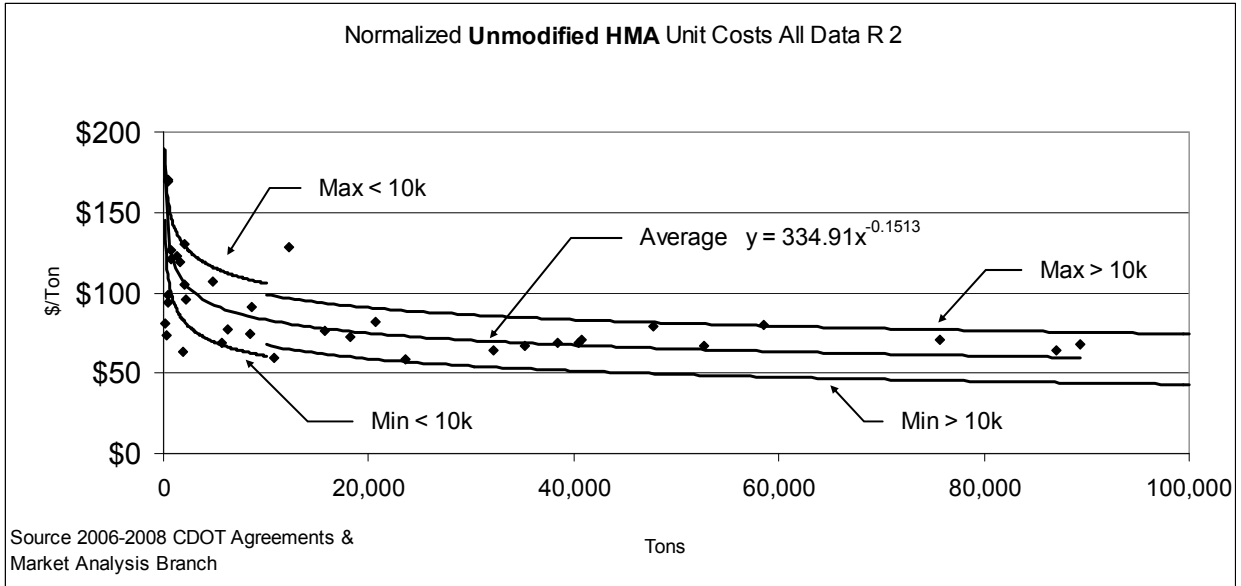

Figure 10.25 Unmodified HMA Unit Costs (Region 2)

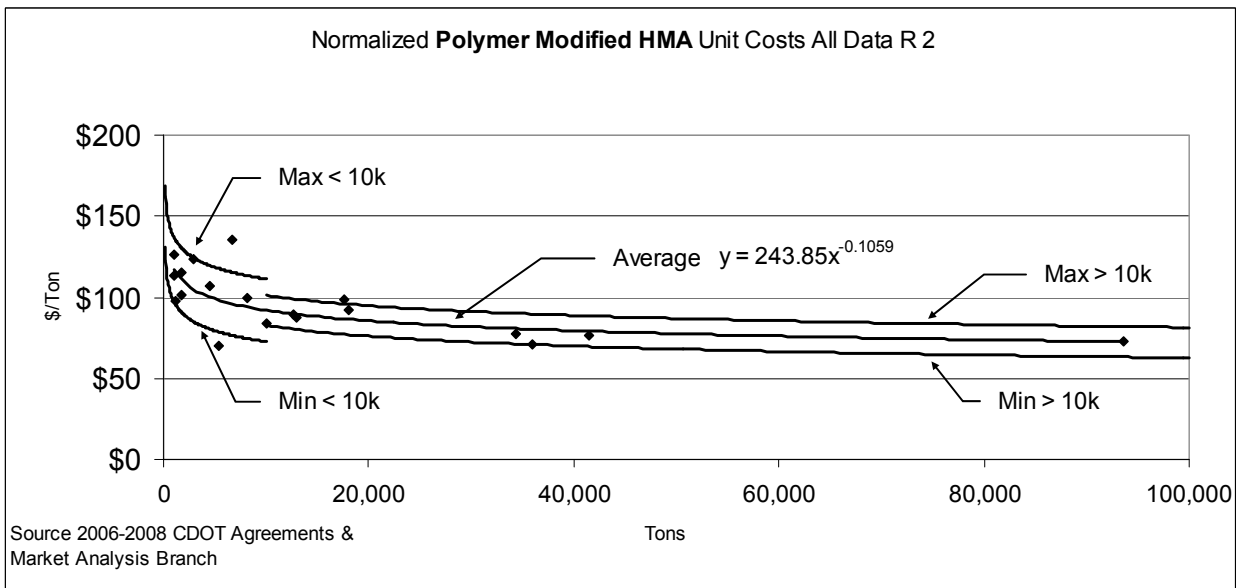

Figure 10.26 Polymer Modified HMA Unit Costs (Region 2)

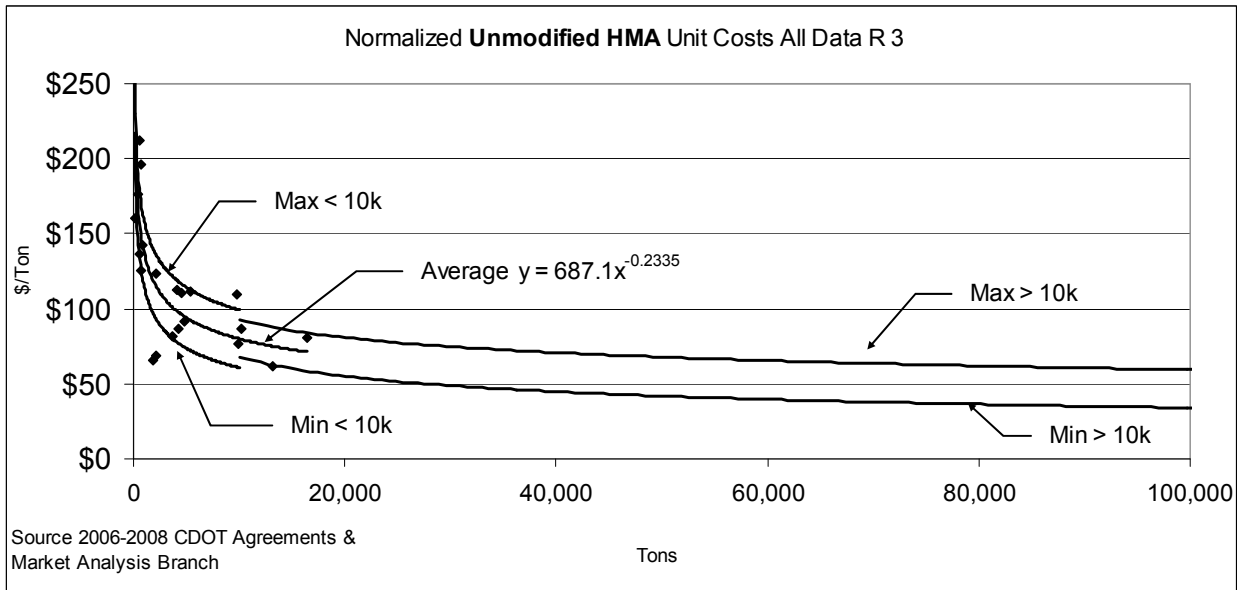

Figure 10.27 Unmodified HMA Unit Costs (Region 3)

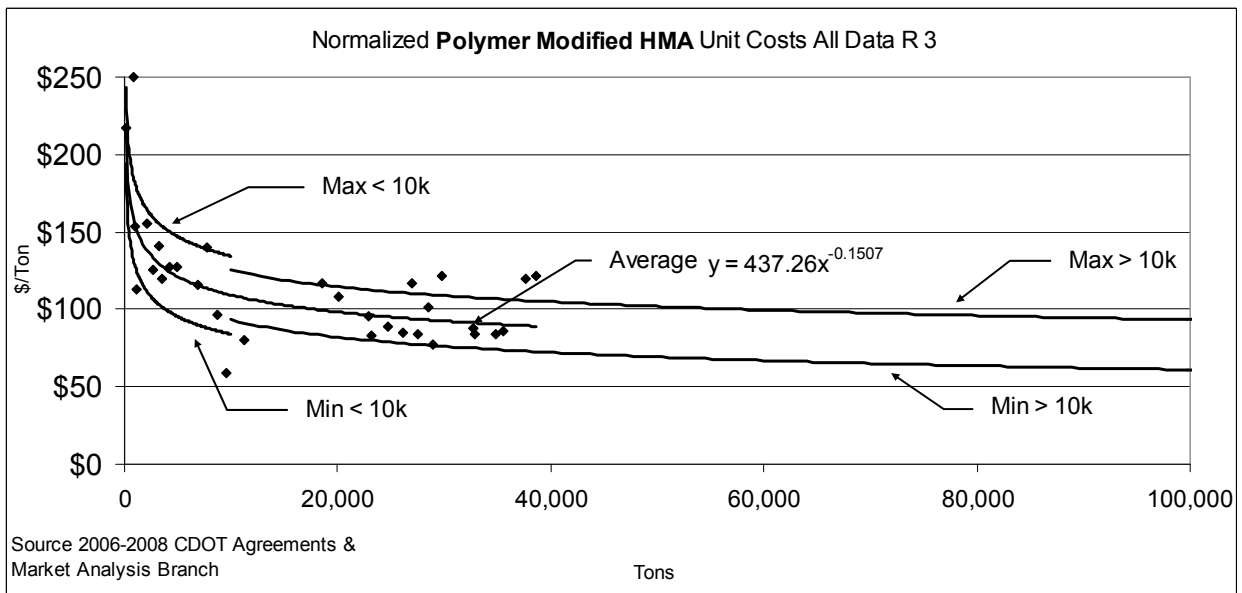

Figure 10.28 Polymer Modified HMA Unit Costs (Region 3)

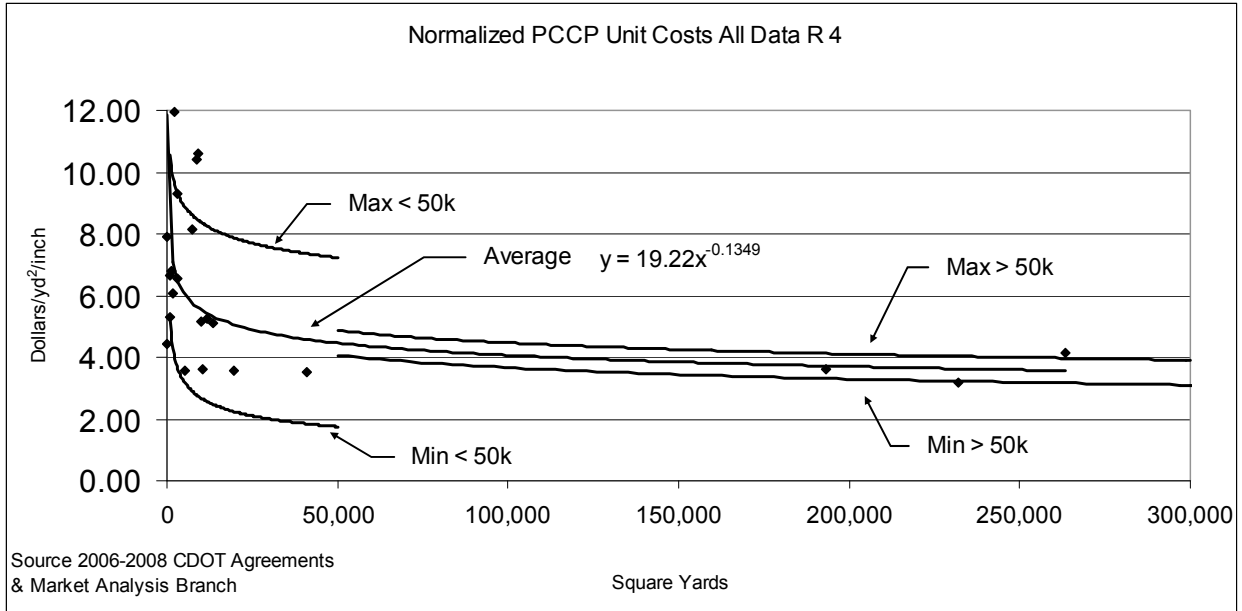

Figure 10.29 PCCP Unit Costs (Region 4)

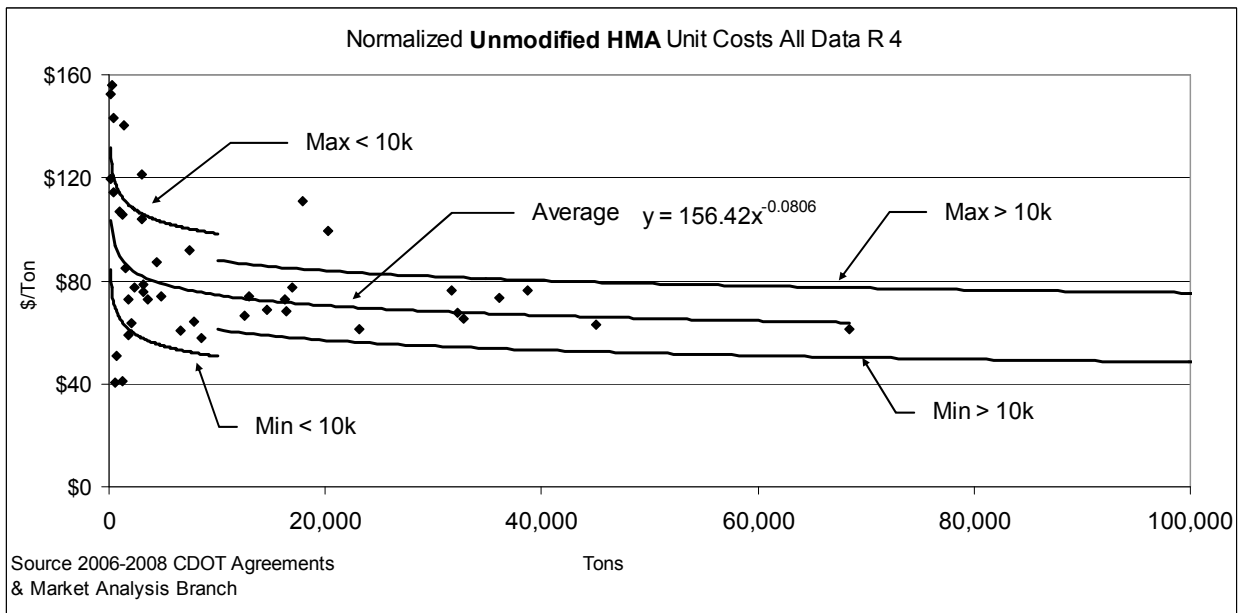

Figure 10.30 Unmodified HMA Unit Costs (Region 4)

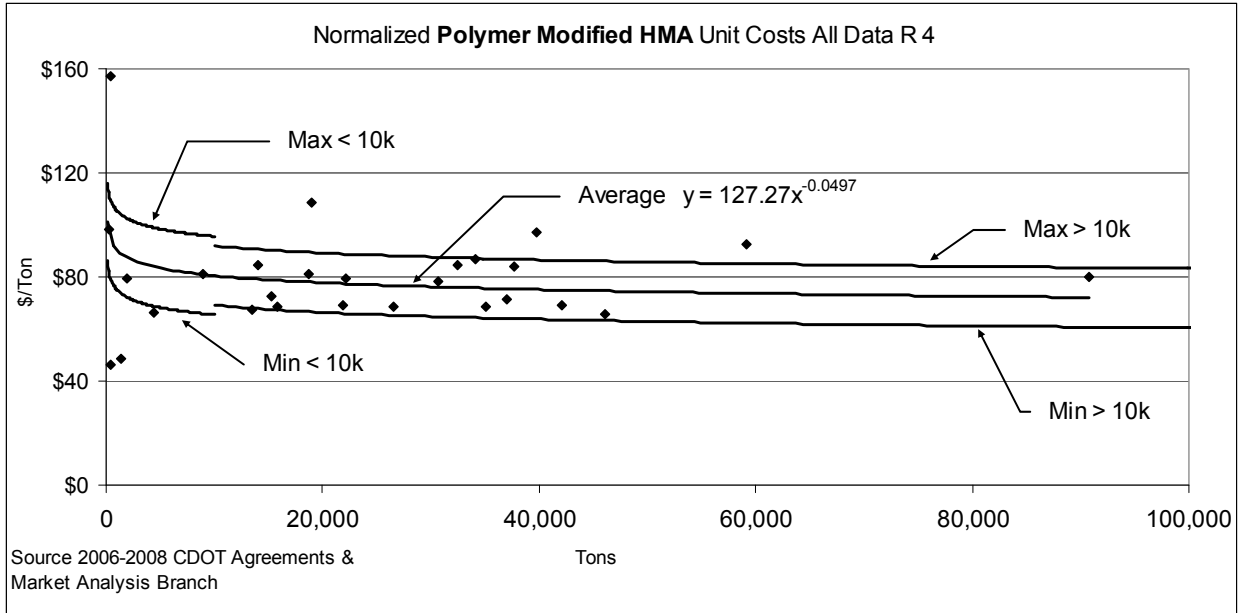

Figure 10.31 Polymer Modified HMA Unit Costs (Region 4)

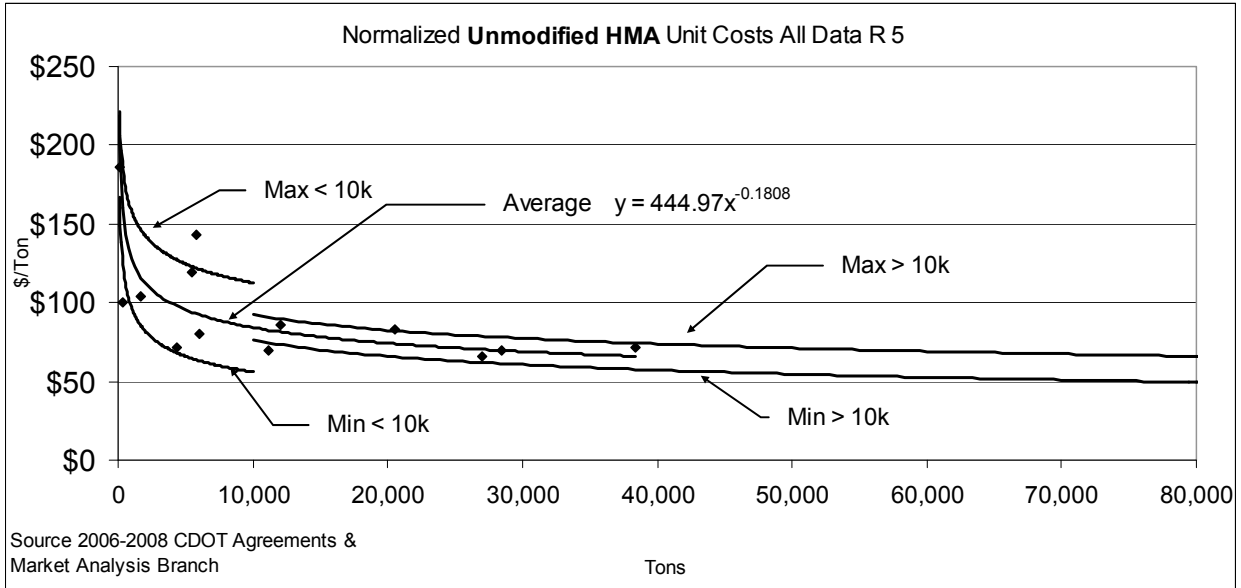

Figure 10.32 Unmodified HMA Unit Costs (Region 5)

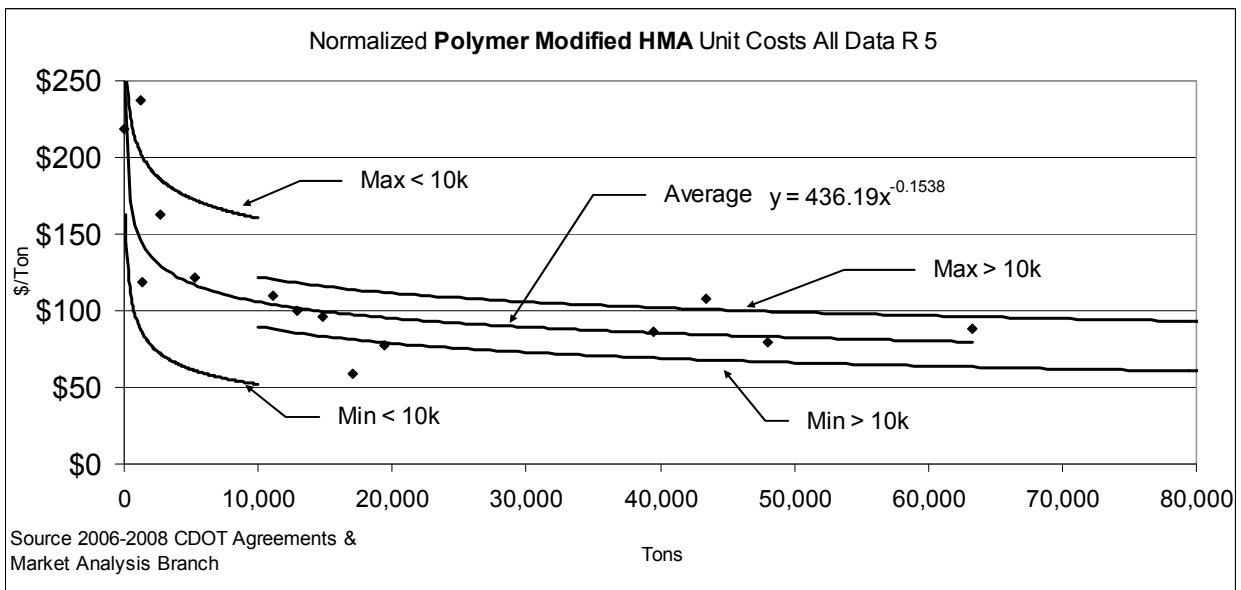

Figure 10.33 Polymer Modified HMA Unit Costs (Region 5)

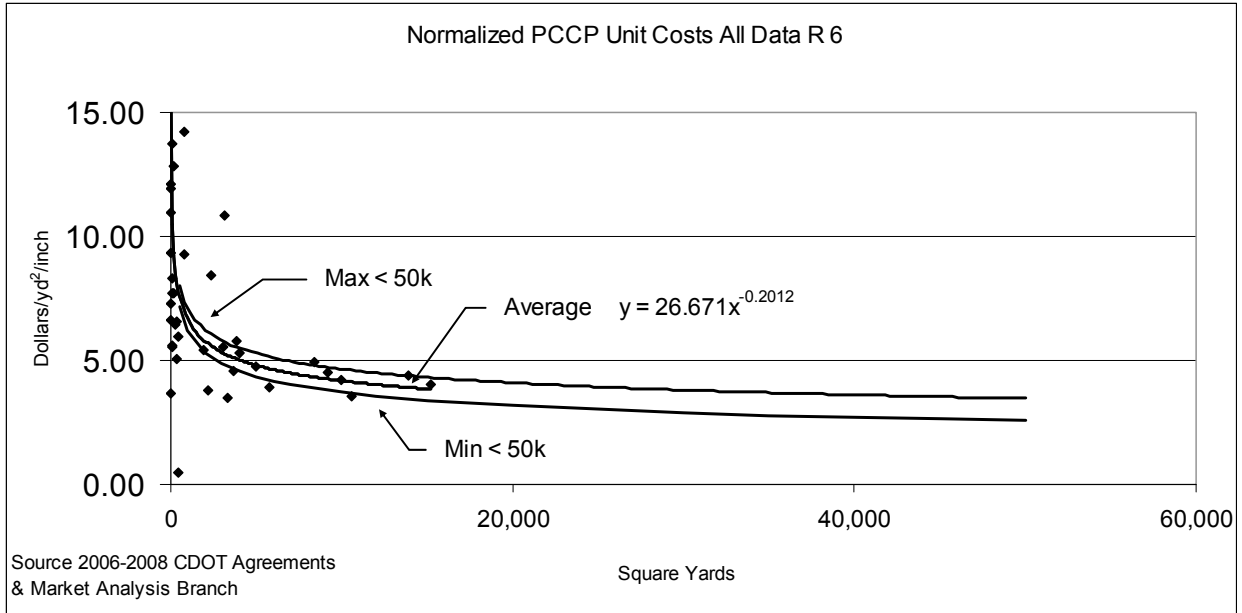

Figure 10.34 PCC Unit Costs (Region 6)

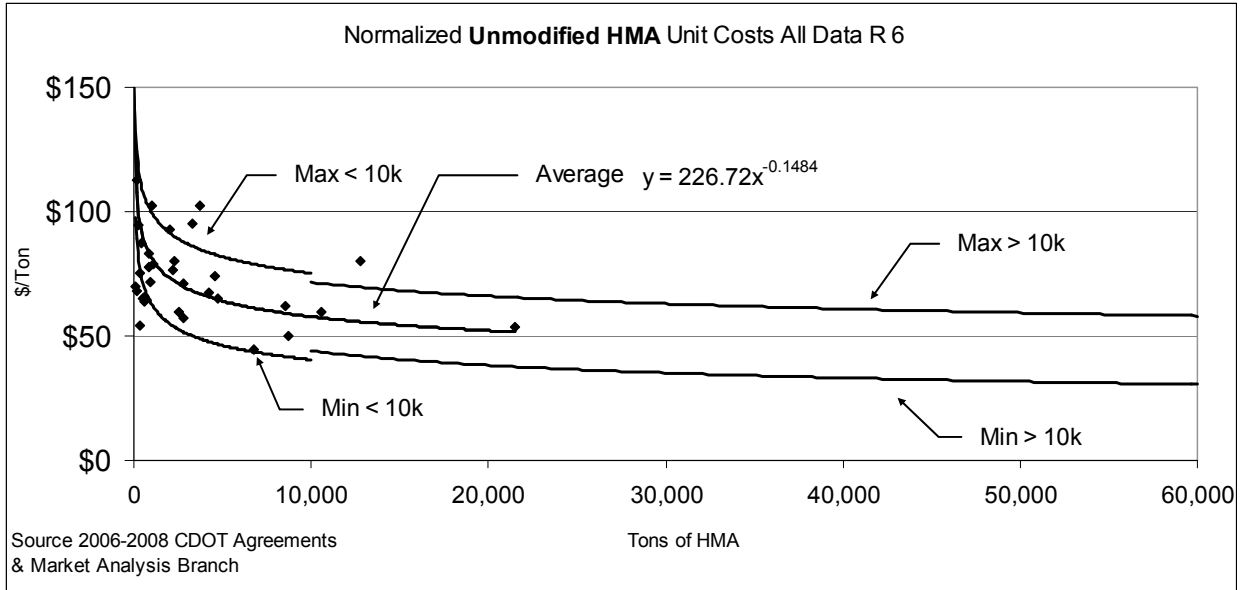

Figure 10.35 Unmodified HMA Unit Costs (Region 6)

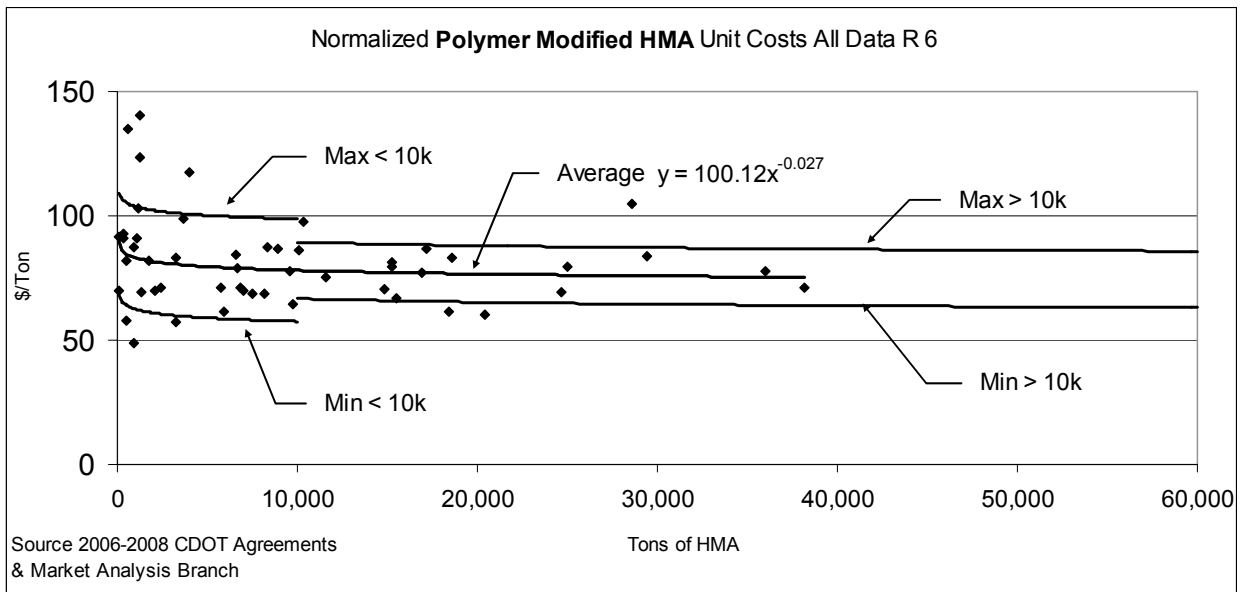

Figure 10.36 Polymer Modified HMA Unit Costs (Region 6)

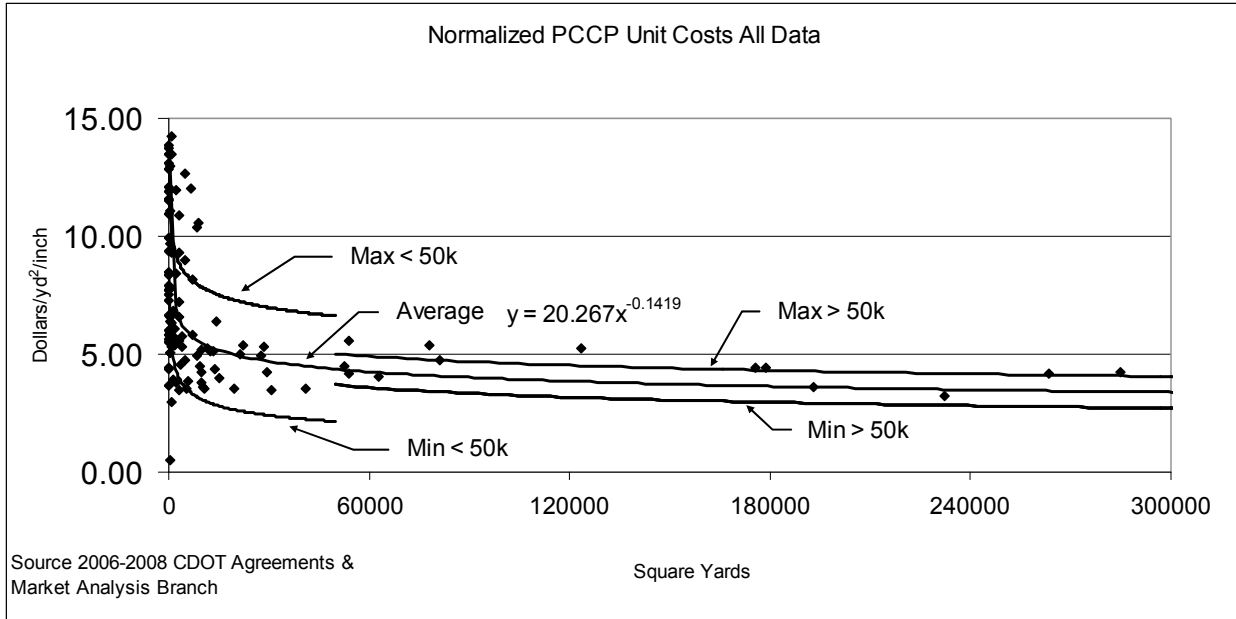

Figure 10.37 PCCP Unit Costs (Statewide)

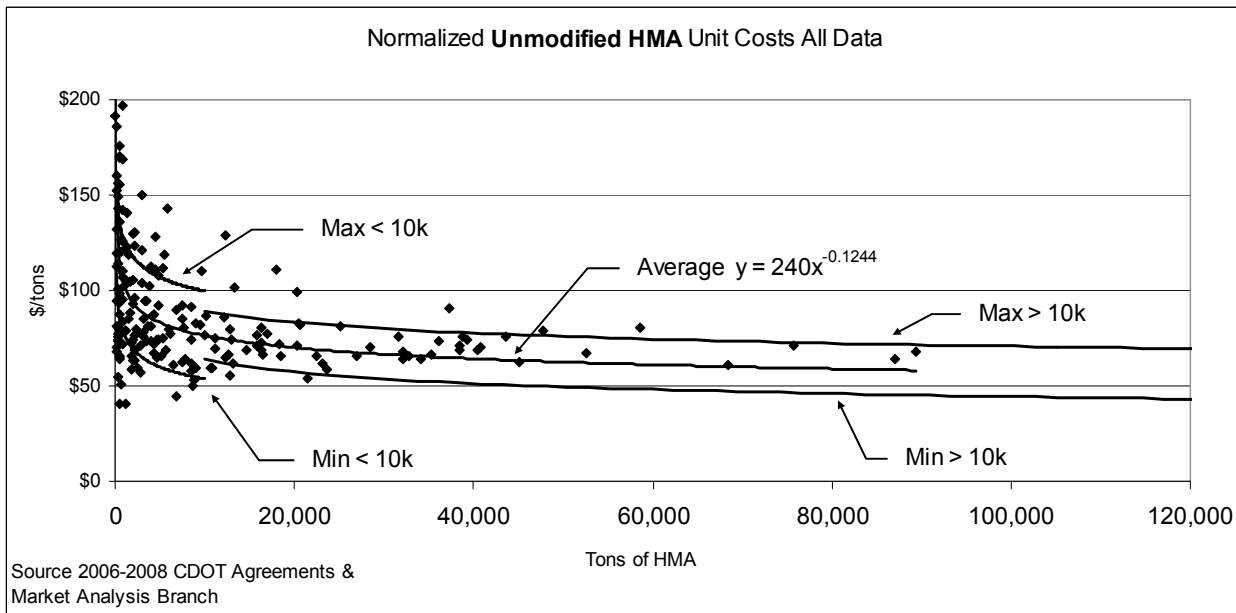

Figure 10.38 Unmodified HMA Unit Costs (Statewide)

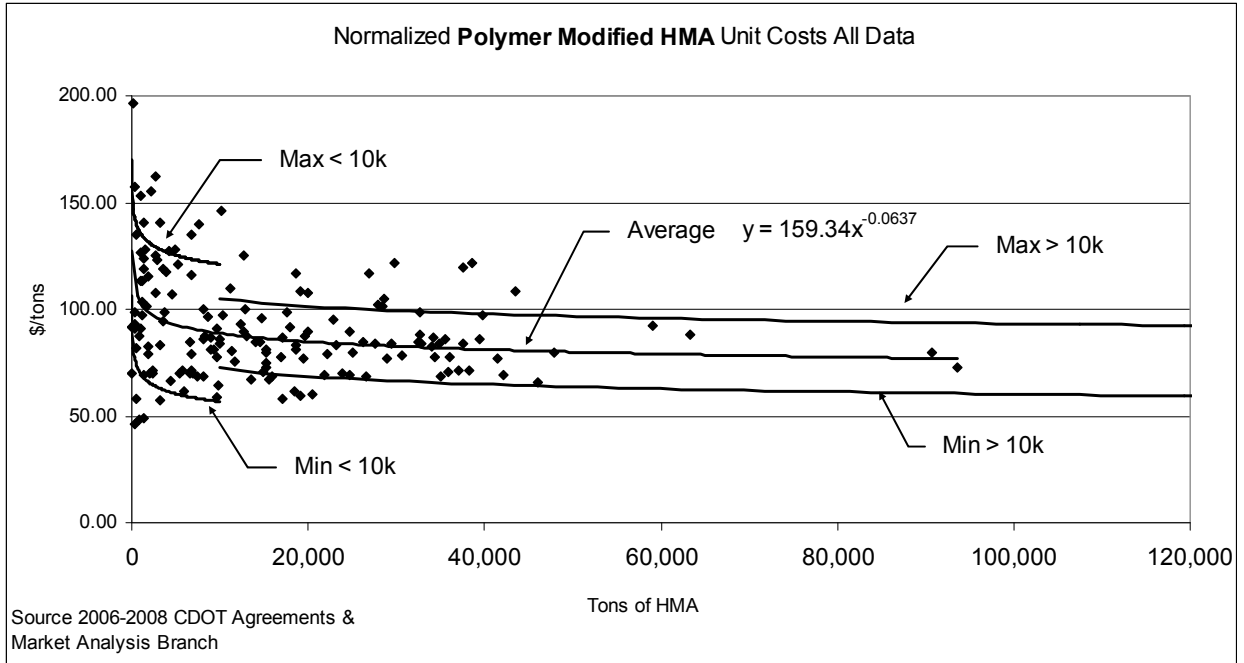

Figure 10.39 Polymer Modified HMA Unit Costs (Statewide)

PCCP			PCCP						
Quantity of Material	yd ²		Less Than 50,000 (yd ²)			Greater Than 50,000 (yd ²)			
			Quantity (yd ²)	Unit Cost (\$/yd ² /in)	Total Construction Cost (\$)	Quantity (yd ²)	Unit Cost (\$/yd ² /in)	Total Construction Cost (\$)	
	177,408.00		REGION						
Total Project Length (Miles)*	3.6		1	MIN 177,408.00	NA	Not-Applicable	MIN 177,408.00	\$3.70	\$9,875,493
Width (Feet)	84			AVG. 177,408.00	NA	Not-Applicable	AVG. 177,408.00	\$4.26	\$11,343,539
Thickness(Inches)	10.5			MAX 177,408.00	NA	Not-Applicable	MAX 177,408.00	\$4.81	\$12,822,123
PE Costs (%)	10.00%		2	MIN 177,408.00	NA	Not-Applicable	MIN 177,408.00	\$4.46	\$11,895,185
Const. Eng. & Indirect (%)	18.10%			AVG. 177,408.00	NA	Not-Applicable	AVG. 177,408.00	\$4.66	\$12,419,633
Traffic Costs (%)	15.00%			MAX 177,408.00	NA	Not-Applicable	MAX 177,408.00	\$4.86	\$12,954,763
* Total length includes both directions (2 times one direction)			3	MIN 177,408.00	NA	Not-Applicable	Not enough data points to determine		
				AVG. 177,408.00	NA	Not-Applicable			
				MAX 177,408.00	NA	Not-Applicable			
			4	MIN 177,408.00	NA	Not-Applicable	MIN 177,408.00	\$3.36	\$8,954,233
				AVG. 177,408.00	NA	Not-Applicable	AVG. 177,408.00	\$3.76	\$10,028,748
				MAX 177,408.00	NA	Not-Applicable	MAX 177,408.00	\$4.17	\$11,112,356
			5	MIN 177,408.00	NA	Not-Applicable	Not enough data points to determine		
				AVG. 177,408.00	NA	Not-Applicable			
				MAX 177,408.00	NA	Not-Applicable			
			6	MIN 177,408.00	NA	Not-Applicable	Not enough data points to determine		
				AVG. 177,408.00	NA	Not-Applicable			
				MAX 177,408.00	NA	Not-Applicable			
			STATEWIDE	MIN 177,408.00	NA	Not-Applicable	MIN 177,408.00	\$2.97	\$7,922,404
				AVG. 177,408.00	NA	Not-Applicable	AVG. 177,408.00	\$3.65	\$9,725,710
				MAX 177,408.00	NA	Not-Applicable	MAX 177,408.00	\$4.32	\$11,517,844

Figure 10.40 PCCP Unit Costs (Statewide)

Unmodified HMA			Unmodified HMA						
Quantity of Material	Tons		Less Than 10,000 (Tons)			Greater Than 10,000 (Tons)			
			Quantity (Tons)	Unit Cost (\$)	Total Construction Cost (\$)	Quantity (Tons)	Unit Cost (\$)	Total Construction Cost (\$)	
	58,544.64		REGION						
Total Project Length (Miles)*	3.6		1	MIN 58,544.64	NA	Not-Applicable	MIN 58,544.64	\$53.65	\$4,494,510.31
Width(Feet)	84			AVG. 58,544.64	NA	Not-Applicable	AVG. 58,544.64	\$64.74	\$5,424,129.56
Thickness(Inches)	6			MAX 58,544.64	NA	Not-Applicable	MAX 58,544.64	\$77.31	\$6,476,544.96
PE Costs (%)	10.00%		2	MIN 58,544.64	NA	Not-Applicable	MIN 58,544.64	\$47.75	\$4,000,129.82
Const. Eng. & Indirect (%)	18.10%			AVG. 58,544.64	NA	Not-Applicable	AVG. 58,544.64	\$63.63	\$5,330,459.27
Traffic Costs (%)	15.00%			MAX 58,544.64	NA	Not-Applicable	MAX 58,544.64	\$79.47	\$6,658,134.84
* Total length includes both directions (2 times one direction)			3	MIN 58,544.64	NA	Not-Applicable	MIN 58,544.64	\$39.98	\$3,349,684.58
				AVG. 58,544.64	NA	Not-Applicable	AVG. 58,544.64	\$52.97	\$4,437,360.69
				MAX 58,544.64	NA	Not-Applicable	MAX 58,544.64	\$65.84	\$5,515,558.39
			4	MIN 58,544.64	NA	Not-Applicable	MIN 58,544.64	\$51.06	\$4,277,471.67
				AVG. 58,544.64	NA	Not-Applicable	AVG. 58,544.64	\$64.54	\$5,407,321.40
				MAX 58,544.64	NA	Not-Applicable	MAX 58,544.64	\$78.08	\$6,540,920.00
			5	MIN 58,544.64	NA	Not-Applicable	MIN 58,544.64	\$52.88	\$4,429,954.80
				AVG. 58,544.64	NA	Not-Applicable	AVG. 58,544.64	\$61.17	\$5,124,801.06
				MAX 58,544.64	NA	Not-Applicable	MAX 58,544.64	\$69.41	\$5,814,648.60
			6	MIN 58,544.64	NA	Not-Applicable	MIN 58,544.64	\$30.69	\$2,570,774.15
				AVG. 58,544.64	NA	Not-Applicable	AVG. 58,544.64	\$44.45	\$3,724,262.19
				MAX 58,544.64	NA	Not-Applicable	MAX 58,544.64	\$58.27	\$4,881,291.05
			STATEWIDE	MIN 58,544.64	NA	Not-Applicable	MIN 58,544.64	\$48.34	\$4,049,633.70
				AVG. 58,544.64	NA	Not-Applicable	AVG. 58,544.64	\$61.28	\$5,134,189.00
				MAX 58,544.64	NA	Not-Applicable	MAX 58,544.64	\$74.72	\$6,259,468.55

Figure 10.41 Unmodified HMA Unit Costs (Statewide)

Polymer Modified HMA Quantity of Material		Tons	Polymer Modified HMA						
		58,544.64	Less Than 10,000 (Tons)		Greater Than 10,000 (Tons)				
			REGION	Quantity (Tons)	Unit Cost (\$)	Total Construction Cost (\$)	Quantity (Tons)	Unit Cost (\$)	Total Construction Cost (\$)
Total Project Length (Miles)*	3.6		1	MIN 58,544.64	NA	Not-Applicable	MIN 58,544.64	\$66.86	\$5,601,255.89
Width(Feet)	84			AVG. 58,544.64	NA	Not-Applicable	AVG. 58,544.64	\$84.41	\$7,071,589.96
Thickness(Inches)	6			MAX 58,544.64	NA	Not-Applicable	MAX 58,544.64	\$101.89	\$8,536,424.32
PE Costs (%)	10.00%		2	MIN 58,544.64	NA	Not-Applicable	MIN 58,544.64	\$66.83	\$5,598,822.02
Const. Eng. & Indirect (%)	18.10%			AVG. 58,544.64	NA	Not-Applicable	AVG. 58,544.64	\$76.29	\$6,391,138.96
Traffic Costs (%)	15.00%			MAX 58,544.64	NA	Not-Applicable	MAX 58,544.64	\$85.67	\$7,177,135.29
* Total length includes both directions (2 times one direction)			3	MIN 58,544.64	NA	Not-Applicable	MIN 58,544.64	\$67.31	\$5,639,024.06
				AVG. 58,544.64	NA	Not-Applicable	AVG. 58,544.64	\$83.66	\$7,008,410.24
				MAX 58,544.64	NA	Not-Applicable	MAX 58,544.64	\$99.89	\$8,368,435.45
			4	MIN 58,544.64	NA	Not-Applicable	MIN 58,544.64	\$62.33	\$5,222,008.42
				AVG. 58,544.64	NA	Not-Applicable	AVG. 58,544.64	\$73.74	\$6,177,453.19
				MAX 58,544.64	NA	Not-Applicable	MAX 58,544.64	\$85.17	\$7,135,561.48
			5	MIN 58,544.64	NA	Not-Applicable	MIN 58,544.64	\$64.20	\$5,378,170.38
				AVG. 58,544.64	NA	Not-Applicable	AVG. 58,544.64	\$80.58	\$6,750,638.25
				MAX 58,544.64	NA	Not-Applicable	MAX 58,544.64	\$97.02	\$8,128,261.28
			6	MIN 58,544.64	NA	Not-Applicable	MIN 58,544.64	\$63.08	\$5,284,797.90
				AVG. 58,544.64	NA	Not-Applicable	AVG. 58,544.64	\$74.43	\$6,235,612.16
				MAX 58,544.64	NA	Not-Applicable	MAX 58,544.64	\$85.80	\$7,187,794.11
			STATEWIDE	MIN 58,544.64	NA	Not-Applicable	MIN 58,544.64	\$62.88	\$5,268,255.57
				AVG. 58,544.64	NA	Not-Applicable	AVG. 58,544.64	\$79.19	\$6,634,606.44
				MAX 58,544.64	NA	Not-Applicable	MAX 58,544.64	\$95.91	\$8,035,288.62

Figure 10.42 Polymer Modified HMA Unit Costs (Statewide)

10.7.10 Alternative-Level Data Input Forms

Data that define the differences between alternatives—the agency costs and work zone specifics for component activities of each project alternative—are alternative-level inputs. Each project alternative is composed of up to seven activities. The activities are performed in sequence. For example, Initial Construction precedes Rehabilitation 1 and Rehabilitation 3 precedes Rehabilitation 4. Data describing these activities are entered for each of the two project alternatives being compared. See (Figure 10.21 through Figure 10.39) for a graphical representation. ALTERNATIVE 1 and ALTERNATIVE 2 inputs: CDOT has created an Excel worksheets for both pavement types to assist the designer in selecting the appropriate costs for both initial and rehabilitation costs and a graphical representation. The user can select cost of the pavement given quantity. The forms for Alternative 1 and Alternative 2 are identical. At the top of the form, a series of tabs access project alternative activities. Each tab accesses a different activity (see Figure 10.43 and Figure 10.44). Data in this form are used to calculate agency and user costs. The construction and maintenance data are agency cost inputs. The service life data affect both agency and user costs (by determining when work zones will be in place). The work-zone-specific data affect user costs. Each of the data inputs on this form is discussed in Table 10.12 Alternative-Level Data Options.

Table 10.12 Alternative-Level Data Options

Variable Name	Probability Distribution (CDOT Default)	HMA Value (CDOT Default)	PCC Value (CDOT Default)	Source
Alternative Description	User Input	User Input	User Input	Site specific
Activity Description	User Input	User Input	User Input	Site specific
Agency Construction Cost (\$1000)	Triangular	User Input	User Input	Figure 10.21 to Figure 10.42 Or Site specific
Activity Service Life (years)	Truncated Normal, min/max ± 3 STD, with min > 0	Mean 10, STD 3.1	Mean 22, STD 6.6	Table 10.1
User Work Zone Costs (\$1000)	Deterministic	User Input	User Input	CDOT Work Zone Software Section 10.5.7
Maintenance Frequency (years)	Deterministic	1 year	1 year	CDOT*
Agency Maintenance Cost (\$1000)	Deterministic	\$1.270/lane mile*	\$ 0.449/lane mile*	CDOT*
Work Zone Length (Miles)	Deterministic	User Input	User Input	Site specific
Work Zone Capacity (vphpl)	Deterministic	User Input	User Input	CDOT Work Zone Software Section 10.5.7
No of Lanes Open in Each Direction During Work Zone	Deterministic	User Input	User Input	Site specific
Work Zone Duration (days)	Deterministic	User Input	User Input	CDOT Work Zone Software Section 10.5.7
Work Zone Speed Limit (mph)	User Input	User Input	User Input	Site specific

Shaded cells will be calculated when user cost computation method has been selected as "Calculated".

* Use site specific or latest data. Recalculate yearly cost to account for number of lanes and project length.

Note 1: The Work Zone Capacity is equal to the WorkZone software's work zone capacity (Inbound/Outbound Capacity) for the type of selected work. If two or more types of work are listed, use the lesser value of the capacity.

Note 2: Work Zone Duration (days) must be reasonable. For a PCC value, the WorkZone program may give a value of 5 days for the actual paving operation. The designer needs to increase the days a reasonable amount to provide for concrete curing. The work zone will be in place for the paving operation and curing time.

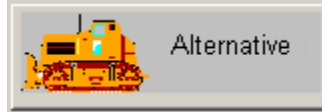

Alternative 1

Alternative: 1

Alternative Description: HMA Number of Activities: 4

Activity 1 | Activity 2 | Activity 3 | Activity 4

Activity Description: 9.0" HBP New Construction

Activity Cost and Service Life Inputs

Agency Construction Cost (\$1000):	9344.333 ...	Activity Service Life (years):	10 ...
User Work Zone Costs (\$1000):	2188.582 ...	Activity Structural Life (years):	 ...
Maintenance Frequency (years):	1 ...	Agency Maintenance Cost (\$1000):	1.27 ...

Activity Work Zone Inputs

Work Zone Length (miles):	10	Work Zone Duration (days):	54 ...
Work Zone Capacity (vphpl):	1123 ...	Work Zone Speed Limit (mph):	45
No of Lanes Open in Each Direction During Work Zone:	1	Traffic Hourly Distribution:	Week Day 1 ▾

Work Zone Hours

	Inbound		Outbound	
	Start	End	Start	End
First Period of Lane Closure:	8	17	8	17
Second Period of Lane Closure:				
Third Period of Lane Closure:				

Copy Activity
Paste Activity

Open...
Save...
Ok
Cancel

Figure 10.43 Alternative 1 (HMA) Screen



Alternative 2

Alternative: 2

Alternative Description: PCC Number of Activities: 2

Activity 1 | **Activity 2**

Activity Description: 12" PCCP New Construction

Activity Cost and Service Life Inputs

Agency Construction Cost (\$1000):	17752.666 ...	Activity Service Life (years):	22 ...
User Work Zone Costs (\$1000):	4635.576 ...	Activity Structural Life (years):	 ...
Maintenance Frequency (years):	1 ...	Agency Maintenance Cost (\$1000):	0.499 ...

Activity Work Zone Inputs

Work Zone Length (miles):	10	Work Zone Duration (days):	100 ...
Work Zone Capacity (vphpl):	1136 ...	Work Zone Speed Limit (mph):	55
No of Lanes Open in Each Direction During Work Zone:	1	Traffic Hourly Distribution:	Week Day 1 ▾

Work Zone Hours

	Inbound		Outbound	
	Start	End	Start	End
First Period of Lane Closure:	0	24	0	24
Second Period of Lane Closure:				
Third Period of Lane Closure:				

Copy Activity
Paste Activity

Open... Save... Ok Cancel

Figure 10.44 Alternative 2 (PCCP) Screen

10.7.11 Executing the Simulation

Running a simulation is a necessary step toward performing a probabilistic analysis. To conduct probabilistic analysis, RealCost uses Monte Carlo simulation, which allows modeling of uncertain quantities in the model with probabilistic inputs. The simulation procedure samples these inputs and produces outputs that are described by both a range of potential values and a likelihood of occurrence of specific outputs. The simulation produces the probabilistic outputs; without running a simulation, probabilistic outputs are not available. The Simulation Screen is shown in **Figure 10.45 Simulation Screen**. The Sampling Scheme section of the form determines from where the software will draw its simulation numbers. Choosing Random Results causes the simulation seed value (where the simulation starts) to come from the computer's internal clock. While not truly random, this seed value cannot be influenced by the software user, and it produces different values with each simulation.

Table 10.13 Simulation Data Options

Variable Name	Probability Distribution (CDOT Default)	Value (CDOT Default)	Source
Random Results	De-Select	No	RealCost Manual
Reproducible Results	Select	Yes	RealCost Manual
Seed Value	Deterministic	2000	RealCost Manual
Number of Iterations	Deterministic	2000	RealCost Manual
Monitor Convergence	Select	Yes	RealCost Manual
Monitoring Frequency (Number Iterations)	Deterministic	50	RealCost Manual
Convergence Tolerance (%)	Deterministic	2.5	RealCost Manual
Tail Analysis Percentiles		See Below	RealCost Manual
Percentile 1	Deterministic	5	RealCost Manual
Percentile 2	Deterministic	10	RealCost Manual
Percentile 3	Deterministic	75	CDOT
Percentile 4	Deterministic	95	RealCost Manual

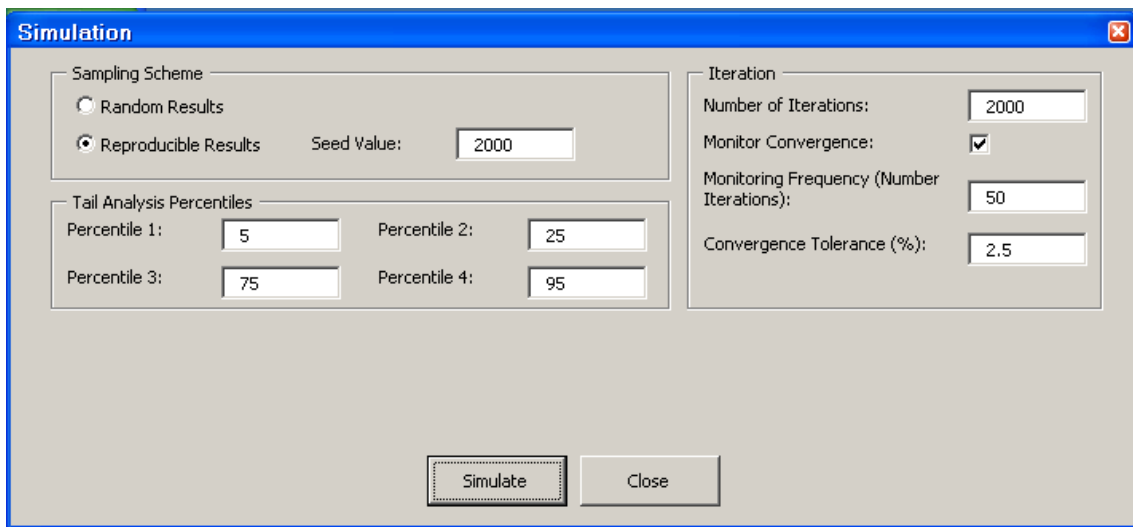

Figure 10.45 Simulation Screen

10.7.12 Analyzing Probabilistic Results

After a simulation run, probabilistic results are available for analysis. A simulation must be run prior to viewing probabilistic results. **Figure 10.46 Probabilistic Results Screen** shows the results of a probabilistic simulation.

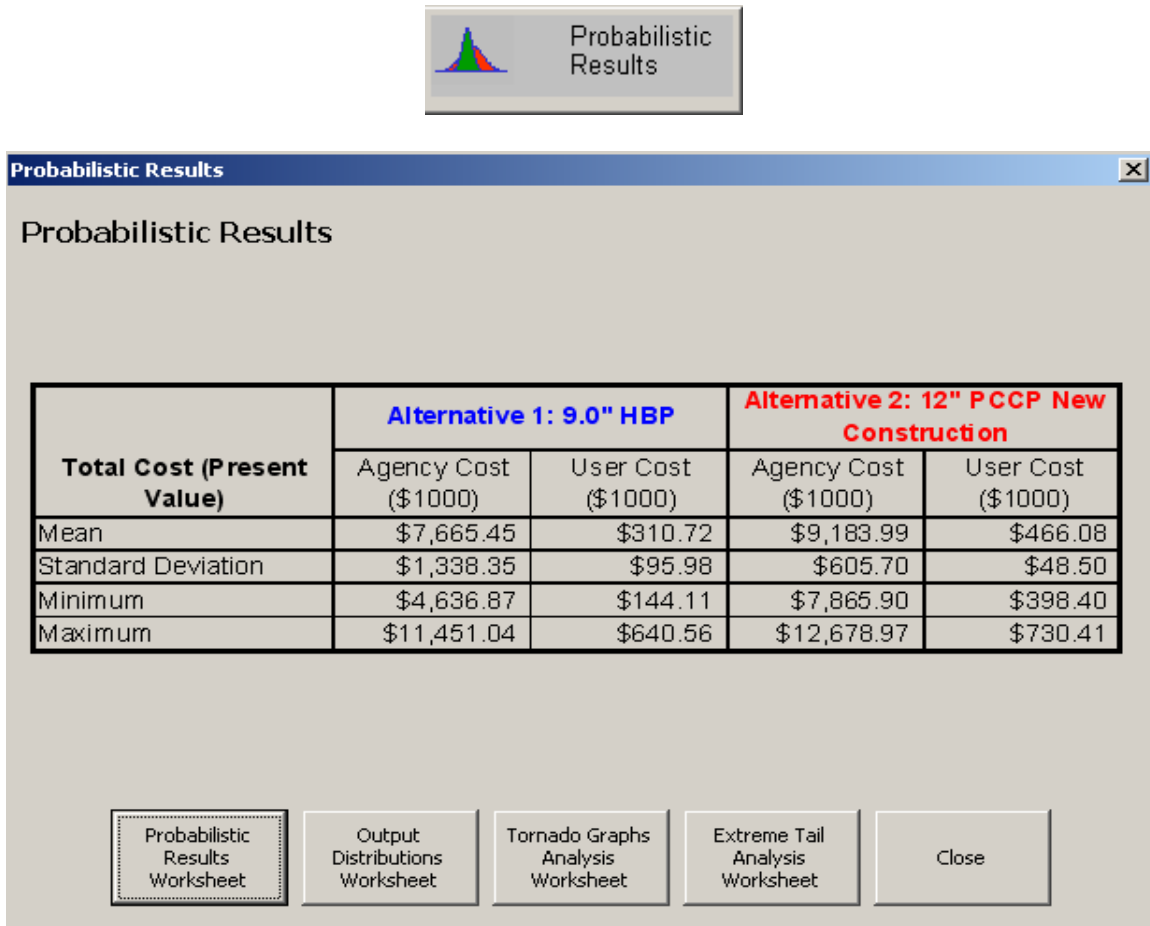

Figure 10.46 Probabilistic Results Screen

10.7.13 Analyzing Probabilistic Agency Costs

Agency Costs are critical to an insightful LCCA are good estimates of the various agency cost items associated with initial construction and periodic maintenance and rehabilitation activities. Construction costs pertain to putting the asset into initial service. Data on construction costs are obtained from historical records, current bids, and engineering judgment (particularly when new materials and techniques are employed). See **Figure 10.47 Agency Cost Results Screen** for a graphical representation of Agency Costs. Similarly, costs must be attached to the maintenance and rehabilitation activities identified in the previous steps to maintain the asset above some predetermined condition, performance, and safety levels. These costs include those for preventive activities that are planned to extend the life of the asset, day-to-day routine maintenance intended to address safety and operational concerns, and rehabilitation or

restoration activities. Another consideration affecting total agency costs is the value of the alternative at the end of the analysis period. One type of terminal value is called “salvage value,” usually the net value from the recycling of materials at the end of a project’s life. A second type of terminal value is the “remaining service life” (RSL) value of an alternative (the residual value of an improvement when its service life extends beyond the end of the analysis period). The RSL value may vary significantly among different alternatives, and should be included in the LCCA.

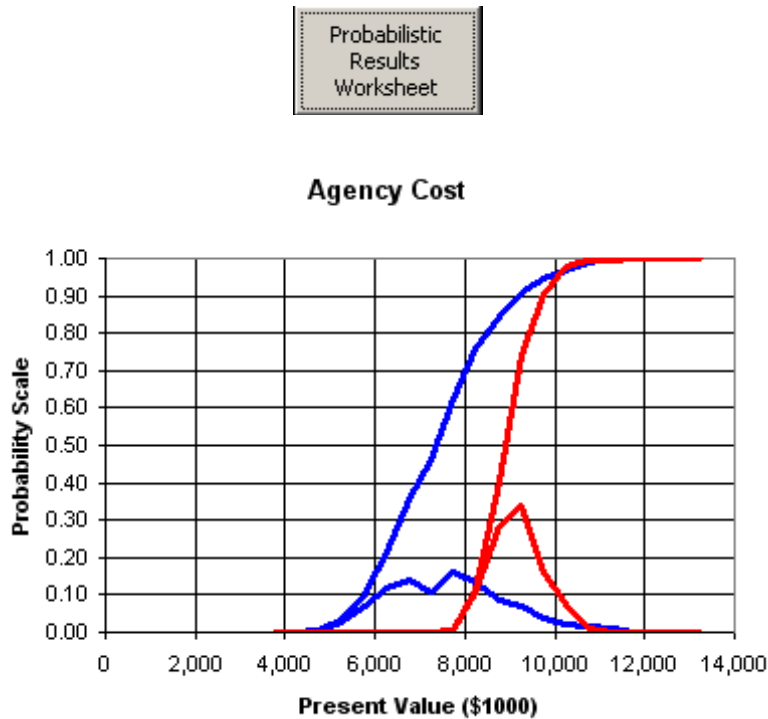

Figure 10.47 Agency Cost Results Screen

10.7.14 Analyzing Probabilistic User Cost

Best-practice LCCA calls for including both the costs accruing to the transportation agency, described above, and costs incurred by the traveling public. In LCCA, user costs of primary interest include vehicle operating costs, travel time costs, and crash costs. Such user costs typically arise from the timing, duration, scope, and number of construction and rehabilitation work zones characterizing each project alternative. Because work zones typically restrict the normal capacity of the facility and reduce traffic flow, work zone user costs are caused by speed changes, stops, delays, detours, and incidents. While user costs do result during normal operations, these costs are often similar between alternatives and may be removed from most analyses. Incorporating user costs into LCCA enhances the validity of the results, but at the same time is a challenging task. User costs can also be defined as the cost of travel that is borne by individual users. Highway user costs are the sum of motor vehicle running cost, the value of travel time, and traffic accident cost. Bus transit user costs on a particular highway segment are the fares, the value of travel time, and traffic accident costs. See **Figure 10.48 User Cost Results Screen**.

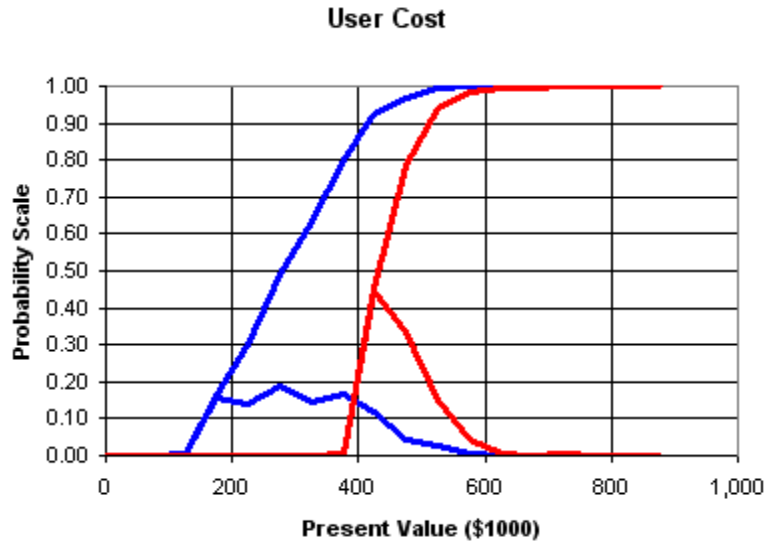
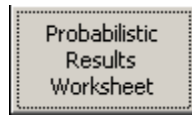

Figure 10.48 User Cost Results Screen

10.8 Comparing Probabilistic Results

To calculate Agency and User cost, the designer must select values that cross both Agency and User cost lines at the 75% probability scale. Once the designer has determined both values, a total of both PV's can be calculated. For example:

Agency Cost

Blue: PCCP Lines 75% PV \$13,000,000

Red: HMA Lines 75% PV \$18,000,000

User Cost

Blue: PCCP Lines 75% PV \$2,000,000

Red: HMA Lines 75% PV \$2,000,000

PCCP Present Value at 75% Probability = \$13,000,000 + \$2,000,000 = \$15,000,000

HMA Present Value at 75% Probability = \$18,000,000 + \$2,000,000 = \$20,000,000

Refer to **Figure 10.49 Agency-User Cost Results Screens** for a graphical representation of the probability vs. agency and user costs.

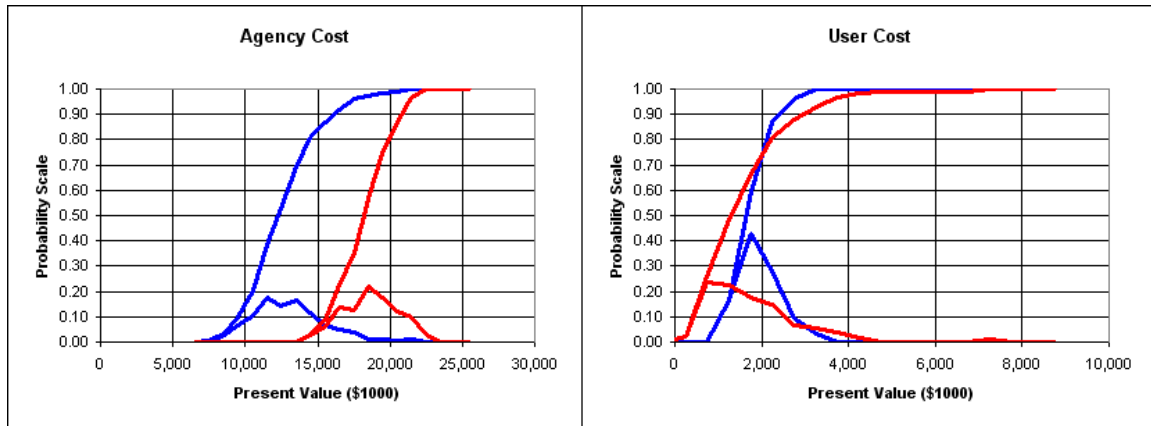

Figure 10.49 Agency-User Cost Results Screens

Equivalent Designs are within 10% if:

$$\frac{(\text{large NPV value} - \text{small NVP value}) \times 100}{(\text{small NVP value})}$$

Eq. 10.2

Comparing the two alternatives yields:

$$\frac{(\$20,000,000 - \$15,000,000)}{\$15,000,000} \times 100 = 33.3\%$$

A comparison that yields results within 10% may be considered to have equivalent designs. A comparison that yields results within 5% would certainly be considered to have equivalent designs. Refer to Section **10.8 Comparing Probabilistic Results** when the alternatives are within 10%. Other secondary factors can and should be used to help in the pavement selection. For more information, contact the Pavement Design Program Manager at 303-398-6561.

10.9 Pavement Type Selection Committee (PTSC)

Whenever the cost analysis does not show a clear LCCA within 10% advantage for one of the feasible alternatives, other secondary factors can be used to help in the selection process. Most of these factors are very difficult to quantify in monetary units. Decision factors considered important in selecting the preferred alternatives are chosen. The design factors are ranked. Some decision factors typically have a greater influence on the final decision than others do. The PTSC members could complete the rating sheet independently or collectively, so that the final results represent a group decision and not just one individual. Other important factors can be considered to help select the best alternative when the life cycle costs comparison yields results within 10%. These secondary factors may include initial construction cost, future maintenance requirements, and performance of similar pavements in the area, adjacent existing pavements, and traffic control during construction (safety and congestion), user costs, conservation of materials and energy (recycling), environmental factors, availability of local materials and contractor capabilities, incorporation of experimental features, stimulation of competition, and local municipal factors. The procedure for selecting the best alternative among these secondary factors is given below.

10.9.1 Purpose

The purpose of the Committee will be to:

- Ensure the decision for the pavement type is in alignment with the unique goals of the project;
- Provide industry with the opportunity to review the life cycle cost analysis (LCCA) document;
- Ensure statewide consistency of decision making;
- Formalize the decision process of the Region's pavement type selection;
- Create accountability of the decision of pavement type at the level of Chief Engineer; and
- Improve credibility of the decision by following a documented process and clearly communicating the reasons for the decision.

10.9.2 Scope

Reconstruction or new construction of corridor projects with large quantities of pavement where the initial life cycle cost analysis (LCCA) results indicates the pavement types are within 10% of each other. The percentage difference will be calculated in such a manner that the alternative with lower LCCA will be the basis, and therefore will be the LCCA value in the denominator.

10.9.3 Membership

The membership in the PTSC should include all of the following individuals:

- Region Materials Engineer
- Resident Engineer
- Headquarters Pavement Design Program Manager
- Region Program Engineer(s)
- Region Transportation Director
- Region Maintenance Superintendent
- Headquarters Materials and Geotechnical Branch Manager
- Headquarters Project Development Branch Manager
- Federal Highway Administration's Pavement and Materials Engineer

10.9.4 Roles of Membership

The following outlines the individual's roles in the PTSC:

- The Region Materials Engineer, Resident Engineer, Region Maintenance Superintendent and Headquarters Pavement Design Manager and Program Engineer will be responsible for the technical details including pavement design, costs, ESALs, construction timing and sequencing, and the LCCA;
- The Program Engineer and Transportation Director will be responsible for identifying the project goals and the corresponding importance of the elements within the LCCA to match the project goals;
- The Branch Managers will ensure the statewide uniformity of the process and prepare the documentation of the recommendation that will be forwarded to the Chief Engineer; and
- The Chief Engineer will make the final decision on the pavement type.

10.9.5 Process

The PTSC will:

- Conduct a critical and independent review of the LCCA;
- Allow industry a period of 2 weeks to review the committee supported LCCA and provide written comments regarding the input assumptions;
- Review written comments from industry to ensure that they are adequately addressed;
- Adjust the LCCA as appropriate. Proceed to the next step if the revised LCCA indicates the pavement alternatives are within 10%;
- Create a list of elements that correlate to the corridor project goals. The following possible elements along with a brief description are shown in the **Table 10.14 Possible Elements for Pavement Type Selection Process**;
- Apply a rating scale, from the most to least important for each element to match the project goals;
- Determine the alternative that the element favors;

- Sum the most important elements for each alternative to establish if there is a clear advantage. If the alternatives have an equal amount of most important goals, run this step again for the secondary goals, then for the least important if necessary; and
- Make a recommendation for pavement type to the Chief Engineer.

Table 10.14 Possible Elements for Pavement Type Selection Process

Element	Description
Total LCCA	Overall cost of the alternative.
Initial cost	Availability of current funds to construct the corridor project.
User cost during construction	Adverse affects to the traveling public during the construction phase.
User cost during maintenance	Future traffic volume may adversely affect the traveling public.
Future rehabilitation efforts	Feasibility of maintenance funds required for future work.
Conservation of materials	Recycling the existing materials into the corridor project.
Constructability	Required construction techniques.
Intersections	Design issues to ensure structural adequacy.
Warranty	Benefit of the experimental feature.
Evaluation of new technology	Advances in technologies may benefit CDOT or the public if they are incorporated.
Traffic Control	If multiple phases are anticipated or the closure of one lane versus a detour.

The above process should be completed by the time of the field inspection review meeting.

After the Chief Engineer has concurred with the preferred alternative for the corridor, no changes to the pavement type will be made unless directed by the Chief Engineer.

References

1. Goldbaum, Jay, *Life Cycle Cost Analysis State-of-the-Practice*, Final Report, Report No. CDOT-R1-R-00-3, Colorado Department of Transportation, March 2000.
2. Demos, George Paul, *Life Cycle Cost Analysis and Discount Rate on Pavements for the Colorado Department of Transportation*, Final Report, Report No. CDOT-2006-17, Colorado Department of Transportation, October 2006.
3. *Life-Cycle Cost Analysis Primer*, Report FHWA IF-02-047, Office of Asset Management, U.S. Department of Transportation, Federal Highway Administration, 400 7th Street, SW, Room 3211, Washington, DC 20590, August 2002.
4. *Life-Cycle Cost Analysis in Pavement Design - In Search of Better Investment Decisions*, Pavement Division Interim Technical Bulletin, Publication No. FHWA-SA-98-079, U.S. Department of Transportation, Federal Highway Administration, 400 7th Street, SW, Washington, DC 20590, September 1998.
5. *Economic Analysis Primer*, Publication No. FHWA IF-03-032, U.S. Department of Transportation, Federal Highway Administration, Office of Asset Management, 400 7th Street, SW, Room 3211, Washington, DC 20590, August 2002.
6. Harris, Scott, *Colorado Department for Transportation's Current Procedure for Life Cycle Cost Analysis and Discount Rate Calculations*, Final Report, Report No. CDOT-2009-2, Colorado Department of Transportation, January 2009.

CHAPTER 11

PAVEMENT JUSTIFICATION REPORT

11.1 Introduction

The intent of this chapter is to provide advice, recommendations, and information needed for a pavement justification report (PJR) to ensure continued quality of pavement structural designs. The final structural design section must be based on a thorough investigation of project specific conditions including materials, environmental conditions, projected traffic, life cycle economics, and performance of other similar structural sections with similar conditions in the same area.

11.2 Pavement Justification Report (PJR)

The designer shall assemble a PJR for all appropriate projects. As stated in **CHAPTER 10**, not every project will require a life cycle cost analysis, but every project should have a rational basis for the selection of the pavement type or rehabilitation alternative. The PJR documents the analysis and procedure the Region used to arrive at its selection of pavement type or rehabilitation method. HMA overlays less than 2 inches are considered a preventive maintenance treatment, and therefore a PJR report may not be required. Submit pavement justification letter (supporting documentation may not be required) to Pavement Design Manager in the Materials and Geotechnical Branch on all surface treatment projects and all new or reconstruction projects with Hot Mix Asphalt (HMA) or Portland Cement Concrete Pavement (PCCP) material costs greater than \$2,000,000. The PDPM will not need PJRs for access and local agency projects. As a minimum, the report should include the following:

- An analysis supporting the pavement type selection or rehabilitation method;
- Life cycle cost analysis of alternate designs;
- Pavement distress survey of existing pavements;
- Pavement thickness calculations of alternate designs;
- Surfacing plan sheet quantities (FIR or post-FIR); and
- Final recommendations for typical sections.

A copy of the pavement justification report should be maintained in the Region.

11.2.1 General Information in a PJR

The following items, as applicable, should be included in a PJR for each CDOT project:

- The proposed type of construction such as rehabilitation or, reconstruction;
- Proposed location and type of facility;
- Special construction requirements such as,
 - Backfilling,
 - Use of geotextile, and
 - Temporary dewatering;
- Geometric problems;

- Utilities;
- Tabulation of input design data and assumed values (both flexible and rigid pavements);
- Applicable CDOT forms, worksheets, and checklists; and
- References, etc.

11.2.2 Site Conditions

The following applicable items should be included in a PJR on the site conditions:

- Fill and cut situations;
- Excavation requirements;
- Backfilling requirements;
- Topography, elevation, and land use;
- General geology; and
- Geotechnical Investigation;
- Drill exploratory borings at site,
- Location and date of task,
- Subsurface conditions (boring logs),
- Laboratory testing,
- Environmental and drainage issues,
- Design approaches to provide removal of water from paved areas such as trench drain and blanket drain (drain detail and length),
- Drainage coefficients, and
- Other construction-related issues to the site.

11.2.3 Subgrade Materials

The following applicable items should be included in a PJR on the subgrade materials:

- Soil and bedrock classification using AASHTO method;
- Hveem test/ R-values, resilient modulus, correlation of soil classification and k-value;
- Slope stability requirements; and
- Special requirements for subgrade.

11.2.4 Design Traffic

- Traffic data (design 18-kip ESAL and volume); and
- Reliability factor.

11.2.5 Pavement Materials Characteristics

- Layer coefficients for subbase, base, base course materials, pavement course materials;
- Pavement distress types and severity (PMS Data); and
- Nondestructive testing (NDT) and falling weight deflectometer (FWD).

11.2.6 Pavement Design and Selection Process

The PJR should include all appropriate documentation on the pavement design and selection process used to determine pavement type and thickness. Refer to the following items for general guidelines in performing the pavement design and selection process:

- Follow steps in **CHAPTER 3** and **CHAPTER 4** for Pavement Selection Process for new construction/reconstruction projects;
- Follow steps in **CHAPTER 5**, **CHAPTER 6** and **CHAPTER 7** for Rehabilitation Alternative Selection Process for Resurfacing, Rehabilitation, and Restoration projects whichever is applicable; or
- Follow steps in **CHAPTER 8** and **CHAPTER 9** for Pavement Selection Process for Intersections;
- Perform LCCA using **CHAPTER 10** as a guide; and
- Tabulate results of pavement design and LCCA.

11.3 Guidelines for Data on Plan Sheets

The following items should be placed on plan sheets:

- Pavement design information;
- Preliminary soil boring information;
- Coring information of existing pavement, for information only, if applicable;
- State cold milling thicknesses and locations of paving fabric, for information only, if applicable;
- When specifying Class E concrete state required strength in required time period; and
- When specifying concrete items, state required sulfate level for project.

APPENDIX A

PROCEDURES FOR FORENSIC STUDY OF DISTRESS OF HOT MIX ASPHALT AND PORTLAND CEMENT CONCRETE

A.1 Introduction

This Section covers the procedure for evaluating premature distress of hot mix asphalt (HMA), Stone Matrix Asphalt (SMA) and Portland Cement Concrete Pavement (PCCP). The procedure calls for reviewing the type of distress with a visual analysis and recommending a sampling and testing program; this could be called a forensic study. Finally, the cause, potential solution, and recommendation for rehabilitation will be reported.

A.2 Formation of an Evaluation Team

A team will be established to perform the evaluation. The Region Materials Engineer, in consultation with all potential team participants, will make the final determination as to the level of investigation that will be required. The team may include members from the following areas or disciplines:

- Materials and Geotechnical Branch;
- Project Development Branch;
- Region Materials;
- Region Design;
- Region Construction (Project Engineer/Resident Engineer);
- Region Maintenance (Maintenance Superintendent/Supervisor);
- Industry; and
- National Experts.

Contractor participation should be dependent on the status of the project, closed or not.

A.3 Levels of Investigation

Based on the degree of complexity and severity of the pavement distress and the urgency of the required response, the following three-tiered investigation levels are recommended:

A.3.1 Level I (CDOT Region)

The team may consist of Region personnel with expertise in various areas of disciplines including Materials, Design, Construction, and Maintenance. Based upon preliminary information and data, the pavement distress is determined to have a low degree of complexity and severity. Preliminary survey indicates the cause can be easily identified.

The investigation should include at least the following:

- Visual Analysis;
- Investigational requirements; and
- Required core samples and testing.

Complete the final report if the problem is resolved. If not, the investigation should proceed to Level II.

A.3.2 Level II (CDOT Statewide)

The team may consist of individuals from Section **A.3.1 Level I (CDOT Region)** along with personnel from CDOT Materials and Geotechnical Branch, Project Development Branch, FHWA, and industry representation (ACPA, Asphalt Institute, CAPA, etc.). Findings from the first level of investigation will be re-evaluated. The pavement distress is concluded to have a moderate degree of complexity and severity. Re-evaluation of initial findings indicates the cause is difficult to ascertain.

The investigation should include at least the following:

- Visual analysis;
- Investigational requirements;
- Required core samples and testing;
- Pavement slab samples may be obtained for further testing; and
- Deflection Analysis may also be conducted.

Complete the final report if the problem is resolved. If not, the investigation will proceed to Level III.

A.3.3 Level III (National Effort)

The team will consist of individuals from Sections **A.3.1 Level I (CDOT Region)** and **A.3.2 Level II (CDOT Statewide)** along with national experts from FHWA, AASHTO, and other state DOTs, or other government entities. Findings from the first and second levels of investigation will be re-evaluated again. The pavement distress is concluded to have a high degree of complexity and severity. The cause of the pavement distress is determined to be highly complex.

The investigation should include at least the following steps:

- Visual Analysis;
- Investigational requirements;
- Required core samples and testing;
- Pavement slab samples may be obtained for further testing;
- Deflection analysis may also be conducted; and
- Other tests as necessary

A.4 Site Investigation

A.4.1 Visual Analysis

The first step in investigating the pavement distress is to perform a complete and comprehensive visual analysis of the entire project. Emphasis will be placed on the distressed areas. See **Figure A.1 Pavement Condition Evaluation Checklist (Rigid)** and **Figure A.2 Pavement Condition Evaluation Checklist (Flexible)** for Pavement Evaluation Checklists for both pavement types. These figures are restatements of **Figure 6.2** and **Figure 5.2**. Guidelines on how to perform the visual distress survey can be found in the *Distress Identification Manual for the Long-Term Pavement Performance Program*. This FHWA publication (1) includes a comprehensive breakdown of common distresses for both flexible and rigid pavements.

Information gathered should include:

- Date;
- Reviewers;
- Project location and size;
- Traffic data;
- Weather information;
- Extent of distress;
- Detailed information concerning each distressed area;
- Photographs of the typical distress on the project will be included; and
- Any other problems that are visible (drainage, frost problems, dips or swells, etc.) should be recorded.

In general, each individual distress type should be rated for severity and the extent (amount) of the distress noted. When determining severity, each distress type can be rated as low, medium (or moderate), or high. This will not apply for some distresses, such as bleeding, which will be characterized in terms of number of occurrences.

When measuring and recording the extent or amount of a certain distress, each should be rated consistent with the type of distress. For example, alligator cracking is normally measured in terms of affected area. As a result, the overall amount of alligator cracking is recorded in terms of total square feet of distress. Alternatively, for quick surveys, the overall amount of alligator cracking can be recorded as a percentage of the overall area (i.e. 10%).

Other distresses, such as cracking, are recorded as total number of cracks or number of cracks per mile, and the overall length of the cracks. For example, for transverse or reflection cracking it is appropriate to record the amount of distress in terms of number of cracks per mile (for each severity level), while for longitudinal cracks it is appropriate to record the total length recorded.

Any assumptions made during the investigation should also be noted.

PAVEMENT EVALUATION CHECKLIST (RIGID)

PROJECT NO.: _____ LOCATION: _____

PROJECT CODE (SA #): _____ DIRECTION: _____ MP _____ TO MP _____

DATE: _____ BY: _____

TITLE: _____

TRAFFIC

- Existing _____ 18k ESAL/YR
- Design _____ 18k ESAL

EXISTING PAVEMENT DATA

- | | |
|-------------------------------------|----------------------------|
| - Subgrade (AASHTO) | - Shoulder Condition |
| - Base (type/thickness) | (good, fair, poor) |
| - Pavement Thickness | - Joint Sealant Condition |
| - Soil Strength (R/M _R) | (good, fair, poor) |
| - Swelling Soil (yes/no) | - Lane Shoulder Separation |
| - Roadway Drainage Condition | (good, fair, poor) |
| (good, fair, poor) | |

DISTRESS EVALUATION SURVEY

Type	Distress Severity*	Distress Amount*
Blowup		
Corner Break		
Depression		
Faulting		
Longitudinal Cracking		
Pumping		
Reactive Aggregate		
Rutting		
Spalling		
Transverse and Diagonal Cracks		
OTHER		

* Distress Identification Manual for the Long-Term Pavement Performance Program, U.S. Department of Transportation, Federal Highway Administration, Publication No. FHWA-RD-03-031, June 2003.

Figure A.1 Pavement Condition Evaluation Checklist (Rigid)

PAVEMENT EVALUATION CHECKLIST (FLEXIBLE)

PROJECT NO.: _____ LOCATION: _____

PROJECT CODE (SA #): _____ DIRECTION: _____ MP _____ TO MP _____

DATE: _____ BY: _____

TITLE: _____

TRAFFIC

- Existing _____ 18k ESAL/YR
- Design _____ 18k ESAL

EXISTING PAVEMENT DATA

- Subgrade (AASHTO) _____
- Base (type/thickness) _____
- Soil Strength (R/M_R) _____
- Roadway Drainage Condition (good, fair, poor) _____
- Shoulder Condition (good, fair, poor) _____

DISTRESS EVALUATION SURVEY

Type	Distress Severity*	Distress Amount*
Alligator (Fatigue) Cracking		
Bleeding		
Block Cracking		
Corrugation		
Depression		
Joint Reflection Cracking (from PCC Slab)		
Lane/Shoulder Joint Separation		
Longitudinal Cracking		
Transverse Cracking		
Patch Deterioration		
Polished Aggregate		
Potholes		
Raveling/Weathering		
Rutting		
Slippage Cracking		
OTHER		

* Distress Identification Manual for the Long-Term Pavement Performance Program, U.S. Department of Transportation, Federal Highway Administration, Publication No. FHWA-RD-03-031, June 2003.

Figure A.2 Pavement Condition Evaluation Checklist (Flexible)

The decision to use the Falling Weight Deflectometer (FWD) will be determined based upon the visual analysis. When the decision has been made to use the FWD, the following steps will be followed:

Deflection tests will be taken throughout the problem areas to determine the extent of the distress. Normal deflection testing frequency is ten sites per mile. However, within an area of concern, a minimum of 30 FWD testing sites will need to be selected. For comparison and control purposes, it is recommended to perform a minimum of 10 FWD tests outside of each end of the area of concern per lane segment. For the control segment, a 200-foot interval between FWD test sites will be used. The deflection analysis will be reviewed for elastic modulus of each layer to determine the in-place strength of the problem. The required design overlay thickness analysis will then be performed.

A.4.2 Review of Construction Documents

Pertinent information from the mix design, binder tests, mixture tests, QC/QA results, and project diary should be reviewed.

A.4.3 Investigational Requirements

After the visual analysis report has been evaluated, the second step of this procedure requires the determination of the investigational requirements. The requirements will depend on the type and extent of the pavement failure. It is recommended to obtain samples of the pavement adjacent to the distress area for comparison and control purposes. A minimum of 5 samples per lane is required outside of each end of the distress area.

A list of investigational requirements may include:

- Core sampling and testing plan;
- Slab sampling of pavement for testing and evaluation;
- Base and subgrade sampling and testing;
- Deflection analysis; and
- Transverse cracking in concrete slab.

A.4.4 Required Core Samples and Testing

Samples of materials at the pavement distress location shall be taken so the tests can be performed to evaluate the problem areas.

For reporting purposes, the core location should be as accurate as possible. The samples shall be submitted to the Materials and Geotechnical Branch for testing unless otherwise specified.

A.4.4.1 Core Samples from Hot Mix Asphalt and PCCP

Samples shall be taken of each HMA, SMA or PCCP layer with at least five 4-inch cores from all locations (bad area, a shoulder next to the bad area, and a good area). Larger cores are

preferred if possible. Each layer of HMA, SMA or PCCP should be tested separately. Contact the Materials and Geotechnical Branch for sampling and removal processes and procedures. In some cases, slab samples may indicate distresses not usually seen in core samples.

A.4.4.2 Base and Subgrade Samples

When obtaining samples of the base and subgrade materials, a sufficient area of HMA, SMA or PCCP should be removed for adequate testing and sampling of each layer of material.

Testing shall include but not limited to:

- Applicable Colorado, AASHTO and ASTM test procedures;
- Nuclear gauge density and moisture determination;
- Soil classification;
- R-value; and
- Proctor testing.

A.5 Final Report

A summary of the tests and other investigational requirements will be submitted to the Materials Advisory Council (MAC) upon the completion of all testing and analysis. The final report will be catalogued in the Technology Transfer Library and copies will be available for loan. The report should include some or all of the following items as applicable:

- Project Overview;
 - Type of pavement (HMA, SMA or PCCP),
 - Location and size of project,
 - Traffic data,
 - Weather conditions,
 - When distress developed, and
 - Historical distresses.
- Visual Inspection;
 - Type, extent and location of distress, and
 - Photographs.
- Summary of Construction Records;
 - Mix design,
 - Central laboratory check tests (Stability, Lottman, Binder tests, Compacted Specimen Tests, Concrete Compressive/Flexural Strength, Chemical tests),
 - Quality Control test results (density, gradation, asphalt, portland cement), and
 - Project diaries.

- Core Sampling and Testing Results;
 - Thickness,
 - Core location and map,
 - Density and air voids,
 - Asphalt content,
 - Gradation,
 - Vacuum extraction and asphalt cement penetration,
 - Geologic analysis of aggregates,
 - Portland cement chemical tests,
 - Petrographic analysis,
 - Alkali-Silica Reactivity (ASR) tests,
 - Modulus of Elasticity, and
 - Resilient Modulus.

- Slab Sample;
 - Thickness,
 - Areas of deformation,
 - Stripping,
 - Determination of subsurface deformation, and
 - Any other items of note.

- Results of Sampling and Testing of Base and Subgrade;
 - R-value,
 - Classification testing, and
 - Moisture and density;
 - Gradation, and
 - Proctor results.

- Deflection Analysis;
 - Overlay thickness required,
 - Comparison to original overlay thickness, and
 - Comparison with component analysis.

- Conclusions and Recommendations;
 - Apparent cause of failure,
 - Potential solutions to prevent future problems with other pavements, and
 - Recommendations for rehabilitation of the distress location.

A.6 Funding Sources

Funds for investigation may come from the Regions and/or Staff Branches depending on the level of investigation. The Research Branch annually allocates funds for experimental and implementation programs. Therefore, if a situation arises, submit a request for assistance to the Research Implementation Council (RIC) as soon as deemed appropriate.

Reference

1. *Distress Identification Manual for the Long-Term Pavement Performance Program*, U.S. Department of Transportation, Federal Highway Administration, Publication No. FHWA-RD-03-031, June 2003.

APPENDIX B FORMS

The Colorado Department of Transportation (CDOT) uses the following forms:

COLORADO DEPARTMENT OF TRANSPORTATION DESIGN DATA <input type="checkbox"/> Metric <input type="checkbox"/> English Page 1 of 2		Orig. date: _____ Rev. date: _____ Revision # _____ Region # _____		Project code # (SA#) _____ STIP # _____ Project # _____ PE project code _____ PE project # _____								
Status: <input type="checkbox"/> Preliminary <input type="checkbox"/> Final <input type="checkbox"/> Revised		Prepared by: _____ Date: _____ Submitted by Project Manager: _____ Date: _____		Revised by: _____ Date: _____ Approved by Preconstruction Engineer: _____ Date: _____								
Project description County1 _____ County2 _____ County3 _____ Municipality _____ System code: <input type="checkbox"/> IM <input type="checkbox"/> NHS <input type="checkbox"/> STP <input type="checkbox"/> Other Oversight by: <input type="checkbox"/> CDOT <input type="checkbox"/> FHWA <input type="checkbox"/> Other Planned length: _____												
Geographic location Type of terrain <input type="checkbox"/> level <input type="checkbox"/> plains <input type="checkbox"/> rolling <input type="checkbox"/> urban <input type="checkbox"/> mountainous Description of proposed construction/improvement (attach map showing site location)												
1 Traffic (Note: use columns A, B, and/or C to identify facility described below)												
		Current year: _____		Future year: _____		Facility location						
Facility	ADT	DHV	DHV % trucks	ADT	DHV	Industrial	Commercial	Residential	Other			
A						<input type="checkbox"/>	<input type="checkbox"/>	<input type="checkbox"/>	<input type="checkbox"/>			
B						<input type="checkbox"/>	<input type="checkbox"/>	<input type="checkbox"/>	<input type="checkbox"/>			
C						<input type="checkbox"/>	<input type="checkbox"/>	<input type="checkbox"/>	<input type="checkbox"/>			
2 Rdwy class						Route	Refpt	Endrpt	Functional classification	Facility type	Rural code	
						1.						
						2.						
						3.						
3 Design standards (identify substandard items with an * in 1st column & clarify in remarks)												
	A=				B=				C=			
	Standard	Existing	Proposed	Ultimate	Standard	Existing	Proposed	Ultimate	Standard	Existing	Proposed	Ultimate
Surface type												
Typical section type												
# of travel lanes												
Width of travel lanes												
Shoulder width lt./median												
Shoulder width rt./outside												
Side slope dist. ("z")												
Median width												
Posted speed												
Design speed												
Max. superelevation												
Min. radius												
Min. horizontal SSD												
Min. vertical SSD												
Max grade												
Project under <input type="checkbox"/> 1R <input type="checkbox"/> 3R <input type="checkbox"/> 4R <input type="checkbox"/> Other: _____ criteria									Existing guardrail meets current standards: <input type="checkbox"/> yes <input type="checkbox"/> no			
<input type="checkbox"/> Variance in minimum design standards required <input type="checkbox"/> Justification attached <input type="checkbox"/> Request to be submitted <input type="checkbox"/> Bridge (see item 4) <input type="checkbox"/> See remarks									<input type="checkbox"/> Safety project not all standards addressed			
<input type="checkbox"/> Stage construction (explain in remarks)									Comments:			
Resurfacing projects <input type="checkbox"/> Recommendations concerning safety aspects attached												

CDOT Form #463 12/03

Figure B.1 Design Data (Page 1 of 2) (CDOT Form 463 12/03)

Page 2 of 2		Project code # (SA#)		Project #		Revise date				
4 Major structures										
S= to stay, R= to be removed, P= proposed new structure										
Structure ID#	▼	Length	Ref. point	Feature intersected	Standard width	Structure Rdwy	load	Horizontal clearance	Vertical clearance	Year built
Proposed treatment of bridges to remain in place (address bridge rail, capacity, and allowable surfacing thickness)										
5 Project characteristics (proposed)					Median (type): <input type="checkbox"/> depressed <input type="checkbox"/> painted <input type="checkbox"/> raised <input type="checkbox"/> none					
<input type="checkbox"/> Lighting		<input type="checkbox"/> Handicap ramps			<input type="checkbox"/> Traffic control signals					
<input type="checkbox"/> Curb and gutter		<input type="checkbox"/> Curb only			<input type="checkbox"/> Striping					
<input type="checkbox"/> Sidewalk width=		<input type="checkbox"/> Bikeway width=			<input type="checkbox"/> Left-turn slots		<input type="checkbox"/> continuous width=			
<input type="checkbox"/> Parking lane width=		<input type="checkbox"/> Detours			<input type="checkbox"/> Right-turn slots		<input type="checkbox"/> continuous width=			
<input type="checkbox"/> Landscaping requirements: (description)					<input type="checkbox"/> Signing <input type="checkbox"/> construction <input type="checkbox"/> permanent					
<input type="checkbox"/> Other: (description)										
6 Right of Way				7 Utilities (list names of known utility companies)						
ROW &/or perm. easement required:		Yes	No	Est. #						
		<input type="checkbox"/>	<input type="checkbox"/>	_____						
Relocation required:		<input type="checkbox"/>	<input type="checkbox"/>	_____						
Temp. easement required:		<input type="checkbox"/>	<input type="checkbox"/>	_____						
Changes in access:		<input type="checkbox"/>	<input type="checkbox"/>	_____						
Changes to connecting roads:		<input type="checkbox"/>	<input type="checkbox"/>	_____						
8 Railroad crossings										
# of crossings: _____										
Recommendations										
9 Environmental										
Type:	Approved on:	under Project Code:	Project #							
Comments										
10 Coordination										
<input type="checkbox"/> Withdrawn lands (power sites, reservoirs, etc.) cleared thru BLM or forest service office						Irrigation ditch name:				
<input type="checkbox"/> New traffic ordinance required						<input type="checkbox"/> Modify schedule of existing ordinance				
Municipality:										
Other:										
11 Construction method										
noAd Reason:		<input type="checkbox"/> Design		<input type="checkbox"/> Local F/A		Entity/Agency contact name:				
Advertised by:		<input type="checkbox"/> P.O.		<input type="checkbox"/> RR F/A						
<input type="checkbox"/> State		<input type="checkbox"/> Study		<input type="checkbox"/> Utility F/A		Phone #:				
<input type="checkbox"/> Local		<input type="checkbox"/> CDOT F/A		<input type="checkbox"/> Miscellaneous						
<input type="checkbox"/> None										
12 Remarks (include additional pages if needed)										

Original to Central Files - Copies to: Region Files, Region Environmental Program Manager, Staff ROW, Staff Bridge or other when appropriate.

Error! Reference source not found. **Design Data (Page 2 of 2) (CDOT Form 463 12/03)**

COLORADO DEPARTMENT OF TRANSPORTATION Maintenance Project Request Form Form 463 M(revised)					
Today's Date: xx/xx/20xx		Proposed Ad Date: xx/xx/20xx		Proposed Completion Date: xx/xx/20xx	
Requestor Name: xxx		Phone: xxx-xxx-xxxx		E-Mail Address: xxx.xxx@dot.state.co.us	
Region No.: X	Main. Sect. No.: X	Project Type: Type of Project		FY: XX	Budget: \$ XXXX.XXX.00
State Hwy No.: XXX	MP Limits: MP xxx.xx to xxx.xx	County(ies): XXXXXX		City(ies): XXXXXX	
Maintenance Superintendent/Resident Engineer: XX				Phone: XXX XXX XXXX	
Design Project Manager: XX			Phone: XXX-XXX-XXXX	Cell: XXX-XXX-XXXX	
Construction Project Engineer: XX			Phone: XXX-XXX-XXXX	Cell: XXX-XXX-XXXX	
SAP CODING INFORMATION					
**SAP Work Order #: XXXXXXXXXXXX			**SAP Purchase Requisition #: XXXXXXXXXXXX		
**Requires Release by Business Office and Maintenance Superintendent prior to Advertisement					
Cost Center	Approp Code	Sub. Obj.	N/P	Report Category	
XXXX	XXX	X	N or P	XXXX	
Fund Number	Funds Center	Functional Area	GL Account	WBS Element	
XXX	RXXXX-XXX	XXXX	XXXXXXXXXX	RXXXXXXXXX	
SCOPE AND PROJECT DETAILS					
(Please provide as much detail as possible regarding Scope of Work) Roadway widths, project limits, preliminary quantities, repair/treatment type (Class of repair, type of surface treatment), temporary/permanent pavement marking, excavation and drainage considerations, Contract Time (Milestone, Working/Calendar Day) and Estimated Construction Duration: ADA Requirements (1.5 inch depth or greater).					
XX					
Material Requirements: Pavement treatment types and recommendations; Structure material considerations; Testing/Inspection requirements; Pavement Marking Types; Project Special Provisions.					
XXX					
Traffic Control Requirements: Regional Lane Closure Policy (Variance Considerations); Posted Speed/Reductions; Working Hour Restrictions (Night, Day, Special Events); Public Information; Pedestrian/Bicycle Considerations, Flagging; Signage, Preliminary Quantities.					
XXX					
CLEARANCES					
(See M-Project Manual, ROW, Utilities and Environmental Sections for more information regarding clearances)					
REGION ROW					
1. Existing ROW Boundaries Determined and Confirmed? Y/N		2. All project requirements constructed within boundary of existing ROW? Y/N			
3. Are Railroad or Temporary Easements Required? Y/N explain					
4. Is work in vicinity of National Forest, BLM, US Army Corps of Engineer Property? Y/N explain					
Notes: xxx					
REGION UTILITIES					
Note any known or observable utility/railroad facilities within project limits: xxx					
Are utility relocations anticipated? Y/N explain					
REGION ENVIRONMENTAL/STORM WATER MANAGEENT PLAN (SWMP)					
Environmental Clearance Form 128 from the respective Region Environmental Manager. SAP Approval Required					
SWMP/ Estimated Preliminary Items, Quantities and Force Accounts: xxx					
Additional Clearance/Considerations may include: Historical Clearance, Noise Variance, Hazardous Materials Testing (Lead, Asbestos, etc.), Army Corps of Engineers Permit, Habitat Protection (Swallows, Prairie Dogs, Preble Mouse, etc.), Dewatering Treatment.					
Information for Project Number and Project Definition obtained from SAP		M-Proj Number: RXXXX-XXX		M-Proj Definition: XXXXX	

CDOT FORM # 463M Rev-4/10

Figure B.2 Maintenance Project - Request Form (CDOT Form 463M Rev 4/10)

COLORADO DEPARTMENT OF TRANSPORTATION OVERLAY DESIGN BY COMPONENT ANALYSIS				Project code (SA#):		Project No.:		Sheet No.:	
				Proj. location:					

Station or Mile	Subgrade R-value	Calculated Subgrade Resilient Modulus	SN ₂ from Design	Existing pavement structure										SN ₁ = SN ₂ - SN ₁	Minimum design thickness (inches) *	Recommended thickness (inches)
				Strength Coefficient of existing pavement structure from CDOT Form #903												
				Pavement			Base			Subbase			SN ₁ = 0.14(D ₁ a ₁ + D ₂ a ₂ + D ₃ a ₃)			
Thickness (D ₁)	Coefficient (a ₁)	(D ₁)(a ₁)	Thickness (D ₂)	Coefficient (a ₂)	(D ₂)(a ₂)	Thickness (D ₃)	Coefficient (a ₃)	(D ₃)(a ₃)								

*Minimum design thickness (inches) = $\frac{SN_2 - SN_1}{\text{Structural layer coefficient (overlay)}}$

Existing pavement condition:	18k ESAL:
Existing drainage:	Design period (years):
Calculations by:	Δ PSI:
Title:	Reliability:
Date:	Overall standard deviation (σ):

Figure B.4 Overlay Design by Component Analysis (CDOT Form 586 3/04)

COLORADO DEPARTMENT OF TRANSPORTATION STRUCTURAL LAYER COEFFICIENTS OF EXISTING PAVEMENTS This is a combination table and worksheet to be used for estimating and documenting the structural layer coefficients of existing pavement layers.	Project code (SA#):	Project No.:
	Proj. location:	
	Date:	Region:

Asphalt Surface Course

Factor Description	Factor	Mile or station representation				
		From:	To:	From:	To:	
Load associated cracking:	0.12					
Virtually none:						
More than 6ft. blocks:						
2 ft. to 5 ft. blocks:						
less than 2 ft blocks:	0.06					
Average age of layer combination:	0.12					
less than 8 years:						
9 to 15 years:		0.09				
more than 16 years:	0.06					
Estimated air voids ¹ :	0.09					
0 - 2%						
3 - 6%		0.12				
7 - 10%		0.09				
more than 10%	0.06					
TOTAL = Structural layer coefficient: (except for pre 1990's Grading F)						
For pre 1990's Grading F, multiply TOTAL by 0.70:						

Base layers

Factor Description	Factor	Mile or station representation			
		From:	To:	From:	To:
Untreated aggregate base (except as noted ²)	0.11				
Classes 1,2,3,4,&5					
Classes 3 & 7		0.10			
Class 6		0.06			
Emulsion asphalt treated base	0.16				

- 1 Air voids may be determined from old project test reports, estimated (based on judgment and experience), or determined from core samples. Generally, under-asphalted pavements are high in voids, and over-asphalted pavements are rutted and low in voids.
- 2 Use the listed structural layers unless actual test have been run (either during previous construction or just prior to overlaying) to confirm otherwise. Document below under REMARKS.

Remarks:	
Note: This form is to be completed in the Region and submitted, along with Proposed Log, to Soils Engineer for "component analysis" of overlay projects.	By: Title:

CDOT Form #903 3/04

Figure B.5 Structural Layer Coefficient of Existing Pavements (CDOT Form 903 3/04)

APPENDIX C

DEFLECTION TESTING AND BACKCALCULATION

C.1 Introduction

Deflection testing is the measurement of the structural strength of the roadway. CDOT has utilized many devices to evaluate the strength of the existing road: the Falling Weight Deflectometer (FWD), the Dynaflect, the Benkelman Beam, and the heel of the Engineer's shoe. CDOT has owned a FWD since April 19, 1988. The FWD is a device capable of applying dynamic loads to the pavement surface, similar in magnitude and duration to that of a single heavy moving wheel. The response of the pavement system measured in terms of vertical deformation, or deflection, of the pavement structure over a given area using seismometers (geophones). Deflection testing devices are considered non-destructive testing (NDT) devices. The FWD as a NDT device should never apply a load to the pavement so great that it will not rebound fully.

The FWD should be calibrated annually using the CDOT FWD calibration center. For more information on FWD test protocols, consult with the Concrete and Physical Properties Program (CPPP) Unit of the CDOT Materials and Geotechnical Branch.

The most cost effective strategy will most likely involve maximum utilization of resources. The existing pavement should be considered as a resource that is already in place. The structural value of the existing pavement needs to be thoroughly investigated and determined. Deflection measurements and analysis will yield structural values of in-place pavements and identify weak zones. During the pavement analysis portion of the thickness design, the designer should compare the information obtained from the deflection data against that noted in the distress survey. Deflection readings do not always address the total scope of corrective action needed, especially in areas with substantial distress conditions present. It is recommended that the designer use a profile plot of distress and deflection to identify areas requiring additional consideration. In areas of high distress, verifying the deflection analysis with a component analysis may be desirable.

Deflection testing and backcalculations are most highly recommended to obtain a k-value of a soil. This method is suitable for analyzing existing pavements to obtain a k-value. Sometimes a design of similar pavements in the same general location on the same type of subgrade may be appropriate, i.e. at an interchange location.

A procedure is outline in the 1998 AASHTO Supplement to compute the dynamic k-value using FWD. The dynamic k-value must then be converted to the initial static k-value. Divide the mean dynamic k-value by two (2) to estimate the mean static k-value for design.

Several software tools are available for production data processing and analysis. The purpose of this section is to provide guideline for engineers to follow when setting up FWD testing on a project and for analyzing results. CDOT recommends using the software MODTAG.

MODTAG is a software tool to allow an engineer to analyze FWD data quickly and efficiently using empirical (Appendix L of the *AASHTO Guide for Design of Pavement Structures – 1993*) and mechanistic-empirical (MODCOMP) methods and procedures. MODTAG is an in-house software tool developed in cooperation by Virginia DOT and Cornell University's Local Roads Program. MODTAG operates in US Customary and Metric Units. However, some of the routines are not available when a metric analysis is selected. MODTAG is being provided without technical/engineering or software support to users outside Virginia DOT. Additional information on analyzing the testing results can be found in the document titled *MODTAG Users Manual* in the software MODTAG.

This appendix is based on CDOT's truck mounted JILS-20T FWD with on board JTEST™ software. If other FWD owners use this appendix, they should follow their manufacturers' recommendations. For example, the one drop setting and drop weight is associated with CDOT's FWD.

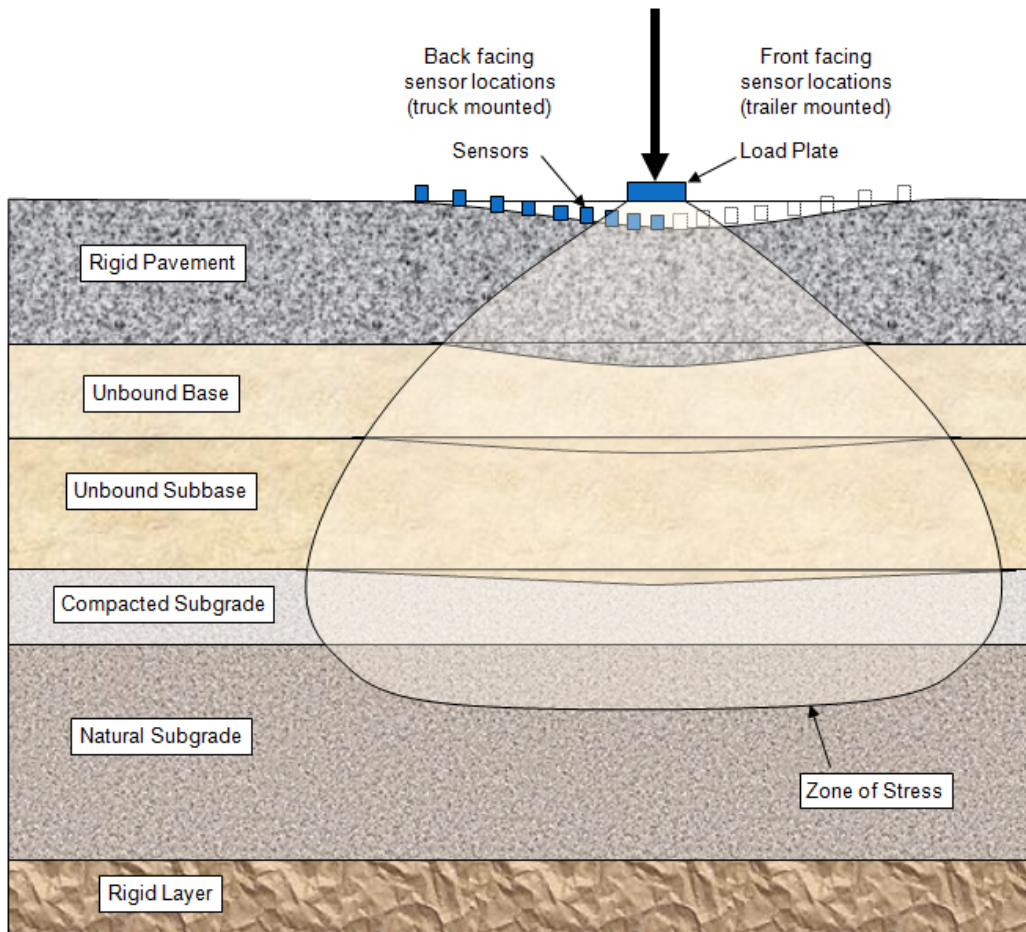

Figure C.1 Depiction of FWD Load Distribution through Pavement

C.2 FWD Testing – Flexible Pavements

For flexible pavements, FWD testing is used to assess the structural capacity of the pavement and estimate the strength of subgrade soils. In addition to the structural capacity, the elastic modulus for the surface, base and subbase layers can be determined.

C.2.1 FWD Testing Pattern - Flexible Pavement

The FWD testing pattern selected for a project should be related to the project's size and layout. The Pavement Engineer should consider the number of lanes to be tested, total length of the project, and any unusual circumstances that would require a change in the testing pattern.

- Project Layout - the project layout will influence the FWD testing pattern. For projects where the pavement is to be repaired in each direction, then travel lanes in each direction should be tested. Typically, this should be the outside travel lane. For projects where only one direction will be repaired and more than two lanes exist, then testing should be conducted on the outside lane and possibly inside lane. The inside lane should be tested if:

Pavement structure is different from the outside lane,
More load related distress is present as compared to the outside lane, or
Heavy truck traffic uses the lane (lane is prior to a left exit).

For projects that contain multiple intersections, then FWD testing may not be possible due to traffic. However, where possible testing should be conducted at approaches and departures to an intersection.

- **Project Size** - the size of a project will influence the test spacing. The project size is determined by the directional length of pavement to be repaired, not necessarily the centerline length. For example, a project that has a centerline distance of one mile and will be repaired in two directions has a directional length of two miles. Therefore, the test spacing should be based on two miles. **Table C.1 Flexible Pavement Test Spacing Guidelines** contains guidelines based on project size, test spacing, and estimated testing days. A testing day is defined as 200 locations tested.
- **Testing Days** - **Table C.1 Flexible Pavement Test Spacing Guidelines** shows the approximate testing days of actually doing the drop testing. Additional time must be allotted for traffic control setup and travel time to the test site. It may also be required to have a pre-testing meeting with the Pavement Engineer.

Table C.1 Flexible Pavement Test Spacing Guidelines

Project Size (miles)	Test Spacing (feet)	Approximate Number of Tests	Testing Days
0 – 0.5	25	75	½ day
0.5 – 1.0	50	90	½ day
1.0 – 2.0	50	175	1 day
2.0 – 4.0	100	175	1 day
4.0 – 8.0	150	200	1 to 1 ½ days
> 8.0	200	>200	> 1 ½ days

For two or three lane bi-directional roadways not separated by a median, the testing should be staggered by one-half the test spacing. See **Figure C.2 Flexible Pavement Staggered Testing Pattern** for clarification. For projects that are separated by a median, a staggered testing pattern is not required.

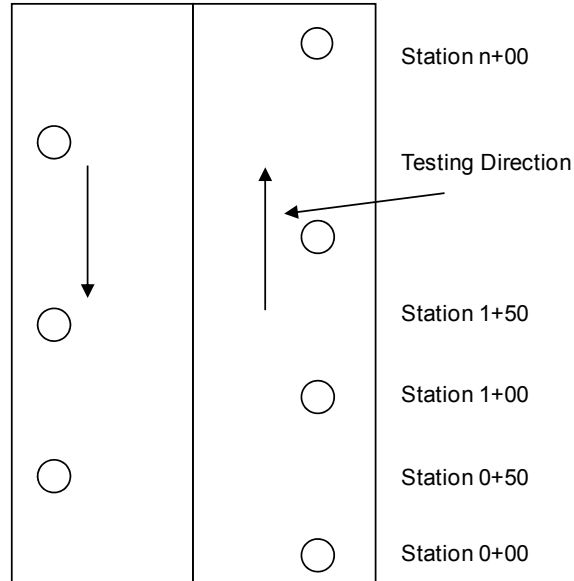

Figure C.2 Flexible Pavement Staggered Testing Pattern

Basin Testing Location - for flexible pavements, FWD testing should be conducted in the wheel path closest to the nearest shoulder. This type of testing is known as basin testing since deflection measurements from all sensors may be used; refer to **Figure C.1 Depiction of FWD Load Distribution through Pavement**. The purpose of this testing is to characterize the structural condition of the pavement where damage due to truck loading should be the greatest. For the outside lanes, testing should be conducted in the right wheel path. For inside lanes, testing should be conducted in the left wheel path.

C.2.2 FWD Drop Sequence – Flexible Pavement

Drop sequences vary based on pavement type and the type of information being gathered. Drop sequence is defined as the order in which impulse loads are applied to the pavement. This includes the “seating drops” and the recorded impulse loads. Below is the recommended drop sequence for basin testing on flexible pavements:

- One Seating Drop at 6,000 pounds
- Three Recorded Drops at 6,000 pounds
- Three Recorded Drops at 9,000 pounds
- Three Recorded Drops at 12,000 pounds
- Three Recorded Drops at 16,000 pounds

Therefore, at each test location the FWD will perform 13 drops and record four sets of deflection and impulse load data. By performing multiple drops at a location, the pavement will react as a homogeneous structure as well as reduce the errors in measurement. Additionally, by recording and analyzing data from four different load levels, the Pavement Engineer can determine if the materials on the project are stress sensitive (non-linearly elastic), if a hard bottom (water table, bedrock or extremely stiff layer) is present, and if compaction/liquefaction is occurring in the subgrade.

C.2.3 FWD Sensor Spacing – Flexible Pavement

FWD sensor spacing to record pavement deflection data is dependent on the pavement type as well as the testing purpose (load transfer testing vs. basin testing). For basin testing on flexible pavements, the recommended spacing from the center of the load plate is given below:

- 0 in., 8 in., 12 in., 18 in., 24 in., 36 in., 48 in., 60 in., and 72 in.

C.2.4 Surface Temperature Measurement – Flexible Pavement

Ideally, the pavement temperature will be recorded directly from temperature holes at each test location as the FWD test is being performed. While this is the preferred approach for research projects, it is not practical for production level testing (maintenance and rehabilitation projects). Therefore, for production level testing the economic and practical approach is by measuring the surface temperature at each test location. This can be easily done using an infrared thermometer. The FWD can automatically measure and record the pavement surface temperature to the FWD file. If the FWD is not equipped with an Infrared thermometer, then the FWD operator can use a hand held thermometer and record the temperature to a file. By measuring and monitoring the surface temperature during testing, the FWD operator can suspend testing if the pavement becomes too hot.

C.3 FWD Testing – Rigid Jointed Plain Concrete Pavements

For rigid pavements, FWD testing is used to assess the structural capacity of the pavement, estimate the strength of subgrade soils, assess load transfer at joints, and detect voids at joints. In addition to the structural capacity, the elastic modulus for the surface, base and sub-base layers can be determined.

C.3.1 FWD Testing Pattern – Rigid Pavement

The FWD testing pattern selected for a jointed concrete pavement project should be related to the project's layout, project size, and slab length. The Pavement Engineer should consider the number of lanes to be tested, total number of slabs, length of the project, and any unusual circumstances that would require a change in the testing pattern.

- Project Layout - the project layout will influence the FWD testing pattern. For projects where the pavement is to be repaired in each direction, then travel lanes in each direction should be tested. Typically, this should be the outside travel lane. For projects where only one direction will be repaired and more than two lanes exist, then testing should be conducted on the outside lane and possibly inside lane. The inside lane should be tested if:

- Pavement structure is different from the outside lane,
 - More load related distress is present as compared to the outside lane, or
 - Heavy truck traffic uses the lane (lane is prior to a left exit).

For projects that contain multiple intersections, then FWD testing may not be possible due to traffic. However, where possible testing should be conducted at approaches and departures to an intersection.

- Slab Length and Project Size - the number of jointed concrete slabs in a project will determine test spacing. For projects with short slab lengths, it may not be practical to test every slab (basin and joint testing).

In addition to slab length, the size of a project will influence the test spacing. The project size is determined by the directional length of pavement to be repaired, not necessarily the centerline length. For example, a project that has a centerline distance of 1 mile and will be repaired in two directions has a directional length of 2 miles. Therefore, the test spacing should be based on two miles. **Table C.2 Jointed Plain Concrete Pavement Test Spacing Guidelines** contains guidelines based on project size, approximate slab length, test spacing, and estimated testing days. A testing day is defined as 175 locations tested (joints, corners and basins).

- Testing Days - **Table C.2 Jointed Plain Concrete Pavement Test Spacing Guidelines** shows the approximate testing days of actually doing the drop testing. Additional time must be allotted for traffic control setup and travel time to the test site. It may also be required to have a pre-testing meeting with the Pavement Engineer.

- Rigid and Composite Basin Testing - The standard procedure will be basin testing only. If additional testing of joint and corner testing is required, a special request is to be submitted.

Table C.2 Jointed Plain Concrete Pavement Test Spacing Guidelines

Project Size (miles)	Slab Length	Basin Test Spacing (no. of slabs)	Joint/Corner Spacing (no. of slabs)	Approximate Number of Tests	Testing Days
0 - 0.5	< 20'	Every 6th Slab	Every 2nd J/C	115	1 day
0.5 – 1.0	< 20'	Every 9th Slab	Every 3rd J/C	180	1 day
1.0 – 2.0	< 20'	Every 12th Slab	Every 4th J/C	250	1 – 2 days
2.0 – 4.0	< 20'	Every 15th Slab	Every 5th J/C	380	1 ½ - 3 days
4.0 – 8.0	< 20'	Every 20th Slab	Every 10th J/C	220	1 ½ - 3 days
> 8.0	< 20'	Every 20th Slab	Every 10th J/C	450	> 3 days

- Testing Location - for jointed concrete pavements, three types of FWD testing are generally conducted – basin, joint, and slab corner testing. Each test provides information on the structural integrity of the pavement.

Basin Testing - for jointed concrete pavements, basin testing should be conducted near the center of the slab (See **Figure C.3 JPCP Testing Pattern**). This testing provides information on the elastic modulus of the PCC and strength of base materials and subgrade soils.

Joint Testing - for jointed concrete pavements, joint testing should be conducted in the wheel path closest to the free edge of the slab (See **Figure C.3 JPCP Testing Pattern**). Typically, for the outside lanes, testing will be conducted in the right wheel path. For inside lanes, testing should be conducted in the left wheel path. If more than two lanes exist and the middle lanes are to be tested, then the nearest free edge must be determined. This testing provides information on joint load transfer – how well a joint, through either aggregate interlock and/or dowel bars, can transfer a wheel load from one slab to an adjacent slab.

Corner Testing - for jointed concrete pavements, corner testing should be conducted at the slab's free edge corner (See **Figure C.3 JPCP Testing Pattern**). Typically, for the outside lanes, testing will be conducted in the right corner edge of the slab. For inside lanes, testing should be conducted in the left corner edge of the slab. If more than two lanes exist, then the middle lanes should only be tested if pumping is suspected in the middle lanes. The Pavement Engineer will determine if pumping is present and if testing should be conducted. Unless otherwise directed by the Pavement Engineer, corner testing shall be conducted on the leave side of the joint where voids are typically located. This testing provides information on the possibility for the presence of voids under a slab corner.

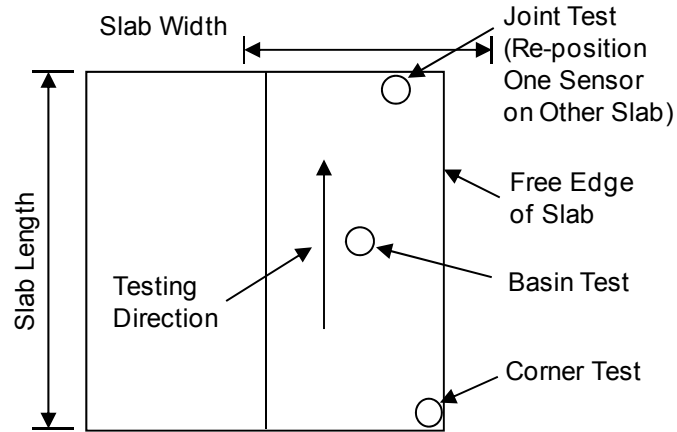

Figure C.3 JPCP Testing Pattern

C.3.2 FWD Drop Sequence – Rigid Pavement

When collecting pavement structure data, the correct drop sequence is required. Drop sequences vary based on pavement type and the type of information being gathered. Drop sequence is defined as the order in which impulse loads are applied to the pavement. This includes the “seating drops” and the recorded impulse loads.

- Basin Testing - below is the recommended drop sequence for basin testing on jointed concrete pavements:

- One Seating Drop at 6,000 pounds
- Three Recorded Drops at 6,000 pounds
- Three Recorded Drops at 9,000 pounds
- Three Recorded Drops at 12,000 pounds
- Three Recorded Drops at 16,000 pounds

Therefore, at each test location the FWD will perform 13 drops and record four sets of deflection and impulse load data. By performing multiple drops at a location, the pavement will react as a homogeneous structure as well as reduce the errors in measurement. Additionally, by recording and analyzing data from four different load levels, the Pavement Engineer can determine if the materials on the project are stress sensitive (non-linearly elastic), if a hard bottom (water table, bedrock or extremely stiff layer), and if compaction/liquefaction is occurring in the subgrade.

- Joint Testing - below is the recommended drop sequence for joint testing on jointed concrete pavements:

- One Seating Drop at 6,000 pounds
- Three Recorded Drops at 6,000 pounds
- Three Recorded Drops at 9,000 pounds
- Three Recorded Drops at 12,000 pounds
- Three Recorded Drops at 16,000 pounds

Therefore, at each test location the FWD will perform 13 drops and record four sets of deflection and impulse load data. Two sensors are needed for the analysis, the sensor at the load and the second sensor on the other side of the joint.

- Corner Testing - below is the recommended drop sequence for corner testing on jointed concrete pavements:

- One Seating Drop at 6,000 pounds
- Three Recorded Drops at 9,000 pounds
- Three Recorded Drops at 12,000 pounds
- Three Recorded Drops at 16,000 pounds

In order to use the AASHTO procedure for the detection of voids, three different load levels are required; therefore, at each test location the FWD will need to perform 10 drops and record three sets of deflection and impulse load data. Only one sensor is needed in the analysis, the sensor at the load.

C.3.3 FWD Sensor Spacing – Rigid Pavement

FWD sensor spacing to record pavement deflection data is dependent on the pavement type as well as the type of testing. For jointed concrete pavements, three types of testing are performed - joint, corner and basin.

- Basin Testing - for basin testing on jointed concrete pavements, below is the recommended spacing:

- 0 in., 8 in., 12 in., 18 in., 24 in., 36 in., 48 in., 60 in., and 72 in.

- Joint Testing - for joint testing on jointed concrete pavements, only two sensors are required. Below is the required spacing:

- 0 in. and 12 in.

The sensors are to be placed on each side of the joint and are to be 6 inches from the joint (**Figure C.4 Joint Load Transfer Testing Sensor Spacing**).

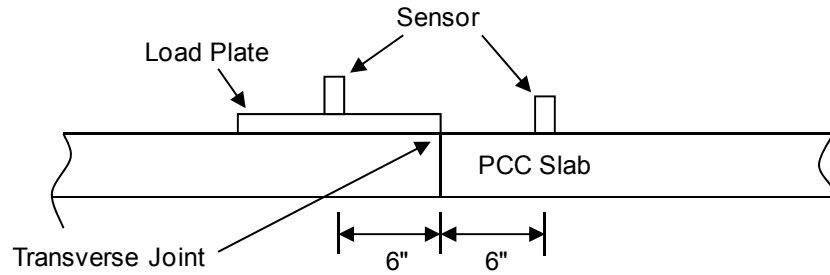

Figure C.4 Joint Load Transfer Testing Sensor Spacing

- Corner Testing - for joint testing on jointed concrete pavements, only one sensor is required. Below is the required sensor location:

0 in. - at the load

The sensor is to be placed on the leave side of the joint and is to be 6 inches from the joint (**Figure C.5 Corner Testing Sensor Location**).

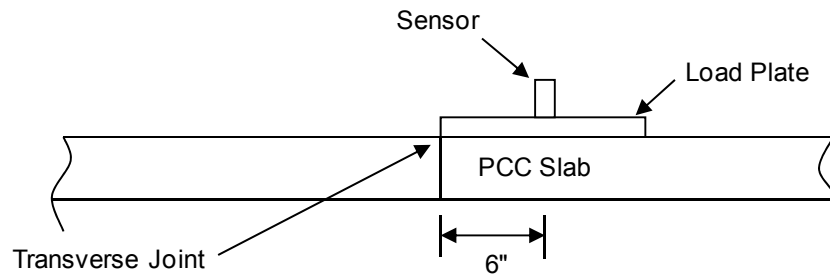

Figure C.5 Corner Testing Sensor Location

C.3.4 Surface Temperature Measurement – Rigid Pavement

Ideally, the pavement temperature will be recorded directly from temperature holes at each test location as the FWD test is being performed. While this is the preferred approach for research projects, it is not practical for production level testing (network level or maintenance and rehabilitation projects). Therefore, for production level testing the economic and practical approach is by measuring the surface temperature at each test location. This can be easily done using an infrared thermometer. The FWD can automatically measure and record the pavement surface temperature to the FWD file. If the FWD is not equipped with an Infrared thermometer, then the FWD operator can use a hand held thermometer and record the temperature to a file. By measuring and monitoring the surface temperature during testing, the FWD operator can suspend testing if the pavement becomes too hot. Note to Pavement Engineer - pavement temperature is recorded for joint and corner testing only.

C.4 FWD Testing – Composite Pavements

For composite pavements, falling weight deflectometer (FWD) testing is used to assess the structural capacity of the pavement and estimate the strength of subgrade soils as well as assess the load transfer at underlying joints. In addition to the structural capacity, the elastic modulus for the surface, base and subbase layers can be estimated.

C.4.1 FWD Testing Pattern – Composite Pavement

The FWD testing pattern selected for a project should be related to the project's size and layout. The Pavement Engineer should consider the number of lanes to be tested, total length of the project, and any unusual circumstances that would require a change in the testing pattern. In addition, the AC overlay thickness should be considered. If the thickness is less than four inches, then the load transfer of the underlying PCC joints may be performed.

- Project Layout - the project layout will influence the FWD testing pattern. For projects where the pavement is to be repaired in each direction, then travel lanes in each direction should be tested. Typically, this should be the outside travel lane. For projects where only one direction will be repaired and more than two lanes exist, then testing should be conducted on the outside lane and possibly inside lane. The inside lane should be tested if:

Pavement structure is different from the outside lane,
More load related distress is present as compared to the outside lane, or
Heavy truck traffic uses the lane (lane is prior to a left exit).

For projects that contain multiple intersections, then FWD testing may not be possible due to traffic. However, where possible testing should be conducted at approaches and departures to an intersection.

- Project Size - the size of a project will influence the test spacing. The project size is determined by the directional length of pavement to be repaired, not necessarily the centerline length. For example, a project that has a centerline distance of 1 mile and will be repaired in two directions has a directional length of 2 miles. Therefore, the test spacing should be based on two miles. **Table C.3 Composite Pavement Test Spacing Guidelines** contains guidelines based on project size, test spacing, and estimated testing days if load transfer testing is not performed. If load transfer testing is desired, then the appropriate spacing should be determined in the field. As a guideline, please refer to Joint/Corner Spacing column in **Table C.2 Jointed Plain Concrete Pavement Test Spacing Guidelines**. A testing day is defined as 200 locations tested.
- Testing Days - **Table C.3 Composite Pavement Test Spacing Guidelines** shows the approximate testing days of actually doing the drop testing. Additional time must be allotted for traffic control setup and travel time to the test site. It may also be required to have a pre-testing meeting with the Pavement Engineer.

- Composite Basin Testing - The standard procedure will be basin testing only. If additional testing of joint testing is required, a special request is to be submitted.

Table C.3 Composite Pavement Test Spacing Guidelines

Project Size (miles)	Test Spacing (feet)	Approximate Number of Tests	Testing Days
0 – 0.5	25	75	½ day
0.5 – 1.0	50	90	½ day
1.0 – 2.0	50	175	1 day
2.0 – 4.0	100	175	1 day
4.0 – 8.0	150	200	1 to 1 ½ days
> 8.0	200	>200	> 1 ½ days

For two or three lane bi-directional roadways not separated by a median, the testing should be staggered by one-half the test spacing. See **Figure C.6 Staggered Testing Pattern** for clarification. For projects that are separated by a median, a staggered testing pattern is not required.

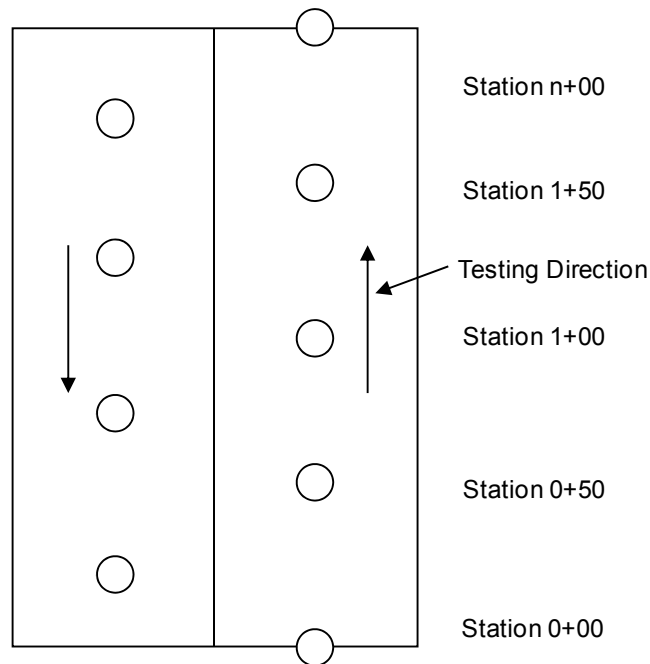

Figure C.6 Staggered Testing Pattern

- Testing Locations - for composite pavements, two types of FWD testing are generally conducted – basin and joint. Each test provides information on the structural integrity of the pavement.

Basin Testing - for composite pavements, basin testing should be conducted in the middle of the lane or near the center of the slab (See **Figure C.6 Staggered Testing Pattern**). This testing provides information on the elastic modulus of the AC, PCC and strength of base materials and subgrade soils.

Joint Testing - for composite pavements, joint testing should be conducted in the wheel path closest to the free edge of the slab (See **Figure C.6 Staggered Testing Pattern**). Typically, for the outside lanes, testing will be conducted in the right wheel path. For inside lanes, testing should be conducted in the left wheel path. If more than two lanes exist and the middle lanes are to be tested, then the nearest free edge must be determined. This testing provides information on joint load transfer – how well a joint, through either aggregate interlock and/or dowel bars, can transfer a wheel load from one slab to an adjacent slab.

C.4.2 FWD Drop Sequence – Composite Pavements

When collecting pavement structure data, the correct drop sequence is required. Drop sequences vary based on pavement type and the type of information being gathered. Drop sequence is defined as the order in which impulse loads are applied to the pavement. This includes the “seating drops” and the recorded impulse loads.

- Basin Testing - below is the recommended drop sequence for basin testing on composite pavements:

- One Seating Drop at 6,000 pounds
- Three Recorded Drops at 6,000 pounds
- Three Recorded Drops at 9,000 pounds
- Three Recorded Drops at 12,000 pounds
- Three Recorded Drops at 16,000 pounds

Therefore, at each test location the FWD will perform 13 drops and record four sets of deflection and impulse load data. By performing multiple drops at a location, the pavement will react as a homogeneous structure as well as reduce the errors in measurement. Additionally, by recording and analyzing data from four different load levels, the Pavement Engineer can determine if the materials on the project are stress sensitive (non-linearly elastic), if a hard bottom (water table, bedrock or extremely stiff layer), and if compaction/liquefaction is occurring in the subgrade.

- Joint Testing - below is the recommended drop sequence for joint testing on composite pavements:

- One Seating Drop at 6,000 pounds
- Three Recorded Drops at 6,000 pounds
- Three Recorded Drops at 9,000 pounds
- Three Recorded Drops at 12,000 pounds
- Three Recorded Drops at 16,000 pounds

Therefore, at each test location the FWD will perform 13 drops and record four sets of deflection and impulse load data. Two sensors are needed for the analysis, the sensor at the load and the second sensor on the other side of the joint.

C.4.3 FWD Sensor Spacing – Composite Pavement

FWD sensor spacing to record pavement deflection data is dependent on the pavement type as well as the type of testing. For composite pavements, two types of testing are performed – joint, and basin.

- Basin Testing - for basin testing on composite pavements, below is the recommended spacing:

0 in., 8 in., 12 in., 18 in., 24 in., 36 in., 48 in., 60 in., and 72 in.

- Joint Testing - for joint testing on composite pavements, only two sensors are required. Below is the required spacing:

0 in. and 12 in.

The sensors are to be placed on each side of the joint and are to be 6 inches from the joint (See **Figure C.7 Joint Load Transfer Testing Sensor Spacing**).

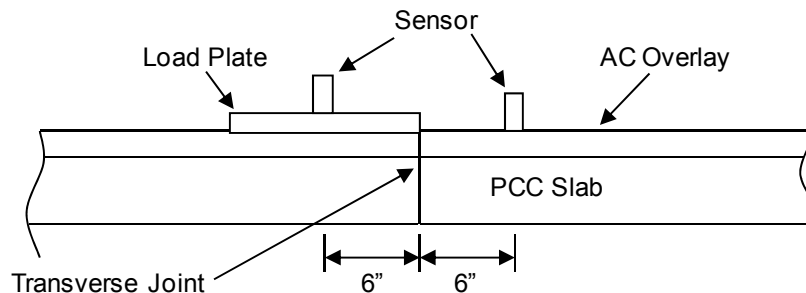

Figure C.7 Joint Load Transfer Testing Sensor Spacing

C.4.4 Pavement Temperature Readings – Composite Pavement

Ideally, the pavement temperature will be recorded directly from temperature holes at each test location as the FWD test is being performed. While this is the preferred approach for research projects, it is not practical for production level testing (network level or maintenance and rehabilitation projects). Therefore, for production level testing the economic and practical approach to determine the mid-depth pavement temperature is by measuring the surface temperature at each test location. This can be easily done using an infrared thermometer. The FWD can automatically measure and record the pavement surface temperature to the FWD file. If the FWD is not equipped with an Infrared thermometer, then the FWD operator can use a hand held thermometer and record the temperature to a file. Using temperature correlation models such as the BELLS3 equation, the mid-depth AC material temperature can be estimated.

C.5 Field Test Report

Additional documentation of the FWD project is necessary besides the FWD drop file. A suggested Field Test Report is presented (**Figure C.8 Field Test Report**).

A log entry should only be made for special conditions, such as test location skipped because it was on a bridge. The FWD operator does not test for frost depth.

**COLORADO DEPARTMENT OF TRANSPORTATION
FALLING WEIGHT DEFLECTOMETER FIELD TEST REPORT**

Project Number		Test Date	
Project Description		Test Start Time	
Project Code		Test End Time	
		Pavement Type	
File Name		Test Type	
Route Number		Purpose of Testing	
Beginning MP		Season	
Beginning MP Description		Weather	
Ending MP		FWD Operator	
Ending MP Description		FWD Serial Number	
Requestor		FWD Company	
Phone Number		FWD Calibration Date	

Test Location Remarks

Use this to indicate abnormal test results, skipped test locations, or other items the Pavement Engineer should be made aware of

FWD Test #	Station	Lane	Direction	Remarks

FWD - Field Test Report.xls

Figure C.8 Field Test Report

C.6 FWD Data Processing

CDOT uses AASHTO PDDX file format in its FWD files. The following is an example of data collected at a test site:

```
*****  
[Test Location 1]  
TestLocation = 45.592  
TestLane = 1  
TestTemperatures = 93.5,105.1  
TestComment = 13:01  
NumberOfDrops = 3  
DropData_1 = 9120.00, 18.32, 12.43, 9.69, 6.95, 5.37, 3.32, 2.43  
DropData_2 = 9040.00, 17.98, 12.24, 9.57, 6.90, 5.42, 3.30, 2.43  
DropData_3 = 8990.00, 17.91, 12.18, 9.56, 6.92, 5.36, 3.31, 2.46  
  ↓  
  ↓  
*****
```

On the "TestTemperatures = 93.5,105.1" line, the first value "93.5" is the air temperature and the second value "105.1" is the pavement surface temperature.

The "TestComment = 13:01" indicates that 1:01 PM is the time of the test. The time uses the 24-hr time format.

In order to process FWD data, many steps are required. These steps include gathering information on the pavement's surface condition, conducting a preliminary analysis on the deflection data, performing pavement coring and subgrade boring operations, processing of all the data collected, and analyzing, interpreting and reporting on the data results. Each one of these steps has numerous tasks associated with them. These steps are detailed in the following sections.

C.6.1 Pre-Analysis

Once FWD data are collected, it is important to perform a preliminary analysis on the deflection data. Please refer to the *MODTAG Users Manual* for further instruction on pre-analysis.

C.6.2 Pavement Surface Condition Survey

Prior to collecting any FWD data, the engineer should conduct a detailed pavement condition and patching survey. These surveys will help the engineer establish possible problem areas with the pavement and set-up the appropriate FWD testing plan. Testing could be concentrated in specific areas while other areas could be avoided completely. Refer to Section **5.5 Pavement Evaluation** in **CHAPTER 5 - PRINCIPLES OF DESIGN FOR PAVEMENT REHABILITATION WITH FLEXIBLE OVERLAYS** and Section **6.4 Existing Pavement Evaluation** in **CHAPTER 6 - PRINCIPLES OF DESIGN FOR PAVEMENT REHABILITATION WITH RIGID OVERLAY**. Once these data are collected, the engineer can plot the results on a straight-line diagram. This will be extremely beneficial when other data are collected and analyzed.

C.6.3 Pavement Coring and Subgrade Boring

In order to conduct an analysis of FWD data, the exact pavement structure must be known. For most roadways, the exact structure is not known; therefore, pavement coring is required. Coring provides thicknesses to be used as seed values for backcalculation analysis. Cores should be retained for further evaluation in the laboratory. Pavement cores identify layer types and conditions to help validate surface course moduli. In addition, while the engineer may know what type of subgrade soils exists in the project area, they cannot be sure without boring the subgrade and extracting samples. These materials collected in field can be analyzed in the lab, and the lab results used to validate FWD Data Analysis results.

The thickness of the existing pavement layers must be known. Cores must be taken at a minimum of one core per mile for pavement layer and base layer thickness measurements. When pavement length is less than one mile, a minimum of one core will be taken. If a review of the as built plans from previous projects indicates there are locations with varying thicknesses, more cores will be taken to verify the existing pavement thickness.

For the materials above the subgrade, the coring and boring crew should record:

- Layer Materials - Asphalt, PCC, Granular, Cement Treated, etc
- Layer Thickness - Thickness for each different layer
- Layer Condition - AC material stripped, PCC deteriorated, granular material contaminated, etc.
- Material Types - For AC Materials, identify various layer types

For the subgrade and base materials refer to Section **2.2 - Soil Survey Investigation** in **CHAPTER 2 - SUBGRADE AND BASE MATERIALS** for three steps that are necessary to conduct a subgrade and base investigation. Document findings and test results on CDOT Forms #554 (Soil Survey Field Report) and #555 (Preliminary Soil Survey). See **Figure C.9 Coring Log Example**.

COLORADO DEPARTMENT OF TRANSPORTATION											LOCATION						
PRELIMINARY PAVEMENT STRUCTURE INVESTIGATION											I-76, US 85 to Burlington Canal						
Date: 4/13/06 Page: 1 of 2 NOTE: If samples are submitted leave sieve analysis section blank.											SUBACCOUNT 15361						
STATION AND LOG	TEST NO.	DESCRIPTION	PERCENT PASSING										LIQUID LIMIT	PLASTIC INDEX	CLASSIFICATION AND GROUP INDEX	MOISTURE %	Mr P.S.I.
			1"	3/4"	1/2"	3/8"	#4	#8	#16	#30	#60	#200					
I-76, US 85 to Burlington Canal																	
Eastbnd. @ MP 12.5, Lane #2																	
0-4.5"	1	HBP	Lift Thickness: 0-1.5", 1.5-2.5", 2.5-4.5" (New 1/2" mix)														
4.5-12"		PCCP	Lift Thickness: 4.5-12"														
12-28"		Roadbase	100	99	97	90	78	66	39	18.5							Class 3
Eastbnd. @ MP 13, Lane #2																	
0-4.5"	2	HBP	Lift Thickness: 0-1.5", 1.5-2", 2-4.5" (New 1/2" mix)														
4.5-12.75"		PCCP	Lift Thickness: 4.5-12.75"														
12.75+*		Roadbase similar as #1															
Eastbnd. @ MP 13.5, Lane #2																	
0-4.25"	3	HBP	Lift Thickness: 0-1.5", 1.5-2", 2-4.25" (New 1/2" mix)														
4.25+*		PCCP	Did not core PCCP because of similar depths														
Eastbnd. @ MP 13.5, Shoulder																	
0-6.75"	4	HBP	Lift Thickness: 0-1.5", 1.5-2.25", 2.25-3", 3-4.25" (New 1/2" mix), 4.25-6.75" (Old 1/2" mix) highly visible air voids														
6.75-12+*		Roadbase	100	96	92	77	58	38	15	6.2							Class 2
Eastbnd. @ MP 14.5, Lane #2																	
0-4"	5	HBP	Lift Thickness: 0-1", 1-1.75", 1.75-4" (New 1/2" mix)														
4-12.25"		PCCP	Lift Thickness: 4-12.25"														
12.25-16"		Roadbase	100	100	99	97	92	87	81	58	27.8						
16+*		Soil															
Eastbnd. @ MP 16, Lane #2																	
0-4.5"	6	HBP	Lift Thickness: 0-2", 2-4.5" (New 1/2" mix)														
4.5+*		PCCP	Did not core PCCP because of similar depths														
Eastbnd. @ MP 16, Shoulder																	
0-6.5"	7	HBP	Lift Thickness: 0-1.75" (New 1/2" mix), 1.75-2.5" (Chip Seal), 2.5-4.5", 4.5-6.5" (New 1/2" mix)														
6.5+*		Roadbase similar as #4															

REGION DESIGN
REGION MATERIALS ENGINEER

C.D.O.T. FORM #55
1/92

Figure C.9 Coring Log Example

C.6.4 Full Data Processing

Once pavement condition data and materials data are collected, then the engineer can perform the data processing. The type of data processing depends on 1) pavement type – flexible, rigid or composite, and 2) testing performed – basin, joint load transfer, or corner void. Please refer to the *MODTAG Users Manual* for further instructions.

C.6.5 Data Analysis, Interpretation and Reporting

Except for operating the FWD processing programs, the data analysis and interpretation is the most difficult portion. Once the analysis and interpretation is completed, then the results must be presented in such a manner to be used in the pavement design programs. Please refer to the *MODTAG Users Manual* for further information.

C.6.5.1 Results Reporting – Flexible Pavements

FWD Analysis results are used to report on the condition of the existing pavement and to provide information for use in future pavement designs. For flexible pavements, the existing conditions and pavement design information should be reported. The following existing conditions should be noted in the report:

- Effective Structural Number
- Subgrade Resilient Modulus
- Remaining Life or Condition Factor

C.6.5.2 Results Reporting – Jointed and Composite Pavements

FWD Analysis results are used to report on the condition of the existing pavement and to provide information for use in future pavement designs. For Jointed and Composite pavements, the existing conditions and pavement design information should be reported. The following existing conditions should be noted in the report:

- Elastic Modulus of the Concrete
- Composite Modulus of Subgrade Reaction (k-value)
- Load Transfer Efficiency and J-Factor
- Corners with Possible Voids

C.6.5.3 Data Analysis and Interpretation – Jointed and Composite Pavements

To minimize errors in interpretation, more than one analysis approach should be used. By using multiple approaches, the engineer can determine if the results correlate between programs or are vastly different. Once results are obtained, then engineering judgment must be employed to see if the results are reasonable or make sense.

References

1. *Chapter VI - Pavement Evaluation and Design*, Virginia Department of Transportation, 1401 Broad Street, Richmond, VA 23219, January 2004.
2. *MODTAG Users Manual Version 4*, Virginia Department of Transportation and Cornell University, Virginia Department of Transportation, 1401 Broad Street, Richmond, VA 23219, June 2006.
3. *Instructional Guide for Back-Calculation and the Use of MODCOMP3*, Version 3.6, CLRP Publication No. 94-10, by Dr. Lynne H. Irwin, Cornell University, Local Roads Program, March 1994.
4. ModTag Analyser, Version 4.0.6, Software.

APPENDIX D

THE NEW ECONOMY; MATERIALS AND PAVEMENT OPTIONS AND CONSIDERATIONS

D.1 Introduction

The New Economy: Materials and Pavement Options and Considerations is a finalized white paper, written by Colorado Department of Transportation (CDOT) Materials Advisory Committee on January 16, 2007. The white paper is important document and is included in this manual as guidance for the pavement engineer. The authors and members of the Materials Advisory Committee at the time of the issuance were:

Tim Aschenbrener, CDOT Materials and Geotechnical Branch
Bill Schiebel, Region 1 Materials
Richard Zamora, Region 2 Materials
Rex Goodrich, Region 3 Materials
Gary DeWitt, Region 4 Materials
Mike Coggins, Region 5 Materials
Masoud Ghaeli, Region 6 Materials
Glenn Frieler, Concrete Pavement Program Manager
Jay Goldbaum, Pavement Design Program Manager
Roy Guevara, Asphalt Pavement Program Manager
Corey Stewart, Pavement Management Program Manager

D.2 White Paper - The New Economy

Introduction

There is a new economy relative to petroleum products. National prices set records in 2006 for crude oil (over \$70 per barrel) and gasoline (over \$3 per gallon). In the Rocky Mountain West there has been an increase in the use of cokers at asphalt refineries which has provided an additional tightening of the supply of asphalt binder. The tighter supply has also had an impact on cost. Unmodified asphalt binder prices exceeded \$450 per ton. These economic changes have been behind the recently introduced term, “new economy.” CDOT’s surface treatment program relies heavily on petroleum products, and the new economy warrants a discussion on the relative impacts and options available to CDOT.

The National Asphalt Pavement Association (NAPA) and Colorado Asphalt Pavement Association (CAPA) have concerns regarding the new economy. They have published methods to encourage owners to be more cost effective. NAPA has focused on the hot-mix asphalt (HMA) materials and pavement design with recommendations on reclaimed asphalt pavement (RAP), appropriate use of polymers, large-stone aggregate mixtures, thin-lift overlays and roofing shingles. CAPA has focused some on HMA materials and pavement design areas (RAP, specification changes, etc) but has also included the project development process (partnering, constructability reviews, etc.). The methods NAPA and CAPA have documented are valid and

need to be considered. However, they do not necessarily represent a complete list of options the owner should consider.

The purpose of this white paper is to document seven strategies that should be considered by the owner in light of the new economy. Some of these are old, tried and true strategies that will now be cost effective more often than in the past. Other strategies are new ideas that can be investigated to get the most from the limited surface treatment program funds. We need to remember that the common strategies used in the past will still work and may still be cost effective; however, we need to be sure to look at a variety of options with the prices of the new economy. Automatically choosing the proven strategies of the past may not be the most cost effective solution.

Preventive Maintenance

Nationally, pavement preservation has been touted as a more cost effective process to maintain the surface condition. It represents a key component of a long-range plan to preserve and prolong the service life of the existing roadway system. Its goal is to keep the pavements that are in good and fair condition in that condition rather than let them deteriorate to a poor condition. When in a poor condition, more costly treatments are needed. States such as Georgia and Michigan have documented that for every \$1 spent on maintaining and preserving roads in good to fair condition, you can save approximately \$5 to \$8 on major rehabilitation and reconstruction. Treating the pavements at the right time with the right maintenance treatments is very cost effective. These cost analyses were for the “old economy” so the “new economy” analyses should be even more persuasive.

Colorado Policy Memo 18 dated October 15, 2003 has started Colorado in the direction of more preventive maintenance. CDOT has committed 5% of the surface treatment program budget to be dedicated to preventive maintenance. With the new economy, it may be time to increase the amount dedicated to preventive maintenance.

Strategy 1: Use more preventive maintenance treatments that have worked.

Standard preventive maintenance treatments that are frequently used by CDOT have been incorporated into the draft CDOT Preventive Maintenance Manual available on the Pavement Management website.

- Chip seals are a commonly used maintenance treatment. Sometimes they are used for corrective maintenance and other times they are used for preventive maintenance. When it comes to preventive maintenance, chip seals provide the biggest bang for the buck. They dramatically slow the deterioration of the underlying asphalt by sealing out water and preventing further oxidation of the underlying asphalt, caused in part by the damaging effects of the sun. An asphalt overlay achieves the same but at a much higher cost. When the structural capacity of the pavement is adequate, a chip seal is often the best value tool in our toolbox for increasing the pavement life. It is necessary to extend the life of HMA overlay treatments as anticipated Surface Treatment budgets may not be sufficient to sustain network conditions.

A recent Region 5 chip seal project was bid at around \$3/SY for 385,000 SY of roadway. A similar 3" HMA overlay project cost about \$12/SY for 241,000 SY of roadway. In this example, the chip seal was approximately 1/4 the cost of a 3" overlay. Chip seals will continue to be widely used by CDOT and, considering our limited funding, are an essential tool for preserving and maintaining our roads.

Regions 4 and 5 have started doing chip seals for preventive maintenance at the 3rd to 5th year of life of an overlay. The goal is to extend the time to the next overlay from 8 to 10 years to 12 to 15 years. By placing 2 or 3 chip seals, the need for the next overlay can be delayed. The chip seals are much less costly than overlays making this strategy cost effective.

Strategy 2: Examine new preventive maintenance techniques.

CDOT should continue to evaluate new treatment strategies and expand upon existing treatment options. Examples of additional treatment options are as follows:

- There are 2 types of Brazier mixes. Understanding the difference is important to a successful application. The original Brazier mix is similar to an asphalt sand mix. The new generation of Brazier mix is a milled asphalt mixed with emulsion in a pug mill prior to placement. A technique called Armor Cote from Nebraska DOT, consisting of small rounded river rock mixed with emulsion, is being studied for a possible treatment.
- Further, project selection is critical. When trying these new techniques, it is important to follow the experimental feature protocol. Region 4 is experimenting with the Brazier mix.
- Cape seals are another new and potentially effective preventive maintenance treatment. Region 4 is experimenting with it. Project selection guidelines and materials and construction specifications need to be followed. The performance will be monitored to see if this is a viable new alternative.

Rehabilitation Strategies

Strategy 3: Use more 100% recycling.

There are several different types of 100% recycling that have been used in Colorado for many years. These options have performed very well when appropriate project selection guidelines have been used and the projects were constructed properly.

- Hot-in-place recycling has been used for many years in Colorado. Regions 3 and 5 have used the three types of hot-in-place recycling on the appropriate projects and have had very good success to date. Some of the projects that have been placed have even won awards. It is interesting to note that the City and County of Denver focuses on the heater repaving option in the major metropolitan area. Using curb line milling, the heater repaving process provides 2 inches of treatment for the cost of 1 inch of new material. The heater-remixing process provides 2 inches of treatment for less than the cost of a 1-inch overlay. Even though the fuel costs of hot-in-place recycling have increased, it is only a fraction of the increase that has been experienced for HMA pavements.

- Full-depth reclamation (FDR) is relatively new to Colorado. This is a version of foamed asphalt that was identified on a recent European scanning tour. In some cases FDR includes an additive and in other cases it does not. Region 4 has used this treatment on many projects with low traffic in the eastern part of the State. This treatment allows for a full depth treatment of the existing pavement section with the addition of just 2-6 inches of new HMA. The feedback on construction and performance to date has been very positive. Test sections in service for several years have shown no reflective cracking.
- Cold-in-place recycling has also been used for many years in Colorado. This is a tried and true method that has worked in the past. The specifications and project selection guidelines are CDOT standards. Once again, the existing pavement can have a deep treatment of up to 8 inches if specialized emulsion and equipment are used. Typical cold-in-place recycling is typically 4 inches deep and then only need 2 to 6 inches of overlay. This method should still be considered.
- Additionally, consideration should be given to performing combinations of various treatments depending on distresses observed during a project level pavement analysis.

Strategy 4: Focus on cost effective wearing surfaces.

- Stone matrix asphalt (SMA) shows a lot of promise. After first being introduced to the United States from a European scanning tour, SMA has shown to be a highly effective wearing surface on the high volume roadways in Colorado. Although the initial costs are higher than conventional HMA, the performance data indicates it is a cost effective choice in those locations.
- Expanding on CDOT's successful implementation of SMA, thin-lift SMA is now being studied and may even be more cost effective than SMA when only a functional overlay is required. The use of a smaller nominal maximum aggregate size (3/8-inch) and a thinner lift (1-inch) will allow for this wearing surface to be more cost effective initially. Data from other states have shown that the thin SMA performs well as a wearing course. Colorado has limited data to date, but we have learned that compaction and aggregate size are critical. Colorado will use thin-lift SMAs on several projects during the 2007 construction season. This may also be a preventative maintenance treatment.
- Micro-surfacing has been used by CDOT to correct minor rutting and to restore the skid resistance of the pavement surface. It is composed of polymer modified asphalt with crushed aggregate, mineral fillers, and field control additives. Due to the quick reaction time, an experienced Contractor is desired. Colorado has had mixed results using micro-surfacing as a wearing surface.
- When using more expensive wearing surfaces, shoulders can be treated differently. When focusing on the wearing surface, it is not necessary to treat the wider shoulders with the same premium HMA pavement that is placed on the shoulders. Consideration should be given to a more economical mix.

Strategy 5: Use more portland cement concrete pavement.

- Thin white topping is a CDOT standard. After 10 years of experimentation, the specifications and project selection guidelines have been refined to provide a product that has proven success. When examining major rehabilitations, this option should be given strong consideration.

Strategy 6: Examine new rehabilitation strategies.

- An [Ultra-thin Whitetopping Overlay](#) (UTW) is a pavement rehabilitation technique that has been marketed by the American Concrete Pavement association (ACPA). UTW projects have provided durable wearing surfaces for pavements that are not subject to frequent heavy truck loadings, and where a substantial thickness of asphalt exists. Given its success in limited applications, UTW is now being considered for a range of other applications. In fact, a few states have pilot projects using UTW as an alternative to asphalt overlays for interstate roads. There are, however, still a lot of unknowns about the process. CDOT's Pavement Design Program and Region 6 have gathered design and construction information and would be glad to share that with anyone that wants to consider this experimental feature. When there is a need to place 4-inches of HMA pavement, ultra-thin white topping may be a cost-effective alternative for pavement rehabilitation.
- Cement-treated bases and roller-compacted concrete (RCC) have been used in the past as strong bases to build up the structural layer coefficient of the pavement section. Possibilities exist for utilization of lesser quality of rock and utilization of asphalt placement equipment. A reduced quantity of HMA overlay that results from a stronger base is one motivation for considering these treatments. Colorado has not used RCC in the past, but is considering potential applications in light of the new economy. There is minimal experience nationally at this time with using RCC for highway applications, but RCC may be evaluated as a finished driving surface. Detour pavements may be the ideal location to begin evaluation of RCC pavement.
- Some geotextiles can reduce the structural layer coefficient needed for rehabilitation with an HMA overlay. Some research has shown that the use of a geo-grid can provide a structural benefit. Region 3 is reviewing this literature and is giving consideration to this treatment. If the overlay can be reduced by a nominal amount, then the use of the geo-grid may be cost effective. Region 1 is evaluating the use of high-tensile strength paving geogrids to mitigate severe crack reflection. These products are specially designed for placement within the asphalt layers. Successful performance may yield an alternative to hot and cold in-place recycling prior to overlay. Considerations need to be made for future rehabilitations that may include milling or 100% recycling options.

New Products

Strategy 7: Examine new products.

- AggCote is a product of the American Gilsonite Company that is an additive for Hot Mix Asphalt pavement that may increase the material's resistance to stripping and subsequently increases resistance to rutting. The product is a mineral called Gilsonite that is mined in

Utah and works by “priming” the aggregates before the liquid asphalt is applied. The AggCote increases the bond strength between the aggregate and asphalt cement, increasing the resistance to stripping while still maintaining the flexural properties of the binder for thermal crack resistance.

Lab studies conducted by CDOT concluded that AggCote does work well in all areas that the manufacturer claims. The product consistently provides both increased durability and rut resistance over the current alternative of hydrated lime. This is all with lab mixed samples only. It is unknown if these same results can be produced with plant mixed material in the field.

AggCote is currently a more expensive alternative to lime but it is undetermined if the benefits are worth the additional costs when this product is applied in the field. Field testing may determine if AggCote’s benefits outweigh the additional costs. With the price of crude oil increasing, the benefits and cost savings of using AggCote may soon surpass that of lime. AggCote can replace some asphalt cement used in the mix and does not require the aggregates to be hydrated and dried, which is another area for fuel savings.

It would be worthwhile to pilot this product on a project and do extensive field testing and comparisons of this product versus hydrated lime.

- Asphalt membranes have been an effective way to protect our bridge decks. However, they often have performance issues due to their unique nature, placement, and environment. Alternate bridge deck protection should be considered. A membrane that shows promise is Dega-deck. Region 1 has experimented with this new product. Applications where short application times are necessary have given support to the Dega-deck process.

Closure

From this discussion it can be observed that every Region within CDOT is proactively evaluating additional options because of costs in the new economy. There are many old strategies being used at increasing levels, and new ideas that are being investigated to get the most from the limited surface treatment program funds. This information is provided to encourage the continued and expanded uses of CDOT’s standard products when cost effective and to encourage the exploration of innovative products.

In looking at these pavement rehabilitation and maintenance strategies, it is important to remember to do the right treatment at the right time. Be sure to use structural fixes when the structure needs it. A recently published document that provides guidance for identifying the right treatment at the right time is *Guidelines for Selection of Rehabilitation Strategies for Asphalt Pavement* report number CDOT-DTD-R-2000-08 written by Bud Brakey.

References

1. CDOT Policy Memo 18, Pavement Preventive Maintenance Initiatives, Oct.1, 2003.
2. Brakey, Bud, *Guidelines for Selection of Rehabilitation Strategies for Asphalt Pavement*, Report No. CDOT-DTD-R-2000-08, Colorado Department of Transportation, 2000.
3. American Concrete Pavement Association, Ultra Thin Whitetopping Calculator, http://www.pavement.com/Concrete_Pavement/Technical/UTW_Calculator/index.asp, (1/16/2007).

APPENDIX E

PRACTICAL DESIGN GUIDE FOR PAVEMENTS

E.1 Introduction

The information provided below is intended as guidance to RME's to assist in making these difficult pavement design decisions. CDOT will consider the following two categories when making pavement design decisions:

Category I- Capacity related, require new alignments or require complete reconstruction of the existing roadway.

Category II- Surface Treatment Program projects whose primary purpose is to maintain the function of the existing facilities.

E.2 Category I Pavement Designs

New Alignments, Capacity Projects and STP projects that require reconstruction will follow the current version of CDOT Pavement Design Manual. Contact the RME for project scoping and preliminary design.

E.3 Category II Pavement Designs

In an effort to maintain existing structural and functional condition of the entire pavement network to the fullest extent possible, the Surface Treatment Program (STP) will focus on Pavement Preservation (PP) treatments for Category II Pavements, Pavement Preservation (PP) is defined as a comprehensive asset management strategy that incorporates the appropriate pavement surface treatments (functional overlays, reactive maintenance, preventative maintenance, minor rehab, major rehab and reconstruction) to provide the system an optimal rate of return in terms of remaining service life (RSL), the benefits received by the CDOT customer, and the cost of the treatment. Definitions for each of these treatment categories are contained in the CDOT Pavement Design Manual and the CDOT Pavement Management Manual. Category II Pavement Recommendations will be developed using the following guidelines for project pavement treatment selection. In general, high average annual daily traffic (AADT) or average annual daily truck traffic facilities (AADTT), will receive higher end treatments than those with lower traffic.

- **Interstate and highways with an AADTT of greater than 1000:**
Pavement Sections with higher volumes typically have higher construction and user delay costs. Therefore, preservation of the structural sections on high volume facilities will be the priority for region project delivery. Treatments for these facilities will be designed in accordance with the CDOT Pavement Design Manual for a minimum of 10 years of traffic loading. Preventative maintenance treatments with design lives less than 10 years may also be utilized where appropriate. These roads consist of approximately 7,040 lane miles of the

approximate total of 23,036 lane miles. These roads carry approximately 69.0% of the traffic volumes on the CDOT network.

- **Highways with an ADT of 2,000 to 4,000 and/or AADTT of 100 to 1000:**
A combination of pavement preservation treatments or minor rehabilitation treatments will be the primary treatments considered for these pavements. These roads consist of approximately 12,525 lane miles of the approximate total of 23,036 lane miles. These roads carry approximately 29.0% of the traffic volumes on the CDOT network.
- **Highways with an ADT of up to 2,000, and/or AADTT of less than 100:**
Pavement preservation treatments will be the primary treatment considered for these pavements. These roads consist of approximately 3,471 lane miles of the approximate total of 23,036 lane miles. These roads carry approximately 1.0% of the traffic volumes on the CDOT network.

If the RME determines a treatment more substantial than the primary treatment identified above is needed, they will obtain concurrence from the appropriate Program Engineer and prepare a pavement justification report (PJR) documenting why the selected treatment is cost effective. The PJR will include the date that concurrence was obtained from the Program Engineer. More substantial treatments than the primary treatment will be designed in accordance with the CDOT Pavement Design Manual. When designing these treatments the RME will consider using reliability levels at the bottom of the range for the appropriate type of facility. The RME will also consider using lower reliability binders for thermal cracking, especially if reflective cracking is expected to occur.

SUPPLEMENT

MATERIAL PROPERTIES OF SUBGRADE, SUBBASE, BASE, FLEXIBLE AND RIGID LAYERS

S.1 Introduction

The designer needs to have a basic knowledge of soil properties. This appendix is to give such knowledge in the design of pavements. Basic knowledge of soil consistency, sieve analysis, unit weight, water content, specific gravity, elastic modulus, Poisson's ratio, unconfined compression strength, modulus of rupture, and indirect tensile strength. Resilient modulus and R-value needs to be understood. These soil properties have been for a long time have been in the Department's testing program. The Mechanistic-Empirical (M-E) Pavement Design Guide (24) will aggressively use these properties in the design of pavements.

The Resilient Modulus (M_R) was selected to replace the soil support value used in previous editions as noted when it first appeared in the *AASHTO Guide for Design of Pavement Structures 1986* (2). The AASHTO guide for the design of pavement structures, which was proposed in 1961 and then revised in 1972 (1), characterized the subgrade in terms of soil support value (SSV). SSV has a scale ranging from 1 to 10, with a value of 3 representing the natural soil at the Road Test. AASHTO Test Method T 274 determined the M_R that is referenced in the 1986 AASHTO Guide. The compacted layer of the roadbed soil was to be characterized by the M_R . Using correlations were suitable to obtain a M_R value. Procedures for assigning appropriate unbound granular base and subbase layer coefficients based on expected M_R values were also given in the 1986 Guide. The *1993 AASHTO Guide for Design of Pavement Structures* (3): Appendix L, lists four different approaches to determine a design resilient modulus value. The first approach is laboratory testing, another approach is by Non-Destructive Testing (NDT) backcalculation, the third approach consists of estimating resilient modulus from correlations with other properties, and the last is from original design and construction data (4).

S.2 Basic Definitions of Engineering Properties

The definitions may be slightly different from the definitions stated at the beginning of this manual. These basic definitions are to agree with the usage as in the Mechanistic-Empirical (M-E) Pavement Design Guide. Some have been modified to clarify this manual's notation.

S.2.1 Basic Definitions of the Roadway

S.2.1.1 Roadbed

Roadbed - The graded portion of a highway between top and side slopes, prepared as a foundation for the pavement structure and shoulder.

S.2.1.2 Surface Course

Surface Course - One or more layers of a pavement structure designed to accommodate the traffic load, the top layer of which resists skidding, traffic abrasion, and the disintegrating effects of climate. The top layer of flexible pavements is sometimes called the "wearing" course.

S.2.1.3 Base

Base - The layer or layers of specified or select material of designed thickness placed on a subbase or subgrade to support a surface course. The layer directly beneath the PCC slab is called the base layer.

Aggregate Base - A base course consisting of compacted mineral aggregates. Also, granular base, unbound granular base.

Asphalt Concrete Base - Asphalt concrete used as a base course. Also, asphalt base course, asphalt-stabilized base - hot-mixed, asphalt-treated base (ATB), bituminous aggregate base, bituminous concrete base, bituminous base, hot-mixed asphalt base, and plant mix bituminous base (PMBB).

Cold Mix Asphalt - Asphalt concrete mixtures composed of aggregate and/or asphalt emulsions or cutback asphalts, which do not require heating during mixing. Also, emulsified asphalt treated base (EAT).

Permeable Aggregate Base - A crushed mineral aggregate base treated or untreated having a particle size distribution such that when compacted the interstices will provide enhanced drainage properties. Also, granular drainable layer, untreated permeable base, free-draining base, and stabilized treated permeable base.

Asphalt Treated Permeable Base - A permeable base containing a small percentage of asphalt cement to enhance stability. Also, asphalt-treated open-graded base, asphalt-treated base - permeable.

Cement Treated Base (CTB) - A base course consisting of mineral aggregates blended in place or through a pugmill with a small percentage of Portland cement to provide cementitious properties and strengthening. Also, aggregate cement, cement-stabilized graded aggregate, cement-stabilized base.

Lean Concrete Base - A base course constructed of mineral aggregates plant mixed with a sufficient quantity of Portland cement to provide a strong platform for additional pavement layers and placed with a paver.

Lime-Fly Ash Base - A blend of mineral aggregate, lime, fly ash and water, combined in proper proportions and producing a dense mass when compacted.

Cement Treated Permeable Base - An open-graded aggregate base treated with Portland cement to provide enhanced base strength and reduce erosion potential.

S.2.1.4 Subbase

Subbase - The layer or layers of specified or selected materials of designed thickness placed on a subgrade to support a base course. Note that the layer directly below the PCC slab is now called a base layer, not a subbase layer. Also, granular subbase and unbound granular subbase.

S.2.1.5 Subgrade

Select Material - A suitable native material obtained from a specified source, such as a particular roadway cut or borrow area, having specified characteristics to be used for a specific purpose.

Subgrade - The top surface of a roadbed upon which the pavement structure and shoulders are constructed.

Soil Cement - A mechanically compacted mixture of soil, Portland cement, and water, used as a layer in a pavement system to reinforce and protect the subgrade or subbase. Also, cement-treated subgrade (CTS).

Lime Stabilized Subgrade - A prepared and mechanically compacted mixture of hydrated lime, water, and soil supporting the pavement system that has been engineered to provide structural support.

S.2.1.6 Fabric Layers

Geosynthetics - A planar material manufactured from a polymeric material used with soil, rock, earth or other geotechnical-related materials and serve six primary functions: filtration, drainage, separation, reinforcement, fluid blockage, and protection. Typical geosynthetics include geotextiles, geomembranes, and geogrids.

Geotextiles - Permeable fabric made of textile materials used as filters to prevent soil migration, separators to prevent soil mixing and as reinforcement to add shear strength to a soil.

Geomembranes - Impermeable polymer sheeting used as fluid barriers to prevent migration of liquid pollutants in soil.

Geogrids - Polymeric grid material having relatively high tensile strength and a uniformly distributed array of large apertures (openings). The apertures allow soil particles on either side to come in direct contact, thereby increasing the interaction between the geogrid and surrounding soils. Used primarily for reinforcement.

S.2.2 Soil Consistency

Soil Consistency is defined as the amount of effort required to deform a soil. This level of effort allows the soil to be classified as either soft, firm, or hard. The forces that resist the deformation and rupture of soil are cohesion and adhesion. Cohesion is a water-to-water molecular bond, and adhesion is the water-to-solid bond (17). These bonds depend on water, so consistency directly relates to moisture content, which provides a further classification of soil as dry consistence, moist consistence, and wet consistence.

The Atterberg Limits takes this concept a step further, by labeling the different physical states of soil based on its water content as liquid, plastic, semi-solid, solid. The boundaries that define these states are known as the liquid limit (LL), plastic limit (PL), shrinkage limit (SL), and dry limit (DL). The liquid limit is the moisture content at which soil begins to behave like a liquid and flow. The plastic limit is the moisture content where soil begins to demonstrate plastic properties, such as rolling a small mass of soil into a long thin thread. The plasticity index (PI) measures the range between LL and PL where soil is in a plastic state. The shrinkage limit is defined as the moisture content at which no further volume change occurs as the moisture content is continually reduced (18). The dry limit occurs when moisture no longer exists within the soil.

The Atterberg limits are typically used to differentiate between clays and silts. The test method for determining LL of soils is AASHTO T 89-02. AASHTO T90-00 presents the standard test method for determining PL and PI.

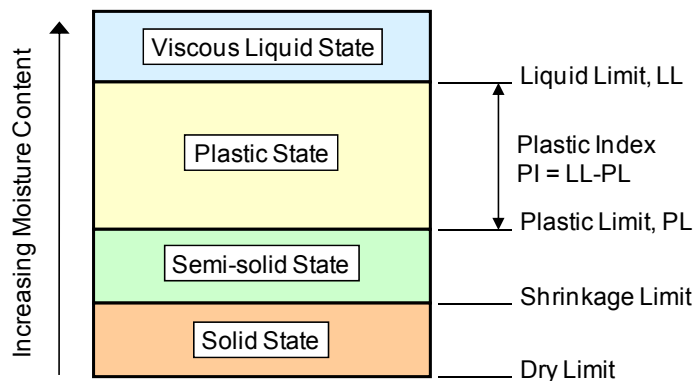

Figure S.1 Atterberg Limits

S.2.3 Sieve Analysis

The sieve analysis is performed to determine the particle size distribution of unbound granular and subgrade materials. In the M-E Design the required size distribution are the percentage of material passing the No. 4 sieve (P_4) and No. 200 sieve (P_{200}). D_{60} represents a grain diameter in inches for which 60% of the sample will be finer and passes through that sieve size. In other words, 60% of the sample by weight is smaller than diameter D_{60} . $D_{60} = 0.1097$ inches.

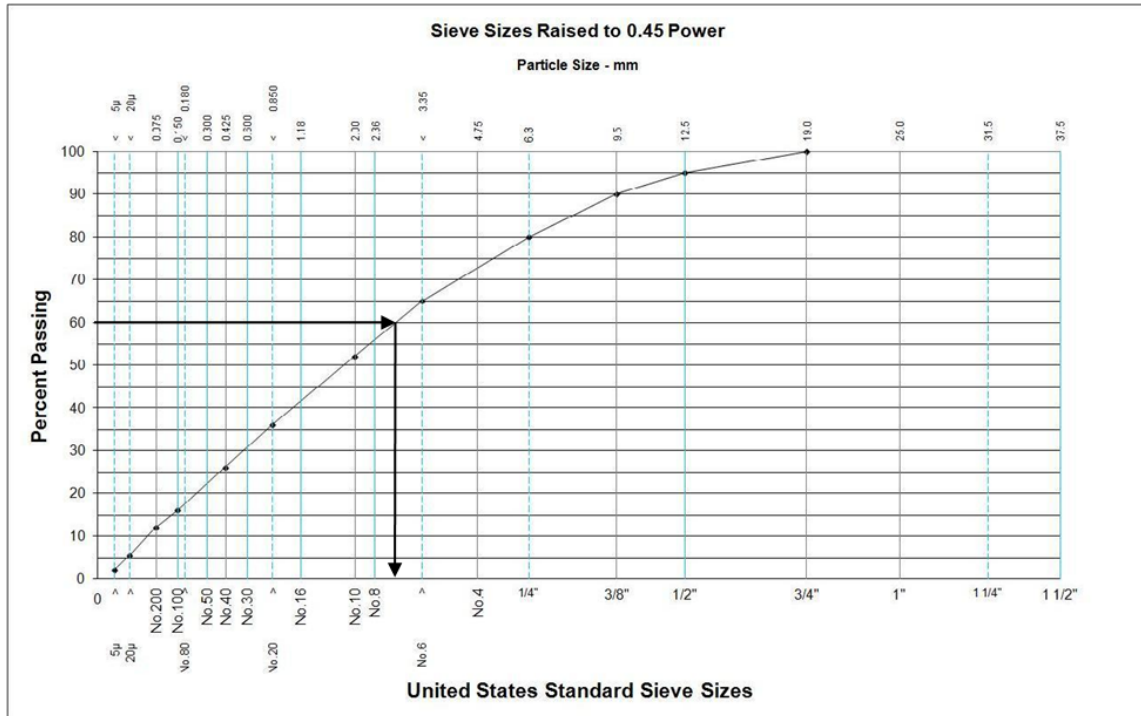

Figure S.2 Gradation Plot

Table S.1 Nominal Dimensions of Common Sieves

US Nominal Sieve Size	Size (mm)	US Nominal Sieve Size	Size (mm)
2"	50.0	No. 8	2.36
1-1/2"	37.5	No. 10	2.00
1-1/4"	31.5	No. 16	1.18
1"	25.0	No. 20	850 μm
3/4"	19.0	No. 30	600 μm
1/2"	12.5	No. 40	425 μm
3/8"	9.5	No. 50	300 μm
1/4"	6.3	No. 80	180 μm
No. 4	4.75	No. 100	150 μm
No.6	3.35	No. 200	75 μm

S.2.4 Unit Weight, Water Content, and Specific Gravity

Maximum dry density ($\gamma_{dry \ max}$) and optimum gravimetric moisture content (w_{opt}) of the compacted unbound material is measured using AASHTO T 180 for bases or AASHTO T 99 for other layers. Specific gravity (G_s) is a direct measurement using AASHTO T 100 (performed in conjunction with consolidation tests - AASHTO T 180 for unbound bases or AASHTO T 99 for other unbound layers).

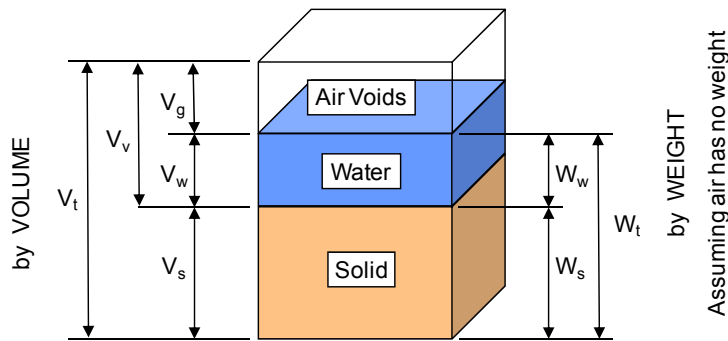

Figure S.3 Soil Sample Constituents

Unit Weight is:

$$\gamma = \frac{W_t}{V_t} = \frac{W_w + W_s}{V_g + V_w + V_s} \quad \text{Eq. S.1}$$

Dry Density (mass) is:

$$\gamma_{dry} = \frac{W_s}{V_t} = \frac{W_s}{V_g + V_w + V_s} \quad \text{Eq. S.2}$$

In the consolidation (compaction) test the dry density cannot be measured directly, what are measured are the bulk density and the moisture content for a given effort of compaction.

Bulk Density or oven-dry unit mass is:

$$\gamma_{bulk} = \frac{W_s + W_w}{V_t} = \frac{W_t}{V_t(1+w)} = \frac{\gamma}{1+w} = \frac{\frac{W_t}{V_t}}{\left(1 + \frac{W_w}{W_s}\right)} \quad \text{Eq. S.3}$$

The maximum dry unit weight and optimum water content are obtained by graphing as shown in **Figure S.4 Plot of Maximum Dry Unit Weight and Optimum Water Content**.

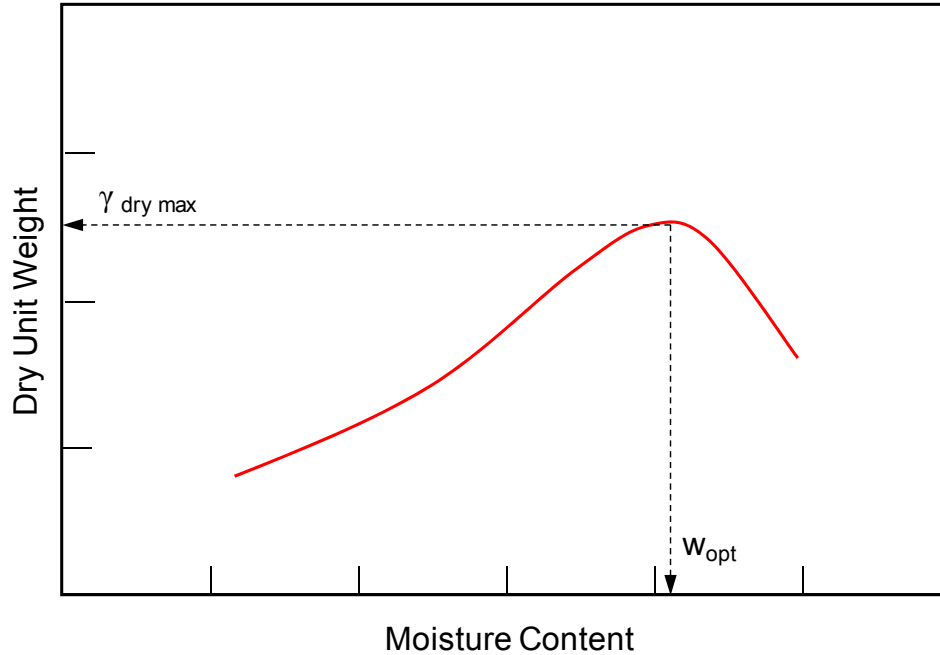

Figure S.4 Plot of Maximum Dry Unit Weight and Optimum Water Content

Specific Gravity is:

$$G_s = \frac{\gamma_s}{\gamma_w} = \frac{\frac{W_s}{V_s}}{\gamma_w} = \frac{\gamma_s}{62.4}$$

Eq. S.4

Where:

- γ = Unit Weight (density), pcf
- γ_{dry} = Dry Density, pcf
- γ_{bulk} = Bulk Density, pcf
- $\gamma_{dry\ max}$ = Maximum dry unit weight, pcf
- G_s = Specific Gravity (oven dry)
- W_t = total weight
- W_w = weight of water
- W_s = weight of solids
- V_t = total volume
- V_v = volume of voids
- V_g = volume of air (gas)
- V_w = volume of water
- V_s = volume of solids
- w = water content
- w_{opt} = optimum water content
- γ_s = density of solid constituents
- γ_w = 62.4 pcf at 4 °C

S.2.5 Pavement Materials Chemistry

S.2.5.1 Periodic Table

The periodic table is a tabular method of displaying the 118 chemical elements. Elements are listed from left to right as the atomic number increases. The atomic number identifies the number of protons in the nucleus of each element. Elements are grouped in columns, because they tend to show patterns in their atomic radius, ionization energy, and electronegativity. As you move down a group the atomic radii increases, because the additional electrons per element fill the energy levels and move farther from the nucleus. The increasing distance decreases the ionization energy, the energy required to remove an electron from the atom, as well as decreases the atom's electronegativity, which is the force exerted on the electrons by the nucleus. Elements in the same period or row show trends in [atomic radius](#), [ionization energy](#), [electron affinity](#), and [electronegativity](#). Within a period moving to the right, the atomic radii usually decreases, because each successive element adds a proton and electron, which creates a greater force drawing the electron closer to the nucleus. This decrease in atomic radius also causes the ionization energy and electronegativity to increase the more tightly bound an element becomes.

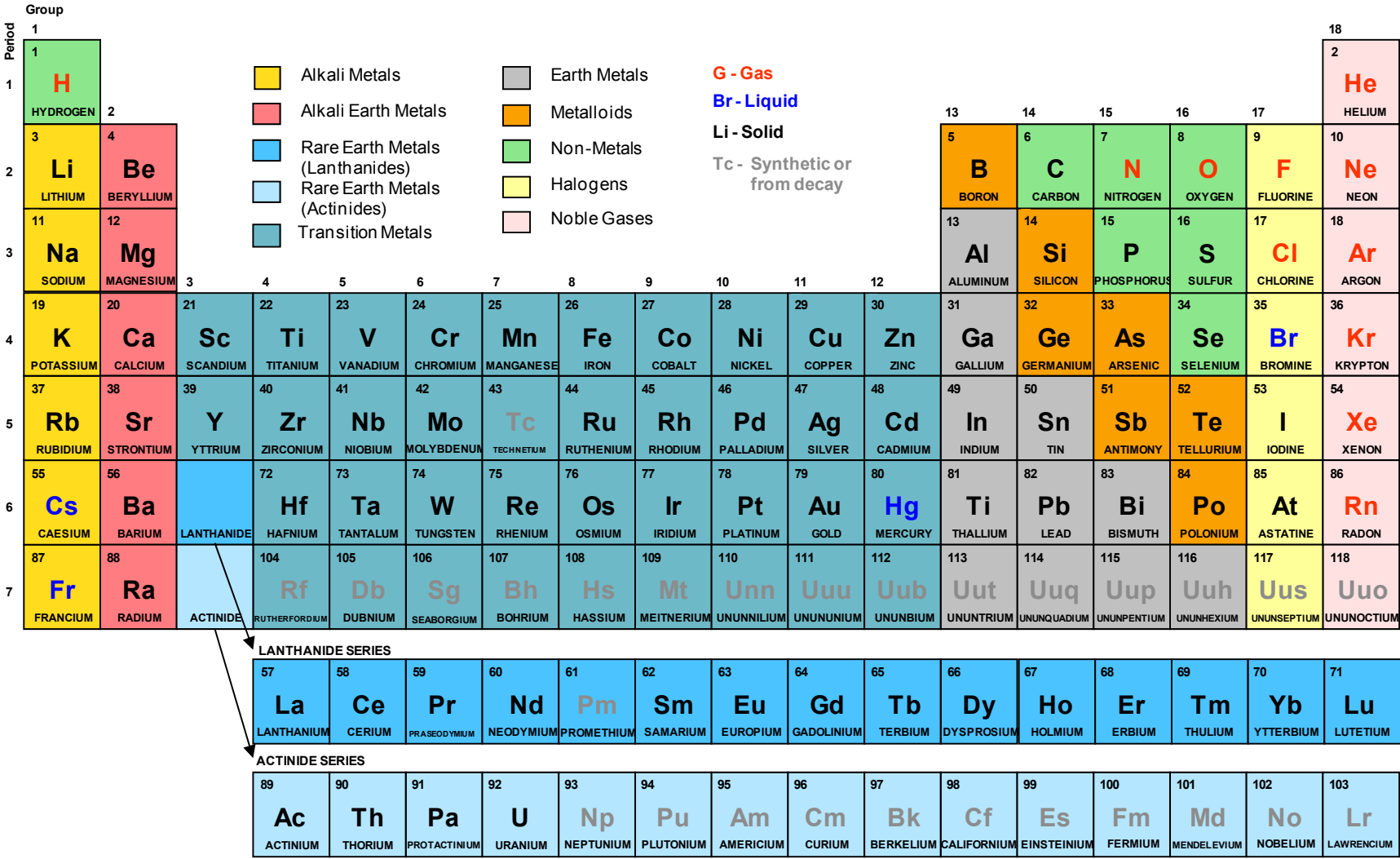

Figure S.5 Periodic Table

S.2.5.2 pH Scale

Water (H₂O) is a substance that can share hydrogen ions. The cohesive force that holds water together can also cause the exchange of hydrogen ions between molecules. The water molecule acts like a magnet with a positive and negative side, this charge can prove to be greater than the hydrogen bond between the oxygen and hydrogen atom causing the hydrogen to join the adjacent molecule (19). This process can be seen molecularly **Figure S.6 Dissociation of Water** and is expressed chemically in **Eq. S.5**.

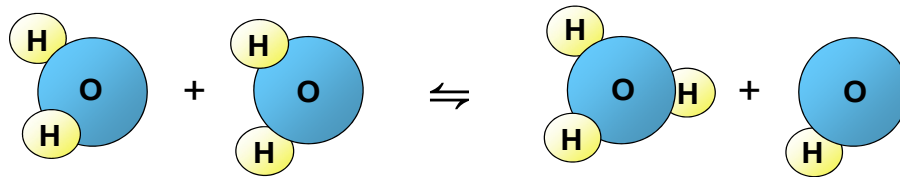
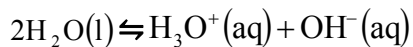

Figure S.6 Dissociation of Water



Eq. S.5

The pH of a solution is the negative logarithmic expression of the number of H⁺ ions in a solution. When this is applied to water with equal amounts of H⁺ and OH⁻ ions the concentration of H⁺ will be 0.00000001, the pH is then expressed as $-\log 10^{-7} = 7$. From the neutral water solution of 7 the pH scale ranges from 0 to 14, zero is the most acidic value and 14 is the most basic or alkaline.

An acid can be defined as a proton donor, a chemical that increases the concentration of hydronium ions [H₃O⁺] or [H⁺] in an aqueous solution. Conversely, we can define a base as a proton acceptor, a chemical that reduces the concentration of hydronium ions and increases the concentration of hydroxide ions [OH⁻] (18).

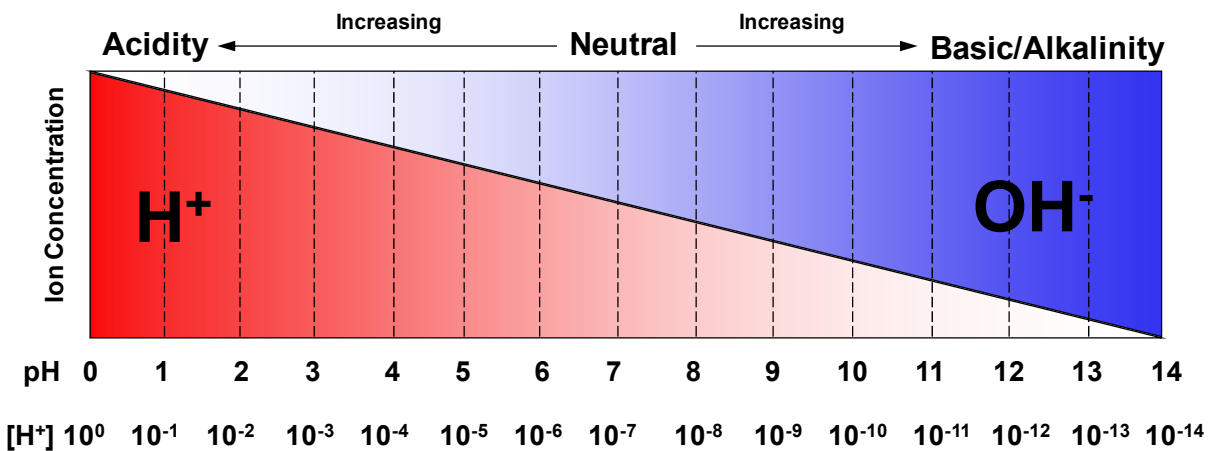

Figure S.7 pH Scale

S.2.6 Elastic Modulus

An Elastic Modulus (E) or Young's Modulus can be determined for any solid material and represents a constant ratio of stress over strain (a stiffness) below the proportional limit:

$$E = \frac{\sigma}{\epsilon} \quad \text{Eq. S.6}$$

Where:

E = Elastic Modulus

σ = stress =

$$\frac{\text{Load } P}{\text{Area } A} \quad \text{Eq. S.7}$$

ϵ = strain =

$$\frac{\text{Change in Length } \Delta L}{\text{Original Length } L_0} \quad \text{Eq. S.8}$$

A material is elastic if it is able to return to its original shape or size immediately after being stretched or squeezed. Almost all materials are elastic to some degree as long as the applied load does not cause it to deform permanently. The modulus of elasticity for a material is basically the slope of its stress-strain plot within the elastic range.

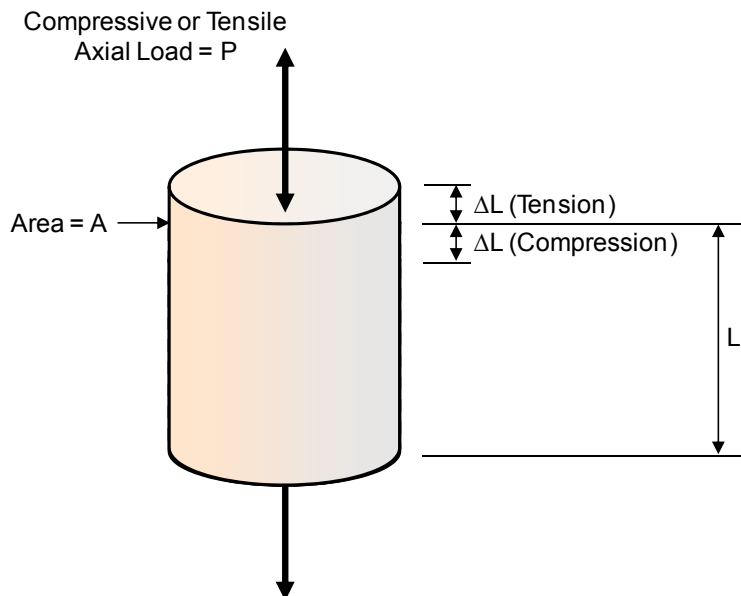

Figure S.8 Elastic Modulus

S.2.6.1 Concrete Modulus of Elasticity

The static Modulus of Elasticity (E_c) of concrete in compression is determined by ASTM C 469. The chord modulus is the slope of the chord drawn between any two specified points on the stress-strain curve below the elastic limit of the material.

$$E_c = \frac{(\sigma_2 - \sigma_1)}{(\varepsilon_2 - 0.000050)} \quad \text{Eq. S.9}$$

Where:

E_c = Chord Modulus of Elasticity, psi

σ_2 = stress corresponding to 40% of ultimate load

σ_1 = stress corresponding to a longitudinal strain, ε_1 , of 50 millionths, psi

ε_2 = longitudinal strain produced by stress σ_2

S.2.6.2 Asphalt Dynamic Modulus $|E^*|$

The complex Dynamic Modulus ($|E^*|$) of asphalt is a time-temperature dependent function. The $|E^*|$ properties are known to be a function of temperature, rate of loading, age, and mixture characteristics such as binder stiffness, aggregate gradation, binder content, and air voids. To account for temperature and rate of loading effects the analysis levels will be determined from a master curve constructed at a reference temperature of 20°C (70°F) (5). The description below is for developing the master curve and shift factors of the original condition without introducing aged binder viscosity and additional calculated shift factors using appropriate viscosity.

$|E^*|$ is the absolute value of the complex modulus calculated by dividing by the maximum (peak to peak) stress by the recoverable (peak to peak) axial strain for a material subjected to a sinusoidal loading.

A sinusoidal (Haversine) axial compressive stress is applied to a specimen of asphalt concrete at a given temperature and loading frequency. The applied stress and the resulting recoverable axial strain response of the specimen is measured and used to calculate the $|E^*|$ and phase angle. See **Eq. S.10** for $|E^*|$ general equation and **Eq. S.11** for phase angle equation. Dynamic modulus values are measured over a range of temperatures and load frequencies at each temperature. See **Table S.2 Recommended Testing Temperatures and Loading Frequencies**. Each test specimen is individually tested for each of the combinations. The table shows a reduced temperature and loading frequency as recommend. See **Figure S.9 Dynamic Modulus Stress-Strain Cycles** for time lag response. See **Figure S.10 $|E^*|$ vs. Log Loading Time Plot at Each Temperature**. To compare test results of various mixes, it is important to normalize one of these variables. 20°C (70°F) is the variable that is normalized. Test values for each test condition at different temperatures are plotted and shifted relative to the time of loading. See **Figure S.11 Shifting of Various Mixture Plots**. These shifted plots of various mixture curves can be aligned to form a single master curve (26). See **Figure S.12 Dynamic Modulus $|E^*|$ Master Curve**. The $|E^*|$ is determined by AASHTO PP 61-09 and PP 62-09 test methods (27 and 28).

Table S.2 Recommended Testing Temperatures and Loading Frequencies

PG 58-XX and Softer		PG 64-XX and PG 70-XX		PG 76-XX and Stiffer	
Temperature, °C	Loading Frequencies, Hz	Temperature, °C	Loading Frequencies, Hz	Temperature, °C	Loading Frequencies, Hz
4	10, 1, 0.1	4	10, 1, 0.1	4	10, 1, 0.1
20	10, 1, 0.1	20	10, 1, 0.1	20	10, 1, 0.1
35	10, 1, 0.1, 0.01	40	10, 1, 0.1, 0.01	45	10, 1, 0.1, 0.01

$$|E^*| = \frac{\sigma_o}{\epsilon_o}$$

Eq. S.10

Where:

$|E^*|$ = Dynamic Modulus

σ_o = average peak-to-peak stress amplitude, psi

ϵ_o = average peak-to-peak strain amplitude, in/in, that coincides with time lag (phase angle)

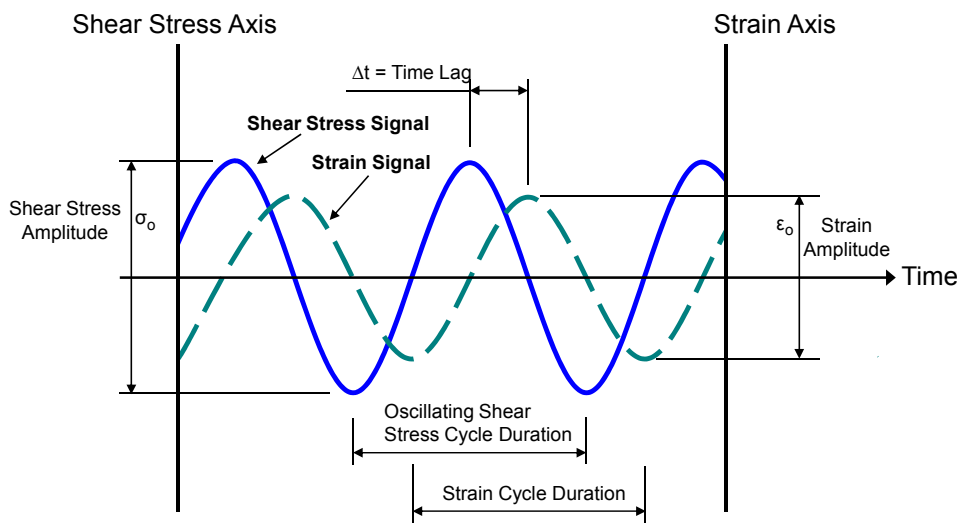

Figure S.9 Dynamic Modulus Stress-Strain Cycles

The phase angle \emptyset is calculated for each test condition and is:

$$\emptyset = 2\pi f \Delta t$$

Eq. S.11

Where:

\emptyset = phase angle, rad

f = frequency, Hz

Δt = time lag between stress and strain, sec.

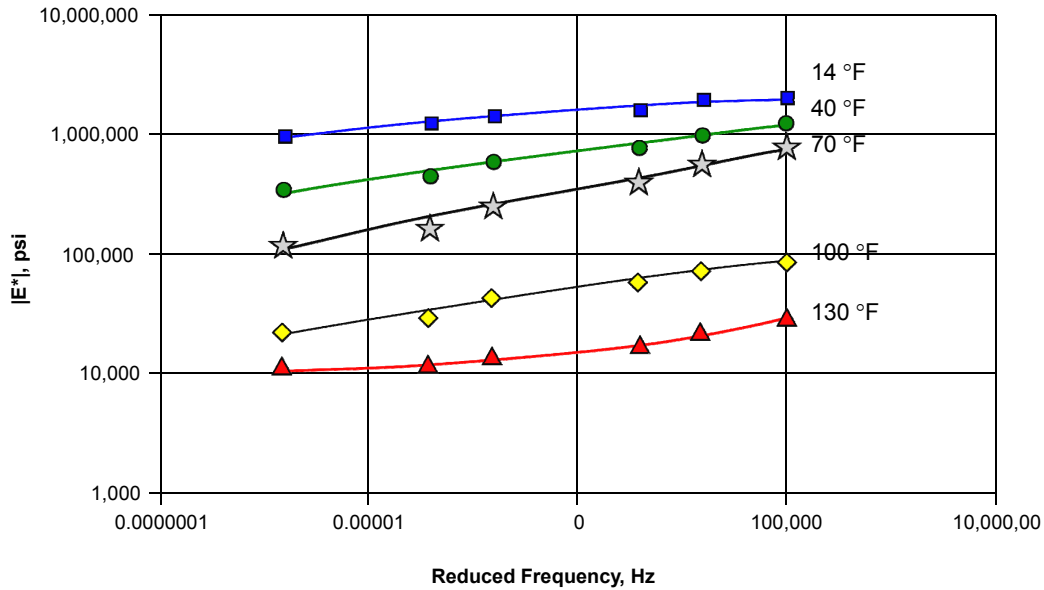

Figure S.10 |E*| vs. Log Loading Time Plot at Each Temperature

The |E*| master curve can be represented by a sigmoidal function as shown (27):

$$\log|E^*| = \delta + \frac{(\text{Max} - \delta)}{1 + e^{\beta + \gamma \left\{ \log f + \frac{\Delta E_\alpha}{19.14714} \left[\left(\frac{1}{T} \right) - \left(\frac{1}{T_r} \right) \right] \right\}}}$$

Eq. S.12

Where:

- |E*| = Dynamic Modulus, psi
- δ , β , and γ = fitting parameters
- Max = limiting maximum modulus, psi
- f = loading frequency at the test temperature, Hz
- E_α = energy (treated as a fitting parameter)
- T = test temperature, °K
- T_r = reference temperature, °K

Fitting parameters δ and α depend on aggregate gradation, binder content, and air void content. Fitting parameters β and γ depend on the characteristics of the asphalt binder and the magnitude of δ and α . The sigmoidal function describes the time dependency of the modulus at the reference temperature.

The maximum limiting modulus is estimated from HMA volumetric properties and limiting binder modulus.

$$|E^*|_{\max} = P_c \left[4,200,000 \left(1 - \frac{\text{VMA}}{100} \right) + 435,000 \left(\frac{\text{VFA} \times \text{VMA}}{10,000} \right) + \frac{1 - P_c}{\frac{1 - \frac{\text{VMA}}{100}}{4,200,000} + \frac{\text{VMA}}{435,000(\text{VFA})}} \right] \text{Eq. S.13}$$

Where:

$$P_c = \frac{\left[20 + \frac{435,000(\text{VFA})}{\text{VMA}} \right]^{0.58}}{650 + \left[\frac{435,000(\text{VFA})}{\text{VMA}} \right]^{0.58}} \text{Eq. S.14}$$

$|E^*|_{\max}$ = limiting maximum HMA dynamic modulus, psi

VMA = voids in the mineral aggregate, %

VFA = voids filled with asphalt, %

The shift factors describe the temperature dependency of the modulus.

Shift factors to align the various mixture curves to the master curve are shown in the general form as (27):

$$\log[\alpha(T)] = \frac{\Delta E_\alpha}{19.14714} \left(\frac{1}{T} - \frac{1}{T_r} \right) \text{Eq. S.15}$$

Where:

$\alpha(T)$ = shift factor at temperature (T)

ΔE_α = the activation energy (treated as a fitting parameter)

T = the test temperature, °K

T_r = the reference temperature, °K

A shift factor plot as a function of temperature for the mixtures is shown in **Figure S.13 Shift Factor Plot**.

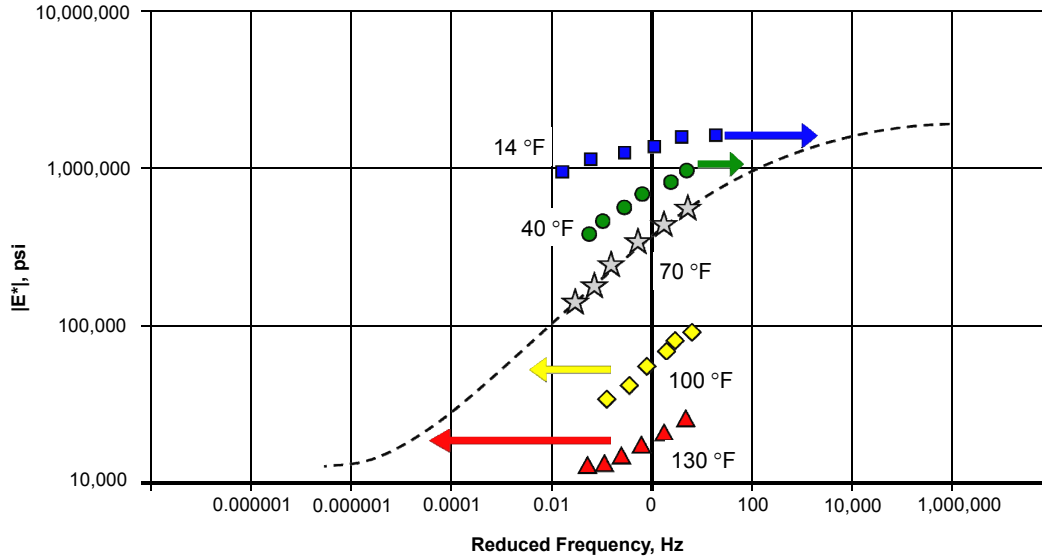

Figure S.11 Shifting of Various Mixture Plots

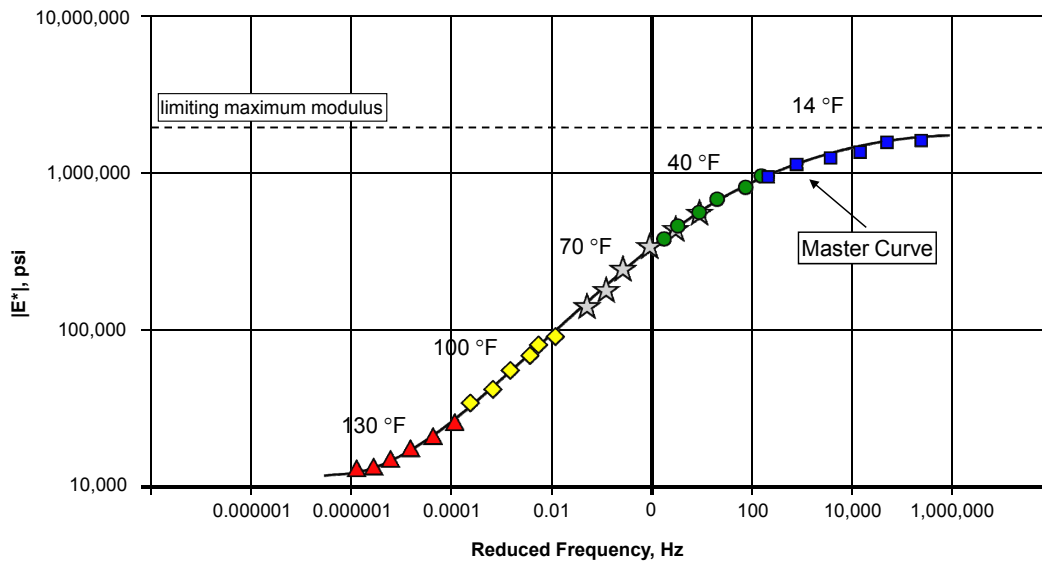

Figure S.12 Dynamic Modulus $|E^*|$ Master Curve

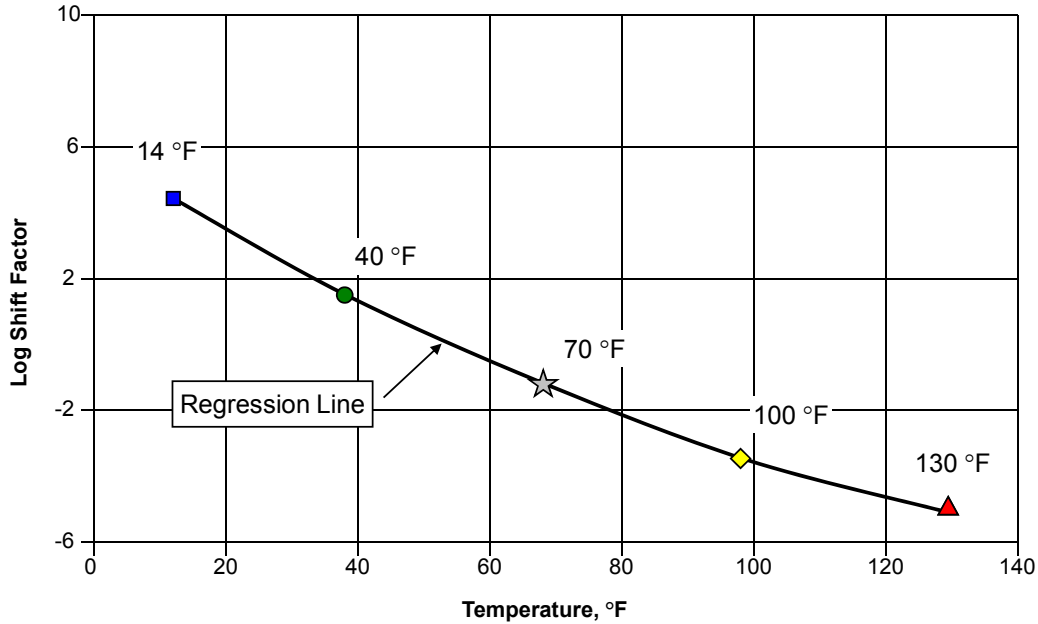

Figure S.13 Shift Factor Plot

S.2.7 Binder Complex Shear Modulus

The complex shear modulus, G^* is the ratio of peak shear stress to peak shear strain in dynamic (oscillatory) shear loading between a oscillating plate a fixed parallel plate. The test uses a sinusoidal waveform that operates at one cycle and is set at 10 radians/second or 1.59 Hz. The oscillating loading motion is a back and forth twisting motion with increasing and decreasing loading. Stress or strain imposed limits control the loading. The one cycle loading is a representative loading due to 55 mph traffic. If the material is elastic, then the phase lag is zero. G' represents this condition and is said to be the storage modulus. If the material is wholly viscous, then the phase lag is 90° out of phase. G'' represents the viscous modulus. G^* is the vector sum of G' and G'' . Various artificially aged specimens and/or in a series of temperature increments may be tested. The DSR test method is applicable to a temperature range of 40°F and above.

at peak angle in radians

$$G^* = \frac{\tau_{\max}}{\gamma_{\max}} \quad \text{Eq. S.16}$$

$$\tau_{\max} = \frac{2T_{\max}}{\pi r^3} \quad \text{Eq. S.17}$$

$$\gamma_{\max} = \frac{\theta_{\max}(r)}{h} \quad \text{Eq. S.18}$$

Where:

- G^* = Binder Complex Shear Modulus
- τ_{max} = maximum shear stress
- γ_{max} = maximum shear strain
- T_{max} = maximum applied torque
- r = radius of specimen
- θ_{max} = maximum rotation angle (radians)
- h = height of specimen

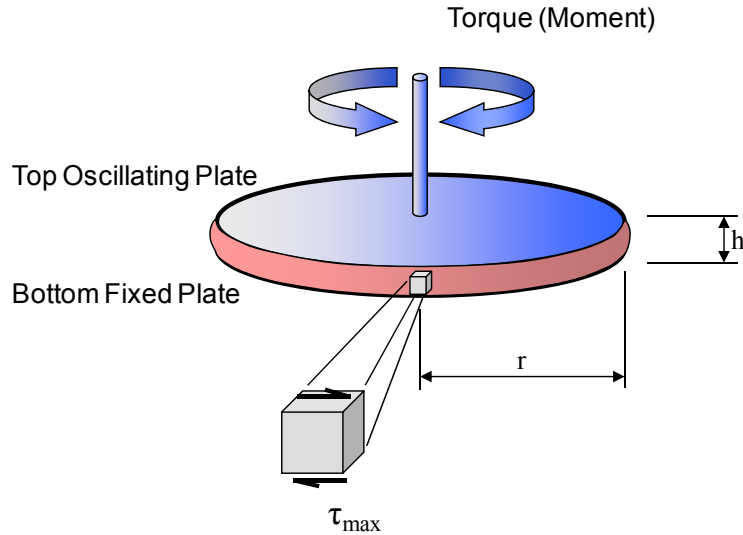

Figure S.14 Binder Complex Shear Modulus Specimen Loading

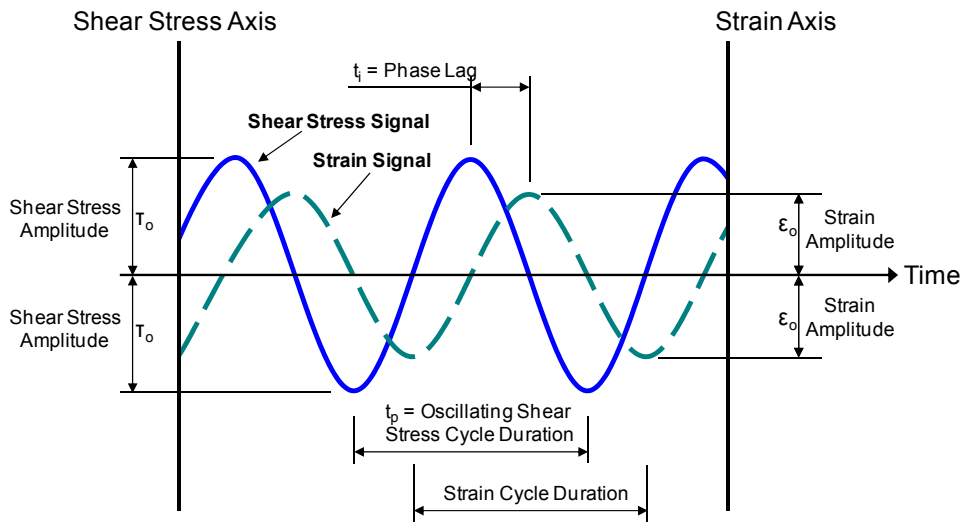

Figure S.15 Binder Complex Shear Modulus Shear-Strain Cycles

A relationship between binder viscosity and binder complex shear modulus (with binder phase angle) at each temperature increment of 40, 55, 70 (reference temperature), 85, 100, 115 and 130°F are obtained by:

$$\eta = \frac{G^*}{10} \left(\frac{1}{\sin \delta} \right)^{4.8628} \quad \text{Eq. S.19}$$

Where:

η = Viscosity
 G^* = binder complex shear modulus
 δ = binder phase angle

The regression parameters are found by using **Eq. S.20** by linear regression after log-log transformation of the viscosity data and log transformation of the temperature data:

$$\log \log \eta = A + VTS \log T_r \quad \text{Eq. S.20}$$

Where:

η = binder viscosity
 A, VTS = regression parameters
 T_r = temperature, degrees Rankin

S.2.8 Poisson's Ratio

The ratio of the lateral strain to the axial strain is known as Poisson's ratio, μ .

$$\mu = \frac{\epsilon_{\text{lateral}}}{\epsilon_{\text{axial}}} \quad \text{Eq. S.21}$$

Where:

μ = Poisson's ratio
 $\epsilon_{\text{lateral}}$ = strain in width or diameter =
 $\frac{\text{Change in Diameter}}{\text{Original Diameter}} = \frac{\Delta D}{D_o}$

Eq. S.22

ϵ_{axial} = strain in length =
 $\frac{\text{Change in Length}}{\text{Original Length}} = \frac{\Delta L}{L_o}$

Eq. S.23

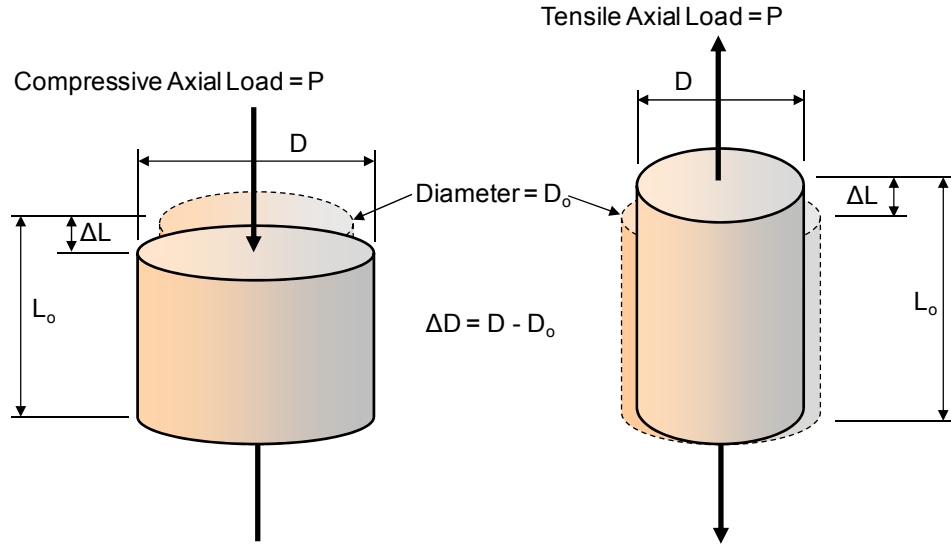

Figure S.16 Poisson's ratio

S.2.9 Coefficient of Lateral Pressure

The coefficient of lateral pressure, k_o , is the term used to express the ratio of the lateral earth pressure to the vertical earth pressure.

Cohesionless Materials:

$$k_o = \frac{\mu}{1-\mu} \quad \text{Eq. S.24}$$

Cohesive Materials:

$$k_o = 1 - \sin\phi \quad \text{Eq. S.25}$$

Where:

k_o = Coefficient of Lateral Pressure

μ = Poisson's ratio

ϕ = the effective angle of internal friction

S.2.10 Unconfined Compressive Strength

Unconfined compressive strength, f'_c is shown in **Eq. S.26**. The compressive strength of soil cement is determined by ASTM D 1633. The compressive strength for lean concrete and cement treated aggregate is determined by AASHTO T 22, lime stabilized soils are determined by ASTM D 5102, and lime-cement-flyash is determined by ASTM C 593.

$$f'_c = \frac{P}{A}$$

Eq. S.26

Where:

f'_c = Unconfined Compressive Strength, psi

P = maximum load

A = cross sectional area

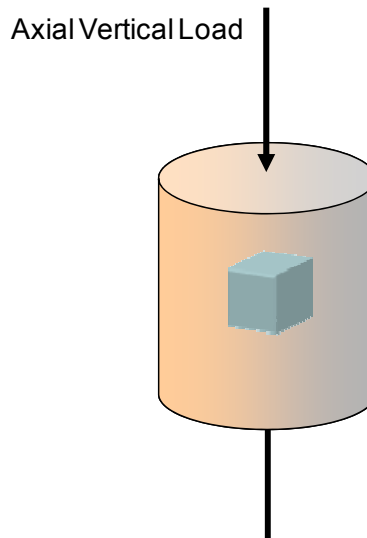

Figure S.17 Unconfined Compressive Strength

S.2.11 Modulus of Rupture

The Modulus of Rupture (MR) is maximum bending tensile stress at the surface of a rectangular beam at the instant of failure using a simply supported beam, loaded at the third points. The MR is a test conducted solely on portland cement concrete and similar chemically stabilized materials. The rupture point of a concrete beam is at the bottom. The classical formula is shown in **Eq. S.27**. The MR for lean concrete, cement treated aggregate, and lime-cement-flyash are determined by AASHTO T 97. Soil cement is determined by ASTM D 1635.

$$\sigma_{b,max} = \frac{M_{max}c}{I_c}$$

Eq. S.27

Where:

M_{max} = maximum moment

c = distance from neutral axis to the extreme fiber

I_c = centroidal area moment of inertia

If the fracture occurs within the middle third of the span length then MR is calculated by:

$$S'_c = \frac{Pl}{bd^2} \quad \text{Eq. S.28}$$

If the fracture occurs outside the middle third of the span length by not more than 5% of the span length the MR is calculated by:

$$S'_c = \frac{3Pa}{bd^2} \quad \text{Eq. S.29}$$

Where:

S'_c = Modulus of Rupture, psi

P = maximum applied load

l = span length

b = average width of specimen

d = average depth of specimen

a = average distance between line of fracture and the nearest support on the tension surface of the beam

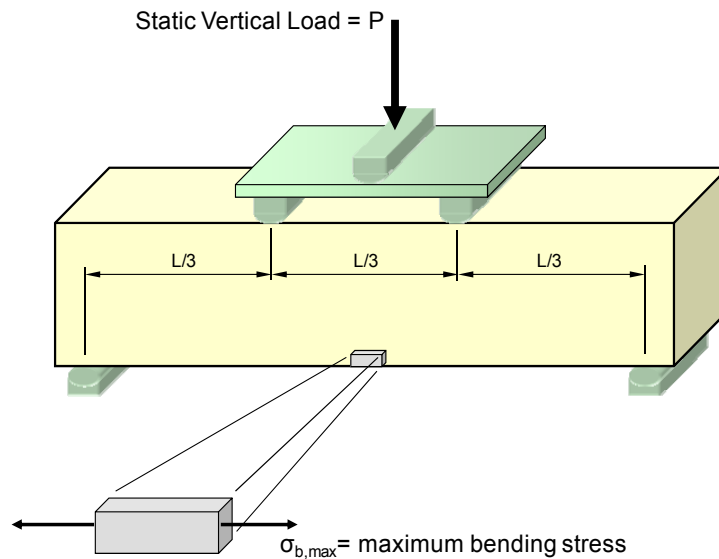

Figure S.18 3-Point Beam Loading for Flexural Strength

S.2.12 Tensile Creep and Strength for Hot Mix Asphalt

The tensile creep is determined by applying a static load along the diametral axis of a specimen. The horizontal and vertical deformations measured near the center of the specimen are used to calculate tensile creep compliance as a function of time. The Creep Compliance, $D(t)$ is a time-dependent strain divided by an applied stress. The Tensile Strength, S_t is determined immediately after the tensile creep (or separately) by applying a constant rate of vertical

deformation (loading movement) to failure. AASHTO T 322 - *Determining the Creep Compliance and Strength of Hot-Mix Asphalt (HMA) Using the Indirect Tensile Test Device*, using 6" diameter by 2" height molds, determines Creep Compliance and Tensile Strength. CDOT uses CP-L 5109 - *Resistance of Compacted Bituminous Mixture to Moisture Induced Damage* to determine the tensile strength using 4" diameter by 2.5" height molds for normal aggregate mixtures.

Creep Compliance is:

$$D(t) = \frac{\epsilon_t}{\sigma} \quad \text{Eq. S.30}$$

Where:

$D(t)$ = Creep Compliance at time, t

ϵ_t = time-dependent strain

σ = applied stress

Tensile Strength is:

$$S_t = \frac{2P}{\pi t D} \quad \text{Eq. S.31}$$

Where:

S_t = Tensile Strength, psi

P = maximum load

t = specimen height

D = specimen diameter

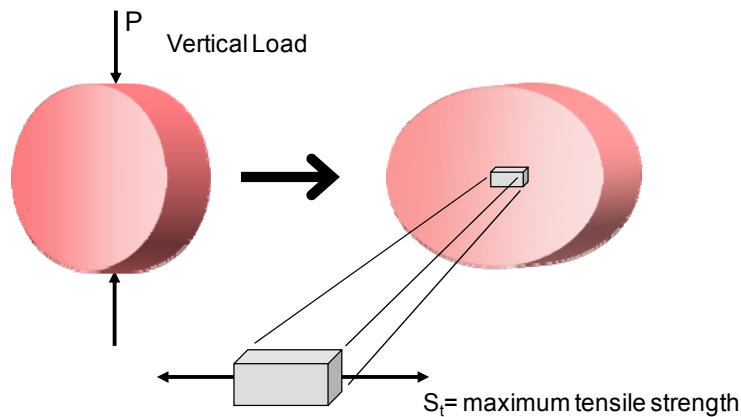

Figure S.19 Indirect Tensile Strength

S.3 Resilient Modulus of Conventional Unbound Aggregate Base, Subbase, Subgrade, and Rigid Layer

Figure S.20 Distribution of Wheel Load to Subgrade Soil (M_R) is a restatement of **Figure 2.2** in **CHAPTER 2**. The subgrade resilient modulus is used for the support of pavement structure in flexible pavements. The graphical representation is the traditional way to explain the interaction of subgrade reaction to a moving wheel load. As the wheel load moves toward an area of concern, the subgrade reacts with a larger reaction. When the wheel loading moves away the subgrade reaction is less. That variable reaction is the engineering property Resilient Modulus. Critical locations in the layers have been defined for the Mechanistic-Empirical Design. Refer to **Figure S.21 Critical Stress/Strain Locations for Bases, Subbases, Subgrade, and Rigid Layer**. CDOT has historically used the empirical design methodology using structural coefficients of base (a_2) and subbase (a_3) layers. The rigid layer was only accounted for when it was close to the pavement structure.

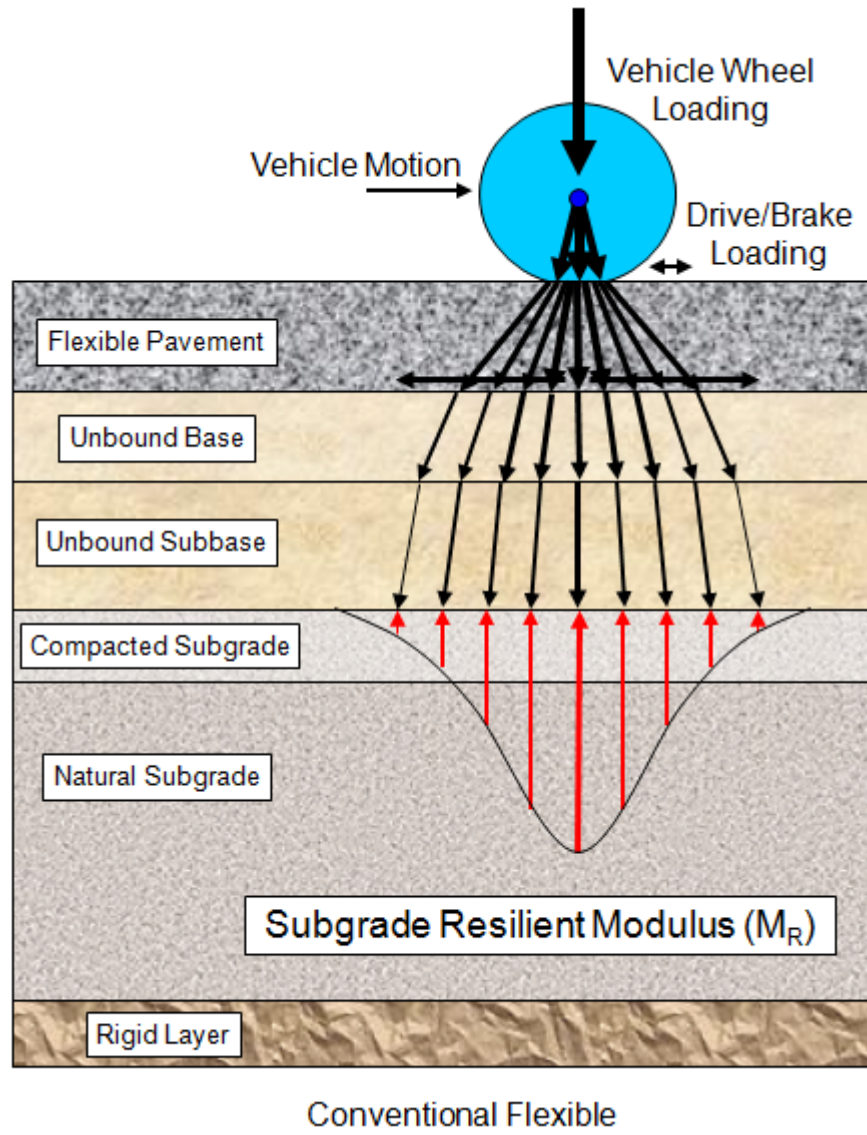

Figure S.20 Distribution of Wheel Load to Subgrade Soil (M_R)
(A restatement of Figure 2.2)

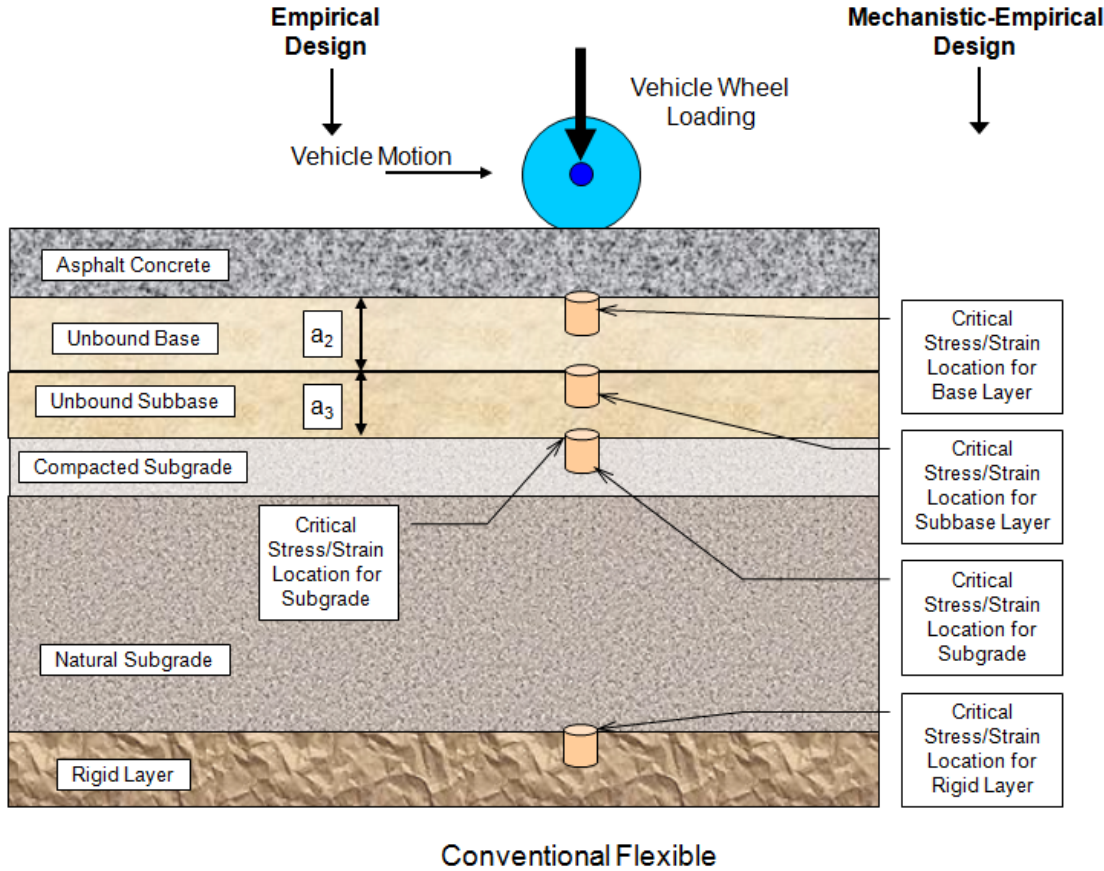

Figure S.21 Critical Stress/Strain Locations for Bases, Subbases, Subgrade, and Rigid Layer

S.3.1 Laboratory M_R Testing

The critical location for the subgrade is at the interface of the subbase and subgrade. The material subgrade element has the greatest loads at this location when the wheel loadings are directly above. Refer to **Figure S.30 Critical Stress Locations for Stabilized Subgrade**.

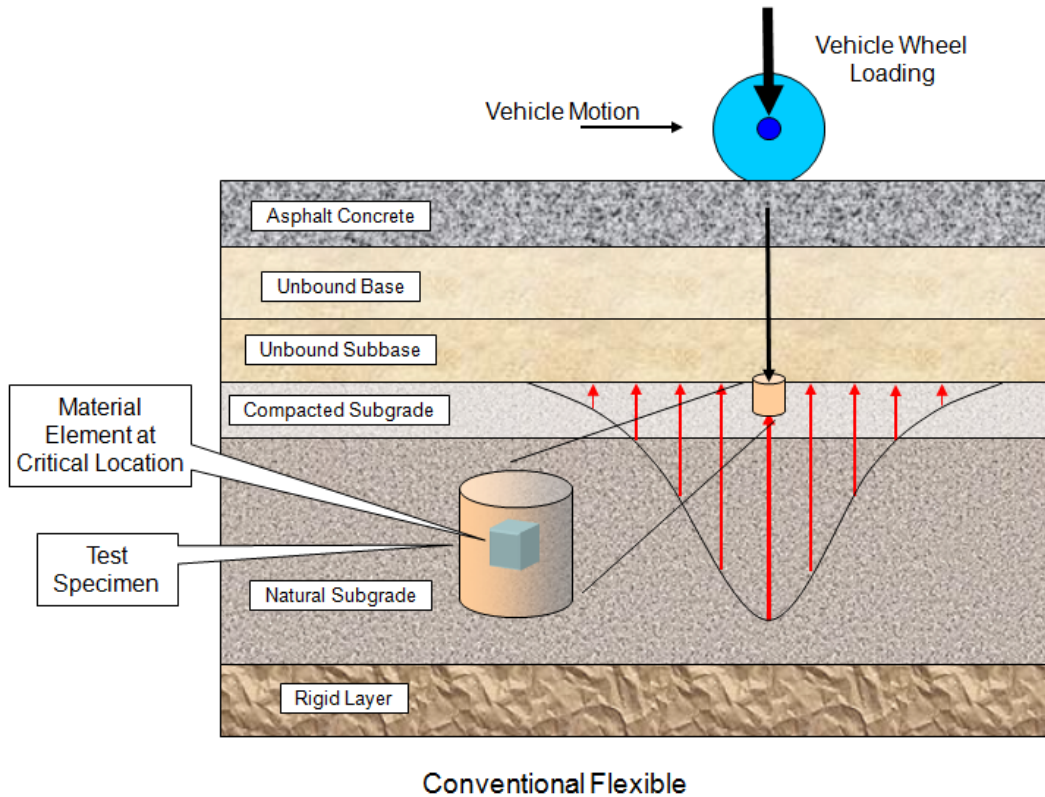

Figure S.22 Subgrade Material Element at Critical Location

While the modulus of elasticity is stress divided by strain for a slowly applied load, resilient modulus is stress divided by strain for rapidly applied loads – like those experienced by pavements.

Resilient Modulus is defined as the ratio of the amplitude of the repeated cyclical (resultant) axial stress to the amplitude of resultant (recoverable) axial strain.

$$M_R = \frac{\sigma_d}{\epsilon_r} \quad \text{Eq. S.32}$$

Where:

M_R = Resilient Modulus

σ_d = repeated wheel load stress (deviator stress) = applied load / cross sectional area

ϵ_r = recoverable strain = $\Delta L/L$ = recoverable deformation / gauge length

The test is similar to the standard triaxial compression test, except that the vertical stress is cycled at several levels to model wheel load intensity and duration typically encountered in pavements under a moving load. The confining pressure is also varied and sequenced through in conjunction with the varied axial loading to specified axial stresses. The purpose of this test procedure is to determine the elastic modulus value (stress-sensitive modulus) and by recognizing certain nonlinear characteristics for subgrade soils, untreated base and subbases, and

rigid foundation materials. The stress levels used are based on type of material within the pavement structure. The test specimen should be prepared to approximate the in situ density and moisture condition at or after construction (5). The test is to be performed in accordance with the latest version of AASHTO T 307. **Figure S.23 Resilient Modulus Test Specimen Stress State** and **Figure S.24 Resilient Modulus Test Specimen Loading** are graphical representations of applied stresses and concept of cyclical deformation applied deviator loading.

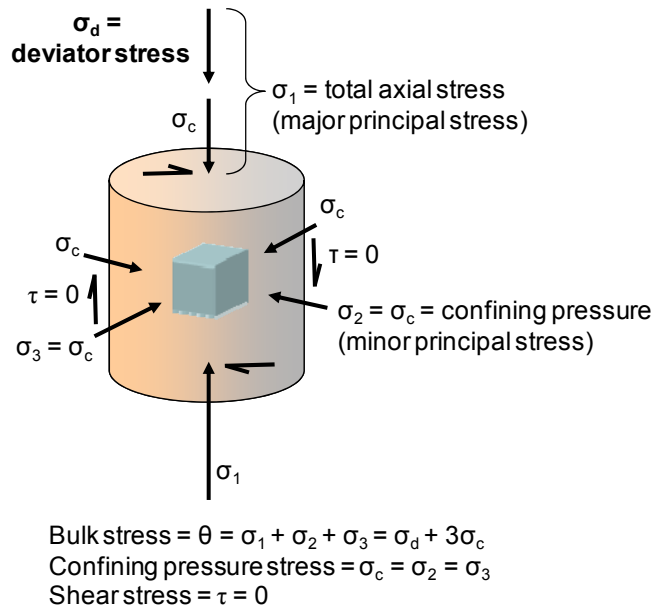

Figure S.23 Resilient Modulus Test Specimen Stress State

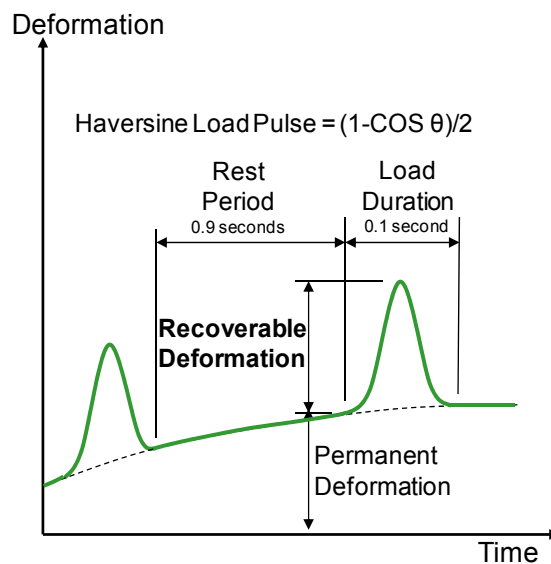

Figure S.24 Resilient Modulus Test Specimen Loading

Traditionally, the stress parameter used for sandy and gravelly materials, such as base courses, is the bulk stress.

$$\theta = \sigma_1 + \sigma_2 + \sigma_3 \quad \text{Eq. S.33}$$

For cohesive subgrade materials, the deviatoric stress is used.

$$\sigma_d = \sigma_1 - \sigma_3 \quad \text{Eq. S.34}$$

In recent years, the octahedral shear stress, which is a scalar invariant (it is essentially the root-mean-square deviatoric stress), has been used for cohesive materials instead of the deviatoric stress.

$$\tau_{\text{oct}} = \frac{1}{3} \sqrt{(\sigma_1 - \sigma_2)^2 + (\sigma_2 - \sigma_3)^2 + (\sigma_3 - \sigma_1)^2} \quad \text{Eq. S.35}$$

The major material characteristics associated with unbound materials are related to the fact that moduli of these materials may be highly influenced by the stress state (non-linear) and in-situ moisture content. As a general rule, coarse-grained materials have higher moduli as the state of confining stress is increased. In contrast, clayey materials tend to have a reduction in modulus as the deviatoric or octahedral stress component is increased. Thus, while both categories of unbound materials are stress dependent (non-linear), each behaves in an opposite direction as stress states are increased (5).

S.3.2 Field M_R Testing

An alternate procedure to determine the M_R value is to obtain a field value. Determination of an in-situ value is to backcalculate the M_R from deflection basins measured on the pavement's surface. The most widely used deflection testing devices are impulse loading devices. CDOT uses the Falling Weight Deflectometer (FWD) as a Nondestructive Test (NDT) method to obtain deflection measurements. The FWD device measures the pavement surface deflection and deflection basin of the loaded pavement, making it possible to obtain the pavement's response to load and the resulting curvature under load. A backcalculation software program analyzes the pavements response from the FWD data. Unfortunately, layered elastic moduli backcalculated from deflection basins and laboratory measured resilient modulus are not equal for a variety of reasons. The more important reason is that the uniform confining pressures and repeated vertical stresses used in the laboratory do not really simulate the actual confinement and stress state variation that occurs in a pavement layer under the FWD test load or wheel loading (9). Additional information on NDT is provided in **CHAPTER 5** and **APPENDIX C**.

S.3.3 Adjustment to Laboratory and Field M_R Values for Climate

The M_R is dependent upon the seasonal variation or climate. **Figure S.25 Resilient Modulus Seasonal Variation** is a graphical representation of the strength of unbound materials varies

with the seasons. Pavement designers should select the MR value that represents the average of the entire pavement foundation.

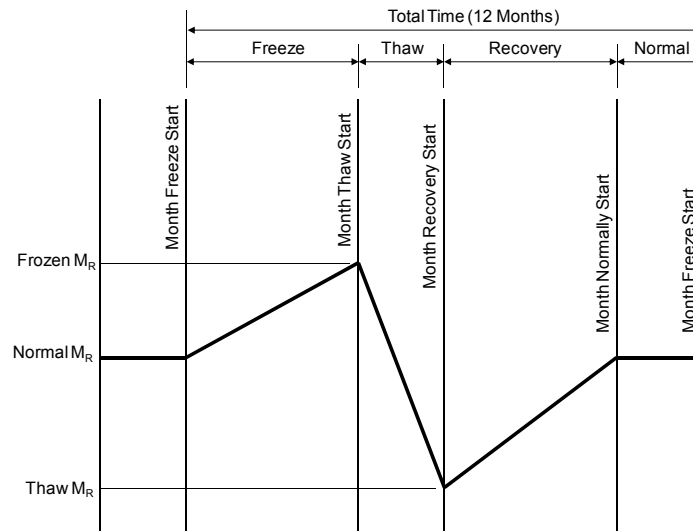

Figure S.25 Resilient Modulus Seasonal Variation

S.4 Resistance Value (R-value)

The Resistance Value (R-value) test is a material stiffness test. The test procedure expresses a material's resistance to deformation as a function of the ratio of transmitted lateral pressure to applied vertical pressure. The R-value is calculated from the ratio of the applied vertical pressure to the developed lateral pressure and is essentially a measure of the material's resistance to plastic flow. Another way the R-value may be expressed is it is a parameter representing the resistance to the horizontal deformation of a soil under compression at a given density and moisture content. The R-value test, while being time and cost effective, does not have a sound theoretical base and it does not reflect the dynamic behavior and properties of soils. The R-value test is static in nature and irrespective of the dynamic load repetition under actual traffic.

CDOT uses Hveem stabilometer equipment to measure strength properties of soils and bases. This equipment yields an index value called the R-value. The R-value to be used is determined in accordance with Colorado Procedure - Laboratory 3102, Determination of Resistance Value at Equilibrium, a modification of AASHTO T 190, Resistance Value and Expansion Pressure of Compacted Soils.

The inability of the Stabilometer R-value to realistically reflect the engineering properties of granular soils with less than 30% fines has contributed to its poor functional relationship to M_R in that range (7).

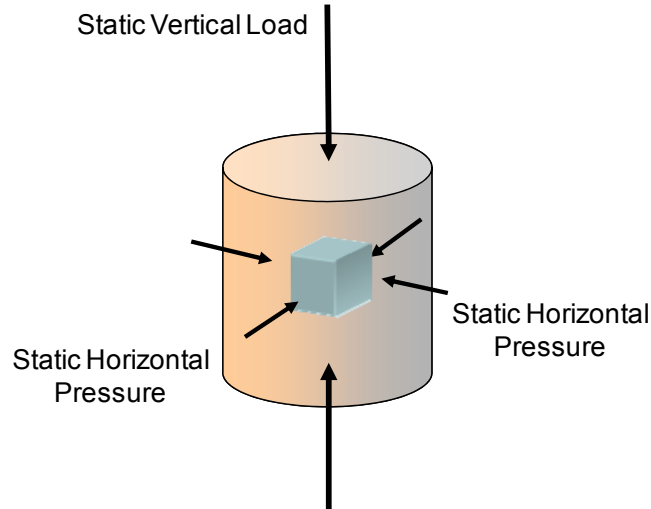

Figure S.26 Resistance R-value Test Specimen Loading State

S.5 M_R and R-value Correlation

A number of correlation equations have been developed. The Asphalt Institute (8) has related M_R to R-value repeated in the 1986 AASHTO Guide and expressed as follows (2)(5)(6):

$$M_R (\text{psi}) = A + B(R - \text{value})^2 \quad \text{Eq. S.36}$$

Where:

A = 772 to 1,155.

B = 396 to 555.

CDOT uses the correlation combining two equations:

$$S_1 = [(R - 5) / 11.29] + 3 \quad \text{Eq. S.37}$$

(Eq. 2.1 re-stated)

$$M_R = 10^{[(S_1 + 18.72) / 6.24]} \quad \text{Eq. S.38}$$

(Eq. 2.2 re-stated)

Where:

M_R = resilient modulus (psi).

S_1 = the soil support value.

R = the R-value obtained from the Hveem stabilometer.

Figure S.27 Correlation Plot between Resilient Modulus and R-value plots the correlations of roadbed soils. In the **Figure S.27 Correlation Plot between Resilient Modulus and R-value**, the CDOH/CDOT current design curve and the referenced 1986 AASHTO equations were based on the AASHTO Test Method T 274 to determine the M_R value. The plot is to show the relative relationship of each equation to each other.

Correlation between Resilient Modulus and R-values
(from 1986 AASHTO Design Guide and CDOH Current Design Curve)

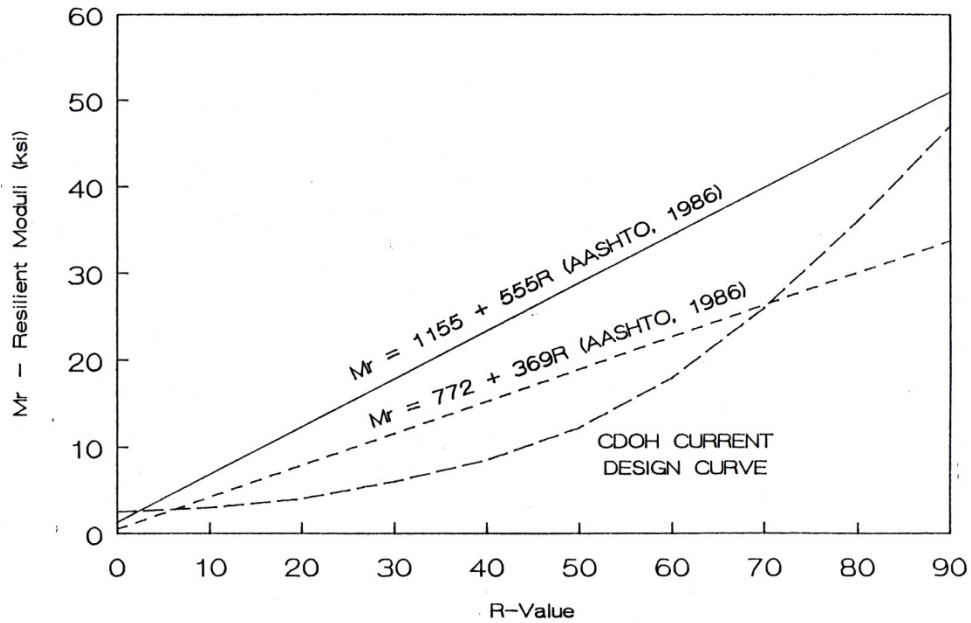

Figure S.27 Correlation Plot between Resilient Modulus and R-value
(*Resilient Properties of Colorado Soils*, pg 15, Figure 2.10, 1989 (6))

Table S.3 Comparisons of MR between Suggested NCHRP 1-40D Values and Colorado Soils with R-values is a comparison of M_R values. The test procedure was in accordance to AASHTO 307, Type 2 Material with a loading sequence in accordance with SHRP TP 46, Type 2 Material. Additional testing of Colorado soils with 2% and 4% above optimum moisture were conducted to simulate greater moisture contents if the in-situ soils have an increase in moisture. Generally, the strengths decreased, but not always. Colorado soils exhibit a lower M_R than the recommended values from publication NCHRP 1-37A, Table 2.2.51.

Table S.3 Comparisons of M_R between Suggested NCHRP 1-40D Values and Colorado Soils with R-values

Research Results Digest of NCHRP Project 1-40D (July 2006)				Soil Classification	Colorado Soils (Unpublished Data 7/12/2002)			
Flexible Subgrades		Rigid Subgrades			R-value	Optimum M_R	2% Over Optimum M_R	4% Over Optimum M_R
Opt. M_R (mean)	Opt. M_R (std dev)	Opt. M_R (mean)	Opt. M_R (std dev)					
29,650	15,315	13,228	3,083	A-1-a	-	-	-	
26,646	12,953	14,760	8,817	A-1-b	32	10,181	9,235	
21,344	13,206	14,002	5,730	A-2-4	50	7,842	5,161	3,917
					37	11,532	5,811	4,706
					40	10,750	7,588	7,591
					38	7,801	7,671	-
-	-	-	-	A-2-5	-	-	-	
20,556	12,297	16,610	6,620	A-2-6	35	8,024	4,664	4,343
					19	7,600	5,271	5,009
					45	8,405	5,954	5,495
					42	8,162	7,262	-
					37	7,814	5,561	4800*
					24	7,932	5,846	5210*
					49	10,425	9,698	8196*
16,250	4,598	-	-	A-2-7	13	7,972	4,702	3,511
					18	7,790	5,427	4,003
					29	8,193	5,558	5,221
					29	8,351	6,604	6,248
					9	11,704	8,825	7,990
					21	-	-	-
24,697	11,903	-	-	A-3	-	-	-	
16,429	12,296	17,763	8,889	A-4	19	6,413	5,233	4,736
					23	10,060	6,069	5,729
					49	7,583	7,087	6,311
					44	11,218	6,795	5794*
-	-	-	-	A-5	-	-	-	
14,508	9,106	14,109	5,935	A-6	21	7,463	3,428	2,665
					8	5,481	3,434	2,732
					12	5,162	3,960	2,953
					14	4,608	3,200	2,964
					10	13,367	4,491	3,007
					19	6,638	3,842	3,456
					10	7,663	4,244	3,515
					15	5,636	3,839	3,551
					17	7,135	4,631	3,821
					21	6,858	5,488	4,010
					14	6,378	4,817	4,234
					8	5,778	5,243	4,934
					40	17,436	7,438	5,870
					27	7,381	5,491	-
					17	8,220	6,724	-
13,004	13,065	7,984	3,132	A-7-5	26	11,229	9,406	5,238
11,666	7,868	13,218	322	A-7-6	6	4,256	2,730	1,785
					8	4,012	2,283	1,909
					10	5,282	2,646	1,960
					11	4,848	3,159	2,157
					5	6,450	3,922	2,331
					6	5,009	2,846	2,410
					6	5,411	3,745	2,577
					11	4,909	3,340	2,795
					15	9,699	4,861	3,018
					16	6,842	4,984	3,216
					29	8,873	4,516	3,308
					14	4,211	3,799	3,380
					7	7,740	5,956	4,107
					23	8,154	6,233	4,734
					27	7,992	6,552	5,210

S.6 Modulus of Subgrade Reaction (k-value)

Figure S.28 Distribution of Wheel Load to Subgrade Reaction (k-value) is a restatement of **Figure 2.5 Distribution of Wheel Load to Subgrade Reaction (k-value)** in **CHAPTER 2**. The k-value is used for the support of rigid pavement structures. The graphical representation is the traditional way to explain the interaction of subgrade reaction to a moving wheel load. As the wheel load moves toward an area of concern, the subgrade reacts with a slightly larger reaction and when the wheel loading moves away the subgrade reaction it is less. That variable reaction is the engineering property k-value. As an historical note, in the 1920's, Westergaard's work led to the concept of the modulus of subgrade reaction (k-value). Like elastic modulus, the k-value of a subgrade is an elastic constant which defines the material's stiffness or resistance to deformation. The value k actually represents the stiffness of an elastic spring.

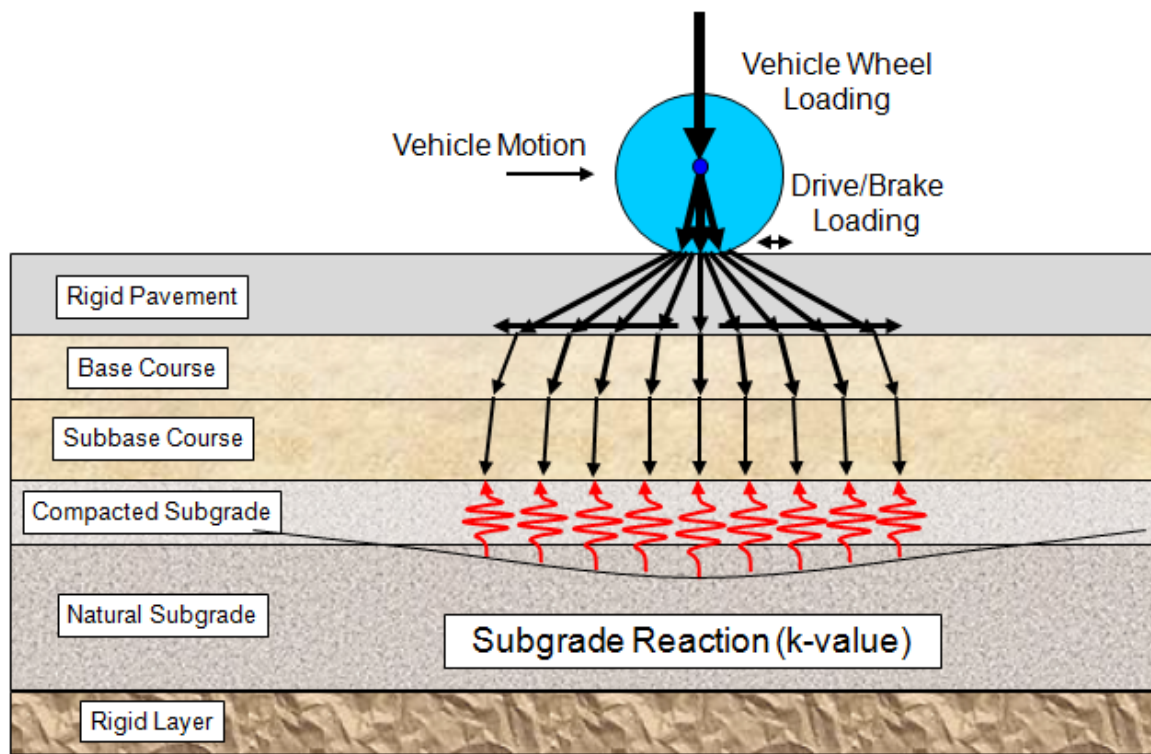

Figure S.28 Distribution of Wheel Load to Subgrade Reaction (k-value)
(A restatement of Figure 2.5)

S.6.1 Static Elastic k-value

The gross k-value was used in previous AASHTO pavement design guides. It not only represented the elastic deformation of the subgrade under a loading plate, but also substantial permanent deformation. The static elastic portion of the k-value is used as an input in the 1998 AASHTO Supplement guide. The k-value can be determined by field plate bearing tests (AASHTO T 221 or T 222) or correlation with other tests. There is no direct laboratory test

procedure for determining k-value. The k-value is measured or estimated on top of the finished roadbed soil or embankment upon which the base course and concrete slab is constructed. The classical equation for gross k-value is shown in **Eq. S.39**.

$$k\text{-value} = \frac{p}{\Delta} \quad \text{Eq. S.39}$$

Where:

k-value = modulus of subgrade reaction (spring constant)

p = applied pressure = $\frac{P \text{ (load)}}{\text{area of 30" diameter plate}}$

Δ = measured deflection

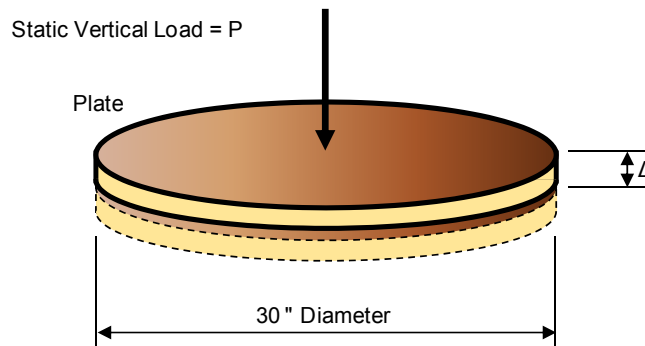

Figure S.29 Field Plate Load Test for k-value

S.6.2 Dynamic k-value

In the *AASHTO Guide for Mechanistic-Empirical Design, A Manual of Practice*, the effective k-value used is the effective dynamic k-value (24). Dynamic means a quick force is applied, such as a falling weight not an oscillating force. CDOT obtains the dynamic k-value from the Falling Weight Deflectometer (FWD) testing with a backcalculation procedure. There is an approximate relationship between static and dynamic k-value. The dynamic k-value may be converted to the initial static value by dividing the mean dynamic k-value by two to estimate the mean static k-value. CDOT uses this conversion because it does not perform the static plate bearing test.

FWD testing is normally performed on an existing surface course. In the Mechanistic-Empirical Design Guide software the dynamic k-value is used as an input for rehabilitation projects only. The dynamic k-value is not used as an input for new construction or reconstruction. One k-value is entered as an input in the rehabilitation calculation. The one k-value is the arithmetic mean of like backcalculated values. It is used as a foundation support value. The software then needs an additional value and that is the month the FWD is performed. The software uses an integrated climatic model to make seasonal adjustments to the support value. The software will backcalculate an effective single dynamic k-value for each month of the design analysis period for the existing unbound sublayers including the subgrade soil. The effective dynamic k-value is essentially the compressibility of underlying layers (i.e., unbound base, subbase, and subgrade layers) upon which the upper bound layers and existing HMA or PCC layer is constructed. The entered k-value will remain as an effective dynamic k-value for that month throughout the

analysis period, but the effective dynamic k-value for other months will vary according to moisture movement and frost depth in the pavement (24).

S.7 Bedrock

Table S.4 Poisson's Ratio for Bedrock

(Modified from Table 2.2.55. and Table 2.2.52., *Guide for Mechanistic-Empirical Design, Final Report*, NCHRP Project 1-37A, March 2004)

Material Description	μ (Range)	μ (Typical)
Solid, Massive, Continuous	0.10 to 0.25	0.15
Highly Fractured, Weathered	0.25 to 0.40	0.30
Rock fill	0.10 to 0.40	0.25

Table S.5 Elastic Modulus for Bedrock

(Modified from Table 2.2.54., *Guide for Mechanistic-Empirical Design, Final Report*, NCHRP Project 1-37A, March 2004)

Material Description	E (Range)	E (Typical)
Solid, Massive, Continuous	750,000 to 2,000,000	1,000,000
Highly Fractured, Weathered	250,000 to 1,000,000	50,000
Rock fill	Not Available	Not Available

S.8 Unbound Subgrade, Granular, and Subbase Materials

Table S.6 Poisson's Ratios for Subgrade, Unbound Granular and Subbase Materials
(Modified from Table 2.2.52., *Guide for Mechanistic-Empirical Design, Final Report*, NCHRP Project 1-37A, March 2004)

Material Description	μ (Range)	μ (Typical)
Clay (saturated)	0.4 to 0.5	0.45
Clay (unsaturated)	0.1 to 0.3	0.2
Sandy Clay	0.2 to 0.3	0.25
Silt	0.3 to 0.35	0.325
Dense Sand	0.2 to 0.4	0.3
Course-grained Sand	0.15	0.15
Fine-grained Sand	0.25	0.25
Clean gravel, gravel-sand mixtures	0.354 to 0.365	0.36

Table S.7 Coefficient of Lateral Pressure
(Table 2.2.53., *Guide for Mechanistic-Empirical Design, Final Report*, NCHRP Project 1-37A, March 2004)

Material Description	Angle of Internal Friction, ϕ	Coefficient of Lateral Pressure, k_o
Clean sound bedrock	35	0.495
Clean gravel, gravel-sand mixtures, and coarse sand	29 to 31	0.548 to 0.575
Clean fine to medium sand, silty medium to coarse sand, silty or clayey gravel	24 to 29	0.575 to 0.645
Clean fine sand, silty or clayey fine to medium sand	19 to 24	0.645 to 0.717
Fine sandy silt, non plastic silt	17 to 19	0.717 to 0.746
Very stiff and hard residual clay	22 to 26	0.617 to 0.673
Medium stiff and stiff clay and silty clay	19 to 19	0.717

S.9 Chemically Stabilized Subgrades and Bases

Critical locations in the layers have been defined for the Mechanistic-Empirical Design. Refer to **Figure S.30 Critical Stress Locations for Stabilized Subgrade** and **Figure S.31 Critical Stress/Strain Locations for Stabilized Bases**. CDOT has historically used the empirical design methodology using structural coefficients of stabilized subgrade and base layers and assigned a_2 for the structural coefficient. Lightly stabilized materials for construction expediency are not included. They could be considered as unbound materials for design purposes (5).

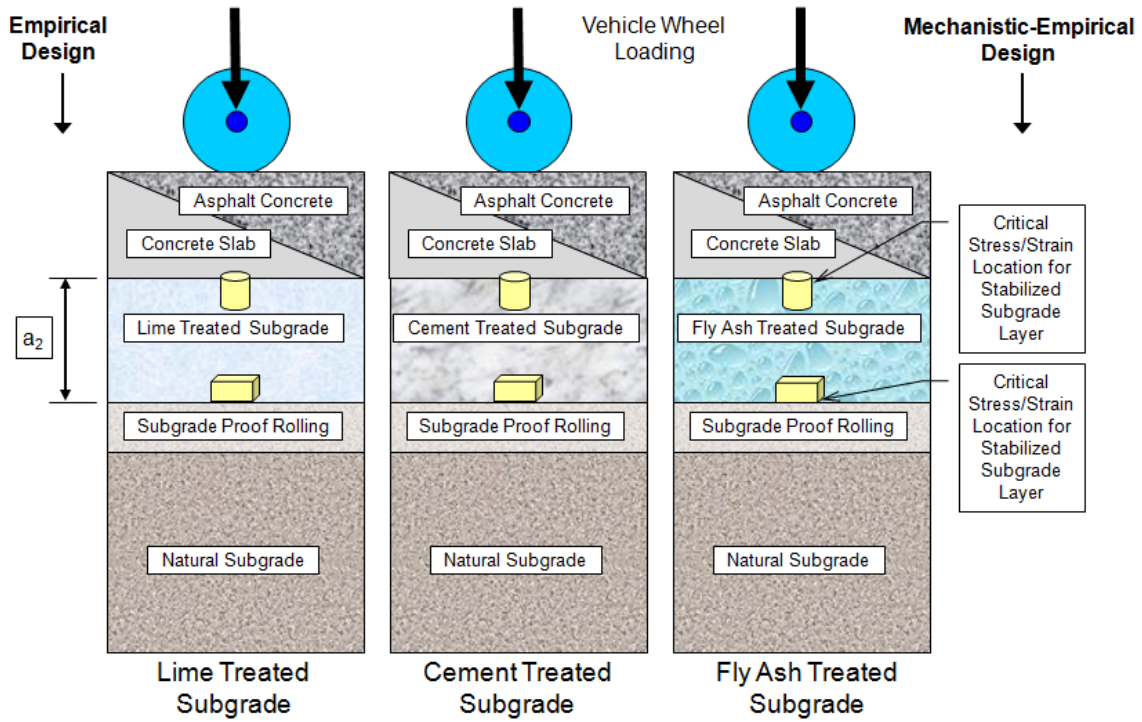

Figure S.30 Critical Stress Locations for Stabilized Subgrade

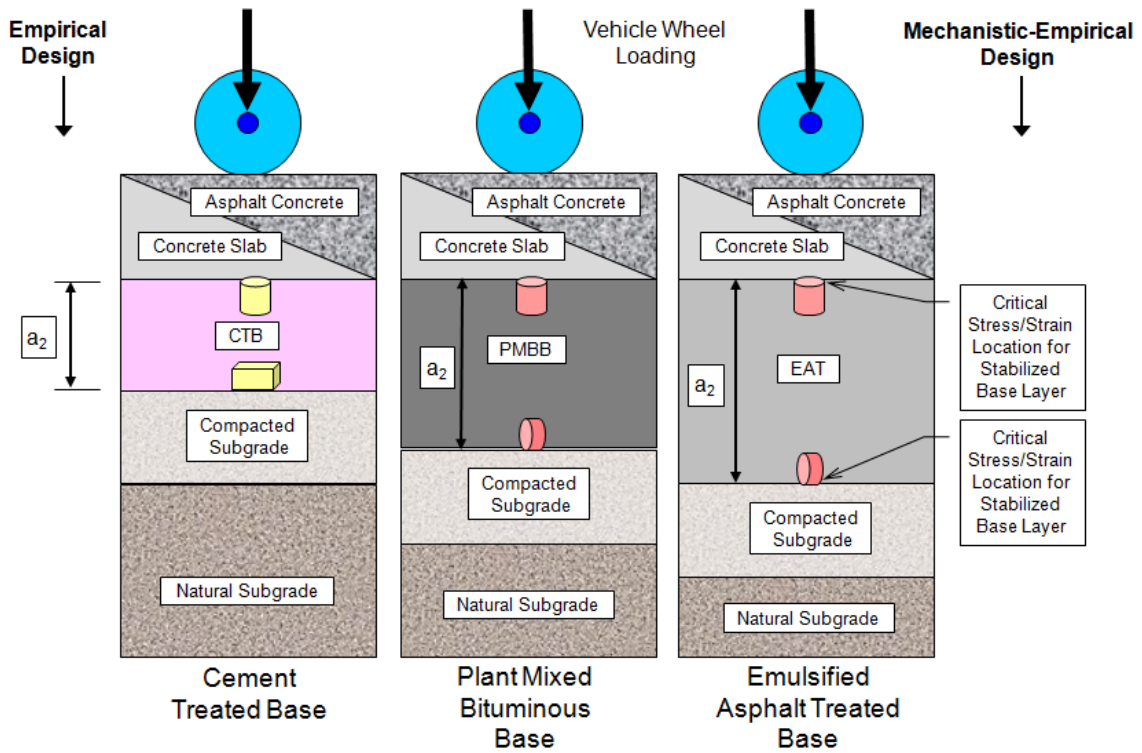

Figure S.31 Critical Stress/Strain Locations for Stabilized Bases

Table S.8 Poisson's Ratios for Chemically Stabilized Materials

(Table 2.2.48., *Guide for Mechanistic-Empirical Design, Final Report*, NCHRP Project 1-37A, March 2004)

Chemically Stabilized Materials	Poisson's ratio, μ
Cement Stabilized Aggregate (including lean concrete, cement treated, and permeable base)	0.1 to 0.2
Soil Cement	0.15 to 0.35
Lime-Fly Ash Materials	0.1 to 0.15
Lime Stabilized Soil	0.15 to 0.2

Table S.9 Poisson's Ratios for Asphalt Treated Permeable Base

(Table 2.2.16. and Table 2.2.17., *Guide for Mechanistic-Empirical Design, Final Report*, NCHRP Project 1-37A, March 2004)

Temperature, °F	μ (Range)	μ (Typical)
< 40 °F	0.30 to 0.40	0.35
40 °F to 100 °F	0.35 to 0.40	0.40
> 100 °F	0.40 to 0.48	0.45

Table S.10 Poisson's Ratios for Cold Mixed Asphalt and Cold Mixed Recycled Asphalt Materials

(Table 2.2.18. and Table 2.2.19., *Guide for Mechanistic-Empirical Design, Final Report*, NCHRP Project 1-37A, March 2004)

Temperature, °F	μ (Range)	μ (Typical)
< 40 °F	0.20 to 0.35	0.30
40 °F to 100 °F	0.30 to 0.45	0.35
> 100 °F	0.40 to 0.48	0.45

The critical location vertical loads for stabilized subgrades are at the interface of the surface course and stabilized subgrade or top of the stabilized subgrade. The material stabilized subgrade element has the greatest loads at this location when the wheel loadings are directly above. Strength testing may be performed to determine compressive strength (f'_c), unconfined compressive strength (q_u), modulus of elasticity (E), time-temperature dependent dynamic modulus (E^*), and resilient modulus (M_R).

The critical locations for flexural loading of stabilized subgrades are at the interface of the stabilized subgrade and non-stabilized subgrade or bottom of the stabilized subgrade. The

material stabilized subgrade element has the greatest flexural loads at this location when the wheel loadings are directly above. Flexural testing may be performed to determine flexural strength (M_R).

S.9.1 Top of Layer Properties for Stabilized Materials

Stabilized materials (chemically) are generally required to have some minimum compressive strength. Refer to **Table S.11 Minimum Unconfined Compressive Strengths for Stabilized Layers** for suggested minimum unconfined compressive strengths. 28-day values are used conservatively in design.

Table S.11 Minimum Unconfined Compressive Strengths for Stabilized Layers
(Modified from Table 2.2.40., *Guide for Mechanistic-Empirical Design, Final Report*, NCHRP Project 1-37A, March 2004)

Stabilized Layer	Minimum Unconfined Compressive Strength, psi ^{1,2}	
	Rigid Pavement	Flexible Pavement
Subgrade, Subbase, or Select Material	200	250
Base Course	500	750
Asphalt Treated Base	Not Available	Not Available
Plant Mix Bituminous Base	Not Available	Not Available
Cement Treated Base	Not Available	Not Available

1. Compressive strength determined at 7-days for cement stabilization and 28-days for lime and lime-cement fly ash stabilization.
2. These values shown should be modified as needed for specific site conditions.

E , E^* , and M_R testing should be conducted on stabilized materials containing the target stabilizer content and molded and conditioned at optimum moisture and maximum density. Curing must also be as specified by the test protocol and must reflect field conditions (5).

Table S.12 Typical E, E*, or M_R Values for Stabilized Materials
(Modified from Table 2.2.43., *Guide for Mechanistic-Empirical Design, Final Report*, NCHRP Project 1-37A, March 2004)

Stabilized Material	E or M _R (Range), psi	E or M _R (Typical), psi
Soil cement, E	50,000 to 1,000,000	500,000
Cement stabilized aggregate, E	700,000 to 1,500,000	1,000,000
Lean concrete, E	1,500,000 to 2,500,000	2,000,000
Lime stabilized soils, M _R ¹	30,000 to 60,000	45,000
Lime-cement-fly ash, E	500,000 to 2,000,000	1,500,000
Permeable asphalt stabilized aggregate, E*	Not Available	Not Available
Permeable cement stabilized aggregate, E	Not Available	750,000
Cold mixed asphalt materials, E*	Not Available	Not Available
Hot mixed asphalt materials, E*	Not Available	Not Available

1. For reactive soils within 25% passing No. 200 sieve and PI of at least 10.

Table S.13 Typical M_R Values for Deteriorated Stabilized Materials presents deteriorated semi-rigid materials stabilized showing the deterioration or damage of applied traffic loads and frequency of loading. The table values are required for HMA pavement design only.

Table S.13 Typical M_R Values for Deteriorated Stabilized Materials
(Modified from Table 2.2.44., *Guide for Mechanistic-Empirical Design, Final Report*, NCHRP Project 1-37A, March 2004)

Stabilized Material	Deteriorated M _R (Typical), psi
Soil cement	25,000
Cement stabilized aggregate	100,000
Lean concrete	300,000
Lime stabilized soils	15,000
Lime-cement-fly ash	40,000
Permeable asphalt stabilized aggregate	Not Available
Permeable cement stabilized aggregate	50,000
Cold mixed asphalt materials	Not Available
Hot mixed asphalt materials	Not Available

S.9.2 Bottom of Layer Properties for Stabilized Materials

Flexural strengths or modulus of rupture (MR) should be estimated from laboratory testing of beam specimens of stabilized materials. MR values may also be estimated from unconfined (q_u) testing of cured stabilized material samples. **Table S.14 Typical Modulus of Rupture (MR) Values for Stabilized Materials** shows typical values. The table values are required for HMA pavement design only.

Table S.14 Typical Modulus of Rupture (MR) Values for Stabilized Materials
(Modified from Table 2.2.47., *Guide for Mechanistic-Empirical Design, Final Report*, NCHRP Project 1-37A, March 2004)

Stabilized Material	Modulus of Rupture MR (Typical), psi
Soil cement	100
Cement stabilized aggregate	200
Lean concrete	450
Lime stabilized soils	25
Lime-cement-fly ash	150
Permeable asphalt stabilized aggregate	None
Permeable cement stabilized aggregate	200
Cold mixed asphalt materials	None
Hot mixed asphalt materials	Not Available

Tensile strength for hot mix asphalt is determined by actual laboratory testing in accordance with CDOT CP-L 5109 or AASHTO T 322 at 14 °F. Creep Compliance is the time dependent strain divided by the applied stress. Creep Compliance is determined by actual laboratory testing in accordance with AASHTO T 332.

S.9.3 Other Properties of Stabilized Layers

S.9.3.1 Coefficient of Thermal Expansion of Aggregates

Thermal expansion is the characteristic property of a material to expand when heated and contract when cooled. The coefficient of thermal expansion is the factor that quantifies the effective change one degree will have on the given volume of a material. The type of course aggregate exerts the most significant influence on the thermal expansion of Portland cement concrete (3). National recommended values for the coefficient of thermal expansion in PCC are shown in **Table S.15 Recommended Values of PCC Coefficient of Thermal Expansion**.

Table S.15 Recommended Values of PCC Coefficient of Thermal Expansion
(Table 2.10., *AASHTO Guide for Design of Pavement Structures 1993*)

Type of Course Aggregate	Concrete Thermal Coefficient (10-6 inch/inch/°F)
Quartz	6.6
Sandstone	6.5
Gravel	6.0
Granite	5.3
Basalt	4.8
Limestone	3.8

The Long-Term Pavement Performance (LTPP) database shows a coefficient of thermal expansion of siliceous gravels in Colorado. Siliceous gravels are a group of sedimentary "sandgravel" aggregates that consist largely of silicon dioxide (SiO₂) makeup. Quartz a common mineral of the silicon dioxide makeup may be classified as such, and is a major constituent of most beach and river sands.

Table S.16 LTPP Values of PCC Coefficient of Thermal Expansion of Siliceous Gravel in Colorado

Range (10-6 inch/inch/°F)	Average (10-6 inch/inch/°F)	Standard Dev (10-6 inch/inch/°F)
4.2 - 6.2	5.3	0.4

S.9.3.2 Dry Thermal Conductivity (K) and Heat Capacity (Q)

Thermal Conductivity and Heat Capacity are material properties that control the heat flow through the pavement system and thereby influence the temperature and moisture regimes within it. Dry Thermal Conductivity (K) is the quantity of heat that flows normally across a surface of unit area per unit of time and per unit of temperature gradient. The thermal or Heat Capacity (Q) is the actual amount of heat energy necessary to change the temperature of a unit mass by one degree. Dry Thermal Conductivity may be measured direct by using ASTM E 1952 procedure. Heat Capacity may be measured direct by using ASTM D 2766 procedure.

Table S.17 Dry Thermal Conductivity (K) and Heat Capacity (Q) for Unbound Compacted Material

(Modified from Table 2.3.5., *Guide for Mechanistic-Empirical Design, Final Report*, NCHRP Project 1-37A, March 2004)

Material Property	Soil Type	(Range)	(Typical)
Dry Thermal Conductivity, K (Btu/hr-ft-°F)	A-1-a	0.22 to 0.44	0.30
	A-1-b	0.22 to 0.44	0.27
	A-2-4	0.22 to 0.24	0.23
	A-2-5	0.22 to 0.24	0.23
	A-2-6	0.20 to 0.23	0.22
	A-2-7	0.16 to 0.23	0.20
	A-3	0.25 to 0.40	0.30
	A-4	0.17 to 0.23	0.22
	A-5	0.17 to 0.23	0.19
	A-6	0.16 to 0.22	0.18
	A-7-5	0.09 to 0.17	0.13
A-7-6	0.09 to 0.17	0.12	
Dry Heat Capacity, Q (Btu/lb-°F)	All soil types	0.17 to 0.20	Not Available

Table S.18 Dry Thermal Conductivity (K) and Heat Capacity (Q) for Chemically Stabilized Material

(Modified from Table 2.2.49., *Guide for Mechanistic-Empirical Design, Final Report*, NCHRP Project 1-37A, March 2004)

Material Property	Chemically Stabilized Material	(Range)	(Typical)
Dry Thermal Conductivity, K (Btu/hr-ft-°F)	Lime	1.0 to 1.5	1.25
Dry Heat Capacity, Q (Btu/lb-°F)	Lime	0.2 to 0.4	0.28

Table S.19 Dry Thermal Conductivity (K) and Heat Capacity (Q) for Asphalt Concrete and PCC Material

(Modified from Table 2.2.21. and Table 2.2.39., *Guide for Mechanistic-Empirical Design*, Final Report, NCHRP Project 1-37A, March 2004)

Material Property	Chemically Stabilized Material	(Range)	(Typical)
Dry Thermal Conductivity, K (Btu/hr-ft-°F)	Asphalt Concrete	Not Available	0.44 to 0.81
	PCC	1.0 to 1.5	1.25
Dry Heat Capacity, Q (Btu/lb-°F)	Asphalt Concrete	Not Available	0.22 to 0.40
	PCC	0.2 to 0.28	0.28

S.9.3.3 Saturated Hydraulic Conductivity

Saturated Hydraulic Conductivity, k_{sat} is required to determine the transient moisture profiles in compacted unbound materials. Saturated Hydraulic Conductivity may be measured direct by using a permeability test AASHTO T 215.

S.10 Reclaimed Asphalt and Recycled Concrete Base Layer

The critical location vertical loads for reclaimed asphalt or recycled concrete bases are at the interface of the surface course and top of the recycled pavement. The recycled pavement element has the greatest loads at this location when the wheel loadings are directly above. Strength testing may be performed to determine modulus of elasticity (E) and/or resilient modulus (M_R). These bases are considered as unbound materials for design purposes. If the reclaimed asphalt base is stabilized and if an indirect tension (S_t) test can be performed then these bases may be considered as bound layers.

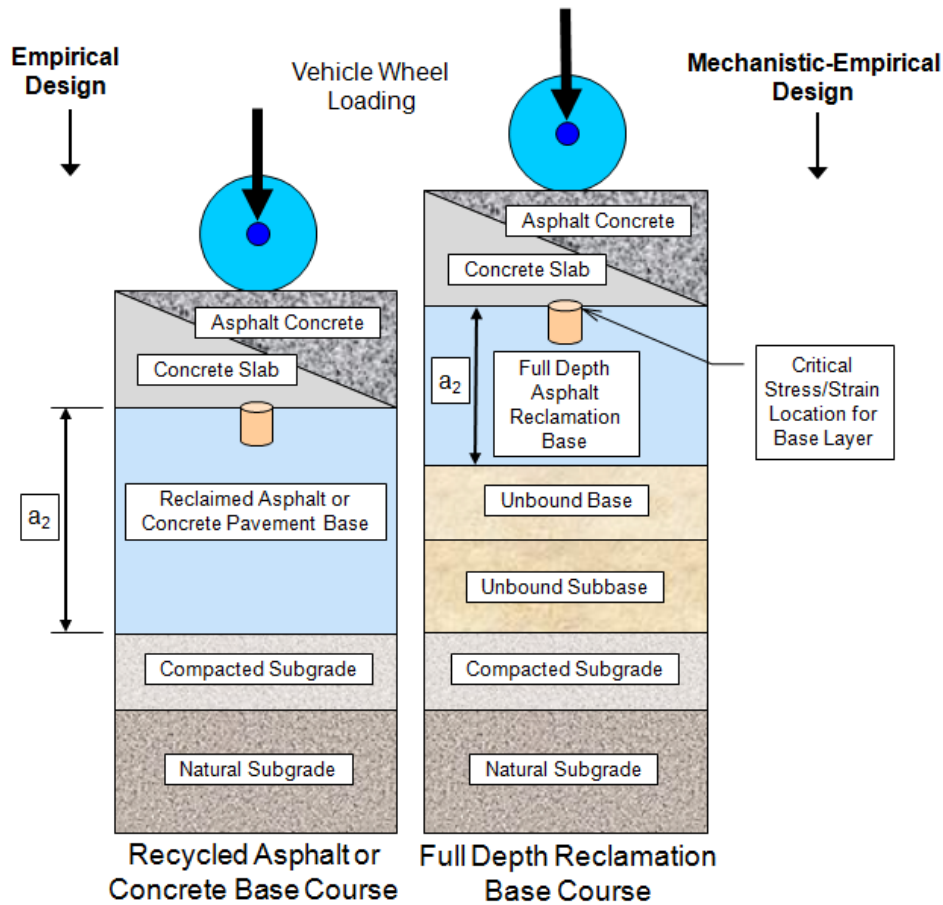

Figure S.32 Critical Stress Locations for Recycled Pavement Bases

Table S.20 Poisson's Ratios for Cold Mixed Asphalt and Cold Mixed Recycled Asphalt Materials

(Table 2.2.18. and Table 2.2.19., *Guide for Mechanistic-Empirical Design, Final Report*, NCHRP Project 1-37A, March 2004)
(A restatement of **Table S.10**)

Temperature, °F	μ (Range)	μ (Typical)
< 40 °F	0.20 to 0.35	0.30
40 °F to 100 °F	0.30 to 0.45	0.35
> 100 °F	0.40 to 0.48	0.45

Table S.21 Typical E, E*, or M_R Values for Stabilized Materials
(Modified from Table 2.2.43., *Guide for Mechanistic-Empirical Design, Final Report*, NCHRP Project 1-37A, March 2004)
(A restatement of **Table S.12**)

Stabilized Material	E or M _R (Range), psi	E or M _R (Typical), psi
Soil cement, E	50,000 to 1,000,000	500,000
Cement stabilized aggregate, E	700,000 to 1,500,000	1,000,000
Lean concrete, E	1,500,000 to 2,500,000	2,000,000
Lime stabilized soils, M _R ¹	30,000 to 60,000	45,000
Lime-cement-fly ash, E	500,000 to 2,000,000	1,500,000
Permeable asphalt stabilized aggregate, E*	Not Available	Not Available
Permeable cement stabilized aggregate, E	Not Available	750,000
Cold mixed asphalt materials, E*	Not Available	Not Available
Hot mixed asphalt materials, E*	Not Available	Not Available

1. For reactive soils within 25% passing No. 200 sieve and PI of at least 10.

S.11 Fractured Rigid Pavement

Rubblization is a fracturing of existing rigid pavement to be used as a base. The rubblized concrete responds as a high-density granular layer.

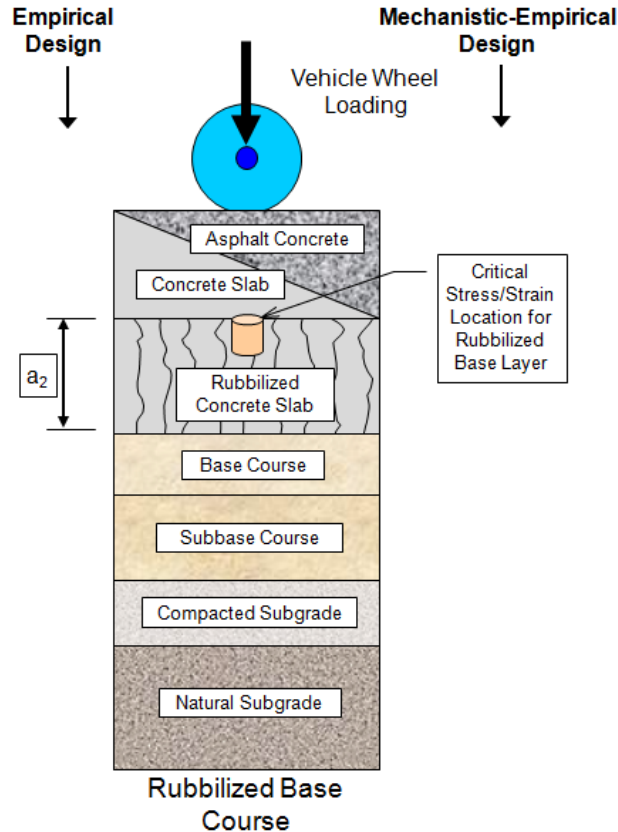

Figure S.33 Critical Stress Location for Rubblized Base

Table S.22 Poisson's Ratio for PCC Materials

(Table 2.2.29., *Guide for Mechanistic-Empirical Design, Final Report*, NCHRP Project 1-37A, March 2004)

PCC Materials		μ (Range)	μ (Typical)
PCC Slabs (newly constructed or existing)		0.15 to 0.25	0.20 (Use 0.15 for CDOT)
Fractured Slab	Crack/Seat	0.15 to 0.25	0.20
	Break/Seat	0.15 to 0.25	0.20
	Rubblized	0.25 to 0.40	0.30

Table S.23 Typical M_R Values for Fractured PCC Layers

(Table 2.2.28., *Guide for Mechanistic-Empirical Design, Final Report*, NCHRP Project 1-37A, March 2004)

Fractured PCC Layer Type	M_R (Ranges), psi
Crack and Seat or Break and Seat	300,000 to 1,000,000
Rubblized	50,000 to 150,000

S.12 Pavement Deicers

S.12.1 Magnesium Chloride

Magnesium Chloride ($MgCl_2$) is a commonly used roadway anti-icing/deicing agent in conjunction with, or in place of salts and sands. The $MgCl_2$ solution can be applied to traffic surfaces prior to precipitation and freezing temperatures in an anti-icing effort. The $MgCl_2$ effectively decreases the freezing point of precipitation to about 16° F. If ice has already formed on a roadway, $MgCl_2$ can aid in the deicing process.

Magnesium chloride is a proven deicer that has done a great deal for improving safe driving conditions during inclement weather, but many recent tests have shown that magnesium may have a negative impact on the life of concrete pavement. Iowa State University performed a series of experiments testing the effects of different deicers on concrete. Their experiment determined that the use of magnesium and/or calcium deicers may have unintended consequences in accelerating concrete deterioration (20). $MgCl_2$ was mentioned to cause discoloration, random fracturing and crumbling (20).

In 1999, a study was performed to identify the environmental hazards of $MgCl_2$. This study concluded that it was highly unlikely that the typical $MgCl_2$ deicer would have any environmental impact greater than 20 yards from the roadway. It is even possible that $MgCl_2$ may offer a positive net environmental impact if it limits the use of salts and sands. The study's critical finding was that any deicer must limit contaminants, as well as the use of rust inhibiting additives like phosphorus (21).

The 1999 study led to additional environmental studies in 2001. One study concluded that $MgCl_2$ could increase the salinity in nearby soil and water, which is more toxic to vegetation than fish (22). Another study identified that certain 30% $MgCl_2$ solutions deicers used in place of pure $MgCl_2$ had far higher levels of phosphorus and ammonia. These contaminants are both far more hazardous to aquatic life than $MgCl_2$ alone (23).

References

1. *AASHTO Interim Guide for Design of Pavement Structures 1972*, published by American Association of State Highway and Transportation Officials, Washington, DC, 1972.
2. *AASHTO Guide for Design of Pavement Structures 1986*, American Association of State Highway and Transportation Officials, Washington, DC, 1986.
3. *AASHTO Guide for Design of Pavement Structures 1993*, American Association of State Highway and Transportation Officials, Washington, DC, 1993.
4. George, K.P., *Resilient Modulus Prediction Employing Soil Index Properties*, Final Report Number FHWA/MS-DOT-RD-04-172, Federal Highway Administration and Mississippi Department of Transportation, Research Division, P O Box 1850, Jackson MS 39215-1850, report conducted by the Department of Civil Engineering, The University of Mississippi, Nov 2004.
5. *Guide for Mechanistic-Empirical Design*, Final Report, NCHRP Project 1-37A, National Cooperative Highway Research Program, Transportation Research Board, National Research Council, Submitted by ARA, INC., ERES Consultants Division, Champaign, IL, March 2004.
6. Yeh, Shan-Tai, and Su, Cheng-Kuang, *Resilient Properties of Colorado Soils*, Final Report CDOH-DH-SM-89-9, Colorado Department of Highways, December 1989.
7. Chang, Nien-Yin, Chiang, Hsien-Hsiang, and Jiang, Lieu-Ching, *Resilient Modulus of Granular Soils with Fines Contents*, Final Research Report CDOT 91-379, Colorado Department of Transportation, May 1994.
8. *Research and Development of the Asphalt Institute's Thickness Design Manual, Ninth Edition*, Research Report No. 82-2, pg. 60-, The Asphalt Institute, 1982.
9. *Design Pamphlet for the Determination of Layered Elastic Moduli for Flexible Pavement Design in Support of the 1993 AASHTO Guide for the Design of Pavement Structures*, Final Report FHWA-RD-97-077, U.S. Department of Transportation, Federal Highway Administration, Research and Development, Turner-Fairbank Highway Research Center, 6300 Georgetown Pike, Mclean VA 22101-2296, September 1997.
10. *Standard Method of Test for Determining Dynamic Modulus of Hot-Mix Asphalt Concrete Mixtures*, AASHTO Designation: TP 62-03 (2005), American Association of State Highway and Transportation Officials, 444 North Capital Street, N.W., Suite 249, Washington, DC 20001, 25th Edition 2005.
11. *Review of the New Mechanistic-Empirical Pavement Design Guide - A Material Characterization Perspective*, Morched Zeghal, National Research Council Canada, Yassin E., Adam, Carleton University, Osman Ali, Carleton University, Elhoussein H.

- Mohamed, National Research Council Canada, Paper prepared for presentation at the Investing in New Materials, Products and Processes Session of the 2005 Annual Conference of the Transportation Association of Canada, Calgary, Alberta.
12. *Changes to the Mechanistic-Empirical Pavement Design Guide Software Through Version 0.900, July 2006*, National Cooperative Highway Research Program (NCHRP).
 13. *Simple Performance Tests: Summary of Recommended Methods and Database*, NCHRP Report 547, Witzak, Matthew, Arizona State University, Transportation Research Board, Washington, D.C., 2005.
 14. *Development of a New Revised Version of the Witzak E* Predictive Models for Hot Mix Asphalt Mixtures*, Final Report, Prepared for NCHRP, Witzak, Dr. M.W., Project Principal Investigator, Arizona State University, October 2005. This report is an Appendix to NCHRP Report 547 *Simple Performance Tests and Advanced Materials Characterization Models* for NCHRP Project 9-19 in DVD format designated as CRP-CD-46.
 15. *Use of the Dynamic Modulus (E*) Test as a Simple Performance Test for Asphalt Pavement Systems (AC Permanent Deformation Distress) Volume I of IV*, Final Report, Prepared for NCHRP, Witzak, Dr. M.W., Project Principal Investigator, Arizona State University, October 2005. This report is an Appendix to NCHRP Report 547 *Simple Performance Tests and Advanced Materials Characterization Models* for NCHRP Project 9-19 in DVD format designated as CRP-CD-46.
 16. *Soil Mechanics & Foundations Lecture 3.1*, Prepared by Liu, Lanbo Referencing *Principles of Geotechnical Engineering 6th Edition*, London: Thomson Engineering, 2006
 17. *Atterberg Limits*, Wikipedia, 22 September 2007. 10 October 2007. http://en.wikipedia.org/wiki/Atterberg_limits
 18. *Acids, Bases, and pH*, Carpi, Anthony 1998-1999, 24 Sept 2007. <http://web.jjay.cuny.edu/~acarpi/NSC/7-ph.htm>
 19. *Dissociation of Water and the pH Scale*, University of British Columbia Department of Chemistry, 24 September 2007. <http://www.chem.ubc.ca/courseware/pH/>
 20. Cody, Robert D., Cody, Anita M., Spry, Paul G., Guo-Liang Gan, *Concrete Deterioration by Deicing Salts: An Experimental Study*, Iowa State University, Center for Transportation Research and Education, Ames, Iowa, May 1996.
 21. Lewis, William M., *Study of Environmental Effects of Magnesium Chloride Deicers in Colorado*, Report No. CDOT-DTD-R-99-10, Colorado Department of Transportation, November 1999.

22. Fischel, Marion, *Evaluation of Selected Deicers Base on A Review of the Literature*, Report No. CDOT-DTD-R-2001-15, Colorado Department of Transportation, October 2001.
23. Lewis, William M., *Evaluation and Comparison of Three Chemical Deicers for Use in Colorado*, Report No. CDOT-DTD-R-2001-17, Colorado Department of Transportation, August 2001.
24. AASHTO *Mechanistic-Empirical Pavement Design Guide, A Manual of Practice*, July 2008, Interim Edition, American Association of State Highway and Transportation Officials, 444 North Capitol St. NW, Suite 249, Washington, DC 20001.
25. *Supplement to the AASHTO Guide for Design of Pavement Structures, Part II, - Rigid Pavement Design & Rigid Pavement Joint Design*, American Association of State Highway and Transportation Officials, Washington, DC, 1998.
26. *Refining the Simple Performance Tester for Use in Routine Practice*, NCHRP Report 614, National Cooperative Highway Research Program, Transportation Research Board, Washington, DC, 2008.
27. *Standard Practice for Developing Dynamic Modulus Master Curves for Hot Mix Asphalt (HMA) Using the Asphalt Mixture Performance Tester (AMPT)*, AASHTO Designation: PP 61-09, American Association of State Highway and Transportation Officials, 444 North Capital Street, N.W., Suite 249, Washington, DC 20001.
28. *Standard Practice for Developing Dynamic Modulus Master Curves for Hot Mix Asphalt (HMA)* AASHTO Designation: PP 62-09, American Association of State Highway and Transportation Officials, 444 North Capital Street, N.W., Suite 249, Washington, DC 20001.

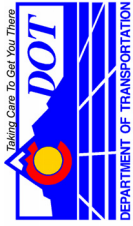

Pavement Design Manual

2011





2011 Pavement Design Manual

