

# **FIELD MATERIALS MANUAL 2021**

**AS REVISED**

To be used on projects advertised after July 1, 2020



**Colorado Department  
of Transportation**

# 2021 CDOT Field Materials Manual

## Introduction

The purpose of this manual is to provide an official guide to CDOT Field Materials Technicians, whether the individuals are CDOT personnel or consultant, for the sampling and testing of materials on construction projects and the subsequent documentation. It is not the intent to publish a complete summary of all sampling and testing methods and procedures. Further, applicable information may be found in either the referenced AASHTO or ASTM documents.

The testing frequency as shown in the Owner Acceptance (OA) Frequency Guide Schedule for Minimum Materials Sampling, Testing, and Inspection are considered to be the minimum necessary to have the degree of control desired. The Sampling and Testing Procedures have in many cases been modified to make them more applicable to Field testing conditions. Further unauthorized modifications should not be attempted. If a valid reason exists, a shortage of tests can be explained and the work accepted. However, improper test procedures cannot be explained nor accepted.

The testing frequency as shown in the Independent Assurance (IA) Frequency Guide Schedule for Evaluation of OA Sampling and Testing is to be established by the Region Materials Engineer.

It is not our intention to discourage efforts to find better or faster methods of testing. Many of the Colorado Procedures are the result of suggestions from field materials personnel. However, before using a procedure other than that listed, it must be approved by the Materials Advisory Committee (MAC) and the FHWA. In addition, the procedure used must be the same as that specified in the project specifications. If this rule is not followed, the acceptance or rejection action cannot be supported and may result in legal rulings against the Department in cases of litigation. The Frequency Guide Schedule for Minimum Materials Sampling, Testing, and Inspection current at the time of contract advertisement shall apply during the full course of that particular project.

We realize the critical importance of materials and the associated personnel, whether they are Process Control (PC) from the contractor, Owner Acceptance (OA) from CDOT, or Independent Assurance (IA) to any construction project. It is our intent to create a Field Materials Manual (FMM) that always reflects the most current and best procedures, and is as user-friendly as possible. Please take the time to review and read this publication, and provide us with the Colorado Procedure (CP) Comment Form or the FMM & CDOT Materials Forms Comment / Correction Form at any time. Download the CP Comment form to your computer and open the form using Adobe Acrobat. Follow the instructions and submit your comments. The form with your comments will be maintained with the FMM, CP, Section or chapter for future reference.

It is critical to follow the *Documentation for SMM / LIMS – Project Materials to Final Materials* or the *Documentation for Design-Build Quality Assurance Program - Project Materials to Final Materials* which is applicable for the vast majority of CDOT projects.

The 2021 CDOT Field Materials Manual is currently updating and adding documents and instructions to meet the recommendations for updating manuals to comply with Procedural Directive 21.1 “Requirements for the Retention of Records for Specified Design, Construction, Engineering, and Specialty Groups (Paper and Electronic) eff. June 20, 2019 and Procedural Directive 508.1 “Requirements for the Use of the Professional engineer’s Seal” eff. May 21, 2019

Though the CDOT Field Materials Manual (FMM) has been available in both a published print format and on the CDOT web site; future FMM's may only be available electronically as CDOT is moving toward a paperless work environment. CDOT is also implementing electronic signatures to facilitate the timely transmission of documents and project closure. Any changes prior to the issuance of the 2021 FMM will be conveyed through a CDOT Materials Bulletin.

**Craig Wieden** Digitally signed by Craig Wieden  
Date: 2020.06.25 08:45:53 -06'00'

Craig Wieden PE., III  
CDOT Materials Engineer

A centralized location for all CDOT Materials related documents and publications is at:

<http://www.codot.gov/business/designsupport/materials-and-geotechnical/>

**Materials Advisory Committee (MAC) information:**

<http://intranet.dot.state.co.us/best-dot/MAC>

**FMM Documents:** A special thank you is extended to the members and participants of the MAC Meetings and the associated task forces who are constantly striving to improve testing methodology and CDOT specifications so that the roads in Colorado are progressively built better and are safer for the public.

## SUMMARY OF 2020-2021 CDOT Field Materials Manual Listed Revisions, Additions, and Deletions

**Changes from the 2020 and added onto the 2021 FMM:** Changes of significance within a particular CP or chapter will contain a "- xx" at the end of the title to coincide with the FMM edition, not the calendar year that changes or revisions were made. Changes to specific text (Sections &/or Subsections) from the previous year will have a **RED** side-bar in either the left or right margin. The 2020-2021 revisions, additions and Deletions are highlighted in **RED**.

- FMM Manual-2020-2021 FMM Updates: Updated format to Single column for new chapters and CP's. Vote held
- Cover Page Updates: 2021 Updates- Changed CDOT Logo
- CP Comments Form: 2021 FMM Update: Updated format and added e-signature block, using "Jotform" PD21.1 requirements
- Comments Corrections Form: 2020 FMM Update: Updated format and added e-signature block
- Table of Contents: 2021 Update: Added new Comments Form Added CP63, Added Electronic Documents Chapter. Vote held.
- QA Procedures 2020 FMM updates: Subsections 3.19, 5.2.2, 7.2, 7.5.1.1, 7.11.1, 11.9.1, 11.11, 11.12.2, 11.12.3.2, 13.2.3, 17.1.
- Documentation for SMM / LIMS: 2021 FMM updates, 3.1(1,2), 3.1(7,8,9), 3.2(13)(17a,b), 9.0, Added the CDOT Form 473,474 in Adobe Sign Guidelines and updated the forms. CDOT Form 474 pg 29(1,2), Instructions for attaching documents to the CDOT Form 474, Instructions for ProjectWise/Share, Vote held .
- Adobe Acrobat Sign instructions: 2021 FMM update Added new chapter with instructions. PD 21.1 Requirements. Vote held.
- Documentation for Design -Build: 2020 FMM Updates-Section 4 total rewrite, edit & re-format. 2021 FMM Updates- 3.4.3.1 Statistical Analysis
- Documentation for Maintenance & LA- 2020 FMM: 8(Note6), updated the CDOT Form 473LA, 473M and CDOT 474.Acrobat DC.
- Contractors, Special Notice: 2021 FMM updates 4.1G, Note 1, 7.3.a.(Products needing Pre-Inspection), APL User Guidance- 6, 9, Notes 5,6,7, 8,9,10, APL Category Edits- Adhesives Note 5, Cement Blended (TypeL,MS) (IL,HS),(IT,MS),(IT,HS), PCCP Grout, Region Approved Plant Mix Grout, Class DR [Pre-Packaged], Environmental Sound Wall, Alternate Traction Device Note 6, Mastic Note 7, Delineator Post Marker Note 8, Concrete Pre-cast Barrier (Type7), Cable Barrier MASH09 TL-3 to meet 2020 compliance, Traffic Control Lighting, Sight Standards. Contractors APL Verification Forms signatures and explanations were added. Added electronic stamp instructions. PD 21.1 requirement.



## SUMMARY OF 2020-2021 CDOT Field Materials Manual Listed Revisions, Additions, and Deletions

- OA Schedule and IA Schedule: 2020 FMM updates- Added CDOT Form Links. Item 203, Item 409, Item 412, Item 420, Item 502, Item 506, Item 601, Item 612.
- OA Schedule: 2021 FMM Updates- 203, Item 208 reference CDOT Form 157, Item 212 reference CDOT Form 157, Item 411, Item 412 Pavement Smoothness, Item 601, 606, Item 607, Item 627
- IA Frequency Guide Schedule: 2020 FMM Updates- Item 203, Item 403, Item 409, Item 412, Item 503, Added Note 4.
- IA Frequency Guide Schedule: 2021 FMM Updates- Item 403, Table IA-1 "Type of Test" Column removed "Nominal Maximum". Added "Flat and Elongated" to Table IA-1. Vote held.
- CP 10: 2020 FMM Updates- Section 2.3, 6.14 Note 1, Note 2.
- CP 10: 2021 FMM update: Added new (Field Lab & Personnel Qualifications Checklist Form) Add Line to Table 10-1, E-Learning Technician Training Program. Add Line to Table 10-1, Edits to Table 10-1 Sampling & Testing Personnel Qualifications, <sup>1</sup> E-Learning Technician Training Program.
- CP 11 (Intro to QML) 2021 FMM update: Added Precast Structures, Added new tab to FMM Manual.
- CP 11-1 (Asphalt Binder) 2021 FMM update: Added new tab to FMM.
- CP 11-2 (Asphalt Emulsion) 2021 FMM update: Added new tab to FMM.
- CP 11-3 (Hydraulic Cement) 2021 FMM update: Added new tab to FMM.
- CP 11-4 (Fly Ash) 2021 FMM update: Added new tab to FMM.
- CP 11-5 (Hydraulic Lime) 2021 FMM update: Added new tab to FMM.
- CP 11-6 (Reinforcing Steel): 2021 FMM Updates- Steel Reinforcing Bars and Steel Dowel Bars, Scope paragraph 2. Added new tab to FMM Manual.
- CP 11-7 (Epoxy-Coater) 2021 FMM update: Added new tab to FMM.
- CP 11-8 (Precast Structures) 2021 FMM update: Section 1.1, 6.3, 9.8.1, 9.8.1.1, 10.1, 11.4. Added new Pre-Cast Checklist and Pre-Cast certification letter. Vote held. Added new tab to FMM

## SUMMARY OF 2020-2021 CDOT Field Materials Manual Listed Revisions, Additions, and Deletions

- CP 12A: 2021 FMM Updates- addition of Section 13 "Submittal of PC Notebook". Added new tab in the 2021 manual.
- CP 12B: 2021 FMM update: Added new tab in the 2021 FMM.
- CP 12C: 2021 FMM Updates: Addition of Section 7 "Submittal of PC Notebook". Added new tab in the 2021 FMM.
- CP 13: 2021 FMM Updates-Changes to Table 13-1, HMA Air Voids, In-Place Density HMA, Longitudinal Joint Density, Flexural Strength PCCP. Added Tab to the manual
- CP 14: Last Update 2021 FMM: Added Tab to the manual, Materials Bulletin January 2020
- CP 15: Last Update 2021 FMM: Added Tab to the manual, Materials Bulletin January 2020
- CP 16: 2021 FMM Updates- CDOT Form 1324 revised. Added Tab to the manual, Materials Bulletin January 2020
- CP 17: 2020 FMM Update- Replaced Process Documentation Worksheet with CDOT Form 417
- CP 20: Last Update 2008
- CP 21: Last Update 2008
- CP 23: Last Update 2013
- CP 24: 2020 FMM Update- 2.1
- CP 25: 2021 FMM Update- 3.5 Changed 10,000 yds<sup>3</sup> to 5000 yds<sup>3</sup>, Added revisions from Chris Russell Vote held.
- CP 26: Last Update 2014
- CP 30: Last Update 2009
- CP 31: 2020 FMM Update- Subsection 3.1.3.1
- CP 32: Last Update 2003
- CP 33: Last Update 2012

## SUMMARY OF 2020-2021 CDOT Field Materials Manual Listed Revisions, Additions, and Deletions

- CP 37: 2020 FMM Update- 2.7
- CP 41: 2020 FMM Update- 13.1
- CP 42: Last update 2005
- CP 43: 2020 FMM Update- 15.1
- CP 44: 2020 FMM Update- The Title, Percent Relative Compaction to, "Just Percent Compaction"
- CP 45: 2020 FMM Update- 7.1
- CP 46: Last update 2008
- CP 47: Last update 1990
- CP 48: 2020 FMM Update- 4.1.1
- CP 50: Last update 2014
- CP 51: 2021 FMM Update- The Title, added the word "Theoretical", Scope 1.1, 3.3, 3.6, 3.9.1, 6.4, Method B title update 10.2
- CP 52: 2021 FMM Update- Subsection 2.2, 2.3, 3.1, 3.2, 4.2, 4.3 (which was 4.2 is renumbered with 4.3,(6), 8.2 delete CDOT Procedural Directives 25.2, 51.2, 51.3 and replace with 25.1. Vote held.
- CP 53: 2021 FMM Update- 1.1 deleted Method C reference, Deleted Method C (8,9), 11.1 deleted the mention of Method C, 13.1. Vote held.
- CP 54: Last update 2013
- CP 55: Last update 2018
- CP 56: 2020 FMM Update-Title, "Guidelines for Using Theoretical Maximum Specific Gravity (RICE) of Project-Produced HMA to Change the Target Specific Gravity for Compaction Compliance".
- CP 57: 2020 FMM Update- 4.2, 6.3 New Form In development.
- CP 58: Last update 2007

# SUMMARY OF 2021 CDOT Field Materials Manual Listed Revisions, Additions, and Deletions

- CP 59: **2021 FMM 3.3 Deleted, 8.1 delete CDOT Procedural Directives 25.2, 51.2, 51.3 and replace with 25.1, Update with electronic Forms.**
- CP 61: **2021 FMM update: 4.2.1., 4.2.4**
- CP 62: **2021 FMM Update- 6.3 delete CDOT Procedural Directives 25.2, 51.2, 51.3 and replace with 25.1. Section 7 Update**
- CP 63: **2021 FMM Update- New Addition of CP 63 added.**
- CP 65: **2020 FMM Update- Text within Example 1 & 2 Table 65-1, Table 65-2, Table 65-3, Table 65-4, Subsection 7.1, 7.6.1, text within Example 3.**
- CP 67: Last update 2008
- CP 69: Last update 2018
- CP 71: Last update 2001
- CP 74: **2021 FMM Update-Added "Smoothness Acceptance Data Submittal Form", 5.4.**
- CP 75: Last update 2008
- CP 76: **2020 FMM Update- Updated the "Checklist for Field Bituminous Equipment Calibration"**
- CP 77: Last update 2018
- CP 78: **2021 FMM Update- 3.2.1,4.1.1, 4.2, 5.1.2, 6.3, 6.6, 9.2.**
- CP 79: **2020 FMM Update- Added MIT Scan Images for Uncut Dowel Baskets. Vote held**
- CP 80: Last update 2013
- CP 81: Last update 2018
- CP 82: **2020 FMM Update- New text for Note 6**
- CP 85: Last update 2013
- Chapter 200: **2020 FMM Update- Added "guide" paragraph at the top of first page.**

## SUMMARY OF 2021 CDOT Field Materials Manual Listed Revisions, Additions, and Deletions

- Chapter 300: 2021 FMM Update- Added Change to Note: Forms are currently in development. Statement added "Contact Ed Trujillo Edward.trujillo@state.co.us 303-398-6566 for assistance with any CDOT form."
- Chapter 400: 2021 FMM update: Updated Forms, Added "guide" paragraph on top of first page.
- Chapter 500: 2021 FMM update: Updated Forms. , Added "guide" paragraph on top of first page.
- Chapter 600: 2021 FMM update: Added Eric Prieve revisions to chapter 600. Updated Forms, , Added "guide" paragraph on top of first page.
- Chapter 700: 2021 FMM update: Updated Forms, Added "guide" paragraph on top of first page.
- Chapter 800: 2020 FMM Update- Deleted Chapter 800, A copy of Chapter 800 will be located with each Nuclear Gauge. Additional copies will be located with each Region Radiation Safety Officer and the Region Safety Officer. Vote held
- Materials Forms – Instructions & Examples: 2020 FMM Update- previously Appendix O, a new chapter, Added CDOT Form 473,474 guidelines and examples. Added Change to Note: Forms are currently in development. Contact Ed Trujillo Edward.trujillo@state.co.us 303-398-6566 for assistance with any CDOT form.
- Electronic Documents Chapter 2021 FMM: Added new chapter Introduction to ProjectWise/Projectshare as per 21.1/508.1.
- JSA: 2021 FMM Update: AASHTO Test Method T90, T190. CP-L Test Method 4301, 4302. Update Note: Regions review and update all Job Safety Analysis (JSA) documents.
- AASHTO / ASTM Online: 2021 FMM Update- Added New Instructions for CDOT personnel needing to register to IHS Markit. Add link to webpage with instructions.
- Inspections: 2020 FMM Update- Table of Contents (V) Protocol for the Audit of Region Materials Finals Review and Acceptance Process by the Central Materials Laboratory.
- Protocol for Round Robin Materials Testing of CDOT Region & Consultant Laboratories: Last update 2018.
- The protocol of the Audit of Region Materials, IA Sampling and Testing Program by the Central Materials Laboratory: 2021 FMM Update - Update all AMRL references with the "AASHTO Re:source" reference. Update the distribution list.

## SUMMARY OF 2021 CDOT Field Materials Manual Listed Revisions, Additions, and Deletions

- The protocol of the Audit of Region Materials, Finals Materials Review and Acceptance Process by the Central Materials Laboratory: 2021 FMM Update- Update all AMRL references with the "AASHTO Re:source" reference. Update the distribution list
- The protocol of the Audit of the Local Agency, Finals Materials Review and Acceptance Process by the Central Materials Laboratory: 2021 FMM Update: Update all AMRL references with the "AASHTO Re:source" reference. Update distribution list.
- Appendix A (MAC Charter) revisions as noted: 2021 FMM Update: Membership change from 10 to 9 with the Research Group removed e-vote to follow. Scope, Guests and Guests Uninvited, Appropriate Topics & Discussion, Taskforce Business, MAC meeting minutes and Executive Summary.
- Appendix A (FPOG): Last update 2018.
- Appendix B Task Force Management Guide: Last update 2018
- Appendix C (Statewide Roster): 2021 FMM Update- Updated region contact information names and phone numbers.
- Appendix D (Definitions): 2020 FMM Update- Owner Acceptance (OA), Owner Verification Testing (OVT).
- Appendix E 2021 FMM Update: AV, AQV, EPE, PEC, OA, OVT, QAP
- Appendix F (Significant Publications): 2021 FMM Update- Updated reference to "Asphalt Institute manual MS-2"
- Appendix G (Colorado Procedures): 2020 FMM Update- Added CP-L 4301, CP-L 4302.
- Appendix H Metric Conversion Tables: 2020 FMM No updates
- Appendix I 2020 FMM update: (Materials Testing Accuracy Criteria): Changed % Soils Relative Compaction (Report to Nearest 0.1%), Base Aggregate Relative Compaction (Report to Nearest 0.1%)
- Appendix J 2021 FMM update: (Laboratory Test Time): Deleted 301 Plant Mix Bituminous Base. Add 409 Flat and Elongated. Added 601 Aggregate Soundness with Sodium Sulfate.
- Appendix K (Establishing Lots or Process Control on the Project) 2020 FMM No updates.
- Appendix L (Random Sampling): 2020 FMM No updates.

## **SUMMARY OF 2021 CDOT Field Materials Manual Listed Revisions, Additions, and Deletions**

- Appendix M (Sample-Processing Procedure): 2020 FMM No updates.
- Appendix N: (Results of Laboratory Check Tests): 2020 FMM Update- Added "Results of Laboratory Check Tests can be used and referenced to more than one project of the RE allows it and if the following criteria are met"

{Page Intentionally Left Blank}





## 2021 Field Materials Manual (FMM)

### FMM & CDOT Materials Forms: Comments and Corrections

Click on the following link to fill out the form and click "submit" the form will automatically be sent to [edward.trujillo@state.co.us](mailto:edward.trujillo@state.co.us) with your comment and corrections :

<https://form.jotform.com/edward.trujillo/2021-field-materials-manual-fmm-cor>

(This form may be utilized if you have discovered an issue the CDOT Field Materials Manual or have a suggestion for improvement.) It is important that you are as specific as possible by referencing the CP number, CP-L number, the Chapter Section / Subsection number, or the Form number.

E-mail or attach all supporting documents for future reference to: [edward.trujillo@state.co.us](mailto:edward.trujillo@state.co.us) or call 303-398-6566 for assistance with this form.

Thank you for your help in making the CDOT Field Materials Manual a better publication by notifying us of errors or points of confusion that require clarity.



## 2021 Field Materials Manual (FMM)

### FMM & CDOT Materials Forms: Comments and Corrections

Copy and paste the following link to your Google E-mail "New Tab" fill out the form and click "submit" the form will automatically be sent to [edward.trujillo@state.co.us](mailto:edward.trujillo@state.co.us) with your :

<https://form.jotform.com/200696381361052>

(This form may be utilized if you have discovered an issue the CDOT Field Materials Manual or have a suggestion for improvement.) It is important that you are as specific as possible by referencing the CP number, CP-L number, the Chapter Section / Subsection number, or the Form number.

E-mail all supporting documents for future reference to: [edward.trujillo@state.co.us](mailto:edward.trujillo@state.co.us) or call 303-398-6566 for assistance with this form.

Signature:

Thank you for your help in making the CDOT Field Materials Manual a better publication by notifying us of errors or points of confusion that require clarity.

## TABLE OF CONTENTS – 21

|   |   |
|---|---|
| <b>Introduction:</b>                    | (1) Cover Page<br>(2) Introduction<br>(3) Dedication / List of Annual FMM Revisions, Additions & Deletions<br><b>(4) Comments / Corrections Form using "Jotform"</b>  |
| <b>Table of Contents</b>                | Table of Contents   |
| <b>QA Procedures</b>                    | Quality Assurance Procedures for Construction and Materials Sampling & Testing  |
| <b>Documentation, SMM/LIMS</b>          | SMM / LIMS – Project Materials to Finals Materials  |
| <b>Documentation, Adobe Sign</b>        | <b>Adobe Sign instructions for CDOT Form 473/474</b>  |
| <b>Documentation, Design-Build</b>      | Design-Build Quality Assurance Program, Project Materials to Finals Materials   |
| <b>Documentation, Non-SMM</b>           | Project Materials to Finals Materials (Non-SMM/LIMS and Design Build, future development for CDOT Maintenance & Local Agencies)   |
| <b>Contractors, Special Notice</b>      | Special Notice to Contractors   |
| <b>Schedule (Owner Acceptance)</b>      | OA Frequency Guide Schedule for Minimum Materials Sampling, Testing, and Inspection   |
| <b>Schedule (Independent Assurance)</b> | IA Frequency Guide Schedule for Evaluation of OA Sampling & Testing   |
| <b>CP 10</b>                            | <b>Colorado Procedures 10</b><br>CP 10 Qualification of Testing Personnel and Laboratories  |
| <b>CP 11</b>                            | <b>Colorado Procedures 11</b><br>CP 11 Quality Management Plans for the Qualified Manufacturers List (QML) or the Approved Products List (APL)<br>CP 11-1 Asphalt Binder<br>CP 11-2 Asphalt Emulsion<br>CP 11-3 Hydraulic Cement<br>CP-11-3 Fly Ash<br>CP 11-4 Hydrated Lime<br>CP 11-5 Steel Reinforcing Bars & Steel Dowel Bars<br>CP-11-6 Epoxy Coating for Reinforcing Steel<br>CP 11-7 Precast Concrete Structures |
| <b>CP 12</b>                            | <b>Colorado Procedures 12</b><br>CP 12A Contractor’s Hot Mix Asphalt Process Control Notebook<br>CP 12B Contractor’s Portland Cement Concrete Paving Process Control Notebook<br>CP 12C Contractor’s Excavation and Embankment Process Control Notebook   |

|               |  |
|---------------|--|
| <b>CP 13</b>  | <b>Colorado Procedure 13</b>   |
| CP 13         | Check Testing  |
| <b>CP 14</b>  | <b>Colorado Procedure 14</b>   |
| CP 14         | F and t-test Statistical Method  |
| <b>CP 15</b>  | <b>Colorado Procedure 15</b>   |
| CP 15         | Certification of Consultant Nuclear Moisture/Density Gauges  |
| <b>CP 16</b>  | <b>Colorado Procedure 16</b>   |
| CP 16         | Management of CDOT & Consultant Materials Testing  |
| <b>CP 17</b>  | <b>Colorado Procedure 17</b>   |
| CP 17         | Hot Mix Asphalt Test Results Verification and Dispute Resolution   |
| <b>CP 20s</b> | <b>Colorado Procedures 20s - Soils</b>   |
| CP 20         | Dry Preparation of Disturbed Soil Samples for Test   |
| CP 21         | Mechanical Analysis of Soils   |
| CP 23         | Determining Maximum Dry Density and Optimum Moisture Content of Soil-Rock Mixtures   |
| CP 24         | Soil Surveys of Constructed Roadbeds   |
| CP 25         | Calculation of Percent Relative Compaction of Soils and Soil-Rock Mixtures   |
| CP 26         | Contractor Approval Process for Subgrade Stabilization   |
| <b>CP 30s</b> | <b>Colorado Procedures 30s - Bases</b>   |
| CP 30         | Sampling of Aggregates   |
| CP 31         | Sieve Analysis of Aggregates   |
| CP 32         | Reducing Field Samples of Soil and Aggregate to Testing Size   |
| CP 33         | Total Evaporable Moisture Content and Surface Moisture Content of Aggregates by Drying                                       |
| CP 37         | Plastic Fines in Graded Aggregates and Soils by Sand Equivalent Test   |
| <b>CP 40s</b> | <b>Colorado Procedures 40s – Asphalt</b>   |
| CP 41         | Sampling Hot Mix Asphalt   |
| CP 42         | Estimation of Asphalt Content in Hot Mix Asphalt through Back Calculations Using $G_{se}$                                    |
| CP 43         | Determining Moisture (Water) or Volatile Distillates Content of HMA  |
| CP 44         | Bulk Specific Gravity and Percent Relative Compaction of Compacted Bituminous Mixtures Using Saturated Surface-Dry Specimens |
| CP 45         | Determining Percent of Particles with Two or More Fractured Faces  |
| CP 46         | Determination of Gradation of Aggregate in a Core from Asphalt Pavement  |
| CP 47         | Rejuvenating Agent Evaluation Procedure  |
| CP 48         | Determination of the Voids in the Mineral Aggregate (VMA)  |

|               |  |
|---------------|--|
| <b>CP 50s</b> | <b>Colorado Procedures 50s - Asphalt</b>   |
| CP 50         | Calculation of Dust to Asphalt Ratio of Bituminous Mixes   |
| CP 51         | Determining the Maximum Specific Gravity of HMA  |
| CP 52         | Contractor Asphalt Mix Design Approval Procedures  |
| CP 53         | Determining Maximum Density of Cold In-Place Recycled Pavement   |
| CP 54         | Approval of Asphalt Mix Designs Using Plant Produced Material  |
| CP 55         | Reducing Field Samples of Hot Mix Asphalt to Testing Size  |
| CP 56         | Guidelines for Using Maximum Specific Gravity (Rice) of Project-Produced HMA to Change the Target Specific Gravity for Compaction Compliance |
| CP 57         | Determining the "Free Moisture" in Cold In-Place Recycled Pavement   |
| CP 58         | Detecting and Measuring Temperature Segregation of HMA   |
| CP 59         | Warm Mix Asphalt Approval  |
| <b>CP 60s</b> | <b>Colorado Procedures 60s - Concrete</b>  |
| CP 61         | Sampling Freshly Mixed Concrete  |
| CP 62         | Contractor Concrete Mix Design Approval Procedure  |
| CP 63         | <b>The Box Test in Slip Form Paving of Fresh Concrete</b>  |
| CP 65         | Evaluating Low Strength Test Results of Concrete Cylinders   |
| CP 66         | Delete effective 7-01-2015   |
| CP 67         | Determining Adhesion of Joint Sealant to Concrete Pavement   |
| CP 69         | Estimating the In-Place Concrete Strength by a Maturity Method   |
| <b>CP 70s</b> | <b>Colorado Procedures 70s - Miscellaneous</b>   |
| CP 71         | Determining Quality Level (Percent within Tolerance Limits)  |
| CP 74         | Operating Inertial Profilers and Evaluating Pavement Profiles  |
| CP 75         | Stratified Random Sampling of Materials  |
| CP 76         | Verification of Equipment Used to Field Test Bituminous Mixtures   |
| CP 77         | Determination of Macro-Texture of a Pavement Surface   |
| CP 78         | Certification of High Speed Profilers  |
| <b>CP 80s</b> | <b>Colorado Procedures 80s - Nuclear</b>   |
| CP 80         | In-Place Density and Moisture Content of Soil and Soil-Aggregate by the Nuclear Method   |
| CP 81         | Density and Percent Relative Compaction of HMA Pavement by the Nuclear Method  |
| CP 82         | Field Correction of the In-Place Measurement of Density of Bituminous Pavement by the Nuclear Method   |
| CP 85         | Asphalt Cement Content of Asphalt Mixtures by the Nuclear Method   |

|                    |  |             |
|--------------------|--|-------------|
| <b>Chapter 200</b> | <b>Soils</b>   | <b>PAGE</b> |
|                    | General Soil Properties.....                             | 1           |
|                    | Laboratory Tests.....                                    | 2           |
|                    | Soil Surveys & Similarization.....                       | 4           |
|                    | Rippability.....   | 5           |
|                    | Item 203 Embankment.....                                 | 5           |
|                    | Item 206 Structure Backfill.....                         | 7           |
|                    | Item 206 Filter Material.....                            | 7           |
|                    | Region Soil Survey Sampling Checklist.....               | 8           |
|                    | Definitions.....   | 12          |
|                    | CDOT Forms – Soils Examples Index.....                   | 15          |
| <br>               |  |             |
| <b>Chapter 300</b> | <b>Bases</b>   | <b>PAGE</b> |
|                    | Item 206 Structure Backfill, Class 1.....                | 1           |
|                    | Item 304 Aggregate Base Course.....                      | 1           |
|                    | Item 308 Portland Cement and Fly Ash.....                | 3           |
|                    | CDOT Forms – Bases Examples Index.....                   | 3           |
| <br>               |  |             |
| <b>Chapter 400</b> | <b>Asphalt</b>   | <b>PAGE</b> |
|                    | Bituminous Mixtures and Binders.....                     | 1           |
|                    | Item 403 Hot Mix Asphalt.....                            | 2           |
|                    | Item 403 Superpave Mix Design.....                       | 2           |
|                    | Item 411 Performance Graded Binders.....                 | 2           |
|                    | Item 403 Hot Mix Asphalt, European Rutting Machines..... | 3           |
|                    | Item 411 Asphalt Materials.....                          | 6           |
|                    | CDOT Forms – Asphalt Examples Index.....                 | 18          |
| <br>               |  |             |
| <b>Chapter 500</b> | <b>Structures/Steel/Miscellaneous</b>                    | <b>PAGE</b> |
|                    | Item 502 Piling.....                                     | 1           |
|                    | Item 503 Drilled Shafts.....                             | 1           |
|                    | Item 504 Soil Nail Walls.....                            | 1           |
|                    | Item 506 Gabions and Slope Mattress.....                 | 1           |
|                    | Item 509 Structural Steel.....                           | 1           |
|                    | Item 509 Structural Steel (Galvanized).....              | 2           |
|                    | Item 510 Structural Plate (Galvanized).....              | 2           |
|                    | Item 515 Waterproofing Membrane (Bridge Deck).....       | 2           |
|                    | CDOT Forms – Structures Examples Index.....              | 3           |
| <br>               |  |             |
| <b>Chapter 600</b> | <b>Concrete &amp; Item 600</b>                           | <b>PAGE</b> |
|                    | Item 601 Structural Concrete.....                        | 1           |
|                    | Item 602 Reinforcing Steel (Epoxy Coated).....           | 12          |
|                    | Item 602 Reinforcing Steel.....                          | 12          |
|                    | Item 603 Culverts & Sewers.....                          | 14          |
|                    | Item 604 Sewers Pipe.....                                | 14          |
|                    | Item 617 Culvert Pipe.....                               | 14          |
|                    | Item 604 Manholes.....                                   | 15          |

Item 606 Guard Rail..... 15  
 Item 606 End Anchors ..... 16  
 Item 607 Fence..... 16  
 Item 613 Lighting..... 16  
 Item 614 Traffic Control Devices ..... 16  
 Item 615 Water Control Devices ..... 17  
 Item 624 Corrosion Resistant Culverts ..... 17  
 CDOT Forms – Concrete Examples Index..... 18

**Chapter 700**

**Paints**

Item 708 Paints (Zinc Rich Paint)..... 1

**Chapter 800**

**Radiological Safety & Nuclear Gauge Operation (Deleted from FMM 2020)**

**Materials Forms Materials Forms, Instructions & Examples**

**Electronic Documents Introduction to ProjectWise/Projectshare as per PD 21.1/508.1**

**Job Safety Analysis** **PAGE**  
 Job Safety Analysis (JSA) – Materials Index  
 Table of Contents..... 1

**IHS Engineering Workbench Instructions** **PAGE**  
 Accessing AASHTO Online..... 1  
 Accessing ASTM Online..... 1

**Inspections: CDOT Central Laboratory of the Regions** **PAGE**

- I. Protocol for Open Laboratory Review of a CDOT Materials Testing Laboratory ..... 1
- II. Protocol for the Inspection of Region Materials Laboratories by the Central Materials Laboratory..... 2
  - (a) Report of Central Laboratory to Region Lab Inspection (Form #520) ... 3
  - (b) Equipment Calibration, Verification and Check Information..... 6
  - (c) Calibration/Verification, and Check of Equipment Inventory ..... 7
  - (d) Summary of Tester Qualifications ..... 8
- III. Protocol for Round Robin Materials Testing of CDOT Region & Consultant Laboratories ..... 9
- IV. Protocol for the Audit of Region Materials IA Sampling and Testing Program by the Central Materials Laboratory..... 13
- V. Protocol for the Audit of Region Materials Final Materials Review and Acceptance Process by the Central Materials Laboratory..... 15
- VI. Protocol for the Audit of Local Agency Final Materials Review and Acceptance Process by the Central Materials Laboratory..... 17

| <b>Appendix</b>   | <b>PAGE</b> |
|---|-------------|
| A - Materials Advisory Committee (MAC) Charter.....             | 2           |
| A - Independent Assurance (IA) Testers Committee Charter .....  | 6           |
| A - Flexible Pavement Operator’s Group (FPOG) Charter.....      | 9           |
| <br>  |             |
| B - Task Force Management Guide .....                           | 12          |
| <br>  |             |
| C - Personnel Roster, Staff & Region Materials .....            | 16          |
| <br>  |             |
| D - Definitions .....   | 20          |
| E - Acronyms.....   | 25          |
| F - Significant Publications .....                              | 29          |
| G- Colorado Procedures - Laboratory <i>Numeric Order</i> .....  | 30          |
| H - Metric Conversion Tables .....                              | 32          |
| I - Materials Testing Accuracy Criteria .....                   | 34          |
| J - Laboratory Test Time.....                                   | 37          |
| K - Establishing Lots or Process Control on the Project .....   | 39          |
| L - Random Sampling .....                                       | 39          |
| M- Sample Processing Procedure .....                            | 40          |
| N - Use of Laboratory Check Tests on More than One Project..... | 40          |

**MATERIALS PAY ITEMS NUMERICAL LIST**

| <b>Item No</b> | <b>Description</b>               | <b>Item No</b> | <b>Description</b>                 |
|----------------|----------------------------------|----------------|------------------------------------|
| 203            | Compaction                       | 309            | Lean Concrete Base                 |
| 206            | Structure Backfill               | 310            | Process Asphalt Mat                |
| 206            | Filter Material                  | 403            | Hot Bituminous Pavement            |
| 206            | Bed Course Material              | 405            | Hot In-Place Recycle               |
| 207            | Topsoil                          | 406            | Cold Bituminous Pavement (Recycle) |
| 208            | Silt Fence                       | 408            | Hot Poured Joint and Crack Sealer  |
| 209            | Watering                         | 409            | Seal Coat                          |
| 212            | Seeding and Sodding              | 409            | Cover Coat Material                |
| 213            | Mulching                         | 411            | Bituminous Materials               |
| 214            | Planting                         | 412            | Portland Cement Concrete Pavement  |
| 215            | Transplanting                    | 420            | Geotextiles                        |
| 216            | Soil Retention System            | 501            | Steel Sheeting Piling              |
| 217            | Soil Sterilization               | 502            | Piling                             |
| 301            | Plant Mix Bituminous Base Course | 503            | Drilled Caissons                   |
| 304            | Aggregate Base Course            | 504            | Cribbing                           |
| 306            | Reconditioning                   | 504            | MSE Walls                          |
| 307            | Lime Treated Subgrade            |                |                                    |
| 307            | Hydrated Lime                    |                |                                    |
| 307            | Mineral Fillers                  |                |                                    |
| 308            | Portland Cement Treated Base     |                |                                    |
| 308            | Portland Cement, Fly Ash         |                |                                    |



|     |   |
|-----|---|
| 506 | Riprap (Gabions) and Slope Mattress           |
| 507 | Slope and Ditch Paving                        |
| 508 | Timber Structures                             |
| 509 | Structural Steel                              |
| 509 | Structural Steel (Galvanized)                 |
| 510 | Structural Plate Structures                   |
| 512 | Bearing Device                                |
| 513 | Drain Pipe                                    |
| 514 | Pipe Railing                                  |
| 515 | Waterproofing Membrane                        |
| 516 | Damproofing                                   |
| 517 | Waterproofing                                 |
| 518 | Expansion Devices and Waterstops              |
| 601 | Structural Concrete                           |
| 602 | Reinforcing Steel                             |
| 603 | Culverts                                      |
| 604 | Sewers, Manholes, Inlets, and Meter<br>Vaults |
| 605 | Underdrains                                   |
| 606 | Guard Rail                                    |
| 607 | Fences  |
| 608 | Sidewalks                                     |
| 609 | Curbing                                       |
| 610 | Median Cover Material                         |
| 611 | Cattle Guard                                  |
| 612 | Markers                                       |
| 613 | Lighting                                      |
| 614 | Traffic Control Devices                       |
| 615 | Water Control Devices                         |
| 616 | Siphons                                       |
| 617 | Culvert Pipe                                  |
| 618 | Pre-stressed Concrete Structures              |
| 619 | Water Lines                                   |
| 622 | Rest Areas and Buildings                      |
| 623 | Sprinkler System                              |
| 624 | Corrosion Resistant Culverts                  |
| 627 | Pavement Marking                              |
| 641 | Shotcrete                                     |
| 708 | Paints  |

**MATERIALS PAY ITEMS  
ALPHABETICAL LIST**

| <b>Description</b>                      | <b>Item No</b> | <b>Description</b>                          | <b>Item No</b> |
|---|----------------|---|----------------|
| Aggregate Base Course .....             | 304            | Markers .....                               | 612            |
| Anchor Bolts.....                       | 613            | Median Cover Material.....                  | 610            |
| Arch Pipe (Plate) .....                 | 510            | Mineral Fillers, Etc. ....                  | 307            |
| Asphalt Cement .....                    | 411            | Mulching (Straw) .....                      | 213            |
| Bearing Device .....                    | 512            | Mulching (Wood Cellulose) .....             | 213            |
| Bed Course Material .....               | 206            | PG Binder.....                              | 411            |
| Bituminous Base (Plant Mix).....        | 301            | Paints .....                                | 708            |
| Bituminous Materials .....              | 411            | Pavement Marking .....                      | 627            |
| Caissons (Drilled) .....                | 503            | Piling .....                                | 502            |
| Cattle Guard.....                       | 611            | Piling (Steel Sheet).....                   | 501            |
| Cold Bituminous Pavement (Recycle)..... | 406            | Pipe (Culvert).....                         | 617            |
| Compaction.....                         | 203            | Pipe (Drain).....                           | 513            |
| Concrete (Structural) .....             | 601            | Pipe Railing .....                          | 514            |
| Concrete Units (Pre-stressed).....      | 618            | Plant Mix Bituminous Base Course.....       | 301            |
| Copper (Sheet).....                     | 511            | Planting.....                               | 214            |
| Corrosion Resistant Culverts .....      | 624            | Plate Pipe (Structural) .....               | 510            |
| Cover Coat Material.....                | 409            | Polyethylene Sheeting.....                  | 610            |
| Cover Material (Median) .....           | 610            | Portland Cement .....                       | 308            |
| Cribbing.....                           | 504            | Portland Cement Concrete Pavement.....      | 412            |
| Culverts.....                           | 603            | Preform Bridge Compression Joint Sealer..   | 518            |
| Culvert Pipe.....                       | 617            | Pre-stressed Concrete Structures.....       | 618            |
| Curbing.....                            | 609            | Process Asphalt Mat.....                    | 310            |
| Damproofing.....                        | 516            | Railing (Pipe).....                         | 514            |
| Drain Pipe .....                        | 513            | Reconditioning.....                         | 306            |
| Drilled Caissons.....                   | 503            | Reinforcing Steel .....                     | 602            |
| Emulsion .....                          | 411            | Rest Areas and Buildings .....              | 622            |
| Expansion Devices and Waterstops.....   | 518            | RipRap.....                                 | 506            |
| Filter Material .....                   | 206            | Seal Coat.....                              | 409            |
| Gabions.....                            | 506            | Seeding and Sodding .....                   | 212            |
| Galvanized Structural Steel.....        | 509            | Sewers, Manholes, Inlets, Meter Vaults..... | 604            |
| Geotextiles.....                        | 420            | Shotcrete .....                             | 641            |
| Guard Rail .....                        | 606            | Sidewalks.....                              | 608            |
| Hot Bituminous Pavement.....            | 403            | Silt Fence .....                            | 208            |
| Hot In-Place Recycle .....              | 405            | Soil Retention System.....                  | 216            |
| Hot Poured Joint and Crack Sealer ..... | 408            | Siphons .....                               | 616            |
| Humus.....                              | 214            | Slope and Ditch Paving .....                | 507            |
| Hydrated Lime .....                     | 307            | Slope Mattress.....                         | 506            |
| Inlets .....                            | 604            | Sprinkler System.....                       | 623            |
| Joint Seal (Preformed) .....            | 518            | Steel (Reinforcing) .....                   | 602            |
| Lean Concrete Base .....                | 309            | Steel Sheet Piling .....                    | 501            |
| Lighting .....                          | 613            | Steel (Structural).....                     | 509            |
| Lime Treated Subgrade.....              | 307            | Structural Concrete .....                   | 601            |
| Liquid Asphalt .....                    | 411            | Structural Plate Pipe.....                  | 510            |
| MSE Wall.....                           | 504            | Structural Steel.....                       | 509            |
| Manholes .....                          | 604            | Structural Steel Galvanized .....           | 510            |

|                              |     |                              |     |
|------------------------------|-----|------------------------------|-----|
| Structure Backfill.....      | 206 | Water Control Devices .....  | 615 |
| Topsoil.....                 | 207 | Watering.....                | 209 |
| Timber Structures .....      | 508 | Water Lines.....             | 619 |
| Traffic Control Devices..... | 614 | Waterproofing.....           | 517 |
| Trash Guards.....            | 616 | Waterproofing Membrane ..... | 517 |
| Underdrains .....            | 605 |                              |     |

{Page Intentionally Left Blank}

## Quality Assurance Procedures for Construction Materials Sampling & Testing - 20

### 1. PURPOSE

- 1.1 To prescribe policies, procedures, and guidelines to assure the quality of materials on all Colorado Department of Transportation (CDOT) construction projects are in accordance with 23 CFR and the FHWA Stewardship agreement.
- 1.2 The revision and/or development of terminology in the Design-Build Quality Assurance Program from Project Materials to Final Materials has caused CDOT to redefine terms and procedures that have been used by the Department for decades on CDOT projects. It is the intent of CDOT to provide as much clarity as possible.

### 2. REFERENCES

- 2.1 AASHTO R 9 – Standard Practice for Acceptance Sampling Plans for Highway Construction
- 2.2 AASHTO R 10 – Standard Practice for Definition of Terms Related to Quality and Statistics as Used in Highway Construction
- 2.3 AASHTO R 18 – Standard Recommended Practice for Establishing and Implementing a Quality Management System for Construction Materials Testing Laboratories (revised in 2016)
- 2.4 AASHTO R 25 – Standard Practice for Technician Training and Qualification Programs
- 2.5 AASHTO R 38 – Standard Practice for Quality Assurance of Standard Manufactured Materials
- 2.6 AASHTO R 44 – Standard Practice for Independent Assurance (IA) Programs
- 2.7 ASTM D 3665 – Standard Practice for Random Sampling of Construction Materials
- 2.8 ASTM E 177 – Standard Practice for Use of the Terms Precision and Bias in ASTM Test Methods
- 2.9 Title 23 Code of Federal Regulations (CFR), Part 637, Subpart B, Quality Assurance Procedures for Construction

### 3. DEFINITIONS

- 3.1 *Acceptance* - The process whereby all factors used by the agency (i.e., sampling, testing, and inspection) are evaluated to determine the degree of compliance with contract requirements and to determine the corresponding value for a given product. (AASHTO R 10)
- 3.2 *Acceptance Sampling and Testing* – Sampling and testing performed by the agency, or its designated agent, to evaluate the acceptability of the final product. Also called “verification sampling and testing” when specifically used to validate the contractor’s data. (AASHTO R 10)

- 3.3 *Accredited Laboratories* - Laboratories that are recognized by a formal accrediting body as meeting quality system requirements including demonstrated competence to perform standard test procedures. (AASHTO R 10) For CDOT, accredited means recognition by the AASHTO Accreditation Program (AAP).
- 3.4 *Certified Technician* – A technician certified by a CDOT recognized agency as proficient in performing certain duties. [A certified technician is considered to be qualified. A qualified technician may or may not be certified.] (AASHTO R 10) CDOT specifies ACI, LabCAT, and WAQTC for the certification of technicians.
- 3.5 *Central Laboratory Samples and Tests* - Random representative samples submitted to CDOT’s Central Laboratory and/or Region Laboratory to additionally evaluate the quality of field produced products and materials, and to perform tests not within the capabilities of the Field and/or Region Laboratories. (CDOT)
- 3.6 *Designated Agent* - An employee or employees of a state, a local agency, consultant, or independent laboratory, which is employed, paid by, and/or directly accountable to CDOT, or a public agency, excludes the contractors’ or vendors’ personnel. (CDOT)
- 3.7 *Dispute Resolution* – Also called “conflict resolution.” The procedure used to resolve conflicts resulting from discrepancies between the agency’s and contractor’s results of sufficient magnitude to impact payment. (AASHTO R 10)
- 3.8 *Independent Assurance (IA)* - Activities that are an unbiased and independent evaluation of all the sampling and testing (or inspection) procedures used in the quality assurance program. [IA provides independent verification of the reliability of the acceptance (or verification) data obtained by the agency and the data obtained by the contractor. The results of IA testing or inspection are not to be used as a basis of acceptance. IA provides information for quality system management]. (AASHTO R-10).
- 3.9 *IA Project Basis* – Based on the quantity, it may provide an easier way to monitor compliance and ensure that all materials are covered on an individual project. This is the normal sampling and testing frequency, per the IA Schedule, for Item 403 [Hot Mix Asphalt (HMA)]. (CDOT)
- 3.10 *IA System Basis* – Typically administered *Region-wide*. *It is personnel-related rather than project-related* and therefore allows easier tracking of individuals. This approach is usually applied on a time-based, rather than on a quantity-based frequency. This is an alternate sampling and testing frequency, per the IA Schedule, for Item 403 [Hot Mix Asphalt (HMA)] where the minimum frequency is based on an expanded unit of material production and a unit of time. (CDOT)
- 3.11 *IA Combination Basis* – To maximize the effectiveness of the IA program, the RME may choose to utilize both the Project and System Basis within their Region. Based on the number, size, location, or Construction phasing of HMA projects, the RME will have the option of choosing either the Project Basis or the System Basis for every project within their Region. If the Combination Basis is used, the RME will document the field tester’s name(s) and the quantity of HMA used for each project. (CDOT)
- 3.12 *Independent Contractor Quality Control (ICQC)* – This term was developed for Design-Build projects whereby the contractor’s test results may be utilized in the acceptance decision. (CDOT)

- 3.13 *LIMS*– Laboratory Information Management System. SiteManager® includes LIMS, which manages and tracks progress through each step of the sample lifecycle to expedite the overall testing process. (See; SiteManager® Materials) (CDOT).
- 3.14 *Owner Acceptance (OA)* – Synonymous with Agency Acceptance; however, Owner Acceptance will be CDOT’s preferred term. See Acceptance Sampling and Testing. (CDOT)
- 3.15 *Owner Verification Testing (OVT)* - The Department has the ultimate responsibility for verifying that the Project is designed and constructed in compliance with the Contract Documents. As such, the Department or its representative will perform owner verification sampling, testing, and inspection, and conduct audits to verify the Design – Build’s (D-B’s) compliance with the approved Plan from the D-B firm. (CDOT)
- 3.16 *Process Control (PC)* – Synonymous with (*and replaces the term*) “Quality Control.” The system used by a Contractor to monitor, assess, and adjust its production or placement processes to ensure that the final product will meet the specified level of quality. Process Control includes sampling, testing, inspection, and corrective action (where required) to maintain continuous control of a production or placement process. (AASHTO R 10) and *to fulfill contract requirements*. (CDOT)
- 3.17 *Proficiency Samples* - Homogeneous samples that are distributed and tested by two or more laboratories. The test results are compared to assure that the laboratories are obtaining the same results. (i.e. as part of laboratory accreditation or round-robin testing). (CDOT)
- 3.18 *Qualified Laboratories* – Laboratories that are capable as defined by appropriate programs established or recognized by each Agency. [Accredited Laboratories are considered Qualified; however, a Qualified Laboratory may or may not be accredited.] Laboratories that participate in a qualification program, approved by CDOT, which shall include provisions for checking testing equipment and maintaining records of all equipment calibrations and verification checks. All testing equipment used to conduct testing shall conform to the standards specified in the testing procedure. (CDOT)
- 3.19 *Qualified Manufacturer* – A commercial or industrial enterprise that uses components, parts or raw materials to make a finished good in compliance with specific CDOT requirements or conditions. (CDOT)
- 3.20 *Qualified Technician* – A technician who has been determined to be qualified (i.e., meeting some minimum standard) to perform specific duties. [A qualified technician may or may not be certified.] (AASHTO R 10)
- 3.21 *Quality Assurance (QA)* – (1) All those planned and systematic actions necessary to provide confidence that a product or facility will perform satisfactorily in service; or (2) making sure the quality of a product is what it should be. [QA addresses the overall process of obtaining the quality of service, product, or facility in the most efficient, economical, and satisfactory manner possible. Within this broad context, QA includes the elements of process control, independent assurance, acceptance, dispute resolution, etc. QA should be used to replace the term “QA/QC or QC/QA.” QA involves continued evaluation of the activities of planning, design, development of plans and specifications, advertising and awarding of contracts, construction, and maintenance, and the interaction of these activities.] (AASHTO R 10)

- 3.22 *Quality Control (QC)* – Synonymous with Process Control (AASHTO R 10) *in construction*. Quality control is still a valid term with respect to Manufacturers. (CDOT)
- 3.23 *Random Locations* – Sampling locations determined by the use of random numbers. (AASHTO R 10)
- 3.24 *Sample* – Also called materials sample when intended to mean: (1) a small physical quantity of material or a measurement obtained in some manner so that the portion (i.e., sample) is representative of the whole, or (2) a quantity of material fabricated in a lab on which future tests can be run. (AASHTO R 10)
- 3.25 *SiteManager® Materials* – AASHTO developed SiteManager®, which integrates the complete construction and materials management process. The SiteManager® Materials Management component provides materials-related information and assists materials laboratory operations for sampling, testing and reporting for all materials. (CDOT)
- 3.26 *Stewardship Agreement, FHWA* – The Federal Highway Administration (FHWA) has stewardship and oversight responsibilities on Federal-aid programs. CDOT has assumed all project approval authority on National Highway System (NHS) projects, excluding the Interstate. The agreement is established through mutual consent and is reviewed annually. (CDOT)
- 3.27 *State Personnel* - An employee or (employees) of CDOT. (CDOT)
- 3.28 *Stratified Random Sample* - A sample in which each increment in the lot has an equal probability of being chosen. [Samples are taken at times or locations chosen by a method not influenced by opinion or judgment, thus eliminating any bias.] (AASHTO R 10) (CP 75)
- 3.29 *Test Result* – The value of a characteristic obtained by carrying out a specified test method. (AASHTO R 10)
- 3.30 *Vendor* - A supplier of project-produced material that is not the contractor. A vendor may or may not be the Manufacturer, but the distributor of a product. (CDOT)
- 3.31 *Verification Sampling and Testing* - Synonymous with Acceptance Sampling and Testing, when specifically used to validate the contractor’s data. (AASHTO R 10) Use of “Project Verification Sampling & Testing Frequency” and “Point of Verification for Quality Determination” in the OA Frequency Guide Schedule for Minimum Materials Sampling, Testing, and Inspection is appropriate because the OA Tester is attempting to validate the contractor’s Process Control data. (CDOT)

**Note 1:** Additional relevant definitions are located in the FMM Appendix.

#### **4. POLICY**

- 4.1 *Quality Assurance Plan (QAP)* – It is the policy of CDOT to have a Plan which will assure that materials, products, and workmanship incorporated in CDOT construction projects, and Local Agency projects, are in conformity with the requirements of the approved plans and specifications, including any approved changes. The program must meet the criteria in 23 CFR, Subsection 637.207 and the FHWA Stewardship agreement.



- 4.2 *CDOT Capabilities* - CDOT shall maintain adequate, qualified staff to administer its Quality Assurance Program. CDOT shall also maintain a Central Laboratory. CDOT's Central Laboratory shall meet the requirements in Sub-section 637.209 (a) (2) of 23 CFR.
- 4.3 *Owner Acceptance (OA) Program* - All factors that comprise CDOT's determination of the quality of the product as specified in the contract requirements. These factors include verification sampling, testing, and inspection and may include results of process control sampling and testing. In the previous terminology, this was called CDOT's QA Program.
- 4.4 *Independent Assurance (IA) Program* - Independent Assurance samples and tests (and observations) or other procedures shall be performed by qualified sampling and testing personnel employed by CDOT or by contract its designated agent, which would be employed by an AASHTO Accredited Laboratory.
- 4.5 *Sampling and Testing* - All samples and tests used in the verification process are to be performed by qualified testing personnel employed by CDOT or its designated agent (employed by a Qualified Laboratory), contractor, and vendor. Also referred to as Quality Assurance (QA) testing.
  - 4.5.1 *Random Samples* – All samples used for verification sampling and testing shall be stratified random samples. Additional samples may be taken at any point in the production for checking quality, but these will not be used for statistical evaluation.
  - 4.5.2 *Test Results* - The results of verification tests will be used in the acceptance decision as specified in the contract requirements and all approved changes.
- 4.6 It will be the responsibility of the Region Materials Engineer (RME), under the direction of the Region Transportation Director (RTD), to implement those portions of the Quality Assurance Program applicable to CDOT Regions.

## **5. SCOPE OF THE QUALITY ASSURANCE (QA) PROGRAM**

- 5.1 The Quality Assurance (QA) Program will provide for:
  - 5.1.1 Owner Acceptance (OA) Program.
  - 5.1.2 Independent Assurance (IA) Program.
  - 5.1.3 Project Materials Certification.
    - 5.1.3.1 Retention of sampling and testing records.
- 5.2 Quality Assurance (QA) Program Evaluation Checks:
  - 5.2.1 Inspection and Accreditation of CDOT's Central Laboratory performed periodically (the number of months per cycle varies) by the National Reference Laboratory utilizing AASHTO R 18.

- 5.2.2 Reviews / Audits conducted biennially by the Central Laboratory and the FHWA (Subsections 7.11 and 11.12.3): Independent Assurance Sampling & Testing Program Review, Finals Materials Documentation Review & Acceptance Process Audit, Maintenance Finals Materials Documentation Review & Acceptance Process Audit, LA Finals Materials Documentation Review & Acceptance Process Audit.

## 6. OWNER ACCEPTANCE (OA) PROGRAM

- 6.1 OA Frequency Guide Schedule for Minimum Materials Sampling, Testing, and Inspection provides general guidance to personnel responsible for the program for each pay item.
- 6.1.1 Identification of the specific location (the point) in the construction or production operation at which verification sampling and testing are to be accomplished.
- 6.1.2 Reference to the specific procedures for Project Verification Sampling and Project Verification Testing.
- 6.2 Project verification sampling and testing through the Owner Acceptance Program will be accomplished and documented on all CDOT construction projects according to the edition of the CDOT Field Materials Manual (FMM) in effect at the time of project advertisement.
- 6.2.1 The Field Materials Manual contains schedules, tables, nomographs, examples, etc. that aid in completing project verification sampling, testing, inspection, and proper documentation.
- 6.2.2 Subsections of the Field Materials Manual contain guidelines for using the CDOT Statistical Sampling and Acceptance Plan.
- 6.3 The results of all project verification (OA) tests will be made available to the FHWA Operations Engineer at the project or residency office when requested.

## 7. INDEPENDENT ASSURANCE (IA) PROGRAM

**Note 2:** The CAR Report Independent Assurance Sampling & Testing Checklist is the name of the document used for all SMM/LIMS projects. For a project not using SMM/LIMS, the CDOT Form 379 will be utilized. Within this Chapter, they are synonymous with intent.

- 7.1 The CDOT Materials Engineer will act in an advisory capacity to the Region Materials Engineer in carrying out this program, and either he or his designee will be the liaison with other CDOT Divisions, other organizations, consultants, designated accredited laboratories, and the FHWA.
- 7.2 The IA Program is an internal program to be administered and performed by CDOT personnel by designated agents from an AASHTO accredited laboratory. **This program is to be applied to all CDOT construction projects, CDOT Maintenance (MTCE) projects, and Local Agency construction projects regardless of whether they are on the NHS or not.**

- 7.3 With respect to non-SMM/LIMS projects, follow the guidelines and instructions in the “IA Frequency Guide Schedule for Evaluation of OA Sampling & Testing”. The Region Materials Engineer will assign an individual from the Region Materials Laboratory to develop the CDOT Form 379, *Project Independent Assurance Sampling & Testing Schedule*. This person will determine the material items and the number of tests required for every project. The Region Materials Engineer, or his designee, will approve the CDOT Form 379 prior to distribution to the Project Engineer (approval signature not required).
- 7.3.1 Where more than one sampling location is permitted, the IA Tester reserves the right to further designate the sampling location.
- 7.3.2 IA System Basis Sampling and Testing on Item 403, if used instead of the Project Basis, should be indicated on Independent Assurance Sampling & Testing Checklist. (Additional information can be obtained in the IA Frequency Guide Schedule for Evaluation of OA Sampling & Testing, Item 403).
- 7.3.3 Sampling, witnessing, testing and equipment checks on a project will be performed by the IA Tester, whether CDOT personnel or CDOT’s designated agent, who has no direct responsibility for project verification (OA) sampling and testing, using equipment other than that assigned to the project. All-Region IA testing of OA samples is to be performed in the Region on independent Region equipment by independent Region personnel. The only exception will be samples of binder or emulsion which will be tested at and by the CDOT Central Laboratory. The IA equipment should be independent of the OA process unless otherwise noted on the Independent Assurance Sampling & Testing Checklist.
- 7.3.4 All personnel performing sampling, observations, and testing on CDOT or Local Agency projects will be qualified personnel as noted in Section 8, *Sampling and Testing Personnel Qualifications*, and/or CP 10, Qualification of Testing Personnel and Laboratories.
- 7.3.5 Project Materials Lab (test trailer) inspections performed prior to construction commencing will review the existence of required equipment and their calibrations or verifications, as well as test procedures and the general organization of the field laboratory. This information will be documented on the CDOT Independent Assurance Sampling & Testing Checklist, listed as Item 620.03, and will show the date of the inspection(s). The inspection will be guided by CP 10 and will utilize the Field Lab & Personnel Qualification Checklist (Form #).
- 7.4 For Local Agency projects on the NHS, CDOT will administer the Independent Assurance testing as if it was a CDOT project.
- 7.4.1 For Local Agency projects not on the NHS, it is required that Independent Assurance testing be performed as stipulated in the CDOT IA Frequency Guide Schedule for Evaluation of OA Sampling & Testing and within the Quality Assurance Procedures Chapter of the FMM. The Local Agency may use their established and documented procedures to independently verify the adequacy of testing equipment and personnel if their program is approved by the FHWA.

- 7.5 State personnel or designated agents employed by an AASHTO designated accredited laboratory, performing IA Sampling and Testing will be limited to witnessing no more than 20% of the QA tests performed. This is defined as no more than 20% of each individual test element. Witnessing more than this limit has the potential of involving the IA Tester in too much of the day-by-day project level responsibilities and activities of the OA Tester. The concept of witnessing testing performed by OA Testers instead of the IA Tester performing the required test is to be minimized as much as possible or completely eliminated.
- 7.5.1 Project inspections performed during construction will check the project (OA) equipment to assure the equipment is adequate for the designated procedure. The equipment will also be checked at that time for the required calibration, if applicable, and that proper documentation of the verification checks are on file. The inspection will be guided by CP 10 and the Field Lab & Personnel Qualification Checklist (Form #).
- 7.5.1.1 The CDOT IA Stamp text which is applied to applicable CDOT forms states the following: **"Equipment used for the sampling & testing was inspected and found to be satisfactory. Sampling & testing complied with CDOT Procedures. IA testing was performed independently of field samples on independent equipment unless noted. Test results were reviewed with project personnel."**
- 7.5.1.2 If any discrepancies to the project equipment are found by the IA Tester, they should be documented and reported to the Project Engineer at the earliest opportunity with a description of the repair or replacement needed. Appropriate notations should be made on the applicable reporting test form or on a separate memo if required.
- 7.6 The IA System Basis for Sampling and Testing may be used in a Region. The testing and sampling frequency will be based on either a unit of production or on a unit of time. (Additional information can be obtained in the IA Frequency Guide Schedule for Evaluation of OA Sampling & Testing, Item 403). If it is used throughout the Region, it should last for the entire calendar year. If it is used for a project, it should be used for the entire project and last for its duration.
- 7.6.1 The Annual Report on Program Wide Independent Assurance Testing of Hot Mix Asphalt Materials using the System Basis will be developed by the Central Laboratory and sent to the FHWA summarizing the results of the IA System Based program, per CFR 23, Subsection 637.207 (2) (iv). The report for the previous calendar year is distributed prior to March 31<sup>st</sup> of the subsequent year.
- 7.6.1.1 Distribution List:  
FHWA - Direct Recipient  
Chief Engineer  
Director of Staff Services  
Regional Transportation Director  
Region Materials Engineer
- 7.7 On CDOT projects the OA testing equipment will be evaluated by using equipment verification checks, testing split samples of verification or proficiency samples, or any combination of methods.
- 7.8 On CDOT projects the OA testing personnel will be evaluated by observation of sampling and testing procedures, along with with testing splits of verification or proficiency samples, or any combination of the methods.

- 7.9 A prompt comparison will be made between the initial test results obtained from the OA Tester being evaluated and the Independent Assurance (IA) Tester, using the guidelines enumerated in the CDOT Field Materials Manual's IA Frequency Guide Schedule for Evaluation of OA Sampling & Testing and Table One Comparison Precision Guide; and then documented as required.
- 7.9.1 Field reviews of IA samples will be documented by signing and dating entries on the applicable test reports by the IA Tester.
- 7.9.2 Initial split-sample test results that agree within the limits of the Comparison Precision Guide from the IA Frequency Guide Schedule (Table One) will not require any comments on the reporting form. Minor Differences do not need to be investigated.
- 7.9.3 If the initial split-sample test results have "Significant" Differences, the Region Materials Engineer or his designee will conduct an investigation to determine the probable cause of the difference.
- 7.9.3.1 This investigation may be as simple as having all testing personnel run their retained split of the sample. The results of the Region Materials Engineer's investigation must be documented on the appropriate CDOT form listed in the Schedule. The statement must reference the exact "difference", the cause of this difference, and the corrective action taken to remedy the issue. If necessary, the investigation may be attached to the appropriate form.
- 7.9.3.2 Prompt and appropriate action will be taken by the Project Engineer to correct or improve sampling and/or testing methods if the need is indicated.
- 7.9.4 The Project Engineer makes acceptance decisions based on verification (OA) sampling and testing, and factors relating to the quality of the material or product. What should not be incorporated into these statements is a recommendation for an acceptance decision at full price. IA testing is not for the purpose of verifying the quality but meant to evaluate personnel and to check equipment. However, these test results may be used by the Project Engineer to support his decisions.
- 7.10 When all IA sampling and testing on the project is completed per the Independent Assurance Sampling & Testing Checklist, the Region Materials Engineer will certify through his Final Approval that: **"The Project Independent Assurance Sampling & Testing Schedule developed for this project has been substantially followed and the test results of the IA samples are within "Minor Differences" of the project acceptance sample test results."**
- 7.10.1 Exceptions to this statement, such as "Significant Differences", have been previously commented on and documented when the test results were reported or are explained on this form or on an attached sheet. The Independent Assurance Sampling & Testing Checklist may include supplemental attachments.
- 7.10.2 The Independent Assurance Sampling & Testing Checklist will be forwarded to the Project Engineer for acknowledgment through his Project Review signature.
- 7.11 A review of each CDOT Region's IA Sampling and Testing Program will be performed every two years, at a minimum, by Central Laboratory Personnel and the FHWA. The purpose of the review will be the verification of compliance with 23 CFR, Part 637, Quality Assurance Procedures for Construction, and the applicable Sections of the CDOT Field Materials Manual.

- 7.11.1 The Biennial Independent Assurance Sampling and Testing Program Review with the Region Materials Engineer will be conducted to check IA program compliance, document problems, document current inclusion of CDOT MTCE projects and LA projects into the program and observe Region-by-Region uniformity. A minimum of two weeks, notice will be given to the Region Materials Engineer. Information on inspections is located in the Inspection (Central-to-Region) Chapter.
- 7.11.2 The findings and recommendations of the review will be discussed with the CDOT Materials Engineer and will be reported to the FHWA.
- 7.11.3 Distribution List:
- FHWA - Direct Recipient
  - Chief Engineer
  - Director of Project Support
  - Regional Transportation Director
  - Region Materials Engineer

## **8. SAMPLING and TESTING PERSONNEL QUALIFICATIONS**

- 8.1 The Code of Federal Regulations (23 CFR) requires that persons conducting tests used in the acceptance decision or in IA inspections be qualified. This includes employees of CDOT and designated agents conducting verification (OA) testing, PC testing used in the acceptance decision (PC-For-Pay) by contractor and vendor employees, and IA testing by employees of CDOT or designated agents of CDOT. The requirements that must be met for an employee to be qualified are defined in CP 10 of this manual.

## **9. LABORATORY QUALIFICATION PROGRAM**

- 9.1 23 CFR requires that laboratories conducting tests used in the acceptance decision or laboratories conducting IA testing be qualified. This includes CDOT and designated agent laboratories conducting verification tests plus contractor and vendor laboratories conducting PC testing used in the acceptance decision. These laboratories are inspected by the Region Materials Laboratory or a designated agent selected by the Region Materials Laboratory before project testing begins. The procedures for conducting inspections are described in CP 10 of this manual.
- 9.2 23 CFR requires that the CDOT Central Laboratory be accredited by AASHTO. Designated agents conducting IA sampling, testing, and inspections for CDOT must also be accredited by AASHTO. The detailed accreditation requirements are in CP 10 of this manual.
- 9.2.1 Qualifications:
- 9.2.1.1 Central Laboratory and designated agents: The CDOT Central Laboratory and designated agents shall be AASHTO accredited.

9.2.1.2 **Annual Region Materials Laboratory Inspections:** Central Laboratory personnel shall perform an inspection of each CDOT Region Materials Laboratory annually.

The CDOT Region Materials Laboratories are:

- Region 1: Denver & HMA Mobile Lab
- Region 2: Pueblo & HMA Mobile Lab
- Region 3: Grand Junction & HMA Mobile Lab
- Region 4: Evans & HMA Mobile Lab
- Region 5: Durango, Alamosa & HMA Mobile Lab

Other permanent laboratories within the Regions are considered Project/Field Laboratories.

9.2.1.3 The Annual Region Materials Laboratory Inspections protocol is located in the Inspection (Central-to-Region) Chapter.

9.2.2 **Equipment Verification Checks:** All laboratories performing IA testing shall conduct verification checks at the minimum frequencies required by the test procedure, equipment operating guides, or Verification schedule included in the Field Materials Manual's Inspections Chapter. The results of the equipment verification checks shall be recorded on CDOT Form 520 and retained for a period of seven years. When testing HMA, the appropriate calibration checks specified in CP-L 5101 shall be used.

9.3 **Verification Testing:** CDOT Laboratories or their designated agent shall be allowed to perform verification testing if they meet the following requirements. All requirements include the verification of testing equipment function, review of equipment maintenance, and review of the records of all equipment calibrations and verifications.

9.3.1 **Annual Inspection:**

9.3.1.1 **CDOT Laboratories:** The Region Materials Laboratory shall conduct a check of project testing Field Laboratory equipment. The Central Laboratory may also conduct random Field Laboratory equipment inspections during project construction. The Resident Engineers, in cooperation with the Region Materials Engineer, shall be responsible for assuring that CDOT owned project testing equipment is acceptable for verification (OA) sampling and testing.

9.3.1.2 **Designated Agent Laboratories:** The Region Materials Laboratory or their designated agent shall conduct a check of project testing laboratory equipment. The Central Laboratory may also conduct random Field Laboratory equipment inspections during project construction. The Region Materials Engineer shall be responsible for assuring that project testing equipment is acceptable for verification (OA) sampling and testing.

9.3.2 **Equipment Verification Checks:** All laboratories performing verification (OA) testing shall conduct equipment verification checks on all testing equipment used. The results of the verification checks shall be recorded on CDOT Form 520 and retained for a period of seven years. When testing HMA, the appropriate verification checks specified in CP-L 5101 shall be used.

9.3.3 If the actual laboratory in which the verification tests are performed holds current AASHTO accreditation, it shall be exempt from the requirements of Subsection 9.3.1 and 9.3.2.

9.4 Round Robins are conducted every year during the winter season. It provides all participating laboratories the opportunity to look at their test procedures and test results in relation to other labs.

9.4.1 The Round Robin protocol is located in the Inspection (Central-to-Region) Chapter.

## **10. LABORATORY ACCREDITATION**

10.1 CDOT's Central Laboratory must be accredited. 23 CFR Part 637 requires that designated agent laboratories conducting IA testing be accredited. Accreditation requirements are detailed in CP 10 of this manual.

10.2 Central Laboratory Inspection. The CDOT's Central Laboratory will be inspected periodically by the AASHTO Accreditation Program utilizing laboratory assessment and proficiency sample services provided by AMRL and CCRL.

10.2.1 The AMRL and CCRL statistical reports and the report on Central Laboratory inspection will be reviewed by the CDOT Materials Engineer and Central Laboratory Program Managers, and copies will be furnished to the FHWA.

10.2.2 Any deficiencies in Central Laboratory procedures or equipment will be corrected at the earliest opportunity, and corrective actions documented when directed and furnished to the appropriate National Standards Reference Laboratory, and with copies furnished to the FHWA.

10.2.3 Any AASHTO Proficiency Sample(s) which have a rating of less than 3 (>2.0 Standard Deviations), will be reviewed by the CDOT Materials Engineer and Central Laboratory Program Managers. The cause of the low ratings will be investigated and corrective action will be taken to prevent future occurrences. These actions will be reported, in writing, to AASHTO - AMRL- CCRL, with copies furnished to the FHWA, within 60 days of the date of AMRL- CCRL inspection.

## **11. PROJECT MATERIALS CERTIFICATION**

11.1 A CDOT Owner Acceptance Sampling & Testing Checklist (CAR Report 250) will be developed by the Documentation Unit of the Materials and Geotechnical Branch for all projects regardless if they are administered by CDOT or by a local agency. On Design/Build projects the Engineer shall send the list of pay items and approximate quantities furnished by the Contractor to the Documentation Unit of CDOT Materials & Geotechnical Branch as soon as it is received.

11.2 The CDOT CAR Report 250 will list the minimum sampling and testing requirements for each product or material bid item, for both, verification (OA) tests and laboratory check tests. The original CAR Report 250 will remain in the Staff Materials project file with duplicate copies being distributed to the Region Materials Engineer, Resident Engineer, Project Engineer, or the Region's Local Agency Coordinator.

11.3 The Engineer will document actions taken by project personnel concerning acceptance decisions based on verification (OA) sampling and testing. Acceptance decisions include price reductions, corrective actions or removals, dispute resolution, etc.

11.4 The results of laboratory check tests will be evaluated using the same criteria detailed in Table One, IA Frequency Guide Schedule. They will be reported to the project personnel as follows:



- 11.4.1 Meets Acceptance Decision Criteria based on verification (OA) sampling and testing.
- 11.4.2 Minor Difference from Acceptance Decision Requirements: No further action required.
- 11.4.3 Significant Differences from Acceptance Decision Requirements: Further action is required.
  - 11.4.3.1 When laboratory check test results do not agree with the contract requirements, whether the check tests are performed at the Central or Region Laboratory, project personnel will be notified, and the reports, by computer reporting, will be forwarded as soon as possible.
  - 11.4.3.2 The Project Engineer will investigate these Significant Differences and attempt to determine why the verification tests did not correlate with the check tests. The Engineer will determine and document the reason for the deviation or difference, and any corrective action taken.
- 11.5 The Project Engineer will document all project materials sampling and testing through the completion of the CDOT SM Report 250 and by signing and dating the last page.
- 11.6 The Region Materials Engineer will furnish the Project Engineer with a signed copy of the CDOT Independent Assurance Sampling & Testing Checklist, *Project Independent Assurance Sampling & Testing Schedule*. The responsibility for the review and completion of the CDOT Independent Assurance Sampling & Testing Checklist through to the final approval will reside with the Region Materials Engineer, as per Subsection 7.3 and 7.10.
- 11.7 In order to make the Final Materials Certification process more efficient it has been decentralized; therefore, the Final Materials Certification for each project is to be completed by Region personnel.
  - 11.7.1 Final Materials Certification. The three applicable Documentation Chapters of the Field Materials Manual provides specific guidelines for the completion of this aspect of the program.
- 11.8 The Project Engineer reviews and signs the developed CDOT Form 473, *Letter of Final Materials Certification*, both Page 1 and 2.
- 11.9 The Resident Engineer certifies on the CDOT Form #473, *Letter of Final Materials Certification*: The results of the tests on the acceptance samples indicate that the material incorporated in the construction work, and the construction operations controlled by sampling and testing, were in conformity with the approved plans and specifications; and such results compare favorably with the results of the Independent Assurance sampling and testing. The signed Form 473 includes all of the following attachments:
  - 11.9.1 A copy of the Final Materials Certification -Explanation of Exceptions, Form 474. |
  - 11.9.2 A copy of the Independent Assurance Sampling & Testing Checklist.
  - 11.9.3 A copy of the Final Materials Documentation Checklist, (Project Closure), Form 1199 Page 1. (This is not required for SiteManager® projects).
  - 11.9.4 A copy of the Finals Materials Documentation Checklist, (Review or Audit), Form 1199 Page 2. (This is not required for SiteManager projects).

- 11.9.5 A copy of the CP 16, Evaluation of Materials Testing, Form 1324 (when applicable).
- 11.10 The Letter of Final Materials Certification (Form 473) will be distributed per the instructions in the applicable Documentation Chapter of this Manual. If any part of the CDOT Form 250 is used to explain exceptions or deviations of product or materials, that part must be attached to the completed Form 474, Explanation of Exceptions. If any of the last five sections [Documentation for Added Materials Items, Documentation for Deleted Materials Items, Summary of Laboratory Check Test Deviations, Summary of Sampling and Testing Deviations, and Summary of Project Price Reduction Documentation] contain information then these pages must also be attached.
- 11.10.1 The Explanation of Exceptions will address all materials deviations from the plans and specifications and the subsequent action taken, as well as any comparison differences between Quality Assurance test results and Independent Assurance test results, and any missing tests.
- 11.11 The Region review process for a completed construction project's materials documentation is that each Region will follow the guidelines as defined in the Documentation Chapter.
- 11.12 The CDOT Materials Engineer will establish a Materials Documentation Quality Review Team to audit each Region's Finals Materials Review and Acceptance Process.
- 11.12.1 The Materials Documentation Quality Review Team will consist of representatives from the Central Materials Laboratory and the FHWA, if they choose to participate, meeting with the CDOT Region Materials Engineer, the Region Finals Administrator, the Region Finals Materials Documentation Coordinator, and the Region LA Coordinator. The Region may invite other interested and knowledgeable individuals.
- 11.12.2 An audit of each CDOT Region's Finals Materials Documentation Process will be performed every two years, at a minimum. The audit will utilize both a questionnaire and an audit of a minimum of two randomly selected completed projects. This process will apply to the CDOT construction and MTCE programs and LA programs.
- 11.12.2.1 Additional reviews may be scheduled as deficiencies are identified and to accommodate contract dollar volume per Region.
- 11.12.3 The **Biennial Finals Materials Documentation Review and Acceptance Process Audit** with the Region Materials Engineer is to ensure compliance with the requirements of the Documentation Chapters of the Field Materials Manual and to identify areas for potential improvement. The **Biennial Local Agency Finals Materials Documentation Review and Acceptance Process Audit** with the Region LA Coordinator is to ensure compliance with the requirements of the Documentation Chapter of the Field Materials Manual and to identify areas for potential improvement. A minimum of four weeks of notice will be given to the Region Materials Engineer, the Finals Administrator, and LA Coordinator to provide a list of all applicable closed out projects. A minimum of ten days will be provided for the selected projects to be made available.
- 11.12.3.1 The findings and recommendations of the audit will be discussed with the CDOT Materials Engineer and will be reported to the FHWA.

**11.12.3.2 Distribution List:**

FHWA - Direct Recipient  
Chief Engineer  
Director of Project Support  
Regional Transportation Director  
Program Engineer  
Resident Engineer  
Region Materials Engineer  
Maintenance Superintendent  
State Maintenance Engineer

**12. MAINTAIN QA PROGRAM REQUIREMENTS**

- 12.1 It will be the responsibility of the CDOT Materials & Geotechnical Branch to maintain and periodically update the QA program as required.
- 12.2 The CDOT Materials Advisory Committee (MAC) will meet, as required, to review the Quality Assurance Procedures and recommend revisions.

**13. FIELD MATERIALS DOCUMENTATION**

- 13.1 It is the responsibility of the Project Engineer to accept or reject materials and/or products based on documentation submitted at the project level. The Central Laboratory personnel will act only in an advisory capacity to the project personnel in determining the acceptability of a product or material unless otherwise stated.
- 13.2 All Materials Forms must have the appropriate Project Number and Contract ID easily identified on them.
- 13.2.1 Project Number: The Alpha-Numeric project identifier that incorporated the highway number.
- 13.2.2 Contract ID: This is a five-digit numeric designator. (Prior to SiteManager® it was referred to as Project Code).
- 13.2.3 Sample ID: All testing and certification documents shall have the SMM/LIMS Sample ID on the document or the first page of multiple pages.

**Note 3:** As accounting processes change, the project information identifiers may also change. Personnel should be aware of the most current method.

- 13.3 All document and reporting Forms must be dated and signed by the appropriate and specified personnel.

**Note 4:** A Materials Bulletin will be issued with the revised text for Subsections 13.4 through 13.4.4. The guiding document will be Procedural Directive 21.1.

13.4 In order to comply with adequate field documentation as stated in the CDOT Construction Manual, project field worksheets should be handled in the following manner:

13.4.1 The first Form will have a printed name and signature.

13.4.2 Thereafter the Form can be initialed by the same person instead of applying a signature.

13.4.3 If at any time the project personnel is changed, the above process will be started over.

13.4.4 The final worksheet in any series of testing for any pay item will have the last Form signed, rather than initialed.

13.5 Where predominately computer forms or worksheets are being used on a project, sufficient information will be available in the project records to determine the responsible party performing the sampling, testing, documentation, and record-keeping.

#### **14. DISTRIBUTION OF MATERIALS RECORDS and RETENTION OF SAMPLING and TESTING RECORDS**

14.1 All originating materials (original document) records for construction projects are to be kept in the project file in the Region. These include, but are not limited to, COCs, CTRs, and all Forms that document test results for acceptance of materials or products used on construction projects.

14.2 These records may be made available to the public through a written request on CDOT Form 1092, *Request to Inspect Public Records*.

14.3 The appropriate Forms that aid in the identification of samples and provide instructions for testing of samples will either be processed electronically for a SiteManager<sup>®</sup> applicable project or if it is not a SiteManager<sup>®</sup> project the appropriate form will be attached to each individual sample submittal addressed to the appropriate laboratory.

14.4 The Central Laboratory personnel will provide acceptance details on products and materials that are stated in the OA Frequency Guide Schedule or other applicable documents that state the Central Laboratory is directly involved.

14.4.1 Do not send copies of product or materials forms, or associated documentation to any Staff Branch unless it is specified on the Form distribution or specifically addressed to do such in the Field Materials Manual.

14.5 Copies of product and/or materials reports for acceptance decisions and IA reports will be retained for all CDOT projects at the designated Region office for the period specified in CDOT's Records Retention Procedural Directive.

#### **15. TRAINING PROGRAMS and SEMINARS for CDOT PERSONNEL**

15.1 Region Materials Training Programs. Formal training courses in materials sampling and testing will be conducted in each Region as needed, by the Region Materials Engineer for new state personnel that is assigned to construction projects.

15.2 Annual refresher courses will be conducted on an as-needed basis in each Region by the Region Materials Engineer for CDOT personnel involved with construction products and materials sampling and testing.

- 15.3 Statewide Materials Training Programs: The Central Laboratory will conduct training programs on an as-needed basis in specific areas of materials engineering properties intended to address statewide concerns. This may include the sampling of materials and testing procedures. Central Laboratory personnel are also available to participate in Region training programs when requested.
- 15.4 Materials engineering conferences may be scheduled by the Central Laboratory. Participants may include representatives from Region Materials and Region Construction Offices as well as Central Laboratory Program Managers and personnel from other Staff Branches. Each Region Materials Engineer may submit items during the construction year for the agenda.
- 15.5 The Concrete Unit of the Central Laboratory will define, coordinate, and support a program for CDOT personnel to assure the accuracy and conformance of compressive strength testing of concrete cylinders. The program shall include equipment checks, procedure checks, inter-lab testing, training, and ACI certification. The details of this program are in Chapter 600 of the Field Materials Manual.
- 15.6 The Nuclear Unit of the Central Laboratory will present the *School of Radiological Safety and Nuclear Gauge Operation* on a biennial basis for re-certification of materials testers, or annually as needed for new employees.

## **16. TERMINOLOGY AND ABBREVIATIONS**

- 16.1 Titles having a masculine gender, such as he, his, him, are utilized for the sake of brevity and are intended to refer to persons of either sex.
- 16.2 Whenever an abbreviation is used, it is to be construed to be the same as the respective expression.
- 16.3 Whenever an acronym is used, it is to be construed to be the same as the respective expression.
- 16.4 Whenever the title, the Engineer, is mentioned it refers to the Chief Engineer of the Department acting directly or through an authorized representative, who is responsible for engineering and administrative supervision of the project.
- 16.5 The Staff Materials & Geotechnical Branch, Staff Materials, the CDOT Materials Lab, and the Central Laboratory are all synonymous with respect to this publication; however, the CDOT Central Laboratory is a national reference and the Staff Materials & Geotechnical Branch is a CDOT administrative reference.

## **17. EXAMPLES**

- 17.1 Examples of the CDOT Form 250 (first and last three pages only), 379, 473, 474, and 1199 (Page 1 & 2) referenced in this chapter can be found in the applicable Documentation for SMM/LIMS Chapter.
- 17.2 An example of CDOT Form 520 referenced in this chapter can be found in the Inspections (Central-to-Region) Chapter.
- 17.3 An example of CDOT Form 1092 is not provided in this Manual; however, it may be obtained through the CDOT Forms Catalog.

{Page Intentionally Left Blank}

## **Documentation for SiteManager® LIMS Project Materials to Final Materials – 21**

### **1. SCOPE**

The intent of this chapter is to provide the Region personnel guidance on materials documentation from the beginning of a project to the closure of the project files when using SiteManager® Materials and the Laboratory Information Management System (SMM/LIMS). The materials documentation on a project needs to be accurate, complete and processed within the official established timeframe after the issuance of the project's Final Acceptance Letter per Section 105.21(b). The Department has stipulated that the Final Material Certification Checklist (Form 473 SMM) located on the CDOT Forms website, will be signed electronically by the Region Independent Assurance representative, Region Materials Engineer, Project Engineer, Project Tester, and the Resident Engineer within 30 calendar days of the project's acceptance to ensure that the quality of the project is maintained and to avoid legal and contractual conflicts.

### **2. GENERAL REQUIREMENTS**

The procedures referenced are to be followed as indicated for CDOT projects' electronic documentation. The materials documentation procedure begins at the Materials and Geotechnical Branch in the Documentation Unit with the creation of the Materials Documentation Records, CAR (CDOT Application for Reporting) Reports. These reports are as follows:

- CODE – Project Material Items Report
- Checklist – Owner Acceptance Sampling & Testing Checklist
- Checklist – Certification Checklist Report

The Region Materials Laboratory will review and edit the:  
Independent Assurance Sampling & Testing Checklist (Form 379)

Materials Documentation records are to be prepared and reviewed as found in this chapter. Details on documentation procedures for project items are contained in the applicable sections of this manual, and they cover most situations encountered, but exceptions may require special attention.

### **3. CDOT PROJECTS – RESPONSIBILITIES & PROCEDURES**

The Project Engineer, as the representative of the Chief Engineer, is responsible for the documentation of the material on a project. The Project Engineer shall take measures to ensure that the documentation procedures of the Department and the Region are followed. All referenced documentation activities within Sections 3.1, 3.2, and 3.3 of this chapter, are the responsibility of the Project Engineer or designee.

### 3.1 BEFORE CONSTRUCTION

**Existing users of SiteManager® Materials/LIMS.** The Finals Administrator can grant contract authority at any time. If the consultant is a New User to SiteManager® Materials/LIMS. Contract authority cannot be given until the consultant has been granted access from OIT to eVPN, SMM/LIMS, and the CDOT SAP NetWeaver Portal (CAR). Allow a minimum of 20 business days for access. Once notified that access has been granted the Project Engineer must contact the Region Finals Administrator requesting project personnel be given Contract Authority for the project.

#### **Access to the CDOT Applications**

All users requiring access to CDOT applications must be completed in the CDOT Portal by the CDOT hiring manager. This is typically the Resident Engineer or the CDOT Project Engineer. All Users must complete the forms and submit them to the hiring manager. The hiring manager will input the information into the CDOT Portal and attach the forms.

**Consultant new users shall use their companies' Non-Project Specific (NPS) contract number and end date when requesting access.**

**New User** - are all users who do not have a SiteManager or VPN USER ID. New users will complete the Statement of Compliance - VPN Request Access Request form and the SiteManager Access agreement form. These forms require the consultant's signature (electronic) and other information. Submit the forms to the CDOT hiring manager for their signature and the Resident Engineer's signature.

**Existing User that has an expired VPN account** – If a user's VPN account has been closed, the user must complete both forms and submit them to the CDOT hiring manager.

Existing users will need to complete the form "Site Manager Access Agreement" and obtain the Resident Engineer's signature on the form. Inform the Resident Engineer that the Existing User will be completing the OIT Service Portal to update the consultant's NPS contract number and end date in order for access to continue. The Resident Engineer will receive an email alerting them that there is a ticket that requires their approval. The Resident Engineer will need to access the OIT Service Portal and complete the approval for the renewal for access for the consultant.

Instructions to complete the update in the OIT Service Portal can be found here:

<https://sites.google.com/a/state.co.us/sitemanager-materials/home>

Look in "Hints, Guides, and Links" for "How to update access in the OIT Service Portal"

Consultants can renew/update their access to the OIT Service Portal at this link.

<https://oitservicedesk.state.co.us/web/frontoffice/login?redirect=/portal>

1. Review the Project Plans, Project Special Provisions (PSP), and Standard Special Provisions (SSP) to become familiar with any modified materials and testing procedures.



2. Review the CAR report – **Project Materials Item Report**. An item that has a red code of **No Testing Assigned** is a flag for the project tester. The project tester shall investigate the item in the PSP, SSP, plans, and FMM, to determine what materials and tests will be required to complete the item. This information must be conveyed to the Central Lab Pavement Design Program or the Region Lab Manager. The materials codes, tests, and frequencies shall be added to meet the testing specifications.
3. Review the Owner Acceptance Sampling & Testing Checklist and Certification Checklist Reports to ensure that sampling frequencies, material codes, and tests represented by each item match the Project Special Provisions and the Field Materials Manual. Any deficiencies or errors must be documented and reported by e-mail to the Pavement Design Program at North Holly to have corrections made. Example #1: Item 411 Emulsion - the contractor is using SS-1H, the Certification Checklist under Item 411 has CSS-1H material code. The material code will need to be changed to reflect the correct product being used. Example #2: Item 304 ABC Class 6 Special, the Owner Acceptance checklist lists the material code (703.03.08.00) for aggregate ABC, the Project Special Provision (PSP) for this item states that recycled concrete, recycled asphalt or a blend of recycled asphalt/aggregate can be used if it meets the gradation specification listed in the PSP. The contractor states they will be using 2 stockpiles of material. One is recycled concrete (703.03.10.00) and the other is RAP/aggregate blend (703.03.15.00). Both material codes for these stockpiles will need to be added under the item, and the aggregate ABC material code will need to be removed as that product will not be incorporated into the project. Tests required for each material shall reflect the requirements of the PSP. The Project Engineer shall be aware of the types of tests required and the frequencies of each test that the project Owner Acceptance tester will be performing
4. The Region Materials Engineer or designee will notify the Project Engineer that the Independent Assurance Sampling & Testing Checklist (Form 379) has been reviewed and is available in CAR. The Project Engineer shall be aware of the type of tests and frequencies of these tests that the Independent Assurance (IA) tester is required to perform. It is the Project Engineer's or designee's responsibility to notify the Region Material Engineer's Independent Assurance technician of upcoming materials that will require Independent Assurance sampling and testing.
5. Project Tester shall set up the Project Materials Electronic Folder to store the documentation for the project. **See the example of electronic folders for documentation on page 36 of this chapter (Addendum 3)**. Follow the format in Organizational Guide for Project Material documentation in Section 8.0. **Binders and hard copy documents are not required.**
6. All documentation pertaining to each sample record shall be uploaded into the attachment icon. This must be completed before the sample record is Authorized and Complete in the LIMS window – Review Sample. All documentation must have the Sample ID clearly recorded on each form/worksheet. This includes all CDOT forms and worksheets either completed electronically or handwritten. Hard copies are not required to be retained.

7. Samples submitted to the Central Laboratory do not require a hard copy of the CDOT Forms 157, 82, 83, 84, 411, and 1304 to be submitted with the sample if an email is shown on the form for the lab unit receiving the sample. Email the completed form to the appropriate lab's email address.

In the e-mail Subject line enter: Contract ID, CDOT Form #, Field Sheet # and Lot # if applicable  
Example:C12345 Form 411 # 4115 Lot #5).

Note: Sample IDs are required to be clearly documented in each form.

8. CDOT forms and worksheets can be found on the CDOT website at this location:

<https://www.codot.gov/library/forms>

Forms and worksheets must be downloaded to your computer. It is recommended to download forms and worksheets before beginning a new project as these documents are updated throughout the year

Note: Do not fill out the form directly from the website in your web browser.

CDOT forms and worksheets are not all available as electronically fillable at this time. Non-fillable forms and worksheets must be downloaded from the CDOT website, printed and completed manually. If the document is not uploaded into the attachment icon, it must be kept in the project files until the Materials Final Documentation Coordinator has accepted the Materials documentation as Final.

9. Review the Chapter in the Field Materials Manual - Special Notice to Contractors. Alert the contractor to the requirements of this chapter and the materials that will require the submittal of a Contractor's APL Verification (AV) Letter and the CDOT Form 595 representing the material. Ensure the contractor is aware of the items that will require submittals for Certificate of Compliance (COC) or Certified Test Report (CTR). Create an Excel spreadsheet to track the COC/CTR's required, received, and accepted or rejected. This spreadsheet can be used to notify the contractor and Project Engineer of the status of submittals. **See the example in this chapter (Addendum 3).**
10. Attend pre-construction, pre-pave, pre-pour, scheduling, and Owner Acceptance (OA)/Process Control (PC) meetings.
11. The contractor shall submit at the Preconstruction meeting a list of proposed materials and the manufacturer of each material. Project personnel must evaluate that the proposed materials are on CDOT's Approved Products List (APL) or Qualified Manufacturers List (QML) for applicable items, per CP 11. CDOT's Approved Products List can be found using the following link.

<https://www.codot.gov/business/apl>

12. Materials supplied to the project that is not required to be selected from the CDOT's APL or QML – must meet the requirements for documentation of the CDOT Standards and Specifications, Section 106.12 and 106.13. The Project tester shall confirm that the Producer/Supplier (P/S) of the materials are in SiteManager® (SM) within the Producer/Supplier list. The material codes for the materials they produce must be associated with that P/S under Producer/Supplier Materials. For any P/S and associated material codes that are not in SM, use the form “Add Producer/Supplier/Material Code” found at the following link, under the tab “Hints, Guides, and Links”, and submit the completed form to the Region Materials Lab Manager or the Pavement Design Program at Central Lab - North Holly. Contact information can be found in “Contacts” at the link below. Open the link in Chrome or Edge. Do not use Internet Explorer. Download documents from this site to your computer. Open your Download folder and save the documents to your computer.

<https://sites.google.com/a/state.co.us/sitemanager-materials/>

13. Develop Random Sample Schedules as per CP 75 for each item requiring random sampling. Random sampling schedules are required for all materials. Excel spreadsheets can be used to generate random schedules. Schedules must be created for the entire item quantity before construction begins. Random Sampling Schedules can be accessed from the SMM site listed in #12, on the home page. The creation of daily random schedules is not acceptable. Do not share the random schedules with the contractor or PC tester.
14. Obtain from the contractor, any proposed concrete mix designs to be used on the project. Submit all required documentation electronically for mix design approval with a completed CDOT Form 1188 to the Concrete Unit at North Holly. Obtain the most recent CDOT Form 1188 at <https://www.codot.gov/library/forms>. **A concrete mix shall not be allowed to be placed on the project until the Concrete Unit has reviewed and approved the mix for the project and the CDOT Form 1373 has been issued.** A CDOT Form 1373 must be issued for mixes from the CDOT Pre-Approved Concrete Mix Designs list and all new concrete mix designs. The CDOT Form 1373 shall be given to the contractor/supplier for the concrete batch tickets to reflect the correct CDOT concrete mix ID.
15. Determine the requirement of aggregate samples to be submitted for Asphalt Job Mix Formula approval per CP 52. Contact the Region Materials Engineer to determine if sampling is necessary or if the materials have been recently tested for another project. It is recommended that enough samples be taken for Central Lab and any labs that will be performing correction or correlation testing for asphalt content. This includes the PC testing firm. Samples shall be combined and split to minimize variations. For information to submit aggregate samples per CP 52, see the instructions CP 52 Submittal Guide. (In the Hints, Guide, and Links tab.) This document can be found at <https://sites.google.com/a/state.co.us/sitemanager-materials/>
16. Coordinate with the Project Engineer, contractor, and PC technician to schedule a pre-testing meeting. Follow CP 16, Pre-Testing Meeting Agenda (CDOT Form 1322) if applicable.

17. Check the CDOT Forms website to download the most recent revision of any forms to be used on the project. Forms previously serialized can be found on the CDOT Forms website. Access to the previously serialized forms is under the menu “CDOT Resources” – Forms Serialized. These forms will require the project to establish field sheet numbers unique to the project. The process will be a 10 digit field that starts with the five digits of the contract ID, not using the “C”, followed by a “dash” followed by a 4 digit sequential number. The project materials personnel shall develop a list of 4 digit sequential numbers. Careful documentation must be done to strikeout numbers that have been used. Groups of numbers may be established for each item estimating the needed amount based on quantities. Numbers 0001 to 0099 are **NOT** to be used by the field testers. These are reserved for the Region Labs. Instructions for the serialized form protocol is available in the chapter Materials Forms - Instructions & Examples.

### 3.2 DURING CONSTRUCTION

1. Samples obtained for preliminary testing, approval for use, and meeting the requirements of 1 per project / 1 per source ARE NOT to be counted toward meeting the sampling and testing requirements for OA tests for Gradation, Atterberg Limits, and Soil Classification.
2. Sample and Test according to the Random Sample Schedule (CP 75) for each applicable item. Be aware of the frequencies of tests on the Owner Acceptance Sampling & Testing Checklist Report.
3. Communicate daily with Project engineers and inspectors about placed quantities, activities, planned production, and material deliveries to ensure inspection and testing frequencies are met.
4. Project Engineer shall communicate with all project personnel the field-adjusted quantities from Contract Modification Order (CMO) and Minor Contract Revisions (MCRs). When CMO or MCRs involve materials that will need to be tested, the Project Engineer must update the items as soon as possible for the tester to access the necessary information to begin the testing.
5. When a CMO or MCR is approved and the Project Engineer has updated the items or quantities in SiteManager®, the CAR reports will automatically reflect the changes. Verify the materials, material codes, tests and testing frequencies for these added items are correct. Notify the Region Lab Manager with any concerns.
6. Alert the Region Material Engineer’s IA technician of CMO or MCR’s that include changes for revised quantities and/or added materials to assist them in verifying the changes appear on the CAR Report - Independent Assurance Sampling & Testing Checklist (Form 379).
7. Complete and file in the appropriate folder/subfolders all daily worksheets or CDOT Forms in the Project Materials Electronic Folder. Document Sample ID’s on each worksheet and/or CDOT Forms to identify the record.

**Note: Summary forms such as CDOT Form 6, 58, 69, 156, 212, 323 are not required.**

8. Complete documentation daily in SiteManager® Materials for sample record entries.
9. In LIMS, enter test results as soon as they become available.
10. Test results entered into LIMS **must be reviewed thoroughly** in the LIMS windows – **Review Test** and **Review Sample**. It is unacceptable for test results to be passed through these windows without a detailed review. The project tester will complete the review in these windows to verify data entry and accuracy of results.
11. Field Testers shall **not** Authorize and Complete or Void any sample records that are not in the Statewide Field when in the LIMS window “Review Samples”. To eliminate this issue, field testers shall set their filter to “Lab Unit” and “FieldLab”. **FieldLab** must be input exactly as shown, click the “Apply” button. It is the responsibility of all the other lab managers to review and authorize samples in their labs. This setting will allow the field tester access to samples that are in the statewide field lab and no other samples. This filter will not change after logging in and out.
12. For HMA, SMA and concrete paving sample records, it is advisable to **NOT** Authorize and Complete in LIMS –Review Sample window, the last 2-3 samples for each mix design and **all** longitudinal joint cores. These records shall be reviewed thoroughly for correct test result entries in the Review Test window. Leaving the sample records in the Review Sample window allows the tester to access the records to edit the quantities to reflect the final quantities paid by the Project Engineer.
13. Ensure all Form 43 Job Mix Formula sheets are signed for HMA and SMA. For all paving, Including, concrete paving review the CAR reports – Asphalt Quality Level Report for accuracy of Acceptance Method, Total Cost/ton, HMA Cost/ton, AC Cost/ton (for binder paid separately), Mix ID, test results, quantities, and processes. For Concrete Quality Level Report, confirm the Acceptance Type, Bid Item Unit Price, Mix ID, thickness, test results, quantities, and processes are correct. These reports must be sent to the Project Engineer and contractor daily. Asphalt 03 and Voids 03 are longer acceptable programs. **The CAR - Asphalt Quality Level report is required to be used for all projects advertised on or after January 1, 2018.**
14. Complete CDOT Form 626 daily for each item’s test results and obtain the contractor’s electronic signature verifying that the contractor has been notified of all test results. Complete the form and sign electronically, email to the contractor for their electronic signature and have the contractor return it. Send a copy to the Project Engineer and place the signed form in the Project Materials electronic folder in the corresponding item tab. CAR reports, Asphalt Quality Level and Concrete Quality Level reports can be substituted for Form 626. The CAR reports for HMA, SMA, and concrete paving should be sent to the Project Engineer and contractor daily. These emailed reports may serve as notification to the contractor of test results. The CDOT Form 626 may not be required for these items.
15. For materials submitted to Central Lab at North Holly, and all-Region Labs for testing, Sample ID’s are required on forms and/or CDOT sample tag 633 or sample label 634. Tags and labels are available at Central Lab, North Holly location. Contact the CDOT North Holly Pavement

Design Program, to schedule obtaining the tags and labels. All other forms are available on the CDOT website as electronically fillable. Some CDOT forms have an email address listed for the different Units within Central Lab. Use these emails to submit completed forms to these Units, do not submit a hard copy with the sample. Form 157's are not required to be completed and submitted for the sample when CDOT Form 633 (Sample Tag) with a revision date of is used, no form required. When Form 633 with a revision date of 8/19 is used, the CDOT Form 157 is required to be completed and emailed to the lab(s) that were shown on the test tab window. See the lab emails below.

16. CDOT Forms 411 and 1304 are required to be completed and submitted for all samples. The CDOT Form 157 is not required with new tags unless requested by the Laboratory.

17. The Central Laboratory E-mails:

[cdot\\_bit.lab@state.co.us](mailto:cdot_bit.lab@state.co.us)  
[cdot\\_chem.lab@state.co.us](mailto:cdot_chem.lab@state.co.us)  
[cdot\\_conc.lab@state.co.us](mailto:cdot_conc.lab@state.co.us)  
[cdot\\_euro.lab@state.co.us](mailto:cdot_euro.lab@state.co.us)  
[cdot\\_flex.lab@state.co.us](mailto:cdot_flex.lab@state.co.us)  
[cdot\\_phpr.lab@state.co.us](mailto:cdot_phpr.lab@state.co.us)  
[cdot\\_soils.lab@state.co.us](mailto:cdot_soils.lab@state.co.us)

17a. The Pavement Design Unit E-mail:  
[cdot\\_pavement.design@state.co.us](mailto:cdot_pavement.design@state.co.us)

17b. The Concrete Mix Design Submittal E-Mail:  
[dot\\_concretemixdesigns@state.co.us](mailto:dot_concretemixdesigns@state.co.us)

**Note: Samples submitted without a Sample ID will not be accepted nor will testing be started until a sample record is completed in SiteManager®.**

18. Verify the documents submitted and file in the electronic folder for the Certification Checklist, all Certificates of Compliance (COCs) or Certified Test Reports (CTRs) received for materials. These documents are required before installation or payment for the materials is completed. Electronic copies of COC/CTRs must be uploaded to each sample record using the attachment icon. Copies of the electronic COC/CTR's shall be stored electronically and are submitted with the final documents. Hard copies of the COC/CTR's are not required for documentation. Any COC/CTR's and Contractor's APL-QML Verification (AQV) documents submitted electronically or hard copy by the contractor must have the required stamps and signatures according to CDOT Standards and Specifications, Section 106.12 and 106.13.

**CDOT Form 157s are not required to be completed for COC/CTRs documentation.**

19. Inform the Region Materials Engineer's IA representative of upcoming materials to be sampled and tested per the CAR Independent Assurance Sampling & Testing Checklist (Form 379) at least three days prior to material placement.

20. Monitor the Owner Acceptance Sampling & Testing Checklist Report to ensure the testing frequencies are being met as the material placement progresses.
21. Monitor the CAR Report Summary of Samples – COC and CTR report to track material quantities paid are matching quantities of documentation received from the contractor. The SM sample record quantity cell shall be updated to reflect the amount of material shown on the COC/CTR's. Upload recently received COC/CTR's in the sample record Attachment Icon.
22. Compare the OA and CERT Checklists with the monthly estimate for discrepancies in items or quantities appearing on the CAR reports. Access the project estimate here: <https://www.codot.gov/content/payestimates/> Use Control key & "F" to use the "Find" feature, type in the contract ID without the "C". Locate the latest estimate to complete the review. A hard copy of the estimate is not needed for this check. If discrepancies are noted, contact the Region Lab Manager or Pavement Design Program at Central Lab for assistance.
23. Perform price adjustment calculations monthly prior to the cutoff date for the estimate in accordance with CDOT Standards and Specifications, Sections 105.03 and 105.07. Verify price adjustments are reflected in the contract estimate.
24. As exceptions to the Specifications occur, document each occurrence to facilitate the completion of CDOT Form 474 Explanation of Exceptions at the closure of the project
25. Review the CAR reports, Asphalt Quality Report & Concrete Quality Report daily to ensure the reports accurately reflect the sample records created in SMM and that the results input into LIMS appears on the report. For instructions to complete the sample records correctly, utilize Addendum 1 on page 23-27 of this chapter. These CAR reports replace Asphalt03 and Voids03 programs and they are no longer to be used on projects advertised after January 1, 2018. When creating concrete paving sample records for Item 412, **(See example Addendum 2 in this Section)**. The CAR report Concrete Quality Level report replaces Concrete03.
26. Review PC data and tests result daily for compliance. Use CP12A, CP12B, and CP12C as applicable.
27. Review data entries to ensure accuracy of test results, and sample review as soon as possible to keep the Owner Acceptance Sampling & Testing Checklist Report up to date.
28. Use CAR Reports - Summary of Samples – COC and Summary of Samples – CTR to track COC and CTR samples created, quantities of materials delivered, attachments, and sample status. These reports will update when data is changed and saved in SiteManager®. COC and CTR records can be left in the LIMS windows of Review Tests or Review Sample allowing the record to be available to upload more documents of shipments that are delivered to the project. Keep the quantity cell updated in SiteManager® Materials – Basic Sample Data tab with the total quantities verified on the attached COC/CTR's.
29. Use CAR reports, Summary of Samples - All to track samples that are incomplete.
30. Resident and Project Engineers can use the CAR Reports – Summary of Samples – COC and CTR to verify quantities and documentation that have been received for materials that will be paid on the monthly estimate.

31. Participate in weekly material testing and scheduling meetings to be up to date on project materials incorporation and deliveries.

### 3.3 AFTER CONSTRUCTION

**Note: Project Owner Acceptance personnel are to review the documentation of the material 100% by completing each of the following steps, 3.3 - 3.3.2**

1. In each electronic item tab, arrange the completed and signed CDOT Form 626s first (if applicable), sort and arrange all documents within the item sequentially by date (beginning with the first test number, ending with the last test number). Naming forms correctly can facilitate the order. Use the CDOT Field Sheet number and/or test number or lot number for identification of each form contained in the folder.
2. Verify with the Project Engineer that the last progress estimate has been completed and authorized for payment. This ensures the quantities shown on the Owner Acceptance Sampling & Testing Checklist Report are accurate. Project estimates can be accessed at this link. (Use Control – F, input the Contract ID without the “C”, in the find box. This will highlight the project, look for the latest estimate. Open the estimate, use Control – F, and input the item number in the "Find" box to search by item.)  
<https://www.codot.gov/content/payestimates/>
3. Verify on the Owner Acceptance Sampling & Testing Checklist Report, that there are no incomplete tests by ensuring that the Sampled Tests to Date column is equal to the Completed Tests to the Date column. Discrepancies must be reconciled by either completing the sample record or voiding it.
4. Verify that the minimum sampling and testing requirements have been met by checking the **Completed Total Tests to Date** column is equal to or greater than the **Required Total Tests to the Date** column. Use the CAR report – Summary of Samples – ALL to find sample records that are not complete. After reconciling the columns, the Owner Acceptance Sampling & Testing Checklist Report shall be placed in the electronic documentation folder - Final Documentation. Deficiencies are required to be explained on the CDOT Form 474 Final Materials Certification - Explanation of Exceptions.
5. Review the CAR Report – Asphalt Quality Level (AQL) (Final). A Final report showing errors shall not be accepted and errors must be corrected
6. Review the AQL report to verify the number of tests shown on the report equals the Completed Tests to Date for each test method shown on the Owner Acceptance Sampling & Testing Checklist Report. Asphalt content element may be the total tests completed for CP 85 and CP-L 5120 to meet the requirements. Mat Density element may be the total tests completed for CP 82, CP 44, and CP 81 to meet the requirements.



7. Verify the quantity for each element in the report matches the quantity for the item on the Owner Acceptance Sampling & Testing Checklist Report. The quantities for each element must be equal or the report will state an error on the first page of the report.
8. Verify with the Project Engineer the dollar amount shown on the AQL report is correct on the estimate.

Notify Staff Materials Pavement Design OA/PC, Program Manager, at:

[cdot\\_pavement.design@state.co.us](mailto:cdot_pavement.design@state.co.us)

And the Region Materials Engineer that the Quality Level reports for the project is complete. Record the Contract ID and Final AQL in the subject line. Export the Final report and include it in the email.

9. Export the Final QL report and save it to the project electronic files - Final Documentation folder.
10. Check all inputs to Concrete03 and the F-test and t-test documents for accuracy if Concrete03 is used on the project. Concrete03 and F-test and t-test documents must have the data files sent to Staff Materials Pavement Design OA/PC Program Manager and the Region Materials Engineer. All QL reports must be the "Final Report". This ensures that all element quantities reconcile.
11. When the CAR Report - Concrete Quality Level Report (CQL) for concrete paving is used by the project, check the final report according to Sections 3.3.5, 3.3.6, 3.3.7, and 3.3.8.
12. Notify the OA/PC manager at [cdot\\_pavement.design@state.co.us](mailto:cdot_pavement.design@state.co.us) that the report is complete. Record the Contract ID and Final CQL in the subject line. Export the report and include it in the email.
13. Place the Final QL reports in the project electronic files - Final Documentation Folder. **(See the example in this Section, Addendum 3).**
14. Place electronic copies of the notification emails sent an acknowledgment from the OA/PC manager in the Final Documentation Folder. This is a requirement for the Final Documentation Materials Coordinator to verify the OA/PC manager has received the information that the project Quality Level reports are complete.

15. Verify COCs and CTRs have been received by ensuring Certs Received to Date column on the CAR Certification Checklist, has a 1 or greater value, for any item showing a quantity paid. Verify Summary of Sample – COC and CTR records have the required attachment noted by showing an asterisk for each sample record. Verify the quantity shown on the Summary of Samples report equals or exceeds the quantity paid, if not an explanation of missing COC/CTR's shall be in the Explanation of Exceptions. Items with a zero quantity, no explanation required. Items deleted by CDOT Form 105 completed by the Project Engineer can be deleted from the project CAR Reports. Send the completed Form 105 to the Central to request the items to be removed. Record in the subject line the **Contract ID: Items to Remove from CAR Reports by Form 105.**  
e-mail requests to: [cdot\\_pavement.design@state.co.us](mailto:cdot_pavement.design@state.co.us)
16. Review CAR reports –Summary of Samples – (ALL) to verify all samples created for the project have a status of "COMP" It is a requirement that all sample records created for a project are in the "Complete" (COMP) status before the documentation of the material is accepted. Sample status of LOGD, RECV, TEST, PREA, must be either completed or voided.
17. Sample records created in SMM that may have been started, but has not had tests assigned will be in the Pending status. These samples may have been forgotten about or made by mistake. The samples must be VOIDED. These types of samples in the Pending status will not be on the Summary of Samples reports. The Sample Backlog report must be reviewed to ensure no samples are in SM incomplete. Projects cannot be closed until all samples are either in the Complete or Void status. (See instructions on the SMM website.)  
<https://sites.google.com/a/state.co.us/sitemanager-materials/>
18. Export and save the CAR Report - Summary of Samples – COC, CTR, QA, and ALL to the project electronic materials folder – Summary of Samples subfolder for availability to the checker for the final documentation review.
19. Pre-inspected items shall have CDOT Form 193, if applicable. This document shall be in the attachment icon on the SMM record for the item.
20. Check all Price Reductions and the supporting documents.
21. Ensure the contractor's PC documentation has been received electronically for HMA, SMA, PCCP, and Excavation & Embankment per the requirements of CP 12A, CP 12B, CP 12C respectively. Save the PC documentation into the Project Electronic Folder.

**3.3.1 CDOT FORM 474, - Final Materials Certification - Explanation of Exception for CAR report: Owner Acceptance Sampling & Testing Checklist Report.**

1. Document on the CDOT Form 474, the date the project was accepted and the date the final documentation is complete. This date shall be the same date that appears on the final copy of the Owner Acceptance Sampling & Testing Checklist. **(See an example of the checklist in this Section)**. Obtain a Project Acceptance letter from the Project Engineer for verification of date of project acceptance.
2. Reference type of tests not used on the Owner Acceptance Sampling & Testing Checklist due to alternative methods completed.
3. Verify and document all shortages of required tests as indicated on the Owner Acceptance Sampling & Testing Checklist Report.
4. Explain quantities and dollars applied per the Quality Level reports. Explain process changes, compaction test sections, and any unusual change in the Quality Level reports. **(See the example in this Section ADDENDUM 1)**.
5. For items that show a Zero Total Quantity Installed, no explanation is required as this indicates no material was installed on the project.
6. Explain and attach supporting documents for material with Percent of reduction in contract price (P) less than 3. **(Instructions for Attaching Documents to the CDOT Form 474 are in this Section)**.
7. Explain and attach supporting documents for material with a price reduction (P) greater than or equal to 3.
8. Explain and document all material repaired or replaced for (P) greater than 25.

**Note: Reference to (P) values are addressed in Standard Specifications, Section 105.03.**

**3.3.2 CDOT FORM 474 Final Materials Certification - Explanation of Exception for CAR report: Certification Checklist Report.**

1. Verify and document all missing COCs and CTRs as indicated on the Certification Checklist and deficiencies in quantities that are shown on the CAR report Summary of Samples – COC and CTR report. COC/CTRs documentation that was not received from the contractor, do NOT make sample records. Document these deficiencies on the CDOT Form 474.
2. Verify the required stamps are applied to the COC/CTRs and/or Contractor's APL-QML Verification (See FMM chapter - Special Notice to Contractors, for more information) and that the required information is complete on each stamp.

3. For COC/CTRs received, sample records in SiteManager® must have the documents uploaded through the attachment icon. Verify the attachment by checking the Summary of Sample – COC or CTR Report. An asterisk will be shown under the column “Attachment” for each sample record with an attachment. **(Instructions for Attaching Documents to the CDOT Form 474 are in this Section).**
  4. For items that show a Zero Total Quantity Installed, no explanation is required as this indicates no material was installed on the project. Attach CDOT Form 105 – Deleted Items - for documentation to the CDOT Form 474.
- 4. INDEPENDENT ASSURANCE Sampling & Testing Checklist and CDOT Form 473 – Final Materials Certification Checklist**
1. The Region’s Independent Assurance (IA) representative shall initiate the Final Materials Certification Checklist - Form 473, by completing the top portion, electronically signing the form, and obtaining the Region Materials Engineer’s electronic signature. This form is available on the CDOT website under the Forms catalog.
  2. The Region’s IA representative is responsible for documenting any deficiencies shown on the CAR Independent Assurance Sampling & Testing Checklist Report on Form 474, Explanation of Exceptions.
  3. The Region’s IA representative shall ensure that differences between Independent Assurance tests results and Owner Acceptance test results if any, are explained.
  4. The Region’s IA representative will send the completed documents for Independent Assurance testing to the project personnel. Submit the Final Materials Certification Checklist (Form 473, top portion completed) and CAR Report - Independent Assurance Sampling & Testing Checklist, Form 474, Explanation of Exceptions, and supporting documentation. Form 473 and 474 shall be electronically completed and signed and emailed to the Project Engineer. The Project Engineer shall verify the project tester completes and signs the required section. The Independent Assurance Sampling & Testing Checklist, supporting documentation, shall be part of the final documentation submittal.
  5. Project personnel and the Resident Engineer’s signature is required on the CDOT Form 473. The completed form must be part of the final documentation with the CDOT Form 474 Final Materials Certification – **Explanation of Exceptions** for the project.
  6. For projects tested by a consultant firm, the CDOT Form 1324 must be completed by the CDOT Representative responsible for the oversight of project materials for evaluating the performance of the consultant firm.

7. Transfer all files from the electronic project materials folder to ProjectWise. Follow the path: **ContractID/Construction/Materials**. Do not use the **Final Documentation/Form 325 folder** in ProjectWise to store these documents. The Region Final Materials Documentation Coordinator or the Finals Administrator is responsible to transfer the required documents from the Materials file to ProjectWise Final Documentation/Form 325 Packet.

**5. INDEPENDENT REVIEW Requirements for Final Materials Documentation Completion**

The Resident Engineer or his designee will notify the Region Finals Administrator or the Region Final Materials Documentation Coordinator when the materials files have been deposited into ProjectWise and are ready for review. This review provides a greater degree of independence and critical evaluation. The Finals Administrator or their designee will check the following items.

1. Verify on the Owner Acceptance Sampling & Testing Checklist that the number of tests shown under Required Total Tests to Date column has been met or exceeded in Completed Total Tests to Date.
2. Verify Sampled Total Test to Date column and Completed Total Test to Date column, match on the entire document. If any discrepancies are found between these two columns, the tester must be notified to reconcile the columns and the final should not be considered complete until the issue is resolved. Verify that all sample records created for the project have a status of Complete by reviewing the CAR report Summary of Samples – **All** report.
3. Verify that all required Certificates of Compliance (COCs) or Certified Test Reports (CTRs) have been received by reviewing the Certification Checklist Report. Certs Received to Date column must show a minimum of one for any item that has an amount shown in Total Installed Quantity for the item. Deficiencies must be explained on the CDOT Form 474 Final Materials Certification - Explanation of Exceptions.
4. Project Testers are required to upload COC/CTRs containing the contractor's stamp (and other required documentation per the FMM chapter - Special Notice to Contractors and the Standards Specification Sections 106.12 and 106.13), into the attachment icon in SiteManager® for each sample record. Using the CAR report - Summary of Samples – COC and CTR, perform random checks in SiteManager® ensuring the documents are in compliance and in the attachment icon. Ensure an asterisk is shown for every sample record for COC and CTR on the CAR reports.
5. Verify on the Independent Assurance Sampling Checklist - Completed Tests to Date column, the required number of tests are completed. Ensure any deficiencies of tests are documented on the CDOT Form 474.
6. Differences between the IA and OA test results must be explained on CDOT Form 474 if applicable.

7. Verify the CDOT Form 473, - Final Materials Certification Checklist has been completed and all required signatures are present.
8. Verify pre-inspected items have a CDOT Form 193, when applicable.
9. Check explanations and calculations for material accepted at full price, the material with price reductions, and material removed and replaced.

Note: Reference to P is addressed in the CDOT Standard Specifications, Section 105.03.

10. Verify the CAR Reports – Quality Level for applicable items (Asphalt or Concrete Paving) have no errors in the Final Report. Final reports showing errors are not acceptable. The first page of the Final Report will show any errors the program has found.
11. Verify the number of each test type completed on the Owner Acceptance Sampling & Testing Checklist, Completed Test to Date column, matches the number of tests shown on the CAR Report Quality Level for asphalt and concrete paving items, if applicable.
12. Verify the quantity for each element in the CAR Quality Level report matches the quantity for the item on the Owner Acceptance Sampling & Testing Checklist Report and the estimate. Check all items that apply to the element for the total quantity paid. This includes asphalt and concrete paving items.
13. Verify the Quality Level payment is correct on the last progress estimate.
14. Verify that the documents for Quality Level reports have been submitted to the Region Materials Engineer and Staff Materials Pavement Design Program OA/PC Manager by e-mail receipt on file.
15. CDOT Form 1324 must be completed and distributed to the Region Materials Engineer and placed in ProjectWise – Form 325 packet.
16. As part of the final Progress Estimate, the Project Engineer has included all the documentary evidence needed to show that the contractor has complied with the requirements of the Contract Plans and Specifications for all materials used in accordance with the CDOT Field Materials Manual - Quality Assurance Procedures for Construction and Materials Sampling and Testing chapter (Owner Acceptance Frequency Guide Schedule for Minimum Materials Sampling, Testing, and Inspection). The Region Finals Administrator is responsible for the development and signature of CDOT Form 325, Final Estimate Data, page 1 and 2, and the distribution per Table 1, and shall be included in this process.

If the existence of discrepancies or unresolved differences remains, a meeting will be scheduled with the Finals Administrator or Finals Documentation Coordinator, Resident Engineer, and Project Engineer to resolve the issues.

The completion of Form 473 - Final Materials Certification Checklist and Form 474 Final Materials Certification - Explanation of Exceptions is required within 30 calendar days after the final acceptance of the project in order to achieve a timely closure. All signatures must be completed electronically on Form 473 and Form 474. If after the project task order is ended, anyone who receives missing documentation and completes SMM/LIMS entries shall complete another Form 474 to update the changes made as missing item documentation is completed. CDOT Form 473 and Form 474 is a requirement for the closure of each project.

#### **6.0 CDOT FORM 211-Completion Instructions (Materials Documentation Request)**

The Final Materials Documentation Project Closeout and the Final Materials Documentation Review or Audit activities will discover that occasionally required documents will be missing. Individuals performing the closeout, review, or audit should use this form or comparable e-mails to allow for a document trail in the effort to obtain the missing documents. The original project personnel may have misplaced or lost a field materials worksheet or report. The contractor may have not forwarded required COCs and CTRs. Time is critical, indicate a due date and follow through immediately if that date has passed. If e-mail queries are being used, write in the "Subject", CDOT Materials Documentation Request or CDOT Form 211. Attach the resolution Form 211's or e-mails to the Form 474 Final Materials Certification Explanation of Exceptions Report. **(Instructions for Attaching Documents to the CDOT Form 474 are in this Section).**

**7.0 DISTRIBUTION OF MATERIALS DOCUMENTATION**

**Table 1. Documentation Distribution  
CDOT SiteManager® Project Final Materials Documentation Packet**

| Documentation Order  | Form / Report     | Distribution |         |        |        |        |
|--|-------------------|--------------|---------|--------|--------|--------|
|  |                   | #1           | #2      | #3     | #4     | #5     |
| Final Materials Certification Checklist with required documents  | Form 473          | Orig.        | Notify  | Notify | Notify |        |
| Final Materials Certification - Explanation of Exceptions with supporting documentation (letters, CMOs, MCRs, etc.)  | Form 474          | Orig.        | Notify  | Notify | Notify |        |
| CAR Report - Owner Acceptance Sampling & Testing Checklist   | Form 250          | Orig.        | Notify  |        | Notify |        |
| CAR Report - Certification Checklist   | -                 | Orig.        | Notify  |        | Notify |        |
| CAR Report - Independent Assurance Sampling & Testing Checklist with supporting documentation  | Form 379          | Orig.        | Notify  | Notify | Notify |        |
| Random Sampling Schedules  | -                 | Orig.        |         |        |        |        |
| Price Reduction Documentation  | -                 | Orig.        |         |        |        |        |
| CAR Quality Level Reports - Incentive/Disincentive documents   | CAR Report QLR    | Orig.        | Notify  |        |        | Notify |
| Buy America Certification letters and Monthly Summary reports  |                   | Orig.        |         |        |        |        |
| PC Data results in digital records   |                   | Orig.        |         |        |        |        |
| Evaluation of Materials Testing (Consultant tested)  | Form 1324 (CP 16) | Orig.        | Notify. |        | Notify |        |
| <p><b>Note:</b> Orig. = original with signature and placed into ProjectWise. Project Engineer will notify the Region Finals personnel when the documentation is available in ProjectWise.<br/>                     Notify = shall email a link to the Units under the Distribution list that all documents are available in ProjectWise as Final. The link referred to is the exact location within ProjectWise for the Project's files.</p> |                   |              |         |        |        |        |



### Distribution

1. Resident/Project Engineer Electronic Files placed into ProjectWise under the path Contract ID/Construction/Materials
2. Region Materials Engineer/Region Finals administrator is responsible for verifying the documentation is complete and acceptable by placing all files into ProjectWise under the path Contract ID/Construction/Finals Documentation/Form 325 and email a link to notify #3, #4, and #5 that the final documents are available.
3. FHWA (Oversite Projects)
4. Staff Materials Pavement Design Program (Documentation Unit)
5. Staff Materials Pavement Design Unit OA/PC Manager

Email address for item 4 and item 5 is: [cdot\\_pavement.design@state.co.us](mailto:cdot_pavement.design@state.co.us)

For Final Documentation, in subject line record Contract ID - Final Materials Documents in ProjectWise. The Region Final Materials Documentation Coordinator or the Region Finals Administrator is responsible for the items in Table 1 and is uploaded into the following ProjectWise path: Contract ID/Construction/Finals/Form 325 Packet.

## **8.0 ORGANIZATIONAL GUIDE FOR PROJECT MATERIALS Electronic Folder**

### **SCOPE**

The Field Materials Manual includes the “OA Frequency Guide Schedule for Minimum Sampling, Testing, and Inspection”. This is the essential document to use when determining which CDOT Forms, worksheets, COCs, CTRs, and miscellaneous documents are required.

Utilize this Organizational Guide for Project Materials Electronic Folder to initially develop the folder and subfolders per the sections for the Owner Acceptance Sampling & Testing Checklist Report. Follow the Item numbering sequential order on the report to develop the order of each sub-folder. See page #36 of this chapter. For the Certification Checklist Report, create one folder to house all the COC/CTR submittals, naming each document according to item number, date received, and/or shipment number. This will facilitate adding each document to the attachment icon much easier.

The Project Materials Electronic Folder shall contain main folders that represent Item Numbers, with sub-folders representing materials within the item. Documents shall be arranged in order of test numbers or documents, oldest to newest (1, 2, 3, 4, etc.) or dates.

Summary of Samples – All, COC, CTR, IAT, and QA reports, 1 copy of the final reports are to be placed within the project electronic folder.

**Final Materials Electronic Folder:**

- CDOT Form 473 - Final Materials Certification Checklist
- CDOT Form 474 – Final Materials Certification – Explanation of Exceptions with any supporting documentation
- CAR Report – Owner Acceptance Sampling & Testing Checklist
- CAR Report - Certification Checklist
- CAR Report - Independent Assurance Sampling & Testing Checklist and supporting documentation
- CAR Report - Summary of Samples- ALL, COC, CTR, IAT, and QA reports
- Random Sampling Schedules (copy - original to remain in item number folder)
- Price Reductions - if applicable
- Quality Control Notebooks (digital) for all required elements
- CAR Final Quality Level reports (copy - original to remain in item number folder)
- CDOT Form 1324, Evaluation of Materials Testing (CP 16) if applicable

**CAR Owner Acceptance Sampling & Testing Checklist**

Create the Project Materials electronic folders in the order the items appear on the Owner Acceptance Sampling & Testing Checklist.

Within each folder, place field worksheets in numerical order starting with test #1. Place CDOT Forms pertaining to the item, Mix Designs, QPM's, Price Reductions, Random Schedules, and supporting documentation as necessary to complete the item.

**CAR Certification Checklist Folder**

Create the Certification Checklist electronic folder. Within this folder, COC/CTR documents shall be clearly named to identify the item, date received, and/or load number the document represents. It is recommended to **not create sub-folders** for each item as this creates extra steps to attach the document to the SiteManager® record.

CDOT Form 157's **are not** required to be completed for COC/CTR documentation. The documentation received from the contractor must meet the requirements of Section 106.12 and 106.13 of the Standard Specifications for Road and Bridge Construction. Determine required documentation from the Field Materials Manual, OA Frequency Guide Schedule for Minimum Materials Sampling, Testing and Inspection, and the "Special Notice to Contractors" chapters. Each COC or CTR received must be uploaded into the attachment icon on each sample record in SiteManager® for the quantity and material the COC/CTR covers. Multiple COC/CTR's can be added to one sample record. As more attachments are added to the record, keep the quantity cell updated to reflect the total quantity cover by the attachments. Name and describe each attachment to identify it.

For materials from the APL or the QML that the contractor is electing to use on the project, it is recommended that the SiteManager® record be developed as soon as possible, due to the fact materials may expire from the APL or QML at any time. Creating the record when the documentation is received ensures the record reflects the material that appears on the corresponding lists at the time of approval.

Note 1: “Special Notice to Contractors” chapter shall be used to determine the requirements of the Contractor’s APL – QML Verification (AQV) document to notify the project personnel of materials to be used on the project from the CDOT Approved Products Lists (APL) or the CDOT Qualified Manufacturers List (QML).

**9.0 Suspension to CDOT’s SiteManager®:** It is not necessarily tied to a review process and may occur at any time for cause. The process for suspension starts with a written complaint to the Materials and Geotechnical Branch Manager (MGBM) or his designee. This document must, at a minimum contain the name of the technician involved, name of the technician's company, date of the incident, detailed accounting of the incident, name and contact information of individuals submitting the request. The Department may start an investigation based on other information, such as:

- Failure to timely supply required information.
- Repeated failure of a tester to meet CDOT requirements.
- Failure to take immediate corrective action relative to deficiencies in the performance of the Quality Control Program.
- Certifying materials that are not produced under an approved Quality Control Program for use on Department projects. (This would include any situation where falsification of records was determined.)

Upon receipt of the complaint, the MGBM will contact the Region Materials Engineer (RME) and Resident Engineer (RE) associated with the technician involved in the written complaint. The MGBM, RME, and RE will review the complaint to determine its credibility.

If the complaint is deemed credible the Department will contact the individual(s) submitting the information. The MGBM will determine if the individual is willing to discuss the reported incident. Documentation submitted to the MGBM for review is otherwise confidential. The MGBM will review the documentation/information within 30 days to determine whether further investigation is required. If further investigation is required, the Department will assign the appropriate Regional Materials Engineer to perform the investigation. The MGBM will review the information obtained through the investigation and may conduct additional interviews. The technician, their supervisor, and/or consulting firm involved will be notified of the Department’s findings.

The technician shall have 15 working days to respond, in writing. At any point in the process, the MGBM may determine, due to insufficient evidence, to discontinue the process. The MGBM will then determine whether the violation(s) fall under the definition of Negligence or Abuse.

**Negligence** is defined as unintentional deviations from approved procedures or the unintentional failure to follow the requirements of the CDOT Field Materials Manual.

**Abuse** is defined as intentional deviations from approved procedures or the intentional failure to follow the requirements of the CDOT Field Materials Manual.

The appropriate process will be followed upon the determination of the category of the violation. If the process results in a period of suspension or revocation, the tester is prohibited from participating in all CDOT projects during that period.

**Process for Negligence:**

Negligence should be resolved in a positive fashion that promotes learning and increased understanding. The complaint process tracks technicians who have repeated incidents of negligence. This process will also allow a means of tracking common problems and issues.

A single incident of negligence may be resolved through intervention by the Tester's Supervisor. After assurances in writing to the Department by the supervisor that the problem(s) are fully corrected, a thorough review of the Tester's materials documentation by the Region Independent Assurance Tester (IAT) and the supervisor will be made to ensure that a full correction of the problem(s) has occurred. Documentation of each incident shall be sent to the MGBM. The Department will maintain records of each incident. If only one report, of a minor nature, is received in a one-year period, no further action may be taken. However, if it is determined that the negligence is significant the requirements under "second incident" will be followed.

If the second incidence of negligence is reported within a one-year period, the Department will require that the technician and his/her employer develop a corrective action plan. The MGBM will notify all the Regional IATs. This notification is intended to make the IATs aware of the problems being encountered.

If a third incident of negligence is reported within a two-year period, the technician and his/her employer will receive a notice and a minimum one-year suspension will apply. The technician and his/her employer will be responsible for providing a plan to correct the deficiencies to ensure no further incidents occur.

Any further incidents of negligence will result in a permanent revocation. The Department can at any point re-classify repeated instances of negligence, as abuse. If this occurs, the issue would be dealt with through the process of abuse.

Regional Materials Engineers reserve the right to work with the tester and their supervisor to correct any aforementioned problems listed in the negligence section in lieu of a tester's suspension.

If a tester is suspended they shall complete an internal training program within their company that is an outside certification and provide documentation showing such training has occurred. The documentation should include a specific description of the training performed, dates, location, procedures, who supervised the training, etc. The documentation will be submitted to the RME who will decide if the training is sufficient to reinstate the suspended tester.

**Letters of Suspension and Revoking:**

A letter stating a tester is being suspended and the reasoning behind the suspension will be sent to the tester, the tester's company, and the RME. The RME will maintain the letter in their records for future reference. If a tester is being revoked, the letter will be sent to the tester, the tester's company, the RME, and the Pavement Design and Documentation Manager. The RME and the Pavement Design and Documentation Manager will keep the letter on file for future reference.

**Process for Abuse:**

The Department will determine the severity of the abuse. The first finding of abuse will result in a minimum one-year suspension and may extend to the permanent revocation of an individual to test on any CDOT project. Any subsequent finding of abuse shall result in permanent revocation of the tester to work on any CDOT project.

Notice of suspensions or revocations will be emailed to the individual and his/her employer along with the individual's right to appeal. A proposed revocation or suspension is effective upon receipt by the technician and will be affirmed, modified, or vacated following any appeal.

The Department should also be aware that both State and Federal laws may govern construction projects, including Title 18, United States Code, Section 1020, that in brief states that anyone making falsifications on Federal-aid projects: "Shall be fined not more than \$10,000 or imprisoned not more than five years, or both."

**Notification of Revocation to Other Agencies**

The Department may notify the other state agencies or certifying agencies of anyone having been revoked for testing on a CDOT project through CDOT's SiteManager program.

**ATTENTION!**

**Referenced CDOT Materials Forms, except those indicated as "computer output", have been revised in 2017. All of these forms state: *Previous editions are obsolete and may not be used.* The use of Materials Forms older than what is indicated in the chapter of the FMM Materials Forms – Instructions & Examples is not authorized.**

**The examples of completed forms are currently being developed, as some will show examples and some will not.**

## Forms 473 and 474 Guidelines

Form 473 and Form 474 is an Adobe Acrobat DC form. The Forms must be downloaded to your computer before editing, open the document using Adobe Acrobat DC. Edit your document and save it. The Form must remain in electronic format, do not scan the form or print the form when sending it to the final or next destination.

### Step 1:

CDOT Form 473, 474 



Trujillo - CDOT, Edward <edward.trujillo@state.co.us>

to Edward

Example

Edward A Trujillo

Product Evaluation Coordinator



P: (303) 798.6566 | F: (303) 798.6514

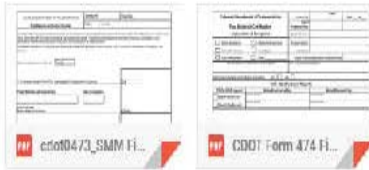
4670 Holly Street Unit A, Denver, CO 80216

edward.trujillo@state.co.us | www.codot.gov | www.colrip.org

*This message may contain confidential information and is intended only for individual(s) named. If you are not the intended recipient, you are not authorized to disseminate, distribute, or copy this email. Please notify the sender immediately if you have received this email by mistake and delete this email from your system. Thank you.*

**"Please consider the environment before printing this email."**

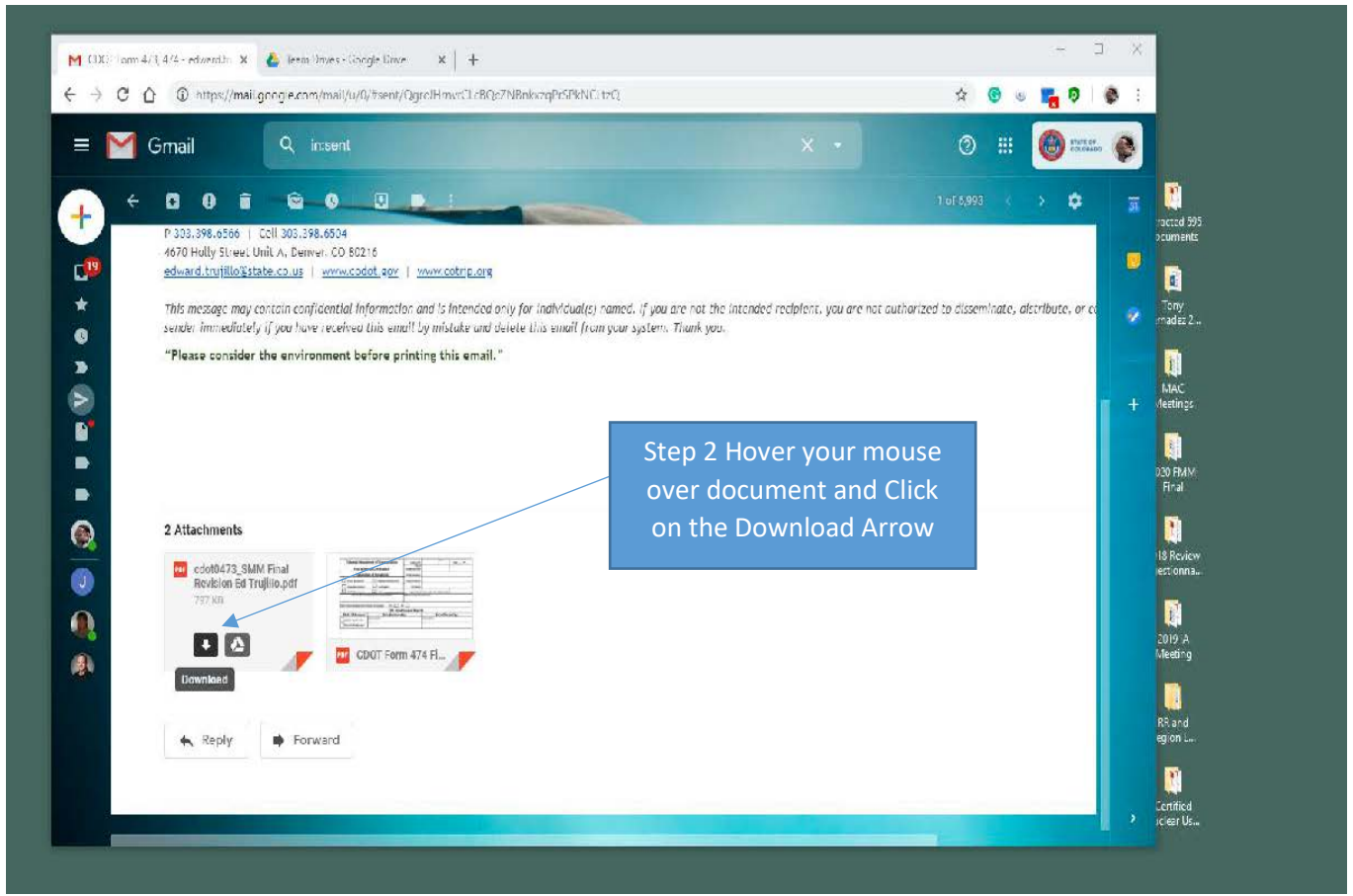
### 2 Attachments



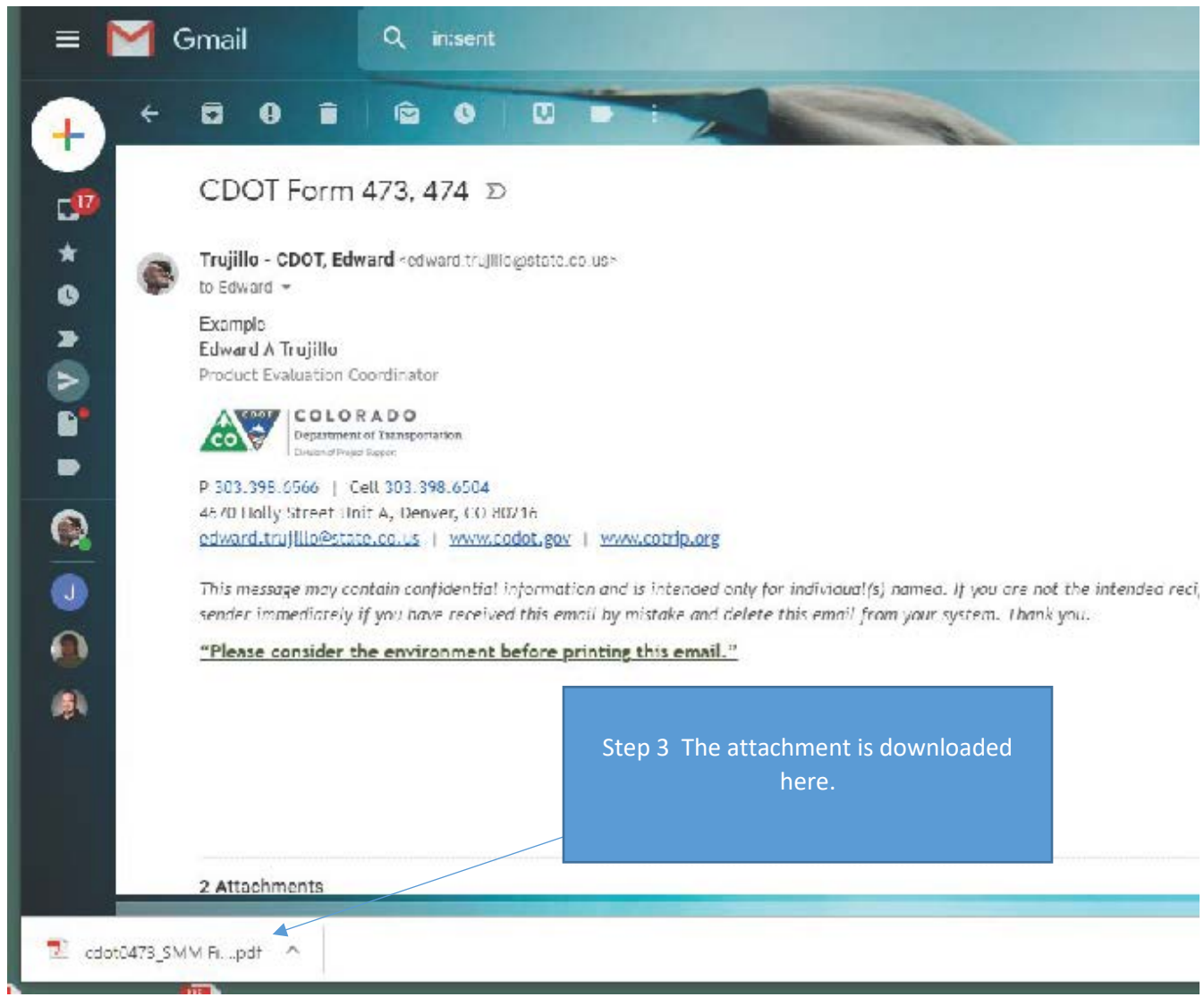
Step 1: Attachments are located at the bottom of your e-mail.



**Step 2:**

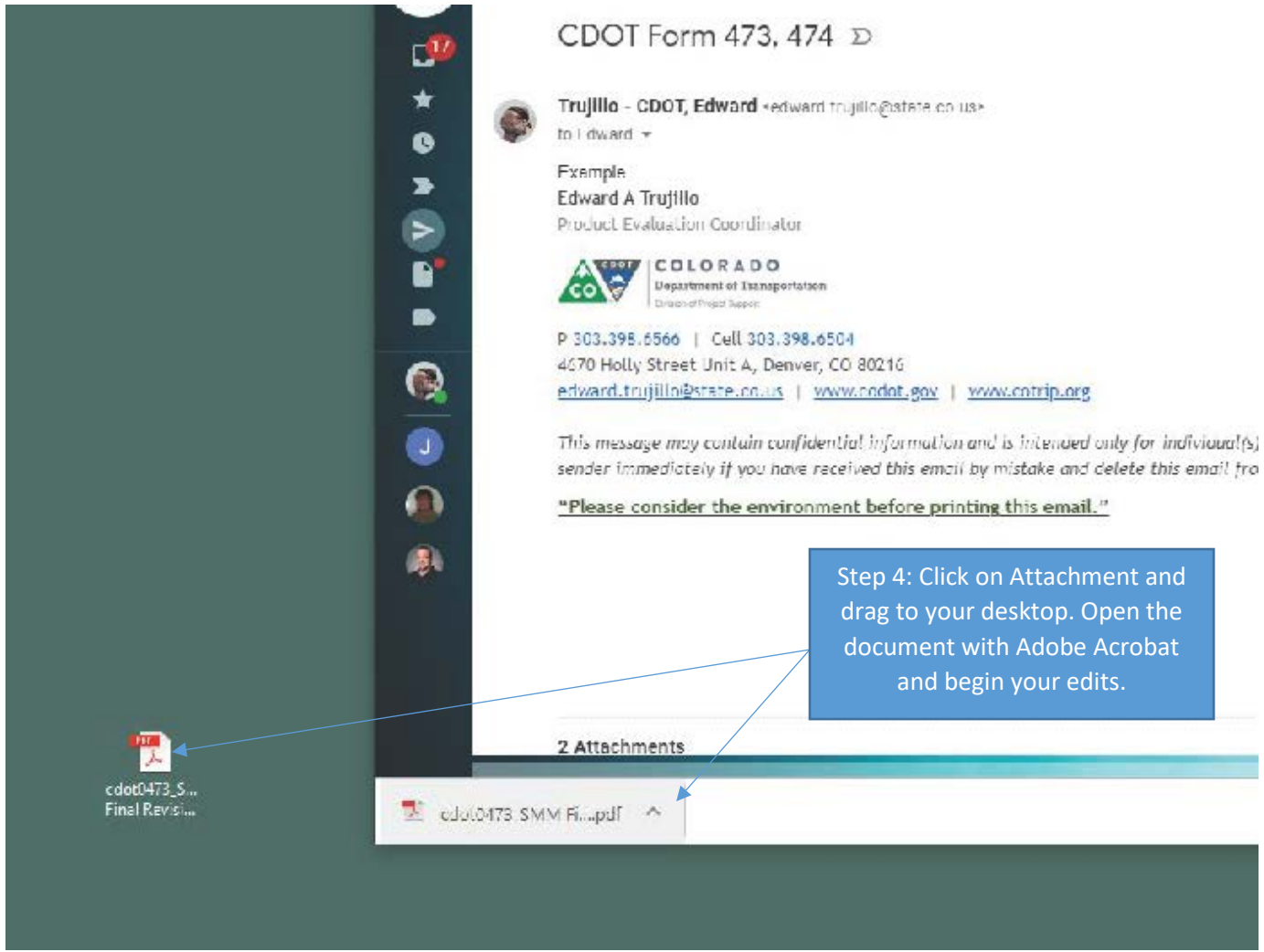


**Step 3:**





**Step 4:**



## Instructions for CDOT FORM 473/474 using Adobe Pro DC

### **Form 473, Page 1**

The intent of Form 473 is to ensure the project materials documentation has been completed per the Quality Assurance Procedures for Construction and Materials Sampling and Testing as stated in Section 19 of the Field Materials Manual and in the coordination of CDOT's stewardship agreement with the FHWA. The federal guidelines may be found in 23 CFR 637.205 and 23 CFR 637.2017. The stewardship agreement can be found on the CDOT internet site at the following address

<https://www.codot.gov/business/designsupport/cdot-fhwa-stewardship-agreement>.

The form is laid out in logical order in which project construction and closure occurs from the top of the form ascending to the bottom. The following is a brief summary of the steps to complete the form:

### **Form 473**

1. The IA initiates Form 473.
2. Lab inspection is performed prior to any project testing. The person performing the inspection and the date of the inspection are documented on CDOT Form 473.
3. IAT testing is completed prior to project testing.
4. Once all IA testing is completed, the Region Materials IA:
  - Signs Form 473
  - The Region Materials Engineer (RME) then signs the CDOT Form 473
  - The RME Forwards the form to the Project Tester
5. The Project Tester
  - Project Tester completes Items 2-8, the Project Engineer may complete Items 6-8 as necessary.
  - Project Tester signs Form 473 and ensure all required attachments are included and project testing has been completed.
6. The Project Engineer signs CDOT Form 473
7. Resident Engineer signs Form 473.
8. The Project Engineer and Resident Engineer's signatures verify the previous sections of the form have been completed and all applicable attachments are present.
9. The form and all attachments are placed in the ProjectWise folder Contract ID/Construction/Materials to be accessed by the Region Finals Materials Coordinator or Region Finals Administrator.  
The Region's finals personnel are required to have the completed form with attachments before final project closure.
10. The Region Finals Materials Documentation Coordinator or Region Finals Administrator signs the document.

**CDOT Form 474**

1. The Project Tester or the Project Engineer (rarely) initiates the Form.
2. The Project Tester fills out project information including the Contract ID, Region, Acceptance Date, Project Number, Project Location, Contractor and Project Final Documentation Completion Date. The Project Final Documentation Completion date shall be the same date that appears on the final copy of the Owner Acceptance Sampling & Testing Checklist. **(See an example of the checklist in this Section).**
3. The Project Tester selects the type of project and testing requirements for the project by checking the box for either Owner Acceptance, Independent Assurance, Innovative Contract, Local Agency, CDOT Maintenance, or Other
4. The Project Tester fills in the consulting company's name and if/whether sampling and testing are performed by a consultant.
5. The Project Tester checks the boxes for asphalt and/or concrete quality level. They also electronically sign the boxes to verify the concrete and asphalt data has been reviewed and checked. These boxes, reviewed by and checked by, are signed by different individuals.
6. Whoever reviews the project data (usually the Project Tester, Head Tester, Project Engineer, or a combination) fills out the bulk of the form which shall contain a detailed list with explanations of all exceptions or changes to a project, incentives and disincentives, failing tests, missing documents, etc.
7. The Project Tester or Project Engineer electronically signs the document, locking all their input from future alterations.

**CDOT Form 473, Page 2**

Form 473, Page 2 has been replaced with CDOT Form 474. Older versions of CDOT Form 473 shall not be used, even if specified in the Field Materials Manual required for the project. Project personnel should replace any older versions of CDOT Form 473 (pages 1 and 2) with the newest versions of CDOT Forms 473 and 474 and document the change in the project.

**CDOT Form 474**

CDOT's directive to go paperless was the primary direction for creating CDOT Form 474, which is essentially the old and cumbersome CDOT Form 473, Page 2. CDOT Form 474, CDOT Final Materials Certification/Explanation of Exceptions was created for supplemental project documentation. Some of the items that must be included on CDOT Form 474 include shortages of tests, missing COC/CTR's, price reductions, and CAR quality level report. As the title suggests this form also requires signatures that were previously on CDOT Form 473, Page 2.

**Signature Blocks**

Both CDOT Forms 473 and 474 have a signature lock feature built into them. Each signature will lock the entire section that particular the signature block is responsible for completing. Thus, each signer must verify their section is correct before signing, as once a signature is applied no changes can be made to that section. A more detailed list of instructions for filling and signing these two forms is as follows.

**CDOT Form 473** There are six required signatures for CDOT Form 473, the following illustrates the proper order in a step by step process for correctly filling out this form.

|  |  |  |             |
|--|--|--|-------------|
| <b>COLORADO DEPARTMENT OF TRANSPORTATION</b><br><b>Final Materials Certification Checklist</b>   |  | Contract ID                                | Project No. |
|  |  | Region                                     | Location    |
| <p>The Independent Assurance Sampling Schedule for this project has been substantially followed and the test results of the IA samples are in reasonably close agreement with the project acceptance (QA) sample test results. Exceptions to this statement have been previously commented on and documented when the test results were reported or are explained on an attached sheet.</p> <p>Independent Assurance (IA) samples were tested with independent equipment unless noted on CDOT Form 474 - Explanation of Exceptions, see attached.</p> <p>Method of Acceptance for Item 403: <input type="text" value="Project"/></p>   |  |  |             |
| 1) IA Summary Report (Form #379), attached with IA Explanation of Exceptions.....  |  | <input type="text" value="N/A"/>           |             |
| Project Materials Lab Inspected by: <input type="text"/><br>Date of inspection: <input type="text"/>   |  | IA Tester                                  |             |
| Final IA Review<br>Region Materials Engineer<br><input type="text"/>   |  | <input type="text"/>                       |             |
| Project Tester - Document all shortages of tests, missing COC/CTR's and explain all quality level incentives/disincentives, price reductions and include supplemental documents as required on the CDOT Form 474 - Final Materials Certification Explanation of Exceptions.  |  |  |             |
| 2) CDOT Form 474 - Final Materials Certification Explanation of Exceptions with supplemental documentation as required.....  |  | <input type="text" value="N/A"/>           |             |
| 3) Completed O/A and Certification Checklists.....   |  | <input type="text" value="N/A"/>           |             |
| 4) Completed Random Sampling Schedules (all required elements).....  |  | <input type="text" value="N/A"/>           |             |
| 5) Quality Control Notebooks (digital) for all required items.....   |  | <input type="text" value="N/A"/>           |             |
| 6) Evaluation of Materials testing, Form 1324.....   |  | <input type="text" value="N/A"/>           |             |
| 7) Buy America monthly summary reports.....  |  | <input type="text" value="N/A"/>           |             |
| 8) Project Engineer has verified Pavement Structural Design Data is complete.....  |  | <input type="text" value="N/A"/>           |             |
| Project Acceptance Date: <input type="text"/>  |  | Project Tester:<br><input type="text"/>    |             |
| Project Engineer: Ensure O/A Sampling & Testing Checklist, Certification Checklist and IA Checklist have met the minimum required testing. Explanation of Exceptions, Buy America summaries, Pavement Structural Design Data is complete. All documentation has been reviewed and placed in ProjectWise in the path ContractID/Construction/Materials.<br>This is to Certify that: The results of the tests on the acceptance samples indicate that the material incorporated in the construction work, and the construction operations controlled by sampling and testing, were in conformity with the approved plans and specifications, and such results compare favorably with results of the Independent Assurance sampling and testing. This form is complete, includes all attachments, and has been reviewed and accepted. |  |  |             |
| Project Engineer:<br><input type="text"/>  |  | Resident Engineer:<br><input type="text"/> |             |
| <input type="checkbox"/> Region Finals Materials Documentation Coordinator or the Region Finals Administrator has verified items 1-8. O/A Sampling Checklist, Certification Checklist, IA Checklist and all documentation is complete. Check for COMP status on Summary of Samples (All) Report.<br><input type="checkbox"/> All items have been properly documented and placed into ProjectWise under the path: ContractID/Construction/FinalsDocumentation/Form 325 Packet   |  |  |             |
| Region Finals Materials Documentation Coordinator or the Region Finals Administrator<br><input type="text"/>   |  |  |             |

Step 1. The IA tester initiates CDOT Form 473 and is responsible for filling out all Items A1 through A6.

- A1: The Contract ID, Project No., Region, and Location.
- A2: Selecting the Item Method of Acceptance for Item 403 using a pull-down menu
- A3: The IA tester states if the IA Summary Report (Form 379) exists using a pull-down menu
- A4: Who inspected the Project Materials Lab, Type in Name of Individual.
- A5: Date of the Project Materials Lab inspection
- A6: The IA Tester electronically signs the document which will lock Items A1 through A6 (circled in blue) from future alterations by another person.

**COLORADO DEPARTMENT OF TRANSPORTATION**  
Final Materials Certification Checklist

Contract ID: \_\_\_\_\_ Project No.: \_\_\_\_\_  
Region: \_\_\_\_\_ Location: \_\_\_\_\_

The Independent Assurance Sampling Schedule for this project has been substantially followed and the test results of the IA samples are in reasonably close agreement with the project acceptance (QA) sample test results. Exceptions to this statement have been previously commented on and documented when the test results were reported or are explained on an attached sheet.  
Independent Assurance (IA) samples were tested with independent equipment unless noted on CDOT Form 474 - Explanation of Exceptions, see attached.

Method of Acceptance for Item 403:  (A2)

1) IA Summary Report (Form #379), attached with IA Explanation of Exceptions.....  (A3)

Project Materials Lab Inspected by: \_\_\_\_\_ (A4)  
Date of inspection: \_\_\_\_\_ (A5)

Final IA Review  
Region Materials Engineer: \_\_\_\_\_

IA Tester: \_\_\_\_\_ (A6)

Project Tester - Document all shortages of tests, missing COC/CTR's and explain all quality level incentives/disincentives, price reductions and include supplemental documents as required on the CDOT Form 474 - Final Materials Certification Explanation of Exceptions.

2) CDOT Form 474 - Final Materials Certification Explanation of Exceptions with supplemental documentation as required.....

3) Completed O/A and Certification Checklists.....

4) Completed Random Sampling Schedules (all required elements).....

5) Quality Control Notebooks (digital) for all required items.....

6) Evaluation of Materials testing, Form 1324.....

7) Buy America monthly summary reports.....

8) Project Engineer has verified Pavement Structural Design Data is complete.....

Project Acceptance Date: \_\_\_\_\_

Project Tester: \_\_\_\_\_

Project Engineer: \_\_\_\_\_ Resident Engineer: \_\_\_\_\_

Region Finals Materials Documentation Coordinator or the Region Finals Administrator has verified items 1-8. O/A Sampling Checklist, Certification Checklist, IA Checklist and all documentation is complete. Check for COMP status on Summary of Samples (All) Report.  
 All items have been properly documented and placed into ProjectWise under the path: ContractID/Construction/FinalsDocumentation/Form 325 Packet

Region Finals Materials Documentation Coordinator or the Region Finals Administrator

CDOT Form #0473SMM 6/18

Step 2. The Final IA Review is performed, verified, and electronically signed by the Region Materials Engineer in Item B.

| COLORADO DEPARTMENT OF TRANSPORTATION   |  | Contract ID                              | Project No. |
|---|--|--|-------------|
| Final Materials Certification Checklist   |  | Region                                   | Location    |
| <p>The Independent Assurance Sampling Schedule for this project has been substantially followed and the test results of the IA samples are in reasonably close agreement with the project acceptance (QA) sample test results. Exceptions to this statement have been previously commented on and documented when the test results were reported or are explained on an attached sheet.</p> <p>Independent Assurance (IA) samples were tested with independent equipment unless noted on CDOT Form 474 - Explanation of Exceptions, see attached.</p>   |  |  |             |
| Method of Acceptance for Item 403: <input type="text" value="Project"/>   |  |  |             |
| 1) IA Summary Report (Form #379), attached with IA Explanation of Exceptions.....   |  | <input type="text" value="N/A"/>         |             |
| Project Materials Lab Inspected by: <input type="text"/>  |  | Date of inspection: <input type="text"/> |             |
| <b>Final IA Review</b><br>Region Materials Engineer: <input type="text"/>   |  | IA Tester: <input type="text"/>          |             |
| <p>Project Tester - Document all shortages of tests, missing COC/CTR's and explain all quality level incentives/disincentives, price reductions and include supplemental documents, as required on the CDOT Form 474 - Final Materials Certification Explanation of Exceptions.</p>   |  |  |             |
| 2) CDOT Form 474 - Final Materials Certification Explanation of Exceptions with supplemental documentation as required.....   |  | <input type="text" value="N/A"/>         |             |
| 3) Completed O/A and Certification Checklists.....  |  | <input type="text" value="N/A"/>         |             |
| 4) Completed Random Sampling Schedules (all required elements).....   |  | <input type="text" value="N/A"/>         |             |
| 5) Quality Control Notebooks (digital) for all required items.....  |  | <input type="text" value="N/A"/>         |             |
| 6) Evaluation of Materials testing, Form 1324.....  |  | <input type="text" value="N/A"/>         |             |
| 7) Buy America monthly summary reports.....   |  | <input type="text" value="N/A"/>         |             |
| 8) Project Engineer has verified Pavement Structural Design Data is complete.....   |  | <input type="text" value="N/A"/>         |             |
| Project Acceptance Date: <input type="text"/>   |  | Project Tester: <input type="text"/>     |             |
| <p>Project Engineer: Ensure O/A Sampling &amp; Testing Checklist, Certification Checklist and IA Checklist have met the minimum required testing. Explanation of Exceptions, Buy America summaries, Pavement Structural Design Data is complete. All documentation has been reviewed and placed in ProjectWise in the path ContractID/Construction/Materials.</p> <p>This is to Certify that: The results of the tests on the acceptance samples indicate that the material incorporated in the construction work, and the construction operations controlled by sampling and testing, were in conformity with the approved plans and specifications, and such results compare favorably with results of the Independent Assurance sampling and testing. This form is complete, includes all attachments, and has been reviewed and accepted.</p> |  |  |             |
| Project Engineer: <input type="text"/>  |  | Resident Engineer: <input type="text"/>  |             |
| <input type="checkbox"/> Region Finals Materials Documentation Coordinator or the Region Finals Administrator has verified items 1-8. O/A Sampling Checklist, Certification Checklist, IA Checklist and all documentation is complete. Check for COMP status on Summary of Samples (All) Report.  |  |  |             |
| <input type="checkbox"/> All items have been properly documented and placed into ProjectWise under the path: ContractID/Construction/FinalsDocumentation/Form 325 Packet  |  |  |             |
| Region Finals Materials Documentation Coordinator or the Region Finals Administrator<br><input type="text"/>  |  |  |             |

B

Step 3. The Project Tester is responsible for a large amount of the required documentation which is listed as Items 2 through 8 in the section circled in blue.

- C1: The Project Tester will verify if the documentation is in the project files or not applicable using a drop-down menu. Items stated as missing with a "No" or not applicable "N/A" shall be listed on Form 474 with a detailed explanation.
- C2: The Project Acceptance Date shall be filled out by the Project Tester
- C3: The Project Tester shall electronically sign the document which will lock all items shown as Section C (Circled in Blue) from future alterations by another person.

| COLORADO DEPARTMENT OF TRANSPORTATION  |  | Contract ID         | Project No. |
|--|--|---------------------|-------------|
| Final Materials Certification Checklist  |  | Region              | Location    |
| The Independent Assurance Sampling Schedule for this project has been substantially followed and the test results of the IA samples are in reasonably close agreement with the project acceptance (IA) sample test results. Exceptions to this statement have been previously commented on and documented when the test results were reported or are explained on an attached sheet.<br>Independent Assurance (IA) samples were tested with independent equipment unless noted on CDOT Form 474 - Explanation of Exceptions, see attached.   |  |                     |             |
| Method of Acceptance for Item 403:   |  | Project             |             |
| 1) IA Summary Report (Form #379), attached with IA Explanation of Exceptions.....  |  | N/A                 |             |
| Project Materials Lab Inspected by:  |  | Date of inspection: |             |
| Final IA Review Region Materials Engineer  |  | IA Tester           |             |
| Project Tester - Document all shortages of tests, missing COC/CTR's and explain all quality level incentives/disincentives, price reductions and include supplemental documents as required on the CDOT Form 474 - Final Materials Certification Explanation of Exceptions.  |  |                     |             |
| 2) CDOT Form 474 - Final Materials Certification Explanation of Exceptions with supplemental documentation as required.....  |  | N/A                 |             |
| 3) Completed O/A and Certification Checklists.....   |  | N/A                 |             |
| 4) Completed Random Sampling Schedules (all required elements).....  |  | N/A                 |             |
| 5) Quality Control Notebooks (digital) for all required items.....   |  | N/A                 |             |
| 6) Evaluation of Materials testing, Form 1324.....   |  | N/A                 |             |
| 7) Buy America monthly summary reports.....  |  | N/A                 |             |
| 8) Project Engineer has verified Pavement Structural Design Data is complete.....  |  | N/A                 |             |
| Project Acceptance Date:   |  | Project Tester      |             |
| Project Engineer: Ensure O/A Sampling & Testing Checklist, Certification Checklist and IA Checklist have met the minimum required testing. Explanation of Exceptions, Buy America summaries, Pavement Structural Design Data is complete. All documentation has been reviewed and placed in ProjectWise in the path ContractID/Construction/Materials.<br>This is to Certify that: The results of the tests on the acceptance samples indicate that the material incorporated in the construction work, and the construction operations controlled by sampling and testing, were in conformity with the approved plans and specifications, and such results compare favorably with results of the Independent Assurance sampling and testing. This form is complete, includes all attachments, and has been reviewed and accepted. |  |                     |             |
| Project Engineer:  |  | Resident Engineer:  |             |
| <input type="checkbox"/> Region Finals Materials Documentation Coordinator or the Region Finals Administrator has verified items 1-8. O/A Sampling Checklist, Certification Checklist, IA Checklist and all documentation is complete. Check for COMP status on Summary of Samples (All) Report.<br><input type="checkbox"/> All items have been properly documented and placed into ProjectWise under the path: ContractID/Construction/FinalsDocumentation/Form 325 Packet   |  |                     |             |
| Region Finals Materials Documentation Coordinator or the Region Finals Administrator   |  |                     |             |



Step 4. The Project Engineer signs the document Item (D) ensuring the:

- O/A Sampling and Testing Checklist, Certification Checklist, and IA Checklist have met the minimum required testing.
- Explanation of Exceptions is complete
- Buy America summaries are complete
- Pavement Structural Design Data is complete
- All documentation has been reviewed and placed in ProjectWise in the path Contract ID/Construction/Materials.
- Certifies the results of tests on acceptance samples indicate the material incorporated was in conformity with plans and specifications and compare favorably with results of IA sampling and testing.

| COLORADO DEPARTMENT OF TRANSPORTATION   |  | Contract ID                      | Project No. |
|---|--|----------------------------------|-------------|
| <b>Final Materials Certification Checklist</b>  |  | Region                           | Location    |
| <p>The Independent Assurance Sampling Schedule for this project has been substantially followed and the test results of the IA samples are in reasonably close agreement with the project acceptance (QA) sample test results. Exceptions to this statement have been previously commented on and documented when the test results were reported or are explained on an attached sheet.</p> <p>Independent Assurance (IA) samples were tested with independent equipment unless noted on CDOT Form 474 - Explanation of Exceptions, see attached.</p> <p>Method of Acceptance for Item 403: <input type="text" value="Project"/></p>  |  |                                  |             |
| 1) IA Summary Report (Form #379), attached with IA Explanation of Exceptions.....   |  | <input type="text" value="N/A"/> |             |
| Project Materials Lab Inspected by:   |  | Date of inspection:              |             |
| <input type="text"/>  |  | <input type="text"/>             |             |
| Final IA Review<br>Region Materials Engineer  |  | IA Tester                        |             |
| <input type="text"/>  |  | <input type="text"/>             |             |
| <p>Project Tester - Document all shortages of tests, missing COC/CTR's and explain all quality level incentives/disincentives, price reductions and include supplemental documents as required on the CDOT Form 474 - Final Materials Certification Explanation of Exceptions.</p>  |  |                                  |             |
| 2) CDOT Form 474 - Final Materials Certification Explanation of Exceptions with supplemental documentation as required.   |  | <input type="text" value="N/A"/> |             |
| 3) Completed O/A and Certification Checklists.....  |  | <input type="text" value="N/A"/> |             |
| 4) Completed Random Sampling Schedules (all required elements).....   |  | <input type="text" value="N/A"/> |             |
| 5) Quality Control Notebooks (digital) for all required items.....  |  | <input type="text" value="N/A"/> |             |
| 6) Evaluation of Materials testing, Form 1324.....  |  | <input type="text" value="N/A"/> |             |
| 7) Buy America monthly summary reports.....   |  | <input type="text" value="N/A"/> |             |
| 8) Project Engineer has verified Pavement Structural Design Data is complete.....   |  | <input type="text" value="N/A"/> |             |
| Project Acceptance Date: <input type="text"/>   |  | Project Tester:                  |             |
| <input type="text"/>  |  | <input type="text"/>             |             |
| <p>Project Engineer: Ensure O/A Sampling &amp; Testing Checklist, Certification Checklist and IA Checklist have met the minimum required testing. Explanation of Exceptions, Buy America summaries, Pavement Structural Design Data is complete. All documentation has been reviewed and placed in ProjectWise in the path ContractID/Construction/Materials.</p> <p>This is to Certify that: The results of the tests on the acceptance samples indicate that the material incorporated in the construction work, and the construction operations controlled by sampling and testing, were in conformity with the approved plans and specifications, and such results compare favorably with results of the Independent Assurance sampling and testing. This form is complete, includes all attachments, and has been reviewed and accepted.</p> |  |                                  |             |
| Project Engineer:   |  | Resident Engineer:               |             |
| <input type="text"/>  |  | <input type="text"/>             |             |
| <p><input type="checkbox"/> Region Finals Materials Documentation Coordinator or the Region Finals Administrator has verified items 1-8. O/A Sampling Checklist, Certification Checklist, IA Checklist and all documentation is complete. Check for COMP status on Summary of Samples (All) Report.</p> <p><input type="checkbox"/> All items have been properly documented and placed into ProjectWise under the path: ContractID/Construction/FinalsDocumentation/Form 325 Packet</p>   |  |                                  |             |
| Region Finals Materials Documentation Coordinator or the Region Finals Administrator  |  |                                  |             |
| <input type="text"/>  |  |                                  |             |

D

Project Engineer:

Resident Engineer:



Step 5. The Resident Engineer signs the document Item (E) ensuring the:

- O/A Sampling and Testing Checklist, Certification Checklist, and IA Checklist have met the minimum required testing.
- Explanation of Exceptions is complete.
- Buy America summaries are complete.
- Pavement Structural Design Data is complete.
- All documentation has been reviewed and placed in ProjectWise in the path Contract ID/Construction/Materials.
- Certifies the results of tests on acceptance samples indicate the material incorporated was in conformity with plans and specifications and compare favorably with results of IA sampling and testing.

| COLORADO DEPARTMENT OF TRANSPORTATION  |  | Contract ID   | Project No. |
|--|--|---|-------------|
| Final Materials Certification Checklist  |  | Region  | Location    |
|  |  | <p>The Independent Assurance Sampling Schedule for this project has been substantially followed and the test results of the IA samples are in reasonably close agreement with the project acceptance (QA) sample test results. Exceptions to this statement have been previously commented on and documented when the test results were reported or are explained on an attached sheet.</p> <p>Independent Assurance (IA) samples were tested with independent equipment unless noted on CDOT Form 474 - Explanation of Exceptions, see attached.</p> <p>Method of Acceptance for Item 403: <input type="text" value="Project"/></p>  |             |
| <p>1) IA Summary Report (Form #379), attached with IA Explanation of Exceptions.....</p>   |  | <input type="text" value="N/A"/>  |             |
| <p>Project Materials Lab Inspected by: <input type="text"/></p> <p>Date of inspection: <input type="text"/></p>  |  | <p>Final IA Review Region Materials Engineer <input type="text"/></p> <p>IA Tester <input type="text"/></p>   |             |
| <p>Project Tester - Document all shortages of tests, missing COC/CTR's and explain all quality level incentives/disincentives, price reductions and include supplemental documents as required on the CDOT Form 474 - Final Materials Certification Explanation of Exceptions.</p>   |  | <p>2) CDOT Form 474 - Final Materials Certification Explanation of Exceptions with supplemental documentation as required..... <input type="text" value="N/A"/></p> <p>3) Completed O/A and Certification Checklists..... <input type="text" value="N/A"/></p> <p>4) Completed Random Sampling Schedules (all required elements)..... <input type="text" value="N/A"/></p> <p>5) Quality Control Notebooks (digital) for all required items..... <input type="text" value="N/A"/></p> <p>6) Evaluation of Materials testing, Form 1324..... <input type="text" value="N/A"/></p> <p>7) Buy America monthly summary reports..... <input type="text" value="N/A"/></p> <p>8) Project Engineer has verified Pavement Structural Design Data is complete..... <input type="text" value="N/A"/></p> <p>Project Acceptance Date: <input type="text"/></p> <p>Project Tester: <input type="text"/></p> |             |
| <p>Project Engineer: Ensure O/A Sampling &amp; Testing Checklist, Certification Checklist and IA Checklist have met the minimum required testing. Explanation of Exceptions, Buy America summaries, Pavement Structural Design Data is complete. All documentation has been reviewed and placed in ProjectWise in the path ContractID/Construction/Materials.</p> <p>This is to Certify that: The results of the tests on the acceptance samples indicate that the material incorporated in the construction work, and the construction operations controlled by sampling and testing, were in conformity with the approved plans and specifications, and such results compare favorably with results of the Independent Assurance sampling and testing. This form is complete, includes all attachments, and has been reviewed and accepted.</p> <p>Project Engineer: <input type="text"/></p> <p>Resident Engineer: <input type="text"/></p> |  |   |             |
| <p><input type="checkbox"/> Region Finals Materials Documentation Coordinator or the Region Finals Administrator has verified items 1-8. O/A Sampling Checklist, Certification Checklist, IA Checklist and all documentation is complete. Check for COMP status on Summary of Samples (AS) Report.</p> <p><input type="checkbox"/> All items have been properly documented and placed into ProjectWise under the path: ContractID/Construction/FinalsDocumentation/Form 325 Packet</p> <p>Region Finals Materials Documentation Coordinator or the Region Finals Administrator <input type="text"/></p>  |  |   |             |

E

Step 6. The Region Finals Materials Documentation Coordinator or the Region Finals Administrator signs the document Item (F). They must also check the following:

- The box stating they have verified Items 1-8 on this form.
- All items have been properly documented and placed in ProjectWise.

| COLORADO DEPARTMENT OF TRANSPORTATION  |  | Contract ID                                | Project No. |
|--|--|--|-------------|
| Final Materials Certification Checklist  |  | Region                                     | Location    |
| <p>The Independent Assurance Sampling Schedule for this project has been substantially followed and the test results of the IA samples are in reasonably close agreement with the project acceptance (QA) sample test results. Exceptions to this statement have been previously commented on and documented when the test results were reported or are explained on an attached sheet.</p> <p>Independent Assurance (IA) samples were tested with independent equipment unless noted on CDOT Form 474 - Explanation of Exceptions, see attached.</p>  |  |  |             |
| Method of Acceptance for Item 403: <input type="text" value="Project"/>  |  |  |             |
| 1) IA Summary Report (Form #379), attached with IA Explanation of Exceptions.....  |  | <input type="text" value="N/A"/>           |             |
| Project Materials Lab Inspected by: <input type="text"/>   |  | Date of inspection: <input type="text"/>   |             |
| Final IA Review<br>Region Materials Engineer<br><input type="text"/>   |  | IA Tester<br><input type="text"/>          |             |
| <p>Project Tester - Document all shortages of tests, missing COC/CTR's and explain all quality level incentives/disincentives, price reductions and include supplemental documents as required on the CDOT Form 474 - Final Materials Certification Explanation of Exceptions.</p>   |  |  |             |
| 2) CDOT Form 474 - Final Materials Certification Explanation of Exceptions with supplemental documentation as required.....  |  | <input type="text" value="N/A"/>           |             |
| 3) Completed O/A and Certification Checklists.....   |  | <input type="text" value="N/A"/>           |             |
| 4) Completed Random Sampling Schedules (all required elements).....  |  | <input type="text" value="N/A"/>           |             |
| 5) Quality Control Notebooks (digital) for all required items.....   |  | <input type="text" value="N/A"/>           |             |
| 6) Evaluation of Materials testing, Form 1324.....   |  | <input type="text" value="N/A"/>           |             |
| 7) Buy America monthly summary reports.....  |  | <input type="text" value="N/A"/>           |             |
| 8) Project Engineer has verified Pavement Structural Design Data is complete.....  |  | <input type="text" value="N/A"/>           |             |
| Project Acceptance Date: <input type="text"/>  |  | Project Tester:<br><input type="text"/>    |             |
| <p>Project Engineer: Ensure O/A Sampling &amp; Testing Checklist, Certification Checklist and IA Checklist have met the minimum required testing. Explanation of Exceptions, Buy America summaries, Pavement Structural Design Data is complete. All documentation has been reviewed and placed in ProjectWise in the path: ContractID/Construction/Materials.</p> <p>This is to Certify that: The results of the tests on the acceptance samples indicate that the material incorporated in the construction work, and the construction operations controlled by sampling and testing, were in conformity with the approved plans and specifications, and such results compare favorably with results of the Independent Assurance sampling and testing. This form is complete, includes all attachments, and has been reviewed and accepted.</p> |  |  |             |
| Project Engineer:<br><input type="text"/>  |  | Resident Engineer:<br><input type="text"/> |             |
| <p><input type="checkbox"/> Region Finals Materials Documentation Coordinator or the Region Finals Administrator has verified items 1-8. O/A Sampling Checklist, Certification Checklist, IA Checklist and all documentation is complete. Check for COMP status on Summary of Samples (All) Report.</p> <p><input type="checkbox"/> All items have been properly documented and placed into ProjectWise under the path: ContractID/Construction/FinalsDocumentation/Form 325 Packet</p>  |  |  |             |
| <b>Region Finals Materials Documentation Coordinator or the Region Finals Administrator</b><br><input type="text"/>  |  |  |             |

F

**CDOT Form 474** is essentially the old CDOT Form 473 Page 2, but with a couple of upgrades. Similar to the new CDOT Form 473, electronic signatures will lock in the various areas the signee is responsible for. The following illustrates the proper step by step process for correctly filling out this form.

**Step 1:** The Project Tester or (in rare cases) the Project Engineer fill out the following:

- Item A1: Contract Id, Region, Acceptance Date, Project Number, Project Location, Contractor and Project Final Documentation Completion Date.
- Item A2: Select the type of project and testing requirements for the project by check the box for either owner acceptance, independent assurance, innovative contract, Local Agency, CDOT Maintenance, or "Other".
- If "Other" is selected then a description must be typed in this box.
- Item A3: Type CDOT or the consulting company's name in the box adjacent to the signature.
- Item A4: Select 'Yes' or 'No' if the CDOT Project sampling and testing are performed by a consultant.
- Item A5: The Project Tester or Project Engineer check the box(s) for asphalt and/or concrete quality Level. They also electronically sign the boxes to verify the concrete and asphalt data has been reviewed and checked. These boxes, reviewed by and checked by, are signed by different individuals.
- Item A6: whoever reviews the project data fills this block out. Usually, it is the Project Tester, Head Tester, Project Engineer, or a combination depending on who has reviewed the project data. This box should contain a detailed list with explanations of all exceptions or changes to a project, incentives, and disincentives, failing tests, missing documents, etc.
- Item A7: The Project Tester or Project Engineer electronically signs the document, locking all their input (outlined in Red) from future alterations.

**Step 2:** Item B: Signed by the Consultant Firm's PE, if a consultant tester was used. If no consultant tester was used, then this block will remain blank.

**Step 3:** Item B1: This block is for comments made by the Consultant Firm's PE if a consultant tester was used. If no consultant tester was used, then this block will remain blank.

**Step 4:** Consultant Firm P.E. Electronic Stamp as per PD 508.1-

Instructions: Signature of Project Tester or Project Engineer shall be signed after explanations are complete. Hand signed document is not acceptable, only electronic signatures.

On or before January 2020, all CDOT, local agency and consulting Engineers shall utilize electronic Sealing. Requests for exemptions shall be submitted to the Chief Engineer prior to mechanical Seals being utilized with the reason why an electronic Sealing cannot be used.

Beginning January 2021, there will be no exemptions to the electronic Sealing requirement, except where stated in section (V) (C) of the CDOT Policy Directive 508.1, REQUIREMENTS FOR THE USE OF THE PROFESSIONAL ENGINEER'S SEAL

See FMM Documentation chapters - After Construction - for more information

All CAR - Quality Level Reports must be Final Report with no errors.

|  |                       |  |         |                         |
|--|-----------------------|--|---------|-------------------------|
| <b>Colorado Department of Transportation</b><br><b>Final Materials Certification</b><br><b>Explanation of Exceptions</b>   |                       | Contract ID:   | Region: | Page ____ of ____       |
|  |                       | Project Acceptance Date:                             |         |                         |
| <input type="checkbox"/> Owner Acceptance <input type="checkbox"/> Independent Assurance<br><input type="checkbox"/> Innovative Contract <input type="checkbox"/> Local Agency<br><input type="checkbox"/> CDOT Maintenance <input type="checkbox"/> Other   |                       | Project Number:                                      |         |                         |
|  |                       | Project Location:                                    |         |                         |
|  |                       | Contractor:  |         |                         |
|  |                       | Project Final Documentation Completion Date:         |         |                         |
| Electronic signature of Project Tester or Project Engineer   |                       | CDOT or Consultant Company Name:                     |         |                         |
| CDOT Project Sampling and Testing by Consultant: YES <input type="checkbox"/> NO <input type="checkbox"/>  |                       |  |         |                         |
| <b>CAR - Quality Level Reports</b>   |                       |  |         |                         |
| <b>FINAL CAR report</b>  |                       | <b>Data Reviewed by:</b>                             |         | <b>Data Checked by:</b> |
| <input type="checkbox"/> Asphalt Quality Level   | Electronic Signature: | Electronic Signature:                                |         | Electronic Signature:   |
| <input type="checkbox"/> Concrete Quality Level  | Electronic Signature: | Electronic Signature:                                |         | Electronic Signature:   |
|  |                       |  |         |                         |
| Consultant Firm PE Comments:   |                       |  |         |                         |
|  |                       |  |         |                         |
| <b>Instructions: Signature of Project Tester or Project Engineer shall be signed after explanations are complete. Hand signed document is not acceptable, only electronic signatures.</b><br>On or before January 2020, all CDOT, local agency and consulting Engineers shall utilize electronic Sealing. Requests for exemptions shall be submitted to the Chief Engineer prior to mechanical Seals being utilized with the reason why an electronic Sealing cannot be used.<br>Beginning January 2021, there will be on exemptions to the electronic Sealing requirement, except where stated in section (V) (C) of the CDOT Policy Directive 508.1, REQUIREMENTS FOR THE USE OF THE PROFESSIONAL ENGINEER'S SEAL<br>See FMM Documentation chapters - After Construction - for more information<br><b>All CAR - Quality Level Reports must be Final Report with no errors.</b> |                       | Consultant Firm PE Electronic Signature              |         |                         |
|  |                       | Consultant Firm PE Electronic Stamp as per PD 508-1: |         |                         |

A2

A7

A5

B1

A1

A3

A4

A6

B

# INSTRUCTIONS FOR ATTACHING DOCUMENTS TO THE CDOT FORM 474

The screenshot shows the Adobe Acrobat Pro DC interface with the CDOT Form 474 open. The window title is "CDOT Form 474 Final Revision Ed Trujillo (1).pdf - Adobe Acrobat Pro DC". The menu bar includes File, Edit, View, Window, and Help. The toolbar shows various icons for navigation and editing. On the left, the "Attachments" panel is visible, showing a list of attached files. A blue callout box with a paperclip icon and a plus sign is positioned over the Attachments panel, containing the following instructions:

- 2) Click on Paperclip Icon to show Attachment options.
- 3) Click on Paperclip with + sign to attach documents. Save file before signing the CDOT Form 474, documents will always be with the form for future reference.

The main content of the form is the "Colorado Department of Transportation Final Materials Certification Explanation of Exceptions". It includes fields for Contract ID, Project, Acceptance Date, Project Number, Project Location, Contractor, and Project Final Documentation Completion Date. There are checkboxes for Owner Acceptance, Independent Assurance, Innovative Contract, Local Agency, CDOT Maintenance, and Other. A section for "CDOT Project Sampling and Testing by Consultant" has YES and NO options. Below this is the "CAR - Quality Level Reports" section, which includes a table for "FINAL CAR report" with columns for "Data Reviewed by:" and "Data Checked by:". The table has rows for Asphalt Quality Level and Concrete Quality Level, each with a checkbox and a signature field. A blue callout box with an arrow pointing to the Attachments panel contains the instruction:

- 1) Click on arrow to expand or hide the Attachment Section

The form also includes a section for "Consultant Firm PE Comments (for this page only, more pages may follow)". At the bottom, there are instructions for signing the document, including a note that "Hand signed document is not acceptable, only electronic signatures." and a field for "Consultant Firm PE Electronic Signature".

## Explanation of Exceptions

The following is an example of what goes into the Explanation of Exceptions CDOT Form 474 Final Materials Certification (A6) block.

### **CAR Report Owner Acceptance Sampling & Testing Checklist:**

**Item 203-00060: Embankment Material (Complete in Place):** The contractor placed 4,115.00 CY of Embankment Material 2 inches thick. Material too thin to perform CP80aa Den/Moist Content of soil by nuclear gauge. Project specials required PI of 5-15, a test result of 13. The project Engineer accepted the material.

The embankment, Rock not encountered on the project.

### **Item 304-06007 Aggregate Base Course (Class 6)**

CP23aa not needed to be based on T180D performed which includes the plus 4 material.

CP25- Not performed due to a small quantity and no change in material observed.

Based on the quantity of 2,113 CY (2 -T89 and T90's) should have been completed. The second test would have covered the fraction of the 113 CY. Based on the results of test #1 -T89 (No Value) and the T90 (Non-Plastic), the 2<sup>nd</sup> test was not completed to cover the 113 CY.

### **Item 403-34741: Hot Mix Asphalt (Grading SX) (75) (PG 64-22)**

#### **Mix ID: 42017B1\_20856\_**

Both Phase 1 and Phase 2 of the US 24 El Paso- Elbert county line projects were completed by Jones Contractors utilizing the same mix designs, the PC tester and the mobile voids trailer personnel were the same. For this reason, check testing and CPL5120C was not performed on phase 2 but was completed on phase 1.

The project was Voids Acceptance, 7,028 tons were placed on a thin lift leveling course (1.5 inches), Project Specials specified the leveling course to be a Pay Factor of 1 for the mat density and longitudinal joints, (CP 44, 15 tests completed). Joint cores were not taken, SMM sample (SMITHJP178G082717) used to document 7,028 tons for CP44L, Pay Factor of 1. Flood plain area required 947 tons to be placed. 2- CP-44 test was completed in this area. 1,244 tons were placed with a 2-inch mat over a milled surface, 2- CP44's were taken due to the small area of placement. A total of 9,219 tons were placed and tested using CP44.

A total of 15,078 tons were placed and tested using CP81 and CP82.

The Asphalt Quality Level report for (42017B1\_20856\_) Mat Density, 1 compaction test section (CP82) representing 500 ton, 3 processes representing 23797 tons.

- Process 1: representing 947 tons, placed in the flood plain.
- Process 2: representing 15,822 tons placed, 2-inch middle mat.
- Process 3: Pay Factor of 1 representing 7,028 tons placed, 1-1/2 inch leveling course.

HMA (Grading SX) (75) (PG 64-22) total tons placed 24,297.

Asphalt content tested using CPL5120. CP85 and CP85C not used.

CPL5120C was completed on phase 1.

**Item 403-34751 Hot Mix Asphalt (Grading SX) (75) (PG 64-28)****Mix ID: 42017T1\_20856\_**

The project was Voids Acceptance, 18,478 tons was placed for a 2 inch top mat. CP44, CP85, CP85C were not used do to alternative test methods used. CP81- 36 tests, CP82- 1 test, for a total of 37 tests completed.

Total tons placed 18,478 on top mat.

Total tons placed on project 42,775, with an incentive of \$134,599.11.

**CP58-** Contractor followed best paving practices. There was not any indication of temperature segregation seen in the mat densities. The mean mat density for the bottom mat was 93.3%. Top mat mean mat density was a 93.6%

**Item 601-01000 Concrete Class B:** Visual inspection due to a small quantity (1.3 CY), material placed in the headwall of pipe.

**Item 603-10120 12 Inch Corrugated Steel pipe.**

Pipe placed under sidewalk with a small amount of structure backfill mostly for bedding of pipe. Testing could not be performed due to the small area of placement. The compaction effort was performed by the contractor and Project Engineer accepted visually. See attached picture.

**Item 608 00010 Concrete Curb Ramp.**

Visual inspection does to small quantities, 37 SY, material placed in curb ramp for the sidewalk.

**CAR Report Certification Checklist:****Item 216-00101 Soil Retention Blanket**

After numerous requests to the contractor, no documentation was received. Material delivered was inspected and the label on the product was found to be on the CDOT APL, Western Excelsior-Excel C5-3 All Natural. Based on the material being an APL product, the Project Engineer accepted the material. Sample record created in Site Manager to document the product, no attachment on sample record.

**Item 601-01000 & 608-00010- Concrete**

Cure

The small quantity used on both of these items, material visually accepted by Project Engineer.

**Item 627-00008 and 627-30405 Pavement Marking Materials**

Two records completed on each item to reflect white and yellow material.

|   |  |                            |                               |                             |            |
|---|--|----------------------------|-------------------------------|-----------------------------|------------|
| <b>COLORADO DEPARTMENT OF TRANSPORTATION</b>  |  | Contract No.   STA0243-087 | Region 4                      | Contract ID                 | C20856     |
| Owner Acceptance Sampling & Testing Checklist |  | Contract Location          | US 24 B Paso-Elbert CL Paving |                             |            |
|   |  | Contractor                 | SIMON CONTRACTORS             | Awd Date                    | 04/05/2017 |
|   |  |                            |                               | Awd Date                    | 02/23/2017 |
|   |  |                            |                               | Field Materials Manual Year | 2017       |

SM Report 250 Revision Date 10/06/2017 Production Date Printed 5/7/2018 Page 1 of 12

\*# Refer to Frequency Guide Schedule for further instructions.

| Project   | Item Code                    | Material Description | Item Description  | Material Unit    | Conversion Factor | Item Unit                | Quantity Reported to Date | Quantity Authorized to Date | Total Installed Quantity  |                         |                           |
|-----------|------------------------------|----------------------|---|------------------|-------------------|--------------------------|---------------------------|-----------------------------|---------------------------|-------------------------|---------------------------|
| Matl Code | Material Description         | Test Description     | Sample Type   | Rate / Frequency | Line Item No.     | Estimated Required Tests | Required Tests to Date    | Sampled Tests to Date       | Estimated Tests Remaining | Completed Tests to Date | Total Tests (+/-) to Date |
| 20856-BID | US24 ELPASO-ELBERT CLEAST PA |                      |   |                  |                   |                          |                           |                             |                           |                         |                           |
| 20856-BID | 203-00060                    | Embankment, Soil     | Embankment Material (Complete in Place)                 | CY               |                   |                          | 4,115.00                  | 4,115.00                    | 4,115.00                  | 4,115.00                |                           |
|           | 203.03.01.01                 | T89                  | T89 Liquid Limit of Soils                               | QA %             | 0035              | 1                        | 1                         | 1                           | 0                         | 1                       | 0                         |
|           |                              | T90                  | T90 Plastic Limit and Plasticity Index of Soils         | QA %             | 0035              | 1                        | 1                         | 1                           | 0                         | 1                       | 0                         |
|           |                              |                      | Number of tests on this row based on summed quantity:   |                  |                   | 1                        | 1                         | 1                           | 0                         | 1                       | 0                         |
|           |                              |                      |   |                  |                   | 1,0000                   |                           |                             |                           |                         |                           |
|           | 203.03.01.02                 | Embankment, Rock     | CP21 Mechanical Analysis of Soils                       | QA %             | 0035              | 1                        | 1                         | 0                           | 1                         | 0                       | -1                        |
|           |                              |                      | CPL2103 S04 Ion Content in H2O & Water Soluble of Soil  | QA %             | 0035              | 1                        | 1                         | 0                           | 1                         | 0                       | -1                        |
|           |                              |                      | CPL2104 Det. Water-Soluble Chloride Ion Content in Soil | QA %             | 0035              | 1                        | 1                         | 0                           | 1                         | 0                       | -1                        |
|           |                              |                      | CPL3104 Durability of Shales for Use as Embankments     | QA %             | 0035              | 1                        | 1                         | 0                           | 1                         | 0                       | -1                        |



|  |  |   |                       |                                  |
|--|--|---|-----------------------|----------------------------------|
| <b>COLORADO DEPARTMENT OF TRANSPORTATION</b> |  | Contract No. STA0243-087                        | Region 4              | Contract ID C20856               |
| <b>Certification Checklist</b>               |  | Contract Location US 24 B Paso-Elbert CL Paving | Award Date 04/05/2017 | Field Materials Manual Year 2017 |
|  |  | Contractor SIMON CONTRACTORS                    | Ad Date 02/23/2017    |                                  |

SM Report CERT Revision Date: 02/13/2017  
 \*% Refer to Frequency Guide Schedule for further instructions.  
 20856-BID US24 EL PASO-ELBERT CL EAST PA

Page 1 of 4  
 Date Printed 5/8/2018

| Project      | Item Code    | Item Description  | Material Unit | Conversion Factor | Total Plan + CO Quantity | Special Instructions   | Quantity Reported to Date | Total Installed Quantity |
|--------------|--------------|---|---------------|-------------------|--------------------------|------------------------|---------------------------|--------------------------|
|              | Test Method  | Test Description  | Sample Type   | Rate/Frequency    | Line Item No.            | Producer/Supplier Name | Rowd Number of Certs      | Certs Received to Date   |
| 20856-BID    | 208-00002    | Erosion Log Type 1 (12 Inch)                              | LF            | 1.0000            | 500.00                   |                        | 546.00                    | 546.00                   |
|              | 208.02.10.00 | Erosion Control, Erosion Log                              | LF            | 1.0000            |                          |                        |                           |                          |
|              | CERT         | CERT Material Certification                               | COC           | %                 | 0038                     |                        | 1                         | 1                        |
| 20856-BID    | 212-00006    | Seeding (Native)  | ACRE          | 1.0000            | 0.15                     |                        | 0.25                      | 0.25                     |
|              | 212.06.01.00 | Seed, Native  | ACRE          | 1.0000            |                          |                        |                           |                          |
|              | CERT         | CERT Material Certification                               | COC           | %                 | 0070                     |                        | 1                         | 1                        |
| 20856-BID    | 212-00032    | Soil Conditioning   | ACRE          | 1.0000            | 0.15                     |                        | 0.25                      | 0.25                     |
|              | 212.02.02.00 | Soil Conditioning   | ACRE          | 1.0000            |                          |                        |                           |                          |
|              | CERT         | CERT Material Certification                               | COC           | %                 | 0075                     |                        | 1                         | 1                        |
| 20856-BID    | 216-00101    | Soil Retention Blanket (Straw-Coconut) (Photo-degradable) | \$ Y          | 1.0000            | 730.00                   |                        | 1799.00                   | 1799.00                  |
|              | 216.02.02.00 | Soil Retention Covering, Blanket                          | \$ Y          | 1.0000            |                          |                        |                           |                          |
|              | CERT         | CERT Material Certification                               | COC           | %                 | 0080                     |                        | 1                         | 1                        |
| 20856-BID    | 403-34741    | Hot Mix Asphalt (Grading SX) (75) (PG 64-22)              | TON           |                   | 23662.00                 |                        | 24297.43                  | 24297.43                 |
|              | 702.01.01.03 | Asphalt Cement, Binder, PG64-22                           | TON           | 1.0000            |                          |                        |                           |                          |
|              | CERT         | CERT Material Certification                               | COC           | %                 | 0095                     |                        | 1                         | 1                        |
| 712.03.01.00 | 712.03.01.00 | Hydrated Lime   | TON           | 1.0000            |                          |                        |                           |                          |
|              | CERT         | CERT Material Certification                               | CTR           | %                 | 0095                     |                        | 1                         | 1                        |

|  |  |   |                       |                                  |
|--|--|---|-----------------------|----------------------------------|
| <b>COLORADO DEPARTMENT OF TRANSPORTATION</b>       |  | Contract No.   STA0243-087                      | Region 4              | Contract ID C20856               |
| Independent Assurance Sampling & Testing Checklist |  | Contract Location US 24 B Paso-Elbert CL Paving |                       |                                  |
|  |  | Contractor SIMON CONTRACTORS                    | Award Date 04/06/2017 | Ad Date 02/23/2017               |
|  |  |   |                       | Field Materials Manual Year 2017 |

SM Report 379 Revision Date 10/06/2017 Production Date Printed 5/7/2018 Page 1 of 3

\*:\* Refer to Frequency Guide Schedule for further instructions.

| Project   | Item Code                      | Material Description  | Item Description | Material Unit | Line Item No. | Sample Type / Frequency | Estimated Required Tests | Plan + COCQ | Conversion Factor | Required Tests to Date | Sampled Tests to Date | Estimated Tests Remaining | Quantity Authorized to Date | Total Installed Quantity |
|-----------|--------------------------------|---|------------------|---------------|---------------|-------------------------|--------------------------|-------------|-------------------|------------------------|-----------------------|---------------------------|-----------------------------|--------------------------|
| 20856-BID | US24 EL PASO-ELBERT CL EAST PA |   |                  |               |               |                         |                          |             |                   |                        |                       |                           |                             |                          |
| 20856-BID | 403-34741                      | Hot Mix Asphalt (Grading SX)(75) (PG 64-22)                 |                  | TON           |               |                         |                          | 1.0000      |                   |                        |                       |                           | 24,297.43                   | 24,297.43                |
|           | 40302.01.11                    | Hot Mix Asphalt (SX)(75)(PG64-22)                           |                  | TON           |               |                         |                          |             |                   |                        |                       |                           |                             |                          |
|           | CP44                           | CP44 Bulk Sp G & Comp. of HMA Using SSD Specimens           |                  | IAT           | 0095          | 1/1000                  | 3                        | 23 852.00   |                   | 3                      | 3                     | 0                         | 0                           | 3                        |
|           | CP44L                          | CP44L Bulk Sp G & Comp. of HMA Using SSD Specimens - Long   |                  | IAT           | 0095          | 1/1000                  | 3                        | 23 852.00   |                   | 3                      | 2                     | 1                         | 2                           | -1                       |
|           | CP48aa                         | CP48aa-Voids in the Mineral Aggregate (VMA)                 |                  | IAT           | 0095          | 1/1000                  | 3                        | 23 852.00   |                   | 3                      | 2                     | 1                         | 2                           | -1                       |
|           | CP51                           | CP51 Maximum Specific Gravity of HMA                        |                  | IAT           | 0095          | 1/1000                  | 3                        | 23 852.00   |                   | 3                      | 3                     | 0                         | 0                           | 3                        |
|           | CPL5106                        | CPL5106 Res. to Deformation of Bitum. Mixture s; Hveem      |                  | IAT           | 0095          | 1/1000                  | 3                        | 23 852.00   |                   | 3                      | 3                     | 0                         | 0                           | 3                        |
|           | CPL5115                        | CPL5115 Dens. of Bitum. Mix Specimens Compacted by the SG C |                  | IAT           | 0095          | 1/1000                  | 3                        | 23 852.00   |                   | 3                      | 3                     | 0                         | 0                           | 3                        |

## Addendum 1

### 1.0 ASPHALT QUALITY LEVEL REPORT

*Introduction:*

The Quality Level Report will be used to replace both the Voids03 and the Asphalt03 programs. The report will generate by choosing the contract in CAR by clicking the “+” in front of the Contract ID, then choose either the Item Code or the report type of Interim or Final. It will be possible to run versions of the report in three ways:

- Item Code – shows the quality level, incentive or disincentive, for each asphalt item on the project.
- Interim – shows a preliminary report without checking for element totals to ensure the tons for each element match and will have all asphalt items in the report.
- Final – shows the final report and will check the element totals to ensure they match.

Like other CAR reports the data is pulled from SiteManager® once the report title is clicked in the Trns\*port folder. Error checking is included in the report to help show what data is missing. This may include not having a Quantity, Control Type, Control Number, Design Type, Mix ID or having incomplete data in a test template, etc.

*Maintain Sample Information Window:*

The report pulls data for all Quality Acceptance Testing samples on a project that have a 403.02.xx.xx material code. The following are also critical fields used by the report that must be correctly populated in SiteManager®

| Basic Sample Data |                                 | Addtl Sample Data | Contract                 | Other                 | Tests                |
|-------------------|---------------------------------|-------------------|--------------------------|-----------------------|----------------------|
| Smpl ID:          | GOODSELM1655125717              | Status:           | Complete                 |                       |                      |
| Revised By:       |                                 | Revising:         |                          | Sample Date:          | 05/04/16             |
| Link To:          |                                 | Link From:        |                          | Log Date:             | 05/05/16             |
| Smpl Type:        | Quality Acceptance Testing      | Acpt Meth:        | Sample and Test          |                       |                      |
| Material:         | 403.02.01.08                    |                   | Hot Mix Asphalt (SX)(75) |                       |                      |
| Sampler:          | ROOTR                           |                   | Richard Root, R3         |                       |                      |
| P/S:              | United Companies Of Mesa County |                   | GEN100042                |                       |                      |
| Type:             | General                         | City:             | Grand Junction           |                       |                      |
| Prod Nm:          |                                 |                   |                          |                       |                      |
| Mnfctr:           | United Companies Of Mesa County |                   | GEN100042                |                       |                      |
| Town:             |                                 | Geog Area:        | Spaces                   |                       |                      |
| Intd Use:         |                                 |                   |                          |                       |                      |
| Repr Qty:         | 1,000.000                       |                   | Ton                      | Lab Control Number:   | CNGOODSELM1655125717 |
| Auth By:          | GOODSELM                        | Auth Date:        | 05/11/16                 | Lab Reference Number: | AC1                  |

**Sample Date:** This field will default to the date the sample was created; however, it can be changed to any time before the sample creation date. **All samples should be created in the order they were obtained and tested.**

**Smpl Type:** The Quality Level Report picks up samples with a sample type of Quality Acceptance Testing and an Acceptable Method of Sample and Test.

**Repr Qty:** This field is used to calculate the quantity represented by the sample being entered. When populated to the report these quantities will be used for each process/mix design to obtain a total quantity for the element.

**Process Type:** This field is used to record what type of paving is being performed. Whether it be a normal Process, a Process Test Section (CTS or DCS) or a Pay Factor of 1 for Mat Density. A process is a group of like samples that are grouped together, a detailed definition can be found in Section 105.05 of the CDOT Standard Specification for Road and Bridge Construction. There are three types of processes that the report uses:

- Process Test Section: Using the CP 82 template from SiteManager® which can use either 3 cores (Demonstration Control Strip) or 7 cores (Compaction Test Section). The percent compaction will be obtained from the Core % Compaction fields on the template. Nuclear density tests may or may not be used for this type of process.
- Pay Factor of 1: This process is used when the pay factor for the element should be set to one. This option should be chosen by paving a leveling course, a bond breaker, roller pass study, or for the Furnish Asphalt item.
- Process: This process will be used for day to day paving operations.

**Cntrl Number:** This field will identify the number of the process. There may be several different processes on a project which will require different combinations of processes and control numbers. For example, you may have Process Type: Process with Cntrl Number: 1 for a 4" bottom lift and a Process Type: Process with a Cntrl Number: 2 for a 2" top lift. There may be several test sections on a project and each should have a unique Cntrl Number.

**Design Type:** This field will be SUPERPAVE for asphalt paving.

**Mix ID:** This field is populated with the mix design that represents the material being tested. The mix design must also be approved for your project and the proper association made in SiteManager® by the Region Lab Manager.

**Material Test Templates:**

The type of acceptance is determined automatically from the mix design in SiteManager® and it can be Voids acceptance or gradation acceptance. The material test templates used by the report are summarized in the tables below.

**Voids Acceptance:**

|                         |                 |
|-------------------------|-----------------|
| Compaction Test Section | CP82            |
| Joint Density           | CP44L           |
| AC Content              | CPL5120 or CP85 |
| Voids                   | CPL5115         |
| VMA                     | CP48            |
| Mat Density             | CP44 or CP81    |

**Gradation Acceptance:**

|   |                 |
|---|-----------------|
| Mat Density   | CP44 or CP81    |
| Joint Density   | CP44L           |
| AC Content  | CPL5120 or CP85 |
| Gradation   | CP31HMA         |
| Compaction Test Section / Demonstration Control Strip | CP82            |

**Binder Paid Separately:**

When the binder is paid for separately from HMA the **ACCOST template will need to be completed for each Item Code/Mix ID combination** that is used on the project. There are two fields on the ACCOST template; The Bid Item # should indicate the 411 Item Code for the binder that is used in the asphalt mix and also listed on the CAR report Owner Acceptance Sampling Checklist. The price per ton of the 411 items will also be entered into the ACCOST template in the AC Cost field. These two pieces of data are used to connect the 403 HMA item to the 411 items which the report will use to calculate the Total Cost/ton of HMA. The ACCOST template shall be completed before any other tests for each HMA item.

The screenshot shows a software window titled "Enter Test Results" with a sub-tab "Test Data". The main content area is titled "ACCOST Document AC Cost per Ton of HMA". On the right side, there are three radio buttons: "In Spec", "Out of Spec", and "No Spec", with "No Spec" being the selected option. Below the radio buttons is a "Print" button. The form contains two input fields: "Bid Item #" with the value "411-03354" and "AC Cost" with the value "320.00". At the bottom, there is a "Remarks:" label followed by a large, empty text input area.

**CAR Quality Level Report:**

The first page of the report will display any error messages that indicate errors that need to be fixed in SiteManager. The report can be generated at any point during the project to get an indication of the moving quality level. The report is broken into the various elements that are used to make up the incentive/disincentive for each Item Code/Mix Design with a summary for each process at the bottom of the element. The elements that make up the report are:

- Asphalt Content
- Compaction Test Section
- Mat Density
- Gradation
- Air Voids
- Voids in Mineral Aggregate (VMA)
- Joint Density

Elements included in the report are based on whether the mix design is determined to be voids or Gradation. There are an Interim or Final Report and a signature block for the tester and crosschecker. Each element has a header which includes Item Code, Material Code, Mix ID, HMA Cost/Ton, etc. There is also a secondary header to indicate spec limits and W and V factors. After each element, there is an indication of the processes that are included and an element summary.

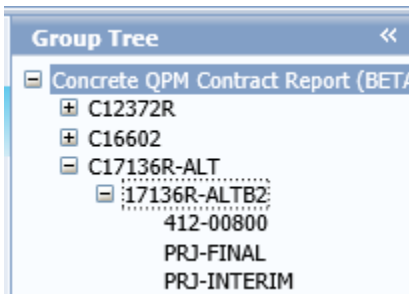
At the end of each item section there is a summary for each mix design and then a final summary at the end of the report for a comparison of the element totals and a list of the total incentive/disincentive by mix design.

## Addendum 2

### 1.0 CONCRETE QUALITY LEVEL REPORT

#### INTRODUCTION:

Standard Specifications for Road and Bridge construction sections 105.06, 106.06 and 412 contain the specifications for concrete paving. The Concrete03 program is replaced by the Quality Level Report. The report will generate by choosing the contract and project in CAR. It will be possible to run different versions of the report by using the expand (+) and collapse (-) icons



- Item Code – shows the quality level, incentive or disincentive, for each concrete item on the project.
- Interim – shows a preliminary report without checking for element totals or sample completion to ensure the square yards for each element match.
- The final – final report will check the element totals to ensure they match.

Like other CAR reports the data is pulled from SiteManager once the report title is clicked in the Trns\*port folder. Error checking is included on the first page of the report to show what data is missing or incorrect. This may include a blank Control Type, Control Number or having incomplete data in a test template, etc.



**Maintain Sample Information Window:**

The report pulls data for all Quality Acceptance Testing samples on a project that has 412 and 601 material codes. The following are critical fields used by the report that must be correctly populated in SiteManager:

**BASIC SAMPLE DATA TAB:**

**Sample Date:** Defaulted to sample creation date and can be changed to any time before the sample Log Date. Sample creation should be completed in the order they are obtained and tested so they appear in the correct order on the report.

**Smpl Type:** The Quality Level Report uses samples with a type of Quality Acceptance Testing and an Acpt Meth of Sample and Test.

**Material:** The material codes used for concrete paving will begin with either 412 (Thickness) or 601 (Strength) refer to the OA Sampling and Testing Checklist for the exact code.

**Repr Qty:** This is the quantity to be represented by the tests that will be assigned to the record. The total quantity for the element will be obtained by adding the Repr Qty's from each sample.

| Maintain Sample Information    |  |  |                |       |
|--------------------------------|--|--|----------------|-------|
| Basic Sample Data              | ADDtl Sample Data                                  | Contract   | Other          | Tests |
| Smpl ID: SEMUSD1586094653      | Buy American: <input type="checkbox"/>             | Spaces   |                |       |
| Reqst By: PROJECT              | Witnessed By: SEMUSD                               |  |                |       |
| Smpl Size: 1                   | Lot  |  |                |       |
| Dist from Grade:               | Spaces   |  |                |       |
| Station: 277+50                | Offset:  | Reference:                                       |                |       |
| Smpld From: GRADE              |  |  |                |       |
| Smpl Origin:                   |  |  |                |       |
| Control Type: PROCESS          | Cntrl Number: 1                                    | Seal Number:                                     |                |       |
| Design Type: PCC               | Mix ID: 2015081R                                   |  |                |       |
| Plant ID:                      | Plant Type: Spaces                                 |  |                |       |
| Creator User ID: SEMUSD        | Include Standard Remarks: <input type="checkbox"/> | Sample Created from DWR <input type="checkbox"/> |                |       |
| Last Modified User ID: MAYHEWT | Last Modified Date: 03/25/16                       | DWR Date: 00/00/00                               | DWR Inspector: |       |

#### ADDTL SAMPLE DATA TAB:

**Control Type:** **Process** is the only entry allowed for concrete. See section 105.06 (a) for process changes

**Cntrl Number:** This field will identify the number of the process. Different combinations of processes and control numbers may be required on a project. For example:

- A Control Type of **Process** with Cntrl Number of 1 for 6-inch concrete pavement
- A Control Type of **Process** with a Cntrl Number of 2 for 8-inch concrete pavement. For the pavement thickness element, a new mix design is not a reason to create a new process as per 105.06 (a) of the Standard Specifications

**Design Type:** This field will be **PCC** for concrete paving.

**Mix ID:** Complete this cell with the mix design that represents the material tested. HQ Concrete Unit must approve the mix design for the project and the proper association between the mix design and project made in SiteManager®. **This is the mix design number shown on the CDOT Form 1373.**

**Note:** For the Thickness element, do not enter a mix design on the sample record, as the cores are associated with the 412 paving element and not the 601 concrete elements. Mix designs are only associated with 601 concrete elements.

| Contract ID | Project      | Line Item | Proposal Line Number | Item Code | Line Item Desc              | Fed State Prj Nbr |
|-------------|--------------|-----------|----------------------|-----------|-----------------------------|-------------------|
| C17136R-ALT | 17136R-ALTB2 | 0220      | 0725                 | 412-00800 | *Concrete Pavement (8 Inch) | STA 0142-051      |

**CONTRACT TAB:**

On the Contract, Tab, choose the appropriate contract and line item that is associated with the sample. There can only be one.

**Material Test Templates:**

Automatic determination of the type of acceptance uses the presence or absence of the T 97-28 and T 97- QC templates.

**Compressive Strength Acceptance:**

|                      |                  |
|----------------------|------------------|
| Thickness            | T148             |
| Compressive Strength | C39-28 or T24-28 |

**Flexural Strength Acceptance:**

|                      |                   |
|----------------------|-------------------|
| Thickness            | T148              |
| Flexural Strength QA | T97-28            |
| Flexural Strength QC | T97-QCaa and C496 |

**Note:** Canceled tests and voided samples will not be included in the report.

**CAR Quality Level Report:**

The report will be accessible in CAR and there will be an interim and final report which can be viewed by expanding the group tree by clicking the (+). Reports can be exported to a PDF and saved or printed using the "Export this Report" icon.

The first page of the report will display any error messages that indicate missing or conflicting issues that are required to be corrected in SiteManager and the report can be generated at any point during the project to get an indication of the moving quality level. The report is broken into the various elements that are used to make up the incentive/disincentive for each Item Code/Mix Design with a summary for each process at the bottom of the element. The elements that make up the report are:

- Thickness
- Compressive Strength
- F & t-Test Comparison
- Flexural Strength

Elements are included in the report based on the presence of the C39-28 or the T97-28/T97-QC templates as well as the F & t Comparison made between the T97-28 and T97-QC

At the end of each item section, there is a summary for each mix design and a final summary at the end of the report for a comparison of the element totals and a list of the total incentive/disincentive.

**Thickness**

The thickness section of the report will use the T148 data and will obtain both the thickness test result and the Plan thickness from this template. There will be a warning message at the bottom of the element to indicate if a result is lower than the lower tolerance limit. If a test result is more than 1 inch below the lower tolerance limit it will be but in a separate process. I/DP will not be calculated on that test as this is a, Remove and Replace situation.

**Compressive Strength**

The compressive strength section of the report will use the C39-28 or the T24-28 template. There will be a warning message on the report if a test value is less than the lower tolerance limit. There is not a specification for 2 x V out of tolerance or removal and replacement for concrete paving. If a test is below the lower tolerance limit and the contractor chooses to core the area, a T24-28 template will need to be added to the same sample ID that contained the C39-28 test.

### Handling Failures or Low Test results

#### Thickness:

- If a core is lower than the Plan Thickness by more than 0.4-inch but not more than 1 inch, obtain an additional core, if that core is greater than Lower Tolerance (TL) no action is necessary. Document additional core results in SMM as Information Only.
  
- If the additional core or any randomly selected core is less than Lower Tolerance Limit (TL) but greater than Plan Thickness (PT) minus 1-inch, the area represented by this core shall become a separate process and this core will not be used to compute an I/DP. The Quality Level Report will remove this test from the element automatically and create a separate process called LOW-X. Obtain four additional randomly selected cores within the area represented by this core. The four additional cores will be used to compute an I/DP in accordance with Section 105. Cores taken at locations not randomly determined, such as process control cores will not be used to compute I/DP.
  - Create **four additional QA samples** for the additional cores; assign the same, unique, process number to the samples, this process number is different from the original sample. The represented quantity on each Sample ID of the four additional cores taken should total the area represented.
  - Cancel/Void the original test/sample.
  
- When the measurement of any core is less than PT minus 1.0 inch, whether randomly located or not, the area represented by this core shall become a separate process and this core will not be used to compute an I/DP. This is a, Remove and Replace situation. The actual thickness of the pavement in this area will be determined by taking exploratory cores. Cores shall be taken at intervals of 15 feet or less, parallel to the centerline in each direction from the affected location until two consecutive cores are found in each direction which is not less than PT minus 1.0-inch.
  - Obtain exploratory cores to define the out of specification area, document additional core results in SMM as Information Only.
  - Once the removal and replacement are complete, create **four additional QA samples** for the four additional cores that represent that area. Assign the same unique process number to the samples, which is different from the original sample. The represented quantity of the four cores should total the area represented.

#### Compressive Strength:

- The higher value between the C39-28 and the T24-28 shall be used when compressive strength is less than TL (4500psi) and the contractor takes additional cores (T24).
- Add the T24-28 to the same sample ID that contains the original C39-28. This can be done using the Maintain Test Queue in LIMS.
- Both tests are left as valid tests and the report will choose the higher value for the I/DP calculations.

**Flexural Strength:**

- When flexural strength is less than 650 psi, the contractor may take cores for split tensile testing (C496). The higher value between the T97-QC and C496 shall be used. The C496 template includes a field for the correlated flexural strength as per CP65. This correlation will be figured outside of SMM/LIMS and manually entered into the template. Only the contractors QC results can be replaced with a C496 (Splitting Tensile).
- - Add the C496 test to the original sample that contains the low T97-QC. This can be done using the Maintain Test Queue in LIMS.
  - Both tests are left as valid tests and the report will choose the higher value for the I/DP Calculations

**A partial list of error or informational messages that appear on the first page of the report:**

A sample ID with two of the same valid tests. (I.e. two T148 tests on the sample)

Specification Height on T148 template is null or zero

Average Core Inch Height cell is null or Zero on T148

Sample with zero (0) Rep. Qty.

Valid sample created with valid control type and null (blank) control number

Total quantities do not match among element totals (final only)

Not all samples are complete (final only)

Compressive and Flexural samples the Mix ID is blank

If there is more than one Item on the Contract tab

**Messages included below the element:**

C39-28 value is below Plan Value

T148 value below Plan Value by more than 1 inch

T148 value below Plan Value by more than .4" but not more than 1 inch

T148 value is more than 1 inch above plan value

Element message for a T148 Value below Plan Value but above TL

Test data that is > 1 inch above Plan Value

**Addendum 3**

**Asphalt Quality Level Report**

**Department of Transportation**

**State of Colorado**

**Report Date:** 5/7/2018

**Contract ID:** C20856

**Project Number:** 20856-BID

**Region No:** 4

**Fed/State Project #:** STA0243-087

**Ad Date:** 20170323

**Acceptance Type:** Void Acceptance

**Location:** US 24 El Paso-Elbert CL Paving

**Item Code:** 403-34741

**Material Code:** 403.02.01.11

**Mix ID:** 42017B1\_20856\_

**Design Type:** SX

**P/S:** Simon Contractors

**Gyrations:** 75

**Total Cost/ton:** \$72.00

**HMA Cost/ton:** \$72.00

**AC Cost/ton:** \$0.00

(\*\* FINAL REPORT \*\*)

**Asphalt Content**

**Upper Test Limit:** 6.00  
**Lower Test Limit:** 5.40

**V Factor:** 0.2  
**W Factor:** 10





















**Design Sp Gr:** 2.424

| Test Date     | Sample ID         | Test Quantity | Total Quantity | Max Sp Gr | % AC | SQL |
|---------------|-------------------|---------------|----------------|-----------|------|-----|
| 1 07/25/2017  | ELLISB177P075534  | 1000          | 1000           | 2.439     | 5.42 |     |
| 2 07/25/2017  | ELLISB177P102740  | 1000          | 2000           | 2.426     | 5.69 |     |
| 3 07/26/2017  | ELLISB177Q092930  | 1000          | 3000           | 2.438     | 5.68 | 100 |
| 4 07/26/2017  | GONSERS177V073643 | 1000          | 4000           | 2.446     | 5.51 | 94  |
| 5 07/28/2017  | ELLISB177S112718  | 1000          | 5000           | 2.425     | 5.61 | 98  |
| 6 07/28/2017  | ELLISB177S144315  | 1000          | 6000           | 2.420     | 5.68 | 100 |
| 7 07/31/2017  | ELLISB177V104002  | 1000          | 7000           | 2.429     | 5.59 | 100 |
| 8 08/01/2017  | ELLISB1781112006  | 1000          | 8000           | 2.430     | 5.53 | 100 |
| 9 08/01/2017  | ELLISB1781184212  | 1000          | 9000           | 2.428     | 5.74 | 100 |
| 10 08/02/2017 | ELLISB1782103724  | 1000          | 10000          | 2.424     | 5.73 | 100 |
| 11 08/02/2017 | ELLISB1782121632  | 1000          | 11000          | 2.427     | 5.78 | 100 |
| 12 08/02/2017 | ELLISB1782150453  | 1000          | 12000          | 2.430     | 5.65 | 100 |
| 13 08/04/2017 | ELLISB1784122100  | 1000          | 13000          | 2.420     | 5.95 | 100 |
| 14 08/04/2017 | ELLISB1784123036  | 1000          | 14000          | 2.427     | 5.87 | 100 |
| 15 08/04/2017 | ELLISB1784161309  | 1000          | 15000          | 2.424     | 5.69 | 99  |
| 16 08/09/2017 | ELLISB1789161743  | 1000          | 16000          | 2.433     | 5.70 | 100 |
| 17 08/11/2017 | ELLISB178B084245  | 1000          | 17000          | 2.434     | 5.68 | 100 |
| 18 08/11/2017 | ELLISB178B130304  | 1000          | 18000          | 2.427     | 5.61 | 100 |
| 19 08/11/2017 | ELLISB178B163659  | 1000          | 19000          | 2.435     | 5.73 | 100 |
| 20 08/12/2017 | ELLISB178C145905  | 1000          | 20000          | 2.441     | 5.43 | 100 |
| 21 08/12/2017 | ELLISB178C172546  | 1000          | 21000          | 2.428     | 5.48 | 95  |
| 22 08/14/2017 | ELLISB178E140506  | 1000          | 22000          | 2.442     | 5.47 | 88  |
| 23 08/14/2017 | ELLISB178E154629  | 1000          | 23000          | 2.427     | 5.61 | 88  |
| 24 08/15/2017 | ELLISB178F100503  | 1000          | 24000          | 2.434     | 5.43 | 87  |
| 25 08/15/2017 | ELLISB178F115131  | 297           | 24297          | 2.435     | 5.60 | 95  |

| Certification Checklist Requirements   |   |                              |  |                       |                      |  |
|--|---|------------------------------|--|-----------------------|----------------------|--|
| Dated submitted to PE & Contractor:    |   |                              | August 1, 2018                                     |                       |                      | Page 1 of 3  |
| ITEM Number                            | Type of Document Required<br>COC or CTR | APL or QML Material Required | Requires Contractor APL/QML Verification<br>YES/NO | Date COC/CTR Received | Accepted or Rejected | Notes  |
| 206-00360 Mech Reinforcement           | COC                                     | NY-APL for geotex            | YES  | 08/17/18              | Accepted             |  |
| 207-00205 Top Soil                     | CTR                                     | NO                           | NO   | 05/25/18              | Rejected             | Missing stamp and signature                          |
| 208-00009 Erosion Logs Typ 2           | COC                                     | YES-APL                      | YES  | 04/05/18              | Rejected             | Missing stamp & signature                            |
| 208-00020 Silt Fence                   | COC                                     | NO                           | NO   | 06/05/18              | Accepted             |  |
| 208-00051 Storm Drain Inlet Protection | COC                                     | YES-APL                      | YES  |                       |                      |  |
| 210 Modify Manhole                     | COC                                     | Precast-YES QML              | YES  |                       |                      | Poured in place-does not require verification letter |
| 212-00006 Seeding                      | COC                                     | NO                           | NO   |                       |                      |  |
| 212-00032 Soil Conditioning            | COC                                     | NO                           | NO   |                       |                      |  |
| 213-00003 Mulching Weed Free HAY       | COC                                     | NO                           | NO   |                       |                      |  |
| 213-00012 Mulch Tackifier              | COC                                     | NO                           | NO   |                       |                      |  |



### Example of Required Project Book Folders

-  COC-CTRs
-  Emails and misc. docs
-  Final Documents
-  Item 203 CIP
-  Item 206 CL 1 and 2
-  Item 206 Filter Material CL A and C
-  Item 304 ABC Class 6
-  Item 403 S(100) PG64-22
-  Item 411 Binder
-  Item 412 8.5 inch
-  Item 412 10 inch
-  Item 412 Mix Designs
-  Item 503 Caissons
-  Item 601 CL D Bridge
-  Item 601 CL D Wall
-  Item 601 Class D concrete
-  Item 603 RCP-all sizes
-  Item 608 Sidewalk
-  Item 609 Curb and Gutter all types
-  Item 624 Pipe all classes

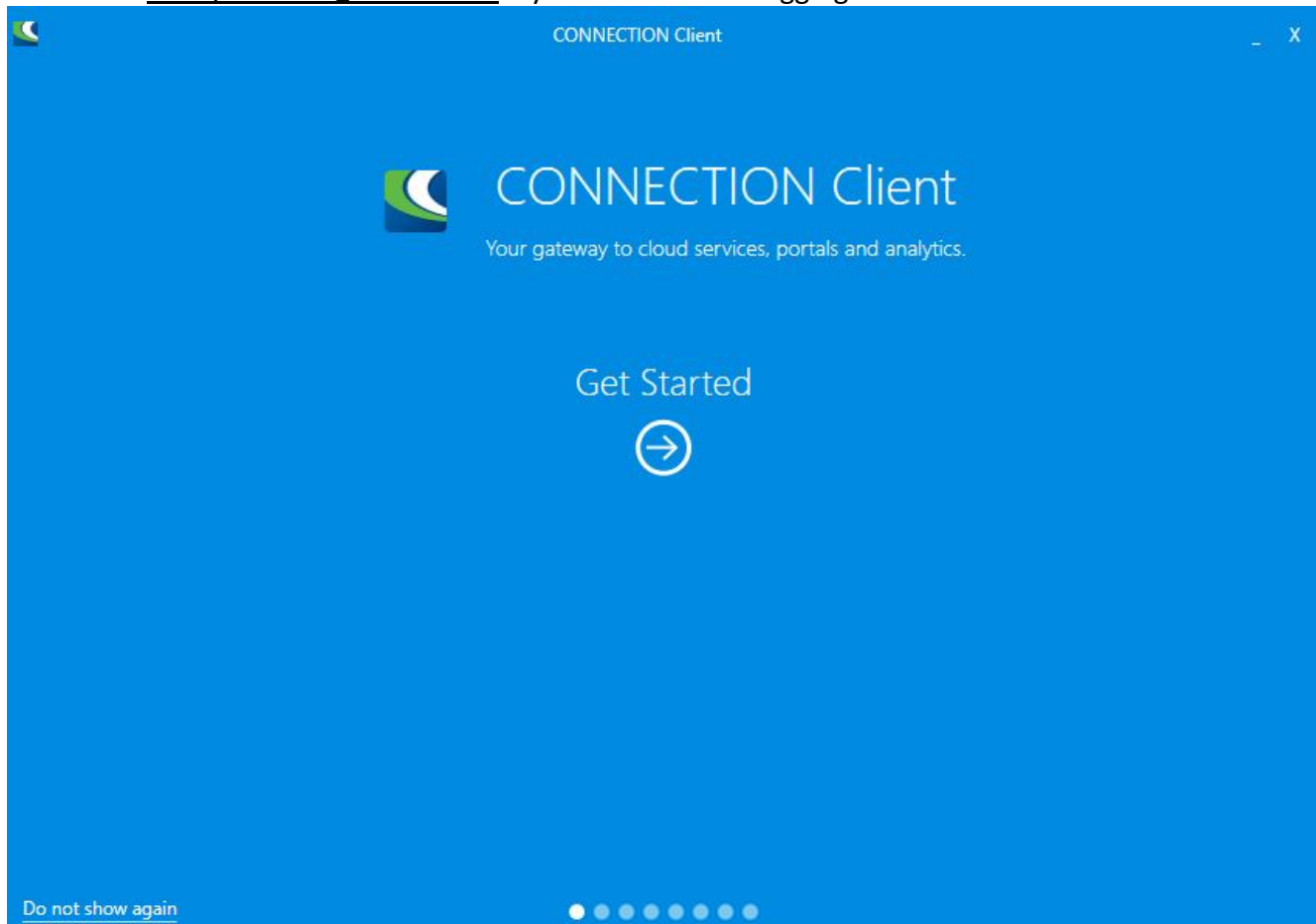
## Instructions for ProjectWise Share

### Project Share and PWZ Explorer for project record retention

Remember that Project Share eliminates the need for consultants to use VPN, and provides the ability for CDOT project records to be automatically archived in ProjectWise Explorer, thus eliminating the burden on CDOT employees to manually obtain and archive critical documents. The CDOT Record File Plans contain which project records need to be retained and which folder they are placed in. When Project Share is linked with PWZ Explorer, this transfer is automatic.


#### Logging on to Project Share:

When you log in on the Connection Client (the blue and green wavy icon) it will take you first to the Connection Client log on. When you try to enter your password, it transfers you to an OIT SSO Portal log on page. In "user name" fill in "dot\your user name" (not your email address). Next, fill in your CDOT password in the password window. This will then automatically route you to your Bentley Project Share portal. This contains the Project Share sites you have been invited to. Ask Kelley Tatman at [Kelley.Tatman@state.co.us](mailto:Kelley.Tatman@state.co.us) if you have trouble logging on.



For additional information on Project Share, please use the Bentley Community resources here: [https://communities.bentley.com/communities/other\\_communities/sign-in\\_assistance\\_and\\_web\\_services/w/wiki/40572/instructional-videos](https://communities.bentley.com/communities/other_communities/sign-in_assistance_and_web_services/w/wiki/40572/instructional-videos)


**Step 1**



**Sign In**  
Access your Bentley Services

**Email**

**Password**

[Forgot password?](#)

**Sign In**

Don't have a profile? [Register](#)

**Step 2**

# State of Colorado - SSO Portal

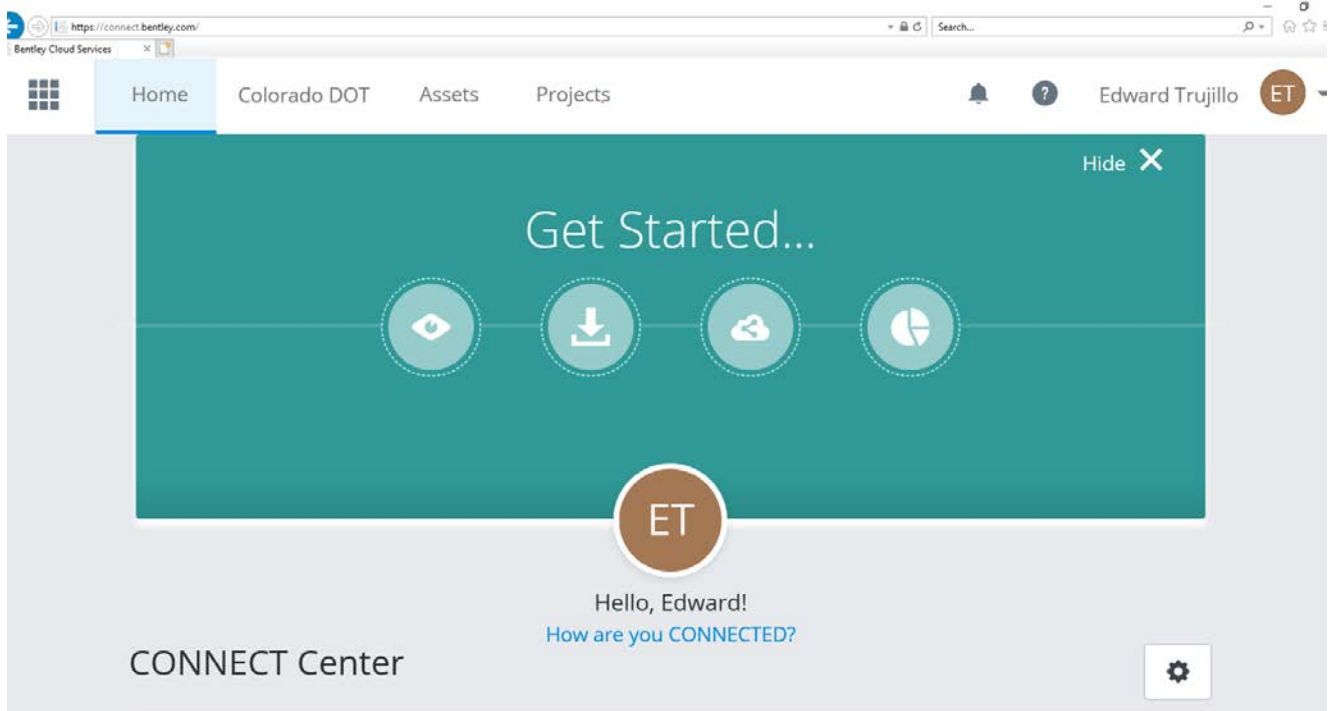
Sign in with your organizational account

Sign in

© 2013 Microsoft

### Step 3



The **power point** developed by Tom Bovee showing the basic functions of Project Share. Note that it depends on the level of authority assigned by the program manager in the Project Share site to other users how much the user can do (i.e., read/write, delete, develop new folders, etc.) so some notes in the powerpoint will not apply to all users.

We hope this allows you to learn more about Project Share, which will facilitate the collaboration between CDOT and consultants to transfer, retain and archive critical project records in compliance with state and federal requirements.

Use the electronic version of the 2021 FMM to view the ProjectWise Share Overview Power Point



{Page Intentionally Left Blank}

## Instructions for CDOT FORM 473/474 using Adobe Pro DC

### **Form 473, Page 1**

The intent of Form 473 is to ensure the project materials documentation has been completed per the Quality Assurance Procedures for Construction and Materials Sampling and Testing as stated in Section 19 of the Field Materials Manual and in the coordination of CDOT's stewardship agreement with the FHWA. The federal guidelines may be found in 23 CFR 637.205 and 23 CFR 637.2017. The stewardship agreement can be found on the CDOT internet site at the following address

<https://www.codot.gov/business/designsupport/cdot-fhwa-stewardship-agreement>.

The form is laid out in logical order in which project construction and closure occurs from the top of the form ascending to the bottom. The following is a brief summary of the steps to complete the form:

### **Form 473**

1. The IA initiates Form 473.
2. Lab inspection is performed prior to any project testing. The person performing the inspection and the date of the inspection are documented on CDOT Form 473.
3. IAT testing is completed prior to project testing.
4. Once all IA testing is completed, the Region Materials IA:
  - Signs Form 473
  - The Region Materials Engineer (RME) then signs the CDOT Form 473
  - The RME Forwards the form to the Project Tester
5. The Project Tester
  - Project Tester completes Items 2-8, the Project Engineer may complete Items 6-8 as necessary.
  - Project Tester signs Form 473 and ensure all required attachments are included and project testing has been completed.
6. The Project Engineer signs CDOT Form 473
7. Resident Engineer signs Form 473.
8. The Project Engineer and Resident Engineer's signatures verify the previous sections of the form have been completed and all applicable attachments are present.
9. The form and all attachments are placed in the ProjectWise folder Contract ID/Construction/Materials to be accessed by the Region Finals Materials Coordinator or Region Finals Administrator.  
The Region's finals personnel are required to have the completed form with attachments before final project closure.
10. The Region Finals Materials Documentation Coordinator or Region Finals Administrator signs the document.

**CDOT Form 474**

1. The Project Tester or the Project Engineer (rarely) initiates the Form.
2. The Project Tester fills out project information including the Contract ID, Region, Acceptance Date, Project Number, Project Location, Contractor and Project Final Documentation Completion Date. The Project Final Documentation Completion date shall be the same date that appears on the final copy of the Owner Acceptance Sampling & Testing Checklist. **(See an example of the checklist in this Section).**
3. The Project Tester selects the type of project and testing requirements for the project by checking the box for either Owner Acceptance, Independent Assurance, Innovative Contract, Local Agency, CDOT Maintenance, or Other
4. The Project Tester fills in the consulting company's name and if/whether sampling and testing are performed by a consultant.
5. The Project Tester checks the boxes for asphalt and/or concrete quality level. They also electronically sign the boxes to verify the concrete and asphalt data has been reviewed and checked. These boxes, reviewed by and checked by, are signed by different individuals.
6. Whoever reviews the project data (usually the Project Tester, Head Tester, Project Engineer, or a combination) fills out the bulk of the form which shall contain a detailed list with explanations of all exceptions or changes to a project, incentives and disincentives, failing tests, missing documents, etc.
7. The Project Tester or Project Engineer electronically signs the document, locking all their input from future alterations.

**CDOT Form 473, Page 2**

Form 473, Page 2 has been replaced with CDOT Form 474. Older versions of CDOT Form 473 shall not be used, even if specified in the Field Materials Manual required for the project. Project personnel should replace any older versions of CDOT Form 473 (pages 1 and 2) with the newest versions of CDOT Forms 473 and 474 and document the change in the project.

**CDOT Form 474**

CDOT's directive to go paperless was the primary direction for creating CDOT Form 474, which is essentially the old and cumbersome CDOT Form 473, Page 2. CDOT Form 474, CDOT Final Materials Certification/Explanation of Exceptions was created for supplemental project documentation. Some of the items that must be included on CDOT Form 474 include shortages of tests, missing COC/CTR's, price reductions, and CAR quality level report. As the title suggests this form also requires signatures that were previously on CDOT Form 473, Page 2.

**Signature Blocks**

Both CDOT Forms 473 and 474 have a signature lock feature built into them. Each signature will lock the entire section that particular the signature block is responsible for completing. Thus, each signer must verify their section is correct before signing, as once a signature is applied no changes can be made to that section. A more detailed list of instructions for filling and signing these two forms is as follows.

**CDOT Form 473** There are six required signatures for CDOT Form 473, the following illustrates the proper order in a step by step process for correctly filling out this form.



|   |                    |  |
|---|--------------------|--|
| <p><b>COLORADO DEPARTMENT OF TRANSPORTATION</b></p> <p><b>Final Materials Certification Checklist</b></p>   | <p>Contract ID</p> | <p>Project No.</p>   |
|   | <p>Region</p>      | <p>Location</p>  |
| <p>The Independent Assurance Sampling Schedule for this project has been substantially followed and the test results of the IA samples are in reasonably close agreement with the project acceptance (QA) sample test results. Exceptions to this statement have been previously commented on and documented when the test results were reported or are explained on an attached sheet.</p> <p>Independent Assurance (IA) samples were tested with independent equipment unless noted on CDOT Form 474 - Explanation of Exceptions, see attached.</p>   |                    |  |
| <p>Method of Acceptance for Item 403: <span style="border: 1px solid black; padding: 2px;">Project</span></p>   |                    |  |
| <p>1) IA Summary Report (Form #379), attached with IA Explanation of Exceptions.....</p>  |                    | <p><span style="border: 1px solid black; padding: 2px;">N/A</span></p>   |
| <p>Project Materials Lab Inspected by: <span style="border: 1px solid black; display: inline-block; width: 150px; height: 20px;"></span>      Date of inspection: <span style="border: 1px solid black; display: inline-block; width: 80px; height: 20px;"></span></p>  |                    |  |
| <p>Final IA Review<br/>Region Materials Engineer</p> <p><span style="border: 1px solid black; display: inline-block; width: 150px; height: 20px;"></span></p>   |                    | <p>IA Tester</p> <p><span style="border: 1px solid black; display: inline-block; width: 150px; height: 20px;"></span></p>          |
| <p>Project Tester - Document all shortages of tests, missing COC/CTR's and explain all quality level incentives/disincentives, price reductions and include supplemental documents as required on the CDOT Form 474 - Final Materials Certification Explanation of Exceptions.</p>  |                    |  |
| <p>2) CDOT Form 474 - Final Materials Certification Explanation of Exceptions with supplemental documentation as required.....</p>  |                    | <p><span style="border: 1px solid black; padding: 2px;">N/A</span></p>   |
| <p>3) Completed O/A and Certification Checklists.....</p>   |                    | <p><span style="border: 1px solid black; padding: 2px;">N/A</span></p>   |
| <p>4) Completed Random Sampling Schedules (all required elements).....</p>  |                    | <p><span style="border: 1px solid black; padding: 2px;">N/A</span></p>   |
| <p>5) Quality Control Notebooks (digital) for all required items.....</p>   |                    | <p><span style="border: 1px solid black; padding: 2px;">N/A</span></p>   |
| <p>6) Evaluation of Materials testing, Form 1324.....</p>   |                    | <p><span style="border: 1px solid black; padding: 2px;">N/A</span></p>   |
| <p>7) Buy America monthly summary reports.....</p>  |                    | <p><span style="border: 1px solid black; padding: 2px;">N/A</span></p>   |
| <p>8) Project Engineer has verified Pavement Structural Design Data is complete.....</p>  |                    | <p><span style="border: 1px solid black; padding: 2px;">N/A</span></p>   |
| <p>Project Acceptance Date: <span style="border: 1px solid black; display: inline-block; width: 80px; height: 20px;"></span></p>  |                    | <p>Project Tester:</p> <p><span style="border: 1px solid black; display: inline-block; width: 150px; height: 20px;"></span></p>    |
| <p>Project Engineer: Ensure O/A Sampling &amp; Testing Checklist, Certification Checklist and IA Checklist have met the minimum required testing. Explanation of Exceptions, Buy America summaries, Pavement Structural Design Data is complete. All documentation has been reviewed and placed in ProjectWise in the path ContractID/Construction/Materials.</p> <p>This is to Certify that: The results of the tests on the acceptance samples indicate that the material incorporated in the construction work, and the construction operations controlled by sampling and testing, were in conformity with the approved plans and specifications, and such results compare favorably with results of the Independent Assurance sampling and testing. This form is complete, includes all attachments, and has been reviewed and accepted.</p> |                    |  |
| <p>Project Engineer: <span style="border: 1px solid black; display: inline-block; width: 150px; height: 20px;"></span></p>  |                    | <p>Resident Engineer:</p> <p><span style="border: 1px solid black; display: inline-block; width: 150px; height: 20px;"></span></p> |
| <p><input type="checkbox"/> Region Finals Materials Documentation Coordinator or the Region Finals Administrator has verified items 1-8. O/A Sampling Checklist, Certification Checklist, IA Checklist and all documentation is complete. Check for COMP status on Summary of Samples (All) Report.</p> <p><input type="checkbox"/> All items have been properly documented and placed into ProjectWise under the path: ContractID/Construction/FinalsDocumentation/Form 325 Packet</p>   |                    |  |
| <p>Region Finals Materials Documentation Coordinator or the Region Finals Administrator</p> <p><span style="border: 1px solid black; display: inline-block; width: 150px; height: 20px;"></span></p>  |                    |  |

Step 1. The IA tester initiates CDOT Form 473 and is responsible for filling out all Items A1 through A6.

- A1: The Contract ID, Project No., Region, and Location.
- A2: Selecting the Item Method of Acceptance for Item 403 using a pull-down menu
- A3: The IA tester states if the IA Summary Report (Form 379) exists using a pull-down menu
- A4: Who inspected the Project Materials Lab, Type in Name of Individual.
- A5: Date of the Project Materials Lab inspection
- A6: The IA Tester electronically signs the document which will lock Items A1 through A6 (circled in blue) from future alterations by another person.

The image shows a screenshot of the CDOT Form 473, titled "Final Materials Certification Checklist". The form is annotated with callouts A1 through A6, which correspond to the steps listed in the previous block. A blue box highlights the top section of the form, and a red box highlights the signature area.

**Callout A1:** Points to the header section containing "Contract ID", "Project No.", "Region", and "Location".

**Callout A2:** Points to the "Method of Acceptance for Item 403" dropdown menu, which is currently set to "Project".

**Callout A3:** Points to the "1) IA Summary Report (Form #379), attached with IA Explanation of Exceptions" dropdown menu, which is currently set to "N/A".

**Callout A4:** Points to the "Project Materials Lab Inspected by:" text input field.

**Callout A5:** Points to the "Date of inspection:" text input field.

**Callout A6:** Points to the "IA Tester" signature field.

The form includes the following text: "The Independent Assurance Sampling Schedule for this project has been substantially followed and the test results of the IA samples are in reasonably close agreement with the project acceptance (QA) sample test results. Exceptions to this statement have been previously commented on and documented when the test results were reported or are explained on an attached sheet. Independent Assurance (IA) samples were tested with independent equipment unless noted on CDOT Form 474 - Explanation of Exceptions, see attached."

The form also includes a "Project Tester" section with a list of items to be checked, each with a dropdown menu set to "N/A":

- 2) CDOT Form 474 - Final Materials Certification Explanation of Exceptions with supplemental documentation as required.
- 3) Completed O/A and Certification Checklists.
- 4) Completed Random Sampling Schedules (all required elements).
- 5) Quality Control Notebooks (digital) for all required items.
- 6) Evaluation of Materials testing, Form 1324.
- 7) Buy America monthly summary reports.
- 8) Project Engineer has verified Pavement Structural Design Data is complete.

At the bottom, there are signature lines for "Project Engineer" and "Resident Engineer", and a checkbox section for verification of documentation.

CDOT Form #0473SMM 6/18

Step 2. The Final IA Review is performed, verified, and electronically signed by the Region Materials Engineer in Item B.

| COLORADO DEPARTMENT OF TRANSPORTATION   |  | Contract ID                              | Project No. |
|---|--|--|-------------|
| Final Materials Certification Checklist   |  | Region                                   | Location    |
| <p>The Independent Assurance Sampling Schedule for this project has been substantially followed and the test results of the IA samples are in reasonably close agreement with the project acceptance (QA) sample test results. Exceptions to this statement have been previously commented on and documented when the test results were reported or are explained on an attached sheet.</p> <p>Independent Assurance (IA) samples were tested with independent equipment unless noted on CDOT Form 474 - Explanation of Exceptions, see attached.</p>   |  |  |             |
| Method of Acceptance for Item 403: <input type="text" value="Project"/>   |  |  |             |
| 1) IA Summary Report (Form #379), attached with IA Explanation of Exceptions.....   |  | <input type="text" value="N/A"/>         |             |
| Project Materials Lab Inspected by: <input type="text"/>  |  | Date of inspection: <input type="text"/> |             |
| <b>Final IA Review</b><br>Region Materials Engineer: <input type="text"/>   |  | IA Tester: <input type="text"/>          |             |
| <p>Project Tester - Document all shortages of tests, missing COC/CTR's and explain all quality level incentives/disincentives, price reductions and include supplemental documents, as required on the CDOT Form 474 - Final Materials Certification Explanation of Exceptions.</p>   |  |  |             |
| 2) CDOT Form 474 - Final Materials Certification Explanation of Exceptions with supplemental documentation as required.....   |  | <input type="text" value="N/A"/>         |             |
| 3) Completed O/A and Certification Checklists.....  |  | <input type="text" value="N/A"/>         |             |
| 4) Completed Random Sampling Schedules (all required elements).....   |  | <input type="text" value="N/A"/>         |             |
| 5) Quality Control Notebooks (digital) for all required items.....  |  | <input type="text" value="N/A"/>         |             |
| 6) Evaluation of Materials testing, Form 1324.....  |  | <input type="text" value="N/A"/>         |             |
| 7) Buy America monthly summary reports.....   |  | <input type="text" value="N/A"/>         |             |
| 8) Project Engineer has verified Pavement Structural Design Data is complete.....   |  | <input type="text" value="N/A"/>         |             |
| Project Acceptance Date: <input type="text"/>   |  | Project Tester: <input type="text"/>     |             |
| <p>Project Engineer: Ensure O/A Sampling &amp; Testing Checklist, Certification Checklist and IA Checklist have met the minimum required testing. Explanation of Exceptions, Buy America summaries, Pavement Structural Design Data is complete. All documentation has been reviewed and placed in ProjectWise in the path ContractID/Construction/Materials.</p> <p>This is to Certify that: The results of the tests on the acceptance samples indicate that the material incorporated in the construction work, and the construction operations controlled by sampling and testing, were in conformity with the approved plans and specifications, and such results compare favorably with results of the Independent Assurance sampling and testing. This form is complete, includes all attachments, and has been reviewed and accepted.</p> |  |  |             |
| Project Engineer: <input type="text"/>  |  | Resident Engineer: <input type="text"/>  |             |
| <input type="checkbox"/> Region Finals Materials Documentation Coordinator or the Region Finals Administrator has verified items 1-8. O/A Sampling Checklist, Certification Checklist, IA Checklist and all documentation is complete. Check for COMP status on Summary of Samples (All) Report.  |  |  |             |
| <input type="checkbox"/> All items have been properly documented and placed into ProjectWise under the path: ContractID/Construction/FinalsDocumentation/Form 325 Packet  |  |  |             |
| Region Finals Materials Documentation Coordinator or the Region Finals Administrator<br><input type="text"/>  |  |  |             |

B

Step 3. The Project Tester is responsible for a large amount of the required documentation which is listed as Items 2 through 8 in the section circled in blue.

- C1: The Project Tester will verify if the documentation is in the project files or not applicable using a drop-down menu. Items stated as missing with a "No" or not applicable "N/A" shall be listed on Form 474 with a detailed explanation.
- C2: The Project Acceptance Date shall be filled out by the Project Tester
- C3: The Project Tester shall electronically sign the document which will lock all items shown as Section C (Circled in Blue) from future alterations by another person.

| COLORADO DEPARTMENT OF TRANSPORTATION  |  | Contract ID                          | Project No. |
|--|--|--------------------------------------|-------------|
| Final Materials Certification Checklist  |  | Region                               | Location    |
| <p>The Independent Assurance Sampling Schedule for this project has been substantially followed and the test results of the IA samples are in reasonably close agreement with the project acceptance (IA) sample test results. Exceptions to this statement have been previously commented on and documented when the test results were reported or are explained on an attached sheet.</p> <p>Independent Assurance (IA) samples were tested with independent equipment unless noted on CDOT Form 474 - Explanation of Exceptions, see attached.</p> <p>Method of Acceptance for Item 403: <input type="text" value="Project"/></p>   |  |                                      |             |
| 1) IA Summary Report (Form #379), attached with IA Explanation of Exceptions.....  |  | <input type="text" value="N/A"/>     |             |
| Project Materials Lab Inspected by:  |  | Date of inspection:                  |             |
| <input type="text"/>   |  | <input type="text"/>                 |             |
| Final IA Review<br>Region Materials Engineer   |  | IA Tester                            |             |
| <input type="text"/>   |  | <input type="text"/>                 |             |
| <p>Project Tester - Document all shortages of tests, missing COC/CTR's and explain all quality level incentives/disincentives, price reductions and include supplemental documents as required on the CDOT Form 474 - Final Materials Certification Explanation of Exceptions.</p>   |  |                                      |             |
| 2) CDOT Form 474 - Final Materials Certification Explanation of Exceptions with supplemental documentation as required.....  |  | <input type="text" value="N/A"/>     |             |
| 3) Completed O/A and Certification Checklists.....   |  | <input type="text" value="N/A"/>     |             |
| 4) Completed Random Sampling Schedules (all required elements).....  |  | <input type="text" value="N/A"/>     |             |
| 5) Quality Control Notebooks (digital) for all required items.....   |  | <input type="text" value="N/A"/>     |             |
| 6) Evaluation of Materials testing, Form 1324.....   |  | <input type="text" value="N/A"/>     |             |
| 7) Buy America monthly summary reports.....  |  | <input type="text" value="N/A"/>     |             |
| 8) Project Engineer has verified Pavement Structural Design Data is complete.....  |  | <input type="text" value="N/A"/>     |             |
| Project Acceptance Date: <input type="text"/>  |  | Project Tester: <input type="text"/> |             |
| <p>Project Engineer: Ensure O/A Sampling &amp; Testing Checklist, Certification Checklist and IA Checklist have met the minimum required testing. <u>Explanation of Exceptions, Buy America summaries, Pavement Structural Design Data is complete. All documentation has been reviewed and placed in ProjectWise in the path ContractID/Construction/Materials.</u></p> <p>This is to Certify that: The results of the tests on the acceptance samples indicate that the material incorporated in the construction work, and the construction operations controlled by sampling and testing, were in conformity with the approved plans and specifications, and such results compare favorably with results of the Independent Assurance sampling and testing. This form is complete, includes all attachments, and has been reviewed and accepted.</p> |  |                                      |             |
| Project Engineer:  |  | Resident Engineer:                   |             |
| <input type="text"/>   |  | <input type="text"/>                 |             |
| <p><input type="checkbox"/> Region Finals Materials Documentation Coordinator or the Region Finals Administrator has verified items 1-8. O/A Sampling Checklist, Certification Checklist, IA Checklist and all documentation is complete. Check for COMP status on Summary of Samples (All) Report.</p> <p><input type="checkbox"/> All items have been properly documented and placed into ProjectWise under the path: ContractID/Construction/FinalsDocumentation/Form 325 Packet</p>  |  |                                      |             |
| Region Finals Materials Documentation Coordinator or the Region Finals Administrator   |  |                                      |             |
| <input type="text"/>   |  |                                      |             |

Step 4. The Project Engineer signs the document Item (D) ensuring the:

- O/A Sampling and Testing Checklist, Certification Checklist, and IA Checklist have met the minimum required testing.
- Explanation of Exceptions is complete
- Buy America summaries are complete
- Pavement Structural Design Data is complete
- All documentation has been reviewed and placed in ProjectWise in the path Contract ID/Construction/Materials.
- Certifies the results of tests on acceptance samples indicate the material incorporated was in conformity with plans and specifications and compare favorably with results of IA sampling and testing.

| COLORADO DEPARTMENT OF TRANSPORTATION   |  | Contract ID                                | Project No. |
|---|--|--|-------------|
| Final Materials Certification Checklist   |  | Region                                     | Location    |
| <p>The Independent Assurance Sampling Schedule for this project has been substantially followed and the test results of the IA samples are in reasonably close agreement with the project acceptance (QA) sample test results. Exceptions to this statement have been previously commented on and documented when the test results were reported or are explained on an attached sheet.</p> <p>Independent Assurance (IA) samples were tested with independent equipment unless noted on CDOT Form 474 - Explanation of Exceptions, see attached.</p>   |  |  |             |
| Method of Acceptance for Item 403: <input type="text" value="Project"/>   |  |  |             |
| 1) IA Summary Report (Form #379), attached with IA Explanation of Exceptions.....   |  | <input type="text" value="N/A"/>           |             |
| Project Materials Lab Inspected by: <input type="text"/>  |  | Date of inspection: <input type="text"/>   |             |
| Final IA Review<br>Region Materials Engineer<br><input type="text"/>  |  | IA Tester<br><input type="text"/>          |             |
| <p>Project Tester - Document all shortages of tests, missing COC/CTR's and explain all quality level incentives/disincentives, price reductions and include supplemental documents as required on the CDOT Form 474 - Final Materials Certification Explanation of Exceptions.</p>  |  |  |             |
| 2) CDOT Form 474 - Final Materials Certification Explanation of Exceptions with supplemental documentation as required.   |  | <input type="text" value="N/A"/>           |             |
| 3) Completed O/A and Certification Checklists.....  |  | <input type="text" value="N/A"/>           |             |
| 4) Completed Random Sampling Schedules (all required elements).....   |  | <input type="text" value="N/A"/>           |             |
| 5) Quality Control Notebooks (digital) for all required items.....  |  | <input type="text" value="N/A"/>           |             |
| 6) Evaluation of Materials testing, Form 1324.....  |  | <input type="text" value="N/A"/>           |             |
| 7) Buy America monthly summary reports.....   |  | <input type="text" value="N/A"/>           |             |
| 8) Project Engineer has verified Pavement Structural Design Data is complete.....   |  | <input type="text" value="N/A"/>           |             |
| Project Acceptance Date: <input type="text"/>   |  | Project Tester:<br><input type="text"/>    |             |
| <p>Project Engineer: Ensure O/A Sampling &amp; Testing Checklist, Certification Checklist and IA Checklist have met the minimum required testing. Explanation of Exceptions, Buy America summaries, Pavement Structural Design Data is complete. All documentation has been reviewed and placed in ProjectWise in the path ContractID/Construction/Materials.</p> <p>This is to Certify that: The results of the tests on the acceptance samples indicate that the material incorporated in the construction work, and the construction operations controlled by sampling and testing, were in conformity with the approved plans and specifications, and such results compare favorably with results of the Independent Assurance sampling and testing. This form is complete, includes all attachments, and has been reviewed and accepted.</p> |  |  |             |
| Project Engineer:<br><input type="text"/>   |  | Resident Engineer:<br><input type="text"/> |             |
| <input type="checkbox"/> Region Finals Materials Documentation Coordinator or the Region Finals Administrator has verified items 1-8.<br>O/A Sampling Checklist, Certification Checklist, IA Checklist and all documentation is complete. Check for COMP status on Summary of Samples (All) Report.   |  |  |             |
| <input type="checkbox"/> All items have been properly documented and placed into ProjectWise under the path: ContractID/Construction/FinalsDocumentation/Form 325 Packet  |  |  |             |
| Region Finals Materials Documentation Coordinator or the Region Finals Administrator<br><input type="text"/>  |  |  |             |

D

Step 5. The Resident Engineer signs the document Item (E) ensuring the:

- O/A Sampling and Testing Checklist, Certification Checklist, and IA Checklist have met the minimum required testing.
- Explanation of Exceptions is complete.
- Buy America summaries are complete.
- Pavement Structural Design Data is complete.
- All documentation has been reviewed and placed in ProjectWise in the path Contract ID/Construction/Materials.
- Certifies the results of tests on acceptance samples indicate the material incorporated was in conformity with plans and specifications and compare favorably with results of IA sampling and testing.

| COLORADO DEPARTMENT OF TRANSPORTATION   |  | Contract ID                                     | Project No. |
|---|--|---|-------------|
| Final Materials Certification Checklist   |  | Region  | Location    |
| <p>The Independent Assurance Sampling Schedule for this project has been substantially followed and the test results of the IA samples are in reasonably close agreement with the project acceptance (QA) sample test results. Exceptions to this statement have been previously commented on and documented when the test results were reported or are explained on an attached sheet.</p> <p>Independent Assurance (IA) samples were tested with independent equipment unless noted on CDOT Form 474 - Explanation of Exceptions, see attached.</p> <p>Method of Acceptance for Item 403: <input type="text" value="Project"/></p>  |  |   |             |
| <p>1) IA Summary Report (Form #379), attached with IA Explanation of Exceptions.....</p>  |  | <input type="text" value="N/A"/>                |             |
| <p>Project Materials Lab Inspected by: <input type="text"/></p>   |  | <p>Date of inspection: <input type="text"/></p> |             |
| <p>Final IA Review<br/>Region Materials Engineer</p> <input type="text"/>   |  | <p>IA Tester</p> <input type="text"/>           |             |
| <p>Project Tester - Document all shortages of tests, missing COC/CTR's and explain all quality level incentives/disincentives, price reductions and include supplemental documents as required on the CDOT Form 474 - Final Materials Certification Explanation of Exceptions.</p>  |  |   |             |
| <p>2) CDOT Form 474 - Final Materials Certification Explanation of Exceptions with supplemental documentation as required.....</p>  |  | <input type="text" value="N/A"/>                |             |
| <p>3) Completed O/A and Certification Checklists.....</p>   |  | <input type="text" value="N/A"/>                |             |
| <p>4) Completed Random Sampling Schedules (all required elements).....</p>  |  | <input type="text" value="N/A"/>                |             |
| <p>5) Quality Control Notebooks (digital) for all required items.....</p>   |  | <input type="text" value="N/A"/>                |             |
| <p>6) Evaluation of Materials testing, Form 1324.....</p>   |  | <input type="text" value="N/A"/>                |             |
| <p>7) Buy America monthly summary reports.....</p>  |  | <input type="text" value="N/A"/>                |             |
| <p>8) Project Engineer has verified Pavement Structural Design Data is complete.....</p>  |  | <input type="text" value="N/A"/>                |             |
| <p>Project Acceptance Date: <input type="text"/></p>  |  | <p>Project Tester:</p> <input type="text"/>     |             |
| <p>Project Engineer: Ensure O/A Sampling &amp; Testing Checklist, Certification Checklist and IA Checklist have met the minimum required testing. Explanation of Exceptions, Buy America summaries, Pavement Structural Design Data is complete. All documentation has been reviewed and placed in ProjectWise in the path ContractID/Construction/Materials.</p> <p>This is to Certify that: The results of the tests on the acceptance samples indicate that the material incorporated in the construction work, and the construction operations controlled by sampling and testing, were in conformity with the approved plans and specifications, and such results compare favorably with results of the Independent Assurance sampling and testing. This form is complete, includes all attachments, and has been reviewed and accepted.</p> |  |   |             |
| <p>Project Engineer:</p> <input type="text"/>   |  | <p>Resident Engineer:</p> <input type="text"/>  |             |
| <p><input type="checkbox"/> Region Finals Materials Documentation Coordinator or the Region Finals Administrator has verified items 1-8. O/A Sampling Checklist, Certification Checklist, IA Checklist and all documentation is complete. Check for COMP status on Summary of Samples (AS) Report.</p> <p><input type="checkbox"/> All items have been properly documented and placed into ProjectWise under the path: ContractID/Construction/FinalsDocumentation/Form 325 Packet</p>  |  |   |             |
| <p>Region Finals Materials Documentation Coordinator or the Region Finals Administrator</p> <input type="text"/>  |  |   |             |

E

Step 6. The Region Finals Materials Documentation Coordinator or the Region Finals Administrator signs the document Item (F). They must also check the following:

- The box stating they have verified Items 1-8 on this form.
- All items have been properly documented and placed in ProjectWise.

| COLORADO DEPARTMENT OF TRANSPORTATION  |  | Contract ID                                | Project No. |
|--|--|--|-------------|
| Final Materials Certification Checklist  |  | Region                                     | Location    |
| <p>The Independent Assurance Sampling Schedule for this project has been substantially followed and the test results of the IA samples are in reasonably close agreement with the project acceptance (QA) sample test results. Exceptions to this statement have been previously commented on and documented when the test results were reported or are explained on an attached sheet.</p> <p>Independent Assurance (IA) samples were tested with independent equipment unless noted on CDOT Form 474 - Explanation of Exceptions, see attached.</p>  |  |  |             |
| Method of Acceptance for Item 403: <input type="text" value="Project"/>  |  |  |             |
| 1) IA Summary Report (Form #379), attached with IA Explanation of Exceptions.....  |  | <input type="text" value="N/A"/>           |             |
| Project Materials Lab Inspected by: <input type="text"/>   |  | Date of inspection: <input type="text"/>   |             |
| Final IA Review<br>Region Materials Engineer<br><input type="text"/>   |  | IA Tester<br><input type="text"/>          |             |
| <p>Project Tester - Document all shortages of tests, missing COC/CTR's and explain all quality level incentives/disincentives, price reductions and include supplemental documents as required on the CDOT Form 474 - Final Materials Certification Explanation of Exceptions.</p>   |  |  |             |
| 2) CDOT Form 474 - Final Materials Certification Explanation of Exceptions with supplemental documentation as required.....  |  | <input type="text" value="N/A"/>           |             |
| 3) Completed O/A and Certification Checklists.....   |  | <input type="text" value="N/A"/>           |             |
| 4) Completed Random Sampling Schedules (all required elements).....  |  | <input type="text" value="N/A"/>           |             |
| 5) Quality Control Notebooks (digital) for all required items.....   |  | <input type="text" value="N/A"/>           |             |
| 6) Evaluation of Materials testing, Form 1324.....   |  | <input type="text" value="N/A"/>           |             |
| 7) Buy America monthly summary reports.....  |  | <input type="text" value="N/A"/>           |             |
| 8) Project Engineer has verified Pavement Structural Design Data is complete.....  |  | <input type="text" value="N/A"/>           |             |
| Project Acceptance Date: <input type="text"/>  |  | Project Tester:<br><input type="text"/>    |             |
| <p>Project Engineer: Ensure O/A Sampling &amp; Testing Checklist, Certification Checklist and IA Checklist have met the minimum required testing. Explanation of Exceptions, Buy America summaries, Pavement Structural Design Data is complete. All documentation has been reviewed and placed in ProjectWise in the path: ContractID/Construction/Materials.</p> <p>This is to Certify that: The results of the tests on the acceptance samples indicate that the material incorporated in the construction work, and the construction operations controlled by sampling and testing, were in conformity with the approved plans and specifications, and such results compare favorably with results of the Independent Assurance sampling and testing. This form is complete, includes all attachments, and has been reviewed and accepted.</p> |  |  |             |
| Project Engineer:<br><input type="text"/>  |  | Resident Engineer:<br><input type="text"/> |             |
| <p><input type="checkbox"/> Region Finals Materials Documentation Coordinator or the Region Finals Administrator has verified items 1-8. O/A Sampling Checklist, Certification Checklist, IA Checklist and all documentation is complete. Check for COMP status on Summary of Samples (All) Report.</p> <p><input type="checkbox"/> All items have been properly documented and placed into ProjectWise under the path: ContractID/Construction/FinalsDocumentation/Form 325 Packet</p>  |  |  |             |
| <b>Region Finals Materials Documentation Coordinator or the Region Finals Administrator</b><br><input type="text"/>  |  |  |             |

F

**CDOT Form 474** is essentially the old CDOT Form 473 Page 2, but with a couple of upgrades. Similar to the new CDOT Form 473, electronic signatures will lock in the various areas the signee is responsible for. The following illustrates the proper step by step process for correctly filling out this form.

**Step 1:** The Project Tester or (in rare cases) the Project Engineer fill out the following:

- Item A1: Contract Id, Region, Acceptance Date, Project Number, Project Location, Contractor and Project Final Documentation Completion Date.
- Item A2: Select the type of project and testing requirements for the project by check the box for either owner acceptance, independent assurance, innovative contract, Local Agency, CDOT Maintenance, or "Other".
- If "Other" is selected then a description must be typed in this box.
- Item A3: Type CDOT or the consulting company's name in the box adjacent to the signature.
- Item A4: Select 'Yes' or 'No' if the CDOT Project sampling and testing are performed by a consultant.
- Item A5: The Project Tester or Project Engineer check the box(s) for asphalt and/or concrete quality Level. They also electronically sign the boxes to verify the concrete and asphalt data has been reviewed and checked. These boxes, reviewed by and checked by, are signed by different individuals.
- Item A6: whoever reviews the project data fills this block out. Usually, it is the Project Tester, Head Tester, Project Engineer, or a combination depending on who has reviewed the project data. This box should contain a detailed list with explanations of all exceptions or changes to a project, incentives, and disincentives, failing tests, missing documents, etc.
- Item A7: The Project Tester or Project Engineer electronically signs the document, locking all their input (outlined in Red) from future alterations.

**Step 2:** Item B: Signed by the Consultant Firm's PE, if a consultant tester was used. If no consultant tester was used, then this block will remain blank.

**Step 3:** Item B1: This block is for comments made by the Consultant Firm's PE if a consultant tester was used. If no consultant tester was used, then this block will remain blank.

**Step 4:** Consultant Firm P.E. Electronic Stamp as per PD 508.1-

Instructions: Signature of Project Tester or Project Engineer shall be signed after explanations are complete. Hand signed document is not acceptable, only electronics signatures.

On or before January 2020, all CDOT, local agency and consulting Engineers shall utilize electronic Sealing. Requests for exemptions shall be submitted to the Chief Engineer prior to mechanical Seals being utilized with the reason why an electronic Sealing cannot be used.

Beginning January 2021, there will be no exemptions to the electronic Sealing requirement, except where stated in section (V) (C) of the CDOT Policy Directive 508.1, REQUIREMENTS FOR THE USE OF THE PROFESSIONAL ENGINEER'S SEAL

See FMM Documentation chapters - After Construction - for more information

All CAR - Quality Level Reports must be Final Report with no errors.



|  |                       |  |         |                         |
|--|-----------------------|--|---------|-------------------------|
| <b>Colorado Department of Transportation</b><br><b>Final Materials Certification</b><br><b>Explanation of Exceptions</b>   |                       | Contract ID:   | Region: | Page ____ of ____       |
|  |                       | Project Acceptance Date:                             |         |                         |
| <input type="checkbox"/> Owner Acceptance <input type="checkbox"/> Independent Assurance   |                       | Project Number:                                      |         |                         |
| <input type="checkbox"/> Innovative Contract <input type="checkbox"/> Local Agency   |                       | Project Location:                                    |         |                         |
| <input type="checkbox"/> CDOT Maintenance <input type="checkbox"/> Other   |                       | Contractor:  |         |                         |
| Electronic signature of Project Tester or Project Engineer   |                       | Project Final Documentation Completion Date:         |         |                         |
| CDOT Project Sampling and Testing by Consultant: YES <input type="checkbox"/> NO <input type="checkbox"/>  |                       | CDOT or Consultant Company Name:                     |         |                         |
| <b>CAR - Quality Level Reports</b>   |                       |  |         |                         |
| <b>FINAL CAR report</b>  |                       | <b>Data Reviewed by:</b>                             |         | <b>Data Checked by:</b> |
| <input type="checkbox"/> Asphalt Quality Level   | Electronic Signature: | Electronic Signature:                                |         | Electronic Signature:   |
| <input type="checkbox"/> Concrete Quality Level  | Electronic Signature: | Electronic Signature:                                |         | Electronic Signature:   |
| [Empty space for reports and comments]   |                       |  |         |                         |
| Consultant Firm PE Comments:   |                       |  |         |                         |
| [Empty space for comments]   |                       |  |         |                         |
| <b>Instructions: Signature of Project Tester or Project Engineer shall be signed after explanations are complete. Hand signed document is not acceptable, only electronic signatures.</b><br>On or before January 2020, all CDOT, local agency and consulting Engineers shall utilize electronic Sealing. Requests for exemptions shall be submitted to the Chief Engineer prior to mechanical Seals being utilized with the reason why an electronic Sealing cannot be used.<br>Beginning January 2021, there will be on exemptions to the electronic Sealing requirement, except where stated in section (V) (C) of the CDOT Policy Directive 508.1, REQUIREMENTS FOR THE USE OF THE PROFESSIONAL ENGINEER'S SEAL<br>See FMM Documentation chapters - After Construction - for more information<br><b>All CAR - Quality Level Reports must be Final Report with no errors.</b> |                       | Consultant Firm PE Electronic Signature              |         |                         |
|  |                       | Consultant Firm PE Electronic Stamp as per PD 508-1: |         |                         |

A2

A7

A5

B1

A1

A3

A4

A6

B

# INSTRUCTIONS FOR ATTACHING DOCUMENTS TO THE CDOT FORM 474

The screenshot shows the Adobe Acrobat Pro DC interface with the CDOT Form 474 document open. The window title is "CDOT Form 474 Final Revision Ed Trujillo (1).pdf - Adobe Acrobat Pro DC". The menu bar includes "File", "Edit", "View", "Window", and "Help". The toolbar shows "Home", "Tools", and "Document" tabs, along with various icons for navigation and editing. The document content includes a header for "Colorado Department of Transportation Final Materials Certification Explanation of Exceptions", a table for "CAR - Quality Level Reports", and a section for "Consultant Firm PE Comments".

Annotations in blue boxes provide instructions:

- 2) Click on Paperclip Icon to show Attachment options.
- 3) Click on Paperclip with + sign to attach documents. Save file before signing the CDOT Form 474, documents will always be with the form for future reference.
- 1) Click on arrow to expand or hide the Attachment Section

The form itself contains the following sections:

- Colorado Department of Transportation  
Final Materials Certification  
Explanation of Exceptions
- Contract ID: \_\_\_\_\_ Region: \_\_\_\_\_ Page \_\_\_\_ of \_\_\_\_
- Project Acceptance Date: \_\_\_\_\_
- Project Number: \_\_\_\_\_
- Project Location: \_\_\_\_\_
- Contractor: \_\_\_\_\_
- Project Final Documentation Completion Date: \_\_\_\_\_
- CDOT or Consultant Company Name: \_\_\_\_\_
- Electronic signature of Project Tester or Project Engineer: \_\_\_\_\_
- CDOT Project Sampling and Testing by Consultant: YES  NO
- CAR - Quality Level Reports
- FINAL CAR report
- Data Reviewed by: \_\_\_\_\_
- Data Checked by: \_\_\_\_\_
- Asphalt Quality Level
- Concrete Quality Level
- Consultant Firm PE Electronic Signature
- Consultant Firm PE Electronic Stamp or Wet Stamp
- Instructions: Signature of Project Tester or Project Engineer shall be signed after explanations are complete. Hand signed document is not acceptable, only electronic signatures.
- Header information will populate to all pages from Page 1. Document has 6 pages available.
- Explain all shortages of tests, missing CDC/CTR's, and price reductions.
- Explain CAR - Quality Level Reports for processes, Pay Factor of 1, quantity discrepancies and total incentive/disincentive payments if QLRs apply to the contract.
- Final package shall include all supporting documentation for price reductions, CMO/MCR's, and CDOT Form 105 detailing deleted items by the PE.
- See FMM Documentation chapters - After Construction - for more information
- All CAR - Quality Level Reports must be Final Report with no errors.
- Previous editions of this form are obsolete and may not be used
- CDOT Form 474 4/19

## Explanation of Exceptions

The following is an example of what goes into the Explanation of Exceptions CDOT Form 474 Final Materials Certification (A6) block.

### **CAR Report Owner Acceptance Sampling & Testing Checklist:**

**Item 203-00060: Embankment Material (Complete in Place):** The contractor placed 4,115.00 CY of Embankment Material 2 inches thick. Material too thin to perform CP80aa Den/Moist Content of soil by nuclear gauge. Project specials required PI of 5-15, a test result of 13. The project Engineer accepted the material.

The embankment, Rock not encountered on the project.

### **Item 304-06007 Aggregate Base Course (Class 6)**

CP23aa not needed to be based on T180D performed which includes the plus 4 material.

CP25- Not performed due to a small quantity and no change in material observed.

Based on the quantity of 2,113 CY (2 -T89 and T90's) should have been completed. The second test would have covered the fraction of the 113 CY. Based on the results of test #1 -T89 (No Value) and the T90 (Non-Plastic), the 2<sup>nd</sup> test was not completed to cover the 113 CY.

### **Item 403-34741: Hot Mix Asphalt (Grading SX) (75) (PG 64-22)**

#### **Mix ID: 42017B1\_20856\_**

Both Phase 1 and Phase 2 of the US 24 El Paso- Elbert county line projects were completed by Jones Contractors utilizing the same mix designs, the PC tester and the mobile voids trailer personnel were the same. For this reason, check testing and CPL5120C was not performed on phase 2 but was completed on phase 1.

The project was Voids Acceptance, 7,028 tons were placed on a thin lift leveling course (1.5 inches), Project Specials specified the leveling course to be a Pay Factor of 1 for the mat density and longitudinal joints, (CP 44, 15 tests completed). Joint cores were not taken, SMM sample (SMITHJP178G082717) used to document 7,028 tons for CP44L, Pay Factor of 1. Flood plain area required 947 tons to be placed. 2- CP-44 test was completed in this area. 1,244 tons were placed with a 2-inch mat over a milled surface, 2- CP44's were taken due to the small area of placement. A total of 9,219 tons were placed and tested using CP44.

A total of 15,078 tons were placed and tested using CP81 and CP82.

The Asphalt Quality Level report for (42017B1\_20856\_) Mat Density, 1 compaction test section (CP82) representing 500 ton, 3 processes representing 23797 tons.

- Process 1: representing 947 tons, placed in the flood plain.
- Process 2: representing 15,822 tons placed, 2-inch middle mat.
- Process 3: Pay Factor of 1 representing 7,028 tons placed, 1-1/2 inch leveling course.

HMA (Grading SX) (75) (PG 64-22) total tons placed 24,297.

Asphalt content tested using CPL5120. CP85 and CP85C not used.

CPL5120C was completed on phase 1.

**Item 403-34751 Hot Mix Asphalt (Grading SX) (75) (PG 64-28)****Mix ID: 42017T1\_20856\_**

The project was Voids Acceptance, 18,478 tons was placed for a 2 inch top mat. CP44, CP85, CP85C were not used do to alternative test methods used. CP81- 36 tests, CP82- 1 test, for a total of 37 tests completed.

Total tons placed 18,478 on top mat.

Total tons placed on project 42,775, with an incentive of \$134,599.11.

**CP58-** Contractor followed best paving practices. There was not any indication of temperature segregation seen in the mat densities. The mean mat density for the bottom mat was 93.3%. Top mat mean mat density was a 93.6%

**Item 601-01000 Concrete Class B:** Visual inspection due to a small quantity (1.3 CY), material placed in the headwall of pipe.

**Item 603-10120 12 Inch Corrugated Steel pipe.**

Pipe placed under sidewalk with a small amount of structure backfill mostly for bedding of pipe. Testing could not be performed due to the small area of placement. The compaction effort was performed by the contractor and Project Engineer accepted visually. See attached picture.

**Item 608 00010 Concrete Curb Ramp.**

Visual inspection does to small quantities, 37 SY, material placed in curb ramp for the sidewalk.

**CAR Report Certification Checklist:****Item 216-00101 Soil Retention Blanket**

After numerous requests to the contractor, no documentation was received. Material delivered was inspected and the label on the product was found to be on the CDOT APL, Western Excelsior-Excel C5-3 All Natural. Based on the material being an APL product, the Project Engineer accepted the material. Sample record created in Site Manager to document the product, no attachment on sample record.

**Item 601-01000 & 608-00010- Concrete**

Cure

The small quantity used on both of these items, material visually accepted by Project Engineer.

**Item 627-00008 and 627-30405 Pavement Marking Materials**

Two records completed on each item to reflect white and yellow material.

|   |  |                            |                               |             |                                  |
|---|--|----------------------------|-------------------------------|-------------|----------------------------------|
| <b>COLORADO DEPARTMENT OF TRANSPORTATION</b>  |  | Contract No.   STA0243-087 | Region 4                      | Contract ID | C20856                           |
| Owner Acceptance Sampling & Testing Checklist |  | Contract Location          | US 24 B Paso-Elbert CL Paving |             |                                  |
|   |  | Contractor                 | SIMON CONTRACTORS             | Award Date  | 04/05/2017                       |
|   |  |                            |                               | Aid Date    | 02/23/2017                       |
|   |  |                            |                               |             | Field Materials Manual Year 2017 |

SM Report 250 Revision Date 10/06/2017 Production Date Printed 5/7/2018 Page 1 of 12

\*# Refer to Frequency Guide Schedule for further instructions.

| Project   | Item Code                    | Item Description  | Material Unit | Conversion Factor     | Item Unit     | Quantity Reported to Date | Quantity Authorized to Date | Total Installed Quantity |
|-----------|------------------------------|---|---------------|-----------------------|---------------|---------------------------|-----------------------------|--------------------------|
| Matl Code | Material Description         | Test Description  | Sample Type   | Rate / Frequency      | Line Item No. | Required To Date          | Estimated To Date           | Completed To Date        |
|           |                              |   |               | Plan + COQT           |               | Required To Date          | Estimated To Date           | Completed To Date        |
|           |                              |   |               | Total Plan + COQuant; |               | Required To Date          | Estimated To Date           | Completed To Date        |
| 20856-BID | US24 ELPASO-ELBERT CLEAST PA |   |               |                       |               |                           |                             |                          |
| 20856-BID | 203-00060                    | Embankment Material (Complete in Place)                 | CY            | 1.0000                |               | 4,115.00                  | 4,115.00                    | 4,115.00                 |
|           | 203.03.01.01                 | Embankment, Soil  | CY            |                       |               |                           |                             |                          |
|           | T89                          | T89 Liquid Limit of Soils                               | QA %          | 2,992.00              | 0035          | 1                         | 1                           | 1                        |
|           | T90                          | T90 Plastic Limit and Plasticity Index of Soils         | QA %          | 2,992.00              | 0035          | 1                         | 1                           | 1                        |
|           | 203.03.01.02                 | Embankment, Rock  | CY            | 1.0000                |               | 1                         | 1                           | 1                        |
|           | CP21                         | CP21 Mechanical Analysis of Soils                       | QA %          | 2,992.00              | 0035          | 1                         | 1                           | 1                        |
|           | CPL2103                      | CPL2103 S04 Ion Content in H2O & Water Soluble of Soil  | QA %          | 2,992.00              | 0035          | 1                         | 1                           | 1                        |
|           | CPL2104                      | CPL2104 Det. Water-Soluble Chloride Ion Content in Soil | QA %          | 2,992.00              | 0035          | 1                         | 1                           | 1                        |
|           | CPL3104                      | CPL3104 Durability of Shales for Use as Embankments     | QA %          | 2,992.00              | 0035          | 1                         | 1                           | 1                        |

|  |  |   |                       |                                  |
|--|--|---|-----------------------|----------------------------------|
| <b>COLORADO DEPARTMENT OF TRANSPORTATION</b> |  | Contract No. STA0243-087                        | Region 4              | Contract ID C20856               |
| <b>Certification Checklist</b>               |  | Contract Location US 24 B Paso-Elbert CL Paving | Award Date 04/05/2017 | Field Materials Manual Year 2017 |
|  |  | Contractor SIMON CONTRACTORS                    | Ad Date 02/23/2017    |                                  |

SMM Report CERT Revision Date: 02/13/2017  
 \*% Refer to Frequency Guide Schedule for further instructions.  
 20856-BID US24 EL PASO-ELBERT CL EAST PA

| Project   | Item Code    | Item Description  | Material Unit | Conversion Factor | Total Plan + CO Quantity | Special Instructions   | Quantity Reported to Date | Total Installed Quantity |
|-----------|--------------|---|---------------|-------------------|--------------------------|------------------------|---------------------------|--------------------------|
|           | Test Method  | Test Description  | Sample Type   | Rate/Frequency    | Line Item No.            | Producer/Supplier Name | Rowd Number of Certs      | Certs Received to Date   |
| 20856-BID | 208-00002    | Erosion Log Type 1 (12 Inch)                              | LF            | 1.0000            | 500.00                   |                        | 546.00                    | 546.00                   |
|           | 208.02.10.00 | Erosion Control, Erosion Log                              | LF            | 1.0000            |                          |                        |                           |                          |
|           | CERT         | CERT Material Certification                               | COC           | %                 | 0036                     |                        | 1                         | 1                        |
| 20856-BID | 212-00006    | Seeding (Native)  | ACRE          | 1.0000            | 0.15                     |                        | 0.25                      | 0.25                     |
|           | 212.06.01.00 | Seed, Native  | ACRE          | 1.0000            |                          |                        |                           |                          |
|           | CERT         | CERT Material Certification                               | COC           | %                 | 0070                     |                        | 1                         | 1                        |
| 20856-BID | 212-00032    | Soil Conditioning   | ACRE          | 1.0000            | 0.15                     |                        | 0.25                      | 0.25                     |
|           | 212.02.02.00 | Soil Conditioning   | ACRE          | 1.0000            |                          |                        |                           |                          |
|           | CERT         | CERT Material Certification                               | COC           | %                 | 0075                     |                        | 1                         | 1                        |
| 20856-BID | 216-00101    | Soil Retention Blanket (Straw-Coconut) (Photo-degradable) | \$ Y          | 1.0000            | 730.00                   |                        | 1799.00                   | 1799.00                  |
|           | 216.02.02.00 | Soil Retention Covering, Blanket                          | \$ Y          | 1.0000            |                          |                        |                           |                          |
|           | CERT         | CERT Material Certification                               | COC           | %                 | 0080                     |                        | 1                         | 1                        |
| 20856-BID | 403-34741    | Hot Mix Asphalt (Grading SX) (75) (PG 64-22)              | TON           |                   | 23662.00                 |                        | 24297.43                  | 24297.43                 |
|           | 702.01.01.03 | Asphalt Cement, Binder, PG64-22                           | TON           | 1.0000            |                          |                        |                           |                          |
|           | CERT         | CERT Material Certification                               | COC           | %                 | 0095                     |                        | 1                         | 1                        |
|           | 712.03.01.00 | Hydrated Lime   | TON           | 1.0000            |                          |                        |                           |                          |
|           | CERT         | CERT Material Certification                               | CTR           | %                 | 0095                     |                        | 1                         | 1                        |

|  |  |   |                       |                                  |
|--|--|---|-----------------------|----------------------------------|
| <b>COLORADO DEPARTMENT OF TRANSPORTATION</b>       |  | Contract No.   STA0243-087                      | Region 4              | Contract ID C20856               |
| Independent Assurance Sampling & Testing Checklist |  | Contract Location US 24 B Paso-Elbert CL Paving |                       |                                  |
|  |  | Contractor SIMON CONTRACTORS                    | Award Date 04/06/2017 | Field Materials Manual Year 2017 |

SM Report 379 Revision Date 10/06/2017 Production Date Printed 5/7/2018  
 \*\* Refer to Frequency Guide Schedule for further instructions.

| Project   | Item Code                      | Material Description  | Item Description | Material Unit | Sample Type / Frequency | Line Item No. | Conversion Factor | Estimated Required Tests | Required Tests to Date | Sampled Tests to Date | Estimated Tests Remaining | Completed Tests to Date | Total Installed Quantity |
|-----------|--------------------------------|---|------------------|---------------|-------------------------|---------------|-------------------|--------------------------|------------------------|-----------------------|---------------------------|-------------------------|--------------------------|
| 20856-BID | US24 EL PASO-ELBERT CL EAST PA |   |                  |               |                         |               |                   |                          |                        |                       |                           |                         |                          |
| 20856-BID | 403-34741                      | Hot Mix Asphalt (Grading SX)(75) (PG 64-22)                 |                  | TON           |                         |               | 1.0000            |                          |                        |                       |                           |                         |                          |
|           | 40302.01.11                    | Hot Mix Asphalt (SX)(75)(PG64-22)                           |                  | TON           |                         |               |                   |                          |                        |                       |                           |                         |                          |
|           | CP44                           | CP44 Bulk Sp G & Comp. of HMA Using SSD Specimens           |                  | IAT           | 1/10000                 | 0095          | 23 852.00         | 3                        | 3                      | 3                     | 0                         | 3                       | 0                        |
|           | CP44L                          | CP44L Bulk Sp G & Comp. of HMA Using SSD Specimens - Long   |                  | IAT           | 1/10000                 | 0095          | 23 852.00         | 3                        | 3                      | 2                     | 1                         | 2                       | -1                       |
|           | CP48aa                         | CP48aa-Voids in the Mineral Aggregate (VMA)                 |                  | IAT           | 1/10000                 | 0095          | 23 852.00         | 3                        | 3                      | 3                     | 0                         | 3                       | 0                        |
|           | CP51                           | CP51 Maximum Specific Gravity of HMA                        |                  | IAT           | 1/10000                 | 0095          | 23 852.00         | 3                        | 3                      | 3                     | 0                         | 3                       | 0                        |
|           | CPL5106                        | CPL5106 Res. to Deformation of Bitum. Mixture s; Hveem      |                  | IAT           | 1/10000                 | 0095          | 23 852.00         | 3                        | 3                      | 3                     | 0                         | 3                       | 0                        |
|           | CPL5115                        | CPL5115 Dens. of Bitum. Mix Specimens Compacted by the SG C |                  | IAT           | 1/10000                 | 0095          | 23 852.00         | 3                        | 3                      | 3                     | 0                         | 3                       | 0                        |

## Addendum 1

### 1.0 ASPHALT QUALITY LEVEL REPORT

*Introduction:*

The Quality Level Report will be used to replace both the Voids03 and the Asphalt03 programs. The report will generate by choosing the contract in CAR by clicking the “+” in front of the Contract ID, then choose either the Item Code or the report type of Interim or Final. It will be possible to run versions of the report in three ways:

- Item Code – shows the quality level, incentive or disincentive, for each asphalt item on the project.
- Interim – shows a preliminary report without checking for element totals to ensure the tons for each element match and will have all asphalt items in the report.
- Final – shows the final report and will check the element totals to ensure they match.

Like other CAR reports the data is pulled from SiteManager® once the report title is clicked in the Trns\*port folder. Error checking is included in the report to help show what data is missing. This may include not having a Quantity, Control Type, Control Number, Design Type, Mix ID or having incomplete data in a test template, etc.

*Maintain Sample Information Window:*

The report pulls data for all Quality Acceptance Testing samples on a project that have a 403.02.xx.xx material code. The following are also critical fields used by the report that must be correctly populated in SiteManager®

| Basic Sample Data |                                 | Contract              | Other                    | Tests        |
|-------------------|---------------------------------|-----------------------|--------------------------|--------------|
| Smpl ID:          | GOODSELM1655125717              | Status:               | Complete                 |              |
| Revised By:       |                                 | Revising:             |                          | Sample Date: |
| Link To:          |                                 | Link From:            |                          | Log Date:    |
| Smpl Type:        | Quality Acceptance Testing      | Acpt Meth:            | Sample and Test          |              |
| Material:         | 403.02.01.08                    |                       | Hot Mix Asphalt (SX)(75) |              |
| Sampler:          | ROOTR                           |                       | Richard Root, R3         |              |
| P/S:              | United Companies Of Mesa County |                       | GEN100042                |              |
| Type:             | General                         | City:                 | Grand Junction           |              |
| Prod Nm:          |                                 |                       |                          |              |
| Mnfctr:           | United Companies Of Mesa County |                       | GEN100042                |              |
| Town:             |                                 | Geog Area:            | Spaces                   |              |
| Intd Use:         |                                 |                       |                          |              |
| Repr Qty:         | 1,000.000                       |                       | Ton                      |              |
| Auth By:          | GOODSELM                        | Auth Date:            | 05/11/16                 |              |
|                   |                                 | Lab Control Number:   | CNGOODSELM1655125717     |              |
|                   |                                 | Lab Reference Number: | AC1                      |              |



**Sample Date:** This field will default to the date the sample was created; however, it can be changed to any time before the sample creation date. **All samples should be created in the order they were obtained and tested.**

**Smpl Type:** The Quality Level Report picks up samples with a sample type of Quality Acceptance Testing and an Acceptable Method of Sample and Test.

**Repr Qty:** This field is used to calculate the quantity represented by the sample being entered. When populated to the report these quantities will be used for each process/mix design to obtain a total quantity for the element.

**Process Type:** This field is used to record what type of paving is being performed. Whether it be a normal Process, a Process Test Section (CTS or DCS) or a Pay Factor of 1 for Mat Density. A process is a group of like samples that are grouped together, a detailed definition can be found in Section 105.05 of the CDOT Standard Specification for Road and Bridge Construction. There are three types of processes that the report uses:

- Process Test Section: Using the CP 82 template from SiteManager® which can use either 3 cores (Demonstration Control Strip) or 7 cores (Compaction Test Section). The percent compaction will be obtained from the Core % Compaction fields on the template. Nuclear density tests may or may not be used for this type of process.
- Pay Factor of 1: This process is used when the pay factor for the element should be set to one. This option should be chosen by paving a leveling course, a bond breaker, roller pass study, or for the Furnish Asphalt item.
- Process: This process will be used for day to day paving operations.

**Cntrl Number:** This field will identify the number of the process. There may be several different processes on a project which will require different combinations of processes and control numbers. For example, you may have Process Type: Process with Cntrl Number: 1 for a 4" bottom lift and a Process Type: Process with a Cntrl Number: 2 for a 2" top lift. There may be several test sections on a project and each should have a unique Cntrl Number.

**Design Type:** This field will be SUPERPAVE for asphalt paving.

**Mix ID:** This field is populated with the mix design that represents the material being tested. The mix design must also be approved for your project and the proper association made in SiteManager® by the Region Lab Manager.

**Material Test Templates:**

The type of acceptance is determined automatically from the mix design in SiteManager® and it can be Voids acceptance or gradation acceptance. The material test templates used by the report are summarized in the tables below.

**Voids Acceptance:**

|                         |                 |
|-------------------------|-----------------|
| Compaction Test Section | CP82            |
| Joint Density           | CP44L           |
| AC Content              | CPL5120 or CP85 |
| Voids                   | CPL5115         |
| VMA                     | CP48            |
| Mat Density             | CP44 or CP81    |

**Gradation Acceptance:**

|   |                 |
|---|-----------------|
| Mat Density   | CP44 or CP81    |
| Joint Density   | CP44L           |
| AC Content  | CPL5120 or CP85 |
| Gradation   | CP31HMA         |
| Compaction Test Section / Demonstration Control Strip | CP82            |

**Binder Paid Separately:**

When the binder is paid for separately from HMA the **ACCOST template will need to be completed for each Item Code/Mix ID combination** that is used on the project. There are two fields on the ACCOST template; The Bid Item # should indicate the 411 Item Code for the binder that is used in the asphalt mix and also listed on the CAR report Owner Acceptance Sampling Checklist. The price per ton of the 411 items will also be entered into the ACCOST template in the AC Cost field. These two pieces of data are used to connect the 403 HMA item to the 411 items which the report will use to calculate the Total Cost/ton of HMA. The ACCOST template shall be completed before any other tests for each HMA item.

The screenshot shows a software window titled "Enter Test Results" with a sub-tab "Test Data". The main content area is titled "ACCOST" and "Document AC Cost per Ton of HMA". On the right side, there are three radio buttons: "In Spec", "Out of Spec", and "No Spec" (which is selected). Below these is a "Print" button. On the left, there are two input fields: "Bid Item #" with the value "411-03354" and "AC Cost" with the value "320.00". At the bottom, there is a "Remarks:" label followed by a large empty text box.

**CAR Quality Level Report:**

The first page of the report will display any error messages that indicate errors that need to be fixed in SiteManager. The report can be generated at any point during the project to get an indication of the moving quality level. The report is broken into the various elements that are used to make up the incentive/disincentive for each Item Code/Mix Design with a summary for each process at the bottom of the element. The elements that make up the report are:

- Asphalt Content
- Compaction Test Section
- Mat Density
- Gradation
- Air Voids
- Voids in Mineral Aggregate (VMA)
- Joint Density

Elements included in the report are based on whether the mix design is determined to be voids or Gradation. There are an Interim or Final Report and a signature block for the tester and crosschecker. Each element has a header which includes Item Code, Material Code, Mix ID, HMA Cost/Ton, etc. There is also a secondary header to indicate spec limits and W and V factors. After each element, there is an indication of the processes that are included and an element summary.

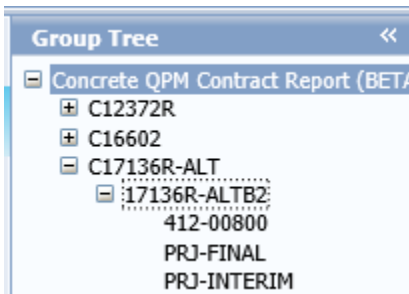
At the end of each item section there is a summary for each mix design and then a final summary at the end of the report for a comparison of the element totals and a list of the total incentive/disincentive by mix design.

## Addendum 2

### 1.0 CONCRETE QUALITY LEVEL REPORT

#### INTRODUCTION:

Standard Specifications for Road and Bridge construction sections 105.06, 106.06 and 412 contain the specifications for concrete paving. The Concrete03 program is replaced by the Quality Level Report. The report will generate by choosing the contract and project in CAR. It will be possible to run different versions of the report by using the expand (+) and collapse (-) icons



- Item Code – shows the quality level, incentive or disincentive, for each concrete item on the project.
- Interim – shows a preliminary report without checking for element totals or sample completion to ensure the square yards for each element match.
- The final – final report will check the element totals to ensure they match.

Like other CAR reports the data is pulled from SiteManager once the report title is clicked in the Trns\*port folder. Error checking is included on the first page of the report to show what data is missing or incorrect. This may include a blank Control Type, Control Number or having incomplete data in a test template, etc.

**Maintain Sample Information Window:**

The report pulls data for all Quality Acceptance Testing samples on a project that has 412 and 601 material codes. The following are critical fields used by the report that must be correctly populated in SiteManager:

**BASIC SAMPLE DATA TAB:**

**Sample Date:** Defaulted to sample creation date and can be changed to any time before the sample Log Date. Sample creation should be completed in the order they are obtained and tested so they appear in the correct order on the report.

**Smpl Type:** The Quality Level Report uses samples with a type of Quality Acceptance Testing and an Acpt Meth of Sample and Test.

**Material:** The material codes used for concrete paving will begin with either 412 (Thickness) or 601 (Strength) refer to the OA Sampling and Testing Checklist for the exact code.

**Repr Qty:** This is the quantity to be represented by the tests that will be assigned to the record. The total quantity for the element will be obtained by adding the Repr Qty's from each sample.

| Maintain Sample Information    |  |  |       |       |
|--------------------------------|--|--|-------|-------|
| Basic Sample Data              | ADDtl Sample Data                                  | Contract   | Other | Tests |
| Smpl ID: SEMUSD1586094653      | Buy American: <input type="checkbox"/>             | Spaces   |       |       |
| Reqst By: PROJECT              | Witnessed By: SEMUSD                               |  |       |       |
| Smpl Size: 1                   | Lot  |  |       |       |
| Dist from Grade:               | Spaces   |  |       |       |
| Station: 277+50                | Offset:  | Reference:                                       |       |       |
| Smpld From: GRADE              |  |  |       |       |
| Smpl Origin:                   |  |  |       |       |
| Control Type: PROCESS          | Cntrl Number: 1                                    | Seal Number:                                     |       |       |
| Design Type: PCC               | Mix ID: 2015081R                                   |  |       |       |
| Plant ID:                      | Plant Type: Spaces                                 |  |       |       |
| Creator User ID: SEMUSD        | Include Standard Remarks: <input type="checkbox"/> | Sample Created from DWR <input type="checkbox"/> |       |       |
| Last Modified User ID: MAYHEWT | Last Modified Date: 03/25/16                       | DWR Date: 00/00/00                               |       |       |
|                                |  | DWR Inspector:                                   |       |       |

#### ADDTL SAMPLE DATA TAB:

**Control Type:** **Process** is the only entry allowed for concrete. See section 105.06 (a) for process changes

**Cntrl Number:** This field will identify the number of the process. Different combinations of processes and control numbers may be required on a project. For example:

- A Control Type of **Process** with Cntrl Number of 1 for 6-inch concrete pavement
- A Control Type of **Process** with a Cntrl Number of 2 for 8-inch concrete pavement. For the pavement thickness element, a new mix design is not a reason to create a new process as per 105.06 (a) of the Standard Specifications

**Design Type:** This field will be **PCC** for concrete paving.

**Mix ID:** Complete this cell with the mix design that represents the material tested. HQ Concrete Unit must approve the mix design for the project and the proper association between the mix design and project made in SiteManager®. **This is the mix design number shown on the CDOT Form 1373.**

**Note:** For the Thickness element, do not enter a mix design on the sample record, as the cores are associated with the 412 paving element and not the 601 concrete elements. Mix designs are only associated with 601 concrete elements.

| Contract ID | Project      | Line Item | Proposal Line Number | Item Code | Line Item Desc              | Fed State Prj Nbr |
|-------------|--------------|-----------|----------------------|-----------|-----------------------------|-------------------|
| C17136R-ALT | 17136R-ALTB2 | 0220      | 0725                 | 412-00800 | *Concrete Pavement (8 Inch) | STA 0142-051      |

**CONTRACT TAB:**

On the Contract, Tab, choose the appropriate contract and line item that is associated with the sample. There can only be one.

**Material Test Templates:**

Automatic determination of the type of acceptance uses the presence or absence of the T 97-28 and T 97- QC templates.

**Compressive Strength Acceptance:**

|                      |                  |
|----------------------|------------------|
| Thickness            | T148             |
| Compressive Strength | C39-28 or T24-28 |

**Flexural Strength Acceptance:**

|                      |                   |
|----------------------|-------------------|
| Thickness            | T148              |
| Flexural Strength QA | T97-28            |
| Flexural Strength QC | T97-QCaa and C496 |

**Note:** Canceled tests and voided samples will not be included in the report.



**CAR Quality Level Report:**

The report will be accessible in CAR and there will be an interim and final report which can be viewed by expanding the group tree by clicking the (+). Reports can be exported to a PDF and saved or printed using the "Export this Report" icon.

The first page of the report will display any error messages that indicate missing or conflicting issues that are required to be corrected in SiteManager and the report can be generated at any point during the project to get an indication of the moving quality level. The report is broken into the various elements that are used to make up the incentive/disincentive for each Item Code/Mix Design with a summary for each process at the bottom of the element. The elements that make up the report are:

- Thickness
- Compressive Strength
- F & t-Test Comparison
- Flexural Strength

Elements are included in the report based on the presence of the C39-28 or the T97-28/T97-QC templates as well as the F & t Comparison made between the T97-28 and T97-QC

At the end of each item section, there is a summary for each mix design and a final summary at the end of the report for a comparison of the element totals and a list of the total incentive/disincentive.

**Thickness**

The thickness section of the report will use the T148 data and will obtain both the thickness test result and the Plan thickness from this template. There will be a warning message at the bottom of the element to indicate if a result is lower than the lower tolerance limit. If a test result is more than 1 inch below the lower tolerance limit it will be but in a separate process. I/DP will not be calculated on that test as this is a, Remove and Replace situation.

**Compressive Strength**

The compressive strength section of the report will use the C39-28 or the T24-28 template. There will be a warning message on the report if a test value is less than the lower tolerance limit. There is not a specification for 2 x V out of tolerance or removal and replacement for concrete paving. If a test is below the lower tolerance limit and the contractor chooses to core the area, a T24-28 template will need to be added to the same sample ID that contained the C39-28 test.

### Handling Failures or Low Test results

#### Thickness:

- If a core is lower than the Plan Thickness by more than 0.4-inch but not more than 1 inch, obtain an additional core, if that core is greater than Lower Tolerance (TL) no action is necessary. Document additional core results in SMM as Information Only.
- If the additional core or any randomly selected core is less than Lower Tolerance Limit (TL) but greater than Plan Thickness (PT) minus 1-inch, the area represented by this core shall become a separate process and this core will not be used to compute an I/DP. The Quality Level Report will remove this test from the element automatically and create a separate process called LOW-X. Obtain four additional randomly selected cores within the area represented by this core. The four additional cores will be used to compute an I/DP in accordance with Section 105. Cores taken at locations not randomly determined, such as process control cores will not be used to compute I/DP.
  - Create **four additional QA samples** for the additional cores; assign the same, unique, process number to the samples, this process number is different from the original sample. The represented quantity on each Sample ID of the four additional cores taken should total the area represented.
  - Cancel/Void the original test/sample.
- When the measurement of any core is less than PT minus 1.0 inch, whether randomly located or not, the area represented by this core shall become a separate process and this core will not be used to compute an I/DP. This is a, Remove and Replace situation. The actual thickness of the pavement in this area will be determined by taking exploratory cores. Cores shall be taken at intervals of 15 feet or less, parallel to the centerline in each direction from the affected location until two consecutive cores are found in each direction which is not less than PT minus 1.0-inch.
  - Obtain exploratory cores to define the out of specification area, document additional core results in SMM as Information Only.
  - Once the removal and replacement are complete, create **four additional QA samples** for the four additional cores that represent that area. Assign the same unique process number to the samples, which is different from the original sample. The represented quantity of the four cores should total the area represented.

#### Compressive Strength:

- The higher value between the C39-28 and the T24-28 shall be used when compressive strength is less than TL (4500psi) and the contractor takes additional cores (T24).
- Add the T24-28 to the same sample ID that contains the original C39-28. This can be done using the Maintain Test Queue in LIMS.
- Both tests are left as valid tests and the report will choose the higher value for the I/DP calculations.

**Flexural Strength:**

- When flexural strength is less than 650 psi, the contractor may take cores for split tensile testing (C496). The higher value between the T97-QC and C496 shall be used. The C496 template includes a field for the correlated flexural strength as per CP65. This correlation will be figured outside of SMM/LIMS and manually entered into the template. Only the contractors QC results can be replaced with a C496 (Splitting Tensile).
- - Add the C496 test to the original sample that contains the low T97-QC. This can be done using the Maintain Test Queue in LIMS.
  - Both tests are left as valid tests and the report will choose the higher value for the I/DP Calculations

**A partial list of error or informational messages that appear on the first page of the report:**

A sample ID with two of the same valid tests. (I.e. two T148 tests on the sample)

Specification Height on T148 template is null or zero

Average Core Inch Height cell is null or Zero on T148

Sample with zero (0) Rep. Qty.

Valid sample created with valid control type and null (blank) control number

Total quantities do not match among element totals (final only)

Not all samples are complete (final only)

Compressive and Flexural samples the Mix ID is blank

If there is more than one Item on the Contract tab

**Messages included below the element:**

C39-28 value is below Plan Value

T148 value below Plan Value by more than 1 inch

T148 value below Plan Value by more than .4" but not more than 1 inch

T148 value is more than 1 inch above plan value

Element message for a T148 Value below Plan Value but above TL

Test data that is > 1 inch above Plan Value

**Addendum 3**

**Asphalt Quality Level Report**

**Department of Transportation**

**State of Colorado**

**Report Date:** 5/7/2018

**Contract ID:** C20856

**Project Number:** 20856-BID

**Region No:** 4

**Fed/State Project #:** STA0243-087

**Ad Date:** 20170323

**Acceptance Type:** Void Acceptance

**Location:** US 24 El Paso-Elbert CL Paving

**Item Code:** 403-34741

**Material Code:** 403.02.01.11

**Mix ID:** 42017B1\_20856\_

**Design Type:** SX

**P/S:** Simon Contractors

**Gyrations:** 75

**Total Cost/ton:** \$72.00

**HMA Cost/ton:** \$72.00

**AC Cost/ton:** \$0.00

(\*\*\* FINAL REPORT \*\*\*)

**Asphalt Content**

**Upper Test Limit:** 6.00  
**Lower Test Limit:** 5.40





















**V Factor:** 0.2  
**W Factor:** 10

**Design Sp Gr:** 2.424

| Test Date     | Sample ID         | Test Quantity | Total Quantity | Max Sp Gr | % AC | ML  |
|---------------|-------------------|---------------|----------------|-----------|------|-----|
| 1 07/25/2017  | ELLISB177P075534  | 1000          | 1000           | 2.439     | 5.42 |     |
| 2 07/25/2017  | ELLISB177P102740  | 1000          | 2000           | 2.426     | 5.69 |     |
| 3 07/26/2017  | ELLISB177Q092930  | 1000          | 3000           | 2.438     | 5.68 | 100 |
| 4 07/26/2017  | GONSERS177V073643 | 1000          | 4000           | 2.446     | 5.51 | 94  |
| 5 07/28/2017  | ELLISB177S112718  | 1000          | 5000           | 2.425     | 5.61 | 98  |
| 6 07/28/2017  | ELLISB177S144315  | 1000          | 6000           | 2.420     | 5.68 | 100 |
| 7 07/31/2017  | ELLISB177V104002  | 1000          | 7000           | 2.429     | 5.59 | 100 |
| 8 08/01/2017  | ELLISB1781112006  | 1000          | 8000           | 2.430     | 5.53 | 100 |
| 9 08/01/2017  | ELLISB1781184212  | 1000          | 9000           | 2.428     | 5.74 | 100 |
| 10 08/02/2017 | ELLISB1782103724  | 1000          | 10000          | 2.424     | 5.73 | 100 |
| 11 08/02/2017 | ELLISB1782121632  | 1000          | 11000          | 2.427     | 5.78 | 100 |
| 12 08/02/2017 | ELLISB1782150453  | 1000          | 12000          | 2.430     | 5.65 | 100 |
| 13 08/04/2017 | ELLISB1784122100  | 1000          | 13000          | 2.420     | 5.95 | 100 |
| 14 08/04/2017 | ELLISB1784123036  | 1000          | 14000          | 2.427     | 5.87 | 100 |
| 15 08/04/2017 | ELLISB1784161309  | 1000          | 15000          | 2.424     | 5.69 | 99  |
| 16 08/09/2017 | ELLISB1789161743  | 1000          | 16000          | 2.433     | 5.70 | 100 |
| 17 08/11/2017 | ELLISB178B084245  | 1000          | 17000          | 2.434     | 5.68 | 100 |
| 18 08/11/2017 | ELLISB178B130304  | 1000          | 18000          | 2.427     | 5.61 | 100 |
| 19 08/11/2017 | ELLISB178B163659  | 1000          | 19000          | 2.435     | 5.73 | 100 |
| 20 08/12/2017 | ELLISB178C145905  | 1000          | 20000          | 2.441     | 5.43 | 100 |
| 21 08/12/2017 | ELLISB178C172546  | 1000          | 21000          | 2.428     | 5.48 | 95  |
| 22 08/14/2017 | ELLISB178E140506  | 1000          | 22000          | 2.442     | 5.47 | 88  |
| 23 08/14/2017 | ELLISB178E154629  | 1000          | 23000          | 2.427     | 5.61 | 88  |
| 24 08/15/2017 | ELLISB178F100503  | 1000          | 24000          | 2.434     | 5.43 | 87  |
| 25 08/15/2017 | ELLISB178F115131  | 297           | 24297          | 2.435     | 5.60 | 95  |

| Certification Checklist Requirements   |   |                              |  |                       |                      |  |
|--|---|------------------------------|--|-----------------------|----------------------|--|
| Dated submitted to PE & Contractor:    |   |                              | August 1, 2018                                     |                       |                      | Page 1 of 3  |
| ITEM Number                            | Type of Document Required<br>COC or CTR | APL or QML Material Required | Requires Contractor APL/QML Verification<br>YES/NO | Date COC/CTR Received | Accepted or Rejected | Notes  |
| 206-00360 Mech Reinforcement           | COC                                     | NY-APL for geotex            | YES  | 08/17/18              | Accepted             |  |
| 207-00205 Top Soil                     | CTR                                     | NO                           | NO   | 05/25/18              | Rejected             | Missing stamp and signature                          |
| 208-00009 Erosion Logs Typ 2           | COC                                     | YES-APL                      | YES  | 04/05/18              | Rejected             | Missing stamp & signature                            |
| 208-00020 Silt Fence                   | COC                                     | NO                           | NO   | 06/05/18              | Accepted             |  |
| 208-00051 Storm Drain Inlet Protection | COC                                     | YES-APL                      | YES  |                       |                      |  |
| 210 Modify Manhole                     | COC                                     | Precast-YES QML              | YES  |                       |                      | Poured in place-does not require verification letter |
| 212-00006 Seeding                      | COC                                     | NO                           | NO   |                       |                      |  |
| 212-00032 Soil Conditioning            | COC                                     | NO                           | NO   |                       |                      |  |
| 213-00003 Mulching Weed Free HAY       | COC                                     | NO                           | NO   |                       |                      |  |
| 213-00012 Mulch Tackifier              | COC                                     | NO                           | NO   |                       |                      |  |

### Example of Required Project Book Folders

-  COC-CTRs
-  Emails and misc. docs
-  Final Documents
-  Item 203 CIP
-  Item 206 CL 1 and 2
-  Item 206 Filter Material CL A and C
-  Item 304 ABC Class 6
-  Item 403 S(100) PG64-22
-  Item 411 Binder
-  Item 412 8.5 inch
-  Item 412 10 inch
-  Item 412 Mix Designs
-  Item 503 Caissons
-  Item 601 CL D Bridge
-  Item 601 CL D Wall
-  Item 601 Class D concrete
-  Item 603 RCP-all sizes
-  Item 608 Sidewalk
-  Item 609 Curb and Gutter all types
-  Item 624 Pipe all classes

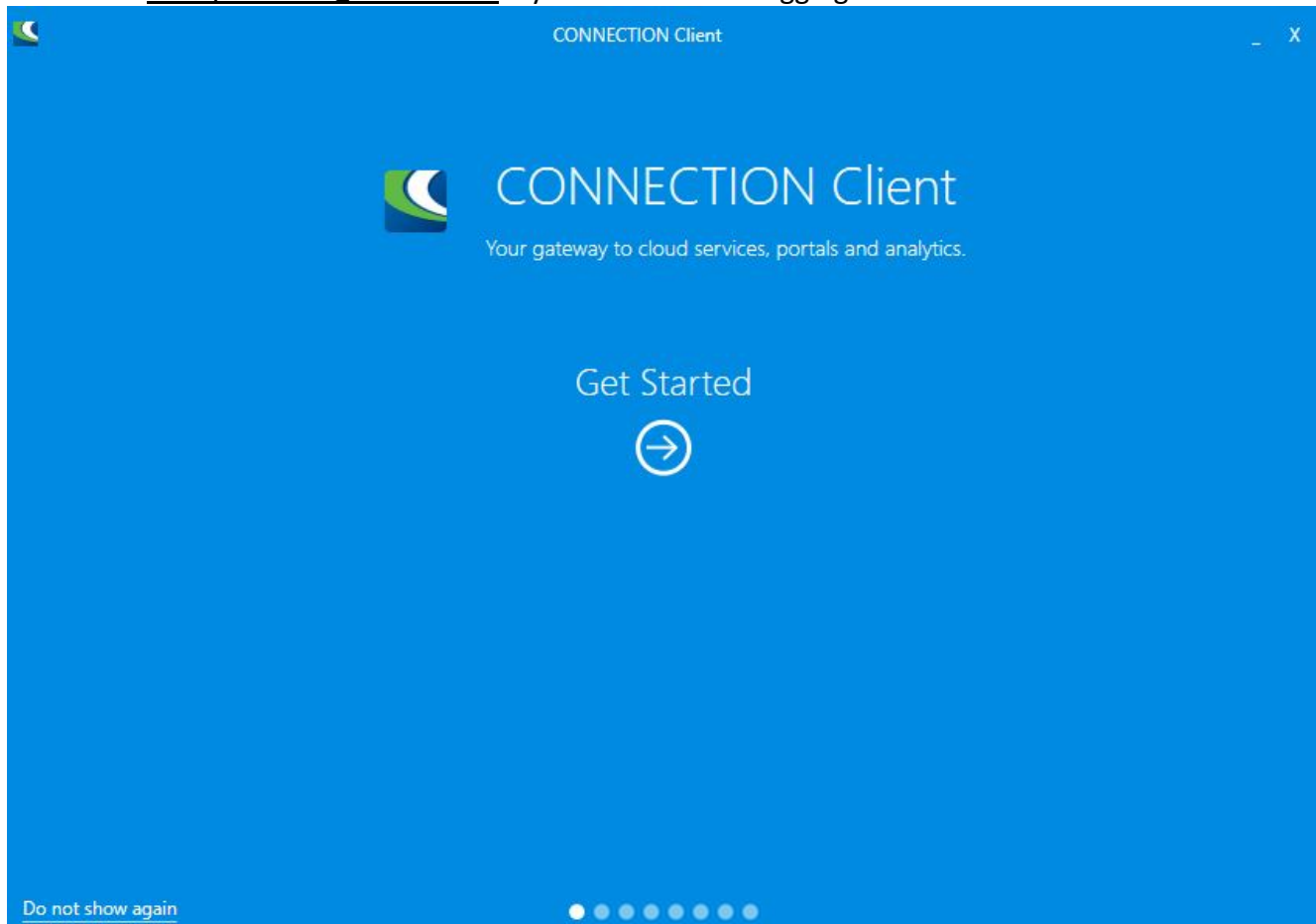
## Instructions for ProjectWise Share

### Project Share and PWZ Explorer for project record retention

Remember that Project Share eliminates the need for consultants to use VPN, and provides the ability for CDOT project records to be automatically archived in ProjectWise Explorer, thus eliminating the burden on CDOT employees to manually obtain and archive critical documents. The CDOT Record File Plans contain which project records need to be retained and which folder they are placed in. When Project Share is linked with PWZ Explorer, this transfer is automatic.


#### Logging on to Project Share:

When you log in on the Connection Client (the blue and green wavy icon) it will take you first to the Connection Client log on. When you try to enter your password, it transfers you to an OIT SSO Portal log on page. In "user name" fill in "dot\your user name" (not your email address). Next, fill in your CDOT password in the password window. This will then automatically route you to your Bentley Project Share portal. This contains the Project Share sites you have been invited to. Ask Kelley Tatman at [Kelley.Tatman@state.co.us](mailto:Kelley.Tatman@state.co.us) if you have trouble logging on.



For additional information on Project Share, please use the Bentley Community resources here: [https://communities.bentley.com/communities/other\\_communities/sign-in\\_assistance\\_and\\_web\\_services/w/wiki/40572/instructional-videos](https://communities.bentley.com/communities/other_communities/sign-in_assistance_and_web_services/w/wiki/40572/instructional-videos)


**Step 1**



**Sign In**  
Access your Bentley Services

**Email**

**Password**

[Forgot password?](#)

**Sign In**

Don't have a profile? [Register](#)



**Step 2**

# State of Colorado - SSO Portal

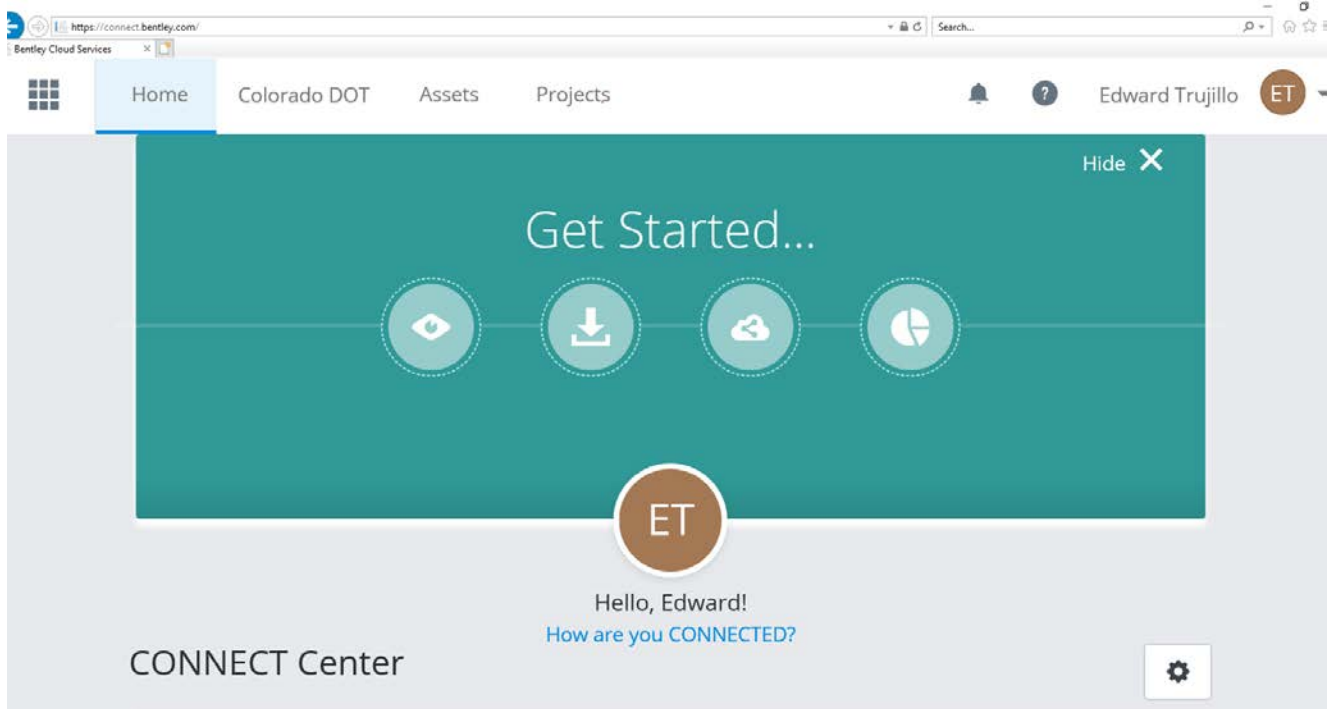
Sign in with your organizational account

 ✕

Sign in

© 2013 Microsoft

### Step 3



The **power point** developed by Tom Bovee showing the basic functions of Project Share. Note that it depends on the level of authority assigned by the program manager in the Project Share site to other users how much the user can do (i.e., read/write, delete, develop new folders, etc.) so some notes in the powerpoint will not apply to all users.

We hope this allows you to learn more about Project Share, which will facilitate the collaboration between CDOT and consultants to transfer, retain and archive critical project records in compliance with state and federal requirements.



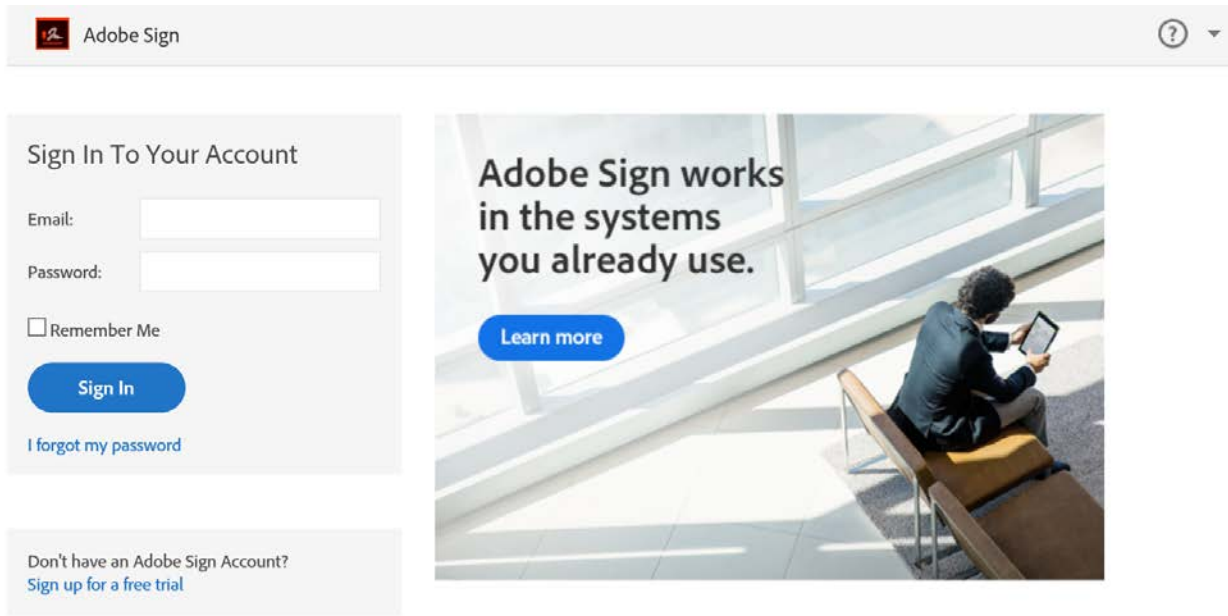
ProjectWise Share  
Overview (1).pptx

{Page Intentionally Left Blank}

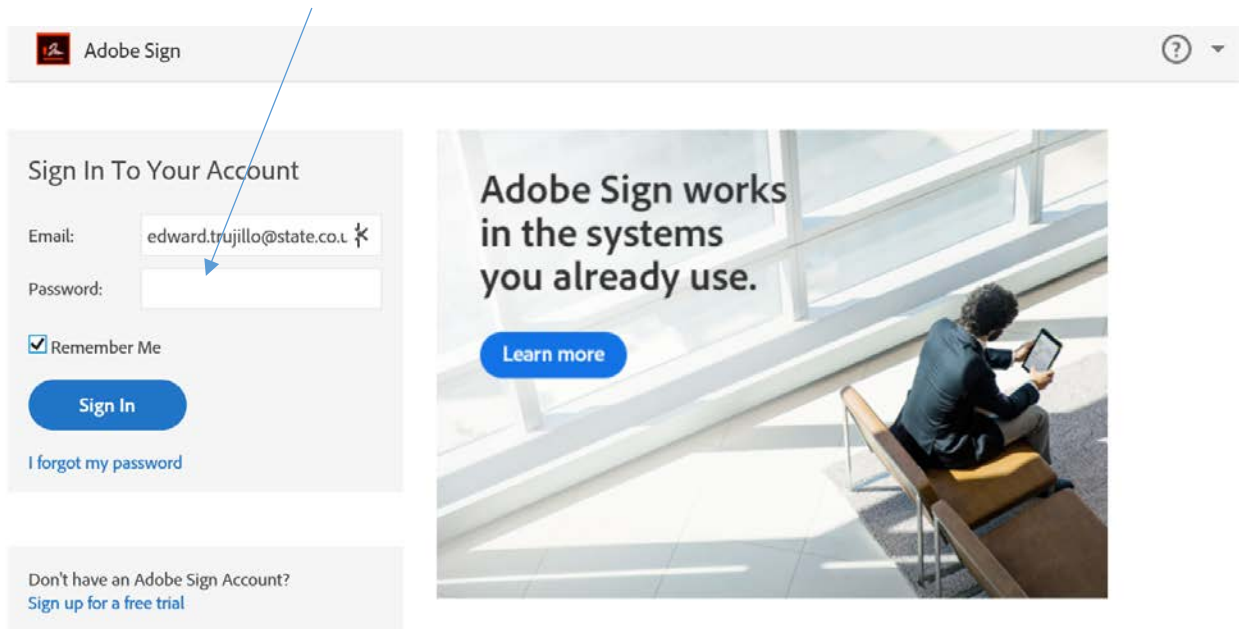
## ADOBE Sign Log-in Instructions for the CDOT Forms 473/474-21

Open the following link to get started.

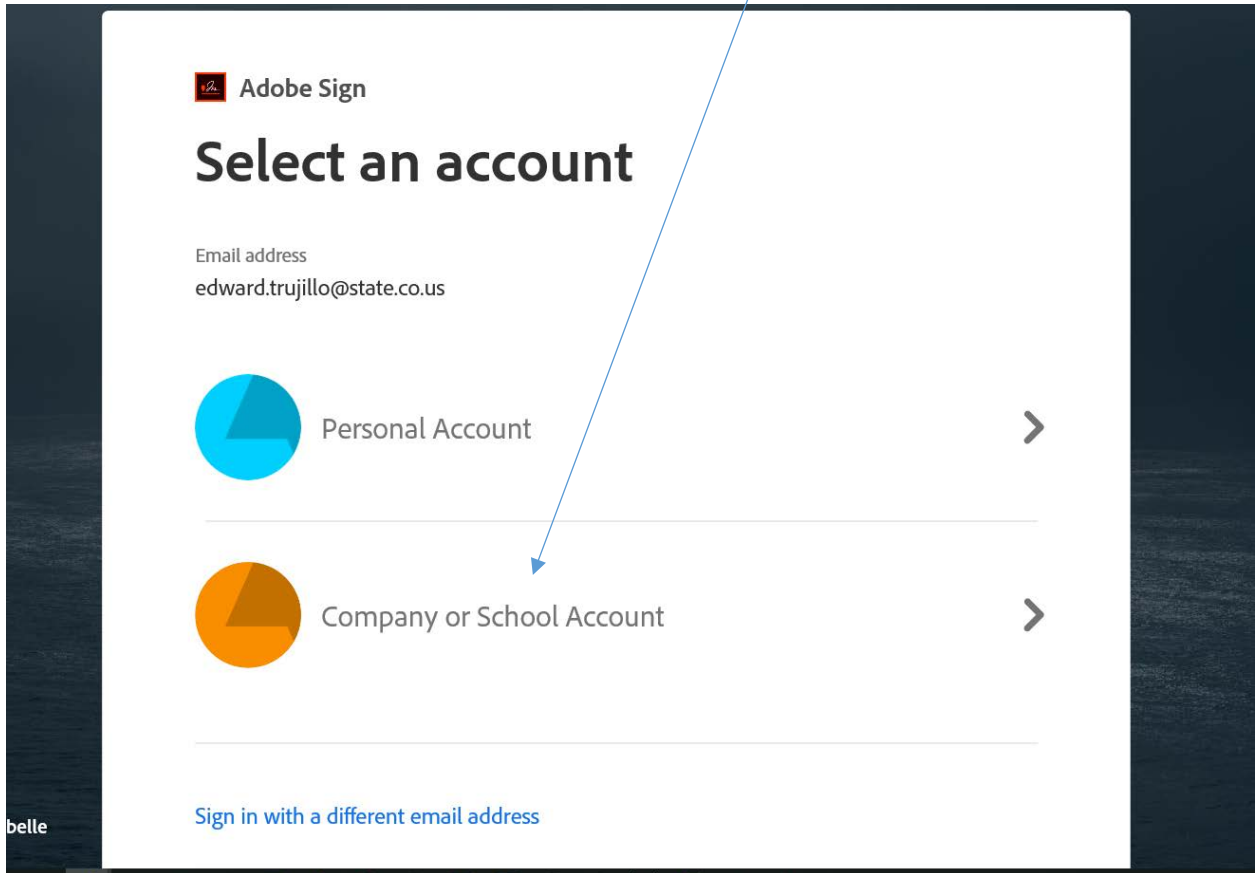
<https://secure.echosign.com/public/login>



Enter your CDOT E-Mail address no password is needed then check "Remember Me" check box, Place your cursor on the Password block and hit "ENTER" on your key board.



Choose "Company or School Account"



Enter your organizational account as follows and Sign in:



# State of Colorado - SSO Portal

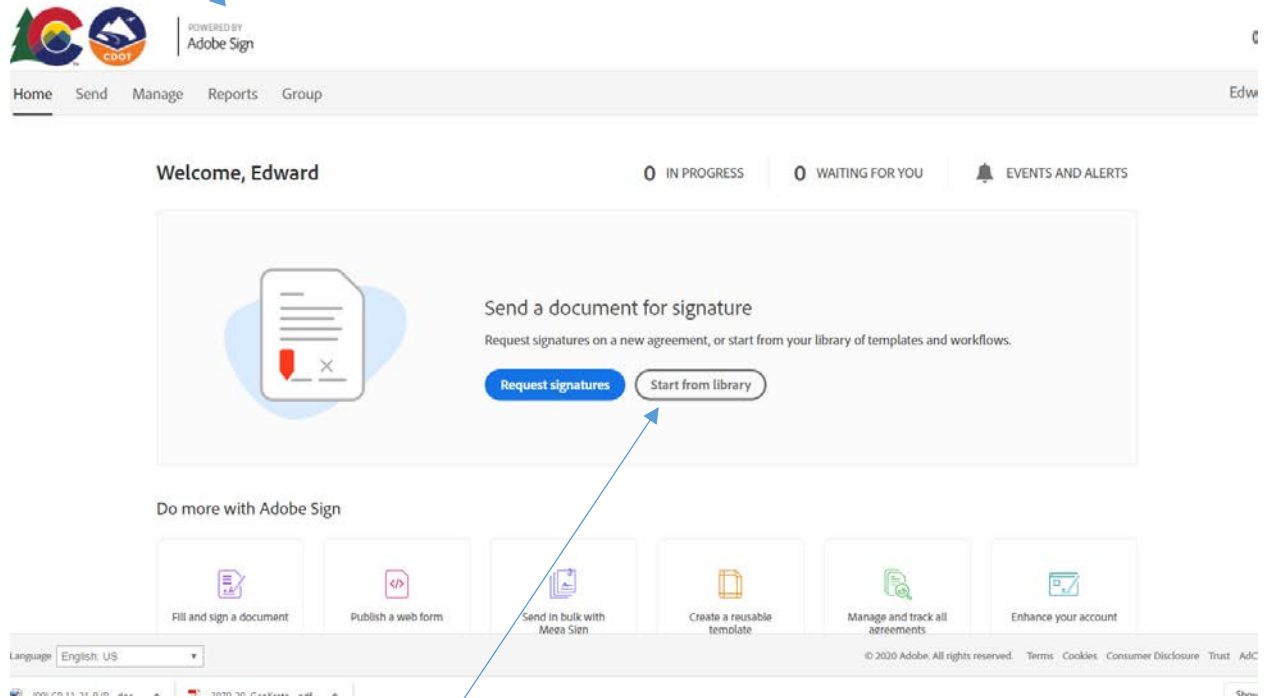
Sign in with your organizational account

 ✕

Sign in

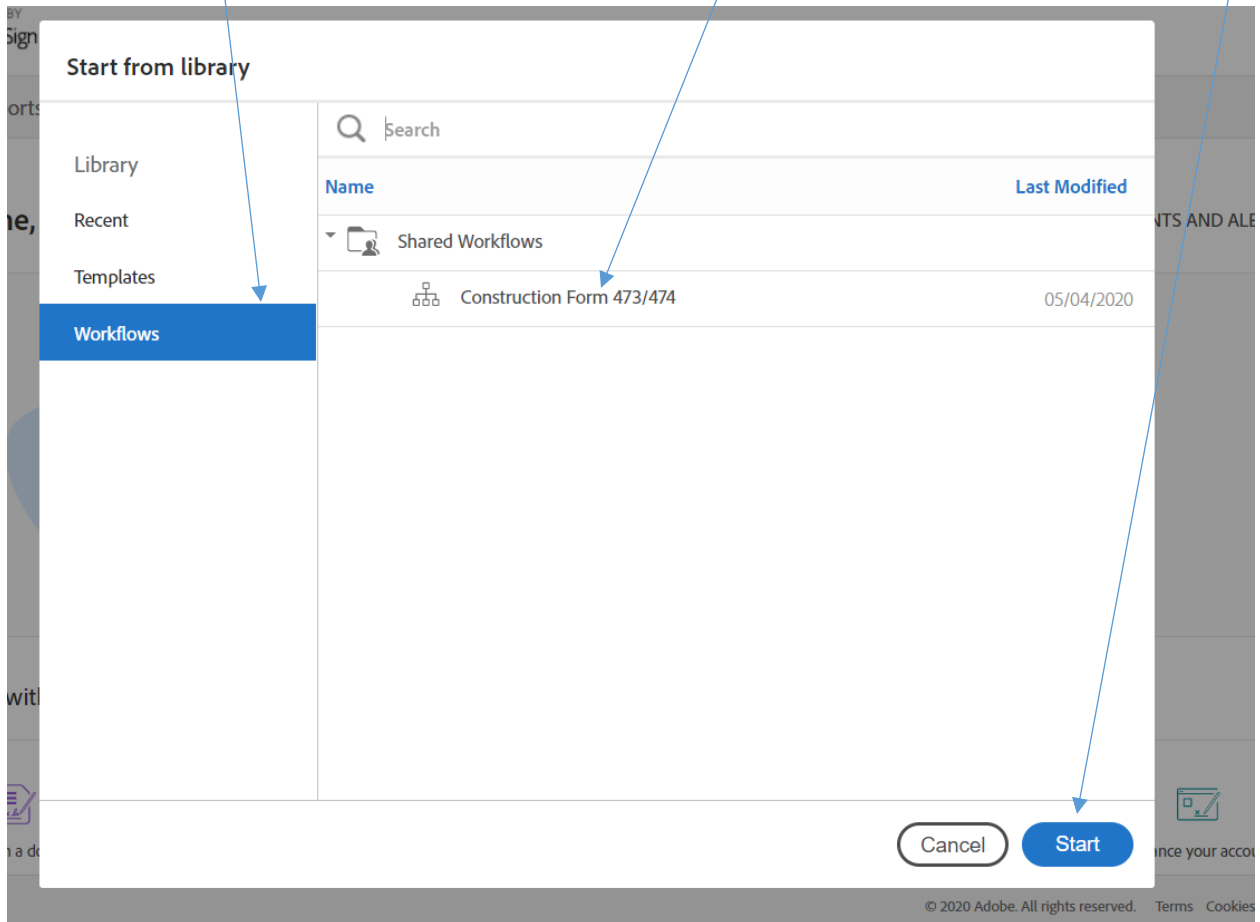
© 2013 Microsoft

You now have access to Adobe Sign, verify that the CDOT Logo is visible that will tell you that you have accessed the Adobe Sign program correctly.



Click on "Start from library" Box

Click on "Workflows" Then the shared workflows will be available for your use, click on the available workflow in this case it will be "Construction Form 473/474". Highlight the workflow and click on "Start"





Enter the e-mails in order of the list that has been given, starting with the Independent Assurance (IA) personnel responsible for initiating the Adobe Sign 473/473 form.

The screenshot shows the Adobe Sign interface for a document titled "Construction Form 473/474". At the top, there are logos for CDOT and Adobe Sign, along with navigation tabs: Home, Send, Manage, Reports, and Group. The user's name "Edward" is visible in the top right. Below the title, there is a section titled "How this workflow works?" with instructions: "Use this workflow to initiate the Form 473/474 automated routing for completion and signatures. Cut and paste each email address into the email location under the 'Recipients' label, select a 'Set Reminder' notification, and select Send to activate the workflow. Remember to add CCs (just below email address fields) for anyone not part of the form completion process but who needs an automatic copy of the executed document." A "less" link is present below the instructions. On the right side, there is a "Guided Help" button. The "Recipients" section is expanded, showing a list of roles with corresponding email input fields and "Email" buttons. A blue arrow points from the text above to the "Myself" recipient entry.

**Recipients**

- IA (Independent Assurance Program) \*  
Myself [Email]
- RME (Region Materials Engineer) \*  
Enter recipient email [Email]
- Project Tester \*  
Enter recipient email [Email]
- PE (Project Engineer) \*  
Enter recipient email [Email]
- RE (Resident Engineer) \*  
Enter recipient email [Email]
- Finals Material Coordinator or Finals Administrator \*  
Enter recipient email [Email]

Enter CC e-mail of persons not on the workflow list but that should get the signed document.

CC | [Hide](#)

Cc

Enter CC's emails

Document Name \* Message Template v

Form 473/474

Message \*

Please complete and or sign/seal each form where indicated.

Files

|                                |   |
|--------------------------------|---|
| Construction Form<br>473/474 * | Construction Materials Form 4<br>73/474 FINAL |
|--------------------------------|---|

Options

Set Reminder

The \* are required but should already be filled out with the appropriate information. When all is completed click "Send" and the document will automatically start circulating through the signing process.

Send

Copy of Audit Report the date and time are in Greenwich Mean Time (GMT)  
subtract 9 hours to get Mountain Standard Time.



audit report.pdf

### EXAMPLE OF SIGNED CDOT 473/474 with Attachments

Double click to open the document:



Construction  
Materials Form 473\_

Note: To view the PDF's us the electronic version of the 2021 FMM.

## Design-Build Quality Assurance Program Project Materials to Final Materials - 21

### 1. INTRODUCTION

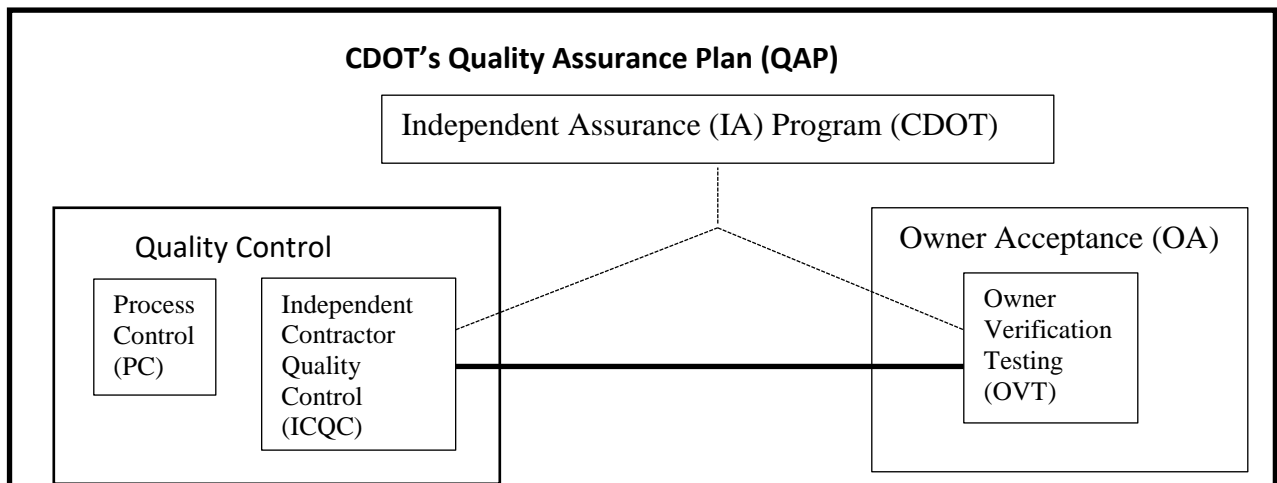
#### 1.1 GENERAL

The intent of this chapter is to provide statewide consistency and a programmatic approach to quality assurance for Design-Build projects where the Contractor's quality control test results may be used in the acceptance decision and to provide the Region personnel guidance on the documentation of the material from the beginning of the Design-Build (D-B) project to the closure of the project files. The D-B delivery is often used for large, complex, fast-paced projects. It can also be used for smaller less complex projects in a streamlined D-B format. While project management and quality management require some adjustment to address these typical D-B project characteristics, it should be understood that the fundamental principles of quality assurance do not go away with this alternative contracting method. The materials documentation on a D-B project needs to be accurate, complete and processed within the officially established time frame after the issuance of the project's Final Acceptance Letter per Section 105.21 (b).

The primary shift in responsibility with D-B is the assignment of the design function to the Contractor. This allows more construction risk to be appropriately shifted to the Contractor, as the Designer on the D-B Team is the Engineer of Record and now owns responsibility for the design. There is no change in the core quality assurance functions of quality control and Owner Acceptance (OA) on D-B projects. CDOT must retain its responsibility for the effective construction acceptance function along with the fundamental quality assurance principles or requirements of Title 23, Code of Federal Regulations, Part 637 (23 CFR 637.207(b)) for Federal-Aid Highway projects. This chapter is intended to provide clear guidance for proper quality assurance roles and responsibilities. The definitions of quality assurance used in this Manual are found in AASHTO R 10-2011, *Standard Practice for Definition of Terms Related to Quality and Statistics as Used in Highway Construction*. In today's practice, the term quality assurance refers to the overall activities of both the Contractor and CDOT. It is the overall system for assuring project quality. Under the quality assurance umbrella, the Contractor's responsibility is quality control and CDOT's responsibility is "Acceptance."

The CDOT Quality Assurance Plan (QAP) consists of a quality control program, an owner acceptance (OA) program, and an independent assurance (IA) Program. The QAP allows for the use of the Contractor's performed test results, referred to as Independent Contractor Quality Control (ICQC), as part of an acceptance decision if those results are validated by the Owner Verification Testing (OVT) results performed by the Department or a representative for CDOT. The CDOT QAP clarifies federal requirements relating to quality assurance and statistical analysis procedures.

The QAP, as stated, is comprised of several components and the relationships between the parties and functions are shown in Figure 1.



**Figure 1 – Components and Relationship in CDOT's QAP**

Acceptance may consist of OA testing or OVT verifying and validating ICQC testing.

## 1.2 Conflict of Interest

To avoid the appearance of a conflict of interest, any independent qualified laboratory shall perform only one of the following types of testing on the same project.

- A. Process Control testing (PC);
- B. Independent Contractor Quality Control testing (ICQC);
- C. Owner Verification Testing\* (OVT);
- D. Independent Assurance testing\* (IA); or
- E. Referee testing\* (See Subsection 3.5.2 for more information).

\* CDOT may perform OVT, IA, and Referee testing as long as separate equipment and personnel are performing the tests.

## 2. QUALITY CONTROL

### 2.1 General

The Contractor is responsible for the quality of the Work as imposed by the Contract. Project quality will be enhanced through the daily efforts of all the workers involved with the Work, supported by the Contractor's quality control plan. The Contractor's PC shall not be part of the acceptance program; this is strictly for the Contractor's internal production control only.

### **2.1.1 Reporting, Record Keeping, and Documentation**

The Contractor's team and the Department's personnel shall maintain construction workmanship and materials quality records of all inspections and tests performed. These records shall include factual evidence that the required inspections or tests have been performed, including type and number of inspections or tests involved; results of inspections or tests; nature of defects, deviations, causes for rejection, etc.; proposed remedial action, and corrective actions taken. These records shall cover both conforming and defective or deficient features, and shall include a statement that all products and materials incorporated in the Work are in full compliance with the terms of the Contract Documents.

### **2.2 Design-Build Process Control (PC) Requirements**

The Contractor shall establish a documented systematic approach to define the processes, methods, procedures, and documentation for delivery of PC on the Project. These methods and procedures shall clearly define the authority and responsibility for the administration of the PC plan.

The Contractor's team and Subcontractors' construction workforce are all considered to be members of the Contractor's Process Control staff as each is responsible for the quality of the Work. Personnel responsible for performing Process Control inspection shall be knowledgeable and trained to perform their duties. Qualified personnel and laboratories performing Process Control sampling and testing shall be knowledgeable in the testing methods and procedures in accordance with Colorado Procedure (CP) 10.

Although not used for acceptance, PC testing and inspection shall ensure quality has been incorporated into all elements of the Work prior to requesting acceptance testing and inspection. Sampling and testing of all materials during the production or manufacturing processes shall be performed by personnel who hold the required certifications as specified in this Manual for the appropriate material. This effort by the Contractor will support CDOT's QAP in that only materials meeting the specifications are supplied for ultimate incorporation into the Work. Minimum PC sampling and testing guidelines are located in this Manual in the chapter entitled *OA Frequency Guide Schedule for Minimum Materials Sampling, Testing, and Inspection* [tab entitled, Schedule (Owner Acceptance)].

## 2.3 Independent Contractor Quality Control (ICQC)

When CDOT uses Contractor Quality Control in the acceptance decision, both the ICQC and OVT testing make up the Department's acceptance decision. Section 3.2 describes the sampling and testing requirements for both the ICQC and OVT groups. Section 3.3 describes materials acceptance specific to ICQC requirements and Section 3.4 describes Owner Verification Testing, statistical analysis, and reporting requirements specific to OVT requirements. The Department's verification sampling and testing are divided into three levels based on the material and method.

Level 1 provides continuous analysis for those materials and tests shown in Table 1 that are strong indicators of performance. Examples include compressive strength for hydraulic cement concrete, percent soil compaction for embankment, and percent asphalt content for hot-mix asphalt (HMA). The OVT frequency is approximately 10 percent of the ICQC testing frequency. A minimum of three OVT results is required. F-tests and t-tests are to be performed on these material categories on a continuous basis with the addition of each OVT result. The p-values (from the F-tests and t-tests) are reported for each analysis and are tracked over time. The p-value is a probability value ranging from 0 to 1 and is an indication of the probability that OVT data does not validate the ICQC test data. To implement this concept, the critical p-value is set equal to the level of significance (or alpha value) for each material category as shown in Table 2. When the calculated p-value is above the established p-value, then statistical validation occurs. This approach of tracking p-values over time enables the Department to efficiently monitor the validation status of each analysis category daily in "real-time" and allows for more timely action to address non-validation.

Level 2 provides an independent verification process for those materials shown in Table 3 that are secondary indicators of performance. An example is the temperature test for hydraulic cement concrete. The OVT frequency should be a minimum of one material test every three months during construction and will be plotted with the ICQC results of the same material.

Level 3 provides observation verification for those materials that only require very few ICQC tests or tests on materials whose risk of failure does not affect the long-term performance of the facility. Under the Level 3 approach, the Department does not perform tests but observes the ICQC test performance for equipment and procedural compliance with the test procedure or obtains a copy of the Certificate of Compliance (COC) or Certified Test Results (CTR). The frequency of this testing is a minimum of once per project per test method, or periodically as determined by the CDOT Region Materials Engineer. For Level 3, the Department's representative observing the ICQC technician performing the test enters his observational findings and retains a copy of the COC or CTR in the appropriate section of the materials books for record-keeping purposes (See Section 16, Organizational Guide for Project Material Books, in the CDOT FMM Chapter entitled Documentation – CDOT Maintenance and Local Agency).

If the Department chooses to shift the risk to the Contractor and include the Contractor's performed tests, the Department will use the sampling and testing frequency shown in Table 1: *Level 1 - Owner Verification Testing Schedule for Minimum Materials Sampling, Testing, and Inspection* with level of significance shown in Table 2: *Level of Significance for F-tests and t-tests* along with the sampling and testing frequency shown in Table 3: *Level 2 - Owner Verification Testing Schedule for Minimum Materials Sampling and Testing* within this chapter.

### **3. QUALITY ACCEPTANCE PROGRAM**

#### **3.1 General**

There are two types of acceptance on D-B projects.

The first type of acceptance is CDOT performed Owner Acceptance (OA) where acceptance testing and inspection are performed by the Department or its representative. If the Department chooses to perform all of the acceptance testings, the sampling and testing frequency is defined by the *OA Frequency Guide Schedule for Minimum Materials Sampling, Testing, and Inspection* as shown in the *CDOT Field Materials Manual*.

The second type of acceptance is when the Department uses contractor quality control tests performed by the Contractor's Independent Contractor Quality Control (ICQC) firm. This type of project acceptance program will require the Contractor to perform the quality inspection, sampling, and testing similar to the Department's requirements for acceptance and will require the Department to implement an OVT program for the project. When the Department uses this method, ICQC and OVT together are the basis for the acceptance decision. CDOT may use ICQC results for acceptance when they are statistically validated and/or verified by the OVT results. ICQC is performed by the Contractor's firm and OVT is performed by the Department or its representative.

The ICQC portion of the Contractor's Quality Control plan shall include the internal procedures used by the Contractor's team to ensure that the Work is inspected and tested to verify compliance with the released-for-construction plans, approved shop drawings, working drawings, and specifications and approved Change Orders. The ICQC program shall be completely separate from the PC program.

#### **3.2 Sampling and Testing**

This section provides guidance on sampling, testing, inspection, and acceptance requirements to be used in the acceptance decision. References in the Contract to a Colorado Procedure (CP), test designation of the American Association of State Highway and Transportation Officials (AASHTO), the American Society for Testing and Materials (ASTM), or any other recognized national organization means the latest revision of that test method or specification for the work in effect on the proposal due date.

##### **3.2.1 Sample Types and Uses**

The F-tests and t-tests described in subsection 3.4.3.1 – Statistical Analysis are only valid when using random independent samples. However, split samples may be used outside of the statistical analysis for owner corroboration of the ICQC tests under the Department's Check Testing program defined in Colorado Procedure (CP) 13. This CP defines a comparison process for performing and analyzing split samples between the Department and ICQC and is necessary during the startup operation of the QAP. These samples will be analyzed by the Department in accordance with CP-13 and the results discussed with the ICQC firm to assure laboratory and technician test results compare favorably. Split samples may also be performed throughout the life of the project as necessary to investigate non-validating material categories and verify or realign testing equipment and personnel. The Department's OVT may observe any sampling and/or testing performed by the Contractor. Members of the D-B team or ICQC team may also observe the sampling and/or testing performed by the OVT and should report any discrepancies to the Project Engineer.



### 3.2.3 Quantities and Testing Frequency

The ICQC firm shall continuously track and record the quantity of material incorporated into the Project and shall generate a weekly report to ensure ICQC compliance with the Minimum Sampling and Testing Schedule. The Department shall use the report to verify compliance of the ICQC and OVT frequencies.

At a minimum, the ICQC firm shall perform material sampling and testing at random locations and frequencies in this Manual in the *Schedule for Owner Acceptance (OA)*. ICQC tests are required to be independent of the OVT tests. To verify ICQC test results, OVT tests shall be performed at a frequency identified in Tables 1 and 3. However, if the ICQC increases their tests above the minimum shown in the *Schedule for Owner Acceptance (OA)*, then the OVT schedule should be adjusted to a frequency no less than 10 percent of the ICQC.

### 3.3 Independent Contractor Quality Control (ICQC) Requirements for Materials Acceptance

The Contractor's ICQC shall establish a documented systematic approach to define the processes, methods, procedures, and documentation for material incorporated into the Work. These methods and procedures shall clearly define the authority and responsibility for the administration of the ICQC. The ICQC must develop and maintain a robust document control system for materials sampling and testing, construction inspections, Non-Compliance Records (NCRs), etc. which is acceptable to the Department.

The ICQC testing shall be performed by personnel who hold the required certifications as specified in this Manual for the appropriate material and shall be responsible for entering materials test data into CDOT's SiteManager® Materials and Laboratory Information Management System (SMM/LIMS) database and shall be independent of the PC. The responsible technician and his/her supervisor shall sign the daily test reports and the results of the daily tests shall be entered into the database and electronically signed within 24 hours of test completion. This electronic reporting is intended to allow the Contractor and the Department to make timely and accurate decisions on workmanship and material quality issues.

### 3.4 Owner Verification Testing (OVT) Requirements

#### 3.4.1 General

The Department has the ultimate responsibility for verifying that the Project is designed and constructed in compliance with the Contract Documents. As such, the Department or its representative will perform owner verification sampling, testing, and inspection, and conduct audits to verify the D-B's compliance with the approved Plan from the D-B firm.

#### 3.4.2 Owner Verification Testing and Inspection

The Owner Verification Testing (OVT) and inspection will be performed by the Department or a qualified firm hired by the Department. OVT Level 1 testing shall be performed at the frequency shown in Table 1. However, if the ICQC increases their tests above the minimum shown in the *Schedule for Owner Acceptance (OA)*, then the OVT schedule should be adjusted to a frequency no less than 10 percent of the ICQC. OVT Level 2 testing shall be performed at the frequency shown in Table 3. On some D-B projects, the Department may decide to perform the acceptance tests. In this case, the Department will perform the tests at the frequency shown in the "OA Frequency Guide Schedule".

**Table 1: Level 1 – Owner Verification Testing,  
Schedule for Minimum Materials Sampling, Testing, and Inspection**

| PAY ITEM   | TYPE OF TEST                        | PROJECT VERIFICATION SAMPLING & TESTING FREQUENCY   | PROCEDURES                    |                              | REMARKS | POINT OF VERIFICATION FOR QUALITY DETERMINATION |
|--|-------------------------------------|---|-------------------------------|------------------------------|---------|---|
|  |                                     |   | PROJECT VERIFICATION SAMPLING | PROJECT VERIFICATION TESTING |         |   |
| <b>203</b><br><b>EMBANKMENT</b><br>Unclassified<br>Excavation<br>(Complete In Place) | IN-PLACE DENSITY / MOISTURE CONTENT | 1 per 15,000 cu. yds. or fraction thereof of testable material as described in Subsection 203.07 of the CDOT Standard Specifications. |                               | CP 80aa                      |         | In the compacted lift.                          |
| <b>206</b><br><b>STRUCTURE BACKFILL</b><br>(Class 1)                                 | IN-PLACE DENSITY / MOISTURE CONTENT | 1 per 1,500 cu. yds. or fraction thereof.   |                               | CP 80aa                      |         | In the compacted lift.                          |
| <b>301</b><br><b>PLANT MIX BITUMINOUS BASE</b>                                       | IN-PLACE DENSITY / MOISTURE CONTENT | 1 per 15,000 tons or fraction thereof.  |                               | CP 80aa                      |         | In the compacted lift.                          |
| <b>304</b><br><b>AGGREGATE BASE COURSE</b>   | IN-PLACE DENSITY / MOISTURE CONTENT | 1 per 20,000 tons (10,000 cu. yds.) or fraction thereof for each class.   |                               | CP 80aa                      |         | In the compacted lift.                          |
| <b>306</b><br><b>RECONDITIONING</b>  | IN-PLACE DENSITY / MOISTURE CONTENT | 1 per 50,000 sq. yds. or fraction thereof.  |                               | CP 80aa                      |         | In the compacted lift.                          |

**Table 1: Level 1 – Owner Verification Testing,  
Schedule for Minimum Materials Sampling, Testing, and Inspection**

| PAY ITEM   | TYPE OF TEST     | PROJECT VERIFICATION SAMPLING & TESTING FREQUENCY | PROCEDURES                    |                              | REMARKS   | POINT OF VERIFICATION FOR QUALITY DETERMINATION |
|--|------------------|---|-------------------------------|------------------------------|---|---|
|  |                  |   | PROJECT VERIFICATION SAMPLING | PROJECT VERIFICATION TESTING |   |   |
| <b>HYDRATED LIME</b><br>307                      | GRADATION        | 1 per 500 tons of lime or fraction thereof.       |                               | CPL 4209                     | Retain CTRs in the project files.   |   |
| <b>PROCESSING LIME TREATED SUBGRADE</b><br>307   | IN-PLACE DENSITY | 1 per 50,000 sq. yds. or fraction thereof.        |                               | CP 80aa                      |   | In the compacted lift.                          |
|  | THICKNESS        | 1 per 10,000 sq. yds. or fraction thereof.        |                               | C 174                        | If the measurement is <0.5" from plan thickness, 2 additional cores shall be taken in that lot and the average of 3 cores will determine the thickness of that lot. | In the compacted lift.                          |
|  | pH               | 1 per 50,000 sq. yds. or fraction thereof.        | CP 30                         | G 51                         | pH will be determined after % lime has been established based on unconfined compressive strength pH.  |   |
| <b>PROCESSING CEMENT TREATED SUBGRADE</b><br>308 | IN-PLACE DENSITY | 1 per 50,000 sq. yds. or fraction thereof.        |                               | CP 80aa                      |   | In the compacted lift.                          |
|  | THICKNESS        | 1 per 10,000 sq. yds. or fraction thereof.        |                               | C 174                        | If the measurement is <0.5" from plan thickness, 2 additional cores shall be taken in that lot and the average of 3 cores will determine the thickness of that lot. | In the compacted lift.                          |

**Table 1: Level 1 – Owner Verification Testing,  
Schedule for Minimum Materials Sampling, Testing, and Inspection**

| PAY ITEM  | TYPE OF TEST                       | PROJECT VERIFICATION SAMPLING & TESTING FREQUENCY | PROCEDURES                    |                              | REMARKS           | POINT OF VERIFICATION FOR QUALITY DETERMINATION |
|---|------------------------------------|---|-------------------------------|------------------------------|-------------------|---|
|   |                                    |   | PROJECT VERIFICATION SAMPLING | PROJECT VERIFICATION TESTING |                   |   |
| <b>310</b><br>PROCESS ASPHALT MAT for BASE COURSE       | IN-PLACE DENSITY                   | 1 per 30,000 sq. yds. or fraction thereof.        |                               | CP 80aa                      |                   | In the compacted lift.                          |
| <b>310</b><br>FULL DEPTH RECLAMATION of HOT MIX ASPHALT | IN-PLACE DENSITY                   | 1 per 30,000 sq. yds. or fraction thereof.        |                               | CP 80aa                      |                   | In the compacted lift.                          |
| <b>403</b><br>STONE MATRIX ASPHALT (SMA)                | BULK SPECIFIC GRAVITY              | 1 per 10,000 tons or fraction thereof.            |                               | CP 44                        | Use SSD specimens |   |
|   | BULK SPECIFIC GRAVITY of the JOINT | 1 per 50,000 linear feet or fraction thereof.     |                               | CP 44L                       | Use SSD specimens | Longitudinal Joint                              |
|   | MAXIMUM SPECIFIC GRAVITY           | 1 per 10,000 tons or fraction thereof.            | CP 41<br>CP 55                | CP 51                        |                   |   |
|   | IN-PLACE DENSITY                   | 1 per 5,000 tons or fraction thereof.             |                               | CP 44                        |                   | In the compacted lift.                          |
|   | ASPHALT CONTENT                    | 1 per 10,000 tons or fraction thereof.            | CP 41<br>CP 55                | CP 85 or<br>CPL 5120         |                   | Plant discharge, at/or behind the paver.        |

**Table 1: Level 1 – Owner Verification Testing,  
Schedule for Minimum Materials Sampling, Testing, and Inspection**

| PAY ITEM   | TYPE OF TEST                       | PROJECT VERIFICATION SAMPLING & TESTING FREQUENCY | PROCEDURES                    |                              | REMARKS                             | POINT OF VERIFICATION FOR QUALITY DETERMINATION |
|--|------------------------------------|---|-------------------------------|------------------------------|-------------------------------------|---|
|  |                                    |   | PROJECT VERIFICATION SAMPLING | PROJECT VERIFICATION TESTING |                                     |   |
| <b>403</b><br><br><b>HOT MIX ASPHALT (HMA)</b>                         | BULK SPECIFIC GRAVITY              | 1 per 10,000 tons or fraction thereof.            |                               | CP 44                        | Use SSD specimens                   |   |
|  | BULK SPECIFIC GRAVITY of the JOINT | 1 per 50,000 linear feet or fraction thereof.     |                               | CP 44L                       | Use SSD specimens                   | Longitudinal Joint                              |
|  | VOIDS IN MINERAL AGGREGATE         | 1 per 10,000 tons or fraction thereof.            | CP 41<br>CP 55                | CP 48aa                      |                                     |   |
|  | MAXIMUM SPECIFIC GRAVITY           | 1 per 10,000 tons or fraction thereof.            | CP 41<br>CP 55                | CP 51                        |                                     |   |
|  | IN-PLACE DENSITY                   | 1 per 5,000 tons or fraction thereof.             |                               | CP 81                        |                                     | In the compacted lift.                          |
|  | ASPHALT CONTENT                    | 1 per 10,000 tons or fraction thereof.            | CP 41<br>CP 55                | CP 85 or<br>CPL 5120         |                                     | Plant discharge, at/or behind the paver.        |
|  | DENSITY OF TEST SPECIMEN           | 1 per 10,000 tons or fraction thereof.            | CP 41<br>CP 55                | CPL 5115                     |                                     | Plant discharge, at/or behind the paver.        |
| <b>405</b><br><br><b>HOT IN-PLACE RECYCLING TREATMENTS (all types)</b> | IN-PLACE DENSITY                   | 1 per 50,000 sq. yds. or fraction thereof.        |                               | CP 81                        |                                     | In the compacted lift.                          |
|  | BULK SPECIFIC GRAVITY              | 1 per 10,000 tons or fraction thereof.            |                               | CP 44                        | Use SSD specimens (Virgin HMA Only) |   |
|  | BULK SPECIFIC GRAVITY of the JOINT | 1 per 50,000 linear feet or fraction thereof.     |                               | CP 44L                       | Use SSD specimens (Virgin HMA Only) | Longitudinal Joint                              |
|  | VOIDS IN MINERAL AGGREGATE         | 1 per 10,000 tons or fraction thereof.            | CP 41<br>CP 55                | CP 48aa                      | (Virgin HMA Only)                   |   |
|  | ASPHALT CONTENT                    | 1 per 10,000 tons or fraction thereof.            | CP 41<br>CP 55                | CP 85 or<br>CPL 5120         | (Virgin HMA Only)                   | Plant discharge, at/or behind the paver.        |

**Table 1: Level 1 – Owner Verification Testing,  
Schedule for Minimum Materials Sampling, Testing, and Inspection**

| PAY ITEM  | TYPE OF TEST         | PROJECT VERIFICATION SAMPLING & TESTING FREQUENCY | PROCEDURES                    |                              | REMARKS | POINT OF VERIFICATION FOR QUALITY DETERMINATION |
|---|----------------------|---|-------------------------------|------------------------------|---------|---|
|   |                      |   | PROJECT VERIFICATION SAMPLING | PROJECT VERIFICATION TESTING |         |   |
| 406<br>COLD BITUMINOUS PAVEMENT (RECYCLE)                     | IN-PLACE DENSITY     | 1 per 50,000 sq. yds. or fraction thereof.        | CP 41 (Meth. C)               | CP 53                        |         | Windrow or roadway after rolling is finished    |
| 409<br>COVER COAT MATERIAL                                    | FRACTURED FACES      | 1 per 50,000 tons or fraction thereof.            | CP 30                         | CP 45                        |         | Spreader or last point of the stockpile.        |
| 412<br>PORTLAND CEMENT CONCRETE PAVEMENT FLEXURAL STRENGTH    | TEXTURE DEPTH        | 1 per 5,000 sq. yds. or fraction thereof.         |                               | CP 77b                       |         |   |
|   | UNIT WEIGHT          | 1 per 25,000 sq. yds. or fraction thereof.        | CP 61                         | T 121                        |         |   |
|   | THICKNESS            | 1 per 25,000 sq. yds. or fraction thereof.        | CP 68                         | T 148                        |         |   |
|   | AIR CONTENT          | 1 per 25,000 sq. yds. or fraction thereof.        | CP 61                         | T 152                        |         |   |
|   | FLEXURAL STRENGTH    | 1 per 50,000 sq. yds. or fraction thereof.        | CP 61                         | T 97-28                      |         |   |
| 412<br>PORTLAND CEMENT CONCRETE PAVEMENT COMPRESSIVE STRENGTH | TEXTURE DEPTH        | 1 per 5,000 sq. yds. or fraction thereof.         |                               | CP 77b                       |         |   |
|   | UNIT WEIGHT          | 1 per 25,000 sq. yds. or fraction thereof.        | CP 61                         | T 121                        |         |   |
|   | THICKNESS            | 1 per 25,000 sq. yds. or fraction thereof.        | CP 68                         | T 148                        |         |   |
|   | AIR CONTENT          | 1 per 25,000 sq. yds. or fraction thereof.        | CP 61                         | T 152                        |         |   |
|   | COMPRESSIVE STRENGTH | 1 per 25,000 sq. yds. or fraction thereof.        | CP 61                         | C 39-28                      |         |   |

**Table 1: Level 1 – Owner Verification Testing,  
Schedule for Minimum Materials Sampling, Testing, and Inspection**

| PAY ITEM                                      | TYPE OF TEST         | PROJECT VERIFICATION SAMPLING & TESTING FREQUENCY | PROCEDURES                    |                              | REMARKS      | POINT OF VERIFICATION FOR QUALITY DETERMINATION |
|---|----------------------|---|-------------------------------|------------------------------|--------------|---|
|   |                      |   | PROJECT VERIFICATION SAMPLING | PROJECT VERIFICATION TESTING |              |   |
| <b>503</b><br>DRILLED CASSIONS                | COMPRESSIVE STRENGTH | 1 per 500 cu. yds. or fraction thereof.           | CP 61                         | C 39-28                      |              |   |
|   | UNIT WEIGHT          | 1 per 500 cu. yds. or fraction thereof.           | CP 61                         | T 121                        |              |   |
|   | AIR CONTENT          | 1 per 500 cu. yds. or fraction thereof.           | CP 61                         | T 152                        |              |   |
| <b>503</b><br>MICROPILE                       | COMPRESSIVE STRENGTH | 1 per 100 cu. yds. or fraction thereof.           | CP 61                         | C 109-28                     | Use 2" cubes |   |
| <b>507</b><br>CONCRETE SLOPE and DITCH PAVING | COMPRESSIVE STRENGTH | 1 per 500 cu. yds. or fraction thereof.           | CP 61                         | C 39-28                      |              |   |
|   | UNIT WEIGHT          | 1 per 500 cu. yds. or fraction thereof.           | CP 61                         | T 121                        |              |   |
|   | AIR CONTENT          | 1 per 500 cu. yds. or fraction thereof.           | CP 61                         | T 152                        |              |   |
| <b>601</b><br>STRUCTURAL CONCRETE             | COMPRESSIVE STRENGTH | 1 per 500 cu. yds. or fraction thereof.           | CP 61                         | C 39-28                      |              |   |
|   | UNIT WEIGHT          | 1 per 500 cu. yds. or fraction thereof.           | CP 61                         | T 121                        |              |   |
|   | AIR CONTENT          | 1 per 500 cu. yds. or fraction thereof.           | CP 61                         | T 152                        |              |   |
| <b>603</b><br>CULVERTS and SEWERS             | IN-PLACE DENSITY     | 1 per 1,500 cu. yds. or fraction thereof.         |                               | CP 80aa                      |              | In the compacted lift.                          |

**Table 1: Level 1 – Owner Verification Testing,  
Schedule for Minimum Materials Sampling, Testing, and Inspection**

| PAY ITEM   | TYPE OF TEST         | PROJECT VERIFICATION SAMPLING & TESTING FREQUENCY | PROCEDURES                    |                              | REMARKS | POINT OF VERIFICATION FOR QUALITY DETERMINATION |
|--|----------------------|---|-------------------------------|------------------------------|---------|---|
|  |                      |   | PROJECT VERIFICATION SAMPLING | PROJECT VERIFICATION TESTING |         |   |
| <b>604</b><br>MANHOLES,<br>INLETS, and METER<br>VAULTS | COMPRESSIVE STRENGTH | 1 per 500 cu. yds. or fraction thereof.           | CP 61                         | C 39-28                      |         |   |
|  | UNIT WEIGHT          | 1 per 500 cu. yds. or fraction thereof.           | CP 61                         | T 121                        |         |   |
|  | AIR CONTENT          | 1 per 500 sq. yds. or fraction thereof.           | CP 61                         | T 152                        |         |   |
|  | IN-PLACE DENSITY     | 1 per 500 cu. yds. or fraction thereof.           |                               | CP 80aa                      |         | In the compacted lift.                          |
| <b>606</b><br>GUARDRAIL and<br>BRIDGE RAIL             | COMPRESSIVE STRENGTH | 1 per 5,000 linear. ft. or fraction thereof.      | CP 61                         | C 39-28                      |         |   |
|  | UNIT WEIGHT          | 1 per 5,000 linear. ft. or fraction thereof.      | CP 61                         | T 121                        |         |   |
|  | AIR CONTENT          | 1 per 5,000 linear. ft. or fraction thereof.      | CP 61                         | T 152                        |         |   |
| <b>608</b><br>CONCRETE<br>SIDEWALK                     | COMPRESSIVE STRENGTH | 1 per 10,000 sq. yds. or fraction thereof.        | CP 61                         | C 39-28                      |         |   |
|  | UNIT WEIGHT          | 1 per 10,000 sq. yds. or fraction thereof.        | CP 61                         | T 121                        |         |   |
|  | AIR CONTENT          | 1 per 10,000 sq. yds. or fraction thereof.        | CP 61                         | T 152                        |         |   |
| <b>609</b><br>CONCRETE<br>CURB and<br>GUTTER           | COMPRESSIVE STRENGTH | 1 per 10,000 sq. yds. or fraction thereof.        | CP 61                         | C 39-28                      |         |   |
|  | UNIT WEIGHT          | 1 per 10,000 sq. yds. or fraction thereof.        | CP 61                         | T 121                        |         |   |
|  | AIR CONTENT          | 1 per 10,000 sq. yds. or fraction thereof.        | CP 61                         | T 152                        |         |   |



**Table 1: Level 1 – Owner Verification Testing,  
Schedule for Minimum Materials Sampling, Testing, and Inspection**

| PAY ITEM  | TYPE OF TEST         | PROJECT VERIFICATION SAMPLING & TESTING FREQUENCY | PROCEDURES                    |                              | REMARKS | POINT OF VERIFICATION FOR QUALITY DETERMINATION |
|---|----------------------|---|-------------------------------|------------------------------|---------|---|
|   |                      |   | PROJECT VERIFICATION SAMPLING | PROJECT VERIFICATION TESTING |         |   |
| <b>LIGHT STANDARD FOUNDATION 613</b>                                    | COMPRESSIVE STRENGTH | 1 per 100 cu. yds. or fraction thereof.           | CP 61                         | C 39-28                      |         |   |
|   | UNIT WEIGHT          | 1 per 100 cu. yds. or fraction thereof.           | CP 61                         | T 121                        |         |   |
|   | AIR CONTENT          | 1 per 100 cu. yds. or fraction thereof.           | CP 61                         | T 152                        |         |   |
| <b>LIGHT STANDARD FOUNDATION (SPECIAL) and HIGH MAST FOUNDATION 613</b> | COMPRESSIVE STRENGTH | 1 per 500 cu. yds. or fraction thereof.           | CP 61                         | C 39-28                      |         |   |
|   | UNIT WEIGHT          | 1 per 500 cu. yds. or fraction thereof.           | CP 61                         | T 121                        |         |   |
|   | AIR CONTENT          | 1 per 500 cu. yds. or fraction thereof.           | CP 61                         | T 152                        |         |   |
| <b>SIPHONS 616</b>  | IN-PLACE DENSITY     | 1 per 1,500 cu. yds. or fraction thereof.         |                               | CP 80aa                      |         | In the compacted lift.                          |
| <b>WATERLINE PIPE 619</b>   | IN-PLACE DENSITY     | 1 per 1,500 cu. yds. or fraction thereof.         |                               | CP 80aa                      |         | In the compacted lift.                          |
| <b>DRAINAGE PIPE 624</b>  | IN-PLACE DENSITY     | 1 per 1,500 cu. yds. or fraction thereof.         |                               | CP 80aa                      |         | In the compacted lift.                          |
| <b>SHOTCRETE 641</b>  | COMPRESSIVE STRENGTH | 1 per 500 cu. yds. or fraction thereof.           | CP 61                         | C 39-28                      |         |   |
|   | AIR CONTENT          | 1 per 500 cu. yds. or fraction thereof.           | CP 61                         | T 152                        |         |   |

### 3.4.3 Material Validation Reporting

For projects that have been identified by FHWA as a Project of Division Interest or a Project of Corporate Interest based on the FHWA and CDOT Stewardship and Oversight Agreement, the Department will submit quarterly reports to the FHWA for concurrence with project compliance with the approved QAP. The report will be submitted 3 weeks after D-B has provided all quarterly inspection and testing documentation. Each report shall cover a period of construction not greater than three months.

#### 3.4.3.1 Statistical Analysis

F-tests and t-tests will be used in accordance with CP 14 to analyze ICQC and OVT data of Level 1 materials. The F-test is a comparison of variances between the ICQC and OVT population to determine if there is a significant difference. The t-test is a comparison of means from the ICQC and OVT population to determine if there is a significant difference. The type of material and the recommended level of significance are shown in Table 2. **F-tests and t-tests comparisons shall be performed by CDOT OA Personnel or CDOT OVT Personnel Only.**

Before performing any statistical analyses, it is important to ensure that the data contained in each analysis is in reasonable compliance with the underlying assumptions of the F-test and t-test.

**Table 2: Level of Significance for F-tests and t-tests**

| Materials Item   | Level of Significance ( $\alpha$ ) |
|--|------------------------------------|
| Unclassified Excavation (Item 203), Structure Backfill (Item 206), Plant Mix Bituminous Base (Item 301), Aggregate Base Course (Item 304), Reconditioning (Item 306), and In-Place Density Testing (Items 603, 604, 616, 619, and 624) | 0.01                               |
| Hydrated Lime, Processing Lime Treated Subgrade (Item 307), Processing Cement Treated Base (Item 308), Processing Asphalt Mat For Base Course and Full Depth Reclamation of HMA (Item 310)   | 0.01                               |
| Stone Matrix Asphalt and Hot Mix Asphalt (Item 403)  | 0.025                              |
| Hot In-Place Recycling (Item 405) and Cold In-Place Recycling (Item 406)   | 0.01                               |
| Cover Coat Material (Item 409)   | 0.01                               |
| Portland Cement Concrete Pavement (Item 412)   | 0.025                              |
| Drilled Caisson and Micropile (Item 503) and Concrete Slope and Ditch Paving (Item 507)  | 0.01                               |
| Structural Concrete (Item 601, 604, 606, and 613)  | 0.025                              |
| Concrete Sidewalk (Item 608) and Curb and Gutter (Item 609)  | 0.10                               |
| Shotcrete (Item 641)   | 0.10                               |

While there are default OVT sampling and testing frequencies shown in Tables 1 and Table 3 for each material, each project has its own unique conditions that may warrant project-specific modifications to the default level for the item and level of significance for the F-tests and t-tests as shown in Table 2.

**Table 3: Level 2 – Owner Verification Testing,  
Schedule for Minimum Materials Sampling, Testing, and Inspection**

| PAY ITEM  | TYPE OF TEST                | PROJECT VERIFICATION SAMPLING & TESTING FREQUENCY   | PROCEDURES                    |                               | REMARKS  | POINT OF VERIFICATION FOR QUALITY DETERMINATION |
|---|-----------------------------|---|-------------------------------|-------------------------------|--|---|
|   |                             |   | PROJECT VERIFICATION SAMPLING | PROJECT VERIFICATION TESTING  |  |   |
| <b>203</b><br><b>EMBANKMENT MATERIAL</b><br><b>Unclassified Excavation and Borrow</b><br><b>(Complete in Place)</b> | MOISTURE-DENSITY CURVE      | 1 per 15,000 cu. yds. or fraction thereof of testable material as described in Subsection 203.07 of the CDOT Standard Specifications  |                               | CP 23<br><br>T 99 or<br>T 180 | Moisture-Density Curve shall be performed on the soil found at The proposed location for CP 25 |   |
|   | PERCENT RELATIVE COMPACTION | 1 per 15,000 cu. yds. or fraction thereof of testable material as described in Subsection 203.07 of the CDOT Standard Specifications. |                               | CP 25                         | CP 25, Subsection 3.4.8, for 1-point check requirements.                                       | In the compacted lift.                          |
| <b>206</b><br><b>STRUCTURE BACKFILL</b><br><b>(CLASS 1 and 2)</b>   | MOISTURE-DENSITY CURVE      | 1 per 15,000 cu. yds. or fraction thereof.  |                               | CP 23<br><br>T 99 or<br>T 180 | T180 for Class 1.<br><br>T 99 or T 180 for Class 2.  |   |
|   | PERCENT RELATIVE COMPACTION | 1 per 15,000 cu. yds. or fraction thereof of testable material as described in Subsection 203.07 of the CDOT Standard Specifications. |                               | CP 25                         | CP 25, Subsection 3.4.8, for 1-point check requirements.                                       | In the compacted lift.                          |
|   | GRADATION                   | 1 per 15,000 cu. yds. or fraction thereof.  | CP 30                         | CP 31                         |  | In-Place, before compaction.                    |
|   | ATTERBERG LIMITS            | 1 per 15,000 cu. yds. or fraction thereof.  |                               | T 89<br>T 90                  |  |   |
| <b>206</b><br><b>MECHANICAL REINFORCEMENT OF SOIL and FILTER MATERIAL (All Classes)</b>                             | GRADATION                   | 1 per 15,000 cu. yds. or fraction thereof for each Class.   | CP 30                         | CP 31                         |  | In-Place.                                       |

**Table 3: Level 2 – Owner Verification Testing,  
Schedule for Minimum Materials Sampling, Testing, and Inspection**

| PAY ITEM  | TYPE OF TEST                | PROJECT VERIFICATION SAMPLING & TESTING FREQUENCY | PROCEDURES                    |                              | REMARKS | POINT OF VERIFICATION FOR QUALITY DETERMINATION |
|---|-----------------------------|---|-------------------------------|------------------------------|---------|---|
|   |                             |   | PROJECT VERIFICATION SAMPLING | PROJECT VERIFICATION TESTING |         |   |
| <b>206</b><br><br><b>BED COURSE MATERIAL</b>  | MOISTURE-DENSITY CURVE      | 1 per 15,000 cu. yds. or fraction thereof.        |                               | CP 23<br>T 180               |         |   |
|   | PERCENT RELATIVE COMPACTION | 1 per 15,000 cu. yds. or fraction thereof.        |                               | CP 25                        |         | In the compacted lift.                          |
|   | GRADATION                   | 1 per 15,000 cu. yds. or fraction thereof.        | CP 30                         | CP 31                        |         | In-Place.                                       |
|   | ATTERBERG LIMITS            | 1 per 15,000 cu. yds. or fraction thereof.        |                               | T 89<br>T 90                 |         |   |
| <b>301</b><br><br><b>PLANT MIX BITUMINOUS BASE and PERMIABLE ASPHALT TREATED BASE</b> | MOISTURE-DENSITY CURVE      | 1 per 15,000 tons or fraction thereof.            |                               | CP 23<br>T 180               |         |   |
|   | PERCENT RELATIVE COMPACTION | 1 per 15,000 tons or fraction thereof.            |                               | CP 25                        |         | In the compacted lift.                          |
|   | GRADATION                   | 1 per 15,000 tons or fraction thereof.            | CP 30                         | CP 31                        |         | In-Place.                                       |
|   | ATTERBERG LIMITS            | 1 per 15,000 tons or fraction thereof.            |                               | T 89<br>T 90                 |         |   |

**Table 3: Level 2 – Owner Verification Testing,  
Schedule for Minimum Materials Sampling, Testing, and Inspection**

| PAY ITEM   | TYPE OF TEST                    | PROJECT VERIFICATION SAMPLING & TESTING FREQUENCY | PROCEDURES                    |                              | REMARKS   | POINT OF VERIFICATION FOR QUALITY DETERMINATION |
|--|---------------------------------|---|-------------------------------|------------------------------|---|---|
|  |                                 |   | PROJECT VERIFICATION SAMPLING | PROJECT VERIFICATION TESTING |   |   |
| <b>304</b><br><b>AGGREGATE<br/>BASE COURSE<br/>(All Classes)</b>               | MOISTURE-DENSITY CURVE          | 1 per 20,000 tons or fraction thereof.            |                               | CP 23<br>T 180               |   |   |
|  | PERCENT RELATIVE COMPACTION     | 1 per 20,000 tons or fraction thereof.            |                               | CP 25                        |   | In the compacted lift.                          |
|  | GRADATION                       | 1 per 20,000 tons or fraction thereof.            | CP 30                         | CP 31                        |   | In-Place.                                       |
|  | R-VALUE                         | 1 per 20,000 tons or fraction thereof.            |                               | CPL 3101                     | 1 R-Value per class   |   |
|  | ATTERBERG LIMITS                | 1 per 20,000 tons or fraction thereof.            |                               | T 89<br>T 90                 |   |   |
| <b>306</b><br><b>RECONDITIONING</b>  | MOISTURE-DENSITY CURVE          | 1 per 50,000 sq. yds. or fraction thereof.        |                               | CP 23<br>T 99<br>T 180       |   |   |
|  | PERCENT RELATIVE COMPACTION     | 1 per 50,000 sq. yds. or fraction thereof.        |                               | CP 25                        |   | In the compacted lift.                          |
| <b>307</b><br><b>PROCESSING LIME and CEMENT KILN<br/>DUST TREATED SUBGRADE</b> | MOISTURE-DENSITY CURVE          | 1 per 50,000 sq. yds. or fraction thereof         |                               | CP 23<br>T 99<br>T 180       | The moisture content of mixture at the start of compaction shall be at 2 ± 1% above optimum moisture content. | In the compacted lift.                          |
|  | PERCENT RELATIVE COMPACTION     | 1 per 50,000 sq. yds. or fraction thereof.        |                               | CP 25                        |   | In the compacted lift.                          |
|  | GRADATION                       | 1 per 50,000 sq. yds. or fraction thereof.        | CP 30                         | CP 31                        | 1" – 100% passing<br>#4 – 60% passing<br>Dry sieving after final mixing.                                      |   |
|  | UNCONFINED COMPRESSIVE STRENGTH | 1 per 50,000 sq. yds. or fraction thereof.        |                               | D 5102 (Proc. B)             | Tests shall be conducted on samples cured in a moist environment for 5 days at 100 F.                         |   |
|  | ATTERBERG LIMITS                | 1 per 50,000 sq. yds. or fraction thereof.        |                               | T 89<br>T 90                 | Reduce by ½ original PI.  |   |

**Table 3: Level 2 – Owner Verification Testing,  
Schedule for Minimum Materials Sampling, Testing, and Inspection**

| PAY ITEM   | TYPE OF TEST                | PROJECT VERIFICATION SAMPLING & TESTING FREQUENCY                      | PROCEDURES                    |                              | REMARKS  | POINT OF VERIFICATION FOR QUALITY DETERMINATION                                       |
|--|-----------------------------|--|-------------------------------|------------------------------|--|---|
|  |                             |  | PROJECT VERIFICATION SAMPLING | PROJECT VERIFICATION TESTING |  |   |
| <b>310</b><br>PROCESSING ASPHALT MAT FOR BASE          | MOISTURE-DENSITY CURVE      | 1 per 30,000 sq. yds. or fraction thereof                              |                               | CP 23<br><br>T 180           | The moisture content of mixture at the start of compaction shall be at $2 \pm 1\%$ above optimum moisture content. | In the compacted lift.  |
|  | PERCENT RELATIVE COMPACTION | 1 per 30,000 sq. yds. or fraction thereof.                             |                               | CP 25                        |  | In the compacted lift.  |
|  | GRADATION                   | 1 per 30,000 sq. yds. or fraction thereof.                             | CP 30                         | CP 31                        | 1" – 100% passing<br>#4 – 60% passing<br>Dry sieving after final mixing.   |   |
| <b>403</b><br>HOT MIX ASPHALT and STONE MATRIX ASPHALT | GRADATION                   | Aggregate: 1 per 10,000 tons or fraction thereof of mix produced.      | CP 30                         | CP 31HMA aa                  |  | Aggregate from the cold feed, pugmill discharge, extraction, or product of CP-L 5120. |
|  | AGGREGATE MOISTURE          | Aggregate: 1 per 10,000 tons or fraction thereof of mix produced.      | CP 30                         | CP 33                        |  | Aggregate from the cold feed.   |
|  | THERMAL SEGREGATION         | 1 per 10,000 tons or fraction thereof.                                 |                               | CP 58                        |  | Behind paver.   |
|  | FIELD CORRECTION OF DENSITY | 1 per 10,000 tons or fraction thereof.                                 |                               | CP 82                        | From core samples  | In the compacted lift   |
|  | LIME PROPERTIES             | Hydrated Lime: 1 per 50,000 tons or fraction thereof of mix produced.  |                               | CPL 4209                     |  |   |
|  | BINDER PROPERTIES           | Asphalt Cement: 1 per 10,000 tons or fraction thereof of mix produced. |                               | T 315                        |  |   |
|  | MINERAL FILLER              | 1 per 50,000 tons or fraction thereof of mix produced.                 |                               | T 37                         | For Stone Matrix Asphalt when a mineral filler is used.  |   |

**Table 3: Level 2 – Owner Verification Testing,  
Schedule for Minimum Materials Sampling, Testing, and Inspection**

| PAY ITEM  | TYPE OF TEST        | PROJECT VERIFICATION SAMPLING & TESTING FREQUENCY                     | PROCEDURES                    |                              | REMARKS | POINT OF VERIFICATION FOR QUALITY DETERMINATION                                       |
|---|---------------------|---|-------------------------------|------------------------------|---------|---|
|   |                     |   | PROJECT VERIFICATION SAMPLING | PROJECT VERIFICATION TESTING |         |   |
| <b>405</b><br><b>HOT MIX ASPHALT USED IN<br/>HOT-IN-PLACE<br/>RECYCLE</b> | GRADATION           | Aggregate: 1 per 50,000 tons or fraction thereof of mix produced.     | CP 30                         | CP 31HMAaa                   |         | Aggregate from the cold feed, pugmill discharge, extraction, or product of CP-L 5120. |
|   | AGGREGATE MOISTURE  | Aggregate: 1 per 50,000 tons or fraction thereof of mix produced.     | CP 30                         | CP 33                        |         | Aggregate from the cold feed.   |
|   | THERMAL SEGREGATION | 1 per 50,000 tons or fraction thereof.                                |                               | CP 58                        |         | Behind paver.   |
|   | LIME PROPERTIES     | Hydrated Lime: 1 per 50,000 tons or fraction thereof of mix produced. |                               | CPL 4209                     |         |   |
| <b>406</b><br><b>COLD BITUMINOUS<br/>PAVEMENT (RECYCLE)</b>               | GRADATION           | 1 per 50,000 sq. yds. or fraction thereof.                            | CP 30                         | CP 31                        |         |   |
|   | IN-PLACE DENSITY    | 1 per 50,000 sq. yds. or fraction thereof.                            | CP 41 *<br>(Meth. C)          | CP 81                        |         |   |
| <b>407</b><br><b>BLOTTER<br/>MATERIAL</b>                                 | GRADATION           | 1 per 2,000 tons or fraction thereof.                                 | CP 30                         | CP 31                        |         | Spreader or the last stockpile prior to placement.                                    |
| <b>409</b><br><b>COVER COAT<br/>MATERIAL</b>                              | GRADATION           | 1 per 5,000 tons or fraction thereof.                                 | CP 30                         | CP 31                        |         | Spreader or the last stockpile prior to placement.                                    |

**Table 3: Level 2 – Owner Verification Testing,  
Schedule for Minimum Materials Sampling, Testing, and Inspection**

| PAY ITEM                        | TYPE OF TEST      | PROJECT VERIFICATION SAMPLING & TESTING FREQUENCY | PROCEDURES                    |                              | REMARKS                                    | POINT OF VERIFICATION FOR QUALITY DETERMINATION                                       |
|---------------------------------|-------------------|---|-------------------------------|------------------------------|--|---|
|                                 |                   |   | PROJECT VERIFICATION SAMPLING | PROJECT VERIFICATION TESTING |  |   |
| 410<br>SLURRY SEAL COAT         | GRADATION         | 1 per 5,000 tons or fraction thereof.             | CP 30                         | CP 31                        |  | Spreader or last point of the stockpile.  |
|                                 | FRACTURED FACES   | 1 per 25,000 tons or fraction thereof.            | CP 30                         | CP 45                        |  | Spreader or last point of the stockpile.  |
| 411<br>ASPHALT CEMENT           | BINDER PROPERTIES | 1 per 500 tons of liquid or fraction thereof.     |                               | T 315                        | When asphalt cement is paid for separately |   |
| 412<br>PCCP                     | TEMPERATURE       | 1 per 25,000 sq. yds. or fraction thereof.        | CP 61                         | C 1064                       |  |   |
| 420<br>SEPARATION MATERIAL      | GRADATION         | 1 per 500 tons or fraction thereof.               | CP 30                         | CP 31                        |  |   |
| 503<br>DRILLED CAISSON          | TEMPERATURE       | 1 per 500 cu. yds. or fraction thereof.           | CP 61                         | C 1064                       |  |   |
| 507<br>CONCRETE SLOPE and DITCH | TEMPERATURE       | 1 per 500 cu. yds. or fraction thereof.           | CP 61                         | C 1064                       |  |   |
| 507<br>ASPHALT SLOPE and DITCH  | GRADATION         | 1 per 5,000 tons or fraction thereof.             | CP 30                         | CP 31HMAaa                   |  | Aggregate from the cold feed, pugmill discharge, extraction, or product of CP-L 5120. |
|                                 | ASPHALT CONTENT   | 1 per 5,000 tons or fraction thereof.             | CP 41<br>CP 61                | CP 85                        |  |   |



**Table 3: Level 2 – Owner Verification Testing,  
Schedule for Minimum Materials Sampling, Testing, and Inspection**

| PAY ITEM   | TYPE OF TEST                | PROJECT VERIFICATION SAMPLING & TESTING FREQUENCY | PROCEDURES                    |                              | REMARKS | POINT OF VERIFICATION FOR QUALITY DETERMINATION |
|--|-----------------------------|---|-------------------------------|------------------------------|---------|---|
|  |                             |   | PROJECT VERIFICATION SAMPLING | PROJECT VERIFICATION TESTING |         |   |
| <b>601</b><br>STRUCTURAL CONCRETE                      | TEMPERATURE                 | 1 per 500 cu. yds. or fraction thereof.           | CP 61                         | C 1064                       |         |   |
| <b>603</b><br>CULVERTS and SEWER PIPE                  | MOISTURE-DENSITY CURVE      | 1 per 1,500 cu. yds. or fraction thereof.         |                               | CP 23<br>T 180 or T99        |         | In the compacted lift.                          |
|  | PERCENT RELATIVE COMPACTION | 1 per 1,500 cu. yds. or fraction thereof.         |                               | CP 25                        |         | In the compacted lift.                          |
|  | GRADATION                   | 1 per 1,500 cu. yds. or fraction thereof.         | CP 30                         | CP 31                        |         |   |
|  | ATTERBERG LIMITS            | 1 per 1,500 cu. yds. or fraction thereof.         |                               | T 89<br>T 90                 |         |   |
| <b>604</b><br>MANHOLES, INLETS, METER VAULTS, CABINETS | TEMPERATURE                 | 1 per 500 cu. yds. or fraction thereof.           | CP 61                         | C 1064                       |         |   |
|  | PERCENT RELATIVE COMPACTION | 1 per 500 cu. yds. or fraction thereof.           |                               | CP 25                        |         | In the compacted lift.                          |
| <b>604</b><br>FENCES, GATES, and CABINETS              | TEMPERATURE                 | 1 per 500 cu. yds. or fraction thereof.           | CP 61                         | C 1064                       |         |   |
|  | COMPRESSIVE STRENGTH        | 1 per 500 cu. yds. or fraction thereof.           | CP 61                         | C39-28                       |         |   |
|  | UNIT WEIGHT / YIELD         | 1 per 500 cu. yds. or fraction thereof.           | CP 61                         | T 121                        |         |   |
|  | AIR CONTENT                 | 1 per 500 cu. yds. or fraction thereof.           | CP 61                         | T 152                        |         |   |

**Table 3: Level 2 – Owner Verification Testing,  
Schedule for Minimum Materials Sampling, Testing, and Inspection**

| PAY ITEM                         | TYPE OF TEST                | PROJECT VERIFICATION SAMPLING & TESTING FREQUENCY | PROCEDURES                    |                              | REMARKS | POINT OF VERIFICATION FOR QUALITY DETERMINATION |
|----------------------------------|-----------------------------|---|-------------------------------|------------------------------|---------|---|
|                                  |                             |   | PROJECT VERIFICATION SAMPLING | PROJECT VERIFICATION TESTING |         |   |
| 608<br>SIDEWALKS<br>(PCCP)       | TEMPERATURE                 | 1 per 10,000 sq. yds. or fraction thereof.        | CP 61                         | C 1064                       |         |   |
| 609<br>CURB and GUTTER<br>(PCCP) | TEMPERATURE                 | 1 per 10,000 cu. yds. or fraction thereof.        | CP 61                         | C 1064                       |         |   |
| 610<br>MEDIAN COVER MATERIAL     | TEMPERATURE                 | 1 per 1,000 sq. yds. or fraction thereof.         | CP 61                         | C 1064                       |         |   |
|                                  | COMPRESSIVE STRENGTH        | 1 per 1,000 sq. yds. or fraction thereof.         | CP 61                         | C39-28                       |         |   |
|                                  | UNIT WEIGHT / YIELD         | 1 per 1,000 sq. yds. or fraction thereof.         | CP 61                         | T 121                        |         |   |
|                                  | AIR CONTENT                 | 1 per 1,000 sq. yds. or fraction thereof.         | CP 61                         | T 152                        |         |   |
| 613<br>LIGHTING                  | TEMPERATURE                 | 1 per 500 cu. yds. or fraction thereof.           | CP 61                         | C 1064                       |         |   |
| 616<br>SIPHONS                   | MOISTURE-DENSITY CURVE      | 1 per 1,500 cu. yds. or fraction thereof.         |                               | CP 23<br>T 180 or T99        |         | In the compacted lift.                          |
|                                  | PERCENT RELATIVE COMPACTION | 1 per 1,500 cu. yds. or fraction thereof.         |                               | CP 25                        |         | In the compacted lift.                          |
|                                  | GRADATION                   | 1 per 1,500 cu. yds. or fraction thereof.         | CP 30                         | CP 31                        |         |   |
|                                  | ATTERBERG LIMITS            | 1 per 1,500 cu. yds. or fraction thereof.         |                               | T 89<br>T 90                 |         |   |

**Table 3: Level 2 – Owner Verification Testing,  
Schedule for Minimum Materials Sampling, Testing, and Inspection**

| PAY ITEM                               | TYPE OF TEST                | PROJECT VERIFICATION SAMPLING & TESTING FREQUENCY | PROCEDURES                    |                              | REMARKS | POINT OF VERIFICATION FOR QUALITY DETERMINATION |
|--|-----------------------------|---|-------------------------------|------------------------------|---------|---|
|  |                             |   | PROJECT VERIFICATION SAMPLING | PROJECT VERIFICATION TESTING |         |   |
| <b>619</b><br><br><b>WATER LINES</b>   | MOISTURE-DENSITY CURVE      | 1 per 1,500 cu. yds. or fraction thereof.         |                               | CP 23<br><br>T 180 or T99    |         | In the compacted lift.                          |
|  | PERCENT RELATIVE COMPACTION | 1 per 1,500 cu. yds. or fraction thereof.         |                               | CP 25                        |         | In the compacted lift.                          |
|  | GRADATION                   | 1 per 1,500 cu. yds. or fraction thereof.         | CP 30                         | CP 31                        |         |   |
|  | ATTERBERG LIMITS            | 1 per 1,500 cu. yds. or fraction thereof.         |                               | T 89<br>T 90                 |         |   |
| <b>624</b><br><br><b>DRAINAGE PIPE</b> | MOISTURE-DENSITY CURVE      | 1 per 1,500 cu. yds. or fraction thereof.         |                               | CP 23<br><br>T 180 or T99    |         | In the compacted lift.                          |
|  | PERCENT RELATIVE COMPACTION | 1 per 1,500 cu. yds. or fraction thereof.         |                               | CP 25                        |         | In the compacted lift.                          |
|  | GRADATION                   | 1 per 1,500 cu. yds. or fraction thereof.         | CP 30                         | CP 31                        |         |   |
|  | ATTERBERG LIMITS            | 1 per 1,500 cu. yds. or fraction thereof.         |                               | T 89<br>T 90                 |         |   |

### 3.5 Dispute Resolution

Through the life of the project, there may be statistically significant differences in material test results or statistical sample populations between the ICQC and the OVT. Due to the natural variability in construction materials testing and unavoidable biases in sampling and testing, these differences are often difficult to avoid. It is important to recognize the difference between material quality and statistical validation.

Material quality is measured by whether a test passes or fails and is an indication of whether the material will perform its intended purpose. Engineering judgment may be used to substantiate the use of material failing to meet the specification if the material still meets the intended purpose and does not affect the service life equivalent to design service life. Statistical validation is a measure of whether or not there is a statistically significant difference between the ICQC and OVT populations. It does not represent the quality of material being incorporated into the Project. It does, however, affect how the Department can use the test results for acceptance.

#### 3.5.1 Non-Validation and Status of Material Quality

When ICQC results do not statistically validate the OVT test results as outlined in Subsection - 3.4.3.1 Statistical Analysis and CP 14, the Region Materials Engineer (RME) will investigate the source of non-validation. The ICQC and OVT firms shall assist in the investigation. The RME, or independent laboratory, will provide the Department's Project Manager with a probable cause of the non-validation and a resolution recommendation. If the non-validation persists over two consecutive analyses, a non-compliance records (NCR) process shall be issued by the Department to formally document and seek resolution to the non-validation.

In addition to the need to investigate the non-validation, the material in question has to be immediately evaluated to determine if it can be left in place or has to be removed, reworked or repaired. The material in question will be evaluated using the process described in this section. There are four possible combinations of passing and failing results between the ICQC and OVT results and the F-test and t-test results when they are not statistically validated.

1. Both the ICQC and OVT results pass specification limits:  
Although statistical validation has not occurred, both the ICQC and OVT results are passing the established specification limits. Thus, material quality in question is considered acceptable.
2. ICQC results fail and OVT results pass specification limits:  
The acceptance of material is subject to one of the two scenarios below.
  - The Project Engineer may exercise approved Engineering Judgment to accept the material if results from all other levels of related OVT material, within the same process, pass specification limits.
  - The ICQC firm needs to provide the Department an explanation of the error and/or proposed correction for acceptance of materials through the NCR process.

3. Both the ICQC and OVT results fail the specification limits:

Material may be left in place if the Department determines that Engineering Judgment may be used to accept the material or if the material is accepted through the NCR process. Results from all other levels of related OVT material, within the questionable area, will be included in the Judgment decision.

The acceptance of material is subject to one of the two scenarios below.

- When the OVT result indicates reasonable conformance with specification requirements for the process in question. The ICQC shall provide to the Department an explanation of the error and/or proposed correction for acceptance of material through the NCR process.
- When the OVT result and/or the results of other levels of related OVT that do not indicate reasonable conformance with the specification requirement for the process in question, Then the ICQC must perform additional testing within the process in question to identify the problem area, based on the results of ICQC testing, all local OVTs of related materials, and subsequent investigation discussions between the Department and the D-B. A determination will be made by the Project Engineer as to the material's outcome and documented through the NCR process.

4. The ICQC results pass but OVT results fail specification limits:

Material may be left in place if the Department determines that Engineering Judgment may be used to accept the material or if the material is accepted through the NCR process. The results from all other levels of related OVT material, within the questionable area, will be included in the Judgment decision. Material that is not statistically validated by OVT cannot be accepted solely on the basis of the ICQC test results. If the material is reworked, ICQC must perform a fixed-independent test at the OVT failed test location followed by random-independent tests by both the ICQC and the OVT.

This is subject to the Department's response in the two scenarios below.

- When the OVT result indicates reasonable conformance with specification requirements for the process in question - the ICQC shall provide to the Department an explanation of the error and/or proposed correction for acceptance of material through the NCR process.
- When the OVT result and/or the results of other levels of related OVTs does not indicate reasonable conformance with specification requirement for the process in question , the ICQC must perform additional testing within the process in question to identify the problem area. Based on the results of ICQC testing, all local OVTs of related materials, and subsequent investigation discussions between the Department and the D-B, a determination will be made by the Project Engineer as to the material's outcome and documented through the NCR process.

### 3.5.2 REFEREE TESTING

Disputes over specific test results may be resolved in a reliable, unbiased manner by referee testing and evaluation performed in accordance with CP 17. The decision by the referee laboratory shall be final and binding on both parties.

## **4. INDEPENDENT ASSURANCE PROGRAM (IA)**

### **4.1 General**

With most DB projects, the pace of construction is extremely quick. Staffing curves are normally established to bring construction inspectors and testing technicians to the project at optimal periods based on the volume of anticipated work. Careful administration of the Independent Assurance (IA) program is essential to the success of the overall project so that unnecessary delays are not encountered, and testing technicians and laboratories are evaluated in a timely manner. This IA program evaluates all sampling and testing procedures, personnel, and equipment used as part of an acceptance decision. Samples and test results from this program are used to independently analyze the reliability of the acceptance program by ensuring that tests are performed by qualified personnel and that laboratory facilities and equipment are adequate to perform the required sampling and testing methods. To ensure that the IA program evaluates the sampling procedures, testing, and testing equipment the samples taken by this program shall be either split samples or proficiency samples. The IA tester will observe the acceptance sampling and testing procedure of the ICQC and OVT. Any equipment used to perform Quality Acceptance (QA) testing in making an acceptance decision will be evaluated by IA sampling and testing personnel. This evaluation includes calibration checks and split-sample tests.

The Department may choose to use the System Basis approach to the IA program on a project-by-project basis. The System Basis approach uses the frequency of IA activities on time, regardless of the number of tests, quantities of materials, or numbers of projects tested by the individual being evaluated. When the System Basis approach is used, the Department will evaluate all ICQC and OVT testers on the project as soon as practical. ICQC and OVT testers will be evaluated for all Level 1 and Level 2 material items they are currently qualified to test. Testers will be re-evaluated on an annual basis.

When the Department uses ICQC in the QAR, the testing frequency for the IA program will be no less than 10 percent of the ICQC and no less than 10 percent of the OVT for all Level 1 and Level 2 testable items. When the Department performs the acceptance tests, the minimum number of samples and tests required can be found in the chapter entitled IA Frequency Guide Schedule for Evaluation of OA Sampling & Testing.

CDOT has the option of designating an independent laboratory that is not associated with the contractor or any subcontractor on the project. This firm will administer the IA program on its behalf and follow the procedures outlined in the Field Materials Manual. When this option is utilized, personnel from the independent laboratory must be qualified by CDOT and the laboratory must be accredited. Laboratory accreditation is a two-fold process. First, each laboratory will require accreditation through the American Association of State Highway and Transportation Officials (AASHTO) Accreditation Program (AAP). Second, each laboratory will be accredited in specific CDOT test methods applicable to the DB project.

## 4.2 Responsibility of the Region Materials Laboratory

The Region Materials Laboratory will be responsible for the implementation and administration of the Independent Assurance Sampling and Testing Program in their Region. The Region Materials Laboratory shall address, at the minimum the following requirements:

- Establish the minimum required IA sampling and testing for the project. The approximate number of samples and tests will be developed prior to the beginning of construction on the D-B Project. To determine the approximate number of samples and tests, the Regional Materials Engineer will use the IA Frequency Guide Schedule in the Field Materials Manual along with Table 1 and Table 3 of this chapter for DB projects with ICQC, or the IA Frequency Guide Schedule Chapter in the Field Materials Manual when CDOT performs the acceptance testing. The Regional Materials Engineer will notify the ICQC and OVT Firms of the anticipated number of IA samples and tests on the CDOT Form 379.
- The Region IA personnel will review the ICQC and OVT independent random sampling procedures for testing.
- The IA personnel will observe the sampling and testing procedures and compare them to the Department's standard procedures.
- The Region IA personnel will compare the IA test results from the split sample with the appropriate ICQC and OVT test results. The Comparison Precision Guide will be used to identify discrepancies. The IA personnel shall report the IA test results to the Region Materials Engineer and the Department's Project Manager as soon as they are completed. Any discrepancies in procedures or test results shall be identified and explanations included in the test report.
- The Region Materials Engineer may increase the frequency of IA sampling and testing at any time during the construction. Any discrepancies will be resolved prior to the signing of the Final Materials Documentation Checklist (Form 473).

### 4.3 Responsibility of the ICQC and OVT Firms

Documentation retention will be for a minimum of four years after the acceptance of the project. When the Project Basis Approach is used, the ICQC and OVT Firms will be responsible for:

- Gathering a summary of approximate quantities from the contractor prior to construction.
- Notifying the Region Materials Engineer when construction activities requiring IA sampling and testing in accordance with the frequency shown on the Independent Assurance Sampling and Testing Checklist (Form #379) are scheduled. This notification, normally one week in advance, is imperative due to the number of IA samples that require split sampling.
- Notifying the Region Materials Engineer of plan changes which will affect anticipated IA sampling and testing.

When the System Basis Approach is used, the ICQC and OVT Firms will be responsible for:

- Maintaining documentation of all individuals qualified under their authority who perform required tests for acceptance of materials. Documentation to be maintained includes:
  - A. Sampling and testing personnel qualification in an electronic format that lists all the testing procedures the individual has been qualified to perform;
  - B. A qualification worksheet listing the key elements of the test method. The evaluator conducting the observation uses the form to record the results;
  - C. Copies of the qualification certificates issued with expirations dates; and
  - D. Results of annual proficiency testing results.
- If the IA sampling was not accomplished due to the lack of notification by the ICQC or the OVT Firms, they shall provide a written explanation to the Region Materials Engineer of the causes and corrective actions implemented to prevent a recurrence.



## 5. REPORTING

### 5.1 Documentation

Documentation will be maintained in the Department's SMM/LIMS when possible. Exception reports or copies of screens showing test results are to be used for reporting purposes. Also, results entered into the SMM/LIMS are to be accumulated under the appropriate Item Number and Material Code. The procedures referenced are to be followed as indicated for CDOT projects that use electronic documentation. The materials documentation procedure begins at the Materials and Geotechnical Branch in the Documentation Unit with the creation of the *Materials Documentation Record*, CAR Report #250 Quality Assurance and Certification Checklists, and at the Region Materials Laboratory with the review of the Project Independent Assurance Sampling Checklist, CAR Report #379. Final Materials Documentation is to be prepared and reviewed as provided in this Manual. Details on Documentation procedures for individual items are contained in the applicable Chapters and Sections of this Manual and they cover most situations encountered; however, exceptions may require special attention.

The Department has stipulated that the Letter of Final Materials Certification #473 will be signed by the Project Engineer, the Region Materials Engineer, and the Resident Engineer within 30 calendar days of the project's acceptance to ensure that the quality of the project is maintained and to avoid legal and contractual conflicts.

Note: SiteManager® Materials and Laboratory Information Management System (SMM/LIMS) Training Manuals, User Guides, Quick Reference Sheets, and CDOT Superusers Contact Information are available at the following Web Site: <https://sites.google.com/a/state.co.us/sitemanager-materials/>

The Project Engineer, as the representative of the Chief Engineer, is responsible for Materials Documentation on the Project. The Project Engineer or his/her designee should take measures to ensure that Documentation Procedures of the Department and the Region are followed. All referenced documentation activities within the *Before Construction*, *During Construction*, and *After Construction* sections found in the Chapter entitled "Documentation for SMM/LIMS" are the responsibility of the Project Engineer.

## Documentation – CDOT Maintenance and Local Agency-20

### 1. SCOPE

The intent of this chapter is to provide the CDOT Maintenance personnel or Colorado Local Agency personnel guidance from the beginning of the project to the closure of the portion of the materials of the project files. The materials documentation on a project needs to be accurate, complete and processed within the officially established time frame after the issuance of the project's Final Acceptance Letter per Section 105.21 (b). The Department has stipulated that the Letter of Final Materials Certification (CDOT Form 473) will be signed by the indicated representatives within 30 calendar days to ensure that the quality of the project is maintained and to avoid legal and contractual conflicts.

### 2. GENERAL REQUIREMENTS FOR CDOT MAINTENANCE PROJECTS

The procedures referenced are to be followed as indicated for CDOT Maintenance (MTCE) projects. The materials documentation procedure begins at the Materials and Geotechnical Branch in the Documentation Unit with the creation of the *Materials Documentation Record*, CDOT Form 250, and at the Region Materials Laboratory with the creation of the *Project Independent Assurance Sampling & Testing Schedule*, CDOT Form 379. Final Materials Documentation is to be prepared and reviewed as provided in this chapter. Details on Documentation procedures for individual items are contained in the applicable Sections of this Manual and they cover most situations encountered, but exceptions may require special attention.

### 3. GENERAL REQUIREMENTS FOR LOCAL AGENCY (LA) PROJECTS

The procedures referenced are to be followed as indicated for Local Agency projects within the state of Colorado. The materials documentation procedure begins at the Materials and Geotechnical Branch in the Documentation Unit with the creation of the *Materials Documentation Record*, CDOT Form 250, and at the Region Materials Laboratory with the creation of the *Project Independent Assurance Sampling & Testing Schedule*, CDOT

Form 379. Final Materials Documentation is to be prepared and reviewed as provided in this chapter. Details on Documentation procedures for individual items are contained in the applicable Sections of this Manual and they cover most situations encountered, but exceptions may require special attention.

### 4. CDOT MAINTENANCE PROJECTS

When a CDOT Maintenance project goes through the CDOT contract process Maintenance will follow the Colorado Department of Transportation Federal-Aid Highway Program Stewardship Agreement, the current CDOT Standard Specifications for Road and Bridge Construction, the current applicable CDOT Field Materials Manual, and the CDOT Maintenance Projects, Guideline Manual.

These are typical CDOT Maintenance project types:

**Roadway & Pavement:**

Pavement Patching and Repair (Concrete and Asphalt), Pavement Treatment or Overlay (Less than 1.5 inches), Pavement Crack Sealing (Concrete and Asphalt), Chip/Fog Sealing Operations, Roto-milling Operations, Mud Jacking Operations.

**Traffic:**

Pavement Marking Operations, Signing Maintenance and Repair, Traffic Signal Maintenance and Repair, Overhead Lighting Maintenance and Repair, VMS Maintenance and Repair

**Bridge and Structure:**

Structure Maintenance and Repair

**Hydraulic and Drainage:**

Culvert Maintenance, Repair and Replacement

**Other:**

Guard Rail Repair and Replacement, Pedestrian and Bike Path Repair, Remote Deicing System Maintenance and Repair, Weather Monitoring System Maintenance and Repair

**If you are unsure whether your project is eligible to become a Maintenance Contract Project, contact the State Maintenance Engineer.**

Tyler Weldon P.E., State Maintenance Engineer

[tyler.weldon@state.co.us](mailto:tyler.weldon@state.co.us)

303-512-5503

- 4.1 Under existing statutes and regulations, CDOT is responsible for ensuring that all Maintenance projects are carried out in accordance with Federal requirements. CDOT is responsible for determining that Maintenance has adequate project delivery systems for projects and sufficient accounting controls to properly manage State Funds and is ultimately accountable for ensuring that requirements are met for all Maintenance projects.
- 4.2 Designate that the Documentation Unit of the CDOT Materials & Geotechnical Branch is responsible for the development of the CDOT Form 250, *Materials Documentation Record*. The checklist will also designate who is the responsible individual for updating the Form 250 as work progresses, and who is the responsible individual required to sign the "Reviewed and Approved By" upon completion of the project.
  - 4.2.1 The CDOT project representative, whether the Maintenance Superintendent or Project Manager, may request a small quantity exemption Form 250 from the CDOT Materials & Geotechnical Branch if a project has only Small Quantities as defined by the OA Frequency Guide Schedule of the applicable Field Materials Manual (FMM).
    - 4.2.1.1 The Maintenance Project Manager will need to complete the appropriate sections of the CDOT Form 250 (e.g. "Added Materials Items", "Price Reduction", "Sampling & Testing Deviations", etc.).

- 4.3 Designate that the applicable CDOT Region Materials Engineer's (RME) staff is responsible for the development of the CDOT Form 379 *Project Independent Assurance Sampling & Testing Schedule*. The CDOT RME will sign the "Initial Approved By". The checklist will designate who is the responsible individual for completing CDOT Form 379 throughout the project, and who is the responsible individual required to sign the "Final Approved By" upon project completion. It will also stipulate who will apply for the subsequent "Project Review By" from the CDOT Maintenance Superintendent.
- 4.3.1 The Maintenance Project Manager shall develop the CDOT Form 473-M, *Final Materials Certification for a CDOT Maintenance Project* and CDOT Form 474 *Final Materials Certification - Explanation of Exceptions* for a CDOT Maintenance Project as per the instructions within this chapter. The applicable CDOT Maintenance Superintendent will sign the second "Approved by" signature block with his title and date.
- 4.2.1.3 Construction administration, inspection, materials testing, and documentation for Maintenance projects shall follow the applicable Field Materials Manual and the current Local Agency Manual for general assistance.
- 4.1.2.4 CDOT Maintenance should utilize Section 6 of this chapter of the Field Materials Manual as much as is applicable in the organization and completion of their project materials documentation.
- 4.1.2.5 CDOT Maintenance should utilize Section 9 of this chapter for the Distribution of their Finals Materials Documentation.

## 5. LOCAL AGENCY (LA) PROJECTS

When projects are funded with Federal and Local Agency funds, an Inter-Governmental Agreement (IGA) is required between CDOT and the Local Agency to define project scope, project responsibilities, detailed funding amounts, encumbered project funds, and payment obligations. The State of Colorado administers, oversees, or monitors the Federal-Aid Local Agency (LA) Transportation Projects.

### 5.1 Federal Oversight Stipulations:

- 5.1.1 In accordance with 49 CFR 18.37, States shall follow state law and procedures when awarding and administering sub-grants of financial assistance to local governments. States shall: Ensure that sub-grantees are aware of requirements imposed upon them by Federal statute and regulation.

5.1.2 Under existing statutes and regulations, State DOTs are responsible for ensuring that all Federal-aid projects are carried out in accordance with Federal requirements (referenced within *Legal and Regulatory Provisions Related to Oversight of Sub-recipients of Federal-aid Funds*). This responsibility was specifically clarified in 23 U.S.C. 106, as amended by Section 1904(a) of the Safe, Accountable, Flexible, Efficient Transportation Equity Act: A Legacy for Users (SAFETEA-LU, Public Law 109-59). This amendment to Section 106 specifically charges the States with the responsibility for determining that sub-recipients of Federal funds (including LPAs) have adequate project delivery systems for projects and sufficient accounting controls to properly manage federal funds. As the recipient of Federal-aid funds for the State, the State DOT may not delegate this responsibility and the State DOT is ultimately accountable for ensuring that Federal requirements are met for all Local Public Agency (LPA) - administered Federal-aid projects.

5.2 Local Agency Contract Administration Checklist will:

5.2.1 Designate that the Documentation Unit of the CDOT Materials & Geotechnical Branch is responsible for the development of the CDOT Form 250, *Materials Documentation Record*. The checklist will also designate who is the responsible individual for updating the Form 250 as work progresses, and who is the responsible individual required to sign the “Reviewed and Approved By” upon completion of the project.

5.2.1.1 The CDOT project representative, whether the Local Agency Coordinator or Project Manager, may request a small quantity exemption Form 250 from the CDOT Materials & Geotechnical Branch if a project has only Small Quantities as defined by the OA Frequency Guide Schedule of the applicable Field Materials Manual.

5.2.1.2 The Local Agency’s Project Engineer will need to complete the appropriate sections of the CDOT Form 250 (ie. “Added Materials Items”, “Price Reduction”, “Sampling & Testing Deviations”, etc.).

5.2.1.3 A small quantity exemption CDOT Form 250 can only be requested by a CDOT representative who has completed the training for the Local Agency Manual – Addendum for Materials Testing and Documentation, as conducted routinely by the CDOT Materials & Geotechnical Branch.

5.2.2 Designate that the applicable CDOT Region Materials Engineer’s (RME) staff is responsible for the development of the CDOT Form 379 *Project Independent Assurance Sampling & Testing*

*Schedule*. The CDOT RME will sign the “Initial Approved By”. The checklist will designate who is the responsible individual for completing CDOT Form 379 throughout the project, and who is the responsible individual required to sign the “Final Approved By” upon project completion. It will also stipulate who will apply for the subsequent “Project Review By” from the Local Agency.

On National Highway System (NHS) projects the Independent Assurance Sampling and Testing shall be accomplished by CDOT personnel or its designated agent employed by an AASHTO Accredited Laboratory. On Non-NHS projects, the Local Agency may use their established and documented procedures to independently verify the adequacy of testing equipment and personnel if their program is approved by the FHWA.

- 5.2.3 The State Transportation Agency, CDOT, is responsible for the construction of Federal-aid projects. This ultimate authority cannot be delegated. The local public agency (LPA), referred to as the Local Agency by CDOT, must provide a full-time employee to be in “responsible charge” of the project. This individual shall be a public employee (an FTE) but does not need to be an engineer. The key regulatory provision is 23 CFR 635.105 and defines through seven bullets the duties and functions that are expected to be performed.

The individual in “responsible charge” shall develop the CDOT Form 473-LA, *Final Materials Certification for a Local Agency Project* and CDOT Form 474 *Final Materials Certification - Explanation of Exceptions* per the instructions within this chapter. The applicable CDOT Resident Engineer will sign the second “Approved by” signature block with his title and date.

- 5.3 Construction administration, inspection, materials testing, and documentation for LA projects shall follow the applicable Field Materials Manual and the current Local Agency Manual.
- 5.3.1 The Local Agency should utilize Section 6 of this chapter as much as is applicable in the organization and completion of their project materials documentation.
- 5.3.2 The Local Agency should utilize Section 9 of this chapter for the Distribution of their Finals Materials Documentation.

## 6. CDOT MAINTENANCE PROJECTS & LOCAL AGENCY PROJECTS – RESPONSIBILITIES & PROCEDURES

### 6.1 Before Construction:

1. Review the Project Plans and check the Project Special Provisions for any modified testing procedures.
2. Review the developed CDOT Form 250. This will enable the Project Engineer to be aware of the types and frequencies of tests that the project quality assurance (QA) tester will be performing.
3. Review the developed CDOT Form 379. This will enable the Project Engineer to be aware of the frequency of the independent assurance (IA) tests that will be performed.
4. Set up Project Material Books. Ensure that the format is as described in the Organizational Guide for Project Material Books in Section 16.
5. Review the Special Notice to Contractors. Make note of the applicable acceptance level for the materials being incorporated into the project.
6. Ensure items and testing frequencies included in other work are accounted for in CDOT Form 250, the CDOT Form #379, or for Pre-inspection. (For example, Structural Backfill has been included with the MSE wall.)
7. Develop a list of Pre-inspected Items.
8. Collect a submitted list of proposed materials suppliers from the Contractor. Ensure that all steel and iron products permanently incorporated in the work are domestically produced in accordance with Section 4 of the Special Notice to Contractors.
9. Evaluate the Contractor’s materials suppliers list against the requirements of CP 11, the **Qualified Manufacturers List (QML)**, and the **Approved Products List (APL)** on the web. [www.codot.gov/business/apl](http://www.codot.gov/business/apl)
10. Identify sources of undesignated materials.
11. Set up Random Sampling Schedules (CP 75).
12. Assure Concrete Mix Design Approval, if required.
13. Assure Asphalt Job Mix Formula Approval, if required.

14. Attend pre-pave, pre-pour, and PC/OA meetings. **If Required**
15. Schedule and participate in pre-testing meeting. Use CP 16, Pre-Testing Meeting Agenda (CDOT Form 1322), if applicable.
16. CDOT Forms must be the most recent revisions as posted on the CDOT Forms Catalog and located on the web: <https://www.codot.gov/library/forms>

## 6.2 During Construction

1. Ensure that the Project Manager and Inspectors have communicated with the OA tester: activities, production, materials or product deliveries, Contract Modification Orders (CMO), altered quantities, and additional items not considered on CDOT Form 250.  
**Note 1:** The Project Manager needs to communicate the field-adjusted quantities from the CMOs and the Minor Contract Revisions (MCRs) to the Region Materials Engineer (RME) and the IA Tester.
2. Complete on a daily basis the sampling and testing documentation (worksheets & reports).
3. File on a daily basis all materials acceptance documents such as Certified Test Reports (CTRs), Certificates of Compliance (COCs), APL – QML Verification (AV), etc. These documents are to accompany the delivered material to the project.
4. File, within appropriate tabbed sections of the project binder(s) on a daily basis, all completed documents.
5. CDOT Maintenance submits required samples to the Region Materials Laboratory in accordance with the OA Frequency Guide Schedule.
- 5a. Local Agencies submit required samples to an AASHTO Accredited Materials Testing Laboratory consultant in accordance with the OA Frequency Guide Schedule.
6. CDOT Maintenance only may submit required samples to the Central Laboratory in accordance with the OA Frequency Guide Schedule. **At the recommendation of the Region Materials Laboratory only.**
7. Inform the CDOT Region Materials Laboratory IA Tester of any upcoming IA sampling and testing per the Form #379.
8. Ensure that all required information is added to the Form 250 as testing progresses. It is very important to complete the applicable portions of the last five sections [Documentation for Added Materials Items, Documentation for Deleted Materials Items, Summary of Laboratory Check Test Deviations, Summary of Sampling and Testing Deviations, and Summary of Project Price Reduction Documentation] at the time this information becomes available.
9. Perform Price Adjustment Calculations prior to Estimates in accordance with Sections 105.03 to 105.07 of the Standard Specifications.
10. On a monthly basis monitor quantities from Progress Report.
11. Make sure Price Adjustments are on the Progress Report. As received from Contractor.
12. On a daily basis keep an updated list of Exceptions to Specifications.
13. Write explanations for each Exception and keep it in the project file as they occur. This will facilitate the completion of CDOT Form 474, Explanation of Exception, at the end of the project.
14. Participate in weekly materials testing meetings as necessary utilizing CP 16, Weekly Meeting Agenda (CDOT Form 1323).

### 6.3 After Construction

**Note 2:** The project personnel is to review 100% of the Items and materials documents at this time. To provide an indication that the review is being performed an actual checkmark (✓) in pencil be placed on all of the applicable documents being reviewed.

1. Sort and arrange all documents within the Project Materials Books sequentially by Item number and then by date (most recent first behind the applicable tab) for ease of review. [The first tabbed section will be the documents as referenced in the Table of Documentation Distribution with all of the documents in the order shown. This will not only aid in the closure process but also facilitate the review and audit process].
2. Use the Finals Materials Documentation Checklist, (Project Closure) CDOT Form 1199 Page 1, to document that the subsequent steps have been followed. A black checkmark (✓) is to be placed within all verification boxes or click on the applicable box if it is being completed on the computer.
3. Compare final quantities from the latest Progress Estimate to the Form #250 final quantities. Write the Progress Estimate Number (date) used on Page 1 of the CDOT Form 1199.
4. Verify that the Serial Numbers on CDOT Form 250 match the project documents.
5. Document on CDOT Form 250 the total number of tests taken by the OA Tester.
6. Verify that any shortages of required tests as indicated on CDOT Form 250 are explained.
7. Independent Assurance (IA) Tests:
  - 7.1 Verify that the Serial Numbers on CDOT Form 379 match the project documents and all tests agree with field acceptance tests, and if applicable, shortages and exceptions are explained.
  - 7.2 Ensure the correct number of tests on the CDOT Form 379.
  - 7.3 Ensure that IA Witness tests if performed at all did not exceed 20% of actual testing for each test element.
  - 7.4 Ensure that Independent (IA) / Acceptance (OA) / Check Test differences are explained.
  - 7.5 Ensure that CDOT Form #379 has a Final Approved By signature of the RME and then has been returned to the Project Engineer.
  - 7.6 Ensure that CDOT Form #379 has a Project Reviewed By signature of the Project Engineer.
8. Make sure all Pre-Inspected items have a Form #193, when applicable.
9. Make sure a Line Item exists for each Price Adjustment. A separate Line Item is preferred.
10. Make sure there is a brief explanation for material accepted at full price, Percent of reduction in contract price (P) less than 3, is noted on the field form(s) when submitted.
 

**Note 3:** Reference to P is addressed in Standard Specifications, Section 105.03.
11. Check all Price Reduction Calculations, P greater than or equal to 3.
12. Check explanation for all material repaired or replaced, P greater than 25.
13. The Project Engineer or the Finals Materials Documentation Coordinator (if so designated by the RTD) is responsible for initially developing the *Final Materials Certification*, CDOT Form 473. This includes the Explanation of Exceptions CDOT Form 474, which must be included and should have been maintained throughout the project in accordance with *During Construction #14*.
14. Prior to the submission of the last Progress Estimate, the Project Engineer shall have all the documentary evidence needed to show that the contractor has complied with the requirements of the Contract Plans and Specifications for all materials used in accordance with the CDOT Field Materials Manual - Quality Assurance Procedures for Construction and Materials Sampling and Testing chapter.
15. Ensure that all required documents from the Contractor have been received: such as: Buy America Certificate, CTRs, COCs, Approved Products Verifications, etc., so that upon Final Acceptance the Finals Materials Documentation review and audit process can be completed within 30 calendar days.



- 15.1 Ensure that the required stamps are applied to the CTRs and COCs and that they are completed with the applicable information for that material submittal.
- 16. CDOT Maintenance: 100% of the Project Material Books are to be immediately forwarded to the Region Final Materials Documentation Coordinator.
- 16.1 Local Agencies: 100% of the Project Material Books are to be immediately forwarded to the CDOT Region Local Agency Coordinator.

## 7. INDEPENDENT REVIEW REQUIREMENT

The State Maintenance Engineer or the Local Agency Coordinator will prepare the CDOT Form 1199 Page 2, Finals Materials Documentation Checklist, (Review or Audit) and list the four major items. The Items of work that involve the four largest amounts of money as indicated by the original contract shall be considered Major Items. Major Item #1 will be the most expensive and Major Item #4 will be the fourth most expensive. Using CDOT Form 1199 the State Maintenance Engineer or Local Agency Coordinator will randomly select one of the listed Major Items for the reviewer to check completely. The actual review process utilizing the Form 1199 for the Review is similar to that used for the Project Closure; however, there are some modifications because the Project Manager or designee is performing a 100% check.

**Note 4:** To verify the steps performed by a reviewer, it is required that an actual checkmark (✓) in [blue ink](#) be placed on all of the applicable documents being reviewed.

1. Compare final quantities from the latest Progress Estimate to the Form 250 final quantities. Verify the number of the Progress Estimate used on Page 1 of the CDOT Form 1199. If a more recent Progress Estimate has been issued it should be used and noted. Document any discrepancies discovered between the “more recent” Progress Estimate and the project closure copy.
2. Verify that the Field Serial Numbers on CDOT Form 250 match the project documents.
3. Verify on CDOT Form 250 the total number of tests taken by the OA Tester.
4. Verify that any shortages of required tests as indicated on CDOT Form 250 are explained.
5. Independent Assurance (IA) Tests:
  - 5.1 Verify that the Field Sheet / Serial Numbers on CDOT Form 379 match the project documents and all tests agree with field acceptance tests, and if applicable, shortages and exceptions are explained.
  - 5.2 Ensure the correct number of tests on the CDOT Form 379.
  - 5.3 Ensure that IA Witness tests did not exceed 20% of the actual testing for each test element.
  - 5.4 Ensure that Independent (IA) / Acceptance (OA) / Check Test differences are explained.
  - 5.5 Ensure that Form 379 has a Final Approved By signature of the RME and a Final Reviewed By signature of the Project Engineer and that it has been attached to CDOT Form 473.
6. Make sure all Pre-Inspected items have a Form 193, when applicable.
7. Make sure a Line Item exists for each Price Adjustment. A separate Line Item is preferred, if a lump sum method is used, submit a detailed explanation.
8. Make sure there is a brief explanation for material accepted at full price, Percent of reduction in contract price (P) less than 3, is noted on the field form(s) when submitted.

**Note 5:** Reference to P is addressed in CDOT Standard Specifications, Section 105.03.

9. Check all Price Reduction Calculations, P greater than or equal to 3.
10. Check explanation for all material repaired or replaced, P greater than 25.
11. Check all of the input values for accuracy on PC/OA projects with incentive/ disincentive specifications.

12. Ensure that verification of receipt for the final PC/OA data being sent to the RME and to the Staff Materials Pavement Design Program (PC/OA Manager) is on file. Send acknowledgment e-mails as required. If it is not included in the file then send a copy of the PC/OA data to guarantee that it has been received. On CDOT Form #1199 include the date sent to the PC/OA Manager.
13. Verify the completion of CP 16, Evaluation of Materials Testing (CDOT Form 1324) for all consultants.
14. Verify that the Final Materials Certification, CDOT Form 473, has an Approved By signature of the Project Engineer. The Explanation of Exceptions, CDOT Form 474, is required to be included even if there is nothing documented on it. See the instructions for CDOT Form 474 to ensure that the Explanation of Exceptions meets the requirements for completeness.
15. As part of the final Progress Estimate, the Project Engineer has included all the documentary evidence needed to show that the contractor has complied with the requirements of the Contract Plans and Specifications for all materials used in accordance with the CDOT Field Materials

Manual - Quality Assurance Procedures for Construction and Materials Sampling and Testing chapter. The CDOT Form 325, Final Estimate Data, is to be included in this process. If there is a delay obtaining CDOT Form 325 then it will be included as soon as it is developed and signed.

If unresolved differences are identified in the complete check of the first randomly selected Major Item a second randomly selected Major Item will be checked completely. If unresolved differences are found in the second Major Item checked then both of the remaining two Major Items will be checked completely. If the existence of discrepancies or continued unresolved differences remains, a meeting will need to be scheduled between the Reviewer, the project's Resident Engineer, and the Project Engineer.

The completion of CDOT Form 473 is required within 30 calendar days after the final acceptance in order to achieve a timely closure of the project. The Final Materials Certification is to have an Approved By signature of the Resident Engineer beneath the signature of the Project Engineer. The Explanation of Exceptions, CDOT Form 474 may be edited as necessary; however, the one provided by the Project Engineer must accompany the edited version so that the RE is aware of the changes. The CDOT Form 473, Final Materials Certification, is a requirement for the closure of each construction project whether it be CDOT Maintenance or Local Agency.

## **8. CDOT MAINTENANCE & LOCAL AGENCY FINAL MATERIALS DOCUMENTATION AUDIT**

The Quality Assurance Procedures Chapter Subsection 11.12 details an audit program in which the CDOT Central Laboratory and the FHWA evaluate the Final Materials Documentation of CDOT Maintenance Projects and Local Agency Projects throughout Colorado.

These audits occur on a biennial basis. The Final Reports are distributed to the FHWA, the CDOT Chief Engineer, and all applicable parties as stipulated in the Quality Assurance Procedures Chapter.

**NOTE 6: All Local Agency projects under CDOT Audit Review, shall present complete electronic documents or complete hard copy 3-ring binders with all project Finals documentation.**

9.

**Table of Documentation Distribution - 1  
LA Project Finals Materials Documentation Packet**

| Document Order   | Distribution |    |    |    |    |
|--|--------------|----|----|----|----|
|  | #1           | #2 | #3 | #4 | #5 |
| Form #473-LA   | X            | X  |    | X  | X  |
| Form #474, Explanation of Exceptions supporting documents (letters, CMOs, MCRs, etc) | X            | X  |    | X  | X  |
| Form #250 (all pages)  | X            | X  |    | X  | X  |
| Form #379  | X            | X  |    | X  | X  |
| Form #1199, Page 2   | X            | X  |    | X  | X  |
| Form #1199, Page 1   | X            | X  |    | X  | X  |
| Random Sample Schedule   | X            | X  |    | X  |    |

Distribution:

- #1 CDOT Resident Engineer.....Original
- #2 LA Project Engineer / Project Manager.....Copy
- #3 CDOT Region Materials Engineer.....Copy(request)
- #4 CDOT Local Agency Coordinator.....Copy
- #5 Documentation Unit, Staff Materials & Geotechnical Branch.....Copy

**Table of Documentation Distribution - 2  
CDOT Maintenance Project Finals Materials Documentation Packet**

| Document Order   | Distribution |    |    |    |    |    |    |
|--|--------------|----|----|----|----|----|----|
|  | #1           | #2 | #3 | #4 | #5 | #6 | #7 |
| Form #473-M  | X            | X  | X  | X  | X  | X  | X  |
| Form #474, Explanation of Exceptions supporting documents (letters, CMOs, MCRs, etc) | X            | X  | X  | X  | X  | X  | X  |
| Form #325, Page 1 & 2  | X            | X  |    | X  |    | X  |    |
| Final Estimate or last Progress Estimate   | X            | X  |    | X  |    | X  |    |
| Form #250 (all pages)  | X            | X  | X  | X  |    | X  | X  |
| Form #379  | X            | X  | X  | X  | X  | X  | X  |
| Form #1199, Page 2   | X            | X  | X  | X  | X  | X  | X  |
| Form #1199, Page 1   | X            | X  | X  | X  |    | X  | X  |
| Price Reduction Calculation  | X            | X  |    | X  |    |    |    |
| PC Data-(If Needed)  | X            | X  |    | X  |    |    |    |
| QA Data-(If Needed)  |              | X  | X  | X  |    |    |    |
| Buy America Certificate  | X            | X  |    | X  |    | X  |    |
| Roadway Surface Accomplishment Report (RSAR)   | X            | X  | X  | X  |    |    |    |

Distribution:

- #1 Maintenance Superintendent.....Original
- #2 State Maintenance Engineer.....Copy
- #3 Region Materials Engineer.....Copy
- #4 Region Finals Engineer.....Copy
- #5 Documentation Unit, Staff Materials & Geotechnical Branch.....Copy
- #6 Records Management / Records Center.....Copy

**10. CDOT FORM 211 – Completion Instruction  
[Materials Documentation Request]**

The Final Materials Documentation Project Closeout and the Final Materials Documentation Review or Audit activities will discover that occasionally required documents will be missing. Individuals performing the closeout, review, or audit should use this form or comparable e-mails to allow for a paper trail in the effort to obtain the missing documents. The original project personnel may have misplaced or lost a field materials worksheet or report. The Contractor may have not forwarded required COCs or CTRs. Because time is critical, always indicate a due date and follow through immediately if that date has passed. If e-mail queries are being used, write on the “Subject:” CDOT Materials Documentation Request or CDOT Form 211. Staple the resolution Form 211s or e-mails to the CDOT Form 1199s.

**Note 5:** The CDOT Forms 250, 379, 473LA/473M,474 and both 1199s that have been referenced are integral to the Materials Documentation process, both at the project level and at the review and audit level. Therefore, the subsequent explanation of each of the form’s requirements is addressed at this point.

**11. CDOT FORM 250 – Completion Instructions  
[Materials Documentation Record]**

The Project Manager is responsible for the initial review of Form 250 and contacting the Staff Materials & Geotechnical Branch if there is a problem with the form. Ensuring the proper completion of the CDOT Form 250 and then applying the signature to Reviewed and Approved by is the Project Engineer’s responsibility. If a consultant tester is utilized on the project a professional engineer with the consulting company must sign and place his PE stamp on the last page of CDOT Form 250.

Completion of the CDOT Form 250 will include the following as substantiating documentation:

1. Entering Final Materials Quantities.
2. Inclusion of Quantities added by Contract Modification Order(s) on CDOT Form 90.
3. Breakout and inclusion of Quantities not listed separately in the Bid Schedule (ie.quantities included in Lump Sum Items, etc.).
4. Verification that minimum testing frequencies have been accomplished.
5. Explanation of Exceptions for Material Specification Deviations.
6. Documentation of Exceptions, for comparison differences between Quality Assurance (OA) Test results and Independent Assurance (IA) Test results.
7. Documentation of Exceptions for Price Reductions when P is greater than or equal to 3. Specification deviations that have a price reduction factor (P) of less than 3 require that the exception be noted on the submittal sheet referenced in the Field Materials Manual – OA Schedule. A copy of the calculations is to be attached.
8. Documentation of Exceptions for remedial action when P is greater than 25.
9. Documentation of Exceptions for an insufficient number of tests.

**Note 6:** If the Guidelines for Test Frequency Reduction are utilized then reference it specifically, do not just state “waived by the Project Manager”.

10. Documentation of Exceptions for a lack of tests for Items included in Lump Sum Payments. PE shall obtain the Region Materials Engineer exemption.
11. Documentation of Exceptions for a lack of tests for Items included in extra work.

Distribution:

**Note 7: Submit the entire completed copy, not just the first and last page.**

**12. CDOT FORM 379 –Completion Instructions  
[Project Independent Assurance Sampling Schedule]**

The Project Manager is responsible for ensuring that the Region Materials Engineer’s IA Staff are kept informed throughout the course of the project. The OA Procedure Chapter, Subsection 7.5.1.2 and throughout Subsection 7.9.4 describes the exact responsibilities that the Project Engineer has with regard to CDOT Form 379.

The Region Materials Engineer will assign an individual from the Region Materials Laboratory to develop the CDOT Form 379, *Project Independent Assurance Sampling & Testing Schedule*. The Region Materials Engineer, or his designee, will perform the initial approval to provide independence between development and review prior to distribution to the Project Engineer. The RME or his designee will send a copy of the 379 to the appropriate Project Engineer, even if a copy has been sent to the project (OA) tester. When all of the Form #379 IA sampling and testing on the project is completed, the RME will certify it through his Final Approval and then forward the signed Form 379 to the Project Engineer or if applicable the LA designee.

Upon receipt from the Region Materials Engineer, the Project Engineer or the Local Agency designee will review and accept for the files the 379 with his Project Reviewed By signature.

Completion of the CDOT Form 379 will include:

1. The actual number of tests completed.
2. An Explanation of Exceptions for comparison differences between Quality Assurance (OA) Test results and Independent Assurance (IA) Test results, as defined in Section 7.9 of the QA Procedures chapter.
3. An Explanation of Exceptions for an insufficient number of tests.
4. The Field Sheet / Serial Numbers from the CDOT Forms correlated to the applicable CDOT Form Number and the test dates.
5. The completion of the statement *“All equipment was independent except as noted: ...”*

**13. CDOT FORM 473-M, 474 and 473-LA, 474 Completion Instructions  
[Final Materials Certification]**

**13.1 CDOT Form 473-M and 474 Completion Instructions for CDOT Maintenance Projects**

The Project Manager is responsible for ensuring that the Final Materials Certification, CDOT Form 473 is developed. This includes the Explanation of Exceptions Form 474 which should have been maintained throughout the project. The Region’s Finals Materials Documentation Coordinator may be designated by the RTD to initially prepare CDOT Form 473. The Project Manager applies the first Approved By signature to the form because it is his project and he would be aware of all issues associated with his project. The Maintenance Superintendent for the project applies his signature under Approved By on CDOT Form 473 because of his ultimate responsibility and authority. He may edit the Explanation of Exceptions CDOT Form 474 as necessary, after the completion of the Final Materials Documentation Review. However, the edits should be documented if they are anything other than editorial.

Explanation of Exceptions CDOT Form #474: [Examples only, not all-inclusive.]

- Missing documents such as CTRs, COCs, Buy America, etc.
- Section 11 (Form 250) and Section 12 (Form 379) have specific Exceptions that should be placed in this document.
- The last five sections of CDOT Form 250 [Documentation for Added Materials Items, Documentation for Deleted Materials Items, Summary of Laboratory Check Test Deviations, Summary of Sampling and Testing Deviations, and Summary of Project Price Reduction Documentation] may be attached to fully document what transpired on the project.

Completion of the CDOT Form 473 will include:

1. The creation of Explanation of Exceptions CDOT Form 474 is a compilation of recorded and documented explanations from throughout the project and also those recorded on CDOT Form 250 (refer to the examples above).
2. All issues that were referenced on the CDOT Form 1199 Page 1 and Page 2 were reviewed.
3. All CDOT forms and documents are assembled in the required order stipulated in Table Documentation-1. These are to be physically attached with pages stapled together as much as is possible or with binder clips if necessary.

13.2. CDOT Form 473-LA and 474 Completion Instructions for Local Agency Projects:

The Local Agency's individual in "responsible charge" shall be responsible for ensuring that the Final Materials Certification, CDOT Form 473-LA, is developed. This includes the Explanation of Exceptions, CDOT Form 474, which should have been maintained throughout the project. This individual applies the first "Approved By" signature to the CDOT Form 473-LA as stated in Subsection 5.2.3 of this chapter. The Resident Engineer applies the second "Approved by" signature block on the CDOT Form 473-LA because this ultimate authority cannot be delegated. The Resident Engineer or their CDOT designee may edit the Explanation of Exceptions as necessary, after the completion of the Final Materials Documentation Review.

Explanation of Exceptions: [Examples only, not all-inclusive.]

- Missing documents such as CTRs, COCs, and Buy America (if applicable)
- Section 11 (CDOT Form 250) and Section 12 (CDOT Form 379) have specific Exceptions that should be placed in this document.
- The last five sections of CDOT Form 250 [Documentation for Added Materials Items, Documentation for Deleted Materials Items, Summary of Laboratory Check Test Deviations, Summary of Sampling and Testing Deviations, and Summary of Project Price Reduction Documentation] may be attached to fully document what transpired on the project.

Completion of the CDOT Form 473-LA will include:

1. The creation of Explanation of Exceptions is a compilation of recorded and documented explanations from throughout the project and also those recorded on CDOT Form 250.
2. All issues that were referenced on the CDOT Form 1199 Page 1 and/or Page 2 were reviewed.
3. All CDOT forms and documents are assembled in the required order stipulated under the Documentation tab, Section 9, Table of Documentation Distribution-1 of the Field Materials Manual. These are to be physically attached with pages stapled together as much as is possible.

**14. CDOT FORM 1199, Page 1 – Completion Instructions  
[Final Materials Documentation Checklist, (Project Closure)]**

The CDOT Form 1199 Page 1 is a checklist to be used by the Project Manager. The Project Manager should utilize this form in the process of completing the CDOT Form 473LA as both a guide and a means of documenting that specific issues were addressed and the required supplemental documentation was included in the finals packet.

It is understood that a subsequent Progress Estimate may be created after the Project Engineer has started to close out the project; therefore, the latest Progress Estimate number is to be recorded.

Thoroughly compare the latest Progress Estimate with CDOT Form 250 to ensure that the quantities of the materials are correct. Verify that the form numbers and their respective serial numbers match the project documents. Verify that the required tests match the tests reported (those actually performed). This process is repeated utilizing CDOT Form 379.

Ensure that all of the supplemental documents referenced in the lower half of the Form 1199 are completed and available for inclusion in the final packet.

The Finals Materials Documentation Checklist for Project Closure is to be signed and dated by the Project Engineer or his designee.

**15. CDOT FORM 1199, Page 2 – Completion Instructions  
[Final Materials Documentation Checklist, (Review or Audit)]**

The CDOT Form 1199 Page 2 is a checklist to be used in the Region Final Materials Documentation Audit. The Resident Engineer's reviewer or the Finals Materials Documentation Coordinator should utilize this form in the process of reviewing and auditing the submitted project files from the Project Engineer.

As stated in the Region Finals Materials Documentation Audit instructions this activity is not meant to repeat the 100% project files check performed by the Project Engineer. Reviewing more than one Major Item is to be reserved for responding to discrepancies and problems discovered in the review process.

Utilize the directions from Page 1 with respect to comparing the Final Estimate with CDOT Form 250. Verify the testing with respect to CDOT Form 379. Ensure that all of the supplemental documents referenced in the lower half of the Form 1199 were completed and included in the final packet.

The Final Materials Documentation Checklist for the Review or Audit is to be signed and dated by the Reviewer or the Finals Materials Documentation Coordinator.

## 16. ORGANIZATIONAL GUIDE FOR PROJECT MATERIAL BOOKS

### SCOPE

The Field Materials Manual includes the “OA Frequency Guide Schedule for Minimum Sampling, Testing, and Inspection. This is the essential document to use when determining which CDOT forms to use as worksheets, which CDOT forms to collect as test reports, and what materials acceptance documents are required.

Utilize this Organizational Guide for Project Materials Books in both initially establishing the binders and maintaining them throughout the project. It is not inclusive of every material Item, but it references the primary Items that you will encounter. It is critical to follow the Item numbering in sequential order to aid in locating project paperwork. Check Project Specials and Project Standard Revisions for additional paperwork that may be required.

The Materials Books need to be marked on both the cover and on the spine to indicate which item numbers are inclusive within the book. No exceptions! Each bullet represents a subsection within the item and therefore needs to be properly divided. Sheet dividers or tabs properly identified will help to delineate the paperwork for ease in locating forms used as worksheets and test reports. Place the most recent or newest documents behind the applicable tab.

Core Project Documents: The required filing order in the first book is established to mirror the Project Finals Materials Documentation Packet. Applicable for either CDOT Maintenance or Local Agency projects.

- CDOT Form 473LA/473M and 474.
- Progress Estimate (from the first through to the Final Estimate).
- CDOT Form 250 in its entirety, even though a copy may be divided with the respective Item pages within each tab.
- CDOT Form 379.
- CDOT Form 1199, Page 2 & Page 1.
- Random Sample Schedule(s). \*
- Price Reduction Calculation (copies).
- PC Data. \*\*
- OA Data. \*\*
- Buy America Certificate(s).
- CDOT Form 513, RSAR.
- CDOT Form 1324, Evaluation of Materials Testing (per CP 16).
- Field Lab & Personnel Qualification Checklist (per CP 10).

\* Random Sample Schedules need to be clearly marked for the item number and the testing element.

\*\* Random Sample Schedule copies and PC/OA Data copies should be filed with the applicable item.



### 203 Embankment

- CDOT Form 564 (Soil Classification) / CDOT Form 24 (Curves) / Computer Moisture / Density with Rock Correction printouts with Curve numbers on it.
- Each Curve will have all of the above stapled/attached together. Make an extra copy of the computer Moisture/Density curve to go with the gauge book.
- CDOT Form 564 (Soil Classifications) for your completed roadway Soil Survey data. (1 per 1000 ft. or change of soils.) Get these tests done as fast as you can so they can be submitted for an R-value in case there is a Stability problem.
- CDOT Form 157 – This is for the samples sent to the Central / Region Laboratory for an R-value to complete your Soil Survey. Attach the test results from the Lab, to the corresponding CDOT Form 157 serial number.  
**Note:** For faster R-value results, attach a copy of your Form 564 (soil classification) that you completed above for that sample.
- CDOT Form 212 (Densities) – with the field test worksheets (in chronological order by date and test number) stapled and attached to this. Make sure your classifications match what is on your computer Moisture/Density curve. Project Engineer must sign this form when it is completed. You do not wait until the end of the project to fill this out. This form can be filled in and submitted weekly, bi-weekly, monthly, or however your Project Engineer may want this information to be submitted for signature. Communication between you and the Project Engineer is very important.
- CDOT Form 219(Roadbed Soil Survey). You fill this in from the test results you receive from the CDOT Form 157 samples submitted. When this is completed, sign it and have it signed also by the Project Engineer. Then submit this to Region Lab, as soon as possible, for final approval. You will get a signed copy back, when it is approved, for your file.
- Sulfate testing for preliminary roadway soil survey data (1 per 1000 ft. or change of soils.) will use the preliminary soil survey CDOT Form 555. Soils sampled for sulfate testing will be identified for each soil layer and boring on this form. Additional information will be submitted on CDOT Form 157 identifying the test bore number, number and type (soil or water) of tests being submitted. The completed soil survey will include the sulfate percentage for each sample submitted.
- Sulfate testing for imported embankment (1 per 2000 yd<sup>3</sup> or change in soils) will use the Laboratory Report on Item 203 (Embankment or Borrow) CDOT Form 323.
- Corrosion tests for pipe material type selection will be submitted on CDOT Form 157 and CDOT Form 555 identifying the test bore or location number, number and type (soil or water) of tests being submitted.

## 206 Structural Backfill

### Class 1

- CDOT Form 157 – Sample submitted to Central / Region Laboratory for a gradation compliance check and a moisture/density curve. Attach the Lab test results to the corresponding 157 serial number.
- (Gradations) CDOT Form 6 that have the field gradation test worksheets (CDOT Form 565) stapled/attached that are represented on that form in chronological order by test number and date.
- (Density) CDOT Form 6 that have the field density worksheets (CDOT Form 427) stapled/attached that are represented on that form in chronological order by test number and date.

### Class 2

- Classification (CDOT Form 564) / Curve (CDOT Form 24) / Computer printout of Moisture / Density Curve with rock correction.  
All of this needs to be attached together with a Curve number on it (if there are several curves). Make an extra copy of the computer printout to go to the gauge book.
- CDOT Form 212 (Densities). Same as per Item 203.

### Flow fill

- You only need the 157 filled out for each Flow-Fill Mix Design used. Do not submit this mix design to the Central Laboratory. This stays in project records. Keep batch tickets.

### Filter Material or Bed Course

- You only need the CDOT Form 6. Attach field test sheets (CDOT Form 565) to this form and get it signed by the project engineer.

### Form 194

- Structural Backfill Density Report is a summary to be filled out at the end of the project when you have the correct number of cross pipes, side drain pipes, minor structure and major structure with their quantities broken out by the type of backfill. You will get this data from your Project Engineer, as well as the Project Plans and As-Builds.

### Item 207

- You will need to have a section for the test results and the CDOT Form 157 that was filed to delineate if it was a Contractor's Source, and this documentation should be accompanied by the Certified Test Reports (CTRs) the Contractor should submit with samples of the material. Check and document that the one the lab used was the one approved for use.
- If the Material used was generated on the project, document on CDOT Form 157 and have the Project Engineer sign the CDOT Form 157.

Item 208

- You should file a 157 for each of the items that you are documenting. Silt fence, Erosion Bales, and the Miscellaneous Items that were used. Make sure the materials have the proper documentation, and if applicable is on the Approved Products List (APL). It is helpful to print the applicable Form 595 with the information on the product found on the APL and file it behind CDOT Form 157 for that item.

Item 209

- You should document if the Landscaping water used was potable, or if a CTR was submitted and approved for use.
- If Magnesium Chloride is used for a Dust Palliative, document on CDOT Form 157 and file the Certificate of Compliance (COC) behind it.
- If an Asphaltic material was used for a Dust Palliative, follow Item 403/411 requirements, and document.
- Embankment Moisture Control should be documented per specification.

Item 212

- You should have separated areas for the seed, sod, and fertilizer. File the COCs behind the Form 157 documenting the quantities approved and that each meets CDOT Standards. Make sure you have copies of the Seed tickets filed behind CDOT Form 157 and COC. Fertilizer should meet requirements of Standard Specification Subsection 212.02.

Item 213

- There should be separate sections for Wood Cellulose, Mulch Tackifier, and Straw or Hay used.
- Wood Cellulose Fiber should be accompanied by a COC.
- The Mulch Tackifier should be accompanied by a COC.
- Straw and Hay should be accompanied by a COC stating material is "Weed Free." then file behind Form 157 documenting that it was acceptable.

Item 214

- You need separate sections for Plants, Humus, and Fertilizer.
- Plants are accepted by COCs, document on Form 157, and file COC behind the Form 157.
- Humus is approved by HQ Staff Landscape Architect. Document on Form 157 and file any paperwork given by HQ behind your Form 157.
- Fertilizer should be accepted by COC. File with Form 157 stating material meets requirements.

Item 215

- Plants are accepted by the Right-Of-Way Engineer, document on #157 his acceptance.
- Fertilizer should be accepted by COC. File with #157 stating material meets requirements.

Item 216

- Soil Retention Blanket should be located on the APL, document and file APL document. It should be weighed, and measured, and document that the material is acceptable.

Item 217

- This material is accepted by Staff Landscape Architect, document on Form 157 their acceptance and any paperwork from HQ should follow your Form 157.

Item 304

- CDOT Form 157's are for the samples sent to Central / Region Laboratories for R-value, Moisture / Density curve, gradation verification, LA Abrasion, etc. Follow "Guide Schedule for Minimum Materials Sampling, Testing, and Inspection." Attach the test results with the appropriate CDOT Form 157 serial number that you receive back from the Lab.
- CDOT Form 6 (Gradations / Atterberg Limits) with the attached field test worksheets attached to this form. Project Engineer needs to sign this form.
- CDOT Form 6 (Densities) with the attached field test worksheets attached to this form. Project Engineer needs to sign this form.

The above section applies to all types of aggregate base courses (ABC). If you have several different types of ABC you need the three (3) sections for each type.

Item 306

- Follow Item 203 requirements for documentation for this item, follow the schedule of Item 306 for the frequency of tests needed.

Item 307 Hydrated Lime

- CDOT Form 157 for each shipment (one per source, 1 per 100 ton, 2<sup>nd</sup> 100 ton, etc.).
- Keep shipment invoices listing "Date, BOL/COC number, tons shipped, and accumulative total". This will help you know when to ship the samples you took per truck represents 100 tons or fraction thereof for testing. Basically, every 4 samples (1 per truck @ 25 tons per truck) you need to ship all of this to the Central Lab.

Item 307

There should be separate sections for the following:

- Lime Treated Sub-Grade
  1. Density reports on CDOT Form 212
  2. CDOT Form 157 documenting the Moisture Density Curves, (copy of curves should be kept in Nuclear Gauge book for field use).
  3. The section should be kept for "depth" of lime treatment measurements.
  4. Check the schedule for lime samples to be submitted to HQ for testing, file results behind CDOT Form 157.
- Quick Lime CTRs and CDOT Form 157 documenting percent purity, source, and supplier.
- Mineral Fillers
  1. Document gradations on Form 6.
  2. Submit samples to Central Lab for testing every 500 tons, file results behind CDOT Form 157.
  3. Document the Source, Supplier, and any other required information on CDOT Form 157 or other documents required by provisions.

Item 308

- Portland Cement Treated Base
  1. Densities should be recorded on CDOT Form 6.
  2. Gradations should be recorded on CDOT Form 6.
  3. Atterberg Limits should be recorded on proper forms and worksheets and filed.
  4. Moisture and Density Curves should be filed behind Form 157 for each blend of soil and Cement.
- Portland Cement and Fly Ash
  1. The product must be on the APL. Print the information and file behind Form 157 that the product is acceptable.
  2. Then file behind the CDOT Form 157 if the Engineer requested Bill of Lading and CTRs from the supplier. Then file results behind CDOT Form 157.

Item 310

- Document as per the Project Contract.

Item 403 HMA

- Form 43 (In this tab, file the Form 157 and supporting documents of mix design from the private lab, CDOT Form 429, and Central Lab CP 52 results).
- Asphalt Content Gauge (Include stat and drift test, & CDOT Form 772). Not needed if Ignition Oven used on Quality Assurance tests.
- Correction Factors Asphalt Content Gauge or Ignition Oven Correction factor. Moisture Density correction factor Form 469 or equivalent, and supporting documentation.
- Check Tests Include QA and QC results, and report passing/failing.
- Random Schedules
- Verification Test Results
- Quality Assurance Result
  1. QPM Report
  2. Asphalt Content or Voids include Form 1304's, 106's,
  3. Gradation
  4. Mat Density
  5. Joint Density
- Micro-Deval
- Hydrated Lime
- Rut Testing

Repeat the same bookkeeping organization for the top mat of HMA. These need to be separated, especially if it is with a different asphalt binder.

405 Hot-In-Place Recycle

- Document in-place densities on Form #69 or computer-generated report, and a specific gravity test result for each density on Form #69.
- Asphalt Rejuvenating Agent, follow Item 411 requirements.

#### 406 Cold Bituminous Pavement (recycle)

- In-place densities should be reported on Form 69.
- Gradations should be reported on Form 6.
- Free moisture should be documented on applicable forms, suggest using Form 6.
- Hveem Stability and Lottmans should be documented and results filed behind Form 157.
- Asphalt Rejuvenating Agent and Asphalt Emulsion should follow Item 411 for documentation.

#### 408 Joint and Crack Sealant

- Hot Poured (HMA only)
  - Document on Form 157 that material is on APL, file APL review sheet behind Form 157. (ENSURE BATCH NUMBERS MATCH)
- Silicone (PCCP only)
  - Document on Form 157 that material is on APL, file APL review sheet behind Form 157.

#### 409 Cover Coat Material

- Submit samples per Field Materials Manual to Central Lab, and file results behind Form 157 used to submit samples.
- Report Gradations on Form 6.
- Report Fractured Faces on Form 6.

#### 411 and test results Asphalt Binders and Emulsions

- Keep a Bill of Lading / COCs daily total of all material shipped with a running accumulative total, just like you do for Item 307.
- CDOT Forms 411. (Separate CDOT Form 411 by type of binder if you have several on the project.) Even if you do not ship in a sample (i.e., like emulsion, and it is pre-approved), you still need to put the quantity on the correct form number for that item.

#### 412 Portland Cement Concrete Pavement

- Follow the frequency outlined in the Project Documents and the Field Materials Manual. Review Item 601 for areas of commonality. Have separate sections as listed below:
- CDOT Form 1373, Concrete Mix Design Report.
- Air Contents, temperatures, yields, slumps, and water-cement ratios should be recorded on Form 156. This should be signed by Project Engineer as soon as reasonable to keep him/her up to date with test results.
- Compressive and Flexural Strengths results should be filed behind the Form 82 that samples were turned in with for testing.

**Note:** Flexural strengths conducted by the Contractor should be filed behind Form 157 or other applicable Forms.

- Sand Equivalent test results should be filed behind Form 157.
- Pull Test for Tie bars (if applicable) should be filed behind Form 157.
- Tining and Saw Cut Depth test results should be filed behind Form 157.
- Pull Tests for Joint Sealants should be reported on Form 389.
- Portland Cement, follow Item 308 requirements.
- Joint Sealant, follow Item 408 requirements.

- Contraction Joint Plastic Strip: Field inspect and document on Form 157 that product is acceptable.
- Reinforcing Steel, Dowels, Tie Bar (follow Item 602).
- Provide the MIT Report.
- Smoothness.
- Other Items not listed, document as necessary.

#### 420 Geosynthetics

- Geosynthetics, which includes Geomembranes, are accepted by COC. File copies behind a CDOT Form 157 stating material are acceptable and note that batch numbers match.
- Geotextiles are located on the New York State Approved Products List. Cross-reference this list and document behind a CDOT Form 157 stating material is acceptable and note that batch numbers match.
- Geogrids are accepted on a project by project basis. Geogrids that are used in conjunction with MSE walls need to be reviewed by Staff Bridge Design & Management Branch for acceptability. Geogrids that are used in conjunction with embankment and roadway need to be reviewed by the Soils & Geotech Program of the Staff Materials & Geotechnical Branch for acceptability. Document behind a CDOT Form 157 stating material is acceptable and note that batch numbers match.
- When Performance Graded Binders or Asphalt Cement is used, follow item 411 of the schedule requirements.

#### 501 Steel Sheet Piling

- Sheet Piling is accepted by COC and Mill Tests Reports. File copies of each behind a Form 157 stating that the materials meet the specifications, and list the heat numbers, reference the mill test reports that are attached, and that the material is acceptable for use.
- Reinforced Sheet Metal Piling Tips should be on a separate CDOT Form 157, with the same information as above.

#### 502 Piling

- Sheet Piling is accepted by COC and Mill Tests Reports. File copies of each behind a Form 157 stating that the materials meet the specifications, and list the heat numbers, reference the mill test reports that are attached, and that the material is acceptable for use.
- Reinforced Sheet Metal Piling Tips should be approved by the Soils & Geotech Program of the Materials and Geotechnical Branch at CDOT, document this acceptance on CDOT Form 157.

#### 503 Drilled Caissons

- Concrete should be documented the same as Item 601 of the Schedule.
- Reinforcing materials should be documented the same as Item 602 of the Schedule.

#### 504 Soil Nail Wall

- Steel Cribbing should be accepted by CTR and Mill Tests. Document on Form 157 that material is acceptable and file all appropriate test results behind Form 157.
- Concrete Cribbing should be documented the same as Item 601 of the Schedule.
- Timber Cribbing should be documented the same as Item 508 of the Schedule.

#### 504 Mechanically Stabilized Earth Wall

- Have the following sections to delineate the acceptance of the wall.
- Foundation Soils should be submitted to the Central Laboratory for Direct Shear, Friction Angles, and possibly Moisture/Density Curves. File test results behind each Form 157 for each type of material that is encountered.  
THIS SHOULD BE DONE RIGHT AWAY, AND BEFORE WALL IS BEING BUILT.
- Other Tests results should be recorded similar to Item 203, if applicable.
- Structure Backfill should be documented the same as Item 206.
- Reinforcing Elements are accepted by COCs, file behind Form 157.
- Facing Elements are accepted by COCs, file behind Form 157.
- Treated Timbers should be documented per Item 508 of the Schedule.
- All other miscellaneous items should be documented as applicable.

#### 506 Rip Rap

- Test and record the specific gravity of the material, document on Form 157 that material was tested and indicate general sizes and other applicable information.
- Bed Course Materials follow Item 206 instructions.
- Gabions and Slope Mattress are COC accepted. Document on Form 157 that the material is acceptable.
- Concrete and Reinforced Concrete, follow the Item 601 and 602 instructions.

#### 507 through 518

- Follow the applicable directions for each item for documentation.

#### 601 Structural Concrete

- Form 1188 (Mix Design Review Sheet), the approved mix designs should be filed behind the copy of the Form 1188.
- Form 1373, Concrete Mix Design Report. Attach changes and approvals.
- Form 82 with the 28 days (or 56 days if applicable) compressive or flexural strength test results recorded on the CDOT Form 192 attached.
- Form 156 Signed by Project Engineer
- Form 157 for curing compound, water, and other incidental items.
- Price Reductions and explanations of deviations.
- Copy of the Structural Concrete Pre-Pour conference agenda.  
Do this for each class of concrete (i.e., Class B, D, etc.)

#### 602 Reinforcing Steel

- Reinforcing Steel is accepted by COC and Mill Tests Reports. File copies of each behind a #157 stating that the materials meet the specifications, and list the heat numbers, reference the mill test reports that are attached, and that the material is acceptable for use.
- Reinforcing Steel, Buy America.
- Test Reports from Central Lab, CDOT Form 1372



607 Fences

- Follow applicable directions for each sub-category as it is listed in the Field Materials Manual.
- For Masonry Sound Barrier Walls, call HQ or designer for copies of the Universal Building Code sections covering the requirements for testing and sampling masonry walls. File test reports behind applicable forms relating to each test. (ie. Prisms, grout, and mortar).

641 Shotcrete

- CDOT Form 1188 (Mix Design Review Sheet), the approved mix designs should be filed behind the copy of the Form 1188.
- CDOT Form 1373, Concrete Mix Design Report
- CDOT Form 82 with the 28-day compressive test results recorded on the CDOT Form 192 attached.
- CDOT Form 156 Signed by Project Engineer
- CDOT Form 157 for curing compound, water, and other incidental items.
- CDOT Form 276 report of concrete placed.
- Price Reductions and explanations of deviations.
- Copy of the Contractor's Quality Control Plan.
- Document if pre-bagged.

**Note 1:** File the remaining Items by Item Number. Use the Field Materials Manual to determine what paperwork is appropriate for that item. Any items not listed above should have an adequate explanation in the Field Materials Manual.

**Note 2:** The "Special Notice to Contractors" describes in detail what is needed on both the COC and CTR. Look at this Notice to determine if a COC or CTR is the applicable acceptance method.

**ATTENTION**

All of the referenced CDOT Materials Forms have been revised. All of these forms state: *Previous editions are obsolete and may not be used.* The use of Materials Forms older than what is indicated is not authorized!

The examples of forms and some completed forms are in the chapter Materials Forms – Instructions & Examples of the FMM.

|  |  |                             |
|--|--|-----------------------------|
| <b>COLORADO DEPARTMENT OF TRANSPORTATION<br/>MATERIALS DOCUMENTATION<br/>REQUEST</b> | Project No.<br>NH-0503-089                         | Project Code (SA#)<br>21255 |
|  | Region<br>2  | Date<br>08/03/2018          |
|  | Proj. location<br>US 50, Royal Gorge West, SH 9 JC |                             |

To: James Caretto Address: 5651 Wills Blvd  
Pueblo, Co. 81009

Upon reviewing the above project for Materials Certification purposes, during the Finals Materials Documentation Checking Procedure, the following items were found to have shortages in materials documentation. Please review these shortages and reply by 08/10/2018. Please return the original Form #211, for tracking purposes, with the missing documentation by 08/24/2018.

| Item | Description       | Materials documentation needed  | Date received |
|------|-------------------|---|---------------|
| 602  | Reinforcing Steel | Summary of Buy America Certifications Received for Installed Steel/Iron Products. The Summary for the month of July 2018 has not been received. |               |

|                                    |                             |                    |
|------------------------------------|-----------------------------|--------------------|
| Signed<br><i>Anthony Hernandez</i> | Title<br>EPS-Technician III | Date<br>08/07/2018 |
|------------------------------------|-----------------------------|--------------------|

- Distribution:
- Resident Engineer
  - Project Engineer
  - Project Tester
  - Materials Project Files

CDOT Form #211 3/04

Colorado Department of Transportation  
CDOT Form #250, 7/18  
Version 19.0

**MATERIALS DOCUMENTATION RECORD**  
Estimated Field Requirements for Minimum Materials  
Sampling, Testing, and Inspection and Record of Field  
and Central Laboratory Documentation of Materials.

Contract ID:  
Project Number:  
Project Location:  
Region:  
Date Developed:  
Contractor:

**PROJECT TO BE TESTED AND DOCUMENTED PER THE 2019 CDOT FIELD MATERIALS MANUAL**

Comply with the Buy America requirements in Section 4 of the Special Notice to Contractors in the Field Materials Manual.

Forward to the Staff Bridge Fabrication Inspectors Unit the list of materials suppliers and subcontractors upon receipt from the contractor.

Attach additional sheets to this form if more space is needed for documentation.

All samples are to be selected using a stratified random sampling schedule. See Colorado Procedure 75 for details on stratified random sampling. Generate and print all random sampling schedules needed before the work begins. Use the random schedule program contained in the Asphalt103 or Void503 computer programs to generate schedules. Contact the Pavement Design Program at the Materials and Geotechnical Branch if you have questions. 303 399-6563.

Tests designated for the Central Lab can be performed in the Field Lab or the Region Lab if adequate facilities and equipment are available.

All CDOT Forms referenced on the Form #250 are to be the most current versions. Verify the revision dates with those listed in the Appendix to the Field Materials Manual and with those listed on the CDOT Form Catalog at [www.dot.state.co.us/FormsMgmt/](http://www.dot.state.co.us/FormsMgmt/), and then use the most recent.

The CDOT Form #250 is to be used in conjunction with the QA Frequency Guide Schedule of the CDOT Field Materials Manual and all referenced Sections or Subsections of the Standard Specifications for Road and Bridge Construction.

**Please reference page 40 and 41 of the QA Schedule of the CDOT Field Materials Manual for guidance on small quantities.**

**LOCAL AGENCY PROJECTS**

All documentation issues should be directed to your CDOT Local Agency Coordinator.

All Local Agency Projects shall use the CDOT Form #250 as developed by the Documentation Unit of CDOT's Materials and Geotechnical Branch.

All Local Agency Projects shall use the CDOT Form #379 as developed by the applicable CDOT Region Materials Engineer.

All Local Agency Projects shall use the CDOT Field Materials Manual referenced on the Form #250 for specific guidance on documentation of project files.

The Field Materials Manual is available for viewing at the CDOT External Web Address: <http://www.dot.state.co.us/DesignSupport/> (see Manuals). The QA Procedures Chapter, the Documentation Chapter, and the Special Notice to Contractors Chapter provide guidance and justification.

**The Item Number, Description, Type of Tests, Plan Quantity, Test Required and Central Laboratory (CL) Test Frequency in this Materials Documentation Record, Colorado Department of Transportation Form #250, shall not be altered in any form or by any means.**





Colorado Department of Transportation  
CDOT Form #250, 7/18  
Version 19.0

**MATERIALS DOCUMENTATION RECORD**

Estimated Field Requirements for Minimum Materials  
Sampling, Testing, and Inspection and Record of Field  
and Central Laboratory Documentation of Materials.

Contract ID:  
Project Number:  
Project Location:  
Region:  
Date Developed:  
Contractor:

**SUMMARY OF PROJECT PRICE REDUCTION DOCUMENTATION**  
Fully document and explain all price reductions on CDOT Form #473 Explanation of Exceptions (page 2)

| ITEM NUMBER | DESCRIPTION | PRICE REDUCTION AMOUNT | CALCULATIONS #266 / #105 DATES | CMO / MCR NUMBERS | LINE ITEM NO. ON FINAL ESTIMATE |
|-------------|-------------|------------------------|--------------------------------|-------------------|---------------------------------|
|             |             |                        |                                |                   |                                 |
|             |             |                        |                                |                   |                                 |
|             |             |                        |                                |                   |                                 |
|             |             |                        |                                |                   |                                 |
|             |             |                        |                                |                   |                                 |
|             |             |                        |                                |                   |                                 |
|             |             |                        |                                |                   |                                 |
|             |             |                        |                                |                   |                                 |
|             |             |                        |                                |                   |                                 |
|             |             |                        |                                |                   |                                 |

**SUMMARY OF SAMPLING AND TESTING DEVIATIONS**  
Deviations from sampling and testing requirements must be fully documented on the CDOT Form #473 Explanation of Exceptions (page 2).

| ITEM NUMBER | TEST ELEMENT OR ACCEPTANCE | EXPLANATION |
|-------------|----------------------------|-------------|
|             |                            |             |
|             |                            |             |
|             |                            |             |
|             |                            |             |
|             |                            |             |
|             |                            |             |
|             |                            |             |
|             |                            |             |
|             |                            |             |
|             |                            |             |

**SUMMARY OF LABORATORY CHECK TEST DEVIATIONS**  
Fully document and explain all laboratory check test deviations on CDOT Form #473 Explanation of Exceptions (page 2)

| ITEM NUMBER | DESCRIPTION | MEMO DATE | CDOT Form #157 FS# | Document Significant Independent Assurance differences as per 1.4 of the QA Procedures in the Field Materials Manual. |
|-------------|-------------|-----------|--------------------|---|
|             |             |           |                    |   |
|             |             |           |                    |   |
|             |             |           |                    |   |
|             |             |           |                    |   |
|             |             |           |                    |   |
|             |             |           |                    |   |
|             |             |           |                    |   |
|             |             |           |                    |   |
|             |             |           |                    |   |
|             |             |           |                    |   |

|   |                                       |   |
|---|---------------------------------------|---|
| Colorado Department of Transportation<br>CDOT Form #250, 7/18<br>Version 19.0   | <b>MATERIALS DOCUMENTATION RECORD</b> | Contract ID:<br>Project Number:<br>Project Location:<br>Region:<br>Date Developed:<br>Contractor: |
| Estimated Field Requirements for Minimum Materials Sampling, Testing, and Inspection and Record of Field and Central Laboratory Documentation of Materials.   |                                       |   |
| Isolated relatively small quantities of concrete, reinforcing steel, wire mesh, bolts etc. which are paid for incidentally shall be field inspected to determine conformance with specifications and Document in Project Records. If any questions arise concerning the proper documentation of materials during construction, contact the Documentation Unit of the Central Laboratory in Denver @ 303-398-6563. |                                       |   |
| FIELD DOCUMENTATION ENTERED BY:   | DATE:                                 | PROJECT ENGINEER / Title:   |
| Distribution: (includes the entire and completed CDOT Form #250)<br>Resident Engineer<br>Region Materials Engineer<br>Region Finals Engineer<br>Documentation Unit (Materials and Geotechnical Branch)<br>FHWA (Oversight Projects only)  |                                       |   |
| End   | Ref # ITOR184-12WB139                 |   |





| COLORADO DEPARTMENT OF TRANSPORTATION<br><b>FINAL MATERIALS DOCUMENTATION CHECKLIST, (PROJECT CLOSURE)</b>  |                                       |  |                     |
|---|---------------------------------------|--|---------------------|
| Project no.<br>FBR 0404-050   | Contract ID<br>C18180                 | Acceptance Date<br>07/01/2015  |                     |
| Project Location<br>US 40 Over Sand Creek   |                                       |  | Region<br>4         |
| Contractor<br>Hamon Contractors, Inc.   | Project Engineer<br>Karl Larson       | Resident Engineer<br>Travis Miller   |                     |
| <input checked="" type="checkbox"/> Project Basis   | <input type="checkbox"/> System Basis | <input checked="" type="checkbox"/> Progress Estimate number: 6-31-2015  | (latest issued)     |
| In order for materials documentation to be complete, the following items need to be checked 100%:   |                                       |  |                     |
| <input checked="" type="checkbox"/> Final Quantities between Progress Estimate and CDOT Form #250 agree. (If different, it is noted)  |                                       |  |                     |
| <input checked="" type="checkbox"/> Field Sheet/Serial number(s) on CDOT Form #250 match project documents, of the item(s) checked.   |                                       |  |                     |
| <input checked="" type="checkbox"/> Tests required and tests reported on the Form #250 agree. (If different, it is noted.)  |                                       |  |                     |
| yes   | no                                    |  |                     |
| <input checked="" type="checkbox"/>   | <input type="checkbox"/>              | If IA tests are involved, Field Sheet/Serial number(s) on CDOT Form #379 match project documents and all test(s) agree with field acceptance tests, and if applicable, shortages and exceptions are explained. |                     |
| <input checked="" type="checkbox"/>   | <input type="checkbox"/>              | Ensure the correct number of tests on the CDOT Form #379.  |                     |
| <input type="checkbox"/>  | <input type="checkbox"/>              | IA Witness tests did not exceed 20% of actual testing, for each test element.  |                     |
| <input checked="" type="checkbox"/>   | <input type="checkbox"/>              | Independent (IA)/Acceptance (QA)/Check Test differences are explained.   |                     |
| <input checked="" type="checkbox"/>   | <input type="checkbox"/>              | Form #250 signed by the Project Engineer and the Form #379 has Final Approved by signature of the Region Materials Engineer and Project Review by signature of the Project Engineer.                           |                     |
| <b>NOTE: The following materials records are required to be attached to complete the finals materials documentation process, if applicable for this project:</b>  |                                       |  |                     |
| <input checked="" type="checkbox"/>   | <input type="checkbox"/>              | Letters, CMOs, MCRs, field sheets, etc. if used as the primary documentation within the Explanation of Exceptions  |                     |
| <input checked="" type="checkbox"/>   | <input type="checkbox"/>              | Progress Estimate (latest issued)  |                     |
| <input checked="" type="checkbox"/>   | <input type="checkbox"/>              | Random Sample Schedule   |                     |
| <input checked="" type="checkbox"/>   | <input type="checkbox"/>              | Price reduction calculations.(with supporting documentation)   |                     |
| <input checked="" type="checkbox"/>   | <input type="checkbox"/>              | QC/QA Data for Item: <u>403</u> . (reference applicable Items)   |                     |
| <input checked="" type="checkbox"/>   | <input type="checkbox"/>              | Buy America Certificate, for steel products, All individual certifications + each monthly summary report included.   |                     |
| <input checked="" type="checkbox"/>   | <input type="checkbox"/>              | Roadway Surface Accomplishment Report (RSAR).  |                     |
| <input type="checkbox"/>  | <input checked="" type="checkbox"/>   | Evaluation of Materials Testing, Form #1324 (per CP 16).   |                     |
| Review notes:<br>All documents required were included in the project files and in the final documentation packet. Form #473, Explanation of Exceptions was used as required. The file is being forwarded to the Finals Materials Documentation Coordinator. |                                       |  |                     |
| This is to certify that the review of the materials documentation indicates the documentation is complete and accurate.   |                                       |  |                     |
| Name (Printed)<br>Leslie Kochis   |                                       | Name (signed)  | Title:<br>EPST III  |
|   |                                       |  | Date:<br>07/02/2015 |

**Distribution:** Previous editions are obsolete and may not be used. Page 1 of 2 CDOT Form #1199 7/14

|  |   |
|--|---|
| <input checked="" type="checkbox"/> Resident Engineer, (included with Project Final Documentation) | <input checked="" type="checkbox"/> Region Finals Engineer                              |
| <input checked="" type="checkbox"/> Project Engineer   | <input checked="" type="checkbox"/> FHWA (Oversight Projects Only)                      |
| <input checked="" type="checkbox"/> Region Materials Engineer                                      | <input checked="" type="checkbox"/> Documentation Unit, Materials & Geotechnical Branch |

CDOT Form #1199, Page 2 of 2

| <b>COLORADO DEPARTMENT OF TRANSPORTATION</b><br><b>FINAL MATERIALS DOCUMENTATION CHECKLIST, (REVIEW or AUDIT)</b>  |                                     |  |                            |
|--|-------------------------------------|--|----------------------------|
| Project No. FBR 0404-050   |                                     | Contract ID C18180   | Acceptance Date 07/01/2015 |
| Residency Finals Review <input type="checkbox"/> or Region Finals Audit <input checked="" type="checkbox"/>  |                                     | Progress Estimate number: 6-31-2015  |                            |
| Major Item 1.) 403   |                                     | Major Item 2.) 206   |                            |
| Major Item 3.) 412   |                                     | Major Item 4.) 203   |                            |
| 1.)  | 2.)                                 | 3.)  | 4.)                        |
| In order for materials documentation to be complete, the following items need to be checked:   |                                     |  |                            |
| <input checked="" type="checkbox"/>  | <input type="checkbox"/>            | <input checked="" type="checkbox"/>  | <input type="checkbox"/>   |
| Final Quantities between Progress Estimate and CDOT Form #250 agree. (If different, it is noted)   |                                     |  |                            |
| <input checked="" type="checkbox"/>  | <input type="checkbox"/>            | <input checked="" type="checkbox"/>  | <input type="checkbox"/>   |
| Field Sheet/Serial number(s) on CDOT Form #250 match project documents, of the item(s) checked.  |                                     |  |                            |
| <input checked="" type="checkbox"/>  | <input type="checkbox"/>            | <input checked="" type="checkbox"/>  | <input type="checkbox"/>   |
| Tests required and tests reported on the Form #250 agree. (If different, it is noted.)   |                                     |  |                            |
| yes  | no                                  |  |                            |
| <input checked="" type="checkbox"/>  | <input type="checkbox"/>            | If IA tests are involved, Field Sheet/Serial number(s) on CDOT Form #379 match project documents and all test(s) agree with field acceptance tests, and if applicable, shortages and exceptions are explained. |                            |
| <input checked="" type="checkbox"/>  | <input type="checkbox"/>            | Ensure the correct number of tests on the CDOT Form #379.  |                            |
| <input checked="" type="checkbox"/>  | <input type="checkbox"/>            | IA Witness tests did not exceed 20% of actual testing, for each test element.  |                            |
| <input checked="" type="checkbox"/>  | <input type="checkbox"/>            | Independent (IA)/Acceptance (QA)/Check Test differences are explained.   |                            |
| <input checked="" type="checkbox"/>  | <input type="checkbox"/>            | Form #250 signed by the Project Engineer and Form #379 has Final Approved by signature of the Region Materials Engineer and Project Review by signature of the Project Engineer.                               |                            |
| <b>NOTE: The following materials records are required to be attached to complete the finals materials documentation process, if applicable for this project:</b>   |                                     |  |                            |
| <input checked="" type="checkbox"/>  | <input type="checkbox"/>            | Letters, CMOs, MCRs, field sheets, etc. if used as the primary documentation within the Explanation of Exceptions  |                            |
| <input checked="" type="checkbox"/>  | <input type="checkbox"/>            | CDOT Form #325, Final Estimate Data. (If not yet developed, indicate this in Review Notes.)  |                            |
| <input checked="" type="checkbox"/>  | <input type="checkbox"/>            | Progress Estimate. <i>Note if a more recent version was used since the Project Closure.</i>  |                            |
| <input checked="" type="checkbox"/>  | <input type="checkbox"/>            | Random Sample Schedule   |                            |
| <input checked="" type="checkbox"/>  | <input type="checkbox"/>            | Price reduction calculations.(with supporting documentation)   |                            |
| <input checked="" type="checkbox"/>  | <input type="checkbox"/>            | QC/QA Data for Item: 403 _____. (reference applicable Items)   |                            |
| <input checked="" type="checkbox"/>  | <input type="checkbox"/>            | Buy America Certificate, for steel products, All individual certifications + each monthly summary report included.   |                            |
| <input checked="" type="checkbox"/>  | <input type="checkbox"/>            | Roadway Surface Accomplishment Report (RSAR).  |                            |
| <input type="checkbox"/>   | <input checked="" type="checkbox"/> | Evaluation of Materials Testing, Form #1324 (per CP 16).   |                            |
| Review notes:<br>The Region Finals Audit discovered no problems. I was impressed with the timeliness in which finals packet was delivered to me, and the order and completeness of all of the documents. |                                     |  |                            |
| This is to certify that the review of the materials documentation indicates the documentation is complete and accurate.  |                                     |  |                            |
| Name (Printed)<br>Steve Heimmer  |                                     | Name (signed)  | Title:<br>EIT 3            |
|  |                                     |  | Date:<br>07/07/2015        |

|   |                  |                 |
|---|------------------|-----------------|
| <b>COLORADO DEPARTMENT OF TRANSPORTATION</b><br><b>FINAL MATERIALS</b><br><b>CERTIFICATION</b><br><b>FOR A LOCAL AGENCY PROJECT</b> | Project No.      | CDOT Region     |
|   | Contract ID      | Acceptance date |
|   | Project Location |                 |
|   | Contractor       |                 |

This is to Certify that:





The results of the tests on the acceptance samples indicate that the material incorporated in the construction work, and the construction operations controlled by sampling and testing, were in conformity with the approved plans and specifications; and such results compare favorably with the results of the Independent Assurance sampling and testing.

All results from the Independent Assurance sampling and testing are within tolerance limits of the results of sampling and testing that are used in the acceptance program.

Exceptions to the plans and specifications are explained on Explanation of Exceptions, #474. A CDOT Form #474 is always required to be attached to the #473.

The referenced documents below are attached with applicable signatures to this form in the order indicated.

- Yes     No    Explanation of Exceptions, Form #474, (as many pages as required.)
- Yes     No    Explanation of Exceptions, Supplemental Documents.
- Yes     No    Materials Documentation Record, Form #250.
- Yes     No    Project Independent Assurance Sampling & Testing Schedule, Form #379.
- Yes     No    Finals Materials Documentation Checklist, (Project Closure) Form #1199, page 1.
- Yes     No    Finals Materials Documentation Checklist, (Review or Audit) Form #1199, page 2.

|  |  |
|--|--|
| Approved by: Person in Responsible Charge, Local Agency<br> | Title:<br> |
| Approved by: The Designated CDOT Engineer<br>               | Title:<br> |

**Distribution:**

- cc:  CDOT Resident Engineer
- xc:  LA Project Engineer / Project Manager
- CDOT Region Materials Engineer
- CDOT Local Agency Coordinator
- cdot\_pavement.design@state.co.us



|   |                  |                 |
|---|------------------|-----------------|
| <b>COLORADO DEPARTMENT OF TRANSPORTATION</b><br><b>FINAL MATERIALS</b><br><b>CERTIFICATION</b><br><b>FOR A CDOT MAINTENANCE</b><br><b>PROJECT</b> | Project No.      | CDOT Region     |
|   | Contract ID      | Acceptance date |
|   | Project Location |                 |
|   | Contractor       |                 |

This is to Certify that:





The results of the tests on the acceptance samples indicate that the material incorporated in the construction work, and the construction operations controlled by sampling and testing, were in conformity with the approved plans and specifications; and such results compare favorably with the results of the Independent Assurance sampling and testing.

All results from the Independent Assurance sampling and testing are within tolerance limits of the results of sampling and testing that are used in the acceptance program.

Exceptions to the plans and specifications are explained on Explanation of Exceptions, #474. A CDOT Form #474 is always required to be attached to the #473.

The referenced documents below are attached with applicable signatures to this form in the order indicated.

- Yes  No Explanation of Exceptions, Form #474, (as many pages as required.)
- Yes  No Explanation of Exceptions, Supplemental Documents.
- Yes  No Materials Documentation Record, Form #250.
- Yes  No Project Independent Assurance Sampling & Testing Schedule, Form #379.
- Yes  No Finals Materials Documentation Checklist, (Project Closure) Form #1199, page 1.
- Yes  No Finals Materials Documentation Checklist, (Review or Audit) Form #1199, page 2.
- Yes  No Evaluation of Materials Testing, Form #1324. Attach only if Consultant Testing.

|  |  |
|--|--|
| Approved by: Project Manager<br><br>(printed name and signature)            | Title:<br> |
| Approved by: Maintenance Superintendent<br><br>(printed name and signature) | Title:<br> |

**Distribution:**

- cc:  Maintenance Superintendent  
 State Maintenance Engineer  
 Region Materials Engineer  
 Regions Final Engineer  
 cdot\_pavement.design@state.co.us  
 ProjectWise

Previous editions are obsolete and may not be used.

CDOT Form #473-M

4/19

CDOT 473M

|  |                               |  |   |                               |
|--|-------------------------------|--|---|-------------------------------|
| <b>Colorado Department of Transportation</b><br><b>Final Materials Certification</b><br><b>Explanation of Exceptions</b>   |                               | Contract ID: _____                                 | Region: _____   | Page _____ of _____           |
|  |                               | Project Acceptance Date: _____                     |   |                               |
| <input type="checkbox"/> Owner Acceptance <input type="checkbox"/> Independent Assurance   |                               | Project Number: _____                              |   |                               |
| <input type="checkbox"/> Innovative Contract <input type="checkbox"/> Local Agency   |                               | Project Location: _____                            |   |                               |
| <input type="checkbox"/> CDOT Maintenance <input type="checkbox"/> Other _____   |                               | Contractor: _____                                  |   |                               |
| Electronic signature of Project Tester or Project Engineer<br>_____  |                               | Project Final Documentation Completion Date: _____ |   |                               |
|  |                               | CDOT or Consultant Company Name: _____             |   |                               |
| CDOT Project Sampling and Testing by Consultant:    YES <input type="checkbox"/> NO <input type="checkbox"/>   |                               |  |   |                               |
| <b>CAR - Quality Level Reports</b>   |                               |  |   |                               |
| <b>FINAL CAR report</b>  |                               | <b>Data Reviewed by:</b>                           |   | <b>Data Checked by:</b>       |
| <input type="checkbox"/> Asphalt Quality Level   | Electronic Signature<br>_____ |  |   | Electronic Signature<br>_____ |
| <input type="checkbox"/> Concrete Quality Level  | Electronic Signature<br>_____ |  |   | Electronic Signature<br>_____ |
|  |                               |  |   |                               |
| Consultant Firm PE Comments (for this page only, more pages may follow).   |                               |  |   |                               |
|  |                               |  |   |                               |
| Instructions: Signature of Project Tester or Project Engineer shall be signed after explanations are complete. Hand signed document is not acceptable, only electronic signatures.<br>Header information will populate to all pages from Page 1. Document has 6 pages available.<br>Explain all shortages of tests, missing COC/CTR's, and price reductions.<br>Explain CAR - Quality Level Reports for processes, Pay Factor of 1, quantity discrepancies and total incentive/disincentive payments if QLRs apply to the contract.<br>Final package shall include all supporting documentation for price reductions, CMO/MCR's, and CDOT Form 105 detailing deleted items by the PE.<br>See FMM Documentation chapters - After Construction - for more information<br><b>All CAR - Quality Level Reports must be Final Report with no errors.</b> |                               |  | Consultant Firm PE Electronic Signature<br>_____<br><br>Consultant Firm PE Electronic Stamp or Wet Stamp: |                               |

Previous editions of this form are obsolete and may not be used

CDOT Form 474 4/19

## Special Notice to Contractors - 21

### 1. SCOPE

- 1.1 It is the intent of this chapter to provide guidelines to the Contractor or Sub-Contractor, so that they can properly present their materials for inclusion in the construction project.
- 1.2 The Contractor shall follow the procedures listed below to ensure the proper inspection, sampling, testing, and certification of materials and products incorporated into all construction projects.
- 1.3 "Prequalification of Bidders" (Standard Specifications, Subsection 102.01) is synonymous with any reference to the CDOT "Pre-Qualification List". A Prime Contractor requiring additional information regarding bidding can go to <https://www.codot.gov/business/bidding>.
- 1.4 The Qualified Manufacturers List (QML) is used for suppliers of Steel Reinforcing Bars & Steel Dowel Bars, Epoxy Coaters for Reinforcing Steel, and Precast Concrete Structures. These products are required to be selected off the QML. All relevant details for the proper submittal of specified Standard Manufactured Materials and Fabricated Structural Materials are found in CDOT's Field Materials Manual under CP 11, Quality Management Plans for the Qualified Manufacturers List or the Approved Products List.

### 2. PROVIDE NOTIFICATION OF MATERIALS SOURCES AND SUPPLIERS

- 2.1 In accordance with Subsection 106.01 of the Standard Specifications: The Contractor shall submit a formal list of material sources and suppliers to the Engineer at least two weeks prior to delivery; however, it is preferable that the list be presented at the Pre-Construction Meeting. The Department will sample and test materials proposed by the Contractor to be utilized for Items 203, 206, and 304. If the Department test results indicate the material is not in conformance with the project specifications, the Contractor is directed to Subsection 106.02 regarding Contractor Source materials and additional testing requirements.
- 2.2 The list shall include: item to be supplied, quantity, a reference to the level of acceptance required by CDOT (per Section 7, Designated Products and Assemblies), company's name and address manufacturing the material or product, and contact person (if the material is to be pre-inspected or if a problem exists with the material delivered). The submitted list shall indicate, immediately after the item being referenced, the applicable acceptance level required:
  - (A) Pre-Inspection (PI)
  - (B) Certified Test Report (CTR)
  - (C) Certificate of Compliance (COC)
  - (D) Pre-Approved (per APL &/or QML)
- 2.3 All required product or material documentation shall be provided at the point and time of delivery to the construction project. Failure to provide the required documents, such as CTRs and COCs, may result in rejection of the materials. Failure to utilize the QML or APL may result in rejection of the materials.

### **3. INNOVATIVE CONTRACTING (DESIGN / BUILD PROJECTS, CM/GC PROJECTS, ETC.) - MATERIALS DOCUMENTATION RECORD, CDOT FORM #250**

- 3.1 Two weeks before construction of any element of work the Contractor shall furnish the Engineer a schedule of items, approximate quantities to be incorporated into the project, and a reference to the method of acceptance required by CDOT (per Section 7, Designated Products and Assemblies). This information is to include the item of work with its placement location and dates. The Contractor shall immediately notify the Engineer, in writing, if the items of work or quantities are revised.
- 3.2 At the completion of the project, the Contractor shall furnish the Engineer with a completed CDOT Form 250 either originally created prior to the start of the project or at the end of the project by the Materials Documentation Unit - Materials Documentation Record listing items utilized to construct the project and the approximate quantity of each item.

### **4. BUY AMERICA REQUIREMENTS**

- 4.1 In accordance with Subsection 106.11 of the Standard Specifications as referenced in 23 CFR Part 635.410:
- 4.1.A Regulations require the use of domestic steel and iron in Federally funded construction projects. Buy America applies to construction components which are “predominately steel products,” defined by CDOT as products which are manufactured with at least 80% steel or iron content when delivered to the job site for installation. (See “C” below for examples.) CDOT provides waivers for manufactured products and products that are not predominately steel or iron. (See “D” below for examples.) Buy American strictly limits, but does not eliminate, the amount of foreign steel. (See “E” for minimum use & waiver information.)
- 4.1.B All manufacturing processes are defined as “processes required to change the raw ore or scrap metal into the finished, in-place steel or iron product”. Manufacturing begins with the initial melting and mixing, and continues through the coating stage. Any process which modifies the chemical content, the physical size or shape, or the final finish is considered a manufacturing process.
- 4.1.C Examples of products that are subject to Buy America requirements include, but are not limited to, the following:
- steel or iron products used in pavements, bridges, tunnels or other structures, which include, but are not limited to, the following: fabricated structural steel, reinforcing steel, piling, high strength bolts, anchor bolts, dowel bars, permanently incorporated sheet piling, bridge bearings, cable wire/strand, pre-stressing / post-tensioning wire, motor/machinery brakes and other equipment for moveable structures;
  - guardrail, guardrail posts, end sections, terminals, cable guardrail;
  - steel fencing material, fence posts;
  - steel or iron pipe, conduit, grates, manhole covers, risers;
  - mast arms, poles, standards, trusses, or supporting structural members for signs, luminaires, or traffic control systems; and
  - steel or iron components of precast concrete products, such as reinforcing steel, wire mesh and pre-stressing or post-tensioning strands or cables.

- 4.1.D Examples of products which are exempt from Buy America requirements include, but are not limited to, the following:
- products made of material other than steel or iron (aluminum, copper, brass, nickel, etc.);
  - cabinets, covers, shelves;
  - clamps, fittings, sleeves;
  - washers, bolts, nuts, screws;
  - tie wire, spacers; chairs;
  - lifting hooks;
  - faucets; and
  - door hinges.
- 4.1.E Buy America will not prevent a minimal use of foreign steel or iron provided the total project delivery cost of all such steel and iron which includes the cost of delivering the steel and iron to the project, does not exceed one-tenth of one percent of the total contract cost or \$2,500, whichever is greater. With prior concurrence from FHWA Headquarters, the FHWA Division Administrator may grant a waiver of the Buy America requirements for specific projects. When domestic steel products are available, meeting the contractor's schedule should not be the basis for requesting a Buy America waiver.
- 4.1.F The Contractor shall maintain the certifications on file at the project that every process, including the application of a coating, performed on steel or iron products either has or has not been carried out in the United States of America. These certifications shall create a chain of custody, and the lack of these certifications will be justification for rejection of the steel or iron product.
- 4.1.G Prior to the permanent incorporation into the project of any steel or iron product (domestic or foreign), the Contractor shall certify in writing to the Project Engineer on a monthly basis that the delivered quantity of each material meets the contract Buy America requirements; that a copy of the Buy America Certification from the Supplier is on file in the Contractor's project office; and the steel or iron products are in compliance with the plans and specifications for this project. {Examples are included in this section}

The Contractor shall maintain a document summarizing the date and quantity of the material utilizing CDOT's Item Number(s) and Item Description(s) delivered to the project (examples on Page 14 & 16), along with the quantity of material installed during the month. The Contractor shall provide documentation of the project delivered cost of all foreign steel or iron permanently incorporated into the project, if any on a monthly basis (example on Page 15). This summary shall be delivered to the Project Engineer on a monthly basis as established per the revision of Section 106.11 of the Standard Specifications for Road and Bridge Construction. A monthly summary shall be required even if no steel or iron products are incorporated into the project during the month.

**Note 1:** CDOT Standards and Specifications Subsection 106.11 contains specific information on Buy America Requirements.

[https://www.codot.gov/business/designsupport/bulletins\\_manuals/2018-cdot-construction-manual](https://www.codot.gov/business/designsupport/bulletins_manuals/2018-cdot-construction-manual)

## 5. GLASS BEADS for PAVEMENT MARKING

- 5.1 The material shall meet the requirements of The CDOT Standard Specifications Subsection 106.11, Section 627, and Subsection 713.08.



## 6. QUALITY MANAGEMENT PLANS FOR THE QUALIFIED MANUFACTURERS LIST OR THE APPROVED PRODUCTS LIST

6.1 CP 11 specifies requirements and procedures for a certification system that shall be applicable to all referenced manufacturers, as well as suppliers and contractors within certain industries. Certifying a Manufacturer's Quality Management Plan is not an automatic acceptance of any particular product, but an acknowledgement that the Manufacturer has taken steps to ensure that their quality controls meet the applicable Industry standards. Manufacturers whose Quality Management Plans are acceptable will be placed on the Qualified Manufacturers List (QML). Only Manufacturers listed on the QML will be eligible to provide the referenced products to a CDOT project.

6.2 The following Standard Manufactured Materials as referenced in CP 11 require an annual submission of a Quality Management Plan (QMP) along with a sample for evaluation. Materials and Geotechnical Branch/ Asphalt Program maintains the QMP for the Sub-Part 1, Asphalt Binder and the Sub Part 2, Asphalt Emulsion. Contact them at: [michael.stanford@state.co.us](mailto:michael.stanford@state.co.us) or 303-398-6576. For the Sub-Part 3,4,and 5 the QMP will be managed by: [eric.prieve@state.co.us](mailto:eric.prieve@state.co.us) or 303-398-6542.

- Part I, Standard Manufactured Materials
  - Sub-Part 1.Asphalt Binder
  - Sub-Part 2.Asphalt Emulsion
- Part I, Standard Manufactured Materials
  - Sub-Part 3.Hydraulic Cement
  - Sub-Part 4.Fly Ash
  - Sub-Part 5.Hydrated Lime

These products are located on the APL. <https://apps.coloradodot.info/apl/AplSearch.cfm>

6.3 The following Fabricated Structural Materials as referenced in CP 11 require an annual submission of a Quality Management Plan (QMP).

- Part II, Fabricated Structural Materials
  - Sub-Part 1.Steel Reinforcing Bars & Steel Dowel Bars.
  - Subject Matter Expert: [eric.prieve@state.co.us](mailto:eric.prieve@state.co.us) or 303-398- 6542
  - <https://www.codot.gov/content/apl/SteelReinforcingBarsAndSteelDowelBars.pdf>
- Sub-Part 2.Epoxy Coaters of Reinforcing Steel.
- Subject Matter Expert: [melody.perkins@state.co.us](mailto:melody.perkins@state.co.us) or 303-398- 6562
- <https://www.codot.gov/content/apl/EpoxyCoatingForReinforcingSteel.pdf>
- Sub-Part 3.Precast Conc. Structures.
- Subject Matter Expert: [melody.perkins@state.co.us](mailto:melody.perkins@state.co.us) or 303-398- 6562
- <https://www.codot.gov/content/apl/PrecastConcreteStructures.pdf>

The QML is located within CDOT's Approved Products List (APL) web site, at:

<https://www.codot.gov/business/apl/qualified-manufacturers-list.html>.

A Notice to Manufacturers is located within the same web site that references specific evaluation protocols including AASHTO's National Transportation Product Evaluation Program (NTPEP).

6.4 The respective QML web site pages are updated regularly. All pages will have at least one revision referencing acceptability for the new calendar year.

## 7. DESIGNATED PRODUCTS AND ASSEMBLIES

7.1 The majority of materials submitted for inclusion on CDOT projects will fall within one of four methods of product acceptance for their sampling and testing. CDOT always retains the right through its Quality Assurance (QA) Program to obtain samples for additional testing and require supplemental documentation.

7.2 If the material or product is not referenced within the four methods of product acceptance then the materials or products must be fabricated or supplied in accordance with the requirements of the applicable Colorado Department of Transportation specifications, plans, and standards. An example of processed materials not found in the following four methods are Aggregate Base Course (ABC), Hot Mix Asphalt (HMA), and Concrete (PCCP). An example of a manufactured product treated uniquely is the Dynamic Message Signs (DMS) which are competitively bid on projects or through state awards.

### 7.3.a. PRE-INSPECTION (PI):

Pre-Inspection is when representatives from the Colorado Department of Transportation visit a manufacturer's facility to perform an initial review of the company's quality control plan and employee certifications, as well as subsequent inspection visitations during the manufacturing of the product. Inspection arrangements shall be made by contacting the CDOT Staff Bridge Fabrication and Construction Inspectors at: [kevin.howland@state.co.us](mailto:kevin.howland@state.co.us) (303) 757-9339 a minimum of 10 days prior to the beginning of fabrication. Failure to give notification will result in delays to the project and/or rejection of materials or products.

**Note:** Bearing Devices and Expansion Devices are inspected randomly at the discretion of the Staff Bridge Fabrication Inspectors.

#### Products needing Pre-Inspection:

- Bearing Devices (Type III) - Bridge<sup>A</sup>
- Expansion Device, Modular - Bridge<sup>A</sup> (0-6", through, 0-24")
- Pre-stressed Concrete Units - Bridge<sup>A</sup>
- Structural Steel - Bridge<sup>A</sup>
- Precast Concrete Deck Panels - Bridge<sup>A</sup>

#### **Note:** <sup>A</sup> - Staff Bridge Fabrication Inspectors

CDOT Form 193 is to be provided with the above referenced products.

### 7.3.b. CERTIFIED TEST REPORT (CTR):

The Certified Test Report method of acceptance is when a manufacturer is required to submit the actual test results performed on the material being provided. The CTR shall contain the actual results of tests for the chemical analysis, heat treatment, and/or mechanical properties per the drawing and/or specification. The contract will designate products and assemblies that can be incorporated in the work, if accompanied by Certified Test Reports. The word preceding the "Test Report" may vary between different industries, such as Certified, Mill, Metallurgical, Laboratory; however, they are all considered equivalent.

In accordance with CDOT Standard Specifications, Subsection 106.13 and the requirements of this document, each CTR shall include:

1. Department's project number,
2. Manufacturer's name,
3. Address of manufacturing facility,
4. Laboratory name & address,
5. Name of product or assembly,
6. Complete description of the material,
7. Model, catalog, stock no. (if applicable),
8. Lot, heat, or batch number identifying the material delivered,
9. Date(s) of the laboratory testing,
10. All test results that are required so as to verify that the material furnished conforms to all applicable Department specifications. Test results shall be from tests conducted on samples taken from the same lot, heat, or batch.
11. The following certification, signed by a person having legal authority to act for the Contractor:  
[Example included in this chapter.]

The Certified Test Report shall be a legible copy or an original document and shall include the Contractor's original signature. The signature (including corporate title) on the Certified Test Report, under penalty of perjury, shall be of a person having legal authority to act for the manufacturer or the independent testing laboratory. It shall state that the test results show that the product or assembly to be incorporated into the project has been sampled and passed all specified tests in conformity to the plans and specifications for this project. One legible copy or original document of the fully signed Certified Test Report shall be furnished to the Engineer prior to installation of the material. Failure to comply may result in delays to the project and/or rejection of the materials.

Each product or assembly delivered to the project must contain the lot, heat, or batch number identical to that on the accompanying Certified Test Report. Products or assemblies furnished on the basis of Certified Test Reports may be sampled and tested by the Department and if determined that the material does not meet the applicable specifications, the material will be rejected or accepted according to CDOT Standard Specifications, Subsection 105.03. [An example of what is required on a CTR is included in this chapter.]

**Products requiring Certified Test Report** (below is an incomplete list):

- Bearing Devices (Type III) - Bridge<sup>A</sup>
- Bridge Deck Forms, Permanent Steel <sup>A</sup>
- Cribbing, Steel
- Geogrid (or COC, per project specs)
- Glass Beads (for pavement marking)
- Mechanical Fasteners (Field) <sup>A</sup>
- Overhead Sign Structures <sup>A</sup>
- Pedestrian & Bikeway Railing
- Quicklime
- Soil Conditioner
- Structural Plate Structures
- Top Soil
- Traffic Signal Structures <sup>A</sup>
- Water, Non-Potable
- Welded Wire Reinforcement

**7.3.c. CERTIFICATE OF COMPLIANCE (COC):**

The Certificate of Compliance method of acceptance is when a manufacturer is required to submit a document certifying that the material being provided meets all required Department specifications. A COC shall reference the required specifications for the chemical analysis, heat treatment, and/or mechanical properties per the drawing and/or specification, but not the actual test results. The contract will designate products and assemblies that can be incorporated in the work, if accompanied by Certificates of Compliance.

In accordance with Subsection 106.12 of the Standard Specifications and the requirements of this document, the certificate shall include:

1. Department's project number,
2. Manufacturer's name,
3. Address of manufacturing facility,
4. Laboratory name & address,
5. Name of product or assembly,
6. Complete description of the material,
7. Model, catalog, stock no.(if applicable),
8. Lot, heat, or batch number identifying the material delivered,
9. Date(s) of the laboratory testing,
10. Listing of all applicable specifications required by the Department for this particular product or assembly. Certificates shall reference the actual tests conducted on samples taken from the same lot, heat, or batch, and shall include a statement that the product or assembly to be incorporated into the project was fabricated in accordance with and meets the applicable specifications.
11. The following certification, signed by a person having legal authority to act for the Contractor:  
[Example included in this chapter.]

The original Certificate of Compliance shall include the Contractor's original signature. The original signature (including corporate title) on the Certificate of Compliance, under penalty of perjury, shall be of a person having legal authority to act for the manufacturer. It shall state that the product or assembly to be incorporated into the project has been sampled and passed all specified tests in conformity to the plans and specifications for this project. One legible copy of the fully signed Certificate of Compliance shall be furnished to the Engineer prior to installation of material. The original shall be provided to the Engineer before payment for the represented item will be made.

Each product or assembly delivered to the project must contain the lot, heat, or batch number identical to that on the accompanying Certificate of Compliance. Products or assemblies furnished on the basis of Certificates of Compliance may be sampled and tested by the Department and if determined that the material does not meet the applicable specifications, the material will be rejected or accepted according to CDOT Standard Specifications, Subsection 105.03.

[An example of what is required on a COC is included in this chapter.]

**Note 3:** If the Plans do not specifically reference a Certified Test Report (Mill Test Report) and the product category is not listed on the Approved Products List within the Pre-Approved level of acceptance, then a COC will be required.

**Products requiring Certificate of Compliance** (below is an incomplete list):

- AEP (Asphalt Emulsion Prime)
- Aggregate Bag (for the bag, CTR for agg.)
- Bearing Devices (Type I, II <sup>A B</sup>)
- Bridge Rail, Steel <sup>A</sup>
- Catch Basin Insert
- Cattle Guard Boxes, Pre-Cast
- Concrete Box Culverts, Precast
- Dampproofing, Asphalt
- Delineator Posts, Steel
- Ditch Control (Erosion Log & Silt Dike)
- Dust Palliative, Asphaltic or Magnesium Chloride
- Erosion Bales <sup>D</sup>
- Expansion Joint Material, Preform. Filler
- Fence (Wires & Posts)
- Fertilizer
- Flumes (all types) Gabions and Slope Mattress
- Gaskets
- Geogrid (for Erosion Control)
- Glass Beads (for PMM)
- Guard Rail - End Anchors
- Guard Rail Metal <sup>A</sup>
- Guard Rail Posts - Metal <sup>A</sup>
- Guard Rail - Precast
- Guard Rail Posts - Timber Blocks and Posts <sup>A</sup>
- Hay <sup>D</sup>
- Headgates
- Hydraulic Soil Stabilizers
- Inlets, Grates and Frames (Prefab)
- Interior Insulation
- Irrigation Systems
- Lighting, all items
- Light Standards, High Mast
- Light Standards, Metal
- Luminaires (Inclusive)
- Manholes, Rings and Covers (Prefab)
- MSE Wall - Elements <sup>A,C</sup>
- Mulch (Hydraulic or Dry Applied)
- Mulch Tackifier
- Pedestrian Bridge <sup>A</sup>
- Perimeter Control (Silt Fence)
- Piling <sup>A</sup>
- Pipes - all material compositions
- Rest Area Materials (construction of)
- Retaining Wall Blocks
- Seeding (Native), Seed <sup>C</sup>

- Sign Panels
- Sprinkler System(s)
- Steel Chairs
- Steel Sign Posts
- Steel Sheet Piling <sup>A</sup>
- Storm Drain Inlet Protection
- Straw <sup>D</sup>
- Structural Glazed Tile and Ceramic Tile
- Structural Plate Structures <sup>A</sup>
- Structural Steel Galvanized <sup>A</sup>
- Treated Timber
- Vegetation (Sod & Plants)
- Water, Potable
- Water Control Devices
- Water Lines
- Welded Wire Mesh

**Note 4:**

- Mill Test Report shall be included.
- Certified Test Report(s) on components must accompany the material or product.
- Certified Test Report shall be included.
- Contractor may obtain a current list of Weed Free Forage Crop Producers by contacting the Colorado Department of Agriculture at (303) 239-4149

Example of stamp or affixed sticker to be placed on Certified Test Reports (CTRs) Electronic CTR Stamp Instructions are located at the end of this chapter. As per CDOT PD 21.1 and CDOT PD 508.1

|   |  |
|---|--|
| <p>I hereby certify under penalty of perjury that the material listed in this Certified Test Report represents _____(quantity and units) of pay item _____</p> <p>_____</p> <p>(pay item # and description) that will be installed in conformance with the plans and specifications on Project Number _____ .</p> <p>_____</p> <p style="text-align: center;"> <span style="margin-right: 200px;">Contractor Rep. Signature</span> <span>Date</span> </p> |  |
|---|--|

Example of stamp or affixed sticker to be placed on Certificates of Compliance (COCs) Electronic COC Stamp instructions are located at the end of this chapter. As per CDOT PD 21.1 and CDOT PD 508.1.

|  |       |
|--|-------|
| I hereby certify under penalty of perjury that the material listed in this Certificate of Compliance represents _____ (quantity and units) |       |
| of pay item _____  |       |
| _____  |       |
| (pay item # and description) that will be installed in conformance with the plans and specifications on Project Number _____ .             |       |
| _____  | _____ |
| Contractor Rep. Signature  | Date  |

#### 7.3.d. PRE-APPROVED (APL):

The Pre-Approved method of acceptance is when a manufacturer is required to submit all relevant documentation on their product in advance of any specific project. A primary requirement to be considered for the Approved Products List (APL) is that the material retains a very high level of uniformity and consistency in its production quality (i.e. not project specific).

The submittal of Product literature /Tech Data Sheet (TDS), Certificates of Compliance, Certified Test Reports, Materials Safety Data Sheets (MSDS), etc., as well as product samples for specific categories combine all previous methods of acceptance into one. A Manufacturer whose product is not currently on the APL should read and follow the instructions within the Notice to Manufacturers on the APL web site at <https://www.codot.gov/business/apl>

Product evaluations can take a minimum of four months to in excess of two years for some product categories. If CDOT specifications need to be altered or created for a product's acceptance then it could take even longer.

In accordance with CDOT's Procedural Directive 1401.1, a manufacturer's product is evaluated within CDOT to determine its acceptability on CDOT construction projects, as defined by CDOT specifications, plans and standards. For additional information on the APL or the web site contact the Product Evaluation Coordinator within the Staff Materials & Geotechnical Branch at: [edward.trujillo@state.co.us](mailto:edward.trujillo@state.co.us) or 303-398-6566.

Locate products on the web site at: <https://www.codot.gov/business/apl> then go to APL search, and then use the referenced Category, the Manufacturer's name, or the Product name. A category search requires that the drop-down menus be used.

## APL User Guidance

1. If three or more products are listed for any applicable category then one of these products shall be selected. If the category is unpopulated a COC will be required for the product actually used. If the category is under-populated a COC will be required for the product actually used if not from the APL. CDOT's Subject Matter Expert (SME) for the applicable category shall be contacted for assistance. A CTR may be requested if the Project Engineer deems it appropriate. Contact the CDOT Product Evaluation Coordinator at: [edward.trujillo@state.co.us](mailto:edward.trujillo@state.co.us) or 303-398-6566 for a list of SME's or assistance with any questions.
2. Products that are evaluated on a batch or lot basis and subsequently posted on the APL web site will not be posted indefinitely. They expire two years after their CTR date or they will be removed sooner if informed that the batch or lot is depleted. Specifically this refers to (1) single component, hot-applied, elastomeric membranes for bridge decks, (2) hot poured, joint/crack sealant, and (3) asphalt plug joints. The Batch # or Lot # must be included in the CTR.
3. Asphalt Binder and Asphalt Emulsions: Approved asphalt binders and emulsions are valid for the calendar year in which they were tested and approved, as per CP 11. The year is incorporated into the product name. On February 1<sup>st</sup> of each calendar year all products from two previous years will be automatically removed. CDOT Asphalt SME: [michael.stanford@state.co.us](mailto:michael.stanford@state.co.us)
4. Environmental Erosion Control and Sediment / Pollution Control: All questions regarding this category's materials, both the current specifications and the products, should be directed to the CDOT Staff Environmental Branch SME: [greg.fischer@state.co.us](mailto:greg.fischer@state.co.us)
5. Traffic Control Pavement Marking Material Sub-Category: All questions regarding pavement marking materials, both the current specifications and the products, should be directed the CDOT Staff Traffic Branch SME: [manjari.bhat@state.co.us](mailto:manjari.bhat@state.co.us) or [Thomas.dinardo@state.co.us](mailto:Thomas.dinardo@state.co.us)
6. Geosynthetics and Geotextiles:  
CDOT Materials and Geotechnical SME: [david.thomas@state.co.us](mailto:david.thomas@state.co.us)  
<https://www.codot.gov/business/designsupport/materials-and-geotechnical/materials-bulletins/Materials%20Bulletin%202008%20No%201.pdf/view>  
This Materials Bulletin clarifies the terminology and application of geosynthetics as specified in the Standard Specifications and the Standard Special Provision (SSP), *Revision of Sections 208, 420, 605, and 712 – Geosynthetics and Geotextiles*.  
Only geotextiles on the New York DOT's Approved Products List (NY APL) may be used on CDOT projects.  
The web address for the NY APL is:  
<https://www.dot.ny.gov/divisions/engineering/technical-services/technical-services-repository/alme/pages/470-1a.html>  
Or follow the New York State web site navigation process you can refer to (NYDOT APL Instructions) at [www.dot.ny.gov/index?nd=nysdot](http://www.dot.ny.gov/index?nd=nysdot) . (See Item 420 on the OA Schedule for instructions should the direct link be broken.)



**Note:** If a proposed geotextile product is not on the NY APL, the manufacturer will need to contact NYDOT and submit samples for testing and approval prior to use on a CDOT project. All geotextiles shall conform to AASHTO M 288; the tables in Subsection 712.08 of the Standard Specifications have been deleted by the SSP, *Revision of Sections 208, 420, 605, and 712 – Geosynthetics and Geotextiles*.

7. Concrete Mix Designs:

The APL website <https://www.codot.gov/business/apl/concrete-mix-designs> contains a folder listing concrete mix designs that have been pre-approved. When a concrete mix is placed on the APL, it meets the most current CDOT Standard Specifications; however, it may not meet a CDOT project's Special Provisions. CP 62 is the procedure for approving all concrete mixes for use on a CDOT project. (Review FMM Chapter 600). Contact [valentino.niculae@state.co.us](mailto:valentino.niculae@state.co.us) or 303-398-6549 for further information.

8. Warm Mix Asphalt (WMA) Mixes:

The APL website contains a folder listing approved WMA technologies and a folder listing approved contractors for specific WMA technologies that have been pre-approved for use on CDOT Projects. Use of a WMA mix on a Project shall be approved by the Project Engineer with the concurrence of the Region Materials Engineer. Warm Mix Asphalt SME: [michael.stanford@state.co.us](mailto:michael.stanford@state.co.us)

9. Contractors are required to submit a document entitled Contractor's APL Verification along with a copy of the CDOT Form 595 to the project engineer documenting the selection of the CDOT APL products that they wish to include for project incorporation. (Example included in this chapter.)

10. APL Quality Assurance Program: Upon selecting the sub-category or base-category the Product Identification Number (PID), Product Name, Manufacturer, and Comments will be displayed.

- A. By clicking on the PID / CDOT Form 595 the Pre-Approved Product Evaluation Request & Summary will be displayed. This will provide the customer with both a mini product data sheet and the information necessary for additional product analysis for specific utilization.
- B. If a product fails to perform within minimum quality expectations contact the CDOT Product Evaluation Coordinator [edward.trujillo@state.co.us](mailto:edward.trujillo@state.co.us) or 303-398-6566, immediately via e-mail also listed in the APL web site.

**DISCLAIMER:** The Colorado Department of Transportation (CDOT) is not obligated to any manufacturer to use any of their products listed in the Approved Products List (APL). The APL simply documents that the listed products have been reviewed, tested, and evaluated against CDOT standards, and were found to be acceptable to be used in CDOT projects. Acceptance is based on product quality; however, price or availability may be the determining factor by a contractor or sub-contractor on the CDOT project.

The product shall be removed from the APL if Product Performance comments indicate that field performance is unacceptable to CDOT quality standards or if the product varies from the data as originally submitted. Additional disclaimer information can be found within the APL web site.

## APL Categories

**Note 5:** Adhesives are no longer listed in the APL. They will be used as project by project basis only. Contact Staff Bridge Subject Matter Expert for further information: [mohamed.zaina@state.co.us](mailto:mohamed.zaina@state.co.us)

**Note 6:** Maintenance\Alternate Traction Devices: House Bill 19-1207 CRS 42-4-106 (5)(a) (I) (F) 2 CCR 601-14 Rules Governing Chain Law and Passenger Vehicle Traction Law Requirements on the State Highways.  
<https://www.sos.state.co.us/CCR/GenerateRulePdf.do?ruleVersionId=8590&fileName=2%20CCR%20601-14>

Contact the Maintenance Staff Engineer for further information: [tyler.weldon@state.co.us](mailto:tyler.weldon@state.co.us)

**Note 7:** Sealant\Mastic\Black for Asphalt/ Grey for Concrete used for Bridge Construction will be Project Special only, for further information contact: [edward.trujillo@state.co.us](mailto:edward.trujillo@state.co.us) . For the Maintenance requirement for the Sealant must meet the required AASHTO / ASTM specifications, for further information contact: [tyler.weldon@state.co.us](mailto:tyler.weldon@state.co.us).

**Note 8:** Traffic Control\Reflective Element\Delineator Post Marker will not be listed in the APL Staff Traffic is moving to replace the product to the Flexible Post Reflector. The project can continue to purchase the Delineator Post Marker (Reflector) as a Project Special only. For further information contact: [manjari.bhat@state.co.us](mailto:manjari.bhat@state.co.us) or [Thomas.dinardo@state.co.us](mailto:Thomas.dinardo@state.co.us)

**Note 9:** Sound Barrier Wall: *Acceptance Method:* Project by Project approval only. The Contractor shall provide the Engineer with one copy of **Certified Test Reports** (*furnished by the supplier*) to validate the structural values required of the wall. Field-inspect and document on CDOT Form 157 that the material is acceptable, then retain all copies in the Project Files. Contact the Staff Bridge SME: [Andy.Pott@state.co.us](mailto:Andy.Pott@state.co.us) for the structure requirements. Contact the Standards and Specifications SME [Joshua.j.palmer@state.co.us](mailto:Joshua.j.palmer@state.co.us) for the MASH 09 testing requirements. Contact the Air Quality and Noise Program Manager SME [rose.waldman@state.co.us](mailto:rose.waldman@state.co.us) for the acoustic qualities guidance.

The CDOT APL currently does not have any listings for Sound Barrier Wall Product Specifications are under development. Currently the Reflective Sound Barrier Walls and Absorptive Sound Barrier Walls are placed on the APL solely based on the acoustic qualities only

**Note 10:** Concrete\Grout\Post Tensioned: Project By Project approval only. This product is no longer on the CDOT Approved Products List. Contact Concrete Program Manager SME [eric.prieve@state.co.us](mailto:eric.prieve@state.co.us)

| <u>APL Category</u> | <u>APL Sub-Category</u> | <u>APL Base Category</u> | <u>Material Code</u> |
|---------------------|-------------------------|--------------------------|----------------------|
| Adhesive:           | Anchoring, Lateral:     | Acrylic                  | See Note 5           |
|                     |                         | Cementitious             | See Note 5           |
|                     |                         | Epoxy                    | See Note 5           |
|                     | Anchoring, Overhead:    | Polyester                | See Note 5           |
|                     |                         | N/A                      | See Note 5           |
|                     | Bonding:                | Epoxy                    | See Note 5           |
| -----               |                         |                          |                      |
| Asphalt:            | Asphalt Release Agent:  | Truck Bed Only           | 401.09.01.00         |
|                     |                         | Truck & Equipment        | 401.09.01.00         |
|                     | Binder:                 | PG 58-28                 | 702.01.01.01         |
|                     |                         | PG 58-34                 | 702.01.01.02         |
|                     |                         | PG 64-22                 | 702.01.01.03         |
|                     |                         | PG 64-28                 | 702.01.01.04         |
|                     |                         | PG 70-28                 | 702.01.01.05         |
|                     |                         | PG 76-28                 | 702.01.01.06         |
|                     | Emulsion:               | CSS-1                    | 702.03.18.00         |
|                     |                         | CSS-1h                   | 702.03.19.00         |

|                   |                    |              |
|-------------------|--------------------|--------------|
|                   | CRS-2              | 702.03.15.00 |
|                   | CRS-2P             | 702.03.21.00 |
|                   | CRS-2R             | 702.03.23.00 |
|                   | CQS-1h             | 702.03.20.00 |
|                   | HFMS-2             | 702.03.08.00 |
|                   | HFMS-2s            | 702.03.10.00 |
|                   | HFMS-2P            | 702.03.25.00 |
|                   | HFMS-2sP           | 702.03.26.00 |
|                   | HFMS-2h            | 702.03.09.00 |
|                   | HFRS-2P            | 702.03.24.00 |
|                   | SS-1               | 702.03.11.00 |
|                   | SS-1h              | 702.03.12.00 |
|                   | ARA-1P             | 702.04.02.00 |
| Hydrated Lime:    | N/A                | 712.03.01.00 |
| Roadway Patching: | Pre-Mixed [Bagged] | 401.02.01.00 |

| <u>APL Category</u> | <u>APL Sub-Category</u>    | <u>APL Base Category</u> | <u>Material Code</u> |
|---------------------|----------------------------|--------------------------|----------------------|
| Bridge Structures:  | Geocomposite Drain:        | N/A                      | 712.08.01.01         |
|                     | Thin Bonded Overlay:       | Epoxy                    | 519.01.00.00         |
|                     |                            | Non-Epoxy                | 519.01.00.00         |
|                     | Structural Wrapping Repair | N/A                      | 601.09.02.00         |

| <u>APL Category</u> | <u>APL Sub-Category</u> | <u>APL Base Category</u>             | <u>Material Code</u>           |              |
|---------------------|-------------------------|--------------------------------------|--------------------------------|--------------|
| Concrete:           | Admixture:              | Air Entraining                       | 711.02.01.00                   |              |
|                     |                         | Water-Reducing                       | 711.02.01.00                   |              |
|                     |                         | Retarding                            | 711.02.01.00                   |              |
|                     |                         | Accelerating                         | 711.02.01.00                   |              |
|                     |                         | Water-Reducing & Retarding           | 711.02.01.00                   |              |
|                     |                         | Water-Reducing & Accelerating        | 711.02.01.00                   |              |
|                     |                         | Water-Reducing, High Range           | 711.02.01.00                   |              |
|                     |                         | Water-Reducing, HR & Retard.         | 711.02.01.00                   |              |
|                     | Concrete                | Admixture                            | Extended Set-Control           | 711.02.01.00 |
|                     |                         |                                      | Specific Performance           | 711.02.01.00 |
|                     |                         |                                      | (Concrete) Corrosion Inhibitor | 711.02.01.00 |
|                     |                         |                                      | Pigments, Integrally Colored   | 711.02.01.00 |
|                     |                         |                                      | Miscellaneous                  | 711.02.01.00 |
| Concrete            | Curing Compound:        | Type 1 [Clear, Wax Based]            | 711.01.01.00                   |              |
|                     |                         | Type 1 [Clear, Resin Based]          | 711.01.01.00                   |              |
|                     |                         | Type 2 [White Pigmented, Wax Base]   | 711.01.01.00                   |              |
| Concrete            | Cement:                 | Type 2 [White Pigmented, Resin Base] | 711.01.01.00                   |              |
|                     |                         | Portland Cement, ASTM C 150          | 701.01.01.00                   |              |
|                     |                         | Blended Cement, ASTM C 595           | 701.01.02.00                   |              |
|                     |                         | Hydraulic Cement, ASTM C 1157        | 701.01.03.00                   |              |
|                     |                         | Blended Cement [Type IL] [MS]        | 701.01.02.06                   |              |
|                     |                         | Blended Cement [Type IL] [HS]        | 701.01.02.07                   |              |
|                     |                         | Blended Cement [Type IT] [MS]        | 701.01.02.08                   |              |
|                     |                         | Blended Cement [Type IT] [HS]        | 701.01.02.09                   |              |
|                     |                         | Slag Cement / Slag Grade 100         | 701.05.01.01                   |              |
|                     |                         | Slag Cement / Slag Grade 120         | 701.05.01.02                   |              |

|           |                                |  |                     |
|-----------|--------------------------------|--|---------------------|
| Concrete: | Pozzolan:                      | Fly Ash, Class C                       | 701.02.01.00        |
|           |                                | Fly Ash, Class F                       | 701.02.02.00        |
|           |                                | High Reactivity                        | 701.02.04.00        |
|           |                                | Silica Fume                            | 701.03.01.00        |
|           | Fiber:                         | Macro Fiber                            | 709.04.02.00        |
|           |                                | Micro Fiber                            | 709.04.02.00        |
|           | Grout:                         | General Purpose [Non-Shrink]           | 601.02.14.00        |
|           |                                | Post-Tensioned Cable                   | See Note 10         |
|           |                                | PCCP Grout                             | 618.09.00.00        |
|           |                                | <b>Region Approved Plant Mix Grout</b> | <b>618.02.14.01</b> |
|           | Tie Bar Anchorage              | PCCP Tie Bar Epoxy                     | 412.13.00.00        |
|           | Repair/Patching:               | Rapid Set, Horizontal                  | 601.09.01.00        |
|           | Rapid Set, Vertical & Overhead | 601.09.01.00                           |                     |
|           | Bonding Agent                  | 601.09.01.00                           |                     |
|           | Class DR [Pre-Packaged]        | 618.08.00.00                           |                     |

| <u>APL Category</u> | <u>APL Sub-Category</u> | <u>APL Base Category</u> | <u>MaterialCode</u> |
|---------------------|-------------------------|--------------------------|---------------------|
| Drainage:           | Culvert Pipe:           | Culvert Lining [Repair]  | 707.12.01.00        |
|                     |                         | Open-Cut/Direct-Bury     | 712.13.02.00        |
|                     | Manholes & Inlets:      | Manhole Riser            | 604.04.01.00        |
|                     |                         | Trench Drain             | 712.14.01.00        |
|                     |                         | Plastic Drains           | 712.14.01.00        |

| <u>APL Category</u>      | <u>APL Sub-Category</u>      | <u>APL Base Category</u>            | <u>Material Code</u> |
|--------------------------|------------------------------|-------------------------------------|----------------------|
| Environmental:           | Sound Wall:                  | Absorptive                          | See Note 9           |
|                          |                              | Reflective                          | See Note 9           |
| Erosion Control:         | Soil Retention Rolled:       | SRB [Biodegradable Class 1]         | 216.02.02.00         |
|                          |                              | SRB [Photodegradable Class 1]       | 216.02.02.00         |
|                          |                              | SRB [Biodegradable Class 2]         | 216.02.02.00         |
|                          |                              | SRB [Photodegradable Class 2]       | 216.02.02.00         |
| Erosion Control:         | Soil Retention Rolled:       | TRM [Class1]                        | 216.02.03.00         |
|                          |                              | TRM [Class 2]                       | 216.02.03.00         |
|                          |                              | TRM [Class 3]                       | 216.02.03.00         |
|                          |                              | TRM [Class 4 / woven]               | 216.02.03.00         |
| Erosion Control:         | Ditch Control:               | Silt Berm                           | 208.02.02.00         |
| Sediment/Pollution Ctrl: | Construction Inlet Protect.: | Storm Drain Inlet Protect. (Type 1) | 208.02.08.01         |
|                          |                              | Storm Drain Inlet Protect. (Type 2) | 208.02.08.01         |
|                          |                              | Storm Drain Inlet Protect. (Type 3) | 208.02.08.01         |
| Sediment/Pollution Ctrl: | Concrete Washout Structure:  | Pre-Fabricated [Above Ground]       | 208.02.14.00         |
| Sediment/Pollution Ctrl: | Vehicle Tracking Control:    | Pre-Fabricated                      | 208.02.15.01         |

| <u>APL Category</u> | <u>APL Sub-Category</u>   | <u>APL Base Category</u>           | <u>Material Code</u> |
|---------------------|---------------------------|------------------------------------|----------------------|
| Maintenance         | Deicing, Liquid           | Magnesium Chloride (Cat. 1)        | 712.04.01.00         |
| Maintenance         | Deicing, Granular         | Brining Salt, Dry, Std (Cat. 8A-B) | 712.04.02.00         |
|                     |                           | Road Salt, Dry, Std (Cat. 8A-R)    | 712.04.02.00         |
|                     |                           | Wet Salt, Std (Cat. 8B)            | 712.04.02.00         |
|                     |                           | Brining Salt, Dry, Fine (Cat. 8C)  | 712.04.02.00         |
|                     |                           | Road Salt, Dry, Fine (Cat. 8C-R)   | 712.04.02.00         |
| Maintenance         | Inhibitor / Enhancer      | Corrosion Inhib, NaCl (Cat. A-1)   | 712.04.02.01         |
|                     |                           | Corrosion Inhib, NaCl (Cat. A-3)   | 712.04.02.01         |
| Maintenance         | Alternate Traction Device | Chain                              | See Note 6           |
|                     |                           | Cable Chain                        | See Note 6           |

| <u>APL Category</u>      | <u>APL Sub-Category</u>       | <u>APL Base Category</u>         | <u>Material Code</u> |
|--------------------------|-------------------------------|----------------------------------|----------------------|
| Paint / Coating:         | Anti-Graffiti:                | N/A                              | 708.02.01.00         |
|                          | Concrete Corrosion Inhibitor: | N/A                              | 708.08.01.00         |
|                          | Epoxy Coating:                | N/A                              | 708.03.03.00         |
|                          | Structural Concrete Coating:  | N/A                              | 708.08.01.00         |
|                          | Structural Steel Paint:       | N/A                              | 708.03.02.00         |
|                          | Wire Coating:                 | N/A                              |                      |
| -----                    |                               |                                  |                      |
| Pedestrian Safety:       | ADA Truncated Dome:           | Embedded                         | 608.02.03.00         |
|                          |                               | Retrofit                         | 608.02.03.00         |
|                          | Joint System                  | N/A                              | 705.01.03.00         |
| -----                    |                               |                                  |                      |
| Right-of-Way Structure:  | Mailbox Support System:       | N/A                              | 210.13.01.00         |
|                          | Utility Enclosure:            | N/A                              | 604.04.02.00         |
|                          | Fence, Non-Standard Coating   | N/A                              | 710.03.01.00         |
|                          | Pole Base Hardware:           | N/A                              | 713.05.01.00         |
| -----                    |                               |                                  |                      |
| <u>APL Category</u>      | <u>APL Sub-Category</u>       | <u>APL Base Category</u>         | <u>Material Code</u> |
| Roadway Safety:          | Cable Barrier:                | MASH 2016 TL-3                   | 606.02.06.00         |
|                          |                               | MASH 2016 TL-4                   | 606.02.06.00         |
|                          | Guardrail W-Beam:             | Guardrail End Treatment          | 606.02.03.00         |
|                          |                               | Guardrail End Treat., Spec. App. | 606.02.03.00         |
|                          |                               | Guardrail Synthetic Blockout     | 606.02.04.00         |
|                          | Crash Cushion:                | Sand Barrel Array                | 614.07.02.00         |
|                          |                               | Guardrail Median Terminal        | 606.02.02.00         |
|                          |                               | Barrier End Treatment (Terminal) | 606.02.02.00         |
|                          |                               | Impact Attenuator, Std, Perm.    | 614.07.02.00         |
|                          |                               | Impact Attenuator, Wide, Perm.   | 614.07.02.00         |
|                          |                               | Impact Atten., Lo-Maint, Perm.   | 614.07.02.00         |
|                          |                               | Impact Atten., Spec-App, Perm.   | 614.07.02.00         |
|                          |                               | Pedestrian & Bicycle Vehicle     | 514.05.01.00         |
|                          | Railing                       |                                  | 606.02.05.00         |
| -----                    |                               |                                  |                      |
| Sealant [Joint & Crack]: | Asphaltic Plug Joint:         | N/A                              | 518.03.01.00         |
|                          | Hot Poured, Joint/Crack:      | ASTM D 6690, Type II             | 702.06.01.00         |
|                          |                               | ASTM D 6690, Type IV             | 702.06.02.00         |
|                          |                               | ASTM D 5078                      | 702.06.03.00         |
|                          | Mastic:                       | Black for Asphalt                | See Note 7           |
|                          | Grey for Concrete             | See Note 7                       |                      |
| -----                    |                               |                                  |                      |
| Sealant [Joint & Crack]: | Silicone, Joint:              | Non-Sag                          | 705.01.01.00         |
|                          |                               | Self-Leveling                    | 705.01.01.00         |
|                          | Pre-Formed Joint Filler:      | N/A                              | 705.01.02.00         |
|                          | Loop Detector Slot:           | One Component                    | 705.01.01.00         |
| Two Component            |                               | 705.01.01.00                     |                      |
| -----                    |                               |                                  |                      |
| Soil / Geotechnical:     | Stabilization:                | Chemical, Liquid                 | 308.03.02.01         |
|                          | Void Elimination:             | Polyurethane Foam, Hi Density    | 308.03.02.01         |
| -----                    |                               |                                  |                      |

| <u>APL Category</u> | <u>APL Sub-Category</u>                   | <u>APL Base Category</u>   | <u>Material Code</u> Traffic   |
|---------------------|---|--|--|
| Control:            | Portable Changeable Message:Trailer Mount | 630.03.01.00   |  |
|                     | Arrow Board:                              | Vehicle Mount<br>Type A<br>Type B<br>Type C<br>Type D  | 630.03.01.00<br>630.03.01.00<br>630.03.01.00<br>630.03.01.00<br>630.03.01.00   |
|                     | Speed Notification:                       | Radar/Message Trailer<br>Speed Display Trailer<br>Speed Display Device   | 630.03.01.00<br>630.03.01.00<br>630.03.01.00   |
|                     | Traffic Control Enhancement:              | AFAD<br>Flashing Beacon<br>Warning Light<br>Raised Island, Temporary<br>Rumble Strip, Temporary<br>Glare Screen  | 630.04.01.00<br>614.06.01.00<br>630.08.02.00<br>630.08.02.00<br>630.08.02.00<br>630.08.01.00   |
|                     | Channelizing Device:                      | Cone<br>Tubular Marker<br>Vertical Panel<br>Drum<br>Barricade, Type 1<br>Barricade, Type 2<br>Barricade, Type 3  | 630.05.01.00<br>630.05.02.00<br>630.06.01.00<br>630.06.02.00<br>630.06.02.00<br>630.06.02.00<br>630.06.02.00   |
| <u>APL Category</u> | <u>APL Sub-Category</u>                   | <u>APL Base Category</u>   | <u>Material Code</u>   |
| Traffic Control     | Channelizing Device:                      | Direction Indicator Barricade<br>Longitudinal Channelizing Device<br>Opposing Traffic Lane Divider   | 630.02.02.00<br>630.06.04.00<br>630.06.03.00   |
|                     | Delineator:                               | Flexible Post<br>Flexible, Multiple Hit Post<br>Guardrail Mount  | 612.02.02.00<br>612.02.02.00<br>612.02.02.00   |
|                     | Reflective Element:                       | Barrier (Solid Wall) Marker<br>Guardrail & Post Marker<br>Delineator Post Marker<br>Linear Reflector Strip   | 612.02.04.00<br>612.02.04.00<br>See Note 8<br>612.02.05.00   |
|                     | Post Anchoring:                           | Mechanical System<br>Polyurethane Foam, Backfill   | 612.05.01.00<br>614.02.03.00   |
|                     | Traffic Barrier, Temporary:               | Barrier, Non-Concrete<br>Barrier Gate<br>Concrete Pre-Cast Barrier [Type 7]  | 630.07.01.00<br>630.07.01.00<br>630.08.00.00   |
|                     | Crash Cushion, Temporary:                 | Impact Attenuator, Temporary<br>Truck Mounted Attenuator (TMA)<br>Trailer Mounted Attenuator   | 630.08.04.00<br>630.08.03.00<br>630.08.03.00   |
| Traffic Control:    | Sign Stand:                               | N/A  | 630.02.01.00   |
| Traffic Control:    | Pave. Marking Material:                   | Preformed Plastic Tape, Type I, Perm.<br>Preformed Plastic Tape, Type II, Perm.<br>Preformed Plastic Tape, Type III Perm.<br>Thermoplastic, Hot Applied<br>Thermoplastic, Preformed, No-Preheat<br>Thermoplastic, Preformed, Preheat<br>Epoxy Paint, Standard<br>Epoxy Paint, Modified<br>Waterborne<br>Waterborne, Hi-Build<br>Polyurea, Paint<br>Methyl Methacrylate | 713.13.01.00<br>713.13.01.00<br>713.13.01.00<br>713.12.01.00<br>713.14.01.00<br>713.14.01.00<br>713.17.01.01<br>713.17.01.02<br>708.05.02.00<br>708.05.03.00<br>713.17.02.00<br>713.19.01.00 |

|                  |                            |  |              |
|------------------|----------------------------|--|--------------|
|                  |                            | Recessed Pavement Marker               | 713.18.02.00 |
|                  |                            | Raised Flexible Marker (Temp.) 7       | 13.18.01.00  |
|                  |                            | Temp. / Construction, Tape             | 713.16.01.00 |
|                  |                            | Temp. / Construction, Paint            | 713.16.02.00 |
| Traffic Control: | Lighting / Light Standards | Conduit, Pull boxes, misc wiring Items | 613.02.00.00 |

---

| <u>APL Category</u> | <u>APL Sub-Category</u> | <u>APL Base Category</u>            | <u>Material Code</u> |
|---------------------|-------------------------|-------------------------------------|----------------------|
| Traffic Control:    | Sign Sheeting:          | ASTM D4956, Type IV                 | 713.04.01.00         |
|                     |                         | ASTM D 4956, Type V                 | 713.04.01.00         |
|                     |                         | ASTM D 4956, Type VI                | 713.04.01.00         |
|                     |                         | ASTM D 4956, Type VI                | 713.04.01.00         |
|                     |                         | [Roll-up & Cone Collar]             | 713.04.01.00         |
|                     |                         | ASTM D 4956, Type VIII              | 713.04.01.00         |
|                     |                         | ASTM D 4956, Type VIII, Fluorescent | 713.04.01.00         |
|                     |                         | ASTM D 4956, Type IX                | 713.04.01.00         |
|                     |                         | ASTM D 4956, Type IX, Fluorescent   | 713.04.01.00         |
|                     |                         | ASTM D 4956, Type XI                | 713.04.01.00         |
|                     |                         | ASTM D 4956, Type XI, Fluorescent   | 713.04.01.00         |
|                     |                         | Films / Miscellaneous               | 713.04.01.00         |

---

| <u>APL Category</u> | <u>APL Sub-Category</u> | <u>APL Base Category</u>      | <u>Material Code</u> |
|---------------------|-------------------------|-------------------------------|----------------------|
| Waterproofing:      | Concrete Sealer:        | Alkyl-alkoxy Silane           | 515.03.01.00         |
|                     |                         | Non-Alkyl-alkoxy Silane       | 515.03.01.00         |
|                     |                         | Penetrating Epoxy             | 515.03.01.00         |
|                     |                         | Micro-Subsurface Repair       | 515.03.01.00         |
|                     | Elastomeric Membrane:   | Single Component, Hot Applied | 705.09.01.00         |
|                     |                         | Non-Asphaltic                 | 705.08.01.00         |

**Example Letters, Notices and Forms**

**Sample Buy America Certification**

The specification requires the Contractor to certify that he has obtained all the correct certifications from the manufacturers and suppliers and maintain the certifications on file at the project. These Buy America certifications are to be received and approved by CDOT before the materials are incorporated into the project. Once the Contractor receives the Buy America certification from manufacturers and suppliers, the Contractor shall provide CDOT with a Buy America certification such as the example below. CDOT does not accept blanket Buy America letters covering all materials.



Kryptonite Construction Inc.  
13369 W. Rocky Rd.  
Smallville, Colorado 91130  
Phone 999-123-4567

Attn: Project Engineer  
Date: August 3, 2022  
Re: CDOT Contract ID: 53124  
Re: CDOT Project No. CC 00-0000-00

**Subject: Buy America Certification & Exception for Foreign Steel**

Kryptonite Construction hereby certifies that during the month of July 2018 the materials and quantities represented below, to be incorporated into the project, meet the contract Buy America requirements. We also certify that the Buy America Documents and certifications required by Section 106.11 are on file at the project.

1.) 550 LF of 24" culvert pipe for bid item 603-01180

**Minor Exceptions:** \_\_\_ Yes  X  No

Value less than 1/10 of 1% of the total contract cost or \$ 2,500.00 whichever is greater.

Documentation is in our Project Files.

Respectfully,

*Clark Kent*

Clark Kent  
Construction Manager  
Kryptonite Construction Inc.

|   |
|---|
| <p><b>EXAMPLE</b></p> <p><b><u>Buy America Requirements</u></b></p> <p><b>(Per requirements of Subsection 4.1)</b></p> <p><b>(Original Signatures Required, No Facsimiles Accepted)</b></p> |
|---|

Note 1: The Buy America Certification is to always be received by the Project Engineer prior to the steel or iron being incorporated into the project.

Note 2: The delivery date and/or the incorporation date may be included in the letter.

**This example depicts what is to be provided for each delivery.**



### Sample Summary of Buy America Quantities

This is a suggested format for the reconciliation of the Buy America Certification quantities with Installed Quantities. The Contractor shall submit this summary on a monthly basis to the Project Engineer for material incorporated during the previous month. The Project Engineer will verify the information in the Summary and all Buy America certifications provided by the Contractor. Before approving a progress payment, the Resident Engineer will verify that the quantities in the Contractor’s summary document match the quantities in the progress payment.



*Kryptonite Construction Inc.*

**Summary of Buy America Certifications Received for Installed Steel / Iron Products**

CDOT Project No.: CC000-000-00  
 CDOT Contract ID: 53124  
 Summary for the Period Ending: July 2018

|              | Item      | Item Description | Delivery Date | Quantity Delivered to Project | Unit | Delivered Cost * | BUY AMERICA CERTIFICATION Quantity | Installed Quantity | Unit | Installation Month | BUY AMERICA CERTIFICATION Date |
|--------------|-----------|------------------|---------------|-------------------------------|------|------------------|------------------------------------|--------------------|------|--------------------|--------------------------------|
|              | 603-01180 | 24" culvert pipe | 11-Jul-18     | 550                           | LF   |                  | 550                                | 300                | LF   | July               | 9-Jul-18                       |
|              |           |                  |               |                               |      |                  | 550                                | 250                | LF   | August             | 9-Jul-18                       |
| <b>Total</b> | 603-01180 | 24" culvert pipe |               | 550                           | LF   |                  |                                    | 550                | LF   |                    |                                |

Prepared by: \_\_\_\_\_ Title: \_\_\_\_\_ Date: \_\_\_\_\_

\* If there is any foreign steel or iron permanently incorporated into the project the Contractor shall provide documentation of the project delivered cost of that foreign steel or iron.

**EXAMPLE**

Suggested format for the reconciliation of the Buy America Certification quantities with Installed Quantities. The Contractor shall submit this summary to the Project Engineer.

Subsection 4.1.G "The Contractor shall maintain a document summarizing the date and quantity of the material utilizing CDOT Item Number(s) and Item Description(s) delivered to the project, along with the quantity of material installed during the month."

**CLARIFICATION:** This summary example indicates that the Period Ended in October. The Buy America Certification date is from July 9th and the Delivery Date is from July 11th. This example document summarizes the quantity delivered along with the quantity installed.

**Note: This example depicts what is to be provided monthly summarizing delivery and installation.**

### Sample Buy America Certification with Exceptions

The specification requires the Contractor to document the project delivered costs of any foreign steel or iron permanently incorporated into the project. This is an example of the requirement.



Kryptonite Construction Inc.  
13369 W. Rocky Rd.  
Smallville, Colorado 91130  
Phone 999-123-4567

Attn: Project Engineer  
Date: October 4, 2022  
Re: CDOT Contract ID: 53124  
Re: CDOT Project No. CC 00-0000-00

#### Subject: **Buy America Certification & Exception for Foreign Steel**

Kryptonite Construction hereby certifies that during the month of September 2018 the materials and quantities represented below, to be incorporated into the project, meet the contract Buy America requirements. We also certify that the Buy America Documents and certifications required by Section 106.11 are on file at the project.

- 1.) 150 LF of 24” culvert pipe for bid item 603-01180

**Minor Exceptions:**   X   Yes        No

Value less than 1/10 of 1% of the total contract cost or \$ 2,500.00 whichever is greater.  
Documentation is in our Project Files.

- 1.) 16 panels of ADA Truncated Domes which were imported from China were incorporated into the project. The total contract cost to date of imported steel or iron is \$1,831.66.

Respectfully,

*Clark Kent*

Clark Kent  
Construction Manager  
Kryptonite Construction Inc.

**EXAMPLE**  
**Buy America Requirements**  
(Per requirements of Subsection 4.1)  
(Original Signatures Required, No Facsimiles Accepted)



*Kryptonite Construction Inc.*

**Summary of Buy America Certifications Received for Installed Steel / Iron Products**

CDOT Project No.: CC000-000-00

CDOT Contract ID: 53124

Summary for the Period Ending: September 2018

| Item         | Item Description    | Delivery Date | Quantity Delivered to Project | Unit | Delivered Cost * | BUY AMERICA CERTIFICATION Quantity | Installed Quantity | Unit | Installation Month | BUY AMERICA CERTIFICATION Date |
|--------------|---------------------|---------------|-------------------------------|------|------------------|------------------------------------|--------------------|------|--------------------|--------------------------------|
| 603-01180    | 24" culvert pipe    | 25-Sep-18     | 150                           | LF   |                  | 150                                | 150                | LF   | September          | 21-Sep-18                      |
| 608.02.03.00 | ADA Trunc Dome, 2x3 | 27-Sep-18     | 16                            | EA   |                  | 0                                  | 16                 | EA   | September          |                                |
|              |                     |               |                               |      |                  |                                    |                    |      |                    |                                |

Prepared by: \_\_\_\_\_ Title: \_\_\_\_\_ Date: \_\_\_\_\_

\* If there is any foreign steel or iron permanently incorporated into the project the Contractor shall provide documentation of the project delivered cost of that foreign steel or iron.

**EXAMPLE**

Suggested format for the reconciliation of the Buy America Certification quantities with Installed Quantities. The Contractor shall submit this summary to the Project Engineer.

Subsection 4.1.G "The Contractor shall maintain a document summarizing the date and quantity of the material utilizing CDOT Item Number(s) and Item Description(s) delivered to the project, along with the quantity of material installed during the month."

**CLARIFICATION:** This summary example indicates that the Period Ended in September. A Buy America Certification was not provided for the embedded type ADA Truncated Dome panels of a dimension of 2' x 3' each. This summary example correlates to the Buy America Certification & Exception for Foreign Steel document on the preceding page.

American Glass Bead Inc.  
 Desert Ray, Tx. 76660  
 Phone: (254)562-2541  
 Fax: (254)562-2542  
[www.agbi.com](http://www.agbi.com)

**CERTIFIED TEST REPORT**

Colorado Department of Transportation (CDOT) project number: MTCE 03-022  
 Name of Product: AASHTO M 247 Type 1 Colorado Spec Glass Beads  
 \*Product Code: AGBI- 0123  
 Product Batch Number: 021805  
 \*Product date of manufacturing: April 25, 2017  
 \*Quantity Shipped: 44000 Pounds  
 \* Date of Shipment: TBA  
 Laboratory Information:  
 \*AGBI Inc.: HWY 40 & FCR 145  
 \*Testing Date: 2/18/05  
 \* Samples Tested: Samples are from Batch # 021805  
 AASHTO Designation M 247  
 \*AASHTO M 247 Type 1 Colorado Spec  
 Test Results: Gradation (ASTM Standard D 1214)

| Sieve Designation  | Specification for AASHTO M 247<br>Mass Percent Passing (Type 1) | Test Result |
|--------------------|---|-------------|
| No. 20 (0.850 mm)  | 100   | 100         |
| No. 30 (0.600 mm)  | 75-95   | 86.9        |
| No. 40 (0.425 mm)  | -   | -           |
| No. 50 (0.300 mm)  | 15-35   | 24.2        |
| No. 80 (0.180 mm)  | -   | -           |
| No. 100 (0.150 mm) | 0-5   | .7          |

**AASHTO M 247 Type 1: Test Results: Other Properties**

| Element / Method                                  | Specification for AASHTO M 247<br>Specification Limit   | Test Result |
|---|---|-------------|
| Roundness/ASTM D 1155                             | 70% min   | 71.4%       |
| Crushing Resistance<br>ASTM D 1213                | Retained 0.425-mm (No. 40) sieve<br>133N (30 lbs.) min. | Passing     |
| Refractive Index<br>(Ref: TT81325C Section 4.3.3) | 1.50 min  | 1.52        |
| Moisture Resistance                               | Non-Moisture absorption &<br>Free flowing               | Passing     |
| Flotation   | 90% of all beads shall float in xylene                  | n/a         |

Certification of Material: The referenced material meets or complies with the AASHTO M 247 Type 1 Colorado Specification.

\_\_\_\_\_  
 Billy Gibbons / Quality Control

\_\_\_\_\_  
 Date

Example CTR:  
 electronic CTR  
 Stamp instructions  
 are located at the  
 end of this  
 chapter. As per  
 PD 21.1 and PD  
 508.1

I hereby certify under penalty of perjury that the material listed in this Certified Test Report  
 Represents 10,000 Tons (quantity and units)  
 of pay item Glass Beads Item 627  
 (pay item # and description) that will be installed in conformance with the plans and  
 specifications on Project Number NPH-09878.

*Clark Kent*  
 Contractor Rep. Signature

04/03/2020  
 Date

**North-By-Northwest, North-By-Northwest, Inc.**  
**9876 S. Eva-Marie Blvd.**  
**Grant, South Dakota 54321**  
**Phone 999-123-4567**

**Certificate of Compliance**

**Product Name:** Universal Bridge Deck Expansion Joint  
**Model:** UBDEJ-101  
**Lot:** 135-02

**Description:** Pre-formed Silicone gland, that can be bonded directly to an Elastomeric concrete joint interface with a single component silicone-locking adhesive.

**Material Testing Specifications:**

| <u>Property</u>                     | <u>Test Method</u> | <u>Mean Value</u> |
|-------------------------------------|--------------------|-------------------|
| Durometer (Shore A)                 | ASTM D 2240        | 55                |
| Tensile (psi)                       | ASTM D 412         | 650 psi           |
| Elongation (%)                      | ASTM D 412         | 382 %             |
| Tear (die B ppi)                    | ASTM D 624         | 88 ppi            |
| Compression Set<br>At 350°F 22 hrs. | ASTM D 395         | 30 %              |
| Operating Temperature Range         |                    | -60° F to 450° F  |
| Specific Gravity                    |                    | 1.51              |

**State Specification Reference:**  
 Colorado DOT Standard Specifications for Road and Bridge Construction,  
 Section 412.13 (c). Project plans as required.

CDOT Project Number NH 0507-123

The above referenced tests were performed within our laboratory on May 10<sup>th</sup> 2017.  
 All tests passed and the minimum required values were exceeded. Applicable laboratory test reports are available upon your request.

North-By-Northwest, Inc.

John Doe  
 John Doe  
 Manager, Quality Assurance

Date: 12 May 2017

Copy of Certificate of Compliance electronic COC Stamp instructions are located at the end of this chapter. As per PD 21.1 and PD 508.1

I hereby certify under penalty of perjury that the material listed in this Certificate of Compliance represents 100 Linear Feet (quantity and units)  
 of pay item Elastomeric Expansion Devices Item 518  
 (pay item # and description) that will be installed in conformance with the plans and specifications on Project Number NPH 8785.

Clark Kent 04/03/2020  
 Contractor Rep. Signature Date



Kryptonite Construction Inc.  
13369 W. Rocky Rd.  
Smallville, Colorado 91130  
Phone: 999-123-4567

### CONTRACTOR'S APPROVED PRODUCTS LIST VERIFICATION

Date: \_\_\_\_\_  
CDOT Contract ID \_\_\_\_\_  
CDOT Project No.: \_\_\_\_\_  
CDOT Project Location: \_\_\_\_\_

The following material was selected from the CDOT Approved Products List (APL) in accordance with the project plans, the 2019 Standard Specifications for Road and Bridge Construction, and the 2021 Field Materials Manual. Include CDOT Form 595 with this letter if selecting from the APL.

APL Category: \_\_\_\_\_  
APL Sub-Category: \_\_\_\_\_  
APL Base Category: \_\_\_\_\_  
APL Reference No.: \_\_\_\_\_  
Product / Facility Name: \_\_\_\_\_  
Manufacturer: \_\_\_\_\_  
Date of Web Site Review & Selection: \_\_\_\_\_

Kryptonite Construction Inc.

*Clark Kent*

Clark Kent  
Construction Manager

|  |                    |
|--|--------------------|
| I hereby certify under penalty of perjury that the material listed in this Certificate of Compliance represents <u>100 Linear Feet</u> (quantity and units) of pay item <u>Elastomeric Expansion Devices Item 518</u> (pay item # and description) that will be installed in conformance with the plans and specifications on Project Number <u>NPH 8785</u> . |                    |
| <i>Clark Kent</i><br>Contractor Rep. Signature   | 04/03/2020<br>Date |

Example of Approved Products List Certificate of Compliance electronic COC Stamp instructions are located at the end of this chapter. As per PD 21.1 and PD 508.1

# EXAMPLE Pre-Approved Product Evaluation CDOT Form 595

|   |  |   |
|---|--|---|
| <b>COLORADO DEPARTMENT OF TRANSPORTATION</b><br><b>PRE-APPROVED PRODUCT EVALUATION REQUEST &amp; SUMMARY</b>  |  | APL Reference No.<br><b>5040-20</b>   |
| Product Evaluation Coordinator<br>Colorado Department of Transportation<br>4670 North Holly Street, Unit A<br>Denver, Colorado 80216  |  | Material code:<br><b>702.01.01.03</b><br>Material code description full name:<br><b>Asphalt Cement, Binder, PG 64-22</b>  |
| <b>PART 1</b>   |  |   |
| Product name:<br><b>PG 64-22 (2020)</b>   |  | Product category:<br><b>Asphalt \ BinderPG64-22</b>   |
| Product Representative (name & address):<br>Attn: John Cheever<br><br>Aggregate Industries<br>1705 South Acoma Street<br>Denver, Colorado 80225<br><br>Phone: (303) 588-0235 E-mail: John.cheever@aggregate-us.com  |  | Manufacturer (name & address):<br>Attn: John Cheever<br><br>Aggregate Industries / West Region Storage Tank<br>8055 North Peterson Road<br>Sedalia, Colorado 80135<br><br>Phone: (303) 588-0235 E-mail: John.cheever@aggregate-us.com |
| Web-site address: <a href="http://www.Lafargeholcim.com">www.Lafargeholcim.com</a>  |  | Web-site address: <a href="http://www.Lafargeholcim.com">www.Lafargeholcim.com</a>  |
| Description of the product: (Include specific quantifiable details from tech data sheet. Advertising generalities are not appropriate.)<br>Performance grade Asphalt Cement designated as PG 64-22.<br><br>This product is from an Aggregate Industries / West Region storage facility, not a refinery or terminal.   |  |   |
| Restrictions, (Installation and/or use):  |  |   |
| Use of the product, (be specific to CDOT highway activities only):<br>HMA   |  |   |
| Benefits to CDOT, (how will your product enhance quality, improve safety, save money, be a better value than other manufacturer's products):  |  |   |
| Specifications: (listing those applicable is required)<br><input checked="" type="checkbox"/> CDOT : Standard Specification, Table 702-1<br><input type="checkbox"/> ASTM :<br><input type="checkbox"/> AASHTO :<br><input type="checkbox"/> FHWA :<br><input type="checkbox"/> other :<br><input type="checkbox"/> Certificate of Compliance (COC) provided <input type="checkbox"/> Certificate of Verification (COV) provided for select categories ONLY |  |   |
| Product Testing: (National/Independent laboratories or universities with Report Data.) Certified Test Report (CTR) provided to validate all claims.<br><input type="checkbox"/> NTPEP-AASHTO:<br><input type="checkbox"/> FHWA :<br><input checked="" type="checkbox"/> other : CDOT Bituminous Lab<br><input type="checkbox"/> other :<br><input type="checkbox"/> other :   |  |   |
| State DOT Approvals, (current documentation required):  |  | Expiration Date < 2 Yrs, / 02-01-2021   |
| Sample submitted: <input checked="" type="checkbox"/> yes <input type="checkbox"/> no <input type="checkbox"/> n/a  |  | Safety Data Sheets (SDS): <input checked="" type="checkbox"/> yes <input type="checkbox"/> no <input type="checkbox"/> n/a  |
| Alternate Product Category:<br>Additional Comments:   |  |   |

## Instructions on adding the Electronic Certified Stamps onto your Adobe Pro DC

Note: you can access the PDF Stamps from the electronic version of the 2021 FMM use the following link.

<https://www.codot.gov/business/designsupport/materials-and-geotechnical/manuals/2021-fmm/coc-crt-stamp-forms>

Step 1: Download the following Adobe Stamps onto your computer in a file or desktop, fill out the stamp with all of your information and electronically sign the stamp, save and continue with the instructions below.



Certified Test  
Report Stamp vertical



Certified Test  
Report Stamp.pdf



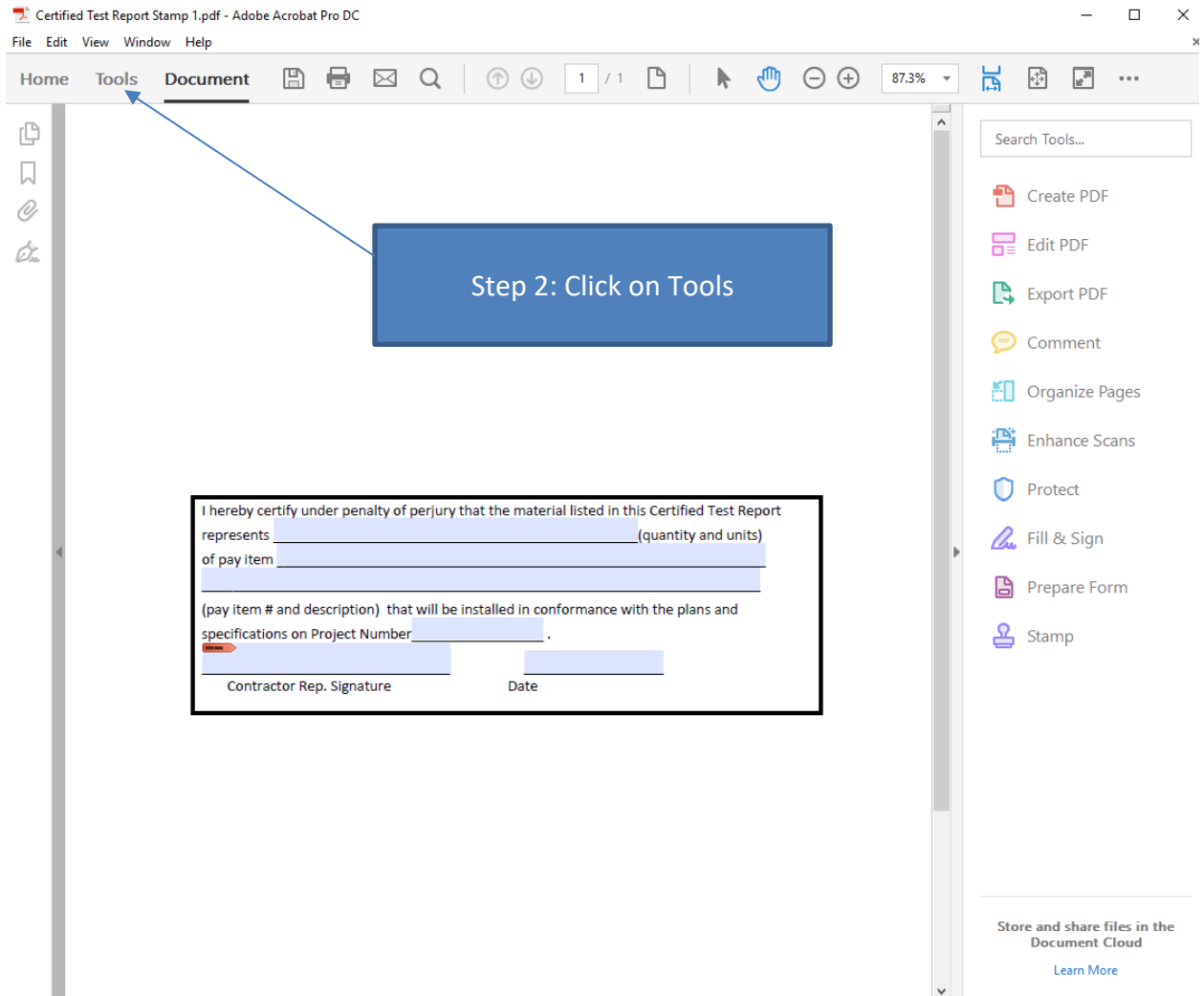
Certificate of  
Compliance Stamp.pdf



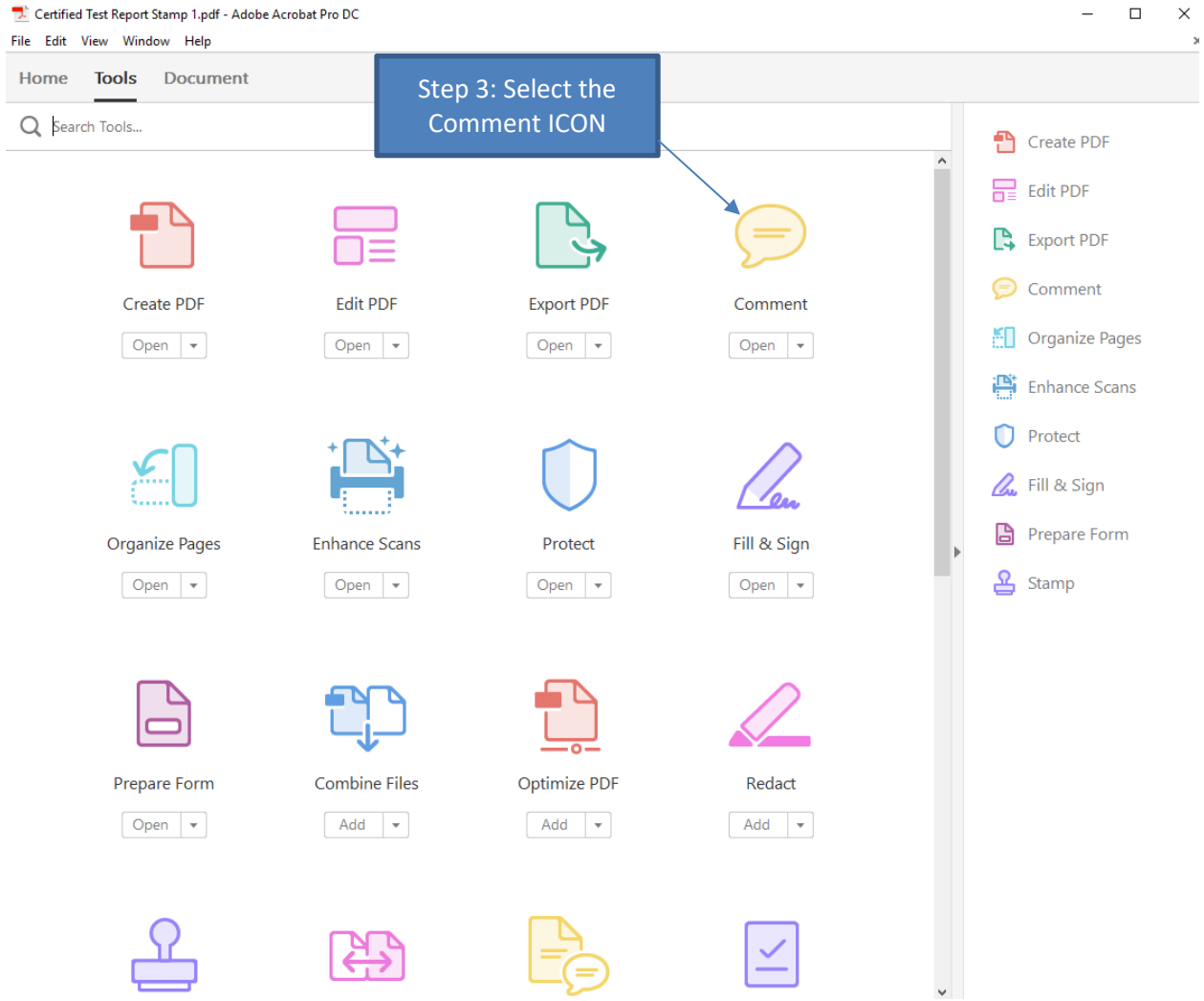
Certificate of  
Compliance Stamp v



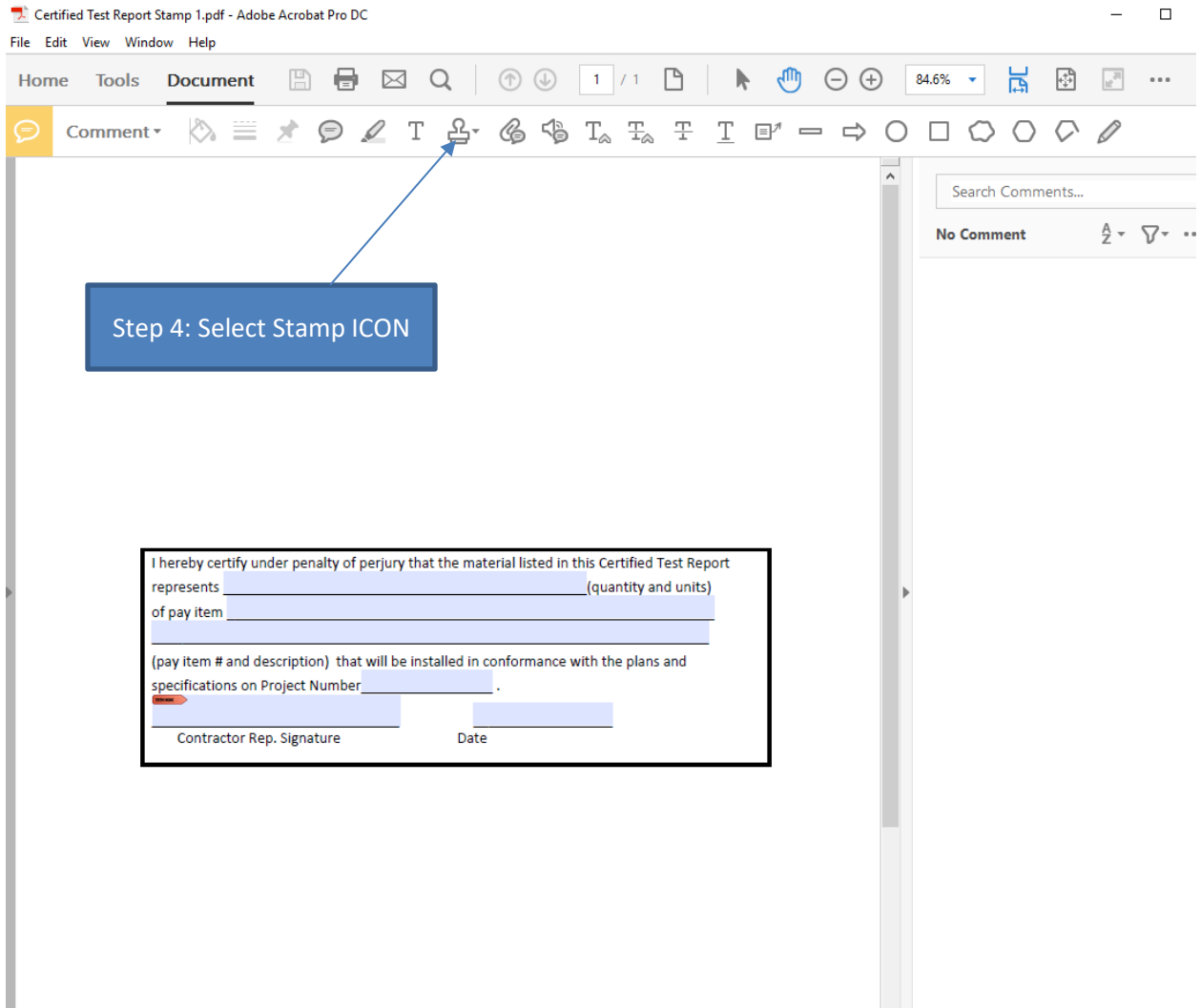
Step 2: Open the file for Certified Stamp using Adobe Pro DC and open "Tools".



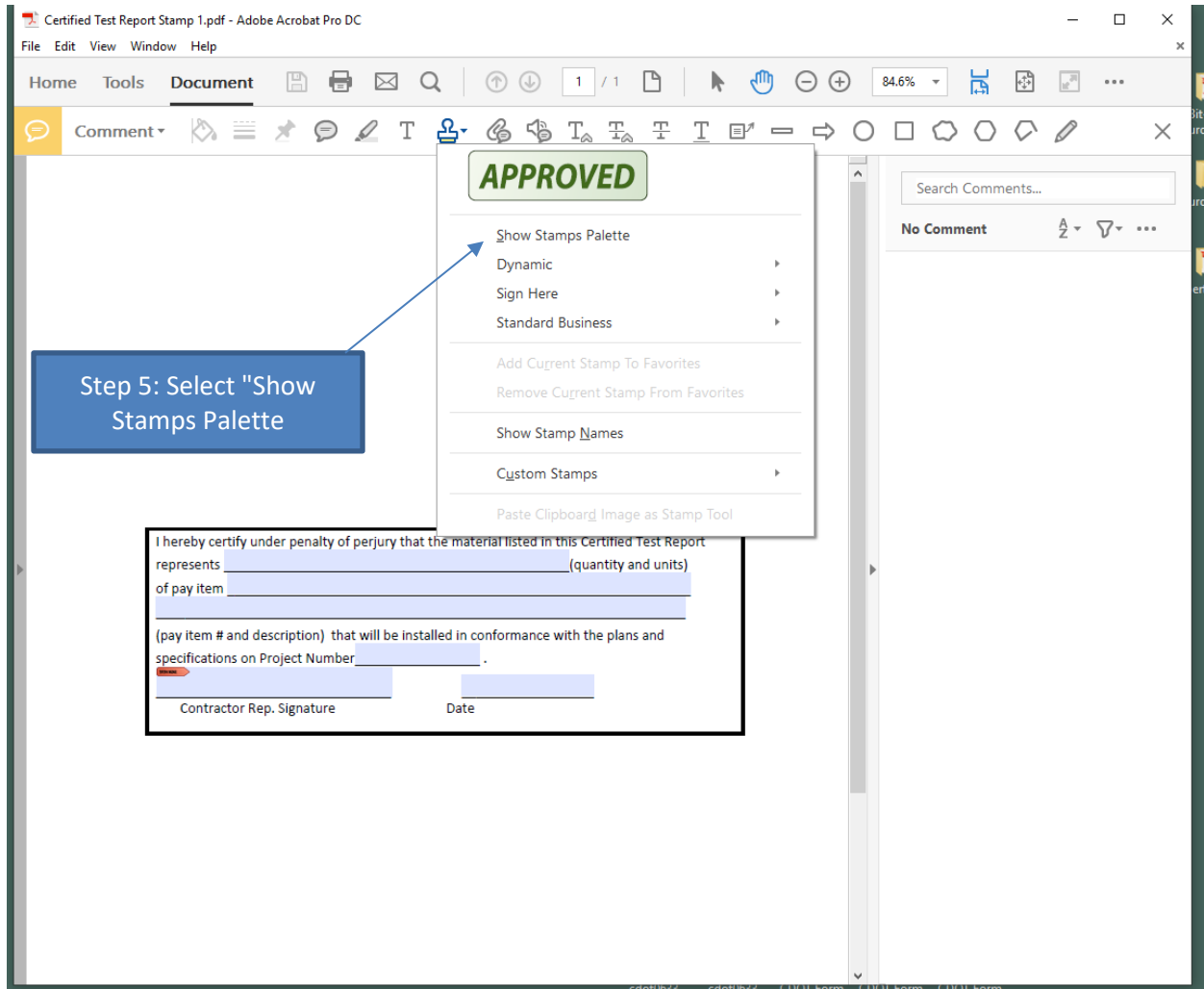
**Step 3: Select the "Comment" ICON.**



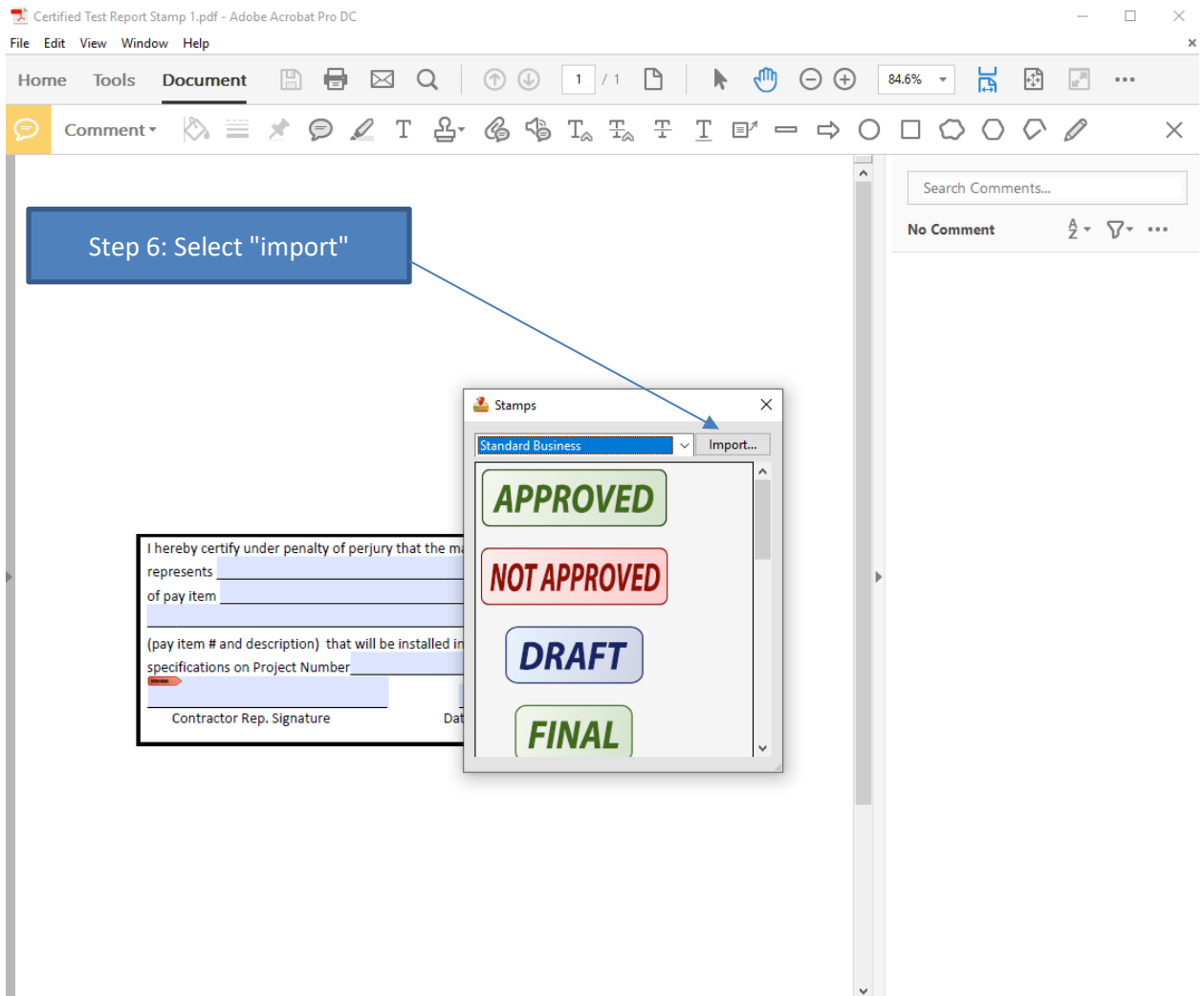
### Step 4: Select Stamp ICON



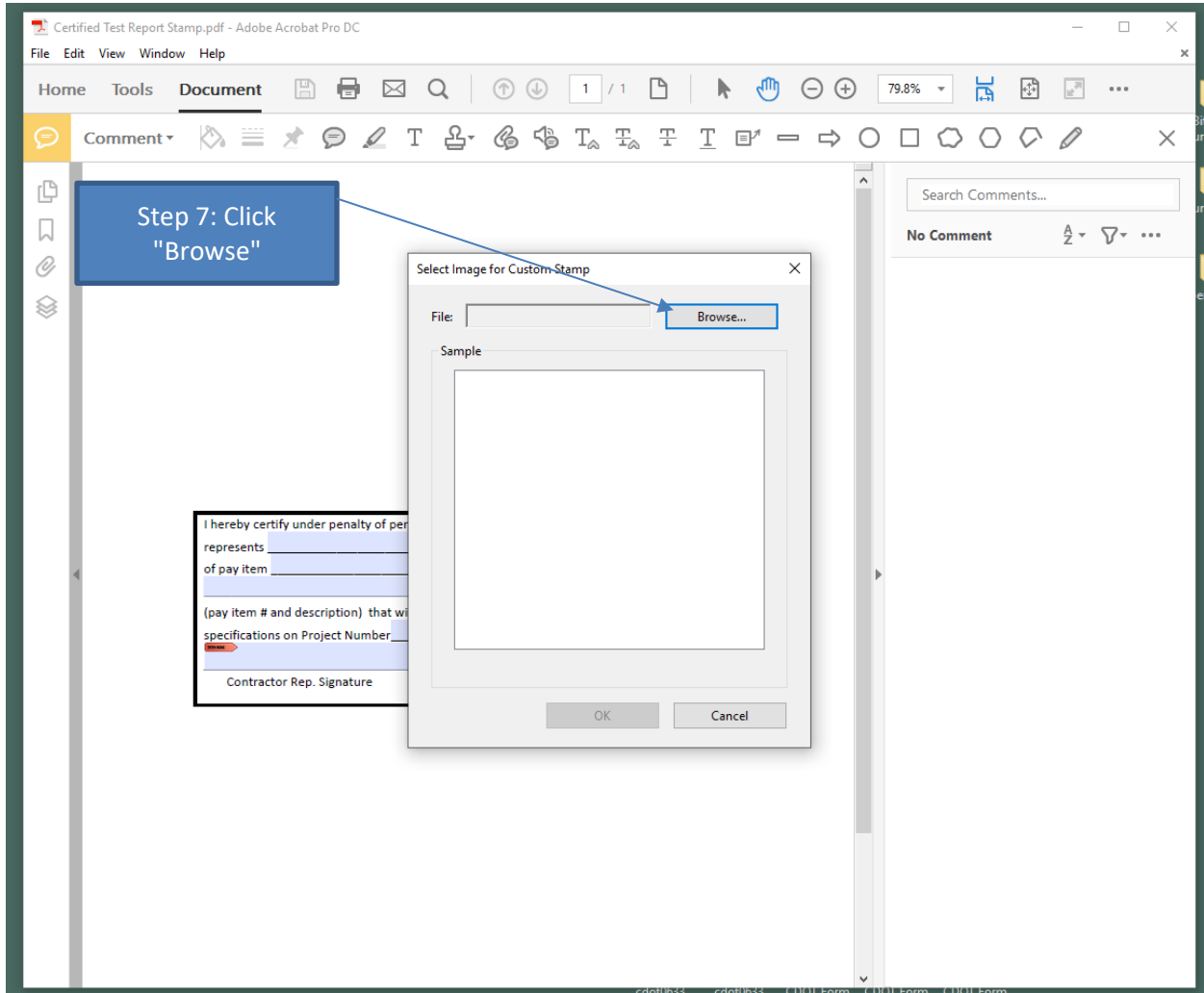
Step 5: Select "Show Stamps Palette"



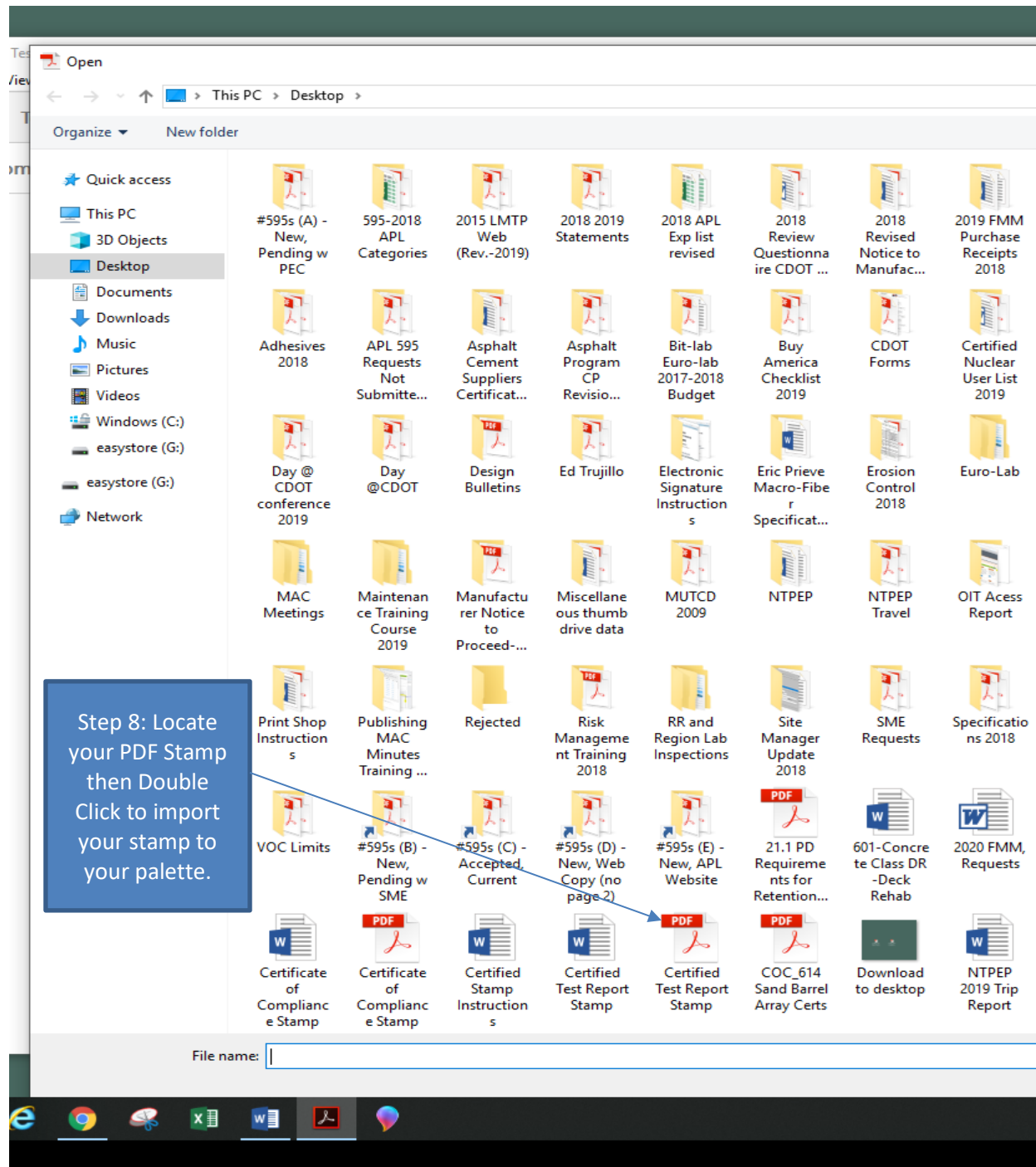
### Step 6: Select "Import"



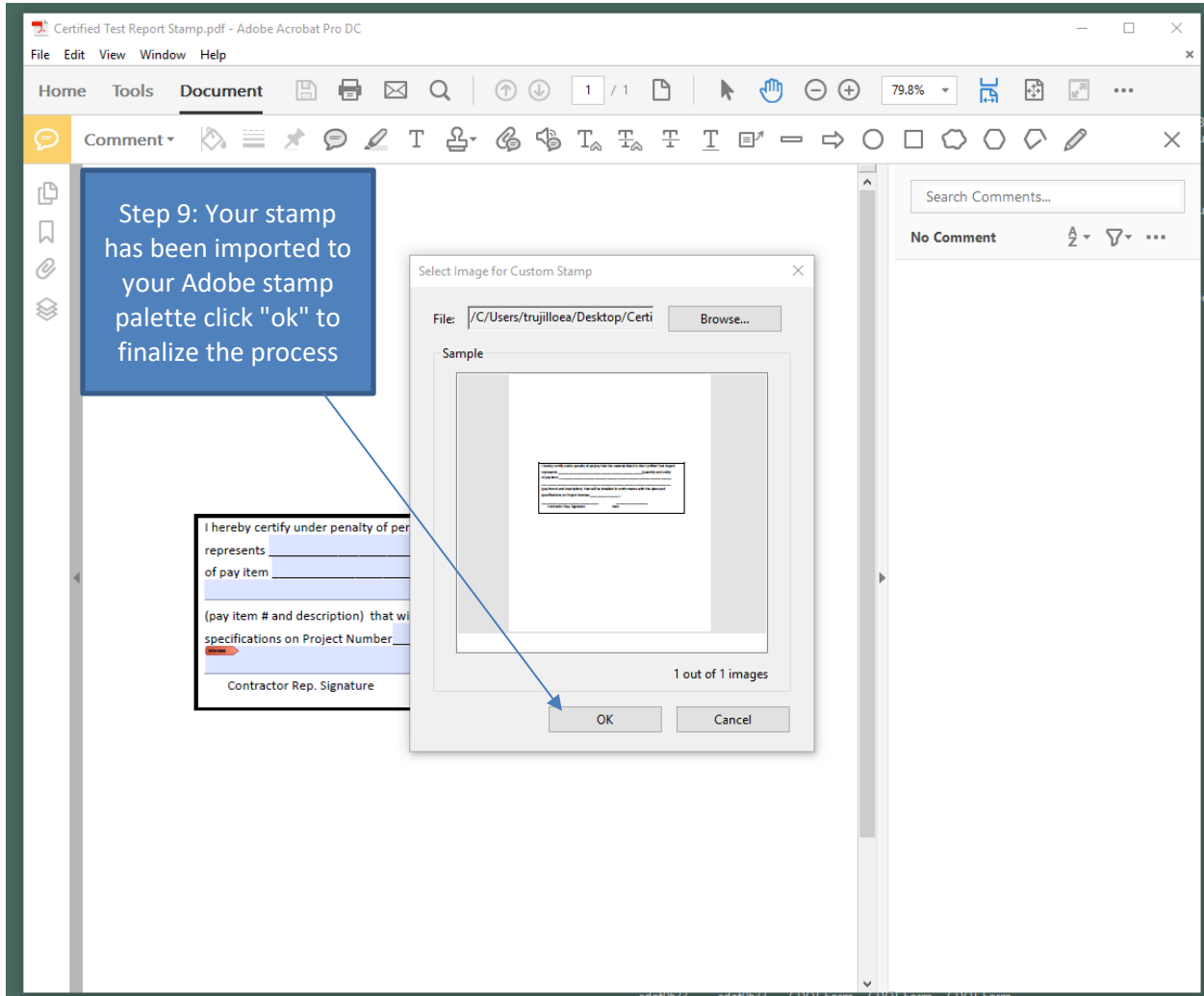
**Step 7: Click on "Browse"**



Step 9: Locate your Stamp on your computer or desktop.

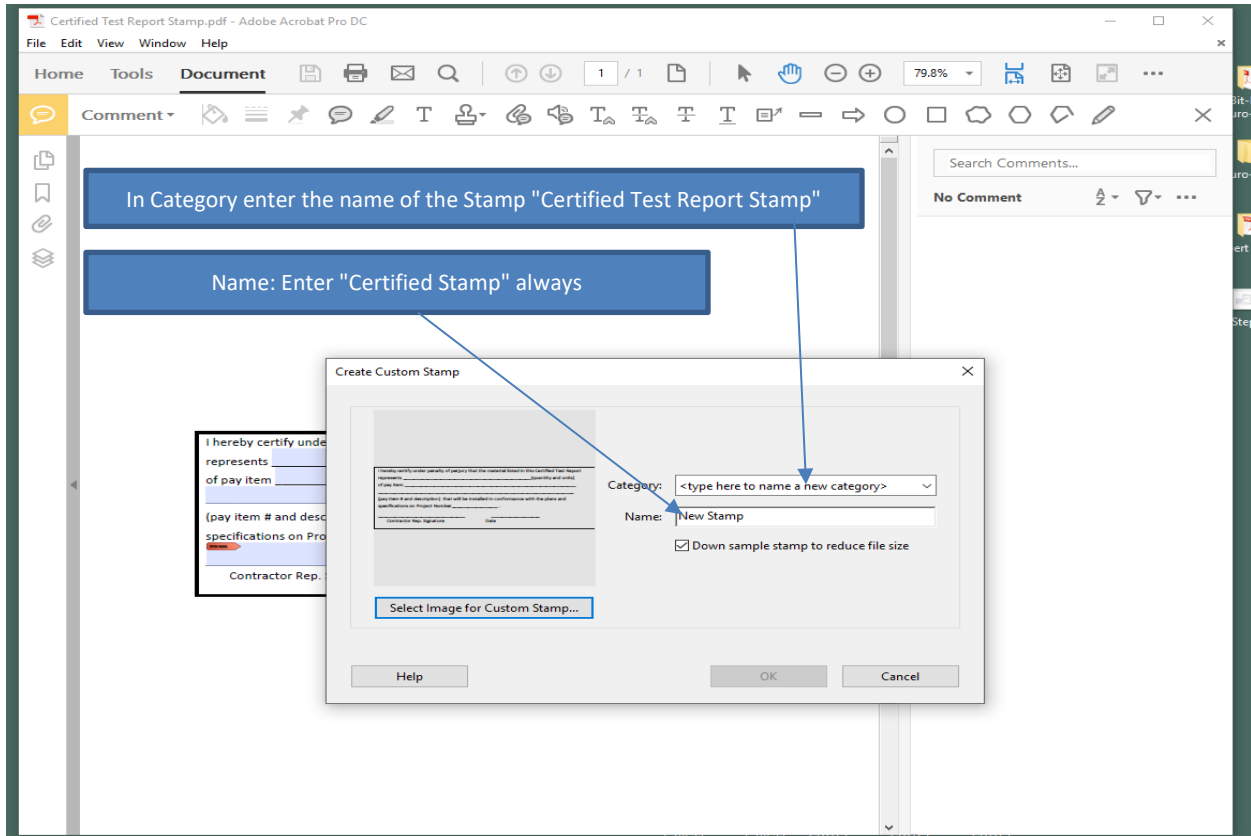


Step 9: Your file "Certified Test Report Stamp" has been imported onto your Electronic Adobe Stamp Palette click "OK" to finalize the process.

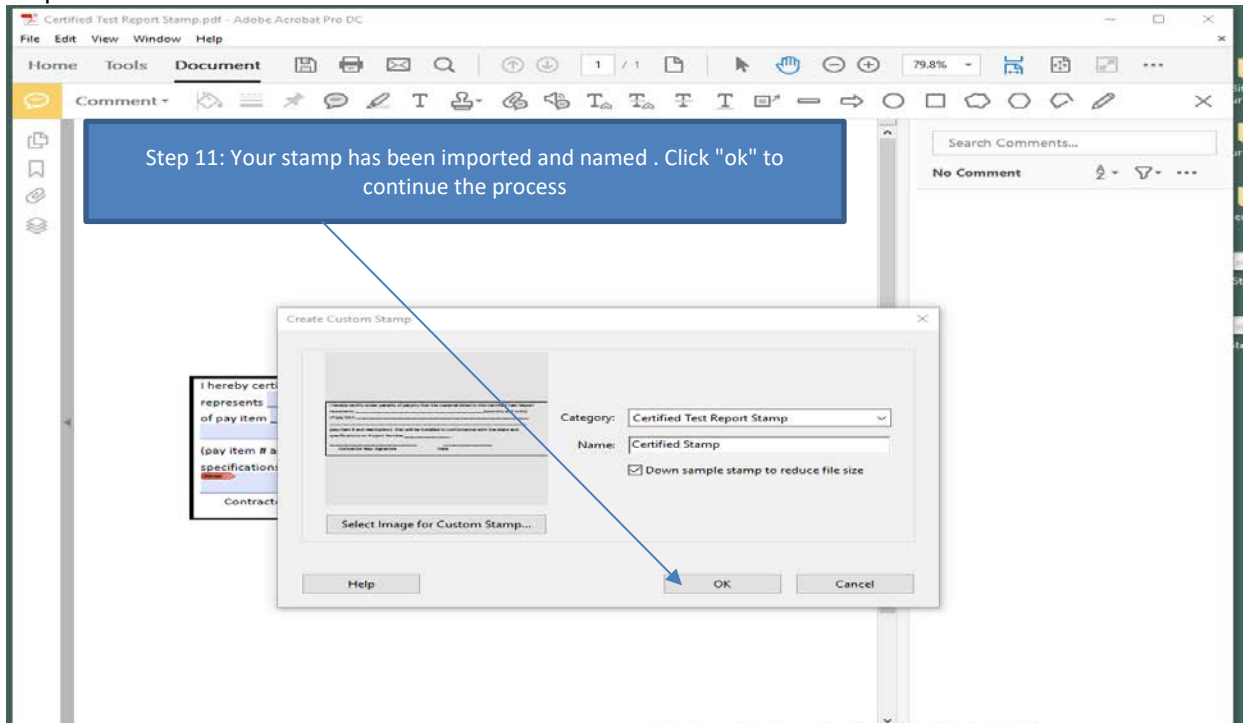




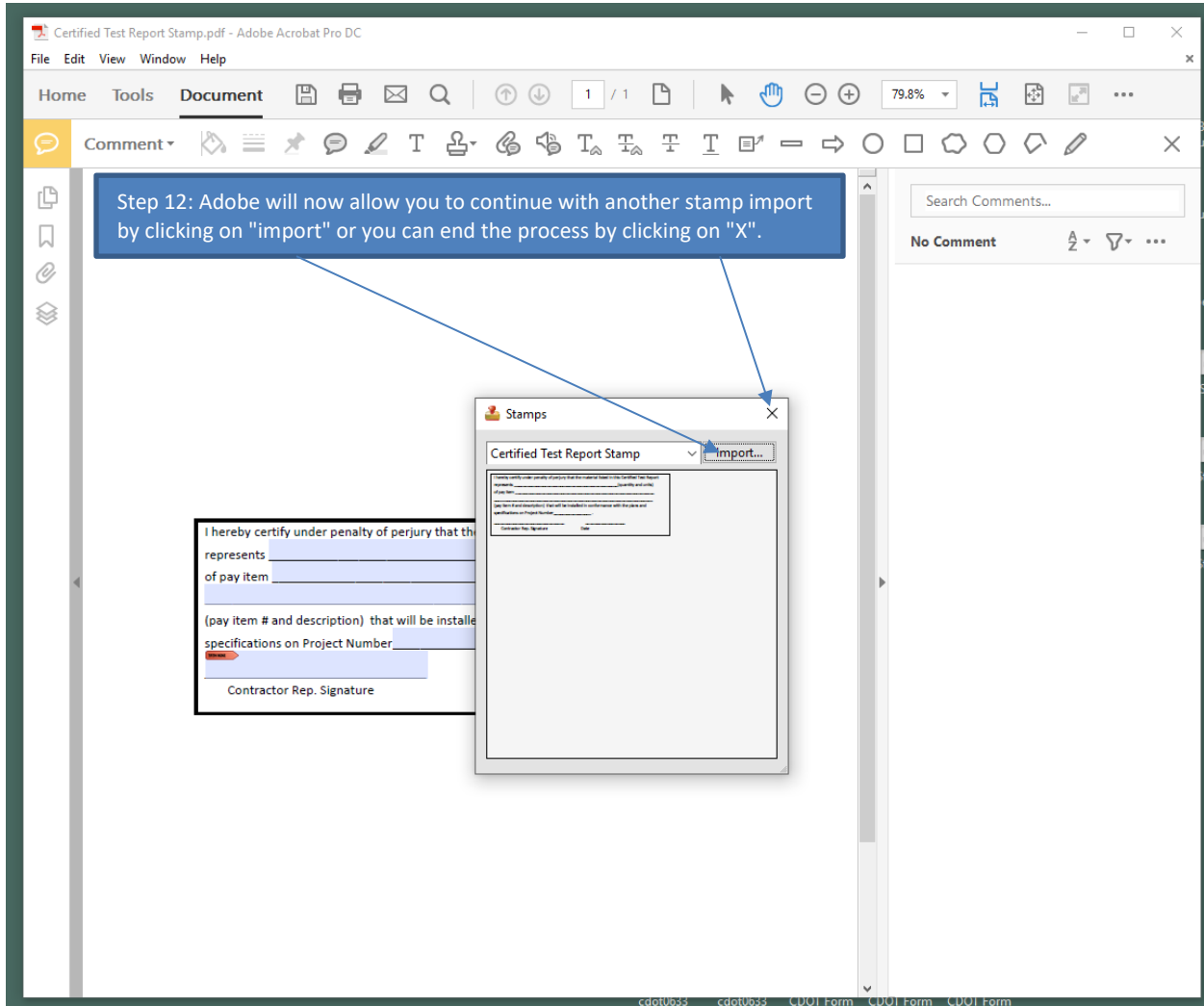
Step 10: You will now name your custom stamp. For "Category" enter the name of the stamp for example "Certified Test Report Stamp".  
For "Name" enter the required name "Certified Stamp" for all of your stamps, this name will not change.



Step 11: Click "ok"



Step 12: Adobe will now allow you to continue with another stamp import by clicking on "import" or you can end the process by clicking on "X". Repeat the steps to add on more stamps in the future.



{Page Intentionally Left Blank}

OA FREQUENCY GUIDE SCHEDULE for Minimum Materials Testing, Sampling and Inspection

- CDOT Materials Forms-Serialized (2017 and newer) can be located at: <https://www.codot.gov/library/forms/materials-forms-serialized>
- CDOT Forms - by Form Number - can be located at: <https://www.codot.gov/library/forms/form-numbers-broken-down>
- SMM/LIMS Projects, report test results in the CDOT SMM/LIMS.
- **Note:** SMM/LIMS Summary forms such as CDOT Form 6, 58, 69, 156, 212, 323 are not required. COC and CTR do not require a CDOT Form 157.
- **Non-SMM/LIMS Projects, All CDOT forms will be completed as required.**
- CDOT Form 43 referenced is generated from the CAR reporting system.

| PAY ITEM   | TYPE OF TEST                                   | PROJECT VERIFICATION SAMPLING & TESTING FREQUENCY   | PROCEDURES                    |                              | REMARKS<br>{New Forms designed to follow SMM Templates.}  | POINT OF VERIFICATION FOR QUALITY DETERMINATION | CENTRAL LAB (CL)<br>[LOCAL AGENCIES ARE TO USE AN ACCREDITED LAB, NOT CDOT CL] |             |
|--|--|---|-------------------------------|------------------------------|---|---|--|-------------|
|  |  |   | PROJECT VERIFICATION SAMPLING | PROJECT VERIFICATION TESTING |   |   | TEST FREQUENCY   | SAMPLE SIZE |
| <b>203</b><br><br><b>EMBANKMENT</b><br><br><b>(≤ 30% Retained on ¾ Inch Sieve)</b> | IN-PLACE DENSITY / PERCENT RELATIVE COMPACTION | 1 per 1,000 cu yds or fraction thereof with one additional test required per change in material type being placed.<br><br>DENSITY: 1 per 500 cu. yds. when within 100 ft. of Bridge Approach(s), with minimum 1 test per lift, and 1 additional test per change in material type. |                               | CP 80<br>CP 25               | <b>CP 25</b> for 1-point check requirements or <b>as required</b> .<br><br>Report on CDOT Form 212; including where roller hours only are specified. See FMM (Chapter 200) for further details. | In the compacted lift.                          |  |             |
|  | MOISTURE-DENSITY CURVE                         | 1 per soil type.  |                               | CP 23<br>T 99 or<br>T 180    | Report on CDOT Form 24.   | From un-compacted lift or stockpile.            |  |             |
|  | SOIL CLASSIFICATION                            | 1 per soil type   |                               | M 145                        | Use AASHTO <b>M 145 for soil classification</b> .<br>Report on CDOT Form 219.   | From un-compacted lift or stockpile.            |  |             |
|  | GRADATION                                      | 1 per soil type   |                               | CP 21                        |   | From un-compacted lift or stockpile.            |  |             |
|  | ATTERBERG LIMITS                               | 1 per soil type   |                               | T 89<br>T 90                 |   | From un-compacted lift or stockpile.            |  |             |

OA FREQUENCY GUIDE SCHEDULE for Minimum Materials Testing, Sampling and Inspection

| PAY ITEM  | TYPE OF TEST                           | PROJECT VERIFICATION SAMPLING & TESTING FREQUENCY                                  | PROCEDURES                    |                              | REMARKS<br>{New Forms designed to follow SMM Templates.}                                | POINT OF VERIFICATION FOR QUALITY DETERMINATION | CENTRAL LAB (CL)<br>[LOCAL AGENCIES ARE TO USE AN ACCREDITED LAB, NOT CDOT CL] |             |
|---|--|--|-------------------------------|------------------------------|---|---|--|-------------|
|   |  |  | PROJECT VERIFICATION SAMPLING | PROJECT VERIFICATION TESTING |   |   | TEST FREQUENCY   | SAMPLE SIZE |
| <b>203</b><br>SOIL EMBANKMENT (with > 30% Retained on 3/4 Inch Sieve),<br>ROCK EMBANKMENT and ROCK FILL | TEST STRIP CONSTRUCTION AND ACCEPTANCE | 1 per test strip constructed.<br>1 test strip required per material type.          |                               |                              | Observation and acceptance of roller pattern, moisture conditioning, and proof rolling. | In the compacted test strip.                    |  |             |
|   | SOIL CLASSIFICATION                    | 1 per soil type.   |                               | M145                         | Use AASHTO M 145 for Soil Classification.<br>Report on CDOT Form 219.                   | From un-compacted lift or stockpile.            |  |             |
|   | GRADATION                              | 1 per soil type.   |                               | CP 21                        |   | From un-compacted lift or stockpile.            |  |             |
|   | ATTERBERG LIMITS                       | 1 per soil type.   |                               | T 89<br>T 90                 |   | From un-compacted lift or stockpile.            |  |             |
|   | SLAKE DURABILITY                       | 1 per stockpile / borrow source and 1 per material type for sedimentary rock only. |                               | CPL 3104                     |   | From un-compacted lift or stockpile.            |  |             |

OA FREQUENCY GUIDE SCHEDULE for Minimum Materials Testing, Sampling and Inspection

| PAY ITEM   | TYPE OF TEST                     | PROJECT VERIFICATION SAMPLING & TESTING FREQUENCY                                   | PROCEDURES                    |   | REMARKS<br>{New Forms designed to follow SMM Templates.}  | POINT OF VERIFICATION FOR QUALITY DETERMINATION     | CENTRAL LAB (CL)<br>[LOCAL AGENCIES ARE TO USE AN ACCREDITED LAB, NOT CDOT CL]  |  |
|--|----------------------------------|---|-------------------------------|---|---|---|---|--|
|  |                                  |   | PROJECT VERIFICATION SAMPLING | PROJECT VERIFICATION TESTING            |   |   | TEST FREQUENCY  | SAMPLE SIZE  |
| <b>203</b><br><b>ALL SOIL EMBANKMENT, ROCK EMBANKMENT, ROCK FILL</b> | SOIL-SURVEY (CLASSIFICATION)     | 1 per 1,000 lin. ft. of two-lane roadway or fraction thereof.                       | CP 20<br>CP 24                | CP 21<br>M 145<br>T 89<br>T 90<br>T 190 | Use AASHTO <i>M 145 for soil classification</i> .<br>Report on CDOT Form 219.   | In the top 2 ft. (600 mm) of the finished subgrade. | Soil-Survey shall be performed on the soil found at the proposed profile grade in the Field Lab or the Region Lab.<br><br><b>1 - R value test, per general soil type. (per T 190)</b> | 33 lb.(15 kg) -#4<br>If the criteria are met for CP 24, Section 4.1, use CDOT Form 564 to classify the material. |
|  | WATER-SOLUBLE SULFATE ION * / ** | 1 per 2,000 cu yds. or fraction thereof. Minimum 1 per source of imported material. | CP 30                         | CPL 2103                                | Report on CDOT Form 212 or CDOT Form 323.<br><br>See Chapter 200, Soil Survey / Preliminary Soil Profile.   | From un-compacted lift or stockpile.                | <b>1 water-soluble sulfate, water-soluble chloride, resistivity, and pH test per source. (see NOTE 1)</b>   | 5 lb. (3 kg) per soil type.<br>#4 material   |
|  | WATER-SOLUBLE CHLORIDE ION **    | 1 per 2,000 cu yds. or fraction thereof. Minimum 1 per source of imported material. | CP 30                         | CPL 2104                                | * Sulfate test required for fill around concrete structures.<br>** For pipe backfill these tests may be required based on the pipe material type. |   |   |  |
|  | RESISTIVITY **                   | 1 per 2,000 cu yds. or fraction thereof. Minimum 1 per source of imported material. | CP 30                         | G 57                                    | See Subsection 203.03.  |   |   |  |
|  | pH **                            | 1 per 2,000 cu yds. or fraction thereof. Minimum 1 per source of imported material. | CP 30                         | G 51                                    |   |   |   |  |

**NOTE 1: This Central Lab test can be performed in the Region Lab or the Field Lab if adequate facilities and equipment are available.**

OA FREQUENCY GUIDE SCHEDULE for Minimum Materials Testing, Sampling and Inspection

| PAY ITEM                                   | TYPE OF TEST                                   | PROJECT VERIFICATION SAMPLING & TESTING FREQUENCY                | PROCEDURES                    |                              | REMARKS<br>{New Forms designed to follow SMM Templates.}  | POINT OF VERIFICATION FOR QUALITY DETERMINATION | CENTRAL LAB (CL)<br>[LOCAL AGENCIES ARE TO USE AN ACCREDITED LAB, NOT CDOT CL]                                      |  |
|--|--|--|-------------------------------|------------------------------|---|---|---|--|
|  |  |  | PROJECT VERIFICATION SAMPLING | PROJECT VERIFICATION TESTING |   |   | TEST FREQUENCY  | SAMPLE SIZE  |
| STRUCTURAL BACKFILL<br>(CLASS 1 & CLASS 2) | <b>CLASS 1</b><br>GRADATION                    | 1 per 200 cu. yds. or fraction thereof.                          | CP 30                         | CP 31                        | Report on CDOT Form 6.  | In-Place, before compaction.                    | 1 per source, per project.<br><i>(see NOTE 1)</i>   | 110 lb. (45 kg) is approx. 2 bags by volume for Class 1, |
|  | ATTERBERG LIMITS                               | 1 per 200 cu. yds. or fraction thereof.                          | CP 30                         | T 89<br>T 90                 |   |   | 1 per source, per project.<br><i>(see NOTE 1)</i>   |  |
|  | <b>CLASS 2</b><br>GRADATION                    | If in roadbed, 1 per source, or soil type.                       | CP 30                         | CP 21                        |   |   |   | 55 lb. (25 kg) for Class 2. See Chap. 300.               |
|  | ATTERBERG LIMITS                               | If in roadbed, 1 per source, or soil type.                       | CP 30                         | M 145<br>T 89<br>T 90        |   |   |   |  |
|  | IN-PLACE DENSITY / PERCENT RELATIVE COMPACTION | 1 per 200 cu. yds. or fraction thereof. Minimum 1 per structure. | CP 30                         | CP 80 / CP 25                | Report on CDOT Form 6. <b>See FMM, Chap. 200, Item 206 Structure Backfill, Note on rocky material. CP 25</b> for 1-point check requirements or <b>as required.</b>              | In the compacted lift.                          |   |  |
|  | MOISTURE-DENSITY CURVE                         | If in roadbed, 1 per source or soil type.                        | CP 30                         | CP 23<br>T 99 or<br>T 180    | Report on CDOT Form 24. Class 1: T 180 Class 2: T 99 or T 180, depending on soil type.  |   | 1 per source, per project.<br><i>(see NOTE 1)</i>   |  |
|  | WATER-SOLUBLE SULFATE ION * / **               | 1 per 2,000 cu yds. or fraction thereof. Minimum 1 per source.   | CP 30                         | CPL 2103                     | Report on CDOT Form 212 or CDOT Form 323.<br><br>See Chapter 200, Soil Survey / Preliminary Soil Profile.   | From un-compacted lift or stockpile.            | <b>1 water-soluble sulfate, water-soluble chloride, resistivity, and pH test per source.</b><br><i>(see NOTE 1)</i> |  |
|  | WATER-SOLUBLE CHLORIDE ION **                  | 1 per 2,000 cu yds. or fraction thereof. Minimum 1 per source.   | CP 30                         | CPL 2104                     | * Sulfate test required for fill around concrete structures.<br>** For pipe backfill these tests may be required based on the pipe material type.<br>See Subsection 206.02 (a). |   |   |  |
|  | RESISTIVITY **                                 | 1 per 2,000 cu yds. or fraction thereof. Minimum 1 per source.   | CP 30                         | G 57                         |   |   |   |  |
|  | pH **  | 1 per 2,000 cu yds. or fraction thereof. Minimum 1 per source.   | CP 30                         | G 51                         |   |   |   |  |

**NOTE 1: This Central Lab test can be performed in the Region Lab or the Field Lab if adequate facilities and equipment are available.**

OA FREQUENCY GUIDE SCHEDULE for Minimum Materials Testing, Sampling and Inspection

| PAY ITEM                                     | TYPE OF TEST                     | PROJECT VERIFICATION SAMPLING & TESTING FREQUENCY              | PROCEDURES                    |                              | REMARKS<br>{New Forms designed to follow SMM Templates.}  | POINT OF VERIFICATION FOR QUALITY DETERMINATION | CENTRAL LAB (CL)<br>[LOCAL AGENCIES ARE TO USE AN ACCREDITED LAB, NOT CDOT CL] |   |
|--|----------------------------------|--|-------------------------------|------------------------------|---|---|--|---|
|  |                                  |  | PROJECT VERIFICATION SAMPLING | PROJECT VERIFICATION TESTING |   |   | TEST FREQUENCY   | SAMPLE SIZE                                     |
| <b>206</b><br><br><b>BED COURSE MATERIAL</b> | GRADATION                        | 1 per 200 cu. yds. or fraction thereof.                        | CP 30                         | CP 31                        | Report on CDOT Form 6*.   | In-Place.                                       | 1 per source, per project.<br>(see NOTE 1)                                     | 55 lb. (25 kg)                                  |
|  | ATTERBERG LIMITS                 | 1 per 200 cu. yds. or fraction thereof.                        |                               | T 89<br>T 90                 |   |   | 1 per source, per project.<br>(see NOTE 1)                                     |   |
|  |                                  |  |                               |                              |   |   |  |   |
|  |                                  |  |                               |                              |   |   |  |   |
|  | WATER-SOLUBLE SULFATE ION * / ** | 1 per 2,000 cu yds. or fraction thereof. Minimum 1 per source. | CP 30                         | CPL 2103                     | Report on CDOT Form 212 or 323.<br>See Chapter 200, Soil Survey / Preliminary Soil Profile.   | From un-compacted lift or stockpile.            |  |   |
|  | WATER-SOLUBLE CHLORIDE ION **    | 1 per 2,000 cu yds. or fraction thereof. Minimum 1 per source. | CP 30                         | CPL 2104                     |   |   |  |   |
|  | RESISTIVITY **                   | 1 per 2,000 cu yds. or fraction thereof. Minimum 1 per source. | CP 30                         | G 57                         | * Sulfate test required for fill around concrete structures.<br>** For pipe backfill these tests may be required based on the pipe material type.<br>See Subsection 206.02 (a). |   |  |   |
|  | pH **                            | 1 per 2,000 cu yds. or fraction thereof. Minimum 1 per source. | CP 30                         | G 51                         |   |   |  |   |
| <b>206</b><br><br><b>FILTER MATERIAL</b>     | GRADATION                        | 1 per 200 cu. yds. or fraction thereof for each Class.         | CP 30                         | CP 31                        | Report on CDOT Form #6. See FMM, Chapter 200 for further details.   | In-Place.                                       | 1 per source, per project.<br>(see NOTE 1)                                     | 55 lb. (25 kg) is approx. 1 full bag by volume. |

**NOTE 1: This Central Lab test can be performed in the Region Lab or the Field Lab if adequate facilities and equipment are available.**



OA FREQUENCY GUIDE SCHEDULE for Minimum Materials Testing, Sampling and Inspection

|  |   |
|--|---|
| <p><b>206</b><br/><b>FLOW FILL</b></p>       | <p><b>Submit to project files a <i>Flow-Fill mix design</i></b> that documents adherence to the Specifications.</p>   |
| <p><b>207</b><br/><b>TOPSOIL</b></p>         | <p><b>Contractor Source(s):</b> <i>Acceptance Method:</i> <b><u>CTR</u></b>.<br/>The Contractor shall provide the Engineer with one copy of <b><u>Certified Test Reports</u></b> documenting: pH, % organic, soluble salts, and nutrient and micro-nutrient requirements as specified in the Contract Documents. The tests shall be in accordance with the "Method of Soil Analysis conducted by the Colorado State University Soil Testing Laboratory" or a Certified Soils Laboratory. A list of qualified laboratories is available by contacting the Landscape Architect's office at (303) 757-9507. Field-inspect and document on CDOT Form 157 that the material is acceptable, then retain all copies in the Project Files.</p>  |
| <p><b>208</b><br/><b>EROSION CONTROL</b></p> | <p><b>Silt Dike:</b> <i>Acceptance Method:</i> <b><u>COC</u></b>.<br/>Dimensions of silt dike including fabric extensions shall be measured as shown in Subsections 208.02 (i), staples shall be measured for gauge and length as indicated in Subsections 208.02 (i). COC's do not require a CDOT Form 157.</p> <p><b>Erosion Log:</b> <i>Acceptance Method:</i> <b><u>COC</u></b>.<br/>Erosion logs, both Type 1 and Type 2 shall be measured for minimum dimensions and weight as shown in the Revision of 208, Subsection 208.02 (h). Stakes shall be measured to meet nominal dimensions in the Revision of 208, Subsection 208.02 (h).<br/>Type 1: Excelsior logs shall be inspected to be fungus free, resin free and free of growth or germination inhibiting substances.<br/>Type 2: The compost in (compost) logs shall be inspected in accordance with Subsection 212.<br/>Field-inspect. COC's do not require a CDOT Form 157.</p> <p><b>Silt Berm:</b> <i>Acceptance Method:</i> <b><u>Pre-Approved (with Contractor's AV for Documentation)</u></b>.<br/>Silt berms shall be inspected and measured for the dimensions, including percent open area, as shown in Subsection 208.02 (e).<br/>Spikes shall be measured to be 10 to 12 inches by 0.375 inch diameter (minimum).<br/>Field-inspect. COC's do not require a CDOT Form 157.</p> <p><b>Erosion Bales:</b> <i>Acceptance Method:</i> <b><u>COC</u></b>.<br/>Erosion bales shall consist of Certified Weed-Free hay or straw. Each bale shall be identified by blue and orange twine. This twine shall not be removed until the Engineer has inspected and accepted the bales. A Certificate of Compliance is required showing the transit certificate number or a copy of the transit certificate as supplied by the forage producer.<br/>Bales shall be measured and weighed to have approximately 5 cubic feet of material and weigh at least 35 pounds.<br/>Stakes shall be measured to be 2 inches by 2 inches nominal.<br/>Field-inspect. COC's do not require a CDOT Form 157</p> <p><b>Silt Fence:</b> <i>Acceptance Method:</i> <b><u>COC</u></b>.<br/>Posts must be measured to be 42 inches (min.) in length and 1.5 inches by 1.5 inches nominal. Posts shall be inspected to confirm that geotextile is attached to posts with 3 or more staples.<br/>A Certificate of Compliance is required indicating that geotextile meet the physical requirements shown in Subsection 208.02 (b) and as tested by ASTM D 4632, ASTM D 4491, and ASTM D 4355.<br/>Field-inspect. COC's do not require a CDOT Form 157</p> <p style="text-align: center;">(Continued on next page.)</p> |

OA FREQUENCY GUIDE SCHEDULE for Minimum Materials Testing, Sampling and Inspection

(Continued from previous page)

**Aggregate bags:** *Acceptance Method:* **COC & CTR.**

A Certificate of Compliance is required stating that the geotextile meets the property requirements of the Revision of 208, Subsection 208.02 (l) as tested by ASTM D 4632, ASTM D 4533, ASTM D 3786, and ASTM D 4355.

Aggregate bags shall be measured and weighed according to the Revision of 208, Subsection 208.02 (l). Rubber in bags shall be inspected to be 95 percent free of metal and other particulates.

A Certified Test Report is required verifying that the crushed stone contained in the aggregate bags shall conform to Subsection 703.09, Table 703-10 for Class C. Field-inspect that the material is acceptable, then retain all copies in the Project Files. COC/CTR do not require CDOT Form 157.

**Concrete Washout Structure:** *Acceptance Method:* **Pre-Approved (with Contractor's AV for Documentation).**

Pre-fabricated concrete washout, as specified in the plans shall be selected from the CDOT Approved Products List, in accordance with Subsection 208.02 (j). Concrete washout shall be inspected and confirmed that it is an approved product and that it is the correct item as specified in the plans.

Field-inspect and document on CDOT Form #157 that the material is acceptable, then retain all copies in the Project Files.

**Storm Drain Inlet Protection:** *Acceptance Method:* **Pre-Approved (with Contractor's AV for Documentation).**

Storm drain inlet protection shall be measured for dimensions as required by size and type of inlet, as shown in Subsection 208.02 (m). The device shall be weighed and is required to have an approximate weight of 7 to 10 pounds per linear foot of device.

The aggregate contained in the storm drain inlet device shall consist of gravel or crushed stone conforming to Table 703-7 for Class C.

A Certificate of Compliance is required stating that the geotextile meets the property requirements of Subsection 208.02 (m) as tested by ASTM D 4632, ASTM D 4533, ASTM D 3786, ASTM D 4491, COE-22125-86 and ASTM D 4355.

Field-inspect and document on CDOT Form #157 that the material is acceptable, then retain all copies in the Project Files.

**Vehicle Tracking Pad:** *Acceptance Method:* **COC & CTR.**

Aggregate shall be a minimum of two fractured faces and that it meets the gradation requirements of 208.02 (k). **CTR**

Geotextile (Erosion Control), when required, shall be Class 2 and conform to the requirements of Subsection 420.02. **COC**

Field-inspect. COC's do not require a CDOT Form 157

**Vehicle Tracking Control \ Pre-Fabricated:** *Acceptance Method:* **Pre-Approved (with Contractor's AV for Documentation).**

209

WATERING

**Landscaping Water:** *Acceptance Method:* **COC or CTR.**

Contractor to provide document stipulating the source of the water if potable, Certified Test Report required if non-potable. Refer to Standard Specifications Subsection 209.02.

**Dust Palliative (Magnesium Chloride):** *Acceptance Method:* **COC.**

The Contractor shall provide one copy of a Certificate of Compliance. Field-inspect and document that the material is acceptable, then retain all copies in the Project Files.

**Embankment Moisture (water) Control:** *Acceptance Method:* **N/A**

Sampling not required unless chemical content and quality are in doubt. Refer to Standard Specifications Subsection 209.02. If water quality test results are required, follow instructions for Landscaping Water above. Field-inspect and document on CDOT Form #157 that the material is acceptable, then retain all copies in the Project Files.

OA FREQUENCY GUIDE SCHEDULE for Minimum Materials Testing, Sampling and Inspection

|  |  |
|--|--|
| <p><b>212</b></p> <p style="writing-mode: vertical-rl; transform: rotate(180deg);"><b>SEEDING, FERTILIZER, SOIL CONDITIONER, AND SODDING</b></p> | <p><b>Seed (Native):</b> <i>Acceptance Method:</i> <b><u>COC</u></b>.<br/>Seed shall be inspected and reviewed according to the Revision of Section 212, Subsection 212.02 (a):</p> <p>All seed shall be furnished in bags or containers clearly labeled to show the name and address of the supplier, the seed name, the lot number, net weight, origin, the percent of weed seed content, the guaranteed percentage of purity and germination, pounds of pure live seed (PLS) of each seed species, and the total pounds of PLS in the container.<br/>Seed species shall be compared to seed mix provided in the project plans. If any species have been omitted or substituted without prior approval, seed mix shall not be accepted.<br/>The Contractor shall furnish to the Engineer a signed statement certifying that the seed is from a lot that has been tested by a recognized laboratory for seed testing within 13 months prior to the date of seeding.<br/>The Engineer may obtain seed samples from the seed equipment, furnished bags or containers to test seed for species identification, purity and germination. Seed tested and found to be less than 10 percent of the labeled certified PLS and different than the specified species will not be accepted.<br/>Seed which has become wet, moldy, or damaged in transit or in storage will not be accepted.<br/>Field-inspect that the material is acceptable, then retain all copies in the Project Files.</p> <p><b>Sod:</b> <i>Acceptance Method:</i> <b><u>COC</u></b>.<br/>The Contractor shall submit to the Engineer a sample of sod 6½ ft X 2 ft (2 m X 50 cm) for a comparison standard. Compliance with Standard Specifications Subsection 212.02. Field-inspect that the material is acceptable, then retain all copies in the Project Files.</p> <p><b>Soil Conditioner:</b> <i>Acceptance Method:</i> <b><u>COC</u></b>.<br/>Organic fertilizer shall conform to the applicable State fertilizer laws and shall be reviewed to confirm the N-P-K and rates as specified in the plans.<br/>Compost shall be weed-free, organic compost derived from a variety of feed stocks including agricultural, bio-solids, forestry, food, leaf and yard trimmings, manure, tree wood with no substances toxic to plants.</p> <p><b>Compost:</b> <i>Acceptance Method:</i> <b><u>CTR</u></b>. [Shall have the required physical properties as shown in Subsection 212.02 (b).]<br/>A <b><u>Certified Test Report</u></b> is required in accordance with Subsection 106.13 confirming that the material has been tested in accordance with the U.S. Composting Council's Test Methods for Examining of Composting and Compost (TMECC) manual. Field-inspect that the material is acceptable, then retain all copies in the Project Files.</p> |
| <p><b>213</b></p> <p style="writing-mode: vertical-rl; transform: rotate(180deg);"><b>MULCHING</b></p>   | <p>Material for mulching shall consist of Certified Weed-Free field or marsh hay or straw of oats, barley, wheat, rye or triticale. Each certified weed free mulch bale shall be identified by one of the following: at least one of the ties binding the bale shall consist of blue and orange twine, or the bale shall have a regional Forage Certification Program tag indicating the Regional Forage Certification Program Number.<br/>The Contractor shall not unload certified weed free mulch bales or remove their identifying twine, wire or tags until the Engineer has inspected and accepted the bales. The Contractor shall provide a transit certificate that has been filled out and signed by the grower and by the Department of Agriculture inspector.</p> <p><b>Hay or Straw:</b> <i>Acceptance Method:</i> <b><u>COC</u></b>.<br/>Straw or hay shall be inspected and any found to be in a stage of decomposition (discolored, brittle, rotten, or moldy) or old, dry mulch which breaks in the crimping process will not be accepted. Field-inspect that the material is acceptable, then retain all copies in the Project Files.</p> <p><b>Hydraulic Mulching &gt; Wood Cellulose:</b> <i>Acceptance Method:</i> <b><u>COC</u></b>.<br/>Field-inspect that the material is acceptable, then retain all copies in the Project Files.</p> <p><b>Mulch Tackifier:</b> <i>Acceptance Method:</i> <b><u>COC</u></b>.<br/><b>Bonded Fiber Matrix and Spray on Mulch Blanket require a <u>Certificate of Compliance</u></b> stating that the product meets the property requirements shown in the Revision of 213 Subsection 213.02. Field inspection is required for all mulching to evaluate installation for uniform cover and correct application rate in accordance with the Revision of 213. Field-inspect that the material is acceptable, then retain all copies in the Project Files.</p>  |

OA FREQUENCY GUIDE SCHEDULE for Minimum Materials Testing, Sampling and Inspection

|  |   |
|--|---|
| <p style="text-align: center;"><b>214</b><br/><b>PLANTING</b></p>                | <p><b>Plants:</b> <i>Acceptance Method:</i> <b><u>COC</u></b>.<br/>Plants from out-of-state sources are to conform to the requirements of Standard Specifications Subsection 214.02 or contract documents. Field-inspect that the material is acceptable, then retain all copies in the Project Files.</p> <p><b>Humus:</b> <i>Acceptance Method:</i> <b><u>N/A</u></b>. &gt;&gt; Contact Staff Landscape Architect at CDOT Headquarters (303) 757-9507 for approval of humus material. Field-inspect and document on CDOT Form #157 that the material is acceptable, then retain all copies in the Project Files.</p> <p><b>Fertilizer:</b> <i>Acceptance Method:</i> <b><u>COC</u></b>.<br/>Field inspect that the material is acceptable, then retain all copies in the Project Files.<br/>See Standard Specifications Subsection 214.02(d).</p> |
| <p style="text-align: center;"><b>215</b><br/><b>TRANS-PLANTING</b></p>          | <p><b>Plants:</b> <i>Acceptance Method:</i> <b><u>N/A</u></b><br/>Selected by Engineer from within ROW. Field-inspect and document on CDOT Form #157 that the material is acceptable, then retain all copies in the Project Files.</p> <p><b>Fertilizer:</b> <i>Acceptance Method:</i> <b><u>COC</u></b>.<br/>See Standard Specifications Subsection 215.03. Field-inspect that the material is acceptable, then retain all copies in the Project Files.</p>  |
| <p style="text-align: center;"><b>216</b><br/><b>SOIL RETENTION COVERING</b></p> | <p><b>Soil Retention Covering:</b> <i>Acceptance Method:</i> <b><u>Pre-Approved (with Contractor's AV for Documentation)</u></b>.<br/>Soil Retention Covering shall be either Soil Retention Blankets (SRB) or Turf Reinforcement Mat (TRM) as specified in the plans and <b><u>shall be selected from the CDOT Approved Products List</u></b>. Soil retention covering shall be inspected and confirmed that it is an approved product and that it is the correct item as specified in the plans.</p> <p>Staples shall be measured for dimensions as shown in Subsection 216.02 (c).</p> <p>Field inspection is required for all soil retention covering to evaluate installation for application and staple quantity and pattern according to manufacturer's recommendation and M-208-01.</p>   |
| <p style="text-align: center;"><b>217</b><br/><b>HERBICIDE TREATMENT</b></p>     | <p><b>Herbicide Treatment:</b> <i>Acceptance Method:</i> <b><u>Pre-Approved (with Contractor's AV for Documentation)</u></b>.<br/>Contact Staff Landscape Architect at CDOT Headquarters (303) 757-9542 for approval of material used as Herbicide Treatment until minimum products are posted on the APL. Field-inspect and document on CDOT Form #157 that the material is acceptable, then retain all copies in the Project Files.</p>   |

OA FREQUENCY GUIDE SCHEDULE for Minimum Materials Testing, Sampling and Inspection

| PAY ITEM   | TYPE OF TEST                                   | PROJECT VERIFICATION SAMPLING & TESTING FREQUENCY   | PROCEDURES                    |                              | REMARKS<br>{New Forms designed to follow SMM Templates.}                                       | POINT OF VERIFICATION FOR QUALITY DETERMINATION   | CENTRAL LAB (CL)<br>{LOCAL AGENCIES ARE TO USE AN ACCREDITED LAB, NOT CDOT CL} |  |
|--|--|---|-------------------------------|------------------------------|--|---|--|--|
|  |  |   | PROJECT VERIFICATION SAMPLING | PROJECT VERIFICATION TESTING |  |   | TEST FREQUENCY   | SAMPLE SIZE  |
| <b>304</b><br><br><b>AGGREGATE<br/>BASE COURSE</b> | GRADATION                                      | 1 per 2,000 tons or 1 per 1,000 cu. yds. or fraction thereof on each Class.   | CP 30                         | CP 31                        | Report on CDOT Form 6.   | Immediately after pugmill mixing or from windrow. | 1 per source, per project.<br>(see NOTE 1)                                     | 55 lb (25 kg) for Gradation Only.  |
|  | ATTERBERG LIMITS                               | 1 per 2,000 tons or 1 per 1,000 cu. yds. or fraction thereof on each Class.   |                               | T 89<br>T 90                 |  |   | 1 per source, per project.<br>(see NOTE 1)                                     | 110 lb. (50 kg) of minus 3/4" (19.0 mm) is required for full testing (moisture density curve). |
|  | IN-PLACE DENSITY / PERCENT RELATIVE COMPACTION | 1 per 2,000 tons or 1 per 1,000 cu. yds. or fraction thereof.   |                               | CP 80 /<br>CP 25             | Report on CDOT Form 6.<br><b>CP 25</b> for 1-point check requirements or <b>as required.</b>   | In the compacted lift.                            |  | or<br>55 lbs. (25 kg) in addition to other test samples.                                       |
|  | MOISTURE-DENSITY CURVE                         | 1 per class / per source  |                               | CP 23<br>T 180               | Report on CDOT Form 24.  |   | 1 per source, per project.<br>(see NOTE 1)                                     | Note:<br>304 Class 1 is 3 full bags by volume.   |
|  | LA ABRASION                                    | 1 per class / per source  |                               | T 96                         | <b>LA Abrasion required for Class 4,5,6,7</b>  |   | 1 per source, per project.<br>(see NOTE 1)                                     | 304 Class 2-7 is 5 full bags by volume.  |
|  | R-VALUE  | 1 per class / per source  |                               | T 190                        |  |   | <b>1 R-value test per Class.</b>   |  |
| <b>306</b><br><br><b>RECONDITIONING</b>            | IN-PLACE DENSITY / PERCENT RELATIVE COMPACTION | 1 per 5,000 sq. yds. or fraction thereof. 1 per 2,500 sq. yds. or fraction thereof for each shoulder (when shoulders only are specified). |                               | CP 80 /<br>CP 25             | Report on CDOT Form 212.<br><b>CP 25</b> for 1-point check requirements or <b>as required.</b> | In the compacted lift.                            |  |  |
|  | MOISTURE-DENSITY CURVE                         | 1 per soil type.  |                               | CP 23<br>T 99<br>T 180       | Report on CDOT Form 24.  |   | (see NOTE 1)   |  |

**NOTE 1: This Central Lab test can be performed in the Region Lab or the Field Lab if adequate facilities and equipment are available.**

OA FREQUENCY GUIDE SCHEDULE for Minimum Materials Testing, Sampling and Inspection

| PAY ITEM                         | TYPE OF TEST                                   | PROJECT VERIFICATION SAMPLING & TESTING FREQUENCY                          | PROCEDURES                    |                              | REMARKS<br>{New Forms designed to follow SMM Templates.}  | POINT OF VERIFICATION FOR QUALITY DETERMINATION | CENTRAL LAB (CL)<br>[LOCAL AGENCIES ARE TO USE AN ACCREDITED LAB, NOT CDOT CL]   |  |
|----------------------------------|--|--|-------------------------------|------------------------------|---|---|--|--|
|                                  |  |  | PROJECT VERIFICATION SAMPLING | PROJECT VERIFICATION TESTING |   |   | TEST FREQUENCY   | SAMPLE SIZE  |
| 307<br><br>LIME TREATED SUBGRADE | IN-PLACE DENSITY / PERCENT RELATIVE COMPACTION | 1 per 5,000 sq. yds. or fraction thereof; or as specified in the Contract. |                               | CP 80 / CP 25                | Report on CDOT Form 212. <b>CP 25</b> for 1-point check requirements or <b>as required</b> .  | In the compacted lift.                          | The Region shall retain a Designated Agent Laboratory to perform the required tests, if proper equipment is not available. | Process control test: Schedules for minimum sampling and testing conducted by the Contractor are listed in Standard Specification Section 307, Table 307-1. Cost shall be included in the bid price. |
|                                  | GRADATION                                      | 1 per 5,000 sq. yds. or fraction thereof.                                  | CP 30                         | CP 31                        | 1" – 100% passing #4 – 60% passing Dry sieving after final mixing.  |   |  |  |
|                                  | ATTERBERG LIMITS                               | 1 per 5,000 sq. yds. or fraction thereof.                                  |                               | T 89<br>T 90                 | Reduce by ½ original PI.  |   |  |  |
|                                  | MOISTURE-DENSITY CURVE                         | 1 per soil type.   |                               | CP 23<br>T 99<br>T 180       | Moisture content of mixture at the start of compaction shall be at 2 ± 1% above optimum moisture content.                                     |   |  |  |
|                                  | UNCONFINED COMPRESSIVE STRENGTH                | 1 per 5,000 sq. yds. or fraction thereof.                                  |                               | D 5102 (Proc. B)             | Tests shall be conducted on samples cured in moist environment for 5 days @ 100 F.  |   |  |  |
|                                  | THICKNESS ACCEPTANCE                           | 1 per 1,500 sq. yds. or fraction thereof.                                  |                               | C 174                        | When measurement is <0.5", 2 additional cores shall be taken in that lot and the average of 3 cores will determine the thickness of that lot. |   |  |  |
|                                  | SWELL TEST                                     | 1 per 5,000 sq. yds. or fraction thereof.                                  |                               | D 4546 (Meth. B)             | ½% or less with 200 psf. surcharge pressure.  | From the compacted roadway.                     |  |  |
|                                  | pH   | 1 per 5,000 sq. yds. or fraction thereof.                                  | CP 30                         | G 51                         | pH will be determined after % lime has been established based on unconfined compressive strength pH.  |   |  |  |
|                                  | SULFATE  | 1 per soil type.   |                               | CPL 2103                     | Water soluble sulfate content in soil shall be less than 0.2% by dry soil weight.   |   |  |  |
|                                  | LIME GRADATION                                 | 1 per 100 tons of lime or fraction thereof, 1 per source, 1 per project.   |                               | CPL 4209                     | Retain one copy of the CTR along with the Form #157 for Project Files.  |   | No verification gradation samples are to be run in the field except for information only.                                  |  |

OA FREQUENCY GUIDE SCHEDULE for Minimum Materials Testing, Sampling and Inspection

|  |   |
|--|---|
| <p style="text-align: center;"><b>307</b></p> <p style="text-align: center;"><b>HYDRATED LIME<br/>For Soil Stabilization</b></p> | <p><b>Hydrated Lime:</b> <i>Acceptance Method: <b>Pre-Approved (with Contractor's AV for Documentation)* and CTR.</b></i><br/> <b>Information available at</b> : <a href="https://apps.coloradodot.info/apl/AplSearch.cfm">https://apps.coloradodot.info/apl/AplSearch.cfm</a> The Contractor shall provide the Engineer with one copy of <b>Certified Test Reports</b> that is <b>furnished by the supplier</b> for Chemical Tests, per AASHTO M 303. Immediately attach one copy of the Certified Test Reports and send it to the Region Materials Engineer for review and comments. Immediately obtain a 2 lb. sample according to AASHTO T 218 and submit it to the Central Laboratory for gradation verification testing. Minimum of one sample per source per project required. Testing must include CP-L 4209. Thereafter; one sample per 100 tons of lime, for gradation only. <i>CPL 4209: 1 per 10,000 tons of HMA mix.</i> Provide the Bill of Lading per CP 11.</p> <p><b>Quicklime:</b> <i>Acceptance Method: <b>CTR.</b></i><br/>                 Test results are to document the percent purity. No sample required.<br/>                 (NOTE: number of tons of quicklime x 1.32 = tons of hydrated lime.)</p> <p>Provide the Bill of Lading per CP 11.</p> <p>* Document the lime source on CDOT Form #157, (include sufficient information on the CDOT Form #157 so that the supplier and source are easily identified).</p> |
| <p style="text-align: center;"><b>MINERAL FILLERS</b></p>  | <p>For project acceptance, test for gradation according to T 37 for Hydraulic Cement and CPL 4209 for Limestone Dust at 1 per 100 tons or fraction thereof used, and report on CDOT Form #6. Submit a 2 lb. sample to Central Laboratory at a frequency of 1 per 500 tons or fraction thereof, for gradation check sample.</p> <p>Document mineral filler source on CDOT Form #157, <b>(include sufficient information on the CDOT Form #157 so that the supplier and source are easily identified).</b></p> <p>The above frequency is only applicable when mineral fillers are required by the plans.</p> <p>Provide the Bill of Lading per CP 11.</p>   |
| <p style="text-align: center;"><b>310</b></p> <p style="text-align: center;"><b>FULL DEPTH RECLAMATION</b></p>                   | <p><b>Full Depth Reclamation:</b></p> <p>Established through a Project Special. Testing and sampling as specified in the contract.</p> <p>Density is performed at 1 per 4,000 sq. yds per 8 inch lift. Gradation is performed as required.</p>  |

OA FREQUENCY GUIDE SCHEDULE for Minimum Materials Testing, Sampling and Inspection

| PAY ITEM   | TYPE OF TEST                                    | PROJECT VERIFICATION SAMPLING & TESTING FREQUENCY   | PROCEDURES                    |                              | REMARKS<br>{New Forms designed to follow SMM Templates.}  | POINT OF VERIFICATION FOR QUALITY DETERMINATION  | CENTRAL LAB (CL)<br>[LOCAL AGENCIES ARE TO USE AN ACCREDITED LAB, NOT CDOT CL]   |  |
|--|---|---|-------------------------------|------------------------------|---|--|--|--|
|  |   |   | PROJECT VERIFICATION SAMPLING | PROJECT VERIFICATION TESTING |   |  | TEST FREQUENCY   | SAMPLE SIZE  |
| <b>HOT MIX ASPHALT (HMA):<br/>VOIDS ACCEPTANCE</b> | 403 ASPHALT CONTENT                             | 1 per 1,000 tons or fraction thereof of mix produced (or as specified in the contract). If less than 5,000 tons see special provisions.   | CP 41<br>CP 55                | CP 43<br>CP 85<br>CPL 5120   | Mix Design as per CP 52; CDOT Form #43 required <u>before</u> mix is produced. Report Asphalt Content on Form #58 and Form #360 | Plant discharge, at/or behind paver. For Central Lab Correction Factor, sample aggregate from belt and Binder from Contractors tank. | CHECK TEST: Minimum of each 10k or fraction thereof. 1 sample (can) is submitted to Central Lab & one to the Region Lab.   | 65 lb. (30 kg)   |
|  | AGGREGATE MOISTURE                              | Aggregate: 1 per 2,000 tons or fraction thereof of mix produced (or as specified in the contract).  | CP 30                         | CP 33                        | Report on Form #6 the results from Form #565 or #106 or #107. Compare to the % absorption (SSD) on the Form #43.                | Aggregate from the cold feed.  | Also needed for Central Lab Correction Factor when new 10K submitted. If Mix Design changes, submit Correction Factor when next 10K is submitted. Submit Correction Factor at beginning of each Paving Season. | 25 lb. (Agg)<br>1 qt (binder)  |
|  | GRADATION                                       | Aggregate: 1 per 10,000 tons or fraction thereof of mix produced (or as specified in the contract).   | CP 30                         | CP 31                        | Report Gradation on CDOT Form #6*.  | Aggregate from the cold feed, pugmill discharge, extraction, or product of CP-L 5120.  | Submit Correction Factor at beginning of each Paving Season.   | 100 lb. (45 kg)<br>(Agg)   |
|  | MICRO DEVAL                                     | 1 per 10,000 tons as specified in the Contract.   | CP 30                         | CPL 4211                     | Mix Design as per CP 52.  | Aggregate from the cold feed.  | <b>See Guidelines for Test Frequency Reduction Item 403 - Hot Mix Asphalt.</b>   | 65 lb. (30kg)  |
|  | FRACTURED FACES AND VOID CONTENT FINE AGGREGATE | As requested by the RME.  | CP 30                         | CP 45<br>T 304 A             | Report on CDOT Form #58.  |  |  | Note for all tests: 1 full bag of each aggregate type.   |
|  | IN-PLACE DENSITY                                | All lifts of Item 403: 1 per 500 tons (500 t) or fraction thereof of mix placed (or as specified in the contract). Minimum of 10 tests per project. If less than 5,000 tons see special provisions. |                               | CP 44<br>CP 81<br>CP 82      | Report on CDOT Form #69*.   | In the compacted lift.   |  | If LA Abrasion is requested, send 1 additional full bag.   |
|  | THERMAL SEGREGATION                             | As specified in the contract.   |                               | CP 58                        | Report on CDOT Form #1346.  | Behind paver.  |  | Micro Deval cold feed is 1 full bag. 1 full bag is required to get the gradation needed to perform a "D" Method. |
|  | LONGITUDINAL JOINT DENSITY                      | 1per 5,000 linear ft. of Joint Minimum of 5 tests per project.  |                               | CP 44                        | Report on CDOT Form #1290. Test template CP 44L in SMM.   |  |  |  |
|  | (Testing Continued on the next page.)           |   |                               |                              |   |  |  |  |
|  |   |   |                               |                              |   |  |  |  |
|  |   |   |                               |                              |   |  |  |  |
|  |   |   |                               |                              |   |  |  |  |



OA FREQUENCY GUIDE SCHEDULE for Minimum Materials Testing, Sampling and Inspection

| PAY ITEM   | TYPE OF TEST   | PROJECT VERIFICATION SAMPLING & TESTING FREQUENCY   | PROCEDURES                    |                              | REMARKS<br>{New Forms designed to follow SMM Templates.}   | POINT OF VERIFICATION FOR QUALITY DETERMINATION | CENTRAL LAB (CL)<br>[LOCAL AGENCIES ARE TO USE AN ACCREDITED LAB, NOT CDOT CL]  |                |  |                                     |
|--|--|---|-------------------------------|------------------------------|--|---|---|----------------|--|-------------------------------------|
|  |  |   | PROJECT VERIFICATION SAMPLING | PROJECT VERIFICATION TESTING |  |   | TEST FREQUENCY  | SAMPLE SIZE    |  |                                     |
| <b>HOT MIX ASPHALT (HMA):<br/>VOIDS ACCEPTANCE</b> | 403 THEORETICAL MAX. SP. GRAVITY                                 | 1 per 1,000 tons. Minimum of 1 test per day if less than 1 000 tons placed in a day.              | CP 41<br>CP 55                | CP 51<br>CP 56               | Report on CDOT Form 69.  | Plant discharge, at/or behind paver.            | CHECK TEST:<br>Minimum of each 10K or fraction thereof for:<br>Hveem Stability, Air Voids, and VMA. Central Lab will run the Lottman test on first 10K or as requested by the Region.<br><br><b>See Guidelines for Test Frequency Reduction Item 403 - Hot Mix Asphalt.</b> | 65 lb. (30 kg) |  |                                     |
|  | HVEEM STABILITY  | 1 per 10,000 tons.  | CP 41<br>CP 55                | CPL 5106                     | Report on Computer accept. form, or equivalent, or CDOT Form # 360 (see all test items).   | Plant discharge, windrow, at/or behind paver.   |   |                |  |                                     |
|  | AIR VOIDS  | 1 per 1,000 tons. Minimum of 5 tests per project. If less than 5,000 tons see special provisions. | CP 41<br>CP 55                | CPL 5115                     |  | Plant discharge, windrow, at/or behind paver.   |   |                |  |                                     |
|  | VOIDS IN MINERAL AGGREGATE                                       | 1 per 1,000 tons. Minimum of 5 tests per project. If less than 5,000 tons see special provisions. | CP 41<br>CP 55                | CP 48                        |  | Plant discharge, windrow, at/or behind paver.   |   |                |  |                                     |
|  | LOTTMAN  | 1 per 10,000 tons, or fraction thereof. (See Subsection 401.02)                                   | CP 41<br>CP 55                | CPL 5109<br>CPL 5115         |  | Plant discharge, windrow, at/or behind paver.   |   |                |  |                                     |
|  | HAMBURG WHEEL-TRACKING   | 1 per project, or mix design change, or as requested by RME. (100 gyrations)                      | CP 41                         | CPL 5112                     | Submit sample to the Euro-Lab Unit of the Central Lab. Applicable with SuperPave gyratory compaction <b>designs with 100 design revolutions only.</b>  | Plant discharge, windrow, at/or behind paver.   |   |                | 1 <sup>st</sup> 10K or each mix design change, or as requested by the Region.  | 65 lb. (30 kg) for the Hamburg test |
|  | FRENCH RUTTING-TESTER  | 1 per project, or mix design change, or as requested by RME. (100 gyrations)                      | CP 41                         | CPL 5114                     |  |   |   |                |  | 65 lb. (30 kg) for the French test. |
|  | ASPHALT MIX PERFORMANCE TEST                                     | As requested by RME. 1 <sup>st</sup> 10K, or mix design change only.                              | CP 41                         | TBD                          | Submit sample to the Euro-Lab. Applicable with SuperPave gyratory compaction designs.  |   |   |                | As requested by RME.   | 130 lb. (60 kg) for the AMPT.       |
|  | PAVEMENT SMOOTHNESS<br><br>(Testing Continued on the next page.) | As specified in contract. Within 14 days after completion of paving.                              |                               | CP 74                        | Testing shall be performed by the Contractor and will be witnessed by the Engineer. Data will be transferred electronically and immediately transferred to the Engineer after testing. Data will be immediately transferred to the Central Lab for analysis. |   |   |                | The Central Lab will perform pavement smoothness verification testing. The min. testing will be statewide, once per certified profiler performing work and 25% of profiles submitted for a certified profiler. |                                     |

OA FREQUENCY GUIDE SCHEDULE for Minimum Materials Testing, Sampling and Inspection

| PAY ITEM  | TYPE OF TEST                                    | PROJECT VERIFICATION SAMPLING & TESTING FREQUENCY  | PROCEDURES                    |                              | REMARKS<br>{New Forms designed to follow SMM Templates.}  | POINT OF VERIFICATION FOR QUALITY DETERMINATION  | CENTRAL LAB (CL)<br>[LOCAL AGENCIES ARE TO USE AN ACCREDITED LAB, NOT CDOT CL]   |  |
|---|---|--|-------------------------------|------------------------------|---|--|--|--|
|   |   |  | PROJECT VERIFICATION SAMPLING | PROJECT VERIFICATION TESTING |   |  | TEST FREQUENCY   | SAMPLE SIZE  |
| <b>403</b><br><b>STONE MATRIX ASPHALT (SMA) &amp; HOT MIX ASPHALT (HMA):</b><br><b>GRADATION ACCEPTANCE</b> | ASPHALT CONTENT                                 | 1 per 1,000 tons or fraction thereof of mix produced (or as specified in the contract).  | CP 41<br>CP 55                | CP 43<br>CP 85<br>CPL 5120   | Mix Design as per CP 52; CDOT Form #43 required <u>before</u> mix is produced. Report Asphalt Content on Form #58 and Form #360 | Plant discharge, at/or behind paver. For Central Lab Correction Factor, sample aggregate from belt and Binder from Contractors tank. | CHECK TEST:<br>Minimum of each 10k or fraction thereof. 1 sample (can) is submitted to Central Lab & one to the Region Lab.<br><br>Also needed for Central Lab Correction Factor when new 10K submitted. If Mix Design changes, submit Correction Factor when next 10K submitted. Submit Correction Factor at beginning of each Paving Season.<br><br><b>See Guidelines for Test Frequency Reduction Item 403 - Hot Mix Asphalt.</b> | 65 lb. (30 kg)   |
|   | AGGREGATE MOISTURE                              | Aggregate: 1 per 2,000 tons or fraction thereof of mix produced (or as specified in the contract).   | CP 30                         | CP 33                        | Report on Form #6* the results from Form #565** or #106**. Compare to the % absorption (SSD) on the Form #43**.                 | Aggregate from the cold feed.  |  | 25 lb. (Agg)<br>1 qt (binder)  |
|   | GRADATION                                       | Aggregate: 1 per 2,000 tons or fraction thereof of mix produced (or as specified in the contract).   | CP 30                         | CP 31                        | Report Gradation on CDOT Form #6*.  | Aggregate from the cold feed, pugmill discharge, extraction, or product of CP-L 5120.  |  | 100 lb. (45 kg)<br>(Agg)   |
|   | MICRO DEVAL                                     | 1 per 10,000 tons as specified in the Contract.  | CP 30                         | CPL 4211                     | Mix Design as per CP 52.  | Aggregate from the cold feed.  |  | 65 lb. (30kg)  |
|   | FRACTURED FACES AND VOID CONTENT FINE AGGREGATE | As requested by the RME.   | CP 30                         | CP 45<br>T 304 A             | Report on CDOT Form #58*.   |  |  | Note for all tests:<br>1 full bag of each aggregate type.  |
|   | IN-PLACE DENSITY                                | All lifts of Item 403: 1 per 500 tons (500 t) or fraction thereof of mix placed (or as specified in the contract). Minimum of 5 tests per project. |                               | CP 44<br>CP 81<br>CP 82      | Report on CDOT Form #69*.   | In the compacted lift.   |  | If LA Abrasion is requested, send 1 additional full bag.   |
|   | THERMAL SEGREGATION                             | As specified in the contract.  |                               | CP 58                        | Report on CDOT Form #1346**.  | Behind paver.  |  | Micro Deval cold feed is 1 full bag. 1 full bag is required to get the gradation needed to perform a "D" Method. |
|   | LONGITUDINAL JOINT DENSITY                      | 1per 5,000 linear ft. of Joint, or fraction thereof.   |                               | CP 44                        | Report on CDOT Form #1290**. Test template CP 44L in SMM.   |  |  |  |
|   | <b>(Testing Continued on the next page.)</b>    |  |                               |                              |   |  |  |  |

OA FREQUENCY GUIDE SCHEDULE for Minimum Materials Testing, Sampling and Inspection

| PAY ITEM  | TYPE OF TEST                 | PROJECT VERIFICATION SAMPLING & TESTING FREQUENCY                                    | PROCEDURES                    |                              | REMARKS<br>{New Forms designed to follow SMM Templates.}  | POINT OF VERIFICATION FOR QUALITY DETERMINATION | CENTRAL LAB (CL)<br>[LOCAL AGENCIES ARE TO USE AN ACCREDITED LAB, NOT CDOT CL]  |                |   |                                     |
|---|------------------------------|--|-------------------------------|------------------------------|---|---|---|----------------|---|-------------------------------------|
|   |                              |  | PROJECT VERIFICATION SAMPLING | PROJECT VERIFICATION TESTING |   |   | TEST FREQUENCY  | SAMPLE SIZE    |   |                                     |
| <b>403</b><br><b>STONE MATRIX ASPHALT (SMA) &amp; HOT MIX ASPHALT (HMA):</b><br><b>GRADATION ACCEPTANCE</b> | THEORETICAL MAX. SP. GRAVITY | 1 per 1,000 tons. Minimum of 1 test per day if less than 1,000 tons placed in a day. | CP 41<br>CP 55                | CP 51<br>CP 56               | Report on CDOT Form 69*.  | Plant discharge, at/or behind paver.            | CHECK TEST:<br>Minimum of each 10K or fraction thereof for:<br>Hveem Stability, Air Voids, and VMA. Central Lab will run the Lottman test on first 10K or as requested by the Region.<br><br><b>See Guidelines for Test Frequency Reduction Item 403 - Hot Mix Asphalt.</b> | 65 lb. (30 kg) |   |                                     |
|   | HVEEM STABILITY              |  | CP 41<br>CP 55                | CPL 5106                     | See Subsection 106.05, Mix Verification Testing, or for SMA see Project Special Provision, Revision of Section 403 Stone Matrix Asphalt Pavement, Sub-section 403.03. | Plant discharge, windrow, at/or behind paver.   |   |                |   |                                     |
|   | AIR VOIDS                    |  | CP 41<br>CP 55                | CP 44<br>CPL 5115            |   | Plant discharge, windrow, at/or behind paver.   |   |                |   |                                     |
|   | VOIDS IN MINERAL AGGREGATE   |  | CP 41<br>CP 55                | CP 48                        |   | Plant discharge, windrow, at/or behind paver.   |   |                |   |                                     |
|   | LOTTMAN                      | 1 per 10,000 tons, or fraction thereof. (See Subsection 401.02)                      | CP 41<br>CP 55                | CPL 5109<br>CPL 5115         |   | Plant discharge, windrow, at/or behind paver.   |   |                |   |                                     |
|   | HAMBURG WHEEL-TRACKING       | 1 per project, or mix design change, or as requested by RME. (100 gyrations)         | CP 41                         | CPL 5112                     | Submit sample to the Euro-Lab Unit of the Central Lab. Applicable with Super-pave gyratory compaction <b>designs with 100 design revolutions only.</b>                | Plant discharge, windrow, at/or behind paver.   |   |                | 1 <sup>st</sup> 10K or each mix design change, or as requested by the Region.                                       | 65 lb. (30 kg) for the Hamburg test |
|   | FRENCH RUTTING-TESTER        | 1 per project, or mix design change, or as requested by RME. (100 gyrations)         | CP 41                         | CPL 5114                     |   |   |   |                |   | 65 lb. (30 kg) for the French test. |
|   | ASPHALT MIX PERFORMANCE TEST | As requested by RME. 1 <sup>st</sup> 10K, or mix design change only.                 | CP 41                         | TBD                          | Submit sample to the Euro-Lab. Applicable with Super-pave gyratory compaction designs.  |   |   |                | As requested by RME   | 130 lb. (60 kg) for the AMPT.       |
|   | PAVEMENT SMOOTHNESS          | As specified in contract. Within 14 days after completion of paving.                 |                               | CP 74                        | Testing shall be performed by the Contractor, witnessed by the Engineer and data will be immediately transferred to the Central Lab for analysis                      |   |   |                | The minimum verification testing will be statewide, once per profiler and 25% of profiles submitted for a profiler. |                                     |

OA FREQUENCY GUIDE SCHEDULE for Minimum Materials Testing, Sampling and Inspection

|  |  |
|--|--|
| <p><b>403</b></p> <p style="writing-mode: vertical-rl; transform: rotate(180deg);">All: HOT MIX ASPHALT (HMA)<br/>Including STONE MATRIX ASPHALT (SMA)</p> | <p><b>NOTE: Subsidiary Item: Asphalt cement / performance graded (PG) binders, follow Item 411 of the Schedule.</b></p> <p>Incidental Items (non-pay):</p> <p><b>Hydrated Lime: Acceptance Method: N/A, required with the Mix Design per CP 52.</b><br/>The Contractor shall provide the Engineer with one copy of <b>Certified Test Reports</b> that is <b>furnished by the supplier</b> for Chemical Tests, per AASHTO M 303. <b>CPL 4209: 1 per 10,000 tons of HMA mix.</b> Obtain a 2 lb. sample according to AASHTO T 218 and submit to the Central Laboratory for testing. Minimum of one sample per source per project required.</p> <p><b>Mineral Filler</b> – The Contractor shall provide the Engineer with one copy of <b>Certified Test Reports</b> that is <b>furnished by the supplier</b> per AASHTO M 17. One test per 10,000 TONS of SMA Mix, per AASHTO T 37, and T 90 (T 90 is not required when Hydrated Lime or Hydraulic Cement is used for Mineral Filler).<br/>CTR is required for SMA including T 88, C 25, and Modified Rigden Voids</p> <p><b>NOTE: Mix Design as per CP 52,</b> Submit a 50 lbs (25 kg) representative sample of each aggregate for testing of aggregate specific gravity, absorption, and plastic index. If Los Angeles (LA) Abrasion or Micro-Deval is also requested for the large aggregate, submit 60 lbs (27 kg) of the large aggregate. Be sure to document on the CDOT Form #157 which tests are requested.</p> <p><b>NOTE: Incentive / Disincentive Computer Test reports are acceptable Documentation for Asphalt Content, Gradation, In-Place Density, Longitudinal Joint Density, Maximum Specific Gravity, Air Voids, and Voids in Mineral Aggregate.</b></p> |
|--|--|

| PAY ITEM                                  | TYPE OF TEST               | PROJECT VERIFICATION SAMPLING & TESTING FREQUENCY                                     | PROCEDURES                    |                              | REMARKS<br>{Forms designed to follow SMM Templates.}                             | POINT OF VERIFICATION FOR QUALITY DETERMINATION | CENTRAL LAB (CL)<br>[LOCAL AGENCIES ARE TO USE AN ACCREDITED LAB, NOT CDOT CL] |             |
|---|----------------------------|---|-------------------------------|------------------------------|--|---|--|-------------|
|   |                            |   | PROJECT VERIFICATION SAMPLING | PROJECT VERIFICATION TESTING |  |   | TEST FREQUENCY   | SAMPLE SIZE |
| <b>405</b><br><b>HOT-IN-PLACE RECYCLE</b> | IN-PLACE DENSITY           | 1 per 5,000 sq. yds. total mix or fraction thereof (or as specified in the contract). |                               | CP 44<br>CP 81<br>CP 82      | Document on CDOT Form 69*. <b>(CP 82 is for Heating &amp; Remixing use ONLY)</b> | Roadway behind paver & after rolling.           |  |             |
|   | MAX. SP. GRAVITY (RICE)    | Minimum, 1 per each density test.   | CP 41                         | CP 51                        | Document on CDOT Form 58*.   |   |  |             |
|   | ASPHALT Rejuvenating Agent | See Item 411. <b>COC</b>  |                               |                              |  |   |  |             |

OA FREQUENCY GUIDE SCHEDULE for Minimum Materials Testing, Sampling and Inspection

| PAY ITEM                                   | TYPE OF TEST  | PROJECT VERIFICATION SAMPLING & TESTING FREQUENCY   | PROCEDURES                    |                               | REMARKS<br>{Forms designed to follow SMM Templates.}  | POINT OF VERIFICATION FOR QUALITY DETERMINATION  | CENTRAL LAB (CL)<br>[LOCAL AGENCIES ARE TO USE AN ACCREDITED LAB, NOT CDOT CL] |   |
|--|---|---|-------------------------------|-------------------------------|---|--|--|---|
|  |   |   | PROJECT VERIFICATION SAMPLING | PROJECT VERIFICATION TESTING  |   |  | TEST FREQUENCY   | SAMPLE SIZE                                     |
| 406<br><br>COLD ASPHALT PAVEMENT (RECYCLE) | IN-PLACE DENSITY  | 1 per 5,000 sq. yds. or fraction thereof.   | CP 41 * (Meth. C)             | CP 53<br>CP 81                | Report on CDOT Form 69*, CDOT Form 6* or computer report.<br>*To obtain material for CP 53.   | Windrow or roadway, after rolling in finished roadway. For cationic emulsions, sample after rolling in the finished roadway. |  |   |
|  | GRADATION   | 1 per 20,000 sq. yds. or fraction thereof.  | CP 41                         | CP 31                         | Report on CDOT Form 6*. Use sieve sizes as required.  |  |  |   |
|  | HVEEM STABILITY   | 1 per 20,000 sq. yds. or fraction thereof.  | CP 41                         | CPL 5106 modified by CPL 5111 | For information only!   |  |  |   |
|  | FREE MOISTURE   | 1 per day or as specified in the contract.  |                               | CP 57                         |   |  |  |   |
|  | ASPHALT Rejuvenating Agent                                  | See Item 411. <u>COC</u>  |                               |                               |   |  |  |   |
|  | Asphalt Emulsion  | See Item 411 <u>COC</u>   |                               |                               |   |  |  |   |
| 408<br><br>SEALANT JOINT/CRACK             |   | <b>Joint &amp; Crack Sealant, Hot Poured:</b><br><i>Acceptance Method: Pre-Approved (per each batch/lot) (with Contractor's AV for Documentation).</i><br><b>Information available at:</b> <a href="https://apps.coloradodot.info/apl/AplSearch.cfm">https://apps.coloradodot.info/apl/AplSearch.cfm</a> . Field-inspect and document on CDOT Form 157 that the material is acceptable, then retain all copies in the Project Files. Tested for compliance with ASTM D 6690 (Type II or Type IV). |                               |                               |   |  |  |   |
| 409<br><br>CHIP SEAL                       | GRADATION<br>Type I: 3/8"<br>Type II: 1/2"<br>Type IV: 3/4" | 1 per 200 tons or 15,000 sq. yds. or fraction thereof.  | CP 30                         | CP 31                         | * NOTE: Report on CDOT Form 6*. Submit 66 lb. (30 kg) sample of field-produced aggregate to the Central Lab before use. Performance Graded Binder / Asphalt: Follow instructions in Item 411. | Spreader or the last stockpile prior to placement as specified in the contract.  | 1 per project.<br>(see NOTE 1)   | 33 lb. (15 kg) is approx. 1 full bag by volume. |
|  | LA ABRASION   | One per source.   | CP 30                         | T 96 or C 535                 |   |  | (see NOTE 1)   |   |
|  | FRACTURED FACES   | 1 per 1,000 tons or 100,000 sq/yd fraction thereof. Minimum 3 per project   | CP 30                         | CP 45                         | Document on CDOT Form # 6*.   | Spreader or last stockpile prior to the spreader as specified in the contract.   |  | 65 lb. (30 kg)                                  |
|  | FLAT AND ELONGATED PARTICLES                                | 1 per 600 tons or 50,000 sq. yds. or fraction thereof, Minimum 3 tests per project.   | CP 30                         | ASTM D4791 Method B           | Use 3:1 ratio   | Spreader or last stockpile prior to the spreader as specified in the contract.   | (see NOTE 1)   | 33 lb. (15 kg) is approx.                       |
|  | COATING TEST  | 1 per source.   | CP 30                         | CPL 2213                      |   | Last stockpile prior to the spreader.  |  |   |

**NOTE 1: This Central Lab test can be performed in the Region Lab or the Field Lab if adequate facilities and equipment are available.**



OA FREQUENCY GUIDE SCHEDULE for Minimum Materials Testing, Sampling and Inspection

| PAY ITEM                                    | TYPE OF TEST   | PROJECT VERIFICATION SAMPLING & TESTING FREQUENCY  | PROCEDURES                    |   | REMARKS<br>{Forms designed to follow SMM Templates.}  | POINT OF VERIFICATION FOR QUALITY DETERMINATION | CENTRAL LAB (CL)<br>[LOCAL AGENCIES ARE TO USE AN ACCREDITED LAB, NOT CDOT CL] |             |   |
|---|--|--|-------------------------------|---|---|---|--|-------------|---|
|   |  |  | PROJECT VERIFICATION SAMPLING | PROJECT VERIFICATION TESTING  |   |   | TEST FREQUENCY   | SAMPLE SIZE |   |
| 412<br><br>PCCP<br><br>COMPRESSIVE STRENGTH | AIR CONTENT  | Minimum 1 per day then 1 per 5,000 sq. yds.  | CP 61                         | T 152   | Report test results on CDOT Form #156**.  | Per CP 61                                       |  |             |   |
|   | UNIT WEIGHT/YIELD TEMPERATURE  | Minimum 3 per mix design.  | CP 61                         | T 121<br>C 1064   |   |   |  |             |   |
|   | SLUMP  |  | CP 61                         | T 119   |   |   |  |             |   |
|   | COMPRESSIVE STRENGTH   | See Note 412 on next page.   | CP 61                         | C 39  | 1 set of 5 cylinders, Test 2 at 7 days and 3 at 28 days, or as specified in the contract.<br><br>Transmit cylinders on CDOT Form #82*. Report on CDOT Form #192. Information cylinders may be cast at the discretion of Proj. Engineer. | Per CP 61                                       |  |             | Cylinders are tested in Central Lab, but may be tested in the Field or Region Lab if adequate equipment is available. |
|   | SAND EQUIVALENT  |  | CP 30                         | CP 37   |   | Stockpile or Plant.                             |  |             |   |
| WATER CEMENTITIOUS MATERIAL RATIO           | 1 <sup>st</sup> three loads each day, then 1 per 2,000 cu. yds. or fraction thereof. |  |                               | W/CM = $\frac{\text{(weight water)}}{\text{(wt. cement + wt. flyash)}}$ | Batch ticket.   |   |  |             |   |
| 412<br><br>PCCP<br><br>FLEXURAL STRENGTH    | AIR CONTENT  | Minimum 1 per day then 1 per 5,000 sq. yds.  | CP 61                         | T 152   | Report test results on CDOT Form #156**.  | Per CP 61                                       |  |             |   |
|   | UNIT WEIGHT/YIELD TEMPERATURE  | Minimum 3 per mix design.  | CP 61                         | T 121<br>C 1064   |   |   |  |             |   |
|   | SLUMP  | 1 per Flexural Strength test.  | CP 61                         | T 119   |   |   |  |             |   |
|   | FLEXURAL STRENGTH  | 1 per 10,000 sq. yds. per mix. Minimum of 3 per process.<br><br>See Note 412 on next page. | CP 61                         | T 97  | 1 set of 4 beams, tested at 28 days.<br>Frequency should be increased to have 1 Owner test per 4 Contractor OA tests.   | Per CP 61                                       |  |             | Beams are tested at the Contractor's Process Control Lab  |
|   | WATER CEMENTITIOUS MATERIAL RATIO  | 1 <sup>st</sup> three loads each day, then 1 per 2,000 cu. yds. or fraction thereof.       |                               |   | W/CM = $\frac{\text{(weight water)}}{\text{(wt. cement + wt. flyash)}}$   | Batch ticket.                                   |  |             |   |

OA FREQUENCY GUIDE SCHEDULE for Minimum Materials Testing, Sampling and Inspection

| PAY ITEM   | TYPE OF TEST                  | PROJECT VERIFICATION SAMPLING & TESTING FREQUENCY   | PROCEDURES                    |                              | REMARKS<br>{Forms designed to follow SMM Templates.}   | POINT OF VERIFICATION FOR QUALITY DETERMINATION | CENTRAL LAB (CL)<br>[LOCAL AGENCIES ARE TO USE AN ACCREDITED LAB, NOT CDOT CL]  |             |
|--|-------------------------------|---|-------------------------------|------------------------------|--|---|---|-------------|
|  |                               |   | PROJECT VERIFICATION SAMPLING | PROJECT VERIFICATION TESTING |  |   | TEST FREQUENCY  | SAMPLE SIZE |
| PORTLAND CEMENT CONCRETE PAVEMENT<br>COMPRESSIVE STRENGTH OR FLEXURAL STRENGTH | THICKNESS                     | Min. 1 per day, per mix. If the project total is <50,000 sq. yds. then a minimum of 10 tests. If the project total is ≥50,000 sq. yds. then 1 per 5,000 sq.yds                    | T 24                          | T 148                        | Report thickness on CDOT Form 157*. None required on bridge approach slabs.  | Hardened concrete.                              | Central Lab will randomly select 1 in 4 files. Send results to the Project Engineer. The Project Engineer will compare these results to the Contractor's results to verify that the results submitted by the Contractor are from the data collected on the project. |             |
|  | PULL TEST for JOINT SEALANTS  | Minimum of 6 transverse and 6 longitudinal joint locations for the first 2,500 linear feet of concrete roadway; 3 transverse and 3 longitudinal joints thereafter on the project. |                               | CP 67                        | Replace joint failures. Report on CDOT Form #389**. Document in Project Files.<br>Witness by Engineer.   | Installed in hardened concrete joint.           |   |             |
|  | DOWEL BAR & TIE BAR PLACEMENT | As specified in the plans.  |                               |                              | Witness Contractor MIT scanning by Engineer & document results. Record time and date and obtain the rea MIT Scan files and submit electronically to Central Lab.<br><a href="mailto:Dot_Profiles@state.co.us">Dot_Profiles@state.co.us</a> | Joint.  |   |             |
|  | PULL TEST for TIE BARS        | <b>As specified in Standard Specification Section 412.13 (a).</b>   |                               |                              |  | Hardened concrete.                              |   |             |
|  | TEXTURE DEPTH                 | 1 per 2500 linear feet or fraction thereof in each lane and shoulder wider than 8 feet at 1 per day.  |                               | CP 77B                       | If stabbed or drilled into the pavement.<br>Witness by Engineer.   | Hardened concrete.                              |   |             |
|  | SAW CUT DEPTH                 | 1 per 528 linear feet, of each longitudinal joint and 1 transverse joint in a section of 528 ft. or fraction thereof.   |                               |                              | Summarize and report texture depth on CDOT Form #157*.<br><br>Summarize and report saw cut depth on CDOT Form #157*.   | Hardened concrete.                              |   |             |
|  | PAVEMENT SMOOTHNESS*          | As specified in contract. Within 14 days after completion of paving.  |                               |                              | CP 74<br>Testing shall be performed by the Contractor, witnessed by the Engineer and data will be immediately transferred to the Central Lab for analysis.   |   |   |             |

\* Note: Item Pavement Smoothness is not paid for separately, included in the cost of Concrete Pavement / Square Yard as per CDOT Standard Specifications, Section 412.24



OA FREQUENCY GUIDE SCHEDULE for Minimum Materials Testing, Sampling and Inspection

|  |   |
|--|---|
| <p><b>412</b><br/><br/>PCCP<br/>Continued</p>  | <p><b>The specified slump is +/- 2 inches of the Lab design slump.</b><br/> <b>NOTE 412: When compressive or flexural strength specimens are cast the tests for air content, unit weight / yield, temperature, and slump shall be made on the same sample at the same time.</b></p> <p>Compressive Strength specimens shall be initially cured by full immersion in saturated limewater at 73.4°F ± 3°, with lime concentrations as per AASHTO M 201. Water temperature shall be recorded by a continuous recording thermometer, calibrated every six months; or a maximum-minimum thermometer read and recorded twice a day on CDOT Form #82.<br/>                 When a field laboratory Class 2 is not specified and when approved by the RME, cylinders may be initially cured in accordance with AASHTO T23 with a curing temperature of 70°F +/- 10°F. The minimum and maximum temperature of the initial curing shall be recorded.</p> <p><b>INCIDENTAL ITEMS (non-pay)</b><br/> <b>Sealant [Joint and Crack]Silicone, Joint:</b> <i>Acceptance Method: <b>Pre-Approved (with Contractor's APL-Verification (AV) for Documentation).</b></i> <a href="https://apps.coloradodot.info/apl/AplSearch.cfm">https://apps.coloradodot.info/apl/AplSearch.cfm</a> Backer Rod is not listed on the CDOT APL and is considered a part of the Sealing Joints as an Incidental Item. (CDOT Standard Specification 412.18).<br/> <b>Contraction Joint Plastic Strip:</b> <i>Acceptance Method:</i> Field-inspect and document on CDOT Form #157 that the material is acceptable, then retain all copies in the Project Files.<br/> <b>Reinforcing Steel, Dowels Bars, Tie Bars:</b> <i>Acceptance Method:</i> Follow Item 602 of Schedule. <b>COC</b> for Dowels &amp; Tie-bars. Tie-bars are sampled/tested. <b>Buy America Certification.</b><br/> <b>Incidental Items not listed above (non-pay):</b> <i>Acceptance Method:</i> Follow Item 601 of Schedule.</p> |
| <p><b>420</b><br/><br/>GEO-<br/>SYNTHETICS</p> | <p><b>Geosynthetics:</b> <i>Acceptance Method: <b>Pre-Approved (with Contractor's AV for Documentation).</b></i></p> <p>Geomembranes. Field-inspect and document on CDOT Form 157 that the material is acceptable, then retain all copies in the Project Files. Reference CDOT Materials Bulletin 2008 No 1.</p> <p><a href="https://www.codot.gov/business/designsupport/materials-and-geotechnical/materials-bulletins/Materials%20Bulletin%202008%20No%201.pdf/view">https://www.codot.gov/business/designsupport/materials-and-geotechnical/materials-bulletins/Materials%20Bulletin%202008%20No%201.pdf/view</a></p>   |
| <p><b>420</b><br/><br/>GEO-<br/>TEXTILES</p>   | <p><b>Geotextiles:</b> <i>Acceptance Method: <b>Pre-Approved (with Contractor's AV for Documentation).</b></i></p> <p>The physical, mechanical, and endurance properties that must be met, or exceeded, by the Geotextile being manufactured must be in compliance with AASHTO M 288, Geotextile Specification for Highway Applications. This Specification covers Geotextile fabrics for use in subsurface drainage, separation, stabilization, erosion control, temporary silt fence, and paving fabrics. Reference CDOT Materials Bulletin 2008 No 1.</p> <p><a href="https://www.codot.gov/business/designsupport/materials-and-geotechnical/materials-bulletins/Materials%20Bulletin%202008%20No%201.pdf/view">https://www.codot.gov/business/designsupport/materials-and-geotechnical/materials-bulletins/Materials%20Bulletin%202008%20No%201.pdf/view</a></p> <p>Materials shall be selected from the New York Department of Transportation's Approved Products List of Geosynthetic materials that meet the National Transportation Product Evaluation Program (NTPEP) and AASHTO M 288. <b><i>The web address to ensure product acceptability is Go to A-Z Index, Approved List, Materials and Equipment, Geosynthetics for Highway Construction, Geotextiles.</i></b> Field-inspect and document on CDOT Form 157 that the material is on the New York State APL.</p> <p><a href="https://www.dot.ny.gov/divisions/engineering/technical-services/technical-services-repository/alme/pages/470-1a.html">https://www.dot.ny.gov/divisions/engineering/technical-services/technical-services-repository/alme/pages/470-1a.html</a></p>   |
| <p><b>420</b><br/><br/>GEOGRIDS</p>            | <p><b>Geogrids for Embankment &amp; Roadway:</b> <i>Acceptance Method: <b>COC or CTR.</b></i></p> <p>Evaluated on a project-by-project basis by the Engineer of Record and the Regional Materials Engineer . After the specific material recommended for use has been evaluated, if approved for use, then field-inspect and document on CDOT Form #157 that the material complies with the project specifications. Certified Test Reports or Certificates of Compliance shall be retained in the Project Files.</p> <p><b>Geogrids for Mechanically Stabilized Earth (MSE) Walls:</b> <i>Acceptance Method: <b>COC or CTR.</b></i></p> <p>Evaluated on a project-by-project basis by the Bridge Design and Management Branch at (303) 512-4072. After the specific material recommended for use has been evaluated, if approved for use, then field-inspect and document on CDOT Form 157 that the material complies with the project specifications. Certified Test Reports or Certificates of Compliance shall be retained in the Project Files.</p>   |

OA FREQUENCY GUIDE SCHEDULE for Minimum Materials Testing, Sampling and Inspection

|  |  |
|--|--|
| <p><b>501</b><br/>STEEL SHEET<br/>PILING</p>                       | <p><b>Sheet Piling:</b> <i>Acceptance Method:</i> <b><u>COC. Buy America Certification.</u></b><br/>The contractor shall provide the Engineer with one copy of a <b><u>Certificate of Compliance and Mill Test Reports</u></b> (furnished by the supplier) showing compliance with Standard Specification Subsection 501.02 (or 501.03 as applicable) and to be retained with CDOT Form 157, then retain in Project Files. State on CDOT Form 157 that: (1) the material has been field-inspected and is acceptable; (2) the Mill Test Reports are on file; and, (3) the heat numbers on piling correspond with the numbers on the Mill Test Reports. Each shipment delivered to the project shall be accompanied by shipping invoices, bar lists and Mill Test Reports.</p> <p><b>Reinforced Sheet Piling Tips:</b> Documentation is the same as for Sheet Piling. <i>Acceptance Method:</i> <b><u>COC. Buy America Certification.</u></b></p>  |
| <p><b>502</b><br/>PILING</p>                                       | <p><b>Steel Piling, Steel Pipe Piling, and Steel Shell Piling:</b> <i>Acceptance Method:</i> <b><u>COC. Buy America Certification.</u></b><br/>Follow the instructions in Item 501 of Schedule, except that the material shall comply with Standard Specifications Subsection 502.02.</p> <p><b>Reinforced Piling Tips:</b> <i>Acceptance Method:</i> <b><u>COC. Buy America Certification.</u></b><br/>Tips should be Associated Pile &amp; Fitting Corp. (APF) HARD-BITE HP-77600 for hard rock, or equivalent.</p>  |
| <p><b>503</b><br/>DRILLED<br/>CAISSONS</p>                         | <p><b>Concrete:</b> Follow instructions in Item 601 of Schedule.</p> <p><b>Reinforcing Steel:</b> Follow instructions in Item 602 of Schedule. NOTE: Do not include quantities listed in Item 602 when reporting.</p>  |
| <p><b>504</b><br/>CRIBBING</p>                                     | <p><b>Steel Cribbing:</b> <i>Acceptance Method:</i> <b><u>CTR. Buy America Certification.</u></b><br/>The Contractor shall provide the Engineer with one copy of <b><u>Certified Test Reports / Mill Test Reports (furnished by supplier)</u></b>, attach and document on CDOT Form 157, then retain in Project Files. State on CDOT Form 157: (1) the material has been field-inspected and is acceptable.</p> <p><b>Concrete Cribbing:</b> Follow Items 601 and 602.</p> <p><b>Timber Cribbing:</b> See Item 508.</p>  |
| <p><b>504</b><br/>MECHANICALLY STABILIZED<br/>EARTH (MSE) WALL</p> | <p><b>Reinforcement Elements:</b> <i>Acceptance Method:</i> <b><u>COC. Buy America Certification (if steel is used).</u></b><br/>Field-inspect and document on CDOT Form 157 that the material is acceptable, then retain all copies in the Project Files.</p> <p><b>Facing Elements:</b> <i>Acceptance Method:</i> <b><u>COC. Buy America Certification.</u></b> Field-inspect and document on CDOT Form #157 that the material is acceptable, retain all copies in the Project Files.</p> <p><b>Treated Timbers:</b> See Item 508 and document acceptance of the material as stated.</p> <p><b>Structure Backfill:</b> See Item 203, 206, 304 or contract documents as appropriate for gradation, atterberg limits, and density testing. Submit a 55 lb. (22 kg) sample to Central Lab for direct shear testing [AASHTO T 236] to verify material's friction angle. Submit the required relative compaction and compaction method if friction angle is required. Submit one sample per source.</p> <p><b>Foundation Soil:</b> Submit a 55 lb. (22kg) sample to Central Laboratory for direct shear testing [AASHTO T 236] to verify material's friction angle. Submit one sample per 500 feet of wall length if the foundation soil type is unchanged. Submit the required relative compaction and compaction method if friction angle is required. Otherwise, submit one sample for each soil type encountered. If the soil type is the same material as the Structure Backfill, then no additional samples will be required for testing.</p> <p><b>Misc Items:</b> Document all items in Project Files. Steel used in leveling pad requires a <b><u>Buy America Certification.</u></b></p> |

OA FREQUENCY GUIDE SCHEDULE for Minimum Materials Testing, Sampling and Inspection

| PAY ITEM  | TYPE OF TEST                       | PROJECT VERIFICATION SAMPLING & TESTING FREQUENCY | PROCEDURES                               |                                       | REMARKS<br>{Forms designed to follow SMM Templates.}   | POINT OF VERIFICATION FOR QUALITY DETERMINATION | CENTRAL LAB (CL)<br>[LOCAL AGENCIES ARE TO USE AN ACCREDITED LAB, NOT CDOT CL]   |             |
|---|------------------------------------|---|--|---------------------------------------|--|---|--|-------------|
|   |                                    |   | PROJECT VERIFICATION SAMPLING            | PROJECT VERIFICATION TESTING          |  |   | TEST FREQUENCY   | SAMPLE SIZE |
| 504   | WATER/ CEMENTITIOUS MATERIAL RATIO | Each grout batch mixed.                           |  |                                       | WCM = (wt.water) / (wt. cement + wt. flyash).<br><br>Report on CDOT Form 82  | Batch Ticket                                    |  |             |
|   | SPECIFIC GRAVITY                   | Perform with compressive strength.                | Baroid Mud Balance (API Method RP 13B-1) |                                       | Report on CDOT Form 157.   |   |  |             |
|   | COMPRESSIVE STRENGTH               | 1 per day.  | T106<br><br>M6 (if sand is used)         | C109<br><br>M6 (#1) (if sand is used) | Submit cubes on CDOT Form 82. Report on CDOT Form 192. Informational cubes may be cast at the discretion of the Project Engineer and cured at the structure. |   | Cubes are tested in the Central Lab, but may be tested in the Field or Region Laboratory if adequate equipment is available. |             |
| <p><b>NOTE (#1):</b> The cubes are cured 24 hours in the molds, and stripped and immersed in lime water until tested.</p> <p><b>INCIDENTAL ITEMS (non-pay)</b><br/> <b>Miscellaneous Items:</b> Document all items in Project Files.<br/> <b>Water, Non-Potable:</b> <i>Acceptance Method: CTR.</i> Obtain <b><i>Certified Test Reports from the Contractor (furnished by the supplier)</i></b> before using. The test shall be in accordance with ASTM C 1602. Document on the CDOT Form 157, and retain in Project Files.</p> <p><b>Soil Nail Bar:</b> Follow instruction in item 602 of Schedule. NOTE: Bar size will be size #11 or smaller.</p> <p><b>Bearing Plates, Washers, Nuts, and Couplers:</b> COC. Buy American Certification. Field-inspected and document on CDOT Form 157 that the material is acceptable, then retain all copies in the Project Files.</p> <p><b>Corrosion Protection (Epoxy Coating):</b> Follow instruction in item 602 of Schedule.</p> <p><b>Geocomposite Strip Drain and Underdrain:</b> Field-inspected and document on CDOT Form 157 that the material is acceptable, then retain all copies in the Project Files.</p> <p><b>Miscellaneous Items:</b> Document all items in Project Files.</p> |                                    |   |  |                                       |  |   |  |             |

OA FREQUENCY GUIDE SCHEDULE for Minimum Materials Testing, Sampling and Inspection

|  |  |
|--|--|
| <p style="text-align: center;"><b>506</b></p> <p style="text-align: center;"><b>RIPRAP</b></p>                 | <p><b>Riprap:</b> <u>Visual-inspect</u> stone to determine compliance with specifications or contract documents, for size, durability, placement, etc. Determine specific gravity (bulk, saturated-surface dry) where specified in accordance with AASHTO T 85. Document on CDOT Form 157 for each pay item and show quantity represented and that the material has been field inspected and is acceptable. <b>Bed Course Material:</b> Follow instructions in Item 206 of Schedule.</p> <p><b>Gabions and Slope Mattress:</b> <i>Acceptance Method:</i> <b>COC. Buy America Certification.</b><br/>Wire mesh and fabricated baskets. Note that the baskets and wire mesh material has been field- inspected and is accepted on the CDOT Form 157. See Chapter 500 for further details.</p> <p><b>Concrete and Concrete Reinforced:</b> Follow instructions in Item 601 and 602 of Schedule.</p>   |
| <p style="text-align: center;"><b>507</b></p> <p style="text-align: center;"><b>SLOPE AND DITCH PAVING</b></p> | <p><b>Concrete and Concrete Reinforced:</b> Follow instructions in Item 601 and 602 of Schedule. See Chapter 600 for more information. <b>Note:</b> Initial water cure of cylinders as per Item 601.</p> <p><b>Welded Wire Mesh:</b> <i>Acceptance Method:</i> <b>COC. Buy America Certification.</b> Field-inspect and document on CDOT Form #157 that the material is acceptable, then retain all copies in the Project Files. Refer to Standard Specifications Subsection 709.01.</p> <p><b>Dry Rubble:</b> Determine specific gravity (bulk, saturated-surface dry) where specified according to AASHTO T 85. *</p> <p><b>Grouted Rubble:</b> Determine specific gravity (bulk, saturated-surface dry) where specified according to AASHTO T 85. *</p> <p><b>Asphalt:</b> Field test for asphalt content and gradation; 1 each per 500 tons or fraction thereof. No Central Laboratory samples required except for Lottmans. Report on CDOT Form #6 and #58, or computer printouts are acceptable. Include bitumen quantity in Item 403 (Patching) quantities. Follow Item 411 of Schedule.<br/>* Document dry rubble and components of grouted rubble in Project Files.</p> |
| <p style="text-align: center;"><b>508</b></p> <p style="text-align: center;"><b>TIMBER STRUCTURES</b></p>      | <p><b>Treated Timber:</b> <i>Acceptance Method:</i> <b>COC.</b><br/>The Contractor shall provide the Engineer with one copy of the <b>Certificate of Compliance (furnished by the supplier)</b> and a copy of treating report(s) or retention assay. Field-inspect and document that the material is acceptable, then retain all copies in the Project Files.</p> <p><b>Timber for Cattle Guards:</b> Follow instructions in Item 611 of Schedule.</p> <p><b>Untreated Timber:</b> <u>Field-inspect</u> and document on CDOT Form 157 that the material is acceptable, then retain all copies in the Project Files.</p>  |
| <p style="text-align: center;"><b>509</b></p> <p style="text-align: center;"><b>STEEL STRUCTURES</b></p>       | <p><b>Steel Structures:</b> <i>Acceptance Method:</i> <b>Pre-Inspected. Buy America Certification.</b><br/>See Special Notice to Contractors for details. Final Inspection Report (<b>CDOT Form 193</b>) will be <b>distributed by the Staff Bridge Fabrication Inspectors</b> after all fabrication is complete and all mill test reports are received from the fabricator. This report will include high strength shop bolts, shop painting and galvanizing. The Staff Bridge Fabrication Inspectors will determine that the structural steel meets all physical and chemical requirements.</p> <p><b>Field painting:</b> <u>Field inspect</u> for conformance with Standard Specifications Subsections 509.29. Paint reporting procedure is outlined in Item 708 of Schedule.</p> <p>Isolated small quantities of structural steel and structural steel-galvanized should be field-inspected and reported on CDOT Form 157, and state that the material is acceptable.</p> <p><b>Structural Steel - Galvanized:</b> The requirements are the same as for non-galvanized steel. <b>Buy America Certification.</b></p>  |

OA FREQUENCY GUIDE SCHEDULE for Minimum Materials Testing, Sampling and Inspection

|   |  |
|---|--|
| <p><b>510</b><br/>STRUCTURAL<br/>PLATE<br/>STRUCTURES</p> | <p><b>Structural Plate Structures:</b> <i>Acceptance Method:</i> <b><u>CTR</u></b>. <b><u>Buy America Certification</u></b>.</p> <p>The contractor shall provide the Engineer with one copy of <b><u>Certified Test Reports (furnished by supplier)</u></b> attached to the CDOT Form 157, then retain in Project Files. State on CDOT Form 157 (1) the material has been field inspected and is acceptable, (2) identification numbers on mill test reports corresponds with heat numbers on plates. State on the CDOT Form 157 that the high strength bolts were field inspected and bear high strength bolt markings.</p>   |
| <p><b>512</b><br/>BEARING<br/>DEVICE</p>                  | <p><b>Type I &amp; II:</b> <i>Acceptance Method:</i> <b><u>COC</u></b>. <b><u>Buy America Certification</u></b>.<br/>Contractor shall provide one copy of <b><u>Certificate of Compliance and including Certified Test Reports on components</u></b>. Copies of this <b><u>Certificate of Compliance</u></b> are to be attached to the CDOT Form #157, then retain in Project Files. State on CDOT Form #157: (1) the material has been field-inspected and is acceptable.</p> <p><b>Type III:</b> <i>Acceptance Method:</i> <b><u>CTR</u></b>. <b><u>Buy America Certification</u></b>.<br/>The contract will list the products and manufacturers specifically approved by the Bridge Design and Management Branch. Field- inspect and document on CDOT Form #157 that the material is acceptable, then retain all copies in the Project Files.</p>   |
| <p><b>514</b><br/>PED. &amp;<br/>BIKEWAY<br/>RAILING</p>  | <p><b>Pedestrian &amp; Bikeway Railing: Steel, Aluminum, Timber (any type).</b> <i>Acceptance Method:</i> <b><u>CTR</u></b>. <b><u>Buy America Certification</u></b>.</p> <p>The contractor shall provide the Engineer with one copy of <b><u>Certified Test Reports (furnished by supplier)</u></b> to be filed in the Project Files with the CDOT Form 157. Field-inspect and document on CDOT Form #157 that the material is acceptable, then retain all copies in the Project Files.</p>   |
| <p><b>515</b><br/>WATERPROOFING<br/>MEMBRANE</p>          | <p><b>Prefabricated, Reinforced Membrane:</b> <i>Acceptance Method:</i> <b><u>COC</u></b>. Field-inspect and document on CDOT Form 157 that the material is acceptable, then retain all copies in the Project Files.</p> <p><b>Single Component, Hot Applied, Elastomeric Membrane:</b> <i>Acceptance Method:</i> <b><u>Pre-Approved (per each batch/lot) (with Contractor's AV for Documentation)</u></b>. <b><u>Information available at</u></b> <a href="https://apps.coloradodot.info/apl/AplSearch.cfm">https://apps.coloradodot.info/apl/AplSearch.cfm</a> Field-inspect and document on CDOT Form 157 that the material is acceptable, then retain all copies in the Project Files.</p> <p><b>Protective Covering (Roofing paper):</b> <i>Acceptance Method:</i> <b><u>COC</u></b>.<br/>Field-inspect and document on CDOT Form 157 that the material is acceptable, then retain all copies in the Project Files.</p> <p><b>Concrete Sealer:</b> <i>Acceptance Method:</i> <b><u>Pre-Approved (with Contractor's AV for Documentation)</u></b>.</p> <p><b><u>Information available at</u></b> <a href="https://apps.coloradodot.info/apl/AplSearch.cfm">https://apps.coloradodot.info/apl/AplSearch.cfm</a> Field-inspect and document on CDOT Form 157 that the material is acceptable, then retain all copies in the Project Files.</p> |

OA FREQUENCY GUIDE SCHEDULE for Minimum Materials Testing, Sampling and Inspection

|   |   |
|---|---|
| <p style="text-align: center;"><b>516</b></p> <p style="writing-mode: vertical-rl; transform: rotate(180deg);"><b>DAMP-PROOFING</b></p>                               | <p><b>Asphalts:</b> <i>Acceptance Method:</i> <u>COC</u>.</p> <p>Materials for damp-proofing with asphalt shall conform to the requirements ASTM D 449. The contractor shall provide the Engineer with one copy of Certificate of Compliance (furnished by supplier). Field-inspect and document on CDOT Form 157 that the material is acceptable, then retain all copies in the Project Files.</p>   |
| <p style="text-align: center;"><b>517</b></p> <p style="writing-mode: vertical-rl; transform: rotate(180deg);"><b>WATER-PROOFING</b></p>                              | <p><b>Waterproofing Materials:</b> <i>Acceptance Method:</i> <u>COC</u>.</p> <p>Field-inspect and document on CDOT Form 157 that the material is acceptable, then retain all copies in the Project Files.</p>   |
| <p style="text-align: center;"><b>518</b></p> <p style="writing-mode: vertical-rl; transform: rotate(180deg);"><b>WATERSTOPS &amp; EXPANSION JOINTS (DEVICES)</b></p> | <p><b>Asphaltic Plug Joints:</b> <i>Acceptance Method:</i> <b>Pre-Approved</b> (per each batch/lot) (<b>with Contractor's AV</b> for Documentation). <u>Information available at</u> <a href="https://apps.coloradodot.info/apl/AplSearch.cfm">https://apps.coloradodot.info/apl/AplSearch.cfm</a>. Field-inspect and document on CDOT Form 157 that the material is acceptable, then retain all copies in the Project Files. If verification testing is requested by the Engineer, submit one box of specimen with a CDOT Form 157 to the Central Lab.</p> <p><b>Waterstops:</b> <i>Acceptance Method:</i> <u>COC</u>.<br/>Complies with the Standard Specifications Subsection 518.02. Field-inspect and document on CDOT Form 157 that the material is acceptable, then retain all copies in the Project Files.</p> <p><b>Asphaltic Expansion Devices:</b> <i>Acceptance Method:</i> <u>COC</u>.<br/>Complies with the Standard Specifications Subsection 518.03. Field-inspect and document on CDOT Form 157 that the material is acceptable, then retain all copies in the Project Files.</p> <p><b>Elastomeric Expansion Devices:</b> <i>Acceptance Method:</i> <u>COC</u>.<br/>Complies with the Standard Specifications Subsection 518.04. Field-inspect and document on CDOT Form 157 that the material is acceptable, then retain all copies in the Project Files.</p> <p><b>Modular Expansion Devices:</b> <i>Acceptance Method:</i> <u>COC</u>.<br/>Complies with the Standard Specifications Subsection 518.05. Field-inspect and document on CDOT Form 157 that the material is acceptable, then retain all copies in the Project Files.</p> <p><b>Elastomeric Concrete End Dam:</b> <i>Acceptance Method:</i> <u>COC</u>.<br/>Complies with the Standard Specifications Subsection 518.06. Field-inspect and document on CDOT Form 157 that the material is acceptable, then retain all copies in the Project Files.</p> |

OA FREQUENCY GUIDE SCHEDULE for Minimum Materials Testing, Sampling and Inspection

| PAY ITEM            | TYPE OF TEST  | PROJECT VERIFICATION SAMPLING & TESTING FREQUENCY   | PROCEDURES                    |                              | REMARKS<br>{Forms designed to follow SMM Templates.}   | POINT OF VERIFICATION FOR QUALITY DETERMINATION | CENTRAL LAB (CL)<br>[LOCAL AGENCIES ARE TO USE AN ACCREDITED LAB, NOT CDOT CL]   |             |
|---------------------|---|---|-------------------------------|------------------------------|--|---|--|-------------|
|                     |   |   | PROJECT VERIFICATION SAMPLING | PROJECT VERIFICATION TESTING |  |   | TEST FREQUENCY   | SAMPLE SIZE |
| 601                 | AIR CONTENT (#1)<br>UNIT WEIGHT (#1)<br>TEMPERATURE   | The 1 <sup>st</sup> three batches at the beginning of a day's production, then one random test per five batches.  | CP 61                         | T 152<br>T 121<br>C 1064     | Report test results on CDOT Form 156, and CDOT Form 82 when batch correlates to cylinders cast.  | Per CP 61.                                      |  |             |
|                     | SLUMP (#1)  | 1 per set of cylinders.   | CP 61                         | T 119                        |  | Per CP 61.                                      |  |             |
|                     | COMPRESSIVE STRENGTH  | One set of cylinders per 100 cu. yds. or fraction thereof. Test 2 at 7 days and 3 at 28 days. For Class H and HT concrete, one set of cylinders per 100 cu. yds. or fraction thereof. Test 2 at 7 days, 3 at 28 days, and 3 at 56 days. | CP 61                         | C 39<br>T 23 (#2)            | Submit cylinders on CDOT Form 82. Report on CDOT Form 192. Information cylinders may be cast at the discretion of Project Engineer and cured at the structure. |   | Cylinders are tested in the Central Lab, but may be tested in the Field or Region Laboratory if adequate equipment is available. |             |
| STRUCTURAL CONCRETE | <p><b>1. NOTE (#1):</b> Slump, Air Content, and Unit Wt. tests are required for each set of cylinders for all Classes of concrete.<br/> <b>Except for Class BZ concrete the specified slump is +/- 2 inches of the Lab mix design slump.</b></p> <p><b>2. NOTE (#2):</b> Specimens shall be initially cured by full immersion in saturated limewater, with lime concentrations as per AASHTO M 201. Water temperature shall be recorded by a continuous recording thermometer, calibrated every six months; or a maximum-minimum thermometer read and recorded, twice a day, on the CDOT Form 82<br/>                     When a field laboratory Class 2 is not specified and when approved by the RME, cylinders may be initially cured in accordance with AASHTO T23 with a curing temperature of 70°F +/- 10°F. The minimum and maximum temperature of the initial curing shall be recorded.</p> <p><b>INCIDENTAL ITEMS (non-pay)</b></p> <p><b>Reinforcing Steel:</b> Follow instructions in Item 602 of the Schedule.</p> <p><b>Water, Non-Potable:</b> <i>Acceptance Method: CTR.</i> Obtain <b><i>Certified Test Reports from the Contractor (furnished by the supplier)</i></b> before using. The test shall be in accordance with ASTM C 1602. Document on the CDOT Form #157, and retain in Project Files.</p> <p><b>Other Additives:</b> Additives included in the approved Mix Design require no additional documentation per Materials Bulletin 2017 Number 1, dated August 23, 2017.</p> <p><b>Curing Compounds:</b> <i>Acceptance Method: Pre-Approved (with Contractor's AV for Documentation).</i><br/> <b>Information available at:</b> <a href="https://apps.coloradodot.info/apl/AplSearch.cfm">https://apps.coloradodot.info/apl/AplSearch.cfm</a> Tabulate the quantity of material used on the project. If you have questions or problems, contact: <a href="mailto:eric.prieve@state.co.us">eric.prieve@state.co.us</a> or 303-398-6542.</p> |   |                               |                              |  |   |  |             |
|                     | <b>(Continued on next page.)</b>  |   |                               |                              |  |   |  |             |



OA FREQUENCY GUIDE SCHEDULE for Minimum Materials Testing, Sampling and Inspection

|   |   |
|---|---|
| <p><b>601</b></p> <p style="writing-mode: vertical-rl; transform: rotate(180deg);"><b>STRUCTURAL CONCRETE</b></p> | <p><b>INCIDENTAL ITEMS (non-pay)</b></p> <p><b>Epoxy Adhesive:</b> Acceptance Method: <b>Project Special Only, No longer listed on the APL</b><br/>                 Information available at: Staff Bridge SME: <a href="mailto:mohamed.zaina@state.co.us">mohamed.zaina@state.co.us</a> For Structural Bridge Adhesives use Staff Bridge SME Guidance.  </p> <p><b>Expansion Joint Material, Preformed Filler:</b> Acceptance Method: <b>Pre-Approved (with Contractor's AV for Documentation)</b>.<br/>                 Information available at: <a href="https://apps.coloradodot.info/apl/AplSearch.cfm">https://apps.coloradodot.info/apl/AplSearch.cfm</a> Field-inspect and document on CDOT Form 157 that the material is acceptable, then retain all copies in the Project Files.</p> <p><b>Cementitious Grouts:</b> Acceptance Method: <b>Pre-Approved(with Contractor's AV for Documentation)</b>. <a href="https://apps.coloradodot.info/apl/AplSearch.cfm">https://apps.coloradodot.info/apl/AplSearch.cfm</a></p> <p><b>Class 5 Masonry Finish:</b> Acceptance Method: <b>Pre-Approved (with Contractor's AV for Documentation)</b>.<br/>                 Information available at: <a href="https://apps.coloradodot.info/apl/AplSearch.cfm">https://apps.coloradodot.info/apl/AplSearch.cfm</a></p> <p><b>Structural Concrete Coating (Acrylic):</b> Acceptance Method: <b>Pre-Approved (with Contractor's AV for Documentation)</b>.<br/>                 Information available at: <a href="https://apps.coloradodot.info/apl/AplSearch.cfm">https://apps.coloradodot.info/apl/AplSearch.cfm</a> Field-inspect and document on CDOT Form 157 that the material is acceptable, then retain all copies in the Project Files.</p> <p><b>Bridge Deck Forms; Permanent (left in-place) Steel:</b> Acceptance Method: <b>CTR. Buy America Certification</b>.<br/>                 The contractor shall provide the Engineer with one copy of <b>Certified Test Reports</b> that are furnished by supplier to be filed with CDOT Form 157. State on CDOT Form #157: (1) the material has been field-inspected and is acceptable, (2) Certified Test Reports are on file.</p>  |
| <p><b>602</b></p> <p style="writing-mode: vertical-rl; transform: rotate(180deg);"><b>REINFORCING STEEL</b></p>   | <p><b>Reinforcing Steel (black bar) &amp; Epoxy Coated Reinforcing Steel (coated bar):</b> Acceptance Method: <b>Pre-Approved (with Contractor's AV for Documentation)</b>. <b>COC</b> with all applicable Mill locations documented. <b>Buy America Certification</b>.<br/> <b>In accordance with CP 11 the Contractor shall only use qualified manufacturer sources of reinforcing steel found on the QML at</b><br/> <a href="https://www.codot.gov/content/apl/SteelReinforcingBarsAndSteelDowelBars.pdf">https://www.codot.gov/content/apl/SteelReinforcingBarsAndSteelDowelBars.pdf</a>.<br/> <a href="https://www.codot.gov/content/apl/EpoxyCoatingForReinforcingSteel.pdf">https://www.codot.gov/content/apl/EpoxyCoatingForReinforcingSteel.pdf</a></p> <p>Each shipment delivered to the project shall be accompanied by shipping invoices, bar lists and Mill Test Reports. These reports are to be retained in the Project Files during construction. Document on a CDOT Form 157: (1) that the steel mill is on the QML (2) the material has been field-inspected and is acceptable, (3) Mill Test Reports are on file, and (4) a tabulation of the quantity used on project. Verify that the bar markings match the source listed on the Mill Test Report. A bar marking identification guide reference is in Chapter 600.<br/> <b>Note: Information on bar markings at CRSI website:</b> <a href="http://www.crsi.org/index.cfm/steel/identification">http://www.crsi.org/index.cfm/steel/identification</a></p> <p>Samples of reinforcing steel shall be submitted to the Central Lab for testing from each approved Mill location delivered to the project. Each sample shall consist of three straight bars, 3-4-feet long of the same grade and size randomly selected by CDOT from bars delivered to the project. The bar size will be a size #10 or smaller. CDOT will take possession after the Contractor has cut them to the proper length. Samples are based on Mill location regardless of it being black bar or epoxy coated. (DO NOT SEND IN MULTIPLE SIZES OF BARS FROM THE SAME MILL LOCATION.)<br/> <b>Note:</b> "Test bars" delivered to the project by the supplier are not random samples and should not be used for acceptance.</p> <p><b>Note: CSRI Plant Identification Guide for Concrete Reinforcing Bars available at CRSI Website:</b> <a href="http://intranet/best-dot/MAC/mac-resources">http://intranet/best-dot/MAC/mac-resources</a></p> <p><b>Steel Chairs:</b> Acceptance Method: <b>COC. Buy America Certification</b>. Field-inspect and document that the material is acceptable, then retain all copies in the Project Files.</p> |



OA FREQUENCY GUIDE SCHEDULE for Minimum Materials Testing, Sampling and Inspection

|  |   |
|--|---|
| <p><b>603</b></p> <p style="writing-mode: vertical-rl; transform: rotate(180deg);"><b>CULVERTS AND SEWERS</b></p>                | <p><b>Corrugated Steel Pipe (CSP) and End Sections. Corrugated Aluminum Pipe (see note). Bonded CSP. Bituminous Coated CSP and Pre-Coated CSP:</b><br/> <i>Acceptance Method: <b>COC. Buy America Certification.</b></i><br/>                     Field inspect for visible defects. Tabulate final quantities. Total quantities must equal or exceed final project quantities. Field-inspect and document that the material is acceptable, then retain all copies in the Project Files. Note: Ensure that the heat numbers in the COC correspond with the heat numbers on the field inspected pipe.</p> <p><b>Cast-in-Place Concrete Pipe:</b> Follow instructions in Item 601 of Schedule. <b>NOTE:</b> T 23, Initial water cure as per Item 601, or as directed by the Engineer.</p> <p><b>Concrete Pipe and Precast Concrete Box Culvert:</b> <i>Acceptance Method: <b>Pre-Approved (with Contractor's AV for Documentation). Buy America Certification.</b></i><br/> <b><i>In accordance with CP 11 the Contractor shall only use qualified manufacturer sources of precast concrete products found on the web site at: <a href="https://www.codot.gov/content/apl/PrecastConcreteStructures.pdf">https://www.codot.gov/content/apl/PrecastConcreteStructures.pdf</a></i></b> Field-inspect for visible defects. Tabulate final quantities on CDOT Form 157. Total quantities must equal or exceed final project quantities. Field-inspect and document on CDOT Form 157 that the material is acceptable, retain all copies in the Project Files.</p> <p><b>Thermoplastic Pipe:</b> <i>Acceptance Method: <b>COC.</b></i><br/>                     Pipe types can include PVC, (PE) Polyethylene. <u>Must have Steel End Section or as approved by the Engineer.</u> Field-inspect and document that the material is acceptable, then retain all copies in the Project Files.</p> <p><b>HDPE Pipe &amp; Polypropylene Pipe:</b> <i>Acceptance Method: <b>COC.</b></i> (Note: Manufacturing facility must have COC from NTPEP, see Special Notice to Contractors.)</p> <p><b>Vitrified Clay Pipe:</b> <i>Acceptance Method: <b>COC.</b></i><br/>                     Field-inspect and document that the material is acceptable, then retain all copies in the Project Files.</p> <p><b>Gaskets:</b> <i>Acceptance Method: <b>COC.</b></i><br/>                     Field-inspect and document that the material is acceptable, then retain all copies in the Project Files.</p> <p><b>Pipe Joint-Sealing Compounds:</b> <i>Acceptance Method: <b>COC.</b></i><br/>                     Field-inspect and document that the material is acceptable, then retain all copies in the Project Files.</p> <p><b>NOTE:</b> See the M Standards for proper types of End Sections when using Aluminum pipe.</p> |
| <p><b>604</b></p> <p style="writing-mode: vertical-rl; transform: rotate(180deg);"><b>MANHOLES, INLETS, AND METER VAULTS</b></p> | <p><b>Manholes, Inlets, Meter Vaults and Precast Concrete Units (Prefabricated):</b> <i>Acceptance Method: <b>Pre-Approved (with Contractor's AV for Documentation). Buy America Certification.</b></i><br/> <b><i>In accordance with CP 11 the Contractor shall only use qualified manufacturer sources of precast concrete products found on the web site at: <a href="https://apps.coloradodot.info/apl/AplSearch.cfm">https://apps.coloradodot.info/apl/AplSearch.cfm</a></i></b></p> <p><b>Field Fabricated:</b> <u>Concrete</u>, follow Item 601. <b>Note:</b> Initial water cure as per Item 601, or as directed by the Engineer. <u>Reinforcing Steel</u>, follow Item 602. Field-inspect and document on CDOT Form 157 that the material is acceptable, then retain all copies in the Project Files.</p> <p><b>Clay or Shale Brick, Concrete Brick, Concrete Masonry Blocks:</b> <i>Acceptance Method: <b>COC.</b></i><br/>                     Must meet individual specifications though not paid for separately. Field-inspect and document that the material is acceptable, then retain all copies in the Project Files.</p> <p><b>Inlet Grates and Frames, Manhole Rings, Covers, and Steps:</b> <i>Acceptance Method: <b>COC. Buy America Certification.</b></i><br/>                     Must meet individual specifications though not paid for separately. Field-inspect and document that the material is acceptable, then retain all copies in the Project Files.</p>   |

OA FREQUENCY GUIDE SCHEDULE for Minimum Materials Testing, Sampling and Inspection

|  |  |
|--|--|
| <p><b>605</b></p> <p style="writing-mode: vertical-rl; transform: rotate(180deg);"><b>SUBSURFACE DRAINS</b></p>                          | <p><b>Corrugated Metal Pipe:</b> <i>Acceptance Method:</i> <b>COC. <u>Buy America Certification.</u></b><br/>Field-inspect and document that the material is acceptable, then retain all copies in the Project Files.</p> <p><b>Vitrified Clay Pipe:</b> <i>Acceptance Method:</i> <b>COC.</b> Follow instructions in Item 603.</p> <p><b>Plastic Pipe:</b> <i>Acceptance Method:</i> <b>COC.</b> Field-inspect and document that the material is acceptable, retain all copies in the Project Files.</p> <p><b>Bedding and Filter Materials:</b> Follow instructions in Item 206 of Schedule. See Chapter 200 for filter material information.</p>  |
| <p><b>606</b></p> <p style="writing-mode: vertical-rl; transform: rotate(180deg);"><b>GUARDRAIL, CABLE BARRIER &amp; BRIDGE RAIL</b></p> | <p><b>Type 3:</b></p> <p><b>Treated Timber Posts and Blocks.</b> <i>Acceptance Method:</i> <b>COC.</b><br/>The Contractor shall provide one copy of a <b>Certificate of Compliance (furnished by the supplier).</b> <b>POSTS MUST BE FIELD INSPECTED</b> (size, straightness, overall quality, visible defects, etc). Document, List source, quantity, and sizes.</p> <p><b>Guardrail Block, Synthetic.</b> <i>Acceptance Method:</i> <b>Pre-Approved (with Contractor's AV for Documentation).</b><br/><b>Information available at:</b> <a href="https://apps.coloradodot.info/apl/AplSearch.cfm">https://apps.coloradodot.info/apl/AplSearch.cfm</a></p> <p><b>Steel Posts for Type 3 (All types)</b> - Document same as Guardrail below.</p> <p><b>Hardware and End Anchors</b> - <i>Acceptance Method:</i> <b>COC. <u>Buy America Certification.</u></b><br/>List each pay item type on CDOT Form 157. Field-inspect and document that the material is acceptable, then retain all copies in the Project Files.</p> <p><b>Rail (Guardrail, Cable Barrier &amp; Bridge Rail)</b> - <i>Acceptance Method:</i> <b>COC. <u>Buy America Certification.</u></b><br/>Contractor shall provide the Engineer with one copy of a <b>Certificate of Compliance</b> and Mill Test Reports (<b>furnished by supplier</b>) to be filed. Field-inspect and document that the material is acceptable, then retain all copies in the Project Files. Note: Ensure that the heat numbers in the COC correspond with the heat numbers on the field inspected guardrail.<br/>Contact SME: Josh Palmer, <a href="mailto:josh.palmer@state.co.us">josh.palmer@state.co.us</a>, 303-757-9229 or <a href="https://www.codot.gov/business/designsupport/bulletins_manuals/cable-barrier-guide/cable-barrier-guide/view">https://www.codot.gov/business/designsupport/bulletins_manuals/cable-barrier-guide/cable-barrier-guide/view</a></p> <p><b>Type 7, Precast:</b> <i>Acceptance Method:</i> <b>Pre-Approved (with Contractor's AV for Documentation).</b> <b>Buy America Certification.</b><br/><b>In accordance with CP 11 the Contractor shall only use qualified manufacturer sources of precast concrete products found on the web site at:</b> <a href="https://www.codot.gov/content/apl/PrecastConcreteStructures.pdf">https://www.codot.gov/content/apl/PrecastConcreteStructures.pdf</a> . The Contractor shall provide a copy of a <b>Certificate of Compliance (furnished by the supplier)</b>, document on CDOT Form 157.</p> <p><b>Type 7, Cast-in-Place:</b> Follow Item 601 of Schedule, except that the test frequency for compressive strength shall be 1 per 1,000 linear feet.<br/><b>NOTE:</b> Initial water cure as per Item 601, or as directed by the Engineer.</p> <p><b>Reinforcing Steel:</b> One sample of reinforcing steel shall be submitted to the Central Lab from each approved source. The sample shall consist of three straight 3-4 foot long pieces of the same grade and size. The bar size will be a size #10 or smaller.</p> <p><b>Incidental Items (non-pay)</b> - Follow instructions in Section 601 of this Schedule.</p> <p><b>Light Weight Aggregates</b> - Follow Section 601 of this Schedule, except that Central Laboratory sample size shall be one full sack.</p> <p><b>Glare Screens:</b> <i>Acceptance Method:</i> <b>Pre-Approved (with Contractor's AV for Documentation).</b><br/><b>Information available at:</b> <a href="https://apps.coloradodot.info/apl/AplSearch.cfm">https://apps.coloradodot.info/apl/AplSearch.cfm</a></p> <p><b>Type 10M, Type H and Type R:</b> <i>Acceptance Method:</i> <b>CTR. <u>Buy America Certification.</u></b><br/>The Contractor shall furnish the Engineer with one copy of <b>Certified Test Reports (furnished by the supplier)</b> including <b>Mill Test Reports</b> to be filed with CDOT Form #157. Field-inspect and document on CDOT Form 157 that the material is acceptable, retain all copies in the Project Files.</p> |

OA FREQUENCY GUIDE SCHEDULE for Minimum Materials Testing, Sampling and Inspection

|   |   |
|---|---|
| <p style="text-align: center;"><b>607</b></p> <p style="writing-mode: vertical-rl; transform: rotate(180deg);"><b>FENCES</b></p>    | <p><b>Barbed Wire:</b> <i>Acceptance Method:</i> <b><u>COC. Buy America Certification.</u></b></p> <p>Each roll shall be tagged with legible markings bearing the following information. ASTM Designation A 121, Design No., Class of Coating, Length of Roll and Name of Manufacturer. Field-inspect and document that the material is acceptable, then retain all copies in the Project Files.</p> <p><b>Woven Wire:</b> <i>Acceptance Method:</i> <b><u>COC. Buy America Certification.</u></b></p> <p>Each roll shall be tagged with legible markings bearing the following information. ASTM Designation A 116, Design No., Class of Coating. Length of Roll, and Name of Manufacturer and document this information.</p> <p><b>Gates, Wire Ties, Wire Stays, Clips, Clamps, Staples, and Miscellaneous Fittings:</b></p> <p>Field-inspect and document on CDOT Form #157 that the material is acceptable, then retain all copies in the Project Files.</p> <p><b>Chain Link Fabric:</b> <i>Acceptance Method:</i> <b><u>COC. Buy America Certification.</u></b></p> <p>Field-inspect and document that the material is acceptable, then retain all copies in the Project Files.</p> <p><b>Steel Posts, Steel Pipe Railing:</b> <i>Acceptance Method:</i> <b><u>COC. Buy America Certification.</u></b></p> <p>Make random check of weight, length, and coating. Field-inspect and document that the material is acceptable, then retain all copies in the Project Files.</p> <p><b>Timber Posts (Treated):</b> <i>Acceptance Method:</i> <b><u>COC.</u></b></p> <p>POSTS MUST BE FIELD-INSPECTED (size, straightness, etc.). Document listing source, number, and sizes.</p> <p><b>Timber Posts (Untreated):</b> <i>Acceptance Method:</i> <b><u>COC.</u></b></p> <p>Field-inspect and document listing the source, number, and sizes.</p> <p><b>Sound Barrier Wall:</b> <i>Acceptance Method:</i> Project by Project approval only. The Contractor shall provide the Engineer with one copy of <b><u>Certified Test Reports (furnished by the supplier)</u></b> to validate the structural values required of the wall. Field-inspect that the material is acceptable, then retain all copies in the Project Files. Contact the Staff Bridge SME: <a href="mailto:Andrew.pott@state.co.us">Andrew.pott@state.co.us</a> for the structure requirements. Contact the Standards and Specifications SME Joshua.j.palmer@state.co.us for the MASH 09 testing requirements. Contact the Air Quality and Noise Program Manager SME <a href="mailto:rose.waldman@state.co.us">rose.waldman@state.co.us</a> for the acoustic qualities guidance.</p> <p><b>Note:</b> The CDOT APL has a category for Sound Barrier Wall Product the Specifications are under development.</p> |
| <p style="text-align: center;"><b>608</b></p> <p style="writing-mode: vertical-rl; transform: rotate(180deg);"><b>CURB RAMP</b></p> | <p><b>Truncated Dome / Detectable Warning Plate:</b> <i>Acceptance Method:</i> <b><u>Pre-Approved (with Contractor's AV for Documentation). Buy America Certification</u></b> (if cast iron or steel).</p> <p><b>Information available at:</b> <a href="https://apps.coloradodot.info/apl/AplSearch.cfm">https://apps.coloradodot.info/apl/AplSearch.cfm</a>. Field-inspect and document on CDOT Form 157 that the material is acceptable, then retain all copies in the Project Files. Reference M-608-1.</p>  |

OA FREQUENCY GUIDE SCHEDULE for Minimum Materials Testing, Sampling and Inspection

| PAY ITEM   | TYPE OF TEST                  | PROJECT VERIFICATION SAMPLING & TESTING FREQUENCY   | PROCEDURES                    |                              | REMARKS<br>{Forms designed to follow SMM Templates.}  | POINT OF VERIFICATION FOR QUALITY DETERMINATION | CENTRAL LAB (CL)<br>[LOCAL AGENCIES ARE TO USE AN ACCREDITED LAB, NOT CDOT CL] |              |
|--|-------------------------------|---|-------------------------------|------------------------------|---|---|--|--------------|
|  |                               |   | PROJECT VERIFICATION SAMPLING | PROJECT VERIFICATION TESTING |   |   | TEST FREQUENCY   | SAMPLE SIZE  |
| 608<br><br>SIDEWALKS AND BIKEWAYS<br>(PCCP)  | AIR CONTENT                   | 1 per 1,000 sq. yd. (840 m <sup>2</sup> ) or fraction thereof.  | CP 61                         | T 152                        | Report on CDOT Form 156.  | Per CP 61.                                      |  |              |
|  | UNIT WEIGHT/YIELD TEMPERATURE | One per set of cylinders.   | CP 61                         | T 121<br>C 1064              |   |   |  |              |
|  | SLUMP                         | One per set of cylinders.   | CP 61                         | T 119                        |   |   |  |              |
|  | COMPRESSIVE STRENGTH          | 1 set of 5 cylinders per 1,000 sq. yds. (840 m <sup>2</sup> ) or fraction thereof. Test 2 at 7 days and 3 at 28 days. | CP 61                         | C 39                         | Submit cylinders on CDOT Form 82. Report on CDOT Form 192. Information cylinders may be cast at the discretion of the Project Engineer. Initial water cure as per Item 601, or as directed by the Engineer. | Per CP 61.                                      |  |              |
| <p><b>NOTE:</b> At the start of each day's production, the first load of concrete will be tested for air content. If the test meets specifications, then revert to the testing frequency above. Slump and air content tests are required for each set of cylinders for all Classes of concrete. <b>The specified slump is +/- 2 inches of the Lab mix design slump.</b></p> <p><b>Incidental Items (non-pay):</b> Follow instructions in Item 601 of Schedule.</p> |                               |   |                               |                              |   |   |  |              |
| SIDEWALKS AND BIKEWAYS<br>(HMA)  | ASPHALT CONTENT               | 1 per project if plan quantity is more than 2,500 tons.   | CP 41<br>CP 55                | CP 85<br>CPL 5120            | Mix Design as per CP 52; CDOT Form 43 required <u>before</u> mix is produced. Report Asphalt Content on Form 58.  | See Item 403                                    | See Item 403   | See Item 403 |
|  | GRADATION                     | 1 per project if plan quantity is more than 2,500 tons.   | CP 30                         | CP 31                        | Report Gradation on CDOT Form 6   | See Item 403                                    |  |              |
|  | IN-PLACE DENSITY              | 1 per project if plan quantity is more than 2,500 tons  |                               | CP 44<br>CP 81               | Report on CDOT Form 69  | See Item 403                                    |  |              |

OA FREQUENCY GUIDE SCHEDULE for Minimum Materials Testing, Sampling and Inspection

| PAY ITEM   | TYPE OF TEST                  | PROJECT VERIFICATION SAMPLING & TESTING FREQUENCY   | PROCEDURES                    |                              | REMARKS<br>{Forms designed to follow SMM Templates.}  | POINT OF VERIFICATION FOR QUALITY DETERMINATION  | CENTRAL LAB (CL)<br>[LOCAL AGENCIES ARE TO USE AN ACCREDITED LAB, NOT CDOT CL] |              |
|--|-------------------------------|---|-------------------------------|------------------------------|---|--|--|--------------|
|  |                               |   | PROJECT VERIFICATION SAMPLING | PROJECT VERIFICATION TESTING |   |  | TEST FREQUENCY   | SAMPLE SIZE  |
| 609<br><br>CURB AND GUTTER (PCCP)  | AIR CONTENT                   | 1 per 2,000 lin. ft. (600 m) or fraction thereof.   | CP 61                         | T 152                        | Report on CDOT Form 156.  | Per CP 61.   |  |              |
|  | UNIT WEIGHT/YIELD TEMPERATURE | One per set of cylinders.   | CP 61                         | T 121<br>C 1064              |   |  |  |              |
|  | SLUMP                         | One per set of cylinders.   | CP 61                         | T 119                        |   |  |  |              |
|  | COMPRESSIVE STRENGTH          | 1 set of 5 Cylinders per 2,000 lin. ft. (600 m) or fraction thereof. Test 2 at 7 days and 3 at 28 days. | CP 61                         | C 39                         | Submit cylinders on CDOT Form 82. Report on CDOT Form 192. Information cylinders may be cast at the discretion of the Project Engineer. Initial water cure as per Item 601, or as directed by the Engineer. | Per CP 61.   |  |              |
| <p><b>NOTE:</b> At the start of each day's production, the first load of concrete will be tested for air content. If the test meets specifications, then revert to the testing frequency above. Slump and air content tests are required for each set of cylinders for all Classes of concrete. <b>The specified slump is +/- 2 inches of the Lab mix design slump.</b></p> <p><b>Incidental Items (non-pay):</b> Follow instructions in Item 601 of Schedule.</p> |                               |   |                               |                              |   |  |  |              |
| CURB AND GUTTER (HMA)  | ASPHALT CONTENT               | 1 per 2,500 lin. ft. (40 tons) or fraction thereof.   | CP 41<br>CP 55                | CP 85<br>CPL 5120            | Mix Design as per CP 52; CDOT Form 43 required <u>before</u> mix is produced. Report Asphalt Content on Form #58.   | Plant discharge, at/or behind paver. For Central Lab Correction Factor, sample aggregate from belt and Binder from Contractors tank. | See Item 403   | See Item 403 |
|  | GRADATION                     | 1 per 2,500 lin. ft. (40 tons) or fraction thereof.   | CP 30                         | CP 31                        | Report Gradation on CDOT Form 6   | Aggregate from the cold feed, pugmill discharge, extraction, or product of CP-L 5120.  |  |              |

OA FREQUENCY GUIDE SCHEDULE for Minimum Materials Testing, Sampling and Inspection

|  |  |
|--|--|
| <p style="text-align: center;"><b>610</b></p> <p style="writing-mode: vertical-rl; transform: rotate(180deg);"><b>MEDIAN COVER MATERIAL</b></p>        | <p><b>Asphalt: Conforms to Item 403 (SEE Section 610.02)</b></p> <p><b>Decorative Concrete and Patterned Concrete:</b> Follow instructions in Item 608 of this Schedule.</p> <p><b>Median Edging (Patterned Concrete):</b> Follow instructions in Item 609 of Schedule.<br/> <b>NOTE:</b> Submit a Median Cover Material mix design documenting adherence to Special Provisions or contract documents.<br/> <b>NOTE:</b> Initial water cure as per Item 601, or as directed by the Engineer.</p> <p><b>Aggregate:</b> Sample according to CP 30 and test for gradation according to CP 31. Test frequency 1 per 1,000 tons or fraction thereof. Report on CDOT Form 6.<br/>                 Points of Acceptance: In stockpile or placed layer.</p> <p><b>Stone:</b> Paid by ton (metric ton). <b>Field inspect</b> for compliance with Special Provisions or contract documents. Field-inspect and document on CDOT Form 157 that the material is acceptable, then retain all copies in the Project Files.</p> <p><b>Herbicide Treatment:</b> Follow instructions in Item 217 of this Schedule. Use under the aggregate or under the stone.</p>   |
| <p style="text-align: center;"><b>611</b></p> <p style="writing-mode: vertical-rl; transform: rotate(180deg);"><b>CATTLE GUARDS</b></p>                | <p><b>Precast Cattle Guard Boxes:</b> <i>Acceptance Method: <b>Pre-Approved (with Contractor's AV for Documentation). Buy America Certification.</b></i><br/> <u><b>In accordance with CP 11 the Contractor shall only use qualified manufacturer sources of precast concrete products found on the web site at: <a href="https://apps.coloradodot.info/apl/AplSearch.cfm">https://apps.coloradodot.info/apl/AplSearch.cfm</a>.</b></u> The Contractor shall provide a copy of a <b>Certificate of Compliance (furnished by the supplier)</b>, document on CDOT Form #157.</p> <p><b>Concrete, Reinforcing Steel, Structural Steel and Treated Timber:</b><br/>                 Follow instructions for 601 and 602 of this Schedule. Field-inspect and document on CDOT Form 157 that the material is acceptable, then retain all copies in the Project Files.</p>  |
| <p style="text-align: center;"><b>612</b></p> <p style="writing-mode: vertical-rl; transform: rotate(180deg);"><b>DELINEATORS &amp; REFLECTORS</b></p> | <p><b>Delineators: Steel Posts:</b> <i>Acceptance Method: <b>COC. Buy America Certification.</b></i><br/> <u><b>Make random check of weight, length, and condition of coating.</b></u> Field-inspect and document on CDOT Form 157 that the material is acceptable, then retain all copies in the Project Files.</p> <p><b>Reflectors :</b> <i>Acceptance Method: Certificate of Compliance (COC).</i><br/>                 Field-inspect and document that the material is acceptable, then retain all copies in the Project Files<br/> <b>Note:</b> The CDOT APL does not currently have approved products listing for Traffic Control\Reflective Element\Delineator Post Marker.<br/>                 Contact Staff Traffic SME: <a href="mailto:manjari.bhat@state.co.us">manjari.bhat@state.co.us</a> or <a href="mailto:esayas.butta@state.co.us">esayas.butta@state.co.us</a> for further information on the Delineator Post Marker.</p> <p><b>Delineators: Flexible Posts -</b> <i>Acceptance Method: <b>Pre-Approved (with Contractor's AV for Documentation).</b></i><br/>                 Field-inspect and document on CDOT Form #157 that the material is acceptable, then retain all copies in the Project Files. <b>Information available at:</b><br/> <a href="https://apps.coloradodot.info/apl/AplSearch.cfm">https://apps.coloradodot.info/apl/AplSearch.cfm</a></p> <p><b>Median Barrier Reflectors:</b> <i>Acceptance Method: <b>Pre-Approved (with Contractor's AV for Documentation).</b></i><br/>                 Field-inspect and document on CDOT Form #157 that the material is acceptable, then retain all copies in the Project Files. <b>Information available at:</b><br/> <a href="https://apps.coloradodot.info/apl/AplSearch.cfm">https://apps.coloradodot.info/apl/AplSearch.cfm</a></p> |

OA FREQUENCY GUIDE SCHEDULE for Minimum Materials Testing, Sampling and Inspection

613

LIGHTING

**Luminaire:** *Acceptance Method:* **COC. Buy America Certification.**

The contractor shall provide the Engineer with one copy of a **Certificate of Compliance** (*furnished by supplier*) to be filed. Field-inspect and document that the material is acceptable, retain all copies in the Project Files.

**Wiring:** *Acceptance Method:* **COC.** Field-inspect for compliance with plans and specifications. Document in Project Files.

**Anchor Bolts:** *Acceptance Method:* **CTR.**

The Contractor shall provide the Engineer with one copy of **Certified Test Reports** (*furnished by supplier*) to be filed. Field-inspect and document that the material is acceptable, then retain all copies in the Project Files.

**Metal or Plastic Conduit:** *Acceptance Method:* **COC. Buy America Certification** (*for metal only*). Field-inspect and document that the material is acceptable, then retain all copies in the Project Files.

**\* Light Standards, High Mast:** *Acceptance Method:* **COC. Buy America Certification.**

Includes poles, luminaries, rings, lowering devices, electrical components. Field-inspect and document that the material is acceptable, then retain all copies in the Project Files.

**Break away couplers and bases:** Field-inspect and document on CDOT Form 157 that the material is acceptable, then retain all copies in the Project Files.

**Light Standards, Precast Concrete:** *Acceptance Method:* **COC. Buy America Certification.**

Field-inspect and document that the material is acceptable, then retain all copies in the Project Files.

**\* Light Standards, Metal (poles and arms):** *Acceptance Method:* **COC. Buy America Certification.**

Field-inspect and document that the material is acceptable, then retain all copies in the Project Files.

**Hardware for Metal Light Standards:** Field-inspect and document on CDOT Form #157 that the material is acceptable, then retain all copies in the Project Files.

**\* Note:** *When light standards (poles and arms) are paid for under Item 613, a **Certificate of Compliance** for all structural components including light standards, bases, couplers, anchor bolts, luminaries, and other attachments shall state that the components will safely resist the higher of a 100 miles per hour wind velocity (Section 715.03 (a)) or the wind velocity specified in the plans or specifications or contract documents. The Certificate of Compliance shall state that static tests have been performed. If the Certified Test Reports are not in the Project File with CDOT, it must be attached to the Certificate of Compliance. The test procedure for aluminum parts shall satisfy the requirements of the Aluminum Association, Inc., "Specifications for Aluminum Structures" Section 8, except that no reduction factors for live load and dead load will be permitted. The **Certificate of Compliance** for breakaway couplers and bases shall state that production lot samples have been tested and meet the breakaway requirements of the AASHTO Standard Specifications for Structural Supports for Highway Signs, Luminaries, and Traffic Signals, Section 7.*

**NOTE:** For any concrete cast-in-place, if cylinders are fabricated, then initial water cure as per Item 601, or as directed by the Engineer.



OA FREQUENCY GUIDE SCHEDULE for Minimum Materials Testing, Sampling and Inspection

614

TRAFFIC CONTROL  
DEVICES

**Sign Panels:** *Acceptance Method: **COC. Buy America Certification** (for steel only, not aluminum or composite).* The Contractor shall provide the Engineer with one copy of a **Certificate of Compliance (furnished by supplier)** to be filed. After arrival on the project, field-inspect fabricated panels for correct sign wording, legend and workmanship. Field-inspect and document that the material is acceptable, then retain all copies in the Project Files.

**Retroreflective Sign Sheeting:** *Acceptance Method: **Pre-Approved (with Contractor's AV for Documentation).** **Information available at:** <https://apps.coloradodot.info/apl/AplSearch.cfm>.*

**Sign Posts - Steel, Wide Flange (WF):** *Acceptance Method: **COC. Buy America Certification.*** The contractor shall provide the Engineer with one copy of a **Certificate of Compliance (furnished by supplier)** to be filed. Field-inspect and document that the material is acceptable, then retain all copies in the Project Files.

**U2 Type:** *Acceptance Method: **COC. Buy America Certification. Make random check of weight, coating, and length for plan requirements.*** Square Tube Posts may be used as alternate. See Standard Drawing for post sizes. Field-inspect and document that the material is acceptable, then retain all copies in the Project Files.

**Timber:** **Field-inspect** and document on CDOT Form 157 that the material is acceptable, then retain all copies in the Project Files.

**Overhead Sign Structures:** *Acceptance Method: **CTR. Buy America Certification.*** The Contractor shall provide the Engineer with one copy of a **Certified Test Report(s) and Certified Mill Test Reports** for all steel materials incorporated into the structure (**furnished by supplier**). Field-inspect and document that the material is acceptable, then retain all copies in the Project Files.

**Traffic Signal Structure(s):** *Acceptance Method: **CTR. Buy America Certification.*** The contractor shall provide the Engineer with one copy of a **Certified Test Report(s) and Certified Mill Test Reports** for all steel materials incorporated into the structure (**furnished by supplier**). Field-inspect and document on CDOT Form #157 that the material is acceptable, then retain all copies in the Project Files. **Structures of aluminum** are accepted by a **COC**.

**Anchor Bolts:** *Acceptance Method: **CTR.*** The contractor shall provide the Engineer with one copy of a **Certified Test Report (furnished by supplier)**. Field-inspect and document that the material is acceptable, then retain all copies in the Project Files.

**Concrete Footings:** Concrete and Reinforcing steel. For large quantities, if cast-in-place cylinders are required, document per Item 601. If Cast-in-Place, initial water cure as per Item 601, or as directed by the Engineer. See the end of the Schedule for small quantities. Field-inspect and document on CDOT Form 157 that the material is acceptable, then retain all copies in the Project Files.

**Construction Traffic Control Signing & Devices:** *Acceptance Method: **Pre-Approved (with Contractor's AV for Documentation).** **Information available at:** <https://apps.coloradodot.info/apl/AplSearch.cfm>. **Verify in APL Traffic Control Sub-Categories.***

**Lighting Fixtures, Flashing Yellow Beacons, Traffic Signal Systems:** *Acceptance Method: **COC***  
Field-inspect for compliance with plans and specifications and if in doubt, contact Region Traffic Signal Technician / Foreman. Field-inspect and document that the material is acceptable, then retain all copies in the Project Files.

**Messenger Cables, Electrical Conduit, Pull Boxes, Direct Burial Cable, Vehicle Detector Wire Loop, Grounding and Bonding, Miscellaneous Hardware, and Barricades:** **Field-inspect** and document on CDOT Form 157 that the material is acceptable, then retain all copies in the Project Files.

**Breakaway Sign Structures:** *Acceptance Method: **COC.*** Field-inspect and document that the material is acceptable, then retain all copies in the Project Files.



OA FREQUENCY GUIDE SCHEDULE for Minimum Materials Testing, Sampling and Inspection

|  |   |
|--|---|
| <p style="text-align: center;"><b>615</b></p> <p style="text-align: center;">WATER<br/>CONTROL<br/>DEVICES</p>         | <p><b>Headgates and Parshall Measuring Flumes:</b> <i>Acceptance Method:</i> <b>COC. <u>Buy America Certification.</u></b><br/>                 The Contractor shall provide the Engineer with one copy of a <b><u>Certificate of Compliance (by supplier)</u></b>. Field-inspect and document that the material is acceptable, then retain all copies in the Project Files.</p> <p><b>Embankment Protectors:</b> Follow instructions in Item 603 of Schedule. Follow individual Item specification for any other type.</p>   |
| <p style="text-align: center;"><b>616</b></p> <p style="text-align: center;">SIPHONS</p>                               | <p><b>Siphon Pipe (metal and concrete), Siphon Drain Pipe:</b> Follow instructions in Item 603 of Schedule.</p> <p><b>Trash Guards, Drain Valves, Valve Boxes:</b> Field-inspect and document on CDOT Form 157 that the material is acceptable, then retain all copies in the Project Files. See Standard Specifications Subsection 712.06 and 716.07. <b><u>Buy America Certification.</u></b></p> <p><b>Gaskets:</b> Follow instructions in Item 603 of Schedule.</p>   |
| <p style="text-align: center;"><b>618</b></p> <p style="text-align: center;">PRESTRESSED CONCRETE<br/>(STRUCTURES)</p> | <p><b>Pre-stressed Concrete Unit:</b> <i>Acceptance Method:</i> <b>Pre-Inspected. <u>Buy America Certification.</u></b><br/>                 A final report (<b>CDOT Form 193</b>) will be <b>issued by the Staff Bridge Fabrication Inspectors</b> stating that the units comply with the specifications and that the Material reports are on file at CDOT. Call the CDOT Staff Bridge Fabrication Inspectors at (303) 757-9339 for information.</p> <p><i>Prestressed and Pre-Inspected Girder members (units) will bear a CDOT stamp.</i> Girder members will be stamped by CDOT personnel or the designated agent, when Quality Assurance determines that the contract requirements have been met.</p> <p>CDOT's Staff Bridge Fabrication Inspectors will notify the Project Engineer or project personnel of any release of girder members planned before the 28-day normal release schedule or specified in the contract documents.</p> <p><b>Post-Tensioned Members:</b> *All components must meet individual specifications. Post-tensioning data must be documented in Project Files. Concrete - follow instructions in Item 601 of Schedule: <u>except</u> that one set (5) of cylinders are required for each concrete placement. Concrete usually is cast-in-place. <u>See note in Item 601 for curing instructions.</u></p> <p><b>Reinforcing Steel:</b> Follow instructions in Item 602 of Schedule.</p> <p><b>Field Post-Tension Elements:</b> *Strand, wire, and bars may be pretested. If not pretested contact Central Laboratory immediately and submit samples at the required frequencies. The Contractor shall provide the Project Engineer with one copy of <b><u>Mill Test Reports</u></b>. These reports are to be filed with the CDOT Form 157: (1) the material has been field-inspected and is acceptable, (2) Mill Test Reports are filed, and (3) a tabulation of the quantity used on the project. <b><u>Buy America Certification.</u></b></p> <p>* <b>Sampling Frequency:</b> Strand 1-per Source (<b>Sample 5.5 ft. (1.7 m) long</b>). Include a copy of the <b><u>Mill Test Report</u></b> attached with the CDOT Form 157.<br/>                 Bars 1 per 5 ton (5 t) or fraction thereof (sample 42" (1070 mm) long).<br/>                 Bars with a diameter greater than 1½ inches will be accepted with a <b><u>Certified Test Report.</u></b></p> |

OA FREQUENCY GUIDE SCHEDULE for Minimum Materials Testing, Sampling and Inspection

|  |   |
|--|---|
| <p><b>619</b></p> <p style="writing-mode: vertical-rl; transform: rotate(180deg);"><b>WATER LINES</b></p>              | <p><b>Cast Iron and Copper Pipe:</b> <i>Acceptance Method:</i> <b><u>COC. Buy America Certification.</u></b><br/>Field-inspect and document that the material is acceptable, then retain all copies in the Project Files.</p> <p><b>Welded Steel Pipe:</b> <b><u>Field-inspect</u></b> and document on CDOT Form 157 that the material is acceptable, then retain all copies in the Project Files. Welding is performed in field as per AWS, D-1.1.</p> <p><b>Standard Galvanized Pipe:</b> <i>Acceptance Method:</i> <b><u>COC. Buy America Certification.</u></b><br/>Field-inspect and document that the material is acceptable, then retain all copies in the Project Files.</p> <p><b>Thermoplastic Pipe:</b> <i>Acceptance Method:</i> <b><u>COC. Field inspect PVC or PE pipe for pressure rating, brand name, and NSF rating upon arrival and before use. It is very important that you must carefully check for NSF rating on pipe when plastic pipe is used for potable and city waterline and domestic consumption.</u></b> Field-inspect and document that the material is acceptable, retain all copies in the Project Files.</p> <p><b>Valves and Valve Boxes:</b> <i>Acceptance Method:</i> <b><u>COC. Buy America Certification.</u></b><br/>Field-inspect and document that the material is acceptable, then retain all copies in the Project Files.</p>   |
| <p><b>622</b></p> <p style="writing-mode: vertical-rl; transform: rotate(180deg);"><b>REST AREAS AND BUILDINGS</b></p> | <p><b>Precast Concrete Units, Light Poles, Picnic Tables, and Septic Tanks:</b> <i>Acceptance Method:</i> <b><u>COC. Buy America Certification.</u></b> Follow Certificate of Compliance procedure.</p> <p><b>Structural Glazed Tile, Ceramic Tile, Interior Insulation, Copper Pipe, Cast Iron Pipe, Perforated Drain Pipe:</b> <i>Acceptance Method:</i> <b><u>COC.</u></b><br/>The Contractor shall provide the Engineer with one copy of a <b><u>COC (furnished by supplier)</u></b>. Field-inspect and document that the material is acceptable, then retain all copies in the Project Files.</p> <p><b>Roofing Asphalt:</b> <i>Acceptance Method:</i> <b><u>COC.</u></b><br/>The Contractor shall provide the Engineer with one copy of a <b><u>Certificate of Compliance (furnished by the supplier) stating conformance to ASTM D 312, Type I and III.</u></b> List all information on CDOT Form 411 that the material is acceptable and retain all copies in the Project Files.</p> <p><b>Brick, Concrete Brick, Concrete Block:</b> Check manufacturer, style, number, and color. The contractor shall provide the Engineer with one copy of a <b><u>Certified Analysis</u></b> to be filed with CDOT Form 157, retained in Project File. State on CDOT Form #157 that the material has been field-inspected and is acceptable, and that the Certified Analysis is on file. If no Certified Analysis is available, submit 5 brick or block per 10,000 or fraction thereof to the Central Laboratory before use.</p> <p><b>Mortar Sand:</b> Submit one 33 lb. (15 kg) sample to Central Laboratory before use. Report on CDOT Form 157.</p> <p><b>Masonry Cement:</b> Must be commercial brand in good condition. Field-inspect and document on CDOT Form 157 that the material is acceptable, then retain all copies in the Project Files.</p> <p><b>Leaching Field Aggregate:</b> Field-inspect and field test to determine compliance with plans and specifications. One field sieve analysis required for each 100 cubic yards or fraction thereof. Report on CDOT Form 6.</p> <p><b>ALL ITEMS NOT INCLUDED ABOVE:</b> FIELD-INSPECT ACCORDING TO SECTION 622 INSPECTION GUIDELINES OF THE CDOT CONSTRUCTION MANUAL. REPORT ON CDOT FORM 157. REPORT AS MANY ITEMS AS PRACTICAL ON A SINGLE CDOT FORM 157. ATTACH ADDITIONAL SHEETS TO THIS FORM IF NECESSARY. RETAIN IN PROJECT FILE.</p> |

OA FREQUENCY GUIDE SCHEDULE for Minimum Materials Testing, Sampling and Inspection

|   |  |
|---|--|
| <p style="text-align: center;"><b>623</b></p> <p style="text-align: center;">IRRIGATION<br/>SYSTEM</p>  | <p><b>Irrigation System:</b> <i>Acceptance Method:</i> <b><u>COC.</u></b></p> <p>The Contractor shall provide the Engineer with one copy of a <b><u>Certificate of Compliance</u></b> (<i>furnished by supplier</i>) to be filed. Field-inspect and document that the material is acceptable, then retain all copies in the Project Files.</p>   |
| <p style="text-align: center;"><b>624</b></p> <p style="text-align: center;">DRAINAGE<br/>PIPE</p>      | <p><b>Drainage Pipe:</b> <i>Acceptance Method:</i> <b><u>COC. Buy America Certification.</u></b> See Item 603 of the Schedule.</p> <p>Note: Item 513 that was discontinued is incorporated into this Section.</p>  |
| <p style="text-align: center;"><b>627</b></p> <p style="text-align: center;">PAVEMENT<br/>MARKING</p>   | <p><b>Glass Beads:</b> <i>Acceptance Method:</i> <b><u>CTR.</u></b></p> <p>The Contractor shall provide the Engineer with one copy of <b><u>Certified Test Reports for Glass Beads</u></b> (<i>furnished by the supplier</i>) to be filed. (A letter is now required by Standard Special Provision 106.12 that recycled glass be documented by CO/letter that the recycled glass comes from North American glass waste streams in the United States of America.)</p> <p><b>Pavement Marking, All Types:</b> <i>Acceptance Method:</i> <b><u>Pre-Approved (with Contractor's AV for Documentation).</u></b><br/><b><u>Information available at:</u></b> <a href="https://apps.coloradodot.info/apl/AplSearch.cfm">https://apps.coloradodot.info/apl/AplSearch.cfm</a>.</p> <p><b>NOTE:</b> Field-inspect that the material is acceptable, then retain all copies in the Project Files. CTR's do not require CDOT Form 157  </p> |
| <p style="text-align: center;"><b>628</b></p> <p style="text-align: center;">PEDESTRIAN<br/>BRIDGES</p> | <p><b>Pedestrian Bridges:</b> <i>Acceptance Method:</i> <b><u>COC. Buy America Certification.</u></b></p> <p>Established through a Project Special.</p> <p>The Contractor shall provide the Engineer one copy of a <b><u>Certificate of Compliance</u></b> (<i>furnished by the supplier, if applicable</i>) and <b><u>Mill Test Reports</u></b>. Individual components should be inspected and documented where possible. Follow the schedule for the appropriate item, (e.g. concrete, timber, etc.) If the bridge is: Pay Item 628 CIP, and you are unable to identify component parts, or if it is precast or prefabricated at an off-site location, then field inspect for adherence to the plans and specifications or special provisions, as applicable. Document on appropriate CDOT forms, listing what material items can be readily identified.</p>   |

OA FREQUENCY GUIDE SCHEDULE for Minimum Materials Testing, Sampling and Inspection

| PAY ITEM             | TYPE OF TEST  | PROJECT VERIFICATION SAMPLING & TESTING FREQUENCY   | PROCEDURES                    |                              | REMARKS<br>{Forms designed to follow SMM Templates.}  | POINT OF VERIFICATION FOR QUALITY DETERMINATION  | CENTRAL LAB (CL)<br>[LOCAL AGENCIES ARE TO USE AN ACCREDITED LAB, NOT CDOT CL] |             |
|----------------------|---|---|-------------------------------|------------------------------|---|--|--|-------------|
|                      |   |   | PROJECT VERIFICATION SAMPLING | PROJECT VERIFICATION TESTING |   |  | TEST FREQUENCY   | SAMPLE SIZE |
| 641<br><br>SHOTCRETE | COMPRESSIVE STRENGTH  | 1 per day if less than 50 cu. yds. are placed. Once per 50 cu. yds. or fraction thereof. 3 cores tested at 28 days.   | C 1140                        | C 1140<br>T 24               | Coring of shotcrete panels shall be performed by the contractor. If 28-day strengths are below specified strength, three additional cores will be tested at 56 days.<br><br>Cores must be delivered to the testing facility 1 work day prior to date of required test for sulfur capping. | Panels shall be field cured. Cores for 28-day strengths are removed 25-27 days after casting. Cores for 56-day strengths are removed 53-55 days after casting. |  |             |
|                      | AIR CONTENT   | The 1 <sup>st</sup> three batches at the beginning of a day's production, then 1 per 50 cu. yds. or fraction thereof. | CP 61                         | T 152                        | Only for the wet process.   | Tested at the point of delivery.   |  |             |
| 708<br><br>PAINTS    | <p><b>Structural Steel Bridge Paint:</b> <i>Acceptance Method: <u>COC</u>.</i><br/>Inorganic Zinc-Rich Polyurethane System. The Contractor shall provide the Engineer one copy of a <b><u>Certificate of Compliance</u></b> (<i>furnished by the supplier or manufacturer</i>) stating that the material complies with Standard Specifications Section 708 and specific requirements stated in the project plans. This information to be filed. Retain in Project Files.</p> <p><b>Structural Concrete Coating:</b> <i>Acceptance Method: <u>Pre-Approved</u> (with Contractor's <u>AV</u> for Documentation).</i><br/><b>Information available at:</b> <a href="https://apps.coloradodot.info/apl/AplSearch.cfm">https://apps.coloradodot.info/apl/AplSearch.cfm</a></p> |   |                               |                              |   |  |  |             |

## OA FREQUENCY GUIDE SCHEDULE for Minimum Materials Testing, Sampling and Inspection

## Guidelines for Test Frequency Reduction

**SCOPE:**

Some relaxation in inspection and testing procedures may be permitted under certain conditions. Reduced engineering control may be particularly applicable to small quantities of intermittently delivered material on large projects and for contracts covering small projects.

It is intended that the reduced engineering control of sampling and testing procedures be permitted only for relatively small quantities of material that will not adversely affect the Traffic carrying capacity of a completed facility. **Such procedures are not to be permitted in concrete for major structures, permanent mainlines of ramp pavements, or other structurally critical items.**

Reduced inspection and testing frequencies are permissible **only** under the provisions outlined herein. **Utilization of these Guidelines will be at the discretion of the Project Engineer following consultation and approval by the Region Materials Engineer.** The Project Engineer will determine the feasibility of reducing any phase of engineering control on his project. His decision shall be documented in the project diary and with supplemental documentation as outlined below. **Additionally, when materials are approved for test frequency reduction, the supplemental documentation shall also include a written concurrence from the RME agreeing with the decision.**

**SAMPLING AND TESTING OF SMALL QUANTITIES:**

The materials listed below may be accepted without further sampling and testing on the basis of visual examination, provided the source has recently furnished or is currently furnishing similar material found to be satisfactory under normal CDOT sampling and testing procedures. **Utilization of these Guidelines will be at the discretion of the Project Engineer following consultation and approval by the Region Materials Engineer.** *Acceptance Method: VISUAL*

The maximum quantities of material, which may be accepted by the above method, are:

**Item 203 - Compaction:**

Project Acceptance Test: 500 cubic yards or less, visually inspect and document in Project Files.

**Item 206 - Structure Backfill:**

50 cubic yards or less, visually inspect and document in Project Files. Central Laboratory Check Samples: 200 cubic yards or less, field test and document in Project Files.

**Item 206 - Filter Material:**

Project Acceptance Tests: 50 cubic yards or less, visually inspect and document in Project Files. Central Laboratory Check Samples: 200 cubic yards or less, field test and document in Project Files.

**Item 206 - Bed Course Material:**

Project Acceptance Tests: 100 cubic yards or less, visually inspect and document in Project Files. Central Laboratory Check Samples: 200 cubic yards or less, field test and document in Project Files.

## OA FREQUENCY GUIDE SCHEDULE for Minimum Materials Testing, Sampling and Inspection

**SAMPLING AND TESTING OF SMALL QUANTITIES (CONTINUED):****Item 304 - Aggregate Base Course:**

Project Acceptance Tests: Gradation, Atterberg limits and compaction 500 tons or less, visually inspect and document in Project Files.

**Item 403 - Hot Mix Asphalt:**

All tests, 500 tons or less, visually inspect and document in Project Files. >500 tons but <2,500 tons perform project level test without sending samples to Central Lab.

**Item 409 - Chip Seal Material:**

50 tons or less, visually inspect and document in Project Files. Central Laboratory Check Sample: 200 tons or less, no sample.

**Item 411 - Asphalt Materials PG Binder:**

AC: 25 tons or less, no sample. Emulsion: 3,000 gallons or less, no sample. Document in Project Files.

**Item 412 - Portland Cement Concrete Pavement:**

Slump, air content, and compressive strength, 1,000 square yards or less combining all thicknesses, visually inspect and document in Project Files.

**Item 601 - Structural Concrete:**

50 cubic yards or less for all Classes of concrete, visually inspect and document in Project Files.

**Item 608 - Sidewalks and Bikeways:**

PCCP: 250 square yards or less combining all thicknesses of sidewalks, visually inspected and document in the Project Files.

HMA: 500 tons or less, combining all thicknesses of sidewalks, visually inspected and document in the Project Files.

**Item 609 - Curb and Gutter:**

500 linear feet or less for all Classes of concrete or HMA in the curbing, visually inspect and document in the Project Files.

## OA FREQUENCY GUIDE SCHEDULE for Minimum Materials Testing, Sampling and Inspection

**SAMPLING AND TESTING OF LARGE QUANTITIES:**

When a project has an unusually **large** quantity on any items it may be desirable to reduce the testing frequency. The following guidelines are suggested when considering test frequency reduction.

1. Region Materials Engineer, in cooperation with the Project Engineer, should analyze the item or items considered for reduction. The analysis should take into consideration the following:
  - a. The effect of reducing test frequency when analyzing a lot for price reduction. The minimum testing frequencies listed in the Frequency Guide Schedule for Minimum Materials Sampling, Testing, and Inspection.
  - b. Overall importance to the finished project should be considered because a reduction in test frequency could possibly allow some out of specification material to be incorporated into the project.
  - c. A source being used to supply material that has a **proven record** of supplying specification material.
2. When the determination is made that a reduced testing frequency is warranted, the Region Materials Engineer should submit a written request to the Materials and Geotechnical Branch Manager for approval. After approval has been obtained from the Materials and Geotechnical Branch Manager, testing will begin using the normal frequency until good control is established. As soon as five consecutive tests indicate no deviation from specification, reduced test frequencies can begin. If a test indicates deviation from specification, normal frequency will be immediately reinstated until five consecutive tests are within specifications. It is not the intent of these guidelines to suggest that a reduction in testing frequency be made on all projects where a large quantity occurs on an item. **This should only be used in isolated cases where it would be impractical to take the normal number of tests.**

**NOTE: The list of CDOT Approved Product / SiteManager Categories and a list of Subject Matter Experts (SME) contact information is available as a PDF document at the end of the OA Schedule.**

### IA FREQUENCY GUIDE SCHEDULE for Evaluation of OA Sampling and Testing-19

| ITEM | DESCRIPTION                   | TYPE OF TEST REQUIRED     | MINIMUM SAMPLING FREQUENCY   | FORM #     | REMARKS   |
|------|-------------------------------|---------------------------|--|------------|---|
| 203  | EMBANKMENT                    | % Compaction              | 1 per 100,000 cu. yds. (75,000 m <sup>3</sup> ), or a fraction thereof greater than 10,000 cu. yds. (7,500 m <sup>3</sup> ),<br>None required if plan quantity is less than 10,000 cu. yds. (7,500 m <sup>3</sup> ), | 427        | Use the same location for % Compaction. Verify curve selection.                             |
| 206  | STRUCTURE BACKFILL (Class I)  | Gradation<br>% Compaction | 1 per 10,000 cu. yds. (7,500 m <sup>3</sup> ), or a fraction thereof greater than 1,000 cu. yds. None required if plan quantity is less than 2,000 cu. yds. (750 m <sup>3</sup> ).                                   | 565<br>427 | Split the gradation sample. Use the same location for % Compaction. Verify curve selection. |
| 206  | STRUCTURE BACKFILL (Class II) | % Compaction              | 1 per 10,000 cu. yds. (7,500 m <sup>3</sup> ), or a fraction thereof greater than 1,000 cu. yds. None required if plan quantity is less than 2,000 cu. yds. (750 m <sup>3</sup> ).                                   | 427        | Use the same location for % Compaction. Verify curve selection.                             |
| 206  | FILTER MATERIAL               | Gradation                 | 1 per 2,000 cu. yds. (1,500 m <sup>3</sup> ), or a fraction thereof greater than 200 cu. yds. None required if plan quantity is less than 1,000 cu. yds. (750 m <sup>3</sup> ).                                      | 565        | Split the gradation sample.   |
| 304  | AGGREGATE BASE COURSE         | Gradation<br>% Compaction | 1 per 20,000 tons (20,000 t), (10,000 cu. yds.) or a fraction thereof greater than 2,000 tons (2,000 t), (1,000 cu. yds.). None required if plan quantity is less than 10,000 tons (10,000 t), (5,000 cu. yds.).     | 565<br>427 | Split the gradation sample. Use the same location for % Compaction. Verify curve selection. |
| 306  | RECONDITIONING                | % Compaction              | 1 per 50,000 sq. yds. (40,000 m <sup>2</sup> ), or a fraction thereof greater than 5,000 sq. yds. (4,000 m <sup>2</sup> ). None required if plan quantity is less than 25,000 sq. yds. (20,000 m <sup>2</sup> ).     | 427        | Use the same location for % Compaction. Verify curve selection.                             |



| ITEM | DESCRIPTION  | TYPE OF TEST REQUIRED  | MINIMUM SAMPLING FREQUENCY  | FORM #        | REMARKS   |
|------|--|--|---|---------------|---|
| 307  | LIME TREATED SUB-GRADE   | % Compaction   | 1 per 50,000 sq. yds. (42,000 m <sup>2</sup> ), or a fraction thereof greater than 5,000 sq. yds. (4,200 m <sup>2</sup> ). None required if plan quantity is less than 25,000 sq. yds. (20,000 m <sup>2</sup> ).  | 427           | Use the same location for % Compaction. Verify curve selection.                             |
| 308  | PORTLAND CEMENT or FLYASH TREATED BASE<br>[Project Special]          | Gradation<br>% Compaction  | 1 per 50,000 tons (50,000 t) or a fraction thereof greater than 5,000 tons (5,000 t). None required if plan quantity is less than 5,000 tons (5,000 t).   | 565<br>427    | Split the gradation sample. Use the same location for % Compaction. Verify curve selection. |
| 310  | FULL DEPTH RECLAMATION<br>[Project Special]                          | % Compaction   | 1 per Project or as determined by the RME.  | 427           | Use the same location for % Compaction. Verify curve selection.                             |
| 403  | HOT MIX ASPHALT (HMA) - VOIDS ACCEPTANCE<br><br><b>PROJECT Basis</b> | % Asphalt<br>Maximum Specific Gravity<br>Air Voids<br>Voids in Mineral Aggregate | 1 per 10,000 tons (10,000 t), or a fraction thereof greater than 2,500 tons (2,500 t). None required if plan quantity is less than 2,500 tons (2,500 t).  | 1304          | Split the sample.   |
|      |  | % Compaction   |   | 428 or<br>582 | Use the same location for % Compaction.   |
|      |  | Joint Density  |   | 1290          | Take an adjacent core for joint density.  |
| 403  | HOT MIX ASPHALT (HMA) - VOIDS ACCEPTANCE<br><br><b>SYSTEM Basis</b>  | % Asphalt<br>Maximum Specific Gravity<br>Air Voids<br>Voids in Mineral Aggregate | 1 per 25,000 tons (25,000 t), or a fraction thereof greater than 2,500 tons (2,500 t), and perform at a minimum one IA every two months on each HMA project tester and their equipment. None required if plan quantity is less than 2,500 tons (2,500 t). | 1304          | Split the sample.   |
|      |  | % Compaction   |   | 428 or<br>582 | Use the same location for % Compaction.   |
|      |  | Joint Density  |   | 1290          | Take an adjacent core for joint density.  |

| ITEM       | DESCRIPTION  | TYPE OF TEST REQUIRED                        | MINIMUM SAMPLING FREQUENCY  | FORM #     | REMARKS   |
|------------|--|--|---|------------|---|
| <b>403</b> | HOT MIX ASPHALT (HMA) & SMA GRADATION ACCEPTANCE<br><br><b>PROJECT Basis</b> | % Asphalt Maximum Specific Gravity Gradation | 1 per 10,000 tons (10,000 t), or a fraction thereof greater than 2,500 tons (2,500 t). None required if plan quantity is less than 2,500 tons (2,500 t).  | 1304       | Split the sample.   |
|            |  | % Compaction                                 |   | 428 or 582 | Use the same location for % Compaction.   |
|            |  | Joint Density                                |   | 1290       | Take an adjacent core for joint density.  |
| <b>403</b> | HOT MIX ASPHALT (HMA) & SMA GRADATION ACCEPTANCE<br><br><b>SYSTEM Basis</b>  | % Asphalt Maximum Specific Gravity Gradation | 1 per 25,000 tons (25,000 t), or a fraction thereof greater than 2,500 tons (2,500 t), and perform at a minimum one IA every two months on each HMA project tester and their equipment. None required if plan quantity is less than 2,500 tons (2,500 t). | 1304       | Split the sample.   |
|            |  | % Compaction                                 |   | 428 or 582 | Use the same location for % Compaction.   |
|            |  | Joint Density                                |   | 1290       | Take an adjacent core for joint density.  |
| <b>405</b> | HOT-IN-PLACE RECYCLE   | % Compaction<br>Maximum Specific Gravity     | 1 per 50,000 sq. yds. (40,000 m <sup>2</sup> ), or a fraction thereof greater than 5,000 sq. yds. (4,000 m <sup>2</sup> ). None required if plan quantity is less than 25,000 sq. yds. (20,000 m <sup>2</sup> ).  | 428 or 582 | Use the same location for % Compaction. Split the HMA sample.                       |
| <b>406</b> | COLD ASPHALT PAVEMENT (RECYCLE)  | % Compaction                                 | 1 per 50,000 sq. yds. (40,000 m <sup>2</sup> ), or a fraction thereof greater than 5,000 sq. yds. (4,000 m <sup>2</sup> ). None required if plan quantity is less than 25,000 sq. yds. (20,000 m <sup>2</sup> ).  | 427        | Use the same location for % Compaction. Witness CP 53 is being conducted correctly. |

| ITEM    | DESCRIPTION                               | TYPE OF TEST REQUIRED                        | MINIMUM SAMPLING FREQUENCY   | FORM # | REMARKS                     |
|---------|---|--|--|--------|-----------------------------|
| 409     | CHIP SEAL COVER COAT MATERIAL - AGGREGATE | Gradation<br>Flat and Elongated<br>Particles | 1 per 5,000 tons (5,000 t), or a fraction thereof greater than 500 tons (500 t). None required if plan quantity is less than 1,200 tons (1,200 t). 1 per 285,000 sq. yds. (230,000 m <sup>2</sup> ). None required if plan quantity is less than 62,500 sq. yds. (50,000 m <sup>2</sup> ).   | 565    | Split the gradation sample. |
|         |   |  |  |        |                             |
| 403-411 | ASPHALT CEMENT MATERIALS                  | Determined by Central Laboratory             | <p>Asphalt Cement / Performance Graded Binder &amp; Emulsion for Chip Seal Coat and Cold-In-Place Recycling:<br/>Project acceptance sampling will be witnessed by the Region IA Tester, and documented on CDOT Form 411.</p> <p><b>Project Basis:</b> 1 per 20,000 tons (20,000 t), or a fraction thereof greater than 2,500 tons (2,500 t) per binder type. None required if plan quantity is less than 2,500 tons (2,500 t).</p> <p><b>System Basis:</b> A minimum of one per two months per tester or one per binder grade. None required if plan quantity is less than 2,500 tons (2,500 t).</p> | 411    |                             |

| ITEM | DESCRIPTION   | TYPE OF TEST REQUIRED   | MINIMUM SAMPLING FREQUENCY   | FORM # | REMARKS  |
|------|---|---|--|--------|--|
| 412  | PORTLAND CEMENT CONCRETE PAVEMENT (PCCP)<br><br><b>(Compressive Strength Alternative)</b> | Air Content<br>Slump<br><br>Compressive Strength                              | 1 set of cylinders per 50,000 sq. yds. (40,000 m <sup>2</sup> ), or a fraction thereof greater than 5,000 sq. yds. (4,000 m <sup>2</sup> ) for all thicknesses. None required if total plan quantity for all thicknesses is less than 5,000 sq. yds. (4,000 m <sup>2</sup> ).                                      | 82     | Shall use the same sampling container of a split sample. |
|      |   | Sand Equivalency  |  |        |  |
|      | <b>(Flexural Strength Alternative)</b>  | Air Content<br>Slump<br><br>Flexural Strength                                 | 1 set of beams per 50,000 sq. yds. (40,000 m <sup>2</sup> ), or a fraction thereof greater than 5,000 sq. yds. (4,000 m <sup>2</sup> ) for all thicknesses. None required if total plan quantity for all thicknesses is less than 5,000 sq. yds. (4,000 m <sup>2</sup> ).  | 83     | Shall use the same sampling container or a split sample. |
| 503  | DRILLED CAISSONS  | Air Content (when specified by the contract)<br>Slump<br>Compressive Strength | 1 set of cylinders per 2,000 cu. yds. (1,500 m <sup>3</sup> ), or a fraction thereof greater than 200 cu. yds. (150 m <sup>3</sup> ). None required if plan quantity is less than 500 cu. yds. (380 m <sup>3</sup> ).  | 82     | Shall use the same sampling container or a split sample. |
| 601  | STRUCTURAL CONCRETE   | Air Content<br>Slump<br>Compressive Strength                                  | 1 per 2,000 cu. yds. (1,500 m <sup>3</sup> ), or fraction thereof greater than 500 cu. yds. for each Class. No tests required if the quantity is less than 500 cu. yds. for each class. <u>Exception</u> : 1 test minimum if the total quantity of all classes is greater than 500 cu. yds. (380 m <sup>3</sup> ). | 82     | Shall use the same sampling container or a split sample. |

| ITEM       | DESCRIPTION  | TYPE OF TEST REQUIRED                        | MINIMUM SAMPLING FREQUENCY   | FORM # | REMARKS  |
|------------|--|--|--|--------|--|
| <b>606</b> | GUARDRAIL<br>(Cast In-Place)                               | Compressive Strength<br>Air Content<br>Slump | 1 per 10,000 linear feet (3,000 m) or a fraction thereof greater than 1,000 linear feet (300 m).<br>None required if plan quantity for all classes is less than 3,000 linear feet (900 m).   | 82     | Shall use the same sampling container or a split sample. |
| <b>608</b> | SIDEWALKS &<br>BIKEWAYS<br><br>(PCCP)                      | Air Content<br>Slump<br>Compressive Strength | 1 per 10,000 sq. yds. (8,000 m <sup>2</sup> ), or a fraction thereof greater than 1,000 sq. yds. (800 m <sup>2</sup> ). None required if total plan quantity for all classes and for all thicknesses is less than 3,000 sq. yds. (2,500 m <sup>2</sup> ) | 82     | Shall use the same sampling container or a split sample. |
|            | (HMA)  | AC Content<br>Gradation                      | 1 per project. None required if total plan quantity is less than 2,500 tons (2,500 t).   | 1304   | Split the HMA sample.                                    |
| <b>609</b> | CURB AND<br>GUTTER<br><br>(PCCP)                           | Air Content<br>Slump<br>Compressive Strength | 1 per project. None required if plan quantity is less than 10,000 linear ft. (3,000 m).  | 82     | Shall use the same sampling container or a split sample. |
|            | (HMA)  | AC Content<br>Gradation                      | 1 per project. None required if total plan quantity is less than 2,500 linear ft. (40 t).  | 1304   | Split the HMA sample.                                    |
| <b>618</b> | PRESTRESSED<br>CONCRETE<br>(STRUCTURES)<br>(Cast In-Place) | Air Content<br>Slump<br>Compressive Strength | 1 per 2,000 cu. yds. (1,500 m <sup>3</sup> ), or a fraction thereof greater than 200 cu. yds. (150 m <sup>3</sup> ). None required if plan quantity is less than 500 cu. yds. (380 m <sup>3</sup> ).   | 82     | Shall use the same sampling container or a split sample. |

- NOTE 1** - When all Items subject to Independent Assurance Sampling on a particular project have quantities less than the minimums set forth in the OA Frequency Guide Schedule for Minimum Materials Sampling, Testing, and Inspection, no IA Samples are required. However, on such projects the Region Materials Engineer will fill in the heading on a CDOT Form 379 and write across the face of this form a statement to the effect that “*No Independent Assurance samples were taken because of the small quantities involved.*” This will fulfill Independent Assurance requirements on this project.
- NOTE 2** - Independent Assurance testing should be accomplished by the same method used for Owner Acceptance (OA) at the Point of Verification or Acceptance listed for each Item in the OA Frequency Guide Schedule for Minimum Materials Sampling, Testing, and Inspection in the Field Materials Manual. Sampling shall be accomplished using CDOT approved sampling methods outlined in the FMM. All samples shall be split with the field tester (OA) and run independently by personnel who have no direct responsibility for Quality Assurance or Verification sampling and testing for the project.
- NOTE 3** - For Item 403 – 411: Local Agency (LA) projects on Colorado State Highways as well as the National Highway System (NHS) shall have the IA's performed by CDOT. The binder and emulsion samples shall be sent to the Central Lab.
- NOTE 4** - Refer to the CDOT Independent Assurance Job Manual for specific item testing information and techniques. The CDOT Independent Assurance Job Manual is available at:

TABLE IA – 1, Comparison Precision Guide

| Element                                   | Type of Test  | Minor Difference   | Significant Difference  |
|---|---|--|---|
| Gradation                                 | Sieve Analysis per CP 31<br>1-1/2" to 1/2"<br>3/8" to #16<br>#30 to #100<br>Sieve Analysis per CP 31<br>#200<br><br><b>NOTE: # 200 (Item 409 per CP 31)</b><br><br><b>NOTE: IA and OA testers need to run the same screens or as requested by IA.</b> | $\leq 3\%$<br>$\leq 6\%$<br>$\leq 3\%$<br><br>$\leq 3\%$<br><br>$\leq 0.5\%$ | $> 3\%$<br>$> 6\%$<br>$> 3\%$<br><br>$> 3\%$<br><br>$> 0.5\%$ |
| Asphalt Content                           | Asphalt Content Gauge per CP 85<br>Ignition Method per CP-L 5120  | $\leq 0.30\%$  | $> 0.30\%$  |
| Maximum Specific Gravity                  | Flask per CP 51   | $\leq 0.019$   | $> 0.019$   |
| Asphalt Compaction                        | M/D Gauge per CP 81<br>Cores per CP 44  | $\leq 2.0\%$   | $> 2.0\%$   |
| Asphalt Compaction at Longitudinal Joints | Cores per CP 44   | $\leq 2.5\%$   | $> 2.5\%$   |
| Air Voids                                 | Per CP-L 5115   | $\leq 1.3\%$   | $> 1.3\%$   |
| Voids in Mineral Aggregate                | Per CP 48   | $\leq 1.2\%$   | $> 1.2\%$   |
| Cold In-Place recycling                   | M/D Gauge per CP 81   | $\leq 2.0\%$   | $> 2.0\%$   |
| Flat and Elongated                        | Per ASTM D4791  |  |   |

**TABLE IA – 1, Comparison Precision Guide (continued)**

| Element                   | Type of Test                       | Minor Difference                        | Significant Difference                                      |
|---------------------------|------------------------------------|---|---|
| Sand Equivalent           | Sand Equivalent per CP 37          | ≤ 5 points                              | > 5 points  |
| Slump                     | Slump Cone per AASHTO T 119        | ≤ 1/2"                                  | > 1/2"  |
| Air Content               | Air Meter per AASHTO T 152         | ≤ 0.5%                                  | > 0.5%  |
| Compressive Strength      | Compressive Strength per ASTM C 39 | Average QA within<br>±10% of average IA | Average QA test result<br>>10% of average IA test<br>result |
| Flexural Strength         | Flexural Strength per AASHTO T 97  | Average QA within<br>±10% of average IA | Average QA test result<br>>10% of average IA test<br>result |
| Soil Compaction           | M/D Gauge per CP 80                | ≤ 2.0%                                  | > 2.0%  |
| Aggregate Base Compaction | M/D Gauge per CP 80                | ≤ 2.0%                                  | > 2.0%  |

**NOTE:** Data based on Empirical Bayesian Statistics and is subject to change as the database increases. Table 1 was reviewed in 2018 based on data from the 2015, 2016, and 2017 construction season for the 2020 FMM.



{PAGE INTENTIONALLY LEFT BLANK}

## Colorado Procedure 10-21

### *Standard Practice for*

## Qualification of Testing Personnel and Laboratories

### 1. INTRODUCTION

- 1.1 This procedure defines the requirements for qualification of people and laboratories. Specifically, all persons and all laboratories conducting tests used in mix design or acceptance must be qualified. Laboratories conducting Independent Assurance (IA) inspections for CDOT must be accredited and the people conducting these inspections must be certified.

### 2. SAMPLING AND TESTING PERSONNEL QUALIFICATIONS

- 2.1 All persons conducting or supervising tests used in mix design, acceptance, or IA must be qualified. The personnel conducting or supervising tests for the contractor's PC Program must be qualified. This includes mix design testing, verification testing by CDOT and designated agents (private laboratories), testing conducted by contractors and vendors and used in the acceptance decision (PC-For-Pay), and IA testing by CDOT and designated agents. The requirements to be qualified are stated below.
- 2.2 The person with overall responsibility for the sampling and testing on construction projects (the Project Engineer or Resident Engineer for CDOT and the Process Control Supervisor if non-CDOT) shall be a registered Professional Engineer in the State of Colorado or possess a National Institute for Certification of Engineering Technologies (NICET) Level III Certificate in Highway Materials or Construction Materials with the soil, concrete, and asphalt sub-fields.
- 2.2.1 Pursuant to Section 12-25-102(10) of the Colorado Revised Statutes all mix designs shall be sealed by a Registered Professional Engineer in the State of Colorado.
- 2.3 All personnel conducting Quality Assurance Testing and acceptance of materials on CDOT projects advertised after January 1, 2020, shall have successfully completed and passed the online e-learning CDOT Materials Technician Training Course offered through the CDOT Transportation Engineering Training Program (TETP). This online course can be accessed at the following link: <https://www.codot.gov/programs/tetp>. This is in addition to qualifications/certifications required for specific materials or test methods as listed in Table 10-1.
- 2.4 Persons performing sampling and testing used in the mix design, acceptance decision, PC, or IA testing shall be qualified by meeting the requirements listed in Table 10-1 and possessing current certifications.
- 2.3.1 To operate a nuclear device, CDOT personnel must possess a current certificate indicating that they have satisfactorily completed CDOT's School of Radiological Safety and Nuclear Gauge Operation. Non-CDOT operators of nuclear gauges must be certified as required by their company's Radioactive Materials License, issued by the Colorado Department of Public Health and Environment.

- 2.4 *New Employees:* New employees not qualified in accordance with Subsection 2.3 may conduct acceptance tests under the direct, day-to-day, supervision of an employee that is qualified (in accordance with Subsection 2.3) to conduct those tests. The maximum time period of supervised testing by any one non-qualified employee for each item is indicated in Subsection 2.4.2. Additional conditions that must be met are listed in Subsection 2.4.1. Note that these provisions do not apply to nuclear testing.
- 2.4.1 *Qualified Supervisor:* The qualified supervisor shall train the new employee, if needed, and then confirm in writing that this employee is capable of performing the tests in accordance with the standards. This written confirmation shall contain the following: identity and signature of the qualified supervisor, name and previous experience of the new employee, the time spent training the new employee, the tests for which the new employee is qualified, and the date the new employee will begin mix design or acceptance testing. The written confirmation shall be delivered to and approved by the Region Materials Engineer before the new employee performs mix design or acceptance tests. The qualified supervisor shall be present on the testing site at least once each day the new employee is conducting tests to closely oversee and check the work of the new employee. The qualified supervisor shall co-sign each test report and worksheet produced by the new employee. The close day-to-day supervision shall continue until the new employee is qualified by meeting the requirements of Subsection 2.3.
- 2.4.2 Time Limits for Acceptance Testing by Non-qualified New Employees:
- 2.4.2.1 *Soils Testing:* A maximum of 2 calendar months of continuous testing before qualification is required. Accumulation of time is not allowed.
- 2.4.2.2 *HMA Testing:* A maximum of two calendar months of continuous testing before qualification is required. Accumulation of time is not allowed. Inexperienced employees (less than one year of documented experience) performing testing on HMA shall successfully complete the *Asphalt Construction PC/OA Technician Education* course provided by the Rocky Mountain Asphalt Education Center (RMAEC) (303-741-6148) before seeking certification.
- 2.4.2.3 *Concrete Testing:* A maximum of six calendar months of continuous testing before qualification is required. Accumulation of time is not allowed.

### **3. LABORATORY QUALIFICATION PROGRAM**

- 3.1 The purpose of the Laboratory Qualification Program is to verify that laboratories conducting testing used in mix design or the acceptance decision are qualified. All laboratories conducting tests used in mix design or the acceptance decision must be qualified before construction of items requiring testing by that lab. Testing used in the acceptance decision includes verification testing by CDOT and designated agents of CDOT, plus PC testing by contractors and vendors.
- 3.2 All laboratories conducting testing used in mix design or the acceptance decision must meet the following requirements. CDOT and designated agent laboratories conducting verification testing, and contractors and vendors conducting PC testing used in the acceptance decision are included.

### 3.2.1 *Laboratory Inspections:*

3.2.1.1 *CDOT Laboratories:* The Region Materials Engineer or his designee shall conduct an inspection of each project laboratory before mix design or verification testing begins. The Central Laboratory may conduct random Field Laboratory inspections during project construction. The inspection shall be documented using the current *Field Lab & Personnel Qualification Checklist* and any supplemental lists deemed necessary. The Region Materials Engineer, his designee, or the Central Laboratory Inspection Coordinator shall indicate on the checklist whether or not the laboratory is qualified. If the laboratory has been determined to not be qualified, the deficiencies will be corrected to the satisfaction of the Region Materials Engineer. Project construction involving items subject to mix design or verification testing shall not begin until the laboratory conducting these tests is determined to be qualified. The Resident Engineer, in cooperation with the Region Materials Engineer, shall be responsible for assuring that CDOT owned project testing equipment is acceptable for mix design or verification sampling and testing.

3.2.1.2 *Designated Agent Laboratories:* All designated agent laboratories shall be part of the AASHTO Accreditation Program (AAP) or Cement and Concrete Reference Laboratory (CCRL) in all of the tests performed. The Region Materials Engineer shall conduct or direct a designated representative to conduct an inspection of each designated agent laboratory used in verification testing before testing begins. The Central Laboratory may conduct random Field Laboratory inspections during project construction. The inspection shall be documented using the current *Field Lab & Personnel Qualification Checklist* and any supplemental lists deemed necessary. The Region Materials Engineer, his designated representative, or the Central Laboratory Inspection Coordinator shall indicate on the checklist whether or not the laboratory is qualified. If the laboratory is determined to not be qualified, the deficiencies will be corrected to the satisfaction of the Region Materials Engineer. Project construction involving items subject to verification testing shall not begin until the laboratory conducting these tests is determined to be qualified. A designated agent may not conduct an inspection for qualification of its own laboratory. The laboratory shall participate in the CDOT round robin program for the required tests and achieve a score of 3.0 or better. Scores below a 3.0 will require approved corrective action and possible retesting.

3.2.1.3 *Contractor and Vendor Laboratories:* The Region Materials Engineer or his designated representative may conduct an inspection of each Contractor or vendor laboratory before PC testing used in the mix design or acceptance decision begins. If the inspection is performed it shall be documented using the current *Field Lab & Personnel Qualification Checklist* and any supplemental lists deemed necessary. The checklist shall indicate if the laboratory is qualified in all required tests. If the laboratory is determined to not be qualified, the deficiencies will be corrected to the satisfaction of the Region Materials Engineer. If the Contractor or vendor laboratory is used for mix design testing and is not AASHTO accredited, the laboratory shall participate in the CDOT round robin program for the required tests and achieve a score of 3.0 or better. Scores below a 3.0 will require approved corrective action and possible retesting. Testing conducted before the laboratory is determined to be qualified may not be used in the acceptance decision. Contractor or vendor laboratories used in PC-for-Pay projects shall be qualified in accordance with this subsection.

- 3.2.2 *Calibration Checks:* All laboratories performing mix design, verification testing, or PC testing used in acceptance shall conduct calibration checks at the minimum frequencies required by the test procedure, equipment operating guides, or Calibration Schedule included in the Field Materials Manual's Inspections (Central -> Region) Chapter. The results of these calibration checks shall be documented on the appropriate forms and retained for a period of seven years. The calibration check documentation shall be made available to the Region Materials Engineer or the Project Engineer upon request.
- 3.2.3 *Lab Personnel Qualifications:* All laboratories performing mix design, verification testing, or PC testing used in the acceptance decision shall maintain documentation of the qualification of all laboratory personnel. This documentation shall indicate that all laboratory personnel are qualified for all the tests they conduct. This documentation shall be current and available at all times for review by the Project Engineer and the Region Materials Engineer.
- 3.3 If the laboratory performing the mix design, verification testing, or PC used in the acceptance decision is AASHTO accredited in the tests performed, it may be exempted from the above requirements for inspection and calibration checks.

#### **4. INDEPENDENT ASSURANCE (IA) LABORATORY REQUIREMENTS**

- 4.1 The CDOT Central Laboratory, the Region Materials Laboratories, and designated agent laboratories conducting Independent Assurance (IA) inspections and testing shall conform to the following requirements.
- 4.1.1 *Central Lab and Designated Agents:* The CDOT Central Lab and designated agents conducting IA testing shall be AASHTO accredited in accordance with the requirements of Section 5.
- 4.1.2 *Region Materials Labs:* An inspection of each Region Materials Laboratory shall be made annually by personnel from the Central Materials Laboratory, as per Subsection 9.2.1.2 of the QA Procedures Chapter. Equipment Verification Checks will be made on equipment used for IA testing including ovens, scales, and balances.
- 4.1.3 All laboratories performing IA testing shall conduct equipment verification checks per AASHTO Accreditation Program (AAP) on all equipment used in IA testing during that period. The results of those checks shall be documented in accordance with AASHTO Accreditation Program on the appropriate forms and retained for a period of seven years.

#### **5. ACCREDITATION**

- 5.1 *CDOT Central Laboratory and Designated Agent Inspection:* The CDOT Central Lab and designated agents conducting IA testing for CDOT will be inspected periodically by the AASHTO Accreditation Program (AAP and/or CCRL) and will maintain accreditation by the AASHTO Accreditation Program.
- 5.1.1 The test procedures covered by the designated agent accreditation shall include all IA tests that the designated agent will conduct or observe for CDOT.
- 5.1.2 AASHTO Accreditation Program (AAP) and Cement and Concrete Reference Laboratory (CCRL) Inspection Reports:

- 5.1.2.1 All AAP and CCRL inspection reports from inspections conducted on the Central Materials Laboratory will be retained and made available to the FHWA upon request.
- 5.1.2.2 All AAP and CCRL inspection reports from inspections conducted on designated agents that conduct IA testing for CDOT will be retained and made available to CDOT upon request.
- 5.1.3 Deficiencies Identified in AAP or CCRL Inspection Reports:
  - 5.1.3.1 Deficiencies indicated in the AAP or CCRL inspection reports for inspections conducted on the CDOT Central Materials Laboratory or on designated agents conducting IA testing for CDOT will be corrected at the earliest opportunity and documentation of the corrective action sent to AAP or CCRL.
- 5.1.4 Proficiency Samples Ratings:
  - 5.1.4.1 CDOT Central Laboratory or designated agent laboratory AASHTO Proficiency Samples with a rating of less than 3 (2 Standard Deviations) will be investigated to determine the cause of the low ratings and corrective action taken to prevent future occurrences. These corrections will be reported, in writing, to AAP or CCRL within 60 days of the receipt of the deficient rating.
- 5.2 Local Agencies shall have IA inspections conducted by an AASHTO-accredited laboratory in accordance with the conditions of Subsection 7.4 of the Quality Assurance Procedures Chapter of the Field Material Manual (FMM). The local agency must confirm that the Accredited Laboratory meets all appropriate criteria.

## **6. INSTRUCTIONS FOR USE OF THE – FIELD LAB & PERSONNEL QUALIFICATION CHECKLIST GENERAL**

- 6.1 Lab Cleanliness & Housekeeping - The field-testing lab is generally clean and organized to the point where it will not affect test results.
- 6.2 Equipment Cleanliness & Functionality - The field-testing equipment is clean and in good working order, with no broken or partially repaired parts that would have a detrimental effect on the test results.
- 6.3 Calibration Checks & Personnel Qualification - Documentation of the calibration checks must be readily available in the field-testing lab, being both complete and up-to-date. This includes calibration checks of scales, ovens, water baths (concrete & bulk), and thermometers. Equipment verification such as sieve examinations, measurements of air meters, slump cones, cylinder molds, beam molds, etc. should also be documented. The qualifications of each person in the lab who conduct the tests are documented, being both current and available.
- 6.4 Scales, Accurate & Level - Verify scales have been checked with a reference weight in accordance with AASHTO M 231 and are level on the testing face.
- 6.5 Ovens, Accurate Temperatures (140°, 230°, 275°, & 300°F) - Verify that oven thermostats are maintaining the temperature of the 140°F ± 5° (60°C ± 2.8°) oven, 230°F ± 9° (110°C ± 5°) oven, 275°F ± 5° (135°C ± 2.8°) oven, and the 300°F ± 5° (149°C ± 2.8°) oven.

- 6.6 Thermometer(s) Accurate - Conforming to the requirements of ASTM. The thermometers shall be capable of reading 77°F by 0.2°F (25°C by 0.1°C), 140°F by 0.2°F (60°C by 0.1°C), 230°F by 1°F (110°C by 0.5°C), 275°F by 2°F (135°C by 1°C), and 300°F by 2°F (149°C by 1°C).
- 6.7 Sieves - In good condition, and checked with comparator. Sieves conform to ASTM E 11 and have been checked with a certified comparator in accordance with ASTM E 11. Verify that there are no visible holes, dents, wire marks, etc. in the sieves or any sagging of the sieve.
- 6.8 Current and Updated CDOT Materials Forms. CDOT Owner Acceptance Sampling Checklist (SM Report 250) and Final Materials Documentation and Checklist, IA Summary Report (SM Report 473) are filled out and complete as of the date of the inspection.
- 6.9 Equipment and Lab Facility supplied by the Contractor meet the M Standards (M-620-11 or M-620-12) or the specification for the project for which the lab is being supplied. If the Contractor has proposed establishing a project field laboratory within a fixed building, the Contractor shall first provide a proposed floor plan layout of the laboratory space to the Project Engineer and Region Materials Engineer for review and approval. The proposed lab space shall be at least the same overall size, have roughly the same dimensions, and have the same general layout and useable work space as the specified laboratory space as shown in the M Standards. If the plan layout is approved by the Project Engineer and the Region Materials Engineer, but the building space requires modification in order to accommodate the proposed lab space, the Contractor shall obtain all required building permits and pass all inspections required for the modifications. Modifications may include, but are not limited to; removal, modification to, or construction of walls, changes to electrical wiring / loading, changes to plumbing, including drains, venting for ovens, providing for nuclear gauge storage / isolation, etc.
- 6.10 Aggregate splitter complies with ASTM C 702 for the correct number of opening and the size of openings. Splitter does not have visible signs of excessive wear, i.e., splitter openings broken, dented, welds detached, etc.
- 6.11 Shaker - Sieving Adequacy Test Performed. Verify the correct aggregate sieving time by running the sieving adequacy test defined in CP 31, ASTM C 136, and AASHTO T 27. Verify that the sieve shaker can hold an entire set of sieves, (10 + catch pan).

#### **CONCRETE**

- 6.12 Curing tanks for concrete cylinders and beams contains lime-water at the correct temperature, 73.5°F ± 3.5° in accordance with ASTM C 31. Verify the recording thermometer is present and is correct in accordance with ASTM C 31.
- 6.13 Verify that all Concrete Testing Equipment meets the appropriate requirements: Air meter (ASTM C 231), Slump Cone (ASTM C 143), Unit Weight (ASTM C 138), Cylinder Molds (ASTM C 31), and Beam Molds (ASTM C 78).

- 6.14 Verify that the Concrete Compression Machine has been calibrated for concrete cylinders, ASTM C 39, and for beams (if tested), ASTM C 78, and has a current (yearly) certified calibration sticker on the machine. Verify that the neoprene pads meet ASTM C 1231 and have been checked for wear and logged for the number of breaks on each pair of pads (maximum of 100 uses per pad). Verify the loading rate of the Concrete Compression Machine and that it meets the ASTM C 39. Verify that calibration records for the Concrete Compression Machine are available and up to date in accordance with ASTM E 4.

**Note 1:** ACI Aggregate Base Testing Technician was added into Table 10-1 and the Field Lab & Personnel Qualification Checklist.

**Note 2:** AASHTO TP118 Characterization of the Air-Void System of Freshly Mixed Concrete by the Sequential Pressure Method (Super Air Meter), was added into Table 10-1 and the Field Lab & Personnel Qualification Checklist.

\*\* Those testing self-consolidating concrete shall have the SCC certification in addition to the FG certification.

### ASPHALT

- 6.15 Verify that a square splitting pan and square sided scoop are being used for asphalt sampling and splitting in accordance with CP 55.
- 6.16 Verify that CP 51 is being followed for determination of Maximum Specific Gravity (Rice). Verify that manometer is free of air bubbles, vacuum pump oil is free of water, desiccating crystals are free of moisture, flasks have been calibrated in accordance with CP 51 and "D" weights have been logged. Verify that vacuum pump pressure can be maintained at  $28 \pm 2$  mm of mercury.
- 6.17 Verify that CP 44 is being followed for determination of Bulk Specific Gravity. Bulk tank is at the correct temperature,  $77^{\circ}\text{F} \pm 1.8^{\circ}$  ( $25^{\circ}\text{C} \pm 1^{\circ}$ ). Suspension line is of the smallest possible diameter at the water surface (and there are no knots in the suspension line at the surface).

### NUCLEAR

- 6.18 Verify that nuclear gauges are stored and secured properly as required by the Radioactive Materials License. Verify that the Caution Radioactive Materials placard, the Notice to Employees document, and the Nuclear Incident Procedure sheet (filled out with responsible individual(s) names and phone numbers) are posted correctly. That the daily gauge logs are filled out and current, and the Moisture / Density Gauge has been calibrated as specified. Consultant M/D Gauges have been certified within the last 12 months and CDOT M/D Gauges have been calibrated within the last 24 months. Verify that Statistical Stability and Drift tests have been run before the start of the project and whenever requested by the Project Engineer.

### SOILS

- 6.19 Verify that soils and base course equipment meet the corresponding AASHTO requirements and that the correct hammers and molds, designated in AASHTO T 99 and T 180, are used. Verify that the atterberg limit equipment is calibrated properly and is within specification in accordance with AASHTO T 89 and T 99. Verify that the #4 riddle meets the AASHTO E 11 standards by using a comparator, micrometer, or other calibrated measuring device. Verify that the compaction base is of sufficient mass ( $> 90$  kg) and that a suitable area for compaction is available in accordance with AASHTO T 99 and T 180.



| AASTHO Test Designation | ASTM Test Designation | CDOT Test Designation | Test Description   | ACI Concrete Field Testing Technician Grade I (FG) - Self-Consolidating Concrete Testing Technician (SCC) | ACI Aggregate Testing Technician - Level 1 (1) - Level 2 (2) | ACI Concrete Lab. Testing Tech. Grade I (G) - Level 1 (1) - Both (B) | ACI Concrete Lab. Testing Tech. Grade II (G) - Level 2 (1) - Both (B) | ACI Concrete Strength Testing Technician | ACI Agg. Base Testing Technician | WAQTC Embankment & Base Excavation & Embankment – Soils Inspector | LABCAT Level A | LABCAT Level B | LABCAT Level C | LABCAT Level E | SiteManager Materials (SMM) /LIMS) |
|-------------------------|-----------------------|-----------------------|--|---|--|--|---|--|----------------------------------|---|----------------|----------------|----------------|----------------|------------------------------------|
| T 2                     | D 75                  | CP 30                 | Sampling Aggregates  |   | 1  | B  |   |  | X                                |   | X              |                |                | X              |                                    |
| T 84                    | C 128                 | CPL 4102              | Specific Gravity and Absorption of Fine Aggregate  |   | 1  | B  |   |  |                                  |   |                |                |                | X              |                                    |
| T 85                    | C 127                 |                       | Specific Gravity and Absorption of Coarse Aggregate  |   | 1  | B  |   |  | X                                |   |                |                |                | X              |                                    |
| T 11                    | C 117                 | CP 31                 | Materials Finer Than 75-µm (No. 200) Sieve in Mineral Aggregates by Washing                                |   | 1  | B  |   |  |                                  |   |                | X              |                |                |                                    |
| T 248                   | C 702                 | CP 32                 | Reducing Samples of Aggregate to Testing Size  |   | 1  | B  |   |  | X                                |   |                | X              |                |                |                                    |
| T 255                   | C 566                 |                       | Total Moisture Content of Aggregate by Drying  |   | 1  | B  |   |  | X                                |   |                |                |                |                |                                    |
| T 27                    | C 136                 | CP 31                 | Sieve Analysis of Fine and Coarse Aggregates   |   | 1  | B  |   |  |                                  |   |                | X              |                |                |                                    |
| T 112                   | C 142                 |                       | Clay Lumps and Friable Particles in Aggregate  |   | 2  |  | G   |  |                                  |   |                |                |                | X              |                                    |
| T 96                    | C 131                 |                       | Resistance to Degradation of Small-Size Coarse Aggregate by Abrasion and Impact in the Los Angeles Machine |   | 2  |  | G   |  |                                  |   |                |                |                | X              |                                    |
|                         | C 535                 |                       | Resistance to Degradation of Large-Size Coarse Aggregate by Abrasion and Impact in the Los Angeles Machine |   | 2  |  | G   |  |                                  |   |                |                |                |                |                                    |
| T 176                   |                       | CP 37                 | Plastic fines in Graded Aggregates and Soils by Use of the Sand Equivalent Test                            |   | 2  |  |   |  |                                  |   |                |                |                | X              |                                    |
| T 304                   |                       |                       | Un-compacted Void Content of Fine Aggregate  |   | 2  |  |   |  |                                  |   |                |                |                | X              |                                    |
| TP 61                   | D 5821                | CP 45                 | Determining the Percentage of Fractured Particles in Coarse Aggregate                                      |   | 1 or 2   |  |   |  |                                  |   |                |                |                | X              |                                    |
| T 104                   |                       |                       | Soundness of Aggregates by Freezing and Thawing  |   | 2  |  |   |  |                                  |   |                |                |                | X              |                                    |
|                         | D 4791                |                       | Flat Particles, Elongated Particles, or Flat and Elongated Particles in Coarse Aggregate                   |   | 2  |  |   |  |                                  |   |                |                |                | X              |                                    |
| T 327                   |                       |                       | Resistance of Coarse Aggregate to Degradation by Abrasion in the Micro-Deval Apparatus                     |   |  |  |   |  |                                  |   |                |                |                | X              |                                    |
| T 166                   |                       | CP 44                 | Bulk Specific Gravity of Compacted Bituminous Mixtures Using Saturated Surface-Dry Specimens               |   |  |  |   |  |                                  |   |                | X              |                |                |                                    |
| T209                    |                       | CP 51                 | Theoretical Maximum Specific Gravity and Density of Bituminous Paving Mixtures                             |   |  |  |   |  |                                  |   |                | X              |                |                |                                    |

| AASTHO Test Designation | ASTM Test Designation | CDOT Test Designation | Test Description  | ACI Concrete Field Testing Technician Grade I (FG) - Self-Consolidating Concrete Testing Technician (SCC) | ACI Aggregate Testing Technician - Level 1 (1) - Level 2 (2) | ACI Concrete Lab. Testing Tech. Grade I (G) - Level 1 (L) - Both (B) | ACI Concrete Lab. Testing Tech. Grade II (G) - Level 2 (L) - Both (B) | ACI Concrete Strength Testing Technician | ACI Agg. Base Testing Technician | WAQTC Embankment & Base Excavation & Embankment - Soils Inspector | LABCAT Level A | LABCAT Level B | LABCAT Level C | LABCAT Level E | SiteManager Materials (SMM) /LIMS) |
|-------------------------|-----------------------|-----------------------|---|---|--|--|---|--|----------------------------------|---|----------------|----------------|----------------|----------------|------------------------------------|
|                         |                       | CP 81                 | In-Place Density of Bituminous Mixes Using the Nuclear Moisture-Density Gauge                       |   |  |  |   |  |                                  |   | X              |                |                |                |                                    |
|                         | D 3665                | CP 75                 | Random sampling   |   |  |  |   |  |                                  |   | X              |                |                |                |                                    |
| T168                    |                       | CP 41                 | Sampling Hot Mix Asphalt  |   |  |  |   |  |                                  |   | X              |                |                |                |                                    |
| T248                    |                       | CP 55                 | Splitting Hot Mix Asphalt   |   |  |  |   |  |                                  |   | X              |                |                |                |                                    |
| T287                    |                       | CP 85                 | Asphalt Content by Nuclear Method   |   |  |  |   |  |                                  |   |                | X              |                |                |                                    |
| T308                    |                       | CPL 5120              | Asphalt Content by Ignition Method  |   |  |  |   |  |                                  |   |                | X              |                |                |                                    |
| T312                    |                       |                       | Superpave Gyrotory Compactor  |   |  |  |   |  |                                  |   |                |                | X              |                |                                    |
| T246                    |                       | CPL 5106              | Hveem Stability   |   |  |  |   |  |                                  |   |                |                | X              |                |                                    |
| T283                    |                       | CPL 5109              | Resistance to Moisture Induced Damage   |   |  |  |   |  |                                  |   |                |                | X              |                |                                    |
|                         | C 1231                |                       | Unbonded Caps for Concrete Cylinders  |   |  | B  |   | X  |                                  |   |                |                |                |                |                                    |
|                         | C 39                  |                       | Compressive Strength of Cylindrical Concrete Specimens  |   |  | B  |   | X  |                                  |   |                |                |                |                |                                    |
|                         | C 617                 |                       | Capping Cylindrical Concrete Specimens  |   |  | B  |   | X  |                                  |   |                |                |                |                |                                    |
|                         | C 1064                |                       | Temperature of Freshly Mixed Hydraulic-Cement Concrete  | FG  |  |  |   |  |                                  |   |                |                |                |                |                                    |
|                         | C 172                 |                       | Sampling Freshly Mixed Concrete   | FG  |  |  |   |  |                                  |   |                |                |                |                |                                    |
|                         | C 143                 |                       | Slump of Hydraulic-Cement Concrete  | FG  |  |  |   |  |                                  |   |                |                |                |                |                                    |
|                         | C 138                 |                       | Density, Yield and Air Content (Gravimetric) of Concrete  | FG**  |  |  |   |  |                                  |   |                |                |                |                |                                    |
|                         | C 231                 |                       | Air Content of Freshly Mixed Concrete by Pressure Method  | FG**  |  |  |   |  |                                  |   |                |                |                |                |                                    |
|                         | C 31                  |                       | Making and Curing Concrete Test Specimens in the Field  | FG**  |  |  |   |  |                                  |   |                |                |                |                |                                    |
|                         | C 42                  |                       | Obtaining and Testing Drilled Cores and Sawed Beams   |   |  |  | B   |  |                                  |   |                |                |                |                |                                    |
|                         | C 78                  |                       | Flexural Strength of Concrete (Using Simple Method with Third-Point Loading)                        |   |  | L  | G   | X  |                                  |   |                |                |                |                |                                    |
| T310                    |                       | CP 80                 | In-Place Density and Moisture Content of Soil and Soil-Aggregate by Nuclear Methods (Shallow Depth) |   |  |  |   |  |                                  | X   |                |                |                |                |                                    |
| T 89                    |                       |                       | Determining the Liquid Limits of Soils  |   |  |  |   |  | X                                | X *   |                |                |                |                |                                    |
| T 90                    |                       |                       | Determining the Plastic Limit and Plasticity Index of Soils   |   |  |  |   |  | X                                | X *   |                |                |                |                |                                    |
| T 99<br>T180            |                       | CP-23                 | Moisture Density Relations of Soils   |   |  |  |   |  | X                                | X   |                |                |                |                |                                    |

| ASTHO Test Designation | ASTM Test Designation | CDOT Test Designation | Test Description  | ACI Concrete Field Testing Technician Grade I (FG) - Self-Consolidating Concrete Testing Technician (SCC) | ACI Aggregate Testing Technician - Level 1 (1) - Level 2 (2) | ACI Concrete Lab. Testing Tech. Grade I (G) - Level 1 (1) – Both (B) | ACI Concrete Lab. Testing Tech. Grade II (G) - Level 2 (1) – Both (B) | ACI Concrete Strength Testing Technician | ACI Agg. Base Testing Technician | WAQTC Embankment & Base Excavation & Embankment – Soils Inspector | LABCAT Level A | LABCAT Level B | LABCAT Level C | LABCAT Level E | SiteManager Materials (SMM) /LIMS) |
|------------------------|-----------------------|-----------------------|---|---|--|--|---|--|----------------------------------|---|----------------|----------------|----------------|----------------|------------------------------------|
|                        | C 1610                |                       | Static Segregation of Self-Consolidating Concrete Using Column Technique  | SSC   |  |  |   |  |                                  |   |                |                |                |                |                                    |
|                        | C 1611                |                       | Slump Flow of Self-Consolidating Concrete   | SCC   |  |  |   |  |                                  |   |                |                |                |                |                                    |
|                        | C 1621                |                       | Passing Ability of Self-Consolidating Concrete by J-Ring  | SCC   |  |  |   |  |                                  |   |                |                |                |                |                                    |
|                        | C 1712                |                       | Rapid Assessment of Static Segregation Resistance of Self-Consolidating Concrete Using Penetration Test               | SCC   |  |  |   |  |                                  |   |                |                |                |                |                                    |
|                        | C 1758                |                       | Fabricating Test Specimens with Self-Consolidating Concrete   | SCC   |  |  |   |  |                                  |   |                |                |                |                |                                    |
| TP 118                 |                       |                       | Characterization of the Air-Void System of Freshly Mixed Concrete by the Sequential Pressure Method (Super Air Meter) | FG  |  |  |   |  |                                  |   |                |                |                |                |                                    |
| T198                   | C 496                 |                       | Split Tensile Strength Testing  |   | 2  |  |   |  |                                  |   |                |                |                |                |                                    |
|                        |                       | TETP                  | CDOT Materials Technician Training Course   |   |  |  |   |  |                                  |   |                |                |                |                | X                                  |

**TABLE 10-1 Sampling & Testing Personnel Qualifications<sup>1</sup>**

\* Those only seeking an inspection certification need only pass the excavation and embankment exam.

\*\* Those testing self-consolidating concrete shall have the SCC certification in addition to the FG certification

<sup>1</sup> **New for projects utilizing the 2020 Field Materials Manual and advertised after January 1, 2020** - All personnel conducting Owner Acceptance Testing and acceptance of materials on CDOT projects advertised after January 1, 2020, shall have successfully completed and passed the online e-learning CDOT Materials Technician Training Course offered through the CDOT Transportation Engineering Training Program (TETP). This online course can be accessed at the following link: <https://www.codot.gov/programs/tetp>. This is in addition to qualifications/certifications required for specific materials or test methods as listed in Table 10-1, above.

## What you need to know about CDOT Materials Technician Certification

Welcome to the CDOT Materials Technician Certification course.

As of January 1, 2020, all Materials Technicians conducting Field Quality Assurance testing on CDOT projects must complete this training and become certified. This applies to both CDOT internal staff and consultant staff.



As a Quality Assurance Materials Technician on a CDOT project, it is critical that you have not only the technical skills required for sampling and testing, but that you also understand what is expected of you in terms of CDOT processes, where to find information, communication protocols, and documentation requirements.



### How the Course Works

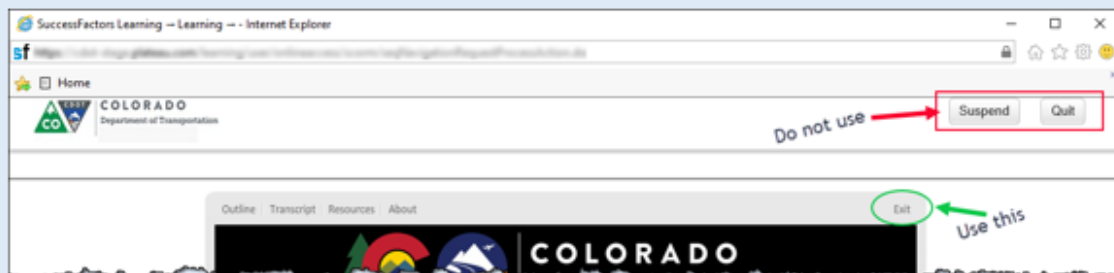
This course is designed to be challenging! Read everything, answer the questions, and refer to the documentation and references linked in the course. You will need all of the information in order to pass the post-course assessment. Remember:

- The course, including the post-course assessment, should take approximately **3½ hours** to complete. You can exit the course and come back to it later if you need to.
- You must pass the post-course assessment with a **score of 70%** or higher.
- You have **three tries** to pass the assessment.
- If you do not pass, you will **not receive your certification** and **will not be able to take the course again** without additional training.



### Tips and Tricks for Success

- If you see “extra” buttons at the top of your training screen, **do NOT use them to exit the course.** Your progress will not be saved and you may not get credit for the training. Use the “Exit” tab at the top right of the course window.



- **Do not take the assessment until you are ready**
- **Review all resources and links** (you may want to keep them open on your desktop)
- Remember that you only get three tries at the assessment; **review carefully.** Ask for **help from your supervisor** or trainer before your third try
- Once you've passed the course, you can go back and review at any time



### Your Tools

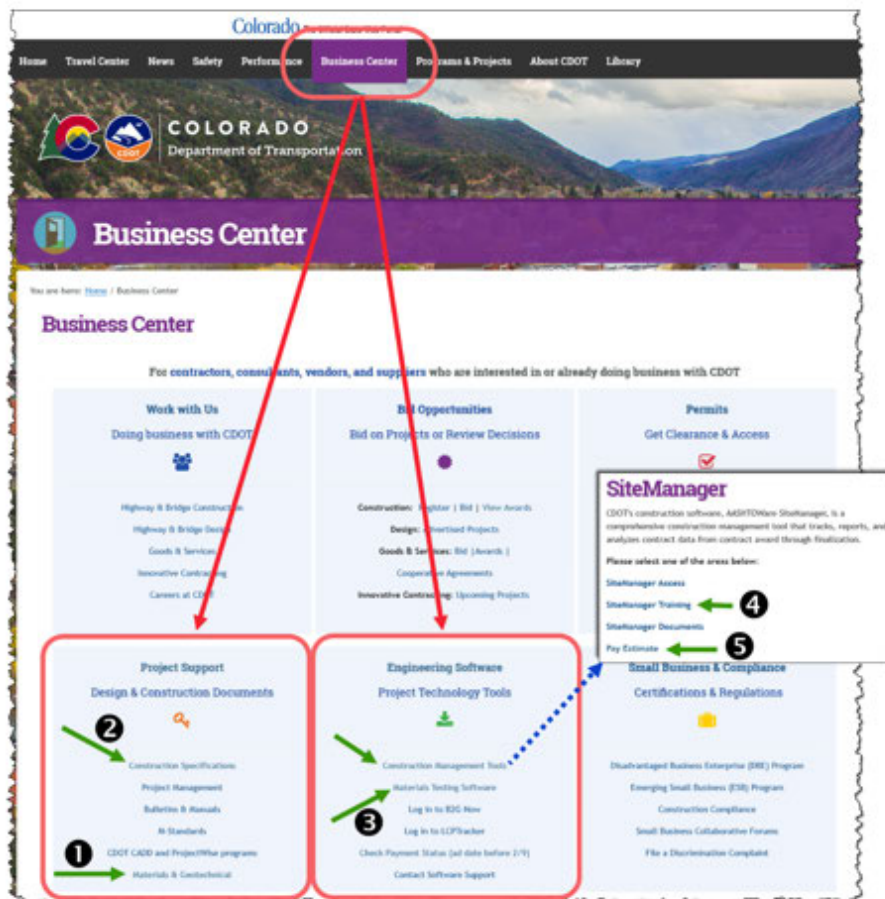
The resources below are linked to and used throughout this course. You may want to become familiar with how to access and use them before you start the course.

|  |   |
|--|---|
| CDOT website   | <a href="https://www.codot.gov/">https://www.codot.gov/</a>   |
| CDOT Standard Specifications for Road & Bridge Construction 2017 | <a href="https://www.codot.gov/business/designsupport/cdot-construction-specifications/2017-construction-standard-specs/2017-specs-book/division-100-2017-final.pdf/view">https://www.codot.gov/business/designsupport/cdot-construction-specifications/2017-construction-standard-specs/2017-specs-book/division-100-2017-final.pdf/view</a> |
| CDOT Field Materials Manual 2019                                 | <a href="https://www.codot.gov/business/designsupport/matgeo/manuals/2019-fmm/intro-docs/%2803%29%20Documentation%20for%20SMM_LIMS-19/view">https://www.codot.gov/business/designsupport/matgeo/manuals/2019-fmm/intro-docs/%2803%29%20Documentation%20for%20SMM_LIMS-19/view</a>   |
| SiteManager Training   | <a href="https://sites.google.com/a/state.co.us/sitemanager-materials/image-heavy-page">https://sites.google.com/a/state.co.us/sitemanager-materials/image-heavy-page</a>   |
| Project Pay Estimates  | <a href="https://www.codot.gov/business/engineeringapplications/project-construction/aashtoware-project-construction-sitemanager-pay-estimates#gsc.tab=0">https://www.codot.gov/business/engineeringapplications/project-construction/aashtoware-project-construction-sitemanager-pay-estimates#gsc.tab=0</a>                                 |

### Navigating the CDOT Website

Many of the resources and information you need for this course and on the job can also be found by navigating through the Business Center section of the CDOT website.

- 1 **CDOT Field Materials Manual**—Business Center>Project Support: Materials & Geotechnical
- 2 **CDOT Standard Specifications**—Business Center>Project Support: Construction Specifications
- 3 **SiteManager information**—Business Center>Engineering Software: Materials Testing Software
- 4 **SiteManager training**—Business Center>Engineering Software: Construction Management Tools: SiteManager Training
- 5 **Pay estimates**—Business Center>Engineering Software: Construction Management Tools: Pay Estimate





### Field Lab & Personnel Qualification Checklist – 2020

Project No: \_\_\_\_\_ Contract ID \_\_\_\_\_

Project Location: \_\_\_\_\_

Consultant / Field Tester \_\_\_\_\_ Project Engineer \_\_\_\_\_

Qualified Laboratory?  Yes  No

General Impression:

Current LIMS Access?  Yes  No

Region Inspection of Project Field Lab

Region Inspection of Contractor Lab

Region Inspection of Consultant Lab

#### GENERAL

- 6.1 Lab Cleanliness & Housekeeping.....
- 6.2 Equipment Cleanliness & Functionality.....
- 6.3 Calibration Checks & Personnel Qualification, Documents present & complete.....
- 6.4 Scales - Accurate & Level.....
- 6.5 Ovens-Verified as Accurate, Temperatures (140°, 230°, 275°, 300°F).....
- 6.6 Thermometer(s)-Accurate.....
- 6.7 Sieves - Good repair, and checked w/ comparator.....
- 6.8 Current CDOT Materials Forms.....
- 6.8 Forms up-to-date (# 250 & # 379, and all others).....
- 6.9 Equipment & Lab facility supplied by Contractor meet Specifications.....
- 6.10 Aggregate Splitter - Correct # of openings.....
- 6.10 Correct size openings.....
- 6.11 Shaker-sieving adequacy performed.....
- 6.11 Holds full set of sieves (10 + catch pan).....

Comments:



- CONCRETE    Applicable.....
- 6.12    Concrete curing water at correct temperature.....
- Recording thermometer present and operating.....
- 6.13    Concrete Testing Equipment.....
- Air Meter Calibrated.....
- Slump Cone Dimensions are accurate.....
- Strike off plate for Unit Wts is accurate.....
- Approved Cylinder/Beam Molds.....
- 6.14    Concrete Compression Machine.....
- Calibrated for Cylinders/Beams.....
- Neoprene Pads checked/logged.....
- Correct Loading Rate.....
- Calibration records present.....

Comments:

- ASPHALT    Applicable.....
- 6.15    Square Splitting Pan for Asphalt.....
- Square Sided Scoop for Asphalt.....
- 6.16    Maximum Specific Gravity (RICE) set up.....
- Manometer free of air.....
- Pump oil free of water.....
- Desiccating crystals free of water.....
- Flasks calibrated and logged.....
- Vacuum Pump Pressure at  $28 \pm 2$  mm Hg.....
- 6.17    Bulk Specific Gravity Equipment.....
- Tank at Correct Temperature.....
- Suspension line of smallest diameter.....

Comments:

|                |   |                          |
|----------------|---|--------------------------|
| <b>NUCLEAR</b> | Applicable.....   | <input type="checkbox"/> |
| 6.18           | Nuclear Gauge Stored Properly & Secured.....                | <input type="checkbox"/> |
|                | Caution Radioactive Materials placard posted correctly..... | <input type="checkbox"/> |
|                | Nuclear Incident Procedures filled out.....                 | <input type="checkbox"/> |
|                | Daily Gauge Logs filled out.....                            | <input type="checkbox"/> |
|                | M/D Gauge Certified.....                                    | <input type="checkbox"/> |
|                | Stat & Drift Test performed.....                            | <input type="checkbox"/> |

Comments:

|              |  |                          |
|--------------|--|--------------------------|
| <b>SOILS</b> | Applicable.....                                  | <input type="checkbox"/> |
| 6.19         | Soils & Base Equipment.....                      | <input type="checkbox"/> |
|              | Hammers & Molds within specification.....        | <input type="checkbox"/> |
|              | Atterberg equipment within specification.....    | <input type="checkbox"/> |
|              | #4 Riddle within specification.....              | <input type="checkbox"/> |
|              | Compaction base of sufficient mass (>90 Kg)..... | <input type="checkbox"/> |

Comments:

Additional Comments:





PERSONNEL

| Tester 1<br>(Name / Title) | Required<br>(Y or N)     | Certification  | Expiration<br>MM-DD-YY |
|----------------------------|--------------------------|--|------------------------|
|                            | <input type="checkbox"/> | CDOT Materials Technician Certification TETP   | *No Expiration Date    |
|                            | <input type="checkbox"/> | ACI Concrete Field Testing Technician Grade I  |                        |
|                            | <input type="checkbox"/> | ACI Aggregate Testing Technician – Level 1   |                        |
| Comments:                  | <input type="checkbox"/> | ACI Aggregate Testing Technician – Level 2   |                        |
|                            | <input type="checkbox"/> | ACI Concrete Laboratory Testing Technician Grade I or ACI Concrete Lab. Testing Tech. Level 1  |                        |
|                            | <input type="checkbox"/> | ACI Concrete Laboratory Testing Technician Grade II or ACI Concrete Lab. Testing Tech. Level 2 |                        |
|                            | <input type="checkbox"/> | ACI Concrete Strength Testing Technician   |                        |
|                            | <input type="checkbox"/> | ACI Aggregate Base Testing Technician  |                        |
|                            | <input type="checkbox"/> | WAQTC Embankment & Base Excavation & Embankment – Soils Inspector                              |                        |
|                            | <input type="checkbox"/> | LabCAT A   |                        |
|                            | <input type="checkbox"/> | LabCAT B   |                        |
|                            | <input type="checkbox"/> | LabCAT C   |                        |
|                            | <input type="checkbox"/> | LabCAT E   |                        |

| Tester 2<br>(Name / Title) | Required<br>(Y or N)     | Certification  | Expiration<br>MM-DD-YY |
|----------------------------|--------------------------|--|------------------------|
|                            | <input type="checkbox"/> | CDOT Materials Technician Certification TETP   | *No Expiration Date    |
|                            | <input type="checkbox"/> | ACI Concrete Field Testing Technician Grade I  |                        |
|                            | <input type="checkbox"/> | ACI Aggregate Testing Technician – Level 1   |                        |
| Comment:                   | <input type="checkbox"/> | ACI Aggregate Testing Technician – Level 2   |                        |
|                            | <input type="checkbox"/> | ACI Concrete Laboratory Testing Technician Grade I or ACI Concrete Lab. Testing Tech. Level 1  |                        |
|                            | <input type="checkbox"/> | ACI Concrete Laboratory Testing Technician Grade II or ACI Concrete Lab. Testing Tech. Level 2 |                        |
|                            | <input type="checkbox"/> | ACI Concrete Strength Testing Technician   |                        |
|                            | <input type="checkbox"/> | ACI Aggregate Base Testing Technician  |                        |
|                            | <input type="checkbox"/> | WAQTC Embankment & Base Excavation & Embankment – Soils Inspector                              |                        |
|                            | <input type="checkbox"/> | LabCAT A   |                        |
|                            | <input type="checkbox"/> | LabCAT B   |                        |
|                            | <input type="checkbox"/> | LabCAT C   |                        |
|                            | <input type="checkbox"/> | LabCAT E   |                        |

Inspected by: \_\_\_\_\_ Date: \_\_\_\_\_ Region Materials Lab: \_\_\_\_\_  
(print name)

Inspected by  \_\_\_\_\_  
(Signature)

Approved by:  \_\_\_\_\_ Date: \_\_\_\_\_  
Project Engineer (print name)

- Distribution:
- Region Materials Engineer- Original
  - Resident Engineer
  - Project Engineer
  - Field Lab Tester

{Page Intentionally Left Blank}



## Field Lab & Personnel Qualification Checklist – 2020

Project No: \_\_\_\_\_ Contract ID \_\_\_\_\_

Project Location: \_\_\_\_\_

Consultant / Field Tester \_\_\_\_\_ Project Engineer \_\_\_\_\_

Qualified Laboratory?      Yes      No      General Impression:

Current LIMS Access?      Yes      No

Region Inspection of Project Field Lab

Region Inspection of Contractor Lab

Region Inspection of Consultant Lab

### GENERAL

- 6.1 Lab Cleanliness & Housekeeping.....
- 6.2 Equipment Cleanliness & Functionality.....
- 6.3 Calibration Checks & Personnel Qualification, Documents present & complete.....
- 6.4 Scales - Accurate & Level.....
- 6.5 Ovens-Verified as Accurate, Temperatures (140°, 230°, 275°, 300°F).....
- 6.6 Thermometer(s)-Accurate.....
- 6.7 Sieves - Good repair, and checked w/ comparator.....
- 6.8 Current CDOT Materials Forms.....
- 6.8 Forms up-to-date (# 250 & # 379, and all others).....
- 6.9 Equipment & Lab facility supplied by Contractor meet Specifications.....
- 6.10 Aggregate Splitter - Correct # of openings.....
- 6.10 Correct size openings.....
- 6.11 Shaker-sieving adequacy performed.....
- 6.11 Holds full set of sieves (10 + catch pan).....

Comments:

- CONCRETE** Applicable.....
- 6.12 Concrete curing water at correct temperature.....
  - Recording thermometer present and operating.....
- 6.13 Concrete Testing Equipment.....
  - Air Meter Calibrated.....
  - Slump Cone Dimensions are accurate.....
  - Strike off plate for Unit Wts is accurate.....
  - Approved Cylinder/Beam Molds.....
- 6.14 Concrete Compression Machine.....
  - Calibrated for Cylinders/Beams.....
  - Neoprene Pads checked/logged.....
  - Correct Loading Rate.....
  - Calibration records present.....

**Comments:**

- ASPHALT** Applicable.....
- 6.15 Square Splitting Pan for Asphalt.....
  - Square Sided Scoop for Asphalt.....
- 6.16 Maximum Specific Gravity (RICE) set up.....
  - Manometer free of air.....
  - Pump oil free of water.....
  - Desiccating crystals free of water.....
  - Flasks calibrated and logged.....
  - Vacuum Pump Pressure at  $28 \pm 2$  mm Hg.....
- 6.17 Bulk Specific Gravity Equipment.....
  - Tank at Correct Temperature.....
  - Suspension line of smallest diameter.....

**Comments:**

- NUCLEAR**     Applicable.....
- 6.18    Nuclear Gauge Stored Properly & Secured.....
- Caution Radioactive Materials placard posted correctly.....
- Nuclear Incident Procedures filled out.....
- Daily Gauge Logs filled out.....
- M/D Gauge Certified.....
- Stat & Drift Test performed.....

**Comments:**

- SOILS**            Applicable.....
- 6.19    Soils & Base Equipment.....
- Hammers & Molds within specification.....
- Atterberg equipment within specification.....
- #4 Riddle within specification.....
- Compaction base of sufficient mass (>90 Kg).....

**Comments:**

**Additional Comments:**

**PERSONNEL**

| <b>Tester 1<br/>(Name / Title)</b> | <b>Required<br/>(Y or N)</b> | <b>Certification</b>   | <b>Expiration<br/>MM-DD-YY</b> |
|------------------------------------|------------------------------|--|--------------------------------|
|                                    |                              | CDOT Materials Technician Certification TETP   | *No Expiration Date            |
|                                    |                              | ACI Concrete Field Testing Technician Grade I  |                                |
|                                    |                              | ACI Aggregate Testing Technician – Level 1   |                                |
| <b>Comments:</b>                   |                              | ACI Aggregate Testing Technician – Level 2   |                                |
|                                    |                              | ACI Concrete Laboratory Testing Technician Grade I or ACI Concrete Lab. Testing Tech. Level 1  |                                |
|                                    |                              | ACI Concrete Laboratory Testing Technician Grade II or ACI Concrete Lab. Testing Tech. Level 2 |                                |
|                                    |                              | ACI Concrete Strength Testing Technician   |                                |
|                                    |                              | ACI Aggregate Base Testing Technician  |                                |
|                                    |                              | WAQTC Embankment & Base Excavation & Embankment – Soils Inspector                              |                                |
|                                    |                              | LabCAT A   |                                |
|                                    |                              | LabCAT B   |                                |
|                                    |                              | LabCAT C   |                                |
|                                    |                              | LabCAT E   |                                |

| <b>Tester 2<br/>(Name / Title)</b> | <b>Required<br/>(Y or N)</b> | <b>Certification</b>   | <b>Expiration<br/>MM-DD-YY</b> |
|------------------------------------|------------------------------|--|--------------------------------|
|                                    |                              | CDOT Materials Technician Certification TETP   | *No Expiration Date            |
|                                    |                              | ACI Concrete Field Testing Technician Grade I  |                                |
|                                    |                              | ACI Aggregate Testing Technician – Level 1   |                                |
| <b>Comment:</b>                    |                              | ACI Aggregate Testing Technician – Level 2   |                                |
|                                    |                              | ACI Concrete Laboratory Testing Technician Grade I or ACI Concrete Lab. Testing Tech. Level 1  |                                |
|                                    |                              | ACI Concrete Laboratory Testing Technician Grade II or ACI Concrete Lab. Testing Tech. Level 2 |                                |
|                                    |                              | ACI Concrete Strength Testing Technician   |                                |
|                                    |                              | ACI Aggregate Base Testing Technician  |                                |
|                                    |                              | WAQTC Embankment & Base Excavation & Embankment – Soils Inspector                              |                                |
|                                    |                              | LabCAT A   |                                |
|                                    |                              | LabCAT B   |                                |
|                                    |                              | LabCAT C   |                                |
|                                    |                              | LabCAT E   |                                |

Inspected by: \_\_\_\_\_ Date: \_\_\_\_\_ Region Materials Lab: \_\_\_\_\_  
(print name)

Inspected by \_\_\_\_\_  
(Signature)

Approved by: \_\_\_\_\_ Date: \_\_\_\_\_  
Project Engineer (print name)

**Distribution:**

- Region Materials Engineer- Original**
- Resident Engineer**
- Project Engineer**
- Field Lab Tester**



## Colorado Procedure 11-21

*Standard Practice for*

### Quality Management Plans for the Qualified Manufacturers List or the Approved Products List

#### 1. SCOPE

- 1.1 This Standard specifies requirements and procedures for a certification system that shall be applicable to all referenced manufacturers, as well as suppliers and contractors within certain industries. Certifying a Manufacturer's Quality Management Plan is not an automatic acceptance of any particular product, but an acknowledgement that the Manufacturer has taken steps to ensure that their quality controls meet the applicable Industry standards. A Quality Management Plan, a Quality Control Plan, and a Quality System Manual are deemed synonymous for this standard.
- 1.2 Manufacturers whose Quality Management Plans are acceptable will be placed on the Qualified Manufacturers List (QML) or their products will be eligible to be placed on the Approved Products List (APL). Only Manufacturers required to be listed on the QML will be eligible to provide the referenced products to a CDOT project. The QML is located within CDOT's Approved Products List (APL) web site, at: <https://www.codot.gov/business/apl>

#### 2. REFERENCED INDUSTRIES

- 2.1 With respect to this Standard there are two materials classes. This Colorado Procedure will be divided into two parts to correlate to these materials classes. Part I will be Standard Manufactured Materials of which upon acceptance of the manufacturer's Quality Control Plans the individual products submitted will be placed on the APL. Part II will be Fabricated Structural Materials of which upon acceptance of the manufacturer's Quality System Manual the individual production facilities will be placed on the QML. Each Material Class will have it's own CP Section within each section there will be instructions and guidance for the Manufactures to become certified so that they can submit their manufactured products or structures for inclusion to the CDOT Approved Products Lists or the Qualified Manufacturers List.

#### 3. TABLE OF CONTENTS

##### Part I. Standard Manufactured Materials

|         |                  |
|---------|------------------|
| CP-11-1 | Asphalt Binder   |
| CP-11-2 | Asphalt Emulsion |
| CP-11-3 | Hydraulic Cement |
| CP-11-4 | Fly Ash          |
| CP-11-5 | Hydrated Lime    |

## Part II. Fabricated Structural Materials

|          |   |
|----------|---|
| CP-11-6  | Steel Reinforcing Bars & Steel Dowel Bars                                 |
| CP-11-7  | Epoxy Coaters of Reinforcing Steel  |
| CP-11-7a | Epoxy Coaters QSM Checklist   |
| CP-11-8  | Precast Concrete Structures   |
| CP-11-8a | Precast Concrete Structures Manufacturers QSM Checklist/ Certified Letter |

### 4. PRODUCT ACCEPTANCE

- 4.1 The majority of materials submitted for inclusion on CDOT projects will fall within one of four levels of product acceptance for their sampling and testing. CDOT always retains the right through its Quality Assurance (QA) Program to obtain samples for additional testing and require supplemental documentation.
- 4.2 The four levels of product acceptance are: Pre-Inspected (PI), Certified Test Report (CTR), Certificate of Compliance (COC), and Pre-Approved (through the APL).
- 4.3 A Manufacturer being placed on the QML is a completely separate activity from how their product(s) are accepted on a CDOT project. The specifics on product acceptance are addressed in the Special Notice to Contractors chapter and with additional reference in the Quality Assurance Schedule.

### 5. DECERTIFICATION

- 5.1 Certification may be withdrawn from suppliers when one or more of the following conditions exist:
- 5.1.1 Failure to consistently supply material of a specific grade meeting specifications for three (3) acceptance samples as determined by CDOT test results.
- 5.1.2 Failure to regularly participate in two (2) WCTG or equal "Round-Robins."
- 5.1.3 Inadequate maintenance of required records.
- 5.1.4 Improper documentation of shipments.
- 5.1.5 A visit by CDOT's Representative to a supplier's facility reveals significant quality control problems.
- 5.1.6 Failure to maintain an acceptable quality control program.
- 5.1.7 Failure to comply with any additional decertification requirements found in the applicable CP of this Standard.
- 5.2 Notification of Decertification will be in writing.

**6. QUALIFYING FOR RECERTIFICATION**

- 6.1 If a supplier has been decertified and seeks to be recertified, then the Supplier Certification Requirements must be fulfilled, as per Section 6 of the applicable CP of this Standard.

{Page Intentionally Left Blank}

## **Asphalt Binder - 21**

### **(Certifying Suppliers and Contractors)**

#### **1. REFERENCED DOCUMENTS**

- 1.1 CDOT Standard Specifications  
Table 702-1, SuperPave Performance Graded Binders
- 1.2 AASHTO Standards:
  - R 29 Practice for Grading or Verifying the Performance Grade of an Asphalt Binder
  - T 40 Method of Sampling Bituminous Materials
  - R 18 AASHTO Accreditation Program
- 1.3 ASTM Standards:
  - D 8 Definitions of Terms Relating to Materials for Roads and Pavements
- 1.4 WCTG Bylaws

#### **2. TERMINOLOGY**

- 2.1 Binder - An asphalt based cement that is produced from petroleum residue either with or without the addition of non-particulate organic modifiers.
- 2.2 PG - Performance Graded, as in Superpave Performance Graded Binders.
- 2.3 Refinery Facility - A facility that is a producer of petroleum asphalts by refining the residuum from crude petroleum. The three types of petroleum asphalts refined are; Asphalt Cements, Emulsion Asphalts, Cutback Asphalts.
- 2.4 Terminal Facility - A facility that can receive, store, and distribute petroleum asphalts. May have the ability to modify petroleum asphalts.
- 2.5 Storage Facility - A facility that can receive, store, and distribute petroleum asphalts. The facility does not have the ability to modify the petroleum asphalt.
- 2.6 Supplier - A Supplier shall be defined as one who produces, controls, and supplies the final binder product to satisfy the PG binder grade specified in Table 702-1 of the Standard Specifications and/or other appropriate CDOT specifications. A Supplier shall be a refinery, a terminal, an HMA producer, or any facility that holds product for more than 30 days from the date of delivery for unmodified binders or 7 days from the date of delivery for a modified binder regardless of binder quantity. If no Modification is made to the PG binder grade after its initial production at the refinery, the refinery shall be the supplier and must provide certification. If there is any grade modification of the PG binder at the terminal, the terminal becomes the supplier and must provide the certification. If an HMA producer blends binder of different grades or binders from different suppliers at the facility, the HMA producer becomes the supplier and must provide the certification to verify the grade of the stored binder and must meet CP 11 requirements for an approved supplier. No PG binder will be produced or blended to specification at the hot mix asphalt (HMA) plant.

2.7 Contractor – The company who places the HMA on the project under contract with CDOT.

2.8 WCTG – Western Cooperative Test Group, a government / industry association.

### **3. SIGNIFICANCE AND USE**

3.1 This Standard specifies requirements and procedures for a certification system that shall be applicable to all suppliers and contractors providing performance graded (PG) binders. The requirements and procedures shall apply to materials that meet the requirements of CDOT specifications for PG binders. These provisions initially apply to the refinery manufacturing the PG binder and/or to terminals where binders are mixed. These provisions subsequently apply to the Contractor, after delivery of the PG binder to the Contractor, for use in hot mix asphalt (HMA) on CDOT projects.

3.2 This Standard specifies procedures intended to minimize disruption of PG binder shipments. This is accomplished by a certification system that evaluates quality control and specification compliance tests performed by the Supplier and the HMA Contractor according to their quality control plans.

### **4. SAMPLING**

4.1 All test samples required by this standard shall be obtained in accordance with AASHTO T 40. A supplier may propose an alternate method of sampling that will ensure the sampling of a non-segregated product.

### **5. TESTING REQUIREMENTS**

5.1 All specification compliance testing required for this Standard shall be performed by a laboratory currently covered by AMRL accreditation. Any satellite laboratory of a Supplier that performs required testing under this Standard will be identified in the submitted Supplier Quality Control Plan (Section 7) and shall be approved by CDOT.

5.2 All laboratories performing routine Quality Control testing shall participate in WCTG round robin testing or an approved equal.

### **6. SUPPLIER CERTIFICATION REQUIREMENTS**

6.1 The Supplier shall submit to CDOT for approval a complete Quality Control Plan that complies with the requirements of Section 7. If the Quality Control Plan is rejected, the Supplier may modify the plan based on the critique provided and then resubmit it to CDOT for approval.

6.2 Once the Supplier's Quality Control Plan is approved by CDOT, the Supplier shall submit to the CDOT Product Evaluation Coordinator a completed copy of CDOT Form #595 (Pre-Approved Product Evaluation Request & Summary) for each performance graded binder. The Form 595 can be located at: [www.codot.gov/business/APL/](http://www.codot.gov/business/APL/) within the Notice to Manufacturers. The Form 595 is designed as a PDF Writeable form, which must be completed by the Supplier. The completed form shall be returned to CDOT's Product Evaluation Coordinator as an e-mail attachment.

6.2.1 The Form 595 "Product name" field shall identify the submitted performance grade binder and the construction year of the submittal (i.e. "PG 76 -28 (2020)").

- 6.2.2 The Form 595 will serve as the request to CDOT for authorization to ship PG binder as referenced within this Colorado Procedure.
- 6.3 The Supplier shall forward to CDOT the initial testing data for the performance grade binder identified in the Form 595 and a copy of the SDS. The Supplier shall also obtain and provide a split sample for the CDOT Central Laboratory from the first production run of the performance graded binder identified on the Form 595. This will be concurrent with the first shipments of the construction season when the performance graded binder is being made for the first time that season.
- 6.3.1 If the submitted sample required in Subsection 6.3 fails the verification testing and is rejected by CDOT, then the Supplier may submit to CDOT a new test sample with a new CDOT Form 595, updated initial test data, and an SDS. If CDOT rejects this second submittal then the Supplier may resubmit again. However, this third submittal for the same Product name (binder grade for that calendar year) shall include, in addition to all requirements in Subsection 6.3, a test report from an independent AMRL accredited laboratory.
- 6.4 The Supplier shall allow CDOT to visit the production and/or shipping site during normal business hours to perform an audit by observing the Supplier's quality control activities, to inspect the facilities, and to obtain samples for test.
- 6.5 The Supplier shall follow the procedures described in the CDOT approved quality control plan.
- 6.6 The Supplier shall establish a continuing test record for every test required for each PG binder included in the written request as prepared to satisfy the requirements of Subsection 6.1.
- 6.7 The Supplier shall submit to CDOT all reports required by this standard in a format approved by CDOT.
- 6.8 The Supplier shall have a satisfactory record of compliance with CDOT project specifications. Decisions by CDOT concerning this requirement shall be based on the test results furnished by the supplier and satisfactory results when the splits and field tests are compared with supplier tests.

## **7. SUPPLIER QUALITY CONTROL PLAN (MINIMUM REQUIREMENTS)**

- 7.1 The Supplier's Quality Control Plan shall identify the following:
- 7.1.1 Facility type (refinery, terminal, HMA producer).
- 7.1.2 Facility location (actual physical address).
- 7.1.3 Name and telephone number of the person responsible for quality control at the facility.
- 7.1.4 Quality control tests and testing frequency to be performed on each PG binder.
- 7.1.5 Name and location of the laboratory performing quality control tests on the PG binder that is shipped.

- 7.2 The Supplier's Quality Control Plan shall include a declaration stating that if a test result indicates that a shipment of PG binder is not in compliance with the purchase specifications, the Supplier shall:
1. Identify the material in the shipment
  2. Immediately cease the shipment until the material complies with the specification
  3. Immediately notify CDOT regarding the shipment in question
  4. Immediately notify the Contractors scheduled to use the material from the shipment in question
  5. Notify CDOT prior to resuming shipment; and
  6. Implement any mutually agreed upon procedures for the disposition of the material.
- 7.3 The Supplier's quality control plan shall describe method and frequency for initial testing, specification compliance testing, and quality control testing for guiding the manufacturer.
- 7.3.1 **Initial Testing** - For each grade of PG binder to be supplied, specification compliance testing shall be initially performed and the results of that testing provided to CDOT, accompanied by a sample of the material represented by the test results. Specification compliance testing shall confirm that the PG binder conforms to all requirements of Table 702-1 of the Standard Specifications. This will be concurrent with the first shipments of the construction season when the performance grade binder is being made for the first time that season. If, during the course of a construction project, the binder used changes such that future binder supply to a project will come from a different refinery, different terminal, or be a different formulation that could potentially affect mix properties, the Supplier shall notify the Contractor and CDOT Project Engineer in writing at least 5 working days before shipment. If the Supplier is changing terminal location and both locations utilize the same formulation, the Supplier shall notify the Contractor and CDOT Project Engineer prior to use on the project and the one point check per CP 52 may be waived with concurrence from the RME.
- 7.3.2 **Specification Compliance Testing** - Specification compliance testing shall be run on a routine basis and the results submitted to CDOT at a minimum of once per month.
- 7.3.3 **Quality Control Testing for Guiding the Manufacturer** – Tests to determine conformance with Table 702-1 of the Standard Specifications tests shall be conducted as needed for quality control. The Quality Control Plan shall indicate the frequency of this testing. Non-Table 702-1 tests, of the Standard Specifications, may be used for guiding the manufacturer. The use of non-Table 702-1 tests does not preclude the need to meet Table 702-1 requirements or to run complete Table 702-1 tests as indicated in the Quality Control Plan.
- 7.4 The Supplier's quality control plan shall include a statement that the Supplier will prepare and maintain summary reports for all quality control and specification compliance tests performed, and will submit them to CDOT on request.
- 7.5 The Supplier's quality control plan shall provide an outline of the procedure to be followed for checking transport vehicles before loading to prevent contamination of shipments. The outline shall include a statement that the Transport Vehicle Inspection Report, signed by the designated inspector, shall be maintained in the Supplier's records and will be made available to CDOT on request.



- 7.6 If the supplier's facility has the capability of introducing any additives to the binder at the point of load-out, then the QC plan shall outline the procedures to control, monitor, and report on the exact amount of additive. Only CDOT approved additives shall be allowed at load-out.
- 7.7 If the Supplier's facility has acid, alkaline, or recycled engine oil bottom modification equipment in place for producing acid, alkaline, or recycled engine oil bottom modified binders for sale in non-CDOT markets, the Supplier's Quality Control Plan shall include a description of the precautions that will be taken to prevent acid, alkaline, or recycled engine oil bottom modified binders from being inadvertently shipped to CDOT.

## **8. CDOT EVALUATION PROCEDURE**

- 8.1 CDOT will verify that the Supplier's quality control plan is adequate. CDOT may visit the shipping site when required.
- 8.2 CDOT will notify the Supplier whether or not the Supplier's application for Certified Binder Supplier status has been granted. The notification shall include a list of the PG binder(s) covered.
- 8.3 CDOT may verify that the Supplier's specification compliance testing laboratory is currently covered by AASHTO accreditation.
- 8.4 CDOT may verify that the Supplier's specification compliance testing laboratory participates in the WCTG round robin testing program or an equal program.
- 8.5 CDOT may perform split sample testing in accordance with Section 10.
- 8.6 CDOT will perform quality assurance testing.
- 8.7 CDOT may inspect the operations of the Supplier's facility including those related to the PG binder shipments if required.
- 8.8 CDOT will post the Supplier's approved binder type with the associated Supplier's facility name on CDOT's Approved Products List. Reference to the web site is at;  
[www.codot.gov/business/APL/](http://www.codot.gov/business/APL/)

## **9. REQUIREMENTS FOR SHIPPING PG BINDER BY AN APPROVED SUPPLIER**

- 9.1 The Supplier's Quality Control Plan as approved by CDOT (Section 8) shall be implemented.
- 9.2 Each shipment shall be accompanied by two copies of the bill of lading, which shall include:
1. The name and location of the Supplier, as stated in the Supplier's Quality Control Plan  
The performance grade of material.
  2. The quantity of material shipped.
  3. The type and quantity of any approved additive introduced at load-out.
  4. The date of shipment.
  5. A certificate of compliance (COC) certifying the material meets specification requirements.  
The COC statement will certify the material was manufactured and tested in accordance with CDOT's approved Quality Control Plan (Section 7) and, therefore meets State requirements.

6. A statement certifying that the transport vehicle was inspected before loading and was found acceptable for the material shipped. The COC statement will certify the material was manufactured and tested in accordance with the CDOT approved Quality Control Plan (Section 7) and, therefore, meets State requirements.

- 9.3 If the specification compliance test results do not conform to PG binder specifications, the Supplier shall remove the non-compliant material from the shipping queue as per Subsection 7.2.

## **10. SPLIT SAMPLE TESTING**

- 10.1 CDOT may request split sample testing. The test results will be exchanged as soon as they are available.

- 10.2 If the split sample test data is not within the precision specified for that particular test a review of both sampling and testing procedures will be conducted by both the supplier and CDOT. If precision statements are not available, the test results should not differ by more than two standard deviations of the latest available WCTG Round Robin test results for that test.

## **11. REPORT AND DATA SHEETS**

- 11.1 Supplier Reports - The Supplier shall prepare the reports described in Subsections 6.1, 6.2, 6.3, 6.6, 6.7, 7.2, 7.4, 7.5, 9.2, and 9.3.

## **12. DECERTIFICATION**

- 12.1 Certification may be withdrawn from suppliers when one or more of the following additional conditions exist:

- 12.1.1 Acid, alkaline, or recycled engine oil bottom modification are discovered in the binder.

## **13. FIELD QUALITY CONTROL OF PERFORMANCE GRADED ASPHALT BINDER(S)**

- 13.1 The field quality control of the binder shall be the responsibility of the Contractor. Prior to accepting deliveries of binder, the Contractor shall submit a Field Quality Control (FQC) Plan for binder addressing all key elements as listed in Section 14. This FQC Plan will be included within the Contractor's quality control plan for asphalt concrete. The FQC Plan shall be submitted at least 10 days prior to commencing paving operations. The purpose of the FQC Plan is to describe proper handling techniques for the binder to maintain specification conformance of binder properties during transportation, storage, and production operations. The Engineer will review the FQC Plan, and paving operations will not begin until the FQC Plan has been approved in writing.

- 13.2 The contents of the binder FQC Plan shall be project specific and shall be kept current to the production and mixture operations employed at any time. Prior to executing any change to binder handling, the FQC Plan shall be revised to incorporate the change. Engineer approval of the revised FQC Plan, in writing, will be required before the change is made to binder handling. Failure to keep the FQC Plan current may affect subsequent decisions by the Engineer, such as those made to address correction of failed material.

- 13.3 The Contractor shall confirm and document that the Supplier that manufactures the binder and the specific binder is on CDOT's Approved Products List as referenced in Subsection 8.8.
- 13.4 The Contractor shall indicate, in writing, what steps will be taken to ensure that the FQC Plan is followed and what action will be taken to correct the situation if it is found that the plan is not being followed.
- 14. MINIMUM REQUIREMENTS FOR THE CONTRACTOR'S BINDER FIELD QUALITY CONTROL PLAN**
- 14.1 The FQC Plan shall identify all subcontractors responsible for handling the binder. This will include the firm hauling the binder unless that firm is the binder supplier or is employed by the binder supplier.
- 14.2 The responsibilities of each party having a role in executing the FQC Plan shall be identified.
- 14.3 The FQC Plan shall describe how changes in grade or supplier of the binder, used in the paving mix, will be implemented. The change must not result in mixing of different binders. If mixing does occur, the mixed binder shall not be incorporated into the paving mix placed on the project. The Contractor shall inform the Engineer in advance of any change in grade or supplier of the binder.
- 14.4 The anticipated mode of binder delivery shall be described. The process of tank inspection, prior to initial filling, will be described. The tanks on the project site must be completely empty and free of contaminants to avoid contamination of the binder delivered to the project.
- 14.5 Any special handling or storage requirements of the binder shall be fully described. These shall comply with the manufacturer's recommendations for that grade of binder. The FQC Plan shall conform to these special requirements.
- 14.6 As detailed by the binder supplier, based on the type of asphalt used to produce the specific grade (i.e. Blended asphalt, Modified asphalt, etc.), any potential limitations of the binder relative to prolonged storage, exposure to prolonged and/or elevated heating, susceptibility to stratification and/or separation, etc. shall be fully described. The Contractor's FQC Plan shall describe how these limitations of the binder shall be addressed.
- 14.7 If agitation is used in binder storage tanks, the capacity and methods of agitation within the storage tank(s) shall be described.
- 14.8 Provisions to avoid damage to binder during the suspension of paving operations shall be described. These provisions will detail limits to storage times and corresponding temperature limits.
- 14.9 The binder rotation FQC Plan shall be described. (i.e. First-in / First-out basis).
- 14.10 Any on-site sampling and testing shall be described with respect to sampling location, tests to be conducted, and control limits for test results. On-site sampling methods and facilities shall be fully described. It is a good practice for the Contractor to obtain and retain samples of binder when delivered to the project. These samples can be tested if binder problems occur. These test results can help isolate the cause of problems with binder properties. Binder performance test requirements are contained in Table 702-1 of the Standard Specifications.

- 14.11 The FQC Plan shall describe methods for identifying the binder contained in each storage tank. Clear and consistent labeling of each tank shall be included in these methods.
- 14.12 The binder temperatures in the tanks shall be routinely monitored, at a minimum of once per day. Procedures and equipment for this monitoring shall be described. Results of this monitoring shall be made available to the Engineer upon request.

### CP 11, Asphalt Binder Supplier Certification Checklist - 2020

Supplier Name: \_\_\_\_\_ Date: \_\_\_\_\_  
 Refinery Name: \_\_\_\_\_ Refinery Location: \_\_\_\_\_  
 Supplier Lab: \_\_\_\_\_ Supplier Lab Location: \_\_\_\_\_  
 PG Binder: \_\_\_\_\_

Yes / No

Subsection

- 5.1 Does supplier's lab have current AMRL accreditation? .....
- 5.2 Do the labs performing routine QC testing participate in WCTG Round Robin testing or equal? .....
- 6.1 QC Plan submitted to CDOT?.....
- 6.2 Completed CDOT Form #595 sent to CDOT as an e-mail attachment? .....
- 6.3 Initial test data supplied? .....
- 6.3 MSDS supplied? .....
- 6.3 Split sample provided to CDOT once per construction season? .....

**SUPPLIER QC PLAN:**

Subsection

- 7.1.1 Facility type listed? .....
- 7.1.2 Facility location listed? .....
- 7.1.3 Name of person responsible for QC at the facility listed?.....
- 7.1.4 List of QC tests and frequency to be used on PG binder? .....
- 7.1.5 Name & location of lab performing these tests listed? .....
- 7.2 Does Plan state that, if a shipment is not within specification, the supplier shall:
  - (1) Identify the material in the shipment?.....
  - (2) Immediately cease shipment until material complies with the specification? .....
  - (3) Immediately notify CDOT regarding the shipment in question? .....
  - (4) Immediately notify the Contractors scheduled to use the material from the shipment in question? .....
  - (5) Notify CDOT prior to resuming shipment? .....
  - (6) Implement any mutually agreed upon procedures for the disposition of the material? .....
- 7.3 Does plan describe the method and frequency for initial testing, QC testing, and specification compliance testing? .....
- 7.3.1 Results of specification compliance testing supplied to CDOT along with a sample? .....
- 7.3.1 Results confirm that the PG binder conforms to Table 702-1?.....
- 7.3.2 Plan states that specification compliance testing is performed routinely and results submitted to CDOT monthly? .....
- 7.3.3 Plan indicates frequency of testing to determine conformance with Table 702-1? .....
- 7.4 Plan states that supplier will maintain summary reports for all QC & Spec Compliance tests performed, and will submit to CDOT upon request? .....

[Continued on the next page.]

Yes / No

Subsection

- 7.5 Plan contains an outline of the procedure for checking transport vehicles before loading to prevent contamination? ..... \_\_\_\_\_
- 7.5.1 Outline includes statement that the transport vehicle inspection report, signed by the designated inspector, shall be maintained in the supplier's records, and will be made available to CDOT upon request? ..... \_\_\_\_\_
- 7.6 If the Supplier has equipment in place for acid, alkaline, or recycled engine oil bottom modification of binder, are precautions described that will be taken to prevent acid, alkaline, or recycled engine oil bottom modified binders from being shipped to CDOT?..... \_\_\_\_\_

### CP 11, Asphalt Contractor Field Quality Control Checklist - 2020

Contractor Name: \_\_\_\_\_ Date: \_\_\_\_\_  
 Contract ID: \_\_\_\_\_  
 Project Number: \_\_\_\_\_  
 Project Location: \_\_\_\_\_

#### FIELD QUALITY CONTROL OF PERFORMANCE GRADED ASPHALT BINDER (S)

Yes / No

Subsection

- 13.1 Was the Contractor's Field Quality Control (FQC) Plan submitted 10 days prior to paving? .....
- 13.2 Is the binder FQC plan specific to this Project? .....
- 13.2 Does the binder FQC plan apply to current binder handling? .....

#### Does the Contractor's Binder Field Quality Control Plan Address the Following:

Subsection

- 14.1 List of the subcontractors handling the binder? .....
- 14.2 Responsibilities of the parties executing the binder FQC Plan? .....
- 14.3 How grade changes will be handled? .....
- 14.4 Delivery mode and tank inspection before filling? .....
- 14.5 Special handling and suppliers recommended handling? .....
- 14.6 Limitations on the type of binder with respect to handling? .....
- 14.7 Method of agitating binder in the tank (if any)? .....
- 14.8 Binder handling during paving delays? .....
- 14.9 Binder rotation plan (i.e. First-in / First-out)? .....
- 14.10 On-site sampling plan (if any)? .....
- 14.11 Binder identification plan (tank labeling)? .....
- 14.12 Binder temperature monitoring (minimum once per day)? .....

{Page Intentionally Left Blank}



## **Asphalt Emulsion - 21** **(Certifying Suppliers and Contractors)**

### **1. REFERENCED DOCUMENTS**

- 1.1 CDOT Standard Specifications:  
Section 702, Bituminous Materials  
Table 702-2 to Table 702-7
- 1.2 AASHTO Standards:  
T 40 Method of Sampling Bituminous Materials  
AASHTO Accreditation Program (AAP)
- 1.3 ASTM Standards:  
D 8 Definitions of Terms Relating to Materials for Roads and Pavements

### **2. TERMINOLOGY**

- 2.1 Emulsion – A binder that is emulsified with water in a colloid mill.
- 2.2 Supplier - A Supplier shall be defined as one who produces the final product or who makes the blend or modification that alters the properties of the emulsion specified in Section 702 of the Standard Specifications and/or other appropriate CDOT specifications. A Supplier shall be a refinery, a terminal, or an emulsion producer. If no modification is made to the emulsion after its initial production at the refinery, the refinery shall be the supplier and must provide certification. If there is any modification of the emulsion at the terminal, the terminal becomes the supplier and must provide the certification. No emulsion will be produced or blended to specification at the hot mix asphalt (HMA) plant.
- 2.3 Refinery Facility - A facility that is a producer of petroleum asphalts by refining the residuum from crude petroleum. The three types of petroleum asphalts refined are; Asphalt Cements, Emulsion Asphalts, Cutback Asphalts.
- 2.4 Terminal Facility - A facility that can receive, store and distribute petroleum asphalts. May have the ability to modify petroleum asphalts.
- 2.5 Storage Facility- A facility that can receive, store and distribute petroleum asphalts. The facility does not have the ability to modify the petroleum asphalt.
- 2.6 Contractor - The Company, who places the emulsion on the project under contract with CDOT.

### **3. SIGNIFICANCE AND USE**

- 3.1 This standard specifies requirements and procedures for a certification system that shall be applicable to all suppliers and contractors providing asphalt emulsions. The requirements and procedures shall apply to materials that meet the requirements of CDOT specifications for emulsions. These provisions initially apply to the refinery manufacturing the emulsion and or to the terminals where emulsions are modified. These provisions subsequently apply to the Contractor, after delivery of the emulsion to the Contractor, for use on CDOT projects.
- 3.2 This standard specifies procedures intended to minimize disruption of emulsion shipments. This is accomplished by a certification system that evaluates quality control and specification compliance tests performed by the Supplier and the Contractor according to their quality control plans.

### **4. SAMPLING**

- 4.1 All test samples required by this standard shall be obtained in accordance with AASHTO T 40. A supplier may propose an alternate method of sampling that will ensure the sampling of a non-segregated product.

### **5. TESTING REQUIREMENTS**

- 5.1 All certification testing required for this standard shall be performed by a laboratory currently covered by AMRL accreditation. Any satellite laboratory of a Supplier that performs required testing under this standard will be identified in the submitted Supplier Quality Control Plan (Section 7) and shall be approved by CDOT.

### **6. SUPPLIER CERTIFICATION REQUIREMENTS**

- 6.1 The Supplier shall submit to CDOT for approval a complete Quality Control Plan that complies with the requirements of Section 7. If the Quality Control Plan is rejected, the Supplier may modify the plan based on the critique provided and then resubmit it to CDOT for approval.
- 6.2 Once the Supplier's Quality Control Plan is approved by CDOT, the Supplier shall submit to the CDOT Product Evaluation Coordinator a completed copy of CDOT Form 595 (Pre-Approved Product Evaluation Request & Summary) for each emulsion. The Form 595 can be located within Notice to Manufacturers at: <https://www.codot.gov/business/apl> The Form 595 is designed as a PDF Writeable form, which must be completed by the Supplier. The completed form shall be returned to CDOT's Product Evaluation Coordinator as an e-mail attachment.
- 6.2.1 The Form 595 "Product name" field shall identify the submitted emulsion and the construction year of the submittal (i.e. "CRS-2P (2018)").
- 6.2.2 The Form 595 will serve as the request to CDOT for authorization to ship emulsion as referenced within this Colorado Procedure.

- 6.3 The Supplier shall forward to CDOT the initial testing data for the emulsion identified on the Form 595 and a copy of the SDS. The Supplier shall also obtain and provide a split sample for the CDOT Central Laboratory from the first production run of the emulsion identified on the Form 595. This will be concurrent with the first shipments of the construction season when the emulsion is being made for the first time that season.
- 6.3.1 If the submitted sample required in Subsection 6.3 fails the verification testing and is rejected by CDOT, then the Supplier may submit to CDOT a new test sample with a new CDOT Form 595, updated initial test data, and an SDS. If CDOT rejects this second submittal then the Supplier may resubmit again. However, this third submittal for the same Product name (emulsion type for that calendar year) shall include, in addition to all requirements in Subsection 6.3, a test report from an independent AMRL accredited laboratory.
- 6.4 The Supplier shall allow CDOT to visit the production and/or shipping site during normal business hours to perform an audit by observing the Supplier's quality control activities, to inspect the facilities, and to obtain samples for test.
- 6.5 The Supplier shall follow the procedures described in the CDOT approved quality control plan.
- 6.6 The Supplier shall establish a continuing test record for every test required for each emulsion included in the written request as prepared to satisfy the requirements of Subsection 6.1.
- 6.7 The Supplier shall submit to CDOT all reports required by this standard in a format approved by CDOT.
- 6.8 The Supplier shall have a satisfactory record of compliance with CDOT project specifications. Decisions by CDOT concerning this requirement shall be based on the test results furnished by the supplier and satisfactory results when the splits and field tests are compared with supplier tests.
- 7. SUPPLIER QUALITY CONTROL PLAN (MINIMUM REQUIREMENTS)**
- 7.1 The Supplier's Quality Control Plan shall identify the following:
- 7.1.1 Facility type (refinery, terminal).
- 7.1.2 Facility location (actual physical address).
- 7.1.3 Name and telephone number of the person responsible for quality control at the facility.
- 7.1.4 Quality control tests and testing frequency to be performed on each type of emulsion.
- 7.1.5 Name and location of the laboratory performing quality control tests on the emulsion that is shipped.

- 7.2 The Supplier's Quality Control Plan shall include a declaration stating that if a test result indicates that a shipment of emulsion is not in compliance with the purchase specifications, the Supplier shall:
1. Identify the material in the shipment
  2. Immediately cease the shipment until the material complies with the specification
  3. Immediately notify CDOT regarding the shipment in question
  4. Immediately notify the Contractors scheduled to use the material from the shipment in question
  5. Notify CDOT prior to resuming shipment
  6. Implement any mutually agreed upon procedures for the disposition of the material
- 7.3 The Supplier's quality control plan shall describe method and frequency for initial testing, specification compliance testing, and quality control testing for guiding the manufacturer.
- 7.3.1 **Initial Testing** - For each type of emulsion to be supplied, specification compliance testing shall be initially performed and the results of that testing provided to CDOT, accompanied by a sample of the material represented by the test results. Specification compliance testing shall confirm that the emulsion conforms to all requirements of Section 702 of the Standard Specifications. This will be concurrent with the first shipments of the construction season when the emulsion is being made for the first time that season.
- 7.3.2 **Specification Compliance Testing** - Specification compliance testing shall be run on a routine basis and the results submitted to CDOT at a minimum of once per month.
- 7.3.3 **Quality Control Testing for Guiding the Manufacturer** – Tests to determine conformance with Section 702 of the Standard Specifications tests shall be conducted as needed for quality control. The Quality Control Plan shall indicate the frequency of this testing. Non-Section 702 tests, of the Standard Specifications, may be used for guiding the manufacturer. The use of non-Section 702 tests does not preclude the need to meet Section 702 requirements or to run complete Section 702 tests as indicated in the Quality Control Plan.
- 7.4 The Supplier's quality control plan shall include a statement that the Supplier will prepare and maintain summary reports for all quality control and specification compliance tests performed, and will submit them to CDOT on request.
- 7.5 The Supplier's quality control plan shall provide an outline of the procedure to be followed for checking transport vehicles before loading to prevent contamination of shipments. The outline shall include a statement that the Transport Vehicle Inspection Report, signed by the designated inspector, shall be maintained in the Supplier's records and will be made available to CDOT on request.

**8. CDOT EVALUATION PROCEDURE**

- 8.1 CDOT will verify that the Supplier's quality control plan is adequate. CDOT may visit the shipping site when required.
- 8.2 CDOT will notify the Supplier whether or not the Supplier's application for Certified Emulsion Supplier status has been granted. The notification shall include a list of the types of emulsions covered.
- 8.3 CDOT may verify that the Supplier's specification compliance testing laboratory is currently covered by AASHTO accreditation.
- 8.4 CDOT may verify that the Supplier's specification compliance testing laboratory participates in a round robin testing program.
- 8.5 CDOT may perform split sample testing in accordance with Section 10.
- 8.6 CDOT will perform quality assurance testing.
- 8.7 CDOT may inspect the operations of the Supplier's facility including those related to the emulsion shipments if required.
- 8.8 CDOT will post the Supplier's approved emulsion type with the associated Supplier's facility name on CDOT's Approved Products List. Reference to the web site is at <https://www.codot.gov/business/apl>.

**9. REQUIREMENTS FOR SHIPPING EMULSIONS BY AN APPROVED SUPPLIER**

- 9.1 The Supplier's Quality Control Plan as approved by CDOT (Section 8) shall be implemented.
- 9.2 Each shipment shall be accompanied by two copies of the bill of lading, which shall include:
  - 1. The name and location of the Supplier, as stated in the Supplier's Quality Control Plan.
  - 2. The type of emulsion.
  - 3. The quantity of material shipped.
  - 4. The date of shipment
  - 5. A certificate of compliance (COC) certifying the material meets specification requirements. The COC statement will certify the material was manufactured and tested in accordance with the CDOT approved Quality Control Plan (Section 7) and, therefore, meets state requirements (example in Chapter 400).
  - 6. A statement certifying that the transport vehicle was inspected before loading and was found acceptable for the material shipped. The COC statement will certify the material was manufactured and tested in accordance with CDOT's approved Quality Control Plan (Section 7) and, therefore, meets state requirements.
- 9.3 If the specification compliance test results do not conform to emulsion specifications, the Supplier shall remove the non-compliant material from the shipping queue as outlined in Subsection 7.2.

**10. SPLIT SAMPLE TESTING**

- 10.1 CDOT may request split sample testing. The test results will be exchanged as soon as they are available.
- 10.2 If the split sample test data is not within the precision specified for that particular test a review of both sampling and testing procedures will be conducted by both the supplier and CDOT.

**11. REPORT AND DATA SHEETS**

- 11.1 Supplier Reports - The Supplier shall prepare the reports described in Subsections 6.1, 6.2, 6.3, 6.6, 6.7, 7.2, 7.4, 7.5, 9.2, and 9.3.

**12. RECERTIFICATION**

- 12.1 If a supplier has been decertified and seeks to be recertified, the supplier must fulfill the requirements for certification, as per Section 6.

**13. FIELD QUALITY CONTROL OF EMULSION(S)**

- 13.1 The field quality control of the emulsion shall be the responsibility of the Contractor. Prior to accepting deliveries of emulsion, the contractor shall submit a Field Quality Control (FQC) Plan for emulsion addressing all key elements as listed in Section 14. This FQC Plan will be included within the Contractor's quality control plan for asphalt concrete. The FQC Plan shall be submitted at least 10 days prior to commencing paving operations. The purpose of the FQC Plan is to describe proper handling techniques for the emulsion to maintain specification conformance of emulsion properties during transportation, storage, and production operations. The Engineer will review the FQC Plan, and the paving operations will not begin until the FQC Plan has been approved in writing.
- 13.2 The contents of the emulsion FQC Plan shall be project specific and shall be kept current to the production and mixture operations employed at any time. Prior to executing any change to emulsion handling, the FQC Plan shall be revised to incorporate the change. Engineer approval of the revised FQC Plan, in writing, will be required before the change is made to emulsion handling. Failure to keep the FQC Plan current may affect subsequent decisions by the Engineer, such as those made to address a correction of failed material.
- 13.3 The Contractor shall confirm and document that the Supplier that manufactures the emulsion and the specific emulsion is on CDOT's Approved Products List as referenced in Subsection 8.8.
- 13.4 The Contractor shall indicate, in writing, what steps will be taken to ensure that the FQC Plan is followed and what action will be taken to correct the situation if it is found that the plan is not being followed.

**14. MINIMUM REQUIREMENTS FOR THE CONTRACTOR'S EMULSION FIELD QUALITY CONTROL PLAN**

- 14.1 The FQC Plan shall identify all subcontractors responsible for handling the emulsion. This will include the firm hauling the emulsion unless that firm is the emulsion supplier or is employed by the emulsion supplier.
- 14.2 The responsibilities of each party having a role in executing the FQC Plan shall be identified.
- 14.3 The FQC Plan shall describe how changes in type or supplier of the emulsion, used on the paving job, will be implemented. The change must not result in mixing of different emulsions. If mixing does occur, the mixed emulsion shall not be incorporated in the project. The Contractor shall inform the Engineer in advance of any change in type or supplier of the emulsion.
- 14.4 The anticipated mode of emulsion delivery shall be described. The process of tank inspection, prior to initial filling, will be described. The tanks on the project site must be completely empty and free of contaminants to avoid contamination of the emulsion delivered to the project.
- 14.5 Any special handling or storage requirements of the emulsion shall be fully described. These shall comply with the manufacturer's recommendations for that type of emulsion. The FQC Plan shall conform to these special requirements.
- 14.6 As detailed by the emulsion supplier, based on the type of materials used to produce the specific emulsion, any potential limitations of the emulsion relative to prolonged storage, exposure to prolonged and/or elevated heating, susceptibility to stratification and/or separation, etc. shall be fully described. The Contractor's FQC Plan shall describe how these limitations of the emulsion shall be addressed.
- 14.7 If agitation is used in emulsion storage tanks, the capacity and methods of agitation within the storage tank(s) shall be described.
- 14.8 Provisions to avoid damage to emulsion during the suspension of paving operations shall be described. These provisions will detail limits to the storage times and corresponding temperature limits.
- 14.9 The emulsion rotation FQC Plan shall be described. (First-in / First-out basis, for example).
- 14.10 Any on-site sampling and testing shall be described with respect to sampling location, tests to be conducted, and control limits for test results. On-site sampling methods and facilities shall be fully described. It is a good practice for the Contractor to obtain and retain samples of emulsion when delivered to the project. These samples can be tested if emulsion problems occur. These test results can help isolate the cause of emulsion problems. Emulsion performance test requirements are contained in Section 702 of the Standard Specifications.
- 14.11 The FQC Plan shall describe methods for identifying the emulsion contained in each storage tank. Clear and consistent labeling of each tank shall be included in these methods.
- 14.12 The emulsion temperatures in the tanks shall be routinely monitored, at a minimum of once per day. Procedures and equipment for this monitoring shall be described. Results of this monitoring shall be made available to the Engineer upon request.

### CP 11, Asphalt Emulsion Supplier Certification Checklist - 2020

Supplier Name: \_\_\_\_\_ Date: \_\_\_\_\_  
 Supplier Lab: \_\_\_\_\_ Supplier Location: \_\_\_\_\_  
 Emulsion Type: \_\_\_\_\_ Supplier Lab Location: \_\_\_\_\_

Yes/ No

Subsection

- 5.1 Does supplier's lab have current AMRL accreditation? ..... \_\_\_\_\_
- 6.1 QC plan submitted to CDOT? ..... \_\_\_\_\_
- 6.2 Completed CDOT Form 595 sent to CDOT as an e-mail attachment? ..... \_\_\_\_\_
- 6.3 Initial test data supplied? ..... \_\_\_\_\_
- 6.3 MSDS supplied? ..... \_\_\_\_\_
- 6.3 Split sample provided to CDOT once per construction season? ..... \_\_\_\_\_

**SUPPLIER QC PLAN:**

Subsection

- 7.1.1 Facility type listed? ..... \_\_\_\_\_
- 7.1.2 Facility location listed? ..... \_\_\_\_\_
- 7.1.3 Name of person responsible for QC at the facility is listed? ..... \_\_\_\_\_
- 7.1.4 List of QC tests & frequency to be used on emulsion? ..... \_\_\_\_\_
- 7.1.5 Name & location of lab performing these tests is listed? ..... \_\_\_\_\_
- 7.2 Does Plan state that, if a shipment is not within specification, the supplier shall:
  - (1) Identify the material in the shipment? ..... \_\_\_\_\_
  - (2) Immediately cease shipment until material complies with the specification? ..... \_\_\_\_\_
  - (3) Immediately notify CDOT regarding the shipment in question? ..... \_\_\_\_\_
  - (4) Immediately notify the Contractors scheduled to use the material from the shipment in question? ..... \_\_\_\_\_
  - (5) Notify CDOT prior to resuming shipment? ..... \_\_\_\_\_
  - (6) Implement any mutually agreed upon procedures for the disposition of the material? ..... \_\_\_\_\_
- 7.3 Does plan describe the method and frequency for initial testing, QC testing, and specification compliance testing? ..... \_\_\_\_\_
- 7.3.1 Results of specification compliance testing supplied to CDOT along with a sample? ..... \_\_\_\_\_
- 7.3.1 Results confirm that the Emulsion conforms to Section 702? ..... \_\_\_\_\_
- 7.3.2 Plan states that specification compliance testing is performed routinely and results are submitted to CDOT monthly? ..... \_\_\_\_\_
- 7.3.3 Plan indicates frequency of testing to determine conformance with Section 702? ..... \_\_\_\_\_
- 7.4 Plan states that supplier will maintain summary reports for all QC and Spec Compliance tests performed, and will submit to CDOT upon request? ..... \_\_\_\_\_
- 7.5 Plan contains an outline of the procedure for checking transport vehicles before loading to prevent contamination? ..... \_\_\_\_\_
- 7.5.1 Outline includes statement that the transport vehicle inspection report, signed by the designated inspector, shall be maintained in the supplier's records, and will be made available to CDOT upon request? ..... \_\_\_\_\_



### CP 11, Asphalt Contractor Field Quality Control Checklist - 2020

Contractor Name: \_\_\_\_\_

Date: \_\_\_\_\_

Contract ID: \_\_\_\_\_

Project Number: \_\_\_\_\_

Project Location: \_\_\_\_\_

#### FIELD QUALITY CONTROL OF EMULSION(S)

Yes/ No

Subsection

- 13.1 Was the Contractor’s Field Quality Control (FQC) Plan submitted 10 days prior to paving? ..... \_\_\_\_\_
- 13.2 Is the emulsion FQC plan specific to this Project? ..... \_\_\_\_\_
- 13.2 Does the emulsion FQC plan apply to current emulsion handling?..... \_\_\_\_\_

#### Does the Contractor’s Emulsion Field Quality Control Plan Address the Following:

Subsection

- 14.1 List of the subcontractors handling the emulsion?..... \_\_\_\_\_
- 14.2 Responsibilities of the parties executing the emulsion FQC Plan? ..... \_\_\_\_\_
- 14.3 How emulsion type changes will be handled? ..... \_\_\_\_\_
- 14.4 Delivery mode and tank inspection before filling? ..... \_\_\_\_\_
- 14.5 Special handling and suppliers recommended handling? ..... \_\_\_\_\_
- 14.6 Limitations on the type of emulsion with respect to handling?..... \_\_\_\_\_
- 14.7 Method of agitating emulsion in the tank (if any)? ..... \_\_\_\_\_
- 14.8 Emulsion handling during paving delays?..... \_\_\_\_\_
- 14.9 Emulsion rotation plan (i.e. First-in / First-out)?..... \_\_\_\_\_
- 14.10 On-site sampling plan (if any)? ..... \_\_\_\_\_
- 14.11 Emulsion identification plan (tank labeling)?..... \_\_\_\_\_
- 14.12 Emulsion temperature monitoring (minimum once per day)? ..... \_\_\_\_\_

{Page Intentionally Left Blank}

## Hydraulic Cement – 21

### 1. REFERENCED DOCUMENTS

#### 1.1 ASTM Standards:

ASTM C 150 Standard Specification for Portland Cement

ASTM C 183 Standard Practice for Sampling and the Amount of Testing of Hydraulic Cement

ASTM C 219 Standard Terminology Relating to Hydraulic Cement

ASTM C 595 Standard Specification for Blended Hydraulic Cement

ASTM C 1157 Standard Performance Specification for Hydraulic Cement

### 2. TERMINOLOGY

2.1 See ASTM C 219 Standard Terminology Relating to Hydraulic Cement.

2.2 Supplier – In this Standard, a *Cement Supplier* shall be defined as one who manufactures hydraulic cement.

2.3 Supplier – In this Standard, a *Concrete Supplier* shall be defined as one who manufactures concrete mix. Among the ingredients of a concrete mix is hydraulic cement.

2.4 Contractor – The Company under contract with CDOT to produce products using hydrated cement.

### 3. SIGNIFICANCE AND USE

3.1 This Standard specifies requirements and procedures for a certification system that shall apply to all Cement Suppliers providing hydraulic cement. These provisions apply to the plant manufacturing the hydraulic cement. These provisions apply to the Contractor, after delivery of the hydraulic cement, for use on CDOT projects.

3.2 This Standard specifies procedures intended to minimize the disruption of hydraulic cement shipments. This is accomplished by a certification system that evaluates quality control and specification compliance tests performed by the Cement Supplier according to their quality control plans.

### 4. SAMPLING

4.1 All test samples shall be obtained per ASTM C 183. The use of a random sampling procedure is mandatory for the establishment of a valid quality assurance program.

## 5. TESTING REQUIREMENTS

- 5.1 Testing shall be performed by a laboratory currently accredited by the Cement and Concrete Reference Laboratory (CCRL). Any satellite laboratory of a Cement Supplier that performs required testing under this Standard shall be identified in the submitted Quality Control Plan (Section 7).

## 6. SUPPLIER CERTIFICATION REQUIREMENTS

- 6.1 Cement Suppliers shall submit to the CDOT Product Evaluation Coordinator (PEC), CDOT Form 595, Pre-Approved Product Evaluation Request & Summary for each type of hydraulic cement intended for use on CDOT projects. Instructions for completing and submitting the CDOT Form 595 can be located within the Notice to Manufacturers at <https://www.codot.gov/business/apl>
- 6.2 In addition to completing CDOT Form 595, the following shall be supplied to the PEC:
- 6.2.1 A brief outline of the procedures used to evaluate the finished product including sampling and testing frequency and the sample preparation employed, including chemical analysis methods used such as X-ray, atomic absorption spectroscopy, and/or wet chemistry.
- 6.2.2 The results of all applicable chemical and/or physical tests required by ASTM C 150, C 595, or C 1157 on the most recent 40 samples (20 pairs) tested. The results shall be submitted in the format outlined in ASTM C 183, in particular the table entitled "Test Data" with the critical limits calculated as described.
- 6.2.3 A copy of the CCRL certification for the laboratory performing testing.
- 6.2.4 A copy of the Cement Supplier's Quality Control Plan, which complies with the requirements of Section 7, if one has not been supplied to CDOT for previously submitted products.
- 6.3 A sample of the proposed hydraulic cement shall be shipped to the PEC at the Materials and Geotechnical Branch, 4670 North Holly Street, Unit A, Denver, Colorado 80216-6408.
- 6.4 The Cement Supplier shall allow CDOT to visit the production and/or shipping site during normal business hours to observe the Cement Supplier's quality control activities, to inspect the facilities, and to obtain samples for tests.
- 6.5 The Cement Supplier shall follow the procedures described in the CDOT approved quality control plan.
- 6.6 The Cement Supplier shall establish a continuing test record for every test required and for each type of hydraulic cement included in the written request as prepared to satisfy the requirements of Subsection 6.1.
- 6.7 The Cement Supplier shall submit to CDOT all reports required by this standard in a format approved by CDOT.

6.8 The Cement Supplier shall have a satisfactory record of compliance with CDOT project specifications. Decisions by CDOT concerning this requirement shall be based on the test results furnished by the Cement Supplier's tests.

## 7. SUPPLIER QUALITY CONTROL PLAN (MINIMUM REQUIREMENTS)

7.1 The Cement Supplier's Quality Control Plan shall identify the following:

7.1.1 Facility location (actual physical address).

7.1.2 Name and telephone number of a person at each production facility, responsible for quality control of the material shipped to CDOT projects.

7.1.3 Quality control tests and testing frequency to be performed on each hydraulic cement.

7.1.4 Name and location of the laboratory performing quality control tests on the hydraulic cement.

7.2 The Cement Supplier's Quality Control Plan shall include a declaration stating that if a test result indicates that a shipment of hydraulic cement does not comply with the purchase specifications, the Cement Supplier shall:

7.2.1 Identify the material in the shipment,

7.2.2 Immediately cease the shipment until the material complies with the specification,

7.2.3 Immediately notify CDOT regarding the shipment in question,

7.2.4 Immediately notify the Contractors and Concrete Suppliers scheduled to use the material from the shipment in question, notify CDOT before resuming shipment; and implement any mutually agreed-upon procedures for the disposition of the material.

7.3 The Cement Supplier's Quality Control Plan shall describe method and frequency for initial testing and quality control testing.

7.3.1 **Initial Testing** - For each type of hydraulic cement to be supplied, testing shall be performed and the results provided to CDOT, accompanied by a sample of the material represented by the test results.

7.3.2 **Quality Control Testing** – Tests to determine conformance with applicable ASTM standards shall be conducted as needed for quality control. The Cement Supplier's Quality Control Plan shall indicate the frequency of this testing.

7.4 The Cement Supplier's Quality Control Plan shall include a statement that the Cement Supplier will prepare and maintain summary reports for all quality control tests performed, and will submit them to CDOT on request.

7.5 The Cement Supplier's Quality Control Plan shall provide an outline of the procedure to be followed for checking transport vehicles before loading to prevent contamination of shipments. The outline shall be maintained in the Cement Supplier's records and will be made available to CDOT on request.

**8. CDOT EVALUATION PROCEDURE**

- 8.1 CDOT will verify that the Cement Supplier's Quality Control Plan is adequate. CDOT may visit the shipping site when required.
- 8.2 CDOT will notify the Cement Supplier whether or not the Cement Supplier's application has been granted.
- 8.3 CDOT may verify that the Cement Supplier's testing laboratory is currently CCRL accredited.
- 8.4 CDOT may perform split sample testing per Section 10.
- 8.5 CDOT may sample and perform testing on random samples.
- 8.6 CDOT may inspect the operations of the Cement Supplier's facility, including those related to shipments if required.
- 8.7 Products approved for use will be posted on the CDOT APL.

**9. REQUIREMENTS FOR SHIPPING HYDRAULIC CEMENT BY AN APPROVED SUPPLIER**

- 9.1 The Cement Supplier's Quality Control Plan as approved by CDOT (Section 7) shall be implemented.
- 9.2 Each shipment shall be accompanied by two copies of the bill of lading, which shall include:
  - 9.2.1 The name and location of the Cement Supplier,
  - 9.2.2 The Type of hydraulic cement shipped,
  - 9.2.3 The quantity of material shipped,
  - 9.2.4 The date of shipment,
  - 9.2.5 A certificate of compliance (COC) certifying that the material meets specification requirements
  - 9.2.6 A statement certifying that the transport vehicle was inspected before loading, and was found acceptable for the material shipped.
- 9.3 If the test results do not conform to the applicable ASTM standards, the Cement Supplier shall remove the non-compliant material from the shipping queue as outlined in Subsection 7.2.

**10. SPLIT SAMPLE TESTING**

- 10.1 CDOT may request split sample testing. The test results will be exchanged as soon as they are available.
- 10.2 If the split sample test data is not within the precision specified for that particular test a review of both sampling and testing procedures will be conducted by both the Cement Supplier and CDOT.

**11. REPORT AND DATA SHEETS**

- 11.1 Cement Supplier Reports - The Cement Supplier shall prepare the reports described in Subsections 6.1, 6.2, 9.2, and 9.3.

{Page Intentionally Left Blank}



Part I, Sub-Part 4:

## Fly Ash - 21

### 1. REFERENCED DOCUMENTS

#### 1.1 ASTM Standards:

ASTM C 219 Standard Terminology Relating to Hydraulic Cement

ASTM C 311 Standard Test Methods for Sampling and Testing Fly Ash or Natural Pozzolans for Use in Portland Cement Concrete.

ASTM C 618 Standard Specification for Coal Fly Ash and Raw or Calcined Natural Pozzolan for Use in Concrete.

### 2. TERMINOLOGY

2.1 See ASTM C 219 Standard Terminology Relating to Hydraulic Cement.

2.2 Supplier, Fly Ash – In this Standard, a *Fly Ash Supplier* shall be defined as one who provides fly ash for use on CDOT projects.

2.3 Supplier, Concrete – In this Standard, a *Concrete Supplier* shall be defined as one who manufactures concrete mix. Fly ash may be among the ingredients of a concrete mix.

2.4 Contractor – The Company under contract with CDOT to produce products using fly ash.

### 3. SIGNIFICANCE AND USE

3.1 This Standard specifies procedures intended to minimize disruption of fly ash shipments. This is accomplished by a certification system that evaluates quality control and specification compliance tests performed by the Fly Ash Supplier according to their quality control plans.

3.2 This Standard specifies requirements and procedures for a certification system that shall be applicable to all fly ash suppliers providing fly ash. The requirements and procedures shall apply to, materials that meet the requirements of CDOT specifications for fly ash. These provisions apply to the plant producing the fly ash. These provisions apply to the Contractor, after delivery of the concrete mix to the Contractor, for use on CDOT projects.

### 4. SAMPLING

4.1 All test samples shall be obtained in accordance with ASTM C 311. The use of a random sampling procedure is mandatory to the establishment of a valid quality assurance program.

**5. TESTING REQUIREMENTS**

- 5.1 Testing shall be performed by a laboratory currently accredited by the Cement and Concrete Reference Laboratory (CCRL). Any satellite laboratory of a Fly Ash Supplier that performs required testing under this Standard shall be identified in the submitted Quality Control Plan (Section 7).

**6. SUPPLIER CERTIFICATION REQUIREMENTS**

- 6.1 Fly Ash Suppliers shall submit to the CDOT Product Evaluation Coordinator (PEC), the CDOT Form 595, Pre-Approved Product Evaluation Request & Summary for each source and Class of fly ash intended for use on CDOT projects. Instructions for completing CDOT Form 595 can be found at [www.codot.gov/business/APL/](http://www.codot.gov/business/APL/) within the Notice to Manufacturers.
- 6.2 In addition to completing the CDOT Form 595, the following shall be supplied to the PEC:
- 6.2.1 A brief outline of the procedures used to evaluate the finished product including; sampling and testing frequency and the sample preparation employed, including chemical analysis methods used such as X-ray, atomic absorption spectroscopy, and/or wet chemistry.
- 6.2.2 The results of all applicable chemical and/or physical tests required by ASTM C 618 on the most recent 40 samples (20 pairs) tested. The results shall be submitted in the format outlined in ASTM C 311, in particular the table entitled "Test Data" with the critical limits calculated as described.
- 6.2.3 A copy of the CCRL certification for the laboratory performing testing.
- 6.2.4 A copy of the Fly Ash Supplier's Quality Control Plan, which complies with the requirements of Section 7, if one has not been supplied to CDOT for previously submitted products.
- 6.3 A sample of the proposed fly ash shall be shipped to the PEC at the Materials and Geotechnical Branch, 4670 North Holly Street, Unit A, Denver, Colorado 80216-6408.
- 6.4 The Fly Ash Supplier shall allow CDOT to visit the production and/or shipping site to observe the Fly Ash Supplier's quality control activities, to inspect the facilities, and to obtain samples for tests.
- 6.5 The Fly Ash Supplier shall follow the procedures described in the CDOT approved quality control plan.
- 6.6 The Fly Ash Supplier shall establish a continuing test record for every test required for each Type of fly ash included in the written request as prepared to satisfy the requirements of Subsection 6.1.
- 6.7 The Fly Ash Supplier shall submit to CDOT all reports required by this standard in a format approved by CDOT.

6.8 The Fly Ash Supplier shall have a satisfactory record of compliance with CDOT project specifications. Decisions by CDOT concerning this requirement shall be based on the test results furnished by the Fly Ash Supplier and satisfactory results when the splits and field tests are compared with Fly Ash Supplier tests.

**7. SUPPLIER QUALITY CONTROL PLAN (MINIMUM REQUIREMENTS)**

7.1 The Fly Ash Supplier's Quality Control Plan shall identify the following:

7.1.1 Facility location.

7.1.2 Name and telephone number of a person at each production facility, responsible for quality control of material shipped to CDOT projects.

7.1.3 Quality control tests and testing frequency to be performed on each fly ash.

7.1.4 Name and location of the laboratory performing quality control tests on the fly ash.

7.2 The Fly Ash Supplier's Quality Control Plan shall include a declaration stating that if a test result indicates that a shipment of fly ash does not comply with the purchase specifications, the Fly Ash Supplier shall:

7.2.1 Identify the material in the shipment,

7.2.2 Immediately cease the shipment until the material complies with the specification,

7.2.3 Immediately notify CDOT regarding the shipment in question,

7.2.4 Immediately notify the Contractors and Concrete Suppliers scheduled to use the material from the shipment in question,

7.2.5 Notify CDOT prior to resuming shipment; and

7.2.6 Implement any mutually agreed upon procedures for the disposition of the material.

7.3 The Fly Ash Supplier's Quality Control Plan shall describe method and frequency for initial testing and quality control testing.

7.3.1 **Initial Testing** – For each fly ash product to be supplied, testing shall be performed and the results of that testing provided to CDOT, accompanied by a sample of the material represented by the test results.

7.3.2 **Quality Control Testing** – Tests to determine conformance with ASTM C 618 shall be conducted as needed for quality control. The Supplier's Quality Control Plan shall indicate the frequency of this testing.

7.4 The Fly Ash Supplier's Quality Control Plan shall include a statement that the Fly Ash Supplier will prepare and maintain summary reports for all quality control tests performed, and will submit them to CDOT on request.

7.5 The Fly Ash Supplier's Quality Control Plan shall provide an outline of the procedure to be followed for checking transport vehicles before loading to prevent contamination of shipments. The outline shall be maintained in the Fly Ash Supplier's records and will be made available to CDOT on request.

## **8. CDOT EVALUATION PROCEDURE**

8.1 CDOT will verify that the Fly Ash Supplier's Quality Control Plan is adequate. CDOT may visit the shipping site when required.

8.2 CDOT will notify the Fly Ash Supplier whether or not the Fly Ash Supplier's application has been granted.

8.3 CDOT may verify that the Fly Ash Supplier's testing laboratory is currently CCRL accredited.

8.4 CDOT may perform split sample testing in accordance with Section 10.

8.5 CDOT may sample and perform testing on random samples.

8.6 CDOT may inspect the operations of the Fly Ash Supplier's facility including those related to shipments if required.

8.7 Products approved for use will be posted on the CDOT APL.

## **9. REQUIREMENTS FOR SHIPPING FLY ASH BY AN APPROVED SUPPLIER**

9.1 The Fly Ash Supplier's Quality Control Plan as approved by CDOT (Section 7) shall be implemented.

9.2 Each shipment shall be accompanied by two copies of the bill of lading, which shall include:

9.2.1 The name and location of the Fly Ash Supplier and the plant producing the fly ash,

9.2.2 The class of fly ash,

9.2.3 The quantity of material shipped,

9.2.4 The date of shipment,

9.2.5 A statement certifying the material meets specification requirements (COC) and,

9.2.6 A statement certifying that the transport vehicle was inspected before loading and was found acceptable for the material shipped.

9.3 If the test results do not conform to ASTM C 618 specifications, the Fly Ash Supplier shall remove the non-compliant material from the shipping queue as outlined in Subsection 7.2.

**10. SPLIT SAMPLE TESTING**

- 10.1 CDOT may request split sample testing. The test results will be exchanged as soon as they are available.
- 10.2 If the split sample test data is not within the precision specified for that particular test a review of both sampling and testing procedures will be conducted by both the Fly Ash Supplier and CDOT.

**11. REPORT AND DATA SHEETS**

- 11.1 Fly Ash Supplier Reports -The Fly Ash Supplier shall prepare the reports described in Subsections 6.1, 6.2, and 9.2.

{Page Intentionally Left Blank}

Part I, Sub-Part 5:

## Hydrated Lime - 21

### 1. REFERENCED DOCUMENTS

#### 1.1 AASHTO Standards:

AASHTO M 303 - Lime for Asphalt Mixtures

AASHTO R 38 – Quality Assurance of Standard Manufactured Materials

#### 1.2 ASTM Standards:

ASTM C 25 - Standard Test Methods for Chemical Analysis of Limestone, Quicklime, and Hydrated Lime

ASTM C 50 - Standard Practice for Sampling, Inspection, Packing, and Marking of Lime and Limestone Products

ASTM C 110 - Standard Test Methods for Physical Testing of Quicklime, Hydrated Lime, and Limestone

ASTM C 207 - Standard Specification for Hydrated Lime for Masonry Purposes

ASTM C 977 - Standard Specification for Hydrated Lime for Soil Stabilization

### 2. TERMINOLOGY

2.1 See ASTM C 51 Standard Terminology Relating to Lime and Limestone (as used by the Industry).

2.2 Supplier – In this Standard, a *Supplier* shall be defined as one who manufactures hydrated lime.

2.3 Contractor – The Company under contract with CDOT to produce products using hydrated lime.

### 3. SIGNIFICANCE AND USE

3.1 This Standard specifies procedures intended to minimize disruption of hydrated lime shipments. This is accomplished by a certification system that evaluates quality control and specification compliance tests performed by the Supplier on samples obtained prior to shipment.

3.2 This Standard specifies requirements and procedures for a certification system that shall be applicable to all Suppliers providing hydrated lime. These provisions apply to the plant manufacturing the hydrated lime. These provisions apply to the Contractor, after delivery of the hydrated lime to the Contractor, for use on CDOT projects.

**4. SAMPLING**

- 4.1 All test samples required by this Standard shall be obtained in accordance with ASTM C 50. The use of a random sampling procedure is mandatory to the establishment of a valid quality assurance program.

**5. TESTING REQUIREMENTS**

- 5.1 Laboratories that perform the required testing under this Standard shall list qualifications in the submitted Supplier Quality Control Plan. Any satellite laboratory of a Supplier that performs required testing under this Standard shall be identified in the submitted Supplier Quality Control Plan (Section 7).

**6. SUPPLIER REQUIREMENTS**

- 6.1 Suppliers shall submit to the CDOT's Product Evaluation Coordinator (PEC) the CDOT Form 595, Pre-Approved Product Evaluation Request & Summary for each source of hydrated lime intended for use on CDOT projects. Instructions for completing the Form 595 can be found in Notice to Manufacturers at [www.codot.gov/business/APL/](http://www.codot.gov/business/APL/).
- 6.2 In addition to completing CDOT Form 595, the following shall be supplied to the PEC:
- 6.2.1 A brief outline of the procedures used to evaluate the finished product including; sampling and testing frequency, and the sample preparation employed, including chemical analysis methods used.
- 6.2.2 The results of all applicable chemical and/or physical tests required by AASHTO M 303, ASTM C 110, ASTM C 207 or ASTM C 977 on the most recent 20 samples tested. The results shall be submitted in a tabular format with the critical limits indicated.
- 6.2.3 A copy of the Supplier's Quality Control Plan, which complies with the requirements of Section 7. Any changes to the supplier's Quality Control plans shall require an updated plan sent to the PEC.
- 6.3 A sample of the proposed hydrated lime shall be shipped to the PEC at the Materials and Geotechnical Branch, 4670 North Holly Street, Unit A, Denver, Colorado 80216-6408.
- 6.4 During normal business hours, the Supplier shall allow CDOT to visit the production and/or shipping site to observe the Supplier's quality control activities, to inspect the facilities, and to obtain samples for tests.
- 6.5 The Supplier shall follow the procedures described in the CDOT approved quality control plan.
- 6.6 The Supplier shall establish a continuing test record for every test required for hydrated lime included in the written request as prepared to satisfy the requirements of Subsection 6.2.
- 6.7 The Supplier shall submit to CDOT all reports required by this standard in a format approved by CDOT.



6.8 The Supplier shall have a satisfactory record of compliance with CDOT project specifications. Decisions by CDOT concerning this requirement shall be based on the test results furnished by the Supplier and satisfactory results when the splits and field tests are compared with Supplier tests.

**7. SUPPLIER QUALITY CONTROL PLAN (MINIMUM REQUIREMENTS)**

7.1 The Supplier's Quality Control Plan shall identify the following:

7.1.1 Facility location.

7.1.2 Name and telephone number of a person at each production facility, responsible for quality control of material shipped to CDOT projects.

7.1.3 Quality control tests and testing frequency to be performed on each hydrated lime product.

7.1.4 Name and location of the laboratory performing quality control tests on the hydrated lime.

7.2 The Supplier's Quality Control Plan shall include a declaration stating that if a test result indicates that a shipment of hydrated lime does not comply with the purchase specifications, the Supplier shall:

7.2.1 Identify the material in the shipment,

7.2.2 Immediately cease the shipment until the material complies with the specification,

7.2.3 Immediately notify CDOT regarding the shipment in question,

7.2.4 Immediately notify the Contractors scheduled to use the material from the shipment in question,

7.2.5 Notify CDOT prior to resuming shipment; and

7.2.6 Implement any mutually agreed upon procedures for the disposition of the material.

7.3 The Supplier's Quality Control Plan shall describe method and frequency for initial and quality control testing.

7.3.1 **Initial Testing** - For each hydrated lime product to be supplied, testing shall be initially performed by the supplier and the results of those tests shall be provided to CDOT, accompanied by a sample of the material represented by the test results.

7.3.2 **Quality Control Testing** – Tests to determine conformance with Subsection 712.03 of the Standard Specifications shall be conducted as needed for quality control. The Supplier's Quality Control Plan shall indicate the frequency of this testing.

7.4 The Supplier's Quality Control Plan shall include a statement that the Supplier will prepare and maintain summary reports for all quality control tests performed, and will submit them to CDOT on request.

- 7.5 The Supplier's Quality Control Plan shall provide an outline of the procedure to be followed for checking transport vehicles before loading to prevent contamination of shipments. The outline shall be maintained in the Supplier's records and will be made available to CDOT on request.

## **8. CDOT EVALUATION PROCEDURE**

- 8.1 CDOT will verify that the Supplier's Quality Control Plan is adequate. CDOT may visit the shipping site when required.
- 8.2 CDOT will notify the Supplier whether or not the Supplier's application has been granted.
- 8.3 CDOT may perform split sample testing in accordance with Section 10.
- 8.4 On a random basis, CDOT may request a sample for testing the supplier's product.
- 8.5 CDOT may inspect the operations of the Supplier's facility including those related to shipments if required.
- 8.6 CDOT will post the Supplier's approved hydrated lime with the associated Supplier's facility name on CDOT's Approved Products List. Reference to the web site is at: [www.codot.gov/business/APL/](http://www.codot.gov/business/APL/).

## **9. REQUIREMENTS FOR SHIPPING HYDRATED LIME BY AN APPROVED SUPPLIER**

- 9.1 The Supplier's Quality Control Plan as approved by CDOT (Section 7) shall be implemented.
- 9.2 Each shipment shall be accompanied by two copies of the bill of lading, which shall include:
- 9.2.1 The name and location of the Supplier,
- 9.2.2 The Type of material shipped,
- 9.2.3 The quantity of material shipped,
- 9.2.4 The date of shipment,
- 9.2.5 A certificate of compliance (COC) certifying the material meets specification requirements. The COC statement will certify the material was manufactured and tested in accordance with CDOT's approved Quality Control Plan (Section 7) and, therefore meets State requirements and,
- 9.2.6 A statement certifying that the transport vehicle was inspected before loading and was found acceptable for the material shipped.
- 9.3 If the test results do not conform to Standard Specification Subsection 712.03, the Supplier shall remove the non-compliant material from the shipping queue as outlined in Subsection 7.2.

**10. SPLIT SAMPLE TESTING**

- 10.1 CDOT may request split sample testing. The test results will be exchanged as soon as they are available.
- 10.2 If the split sample test data is not within the precision specified for that particular test a review of both sampling and testing procedures will be conducted by both the Supplier and CDOT.

**11. REPORT AND DATA SHEETS**

- 11.1 Supplier Reports - The Supplier shall prepare the reports described in Subsections 6.1, 6.2 and 9.2.

{Page Intentionally Left Blank}

## **Steel Reinforcing Bars and Steel Dowel Bars – 21**

### **SCOPE:**

This subpart provides procedures for being included on the Qualified Manufacturer List (QML) as a Fabricator of steel reinforcing bars and dowel bars for CDOT projects. CDOT will only accept steel reinforcing bars and dowel bars from a Fabricator on the QML.

CDOT will only accept steel reinforcing bar suppliers who have both participated in AASHTO's NTPEP (National Transportation Product Evaluation Program) audit program of steel rebar. A copy of the NTPEP Audit Report as well as any applicable documentation from the audit reports are required. CDOT may request additional information if necessary and may decertify a supplier for failing to meet CDOT expectations.

### **1. REFERENCED DOCUMENTS**

Where applicable, the latest edition of the following standards shall be considered a part of these requirements.

#### **1.1 CDOT Standard Specifications for Road and Bridge Construction:**

Section 412.13 – Joints

Section 602 – Reinforcing Steel

Section 709.01 – Reinforcing Steel

Section 709.03 – Dowel Bars and Tie Bars

#### **1.2 AASHTO Standards:**

AASHTO M 31 – Standard Specification for Deformed and Plain Carbon Steel Bars for Concrete Reinforcement

AASHTO R 38 – Standard Practice for Quality Assurance of Standard Manufactured Materials

AASHTO T 244 – Standard Method of Test for Mechanical Testing of Steel Products

AASHTO M 55 – Standard Method of Test for Steel Welded Wire Reinforcement, Plain, for Concrete

AASHTO M 221 – Standard Method of Test for Steel Welded Wire Reinforcement, Deformed, for Concrete

#### **1.3 ASTM Standards:**

ASTM A 184 – Standard Specification for Welded Deformed Steel Bar Mats for Concrete Reinforcement

ASTM A 370 – Standard Test Methods and Definitions for Mechanical Testing of Steel Products

ASTM A 615 – Standard Specification for Deformed and Plain Billet-Steel Bars for Concrete Reinforcement

ASTM A 706 – Low-Alloy Steel Deformed and Plain Bars for Concrete Reinforcement

ASTM A 996 – Standard Specification for Rail-Steel and Axle-Steel Deformed Bars for Concrete Reinforcement

ASTM D 3665 – Standard Practice for Random Sampling of Construction Material

1.4 NTPEP Documents:

Reinforcing Steel and Welded Wire Reinforcement Audit Program

[http://www.ntpep.org/Pages/REBAR\\_WWR.aspx](http://www.ntpep.org/Pages/REBAR_WWR.aspx)

NTPEP Committee Work Plan for Evaluation of Reinforcing Steel Manufacturers; REBAR 01-15

[http://www.ntpep.org/Documents/Technical\\_Committee/REBAR\\_WWR/Documents/Rebar\\_WWR%20Work%20Plan.pdf](http://www.ntpep.org/Documents/Technical_Committee/REBAR_WWR/Documents/Rebar_WWR%20Work%20Plan.pdf)

**2. TERMINOLOGY**

2.1 See AASHTO M 31 and ASTM A 370 for terminology related to steel reinforcing bars and dowel bars.

2.2 Coating Application Plant – The one who produces a protective coated steel reinforcing bar and a protective coated dowel bar.

2.3 Deformed bar – Steel bar with protrusions; a bar that is intended for use as reinforcement in reinforced-concrete construction.

2.4 Fabricator – The Company, which cuts and bends steel reinforcing bars either coated or uncoated and/or assembles dowel bar baskets. The company may also provide uncut lengths of steel bars to the construction project site. Each plant constitutes a separate company.

2.5 Plain bar – Steel bar without protrusions; a bar that is intended for use as a dowel bar in transverse joints of concrete pavement construction.

2.6 Supplier – In this sub-part supplier shall be defined as one who produces or mills uncoated deformed steel reinforcing bars and steel plain bars used by the Fabricator.

2.7 Uncoated bar – Steel bar without protective coating.

**3. SIGNIFICANCE AND USE**

3.1 This Standard specifies requirements that shall be followed by the Supplier to be included on CDOT's QML.

3.2 This Standard specifies requirements and procedures for a certification system that shall apply to all Suppliers providing steel reinforcing bars and dowel bars.

3.2.1 This Standard covers the responsibilities of the Supplier from point of delivery of steel reinforcing bars and dowel bars to the Fabricators plant, construction project site, and/or Coating Application Plant.

**4. Deleted**

**5. Deleted**

## **6. SUPPLIER REQUIREMENTS**

6.1 Uncoated bar Suppliers shall be on CDOT's Qualified Manufacturers List (QML) before use by the Fabricator. The QML can be found at the following web address:

<https://www.codot.gov/content/apl/SteelReinforcingBarsAndSteelDowelBars.pdf>.

## **7. CERTIFICATION**

7.1 This section details the required documentation to be submitted to the CDOT by the Supplier requesting to be added to the QML.

7.2 The most recent NTPEP audit report shall be submitted to the PEC at least 6 months before the steel product being incorporated onto a CDOT project. The NTPEP audit report may not be more than 2 years old.

7.3 Shall provide documentation that the supplier is scheduled for an audit, or has been audited in the current calendar year.

## **8. DECERTIFICATION**

8.1 CDOT may decertify the Fabricator when conditions exist as specified on page 2 of CP 11 (Section 5 – Decertification).

**Note 2:** The term Supplier and Fabricator are interchangeable when reading Section 5 – Decertification on page 2.

8.2 CDOT may decertify a supplier when they fail to comply with the requirements of the NTPEP audit or have not participated in an audit in the past two years following certification.

**9. Deleted**

## **10. CDOT EVALUATION PROCEDURE**

10.1 Suppliers producing steel reinforcing bars and dowel bars shall meet the minimum industry standards.

10.2 Suppliers shall submit the required documentation described in Section 7.

- 10.3 Within two months after submitting all required information, CDOT will notify the Supplier whether or not the manufacturing facility's application for the Qualified Manufacturer List has been granted.
- 10.4 CDOT may perform quality assurance testing.
- 10.5 CDOT will post the Fabricator's name and approved plant on CDOT's Qualified Manufacturer List (QML) in the web site at:  
<https://www.codot.gov/content/apl/SteelReinforcingBarsAndSteelDowelBars.pdf>.
- 10.6 Failure in one or more Sections or Sub-sections listed in this Standard may result in decertification of the plant and the plant will be removed from the QML. The Supplier may apply for reinstatement on the QML.

**11. Deleted**

**12. REQUIREMENTS FOR SHIPPING STEEL REINFORCING BARS AND DOWEL BARS BY AN APPROVED FABRICATOR**

- 12.1 The steel reinforcing bars and dowel bars Supplier's QSM as approved by CDOT shall be implemented.
- 12.2 Each shipment shall be accompanied by two copies of the bill of lading, which shall include:
- 12.2.1 The name and location of the steel reinforcing bars and dowel bars Fabricator and the Supplier producing the steel reinforcing bars and dowel bars,
- 12.2.2 The size and grade of steel reinforcing bars and dowel bars conforming to the specified specification,
- 12.2.3 Bars shall be separated and tagged with the Supplier's heat identification number,
- 12.2.4 The quantity of material shipped,
- 12.2.5 The date of shipment,
- 12.2.6 A copy of the mill test reports.
- 12.3 If the specification compliance test results do not conform to Subsection 709.01 and 709.03 of the CDOT Standard Specifications, the Fabricator shall remove the non-compliant material from the shipping queue.



## Epoxy Coaters of Reinforcing Steel - 21

**SCOPE:** This sub-part provides procedures for being included on the Qualified Manufacturers List (QML) as a producer of epoxy-coated steel reinforcing bars and epoxy-coated steel dowel bars for CDOT projects. CDOT will only accept epoxy-coated steel reinforcing bars and epoxy-coated steel dowel bars by a Manufacturer on the QML.

### 1. REFERENCED DOCUMENTS

Where applicable, the latest edition of the following standards shall be considered a part of these requirements.

#### 1.1 CDOT Standard Specifications for Road and Bridge Construction:

Section 412.13 – Joints

Section 602 – Reinforcing Steel

Section 709.01 – Reinforcing Steel

Section 709.03 – Dowel Bars and Tie Bars

#### 1.2 AASHTO Standards:

AASHTO M 31 – Standard Specification for Deformed and Plain Carbon Steel Bars for Concrete Reinforcement

AASHTO M 254 – Standard Specification for Corrosion-Resistant Coated Dowel Bars

AASHTO M 284 – Discontinued

AASHTO M 317 – Discontinued

AASHTO R 38 – Standard Practice for Quality Assurance of Standard Manufactured Materials

AASHTO T 253 – Standard Method of Test for Coated Dowel Bars

#### 1.3 ASTM Standards:

ASTM A 615 – Standard Specification for Deformed and Plain Billet-Steel Bars for Concrete Reinforcement

ASTM A 775 – Standard Specification for Epoxy-Coated Steel Reinforcing Bars

ASTM D 3665 – Standard Practice for Random Sampling of Construction Material

ASTM D 3963 – Standard Specification for Fabrication and Jobsite Handling of Epoxy-Coated Steel Reinforcing Bars

#### 1.4 Concrete Reinforcing Steel Institute (CRSI): Epoxy Coating Plant Certification Manual

**2. TERMINOLOGY**

- 2.1 See ASTM A 775 for terminology related to epoxy-coated steel reinforcing bars.
- 2.2 Coated bar – Steel bar with protective epoxy coating applied by the electrostatic spray method.
- 2.3 Contractor – The Company under contract with CDOT to produce products using epoxy-coated steel reinforcing bars and epoxy-coated steel dowel bars.
- 2.4 Deformed bar – Steel bar with protrusions; a bar that is intended for use as reinforcement in reinforced concrete construction.
- 2.5 Fabricator – The Company, which cuts and bends steel reinforcing bars either coated or uncoated and/or assembles dowel bar baskets.
- 2.6 Manufacturer – The Company, which produces epoxy-coated steel reinforcing bars and epoxy-coated steel dowel bars. Each epoxy-coated applicator plant constitutes a separate company.
- 2.7 Plain bar – Steel bar without protrusions; a bar that is intended for use as a dowel bar in transverse joints of concrete pavement construction.
- 2.8 Supplier – In this sub-part it shall be defined as one who provides materials used in the manufacturing of epoxy-coated steel reinforcing bars and epoxy-coated steel dowel bars. Uncoated steel reinforcing bars, uncoated dowel bars, and powder coating are among the materials provided to the Manufacturer.
- 2.9 Uncoated bar – Steel bar without protective epoxy coating.

**3. SIGNIFICANCE AND USE**

- 3.1 This Standard specifies requirements that should be followed by the Manufacturer in implementing an effective Quality Control (QC) system. This is accomplished by a certification system that evaluates quality control practices and specification compliance tests performed by the Manufacturer according to their quality control plans.
- 3.2 This Standard specifies requirements and procedures for a certification system that shall be applicable to all Manufacturers providing epoxy-coated steel reinforcing bars and epoxy-coated steel dowel bars. These provisions initially apply to the plant manufacturing the epoxy-coated steel reinforcing bars and epoxy-coated steel dowel bars.
  - 3.2.1 This Standard covers the responsibilities of the Manufacturer from point of delivery of uncoated deformed or plain bars at the applicator plant to point of delivery on the construction project site and/or Fabricator plant.
- 3.3 This Standard applies to Fabricators that use epoxy-coated bars. The Fabricator shall conform to the requirements of ASTM D 3963 for fabrication of bars and dowel bar assemblies after the application of the epoxy-coating.

- 3.3.1 This Standard covers the responsibilities of the Fabricator from point of delivery of epoxy-coated steel reinforcing bars and epoxy-coated steel dowel bars at the Fabricators plant to point of delivery on the construction project site.
- 3.3.2 This Standard covers the responsibilities of the Fabricator from point of delivery of uncoated bars to point of delivery of the Manufacturers application site.
- 3.3.3 This Standard subsequently covers epoxy-coated steel reinforcing bars and epoxy-coated steel dowel bars for use on CDOT projects. The Contractor shall conform to the requirements of ASTM D 3963 for job site handling of epoxy-coated bars.

#### 4. SAMPLING

- 4.1 All number and frequency of test samples required by this Standard shall be in accordance with ASTM A775 (as a minimum) and the enhanced Manufacturer QC program. It is expected the QC tests are to be tied to critical production processes as well as to the final product.

**Note 1:** ASTM A 775 specifies the number and frequency of tests for coating thickness, continuity, flexibility, and adhesion. For example, an enhanced Manufacturer QC program that exceeds the minimum set forth in ASTM A 775 would document the method of determination of an additional randomly selected bar to test the bar surface temperature before applying the coating.

- 4.2 In addition, the QC program required by this Standard shall use stratified random sampling techniques. Stratified random sampling should be performed in accordance with ASTM D 3665. The use of a stratified random sampling procedure is mandatory to the establishment of a valid QC program. All random QC sample locations shall be properly documented.

**Note 2:** Determination of random locations (or timing) is universally applied to a construction site or to a Manufacturer's production line. ASTM D 3665 covers a flowing stream of material that can be applied to the production line of epoxy-coated bars.

#### 5. TESTING REQUIREMENTS

- 5.1 An internal designated testing location and/or facility of a Manufacturer that performs the required testing under this Standard shall be identified in the submitted Quality System Manual (QSM) (Section 9).
- 5.2 Testing required for this Standard shall be performed by qualified Manufacturers personnel through appropriate QC programs or appropriate training programs.
- 5.3 As a minimum, the Manufacturers programs used shall include the following;
  - 5.3.1 Training in AASHTO, ASTM, or CRSI test procedures.
  - 5.3.2 Demonstration of proficiency in each Manufactures QC test.
  - 5.3.3 Demonstration of ability to properly document Manufactures QC test results.

5.3.4 Demonstrate the ability to interpret all the test results.

## 6. SUPPLIER REQUIREMENTS

6.1 Uncoated bar Suppliers shall be on CDOT's Qualified Manufacturers List (QML) prior to use by the Manufacturer. The QML can be found at the following web address: [www.codot.gov/business/APL/](http://www.codot.gov/business/APL/).

6.2 Uncoated bar Suppliers shall follow the procedures described in the CDOT approved quality control plan as required in CP 11 Part I, Sub-Part 6.

6.3 The uncoated bar Supplier shall provide an annual certification that all steel products delivered to the Manufacturer and permanently incorporated in the work shall have occurred in the United States of America.

6.4 Suppliers of epoxy powder shall be on CDOT's Approved Product List (APL). The APL along with instruction for completing CDOT Form 595, Pre-Approved Product Evaluation Request & Summary, can be found at the web address: [www.codot.gov/business/APL/](http://www.codot.gov/business/APL/).

## 7. CURRENTLY CERTIFIED MANUFACTURERS

7.1 A Manufacturer, which has been certified for the past three consecutive years under the Concrete Reinforcing Steel Institute (CRSI) certification plant program, will be placed on CDOT's QML after submitting all of the following:

- The certificate from the current year and the preceding three consecutive years of evaluations from CRSI,
- The inspection report from the current year and the preceding three consecutive years of evaluations from CRSI,
- The Quality System Manual as outlined in Section 9 of this Standard.
- 7.2 A Manufacturer, which has been certified for less than three consecutive years under the CRSI certification plant program will be on probation and placed on the QML after submitting all of the following:
  - The certificate from the current year along with any preceding years of evaluations from CRSI,
  - The inspection report from the current year along with any preceding years of evaluations from CRSI,
  - The Quality System Manual as outlined in Section 9 of this Standard.

7.2.1 The probation period will be for three consecutive years after being placed on the QML.

## 8. DECERTIFICATION

- 8.1 This section applies to Manufacturers that are classified under Subsection 7.1. If the Manufacturer becomes decertified by CRSI certification plant program after being placed on the QML, the Manufacturer will be removed from the QML until successfully completing and submitting to CDOT the requirements within this Standard. Decertification is the final ruling after the CRSI dispute process has been completed. The Manufacturer may apply for reinstatement on the QML no sooner than six months after removal from the QML. The probationary period will be for one year after being placed back on the QML with Subsections 7.2, 8.2, and 8.3 of this Standard being applied.
- 8.2 This section applies to Manufacturers that are classified under Subsection 7.2. If the Manufacturer becomes decertified by CRSI certification plant program after being placed on the QML, the Manufacturer will be removed from the QML until successfully completing and submitting to CDOT the requirements within this Standard. The Manufacturer may apply for reinstatement on the QML no sooner than three years after removal from the QML.
- 8.3 CDOT may decertify the Manufacturer when conditions exist as specified in Section 5 - Decertification within the Introduction of the CP 11 Page 2.

**Note 3:** The term Supplier and Manufacturer are interchangeable when reading Section 5 – Decertification from page 2.

## 9. MANUFACTURER'S QUALITY SYSTEM MANUAL (MINIMUM REQUIREMENTS)

- 9.1 On an annual basis, at a minimum of two months prior to producing epoxy-coated steel reinforcing bars and epoxy-coated steel dowel bars for a CDOT project, one copy of the Manufacturer's Quality System Manual (QSM) shall be submitted for review and approval to CDOT's Product Evaluation Coordinator (303) 398-6566 within the Staff Materials & Geotechnical Branch at 4670 North Holly Street, Unit A, Denver, Colorado 80216-6408. In lieu of a hard copy QSM, a PDF format document may be submitted. The PDF manual submittal must be complete and whole. CDOT's approval of the QSM is intended only to indicate that the QSM is in conformance with the minimum QC requirements set forth in this Standard. Once the Manufacturer is approved and on the Qualified Manufacturers List (QML), the QSM provisions will remain in effect for a period of one year, unless revisions are determined to be necessary by the Quality Control Manager or requested by CDOT, or if the Manufacturer is decertified. If any changes are made to the QSM, an updated copy shall be submitted to CDOT for review and approval. In lieu of a full updated copy, submittals of updates are acceptable. Updates shall be in the same format as the manual and are to be inserted into the manual to replace outdated pages. The updates may be in PDF format. The updated pages will have the date of update issuance and is to be recorded in a table of revisions. Guidelines for preparing a QSM may be available from the Concrete Reinforcing Steel Institute (CRSI). Guidelines are also documented in AASHTO R 38.
- 9.2 The Manufacturer's QSM shall include the latest edition of CRSI Plant Certification Manual.

- 9.3 The Manufacturer's QSM may be maintained in electronic format. However, one or more copies of the QSM shall be maintained by the Manufacturer's QC Manager in a printed and bound format (3-ring or other). The QSM shall be available to all of the Manufacturer's employees. Each document in the QSM shall indicate its preparation date and all pages of the QSM shall be numbered. If a document is revised, the date of revision shall be indicated on the document and recorded in a table of revisions.
- 9.4 The Manufacturer's QSM shall be formatted to provide numbered sections which meet the following order, format, and content:
- 9.4.1 Manufacturer's quality policy or mission Statement endorsed by the company's Chief Executive Officer.
- 9.4.1.1 The quality policy / mission statement shall indicate support of top management to enforce the QC requirements contained in the QSM.
- 9.4.2 The QSM shall include the address and telephone numbers of applicable personnel at the manufacturing facility. If applicable, the QSM shall include the address and telephone numbers of responsible personnel of the Fabricators.
- 9.4.3 The QSM shall include a brief listing and description of all the epoxy-coated deformed and plain bars being manufactured at the facility.
- 9.4.4 The QSM shall present and define any significant terms used throughout the QSM.
- 9.4.5 For all manufactured items addressed in the QSM, the applicable AASHTO, ASTM, or CDOT specification shall be identified.
- 9.4.6 The QSM shall present the personnel structure established to implement the Manufacturer's quality system. The specific roles and responsibilities of all QC personnel shall be documented as follows:
- 9.4.6.1 The QSM shall contain an organizational chart. The chart shall indicate a clear separation between the QC personnel and the production personnel. The QC Manager shall be allowed direct access to top management, independent from production. The names of personnel shall be placed on the chart.
- 9.4.6.2 Each facility shall have a Quality Control Manager who has the overall responsibility for implementing the requirements of the QSM. The QC Manager shall review the established QC system annually in order to satisfy this requirement, or if changes in the manufacturing process(s) occur, or whenever technical or CDOT information indicate a trend in reduced quality.

- 9.4.6.3 Each facility shall have at least one Quality Control Technician to perform QC sampling, testing, and inspection. At least one QC Technician shall be on-site during production. The QC Technicians shall be familiar with the tests they perform and have sufficient authority to assure corrective actions are carried out when necessary. The QSM shall indicate the line of authority of the QC Technicians, which shall demonstrate their authority to require corrective action. The QSM shall designate the QC Technicians at the facility and laboratory involved in the production or testing of the epoxy-coated steel reinforcing bars and epoxy-coated steel dowel bars.
- 9.5 The QSM shall contain a description of the qualifications required and attained, and years of experience for each QC Manager and QC Technician. All QC sampling, testing, and inspection personnel shall be trained. Plants certified by CRSI shall have at least one QC Manager and at least one QC Technician who are capable of performing and correctly interpreting all the tests required by CRSI Plant Certification Manual. The QSM shall also include periodic auditing of each QC Technician's ability to satisfactorily perform the required tests. Retraining shall be provided when the test method is revised.
- 9.6 The QSM shall provide for specific training for frontline production personnel in the safe and correct operating procedures implemented to ensure the required quality of all epoxy-coated steel reinforcing bars and epoxy-coated steel dowel bars.
- 9.7 The Manufacturer shall maintain its own qualified internal designated testing location and/or facility to perform QC testing. The Manufacturer shall provide backup QC testing personnel and any necessary backup laboratory equipment. The QSM shall include the address and telephone numbers of a designated backup personnel. The Manufacturer's internal designated testing location and/or facility shall meet the minimum accreditations or qualifications obtained through one or more of the following programs:
- 9.7.1 The manufacturing industry's Concrete Reinforcing Steel Institute Certification Plant Program.
- 9.7.2 National accreditation programs such as AASHTO Accreditation Program or American Association for Laboratory Accreditation.
- 9.8 The QSM shall contain an inventory of the necessary equipment used for sampling and testing along with associated calibration equipment used for each required test procedure. The QSM shall assign a unique identification number to each piece of testing equipment. The QSM inventory for each necessary piece of equipment shall include the following information:
- 9.8.1 The name of each necessary piece of equipment, date placed in service, Manufacturer, model and serial number. The QSM shall include the location where the instructions for use and operation of each necessary piece is stored if not included in the QSM.

- 9.8.1.1 For each necessary piece of equipment, the QSM shall include the interval of calibration or verification, a reference to the calibration or verification procedures used, and the location where the current calibration or verification records are stored. The QSM shall describe the methods of calibration and verification procedures that are performed at the specified intervals.
- 9.9 The QSM shall identify all types of Supplier delivered materials used for the production of epoxy-coated steel reinforcing bars and epoxy-coated steel dowel bars.
  - 9.9.1 The QSM shall contain a copy of the signed certification from the steel Supplier that all steel products permanently incorporated into the manufactured product shall have occurred in the United States of America.
  - 9.9.2 The QSM shall contain a description of the specification requirements for all Supplier delivered materials.
  - 9.9.3 The QSM shall contain a description of the certification and test reports delivered by the Supplier and a location where these records are stored.
  - 9.9.4 The QSM shall include all QC testing of the supplied materials and shall contain a statement that no raw materials shall be used unless they are on the APL or they have been tested and meet all appropriate CDOT, AASHTO, or ASTM specifications.
  - 9.9.5 All Supplier delivered materials shall be properly stored to prevent damage, contamination, or other alterations prior to use in production. The QSM shall include procedures for the adequate storage of supplied materials.
- 9.10 The QSM shall describe the procedure and frequency for inspection and selection of material samples during production. Sampling shall be performed on a stratified random procedure in accordance with ASTM D 3665. All random QC sample locations shall be properly documented and these procedures shall be included in the QSM.
- 9.11 The QSM shall contain descriptions and examples of the test report forms used by the Manufacturer. The QSM shall identify the individual(s) responsible for maintaining all test records and reports along with the location where the reports are stored.
  - 9.11.1 The test reports shall be maintained and available for inspection for a minimum of three years.
- 9.12 The QSM shall contain a description of the procedures used to identify and document all material or test results that do not conform to specification requirements. The QSM shall contain provisions for resolving non-conforming material or test results.
- 9.13 The QSM shall describe procedures used to properly handle, store, and ship epoxy-coated steel reinforcing bars and epoxy-coated steel dowel bars.



**10. CDOT EVALUATION PROCEDURE**

- 10.1 Manufacturing facilities producing epoxy-coated steel reinforcing bars and epoxy-coated steel dowel bars shall meet the minimum industry standards, and be annually inspected and certified by CRSI. A copy of the certification shall be submitted to CDOT as part of the QML process.
- 10.2 Initially the Manufacturer shall submit a representative sample of epoxy-coated steel reinforcing bars and epoxy-coated steel dowel bars, test result documentation, and QSM to CDOT's Product Evaluation Coordinator (303) 398-6566 within the Staff Materials & Geotechnical Branch at 4670 North Holly Street, Unit A, Denver, Colorado 80216-6408.
- 10.2.1 A representative sample of an epoxy-coated steel reinforcing bar at least 3 foot in length and an epoxy-coated steel dowel bar 18 inches long shall be shipped.
- 10.2.2 The results of all applicable chemical and/or physical tests required by ASTM A 775 on the most recent 20 samples tested. The results shall be submitted in the format outlined in ASTM A 775 and as documented in the Manufacturer's QSM.
- 10.2.3 One copy of the Manufacturer's Quality System Manual shall be submitted.
- 10.3 CDOT will verify that the Manufacturer's QSM is adequate.
- 10.4 Within two months after submitting all required information, CDOT will notify the Manufacturer whether or not the manufacturing facility's application for the Qualified Manufacturers List has been granted.
- 10.5 CDOT may perform split sample testing in accordance with Section 11.
- 10.6 CDOT may perform quality assurance testing.
- 10.7 CDOT may visit the Manufacturer's site when required. CDOT may inspect the operations of the Manufacturer's facility including those related to shipments if required.
- 10.8 CDOT will post the Manufacturer's name and approved plant on CDOT's Qualified Manufacturers List in the web site: [www.codot.gov/business/APL/](http://www.codot.gov/business/APL/) .
- 10.9 Failure in one or more Sections or Sub-sections listed in this Standard may result in an accelerated inspection program. Any additional failures to meet these minimum requirements shall result in the decertification of the plant and the plant will be removed from the QML. The Manufacturer may apply for reinstatement on the QML no sooner than stipulated in Section 8 of this Standard.

**11. SPLIT SAMPLE TESTING**

- 11.1 CDOT may request split sample testing. A split sample is a sample taken and evenly divided to be tested by two or more individuals or laboratories. The test results will be exchanged as soon as they are available.
- 11.2 If the split sample test data is not within the agreed to precision for that particular test a review of both sampling and testing procedures will be conducted by both the Manufacturer and CDOT.

**12. REQUIREMENTS FOR SHIPPING EPOXY-COATED STEEL REINFORCING BARS AND EPOXY-COATED STEEL DOWEL BARS BY AN APPROVED MANUFACTURER**

- 12.1 The epoxy-coated steel reinforcing bars and epoxy-coated steel dowel bars Manufacturer's QSM as approved by CDOT shall be implemented.
- 12.2 Each shipment shall be accompanied by two copies of the bill of lading, which shall include:
  - 12.2.1 The name and location of the epoxy-coated steel reinforcing bars and epoxy-coated steel dowel bars Manufacturer and the plant producing the epoxy-coated steel reinforcing bars and epoxy-coated steel dowel bars,
  - 12.2.2 The size and grade of epoxy-coated steel reinforcing bars and epoxy-coated steel dowel bars conforming to CDOT specification,
  - 12.2.3 Certifications for the powder coating,
  - 12.2.4 The quantity of material shipped,
  - 12.2.5 The date of shipment,
  - 12.2.6 A copy of the mill test reports.
- 12.3 If the specification compliance test results do not conform to Subsection 709.01 and 709.03 specifications, the Manufacturer shall remove the non-compliant material from the shipping queue.

**13. FABRICATION AND JOBSITE HANDLING**

- 13.1 The coated bars to be fabricated by the Fabricator or field fabricated by the Contractor after application of the coating shall meet the following:
  - 13.1.1 Contact points, such as drive rollers, shear contacts, mandrels and backup barrels on benders shall be protected with a suitable covering to minimize damage during the fabrication process.
  - 13.1.2 The Fabricator shall be responsible for repair to the coating due to damage during shipment, storage, or fabrication at the Fabricator's facility.
  - 13.1.3 The Contractor shall be responsible for repair to the coating due to damage during shipment, storage, fabrication, or placement at the construction jobsite.
- 13.2 Coating damaged due to fabrication or handling shall be repaired with patching material. The patching or repairing shall be performed in accordance with the written recommendations of the patching material Supplier.
- 13.3 Patching or repair material shall be compatible with the coating, inert in concrete, and feasible for repairs. The patching or repair material shall conform to ASTM D 3963.

{Page Intentionally Left Blank}

# CDOT EPOXY COATER QSM CHECKLIST

Manufacturer Name \_\_\_\_\_ Date: \_\_\_\_\_

Plant Facility Name and Location: \_\_\_\_\_

Submitted By: \_\_\_\_\_ Phone number: \_\_\_\_\_

E-Mail: \_\_\_\_\_

Manufacturers Comments

Reference: 2020 CDOT Field Materials Manual, CP-11 (Epoxy Coater)

<https://www.codot.gov/business/designsupport/materials-and-geotechnical/manuals>

## 9. MANUFACTURER'S QUALITY SYSTEM MANUAL (MINIMUM REQUIREMENTS)

- 9.1 On an annual basis, at a minimum of two months prior to producing epoxy-coated steel reinforcing bars and epoxy-coated steel dowel bars for a CDOT project, one copy of the Manufacturer's Quality System Manual (QSM) shall be submitted for review and approval to CDOT's Product Evaluation Coordinator (303) 398-6566 within the Staff Materials & Geotechnical Branch at 4670 North Holly Street, Unit A, Denver, Colorado 80216-6408. In lieu of a hard copy QSM, a PDF format document may be submitted. The PDF manual submittal must be complete and whole. CDOT's approval of the QSM is intended only to indicate that the QSM is in conformance with the minimum QC requirements set forth in this Standard. Once the Manufacturer is approved and on the Qualified Manufacturers List (QML), the QSM provisions will remain in effect for a period of one year, unless revisions are determined to be necessary by the Quality Control Manager or requested by CDOT, or if the Manufacturer is decertified. If any changes are made to the QSM, an updated copy shall be submitted to CDOT for review and approval. In lieu of a full updated copy, submittals of updates are acceptable. Updates shall be in the same format as the manual and are to be inserted into the manual to replace outdated pages. The updates may be in PDF format. The updated pages will have the date of update issuance and is to be recorded in a table of revisions. Guidelines for preparing a QSM may be available from the Concrete Reinforcing Steel Institute (CRSI). Guidelines are also documented in AASHTO R 38.

# CDOT EPOXY COATER QSM CHECKLIST

YES/NO/NA

- 9.2 The Manufacturer's QSM shall include the latest edition of CRSI Plant Certification Manual.....\_\_\_\_\_
- 9.3 The Manufacturer's QSM may be maintained in electronic format. However, one or more copies of the QSM shall be maintained by the Manufacturer's QC Manager in a printed and bound format (3-ring or other). The QSM shall be available to all of the Manufacturer's employees. Each document in the QSM shall indicate its preparation date and all pages of the QSM shall be numbered. If a document is revised, the date of revision shall be indicated on the document and recorded in a table of revisions.....\_\_\_\_\_
- 9.4 The Manufacturer's QSM shall be formatted to provide numbered sections which meet the following order, format, and content:.....\_\_\_\_\_
- 9.4.1 Manufacturer's quality policy or mission Statement endorsed by the company's Chief Executive Officer.....\_\_\_\_\_
- 9.4.1.1 The quality policy / mission statement shall indicate support of top management to enforce the QC requirements contained in the QSM.....\_\_\_\_\_
- 9.4.2 The QSM shall include the address and telephone numbers of applicable personnel at the manufacturing facility. If applicable, the QSM shall include the address and telephone numbers of responsible personnel of the Fabricators.....\_\_\_\_\_
- 9.4.3 The QSM shall include a brief listing and description of all the epoxy-coated deformed and plain bars being manufactured at the facility.....\_\_\_\_\_
- 9.4.4 The QSM shall present and define any significant terms used throughout the QSM.....\_\_\_\_\_
- 9.4.5 For all manufactured items addressed in the QSM, the applicable AASHTO, ASTM, or CDOT specification shall be identified.....\_\_\_\_\_
- 9.4.6 The QSM shall present the personnel structure established to implement the Manufacturer's quality system. The specific roles and responsibilities of all QC personnel shall be documented as follows:.....\_\_\_\_\_
- 9.4.6.1 The QSM shall contain an organizational chart. The chart shall indicate a clear separation between the QC personnel and the production personnel. The QC Manager shall be allowed direct access to top management, independent from production. The names of personnel shall be placed on the chart.....\_\_\_\_\_

# CDOT EPOXY COATER QSM CHECKLIST

YES/NO/NA

- 9.4.6.2 Each facility shall have a Quality Control Manager who has the overall responsibility for implementing the requirements of the QSM. The QC Manager shall review the established QC system annually in order to satisfy this requirement, or if changes in the manufacturing process(s) occur, or whenever technical or CDOT information indicate a trend in reduced quality.....\_\_\_\_\_
  
- 9.4.6.3 Each facility shall have at least one Quality Control Technician to perform QC sampling, testing, and inspection. At least one QC Technician shall be on-site during production. The QC Technicians shall be familiar with the tests they perform and have sufficient authority to assure corrective actions are carried out when necessary. The QSM shall indicate the line of authority of the QC Technicians, which shall demonstrate their authority to require corrective action. The QSM shall designate the QC Technicians at the facility and laboratory involved in the production or testing of the epoxy-coated steel reinforcing bars and epoxy-coated steel dowel bars.....\_\_\_\_\_
  
- 9.5 The QSM shall contain a description of the qualifications required and attained, and years of experience for each QC Manager and QC Technician. All QC sampling, testing, and inspection personnel shall be trained. Plants certified by CRSI shall have at least one QC Manager and at least one QC Technician who are capable of performing and correctly interpreting all the tests required by CRSI Plant Certification Manual. The QSM shall also include periodic auditing of each QC Technician's ability to satisfactorily perform the required tests. Retraining shall be provided when the test method is revised.....\_\_\_\_\_
  
- 9.6 The QSM shall provide for specific training for frontline production personnel in the safe and correct operating procedures implemented to ensure the required quality of all epoxy-coated steel reinforcing bars and epoxy-coated steel dowel bars.....\_\_\_\_\_
  
- 9.7 The Manufacturer shall maintain its own qualified internal designated testing location and/or facility to perform QC testing. The Manufacturer shall provide backup QC testing personnel and any necessary backup laboratory equipment. The QSM shall include the address and telephone numbers of a designated backup personnel. The Manufacturer's internal designated testing location and/or facility shall meet the minimum accreditations or qualifications obtained through one or more of the following programs:.....\_\_\_\_\_
  
- 9.7.1 The manufacturing industry's Concrete Reinforcing Steel Institute Certification Plant Program.....\_\_\_\_\_

# CDOT EPOXY COATER QSM CHECKLIST

YES/NO/NA

- 9.7.2 National accreditation programs such as AASHTO Accreditation Program or American Association for Laboratory Accreditation..... \_\_\_\_\_
  
  - 9.8 The QSM shall contain an inventory of the necessary equipment used for sampling and testing along with associated calibration equipment used for each required test procedure. The QSM shall assign a unique identification number to each piece of testing equipment. The QSM inventory for each necessary piece of equipment shall include the following information:..... \_\_\_\_\_
    - 9.8.1 The name of each necessary piece of equipment, date placed in service, Manufacturer, model and serial number. The QSM shall include the location where the instructions for use and operation of each necessary piece is stored if not included in the QSM..... \_\_\_\_\_
      - 9.8.1.1 For each necessary piece of equipment, the QSM shall include the interval of calibration or verification, a reference to the calibration or verification procedures used, and the location where the current calibration or verification records are stored. The QSM shall describe the methods of calibration and verification procedures that are performed at the specified intervals..... \_\_\_\_\_
- 
- 9.9 The QSM shall identify all types of Supplier delivered materials used for the production of epoxy-coated steel reinforcing bars and epoxy-coated steel dowel bars.... \_\_\_\_\_
- 9.9.1 The QSM shall contain a copy of the signed certification from the steel Supplier that all steel products permanently incorporated into the manufactured product shall have occurred in the United States of America..... \_\_\_\_\_
  - 9.9.2 The QSM shall contain a description of the specification requirements for all Supplier delivered materials..... \_\_\_\_\_
  - 9.9.3 The QSM shall contain a description of the certification and test reports delivered by the Supplier and a location where these records are stored..... \_\_\_\_\_
  - 9.9.4 The QSM shall include all QC testing of the supplied materials and shall contain a statement that no raw materials shall be used unless they are on the APL or they have been tested and meet all appropriate CDOT, AASHTO, or ASTM specifications..... \_\_\_\_\_



# CDOT EPOXY COATER QSM CHECKLIST

YES/NO/NA

- 9.9.5 All Supplier delivered materials shall be properly stored to prevent damage, contamination, or other alterations prior to use in production. The QSM shall include procedures for the adequate storage of supplied materials.....\_\_\_\_\_
  
- 9.10 The QSM shall describe the procedure and frequency for inspection and selection of material samples during production. Sampling shall be performed on a stratified random procedure in accordance with ASTM D 3665. All random QC sample locations shall be properly documented and these procedures shall be included in the QSM.....\_\_\_\_\_
  
- 9.11 The QSM shall contain descriptions and examples of the test report forms used by the Manufacturer. The QSM shall identify the individual(s) responsible for maintaining all test records and reports along with the location where the reports are stored.....\_\_\_\_\_

  - 9.11.1 The test reports shall be maintained and available for inspection for a minimum of three years.....\_\_\_\_\_

- 9.12 The QSM shall contain a description of the procedures used to identify and document all material or test results that do not conform to specification requirements. The QSM shall contain provisions for resolving non-conforming material or test results.....\_\_\_\_\_
  
- 9.13 The QSM shall describe procedures used to properly handle, store, and ship epoxy-coated steel reinforcing bars and epoxy-coated steel dowel bars.....\_\_\_\_\_

CDOT EPOXY COATER QSM CHECKLIST

Reviewers Signature

Reviewers Comments

CDOT Approving Engineer Signature

Part II, Sub-Part 3:

## Precast Concrete Structures - 21

### SCOPE:

This sub-part provides procedures for being included on the Qualified Manufacturers List (QML) as a fabricator of precast **(not prestressed)** concrete structures for CDOT projects. The precast concrete structures may include, but are not limited to: inlets, manholes, junction boxes, box culverts, modular bridges (3-sided box culvert), pipes, cattle guards, and Type 7 barrier. CDOT will only accept precast concrete structures by a manufacturer listed on the QML. Precast manufacturers of walls and girders will not be required to be on this QML.

### 1. REFERENCED DOCUMENTS

Where applicable, the latest edition of the following standards shall be considered a part of these requirements.

#### 1.1 CDOT Standard Specifications for Road and Bridge Construction:

- Section 106 - Control of Material
- Section 601 – Structural Concrete
- Section 603 – Culverts and Sewers
- Section 604 – Manholes, Inlets, and Vaults
- Section 606 – Guardrail
- Section 611 – Cattle Guards
- Section 617 – Culvert Pipe
- Section 701 – Hydraulic Cement
- Section 703 – Aggregates
- Section 709 – Reinforcing Steel and Wire Rope
- Section 711 – Concrete Curing Materials and Admixtures
- Section 712 - Miscellaneous

#### 1.2 CDOT Standard Plans (M & S Standards):

|          |  |
|----------|--|
| M-601-1  | Single Concrete Box Culvert                    |
| M-601-2  | Double Concrete Box Culvert                    |
| M-601-3  | Triple Concrete Box Culvert                    |
| M-601-10 | Headwalls for Pipe Culverts                    |
| M-603-2  | Reinforced Concrete Pipe                       |
| M-603-3  | Precast Concrete Box Culvert,                  |
| M-603-10 | Concrete and Metal End Sections,               |
| M-604-10 | Inlet, Type C                                  |
| M-604-11 | Inlet, Type D                                  |
| M-604-12 | Inlet, Type R                                  |
| M-604-13 | Inlet, Type 13                                 |
| M-604-20 | Manholes                                       |
| M-604-25 | Vane Grate Inlet with Frame and Concrete Apron |
| M-606-14 | Precast Type 7 Concrete Barrier                |
| M-611-1  | Cattle Guard                                   |

### 1.3 AASHTO Standards:

- M 6 Fine Aggregate for Portland Cement Concrete
- M 43 Sizes of Aggregate for Road and Bridge Construction
- M 55 Steel Welded Wire Reinforcement, Plain, for Concrete
- M 86 Standard Specification for Concrete Sewer, Storm Drain, and Culvert Pipe
- M 157 Ready-Mixed Concrete
- M 170 Standard Practice for Reinforced Concrete Culvert, Storm Drain, and Sewer Pipe
- M 206 Reinforced Concrete Arch Culvert, Storm Drain, and Sewer Pipe
- M 207 Reinforced Concrete Elliptical Culvert, Storm Drain, and Sewer Pipe
- M 221 Steel Welded Wire Reinforcement, Deformed, for Concrete
- M 242 Reinforced Concrete D-Load Culvert, Storm Drain, and Sewer Pipe
- M 284 Discontinued
- R 38 Quality Assurance of Standard Manufactured Materials

### 1.4 ASTM Standards:

- A 775 Standard Specification for Epoxy-Coated Steel Reinforcing Bars
- C 361 Standard Specification for Reinforced Concrete Low-Head Pressure Pipe
- C 923 Standard Specification for Resilient Connectors between Reinforced Concrete Manhole Structures, Pipes, and Laterals
- C 936 Standard Specification for Joints for Concrete Pipe, Manholes, and Precast Box Sections using Preformed Flexible Joint Sealants
- C 1017 Standard Specification for Chemical Admixtures for Use in Producing Flowing Concrete
- C 1478 Standard Specification for Storm Drain Resilient Connectors between Reinforced Concrete Storm Sewer Structures, Pipes, and Laterals
- D 3665 Standard Practice for Random Sampling of Construction Materials

## 2. TERMINOLOGY

- 2.1 See AASHTO M 262 Standard Terminology Relating to Concrete Pipe.
- 2.2 Conventional mix – In this Standard it shall be defined as a Class of concrete in Section 601 of CDOT's Standard Specifications for Road and Bridge Construction.
- 2.3 Dry Cast – In this Standard it shall be defined as zero slump concrete most often used for pipes, box culverts, and manholes.
- 2.4 Manufacturer – A Company which manufactures and supplies Standard Manufactured Materials for the Prime Contractor, Sub-contractor, or CDOT.
- 2.5 Prime Contractor – The Company under contract with CDOT to produce products using precast concrete structures.
- 2.6 Quality System Manual (QSM) – A written document that describes the overall internal quality control operating procedures of a Manufacturer. The QSM documents the internal policies for achieving quality and the assignment of responsibility and accountability for quality control within the Manufacturer's organization. It shall describe the minimum quality control requirements expected of material suppliers who are involved with the Manufacturer's product.

- 2.7 Self-Compacting (leveling) Concrete – In this Standard it shall be defined as a very high slump concrete where the spread is measured using a slump cone. The spread is usually between 22 to 32 inches in diameter. In addition, the mix usually contains a superplasticizer and a viscosity-modifying admixture (VMA). This concrete is usually used for manholes and inlets
- 2.8 Supplier – In this Standard it shall be defined as one who provides materials used in the manufacturing of precast concrete structures. Cement, fly ash, welded wire reinforcement (WWR), and epoxy coated reinforcing bar are among the materials provided to the manufacturer.
- 2.9 Wet Cast – In this Standard it shall be defined as anything other than zero slump concrete. This concrete is usually used for manholes and inlets.

### **3. SIGNIFICANCE AND USE**

- 3.1 This procedure specifies requirements that should be followed by the Manufacturer in implementing an effective Quality Control (QC) system. This is accomplished by a certification system that evaluates quality control practices and specification compliance tests performed by the Manufacturer according to their quality control plans.
- 3.2 This Standard specifies requirements and procedures for a certification system that shall be applicable to all Manufacturers providing precast concrete structures. These provisions initially apply to the plant manufacturing the precast concrete structures. These provisions subsequently apply to the Contractor, after delivery of the precast concrete structure to the Contractor, for use on CDOT projects.

### **4. SAMPLING**

- 4.1 All test samples required by this Standard shall be obtained using stratified random sampling techniques. Stratified random sampling should be performed in accordance with ASTM D 3665. The use of a stratified random sampling procedure is mandatory to the establishment of a valid QC program. All random QC sample locations shall be properly documented.

### **5. TESTING REQUIREMENTS**

- 5.1 Testing required for this Standard shall be performed by certified personnel or in accredited laboratories through appropriate QC Certification programs. Any satellite laboratory of a Manufacturer that performs required testing under this Standard shall be identified in the submitted Quality System Manual (QSM) (Section 9).
- 5.2 As a minimum, the certification program used shall include the following;
- 5.2.1 Training in AASHTO, ASTM, or ACI test procedures.
- 5.2.2 Demonstration of proficiency in each required test.
- 5.2.3 Demonstration of ability to properly document test results.

## 6. SUPPLIER REQUIREMENTS

- 6.1 Cement, fly ash, and concrete admixture suppliers shall be on CDOT's Approved Product List (APL) prior to use by the manufacturer. The APL along with instruction for completing CDOT Form #595, Pre-Approved Product Evaluation Request & Summary, can be found at: [www.codot.gov/business/APL/](http://www.codot.gov/business/APL/). The Form #595 is designed as a PDF Writable form, which must be completed by the supplier or their Product Representative. The completed form shall be returned to CDOT's Product Evaluation Coordinator as an e-mail attachment.
- 6.2 The cement and fly ash suppliers shall follow the procedures described in the CDOT approved quality control plan as required in CP 11 Part I, Sub-Part 3 and 4 respectively.
- 6.3 The steel supplier shall provide a copy of the Mill Test Report with each delivery which complies with CDOT's Buy America Requirement found in Subsection 106.11 of CDOT's Standard Specifications for Road and Bridge Construction.

## 7. CURRENTLY CERTIFIED MANUFACTURERS

- 7.1 A manufacturer, regardless of their current casting process, which has been certified for the past three consecutive years under the American Concrete Pipe Association (ACPA) for all pipe products, dry cast box culverts, and manholes, or under the National Precast Concrete Association (NPCA) for all pipe products, manholes, modular bridges, and other wet cast products, will be placed on the QML after submitting all of the following:
- The certificate from the current year and the preceding three consecutive years of evaluations from NPCA or ACPA,
  - The score summary sheets from the current year and the preceding three consecutive years of evaluations from NPCA or ACPA,
  - The Quality System Manual as outlined in Section 9 of this Standard.
- 7.2 A manufacturer, regardless of their current casting process, which has been certified for less than three consecutive years under the American Concrete Pipe Association (ACPA) for all pipe products, dry cast box culverts, and manholes or under the National Precast Concrete Association (NPCA) for manholes, modular bridges, and other wet cast products will be on probation and placed on the QML after submitting all of the following:
- The certificate from the current year along with any preceding years of evaluations from NPCA or ACPA,
  - The score summary sheets from the current year along with any preceding years of evaluations from NPCA or ACPA,
  - The Quality System Manual as outlined in Section 9 of this Standard.
- 7.2.1 The probation period will be for three consecutive years after being placed on the QML.

## **8. DECERTIFICATION**

- 8.1 If the manufacturer becomes decertified after being placed on the QML, the manufacturer will be removed from the QML until successfully completing and submitting to CDOT the requirements within this Standard. The manufacturer may apply for reinstatement on the QML no sooner than six months after removal from the QML.
- 8.2 If the manufacturer becomes decertified due to a structural failure of a product during the probationary period, the manufacturer will be removed from the QML until successfully completing and submitting to CDOT the requirements within this Standard. A structural failure will be determined by the Engineer in accordance with the FHWA Report Number FHWA-IP-86-2 "Culvert Inspection Manual." The manufacturer may apply for reinstatement on the QML no sooner than three years after removal from the QML.

## **9. MANUFACTURER'S QUALITY SYSTEM MANUAL (MINIMUM REQUIREMENTS)**

- 9.1 On an annual basis, at a minimum of one month prior to producing any precast concrete structure for a CDOT project, one complete printed and bound original, and one complete electronic copy of the Manufacturer's Quality System Manual (QSM) shall be submitted for review and approval to CDOT's Product Evaluation Engineer (303) 398-6505 within the Staff Materials & Geotechnical Branch at 4670 North Holly Street, Unit A, Denver, Colorado 80216-6408. CDOT's approval of the QSM is intended only to indicate that the QSM is in conformance with the minimum QC requirements set forth in this Standard. Once the manufacturer is approved and on the Qualified Manufacturers List (QML), the QSM provisions will remain in effect for a maximum period of one calendar year, unless revisions are determined to be necessary by the Quality Control Manager or requested by CDOT, or if the manufacturer is decertified. If any revisions are made to the current year QSM, such revisions shall be submitted to CDOT in both printed and electronic format for review and approval. Guidelines for preparing a QSM may be available from the National Precast Concrete Association (NPCA) or the American Concrete Pipe Association (ACPA).
- 9.2 The Manufacturer's QSM may be maintained in electronic format. However, one or more copies of the QSM shall be maintained by the Manufacturer's QC Manager in a printed and bound format (3-ring binder or other). The QSM shall be available to all of the Manufacturer's employees. Each document in the QSM shall indicate its preparation date and all pages of the QSM shall be numbered. If a document is revised, the date of revision shall be indicated on the document and recorded in a table of revisions.
- 9.3 The Manufacturer's QSM shall be formatted to provide numbered sections which meet the following order, format, and content:
- 9.3.1 Manufacturer's quality policy or mission Statement endorsed by the company's Chief Executive Officer.
- 9.3.1.1 The quality policy / mission statement shall indicate support of top management to enforce the QC requirements contained in the QSM.
- 9.3.2 The QSM shall include the address and telephone numbers of applicable personnel at the manufacturing facility.

- 9.3.3 The QSM shall include a brief listing and description of all the precast products being manufactured at the facility.
- 9.3.4 The QSM shall present and define any significant terms used throughout the QSM.
- 9.3.5 For all manufactured items addressed in the QSM, the applicable AASHTO, ASTM, or CDOT specification shall be identified.
- 9.3.6 The QSM shall present the personnel structure established to implement the Manufacturer's quality system. The specific roles and responsibilities of all QC personnel shall be documented as follows:
- 9.3.6.1 The QSM shall contain an organizational chart. The chart shall indicate a clear separation between the QC personnel and the production personnel. The QC Manager shall be allowed direct access to top management, independent from production.
- 9.3.6.2 Each facility shall have a Quality Control Manager who has the overall responsibility for implementing the requirements of the QSM. At least one QC Manager shall be on-site during production. The QC Manager shall review the established QC system annually in order to satisfy this requirement, or if changes in the manufacturing process(s) occur, or whenever technical or CDOT information indicate a trend in reduced quality.
- 9.3.6.3 Each facility shall have at least one Quality Control Technician to perform QC sampling, testing, and inspection. At least one QC Technician shall be on-site during production. The QC Technicians shall be familiar with the tests they perform and have sufficient authority to assure corrective actions are carried out when necessary. The QSM shall indicate the line of authority of the QC Technicians, which shall demonstrate their authority to require corrective action. The QSM shall designate the certified QC Technicians at the facility and laboratory involved in the production or testing of the precast concrete structures.
- 9.4 The QSM shall contain a description of the certifications required and attained and years of experience for each QC Manager and QC Technician. All QC sampling, testing, and inspection personnel shall be certified by ACI Concrete Field Technician Level 1 or higher. Plants certified by NPCA shall have at least one QC Manager and at least one QC Technician who has successfully completed the NPCA's Production and Quality School or ACPA's approved equivalent. The QSM shall also include periodic auditing of each QC technician's ability to satisfactorily perform the required tests. Retraining shall be provided when the test method is revised.
- 9.5 The QSM shall provide for specific training for frontline production personnel in the safe and correct operating procedures implemented to ensure the required quality of all precast concrete structures.
- 9.6 The Manufacturer shall maintain its own accredited or qualified laboratory to perform QC testing. The QSM shall include the address and telephone numbers of a designated backup accredited or qualified laboratory. The laboratory shall meet the minimum accreditations or qualifications obtained through one or more of the following programs depending on the casting process:



- 9.6.1 For “dry” cast plant laboratories:
  - 9.6.1.1 National accreditation programs such as AASHTO Accreditation Program or American Association for Laboratory Accreditation.
  - 9.6.1.2 Either the Manufacturing industry’s American Concrete Pipe Association’s Q-Cast program or the National Precast Concrete Association Certification program.
- 9.6.2 For “conventional”, “wet”, or “Self-Compacting” cast plant laboratories:
  - 9.6.2.1 National accreditation programs such as AASHTO Accreditation Program or American Association for Laboratory Accreditation.
  - 9.6.2.2 The Manufacturing industry’s National Precast Concrete Association Certification program.
- 9.7 The QSM shall contain an inventory of the major equipment used for sampling and testing along with associated calibration equipment used for each required test procedure. The QSM shall assign a unique identification number to each piece of testing equipment. The QSM inventory for each major piece of equipment shall include the following information:
  - 9.7.1 The name of each major piece of equipment, date placed in service, manufacturer, model and serial number. The QSM shall include the location where the instructions for use and operation of each major piece is stored if not included in the QSM.
    - 9.7.1.1 For each major piece of equipment, the QSM shall include the interval of calibration or verification, a reference to the calibration or verification procedures used, and the location where the current calibration or verification records are stored. The QSM shall describe the methods for ensuring that the calibration and verification procedures are performed at the specified intervals.
- 9.8 The QSM shall identify all types of supplier delivered materials used for the production of precast concrete structures.
  - 9.8.1 The QSM shall contain a copy of the signed certification from each steel supplier that all steel products delivered to the manufacturer will be from products manufactured in the United States of America as stipulated in Section 6 of this Standard.
    - 9.8.1.1 The QSM shall include the manufacture’s process for tracking and submitting the Mill Test Reports on reinforcing steel permanently incorporated into each segment of precast concrete box culverts delivered to a CDOT project.
  - 9.8.2 The QSM shall contain a description of the specification requirements for all supplier delivered materials.
  - 9.8.3 The QSM shall contain a description of the certification and test reports delivered by the supplier and a location where these records are stored.

- 9.8.4 The QSM shall include all QC testing of the supplied materials and shall contain a statement that no raw materials shall be used unless they are on the APL or they have been tested and meet all appropriate CDOT, AASHTO, or ASTM specifications.
- 9.8.5 All supplier delivered materials shall be properly stored to prevent damage, contamination, or other alterations prior to use in production. The QSM shall include procedures for the adequate storage of supplied materials.
- 9.9 The QSM shall describe the procedure and frequency for inspection and selection of material samples during production. Sampling shall be performed on a stratified random procedure in accordance with ASTM D 3665. All random QC sample locations shall be properly documented and these procedures shall be included in the QSM.
- 9.10 The QSM shall contain descriptions and examples of the test report forms used by the manufacturer. The QSM shall identify the individual(s) responsible for maintaining all test records and reports along with the location where the reports are stored.
- 9.10.1 The test reports shall be maintained and available for inspection for a minimum of three years.
- 9.11 The QSM shall contain a description of the procedures used to identify and document all material or test results that do not conform to specification requirements. The QSM shall contain provisions for resolving non-conforming material or test results.
- 9.12 The QSM shall include drawings, with dimensions, of the forms used to produce precast concrete structures for CDOT.
- 9.12.1 Drawings and dimensions for precast modular concrete bridges will not be required with the QSM. However, they shall be submitted to Staff Bridge in accordance with Subsection 105.02 of the Standard Specifications.
- 9.13 The QSM shall describe the method used to permanently mark the precast concrete structure in accordance with the appropriate AASHTO or ASTM standard.
- 9.14 The QSM shall describe procedures used to properly handle, store, and ship precast concrete structures.

## **10. CERTIFICATE OF COMPLIANCE**

- 10.1 The manufacturer shall prepare a standard Certificate of Compliance (COC) for each precast concrete structure delivered to a CDOT project. The COC shall contain all of the required information as stipulated in the CDOT Special Notice to Contractors. The COC shall include all necessary information to properly identify each precast concrete structure represented by the COC. The COC shall include a statement as to whether the element(s) being shipped complies with the Buy America Requirements found in Subsection 106.11 of CDOT's Standard Specifications for Road and Bridge Construction.

**11. MANUFACTURING FACILITY INSPECTION AND CERTIFICATION**

- 11.1 Manufacturing facilities producing precast pipe and box culvert shall meet the minimum industry standards, and be annually inspected and certified by the ACPA. Manufacturing facilities producing manholes shall meet the minimum industry standards, and be annually inspected and certified by either the ACPA or the NPCA. Manufacturing facilities producing precast pipe, modular bridges, and other precast concrete structures shall meet the minimum industry standards, and be annually inspected and certified by the NPCA. A copy of the certification shall be submitted to CDOT as part of the QML process.
- 11.2 Failure in one or more Sections or Sub-sections listed in this Standard may result in an accelerated inspection program. Any additional failures to meet these minimum requirements shall result in the decertification of the plant and the plant will be removed from the QML. The manufacturer may apply for reinstatement on the QML no sooner than six months after removal from the QML as stipulated in Section 8 of this Standard.
- 11.3 Within two months after submitting all required information, CDOT will notify the manufacturer of precast concrete structures whether or not the manufacturing facility's application for the Qualified Manufacturers List has been granted.
- 11.4 CDOT or CDOT representative will randomly inspect the operations or perform quality assurance testing each plant on the QML a minimum of once every 5 years. Additionally, CDOT may inspect the operations or perform quality assurance testing at any time.

{Page Intentionally Left Blank}

# CDOT PRECAST MANUFACTURERS QSM CHECKLIST

Manufacturer Name: \_\_\_\_\_ Date: \_\_\_\_\_

Plant Facility Name and Location: \_\_\_\_\_

Submitted By: \_\_\_\_\_ Phone number: \_\_\_\_\_

E-Mail: \_\_\_\_\_

Manufacturer Additional Comments:

Reference: 2020 CDOT Field Materials Manual, CP-11 (Precast Structures)

<https://www.codot.gov/business/designsupport/materials-and-geotechnical/manuals>

## 9. MANUFACTURER'S QUALITY SYSTEM MANUAL (QSM) (MINIMUM REQUIREMENTS)

- 9.1 On an annual basis, at a minimum of one month prior to producing any precast concrete structure for a CDOT project, one complete printed and bound original, and one complete electronic copy of the Manufacturer's Quality System Manual (QSM) shall be submitted for review and approval to CDOT's Product Evaluation Administrator (303) 398-6566 within the Staff Materials & Geotechnical Branch at 4670 North Holly Street, Unit A, Denver, Colorado 80216-6408. CDOT's approval of the QSM is intended only to indicate that the QSM is in conformance with the minimum QC requirements set forth in this Standard. Once the manufacturer is approved and on the Qualified Manufacturers List (QML), the QSM provisions will remain in effect for a maximum period of one calendar year, unless revisions are determined to be necessary by the Quality Control Manager or requested by CDOT, or if the manufacturer is decertified. If any revisions are made to the current year QSM, such revisions shall be submitted to CDOT in both printed and electronic format for review and approval. Guidelines for preparing a QSM may be available from the National Precast Concrete Association (NPCA) or the American Concrete Pipe Association (ACPA)
- 9.2 The Manufacturer's QSM may be maintained in electronic format. However, one or more copies of the QSM shall be maintained by the Manufacturer's QC Manager in a printed and bound format (3-ring binder or other). The QSM shall be available to all of the Manufacturer's employees. Each document in the QSM shall indicate its preparation date and all pages of the QSM shall be numbered. If a document is revised, the date of revision shall be indicated on the document and recorded in a table of revisions.

# CDOT PRECAST MANUFACTURERS QSM CHECKLIST

YES/NO/NA

- 9.3 The Manufacturer's QSM shall be formatted to provide numbered sections which meet the following order, format, and content:..... \_\_\_\_\_
- 9.3.1 Manufacturer's quality policy or mission Statement endorsed by the company's Chief Executive Officer..... \_\_\_\_\_
- 9.3.1.1 The quality policy / mission statement shall indicate support of top management to enforce the QC requirements contained in the QSM..... \_\_\_\_\_
- 9.3.2 The QSM shall include the address and telephone numbers of applicable personnel at the manufacturing facility..... \_\_\_\_\_
- 9.3.3 The QSM shall include a brief listing and description of all the precast products being manufactured at the facility..... \_\_\_\_\_
- 9.3.4 The QSM shall present and define any significant terms used throughout the QSM..... \_\_\_\_\_
- 9.3.5 For all manufactured items addressed in the QSM, the applicable AASHTO, ASTM, or CDOT specification shall be identified..... \_\_\_\_\_
- 9.3.6 The QSM shall present the personnel structure established to implement the Manufacturer's quality system. The specific roles and responsibilities of all QC personnel shall be documented as follows:..... \_\_\_\_\_

# CDOT PRECAST MANUFACTURERS QSM CHECKLIST

YES/NO/NA

- 9.3.6.1 The QSM shall contain an organizational chart. The chart shall indicate a clear separation between the QC personnel and the production personnel. The QC Manager shall be allowed direct access to top management, independent from production..... \_\_\_\_\_
  
- 9.3.6.2 Each facility shall have a Quality Control Manager who has the overall responsibility for implementing the requirements of the QSM. At least one QC Manager shall be on-site during production. The QC Manager shall review the established QC system annually in order to satisfy this requirement, or if changes in the manufacturing process(s) occur, or whenever technical or CDOT information indicate a trend in reduced quality..... \_\_\_\_\_
  
- 9.3.6.3 Each facility shall have at least one Quality Control Technician to perform QC sampling, testing, and inspection. At least one QC Technician shall be on-site during production. The QC Technicians shall be familiar with the tests they perform and have sufficient authority to assure corrective actions are carried out when necessary. The QSM shall indicate the line of authority of the QC Technicians, which shall demonstrate their authority to require corrective action. The QSM shall designate the certified QC Technicians at the facility and laboratory involved in the production or testing of the precast concrete structures..... \_\_\_\_\_
  
- 9.4 The QSM shall contain a description of the certifications required and attained and years of experience for each QC Manager and QC Technician. All QC sampling, testing, and inspection personnel shall be certified by ACI Concrete Field Technician Level 1 or higher. Plants certified by NPCA shall have at least one QC Manager and at least one QC Technician who has successfully completed the NPCA's Production and Quality School or ACPA's approved equivalent. The QSM shall also include periodic auditing of each QC technician's ability to satisfactorily perform the required tests. Retraining shall be provided when the test method is revised..... \_\_\_\_\_
  
- 9.5 The QSM shall provide for specific training for frontline production personnel in the safe and correct operating procedures implemented to ensure the required quality of all precast concrete structures..... \_\_\_\_\_
  
- 9.6 The Manufacturer shall maintain its own accredited or qualified laboratory to perform QC testing. The QSM shall include the address and telephone numbers of a designated backup accredited or qualified laboratory. The laboratory shall meet the minimum accreditations or qualifications obtained through one or more of the following programs depending on the casting process:..... \_\_\_\_\_

# CDOT PRECAST MANUFACTURERS QSM CHECKLIST

YES/NO/NA

## 9.6.1 For “dry” cast plant laboratories:

9.6.1.1 National accreditation programs such as AASHTO Accreditation Program or American Association for Laboratory Accreditation..... \_\_\_\_\_

9.6.1.2 Either the Manufacturing industry’s American Concrete Pipe Association’s Q-Cast program or the National Precast Concrete Association Certification program..... \_\_\_\_\_

## 9.6.2 For “conventional”, “wet”, or “Self-Compacting” cast plant laboratories:

9.6.2.1 National accreditation programs such as AASHTO Accreditation Program or American Association for Laboratory Accreditation..... \_\_\_\_\_

9.6.2.2 The Manufacturing industry’s National Precast Concrete Association Certification program..... \_\_\_\_\_

9.7 The QSM shall contain an inventory of the major equipment used for sampling and testing along with associated calibration equipment used for each required test procedure..... \_\_\_\_\_

The QSM shall assign a unique identification number to each piece of testing equipment..... \_\_\_\_\_

### The QSM inventory for each major piece of equipment shall include the following information:

9.7.1 The name of each major piece of equipment, date placed in service, manufacturer, model and serial number. The QSM shall include the location where the instructions for use and operation of each major piece is stored if not included in the QSM..... \_\_\_\_\_

9.7.1.1 For each major piece of equipment, the QSM shall include the interval of calibration or verification, a reference to the calibration or verification procedures used, and the location where the current calibration or verification records are stored. The QSM shall describe the methods for ensuring that the calibration and verification procedures are performed at the specified intervals..... \_\_\_\_\_

9.8 The QSM shall identify all types of supplier delivered materials used for the production of precast concrete structures..... \_\_\_\_\_

9.8.1 The QSM shall contain a copy of the signed certification from each steel supplier that all steel products delivered to the manufacturer will be from products manufactured in the United States of America as stipulated in Section 6 of this Standard..... \_\_\_\_\_

9.8.1.1 The QSM shall include the manufacture’s process for tracking and submitting the Mill Test Reports on reinforcing steel permanently incorporated into each segment of precast concrete box culverts delivered to a CDOT project..... \_\_\_\_\_

9.8.2 The QSM shall contain a description of the specification requirements for all supplier delivered..... \_\_\_\_\_



# CDOT PRECAST MANUFACTURERS QSM CHECKLIST

YES/NO/NA

- 9.8.3 The QSM shall contain a description of the certification and test reports delivered by the supplier and a location where these records are stored..... \_\_\_\_\_
- 9.8.4 The QSM shall include all QC testing of the supplied materials and shall contain a statement that no raw materials shall be used unless they are on the APL or they have been tested and meet all appropriate CDOT, AASHTO, or ASTM specifications..... \_\_\_\_\_
- 9.8.5 All supplier delivered materials shall be properly stored to prevent damage, contamination, or other alterations prior to use in production. The QSM shall include procedures for the adequate storage of supplied materials..... \_\_\_\_\_
- 9.9 The QSM shall describe the procedure and frequency for inspection and selection of material samples during production. Sampling shall be performed on a stratified random procedure in accordance with ASTM D 3665. All random QC sample locations shall be properly documented and these procedures shall be included in the QSM..... \_\_\_\_\_
- 9.10 The QSM shall contain descriptions and examples of the test report forms used by the manufacturer. The QSM shall identify the individual(s) responsible for maintaining all test records and reports along with the location where the reports are stored..... \_\_\_\_\_
- 9.10.1 The test reports shall be maintained and available for inspection for a minimum of three years..... \_\_\_\_\_
- 9.11 The QSM shall contain a description of the procedures used to identify and document all material or test results that do not conform to specification requirements. The QSM shall contain provisions for resolving non-conforming material or test results..... \_\_\_\_\_
- 9.12 The QSM shall include drawings, with dimensions, of the forms used to produce precast concrete structures for CDOT..... \_\_\_\_\_
- 9.12.1 Drawings and dimensions for precast modular concrete bridges will not be required with the QSM. However, they shall be submitted to Staff Bridge in accordance with Subsection 105.02 of the Standard Specifications..... \_\_\_\_\_
- 9.13 The QSM shall describe the method used to permanently mark the precast concrete structure in accordance with the appropriate AASHTO or ASTM standard..... \_\_\_\_\_
- 9.14 The QSM shall describe procedures used to properly handle, store, and ship precast concrete structures..... \_\_\_\_\_

# CDOT PRECAST MANUFACTURERS QSM CHECKLIST

CDOT Reviewers Comments:

CDOT Reviewers Signature

Approving Engineer Comments:

CDOT Approving Engineer Signature



# COLORADO

## Department of Transportation

Materials and Geotechnical Branch  
4670 North Holly Street  
Denver, CO 80216  
303-398-6502

### Precast Structure Manufacturers Certification Letter

January 2, 2021

Manufacturers,

This letter is a notification to all Precast Structure Suppliers as defined in CP 11 (Precast Structure) of the CDOT Field Materials Manual (FMM) that will be supplying Precast Structure product for CDOT projects for the calendar year 2021. Failure to comply with the protocol as described may delay or prevent your specific facility from being posted to the CDOT Qualified Manufacturers List (QML) and therefore delaying your Precast Facility products from being used on CDOT projects.

Please review the 2020 CDOT FMM requirements [CP 11 (Precast Structure)].

February 1st of each year is considered the end of the previous construction season and the beginning of a new season. All Precast Structure Manufacturers approved will remain on the CDOT QML until suspension or removal by CDOT Engineer. The referenced Manufacturers will remain posted only as an aid to the Manufacturer and CDOT Project Personnel as to what Manufacturers are available for use on CDOT projects.

1) Manufacturers must submit an updated Quality Systems Manual [CP11 (Precast Structure Section, 9.1)] both a complete printed and bound original (3-ring binder) and one complete electronic copy (Adobe Acrobat PDF format) dated February 1, 2020 or newer and sent to the following address;

Colorado Department of Transportation  
Attn: Melody Perkins / Edward Trujillo  
4670 North Holly St., Unit A  
Denver, Colorado 80216  
melody.perkins@state.co.us  
edward.trujillo@state.co.us

2) Manufacturers must submit a completed CDOT Precast Manufacturers QSM checklist for each Precast Structure facility expected to be placed on the CDOT Qualified Manufacturers List [CP 11 (Precast Structure) Section 9.1]. Your approved and accepted Precast Structure facilities can be viewed on the CDOT Qualified Materials List (QML) from the CDOT link listed below.

<http://apps.coloradodot.info/apl/AplSearch.cfm>

2a) The Posted CDOT Precast Manufacturers QSM Checklist should be used as examples of what is correct in format and content. They should be adhered to unless there is an error. Errors are to be communicated immediately to the CDOT Product Evaluation Coordinator. It must be indicated within the Description of the Precast Facility.



Please submit the completed CDOT Precast Manufacturers QSM Checklist to the following e-mail address as soon as possible after the distribution of Quality Systems Manual and updates CDOT to;

Colorado Department of Transportation  
Attn: Edward A Trujillo,  
Product Evaluation Coordinator  
4670 North Holly St., Unit A  
Denver, Colorado 80216  
edward.trujillo@state.co.us

3) Once we have received and approved your Quality Systems Manual both a complete printed and bound original (3-ring binder) and one complete electronic copy (Adobe Acrobat PDF format), The approved Precast Manufacturer will be placed on the 2021 Qualified Manufactures List (CP 11(Precast Structure), Section 9).

If you need additional information, please feel free to give me a call or send an e-mail.

Edward A Trujillo,  
Product Evaluation Coordinator  
4670 North Holly St., Unit A  
Denver, Colorado 80216

edward.trujillo@state.co.us

Office: 303-398-6566  
Cell: 303-304-3468



**Colorado Procedure 12A-21**  
*Standard Practice for*

**Contractor's Hot Mix Asphalt  
Process Control Notebook**

**1. SCOPE**

- 1.1 This Standard describes the best practice to be used when developing appropriate worksheets and forms in a Process Control (PC) notebook.
- 1.2 The requirements such as, but not limited to: the sample size, specimen size, number of specimens, interpretation of results, reporting significant digits, and precision statements are in the specific test method.
- 1.3 This practice is to be used when quantities exceed 500 tons of Item 403.

**2. GENERAL PC NOTEBOOK REQUIREMENTS**

- 2.1 The following information shall be included on each page of a worksheet or form:

- 1. Project number, Contract ID, and Project location
- 2. Item number and grading
- 3. Supplier's name and address
- 4. Name of the laboratory performing the test
- 5. CDOT Form #43 HMA mix design number
- 6. Date, location, and time the sample was taken or the beginning of the test
- 7. Name of the person taking the sample and performing the test
- 8. Test number
- 9. Quantity of material placed to date at the time of taking the sample
- 10. Type of test performed
- 11. Specification limits
- 12. Remarks area

**3. SAMPLE LOCATION WORKSHEET**

- 3.1 The following shall be included on the sample location worksheet:

- 1. Temperature of the mix at the time sampled
- 2. Sampling method (plant, windrow, etc.)

**4. PERCENT ASPHALT CEMENT CONTENT WORKSHEET**

4.1 When using the asphalt cement (AC) content gauge [nuclear] to determine percent asphalt cement in the specimen, the following shall be included on the worksheet:

1. Base weight
2. HMA sample location or lift
3. Test temperature (if applicable)
4. Background count
5. Measured count
6. Gauge measured percent AC
7. Percent moisture as determined from Subsection 5.1
8. Corrected percent AC
9. Dry aggregate count (if applicable)

4.2 When using the ignition oven to determine percent asphalt cement in the specimen, the following shall be included on the worksheet:

1. Weight of the baskets
2. Weight of each basket and HMA before ignition from both the external and internal scales
3. Weight of each basket and HMA after ignition
4. Weight of HMA before ignition
5. Weight of HMA after ignition
6. Lost HMA weight due to ignition
7. Percent uncorrected AC in HMA
8. Asphalt correction factor
9. Corrected percent AC

**5. PERCENT MOISTURE WORKSHEET**

5.1 When determining the percent moisture in a HMA specimen, the following shall be included on the worksheet:

1. Weight of the tare (if applicable)
2. Wet and dry weights of the specimen
3. Weight of lost moisture
4. Percent moisture

**6. SIEVE ANALYSIS WORKSHEET**

6.1 When performing a sieve analysis and determining the aggregate gradation, the following shall be included on the worksheet:

1. Weight of the tare (if applicable)
2. Wet weight of material before washing
3. Dry weight of material before washing
4. Weight of moisture lost due to drying
5. Percent moisture
6. Weight retained on the applicable sieve size
7. Percent retained on the applicable sieve size
8. Percent passing the applicable sieve size
9. Total weight sieved
10. Dry weight after washing
11. Percent difference between item 9 and 10

**7. MAXIMUM SPECIFIC GRAVITY WORKSHEET**

7.1 When determining the maximum specific gravity, the water temperature calibration for each flask shall be developed and in the contactor's files. When determining the maximum specific gravity, the following shall be included on the worksheet:

1. Weight of each flask
2. Weight of each sample and flask
3. Weight of each sample
4. Weight of each flask filled with water and the lid
5. Weight of each flask filled with the sample, water, and lid
6. Temperature of the water
7. Maximum specific gravity
8. Average maximum specific gravity

**8. AIR VOIDS and VMA WORKSHEET**

8.1 When determining the air voids of a laboratory compacted specimen, the following shall be included on the worksheet:

1. Total weight of the specimen in air
2. Weight of the surface-dry specimen in air
3. Weight of the specimen in water
4. Percent water absorbed by volume
5. Bulk specific gravity of the specimen
6. Average maximum specific gravity as determined from Subsection 7.1
7. Percent air voids

8.2 When determining the voids in the mineral aggregate (VMA) of a laboratory compacted HMA specimen, the following shall be included on the worksheet:

1. Bulk specific gravity of the aggregate as determined from Subsection 8.1 steps 1 through 4
2. Percent of aggregate based on the total weight of the mix
3. Percent of voids in the mineral aggregate based on bulk volume

**9. LOTTOMAN WORKSHEET** (when Lottman PC testing is required by the Contract)

9.1 When determining the Resistance of Compacted Bituminous Mixture to Moisture Induced Damage (Lottman Test), the following shall be included in the worksheet:

1. Specimen height
2. Theoretical maximum specific gravity of mixture
3. Percent air voids (individual specimen)
4. Average air voids (dry specimens)
5. Average air voids (conditioned specimens)
6. Total dry weight of specimen in air
7. Weight of the surface-dry specimen in air
8. Weight of the specimen in water
9. Percent water absorbed by volume
10. Dry Tensile Strength (individual specimen)
11. Wet Tensile Strength (individual specimen)
12. Average Dry Tensile Strength
13. Average Wet Tensile Strength
14. Maximum loading (individual specimen)
15. Percent Tensile Strength Retained (%TSR)
16. Percent saturation (individual specimen)
17. Percent swell (individual specimen)

**10. HOT MIX ASPHALT DENSITY WORKSHEET**

10.1 When determining the density of the compacted HMA mat using a moisture-density gauge [nuclear], the following shall be included on the worksheet:

1. Station and distance from centerline (right or left)
2. Daily maximum specific gravity
3. Standard count
4. Measured count or wet density for each reading
5. Average of the measured counts or wet densities
6. Ratio of the average density count and the standard count (if applicable)
7. Field specific gravity
8. Correction factor determined from CDOT Form #469 (if applicable)
9. Adjusted field specific gravity
10. Percent relative compaction



10.2 When determining the density of the compacted HMA mat using cores, the following shall be included on the worksheet:

1. Date specimen was retrieved
2. Dry weight in air
3. Weight of the saturated surface dried specimen
4. Weight of the specimen in water
5. Bulk specific gravity of the specimen
6. Daily maximum specific gravity
7. Percent relative compaction

#### **11. LONGITUDINAL JOINT WORKSHEET**

11.1 When determining the longitudinal joint density of the compacted HMA mat using cores, the following shall be included on the worksheet:

1. Date the lift was placed
2. Date the specimen was retrieved
3. Average lift thickness
4. Dry weight in air
5. Weight of the saturated surface dried specimen
6. Weight of the specimen in water
7. Bulk specific gravity of the specimen
8. Maximum specific gravity in accordance with specifications
9. Percent relative compaction at the longitudinal joint

#### **12. FREE MOISTURE FOR PERCENT LIME WORKSHEET**

12.1 When determining the percent free moisture specified for hydrated lime used in HMA, the following shall be included on the worksheet:

1. Weight of the tare
2. Wet and dry weights of the specimen
3. Weight of lost moisture
4. Percent moisture
5. Percent absorption (from the mix design)
6. Percent surface (free) moisture

#### **13. SUBMITTAL OF PC NOTEBOOK**

Once the Contractor has completed production of all Hot Mix Asphalt on the Project the Contractor shall submit the final PC notebook to the Department in an electronic format. The file shall be scanned in sequential order by date and the file should be a pdf. The electronic PC notebook shall be delivered to the Department within 10 working days after the end of production.

{Page Intentionally Left Blank}

## Colorado Procedure 12B-21

*Standard Practice for*

### **Contractor's Portland Cement Concrete Paving Process Control Notebook**

#### **1. SCOPE**

- 1.1 This Standard describes the best practice to be used when developing appropriate worksheets and forms in a Process Control (PC) notebook.
- 1.2 The requirements such as, but not limited to: the sample size, specimen size, number of specimens, interpretation of results, reporting significant digits, and precision statements are in the specific test method.
- 1.3 This practice is to be used when quantities exceed 1000 square yards of Item 412.

#### **2. GENERAL PC NOTEBOOK REQUIREMENTS**

- 2.1 The following information shall be included on each page of a worksheet or form:

- 1. Project number, Contract ID, and Project location
- 2. Item number and grading or class
- 3. Supplier's name and address
- 4. Name of the laboratory performing the test
- 5. Date, location, and time the sample was taken or the beginning of the test
- 6. Type of test performed
- 7. Sampling method
- 8. Name of the person taking the sample and performing the test
- 9. Sample ID number
- 10. Quantity of material placed to date at the time of taking the sample
- 11. Specification limits
- 12. Remarks area

#### **3. PAVEMENT TEXTURE WORKSHEET**

- 3.1 When determining the texture depth, the following shall be included on the worksheet:
  - 1. 10 consecutive texture depth readings
  - 2. Average depth

**4. SIEVE ANALYSIS WORKSHEET**

4.1 When performing a sieve analysis and determining the aggregate gradation, the following shall be included on the worksheet:

1. Weight of the tare
2. Wet weight of material before washing
3. Dry weight of material before washing
4. Weight of moisture lost due to drying
5. Percent moisture
6. Dry weight after washing
7. Weight retained on the applicable sieve size
8. Percent passing the applicable sieve size
9. Total weight sieved
10. Percent difference between number 6 & 9
11. Test Date

**5. WATER CEMENTITIOUS MATERIAL RATIO WORKSHEET**

5.1 When determining the water cementitious material ratio the following shall be included on the worksheet:

1. CDOT Form #1373 mix design number
2. Weight of Cement
3. Weight of Fly ash
4. Weight of total cementitious material
5. Moisture content of each aggregate
6. Absorption of each aggregate
7. Free moisture of each aggregate
8. Weight of batch water
9. Weight of total water
10. Water cementitious material ratio

**6. JOINT SEALANT PULL TEST WORKSHEET**

6.1 When determining the joints pull test, the following shall be included on the worksheet:

1. Method Used
2. Pass / Fail

**7. COMPRESSIVE STRENGTH WORKSHEET**

7.1 When determining the compressive strength of a molded cylinder the following shall be included on the worksheet:

1. CDOT Form #1373 mix design number
2. Time of initial cure
3. Minimum & maximum temperature of curing facility
4. Age of specimen
5. 2 diameter measurements & average diameter or established diameter
6. Cross sectional area
7. Cylinder cap type
8. Maximum load
9. Fracture type (if necessary)
10. Compressive strength of each cylinder
11. Average compressive strength
12. Slump of the fresh concrete
13. Air temperature at the time of sampling
14. Temperature of the fresh concrete
15. Air content of the fresh concrete
16. Unit weight of the fresh concrete including the following:
  - a. Pot tare weight
  - b. Pot volume
  - c. Weight of pot & concrete
17. Yield of the fresh concrete

7.2 When determining the compressive strength of a core the following shall be included on the worksheet:

1. CDOT Form #1373 mix design number
2. Age of specimen
3. 2 diameter measurements & average diameter or established diameter
4. Cross sectional area
5. Core length
6. L/D ratio & correction factor
7. Core cap type
8. Maximum load
9. Fracture type
10. Compressive strength of each core
11. Average compressive strength

**8. FLEXURAL STRENGTH WORKSHEET**

8.1 When determining the flexural strength the following shall be included on the worksheet:

1. CDOT Form #1373 mix design number
2. Time of initial cure
3. Minimum & maximum temperature of curing facility
4. Age of specimen
5. 3 width measurements & average width
6. 3 height measurements & average height
7. Span length
8. Maximum load
9. Distance between fracture & nearest support
10. Modulus of rupture of each beam
11. Average modulus of rupture
12. Slump of the fresh concrete
13. Air temperature at the time of sampling
14. Temperature of the fresh concrete
15. Air content of the fresh concrete
16. Unit weight of the fresh concrete including the following:
  - a. Pot tare weight
  - b. Pot volume
  - c. Weight of pot & concrete
17. Yield of the fresh concrete

**9. PAVEMENT THICKNESS WORKSHEET**

9.1 When determining the pavement thickness, the following shall be included on the worksheet:

1. Thickness
2. Difference in thickness from plan thickness

**10. SAND EQUIVALENT WORKSHEET**

10.1 When determining the equivalency the following shall be included on the worksheet:

1. Type of shaker
2. Age of stock solution
3. Clay reading of each specimen
4. Sand reading of each specimen
5. Sand equivalent of each specimen
6. Average sand equivalent
7. Date Tested

**11. Pavement Smoothness**

11.1 When determining the pavement smoothness, the following shall be included:

1. Distance calibration site
2. Start and stop locations
3. Time of each test
4. MRI of each section

**12. Pavement Texture**

12.1 When determining the pavement texture, the following shall be included on the worksheet:

1. Location of test
2. Diameter of each measurement
3. Average diameter at test location
4. Macro-texture thickness

**13. SUBMITTAL OF PC NOTEBOOK**

Once the Contractor has completed production of all Portland Cement Concrete on the Project the Contractor shall submit the final PC notebook to the Department in an electronic format. The file shall be scanned in sequential order by date and the file should be a pdf. The electronic PC notebook shall be delivered to the Department within 10 working days after the end of production.

{Page Intentionally Left Blank}



## Colorado Procedure 12C-21

*Standard Practice for*

### **Contractor's Excavation and Embankment Process Control Notebook**

#### **1. SCOPE**

- 1.1. This Standard describes the best practice to be used when developing appropriate worksheets and forms in a Process Control (PC) notebook.
- 1.2. The requirements such as, but not limited to: the sample size, specimen size, number of specimens, interpretation of results, reporting significant digits, and precision statements are in the specific test method.

#### **2. GENERAL PC NOTEBOOK REQUIREMENTS**

- 2.1. The following information shall be included on each page of a worksheet or form:
  1. Project number, Contract ID, and Project location
  2. Name of the laboratory performing the test
  3. Date, location, and time the sample was taken or the beginning of the test
  4. Name of the person taking the sample, performing the test, and certifications
  5. Test number
  6. Type of test performed
  7. Remarks area

#### **3. SAMPLE LOCATION WORKSHEET**

- 3.1. The following shall be included on the sample location worksheet:
  1. Stationing, elevation, lift thickness, and lift number placed
  2. Sampling method (core, grab, auger, shovel, in place, etc.)

**4. SITE PREPERATION WORKSHEET**

4.1. When preparing the site for embankment, the following shall be included in the worksheet:

1. Clearing and grubbing conducted in accordance with Specification 201.
2. Thickness of top soil removed by Station interval.
3. Type, thickness, and volume of unsuitable materials removed.
4. Area and depth of material plowed or scarified
5. Depth of excavation below subgrade elevation in bedrock areas
6. Description of foundation materials below embankment fill (include AASHTO soil classification) by Station interval
7. Compaction methods used to prepare embankment foundation by Station interval
8. Moisture content, dry density, and percent relative compaction of foundation materials where applicable.
9. Existing slope of embankment foundation area by Station interval
10. Bench key depth where required
11. Number of benches and depth of each bench as embankment is constructed to grade
12. Volume of bench excavation used in embankment
13. Trouble area location, type (swampy ground, springs, etc.), and mitigation

**5. EMBANKMENT PLACEMENT AND COMPACTION WORKSHEET**

5.1 When placing and compacting embankment material the following shall be included on the worksheet:

1. Site conditions (standing water, weather, temperature, etc.)
2. Material processing performed prior to placement to meet material requirements specified
3. Material placement method (end dump, side dump, belly dump, cast, etc.)
4. Structure type adjacent to embankment
5. Embankment Material Classification and results to verify classification
6. Changes in material types and corresponding changes in construction methods
7. Lift number and loose lift thickness
8. Spreading equipment used
9. Moisture conditioning and compaction methods and equipment used
10. Methods to document or test compaction, and results of observations or tests conducted. Description of defective work and corrective action taken.
11. Location and elevation of fill placement by Station interval and volume placed daily.
12. Daily summary of all tests conducted and results.

5.2 When placing and compacting Soil Embankment, the following shall be included on the worksheet:

1. Classification and corresponding compaction and testing methods used
2. Processing methods to achieve maximum particle size
3. Changes in material type and corresponding changes to construction and testing methods
4. Processing methods for Non-durable bedrock and placement location
5. Results of moisture-density testing, proof rolls, and documentation of test strip acceptance where applicable
6. Condition and performance of each lift of material placed and compacted

5.3 When placing and compacting Rock Embankment and Rock Fill, the following shall be included on the worksheet:

1. Processing methods to achieve material requirements in accordance with Specification 203
2. Documentation of sampling for and results of slake durability testing
3. Contractor moisture conditioning, placement and compaction methods
4. Results of proof rolls, documentation of test strip acceptance
5. Changes in material type and corresponding changes to construction and testing methods
6. Description of compaction equipment and methods used, and documentation of deviations from minimum equipment requirements specified if applicable
7. Condition and performance of each lift of material placed and compacted

## 6. TEST STRIP OR PROOF ROLL

6.1. When constructing a test strip or conducting a proof roll, the following shall be included on the worksheet:

1. Moisture conditioning, compaction equipment, and compaction methods used to construct the test strip
2. Equipment used in proof roll
3. Axle load and weight ticket
4. Lift thickness and lift number
5. Results of proof roll pass/fail
6. Observation of deflection, rutting, or pumping and corrective action taken.
7. Start and end time
8. Was test strip or proof roll separate or incorporated into embankment

## 7. SUBMITTAL OF PC NOTEBOOK

Once the Contractor has completed all Excavation and Embankment work on the Project the Contractor shall submit the final PC notebook to the Department in an electronic format. The file shall be scanned in sequential order by date and the file should be a pdf. The electronic PC notebook shall be delivered to the Department within 10 working days after the end of the work.

{Page Intentionally Left Blank}

## Colorado Procedure 13-21

### *Standard Procedure for*

### **Check Testing**

#### **1. SCOPE**

- 1.1 The purpose of check testing is to compare the testing equipment and personnel that will be used according to the contract. With the successful completion of check testing within acceptable limits, both the Engineer and the Contractor should have confidence in test results. This procedure can be used at any time the Engineer needs to determine a level of confidence in test results between two or more sets of testing equipment and personnel.

#### **2. REFERENCED DOCUMENTS**

CDOT Quality Assurance Program for Construction and Materials Sampling and Testing.

An Investigative Study of the CDOT Asphalt Mixture Design Procedure, October 1993, Aguirre Engineers, Inc.

Spring 1998 Round Robin Results, October 1998, by Bob LaForce, CDOT.

Sixth Annual Report: HBP QC&QA Projects Constructed in 1997 Under QPM2 Specifications, May 1998, by Bud A. Brakey, CDOT.

HBP QA/QC Pilot Projects Constructed in 1993, May 1994, by Bud A. Brakey, CDOT.

HBP Pilot Void Acceptance Projects in Region 2 in 1997, May 1998, by Bud A. Brakey, CDOT.

ASTM C 39, Compressive Strength of Cylindrical Concrete Specimens.

AASHTO T 97, Flexural Strength of Concrete Using Simple Beam with Third-Point Loading.

AASHTO T 99, The Moisture-Density Relations of Soils Using a 2.5 kg Rammer and a 305 mm Drop.

Surface Moisture-Density Gauges, November 1992, Troxler Electronic Laboratories, Inc.

Gyratory Task Force, MAC Minutes of 03/08/00

ASTM E177, Standard Practice for Use of the Terms Precision and Bias in ASTM Test Methods.

ASTM E 691, Standard Practice for Conducting an Inter-Laboratory Study to Determine the Precision of a Test Method.

#### **3. DEFINITIONS**

- 3.1 Base Data - The historical standard deviation ( $\sigma$ ) between two operators performing a test on split samples of the same material. This is shown in Column 1 of Table 13-1.

- 3.2 Maximum Difference - The expected difference between two operators performing a test on split samples of the same material ( $\delta$ ) is calculated by multiplying  $\sigma$  by 1.96 times the square root of two. This is shown in Column 2 of Table 13-1.
- 3.3 Acceptable Check Test Limit - The limit for check tests is the maximum difference between the averages of the absolute values of differences of five tests performed by two different operators on split samples ( $\delta'$ ) and is calculated by dividing  $\delta$  by the square root of five. This is shown in Column 3 of Table 13-1. For any given element and number of tests ( $n$ ) greater than 1 performed on a split sample, the acceptable check test limit can be calculated by dividing Column 2 of Table 13-1 by the square root of  $n$ .
- 3.4 Check Test Limit / HMA In-Place Density - Since seven split samples are used to correlate nuclear gauges on HMA pavements, the acceptable limit for check tests is the difference between the averages of the absolute values of the differences of seven tests performed by two different operators on split samples and is calculated by dividing  $\delta$  (Column 2) by the square root of seven. This is shown in the junction of the row In-Place Density HMA and Column 3 of Table 13-1.

#### **4. APPARATUS, SAMPLING AND TESTING PROCEDURES**

- 4.1 Apparatus, sampling and testing procedure are described in the specified procedure for the subject tests. Samples used in check testing do not need to be from random samples nor do they need to represent any certain project or location. Samples should be split samples or as close to identical as possible. Samples are split according to splitting procedures for the subject material. If tests are to be taken on material in-place, then the tests shall be taken at the same place.
- 4.2 When successful check test results are derived from previous check testing efforts, the results may be used in lieu of new check testing as agreed upon in writing by the Engineer and the Contractor, and as approved by the Region Materials Engineer. This will only be allowed when the same equipment and same testers are used out of a fixed lab.

#### **5. PROCEDURE**

- 5.1 The subject test is performed on at least five split samples. In the case of in-place density of HMA pavements, seven test locations are used.
- 5.2 Calculate the absolute values of the differences between test results on each sample.
- 5.3 Calculate the average of the absolute values determined in 5.2.
- 5.4 Results of 5.3 are compared to acceptable limits for check tests as shown in Column 3 of Table 13-1.
- 5.5 Column 3 of Table 13-1 shows the acceptable limits for check tests of some materials used in roadway construction. Other values for the acceptable limits for check tests can be derived by following the procedure used to derive values for Table 13-1 and stated in the Definitions.

**Example: Check Testing Program results and calculations for Asphalt Content**

| Split Sample "n" | PC Tester | OA Tester | Absolute Value of Difference<br>$ PC_n - OA_n $ |
|------------------|-----------|-----------|---|
| 1                | 6.03%     | 6.19%     | 0.16%   |
| 2                | 6.15%     | 5.97%     | 0.18%   |
| 3                | 6.09%     | 6.20%     | 0.11%   |
| 4                | 5.92%     | 6.25%     | 0.33%   |
| 5                | 6.20%     | 6.11%     | 0.09%   |

- A. Compare each  $|PC_n - OA_n|$  with appropriate value from Column 2 of Table 13-1**  
Each  $|PC_n - OA_n| < 0.69\%$  (Column 2 for Asphalt Content), so each test is within the necessary range.
- B. Calculate Average of Absolute Value of Differences:**  
 $(0.16\% + 0.18\% + 0.11\% + 0.33\% + 0.09\%) / 5 = 0.17\%$
- C. Compare value from "B" with appropriate value in Column 3 of Table 13-1**  
 $0.17\% < 0.31\%$  (from Column 3 for Asphalt Content); therefore, results of the Check Testing Program for this element are acceptable.

**Note 1:** The values in Table 13-1 were reviewed at the 2018 FMM Meeting for accuracy and intent. There is no direct correlation between Table 13-1 and the Table IA-1, IA Comparison Precision Guide.

**Note 2:** Compressive Strength and Flexural Strength Elements (Procedures) are performed in accordance with Standard Specification Subsection 106.06 (d).

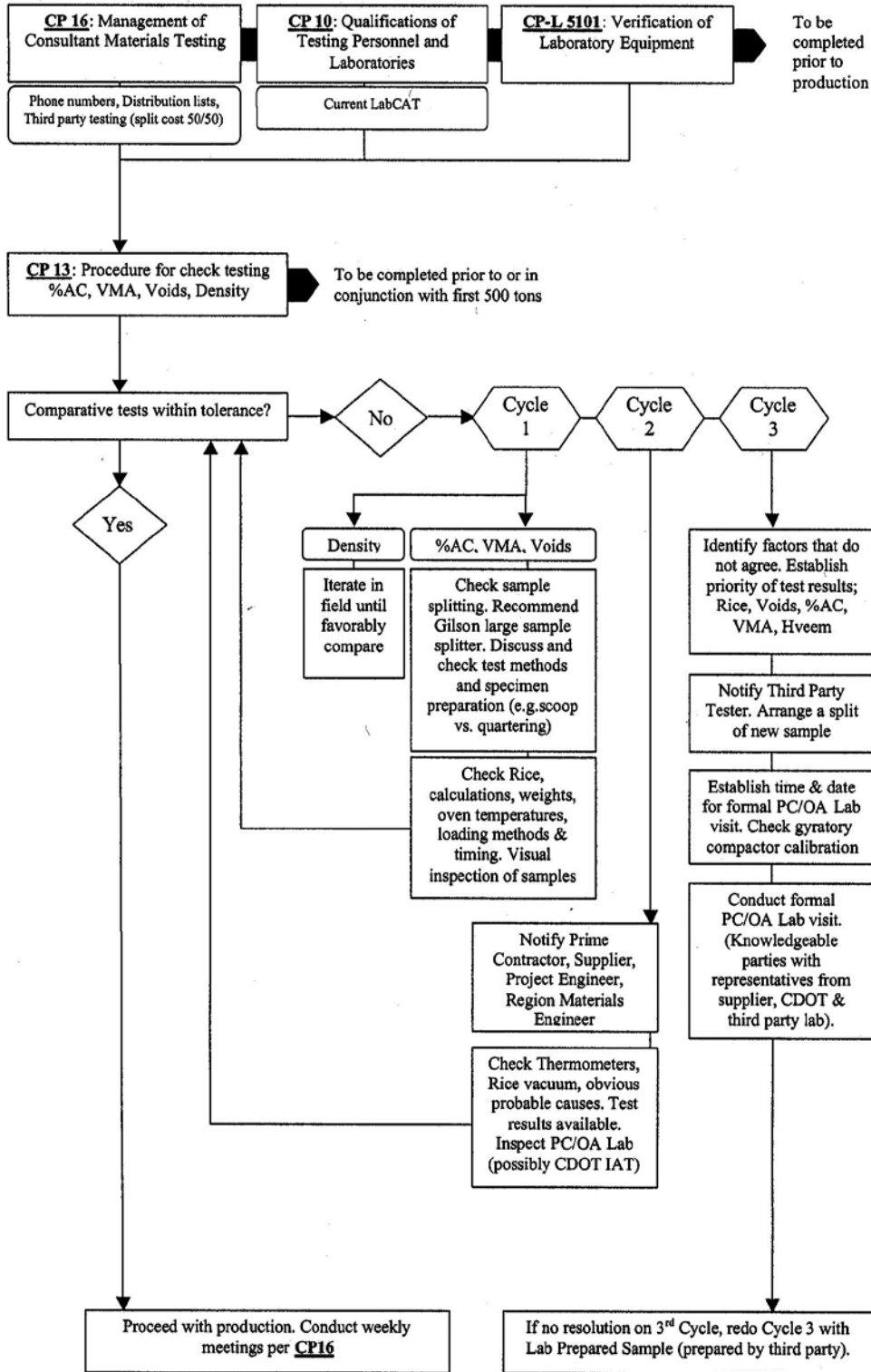
**Note 3:** For inter-laboratory (multiple-laboratories) test results, the expected difference shall be calculated by multiplying Column 1 by the factor 1.96 times the square root of 2.

**TABLE 13-1  
Acceptable Limits of Two Laboratory Test Precision**

| Element<br>(Procedure)                              | Column 1  | Column 2                                       | Column 3                                   |
|---|---|--|--|
|   | $\sigma$ (Base Data,<br>two operators,<br>split sample) | $\delta$ (Maximum Difference,<br>split sample) | $\delta'$ (Acceptable<br>Check Test Limit) |
| Asphalt Content<br>[Nuclear Method] (CP 85)         | 0.25%   | 0.69%  | 0.31%                                      |
| Asphalt Content<br>[Ignition Method]<br>(CP-L 5120) | 0.25%   | 0.69%  | 0.31%                                      |
| HMA #4 Sieve<br>(CP 31)                             | 2.04%   | 5.65%  | 2.53%                                      |
| HMA #8 Sieve<br>(CP 31)                             | 1.92%   | 5.32%  | 2.38%                                      |
| HMA #200 Sieve<br>(CP 31)                           | 0.56%   | 1.55%  | 0.69%                                      |
| HMA Voids in the Mineral<br>Aggregate<br>(CP 48)    | 0.40%   | 1.11%  | 0.50%                                      |
| HMA Air Voids<br>(CP-L 5115)                        | 0.37%   | 1.03%  | 0.46%                                      |
| HMA Hveem Stability<br>(CP-L 5106)                  | 3.9   | 10.8   | 4.8  |
| HMA Maximum Specific<br>Gravity (CP 51)             | .009  | .025   | .011                                       |
| In-Place Density HMA<br>(CP 44)<br>(CP 81)          | 0.70%<br>0.72%  | 1.94%<br>2.00%                                 | 0.87%<br>0.89%                             |
| Longitudinal Joint Density<br>(CP 44)               | 1.29 %  | 3.58%  | 1.60%                                      |
| Compressive Strength PCCP<br>(ASTM C 39)            | 192 psi<br>(1324 KPa)                                   | 532 psi<br>(3670 KPa)                          | 238 psi<br>(1641 KPa)                      |
| Sand Equivalent<br>(CP 37)                          | 3 points  | 8 points                                       | 4 points                                   |
| Flexural Strength PCCP<br>(AASHTO T 97)             | 44 psi<br>(303 KPa)                                     | 122 psi<br>(840 KPa)                           | 55 psi<br>(376 KPa)                        |
| In-Place Density Soils<br>(CP 80)                   | 0.34 pcf<br>(5450 g/m <sup>3</sup> )                    | 0.94 pcf<br>(15107 g/m <sup>3</sup> )          | 0.42 pcf<br>(6756 g/m <sup>3</sup> )       |
| In-Place Soil Moisture<br>(CP 80)                   | 0.45 pcf<br>(7210 g/m <sup>3</sup> )                    | 1.25 pcf<br>(19985 g/m <sup>3</sup> )          | 0.56 pcf<br>(8938 g/m <sup>3</sup> )       |



**FIELD MANAGEMENT OF TEST RESULTS  
ASPHALT CHECK TESTING**



{Page Intentionally Left Blank}

## Colorado Procedure 14-21

### *Standard Practice for*

### **F and t-test Statistical Method**

#### **1. SCOPE**

- 1.1 Use this procedure as required by the project specifications to provide a method of comparing two independent data sets of multiple test results (e.g. Contractor's Process Control and the Department's Acceptance test results, Contractor's Process Control and CDOT Verification test results, CDOT and Contractor's Verification test results, etc.) to determine if the materials tested come from the same population. This statistical procedure employs estimation and hypothesis testing using F-test and t-tests to make comparisons.
- 1.2 Compare two populations that are assumed normally distributed by calculating and comparing the population means (arithmetic averages) and variances (standard deviation x standard deviation). The *F-test compares the population variances* while the *t-test compares the population means*.
- 1.3 Select all samples using random or stratified random procedures. Perform all testing and measuring per standard acceptable practices. All sampling and testing will be per applicable specifications.
- 1.4 The following sections provide reference materials, the mathematical equations, combined manual, and computer-assisted calculations, and completely automated procedure using computer software to calculate the F-test and t-test statistics.

#### **2. REFERENCED DOCUMENTS**

##### 2.1 *Colorado Procedures:*

- CP 41 Sampling Hot Mix Asphalt
- CP 55 Reducing Field Samples of Hot Mix Asphalt to Testing Size.
- CP 61 Sampling Freshly Mixed Concrete

##### 2.2 **Other References:**

AASHTO R 9 "Standard Practice for Acceptance Sampling Plans for Highway Construction".

Implementation Manual for Quality Assurance, 1996, AASHTO Highway Subcommittee on Construction.

Statistical Reasoning, 1985, Gary Smith.

Probability and Statistics, 1975, Murray R. Spiegel.

Elementary Statistics, 1976, Robert R. Johnson.

Probability and Statistics for Engineers and Scientists, 1972, Ronald E. Walpole and Raymond H. Myers.

### 3. DEFINITION OF TERMS, SYMBOLS, AND EQUATIONS

#### 3.1 Equations and Definitions

##### Eq. 3.1

$$\bar{X} = \sum x_i / n$$

Where  $\bar{X}$  is the sample mean or (average).

$\sum$  = summation symbol  
 $x_i$  = any individual test value (i = 1, 2, 3, ...n)  
 $n$  = total number of tests (sample size)

##### Eq. 3.2

$$S = \sqrt{\frac{\sum (X_i - \bar{X})^2}{n - 1}}$$

Where S is the standard deviation

n-1 = degree of freedom

##### Eq. 3.3

$$V = S^2$$

Where V is the sample variance

##### Eq. 3.4

$$F = (V_1/V_2) \text{ or } (V_2/V_1)$$

Where F is the ratio of the variance from each data set (larger variance divided by the smaller variance) depending on which ratio yields a value equal to or greater than 1. This is called the F distribution (aka F-test).

##### Eq. 3.5

$$S_p = \sqrt{\frac{(n_1 - 1)S_1^2 + (n_2 - 1)S_2^2}{(n_1 + n_2 - 2)}}$$

Where  $S_p$  is a weighted average of the sample variances each weighted by the degrees of freedom.

**Eq. 3.6**

$$t = (\bar{X} - \mu) / (S_p / n_c + S_p / n_a)^{1/2}$$

Where  $t$  is the statistic used to compare the mean of a sampled population to some fixed, known value (aka t-test).

$\mu$  = Mean from the contractor's population

$S_p$  = Variance of the pooled data

$n_c$  = Number of tests in the contractor's population

$n_a$  = Number of tests in CDOT's population

$\alpha$  = level of significance or critical region. This is the probability of incorrectly deciding the data sets are different when they actually come from the same population. In either the construction or the manufacturing industry,  $\alpha$  is the risk of rejecting a good material or product. The critical region,  $\alpha$  in the F and t probability distribution curves, is equivalent to the rejection area. Since the total area bounded by either the F or t distribution curve is equal to 1, the acceptance region is  $1 - \alpha$ . For example, when  $\alpha = 0.05$ , there is a probability of 95 percent that the two data sets are from the same population.

$\alpha_{critical}$  = is the maximum value in the F distribution and  $t$  statistic for the level of significance and the degree of freedom for the contractor and CDOT at which the comparison between the two sample populations should not be exceeded. If the  $t$  statistic is less than the critical value, the hypothesis is that they came from the same population.

The Two-Tailed Test determines if the population parameters (variances or averages) are either equal or not equal. All the values of  $\alpha$  obtained from this procedure are based on the two-tails of the distribution curve.

#### 4. SUMMARY OF METHOD

- 4.1 The method involves calculating sample statistics from three or more representative measurements, test results, or values, for each specified element in a lot, or sample. The specimen will be independent samples. The statistical variables to be calculated include the mean, standard deviation, variance, F and t values, and the  $\alpha_{critical}$  value. The following sections summarize the F-test and t-test method to be employed in this procedure.
- 4.2 Determine the appropriate population parameters and sample statistics to be used in estimation and hypothesis testing (F & t-tests). For the F-test calculation, test the assumption that the population variances are equal against the assumption that they are not equal (use a two-tailed F-test). For the t-test calculation, assume the population variances are equal and test the assumption that the population means are equal against the assumption that they are not equal (use a two-tailed t-test).
- 4.3 Choose a level of significance or critical region ( $\alpha$ ) for each of the F-test and t-test calculations. AASHTO R 9 provides suggested critical values of  $\alpha_{critical}$  used in the highway construction industry. CDOT typically uses  $\alpha_{critical}$  values of 0.10, 0.05, 0.01, and 0.005. In this procedure, use  $\alpha_{critical}$  values as specified in the project specifications.
- 4.4 Calculate all the required variables in the appropriate F-test and t-test equations and compare the calculated  $\alpha_{critical}$  with the level of significance chosen in the previous subsection.

- 4.5 Conclude that the measurements, test results, or test values come from the same population if the calculated  $\alpha$ -value is less than the  $\alpha_{\text{critical}}$  at the selected level of significance. Conclude that the measurements, test results, or test values do not come from the same population if the calculated  $\alpha$ -value is less than the  $\alpha_{\text{critical}}$  value at the selected level of significance.

## 5. COMPUTER-ASSISTED PROCEDURE

- 5.1 Any applicable computer software with statistical functions may be used to conduct F-test and t-test calculations. The Microsoft Excel statistical function FTEST can be used to calculate the  $\alpha_{\text{critical}}$  value for the F-test while the Microsoft Excel statistical function TTEST can be used to calculate the  $\alpha_{\text{critical}}$  value for the t-test. The FTEST function has the command format FTEST [array1, array2]. Array1 is the first data set and array2 is the second data set. The FTEST function directly calculates the two-tailed  $\alpha_{\text{critical}}$  value. Compare this value with the selected level of significance. Conclude that the test data are from the same population if the result of the FTEST calculation is less than the selected level of significance. Proceed to conduct a t-test assuming equal population variances if the result of the FTEST calculation is less than the selected level of significance.
- 5.2 The Microsoft Excel TTEST function has the command format TTEST [array1, array2, tails, type]. Array1 is the first data set and array2 is the second data set. The tails parameter specifies the number of distribution tails and type refers to the kind of t-test to perform. The type can be 1 (paired t-test), 2 (two-sample equal variance) and 3 (two-sample unequal variance). Type 3 is not used in this procedure because the test data sets are automatically concluded to be not from the same population if the sample variances are found to be unequal. The t-test directly calculates the  $\alpha_{\text{critical}}$  value, given the required values of the variables in the TTEST function. Compare this value with the selected level of significance. Conclude that the test data are from the same population if the result of the TTEST calculation is less than the selected level of significance. Conclude that the test data are not from the same population if the result of TTEST calculation is greater than the selected level of confidence.
- 5.3 The Department has software to perform F-test and t-test analysis. The software calculates the F-test and t-test values and compares them with the selected level of significance. The software automatically indicates if the test data are either from the same population or not using the appropriate label or designation.

## 6. SAMPLE CALCULATIONS F-test and t-test

### 6.1 Independent Samples (Non-paired Observations)

This example will demonstrate the procedures to conduct F-test and t-test calculations for independent samples.

Problem Statement:

Using the ignition furnace method to determine the asphalt content of a mix, the following test results were obtained for independent sample populations A and B:

| Test Number | Population A | Population B |
|-------------|--------------|--------------|
| 1           | 4.65         | 4.75         |
| 2           | 4.84         | 4.79         |
| 3           | 4.59         | 4.74         |
| 4           | 4.75         | 4.41         |
| 5           | 4.63         | 4.77         |
| 6           | 4.75         | 4.58         |
| 7           | 4.58         | 4.81         |
| 8           | 4.82         |              |
| 9           | 4.86         |              |
| 10          | 4.60         |              |
| 11          | 4.77         |              |
| 12          | 4.65         |              |
| 13          | 4.80         |              |

Using F-test and t-test, determine if sample A and sample B are from the same population.

Solution:

- a) Select the level of significance ( $\alpha$ ) at which to evaluate the F-test and t-test. Use the level specified in the project special provisions. Assuming that  $\alpha = 0.01$  is specified, determine the F-value using Eq. 3.4 which comes from Eq. 3.3 (variance), Eq. 3.2 (standard deviation), and Eq. 3.1 (mean) in each data set.

|                    | <u>Sample A</u> | <u>Sample B</u> |
|--------------------|-----------------|-----------------|
| Arithmetic Average | 4.71            | 4.69            |
| Standard Deviation | 0.1013          | 0.1457          |
| Variance           | 0.010260        | 0.021224        |

|  |      |
|--|------|
| F-value (larger variance is divided by smaller variance, $0.021224 / 0.010260$ ) | 2.07 |
| Degrees of freedom, n-1, (numerator, 7-1)  | 6    |
| Degrees of freedom, n-1, (denominator, 13-1)                                     | 12   |

- b) From AASHTO R 9, Table X2.1, the  $\alpha$  critical value for the F-test using 6 degrees of freedom in the numerator and 13 degrees of freedom in the denominator translates into  $\alpha$  critical of 5.76.
- c) Compare this calculated  $\alpha$  critical value with the F-value. Since the  $\alpha$  critical is greater than the calculated value ( $5.76 > 2.07$ ), **conclude that the sample variances are equal and proceed to conduct a t-test.**

- d) Calculate the arithmetic averages ( $\bar{X}_1$  and  $\bar{X}_2$ ) and variances ( $S_1^2$  and  $S_2^2$ ) for each data set. Calculate the pooled variance,  $S_p$  for both data sets using Eq. 3.5. Calculate the absolute t-value using Eq. 3.6. The sample size for sample A is  $n = 13$  and the sample size for sample B is  $n = 7$ .

|   |         |         |
|---|---------|---------|
| Arithmetic Average ( $\bar{X}_1$ or $\bar{X}_2$ ) | 4.71    | 4.69    |
| Variance ( $S_1^2$ or $S_2^2$ )                   | 0.01026 | 0.02122 |
| Pooled Variance ( $S_p$ )                         | 0.11796 |         |

Calculating the absolute value of t yields:  $(4.69 - 4.71) / ((0.11796/14) + (0.11796/7))^{1/2} = 0.126$

- e) From AASHTO R 9, Table X2.2, the  $\alpha_{\text{critical}}$  value is = 2.878. Since the  $\alpha_{\text{critical}}$  is greater than the calculated value ( $2.878 > 0.126$ ), **conclude that the two data sets are from the same population.**



{Page Intentionally left Blank}

## Colorado Procedure 15-21

### *Standard Practice for*

### **Certification of Consultant Nuclear Moisture/Density Gauges**

#### **1. SCOPE**

An engineering consulting company contracted to perform materials testing for the Department must have their designated nuclear moisture / density gauges certified in the calibration bay located at CDOT's Central Materials Laboratory. Nuclear M/D gauges used for Process Control (PC) testing by the contractor or the contractor's agent will not be certified on the Department's calibration blocks.

#### **2. REFERENCED DOCUMENTS**

CP-L 5306, Certification of Consultant Nuclear Moisture / Density and Thin Layer Density Gauges

Statistical Stability Test and Drift Test, CDOT Form 1151

OA/PC Certified Nuclear Gauge – Consultant Nuclear Gauge Assignment Document, CDOT

CDOT Certified Nuclear Gauge Label, CDOT Form 30

#### **3. REQUIREMENTS**

- 3.1 The company must contact the Central Laboratory (aka Staff Materials & Geotechnical Branch at (303) 398-6547 to make an appointment to certify their M/D gauge. It is recommended that an adequate amount of time, i.e., at least two months, be allowed to ensure that the gauge is available when the contract commences.
- 3.2 The company must provide the Central Laboratory with a current copy of The Notice to Proceed and the referenced Task Order. Documentation provided must include project number, Contract ID (previously referred to as project code), project location, contract commencement date, and the contract expiration date or work duration time frame.
- 3.3 The company must ensure that the gauge requiring certification is clean and is in no need of maintenance or repairs. Cleaning, maintenance, and repairs will not be performed by CDOT's Central Laboratory personnel.
- 3.4 The company is required to have one gauge certified for the contracted project, plus one additional gauge certified as an emergency replacement. If the company has two contracted projects with the Department, three certified gauges would be required, that is, one M/D gauge for each project plus one emergency replacement gauge.
- 3.5 The company must have a recently performed passing Statistical Stability Test and Drift Test, CDOT Form 1151, for their gauge when they arrive for the certification.
- 3.6 The company employee who will be performing the certification procedure shall be capable of running the basic operations of the gauge and must have a personnel monitoring device, a calculator, and a minimum of 3 hours of available time. Arrival must be at the time of the appointment, and rescheduling will be required if the operator and gauge are not in the calibration room, commencing with the certification within 30 minutes of the established time.

**Note:** CDOT requires personnel monitoring devices be worn by an individual within proximity to its nuclear gauges. If the company's policy is to not require personnel monitoring devices of its employees, per current Colorado Department of Public Health & Environment directives, then a letter stating that CDOT will be held harmless from any exposure to CDOT nuclear gauges must be provided and signed by the company's Radiation Safety Officer (RSO).

- 3.7 A gauge passing the calibration will be certified with a label stating "CDOT OA/PC CERTIFIED NUCLEAR GAUGE" (CDOT Form 30).
- 3.8 The company will receive an OA/PC Certified Nuclear Gauge – Consultant Nuclear Gauge Assignment certificate. It must be completed, signed by the company's designated Radiation Safety Officer, and returned as soon as possible. If the nuclear gauge is assigned to a different project from the one listed on the Assignment certificate at any time during the certification period, then CDOT's Central Laboratory must be informed in writing.
- 3.9 The certification is valid for no more than 12 months.
- 3.10 The company must inform CDOT's Central Laboratory if any repairs take place on the gauge within this period of acceptance.



**COLORADO**  
Department of Transportation  
Division of Engineering Support

**OA/PC Certified Nuclear Gauge  
Consultant Nuclear Gauge Assignment**

**Consultant Name** \_\_\_\_\_  
**Address** \_\_\_\_\_  
\_\_\_\_\_  
\_\_\_\_\_

The above named entity will be utilizing Gauge No \_\_\_\_\_ (Certification Date \_\_\_\_\_)  
under contract with the Colorado Department of Transportation, or the entity was sub-contracted to perform testing by the  
contracted engineering consulting company of \_\_\_\_\_

**Project No.** \_\_\_\_\_  
**Contract ID** \_\_\_\_\_  
**Project Location** \_\_\_\_\_  
**Contract Commences** \_\_\_\_\_ **Expires** \_\_\_\_\_

**Gauge Serial Number:** \_\_\_\_\_  
**Gauge Model** \_\_\_\_\_  
**Certified By:** \_\_\_\_\_  
**Expiration Date** \_\_\_\_\_

The following conditions that must be met to use the above gauge on a CDOT project:

1. Radioactive material shall be used by individuals, designated as users by the R.S.O.
2. Personnel monitoring devices capable of detecting both gamma and neutron radiation may not be required. However, CDOT must be informed in writing as to the Licensee's policy and the individual tester must comply for the duration of the contract.
3. Each sealed source containing radioactive material shall be tested for leakage and/or contamination in accordance with RH 4.16 of the State of Colorado *Rules and Regulations Pertaining to Radiation Control*.
4. Radioactive material shall be stored and used in a manner that will preclude use by unauthorized personnel.
5. The nuclear gauge and its associated DOT Type "A" carrying case will meet marking and labeling requirements. The carrying case must be capable of meeting the requirements of a DOT Type "A" transport container.
6. If a nuclear gauge is to be stored in a CDOT facility, the Consultant shall provide the Project Engineer a copy of the Consultant's Nuclear Incident Procedures to be posted in the facility.

**Print** \_\_\_\_\_ **Date** \_\_\_\_\_

**Signature** \_\_\_\_\_

Designated Radiation Safety Officer (RSO)

**Emergency Notification Telephone No.(s):** 1) \_\_\_\_\_  
2) \_\_\_\_\_

4670 Holly Street, Denver, CO 80216 Phone: 303-398-6547 <http://www.coloradodot.info/>  
(rev. 4/14)



{Page Intentionally Left Blank}

## Colorado Procedure 16-21

### *Standard Practice for*

## Management of CDOT & Consultant Materials Testing

### 1. SCOPE

This procedure contains a summary of the responsibilities and the process for developing the consultant materials testing contract and administering task orders. Also contained in this procedure are examples of the forms for management and evaluation of consultant materials testing on CDOT projects.

### 2. SUMMARY OF RESPONSIBILITIES AND PROCESSES

The Region Materials Engineer develops the non-project specific (NPS) materials testing consulting contract that is then reviewed for approval by the Program Engineer and Region Transportation Director. The contract is distributed to interested consultants as a part of a request for proposals. Proposals are reviewed by Region Engineers and then the Consultants are selected. Resident Engineers write task orders to provide consultant materials testing for specific projects. The business office tracks expenditures and assists in the paperwork involved in administering the NPS contracts and the task orders written under each contract. The Region Materials Engineer reviews and retains copies of consultant evaluations and coordinates solving of problems with consultant testing.

### 3. MANAGEMENT AND EVALUATION OF CDOT & CONSULTANT MATERIALS TESTING

#### 3.1 CP 16, Pre-Testing Meeting Agenda – CDOT & Consultant Materials Testing (CDOT Form 1322)

This form is used to guide discussion and document results of a pre-testing meeting. This meeting allows the key people involved in the testing to discuss and define each of the issues involved in consultant testing. Each item should be discussed and the results of that discussion written on the form. Pre-testing meetings have been a valuable tool to avoid problems by promoting communication on important issues before testing begins.

#### 3.2 CP 16, Weekly Meeting Agenda – CDOT & Consultant Materials Testing (CDOT Form 1323)

This form is used to guide discussion and document results of a meeting held each week, if needed, to determine if the consultant testing is going smoothly. These meetings allow early identification and resolution of problems. Key issues addressed at the weekly meetings are distribution of test results, documentation of testing, proper test procedures, and how failing tests are handled. If the consultant testing is going well, then brief and informal meetings between the CDOT head tester and the consultant tester, or skipping some of these meetings, may be appropriate. If there are substantial problems then a formal meeting including the Project Engineer and the supervisor of the consultant materials tester may be needed. Use the form to document all meetings, however brief.

#### 3.3 CP 16, Evaluation of Materials Testing – Consultant Materials Testing (CDOT Form 1324)

- 3.3.1 This form is used to evaluate the Consultant Project Tester and Consultant Management / Support (CM/S) after consultant testing on the project is completed. This evaluation is normally conducted by the Project Engineer. The contractor, consultant, and head tester should be interviewed prior to completing this form. A final meeting with the consultant to discuss strengths and weaknesses is also recommended. A copy of the completed evaluation form is part of the Finals packet and must be sent to the Region Materials Engineer and the Documentation Unit of the Central Materials Laboratory. This central record of evaluations will support statewide review of consultant performance.
- 3.3.2 The Project Tester [A] section is an evaluation of the individual materials tester only.
- 3.3.3 The Consultant Management / Support (CMS) [B] section is an evaluation of the consultant company beyond the project tester. Description of the evaluation factors is discussed below.
- 3.3.3.1 Quality: Achieved desired outcomes with a minimum of avoidable errors and problems. The work was accurate and complete. The work was done in an efficient and effective manner.
- 3.3.3.2 Timeliness: Performs work within the time frames identified. Responds / replies to requests for information or assistance in a reasonable period of time.
- 3.3.3.3 Price / Budget: Effectively manages costs and adheres to the budget as specified in the contract / scope of work.
- 3.3.3.4 Business Relations / Customer Service: The degree to which the consultant is professional and respectful in its business approach and interactions with the agency.
- 3.3.3.5 Deliverables / Requirements: The degree to which the consultant is compliant in meeting the standards of contract requirements and deliverables (i.e. documentation).

#### **4. CONSULTANT PERFORMANCE EVALUATION**

- 4.1 The CDOT Consultant Performance Evaluation, CDOT Form 313, is a general evaluation of consultants performing any services for the Department.

Senate Bill 07 228 requires that all state contracts greater than \$100,000 that were signed, or changed, after July 1, 2009 must have Contractor evaluations and ratings performed. The final evaluation rating will be posted to the Contract Management Systems (CMS) public website at <http://contractsweb.state.co.us>. All CDOT guidance documents, which include instructions, procedures, forms, email language, memorandums and other information related to contractor performance evaluation, are posted on the Purchasing web page located at [//internal/Purchasing/PurchasingDocuments.cfm](http://internal/Purchasing/PurchasingDocuments.cfm).

These evaluations are separate from the CP 16, Evaluation of Materials Testing (CDOT Form 1324). All forms are required to be completed.

|  |                 |            |
|--|-----------------|------------|
| <b>COLORADO DEPARTMENT OF TRANSPORTATION</b><br><b>CP 16, PRETESTING MEETING</b><br><b>AGENDA</b><br>The purpose of this meeting is to clarify the expectations of CDOT for the consultant materials tester and to review some of the common issues that arise during typical projects. This form shall be used for consultants and may be used when CDOT is performing the testing. | Region:         | Residency: |
|  | Contract ID:    | Date       |
|  | Project No.:    |            |
|  | Proj. location: |            |

**Attendance:** It is recommended that the following people be in attendance:

|  |   |
|--|---|
| CDOT Project Engineer:   | Consultant materials tester's supervisor: |
| CDOT head tester:  | Contractor quality control tester:        |
| Region Laboratory representative (if available):   | Contractor representative(s):             |
| Consultant materials tester:   | Supplier representative(s):               |
| It is recommended this meeting occur <b>one week prior</b> to the need for testing. If some of the issues brought up at the meeting are not initially resolved, then there will be time to address them. |   |

**1) Test result distribution:**

|  |      |  |   |
|--|------|--|---|
| Payment to the contractor is dependent on test results of materials. Therefore, it is critical that test results are distributed <b>before the next day of production</b> . Computer printout of the Moving Quality Level (MQLs) needs to be sent as well. |      |  |   |
| Have all forms for reporting test results been provided to the consultant materials tester and contractor? <input type="checkbox"/> yes <input type="checkbox"/> no  |      | Test results will be distributed by:   |   |
| Test results will be distributed to:   | FAX: | CDOT Form #626*<br>yes no  | QLs**<br>yes no                                   |
| 1)   |      | <input type="checkbox"/> <input type="checkbox"/>  | <input type="checkbox"/> <input type="checkbox"/> |
| 2)   |      | <input type="checkbox"/> <input type="checkbox"/>  | <input type="checkbox"/> <input type="checkbox"/> |
| 3)   |      | <input type="checkbox"/> <input type="checkbox"/>  | <input type="checkbox"/> <input type="checkbox"/> |
| 4)   |      | <input type="checkbox"/> <input type="checkbox"/>  | <input type="checkbox"/> <input type="checkbox"/> |
| 5)   |      | <input type="checkbox"/> <input type="checkbox"/>  | <input type="checkbox"/> <input type="checkbox"/> |
| *When test results fail, a CDOT Form #626 (Field Laboratory Test Results) shall be sent to the above people that request it.<br>**When QLs (Quality Levels) and pay factors are calculated, they shall be sent to the above people that request it.        |      |  |   |
| What mix designs have been submitted and approved?   |      |  |   |
| Who is authorized to sign the Form #626?   |      | Who will calculate the QLs and pay factors?  |   |
| Who will distribute the QLs and pay factors?   |      | How often will the QLs and pay factors be distributed?   |   |
| Which versions of software will be used to calculate pay factors?  |      |  |   |
| Does the consultant have this software installed? <input type="checkbox"/> yes <input type="checkbox"/> no   |      | Does the contractor have copies of this software? <input type="checkbox"/> yes <input type="checkbox"/> no |   |
| Who from the contractor will be responsible for maintaining the MQLs?  |      |  |   |

Previous editions are obsolete and may not be used.



**2) Special reports**

|  |                |                  |
|--|----------------|------------------|
| In some instances that involve a long testing procedure (volumetrics, cylinders, etc.), the results need to be distributed no later than the day after the test is completed. The following protocol should be used for the distribution of these tests. |                |                  |
|  | Distributed by | Distributed when |
| Concrete cylinder breaks:  |                |                  |
| Asphalt volumetrics:   |                |                  |
| Rice:  |                |                  |

**3) Procedural review**

|  |   |   |   |
|--|---|---|---|
| These are common areas of concern for testing materials on CDOT projects. It is recommended to review these during this meeting. |   |   |   |
| Forms:   | Does the consultant materials tester have the Form #250? <input type="checkbox"/> | Does the consultant materials tester have the Form #379? <input type="checkbox"/> | Does the consultant materials tester have the Confidential Random Sampling Schedule? <input type="checkbox"/> |
| Concrete: Time constraints and procedures for making cylinders and beams (AASHTO T 141, 23, and 97)                              |   |   |   |
| Acceptance cylinders and/or beams:   |   | Field cured cylinders:  |   |
| Sampling location within load:   |   | Special requirements:   |   |
| Sampling method (divert entire stream):<br>(i.e. wheelbarrow preferred)  |   |   |   |
| Location of water tank for initial cure (first 24 hours):  |   | Bridge Deck Curing Measures (thermocouples etc.):                                 |   |
| Weekend pours (sampling and handling after 24 hours):  |   | Maturity meter calibrations for fast track paving, completed by?                  |   |
| Location of cure (after 24 hours):   |   |   |   |
| Transportation (how and when):   |   |   |   |
| Asphalt:   | Gradation   | AC/Rice   | Binder  |
| Density  |   |   |   |
| Sample location:   |   |   |   |
| Sample taken by:   |   |   |   |
| Sample witnessed by:   |   |   |   |
| Sample method:   |   |   |   |
| Sample split by:   |   |   |   |
| Sample delivered by:   |   |   |   |
| Test location:   |   |   |   |
| Tested by:   |   |   |   |
| Review sample size:  | Aggregate:  | Binder:   | HBP:  |
| Special sampling requirements:   |   |   |   |

Previous editions are obsolete and may not be used.

**4) Protocol for failing tests**

|  |   |
|--|---|
| During production of materials, it is possible that test results of materials could fail. It is desirable to understand the protocol that will be followed when this happens. Typical actions could include: meeting, coring, retest, third party testing, check testing program, price reduction, test saved splits, etc. |   |
| <b>Concrete:</b>   |   |
| Slump:   | Air:  |
| Compressive Strength (CP 65):  | Yield:                                      |
| Flexural Strength:   | How will the QLS and pay factor be handled? |
| <b>Asphalt:</b>  |   |
| Density:   | Gradation:                                  |
| Asphalt Content:   | Stability:                                  |
| Volumetrics:   | Binder:                                     |
| How will the QLS and pay factor be handled?  |   |
| <b>Soils:</b>  |   |
| Density:   | Moisture:                                   |
| Soil Bearing Value:  | Soil type:                                  |
| Soil Profile:  |   |

**5) Head tester commitments**

|  |        |       |      |
|--|--------|-------|------|
| <p>The CDOT head tester will assist the consultant materials tester with a limited amount of help. This assistance will be scheduled between the two testers. This will include: review of the Field Materials Manual, setting up the book for project documentation, reviewing the book throughout the project, new CDOT tests and protocols, and one copy of the project plans and specifications.</p> <p>The CDOT head tester will not assist in training the consultant materials tester in test procedures or protocol. Consultants will provide cylinder molds (Jatco), asphalt binder cans, and 3 ring binders (all shall be new). Current copies of the specification book, Field Materials Manual, and other publications/materials needed for the project will also be provided by the consultant.</p> |        |       |      |
| Head tester:   | Phone: | Cell: | FAX: |

**6) Protocol for switching consultant materials testers**

|  |                            |       |
|--|----------------------------|-------|
| <p>It is desirable for the consultant materials tester to be the same throughout the entire project. However, it is understood that situations arise that create the need for the consultant to switch the tester. <b>This should be minimized.</b> When a switch does occur, the following protocol is required for a smooth transition.</p> <p>If known in advance - A reduced check testing program (at least 3 samples) needs to be performed. The replacement tester needs to spend at least one day on the project with the original tester.</p> <p>If not known in advance - A reduced check testing program (at least 3 samples) needs to be performed within one week. Additionally, the replacement tester's supervisor needs to be present for at least one full day or night of testing with the replacement tester and until the replacement tester is familiar with the project.</p> <p><b>Short term (only 1 or 2 days)</b> - The replacement tester's supervisor needs to be present for the days or nights of testing with the replacement tester until the original tester returns.</p> <p>Any additional supervision costs incurred as a result of switching consultant materials testers will not be charged to the project.</p> |                            |       |
| Materials consultant tester's immediate supervisor is:   | Supervisor's phone number: | Cell: |

**7) Equipment changes**

|   |
|---|
| <p>The same equipment (nuclear moisture/density gauge, air meter, etc.) needs to be used throughout the project. When a tester is switched, the new tester needs to use equipment that was used previously on the project. If the equipment breaks down or is replaced, it has to be calibrated or correlated appropriately before use.</p> |
|---|

**8) Check testing program**

|   |                                     |
|---|-------------------------------------|
| The check testing program needs to be completed before production begins. |                                     |
| Check testing started on:   | Check testing completed on:         |
| What was the average of the differences in each of the tests?             |                                     |
| Gradation:  | Rice:                               |
| Asphalt content:  | Density:                            |
| Did it correlate?   | If not, then what is the next step? |

**9) Independent Assurance Tests**

|  |        |       |
|--|--------|-------|
| The Form #379 indicates the number of Independent Assurance Tests (IAT) that are required. It is the responsibility of the materials consultant to schedule these tests. It is necessary to schedule the tests a minimum of 24 hours in advance. To schedule the test contact: |        |       |
| Contact:   | Phone: | Cell: |
| Additionally, the tests should be scheduled (when possible) during a large or typical production operation - not the end of a job or small quantity. If there are problems with the test results, it is better to schedule the IAT sooner rather than later.                   |        |       |

**10) Qualified laboratory**

|  |        |       |
|--|--------|-------|
| The consultant laboratory needs to be qualified in order to perform verification testing. The equipment serial numbers to be used on the project will also be documented and given to the head tester. In order to get the laboratory inspected, so that it may become qualified, contact: |        |       |
| Contact:   | Phone: | Cell: |
| Date laboratory was qualified:   | By:    |       |
| AASHTO accredited laboratories will be considered qualified.   |        |       |

**11) Certified personnel**

|  |                 |
|--|-----------------|
| Do the testers have the appropriate certifications for concrete testing (ACI Lab Tech I, Lab Tech II or Field Tech I), asphalt testing (LabCAT Level A, Level B or Level C), and soils (WAQTC, Embankment and Base)? |                 |
| Tester:  | Certifications: |
| Tester:  | Certifications: |

**12) Resolution of testing issues**

|   |
|---|
| Issues may develop on the project between the contractor, consultant, and/or CDOT as a result of test results or test procedures. It is recommended that the issues be dealt with appropriately. The CDOT Head Tester or Project Engineer should deal with all issues that arise from the testers. The consultant tester should not try to resolve issues with the contractor. If the problem is not resolved, then the two supervisors should meet. Every effort should be made to resolve the issue at the lowest possible level. |
|---|

**13) Materials consultant supervisor**

|  |                            |                 |
|--|----------------------------|-----------------|
| The materials consultant tester project supervisor is: | Supervisor's phone number: | Cell or Mobile: |
|--|----------------------------|-----------------|

**14) Weekly meetings**

| The purpose of weekly meetings is to ensure that an adequate job is being performed. If there are any issues, they need to be addressed. This meeting can be a regularly scheduled meeting or can occur sporadically depending on the progress on the project and the consultant's expertise. |      |         |       |
|---|------|---------|-------|
| Attendance: CDOT representative, consultant tester, and contractor representative.  |      | Where:  |       |
| Day:  |      | Time:   |       |
| Who will attend?  | Name | Company | Phone |
| 1)  |      |         |       |
| 2)  |      |         |       |
| 3)  |      |         |       |
| 4)  |      |         |       |

|   |                 |            |
|---|-----------------|------------|
| <b>COLORADO DEPARTMENT OF TRANSPORTATION</b><br><b>CP 16, WEEKLY MEETING AGENDA</b><br>The purpose of weekly meetings is to ensure that an adequate job is being performed. If there are any issues, they need to be addressed. This shall be used for Consultants and may be used when CDOT is performing the testing. | Region:         | Residency: |
|   | Contract ID:    | Date:      |
|   | Project No.:    |            |
|   | Proj. location: |            |

**Attendance:**

| Name | Company | Phone |
|------|---------|-------|
| 1)   |         |       |
| 2)   |         |       |
| 3)   |         |       |
| 4)   |         |       |
| 5)   |         |       |

**1) Test result distribution**

Is everyone receiving their test results?

---

Are there any issues?

**2) Special reports**

Are test results for tests that take over 1 day being distributed timely?

**3) Paperwork and documentation (Is the paperwork and documentation up to date for:)**

Acceptance testing:

---

IATS:

---

COCs and CTRs (Obtained for the tires):

**4) Procedural review**

Are there any questions about the procedures being used?

**5) Protocol for failing tests**

|                                      |
|--------------------------------------|
| Have there been any failing tests?   |
| If so, what actions have been taken? |

**6) Head tester commitments**

|  |
|--|
| Has the head tester provided the necessary assistance?         |
| Has the consultant requested assistance in areas not required? |

**7) Protocol for switching consultant materials testers**

|  |
|--|
| Has the consultant materials tester been switched? |
| If so, how was the switch handled?                 |

**8) Equipment changes**

|   |
|---|
| Has the same equipment been used throughout the project?            |
| If equipment was changed, was it properly correlated or calibrated? |

**9) Check testing**

|  |
|--|
| Is the check testing program complete?   |
| Is the check testing program up to date? |

**10) Independent Assurance Tests**

|  |
|--|
| Have the Independent Assurance tests been scheduled? |
|--|

**11) Miscellaneous**

|   |
|---|
| Are other pre-testing meeting checklist items complete? |
|---|

|  |                 |            |
|--|-----------------|------------|
| <b>COLORADO DEPARTMENT OF TRANSPORTATION</b><br><b>CP 16, EVALUATION OF MATERIALS TESTING</b><br>The contractor, consultant and head tester should be interviewed prior to completing this form. There should be a final meeting with the consultant to review strengths and weaknesses. | Region:         | Residency: |
|  | Contract ID:    | Date:      |
|  | Project No.:    |            |
|  | Proj. Location: |            |

|                             |                            |  |
|-----------------------------|----------------------------|--|
| Name of Consultant Company: | Name of Consultant Tester: | Quality of Work/Total Rating: <b>0.0</b> |
|-----------------------------|----------------------------|--|

**PROJECT TESTER (A)**

| Evaluation Factors:  | Ratings: (5) very good, (4) good, (3) average, (2) below average, (1) poor |
|--|--|
| 1. Knowledge of test procedures  | ▼  |
| 2. Following test procedures   | ▼  |
| 3. Knowledge of project specifications   | ▼  |
| 4. Following project specifications  | ▼  |
| 5. Test result distribution  | ▼  |
| 6. Following protocol for failing tests  | ▼  |
| 7. Following instructions / directions of CDOT management staff                      | ▼  |
| 8. Paperwork / documentation (during construction)                                   | ▼  |
| 9. Final paperwork / documentation (after construction)                              | ▼  |
| 10. Time management  | ▼  |
| 11. Scheduling I.A. testing  | ▼  |
| 12. Attendance at weekly / required meetings   | ▼  |
| 13. Housekeeping / field lab organization  | ▼  |
| 14. Test equipment maintenance   | ▼  |
| 15. Proficient in SiteManager LIMS software program (CDOT FMM SMM/LIMS Section 9.0 ) | ▼  |
| Subtotal: <b>0.0</b>   | Average A: <b>0.0</b>  |

**CONSULTANT MANAGEMENT SUPPORT (B)**

| Evaluation Factors:   | Ratings: (5) above standard, (3) standard, (1) below standard |
|---|---|
| Note: Description of the factors can be found in CP 16, Subsection 3.3.3. |   |
| 1. Quality  | ▼   |
| 2. Timeliness   | ▼   |
| 3. Price / Budget   | ▼   |
| 4. Business Relations / Customer Service                                  | ▼   |
| 5. Deliverables / Requirements  | ▼   |
| Subtotal: <b>0.0</b>  | Average B: <b>0.0</b>   |

**CUMULATIVE RATING**

|  |            |
|--|------------|
| Weighted average total score (sections A and B): | <b>0.0</b> |
|--|------------|

|  |       |
|--|-------|
| Comments on referenced evaluation factors: |       |
| Rater: (Project Engineer)                  | Date: |
| Reviewer: (Region Materials Engineer)      | Date: |

Copy distribution: Project Engineer (Original), Consultant, Region Materials Engineer, Central Laboratory (Documentation Unit)

Previous editions of this form are obsolete and may not be used.

CDOT Form #1324 12/19

CDOT Form # 1324

{This page was intentionally left blank.}

## Colorado Procedure 17-20

### *Standard Practice for*

### **Hot Mix Asphalt Test Result Verification and Dispute Resolution**

#### **1. SCOPE**

- 1.1 The purpose of this Hot Mix Asphalt (HMA) Test Result Verification and Dispute Resolution Procedure is to establish a process to address questions over acceptance test result differences between the Contractor and the Colorado Department of Transportation (CDOT) in the properties and pay for HMA. Outliers will be addressed using the 2v process listed in the Revision of Sections 105 and 106 of the Standard Special Provisions.

#### **2. REFERENCED DOCUMENTS**

- 2.1 CDOT Field Materials Manual  
2.2 CDOT Laboratory Manual of Test Procedures  
2.3 AASHTO Test Procedures  
2.4 ASTM Test Procedures

#### **3. DEFINITIONS**

- 3.1 Check Testing – as defined in CP 13.
- 3.2 Blind Split Sample – Sample submitted by the Engineer to the CDOT Central Materials Laboratory (administratively the Materials and Geotechnical Branch) to resolve differences in test results between OA testing and PC testing in accordance with this procedure. This sample shall be a split sample in accordance with procedures in CP 55. The Method from CP 55 to be utilized will be established in the Pre-Pave Meeting.

#### **4. REQUIRED CONDITIONS**

- 4.1 The Check Testing provisions of the Contract must have been satisfactorily completed in accordance with CP 13.
- 4.2 If the Check Testing has not been satisfactorily completed in accordance with the contract, no challenge of the QA results will be allowed.



**TABLE 17-1: Required Test Result Differences to Qualify for Dispute Resolution Testing**

| Element                                | Type of Test       | Difference Between Test Results |
|--|--------------------|---------------------------------|
| Gradation:<br>#8 and larger Sieves     | CP 31              | ≥ 5 %                           |
| #16 to #100 Sieves                     | CP 31              | ≥ 3 %                           |
| #200 Sieve                             | CP 31              | ≥ 2.0 %                         |
| Asphalt Content                        | CP 85<br>CP-L 5120 | ≥ 0.27 %<br>≥ 0.27 %            |
| Asphalt Compaction                     | CP 81<br>CP 44     | ≥ 1.5 %<br>≥ 1.5 %              |
| Asphalt Compaction Longitudinal Joints | CP 44              | ≥ 1.5%                          |
| Air Voids                              | CP-L 5115          | ≥ 0.7 %                         |
| Voids in Mineral Aggregate             | CP 48              | ≥ 0.7 %                         |

4.3 Test result differences shall be larger than the tolerances listed in Table 17-1 or no dispute will be allowed.

4.4 If a documented split sample for dispute resolution is not submitted to the Engineer, dispute resolution testing will not be allowed. The Engineer shall store and maintain all split samples submitted for disputes, including CP85 correlation split samples.

4.5 For any disputed property, the CP 17 Process Documentation Worksheet (CDOT Form 417) shall be used for guidance and the following steps will be followed:

4.5.1 Level 1 – Test Result Questioned Affected parties will immediately notify the Engineer and describe the issue in writing.

- Project and Contractor personnel will perform an investigation, review data, and possibly retest samples.
- All Level 1 tasks must be completed within 3 working days from the time written notification is presented to the Engineer.

4.5.2 Level 2 – Issue Not Resolved by Level 1

Engineer and Contractor personnel will perform an investigation and review data to determine if the questioned sample is an isolated sample (test differences outside of multi-lab precision).

- PC and OA must be complete and up-to-date.
- If the dispute is a result of a bias between the PC and Acceptance test results, then the project will perform a new round of check testing (CP 13) before determining if Level 3 should be used. The check test at this level is performed only on the item(s) being disputed. If volumetric properties are being disputed, retain a set of check testing samples for the dispute lab.
- All Level 2 tasks must be completed within 8 working days from the time written notification is presented to the Engineer.

#### 4.5.3 Level 3 – Issue Not Resolved by Level 2

- Engineer shall submit Blind Split Sample to the CDOT Central Materials Laboratory within 18 working days from the time written notification is presented to the Engineer. Engineer shall coordinate directly with CDOT Central Materials Laboratory Asphalt Program Manager (303) 398-6576.
- The blind split sample shall be confidentially submitted only to the CDOT Central Materials Laboratory, Asphalt Program Manager by the Engineer using a CDOT Form #1304 and the completed CP Process Documentation Worksheet. Samples shall be submitted only when the decision has been formally made at the project to conduct dispute testing. The CDOT Form #1304 shall contain the following information:
  - Contract ID (Project Code)
  - Form 43 number for the sample
  - Date of the Form 43
  - Name and title of sample submitter
  - Project contact information for reporting test results.
  - List of disputed tests
  - Independent lab who will perform test (either “Central Lab” or “Private Lab”)
  - Witness information, if applicable (see Subsection 7.1)
  - Sample testing shall be completed by the CDOT Central Materials Laboratory or third party lab within 10 working days of sample receipt.

### 5. DISPUTE LAB PROCEDURES

Items to consider:

1. Engineer and Contractor shall confirm that Level 1 and Level 2 have been completed. Through the use of the CP 17 Process Documentation Worksheet detail the Level 1 and 2 investigations, and provide dates and personnel involved in the Level 1 and 2 investigations.
  2. For Volumetric Properties require new check testing process be completed that includes the dispute lab. Contractor shall provide all materials for check testing. When volumetric properties are being disputed, the dispute lab’s bulk specific gravity will be corrected to the OA lab bulk specific gravity.
- 5.1 The blind split samples will either be tested by the CDOT Central Materials Laboratory or forwarded to a consultant laboratory in accordance with the selection made by the contractor. The test results from the blind split samples will be used in the pay factor calculation in place of the test results that are questioned.
  - 5.2 When a volumetric property is questioned, all volumetric properties (including asphalt content, which affects VMA) shall be retested and the new values used for the re-calculation of pay factors. Recent PC data for aggregate bulk specific gravity may also be requested and evaluated during dispute testing.
  - 5.3 When a gradation result is questioned, the percent passing all specified sieves shall be retested and included in the calculation of dispute resolution pay factors. If acceptance gradations are based on post-burn ignition oven samples, asphalt content will also be re-tested by the dispute lab and the new result will be used for the re-calculation of pay factors.

- 5.4 All properties will be tested using the method used for project acceptance. For example, if acceptance testing for percent AC content is based on the nuclear AC gauge, the dispute resolution sample shall be tested using a nuclear AC gauge. The nuclear AC correlation method shall be the same for all labs in the dispute process.
- 5.5 The Project Engineer indicated on the Form 1304 shall be the only contact point for information and test result distribution by the CDOT Asphalt Program Manager.

## **6. DENSITY DISPUTES**

- 6.1 As addressed in the Specification, disputes involving mat and longitudinal joint density, shall be resolved using roadway cores. The cores shall be taken by the Contractor within the time required by the specification.
- 6.2 Where cores are used for density acceptance, for example, SMA or Longitudinal Joints, dispute resolution will not be allowed unless companion PC cores were taken at the same time and with the edge of the core within six inches of the acceptance cores. Dispute resolution cores will also be taken within six inches of the edge of the acceptance cores.
- 6.3 Where acceptance for density was made using a nuclear density gauge, dispute resolution cores will be taken at the same location as the nuclear gauge density measurements.

## **7. WITNESSING SAMPLE TESTING**

- 7.1 The Contractor or his representative may witness the testing of the disputed sample if tested by the CDOT Central Materials Laboratory. One testing witness will be allowed and shall be identified in writing along with his qualifications prior to the testing. The CDOT Asphalt Program Manager will schedule the testing time and will notify the designated witness. Witnessing of testing shall be by visual observation only, no comments or discussion of the testing with the technicians performing the tests will be allowed. Questions on the testing procedures shall be directed to the CDOT Flexible Pavement Laboratory Manager after the completion of testing. If the witness has any formal comments on the tests, they shall be submitted in writing to the Engineer with a copy also sent to the CDOT Asphalt Program Manager prior to the scheduled distribution of the test results.

## **8. RESPONSIBILITY FOR TESTING EXPENSE**

- 8.1 For single property disputes such as asphalt content on a gradation acceptance project, the lab whose result is furthest from the dispute resolution lab will pay for testing.
- 8.2 For disputes where more than a single property is affected by the retest, the lab furthest from the dispute resolution lab on the property questioned will pay for the testing, but the entire test result will be entered into the pay calculations for the material represented by that sample. For example:
- 8.2.1 Gradation - The test results for the disputed sieve will be used to determine who is furthest, but the entire gradation will be entered into the pay formula.
- 8.2.2 Volumetric properties - VMA, Air Voids and percent AC will be entered into the formula, while payment for testing will be determined based on the results for the single property disputed.

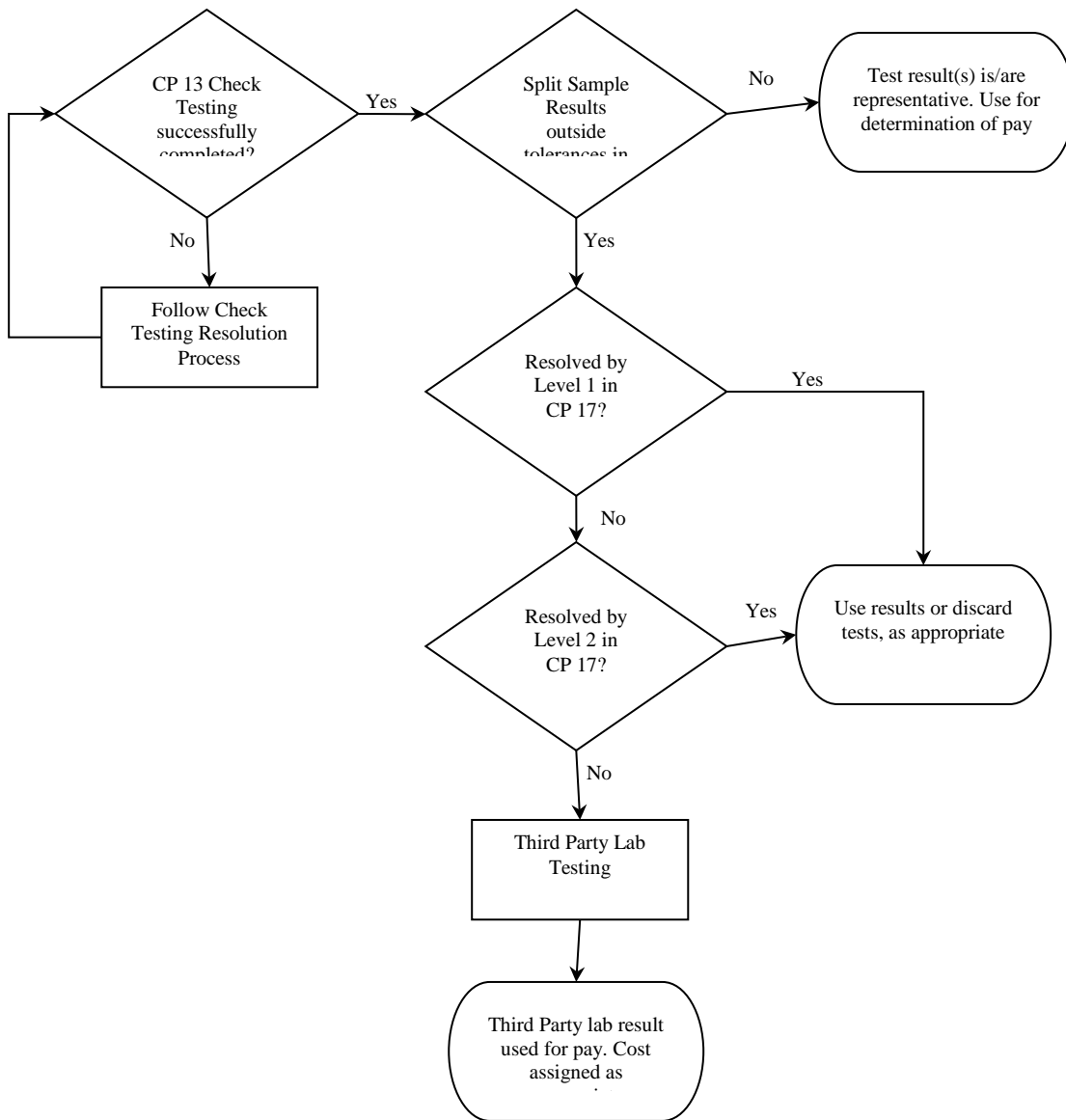
- 8.3.1 In the case of a tie, the testing cost will be divided equally between both parties.
- 8.4 The costs for third party testing is shown in Table 17-2. An administrative cost of \$230 per sample will be charged in addition to the costs shown.

**TABLE 17-2: Costs for Third Party Testing**

| <b>Test</b>                                      | <b>Cost</b> |
|--|-------------|
| AC Ignition Correction                           | \$318       |
| AC Nuclear Correction                            | \$373       |
| AC Content by Ignition                           | \$109       |
| AC Content by Nuclear                            | \$86        |
| Gradation  | \$115       |
| Mixture Volumetrics (Rice, Air Voids, VMA)       | \$338       |
| Core Bulk Specific Gravity                       | \$32        |
| AC Content by Ignition (CTP)                     | \$545       |
| AC Content by Nuclear (CTP)                      | \$430       |
| Mixture Volumetrics (Rice, Air Voids, VMA) (CTP) | \$1690      |

Note: Check Testing Program (CTP).

### Dispute Resolution Flowchart



|   |  |                  |        |                                 |
|---|--|------------------|--------|---------------------------------|
| <b>Colorado Department of Transportation</b>                    |  | Contract ID      | Region | Date of Engineer's Notification |
| Colorado Procedure 17 - Process Documentation Worksheet         |  | Project Number   |        |                                 |
| Hot Mix Asphalt Test Result Verification and Dispute Resolution |  | Project Location |        |                                 |

|  |   |  |
|--|---|--|
| <b>Sample Method (CP 41)</b>                                 |   |  |
| <input type="checkbox"/> Method A - Tube Sampler             | <input type="checkbox"/> Method B - Point of Delivery                   | <input type="checkbox"/> Method C - Behind Paver |
| Tube Dia. <input type="text"/>                               | Tube Length <input type="text"/>  | Auger <input type="text"/>                       |
|  |   | Windrow <input type="text"/>                     |
| <b>Split Sample Method (CP 55)</b>                           |   |  |
| <input type="checkbox"/> Method A - Selection by Scoop       | <input type="checkbox"/> Method D - Selection by Cross Section          |  |
| <input type="checkbox"/> Method B - Quartering               | <input type="checkbox"/> Method E - Quartermaster Mechanical Splitter   |  |
| <input type="checkbox"/> Method C - Mechanical Splitter      |   |  |
| <b>Element</b>   |   |  |
| <input type="checkbox"/> Gradation (CP 31)                   | <input type="checkbox"/> Asphalt Compaction Longitudinal Joints (CP 44) |  |
| <input type="checkbox"/> Asphalt Content (CP 85 / CP-L 5120) | <input type="checkbox"/> Air Voids (CP-L 5115)                          |  |
| <input type="checkbox"/> Asphalt Compaction (CP 81 / CP 44)  | <input type="checkbox"/> Voids in Mineral Aggregate (CP 48)             |  |

**Level 1** CP 17 (4.5.1) - Project and Contractor personnel will perform investigation, review data and possibly retest samples. Must be completed within 3 working days from the time written notification is presented to the Engineer. In the space below, include detailed description of actions taken to resolve the dispute. Attach an additional page if necessary.

Investigated by:   
Electronic signature required

Concurrence - Region Materials    Yes     No     by:   
Electronic signature required

**Level 2** CP 17 (4.5.2) - Issue not resolved by Level 1. Engineer and Contractor personnel will perform an investigation and review data to determine if the questioned sample is an isolated sample (test differences outside of multi-lab precision). All Level 2 tasks must be completed within 8 working days from the time written notification is presented to the Engineer. In the space below, include a detailed description of actions taken to resolve the dispute. Attach an additional page if necessary.

Investigated by:   
Electronic signature required

Concurrence - Region Materials    Yes     No     by:   
Electronic signature required

**Level 3** CP 17 (4.5.3) - Issue not resolved by Level 2. Project Engineer will submit Blind Split Sample to CDOT Central Materials Lab within 18 working days from the time written notification is received. The blind split sample shall be confidentially submitted only to the Materials and Geotechnical Branch, Asphalt Program Manager, by the Engineer, using a CDOT Form #1304. Samples shall be submitted only when the decision has been formally made at the project to conduct dispute testing.

Project Engineer: \_\_\_\_\_  
Project Engineer E-Mail: \_\_\_\_\_  
Project Engineer Cell Number: \_\_\_\_\_

{Page Intentionally Left Blank}

## Colorado Procedure 20-08

### *Standard Practice for*

### **Dry Preparation of Disturbed Soil Samples for Test**

#### **1. SCOPE**

- 1.1 This procedure describes the dry preparation of soil and soil aggregate samples for mechanical analysis, liquid and plastic limits, and moisture density relations test.

#### **2. REFERENCED DOCUMENTS**

2.1 *AASHTO Procedures:*

T 89 Determining the Liquid Limit of Soil

T 90 Determining the Plastic Limit and Plasticity Index of Soil

T 99 Moisture-Density Relations of Soils Using a 2.5-kg Rammer and a 305-mm Drop

T 180 Moisture-Density Relations of Soils Using a 4.54-kg Rammer and a 457-mm Drop

M 92 (ASTM E 11)

M 145 Classification of Soils and Soil-Aggregate Mixtures for Highway Construction Purposes

2.2 *ASTM Procedures:*

E 11 Standard Specifications for Wire Cloth and Sieves for Testing Purposes

2.3 *Colorado Procedures:*

CP 21 Mechanical Analysis of Soils

CP 32 Reducing Field Samples of Soils and Aggregate to Testing Size

#### **3. APPARATUS**

- 3.1 *Scales* – Scale of suitable capacity and sensitive to .01 lb (.01 kg).

- 3.2 *Balance* – Balance of suitable capacity and sensitive to 0.1 g.

- 3.3 *Sieves* – Series of sieves conforming to AASHTO M 92 of the following sizes: No. 4, No. 10, and No. 40.

- 3.4 *Drying Apparatus* – Oven or other suitable device.

- 3.5 *Sample Splitter* – Riffle type sample splitter to reduce sample to test portion size in accordance with CP 32.

- 3.6 *Pulverizing Apparatus* – Either a mortar and rubber covered pestle, or a mechanical device consisting of a power driven rubber covered mauler and a mortar suitable for breaking up the aggregations of soil particles without reducing the size of the individual grains.



#### 4. SAMPLE SIZE

4.1 The amounts of material required to perform the individual tests are as follows:

4.1.1 Mechanical Analysis of Soils (CP 21) – For the mechanical analysis, material passing the No. 4 is required in the amount of approximately 500 g. The total portion of the sample retained on the No. 4 shall be used for gradation.

**Note 1:** When the mechanical analysis is to be used to determine the soil classification in accordance with AASHTO M 145, material retained on the 3-in. (75 mm) sieve shall not be included in the gradation of the material retained on the No. 4 sieve.

4.1.2 Liquid Limit (AASHTO T 89) and Plastic Limit (AASHTO T 90) – For the liquid and plastic limit tests, material passing the No. 40 sieve is required in total amounts of 100 to 300 g.

4.1.3 For Moisture Density Relations (AASHTO T 99 and T 180) test the following minimum amounts of material as required.

| <u>Passing Method</u> | <u>Minimum Sieve</u> | <u>Quantity</u>  |
|-----------------------|----------------------|------------------|
| A                     | No. 4                | 10 lb. (4.5 kg)  |
| B                     | No. 4                | 16 lb. (7.3 kg)  |
| C                     | 3/4 in. (19.0 mm)    | 12 lb. (5.4 kg)  |
| D                     | 3/4 in. (19.0 mm)    | 25 lb. (11.3 kg) |

#### 5. PREPARATION OF TEST SAMPLES

5.1 The sample shall be dried in air or by use of a drying apparatus that does not exceed 140°F (60°C). When sufficiently dry, break up the aggregations and separate the material into two fractions using a No. 4 sieve. Care shall be taken when processing the material through the No. 4 sieve to avoid reducing the natural size of the individual particles. Material retained on the No. 4 sieve shall be thoroughly cleaned using the apparatus described in Subsection 3.6 and a wire brush when necessary. The minus No. 4 material removed shall be combined with the material previously processed through the No. 4 sieve, and added to the total weight (mass) of the material passing the No. 4 sieve, uncorrected for hygroscopic moisture. (See NOTE 1).

5.2 Test Specimen for Mechanical Analysis – The total fraction of the sample retained on the No. 4 sieve as prepared in Subsection 5.1 shall be set aside for use in the sieve analysis of the plus No. 4 material in CP 21. Immediately after weighing the total amount of material passing the No. 4 sieve as prepared in Subsection 5.1, select by use of a sample splitter, a representative specimen weighing (with a mass of) approximately 500g for the washed sieve analysis in CP 21 and another representative specimen weighing (with a mass of) approximately 250g for a moisture specimen to correct the total weight (mass) of the minus No. 4 fraction and to correct the weight (mass) of the specimen selected for the washed sieve analysis to oven dry weight (mass).

5.3 Test Specimen for Liquid and Plastic Limits Tests (T 89, T 90) – By use of a sample splitter, select a representative portion of minus No. 4 material as prepared in Subsection 5.1 which will provide approximately 100g to 300g of minus No. 40 material when processed as follows:

- 5.3.1 The aggregations of soil particles shall be mauled using a rubber covered pestle or a power driven rubber covered mauler and mortar. Separate the specimen on the No. 10 sieve and alternately grind and sieve the material until the plus No. 10 particles appear clean. Discard the material retained on the No. 10 sieve. Alternately maul and sieve the material retained on the No. 40 sieve until only a small quantity passes the sieve and the retained particles appear clean. Discard the material retained on the No. 40 sieve. The thoroughly mixed minus No. 40 material shall be used for the liquid and plastic limits tests. (See Note 2).

**Note 2:** When mauling material with a pulverizing apparatus it shall be done in such a manner as to break up the aggregations without fracturing the individual grains.

- 5.4 Moisture Density Relations Test - By use of a sample splitter select a representative portion of minus No. 4 material as prepared in Subsection 5.1. Prepare the plus No. 4 material according to the procedure described in AASHTO T 99 or T 180 Method C or D. The minimum weight (mass) requirement shall be as shown for the applicable method in Subsection 4.1.3.

{Page Intentionally Left Blank}

## Colorado Procedure 21-08

*Standard Method of Test for*

### Mechanical Analysis of Soils

#### 1. SCOPE

- 1.1 This method describes the procedure for the quantitative determination of the distribution of particle size in soils and soil aggregate mixtures.

#### 2. REFERENCED DOCUMENTS

- 2.1 *AASHTO Procedures:*  
M 92 (ASTM E 11)  
M 145 Classification of Soils and Soil-Aggregate Mixtures for Highway Construction Purposes
- 2.2 *Colorado Procedures:*  
CP 20 Dry Preparation of Disturbed Soil Samples for Test

#### 3. APPARATUS

- 3.1 *Balance* – A balance sensitive to within 0.1 gram.
- 3.2 *Container* – A pan or vessel with sufficient capacity to contain the specimen when covered with water.
- 3.3 *Washing Device* (Optional) – Any approved device designed to facilitate the removal of material finer than the No. 200 sieve from the test specimen. The device shall be capable of producing a result equivalent to that described in Subsection 5.2.2 and Note 2.
- 3.4 *Sieves* – A series of sieves of the following sizes conforming to AASHTO M 92: 3-in. (75 mm), 1-in. (25.0 mm), 3/4-in. (19.0 mm), No. 4, No. 10, No. 40, and No. 200.
- 3.5 *Drying Equipment* – Hot plate, stove, or oven.

#### 4. TEST SPECIMEN

- 4.1 The test specimen shall be prepared in accordance with CP 20, Subsections 5.1 and 5.2.

## 5. PROCEDURE

5.1 Sieve Analysis of Plus No. 4 Material – The total fraction of the sample retained on the No. 4 sieve as prepared in CP 20, Subsection 5.1, shall be separated into a series of sizes by the use of the 3-in. (75 mm), 1-in. (25.0 mm), 3/4-in. (19.0 mm), 3/8-in. (9.5 mm), and the No. 4 sieves. The sieving operation shall be conducted in such a manner so as to keep the particles moving continuously over the surface of the sieve. Care shall be taken not to overload the sieves. Sieving shall continue until not more than 1% by weight (mass) of the residue passes any sieve during 1 minute. When mechanical sieving is used the thoroughness of sieving shall be checked occasionally by using the method as described above.

5.1.1 Weigh and record the portion of the specimen retained on each sieve. It is permissible to record the accumulated weights (masses) as the contents of each successive sieve are added to the fractions previously deposited on the scale pan.

**Note 1:** For the purpose of soil classification in accordance with AASHTO M 145, material retained on the 3 in. (75 mm) sieve shall not be included in the total weight (mass) of the specimen. The approximate maximum size shall be noted and reported on CDOT Form #219. When there is an appreciable amount of plus 3 in. (75 mm) material the percentage should be estimated and included in the notes on CDOT Form # 219.

5.2 Sieve Analysis of Minus, No. 4 Material – The minus No. 4 specimen for moisture determination, as prepared by CP 20, Subsection 5.2, shall after weighing be dried to a constant weight (mass) at  $230^{\circ}\text{F} \pm 9^{\circ}$  ( $110^{\circ}\text{C} \pm 5^{\circ}$ ). When cool (room temperature) and dry, weigh, calculate, and record the percent moisture.

5.2.1 The minus No. 4 specimen for the washed sieve analysis as prepared by CP 20, Subsection 5.2, shall, after weighing, be placed in a container and covered with water for a sufficient length of time to assure complete separation of the material finer than the No. 200 sieve from the coarser particles. A small amount of organic wetting agent may be added to the water to facilitate wetting.

5.2.2 Transfer the soaked specimen from the container onto a nest of two sieves of which the top "breaker" sieve is a No. 8 or No. 10 and the bottom sieve is a No. 200. Wash the specimen over the "breaker" sieve until the material retained on the sieve is clean. Transfer the clean retained material to a suitable container and set aside. Wash the material passing the "breaker" sieve over the No. 200 sieve, using any method or device, which will assure the removal of that portion of the specimen, which is finer than the No. 200 sieve size. When clean, transfer the material remaining on the No. 200 sieve to the container with the material retained on the "breaker" sieve and dry to a constant weight (mass) at  $230^{\circ}\text{F} \pm 9^{\circ}$  ( $110^{\circ}\text{C} \pm 5^{\circ}$ ).

**Note 2:** Washing over the No. 200 sieve by decantation, using a pinched hose or by mechanical or automatic washing devices, shall be performed in such a manner so as not to reduce the individual particle size. Manipulation of the material on the No. 200 sieve will be permitted, provided direct force or pressure is not applied to the sieve. The specimen shall be considered clean when the water washed through the sieve and caught in a clean white pan shows only a negligible amount of material passing the sieve.

- 5.2.3 When cool (room temperature), separate the specimen into a series of sizes by the use of the No. 10, No. 40, and No. 200 sieves. The sieving shall be conducted as described in Subsection 5.1.
- 5.2.4 Weigh and record the material retained on each sieve. This may be done either individually or accumulatively as in Subsection 5.1.1.

## 6. CALCULATIONS

- 6.1 Using the percent moisture as determined in Subsection 5.2, correct the original moist weight (mass) of the total minus No. 4 material and the moist weight (mass) of the minus No. 4 specimen selected for the washed sieve analysis to dry weight (mass) as follows:

$$\text{Dry Weight (Mass)} = \frac{\text{wet weight (mass)}}{100 + \% \text{moisture in specimen}} \times 100$$

- 6.2 After correcting the total moist weight (mass) of the minus No. 4 fraction to dry weight (mass), calculate the percentage of material retained on each sieve larger than the No. 4 sieve and the total percentage of material passing the No. 4 sieve by dividing each by the total combined dry weight (mass) of both the plus and minus No. 4 fractions. Convert percent retained to percent passing each sieve and total percent passing the No. 4 sieve. (See Note 1)
- 6.3 Calculate the percentages retained on the No. 10, No. 40, and No. 200 sieves from the washed sieve analysis specimen by dividing the weight (mass) retained on each sieve by the total dry weight (mass) of the minus No. 4 sieve analysis specimen before washing. Convert percent retained to percent passing each sieve.
- 6.4 Calculate the percent passing each sieve on a total sample basis by multiplying the percent passing each sieve of the washed sieve analysis specimen by the percent passing the No. 4 sieve of the total sample divided by 100.

## 7. RECORD

- 7.1 CDOT Form 564, Soils and Aggregates Sieve Analysis When Splitting on the No. 4 Sieve.
- 7.2 CDOT Form 219, Soil Survey of the Completed Roadbed.

{Page Intentionally Left Blank}

## Colorado Procedure 23-13

*Standard Method of Test for*

### Determining Maximum Dry Density and Optimum Moisture Content of Soil-Rock Mixtures

#### 1. SCOPE

- 1.1 This method of test is intended for determining the maximum dry density and optimum moisture content of soil-rock mixtures

#### 2. REFERENCED DOCUMENTS

2.1 *AASHTO Procedures:*

- T 85 Specific Gravity and Absorption of Coarse Aggregate
- T 99 Moisture-Density Relations of Soils Using a 2.5-kg Rammer and a 305-mm Drop
- T 180 Moisture-Density Relations of Soils Using a 4.54-kg Rammer and a 457-mm Drop
- T 265 Laboratory Determination of Moisture Content of Soils

2.2 *Colorado Procedures:*

- CP 80 In-Place Density and Moisture Content of Soil and Soil-Aggregate by the Nuclear Method
- CP-L 3104 Determining the Durability of Shales for Use as Embankments

#### 3. APPARATUS

- 3.1 *Balance* - Capacity of 2,500g or more and accurate to 0.1g.
- 3.2 *Drying Equipment* - Stove or oven.
- 3.3 No. 4 and  $\frac{3}{4}$  inch Sieve.

#### 4. PROCEDURE

##### Moisture / Density Curve Development

- 4.1 Obtain a representative sample of the soil-rock mixture. The sample should be of sufficient size to yield 3-5 pounds of minus 3 in. plus No. 4 material.
- 4.2 Process the sample over a No. 4 sieve, saving both the minus No. 4 and plus No. 4 material.
- 4.3 Determine the maximum dry density and the optimum moisture content of the minus No. 4 material in accordance with AASHTO T 99 or T 180, Method A.
- 4.4 Determine the bulk specific gravity and absorption of the plus No. 4 material in accordance with AASHTO T 85.



**In-Place Rock Correction**

- 4.5 Determine the rock corrected maximum dry density and optimum moisture content of the in-place soil-rock mixture at a test site as follows:
- 4.5.1 Obtain a minimum 5lb sample of material from the density test as described in CP 80.

**Method A - Oven Dry**

- 4.6 Dry the entire specimen and determine the dry weight of the entire specimen in accordance with AASHTO T 265.
- 4.6.1 Separate the material by using a No. 4 sieve and weigh the plus No. 4 fraction retained. Calculate the percentage retained as follows:

$$\text{Percent plus No. 4 (rock)} = \frac{\text{Dry wt. of plus No. 4}}{\text{Dry wt. of total specimen}} \times 100\%$$

**Method B – Using Gauge MC**

- 4.7 Wet sieve the entire sample over the No. 4 sieve.
- 4.7.1 Weigh the retained on the No. 4 sieve and material passing the No. 4 sieve.
- 4.7.2 Calculate the dry weight of the material retained on the No. 4 sieve by dividing its weight by  $1 + (\text{absorption}/100)$ .
- 4.7.3 Calculate the dry weight of the material passing the No. 4 sieve by dividing its weight by  $1 + (M/D \text{ gauge MC reading}/100)$ .
- 4.7.4 Calculate the percentage retained:

$$\text{Percent plus No. 4} = \frac{\text{Dry wt. of plus No. 4}}{\text{Dry wt. of plus No. 4} + \text{Dry wt. of minus No. 4}} \times 100\%$$

**Note 1:** Method B may be used if the gauge's MC is within +/- 1% of the AASHTO T 265 MC when checked in CP 80.

## 5. CALCULATIONS

- 5.1 Determine the corrected optimum moisture content ( $OMC_c$ ) of the soil-rock mixture by the following formula:

$$OMC_c = \frac{(M_f \times P_f) + (M_c \times P_c)}{100}$$

- 5.2 Determine the maximum dry density of the soil-rock mixture.

- 5.2.1 When AASHTO T 99 is used to determine the maximum dry density of the minus No. 4 material, use the following equation to determine the corrected maximum dry density ( $MDD_c$ ) of the soil-rock mixture:

$$MDD_c = \frac{(P_f \times D_f) + (P_c \times 0.90 \times D_c)}{100}$$

- 5.2.2 When AASHTO T 180 is used to determine the maximum dry density of the minus No. 4 material, use the following equation to determine the corrected maximum dry density ( $MDD_c$ ) of the soil-rock mixture:

$$MDD_c = \frac{(P_f \times D_f) + (P_c \times 0.95 \times D_c)}{100}$$

Where:

$P_f$  = Percent fine particles by weight (minus No. 4);

$P_c$  = Percent coarse particles by weight (plus No. 4);

$D_f$  = Maximum dry density of fine particles (minus No. 4), pcf;

$D_c$  = 62.4 x bulk specific gravity of coarse particles (plus No. 4), pcf;

$P_c$  = Percent coarse particles by weight (plus No. 4);

$M_f$  = Optimum moisture content of the minus No. 4 material as determined by AASHTO T 99 or T180;

$M_c$  = Absorption of the plus No. 4 material as determined by AASHTO T85.

## 6. LIMITATION FOR USE OF CP 23

- 6.1 CP 23 shall not be used when the plus No. 4 fraction of the sample consists of cinders, crushed concrete, recycled asphalt pavement, or other light porous rock since an accurate specific gravity determination is difficult to make on this type of material. For these materials AASHTO T 99 or T 180, Method D shall be used.

6.2 The plus No. 4 fraction of the sample shall be determined to be Rock-like (Durable) or Soil-like (Non-durable) either visually, by experienced field personnel or in the Central Laboratory, according to CP-L 3104. If the plus No. 4 fraction is classified as Non-durable, then CP 23 will not apply and the total sample shall be treated as minus No. 4 material for moisture / density determination.

**Note 2:** Non-durable plus No. 4 material will usually be found in soils with a classification of A-6 or A-7.

6.3 When the soil-rock mixture contains more than 30% plus No.4 material but 30% or less of the material is retained on the  $\frac{3}{4}$  inch sieve AASHTO T 99 or T 180 method D may be used as approved by the Engineer.

6.3.1 When Method D is used, procedures 4.1 thru 5.1 shall be used. The  $\frac{3}{4}$  inch sieve shall be substituted for the No. 4 sieve. The material passing the  $\frac{3}{4}$  inch sieve will be used for determining the un-corrected maximum dry density and optimum moisture content. The material retained on the  $\frac{3}{4}$  inch sieve will be used for T85.

6.4 When the soil-rock mixture contains more than 50% plus No.4 material and more than 30% plus  $\frac{3}{4}$  inch material, CP 23 cannot be used.

## 7. RECORD

7.1 CDOT Form 24, Moisture - Density Relation.

7.2 CDOT Form 584, Moisture - Density Relation Graph.

7.3 CDOT Form 427, Nuclear Moisture / Density Soils Test.

## Colorado Procedure 24-20

### *Standard Practice for*

## Soil Surveys of Constructed Roadbeds

### 1. SCOPE

1.1 This procedure provides the substantiation for the cover placed and the data required to justify changes from plan cover. A soil survey of the constructed roadbed consists of the following:

1.1.1 Obtaining representative samples of all soil types, the determination of soil profiles, and the significant soil layers to a depth of two feet (600 mm) below any aggregate base or sub-base.

1.1.2 The classification and extent of each soil type.

### 2. EQUIPMENT

2.1 The amount and type of equipment required for making a survey depends on the type of material in the roadbed. Refer to the SOIL SURVEYS & SIMILARIZATION Section within Chapter 200 for additional information.

### 3. SUB-GRADE INVESTIGATION

3.1 Soil identification, sampling, and testing provide the fundamental framework of the complete survey. This emphasizes the necessity of using care in identifying and sampling soils. Laboratory tests are of little or no value if the samples selected are not representative of the materials to be considered.

3.2 Make a sufficient number of investigations to assure all significant variations in soil types are determined. A minimum of one investigation per 1,000 linear ft. (300 m) is required. Make all investigations to a depth of at least two feet (600 mm) below the finished sub-grade elevation. Number the investigations consecutively as the survey moves progressively forward. For vertical changes in the same test hole use suffixes A, B, etc. Take a new sample for every change in soil type. An investigation may include referencing a sample to one previously taken. Referencing samples should be done by those who are thoroughly experienced in soils technology. Show the limits of all investigations consecutively with no breaks except for bridges. In areas where several soil types are so intermixed that no limits can be determined, show the various tests with separate numbers, with no suffixes, and show the limits for this area. Stabilization will be based on the least desirable soil in the area.

3.2.1 When the Pavement Stabilization is based on a design R Value that equals 5; the Region Materials Engineer in cooperation with the Resident Engineer and the Staff Soils Engineer may elect to eliminate the requirement for the Final Soil Survey of the Constructed Roadbed. This decision should be evaluated and documented on a project-by-project basis.

- 3.3 Place the soil sample for laboratory analysis in tightly woven sacks. A minimum of 25 lbs. (10 to 12 kg) of minus No. 4 material is required for classification, stabilometer and expansion pressure tests. Additional material, in the approximate amount of the plus No. 4 material contained in the sample, is required when a soil rock mixture is sampled. For field laboratory gradation and Atterberg limits, approximately 15 lbs. (10 kg) of minus No. 4 material is required.

#### **4. COVER DETERMINATIONS**

- 4.1 The field laboratory will conduct gradation and Atterberg Limits to classify soils for the substantiation of cover placed. Keep graded material segregated until it is determined there are no significant variations in the material from the preliminary soil survey. If significant variations of the material from the preliminary soil survey are determined, the segregated material should be sent with the Form #564 to either the Central or Region Laboratory for R-value tests.
- 4.2 The Central Laboratory or Region Laboratory will determine the R-Value on soils submitted for cover determinations. Use the R-Value as instructed in the current CDOT Pavement Design Manual. When available, Structural Coefficients should be taken from the pavement stabilization plan contained in the plan sheets. In the field, soils may be referenced to samples of similar soils from the same or adjacent projects.
- 4.3 Reference R-Values on soil by comparing the classification, Atterberg Limits, and the "as run" gradation reported on CDOT Form 555 with the field sample which has been mathematically "scalped" on the same sieve as the laboratory sample. Only experienced materials personnel should attempt to reference soil to determine R-Values.

#### **5. REPORTING**

- 5.1 Report the Soil Survey on CDOT Form 219. Leave Sample No. blank. No serial number is required. Date and project number are sufficient for identification. A CDOT Form 219 will not be required for overlay projects or projects where there has not been any change in the top two feet (600 mm) of sub-grade as shown by the preliminary soil survey.
- 5.2 Document on CDOT Form 219 any significant variation from the cover required by the as-constructed soil survey. Areas, which contain mixtures of soil types, shall have sufficient cover to satisfy the lowest R-Value of the material in the area.
- 5.3 Submit a CDOT Form 219 on all newly completed roadbeds and roadbeds that are modified resulting in soil changes in the top two feet (600 mm).
- 5.3.1 Main-line roadbed includes each side of the median on divided highways.
- 5.3.2 All service roads and interchanges.
- 5.3.3 Widening (each side if applicable).
- 5.3.4 All work sections of old roadbeds.
- 5.3.5 Identify and report each of the above separately on CDOT Form 219. See Chapter 200 for an example of CDOT Form 219.

5.4 When change orders are required to document changes in cover requirements, support them with a CDOT Form 219 for the portion affected. Route the change orders through the Region Materials Engineer's office so the supporting data on CDOT Form 219 may be checked.

**6. RECORD**

6.1 CDOT Form 555, Preliminary Soil Survey.

6.2 CDOT Form 219, Soil Survey of the Completed Roadbed.

{Page Intentionally Left Blank}

## Colorado Procedure 25-21

*Standard Practice for*

### Calculation of Percent Relative Compaction of Soils and Soil-Rock Mixtures

#### 1. SCOPE

- 1.1 This procedure describes the method to use a one-point for calculating percent relative compaction of soils and soil-rock mixtures.

#### 2. REFERENCED DOCUMENTS

2.1 *AASHTO Procedures:*

- T 99 Moisture-Density Relations of Soils Using a 2.5-kg Rammer and a 305-mm Drop
- T 180 Moisture-Density Relations of Soils Using a 4.54-kg Rammer and a 457-mm Drop
- T 272 One-Point Method for Determining Maximum Dry Density and Optimum Moisture
- T 265 Laboratory Determination of Moisture Content of Soils

2.2 *Colorado Procedures:*

- CP 23 Determining Maximum Dry Density and Optimum Moisture Content of Soil-Rock Mixtures
- CP 80 In-Place Density and Moisture Content of Soil and Soil-Aggregate by the Nuclear Method

#### 3. PROCEDURE

- 3.1 Determine the maximum dry density of the soil-rock mixture following the procedures of Subsection 3.2, 3.3, or 3.4.
- 3.2 Determine the valid project developed moisture / density curve for the soil-rock mixture.
- 3.2.1 Following the determination of the in-place density, obtain a minimum 9 lb sample of material from the density test as described in CP 80.
- 3.2.2 Determine the percent plus No. 4 in the material.
- If necessary, air dry the minus No. 4 portion of the material to a condition in which the material is within 80 to 100 percent of the optimum moisture content.
- 3.2.3 Use the minus No. 4 portion of the material to perform a one-point AASHTO T 99 or T 180, whichever is applicable.



- 3.2.4 Using the percent moisture from a representative moisture specimen taken from the material in the compaction cylinder and dried per AASHTO T 265, calculate the dry density of the material from the compaction cylinder using the formula:

$$D_D = \frac{\frac{W_w}{M_v}}{1 + \frac{M}{100}}$$

Where:

$D_D$  = Dry Density of compacted soil, lbs/ft<sup>3</sup>;

$W_w$  = Wet weight of compacted soil, lbs;

$M_v$  = Mold Volume for 4" mold = 0.0333 ft<sup>3</sup> and for a 6" mold = 0.0750 ft<sup>3</sup>;

$M$  = percent moisture.

**Note 1:** Use the actual mold volume in this calculation if it has been determined.

- 3.2.5 Using the calculated dry density and the percent moisture of this material, plot the location of this data point on the appropriate moisture density relation curve.
- 3.2.6 A moisture density relation curve is valid and will be used when the plotted one-point data is within 2.0 lbs/ft<sup>3</sup> at the specimen's moisture content and when the specimen's moisture content is within 80 to 100 percent of the optimum moisture content of the reference curve.

**Note 2:** This moisture density relation curve must be from a soil on the project with the same soil classification. If the soil being tested has not been classified previously, it must be classified.

- 3.2.7 If the one-point data determined does not plot within 2.0 lbs/ft<sup>3</sup> at the specimen's moisture content, or if the moisture content of the one point is not within 80 to 100 percent of the optimum moisture content of the reference curve, check additional curves of the same soil classification that were generated on the project and meet the aforementioned criteria. If an applicable curve of the same soil classification is not found, refer to Subsection 3.3 of this procedure.
- 3.3 If a valid moisture density curve cannot be determined from the one-point test, use the material collected in Subsection 3.2.1 to determine the maximum dry density and optimum moisture content according to AASHTO T 99 or T 180, whichever is applicable, on the material passing the No. 4 sieve.
- 3.4 When the source of the soil-rock mixture is known and the maximum dry density, optimum moisture content, and soil classification has been previously determined:
- 3.4.1 The tester may use the moisture density relation curve after a one-point test has been performed. The result must meet the criteria of Subsection 3.2. and then use the moisture density relation curve that has been approved by the Engineer.

- 3.5 The maximum dry density and optimum moisture content of a soil-rock mixture must be validated a minimum of 1 per 5000 yds<sup>3</sup> for each soil classification using Subsection 3.2.

**Note 3:** This is required to verify and document that there has not been subtle or unnoticed changes in soil characteristics.

- 3.6 For soil-rock mixtures containing 5% or more plus No. 4 material, the maximum dry density of the soil-rock and optimum moisture content shall be rock corrected according to CP 23.

- 3.7 Calculate percent relative compaction by dividing the dry density of the material from the test site by that material's moisture density relation curve's maximum dry density, and multiply by 100%.

**Note 4:** When AASHTO T99/T180 Method D is used by CP 23, the ¾ inch sieve shall be substituted for the No. 4 sieve. The material passing the ¾ inch sieve will be used for determining the un-corrected maximum dry density and optimum moisture content.

#### 4. RECORD

- 4.1 CDOT Form 427, Nuclear Moisture/Density Soils Test.

{Page Intentionally Left Blank}

## Colorado Procedure 26-14

*Standard Practice for*

### Contractor Approval Process for Subgrade Stabilization

#### 1. SCOPE

- 1.1 This practice describes the procedures for submitting design and construction information using mechanical stabilization with geosynthetics or chemical stabilization for subgrade stabilization in lieu of unbound aggregates.

#### 2. REFERENCED DOCUMENTS

- 2.1 CDOT 2013 Pavement Design Manual.
- 2.2 Chapter 5 of the FHWA Geosynthetic Design and Construction Guidelines dated August 2008.

#### 3. APPROVAL OF SUBGRADE DESIGN

- 3.1 The design of the subgrade stabilization shall be in conformance with CDOT Pavement Design Manual and other specified Colorado, AASHTO, ASTM, and FHWA procedures. Significant variances from these specifications will require an Experimental Feature in accordance with CDOT's Procedural Directive 1401.1.
- 3.2 Mechanical Stabilization with Geosynthetics.
  - 3.2.1 Geotextile material shall be on the New York State DOT's Approved Products List for Geotextiles in the Stabilization Application.
  - 3.2.2 Designs using other geotextile or geogrids shall be submitted and approved by the Engineer prior to incorporation into the work.
  - 3.2.3 Design must be calculated with an AASHTO or FHWA approved methodology. Design considerations include, but are not limited to the following:
    - 3.2.3.1 Submit geosynthetic subgrade stabilization design calculations with input values and any assumptions used in the calculations.
    - 3.2.3.2 State geo-synthetic design methodology used in design calculation and output values.
    - 3.2.3.3 State the estimated effective resilient modulus of construction platform. Note: the minimum resilient modulus value used in the design shall be equal to or greater than the value shown on the plans or in the Pavement Justification Report.
    - 3.2.3.4 Upon request, the design software shall be made available to CDOT personnel.
    - 3.2.3.5 The design shall be stamped by a Professional Engineer registered in the State of Colorado.

3.2.4 Construction requirements include, but are not limited to the following:

3.2.4.1 The subgrade material shall be placed in accordance with the manufacturer's recommendations and Subsection 203.07.

3.2.4.2 Proof rolling shall be in accordance with Subsection 203.09.

3.3 Chemical stabilization may be accomplished with lime, cement, fly ash or other chemical agents approved by the Engineer.

3.3.1 Design must be calculated with a CDOT, AASHTO or ASTM approved methodology.

3.3.1.1 Submit design calculations at various application rates.

3.3.1.2 State the chemical-soil proportion for stabilization.

3.3.1.3 State unconfined compressive strength at the design value.

3.3.1.4 The design shall be stamped by a Professional Engineer registered in the State of Colorado.

3.3.2 Construction requirements using lime shall be in accordance with Subsection 307.04.

3.3.3 Construction requirements using other chemical agents shall be submitted and approved by the Engineer prior to incorporation into the work.

#### **4. DESIGN SUBMITAL REQUIREMENTS**

4.1 All required design and supporting information shall be submitted electronically to the Project Engineer. Acceptable formats include pdf, MS Excel, MS Word, PowerPoint, jpg and other compatible formats. Submittal shall be submitted in the order listed below.

4.2 Subgrade Stabilization Technology Supplier – Submittal shall include, but not limited to the following:

4.2.1 The Submittal for Mechanical Stabilization with Geo-synthetics:

- Manufacturer's product data sheets.
- One sample measuring at least 4 inches by 8 inches.
- Quality control data for each lot incorporated into the project.
- The laboratory performing the quality control shall be currently accredited by GAI-LAP and shall include a copy of their current certificate.
- The manufacturer shall be registered in ISO 9000.
- Provide the name of the manufacturer's representative who will be available during construction.
- If available, include project locations, supporting design information and any performance data from previous CDOT projects constructed within the last 10 years.

#### 4.2.2 The Submittal for Chemical Stabilization:

- Manufacturer's product data sheets.
- Quality control data on the chemical composition for each lot incorporated into the project.
- Quality control data on the gradation analysis for each lot incorporated into the project.
- Provide the name of the manufacturer's representative who will be available during construction.

#### 4.3 Subgrade Stabilization Contractor Submittals shall include:

- Summary of contractor's subgrade stabilization experience, if any. Contact names shall be included for owners of past projects.
- A list of best practices for subgrade stabilization.
- Solutions for corrective actions for typical problems that may need to be utilized. Written explanation shall be provided for the failures.

### 5. CDOT REVIEW PROCESS

- 5.1 Preliminary review of contractor's subgrade stabilization proposal will be performed by the Project Engineer in conjunction with Regional Material Engineers as needed.
- 5.2 CDOT may request additional information from Contractor.
- 5.3 Incomplete submittals may be rejected as unacceptable.
- 5.4 Preliminary review is estimated to take up to two weeks, depending upon completeness of initial submittal.
- 5.5 Final approval may take an additional week after the conclusion of the preliminary review.

{Page Intentionally Left Blank}

## Colorado Procedure 30-09

*Standard Practice for*

### Sampling of Aggregates

#### 1. SCOPE

- 1.1 These methods are intended to apply to the sampling of aggregates used in acceptance and quality control from the points of acceptance designated in the Schedule for Minimum Materials Sampling, Testing, and Inspection for the following items:

Item 206 - Structure Backfill, Filter Material, Bed Course Material

Item 304 - Aggregate Base Course

Item 308 - Aggregate for Portland Cement Treated Base

Item 403 - Aggregates for Hot Mix Asphalt

Item 409 - Cover Coat Material

Item 412 - Aggregate for Portland Cement Concrete Pavement

Item 601 - Aggregate for Structural Concrete

Item 608 - Aggregate for Concrete Sidewalk, Bituminous Sidewalk, Concrete Bikeways, and Bituminous Bikeways

Item 609 - Aggregate for Concrete Curbing and Bituminous Curbing

Item 610 - Aggregate for Median Cover Material

**Note 1:** Sampling plans and the acceptance and control tests vary with the type of construction in which the material is used.

- 1.2 The values stated in English units are to be regarded as the standard. The values in parentheses are provided for information purposes only.
- 1.3 This standard may involve hazardous materials, operations, and equipment. This standard does not purport to address all of the safety problems associated with its use. It is the responsibility of the user of this standard to establish appropriate safety and health practices and determine the applicability of regulatory limitations before use.

#### 2. REFERENCED DOCUMENTS

- 2.1 *Colorado Procedure:*  
CP 75 Stratified Random Sampling of Materials

#### 3. SIGNIFICANCE AND USE

- 3.1 Sampling is equally as important as the testing, and the sampler shall use every precaution to obtain samples that will show the nature and condition of the materials which they represent.



- 3.2 Samples of all aggregates used in HMA and being tested by the Colorado Department of Transportation (CDOT) or its representative shall be taken by the contractor or his representative with an authorized representative of CDOT present during the sampling procedure. Samples of all non-HMA aggregates being tested by CDOT or its representative shall be taken by or, at CDOT's option, witnessed by an authorized representative of CDOT. The CDOT representative present shall take immediate possession of all samples taken. CDOT reserves the right to designate the locations to be sampled and the procedure to be used.

#### **4. SECURING SAMPLES**

- 4.1 *General.* Where practicable, a minimum of one sample per stockpile to be tested for quality shall be obtained from the finished product. Samples from the finished product to be tested for abrasion loss shall not be subject to further crushing or manual reduction in particle size in preparation for the abrasion test unless the size of the finished product is such that it requires further reduction for testing purposes.

- 4.2 *Sampling Equipment.* The contractor shall provide suitable equipment needed for proper sampling.

#### **4.3 Procedure:**

- 4.3.1 *Sampling from a Flowing Aggregate Stream* - Samples shall be selected from all of the material produced using CP 75. Use extreme care to avoid segregation when sampling. Sampling the initial discharge or the final few tons from a bin or conveyor belt increases the chances of obtaining segregated material and should be avoided.

##### *4.3.1.1 Belt Discharge:*

- 4.3.1.1.1 *Belt Discharge using Hand Tools* - If it is safe and practical to sample directly from the belt discharge, hand tools may be used. Obtain one or more approximately equal increments, selected at random. Combine to form a field sample that has a mass equal to or exceeding the minimum recommended in Subsection 4.4.2. Take each increment from the entire cross-section of the material as it is being discharged using a container at least 12 in. (30 cm) in diameter (or minimum lateral dimension) and having sufficient capacity to hold the sample increment. Make several quick passes through different sections of the material rather than one slow pass. A sampling platform or other means is required to enable the sampler to safely stand within 2 ft. (0.6 meters) of the belt discharge.

- 4.3.1.1.2 *Belt Discharge using an Automatic Belt Sampler* - Belt discharge samples may be taken using an automatic belt sampler designed to cut the full discharge of the belt without loss of any portion of the material. Take one or more field samples whose combined mass equals or exceeds the minimum recommended in Subsection 4.4.2.

- 4.3.1.1.3 *Belt Discharge using Power Equipment* - A belt discharge sample may be taken by positioning a front-end loader bucket, truck, or similar equipment beneath the belt discharge. The material obtained shall be placed in a separate, small sampling pile and sampled according to Subsection 4.3.3.2. Obtain a field sample where mass equals or exceeds the minimum recommended in Subsection 4.4.2.

- 4.3.1.2 *Bin Discharge* - Test results obtained using bin discharge samples shall not be used for acceptance.
- 4.3.1.3 *Dry Batch* - When sampling a dry batch, an initial dry batch must be wasted. A second batch may then be sampled as follows. A front-end loader bucket, truck, or similar equipment is positioned under the pugmill to obtain a large sample in one increment. Sample the material according to Subsection 4.3.3.2. Extreme care must be used to avoid segregation and loss of dust-sized particles from the sample.
- 4.3.2 *Sampling from the Stopped Conveyor Belt* Samples shall be selected from all of the material being produced by CP 75 Obtain one or more approximately equal increments and combine to form a field sample where mass equals or exceeds the minimum recommended in Subsection 4.4.2. Stop the conveyor belt while the sample increments are being obtained. To obtain each increment, insert two templates, the shape of which conforms to the shape of the belt into the aggregate stream on the belt, and space them such that the material contained between them will yield an increment of the required weight. Carefully scoop all material between the templates into a suitable container and collect the fines on the belt with a brush and dustpan and add to the container.
- 4.3.3 *Sampling from Stockpiles* - When sampling from stockpiles, it may be difficult to obtain representative samples. Sampling from stockpiles should only be done by or under the direction of experienced personnel. When sampling stockpiles of coarse or coarse and fine aggregates, power equipment, when available, should be utilized as described in Subsections 4.3.3.1 and 4.3.3.2. For general guidance in sampling from stockpiles, see Subsections 4.3.3.1 or 4.3.3.3. When sampling Cover Coat Material from the stockpile, the sample shall be taken from the last stockpile before delivery to the spreader. The material will be sampled by the random sampling procedure as it is being delivered to the stockpile, or as it is being removed and hauled to the spreader. This will assure that all portions of the material will be sampled.
- 4.3.3.1. When using power equipment, develop a separate, small sampling pile composed of materials drawn from various levels and locations in the main pile as follows. Remove material from the sides of stockpiles to expose a representative face for sampling. Judgment must be used to determine the number and locations of areas in the big pile to sample to represent the stockpile as accurately as possible. The number of portions required will depend on the size of the stockpile, the method of stockpiling, and the visual degree of segregation. Channel the faces thus exposed from bottom to top and sample the material obtained according to Subsection 4.3.3.2.
- 4.3.3.2 The power equipment should combine the material obtained in a separate small sampling pile. Flatten the pile to form a pad having depth that is no thicker than approximately 1 ft. (0.3 meters). Use a flat, square end shovel and sample the pad from at least three locations, sampling through the full depth of the pad if possible. Several increments shall be combined to compose a field sample where mass equals or exceeds the minimum recommended in Subsection 4.4.2.

- 4.3.3.3 Where power equipment is not available, samples from stockpiles should be made up of at least two sets of three increments (180 degrees apart) taken from the top third, at the midpoint, and the bottom third of the volume of the pile. Place a board or metal shelf vertically into the pile just above the sampling point to prevent loose aggregate from sliding into the sampling area and to aid in preventing segregation. Remove approximately 6 inches (15 cm) of surface material. Use a flat, square end shovel or scoop with sides for sampling. In sampling stockpiles of fine aggregate (3/8 in. (minus 9.5 mm)), the outer layer, which may have become segregated, should be removed and the sample taken from the material beneath. The use of sampling tubes has proven to be satisfactory. Sampling tubes approximately 1 1/4 in. (30 mm) the minimum in width by 6 ft. (2 m) in length may be inserted into the pile at random locations to extract a minimum of five increments of material to form the sample. Several increments shall be combined to compose a field sample where mass equals or exceeds the minimum recommended in Subsection 4.4.2.
- 4.3.4 *Sampling from Roadway (Bases and Sub-bases)* - Select material to be sampled from all of the material produced (e.g. A station or tonnage) by utilizing CP 75. Obtain at least three approximately equal increments, selected at random from the unit being sampled, and combine to form a field sample where mass equals or exceeds the minimum recommended in Subsection 4.4.2. Using a flat, square end scoop or shovel, take all sample increments from the roadway for the full depth of the material, wherever possible, taking care to exclude any underlying material.
- 4.3.5 *Sampling Aggregates from Processed Windrows* - Select material to be sampled from all of the material produced using CP 75. For processed material containing sufficient moisture to maintain a near-vertical face, remove material from one side toward the center to the full depth until a representative face is exposed. Channel the face just exposed from bottom to top and obtain a sample where mass equals or exceeds the minimum recommended in Subsection 4.4.2 by combining portions from at least three equally spaced locations on the exposed face. Use a flat, square end shovel and, exercising care, remove the portions making sure that particles do not roll off the shovel.
- 4.3.6 *Sampling Aggregates from a Cover Coat Material Spreader* - Samples shall be taken at the last possible location before placement on the pavement. With the spreader stopped, samples will be taken from a minimum of three of the individual chip spreader gates as the aggregate is falling from the spreader to the sample container placed on the pavement. These samples will be combined into one sample where mass equals or exceeds the minimum requirements shown in Subsection 4.4.2. If there is a belt transfer device on the spreader, the Engineer may approve obtaining a representative sample from the belt when the machine is at rest as detailed in Subsection 4.3.2. If neither of these sampling methods is possible, the Engineer may allow random sampling from the stockpile as detailed in Subsection 4.3.3.

#### **4.4 Number and Mass of Field Samples:**

- 4.4.1 The minimum number of field samples required is specified in the CDOT Field Materials Manual under the Schedule for Minimum Materials Sampling, Testing, and Inspection.

- 4.4.2 The minimum mass for lab samples is given in the CDOT Field Materials Manual in the Schedule for Minimum Materials Sampling, Testing, and Inspection. The minimum mass for field samples is given in Table 30-1. The sample must be large enough to include representative portions of each component of the material. The mass must be predicated on the type and number of tests to which the material is to be subjected and with sufficient material obtained to provide for the proper execution of these tests.

**TABLE 30-1: Size of Field Samples**

| Nominal Maximum Aggregate Size of Aggregates <sup>A</sup> | Minimum Weight of Field Sample lbs. |
|---|-------------------------------------|
| <b>Fine Aggregate</b>                                     |                                     |
| No. 8   | 10                                  |
| No. 4   | 10                                  |
| <b>Coarse Aggregate</b>                                   |                                     |
| 3/8 in.   | 15                                  |
| 1/2 in.   | 20                                  |
| ¾ in.   | 25                                  |
| 1 in.   | 30                                  |
| 1 ½ in.   | 40                                  |
| 2 in.   | 45                                  |
| 2 ½ in.   | 50                                  |
| 3 in.   | 55                                  |
| 3 ½ in.   | 60                                  |

<sup>(A)</sup> For processed aggregate, the nominal maximum size is defined in the Appendix to the CDOT Field Materials Manual.

## 5. SHIPPING SAMPLES

- 5.1 Transport aggregates in bags or other containers so constructed as to preclude loss or contamination of any part of the sample or damage to the contents from mishandling during shipment. When the moisture content is being measured in the aggregate sample, the representative sample must be stored in a sealed container that will prevent any moisture loss.
- 5.2 Shipping containers for aggregate samples shall have suitable individual identification attached and enclosed so that field reporting, laboratory logging, and test reporting may be facilitated. **Utilization of CDOT Form 633, Sample Tag (for Sacks), is required for all submitted samples.**

{Page Intentionally Left Blank}

## Colorado Procedure 31-20

*Standard Method of Test for*

### Sieve Analysis of Aggregates

#### 1. SCOPE

1.1 This method covers the determination of the particle size distribution of fine and coarse aggregate

#### 2. REFERENCED DOCUMENTS

2.1 AASHTO Standards:

T 11 Materials Finer than the No. 200 Sieve in Mineral Aggregates by Washing  
T 27 Sieve Analysis of Fine and Coarse Aggregates

2.2 Colorado Procedures:

CP 30 Sampling of Aggregates  
CP 32 Reducing Field Samples of Soil and Aggregate to Testing Size

#### 3. PROCEDURE

3.1 AASHTO T 11 and T 27 shall be used to determine the sieve analysis of fine and coarse aggregates with the following exceptions:

3.1.1 Unless otherwise specified, follow CP 30 for obtaining a sample of aggregates.

3.1.2 The minimum test sample weight shall be that in Table 31-1.

Table 31-1

| Aggregate Nominal<br>Maximum Size<br>Square Opening,<br>inches | Minimum Weight<br>(Mass) of Test<br>Sample, Pounds<br>(kg) |
|--|--|
| < 3/8  | 0.66 (0.30)  |
| 3/8  | 2.2 (1.0)  |
| 1/2  | 3.3 (1.5)  |
| 3/4  | 4.4 (2.0)  |
| 1  | 5.5 (2.5)  |
| 1-1/2  | 11.0 (5.0)   |
| 2  | 16.0 (7.5)   |
| 2-1/2  | 22.0 (10.0)  |
| 3  | 27.5 (12.5)  |
| 3-1/2  | 33.0 (15.0)  |

**NOTE 1:** Nominal maximum size is as defined in the Appendix of the Field Materials Manual.

3.1.3 A split moisture sample may be used to accelerate the test procedure using the following procedure:

3.1.3.1 Following CP 32 split and weigh the material immediately into two approximately equal samples.

3.1.3.2 Dry one of the samples to a constant mass using a hot plate or a 230°F ± 9° F oven to determine its moisture content.

3.1.3.3 Determine the dry weight of the second sample using the following equation:

$$W_{Dry} = \frac{W_{Wet}}{100+MC} \times 100$$

Where:

$W_{Dry}$  = Dry weight (mass) of 2<sup>nd</sup> sample

$W_{Wet}$  = Wet weight of 2<sup>nd</sup> sample

MC = Moisture content of 1<sup>st</sup> sample

3.1.3.4 Determine the sieve analysis on the 2<sup>nd</sup> sample using AASHTO T 11 and T 27.

## Colorado Procedure 32-03

### *Standard Practice for*

## Reducing Field Samples of Soil and Aggregate to Testing Size

### 1. SCOPE

- 1.1 These methods cover the reduction of field samples of soil and aggregate to the appropriate size for testing employing techniques that are intended to minimize variations in measured characteristics between the test samples selected and the field sample. CP 55 is used for the reduction of samples of HMA to test size.
- 1.2 The values stated in acceptable English units are to be regarded as the standard.

### 2. REFERENCED DOCUMENTS

#### 2.1 *AASHTO Standards:*

- T 2 Sampling Aggregates
- T 84 Specific Gravity and Absorption of Fine Aggregate

#### 2.2 *Colorado Procedures:*

- CP 20 Dry Preparation of Disturbed Soil Samples for Test
- CP 30 Sampling of Aggregates
- CP 55 Reducing Field Samples of Hot Mix Asphalt to Testing Size
  
- CP-L 4102 Specific Gravity and Absorption of Fine Aggregate

### 3. SIGNIFICANCE AND USE

- 3.1.1 The necessity for selecting representative samples and reducing them to test specimen size is emphasized in many test procedures. Using the proper equipment for the type of material to be reduced in size is important. However, unless used correctly, the final test specimen will not necessarily be representative of the total sample.
- 3.1.2 Specifications for aggregates indicate the sampling portions of the material required for testing. Other factors being equal, larger samples will tend to be more representative of the total aggregate source. These methods provide for reducing the large sample obtained in the field to a convenient size for conducting a variety of tests to describe the material and to measure its quality in such a manner that the smaller portion is most likely to be a true representation of the field sample, and thus of the total aggregate source. The individual test methods indicate the minimum weights of material to be tested.



- 3.2 Under certain circumstances, reduction in size of the field sample prior to testing is not recommended. Substantial differences between the selected test samples sometimes cannot be avoided, as for example, in the case of an aggregate having relatively few large size particles in the field sample. The laws of chance dictate that these few particles may be unequally distributed among the reduced size test samples. Similarly, if the test sample is being examined for certain contaminants occurring as a few discrete fragments in only small percentages, caution should be used in interpreting results from the reduced size test sample. Chance inclusion or exclusion of only one or two particles in the selected sample may importantly influence interpretation of the characteristics of the field sample. In these cases, the entire field sample should be tested.
- 3.3 Failure to carefully follow the procedures in these methods could result in providing a non-representative sample to be used in subsequent testing.

#### 4. SELECTION OF METHOD

- 4.1 The use of a riffle sample splitter is always preferable to hand quartering. A riffle splitter should be used whenever one exists with the proper sized openings. The splitter openings should be sufficiently wide to permit easy passage of the largest particles in the sample. When splitters with adjustable openings are used, the width of the openings should be adjusted to approximately 1-1/2 times the size of the largest particle in the sample.
- 4.2 Fine Aggregate - Field samples of fine aggregate that are drier than the saturated-surface-dry condition (Note 1) shall be reduced in size by a mechanical splitter according to Method A. Field samples having free moisture on the particle surfaces may be reduced in size by quartering according to Method B or by treating it as a miniature stockpile as described in Method C.
- 4.2.1 If the use of Method B or Method C is desired, and the field sample does not have free moisture on the particle surfaces, the sample may be first moistened to achieve this condition, and then it should be thoroughly mixed prior to the sample reduction being performed.

**Note 1:** The method of determining the saturated-surface-dry condition is described in AASHTO T 84. As a quick approximation, if the fine aggregate retains a balled shape when molded in the hand, it may be considered to be wetter than saturated-surface-dry.

- 4.2.2 If use of Method A is desired and the field sample has free moisture on the particle surfaces, the entire field sample may be dried to at least the surface-dry condition, using temperatures that do not exceed those specified for any of the tests contemplated, and then the sample reduction performed. Alternatively, if the moist field sample is very large, a preliminary split may be made using a mechanical splitter having wide chute openings 1-1/2 in. (38 mm) or more to reduce the sample to not less than 5000g. The portion obtained is then dried, and the reduction to test sample size is completed using Method A.
- 4.3 *Coarse Aggregates and Mixtures of Coarse and Fine Aggregates* - Reduce the sample using a mechanical splitter in accordance with Method A (preferred method) or by quartering in accordance with Method B. The miniature stockpile Method C is not permitted for coarse aggregates or mixtures of coarse and fine aggregates.

**Note 2:** Past experience has shown that when adjustable splitter openings are adjusted too wide or too narrow improper splitting will occur (see Subsection 6.1).

## 5. SAMPLING

- 5.1 The field sample of aggregate shall be taken in accordance with CP 30 or as required by individual test methods. When tests for sieve analysis only are contemplated, the size of the field sample listed in CP 30 is usually adequate. When additional tests are to be conducted, the tester shall satisfy himself that the initial size of the field sample is adequate to accomplish all intended tests.
- 5.2 Soil samples to be reduced to test specimen size shall be prepared in accordance with CP 20.

### METHOD A - MECHANICAL SPLITTER

## 6. APPARATUS

- 6.1 *Sample Splitter* - Sample splitters shall have an even number of equal width chutes, but not less than a total of eight for coarse aggregate, or twelve for fine aggregate, which discharge alternatively to each side of the splitter. For coarse aggregate and mixed aggregate the minimum width of the individual chutes shall be approximately 50 percent larger than the largest particles in the sample to be split (Note 3). For dry fine aggregate in which the entire sample will pass the 3/8 in. (9.5-mm) sieve, a splitter having chutes 1/2 to 3/4 in. (12.5 to 20 mm) wide shall be used. The splitter shall be equipped with a minimum of two collection pans, having a width equal to or slightly less than the overall assembly of chutes in the splitter to hold the two halves of the sample following the splitting. It shall also be equipped with a hopper, a flat scoop, or straight-edged pan which has a width equal to or slightly less than the overall width of the assembly of chutes, by which the sample may be fed at a controlled rate to the chutes. The splitter and accessory equipment shall be so designed that the sample will flow smoothly without restriction or loss of material (Figure 32-1). A splitter brush should be used to clean the chutes of adhering fines.

**Note 3:** Mechanical splitters are commonly available in sizes adequate for coarse aggregates in which the largest particle does not exceed 1-1/2 in. (37.5 mm).

## 7. PROCEDURE

- 7.1.a **Riffle Splitters Without Control Flow Hoppers** - After placing the sample in a large flat-bottomed mixing pan, mix the sample thoroughly by turning the entire sample over three times. Using a flat scoop equal in length to the overall width of the riffles (feeder pan) remove the material from the mixing pan and uniformly distribute the material in the scoop so that when it is introduced to the splitter equal amounts of material will flow through each chute. Pour half of the sample through the riffles in a manner to allow the material to flow freely through the chutes without clogging any riffle. Reverse the ends of the feeder pan and pour the other half through the splitter. Continue this process until the entire sample has been introduced to the splitter.
- 7.1.b **Riffle Splitters With Control Flow Hoppers** - Place the entire sample in the closed hopper and uniformly distribute it from edge to edge. Using the handle, slowly release the material from the hopper through the chutes in a manner to allow the material to flow freely through the chutes without clogging any riffles. The first split is only to assist in mixing the sample. Remove both catch pans. Uniformly distribute the material in the first of the pans and pour it into the closed hopper by pouring half of the sample into the closed hopper, then reversing the ends of the pan, pouring the remaining half into the closed hopper. Repeat this process with the second pan. Place the emptied pans beneath the splitter under the riffles. With the material uniformly distributed in the closed hopper and using the handle, slowly release the material through the chutes as noted above.

- 7.2 Reintroduce the portion of the sample from alternating receptacles into the splitter as noted in Subsections 7.1.a or 7.1.b as many times as necessary to reduce the sample to at least the minimum size required for the intended test. Clean the riffles and the splitter with a brush after each split. Retain the portion from the other receptacle in case it becomes necessary to re-run the test.

### **METHOD B - QUARTERING**

#### **8. APPARATUS**

- 8.1 Apparatus shall consist of a straight-edge scoop, or a flat, square end shovel; a broom or brush; and a canvas blanket at least 6 by 8 ft (2 by 2.5 m).

#### **9. PROCEDURE**

- 9.1 The field sample shall be placed on a canvas blanket laid on a clean, hard, level surface. Mix the material thoroughly by turning the entire sample over three times. With the last turning, shovel the entire sample into a conical pile by depositing each full shovel on top of the preceding one. Alternatively lift each corner of the canvas and pull it over the sample toward the diagonally opposite corner causing the material to be rolled. Carefully flatten the conical pile to a uniform thickness and diameter by pressing down the apex with a shovel so that each quarter sector of the resulting pile will contain the material originally in it. The diameter should be approximately four to eight times the thickness. Divide the flattened mass into four equal quarters with a shovel or trowel. If the surface beneath the blanket is uneven, insert a stick or pipe beneath the blanket and under the center of the pile, then lift both ends of the stick, dividing the sample into two equal parts. Remove the stick leaving a fold of the blanket between the divided portions. Insert the stick under the center of the pile at right angles to the first division and again lift both ends of the stick, dividing the sample into four equal parts. Remove two diagonally opposite quarters, being careful to clean the fines from the blanket. Brush the cleared spaces clean and include the material in the sample. Successively mix and quarter the remaining material until the sample is reduced to the desired size (Figure 32-2). Save the remaining two quarters in case a retest is necessary.

### **METHOD C - SELECTION BY SCOOP**

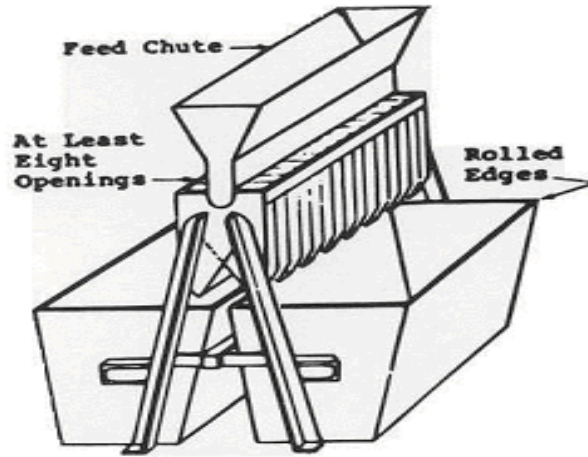
[Damp Fine (minus 3/8 in. (9.5 mm)) Aggregate Only]

#### **10. APPARATUS**

- 10.1 Apparatus shall consist of a small, flat, square end scoop with sides and a large flat- bottomed mixing pan.

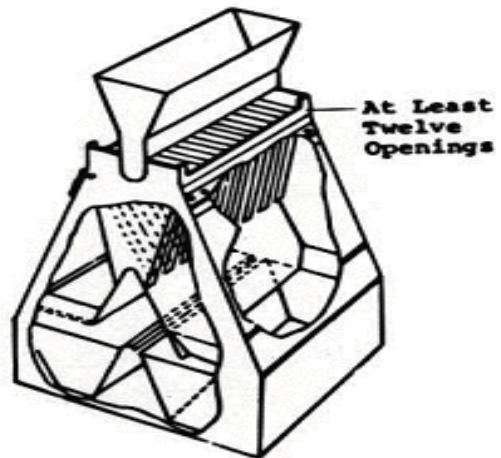
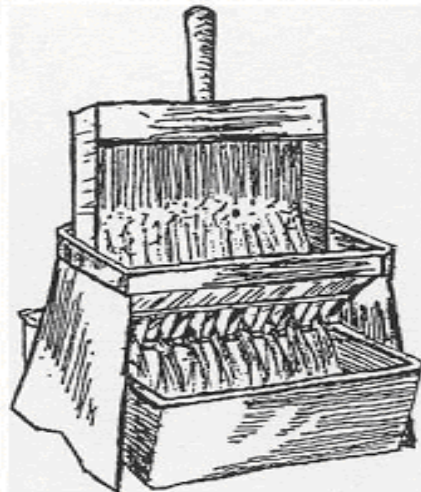
#### **11. PROCEDURE**

- 11.1 Place the field sample of damp fine aggregate in the mixing pan where there will be neither loss of material nor the accidental addition of foreign material. Mix the material thoroughly by turning the entire sample over three times. Flatten the sample in the pan to a uniform depth. Obtain a sample for each test by selecting at least three increments of material at random locations from the miniature stockpile, using a small flat square end scoop. Insert the scoop to the full depth of the material. Every attempt should be made to minimize the loss of particles over the sides of the scoop. Combine the portions to obtain a test specimen having the required weight. Save the remaining portion of the sample until tests are completed.



**Riffle Sample Splitter**

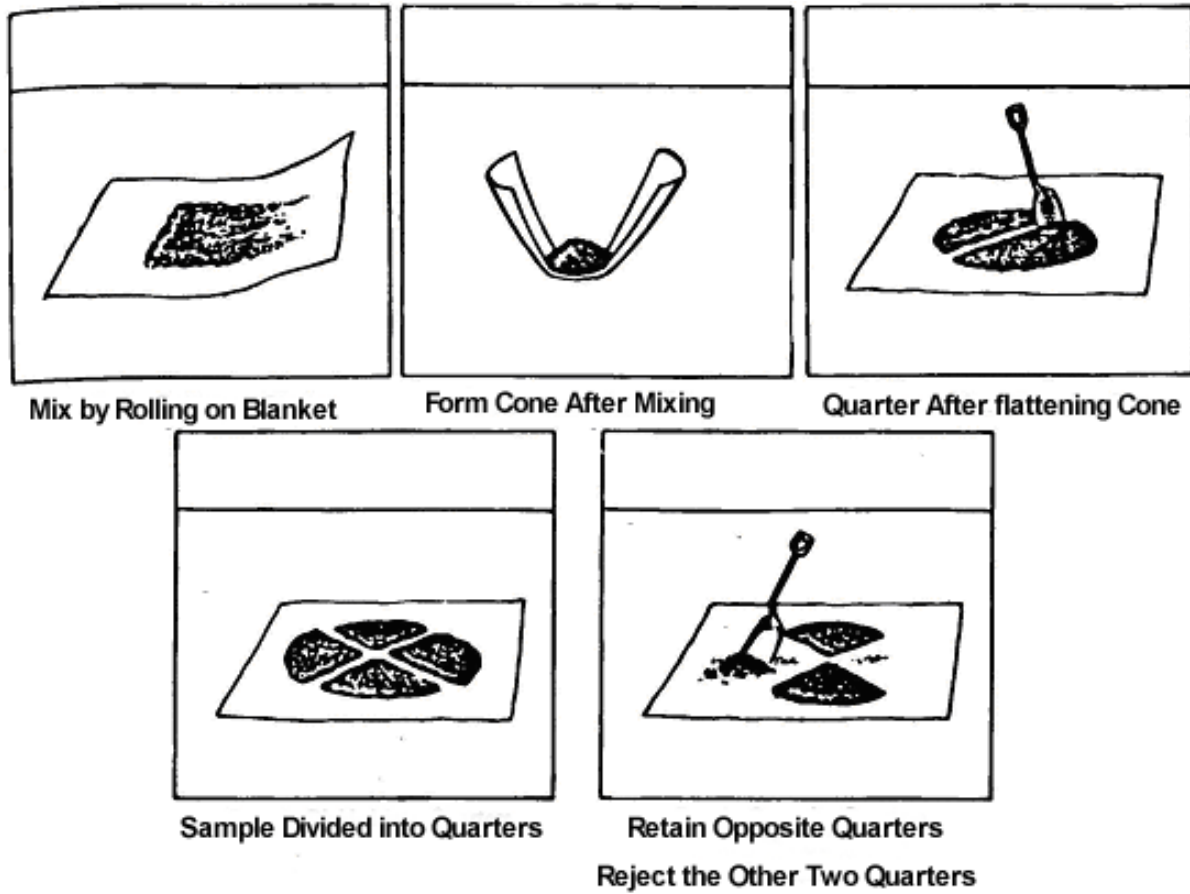
*(a) Large Sample Splitter for Coarse Aggregate*



*(b) Small Sample Splitters For Fine Aggregate*

**NOTE:** May be constructed as either closed or open type. Closed type is preferred.

**FIGURE 32-1: Sample splitters (Riffles)**



**FIGURE 32-2: Quartering on a Canvas Blanket**

## Colorado Procedure 33-12

*Standard Method of Test for*

### Total Evaporable Moisture Content and Surface Moisture Content of Aggregates by Drying

#### 1. SCOPE

- 1.1 This procedure covers the determination of the percentage of evaporable moisture in a sample of aggregate by drying both surface moisture and the moisture in the aggregate. To be used in the field to determine the percentage of surface moisture content in aggregates.

#### 2. APPARATUS

- 2.1 Balance - Sufficient capacity and sensitive to 0.1 g.
- 2.2 Drying equipment - Hot plate, ventilated oven, or a ventilated microwave oven.
- 2.3 Drying pan and necessary hand tools.

#### 3. PROCEDURE

- 3.1 The minimum test sample mass shall be that in Table 33-1.

**Table 33-1**

| Aggregate Nominal<br>Maximum Size<br>Square Opening,<br>inches | Minimum Weight<br>(Mass) of Test<br>Sample, Pounds<br>(kg) |
|--|--|
| < 3/8  | 0.66 (0.30)  |
| 3/8  | 2.2 (1.0)  |
| 1/2  | 3.3 (1.5)  |
| 3/4  | 4.4 (2.0)  |
| 1  | 5.5 (2.5)  |
| 1-1/2  | 11.0 (5.0)   |
| 2  | 16.0 (7.5)   |
| 2-1/2  | 22.0 (10.0)  |
| 3  | 27.5 (12.5)  |
| 3-1/2  | 33.0 (15.0)  |

**Note 1:** Nominal maximum size is as defined in the Appendix of the Field Materials Manual.

- 3.2 Immediately after obtaining the specimen, weigh to the nearest 0.1 g and record as wet weight (mass). Dry to a constant weight (mass). Constant weight (mass) is achieved when further heating causes, or would cause, less than 0.1 percent additional loss in mass. If using a ventilated oven, set it at 230°F  $\pm$  9° (110°C  $\pm$  5°). When dry, weigh to the nearest 0.1 g and report as dry weight (mass).

#### 4. CALCULATIONS

4.1 Determine the total percentage of moisture on an oven dry basis as follows:

$$\% \text{ moisture, (oven dry basis)} = \frac{\text{Wet wt} - \text{Dry wt}}{\text{Dry wt}} \times 100$$

4.2 Calculate the percent surface (free) moisture as follows:

$$\% \text{ surface moisture} = \left( \begin{array}{c} \% \text{ moisture} \\ \text{(oven dry basis)} \end{array} \right) - \left( \begin{array}{c} \% \text{ absorption} \\ \text{(from mix design)} \end{array} \right)$$

**Note 2:** The calculations in Subsection 4.2, for percent surface moisture, does not give exactly the same result as calculating percent surface moisture on a saturated surface dry method as called for by design procedures. However, for the degree of accuracy required, the simpler method is acceptable for field control of aggregate batch weights (masses).

The following examples will illustrate the comparison between the two methods of calculation.

**EXAMPLE:**

|                                 |   |         |
|---------------------------------|---|---------|
| Wet weight                      | = | 100.0 g |
| (Oven) Dry wt.                  | = | 95.0 g  |
| Loss                            | = | 5.0 g   |
| % Absorption<br>from Mix Design | = | 2.0     |

**% Surface Moisture, Oven Dry Method**

$$\begin{aligned} &= \left( \frac{100 - 96.9}{96.0} \times 100 \right) - 2.0\% \\ &= 5.26 - 2.0 \\ &= 3.26\% \end{aligned}$$

**% Surface Moisture, Saturated Surface Dry Method (SSD)**

$$\% \text{ moisture, (SSD)} = \frac{\text{Wet wt} - \text{SSD wt}}{\text{SSD wt}} \times 100$$

$$\text{SSD wt.} = \frac{\text{Oven Dry wt} \times (100 + \text{absorption})}{100}$$

$$\text{SSD wt.} = \frac{95.0 \times 102}{100} = 96.9$$

$$\% \text{ surface moisture, (SSD)} = \frac{100 - 96.9}{96.0} \times 100 = 3.20\%$$

Difference between the two methods is:

$$\begin{array}{r} 3.26 \\ -3.20 \\ \hline 0.06 \% \end{array}$$

**5. REPORT**

5.1 Report % SSD on Form 6 in the "Remarks" field.



{Page Intentionally Left Blank}

## Colorado Procedure 37-20

### *Standard Test Method for*

### **Plastic Fines in Graded Aggregates and Soils by Sand Equivalent Test**

#### **1. SCOPE**

- 1.1. This test is for the determination of the proportion of fine dust or claylike material in graded aggregates and soils.

#### **2. APPARATUS**

- 2.1 A graduated plastic cylinder, rubber stopper, irrigator tube, weighted foot assembly, and siphon assembly, all conforming to their respective specifications and dimensions shown in Figure 37-1. Fit the siphon assembly to a 1-gallon bottle of working calcium chloride solution placed on a shelf 36 +/- 1 inch above the working surface. In place of the specified 1-gallon bottle, a glass or plastic vat having a larger capacity may be used provided the liquid level of the working solution is maintained between 36 to 46 inches above the work surface.
- 2.2 A tinned measure, having a capacity of 85 +/- 5 mL (3 oz), approximately 57 mm (2.25 in) in diameter.
- 2.3 A wide-mouth funnel approximately 4 inches in diameter at the mouth.
- 2.4 A clock or watch reading in minutes and seconds.
- 2.5 A mechanical shaker, powered by an electric motor, having a throw of 8.00 +/- 0.04 in. (203.2 +/- 1.0mm) and operating at 175 +/- 2 cycles per minute. The shaker shall be securely affixed to a firm and level mount.
- 2.6 Stock Solution – The materials listed in Subsections 2.6.1, 2.6.2, or 2.6.3 may be used to prepare the stock solution. A fourth alternative is not to use any biocide provided the time of storage of stock solution is not sufficient to promote the growth of fungi.
- 2.6.1 Stock solution with formaldehyde:
- 2.6.1.1 Anhydrous Calcium Chloride, 454g of technical grade.
- 2.6.1.2 USP Glycerin, 2,050g (1640 mL).
- 2.6.1.3 Formaldehyde, (40 volume percent solution) 47g (45 mL).
- 2.6.1.4 Dissolve the 454g of calcium chloride in 1.89 L of distilled water. Cool and filter it through ready pleated rapid filtering paper. Add the 2,050g of glycerin and the 47g of formaldehyde to the filtered solution, mix well and dilute to 3.78 L.
- 2.6.2 Stock solution with glutaraldehyde:

2.6.2.1 Calcium Chloride Dihydrate, 577g of A.C.S. grade.

2.6.2.2 USP Glycerin, 2,050g (1640 mL).

2.6.2.3 1.5-Pentanedial (Glutaraldehyde), 50 percent solution in water 59g (53 mL).

**Note 1:** 1.5-pentanedial, also known as glutaraldehyde, glutaric dialdehyde, and trade name UCARCIDE 250, may be obtained as Glutaraldehyde Solution 50 percent.

2.6.2.4 Dissolve the 577g of calcium chloride dehydrate in 1.89 L of distilled water. Cool and add the 2050g of glycerin and the 59g of glutaraldehyde to the solution, mix well and dilute to 3.78 L.

2.6.3 Stock solution with Kathon CG/ICP:

2.6.3.1 Calcium Chloride Dihydrate, 577g of A.C.S. grade.

2.6.3.2 USP Glycerin, 2050g (1640 mL).

2.6.3.3 Kathon CG/ICP, 563g (53 mL).

2.6.3.4 Dissolve the 577g of calcium chloride dehydrate in 1.89 L of distilled water. Cool and add the 2050g of glycerin and the 63g of Kathon CG/ICP to the solution, mix well and dilute to 3.78 L.

2.7. Working calcium chloride solution: Prepare the working calcium chloride solution by diluting  $85 \pm 5$  mL of the stock calcium chloride solution with water until it reaches a total volume of 3.8 L. Thoroughly mix the solution by filling the bottle with approximately 2 L of water. Add the stock solution and agitate vigorously for 1 to 2 minutes. Add the remainder of the water and repeat the agitation process. Use distilled or demineralized water for the preparation of the working solution. Discard working solutions more than 30 days old.

2.8 A straightedge or spatula, suitable for striking off the excess soil from the tin measure.

2.9. A thermostatically controlled drying oven capable of providing a temperature up to  $60^{\circ}\text{C}$  ( $140^{\circ}\text{F}$ ).

2.10. A non-absorbent plastic quartering or splitting sheet or non-absorbent pan.

2.11 Optional handle for irrigation tube – A 25-mm diameter wooden dowel to aid in pushing the irrigation tube into firm materials.

### 3. CONTROL

3.1. The temperature of the working solution should be maintained at  $22^{\circ}\text{C} \pm 3^{\circ}$  ( $72^{\circ}\text{F} \pm 5^{\circ}$ ) during the performance of the test. If field conditions prevent the maintenance of the temperature range frequent samples should be submitted to a laboratory where proper temperature can be maintained. A correction curve may be established for each material being tested where proper temperature control is not possible. No general correction curve should be used on several materials even within a narrow range of values. Samples that meet the minimums and equivalent requirements at a solution temperature below the recommended range need not be subject to reference testing.

#### 4. SAMPLE PREPARATION

- 4.1. All materials being tested by this method shall pass the 4.75 mm (#4) sieve. Pulverize all aggregations of fine-grained soil material to pass the 4.75 mm (#4) sieve and clean all fines from the particles retained on the 4.75 mm (#4) sieve. All aggregations passing the 4.75 mm (#4) sieve shall be tested.
- 4.2. Split or quarter to yield a representative sample of at least 1,500g of material passing the 4.75 mm (#4) sieve. Extreme care should be used to ensure the test sample is truly representative of the original sample.
- 4.3. Dry the sample to constant mass at a temperature not to exceed 60°C (140°F).
  - 4.3.1. Weigh the dried sample to the nearest 0.1g. Thoroughly mix  $3 \pm 1\%$  moisture into the material, cover and allow tempering for  $45 \pm 15$  minutes.
  - 4.3.2. After the tempering period, place the material on the splitting sheet or pan. Mix the sample until it appears homogeneous forming a pile. Using the splitting sheet, mixing can be accomplished by pulling a corner of the sheet diagonally across the material toward the opposite corner causing the material to be rolled. Continue pulling the corners of the sheet across until the sample appears homogeneous. Finish mixing with the sample in a pile near the center of the splitting sheet. Using the pan, mixing can be accomplished by turning the entire sample over at least 3 times. Upon the final turning, form the material in a conical pile by depositing each scoopful on top of the preceding one.
  - 4.3.3. Fill three 85 ml tins by pushing them through the base of the pile while exerting pressure with the hand on the opposite side of the pile. Use enough pressure to cause the tins to fill to overflowing. Press the material firmly into the tins with the palm allowing the maximum amount of material to be placed in the tins. Using the spatula, strike off the excess material above the top of the tins.
  - 4.3.4. Each of the three tins prepared in Subsection 4.3.3 is an individual test sample.

#### 5. PROCEDURE

- 5.1. Siphon  $101.6 \pm 2.5$  mm ( $4.0 \pm 0.1$  in.) of the working solution into the graduated cylinder. Pour a prepared test sample into a graduated cylinder using the funnel to avoid spillage. Tap the bottom of the cylinder sharply with the heel of the hand several times to release air bubbles and promote thorough wetting of the sample.
- 5.2. Allow the sample to stand undisturbed for  $10 \pm 1$  minute. After the 10 minute soaking period, stopper the cylinder and loosen the material from the bottom of the cylinder by partially inverting the cylinder and shaking simultaneously.
- 5.3. After loosening the material place the cylinder into the shaker, set the timer and allow the machine to shake the sample for  $45 \pm 1$  second.
- 5.4. Following the shaking period place the cylinder upright on the work surface and remove the stopper.

- 5.5. Insert the irrigator tube in the cylinder and rinse the material from the cylinder walls as the irrigator is lowered. Force the irrigator through the material to the bottom of the cylinder by using a gentle stabbing and twisting motion while the working solution is flowing from the irrigator tip. Continue to apply the stabbing and twisting action of the irrigator to suspend the fine material until the level nears the 381mm (15 in.) mark. As the level nears the 381 mm (15 in.) mark, without stopping the flow, slowly raise the irrigator as to maintain the 381mm (15 in.) level. Adjust the final level to 381mm (15 in.). The final level, as judged by the bottom of the meniscus, shall be between the top two graduations of the cylinder but not above the 381mm (15 in.) mark.

**Note 2:** On certain soils, particularly crushed materials, the stabbing action may not be possible. For such materials, the irrigation method is as follows: Continue to apply the twisting action as the irrigator tube is slowly withdrawn. As the irrigator tube is withdrawn, as many of the fines possible must be flushed upward until the level reaches the 381mm (15in.) level.

- 5.6. Allow the cylinder and contents to stand undisturbed for 20 minutes  $\pm$  15 seconds. Start timing immediately after withdrawing the irrigator tube.
- 5.7. At the end of the 20 minute settling period, read and record the top of the clay layer. This is referred to as the "clay reading". If no clear line is formed at the end of the 20 minutes, allow the sample to stand undisturbed until a reading can be obtained. Once the reading can be made, record the clay reading and the total sedimentation time.

If the sedimentation time exceeds 30 minutes, retest the material using 3 individual samples of the same material. Read and record the clay reading of the sample that takes the least amount of time to form a clear line. Do not record the readings from the other two samples.

- 5.8. Immediately after taking the clay reading, gently lower the weighted foot assembly into the cylinder. Do not allow the indicator to hit the mouth of the cylinder as it is lowered. As the foot comes to rest on the sand, tip the assembly toward the graduations until the indicator touches the inside of the cylinder. Subtract 254 mm (10 in.) from the level indicated by the top edge of the indicator and record this value as the sand reading.
- 5.9. If the clay or sand reading falls between the graduations, record the next higher graduation line as your reading. For example, The indicator level is 6.22. The recorded level would be 6.3.
- 5.10 Repeat Subsections 5.1 to 5.9 for each of the three samples prepared in Subsections 4.3.3.

## 6. CALCULATIONS

- 6.1. Calculate the sand equivalent for each of the three test samples to the nearest 0.1 using the following formula:

$$SE = \frac{\text{Sand Reading} \times 100}{\text{Clay Reading}}$$

If the sand equivalent is not a whole number, report as the next higher whole number.

For example:

$$SE = 3.3 \times 100 / 8 = 41.25$$

Report as 42

- 6.2. Average the three SE values obtained in 6.1 to the nearest 0.1. If the average sand equivalent is not a whole number, report as the next higher whole number.

For example:

$$(42 + 44 + 41) / 3 = 42.3$$

Report as 43

## 7. PRECAUTIONS

- 7.1. When performing this test the work surface must be free of vibration. During the sedimentation period, vibration may cause the suspended material to settle at a greater rate than normal, resulting in false readings. The shaker shall not be mounted on the same surface as the cylinders during the sedimentation period.
- 7.2. Do not expose the cylinders to direct sunlight any more than necessary.
- 7.3. On occasion, organic growth in the working solution container and tubing will need to be removed. Growth can be seen as a slimy substance in the solution or as grayish black deposits on the sides of the container and in the tubing. To remove the growth prepare a solution of sodium hypochlorite<sup>3</sup> and water in equal amounts. Fill the container and allow about a liter to flow through the siphon assembly and irrigator tube. Refill the container and allow it to stand overnight. After soaking allow the solution to flow out through the siphon assembly and irrigator tube. Remove the siphon assembly and rinse both the container and assembly with clear water. Allow water to flow through the assembly and irrigator tube to rinse the solvent from the inside of the tubing.
- 7.4. Occasionally the holes on the tip of the irrigator tube can become clogged. This can be checked easily while filling the cylinder to the initial amount as in Subsection 5.1. If the particle cannot be removed by any other method, carefully use a pin or small wire to dislodge the particle, taking care to not enlarge the opening.
- 7.5. Upon receipt of a new weighted foot assembly and before placing it in service, measure and adjust the height of the indicator to 256.5 mm (10.1 in.).

## 8. PRECISIONS AND BIAS

- 8.1 *Multi-laboratory Precision* – Using CDOT IA test results; the standard deviation of the difference between values obtained on the same sample from different laboratories is 2.3 (d2s). Therefore, the results of two properly conducted tests from different laboratories on similar material should not differ by more than 5.0 with a 95% confidence limit.
- 8.2 *Bias* – The procedure in this test method has no bias because of the value of the sand equivalent is defined only in terms of the test method.

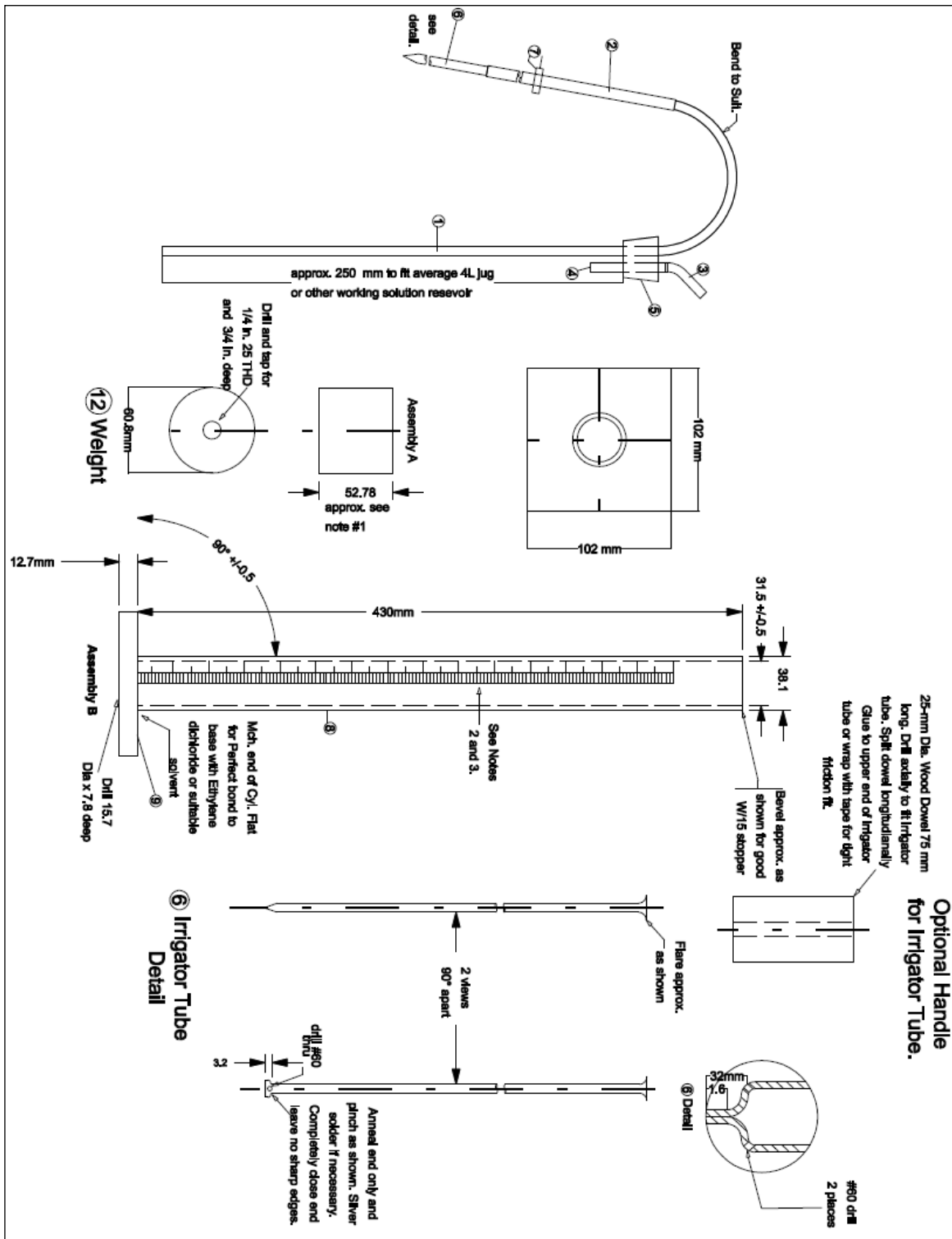


FIGURE 37-1

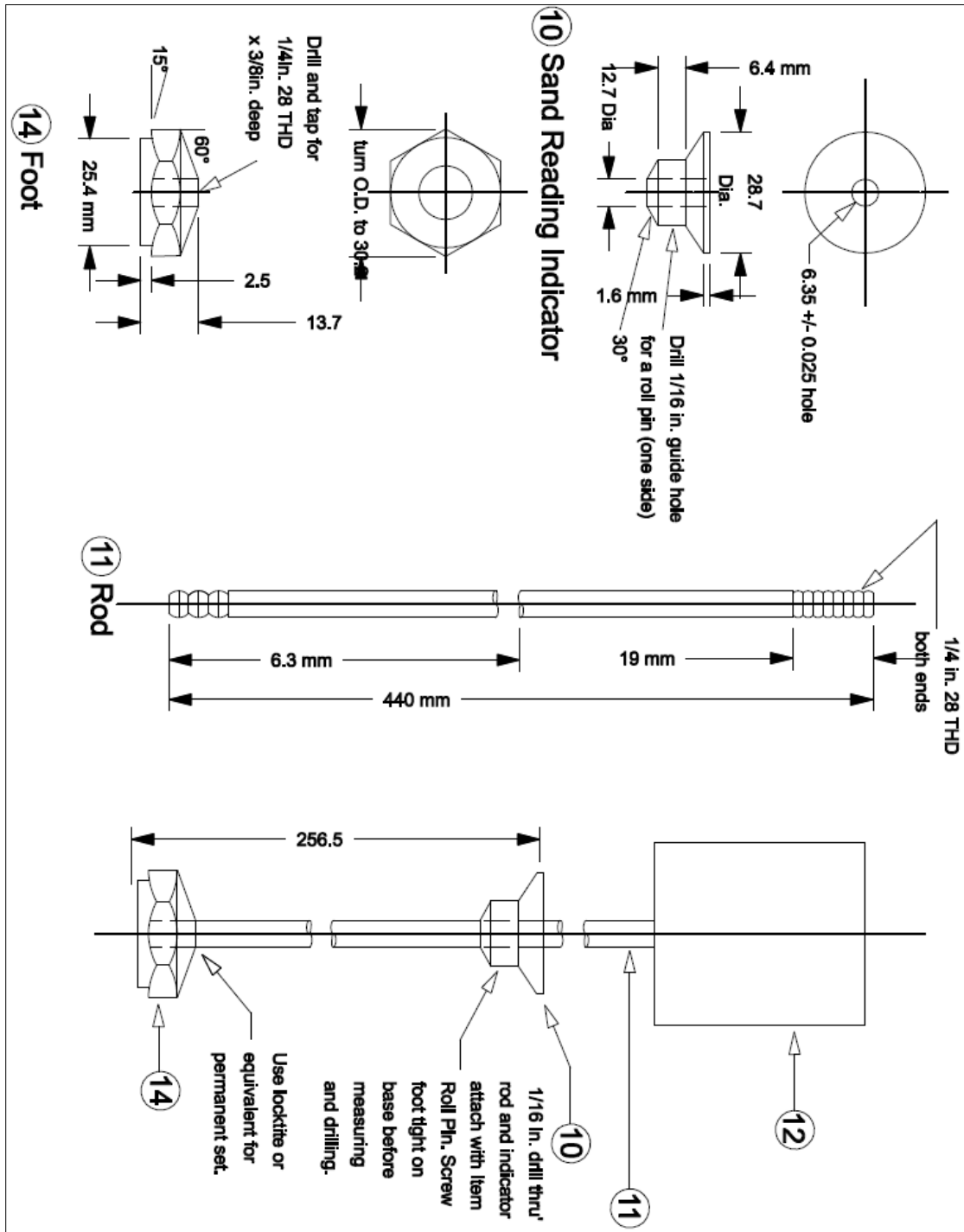


FIGURE 37-1 (Continued)



| Assembly | No. Reg. | Description   | Stock Size (mm)                             | Material                 | Heat Treatment |
|----------|----------|---|---|--------------------------|----------------|
| <b>A</b> |          | <b>Siphon Assembly</b>  |   |                          |                |
|          | 1        | Siphon Tube   | 6.4 dia. x 400                              | Copper Tube              |                |
|          | 2        | Siphon Hose   | 4.8 I.D. x 200                              | Rubber Tube              |                |
|          | 3        | Blow Hose   | 4.8 I.D. x 50.8                             | Rubber Tube              |                |
|          | 4        | Blow Tube   | 6.4 dia. x 50.8                             | Copper Tube              |                |
|          | 5        | Two-Hole Stopper  | No. 6                                       | Rubber                   |                |
|          | 6        | Irrigator Tube  | 6.4 O.D. 0.89 Wall x 500                    | Stainless Tube, Type 316 |                |
|          | 7        | Clamp   | Pinchcock, Day, BKH No. 21730 or Equivalent |                          |                |
| <b>B</b> |          | <b>Graduate Assembly</b>  |   |                          |                |
|          | 8        | Tube  | 38.1 O.D. x 430                             | Trans Acrylic Plastic    |                |
|          | 9        | Base  | 12.7 x 102 x 102                            | Trans Acrylic Plastic    |                |
| <b>C</b> |          | <b>Weighted Foot Assembly</b>   |   |                          |                |
|          | 10       | Sand Reading Indicator  | 6.4 dia x 14.9                              | Nylon 101 Type 66        | Annealed       |
|          | 11       | Rod   | 6.4 dia x 438.2                             | Brass                    |                |
|          | 12       | Weight  | 50.8 dia x 52.78                            | C.R.SH                   |                |
|          | 13       | Roll Pin  | 0.16 dia x 12.7                             | Steel                    |                |
|          | 14       | Foot  | 0.16 Hex x 13.7                             | Brass                    |                |
|          | 15       | Solid Stopper   | No. 7                                       | Rubber                   |                |
| Notes:   | 1        | "C" Mounted Foot Assembly to Weight 1000+/- 5g  |   |                          |                |
|          | 2        | Graduations on graduate to be 2.54 mm apart and every tenth mark to be numerically designated as shown. Every fifth line should be approximately 9.5 mm long. All other lines should be approximately 5.5 mm long. Depth to be 0.4 mm. Width to be 0.8 mm across the top. |   |                          |                |
|          | 3        | Accuracy of scale to be +/- 0.25 mm per 2.5 mm. Error at any point on scale to be +/- 0.75 mm of true distance to zero  |   |                          |                |
|          | 4        | Glass or stainless steel may be substituted as a material type for the copper siphon and blow tubing  |   |                          |                |

**FIGURE 37-1 (Continued)**

## Colorado Procedure 41-20

*Standard Practice for*

### Sampling Hot Mix Asphalt

(This procedure is based upon AASHTO T 168-91. AASHTO T 168-91 or any subsequent revisions may not be used in place of this procedure.)

#### 1. SCOPE

- 1.1 This procedure covers the sampling of hot mix asphalt (HMA) at points of manufacture, storage, or delivery.
  - 1.1.1 Samples obtained by this procedure may be used for acceptance and quality control of hot mix asphalt (HMA).
- 1.2 This Standard may involve hazardous materials, operations, and equipment. This Standard does not purport to address all of the safety problems associated with its use. It is the responsibility of the user of this Standard to establish appropriate safety and health practices and determine the applicability of regulatory limitations before use.
- 1.3 The values stated in acceptable English units are to be regarded as the standard. The values in parentheses are provided for information purposes only.

#### 2. REFERENCED DOCUMENTS

- 2.1 *Colorado Procedures:*
  - CP 75 Stratified Random Sampling of Materials

#### 3. SIGNIFICANCE AND USE

- 3.1 *General:*
  - 3.1.1 Sampling is equally as important as the testing, and the sampler shall use every precaution to obtain samples that will yield an acceptable estimate of the nature and conditions of the materials which they represent.
  - 3.1.2 Care shall be taken in sampling to avoid segregation of the material being sampled. Care shall be taken also to prevent contamination by dust or other foreign matter.
  - 3.1.3 Samples to be used for acceptance or assurance testing shall be taken by the contractor or his representative. An authorized representative of the Colorado Department of Transportation shall be present during the sampling procedure. The CDOT Representative present shall take immediate possession of all samples taken. CDOT reserves the right to designate the method and location of material to be sampled.

**4. PROCEDURE, GENERAL**

- 4.1 *Sampling Equipment* - The contractor shall provide the equipment needed for safe and appropriate sampling.
- 4.2 *Sample Handling* - Combine all sample increments. Place sample in a container with 3 to 4-gallon capacity, made of at least 30 gauge non-galvanized metal, having a "bail" type handle and a tight-fitting lid.
- 4.3 *Sampling* - The procedures for selecting samples are described in CP 75. The material shall be sampled using stratified random sampling from all of the material delivered to the job site.

**METHOD A - TUBE SAMPLER****5. APPARATUS**

- 5.1 Tube sampler, with a minimum of 2-7/8 in. (73 mm) inside diameter, 16 gauge minimum thickness, and a length and diameter that are variable with desired test specimen size.
- 5.2 Tube sampler holder with a metal collar into which the sampler fits, with a 3 ft. (1 m) handle or a tube sampler holder with suitable arm arrangement to hold two tube samplers, which can be positioned directly beneath the discharge opening.
- 5.3 Containers for transporting samples shall have 3 to 4-gallon capacity, be made of at least 30 gauge non-galvanized metal, have a "bail" type handle and a tight-fitting lid.

**6. PROCEDURE**

- 6.1 Batch Plant and Storage Silos - Insert one or two tube samplers into the sampler holder arm while the arm is swung away from the discharge. Obtain one or more samples from the material being loaded into a single truck using one of the following methods: (1) during discharge of mixture, swing the arm holding the tube(s) through the discharge stream at a rate fast enough to obtain a representative sample filling the tube(s) or (2) before the discharge, center the sampling tube(s) directly under the discharge flow. After the mixture has been discharged, return the apparatus to the storage position away from the point of discharge and remove the tube(s). Strike off any material above the top rim of the tube sampler.

**METHOD B - POINT OF DELIVERY****7. APPARATUS**

- 7.1 Small flat scoop with vertical sides or square-ended shovel.
- 7.2 Container for transporting samples shall have 3 to 4-gallon capacity, be made of at least 30 gauge non-galvanized metal, have a "bail" type handle and a tight-fitting lid.

**8. PROCEDURE**

- 8.1 *Sampling from the Windrow Before Laydown* - Select three or more locations at random from the windrow. Samples of the windrow shall be secured at each location by removing material from one side of the Windrow through the full depth to expose a face. Using the flat scoop, or a square shovel with sides, trench the exposed face from bottom to top, taking care to avoid segregation of particle sizes. Combine the samples from the different locations to obtain the required sample size as specified in Section 11.
- 8.2 *Sampling from Paving Machine Augers* - While the paver is in motion, observe the operation of the augers, which transport the mixture from the slat feeders to either side of the paver. These augers should be operating eighty percent or more of the time and be at least two-thirds covered with the mixture, if this is not the case, samples taken from the screws may be segregated and this method of sampling should not be used.
- 8.2.1 If the conditions of Subsection 8.2 are met, obtain at least three approximately equal increments of mixture ahead of the augers which transport the mixture from the slat feeders to either side of the Paver as follows: insert the flat scoop or shovel into the mixture and remove the portion with minimal loss of the larger particles.
- 8.3 *Sampling from a Conveyor Belt* --CDOT does not utilize this sampling technique.

**METHOD C - BEHIND PAVER****9. APPARATUS**

- 9.1 Small flat scoop, square-ended shovel with vertical sides, or sampling device similar to Figure 41-1.
- 9.2 Container for transporting samples shall have 3 to 4-gallon capacity, be made of at least 30 gauge non-galvanized metal, have a "bail" type handle and a tight-fitting lid.

**10. PROCEDURE**

- 10.1 *Sampling from the Roadway Before Compaction* - Obtain at least three approximately equal increments, at a longitudinal location selected at random using CP 75, and combine to form a field sample whose quantity equals or exceeds the minimum recommended in Section 11.
- 10.1.1 Obtain all increments from the roadway immediately behind the machine for the full depth of the material, taking care to exclude any underlying material. Locate the sampling position across the width of the roadway using CP 75. When necessary, place templates on the existing roadway to exclude any underlying material. Mark the specified area from which each increment or sample is to be removed. Templates, which are placed before the mixture is spread, will be a definite aid in securing approximately equal increment weights.

- 10.2 *Sampling from Roadway after Compaction* - Select the areas to be sampled using CP 75 from the material in place. Obtain at least three approximately equal increments selected from the area being sampled. Take all increments from the roadway through the full depth of the material, taking care to exclude any underlying material. Each increment shall be obtained by coring, sawing, or other methods in such a manner as to ensure a minimum disturbance of the material.

## 11. SIZE OF SAMPLE

### 11.1 *Number and Quantities of Field Samples:*

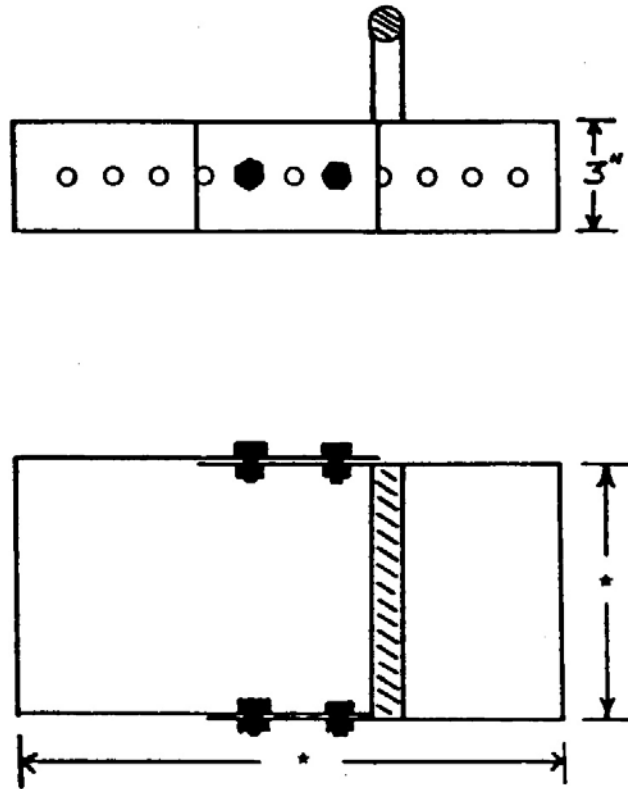
- 11.1.1 The number of field samples required is specified in the Schedule for Minimum Materials Sampling, Testing, and Inspection contained in the CDOT Field Materials Manual. The CDOT Field Materials Manual specifies the quantities of samples required for testing in the Central Laboratory and the Region Materials Laboratory. Project field tests will require a minimum sample size of 30 lbs (14 kg).

## 12. SHIPPING SAMPLES

- 12.1 Transport samples in a container with a 3 to 4-gallon capacity, made of at least 30 gauge non-galvanized metal, having a “bail” type handle and a tight-fitting lid so constructed as to preclude loss or contamination of any part of the sample or damage to the contents from mishandling during shipment.
- 12.2 Samples shall have individual identification attached providing the information required by the sample user. **Utilization of CDOT Form 633, Sample Tag (for Sacks), is required for all submitted samples.**

## 13. RECORD

- 13.1 Document information on CDOT Form 633 or Form 1304. |



\*Shape and area variable to accomodate sample size required.

Sampler is placed in the uncompacted lift directly behind paver and all material is removed.

FIGURE 41-1

{Page Intentionally Left Blank}

## Colorado Procedure 42-05

*Standard Method of Test for*

### **Estimation of Asphalt Content in Hot Mix Asphalt Through Back Calculations Using $G_{se}$**

#### **1. SCOPE**

- 1.1 This is a Colorado investigative procedure that covers the quantitative estimation of the asphalt cement content of hot mix asphalt mixtures by calculating the value from the maximum specific gravity and the effective specific gravity of the aggregate. This procedure is not appropriate for determining percent asphalt content for payment.

#### **2. REFERENCED DOCUMENTS**

2.1 *Colorado Procedures:*

- CP 30 Sampling of Aggregates
- CP 32 Reducing Field Samples of Aggregate to Testing Size
- CP 41 Sampling Hot Mix Asphalt
- CP 51 Determining the Maximum Specific Gravity of Bituminous Mixtures
- CP 55 Reducing Field Samples of Hot Mix Asphalt to Testing Size

CP-L 5115 Preparing and Determining the Density of Bituminous Mixture Test Specimens Compacted by the Super-pave Gyratory Compactor.

#### **3. SIGNIFICANCE AND USE**

- 3.1 Current procedures for determining the percent binder in hot mix asphalt are greatly affected by changes in the percent lime in the mix. If there is less lime in a mix than the nuclear gauge or ignition oven was correlated with, the mix will yield a low percent binder in the nuclear gauge and a high percent binder in the ignition oven. The reverse is true if there is more lime in the mix than the nuclear gauge or ignition oven was correlated with. This procedure can be used to further investigate the percent binder in the mix. This procedure may yield questionable results when used with absorptive aggregates.

#### **4. APPARATUS**

- 4.1 CP 51, Subsections 3.1 – 3.8
- 4.2 Mixing bowl and mixing utensils.

#### **5. PROCEDURE**

- 5.1 Sample aggregates per CP 30. The aggregates should be representative of the aggregates in the asphalt mix; therefore pull the aggregate sample near the time the plant-produced hot mix asphalt is produced. Reduce the aggregates for mixing per CP 32. Utilizing CP 51 and the mix's nominal maximum aggregate size determine the minimum size of the aggregate sample needed for mixing.



- 5.2 Reduce the plant-produced hot mix asphalt per CP 55 and determine the maximum specific gravity per CP 51.
- 5.3 Mix the aggregates at the optimum percent binder. The required mixing temperature is in CP-L 5115.
- 5.4 Cure the lab produced mixture for 2-3 hours or, if you know how long the plant-produced material was cured, then cure the lab-produced sample for the same length of time. The cure time is particularly important for mixes with absorptive aggregates.
- 5.5 Determine the maximum specific gravity of the lab-produced mixture per CP 51.

## 6. CALCULATIONS

- 6.1 Determine the  $G_{se}$  of the lab- produced material as follows:

$$G_{se} = \frac{(100 - Pb)}{\left(\frac{100}{G_{mm}} - \frac{Pb}{G_b}\right)}$$

Where:

- $G_{se}$  = Effective specific gravity of the aggregate  
 Pb = Percent binder  
 $G_{mm}$  = Average maximum specific gravity  
 $G_b$  = Specific gravity of binder.

(This value can be found in the mix design. If the value is unknown, use 1.03.)

- 6.2 Determine the percent binder of the plant-produced mix as follows:

$$Pb = 100 \times \frac{\left(\frac{G_{se}}{G_{mm}} - 1\right)}{\left(\frac{G_{se}}{G_b} - 1\right)}$$

Where:

- Pb = Percent binder of the Plant-produced mix  
 $G_{se}$  = Effective specific gravity of the aggregate from the lab-produced mix  
 $G_{mm}$  = Maximum specific Gravity of the field- produced mix  
 $G_b$  = Specific gravity of binder.

(This value can be found in the mix design. If the value is unknown, use 1.03.)

## Colorado Procedure 43-20

### *Standard Method of Test for*

## **Determining Moisture (Water) or Volatile Distillates Content of HMA**

### **1. SCOPE**

- 1.1 This procedure covers two methods for the quantitative determination of moisture in Hot Mixture Asphalt (HMA).
- 1.2 The procedures are intended for the determination of moisture content or volatile fraction of the bitumen, in HMA.
- 1.3 The water content of a mixture is defined by this Standard as the ratio, expressed as a percentage of the mass of “pore” or “free” water in a given mass of material to the mass of the solid mixture.
- 1.4 The methods are intended to apply to samples of HMA used in verification and quality control from the points of acceptance designated in the Schedule for Minimum Materials Sampling, Testing, and Inspection.
- 1.5 This Standard may involve hazardous materials, operations, and equipment. This Standard does not purport to address all of the safety problems associated with its use. It is the responsibility of whoever uses this Standard to consult and establish appropriate safety and health practices and determine the applicability of regulatory regulations prior to use.
- 1.6 Unless otherwise specified in the Contract Documents, either method is acceptable for use.

### **2. REFERENCED DOCUMENTS**

- 2.1 *Colorado Procedures:*  
CP 41 Sampling Hot Mix Asphalt  
CP 55 Reducing Field Samples of Hot Mix Asphalt to Testing Size
- 2.2 Manufacturer’s instruction manual.
- 2.3 CDOT Standard Special Provisions and/or Project Special Provisions for Item 620
- 2.4 CDOT M & S Standards, Item 620

### **3. SIGNIFICANCE AND USE**

- 3.1 These test methods are used for determining either the amount of moisture or the amount of volatile petroleum distillates in bituminous paving mixtures.

**METHOD A**

Determining Moisture or Volatile Petroleum Distillates Content of HMA by the Microwave Method

**4. APPARATUS**

- 4.1 *Microwave oven* - Having variable time and power controls.
- 4.2 *Pyrex dish* – (or similar microwave proof glass container) Capable of holding the entire test specimen being tested.
- 4.3 *Balance* - Having sufficient capacity and sensitivity to 0.1g.

**5. TEST SPECIMEN**

- 5.1 Sample the material in accordance with CP 41 and reduce it to test specimen size in accordance with CP 55.

**6. SAFETY PRECAUTIONS**

- 6.1 See the Manufacturer's Operator's Manual for the microwave oven.
- 6.2 Do not place any metallic containers or metallic material in any microwave oven at any time.

**7. DETERMINE VARIABLE POWER SETTING**

- 7.1 Set variable power control to approximately 50% power.
- 7.2 Place  $550 \pm 50$  ml (or  $550 \pm 50$  g) of tap water in a Pyrex (or similar microwave proof glass) container. Record temperature of water (T1). Set microwave oven timer for five minutes and heat the  $550 \pm 50$  ml of water. Record the water temperature (T2). The difference between temperature T1 and T2 should be  $75^{\circ}\text{F} \pm 10^{\circ}$  ( $42^{\circ}\text{C} \pm 6^{\circ}$ ). If the difference is too low (or high) increase (or decrease) the variable power control setting and repeat 7.2. This procedure will determine the power control setting to be used in Subsection 8.2.

**8. PROCEDURE**

- 8.1 Place the specimen in a clean, glass, dry, tared container and weigh to the nearest 0.1g. The weighed sample should be  $550 \pm 50$ g for Grading S and SX mixtures. (Grading SG mixtures will require a minimum mass of 2,000 grams for testing.)
- 8.2 Dry the specimen in the microwave oven using the variable power setting determined in Subsection 7.2. Continue to dry the test specimen until the mass of the specimen does not change after further heating for a 5-minute period. Care should be taken to avoid overheating of the specimen. An indication of overheating is blue smoke.

**9. CALCULATIONS**

9.1 Determine the percent moisture to the nearest 0.01% as follows:

$$\text{Percent Moisture} = \frac{A - B}{A} \times 100$$

Where:

A = Wet weight (mass) of test specimen,  
B = Dry weight (mass) of test specimen.

**10. RECORD**

10.1 No CDOT Form is used, record on your own worksheet.

**Method B**

Determination Moisture of Bituminous Paving Mixtures by Convection Oven

**11. APPARATUS**

- 11.1 *Drying oven* - Thermostatically controlled forced draft oven meeting the requirements of Section 620 of the Standard Special Provisions.
- 11.2 *Specimen container* - Capable of holding the entire test specimen being tested.
- 11.3 *Balance* - Having sufficient capacity and sensitivity to 0.1g.
- 11.4 *Miscellaneous* - Knives, spatulas, scoops, tools, etc., as required in applicable CPs and CP-Ls.

**12. TEST SPECIMEN**

- 12.1 Sample the material in accordance with CP 41 and reduce it to test specimen size in accordance with CP 55.
- 12.2 The moisture content determination shall be done as soon as practicable after the original sample has been split down to test sample size.
- 12.2.1 If determining moisture content only, determine wet weight (mass) "A" in Subsection 14.1 as soon as the sample has been split.
- 12.2.2 If using it for moisture correction applied to the asphalt content, then determine wet weight (mass) "A" at the same time the asphalt content sample is done, i.e., during ignition oven asphalt content test.

**13. PROCEDURE**

- 13.1 Place the specimen in a clean, dry, tared container and weigh to the nearest 0.1g. The weighed sample mass shall not be less than 500 grams for grading S and SX mixtures. (Grading SG mixtures will require a minimum mass of 2000 grams for testing.)
- 13.2 Dry the specimen in the oven at the specified binder compaction temperature for that mixture, as per Table 43-1 for a minimum of 3 hours. Remove specimen and immediately weigh to the nearest 0.1g. No manipulation, i.e., stirring of the specimen, shall be permitted. Place specimen back in the oven and continue drying, checking mass of the specimen every ½ hour, ± 5 minutes. The specimen is considered dry when the loss in mass between two consecutive measurements is equal to 0.00%.

**TABLE 43-1**

| SuperPave Binder Grade | Lab Mixing Temp. | Lab Compaction Temp. |
|------------------------|------------------|----------------------|
| PG 58-28               | 310°F (154°C)    | 280°F (138°C)        |
| PG 58-34               | 310°F (154°C)    | 280°F (138°C)        |
| PG 64-22               | 325°F (163°C)    | 300°F (149°C)        |
| PG 64-28               | 325°F (163°C)    | 300°F (149°C)        |
| PG 70-28               | 325°F (163°C)    | 300°F (149°C)        |
| PG 76-28               | 325 F (163°C)    | 300°F (149°C)        |

All temperatures in this table have a tolerance of ± 5°F (± 2.8°C)

**14. CALCULATIONS**

- 14.1 Determine the percent moisture to the nearest 0.01% as follows:

$$\text{Percent Moisture} = \frac{A - B}{A} \times 100$$

Where:

A = Wet weight (mass) of test specimen,

B = Dry weight (mass) of test specimen.

**15. RECORD**

- 15.1 CDOT Form 106 or 107 is used to record the information. |

## Colorado Procedure 44-20

*Standard Method of Test for*

### **Bulk Specific Gravity and Percent Compaction of Compacted Bituminous Mixtures Using Saturated Surface-Dry Specimens**

(This procedure is based upon AASHTO T 166-13. AASHTO T 166-13 or any subsequent revisions may not be used in place of this procedure.)

#### **1. SCOPE**

- 1.1 These test methods cover the determination of bulk specific gravity of specimens of compacted bituminous mixtures as defined in ASTM E 1547, Terminology Relating to Industrial and Specialty Chemicals.
- 1.2 The bulk specific gravity of the compacted bituminous mixtures may be used in calculating the unit weight of the mixture.

#### **2. REFERENCED DOCUMENTS**

- 2.1 *AASHTO Standards:*  
M 231 Weighing Devices Used in the Testing of Materials
- 2.2 *ASTM Standards:*  
D 2726 Test Method for Bulk Specific Gravity and Density of Non-Absorptive Compacted Bituminous Mixtures  
E 1547 Terminology Relating to Industrial and Specialty Chemicals
- 2.3 *Colorado Procedures:*  
CP 51 Determining the Maximum Specific Gravity of HMA  
  
CP-L 5115 Preparing & Determining the Density of Bituminous Mixture Test Specimens Compacted by the Superpave Gyrotory Compactor

#### **3. SIGNIFICANCE AND USE**

- 3.1 This procedure covers and describes two test methods for determining bulk specific gravity to calculate the percent relative compaction of Hot Mix Asphalt.

#### **4. TERMINOLOGY**

- 4.1 Definitions:
  - 4.1.1 *Constant Mass* – The mass at which further drying at either temperature as noted in Subsection 10.4 for two hours does not alter the mass.

## 5. TEST SPECIMENS

- 5.1 Test specimens may be either laboratory-molded bituminous mixtures or from the bituminous pavements. The mixtures may be surface or wearing course, or leveling course.
- 5.2 Size of Specimens--It is recommended (1) that the diameter of cylindrically molded or cored specimens, or the length of the sides of sawed specimens, be at least equal to four times the maximum size of the aggregate; and (2) that the thickness of specimens is at least one and one-half times the maximum size of the aggregate.
- 5.3 Pavement specimens shall be taken from pavements with a core drill, a diamond or Carborundum saw, or by other suitable means.
- 5.4 Care shall be taken to avoid distortion, bending, or cracking of specimens during and after the removal from pavement or mold. Specimens shall be stored in a safe, cool place.
- 5.5 Specimens shall be free from foreign materials such as seal coat, tack coat, foundation material, soil, paper, or foil.
- 5.6 If desired, specimens may be separated from other pavement layers by sawing or other suitable means.

## 6. APPARATUS

- 6.1 *Balance* – Conforming to the requirements of AASHTO M 231, for the class of balance required for the principle sample weight of the sample being tested. The balance shall be equipped with suitable suspension apparatus and holder to permit weighing the specimen while suspended from the center of scale pan or balance.
- 6.2 *Suspension Apparatus* -- Wire suspending the container shall be the smallest practical size at the point where it penetrates the water's surface to minimize any possible effects of a variable immersed length. The suspension apparatus shall be constructed to enable the container to be immersed to a depth sufficient to cover it and the test sample during weighing without contacting the bottom of the water bath.
- 6.3 *Water Bath* -- For immersing the specimen in the water while suspended under the balance, equipped with an overflow outlet for maintaining a constant water level.
- 6.4 *Damp Towel* -- Flannel or terry cloth towel.
- 6.5 *Oven* – If using Method B (Rapid Test), a forced draft oven capable of maintaining  $230^{\circ}\text{F} \pm 9^{\circ}$  ( $110^{\circ}\text{C} \pm 5^{\circ}$ ).
- 6.6 *CoreDry<sup>TM</sup>* – If using Method C (CoreDry<sup>TM</sup> Test), a CoreDry unit from Instrotek® Inc.

**METHOD A****7. PROCEDURE**

- 7.1 Method A shall be used for laboratory compacted specimens only.
- 7.2 Laboratory compacted specimens, which have not been exposed to moisture, do not require additional drying. Cool the specimen to room temperature at  $77^{\circ}\text{F} \pm 9^{\circ}$  ( $25^{\circ}\text{C} \pm 5^{\circ}$ ). Samples must not feel warm to the touch. Record the dry mass A. If laboratory compacted specimens are wetted before the dry mass is determined, dry them as specified in Subsection 10.4 once the immersed mass and surface-dry mass have been determined. Immerse each specimen in the water at  $77^{\circ}\text{F} \pm 1.8^{\circ}$  ( $25^{\circ}\text{C} \pm 1^{\circ}$ ) for  $4 \pm 1$  minute and record the immersed mass, C. Remove the specimen from the water, damp-dry the specimen by blotting it as quickly as possible with a flannel cloth or terry cloth towel which has been thoroughly wetted and wrung out, then immediately determine the surface-dry mass, B. The objective of blotting is to remove all of the surface water without losing any water that has been absorbed into the sample. Any water that seeps from the specimen during the weighing operation is considered part of the saturated specimen.

**Note 1:** If desired, the sequence of testing operations may be changed to expedite the test results. For example, first, the immersed mass (C) can be taken, then the surface-dry mass (B) and finally the dry mass (A).

**8. CALCULATIONS**

- 8.1.1 Calculate the bulk specific gravity of the specimens as follows (round and report the value to the nearest three decimal places):

$$\text{Bulk Specific Gravity} = \frac{A}{(B - C)}$$

Where:

A = Mass (in grams) of sample in air,

B = Mass (in grams) of surface-dry specimen in air,

C = Mass (in grams) of sample in water.

- 8.2 Calculate the percent of water absorbed by the specimen (on a volume basis) as follows:

$$\frac{\text{Percent Water Absorbed by Volume}}{\text{Absorbed by Volume}} = \frac{(B - A)}{(B - C)} \times 100$$

**9. RECORD**

- 9.1 No CDOT Form, record on your worksheet.



**METHOD B (RAPID TEST)****10. PROCEDURE**

- 10.1 Method B shall be used for pavement cores.
- 10.2 This procedure can be used for testing specimens, which are not required to be saved, and which contain substantial amounts of moisture. Specimens obtained by coring or sawing can be tested the same day by this method. Specimens obtained by coring or sawing shall be tested using Method B or C and shall not be tested using Method A.
- 10.3 The testing procedure to determine the immersed mass (C) and the surface dry mass (B) shall be the same as given in Section 7. The dry mass (A) of the specimen is determined last, as per Subsection 10.4.
- 10.4 Determine and record the weight of a large flat bottom drying pan and place the weighed specimen into the pan. For Forced Draft Ovens, place the pan and specimen in a  $230^{\circ}\text{F} \pm 9^{\circ}$  ( $110^{\circ}\text{C} \pm 5^{\circ}$ ) oven. For 5½ in. (140 mm) the diameter or larger cores, or for porous or wet cores, leave the specimen in the oven until it can be easily separated into pieces not larger than 2 in. (50 mm) in diameter. Use extreme caution not to lose any portion of the original specimen while separating it. Replace the separated specimen in the oven. Document the start time. Dry all of the specimen(s) for 3 hours minimum and determine the weight at that time, (record the time). After an additional 2 hours of drying determine the weight at the time, (record the time if needed). The drying of the specimen can be stopped at this minimum of 5 total hours if a constant mass is reached. Continue the drying and weighing at 2-hour intervals until the constant mass is reached, up to the 24-hour maximum period. Determine the final weight of the heated specimens and use this weight as the dry mass A in the equation in Subsection 8.1.

**METHOD C (COREDRY™ TEST)****11. PROCEDURE**

- 11.1 Method C may be used for pavement cores in place of Method B.
- 11.2 This procedure can be used for testing specimens, which can be saved, and which contain substantial amounts of moisture. Specimens obtained by coring or sawing can be tested the same day by this method. Specimens obtained by coring or sawing shall be tested using Method B or C and shall not be tested using Method A.
- 11.3 The testing procedure to determine the immersed mass (C) and the surface dry mass (B) shall be the same as given in Section 7. The dry mass (A) of the specimen is determined last, as per Subsection 11.4.

**Note 2:** If desired, the sequence of testing operations may be changed to expedite the test results. For example, first, the dry mass (A) can be taken, then the immersed mass (C), and finally the surface-dry mass (B).

- 11.4 Turn CoreDry™ to ON position. Allow the CoreDry™ to warm up and go through preparation cycles until the “System Ready” prompt appears. Allow cores to warm to room temperature and towel dry the surface of cores if there is free standing moisture on the surface. Place core on its side on wire mesh in the vacuum chamber. Clean any ice or moisture out of moisture trap with a lint-free cloth. Place lids on the vacuum chamber and moisture trap and press START. CoreDry™ will cycle until drying is complete and the chamber will pressurize so the lid can be freely removed. If moisture is visible on the core surface clean moisture trap and then repeat the drying process. Determine the final weight of the dried specimens and use this weight as the dry mass A in the equation in Subsection 8.1.

## 12. CALCULATIONS

- 12.1 Calculate the bulk specific gravity as shown in Subsection 8.1.

- 12.2 Calculate percent relative compaction as follows:

$$\text{Percent Relative Compaction} = \frac{\text{Bulk Sp. Gravity}}{\text{Max. Sp. Gravity}} \times 100$$

**Note 3:** Max. Sp. Gr. information is in CP 51.

- 12.3 Calculate the percent air voids as follows:

$$\text{Air Voids} = 100 - \text{Percent Relative Compaction}$$

- 12.4 Calculate the VMA as follows:

$$\text{VMA} = 100 - \frac{G_{mb}P_s}{G_{sb}}$$

Where:

VMA = Voids in mineral aggregate in percent of bulk volume,

$G_{sb}$  = Bulk specific gravity of the aggregate,

$G_{mb}$  = Bulk specific gravity of compacted mix,

$P_s$  = Aggregate, percent by total weight of the mix.

## 13. PRECISION

- 13.1 Duplicate specific gravity results by the same operator should not be considered suspect unless they differ more than 0.020.

## 14. RECORD

- 14.1 CDOT Form 582 is to be used as applicable.

(Page Intentionally Left Blank)

## Colorado Procedure 45-20

*Standard Method of Test for*

### Determining Percent of Particles with Two or More Fractured Faces

**1. SCOPE**

1.1 This method describes the procedure for determining the percentage of crushed particles in an aggregate sample.

**Note 1:** If the test is performed in conjunction with a sieve analysis test such as CP 31, save the plus No. 4 portion and reduce, if desired, by splitting to the test size shown in Table 45-1 and proceed as in Subsection 5.2.

**2. REFERENCED DOCUMENTS**

2.1 *Colorado Procedures:*

CP 30 Sampling of Aggregates

CP-L 5120 Determination of the Asphalt Binder Content of Bituminous Mixtures by the Ignition Method

**3. APPARATUS**

3.1 *Balance* - Sufficient capacity and sensitivity to 0.1 gram.

3.2 *Sieve, No. 4* - With square openings conforming to AASHTO M 92.

3.3 *Sample Splitter* - For the selection of a representative specimen.

3.4 *Drying Equipment* - An oven or hot plate capable of drying a sample completely.

**4. SAMPLE AND TEST SPECIMEN SIZE**

4.1 The minimum required weight (mass) of the total sample shall conform to the requirements of the Table as shown in CP 30 or CP-L 5120 if the test is to be determined on the residual aggregate.

4.2 The minimum weight (mass) of the total specimen shall be sufficient to yield a plus No. 4 test specimen conforming to the following table:

**TABLE 45-1**

SIZE OF PLUS NO. 4 TEST SPECIMEN

| <u>Nominal Maximum<br/>Aggregate Size</u> | <u>Minimum Weight<br/>of Specimen, grams</u> |
|---|--|
| 3/8 in. (9.5 mm),                         | or under 100                                 |
| 1/2 in. (12.5 mm)                         | 200  |
| 3/4 in. (19.0 mm),                        | or over 300                                  |

## 5. PROCEDURE

- 5.1 Sieve the total unwashed specimen over the No. 4 sieve and discard the minus No. 4 material. Wash the retained material and dry at  $230^{\circ}\text{F} \pm 9^{\circ}$  ( $110^{\circ}\text{C} \pm 5^{\circ}$ ) if using a Forced Draft Oven. When dry, sieve it over a No. 4 sieve per Note 1.
- 5.2 Weigh the plus No. 4 specimen and then spread onto a work table large enough so the individual particles may be inspected.
- 5.3 Separate the particles with two or more fractured faces from those without. A rounded particle with a small chip broken off shall not be counted as having a fractured face. If the face constitutes at least one-quarter of the maximum cross-sectional area of the rock particle, consider it a fractured face.
- 5.4 Weigh the particles with two or more fractured faces and record as "weight (mass) of fractured aggregate."

## 6. CALCULATIONS

- 6.1 Determine the percentage of particles with two or more fractured faces by dividing the weight (mass) of the fractured aggregate by the total weight (mass) of the plus No. 4 test specimen and calculate:

$$\text{Percent of Particles with two or more fractured faces} = \frac{\text{weight of fractured aggregate}}{\text{total weight of specimen}} \times 100$$

## 7. RECORD

- 7.1 CDOT Form #106 or #107 are to be used to record your information. |

## Colorado Procedure 46-08

### *Standard Method of Test for*

## Determination of Gradation of Aggregate in a Core from Asphalt Pavement

### 1. SCOPE

- 1.1 This Procedure is part of the process to determine if an area designated by the Engineer as questionable is segregated. Five, 10" cores are taken at random locations (CP 75) to represent the segregated area. This procedure removes the surface areas (containing cut aggregate) from each core. The material is then combined, split, asphalt cement is removed in the ignition oven, and finally gradation is determined. Key sieve sizes of this gradation are compared to average field gradation or CDOT Form #43 gradations to determine if the area is segregated as defined by the specification.

### 2. REFERENCED DOCUMENTS

2.1 *Colorado Procedure:*

CP 31 Sieve Analysis of Aggregates

CP 55 Reducing Field Samples of Hot Mix Asphalt to Testing Size

CP 75 Stratified Random Sampling of Materials

2.2 *Colorado Procedure – Laboratory:*

CP-L 5120 Determination of the Asphalt Binder Content of Bituminous Mixtures by the Ignition Method

### 3. APPARATUS

- 3.1 *Oven* - Capable of holding five pans with cores, a 6" ID template (core barrel, pipe section, etc) and capable of maintaining 230°F.
- 3.2 *Five Pans* - Each large enough to hold a 10" core.
- 3.3 *6" ID Template* - Core barrel, pipe section, etc.

### 4. PROCEDURE

- 4.1 Remove foreign material from the cores. Separate the lift to be tested from the other lift(s). Freezing of the cores and the use of a chisel may facilitate this process.

- 4.2 Place each core in a separate pan and place all pans in a 230°F oven for two hours or until the core is soft enough for the following separation procedure. Heat a 6" ID (inside diameter) template. Remove each specimen and pan, one at a time. Remove the outer layer of each core in the following manner. Center the 6" ID template over the 10" core and pass the template vertically down the entire specimen. Maintain downward pressure on the core barrel with one hand and remove all the trimmed material with the other hand. Lift the core barrel to reveal the material. Place the material in the container to be used for combining and remixing.
- 4.3 Repeat this process with the other four cores. Mix the material from the five cores.
- 4.4 Following CP 55, split the combined material to result in two portions of the appropriate size for ignition oven testing.
- 4.5 Remove asphalt cement per CP-L 5120.
- 4.6 Determine gradations per CP 31.
- 4.7 Apply aggregate gradations correction factors per CP-L 5120.

## Colorado Procedure 47-90

### *Standard Method of Test for*

## Rejuvenating Agent Evaluation Procedure

### 1. SCOPE

- 1.1 The layout of a rejuvenating agent test area, application of the test rejuvenating agent, and determination of whether or not rejuvenating agent is needed.
- 1.2 Asphalt Rejuvenating Agents are composed of a petroleum resin-oil base uniformly emulsified with water. Rejuvenating Agents are used as an agent to counter roadway oxidation and add new life into the existing material. A Rejuvenating agent may need to be added to a pavement undergoing rehabilitation per the test.

### 2. APPARATUS

- 2.1 Covered applicator, keel, tape measure, paint brush, rejuvenating agent, camera (optional).

**Note 1:** The applicator should have a perforated top that allows a rapid dispersal of the rejuvenating agent. Measure and mark the applicator so that the markings will correspond to the desired rate of application for the test section in gal/sq.yd., i.e., .03, .05, .075, .10, .125, and .15 gal/sq. yd. ( $L/m^2$ , i.e., .14, .23, .34, .45, .57, .68  $L/m^2$ ). See Figure 47-1.

### 3. LOCATION OF TEST SITES

- 3.1 A minimum of three locations should be selected for each project. It may be necessary to increase the number of test locations depending on the length of the projects.
- 3.2 Each test site should be two feet in length by two feet in width (0.6 m x 0.6 m). Approximately one-half of the area should be located in the outside wheel path, and approximately one-half should not be within the wheel path.

**Note 2:** The first test location should contain three test sites to determine the approximate amount of rejuvenating agent that may be required. The other test locations would require one test site. Suggested starting rates are .05, .10, and .15 gal/sq.yd. (.23, .45, and .68  $L/m^2$ ).

### 4. PREPARATION

- 4.1 Dilute the full strength rejuvenating agent into to two parts of rejuvenating to one part water.
- 4.2 Pour the proper amount of diluted rejuvenating agent into the applicator and cover.
- 4.3 Pour enough rejuvenating agent into a container of sufficient size to hold the paintbrush so that all of its bristles are covered. Let stand until the test site is prepared.



**5. PROCEDURE**

- 5.1 Mark each test site on the pavement.
- 5.2 Photograph each test site before the rejuvenating agent is applied. (Optional)
- 5.3 Remove the paintbrush from the container and wipe the excess rejuvenating agent back into the container.
- 5.4 Apply the rejuvenating agent to the test site as evenly as possible.
- 5.5 Use the paintbrush to distribute the rejuvenating agent over the test site more uniformly.
- 5.6 Note the time of application and record the time and the rate of application on the pavement adjacent to the test site.
- 5.7 Let the rejuvenating agent stand undisturbed on the test site until it has penetrated. Record the time. If the rejuvenating agent fails to penetrate the pavement in 20 minutes or less, try a smaller amount of rejuvenating agent. If this is not practical, then note that no rejuvenating agent is required for that test site.

**Note 3:** See Figure 47-2 A and B for examples of total penetration and partial penetration.

- 5.8 Photograph the test site after the test is completed. (Optional)

**6. RECORD**

- 6.1 No CDOT Form. Record on your worksheet.

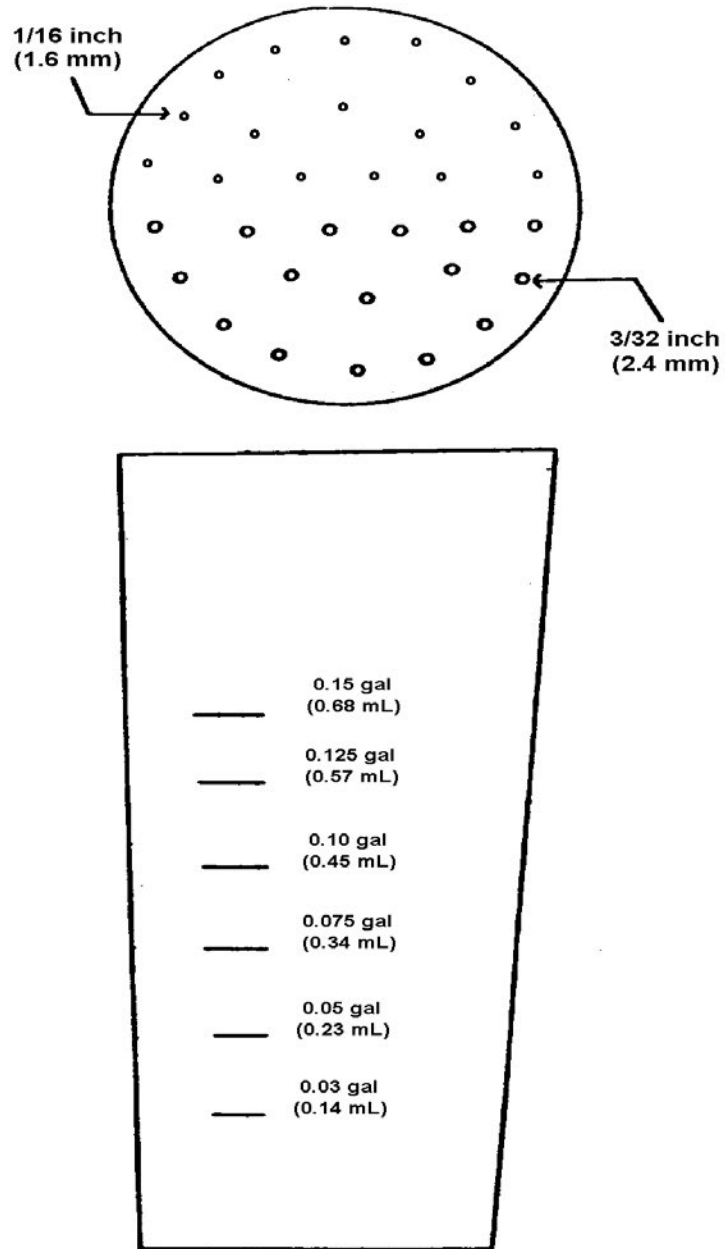
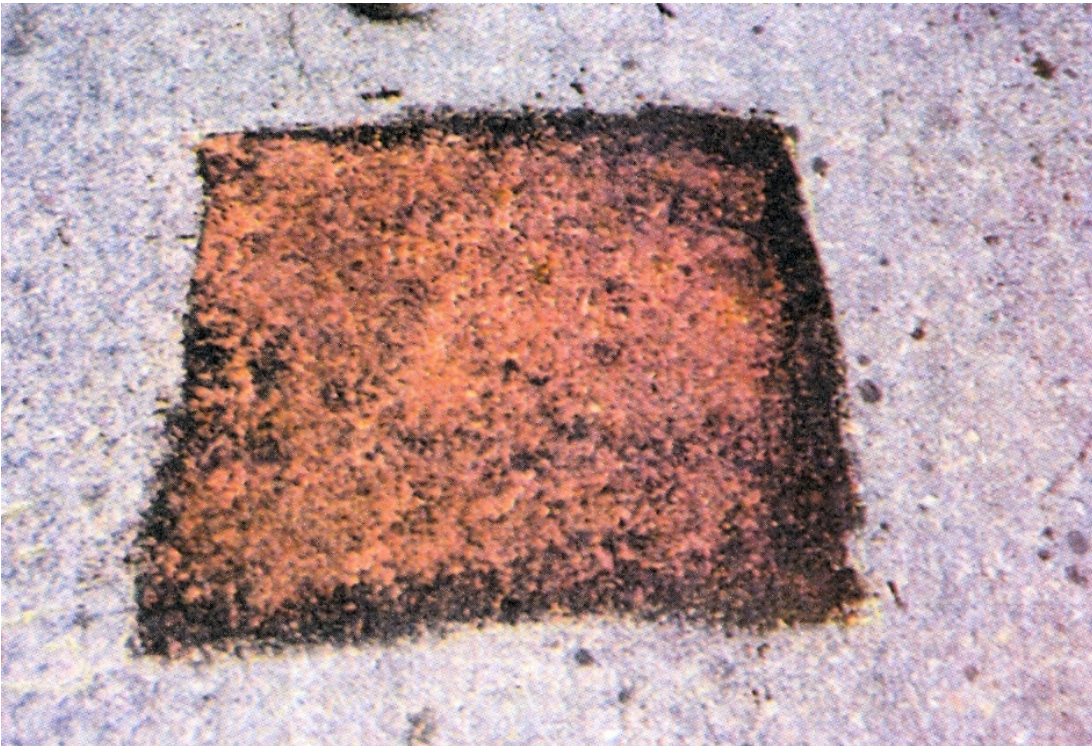


FIGURE 47-1



**FIGURE 47-2 A: Total Penetration**



**FIGURE 47-2 B: Partial Penetration**

## Colorado Procedure 48-20

*Standard Method of Test for*

### Determination of the Voids in the Mineral Aggregate (VMA)

#### 1. SCOPE

- 1.1 Voids in the mineral aggregate (VMA) are the void spaces between the aggregate particles of the compacted mix. This void space includes the air voids and the effective asphalt content.

#### 2. REFERENCED DOCUMENTS

- 2.1 *Colorado Procedures:*  
CP 56 Guidelines for Using Maximum Specific Gravity (Rice) of Project-Produced HMA to Change the Target Specific Gravity for Compaction Compliance

#### 3. CALCULATION

- 3.1 VMA is computed as follows:

$$VMA = 100 - \frac{G_{mb} P_s}{G_{sb}}$$

Where:

VMA = Voids in mineral aggregate, in percent of bulk volume,  
 $G_{sb}$  = Bulk specific gravity of the aggregate,  
 $G_{mb}$  = Bulk specific gravity of compacted mix,  
 $P_s$  = Aggregate, percent by total weight of the mix.

- 3.2 When the total aggregate consists of separate fractions, the bulk specific gravity of the total aggregate is computed as follows:

$$G_{sb} = \frac{P_1 + P_2 + \dots + P_n}{\frac{P_1}{G_1} + \frac{P_2}{G_2} + \dots + \frac{P_n}{G_n}}$$

Where:

$P_1$  = Percent by weight of aggregate 1, etc.,

$G_1$  = Bulk specific gravity of aggregate 1, etc. 3.3 When the total mix contains 20 percent or less of reclaimed asphalt pavement (RAP), the bulk specific gravity of the aggregate contained in the RAP shall be assumed to be the same as the effective specific gravity of the aggregate contained in the RAP for the calculation in Subsection 3.2. The calculation for the effective specific gravity may be found in CP 56.

**Note 1:** For more detailed information on VMA determination and related subjects, refer to the Asphalt Institute publication MS-4.

3.4 When hydrated lime is used in the mix, the  $G_{sb}$  value for the lime shall be 2.38.

**4. REPORT**

4.1 *Report the following information:*

4.1.1 Each VMA to the nearest 0.01%. The average of three VMA to the nearest 0.1%.

**Note 2:** Each VMA shall be considered an intermediate value. Each VMA shall be calculated according to Appendix I.

## Colorado Procedure 50-14

### *Standard Method of*

### Calculation of Dust to Asphalt Ratio of Bituminous Mixes

#### 1. SCOPE

- 1.1 This method covers the calculation used to determine the dust to asphalt (D/A) ratio of bituminous mixes.

#### 2. CALCULATIONS

2.1 
$$DA = (P_{200} - 1) / P_{be}$$

Where:

DA = Dust to Asphalt Ratio,

$P_{20}$  = Aggregate content passing the 0.075-mm sieve, the percent by mass of aggregate,

$P_{be}$  = Effective asphalt content, percent by total mass of mixture.

#### 2.2

$$P_{be} = - (P_s \times G_b) \times \left( \frac{G_{se} - G_{sb}}{G_{se} \times G_{sb}} \right) + P_b$$

Where:

$P_{be}$  = Effective asphalt content, percent by total mass of mixture,

$P_s$  = Aggregate content, percent by total mass of mixture,

$G_b$  = Specific gravity of asphalt,

$G_{se}$  = Effective specific gravity of aggregate,

$G_{sb}$  = Bulk specific gravity of aggregate,

$P_b$  = Asphalt Content, percent by total mass of mixture.

{Page Intentionally Left Blank}



## Colorado Procedure 51-21

### *Standard Method of Test for*

### **Determining the Theoretical Maximum Specific Gravity of HMA**

(This procedure is based upon AASHTO T 209-19. AASHTO T 209-19 or any subsequent revisions may not be used in place of this procedure.)

#### **1. SCOPE**

- 1.1 This method covers the determination of the theoretical maximum specific gravity of un-compacted bituminous paving mixtures.

#### **2. REFERENCED DOCUMENT**

##### *AASHTO Standards:*

T 164 Quantitative Extraction of Bitumin from Bituminous Paving Materials

T 168 Sampling Bituminous Paving Mixtures.

##### *ASTM Standards:*

E1 Specification for ASTM Thermometers

##### *Colorado Procedures:*

CP 41 Sampling Hot Mix Asphalt

CP-L 5101 Verification of Laboratory Equipment used to Test Bituminous Mixtures

CP-L 5115 Preparing & Determining the Density of Bituminous Mixture Test Specimens Compacted by the Superpave Gyratory Compactor

CP-L 5120 Determination of the Asphalt Binder Content of Bituminous Mixtures by the Ignition Method

#### **3. APPARATUS**

- 3.1 *Balance* – A balance conforming to the requirements of AASHTO M 231, Class G 2. The balance shall be standardized at least every 12 months.

- 3.2 *Container* - Heavy walled volumetric flask, with the top sanded flat to provide a good seal with a cover plate, having a capacity of at least 2,000 ml. If containers other than heavy-walled flasks are used, repeated weightings of the flask as specified in Subsection 4.1 must be within 0.2 grams of one another. Containers shall be sufficiently strong to withstand a partial vacuum and shall have covers as follows: for use with the flask, a rubber stopper with a hose connection. The hose opening shall be covered with a small piece of fine wire mesh to minimize the possibility of a loss of fine material. The top surfaces of all containers shall be smooth and substantially plane.

- 3.3 *Thermometers (Mass Determination in Air)* - A liquid-in-glass thermometer or other thermometric devices, accurate to 0.5°C (1°F), of suitable range with subdivisions of 0.5°C (1°F). The thermometers shall be standardized at the test temperature at least every 12 Months



- 3.4 *Vacuum Pump or Water Aspirator* - Capable of developing a partial vacuum of  $28 \pm 2$  mm of mercury (Hg) for evacuating air from the container.
- 3.5 *Water Bath* - Constant temperature water bath capable of maintaining a temperature of  $77^{\circ}\text{F} \pm 1^{\circ}$  ( $25^{\circ}\text{C} \pm 0.5^{\circ}$ ).
- 3.6 *Thermometers (Mass Determination in Water)*- A liquid-in-glass thermometer or other thermometric devices, accurate to  $0.5^{\circ}\text{C}$  ( $1^{\circ}\text{F}$ ) shall be used to measure the temperature of the water bath. The thermometer shall be standardized at least every 12 months.
- 3.7 *Manometer or Vacuum Gauge* - Free of air bubbles, initially traceable to NIST, and be capable of measuring residual pressure down to 30 mm Hg or less.
- 3.8 *Needle Valve* - Capable of adjusting the partial vacuum applied to the specimen to  $28 \pm 2$  mm of mercury.
- 3.9 *Oven* – If using Section 8, capable of maintaining a temperature of  $230^{\circ}\text{F} \pm 9^{\circ}$  ( $110^{\circ}\text{C} \pm 5^{\circ}$ ). If short-term aging is required, an oven capable of maintaining  $200^{\circ}\text{F}$  ( $94^{\circ}\text{C}$ ).
- 3.9.1 *Thermometer*- A liquid-in-glass thermometer or other thermometric devices accurate to  $3^{\circ}\text{C}$  ( $5^{\circ}\text{F}$ ) shall be used to measure the temperature of the oven. The thermometer shall be standardized at least every 12 months.

#### **4. CALIBRATION OF FLASK**

- 4.1 Approximately once per month, accurately determine the mass of the flask filled with water at  $77.0^{\circ}\text{F} \pm 1.0^{\circ}$  ( $25.0^{\circ}\text{C} \pm 0.5^{\circ}$ ) and covered by the cover plate to be used for testing. Average the last three determinations of the weight of the flask, water, and cover plate and record this number. Alternatively, generate a curve as described in Subsection 6.5 and verify at least one point on this curve approximately once per month.

#### **5. TEST SAMPLES**

- 5.1 Field samples shall be obtained, as required by the Schedule, per CP 41, Sampling Hot Mix Asphalt.
- 5.2 The size of the test specimens shall be governed by the nominal maximum aggregate size of the mixture and conform to the mass requirement of Table 51-1. Split or quarter the field sample per CP 55 until the mass of the material required for the test is obtained. Two separately taken identical test specimens shall be obtained. The two specimens shall not be recombined at any time after they have been taken.
- 5.3 If laboratory or field produced specimens are to be compacted for voids analysis using CP-L 5115, the specimens used to determine the theoretical maximum specific gravity should be short-term aged using the same heating procedure as used for the specimens being compacted. Specimens, which have been held at a temperature above  $200^{\circ}\text{F}$  ( $94^{\circ}\text{C}$ ) for 1 or more hours after mixing, do not require additional aging.

**TABLE 51-1:  
Sample Mass for Various Nominal Maximum Sizes of Aggregate.**

| Nominal Maximum<br>Size of Aggregate |      | Number and Minimum<br>Mass of Specimens |
|--------------------------------------|------|---|
| in.                                  | mm   | specimens x grams                       |
| 1 ½                                  | 37.5 | 2 × 3000 g                              |
| 1                                    | 25.0 | 2 × 1500 g                              |
| ¾                                    | 19.0 | 2 × 1000 g                              |
| ½                                    | 12.5 | 2 × 750 g                               |
| ¾                                    | 9.5  | 2 × 500 g                               |
| No. 4                                | 4.75 | 2 × 500 g                               |

## 6. PROCEDURE

6.1 For each specimen, separate the particles of the specimen, taking care not to fracture the mineral particles so that the particles of the fine aggregate portion are not larger than 1/4 in. (6.4 mm). If the mixture is not sufficiently soft to be separated manually, place it in a large flat pan and warm in an oven only until it can be so handled.

6.2 Cool the specimen to room temperature, place in the tared flask and weigh. Designate the net mass of specimen as A. Add sufficient water at approximately 77°F (25°C) so that the specimen is covered to a minimum depth of 1 in. (25 mm) and remains covered while it is agitated.

**Note 1:** If the potential presence of lime in asphalt paving mixture needs to be determined, add 2-4 drops of phenolphthalein alcohol indicator into the flasks after adding sufficient water and before subjecting the contents to a partial vacuum. Let it rest for 10 seconds and look for the indicator to show the potential presence of lime.

6.3 Remove entrapped air by subjecting the contents to a partial vacuum of  $28 \pm 2$  mm Hg for  $15 \pm 2$  minutes. Agitate the container and contents manually by vigorous shaking for  $15 \pm 5$  seconds at intervals of about 2 minutes. Alternatively, a mechanical device, shown to be at least as effective at removing entrapped air as the manual method and shown to not result in stripping of the asphalt binder from the aggregate, may be used to agitate the container.

**Note 2:** If there are multiple, broken or sawed uncoated aggregate surfaces or if uncoated fine material separates from the specimen and settles to the bottom of the flask once the test is complete, use the supplemental procedure described in Section 8.

**Note 3:** The release of entrapped air may be facilitated by the addition of a suitable wetting agent such as Aerosol OT in a concentration of 0.001 percent or 0.2 grams in 20 liters of water. This solution is then diluted to about 20:1 to make a wetting agent of which 5 to 10 ml may be added to each sample to give a final concentration of Aerosol OT of about 1 gram per 200,000 liters.

- 6.4 *Flask Determination* - Fill the flask with water, at a temperature of  $77^{\circ}\text{F} \pm 1^{\circ}$  ( $25^{\circ}\text{C} \pm 0.5^{\circ}$ ), being careful not to introduce air bubbles into the flask. Optionally, if air bubbles are observed or suspected in the flask, gently stir the specimen with a rod to dislodge any air bubbles that may still be trapped in the flask. Fill the flask to the top with water and cover the flask with the same cover plate used in the flask's calibration, making sure that there are no air bubbles beneath the flask's cover plate. Place the flask and contents into a  $77^{\circ}\text{F} \pm 1^{\circ}$  ( $25^{\circ}\text{C} \pm 0.5^{\circ}$ ) constant temperature water bath. The flask shall remain in the water bath until the water temperature in the flask stabilizes at  $77^{\circ}\text{F} \pm 1^{\circ}$  ( $25^{\circ}\text{C} \pm 0.5^{\circ}$ ) or for a minimum of 10 minutes, whichever is achieved first. Remove the flask from the water bath and dry the exterior of the flask completely. Check that no air bubbles have appeared beneath the flask's cover plate. Determine the weight of the flask, water, specimen, and cover plate within 2 minutes of removing the flask from the water bath.
- 6.5 In place of a constant temperature water bath, determine the temperature of the water within the flask immediately after weighing the flask, water, and specimen and make the appropriate density correction to  $77^{\circ}\text{F}$  ( $25^{\circ}\text{C}$ ) using the curve in Figure 51-1. In this case, the mass of the flask, water, and cover glass must be determined at the same temperature as the test temperature. This shall be done by plotting the mass of the flask, water, and cover plate for at least five approximately / equally spaced temperatures, which span the range of test temperatures to be used. Allow the flask and water to equilibrate at each temperature for at least one minute before measuring the water temperature and then weighing the flask, water, and cover plate. Alternatively, one point (using three trials) near the middle of the expected temperature range may be determined. The volume of the flask may then be calculated by subtracting the mass of the flask and cover glass, and then dividing the mass of the water by the density of the water at that temperature using the equation from FIGURE 51-1. A table may be constructed by multiplying the volume of the flask by the density of water and adding the mass of the flask and cover glass for each temperature desired. This method may be used for containers that have a minimal change in volume over the temperature range to be expected, such as annealed glass flasks. At least one point on the resulting plot of mass vs. temperature should be verified monthly.

## 7. CALCULATION

7.1 Calculate the specific gravity of the specimen as follows:

7.1.1 *Flask Determination:*

[Equation 1]

$$\text{Specific Gravity} = \frac{A}{(A + D - E)}$$

Where:

A = Mass of the dry specimen in air, g,

D = Mass of the flask filled with water at 77°F (25°C), g,

E = Mass of the flask filled with water and specimen at 77°F (25°C), g.

7.2 Whenever water temperatures other than 77°F are used, use the following equation:

[Equation 2]

$$\text{Specific Gravity} = \frac{A}{(A + F) - (G + H)} \times \frac{dw}{0.9970}$$

Where:

A= Mass of the dry specimen in air, g,

F= Mass of a flask filled with water at test temperature, g, as read from the plot generated in Subsection 6.5,

G= Mass of a flask filled with water and specimen at test temperature, g,

H= Correction for thermal expansion of bitumen, g, from Figure 51-2.

**Note:** H may be assumed to be zero for test temperatures between 70°F and 90°F (21.1°C and 32.3°C),

dw= Density of water at the test temperature. Curve D in Figure 51-1, Mg/m<sup>3</sup>, 0.9970 = Density of water at 77°F (25°C). Mg/m<sup>3</sup>.

The ratio (dw/0.9970) is Curve R in Figure 51-1.

**Note 4:** This general procedure for correcting for thermal effects should also apply to corresponding measurements made with other suitable containers.

7.3 *Repeatability* - If the specific gravities of the two specimens are not within 0.011 of each other, the results should be discarded, a new specimen obtained, and the specific gravity of the material retested.

**8. SUPPLEMENTAL PROCEDURES FOR MIXTURES CONTAINING POROUS AGGREGATE NOT COMPLETELY COATED****METHOD A – DRY-BACK**

- 8.1 Proceed as follows after completing Section 6.
  - 8.1.1 Oven dry a filter paper and record its weight. Place the filter paper into a filter paper cone holder.
  - 8.1.2 Drain the water from the specimen through the filter paper cone being careful not to lose any of the Specimen. Allow the Specimen to drain completely.
  - 8.1.3 Weigh an empty pan sufficient in size to hold the test specimen while it dries in Subsection 8.2.
  - 8.1.4 Empty the specimen from the filter paper into the pan from Subsection 8.1.3 and place the pan before an electric fan.
  - 8.1.5 Oven dry the filter paper and any Specimen which may remain on the paper's surface at a temperature of  $230^{\circ}\text{F} \pm 9^{\circ}$  ( $110^{\circ}\text{C} \pm 5^{\circ}$ ) for more than 30 minutes. Subtract the weight of the filter paper used in Subsection 8.1.1 and record this weight.
- 8.2 Spread Specimen before an electric fan to remove surface moisture. Weigh at 15-minute intervals and when the loss in mass is less than 0.5g for this interval, the specimen may be considered to be surface dry. This procedure requires about 2 hours and should be accompanied by an intermittent stirring of the specimen. Conglomerations of the mixture should be broken by hand. Care must be taken to prevent the loss of particles of the mixture.
- 8.3 To calculate the specific gravity of the specimen, the sum of the final surface-dry mass and the mass of any specimen remaining on the filter paper from Subsection 8.1.5 is substituted for A in the denominator of Equation 1 or 2.

**METHOD B – PG GRADED BINDER ADD-IN FOR CALCULATING THE EFFECTIVE SPECIFIC GRAVITY FOR RAP  
(Reclaimed Asphalt Pavement)**

- 8.4 Before Subsection 6.1, add in 2% to 3% virgin asphalt cement per CP-L 5120 Subsection 9.1, to the specimen. Use the binder mixing temperature stated in CP-L 5115 Table 2.
  - 8.4.1 After the specimen has properly cooled proceed with Subsection 6.1.
- 8.5 For calculating the effective specific gravity of the aggregates, the percent binder is the virgin binder added per this procedure and any binder that is already on the aggregate that is determined by CP-L 5120 or AASHTO T 164.

**METHOD C – CALCULATING THE EFFECTIVE SPECIFIC GRAVITY FOR RAS  
(Reclaimed Asphalt Shingles)**

- 8.6 Determine the maximum specific gravity according to AASHTO T 209.
- 8.7 For calculating the effective specific gravity of the aggregates, the percent binder is any binder that is already on the aggregate that is determined by CP-L 5120 or AASHTO T 164.

**9. PRECISION**

9.1 Criteria for judging the acceptability of specific gravity test results obtained by this method are given in Table 51-2 entitled "Specific Gravity Test Results." The figures given in column 2 are the standard deviations that are appropriate for the conditions of the test described in column 1. The figures given in column 3 are the limits that should not be exceeded by the difference between the results of two properly conducted tests

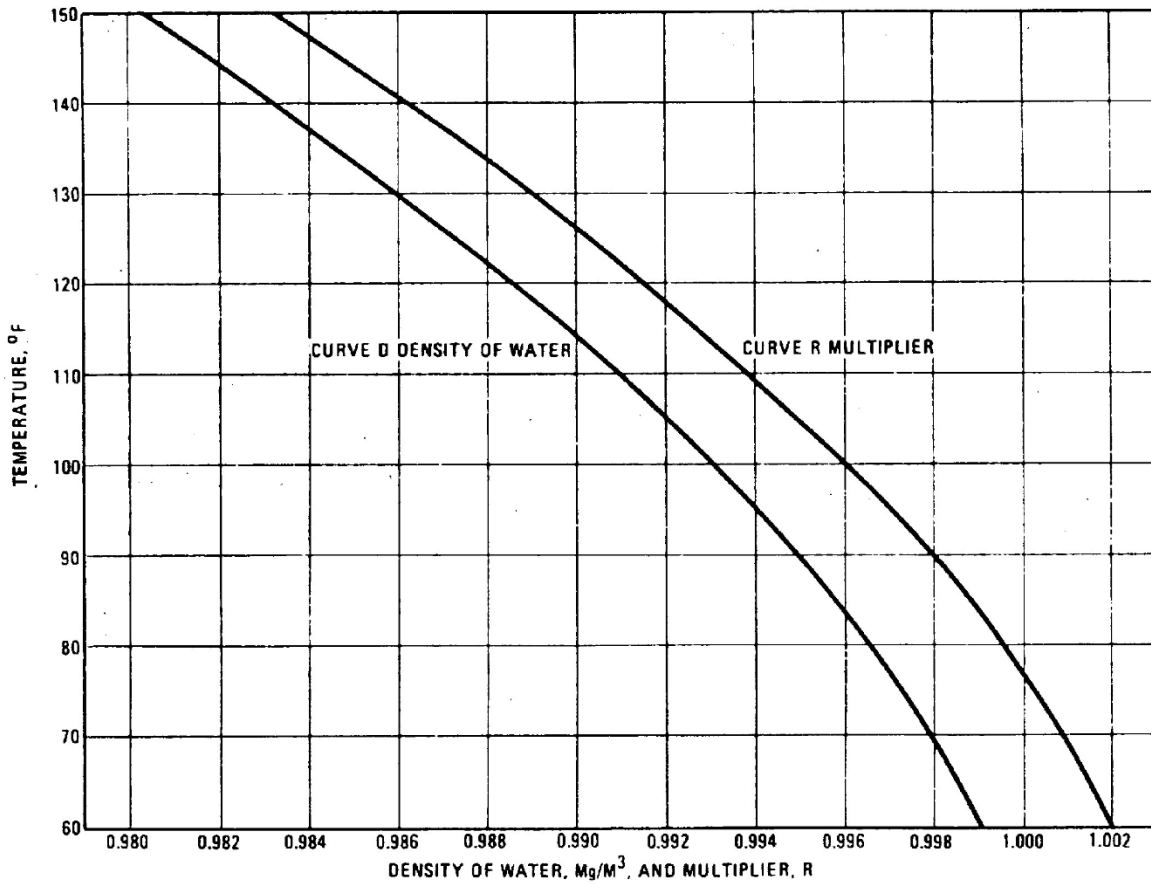
**10. Report**

- 10.1 *Report the following information:*
  - 10.1.1 The specific gravity of each specimen to the nearest 0.001. The average specific gravity of two specimens to the nearest 0.001.
- 10.2 Document the information on CDOT Form 106 or Form 107.

**TABLE 51-2: Specific Gravity Test Results**

| <b>Test and Type Index</b>   | <b>Acceptable<br/>Standard<br/>Deviation<br/>(1S)</b> | <b>Range of<br/>Two Results<br/>(D2S)</b> |
|--|---|---|
| <b>Test results obtained without the use of Section 8<sup>a</sup>:</b> |   |   |
| <b>Single-operator precision</b>                                       | <b>0.0040</b>   | <b>0.011</b>                              |
| <b>Multi laboratory precision</b>                                      | <b>0.0064</b>   | <b>0.019</b>                              |

<sup>a</sup> **Basis of estimate:** 3 replicates, 5 materials, 5 laboratories.



**FIGURE 51-1: Curves D and R for Equation 2**

The equation of curve D, the density of water from 60°F to 150°F is:

$$D = (1.001\ 402) + (0.000\ 029\ 42) \times T - (0.000\ 001\ 133) \times T^2$$

Where: T = Temperature in degrees Fahrenheit.

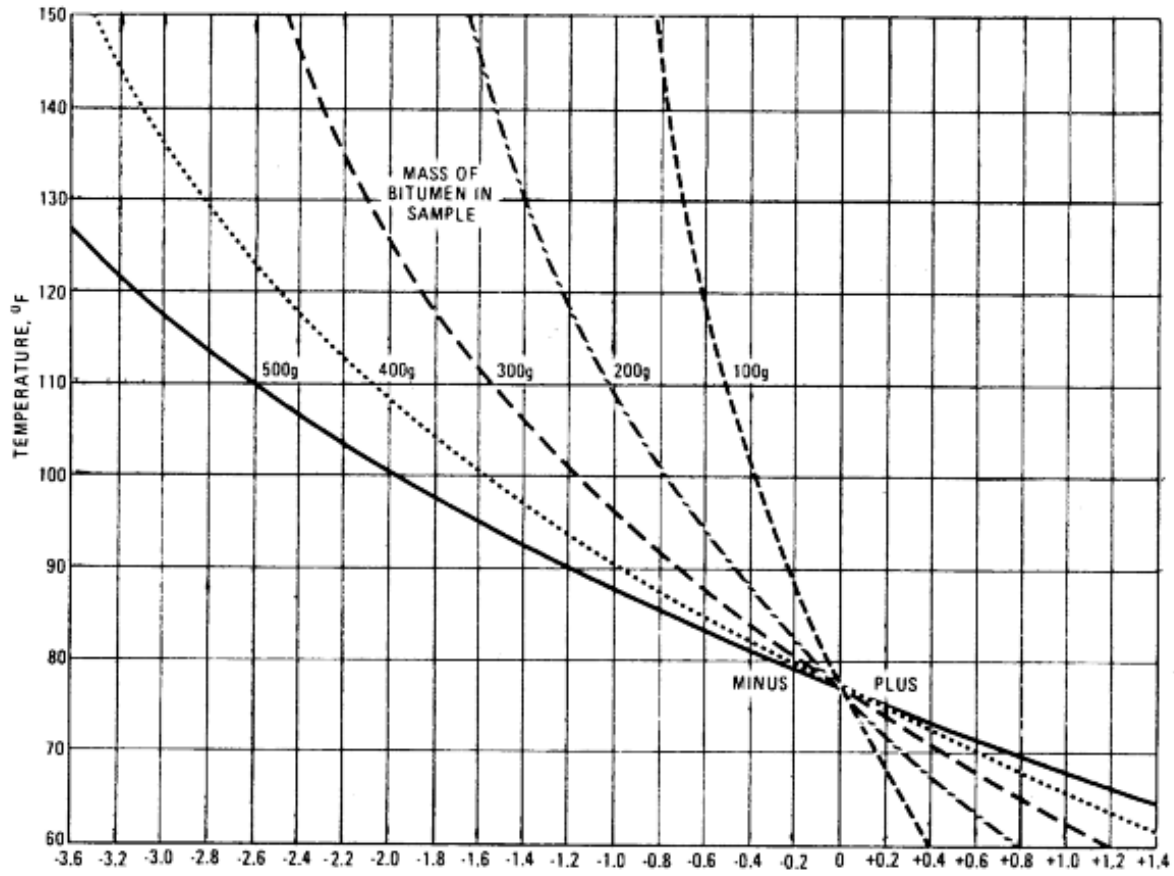
The equation for the multiplier R from 60°F to 150°F is:

$$R = (1.004\ 385) + (0.000\ 028\ 68) \times T - (0.000\ 001\ 129) \times T^2$$

Where: T = Temperature in degrees Fahrenheit.

(Please check all results against the graph for correctness.)

Curve R is the Ratio (dw / 0.9970)



**FIGURE 51-2: Correction Curves for Thermal Expansion of Bitumen, H, in Equation 3**

The equation for the correction for the thermal expansion of bitumen, H, from 60°F to 150°F is:

$$H = [\text{grams bitumen}] \times [ (0.022\ 71) - (0.000\ 386) \times T + (0.000\ 001\ 201) \times T^2 ]$$

Where: T = Temperature in degrees Fahrenheit.

(Please check all results against the graph for correctness.)



{Page Intentionally Left Blank}

## Colorado Procedure 52-21

### *Standard Practice for*

## Contractor Asphalt Mix Design Approval Procedures

### 1. SCOPE

- 1.1 This practice describes the procedures for asphalt mix design approval, the time required to perform the required tests, and the cost of the testing.

### 2. REFERENCED DOCUMENTS

#### 2.1 *AASHTO Standards:*

- T 85 Specific Gravity & Absorption of Coarse Aggregate
- T 90 Determining the Plastic Limit & Plasticity Index of Soils
- T 96 Resistance to Degradation of Small-Size Coarse Aggregate by Abrasion and Impact in the Los Angeles Machine
- PP 78 Design Considerations When Using Reclaimed Asphalt Shingles (RAS) in Asphalt Mixtures

#### 2.2 *Colorado Procedures:*

- CP 10 Qualification of Testing Personnel and Laboratories
- CP 30 Sampling of Aggregates
- CP 31 Sieve Analysis of Aggregates
- CP 32 Reducing Field Samples of Soil and Aggregate to Testing Size
- CP 51 Determining the Maximum Specific Gravity of HMA

#### 2.3 *Colorado Procedures – Laboratories:*

- CP-L 4102 Specific Gravity and Absorption of Fine Aggregate
- CP-L 4211 Resistance of Coarse Aggregate to Degradation by Abrasion in the Micro-Deval Apparatus
- CP-L 5106 Resistance to Deformation of Bituminous Mixtures by Means of Hveem Apparatus
- CP-L 5109 Resistance of Compacted Bituminous Mixture to Moisture Induced Damage
- CP-L 5115 Preparing & Determining the Density of Bituminous Mixture Test Specimens Compacted by the Superpave Gyratory Compactor
- CP-L 5117 Superpave Design for Hot Mix Asphalt
- CP-L 5145 Contractor Asphalt Mix Design Approval Procedures Utilizing RAP Millings from the Same Project

### 3. APPROVAL OF MIX DESIGNS

- 3.1 Asphalt mix designs shall be performed in conformance with CP-L 5115, CP-L 5106, CP-L 5109 and CP-L 5117 as well as other specified Colorado, AASHTO, and ASTM procedures. Mix designs for S, SX and ST mixes will be done using 4-inch molds. Mix designs for SG mixes will be done using 6-inch molds. A complete mix design will be required for all mixtures placed on the project.

- 3.2 The Contractor must submit to the Engineer three copies of the asphalt mix design on CDOT Form #429, which contains all the information detailed in Subsection 4.2, and the aggregate samples, a minimum of 4 weeks prior to the anticipated paving start date. **All asphalt mix designs shall be stamped by a registered Professional Engineer in the State of Colorado pursuant to Section 12-25-117 of the Colorado Revised Statutes.** Mix designs shall have an original manual ink signature. Copied or faxed mix designs will not be accepted. Scans of Wet-Stamped mix design submittals in pdf format are acceptable.

The cover letter describing the asphalt mix design, as a minimum, shall be stamped by a registered Professional Engineer in the State of Colorado. If the supporting documentation listed in Subsection 4.3 is not covered by the Engineer of Record, each supporting page shall be stamped by a registered Professional Engineer in the State of Colorado. The Region Materials Engineer (RME) must approve the Contractor's proposed asphalt mix design before paving may proceed. The Engineer may reject a mix design that appears to have errors. The Contractor shall use the latest version of the CDOT Form 429 which may be obtained through the RME or through the Flexible Pavement Unit of the Central Laboratory. Additionally, each mix design submitted for approval must be accompanied by a Microsoft® Excel® electronic version of the CDOT Form 429 specific to each mix.

- 3.2.1 To verify the asphalt mix design, the aggregates to be used in the mix design, shall be sampled by the contractor in accordance with CP 30 and split in accordance with CP 32 in the presence of the Engineer. The split aggregates shall be tested by the Contractor and CDOT Central Laboratory Concrete/Physical Properties Unit. The aggregates shall be tested for: Gradation (CP 31), Aggregate Specific Gravity and Absorption, (AASHTO T 85 & CP-L 4102) and Plastic Index (AASHTO T 90). The Engineer will coordinate with the Region Materials Engineer to determine the need to run the Micro-Deval (CP-L 4211) and/or the Los Angeles Abrasion (AASHTO T 96).

**Note 1:** If the combined aggregate specific gravity of the contractor's asphalt mix design is not within 0.020 of the test results for the combined aggregates derived from the CDOT Central Laboratory testing as specified in Subsection 3.2.1, the Contractor and CDOT Central Laboratory shall both recheck calculations, retest, and/or resample/retest as needed until the resulting mix combined aggregate specific gravities agree to within 0.020. The contractor's aggregate specific gravity values will then be used to calculate the HMA mixture volumetric properties. At the discretion of the Region Materials Engineer, the use of the aggregate test results from the CDOT Central Laboratory as listed in Subsection 3.2.1 may be allowed for mix development only if all other mix design criteria are met when using Central Laboratories test results. The mix design criteria that must be met includes minimum VMA and VFA criteria and dust to asphalt ratio, as required by the Contract.

- 3.2.2 The Reclaimed Asphalt Pavement (RAP) to be used shall be sampled by the contractor in accordance with CP 30, in the presence of the Engineer, and will be tested by the Flexible Pavement Unit of the CDOT Central Laboratory. The RAP shall be tested for: Asphalt Binder Content (uncorrected) and Gradation (uncorrected) (CP-L 5120) and Effective Specific Gravity (CP 51, Method B). Two individual samples are used to determine the average Asphalt Binder Content and Gradation.

- 3.3 The asphalt mix design cannot be approved when the laboratory trial, binder data, or aggregate data possess results from tests performed more than one year in the past.

If the Form #429 submitted is from a mix design developed more than 2 months prior, the Region Materials Engineer may request additional aggregate data meeting the requirements of Subsection 4.3 (1) B and C be provided.

Based on the new data provided, the Region Materials Engineer may require additional testing.

If the average gradation for any material on any individual sieve varies by more than 5 percent from design gradation or 2 percent on the #200 sieve, or the combined gradation based on the averages varies by more than 3 percent on any sieve or 1 percent on the #200 sieve, a one point verification, performed at the design optimum asphalt content, may be required using current production aggregate.

The results of the one point verification shall meet the project design specifications. In addition, the results for air voids and voids in mineral aggregate shall be within 1 percent of design target. If the one point does not meet these criteria a new mix design may be required by the Region Materials Engineer.

- 3.4 If all tests conform to the specifications, a CDOT Form 43 (Job Mix Formula) will be executed.
- 3.5 All mix design properties must satisfy Table 403-1 from the Project Special Provisions. The CDOT Form #43 will establish construction targets for Asphalt Content and all mix properties at Air Voids up to 1.0% below the mix design optimum.
- 3.6 After an asphalt mix design is approved for use, binder changes shall be handled as follows:
- 3.6.1 If the Supplier remains the same, but the binder used changes, such that future binder supply to a project will come from a different refinery, different terminal, or be a different formulation that could potentially affect mix properties, a one point check at the Form 43 target AC content shall be done by the Contractor to verify that asphalt mix design properties are still valid. The one point check verification shall be reviewed and stamped by a registered Professional Engineer in the State of Colorado and shall be submitted to the Engineer. Production shall not commence until one point verification is completed and is approved by the RME. A new mix design shall be required if the one point check is not accepted by the RME. If the supplier is changing terminal location and both locations utilize the same formulation, the one point check may be waived with concurrence from the RME.
- 3.6.2 If the Supplier or grade changes, a new asphalt mix design shall be submitted for approval.

#### 4. MIX DESIGN REQUIREMENTS

4.1 Labs and personnel providing asphalt mix designs shall comply with the requirements listed in CP 10.

4.2 Cover Letter – A cover letter including the following:

- Laboratory name & address
- Supplier's name & address
- Supplier's mix design number
- Date of trial batch testing
- Source of all mix design components
- Stamped & signed by a Professional Engineer registered in the State of Colorado

4.3 It is recommended that a complete mix design consisting of test results from three trial blends (in accordance with Superpave Mix Design Methods MS-2) be conducted when the materials sources used in the mix design have not been verified on past CDOT projects. A complete mix design must contain all of the following:

(1) For each aggregate stockpile:

- A. Aggregate source
- B. Target gradation along with gradation results from at least the 10 most current samples taken during production. These samples shall have been sampled and tested within two months (see Note 2) of submitting the mix design.
- C. Coarse Aggregate Bulk specific gravity and fine aggregate bulk specific gravity from at least the 3 most current samples taken during production. These samples shall have been sampled and tested within two months (see Note 3) of submitting the Mix Design.
- D. Atterberg limits.
- E. Los Angeles Abrasion.
- F. Statistical data for the Apparent Specific Gravity and Bulk Specific Gravity.

(2) Reclaimed asphalt pavement (RAP) if used shall include the source and following statistical data from at least 10 samples tested within two months (see Note 2) of mix design submittal:

- A. Percent RAP Binder Content - AASHTO T-164, Method A or B, or CP-L 5120 if correction established per Revision of 401 – Reclaimed Asphalt Pavement.
- B. RAP Aggregate Gradation – CP 31.
- C. Effective Specific Gravity.
- D. Uniformity Calculations for the Processed RAP, to include Binder Content and Aggregate Gradation.

**Note 2:** The RAP aggregate bulk specific gravity will be back-calculated using an assumed average aggregate water absorption of 1.01%. The corresponding assumed aggregate asphalt absorption will be 0.61%.

- (3) Reclaimed asphalt shingles (RAS) if used, shall include the source and following statistical data from at least 10 samples tested within two months (see Note 2) of mix design submittal:
- Percent Asphalt – AASHTO T-164, Method A or B, or CP-L 5120 if correction established per Revision of 401 – Reclaimed Asphalt Shingles.
  - RAS Aggregate Gradation – AASHTO PP 53.
  - Effective Specific Gravity (in lieu of the RAS aggregate specific gravity – AASHTO PP 53.
  - Uniformity Calculations for the RAS to include gradation (on the processed RAS material), Asphalt Binder Content, and Percent Passing #200 Sieve (on the extracted RAS aggregate).
  - A copy of the RAS QC Plan from the contractor or RAS supplier per Section 401.

**Note 3:** If the material used in the mixture design submittal was crushed/stockpiled more than two months prior to submitting the design for approval, the required 10 gradation sample results shall be the 10 most recent to the submittal date.

**Note 4:** If the material used in the mixture design submittal was crushed/stockpiled more than two months prior to submitting the design for approval, the required 3 aggregate bulk specific gravities shall be the 3 most recent to the submittal date.

- (4) Combined Aggregate Properties:
- Percentage of each aggregate used,
  - Combined Aggregate Gradation and Virgin Aggregate Gradation.
  - Sand Equivalent.
  - Fine Aggregate Bulk Specific Gravity and Coarse Aggregate Bulk Specific Gravity on the virgin portion of the mix aggregates.
  - Fine Aggregate Angularity.
  - Combined Aggregate, Apparent and Bulk Specific Gravity.
  - Fractured Faces.
  - Micro-Deval according to CP-L 4211.
  - Effective Specific Gravity.
- (5) Source and grade of asphalt cement from a CDOT Certified Binder Supplier as listed on the CDOT APL. Use the actual specific gravity of the asphalt cement in calculations.
- (6) Hydrated Lime – Provide the Contractor's APL- Verification (AV). |
- (7) Name and percentage of each additive.
- (8) For each asphalt content tested:
- Void in Mineral Aggregate (VMA) @  $N_{des}$ .
  - Dust to Asphalt ratio.
  - Percent Voids Filled with Asphalt (VFA) @  $N_{des}$ .
  - Hveem Stability (@ $N_{des}$ ) for Grading S and Grading SX mixes only.
  - Maximum Theoretical Specific Gravity,
  - Bulk specific gravity @  $N_{des}$ .
  - Air voids, Voids in Total Mix (VTM) @  $N_{des}$ .
- (9) Graphs of stability, Air Voids, VMA, VFA and virgin effective AC content (for RAP/RAS mixtures) vs. total Asphalt content.
- (10) Lottman and wet/dry tensile strength at optimum asphalt content.

- (11) A 0.45 power plot of the proposed combined aggregate gradation, with maximum density line and control points included.
- (12) For SMA, submit the following additional aggregate information:
- A. Bulk Specific Gravity of the coarse-aggregate fraction.
  - B. Unit weight of the coarse aggregate fraction in the dry-rodded condition.
  - C. Draindown test results (at production temperature).
  - D. Mineral filler gradation (for limestone dust); or, plasticity index, hydrometer analysis, gradation, calcium oxide content, and modified Rigden Voids (if alternate mineral fillers are used).
- (13) For Warm Mix Asphalt, submit the following additional information.
- A. Contractor WMA Design Considerations:
    - i. A brief summary of mix design practices with WMA technology if different from HMA procedures.
    - ii. WMA deviations from CDOT design and acceptance criteria. All mix will be tested for acceptance in accordance with existing HMA procedures. Significant deviation from these criteria will require an experimental feature in accordance with PD 1401.1.
  - B. WMA Production Considerations:
    - i. Summary of equipment and plant requirements to control WMA production.
    - ii. For WMA mixtures provide data illustrating differences between mix design properties and the anticipated WMA production properties. WMA volumetric targets may be adjusted as approved by the RME. See CP-59 for details on the required data to be submitted.
    - iii. If the WMA produced on the project fails mixture verification, goes in to condition red, or if the asphalt plant fails to satisfy the WMA production controls outlined in the submittal for WMA approval, WMA production shall cease, written explanation shall be provided for the failures, and production may be required to revert to conventional HMA. WMA mix design submittals shall include a summary of contractor production plans should this occur during production.
  - C. WMA Contacts:
    - i. WMA product manufacturer representative name, email, and phone number.
    - ii. Name, email, and phone number of WMA product manufacturer representative who will be available during construction.

## 5. CONTRACTOR CHECKS

- 5.1 If a contractor wishes to check a test result with CDOT, they should make arrangements with the Flexible Pavement Unit or Physical Properties Unit of the CDOT Staff Materials Laboratory, depending upon the properties (mix or aggregate) that are to be tested. The Unit will work one-on-one with the contractor, as time permits, to improve inter-lab agreement. The testing will not be a part of the mix design process.

**6. COST OF MIX AGGREGATE TESTING**

- 6.1 CDOT Staff Materials Laboratory will conduct one complete set of mix aggregate tests at no cost to the Contractor upon receipt of a completed asphalt mix design submittal from the Contractor. (See Subsection 3.2.1) The Contractor must pay \$500 per aggregate for each subsequent set of mix aggregate tests performed by the CDOT Central Laboratory. The Project Engineer will document the additional tests performed and the appropriate charges will be passed through to the Contractor.

**7. TIME REQUIRED FOR AGGREGATE TESTS**

- 7.1 Reference the Laboratory Test Time table located in the Appendix of the Field Materials Manual.

**8. RECORD**

- 8.1 CDOT Form # 429 is used. It is available electronically from the Central Lab at 303-398-6576 or from the Region Materials Engineers. See Chapter 400 for an example and instructions on the use of this form.
- 8.2 All requests for mix design information shall be made under the Colorado Open Records Act and shall follow CDOT Procedural Directives 25.1.



{Page Intentionally Left Blank}

## Colorado Procedure 53-21

*Standard Method of Test for*

### Determining the Maximum Density of Cold In-Place Recycled Pavement

(This procedure modifies AASHTO T 180. The current AASHTO T 180 is to be used in conjunction with this procedure.)

#### 1. SCOPE

- 1.1 This test is intended for determining the maximum density of cold in-place recycled pavement using AASHTO T 180. Two alternate procedures are recommended as follows:

Method C - Deleted

Method D - 6-inch (152.60 mm) mold, material passing a 3/4 in. (19.0 mm) sieve.

#### 2. REFERENCED DOCUMENTS

2.1 *AASHTO Standards:*

T 119 Bulk Density ("Unit Weight") & Voids in Aggregate

T 180 Moisture-Density Relations of Soils Using a 4.54-kg (10-lb) Rammer and a 457-mm (18-in.) Drop

2.2 *Colorado Procedures:*

CP 41 Sampling Hot Mix Asphalt

#### 2A. SAMPLING

- 2A.1 Obtain a sample from the windrow or roadway, after rolling in the finished roadway. For cationic emulsions, sample after rolling in the finished roadway. **Follow CP 41, Method C.** Prepare and compact the sample as described in Method D below.

**METHOD C (Deleted)**

#### METHOD D

#### 10. SAMPLE

- 10.1 (Follow as modified.) Select the representative sample following CP 41, Method C, except that it shall weigh (have a mass of) approximately 12 lb. (5 kg).

**11. PROCEDURE**

- 11.1 (Follow per AASHTO T 180.) Form a specimen by compacting the prepared sample in the 6 in. (152.40 mm) mold (with collar attached) in five approximately equal layers, to give a total compacted depth of about 5 in. (127 mm), each layer being compacted by applying 56 uniformly distributed blows from the rammer. For molds conforming to tolerances in Subsection 3.1, and masses recorded in pounds, multiply the mass of the compacted specimen and the mold, minus the mass of the mold, by 13.33, and record the result as the wet density,  $W$ , in  $\text{lb/ft}^3$  of the compacted material. For molds conforming to tolerances in Subsection 3.1, and masses recorded in kilograms, multiply the mass of the compacted specimen and the mold, minus the mass of the mold, by 471, and record the result as the wet density,  $W$ , in kilograms per cubic meter, of compacted material. For used molds out of tolerance by not more than 50 percent (Subsection 3.1), use the factor for the mold, as determined in accordance with Section 8 (Calibration of Measure) AASHTO T 19.

**12. CALCULATIONS**

- 12.1 (Follow as modified.) The wet density, which was calculated in Subsection 11.1, will be the maximum density used for determining the percent relative compaction.

**13. FIELD TESTING OF IN-PLACE DENSITY**

- 13.1 Perform the Field Test following CP 81.

**14. RECORD**

- 14.1 No CDOT Form. Record on your worksheet.

## Colorado Procedure 54-13

### *Standard Practice for*

### **Approval of Asphalt Mix Designs Using Plant Produced Material**

#### **1. SCOPE**

- 1.1 This procedure defines the process of approving asphalt mix designs using plant-produced material.

#### **2. REFERENCED DOCUMENTS**

##### 2.1 *AASHTO Standards:*

T 164 Quantitative Extraction of Asphalt Binder from Hot-Mix Asphalt (HMA) by the Ignition Method

T 308 Determining the Asphalt Binder Content of Hot-Mix Asphalt (HMA) by the Ignition Method

##### 2.2 Colorado Procedures:

CP 85 Asphalt Cement Content of Asphalt Mixtures by the Nuclear Method

CP-L 5120 Determination of the Asphalt Binder Content of Bituminous Mixtures by the Ignition Method

#### **3. SAMPLING**

- 3.1 The mixture proposed for use on the project shall be sampled by the Supplier in the presence of a CDOT witness. A split of the samples shall be submitted to the CDOT Region Materials Lab. A minimum sample size of the CDOT portion of the split is 60 lb. (30 kg) at each asphalt content. Before requesting approval of an asphalt mix design using plant produced material, the Supplier shall have completed and provided the information required in Section 4.2 of CP 52 for all HMA mix constituents.

#### **4. ASPHALT MIX DESIGN APPROVAL**

- 4.1 Any asphalt mix design may be approved using plant-produced material.
- 4.2 Three samples at asphalt cement contents approximately 0.7% apart shall be produced and sampled. The material produced in this process shall not be placed on CDOT projects. The Contractor will supply the asphalt cement contents of each of the three samples as determined by AASHTO T 164, AASHTO T 308, CP-L 5120 or CP 85. The Contractor shall also determine the gradation of each produced sample and provide the data to the Department.
- 4.3 At each asphalt cement content, the Contractor shall determine the theoretical maximum specific gravity, air voids, VMA, VFA, and stability. The Contractor shall provide graphs of these values.

- 4.4 If the test results indicate conformance with specifications, the optimum asphalt cement content will be determined and the Department will verify the mixture properties using the sampled material closest to the optimum. The Lottman test will also be conducted using the sampled material closest to the optimum.
- 4.5 If all test results conform to specifications, a CDOT Form 43 may be executed to establish the asphalt job mix formula.

## Colorado Procedure 55-18

### *Standard Method of Test for*

## **Reducing Field Samples of Hot Mix Asphalt to Testing Size**

(This procedure is based upon AASHTO T 248-89. AASHTO T 248-89 or any subsequent revision may not be used in place of this procedure.)

### **1. SCOPE**

- 1.1 These methods cover the reduction of field samples of hot mix asphalt (HMA), having a nominal maximum size equal to or less than 1.5 in. (37.5 mm), to the appropriate size for testing, employing techniques that are intended to minimize variations in measured characteristics between the test samples so selected and the field sample.
- 1.2 The values stated in English units are to be regarded as the standard.

### **2. REFERENCED DOCUMENTS**

- 2.1 *Colorado Procedures:*

CP 41 Sampling Hot Mix Asphalt

### **3. SIGNIFICANCE AND USE**

- 3.1 The necessity for selecting representative samples and reducing them to test specimen size is emphasized in many test procedures. Using the proper equipment for the type of material to be reduced in size is important. However, unless used correctly, the final test specimen will not necessarily be representative of the total sample.
- 3.2 Specifications for HMA require sampling portions of the material for testing. Other factors being equal, larger samples will tend to be more representative of the total supply. These methods provide for reducing the large sample obtained in the field to a convenient size for conducting several tests to describe the material. The reduction is done in a manner such that the smaller portion is most likely to be a representation of the field sample, and thus of the total supply. The individual test methods provide for minimum weights of material to be tested.

### **4. SAMPLING**

- 4.1 The field sample of HMA shall be taken per CP 41, or as required by individual test methods. The user shall satisfy himself that the initial size of the field sample is adequate to accomplish all the intended tests.
- 4.2 Before sample reduction, the field sample of HMA should be heated just until a temperature, which allows for the easy separation of particles is attained. HMA samples should not be reheated more than necessary to separate particles.

## **5. SAMPLE PREPARATION**

HMA samples shall be prepared for the reduction required for Methods A, B, or D by using either Method 1 or 2.

### **5.1 Method 1**

#### 5.1.1 Apparatus

5.1.2 Apparatus shall consist of a small, flat, square-end scoop with sides and a large flat-bottomed mixing pan.

#### 5.1.3 Procedure

5.1.4 Place the field sample of HMA into the mixing pan where there will be neither loss of material nor the accidental addition of foreign material. Mix the material thoroughly by turning the entire sample over three times. Flatten the sample in the pan to a uniform depth, which should be the same or lower than the sides of the scoop.

### **5.2 Method 2**

#### 5.2.1 Apparatus

5.2.2 Apparatus shall consist of a small, flat, square-end scoop with sides and a large flat-bottomed mixing pan.

#### 5.2.3 Procedure

5.2.4 Place the can containing the field sample of HMA into the mixing pan with the opening of the can resting downwards on the bottom of the pan. Elevate the can approximately 1 inch above the pan bottom. Move the can in a circular motion allowing a thin, uniform layer to form a trail behind the can. Try to distribute the material into two or more layers. If visible areas of segregation exist, mix the material thoroughly by turning the entire sample over onto itself using the scoop.

**METHOD A - SELECTION BY SCOOP****6. APPARATUS**

6.1 Apparatus shall consist of a small, flat, square-end scoop with sides and a putty knife.

**7. PROCEDURE**

7.1 Prepare the sample for reduction per Subsection 5.1 or Subsection 5.2.

7.2 Obtain a sample for each test by selecting at least three increments of material at random locations, using a small, flat, and square-end scoop. Insert the scoop to the full depth of the material. Every attempt should be made to minimize the loss of particles, especially large aggregate particles, over the sides of the scoop. A putty knife may be used to separate the material in the scoop from the material in the pan and also to cut increments of material from the main body of material in the scoop. Do not shake the material in the scoop to add small, additional amounts of material to the specimen, as this may introduce segregated material to the specimen. Combine the portions to obtain a test specimen having the required weight. Save the remaining portion of the sample until the tests are completed.

7.3 This Method shall not be used for combining and splitting large samples for testing between two or more labs.

**METHOD B - QUARTERING****8. APPARATUS**

8.1 Apparatus shall consist of a small, flat, square-end scoop with sides and a putty knife.

**9. PROCEDURE**

9.1 This procedure may be used for combining and splitting large samples for testing between two or more labs.

9.2 Prepare the sample for reduction per Subsection 5.1 or Subsection 5.2.

9.3 Divide the mixture into four equal quarters with a square scoop and remove two diagonally opposite quarters, including all fine material. Successively mix and quarter the remaining material until the sample is reduced to the desired size. Save the remaining portion of the sample until tests are completed.



## METHOD C – MECHANICAL SPLITTER

### 10. APPARATUS

- 10.1 *Sample Splitter* - Sample splitters shall have an even number of equal width chutes, but not less than a total of eight for coarse aggregate, or twelve for fine-aggregate, which discharges alternatively to each side of the splitter. For HMA samples, the minimum width of the individual chutes shall be approximately 50 percent larger than the largest particles in the sample to be split (Note 1). The splitter shall be equipped with a minimum of two collection pans, having a width equal to or slightly less than the overall assembly of chutes in the splitter to hold the two halves of the sample following splitting. It shall also be equipped with a hopper, a flat scoop, putty knife or straight-edged pan which has a width equal to or slightly less than the overall width of the assembly of chutes, by which the sample may be fed at a controlled rate into the chutes. The splitter and accessory equipment shall be so designed that the sample will flow smoothly without restriction or loss of material. A splitter brush should be used to clean the chutes of adhering fines.

**NOTE 1:** Mechanical splitters are commonly available in sizes adequate for coarse aggregate having the largest particle not over 1½ in. (37.5 mm).

### 11. PROCEDURE

- 11.1 The riffle splitter must be clean and dry before use. Place the material into a large, flat- bottomed mixing pan. Mix the material thoroughly. Using a flat scoop equal in width to the overall length of the riffles, remove material from the pan and slowly pour the material into the riffle splitter, first from one side and then the other. Alternatively, use a flat, square-end scoop to load the sample from the mixing pan into two extra splitter pans placed side-by-side. Slowly pour approximately half of the sample in the pan from one side and then reverse the ends of the pan and pour the remainder from the other side. A slight jarring action by the pan against the splitter helps keep the riffles from clogging. Uniformly distribute the sample from edge to edge, so that when it is introduced into the chutes, approximately equal amounts will flow through each chute. The rate at which the sample is introduced shall be such as to allow free flow through the chutes into the receptacles below. Do not allow any of the riffles to become plugged since this will divert material to the two adjacent riffles and send too much material to the opposite receiving pan.
- 11.2 Reintroduce the portion of the sample from alternating receptacles into the splitter as many times as necessary to reduce the sample to the size specified for the intended test. Retain the portion of the material collected in the other receptacle at the last split until tests are completed.

**NOTE 2:** As an alternative to Subsection 11.2, further splitting to testing size can be achieved with Subsection 11.3.

- 11.3 After splitting the material into two or four equal measures (depending on the size of the field sample), leave the divided sample in the splitter pans and place it in the oven. Use the flat, square-end scoop to obtain individual test samples of the required weight. Work from one end of the pan to the other. Insert the scoop to the full depth of the material. Every attempt should be made to minimize the loss of particles over the sides of the scoop. A putty knife may be used to separate the material in the scoop from the material in the pan and also to cut increments from the main body of material in the scoop. Do not shake the material in the scoop to add small, additional amounts to the specimen, as this may introduce segregated material to the specimen. Save the remaining portion of the sample until tests are completed.
- 11.4 This Method shall not be used for combining and splitting large samples for testing between two or more labs.

#### **METHOD D - SELECTION BY CROSS SECTION**

#### **12. APPARATUS**

- 12.1 Apparatus shall consist of a small, flat, square-end scoop with square sides; a putty knife; and two slats having a height at least one inch taller than the sides of the splitting pan. The slats shall conform within one inch to the sides of the pan so that material cannot fall from the vertical face into the sample being separated.

#### **13. PROCEDURE**

- 13.1 Prepare the sample for reduction per Subsection 5.1 or Subsection 5.2.
- 13.2 Obtain a sample for each test by pushing a dividing slat vertically through the entire width of the sample until it contacts the bottom of the pan. Next, place a second slat parallel to the first and push it vertically to the bottom of the pan. Remove all of the material between the slats. Take care to include all fines from the pan, the slat sides, and the utensil in the sample. Obtain additional samples by pushing one of the slats vertically into the remaining material and repeating the process. Save the remaining portion of the sample until tests are completed.
- 13.3 This Method shall not be used for combining and splitting large samples for testing between two or more labs.

**METHOD E - QUARTERMASTER MECHANICAL SPLITTER****14. APPARATUS**

14.1 Apparatus shall consist of a Quartermaster mechanical splitter and a spatula.

**15. PROCEDURE**

15.1 This procedure may be used for combining and splitting large samples for testing between two or more labs.

15.2 The splitter shall be level. The splitter and accessory equipment shall be clean and heated to not exceed 110°C (230°F) by a non-contact temperature device.

15.3 Close the hopper doors. Place the mixture into the mechanical splitter hopper and position four receptacles to receive the reduced portions of the original sample. Avoid segregation by using a continuous or segmented pour from multiple directions around the hopper and level it out with a spatula. Release the handle to drop the mixture through the dividers into the sample receptacles. When combining and splitting more than one sample, rotate the sample receptacles in a clockwise direction after each split. Repeat Subsection 15.3 until the specified sample size is achieved.

15.4 This Method shall not be used for further reductions in sample size.

## Colorado Procedure 56-20

*Standard Practice for*

### **Guidelines for Using Theoretical Maximum Specific Gravity (Rice) of Project-Produced HMA to Change the Target Specific Gravity for Compaction Compliance**

#### **1. SCOPE**

- 1.1 During the production of Hot Mix Asphalt, changes may occur in the maximum specific gravity of the mix. This change may be detected, and target specific gravity corrected, by measuring the maximum specific gravity (CP 51) of the project-produced material.

#### **2. REFERENCED DOCUMENTS**

##### *AASHTO Standards:*

- T 84 Specific Gravity and Absorption of Fine Aggregate  
T 85 Specific Gravity and Absorption of Coarse Aggregate  
T 164 Quantitative Extraction of Asphalt Binder from Hot-Mix Asphalt (HMA) by the Ignition Method  
T 308 Determining the Asphalt Binder Content of Hot-Mix Asphalt (HMA) by the Ignition Method

##### *Colorado Procedures:*

- CP 55 Reducing Field Samples of Hot Mix Asphalt to Testing Size  
CP 85 Asphalt Cement Content of Asphalt Mixtures by the Nuclear Method  
  
CP-L 5120 Determination of the Asphalt Binder Content of Bituminous Mixtures by the Ignition Method

#### **3. APPARATUS**

- 3.1 For the determination of the maximum specific gravity, the equipment shall be per CP 51.  
3.2 For the determination of the asphalt cement content, the equipment shall be per AASHTO T 164, AASHTO T 308, CP-L 5120 or CP 85.

#### **4. SAMPLING**

- 4.1 A portion of the sample from CP 85, or a split sample, shall be used for determining the maximum specific gravity (CP 51). Reduction to test size shall be per CP 55.  
4.2 Measure and record the maximum specific gravity per CP 51.  
4.3 Measure and record the asphalt cement content following AASHTO T 164, AASHTO T 308, CP-L 5120 or CP 85.

## 5. PROCEDURE

- 5.1 A test for maximum specific gravity may be run for information during nuclear asphalt content gauge correlation and compared to the maximum specific gravity reported on Form 43. This optional test yields information that compares the maximum specific gravity of materials on the project with materials used in the design.
- 5.2 The tests for maximum specific gravity should be performed as early during production as possible. The best time to start is during the compaction test section.
- 5.2.1 Average the results of three maximum specific gravity tests (6 values) from known asphalt cement contents from the field-produced material.
- 5.2.2 Average the results of three asphalt cement content tests from the field-produced material.

**Note 1:** If all the design criteria are within specification, and the plot of the point determined in Subsections 5.2.1 and 5.2.2 differs by more than 0.010 from the graph sent with the mix design of the asphalt cement content versus maximum specific gravity, then the target maximum specific gravity for compaction shall be changed on the Form #43, as follows.

**Note 2:** If the maximum specific gravity is adjusted, the aggregate specific gravity may have changed. The Contractor or the Engineer may request that the individual aggregates be re-sampled and retested to determine a new aggregate specific gravity (AASHTO T 84 & T 85). The re-sampled individual aggregates will be split and the Contractor will keep one split for testing while the other split will be immediately given to the Engineer for possible testing. The new aggregate specific gravity will be entered on the new Form 43 and a new VMA target will be calculated. If the new VMA target does not meet the minimum requirements specified in the Revision of 403, work shall be suspended and the Contractor shall complete and submit a new mix design meeting all of the requirements at no additional cost to the Department.

## 6. CALCULATIONS

- 6.1 Determine the effective specific gravity of the aggregate, as follows:

$$G_{se} = \frac{100 - P_{ba}}{\frac{100}{G_{mm}} - \frac{P_{ba}}{1.03}}$$

Where:

- $G_{se}$  = Effective specific gravity of the aggregate,  
 $G_{mm}$  = Average maximum specific gravity (from Subsection 5.2.1),  
 $P_{ba}$  = Average percent asphalt cement (from Subsection 5.2.2).

- 6.2 Determine the new target maximum specific gravity at optimum asphalt cement content, as follows:

Note: Optimum asphalt cement content is from Form 43.

$$G_{\max} = \frac{100}{\frac{P_s}{G_{se}} + \frac{P_{bo}}{1.03}}$$

Where:

$G_{\max}$  = New target maximum specific gravity at optimum asphalt cement content,

$P_s$  = Percent of aggregate at optimum asphalt cement content (100 minus optimum asphalt cement content),

$P_{bo}$  = Optimum asphalt cement content,

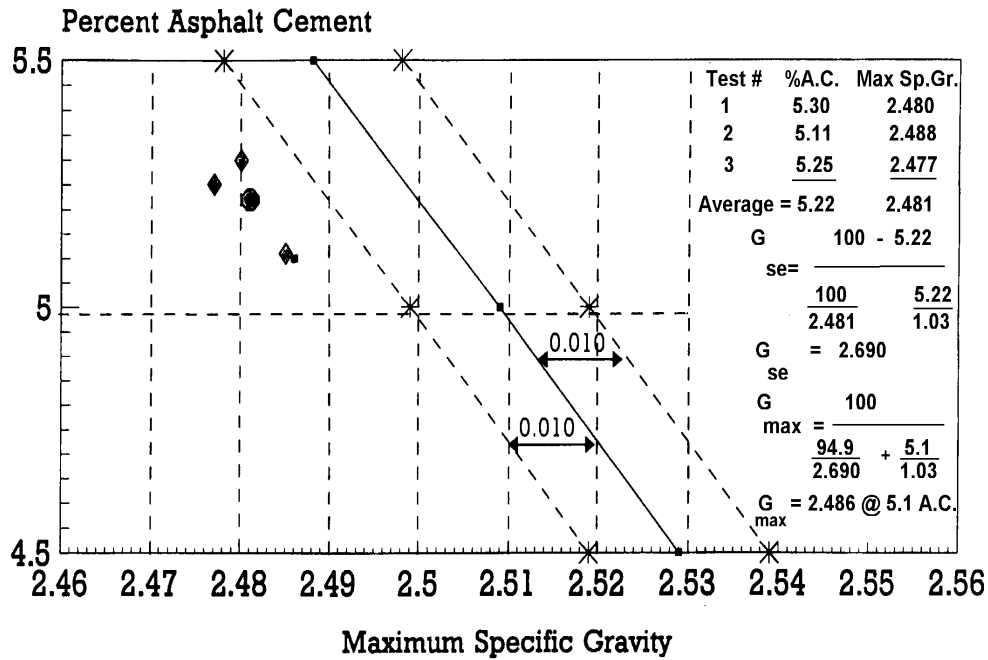
$G_{se}$  = Effective specific gravity (from Subsection 6.1).

- 6.3 The new target maximum specific gravity shall be reported on Form 43. Form 43 shall be dated when the contractor is notified of the new target. Form 43 shall be signed by all of the involved parties.

**Note 3:** Following the establishment of the new target maximum specific gravity, a new tolerance band of  $\pm 0.01$  shall be made and all further Rice values should be inside the tolerance band. If two consecutive maximum specific gravity values fall outside the 0.01 tolerance band, the next sample shall be taken immediately and a maximum specific gravity test performed. A new target maximum specific gravity based on three consecutive tests shall be specified on Form 43, provided that all the design criteria are within specification. Aggregate specific gravity will again be determined under Note 2.

**Example**

Design = 5.1% A.C. and 2.507 Max. Sp. Gr.



- CDOT Design      ◆ Field Results      \* Minimum Spec.
- \* Maximum Spec.      ● Ave. Field Results      ▪ New Max. Sp. Gr.

Field Sheet #

## Colorado Procedure 57-20

### *Standard Method of Test for*

### **Determining the "Free Moisture" in Cold In-Place Recycled Pavement**

#### **1. SCOPE**

- 1.1 This procedure is to be used to determine the "free moisture" in the cold in-place bituminous recycled pavement.

#### **2. REFERENCED DOCUMENTS**

- 2.1 Two alternate procedures are recommended as follows:

CP 43 Method A (Microwave Procedure)

CP 21 (Oven Dry Procedure)

**Note 1:** Use of a hot plate is not allowed, the sample shall be dried to constant weight (mass) in an oven at  $230^{\circ}\text{F} \pm 9^{\circ}$  ( $110^{\circ}\text{C} \pm 5^{\circ}$ ) if CP 21 is used.

#### **3. SAMPLING**

- 3.1 Obtain a sample of the existing pavement from the roadway before cold in-place recycling. One sample per day of each pavement type being recycled should be sampled and tested.

**Note 2:** One sample per day needs to be taken to account for the variation in the in-place moisture of the existing pavement.

**Note 3:** Core samples are not recommended because of the excessive moisture introduced by the coring process.

- 3.2 Obtain a sample of the in-place recycled pavement, which has been compacted and is ready for either placement of the sealing emulsion or hot mix asphalt pavement overlay.

#### **4. PROCEDURE**

- 4.1 Determine the moisture content of the existing pavement sample by one of the procedures listed in Subsection 2.1.

- 4.2 Determine the moisture content of the cold in-place recycled sample from the same location as referenced in Note 2 by one of the procedures listed in Subsection 2.1.



**5. CALCULATIONS**

- 5.1 Calculate the percent "free moisture" as follows:

$$\text{Percent "free moisture"} = B - A$$

Where:

A = Percent moisture in Existing Pavement,  
B = Percent moisture in Cold Recycled Material.

**6. REPORTING**

- 6.1 Report the "free moisture" to the nearest 0.1%.
- 6.2 Record the "free moisture" on the field density report for cold recycled pavement.
- 6.3 Document results on your form.

NOTE: The CDOT Form is currently in development. |

## Colorado Procedure 58-07

*Standard Method of Test for*

### Detecting and Measuring Temperature Segregation of HMA

#### 1. SCOPE

- 1.1 This method describes the procedure for detecting and measuring temperature segregation of HMA using a handheld temperature device.

#### 2. REFERENCED DOCUMENTS

- 2.1 CP 81 Density and Percent Relative Compaction of In-Place Bituminous Pavement by the Nuclear Method

#### 3. APPARATUS

- 3.1 *Handheld Temperature Device* – An infrared temperature gun or infrared camera that is capable of measuring in one degree or finer increments between the temperatures of 150° to 400° F. For best clarity in readings, it is suggested that the temperature gun have a distance-to-spot size ratio (D:S) of 30:1 or greater.
- 3.2 Paint, grease crayon, or some other tool to mark locations to be tested for density.
- 3.3 Tape measure long enough to span the width of the paving area.

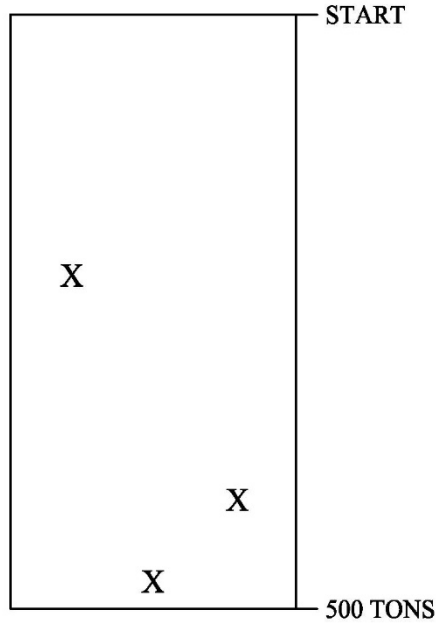
#### 4. PROCEDURE

- 4.1 Mark the start of the area that will be examined. The tonnage of the area can be calculated in length by using 110 lbs/yd<sup>2</sup>/inch or can be found by tracking asphalt tickets. See Figure 58-1.
- 4.2 Scan the paving area with the hand-held temperature device looking for an area that is 25°F cooler than other areas across the width of the mat. Do not stand on or walk on the paving area. Stand adjacent to the paving area, behind the paver but ahead of the breakdown roller, and scan slowly across the width of the mat excluding the outer one foot on each side of the mat. Move three feet forward and repeat scanning. Repeat as needed.
- 4.3 If an area is 25°F cooler than other areas across the width of the mat, mark the location on the edge of the mat and use a tape measure to locate the cooler area. Record on CDOT Form 1346.
- 4.4 Following finish rolling, locate the cooler area and find the density of the area per CP 81. Record on CDOT Form 1346.

#### 5. REPORT

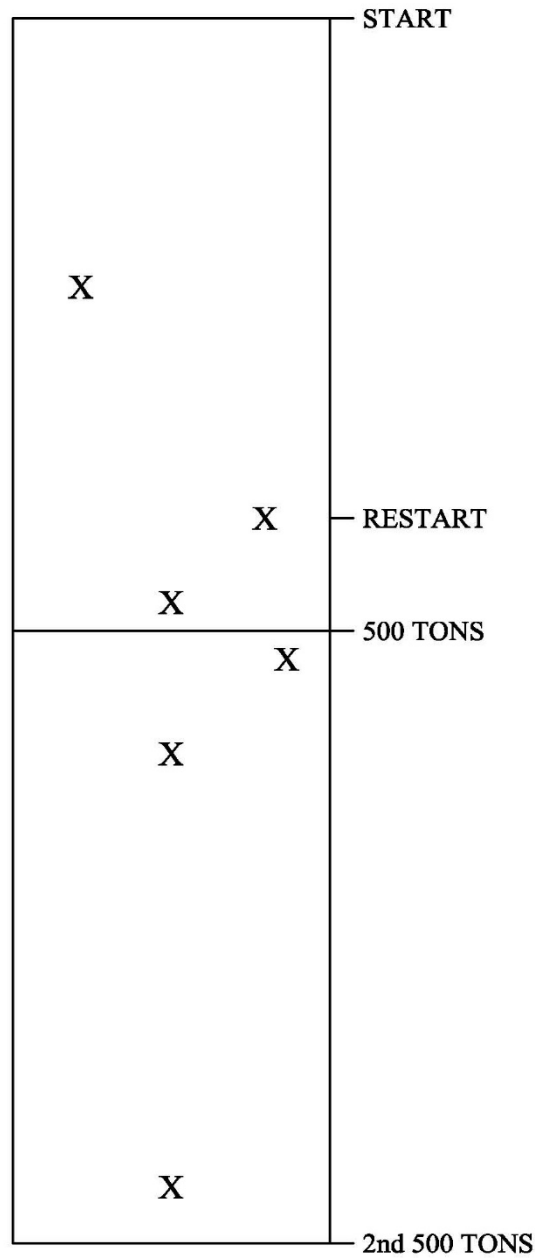
- 5.1 CDOT Form 1346, HMA Segregation Data, will serve as the report document.

In Figure 58-1 below, the tester performed the temperature segregation check correctly. A start was established and 500 tons were checked for temperature segregation. Three cool areas were found in the 500-ton temperature segregation check.



**Figure 58-1: Temperature Segregation Study Done Correctly**

In Figure 58-2 below, the tester did not perform the temperature segregation check correctly. A start was established and the tester went about 400 yards finding just two cool areas. He then restarted the temperature segregation check at the second cool area by establishing a new 500-ton test section. This resulted in finding five cool areas over the next 500 tons. This is incorrect.



**Figure 58-2: Temperature Segregation Study Done Incorrectly**

{Page Intentionally Left Blank}

## Colorado Procedure 59-21

*Standard Practice for*

### Warm Mix Asphalt Approval

#### 1. SCOPE

- 1.1 This practice describes the procedures for submitting Warm Mix Asphalt (WMA) technologies.
- 1.2 This procedure was originally included in the 2012 FMM and was referred to as the Contractor Non-Standard Asphalt Mix (NSM) Approval.

#### 2. REFERENCED DOCUMENTS

- 2.1 *CDOT Procedural Directives:*  
PD 1401.1 Product Evaluation and Experimental Features
- 2.2 *Colorado Procedures:*  
CP 52 Contractor Asphalt Mix Design Approval Procedures
- 2.3 *AASHTO Procedure:*  
AASHTO R35 (Appendix to) *Special Mixture Design Considerations and Methods for Warm Mix Asphalt (WMA)*

#### 3. APPROVAL OF WMA TECHNOLOGIES

- 3.1 WMA technologies shall be in conformance with CP 52, CDOT Specifications and other specified Colorado, AASHTO, and ASTM procedures. Significant variances from these specifications will require an Experimental Feature per PD 1401.1.
- 3.2 For WMA mixtures using proposed aggregate blends with total absorption equal to or less than 1.3% mix designs shall be conducted without additives for approval and setting of production targets. For WMA mixtures using proposed aggregate blends with total absorption greater than 1.3%, the mix designs shall be conducted per the Appendix to R35 referenced in Subsection 2.3 above. Regardless of the mix design method, all WMA mixture and binder acceptance testing will be conducted according to existing CDOT HMA procedures, including established mixing and compaction temperatures. Proposed modifications to production properties and handling processes for WMA mixtures shall be detailed. Binder grade selection shall be per existing CDOT Superpave criteria. WMA shall not be produced at plant temperatures more than 100°F below existing HMA Superpave mixing temperatures.

- 3.4 WMA approval is required for each WMA Technology and/or each Contractor intending to use WMA. If the WMA Technology is already approved for use by CDOT each Contractor must receive approval to supply WMA based on their submittal before placement on a CDOT project.
- 3.5 Changes in WMA properties or formulations that result in changes to mixture properties will require new WMA Technology submittal and approval.
- 3.6 Only approved WMA technologies will be allowed on CDOT Projects.

#### **4. WMA SUBMITTAL REQUIREMENTS**

- 4.1 All WMA requests for approval shall be submitted electronically, using the format and numbering of this CP, to CDOT's Asphalt Program Manager. Acceptable formats include pdf, MS Excel, MS Word, PowerPoint, jpg and other compatible formats. Requests shall be submitted in the order listed below. WMA must conform to the current CDOT HMA acceptance criteria.

##### 4.2.1 WMA Technology Supplier - Submittals shall include:

(1) A summary of the WMA Technology:

- A. Process controls.
- B. A detailed list of additive types and quantities.
- C. Description of additives' influence on asphalt mixture.
- D. Benefits of the WMA technology.
- E. Equipment and plant requirements.
- F. SDS for the additives

(2) Performance History:

- A. Product history.
- B. Other projects, if available including those within Colorado, which utilized the WMA technology. Include site conditions, environmental conditions, traffic, lab data, and in-service pavement performance data.
- C. Research data on the WMA technology.
- D. Sample specifications, best practices or guidelines from other agencies.
- E. WMA Approvals from other agencies.

(3) Design Considerations:

- A. Lab design practices with WMA technology.
- B. Conformities and deviations from CDOT design and acceptance criteria. See CP 52 and Specifications for Road and Bridge Construction.

(4) Production Considerations:

- A. Provide a summary of anticipated differences in volumetric mix properties between the mix design values and the production target values.
- B. Sampling and testing requirements, including temperatures, laboratory handling, and variances from standard CDOT testing procedures. Detailed design, production, and testing requirements for use of the WMA shall be provided.
- C. Acceptance criteria and justification if different than CDOT Superpave requirements. A significant deviation from these criteria will require an experimental feature per PD 1401.1. Note: CDOT acceptance testing and criteria will follow conventional HMA requirements.

(5) Contacts:

- A. WMA product manufacturer's representative name, email, and phone number.
- B. Name, email, and phone number of WMA product manufacturer's representative who will be available during construction.

4.2.2 WMA Technology Contractor -Submittals shall include:

(1) Summary of Contractor's WMA

Experience, if any. Contact names and contact information shall be included for agency owners of past projects placed. The contractor shall summarize equipment and plant requirements to control WMA production.

(2) Contractor Design Considerations:

- A. Lab design practices with WMA technology if different from HMA procedures.
- B. Conformities and deviations from CDOT design and acceptance criteria. See CP 52 and Specifications for Road and Bridge Construction. A significant deviation from these criteria will require an experimental feature per PD 1401.1.

4.2.3 Contractor- Submittal Considerations for WMA Use at Region / Project Level

- (1) In addition to all the requirements outlined in CP 59 Section 4.2.3, the submittal shall meet all requirements outlined in CP 59 Sections 1 to 4.2.2.



- (2) For all WMA submittals, the Contractor shall submit a mix design for conventional HMA following CP 52. Concurrently, the Contractor shall inform the Project Engineer of their intent to utilize WMA technology and shall submit the following information.

For WMA asphalt submittals: The Contractor shall provide a four (4) point verification of the WMA. The four-point verification shall be presented in a manner that facilitates a comparison between the HMA mix and the WMA mix. The Region Materials Engineer (RME) may at their discretion elect to reduce the number of points required and/or forgo "point verification" altogether for production verification as described in Section 4.2.3 (3).

- (3) Production Considerations: All WMA will be tested for acceptance by existing HMA procedures.
  - A. For WMA mixtures with aggregate absorption of 1.3% or less, provide a summary of anticipated differences in volumetric mix properties between the HMA mix design values and the WMA production values. The Contractor shall provide necessary data to support field volumetric targets that are different from the HMA mix design values. At a minimum, three full volumetric samples will be produced with WMA additive at HMA design optimum AC and compared to the HMA design properties to document the anticipated impact on field volumetric properties. WMA volumetric acceptance targets may be adjusted as approved by the RME.
  - B. For WMA mixtures with aggregate absorption greater than 1.3%, provide a summary of anticipated differences between mix design, WMA volumetric mix properties, and anticipated WMA production and acceptance values. The Contractor shall provide data to support field volumetric targets that are different from the WMA mix design values. At a minimum, three (3) full volumetric samples will be produced with WMA additive at design optimum AC tested by the acceptance test procedures to document the anticipated impact on field volumetric acceptance properties. WMA volumetric acceptance targets may be adjusted as approved by the RME.
  - C. If the WMA produced on a project fails mixture verification, goes into condition red, or if the asphalt plant fails to satisfy the WMA production controls outlined in the submittal for WMA approval, WMA production shall cease, a written explanation shall be provided for the failures, and production may be required to revert to conventional HMA.

- (4) Contacts:

- A. Contractor representative name, email, and phone number.
  - B. WMA product manufacturer's representative name, email, and phone number.
  - C. Name, email, and phone number of WMA product manufacturer's representative who will be available during construction.
  - D. Mix Designer name, email, and phone number.
- (5) An approved Form #43 for both the conventional HMA and the HMA with WMA additive shall be required before production commences.

## **5. PRELIMINARY CDOT REVIEW PROCESS**

- 5.1 Preliminary review of Contractor's WMA proposal will be performed by the CDOT Asphalt Program, in conjunction with Region Material Engineers as needed.
- 5.2 CDOT may request additional information from the Applicant.
- 5.3 Incomplete submittals may be rejected as unacceptable.
- 5.4 CDOT Asphalt Program will notify the Material Advisory Committee (MAC) of all WMA submittals processed.
- 5.5 If the submittal package is not rejected during the preliminary review, and when the submittal package is deemed complete by the CDOT Asphalt Program, the WMA submittal will be sent to the MAC for formal review.
- 5.6 Preliminary review is estimated to take two weeks, depending upon the completeness of the initial WMA submittal.

## **6. CDOT REVIEW PROCESS**

- 6.1 Formal review of WMA submittals will be performed by the MAC. The review may take place at a regularly scheduled MAC meeting (MAC meetings are scheduled once every-other-month) or at a separate formal meeting, depending upon schedule.
- 6.2 The MAC, via the CDOT Asphalt Program, may request additional information from the Contractor.
- 6.3 Submittal may be rejected by the MAC as unacceptable under WMA procedures.
- 6.4 The MAC will determine if the WMA submittal falls under the jurisdiction of PD 1401.1. If so, the MAC will approve the WMA with recommendations for the experimental feature process. If the WMA submittal is not under the jurisdiction of PD 1401.1, then it will be approved with recommendations on the scope of allowed project use.
  - 6.4.1 Approval and usage limitations will be based on the quality and level of documentation for field pavement performance. The sites monitored for field performance will ideally have traffic and climate conditions similar to typical Colorado state highways. Specifically, the performance data provided shall document rutting, cracking and raveling/weathering as measured by established field performance data gathering methods. HMA Control sections or similar HMA comparison sections shall be provided when available.
    - 6.4.1a Less than 18 months of successful documented field performance will have a project placement limit of 5,000 tons of WMA.

- 6.4.1b 18 to 36 months of successful documented field pavement performance will have a project placement limit of 10,000 tons of WMA.
- 6.4.1c Successful documented field pavement performance over 36 months will have no tonnage limit on projects.
- 6.5 For WMA mixtures, existing HMA bid items will be used.
- 6.6 The MAC will itemize any limitations to the use of the WMA submittal on CDOT projects.
- 6.7 MAC review is estimated to take six weeks upon receipt of a complete WMA submittal.
- 6.8 If the WMA technology submittal is approved, both the conventional HMA and the conventional HMA with WMA additive / WMA utilizing foaming technology will be reviewed at the Region / Project level per CP 52.

## **7. SCHEDULE**

- 7.1 Notification of WMA technology approval/rejection from CDOT may take a minimum of 8 weeks. This time frame may be significantly increased if additional information is requested from the Contractor, or if the submittal is delivered during the peak construction/production season. Approval of a WMA technology does not constitute approval for use of WMA on a Region / Project level. Additional time should be allotted to follow the requirements outlined in CP 52.

## **8. RECORD**

- 8.1 All requests for WMA information shall be made under the Colorado Open Records Act (CORA) and shall follow CDOT Procedural Directives 25.1.

The Colorado Department of Transportation is subject to the provisions of the Colorado Open Records Act (C.R.S. 24-72-201, et seq.). Unless specifically excluded by the language of the act, all documents provided to or maintained by CDOT are considered to be a matter of public record.

Contractors submitting a WMA proposal to CDOT must identify the proposal as “Confidential” or “Available for Release”. If, at any future date, a CORA request is made for any proposal identified as “Confidential”, CDOT will notify the entity or individual requesting that the information is not available.

By identifying a proposal as “Confidential”, the Contractor agrees to indemnify and hold harmless the Department and its employees from any legal action resulting from this decision to deny the documents and to provide any necessary legal defense.

The WMA submittals shall include the following signed and checked statement:

Available for Release

Confidential

With this signature, I \_\_\_\_\_ (Name) with \_\_\_\_\_ (Business Name) agrees to indemnify and hold harmless the Colorado Department of Transportation and its employees from any legal action which may result from its decision to withhold this document in response to requests made under the Colorado Open Records Act, and to provide any legal defense necessary if this decision is appealed.

8.2 All approved WMA technologies will be posted on the CDOT website.

8.3 All approved contractor users of an approved WMA technology will be posted on the CDOT website.

<https://www.codot.gov/business/apl/asphalt-warm-mix.html>

### CP 59, WMA Technology Supplier - Submittal Checklist

Supplier Name: \_\_\_\_\_

Date: \_\_\_\_\_

Contact Name: \_\_\_\_\_

Contact Phone Number: \_\_\_\_\_

Contact Email: \_\_\_\_\_

Technology Type: \_\_\_\_\_

Technology Name: \_\_\_\_\_

| <u>Subsection</u>  | <u>Yes/ No</u> |
|--|----------------|
| 4.1 All material submitted electronically.....   | _____          |
| 4.2.1 (1) Summary of the WMA technology .....  | _____          |
| Process controls .....   | _____          |
| A detailed list of additive types and quantities.....                                    | _____          |
| Description of additives influence .....   | _____          |
| WMA benefits .....   | _____          |
| Equipment and plant requirements .....   | _____          |
| SDS for additives .....  | _____          |
| 4.2.1 (2) Performance history .....  | _____          |
| Product history .....  | _____          |
| Other projects utilizing WMA (includes site conditions and performance data) .....       | _____          |
| Research data .....  | _____          |
| Specifications used on other projects .....  | _____          |
| Approvals from other agencies .....  | _____          |
| 4.2.1 (3) Design considerations.....   | _____          |
| Lab design practices .....   | _____          |
| Conformities and deviations from CDOT criteria .....                                     | _____          |
| 4.2.1 (4) Production considerations.....   | _____          |
| Summary of anticipated differences between mix design values and production targets..... | _____          |
| Sampling and testing requirements .....  | _____          |
| Acceptance criteria and justification .....  | _____          |
| 4.2.1 (5) Contacts .....   | _____          |
| Manufacturer representative name, email, and phone number .....                          | _____          |
| On-site manufacturer representative name, email, and phone number .....                  | _____          |
| 8.1 Confidentiality statement .....  | _____          |

### CP 59, WMA Contractor - Submittal Checklist

Contractor Name: \_\_\_\_\_ Date: \_\_\_\_\_  
 Contact Name: \_\_\_\_\_ Contact Phone Number: \_\_\_\_\_  
 Contact Email: \_\_\_\_\_  
 Technology Type: \_\_\_\_\_ Technology Name: \_\_\_\_\_

| <u>Subsection</u>  | <u>Yes/ No</u> |
|--|----------------|
| 4.1 All material submitted electronically.....   | _____          |
| 4.2.2 (1) Summary of contractor's experience with this technology including plant controls ..... | _____          |
| 4.2.2 (2) Design considerations.....   | _____          |
| Lab design practices .....   | _____          |
| Conformities and deviations from CDOT criteria .....   | _____          |
| 4.2.3 (1) Compliance with Section 1 thru Subsection 4.2.3 .....                                  | _____          |
| 4.2.3 (2) Mix design for conventional HMA & communicating with PE .....                          | _____          |
| Four-point verification to facilitate comparison .....   | _____          |
| 4.2.3 (3) Production considerations.....   | _____          |
| Summary of anticipated differences between mix design values and production targets .....        | _____          |
| Sampling and testing requirements, including design and production methods .....                 | _____          |
| Contingency plan if WMA fails during production .....  | _____          |
| 4.2.3 (4) Contacts .....   | _____          |
| Contractor representative name, email, and phone number .....                                    | _____          |
| WMA manufacturer representative name, email, and phone number .....                              | _____          |
| On-site WMA manufacturer representative name, email, and phone number .....                      | _____          |
| Mix designer name, email, and phone number .....   | _____          |
| 4.2.3 (5) Form 43 for Conventional HMA & HMA with WMA additive .....                             | _____          |
| 8.1 Confidentiality statement .....  | _____          |

{Page Intentionally Left Blank}

## Colorado Procedure 61-20

### *Standard Practice for*

## Sampling Freshly Mixed Concrete

### 1. SCOPE

- 1.1 This practice covers procedures for obtaining representative samples of fresh concrete on which tests are to be performed to determine compliance with specifications.
- 1.2 The values stated in ft-lbs units are to be regarded as the standard.
- 1.3 This standard does not address all of the safety concerns, if any, associated with its use. It is the responsibility of the user of this standard to establish appropriate safety and health practices and to determine the applicability of regulatory limitations before use.

**(Warning:** Fresh hydraulic cementitious mixtures are caustic and may cause chemical burns to skin and tissue upon prolonged exposure.)

### 2. SIGNIFICANCE AND USE

- 2.1 This practice is intended to provide standard requirements and procedures for sampling freshly mixed concrete from different containers used in the transportation or placement of concrete. The detailed requirements as to materials, mixtures, air content, unit weight, temperature, number of specimens, slump, interpretation of results, and precision and bias are in specific test methods.

### 3. SAMPLING

- 3.1 The elapsed time shall not exceed 15 minutes between obtaining the first and final portions of the composite sample.
- 3.2 Transport the individual samples to the place where fresh concrete tests are to be performed and/or where test specimens are to be molded. They shall be combined and remixed with a shovel, the minimum amount necessary to ensure uniformity and compliance with the maximum time limits specified in Subsection 3.3.
- 3.3 Start tests for the slump, unit weight, temperature, and air content within 5 minutes after obtaining the final portion of the composite sample. Start molding specimens for strength tests within 15 minutes after fabricating the composite sample. Protect the sample from the sun, wind, and other sources of rapid evaporation, and contamination.

### 4. PROCEDURE

- 4.1 *Size of Sample* — Make the samples to be used for strength tests a minimum of 1 cu. ft. Smaller samples are allowed for routine air content, unit weight, temperature, and slump tests. The size of the sample is dictated by the maximum nominal aggregate size.



- 4.2 The procedures used in sampling shall include the use of precautions that will assist in obtaining samples that are representative of the nature and condition of concrete sampled as follows:
- 4.2.1 *Sampling for PCCP* — As per CP 75 sample the concrete after it has been placed on grade. Obtain samples from at least five different portions of the pile and then combine them into one sample for test purposes. Avoid contamination with subgrade material or prolonged contact with an absorptive subgrade.
- 4.2.2 *Sampling for concrete placed from a ready-mix truck* — Sample the concrete by collecting two or more portions taken at regularly spaced intervals during discharge of the middle portion of the batch. Take the samples within the time limit specified in Section 3 and combine them into one sample for test purposes. Do not obtain samples until after all of the water has been added to the mixer. No samples shall be taken before 10 % or after 90 % of the batch has been discharged. Due to the difficulty of determining the actual quantity of concrete discharged, the intent is to provide samples that are representative of widely separated portions, but not the beginning and the end of the load. Obtain a sample by repeatedly passing a receptacle through the entire discharge stream or by completely diverting the discharge into the sample container(s). Regulate the rate of discharge of the batch by the rate of revolution of the drum and not by the size of the gate opening.
- 4.2.3 *Sampling for piers, footings, walls, and caissons* – Refer to Subsection 4.2.2.
- 4.2.4 *Sampling from concrete placed by pumps* – Refer to Subsection 4.2.2..
- 4.2.5 *Sampling from conveyer placed concrete* – Refer to Subsections 4.2.1 or 4.2.2.
- 4.2.6 *Sampling from crane & bucket placed concrete* – Refer to Subsections 4.2.1 or 4.2.2.

## Colorado Procedure 62-21

*Standard Practice for*

### Contractor Concrete Mix Design Approval Procedure

#### 1. SCOPE

1.1 This practice describes the procedures for concrete mix design approval.

#### 2. APPROVAL OF CONCRETE MIX DESIGNS SUBMITTED TO A PROJECT

2.1 This process will be used for Project-specific concrete mix designs or concrete mix designs that are not on CDOT's Approved Products List (APL).

2.2 Concrete mix designs shall be performed in conformance with Colorado, AASHTO, and ASTM procedures.

2.3 The Contractor submits to the Project Engineer two copies of the concrete mix design, which <https://www.codot.gov/business/apl/concrete-mix-designs> contains all the information detailed in Section 5, a minimum of three weeks before the anticipated concrete placement date. The Project Engineer will submit the Contractor's concrete mix design to the Concrete & Physical Properties (CPP) Unit primarily or the Region Materials Engineer (RME) for review and approval along with CDOT Form #1188 and a copy of the Index Pages for the Project Special Provisions and Standard Special Provision.

2.3.1 All mix designs shall be stamped by a registered Professional Engineer in the State of Colorado according to Section 12-25-117 of the Colorado Revised Statutes. Copied or faxed mix designs will not be accepted. Scans of Wet-Stamped mix design submittals in pdf format are acceptable.

2.3.2 The CPP Unit or RME may verify any or all properties of the concrete mix design or individual component properties before mix design approval. The CPP Unit or RME will notify the Contractor that a mix design will be verified. The Contractor shall sample and submit the components to the CPP Unit or RME.

2.3.3 If requested, all worksheets and other supporting information shall be submitted to the CPP Unit or RME for their review before mix design approval.

2.4 If all tests conform to the specifications, a Concrete Mix Design Report (CDOT Form 1373) will be issued for the project.

2.4.1 A CDOT Form 1373 is only valid for the Project which it was issued to. If a concrete mix design is to be used on multiple Projects, the mix design, CDOT Form 1188, and a copy of the Project's Index of Special Provisions must be submitted for each Project. Concrete mixes approved for use on a project will remain valid for the life of the project, after the APL expiration date. The Project Engineer may direct the contractor to discontinue the use of a concrete mix.

2.5 When a standard mix design is approved by the CPP Unit the mix design will be placed on CDOT's APL. The Concrete Supplier may request a CDOT Form 1373 from the Project.

- 2.6 When the mix design is approved by the RME instead of the CPP Unit, the mix design will be forwarded to the CPP Unit for review.

### **3. USE OF PRE-APPROVED CONCRETE MIX DESIGNS ON PROJECTS**

- 3.1 This process will be used when a contractor wants to use a pre-approved concrete mix design listed on CDOT's APL on a Project.
- 3.2 The Contractor shall submit to the Project Engineer a letter stating his intent to use a pre-approved concrete mix design. The letter shall state at a minimum, the Concrete Supplier, the supplier's mix design number, and CDOT's Concrete Mix Design Report (CDOT Form 1373) number a minimum of one week before the anticipated concrete placement date.
- 3.3 The Project Engineer will submit a CDOT Form 1188 and a copy of the Project's Index of Special Provisions to the CPP Unit or RME.
- 3.4 If a pre-approved concrete mix design conforms to the Project's specifications, a Concrete Mix Design Report (CDOT Form 1373) will be issued for the project. Concrete mixes approved for use on a project will remain valid for the life of the project, after the APL expiration date. The Project Engineer may direct the contractor to discontinue the use of a concrete mix.
- 3.4.1 A CDOT Form 1373 is only valid for the Project in which it was issued.

### **4. PRE-APPROVAL OF CONCRETE MIX DESIGNS**

**NOTE 1:** Mix designs are not required to be on the CDOT APL for them to be used on a Project.

- 4.1 This process will place a Concrete Supplier's concrete mix on CDOT's Approved Products List (APL). The APL is located at <https://www.codot.gov/business/apl/concrete-mix-designs>
- 4.1.1 Only standard mix designs will be placed on CDOT's APL. Project-specific mix designs such as Class D (special) will not be added to CDOT's APL. Concrete mix design approval will follow the procedures listed in Section 5.
- 4.2 Concrete mix designs shall be performed in conformance with Colorado, AASHTO, and ASTM procedures.
- 4.3 The Concrete Supplier submits to the CDOT Central Laboratory's Concrete & Physical Properties (CPP) Unit one copy of the concrete mix design, which contains all of the information detailed in Section 5.
- 4.3.1 All mix designs shall be stamped by a registered Professional Engineer in the State of Colorado according to Section 12-25-117 of the Colorado Revised Statutes. Copied or faxed mix designs will not be accepted.
- 4.3.2 The CPP Unit may verify any or all properties of the concrete mix design or individual component properties before mix design approval. The CPP Unit will notify the Concrete Supplier that a mix design will be verified. The Concrete Supplier will sample and submit the components to the CPP Unit.

- 4.3.3 If requested, all worksheets and other supporting information shall be submitted to the CPP Unit for their review before mix design approval.
- 4.4 If all tests conform to the specifications, a Concrete Mix Design Report (CDOT Form 1373) will be created and sent to the Concrete Supplier.
- 4.5 The approved mix design will be placed on CDOT's APL.
- 4.5.1 A concrete mix placed on the APL is not guaranteed to be approved for use on a particular Project.

## 5. CONCRETE MIX DESIGN REQUIREMENTS

- 5.1 Labs and personnel providing mix designs shall comply with the requirements listed in CP 10.
- 5.2 A concrete mix design shall contain the following information:
- 5.2.1 Cover Letter – A cover letter including the following:
- Laboratory name & address
  - Concrete supplier's name & address
  - Concrete supplier's mix design number
  - CDOT concrete class
  - Date of trial batch testing
  - Source of all mix design components
  - Stamped & signed by a Professional Engineer registered in the State of Colorado
- 5.2.2 Mix Design Sheet – A mix design sheet identifying the following:
- Name of the testing laboratory
  - Concrete supplier's name & address
  - Concrete supplier's mix design number
  - Components of the mix design:
    - Aggregates – Source, grading, and pit name
    - Cement – Source, type, and plant
    - Pozzolan – Source, class, and plant
    - Silica Fume – Source and plant
    - Admixtures – Source and type
    - Water – Source.
  - Mix design proportions and trial mix data per CDOT Standard Specification Section 601.05
  - Stamped & signed by a Professional Engineer registered in the State of Colorado
- 5.2.3 Appendix – An appendix shall include all supporting data and documentation required in Section 601.05. This shall include, but is not limited to aggregate data and certified test reports. Any test report or supporting documentation that is used in this report from sources not covered by the Engineer of Record shall be stamped & signed by a Professional Engineer registered in the State of Colorado in charge of that work.

- 5.3 When the source of an admixture changes on pre-approved mix design, the Concrete Supplier shall submit a letter stamped by the Concrete Mix Design Engineer approving the changes to the existing mix design to the CPP Unit. The letter shall list all mix designs that will be affected by the change. If the change is approved by the CPP Unit, the affected mix designs on the APL will be changed to reflect the new admixture source.

## **6. RECORD**

- 6.1 The CPP Unit or RME will issue a CDOT Form 1373 to the Project Engineer. See Chapter 600 of the CDOT Field Materials Manual for an example.
- 6.2 The Project Engineer will supply the Contractor the CDOT Form 1373 mix design number.
- 6.3 All requests for mix design information shall be made under the Colorado Open Records Act and shall follow CDOT Procedural Directives 25.1.

## **7. REMOVAL OF A MIX DESIGN FROM THE APL**

- 7.1 The CPP Unit may elect to test any or all components of the mix design on the APL.
- 7.2 The CPP Unit will request that a Project sample the mix design constituents from the batch plant. The sample will be sent to the CPP Unit for testing.
- 7.3 When a material does not meet CDOT mix design specifications, the Concrete Supplier will be notified.
- 7.3.1 The material will be re-sampled by the Project and sent to the CPP Unit for retesting.
- 7.3.2 Upon a second failure, any mix design using the material will be removed from the APL.
- 7.3.3 The CPP Unit will send notice to the Region Materials Engineers that a mix design(s) has been removed from the APL and any Projects using the mix design(s) should discontinue its use.

## Colorado Procedure 63-21

### *Standard Practice for*

## **The Box Test in Slip Form Paving of Fresh Concrete**

### **1. SCOPE**

- 1.1 This test method describes the workability measurement of hydraulic-cement concrete in a slip formed paving applications, both in the laboratory and in the field.
- 1.2 The values stated in inch-pound units are to be regarded as the standard.
- 1.3 The standard does not purport to address all the safety concerns, if any, associated with its use. It is the responsibility of the user of this standard to establish appropriate safety and health practices and to determine the applicability of regulatory limitations before use.

### **2. REFERENCED DOCUMENTS**

- 2.1 AASHTO Standard:  
T119, Slump of Hydraulic Cement Concrete
- 2.2 *Colorado Procedures*  
CP 61, Sampling Freshly Mixed Concrete

### **3. SUMMARY OF TEST METHOD**

- 3.1 This test method composes a two-part measurement to assess the dynamic behavior (ability to flow) of plastic concrete through vibration and the static behavior (ability to hold an edge) of plastic concrete mixtures through the removal of forms.
- 3.2 First, a sample of unconsolidated concrete is filled into a standard box.
- 3.3 Second, a vibrator is used to consolidate the concrete using the standard procedure.
- 3.4 Third, the forms are removed and the number of voids is determined. This the parameter indicates the responsiveness of a mixture to vibration.
- 3.5 Last, a straight edge is used to measure the top and bottom edge slumping. The parameter indicates the potential of a mixture to edge slump.

### **4. SIGNIFICANCE AND USE**

- 4.1 This test method provides a simplistic and economic approach to determine the workability of slip formed paving applications. This test method measures the response of a pavement mixture to vibration and the ability of the concrete to hold an edge.
- 4.2 This test method is not considered applicable to mixtures with a slump greater than 3 in. as measured with T119.

## 5. APPARATUS

- 5.1 The Box Test apparatus is composed of a platform, Box Test Forms, form holders, a vibrator, and a straight edge as shown in Figure 1.
- 5.2 Box Test forms—for enclosing a 1 ft<sup>3</sup> as shown in Figure 2, shall be made of a 0.5 in or thicker plywood with an inside measurement for length, width, and height of 12 in when connected for a box shape with an open top and bottom. Two form clamps are installed in two of the four corners of the forms to create L-shaped forms as shown in Figure 2.
- 5.3 Form clamps— two pipe clamps with a minimum span of 14 in are used to hold L-shaped forms together as shown in Figure 2. These clamps must be strong enough to keep the forms together throughout the testing process.
- 5.4 Platform— for performing the Box Test on it, shall be made of a 0.5 in or thicker plywood with a minimum length and width of 18 in.
- 5.5 Vibrator— a portable electrical vibrator with a 1 in. square head and a vibration frequency of 12500 vibrations per minute (vpm)
- Note 1**—Some examples of electric vibrator motors meeting this include: Wyco 992, Wyco Sure Speed (@12,500 vpm), Wacker M1500, Northrock Pro 1.5, MultiQ Cv2A
- 5.6 Straight-edge— a 12 in metal tool commonly used in carpentry to measure the vertical alignment of the fresh concrete sample.

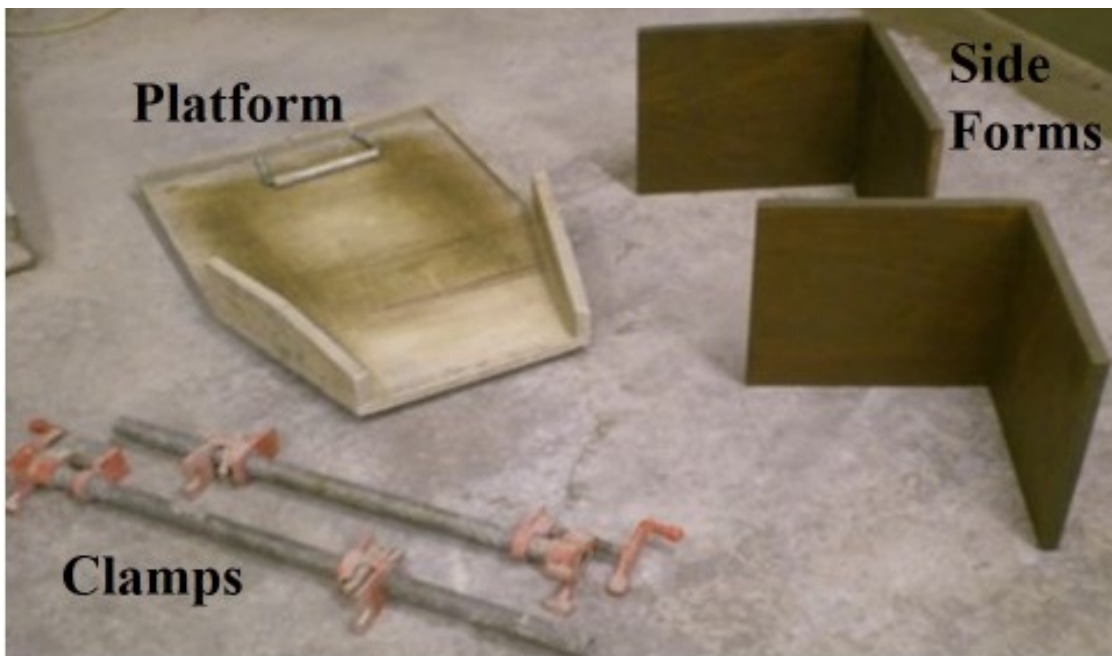


Figure 1 Each Component of the Box Test

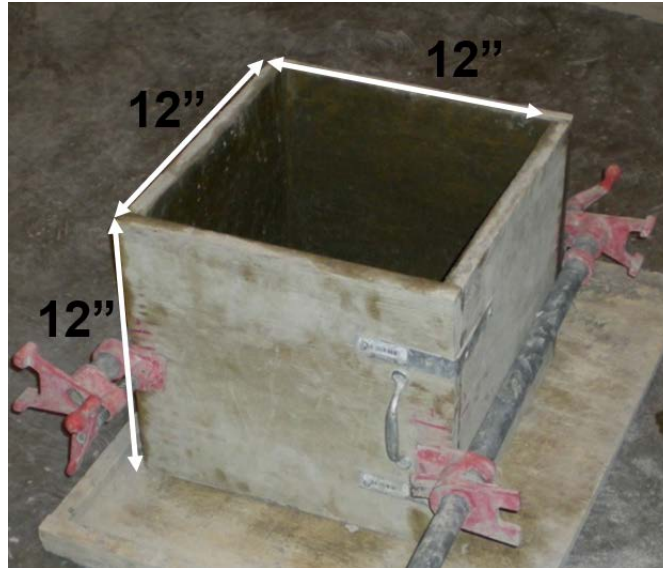


Figure 2 The Box Test Assembled with dimensions of 12 in (305 mm).

## 6. PROCEDURE

6.1 Sample concrete per CP 61

6.2 This process can be described as four steps as shown in Figure 3

6.3 Dampen the forms with form oil and construct Box Test components on a flat and level surface.

6.4 Using a hand scoop place fresh, unconsolidated concrete in the constructed box forms to a depth of 9.5 in.

6.5 Keeping the head of the vibrator perpendicular to the platform, insert the vibrator head with 12,500 vibrations per minute at the top center of the sample and vertically lower it in a continuous downward direction for three seconds to reach the bottom of the concrete sample. Attention should be taken to ensure the vibrator does not touch the platform.

6.6 Next, move the vibrator in a vertically upward direction to the top of the concrete sample for three seconds while keeping the head of the vibrator perpendicular to the platform.

6.7 Loosen and detach the form clamps. Then remove the Box Test forms in an ascending vertical direction. Care must be taken to ensure the concrete will not stick to the forms.

6.8 Estimating voids– Rank each side based on the number of voids as shown in Figure 4. An average of the four sides should be calculated as described in Section 7 and used as the overall ranking.

6.9 Edge slump– Then vertically align a straight edge onto a corner of the sample and measure the largest extruding length to the nearest 0.25" as shown in Figure 5. This shall be conducted for all four sides of the sample and each value shall be reported.

6.10 The Box Test shall be conducted within 45 minutes after discharging concrete.







|  |   |
|--|---|
|   |   |
| <p style="text-align: center;"><b>Step 1</b></p> <p>Assemble the components. Hand scoop mixture into box until the concrete level is 9 in. (240 mm).</p> | <p style="text-align: center;"><b>Step 2</b></p> <p>From the top surface of the concrete, vibrate straight downward for 3 seconds.</p>              |
|   |   |
| <p style="text-align: center;"><b>Step 3</b></p> <p>Now, vibrate straight upward for 3 seconds. Then remove vibrator.</p>                                | <p style="text-align: center;"><b>Step 4</b></p> <p>After removing the clamps and forms, inspect the sides for surface voids and edge slumping.</p> |

Figure 3 The Box Test Steps

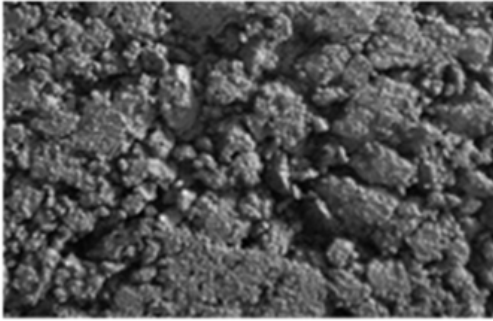
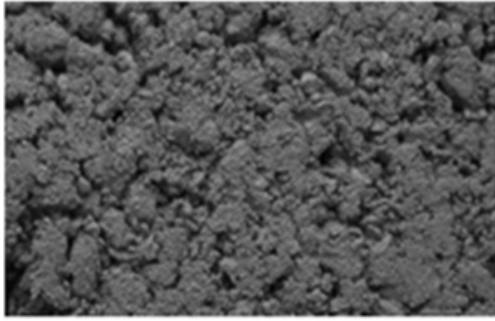
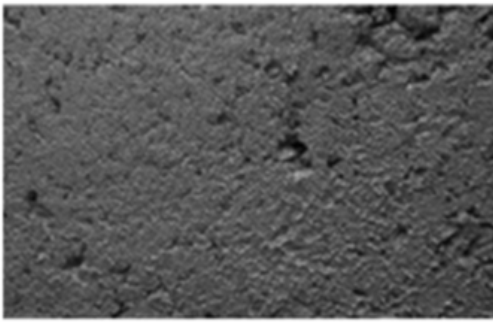
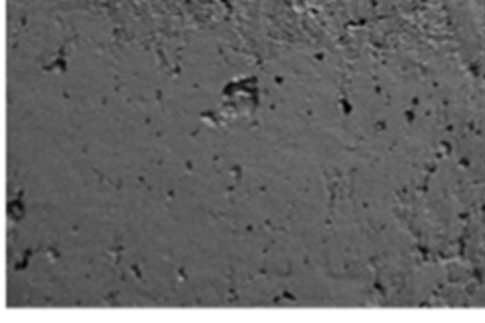
|  |   |
|--|---|
|                               |                                   |
| <p style="text-align: center;"><b>4</b></p> <p style="text-align: center;">Over 50% overall surface voids.</p> | <p style="text-align: center;"><b>3</b></p> <p style="text-align: center;">30-50% overall surface voids.</p>        |
|                               |                                   |
| <p style="text-align: center;"><b>2</b></p> <p style="text-align: center;">10-30% overall surface voids.</p>   | <p style="text-align: center;"><b>1</b></p> <p style="text-align: center;">Less than 10% overall surface voids.</p> |

Figure 4 The Box Test Ranking Scale

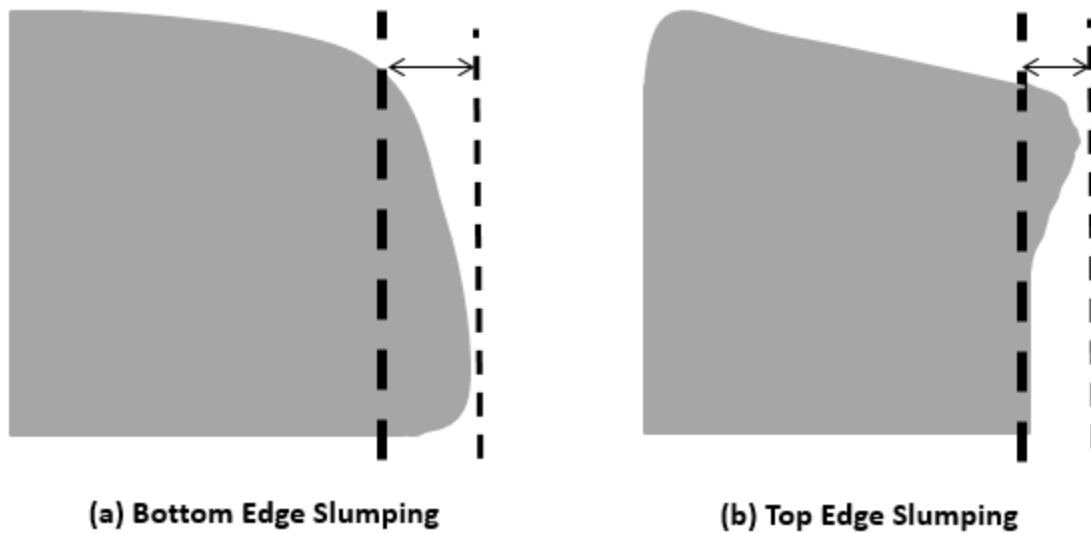


Figure 5 Edge Slump Measurement illustrated for (a) Bottom Edge Slumping and (b) Top Edge slumping.

**7. CALCULATION AND REPORT**

- 7.1 Estimating voids– After ranking each side of four sides based in Figure 4, calculate the average and standard deviation of these numbers.
- 7.2 Edge slump– Report all 4 side measurements.

**8. PRECISION AND BIAS**

- 8.1 Precision – The visual rating of voids was evaluated for single and multiple operator repeatability.
- 8.2 Single-Operator Precision- Ten different mixtures were blindly replicated three times and evaluated each of the three times by a single operator. The standard deviation of the estimated void count was 1.3% and the coefficient of variation was 14.7.
- 8.3 Multiple-Operator Precision – The different mixtures were blindly replicated three times and evaluated each of the three times by three different operators. The standard deviation of the estimated void count was 2.8% and the coefficient of variation was 21.0.

## Colorado Procedure 65-20

### *Standard Practice for*

## Evaluating Low Concrete Strength Test Results

### 1. SCOPE

1.1 Field test procedures and strength test results for standard molded and cured cylinders and beams shall be evaluated separately for each class of concrete. Such evaluation shall be conducted to determine if tests have been conducted per the ASTM, AASHTO, and/or approved CDOT procedures and specifications.

1.1.1 The evaluation process will include an investigation to ensure that proper procedures were followed in the following areas:

- Molding
- Curing methods and temperatures
- Initial curing period
- Laboratory curing period
- Testing procedure
- Personnel qualifications

**Note: Contact the Central Laboratory at (303) 398-6543 at least 48 hours before coring so that additional instruction can be given.**

1.2 This practice is comprised of two methods. Method A for evaluation of low concrete compressive strength and Method B for the evaluation of low concrete flexural strength.

### 2. EVALUATION

2.1 Should cylinders or beams fall below the specified strength, a field investigation will be conducted as follows:

2.1.1 If test procedures outlined in Subsection 1.1 were not followed, results will be considered to be invalid and the tests shall be discarded. If cores are required, they will be at the expense of CDOT to replace acceptance cylinders and at the expense of the Contractor to replace PC/OA beams.

2.1.2 The concrete supplier will furnish concrete batch tickets of the suspected low strength concrete for comparison against approved mix design.

2.1.3 Batch tickets will be checked to determine job site water addition.

2.1.4 Evaluation of the concrete in question will be made based on Subsections 2.1.1, 2.1.2, and 2.1.3.

**3. SECTION DELETED****4. CORING**

- 4.1 This procedure describes the method used to obtain and evaluate cores from in-place concrete. This will be performed per the latest revision of AASHTO T 24 (ASTM C 42), with the exception that immediately after removal from the structure, cores will be cured at a temperature between 60° - 80°F (15° - 27°C) and at a relative humidity below 60% for the first 24 hours.
- 4.2 Cores taken for the determination of strength shall be of a standard size and within appropriate tolerance.

**Note 1:** Bits cut approximately 1/4" smaller than nominal OD (outside diameter). The 4-1/4" and 6-1/4" OD bits produce 4" and 6".

**5. APPARATUS**

- 5.1 The apparatus shall be as described in AASHTO T 24 (ASTM C 42).

**Method A Compressive Strength****6. PROCEDURE**

- 6.1 Within 45 days after placement, cores with a diameter at least 3 times the nominal maximum size of the coarse aggregate used in the concrete shall be obtained per AASHTO T 24 (ASTM C 42). The cores shall be conditioned per Subsection 4.1. The cores will then be tested for compressive strength between 24 and 48 hours after removal.
- 6.2 At least 3 representative cores shall be taken from the concrete represented by each out-of-specification cylinder set.
- 6.3 Coring location shall be in locations directed by the Engineer.
- 6.4 Core holes shall be filled with low slump concrete or mortar.
- 6.5 If the compressive strength of any one core differs from the average by more than 10% that core will be discarded and the average will be determined using the compressive strengths of the remaining two cores. If more than one core's compressive strength differs from the average by more than 10%, the average will be determined using all three cores.
- 6.6 Pay factors for the strength of structural concrete shall be according to Table 601-3 of the CDOT Standard Specifications and will be used to price reduce the cores or standard test cylinders, whichever are higher in strength. Pay factors for concrete pavement will be evaluated according to Subsection 105.06 of the CDOT Standard Specifications.
- 6.7 The following examples are for structural concrete per Subsection 601.17 of the CDOT Standard Specifications:

**Example 1:**

Given:  $f'_c = 4,500$  psi  
 Concrete test cylinders averaged 4220 psi.

|        | <u>PSI</u> |
|--------|------------|
| Core 1 | 4,208      |
| Core 2 | 4,321      |
| Core 3 | 3,433      |

Average compressive strength of 3 cores = 4320 psi.

Find: Is the concrete in the structure adequate under CDOT specifications?

Solution:

Test Evaluation:

$f'_c = 4,500$  psi

Average compressive strength of 3 cores - 3990 psi

Do any compressive strengths differ from the average by more than 10%?

10% of Average compressive strength = 399 psi

Core 1:  $4,208 - 4,320 = 218$  psi, < 399 therefore OK

Core 2:  $4,321 - 3,990 = 331$  psi, < 399 therefore OK

Core 3:  $3,433 - 3,990 = 557$  psi, > 399 therefore -discard core and re-compute average compressive strength using two remaining cores. New average compressive strength = 4,265 psi

Use Table 601-3 to compute appropriate price reduction based on 4,320 psi, since core strengths were lower than the cylinder's strengths.

**Example 2:**

Price Reduction of Concrete

In this example calculation, a certain project has a pay item for 720 cubic yards of Concrete Class D (bridge). The contractor bid \$700 per cubic yards. To cover this quantity 8 sets of cylinders were molded and tested for compressive strength at 28 days. Some of the test results showed the concrete had less than the required 28-day compressive strength of 4500 psi. The project engineer has used all eight sets of cylinders to calculate the appropriate price reduction.

| Test Number | Cylinder Strength psi | Cylinder Strength psi | Cylinder Strength psi | Average Cylinder Strength Psi |
|-------------|-----------------------|-----------------------|-----------------------|-------------------------------|
| 1           | 4527                  | 4273                  | 4583                  | 4460                          |
| 2           | 6213                  | 6057                  | 6222                  | 6160                          |
| 3           | 3775                  | 4302                  | 3831                  | 3970                          |
| 4           | 4163                  | 4388                  | 4057                  | 4200                          |
| 5           | 4039                  | 3833                  | 3786                  | 3890                          |
| 6           | 4111                  | 4017                  | 3929                  | 4020                          |
| 7           | 4702                  | 4678                  | 4784                  | 4720                          |
| 8           | 4959                  | 5141                  | 5232                  | 5110                          |

**TABLE 65-1**

The average strength of three 28-day cylinders is used to determine the acceptability of concrete placed in a structure. The break results of test numbers 1, 3, 4, 5 & 6 are below the required 28-day strength of 4500 psi for bridge decks. According to Section 601.17(c) of the *CDOT Standard Specification for Road and Bridge Construction* "The concrete will be considered acceptable when the running average of three consecutive strength tests is equal to or greater than the specified strength and no single test falls below the specified strength by more than 500 psi."

| Test Number | Average Cylinder Strength psi | Average of Three Consecutive Tests (psi) | Strength Below $f_c'$ psi |
|-------------|-------------------------------|--|---------------------------|
| 1           | 4460                          | ---                                      | ---                       |
| 2           | 6160                          | ---                                      | ---                       |
| 3           | 3970                          | 4863                                     | 530                       |
| 4           | 4200                          | 4777                                     | 300                       |
| 5           | 3890                          | 4020                                     | 610                       |
| 6           | 4020                          | 4037                                     | 480                       |
| 7           | 4720                          | 4210                                     | ---                       |
| 8           | 5110                          | 4617                                     | ---                       |

**TABLE 65-2**

The table above shows that the running average of three consecutive tests falls below the required strength of 4500 psi, and the concrete placed will be price reduced according to the pay factors in Table 601-3 in Subsection 601.17. Test numbers 3, 4, 5, & 6 are represented in the low consecutive averages and will be price reduced. Test number 1 is considered acceptable and will not be price reduced because its running average with the next two tests is greater than the required strength, and it is not more than 500 psi below the required strength.

To price reduce the low strength results you need to know the bid price for the concrete and the quantity represented by each test. As stated above, the concrete was bid at \$700.00 per cubic yard. The contractor placed 720 cubic yards of Concrete Class D (bridge). The 720 cubic yards are represented by 8 sets of cylinders. Therefore, on this project, the Engineer determined that each test represents 90 cubic yards. This is only an example and the quantity represented per test shall be determined by the Project Engineer. The formula for price reduction is:

$$PR = P \times (1 - PF) \times CY$$

Where:

PR = Price Reduction,

P = Bid Price of Concrete,

PF = Pay Factor from Table 601-3 of Subsection 601.17,

CY = Cubic Yards represented by the test.



| Test Number           | Average Strength Psi | Average of Three Consecutive Tests (psi) | Strength Below $f_c'$ psi | Pay Factor Table 601-2E | Price Reduction |
|-----------------------|----------------------|--|---------------------------|-------------------------|-----------------|
| 1                     | 4460                 | ---                                      | ---                       | ---                     | ---             |
| 2                     | 6160                 | ---                                      | ---                       | ---                     | ---             |
| 3                     | 3970                 | 4863                                     | 530                       | 0.65                    | \$22,050.00     |
| 4                     | 4200                 | 4777                                     | 300                       | 0.92                    | \$ 5,040.00     |
| 5                     | 3890                 | 4020                                     | 610                       | 0.54                    | \$28,980.00     |
| 6                     | 4020                 | 4037                                     | 480                       | 0.75                    | \$15,750.00     |
| 7                     | 4720                 | 4210                                     | ---                       | ---                     | ---             |
| 8                     | 5110                 | 4617                                     | ---                       | ---                     | ---             |
| Total Price Reduction |                      |  |                           |                         | \$71,820.00     |

**TABLE 65-3**

The Contractor has the option to obtain cores from the areas represented by tests 3, 4, 5 & 6 before the concrete is 45 days old. Coring will be as per CP 65. In this case, the contractor elected to obtain cores from the bridge deck. The following is a summary of the core break results:

| Test Area | Core Strength psi | Core Strength psi | Core Strength psi | Average Core Strength psi |
|-----------|-------------------|-------------------|-------------------|---------------------------|
| 3         | 4221              | 4002              | 4106              | 4110                      |
| 4         | 4638              | 4566              | 4517              | 4570                      |
| 5         | 3711              | 3737              | 3708              | 3720                      |
| 6         | 4266              | 4504              | 4411              | 4390                      |

**TABLE 65-4**

The core strength results will replace the cylinder strength results if the core strengths are higher. In this case, cores from areas 3, 4 & 6 will replace the cylinder strength results for tests 3, 4 & 6. The following table shows the new price reductions:

| Test Number                    | Average Cylinder Strength<br>psi | Average Core Strength<br>psi | Strength Below $f_c'$<br>psi | Pay Factor Table 601-2E | Price Reduction |
|--------------------------------|----------------------------------|------------------------------|------------------------------|-------------------------|-----------------|
| 1                              | 4460                             | ---                          | ---                          | ---                     | ---             |
| 2                              | 6160                             | ---                          | ---                          | ---                     | ---             |
| 3                              | <del>3970</del>                  | 4110                         | 390                          | 0.84                    | \$ 10,080.00    |
| 4                              | <del>4200</del>                  | 4570                         | ---                          | ---                     | ---             |
| 5                              | 3890                             | <del>3720</del>              | 610                          | 0.54                    | \$28,980.00     |
| 6                              | <del>4020</del>                  | 4390                         | 110                          | 0.96                    | \$ 2,520.00     |
| 7                              | 4720                             | ---                          | ---                          | ---                     | ---             |
| 8                              | 5110                             | ---                          | ---                          | ---                     | ---             |
| Total Adjusted Price Reduction |                                  |                              |                              |                         | \$41,580.00     |

**TABLE 65-5**

**Method B Flexural Strength**

**7. PROCEDURE**

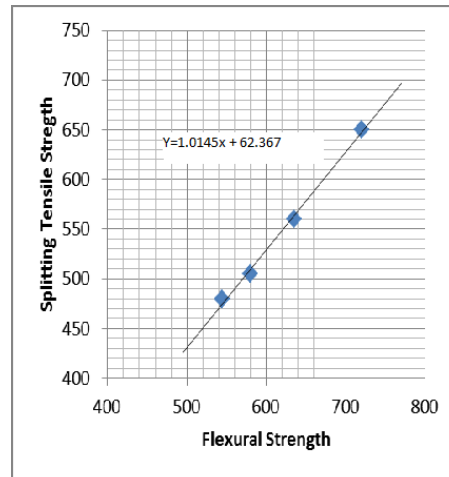
- 7.1 After 28 days, but within 45 days following placement, cores of the same size as the splitting tensile cylinders used in the trial mix shall be obtained following AASHTO T 24 (ASTM C 42). Coring will be witnessed by the Engineer. The cores shall be conditioned per Subsection 4.1. The cores will then be tested for splitting tensile strength between 24 and 48 hours after removal at a Department Region or Central Lab per AASHTO T198 (ASTM C496).
- 7.2 At least 3 representative cores shall be taken from a single slab represented by each low flexural strength. A core containing rebar or dowel bars shall be discarded and a new core shall be taken.
- 7.3 Coring location shall be in locations directed by the Engineer.
- 7.4 Core holes shall be filled with low slump concrete or mortar.
- 7.5 If the splitting tensile strength of any one core differs from the average by more than 10% that core will be discarded and the average will be determined using the splitting tensile of the remaining two cores. If more than one core's splitting tensile strength differs from the average by more than 10%, the average will be determined using all three cores.
- 7.6 The flexural strength of the concrete will be determined by using a correlation of the concrete's flexural strength to its splitting tensile strength.

- 7.6.1 Using the flexural strength and splitting tensile strengths from the concrete’s correlation curve samples, for each age, plot the flexural strength on one axis and the splitting tensile strength on the second axis. Determine a linear equation relating the two strengths.
- 7.6.2 Using the average splitting tensile strength from a set of cores, and the equation in Subsection 7.6.1, determine the corresponding flexural strength.
- 7.7 Pay factors for concrete pavement will be evaluated according to Subsection 105.06 of the CDOT Standard Specifications.

**Example 3:**

The following example shows a plot of flexural strength and splitting tensile strength.

| Age | Average Flexural Strength (psi) | Average Splitting Tensile Strength (psi) |
|-----|---------------------------------|--|
| 3   | 545                             | 480                                      |
| 7   | 580                             | 505                                      |
| 14  | 635                             | 560                                      |
| 28  | 720                             | 650                                      |



Using this example plot, a contractor’s flexural strength result from a set of beams is below 570 psi and chooses to core the pavement to replace the low flexural strength results. If the splitting tensile results from the cores is 535 psi the corresponding flexural strength would be 605 psi. Since the core flexural strength is greater than the cast beam flexural strength, the core flexural strength will be used for determining the incentive/disincentive in SMM.

## Colorado Procedure 67-21

*Standard Method of Test for*

### Determining Adhesion of Joint Sealant to Concrete Pavement

#### 1. SCOPE

- 1.1 This procedure is designed to test the adhesion of the joint filler to the concrete pavement in sawed joints or routed cracks where the backer rod is used.

#### 2. TERMINOLOGY

- 2.1 *Adhesion* - The molecular attraction exerted between the surfaces of two different materials in contact (ie. joint sealant and concrete surface).
- 2.2 *Cohesion* - The molecular attraction exerted between adjacent molecules of a single material (i.e. The joint sealant's ability to stay together by its properties).

#### METHOD A: NON-SELF-LEVELING SEALANT

#### 3. APPARATUS

- 3.1 Pulling hook conforming to Figure 67-1. The hook shall be made of a metal rod smaller than the joint width with a ninety (90) degree bend. The tip of the hook portion shall be flattened as shown in Figure 67-1, and the width shall be 1/16 inch (2 mm) less than the width of the sawed joint.

**Note 1:** M Standards show both 3/16" (4.8 mm) and 1/4" (6.4 mm) joint widths depending on location.

- 3.2 A spring scale capable of attachment to the pulling hook with a minimum capacity of 25 pounds (11.4 kg).

#### 4. TEST CONDITIONS

- 4.1 Joint sealer shall have been in place for a minimum of ten (10) days before performing the pull test.
- 4.2 Weather conditions: Ambient temperature shall be at a minimum of 70°F (21°C).

#### 5. PROCEDURE

- 5.1 Embed hook into joint sealant as shown in Figure 67-2.
- 5.2 The tip of the pulling hook shall be embedded under the joint sealant a distance of 1-½ inches (38 mm), to bend.

- 5.3 Attach spring scale to the handle of the pulling hook and pull vertically (steady pull, no jerking motion). The rate of pulling from the initial 0 pounds to twenty (20) pounds (90 N) is to be applied over 3 to 5 seconds.
- 5.4 When the spring scale reaches 20 pounds (90 N), then hold for a minimum of one second.
- 5.5 If the material fails in cohesion (tears) before reaching the 20 pounds (90 N) force, without loss of adhesion to the sidewall, the application is accepted. (NOTE: This is often the case with silicone joint sealers.)
- 5.6 If a joint sealer pulls away from the sidewall before the 20 pounds (90 N) applied force, the Joint-sealing application is considered failing.

## **6. FREQUENCY**

- 6.1 Reference CP-75 Stratified Random Sampling of Materials for frequency site selection. |
- 6.2 If a failing joint is discovered, the tester shall isolate the failing area by testing all adjacent joints locations until passing joints are located.
- 6.3 Joints failing the pull test (CP 67 Method A) shall be removed, cleaned, and replaced at no additional cost to the project. Any joint that fails the pull test (CP 67 Method A) shall be removed the full width of the pavement or longitudinally between transverse joints.

FIGURE 67-1

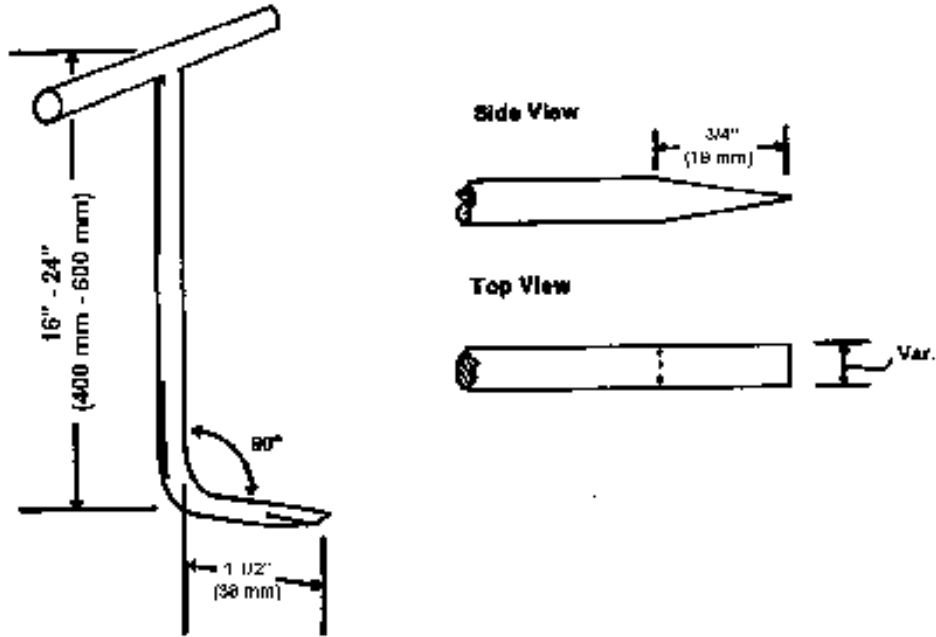
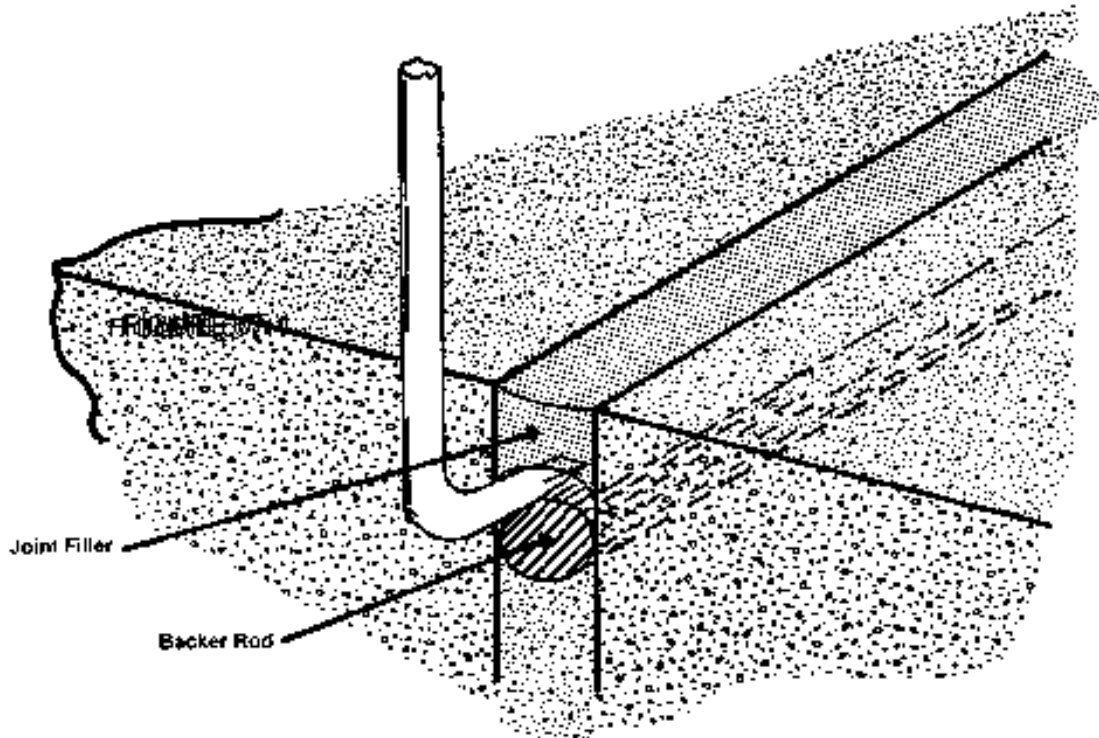


FIGURE 67-2



**METHOD B: SELF- LEVELING SEALANT****7. APPARATUS**

- 7.1 A sharp knife with a minimum 2" smooth blade such as a folding pocket knife. (Many knives are available, an example: Gerber Gator 3-1/8" blade, blade thickness .100")

**Note 2:** M Standards show both 3/16" (4.8 mm) and 1/4" (6.4 mm) joint widths depending on the location of the joint.

**8. TEST CONDITIONS**

- 8.1 Joint sealant shall be fully cured (this is usually within 14 to 21 days of placement).
- 8.2 Weather conditions: The test shall be conducted at any ambient temperature.

**9. PROCEDURE**

- 9.1 Make a knife cut horizontally from one side of the joint to the other. (See Figure 67-3)
- 9.2 Make two vertical cuts approximately 2 inches long, at the sides of the joint, meeting the horizontal cut at the top of the two-inch cuts. (See Figure 67-3)
- 9.3 Make a 1" mark on the sealant tab (in the middle of the 2" piece cut in Subsection 9.2).
- 9.4 Grasp the two-inch piece of sealant (above the 1" mark) firmly between the fingers and pull at a 90-degree angle. (See Figure 67-5) Hold a ruler alongside the extending sealant. (See Figure 67-4) Try to pull the uncut sealant out of the joints.
- 9.5 If the 1" mark can be pulled 3 inches before tearing, the test is successful.
- 9.6 If adhesion is proper, the sealant should tear cohesively in itself before releasing adhesively from the substrate.

**10. FREQUENCY**

- 10.1 If a failing joint is discovered, the tester shall isolate the failing area by testing all adjacent joint locations until passing joints are located.
- 10.2 Joints failing the pull test (CP 67 Method B) shall be removed, cleaned, and replaced at no additional cost to the project. Any joint that fails the hand pull test (CP 67 Method B) shall be removed the full width of the pavement or longitudinally between transverse joints.

**11. TROUBLESHOOTING**

11.1 Adhesion may be adversely affected by:

1. Moisture in or on the substance during sealant application and cure.
2. Contaminated or weak surfaces.
3. Poor application technique.

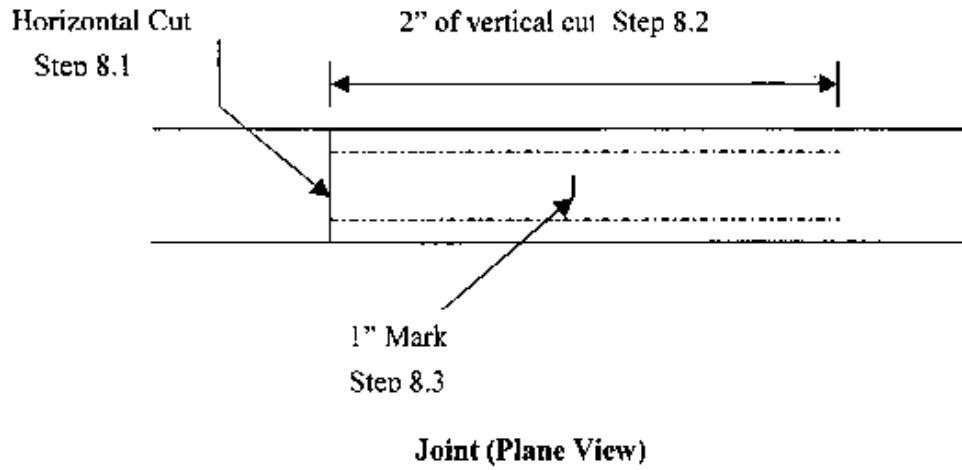
**12. REPAIR OF TEST AREA**

12.1 Sealant may be replaced in the test area, in the same manner, it was originally installed (assuming good adhesion was obtained). Care should be taken to assure that the new sealant is in contact with the original and that the original sealant surfaces are clean so that a good bond between the new and old sealant will be obtained.

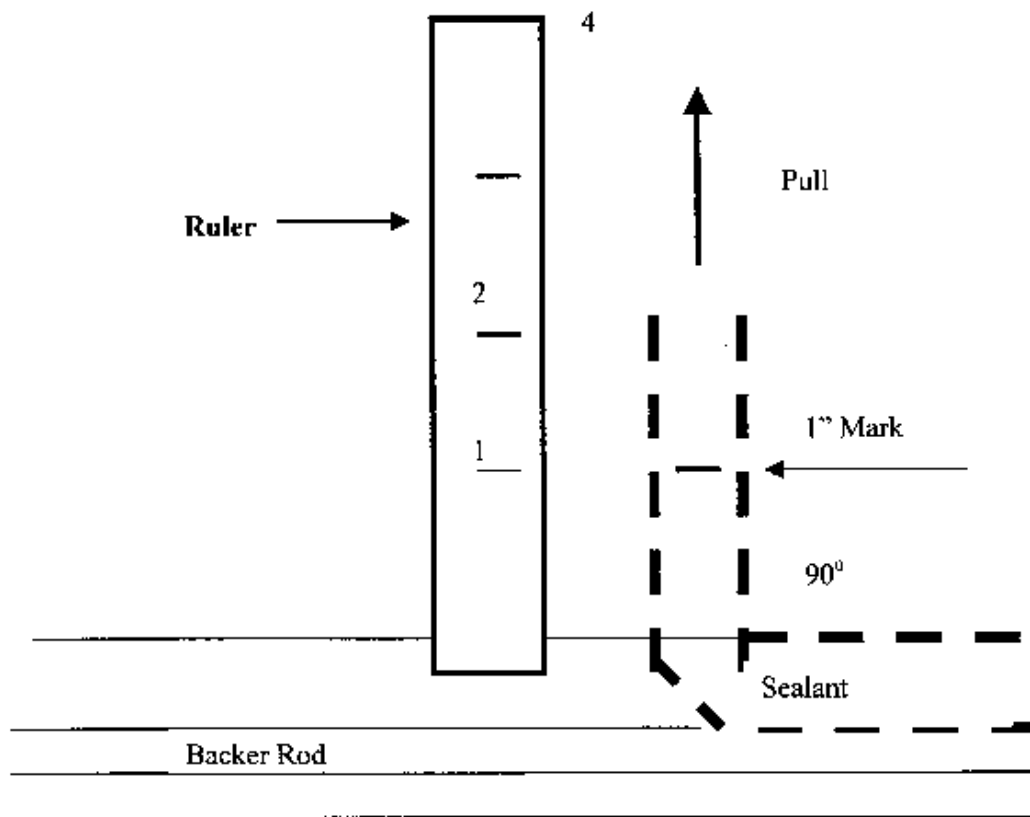
**13. REPORT**

13.1 Document on CDOT Form 389.





**FIGURE 67-3 Joint Test preparation**



**FIGURE 67-4 Pull Initiation**

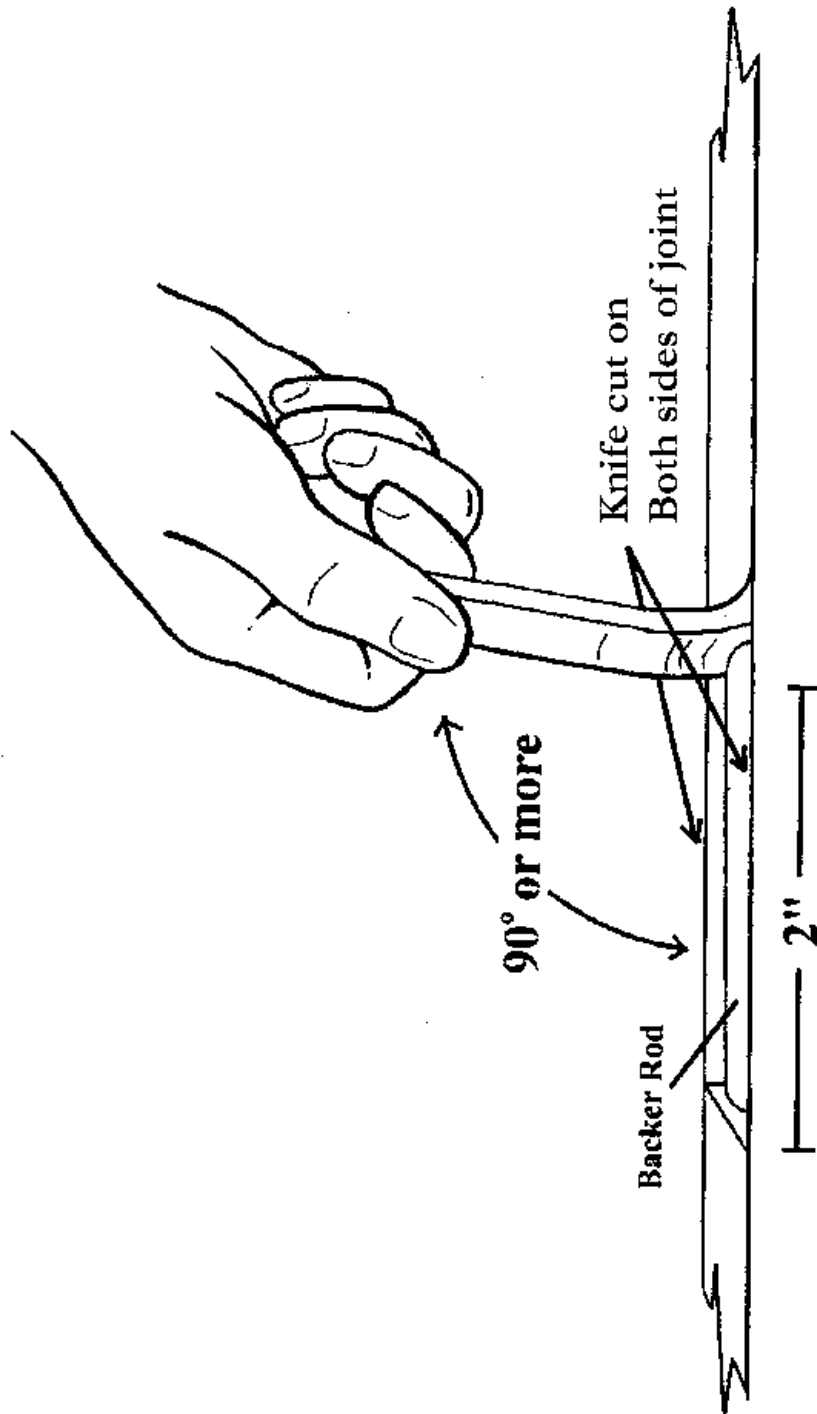


FIGURE 67-5

{Page Intentionally Left blank}

## Colorado Procedure 69-18

### *Standard Method for*

## **Estimating the In-Place Concrete Strength by a Maturity Method**

(This procedure modifies ASTM C 1074-11. The current ASTM C 1074 is to be used in conjunction with this procedure.)

### **1. SCOPE**

- 1.1 This provides a procedure for estimating in-place concrete strength using the maturity method. The maturity index is expressed either in terms of the temperature-time factor or in terms of the equivalent age at a specified temperature.
- 1.2 This procedure is identical to ASTM C 1074 Estimating Concrete Strength by the Maturity Method, with the following exceptions:

### **8. PROCEDURE TO DEVELOP STRENGTH-MATURITY RELATIONSHIP**

Delete Subsection 8.4 from ASTM C 1074 and replace with the following Subsections:

- 8.4 Test the cylinders in pairs at times that yield compressive strengths in which at least three sets are at or below 3000 psi (17 MPa), at least two sets are between 3000 psi and 4500 psi, and at least one set is above 4500 psi (17 MPa). Perform compression tests per ASTM C 39. When the specified compressive strength of the concrete is greater than 4500 psi, at least two sets shall have a compressive strength between 4500 psi and the specified compressive strength. If the range of the compressive strength of the two cylinders exceeds 10% of their average strength, test another cylinder and compute the average of three tests. If a test result is due to a defective specimen, discard the test result.
- 8.4.1 When a strength other than 3000 psi is specified for opening a structure, at least three sets of cylinders shall be tested below the specified strength, and at least one set of cylinders shall be tested above the specified strength.
- 8.8 Testing to determine datum temperature or activation energy will not be required.

### **9. PROCEDURE TO ESTIMATE IN-PLACE STRENGTH**

Delete Subsections 9.5 to 9.5.4 from ASTM C 1074 and replace with the following Subsections:

- 9.5 Verification of the Strength Maturity Relationship. Verification of the Strength Maturity Relationship is performed when safety-critical elements are identified by the Engineer.
- 9.5.1 Cast at least three field-molded cylinders. The size of the cylinders shall be 6" by 12". A maturity meter will be placed in the center mass of one cylinder. The maturity meter will be activated when concrete comes in contact with the meter.

- 9.5.2 These cylinders shall be cured together in identical conditions.
- 9.5.3 When the compressive strength of the cylinder as indicated by the maturity meter is 90 to 110 percent of the target compressive strength, the compressive strength of at least two of the remaining cylinders will be determined and averaged. If the average compressive strength of the cylinders deviates by more than 10 percent from the compressive strength of the maturity meter, the Strength Maturity Relationship is no longer valid and a new Strength Maturity Relationship shall be developed.

**Colorado Procedure 71-01**  
*Standard Practice for*  
**Determining Quality Level**  
**(Percent Within Tolerance Limits)**

**1. SCOPE**

- 1.1 Use this procedure with Quality Assurance type specifications where Pay Factors or acceptance decisions are based on Quality Level (QL), defined as percent within specification (tolerance) limits. QL is a measure of the quality of a (Lot or Process).
- 1.2 QL represents the percentage of the population (Lot or Process) that falls above a single lower limit, below a single upper limit, or between the upper and lower limits of double-limit specifications.
- 1.3 For this procedure to be meaningful, select all samples by random or stratified random procedures. Perform all testing and measuring strictly per standard acceptable practices. When used for contractual purposes, perform all sampling and testing per the applicable specifications.
- 1.4 Manual, computer-assisted, and mathematical procedures are described. Where contractual pay factors are based on QL, use only the computer-assisted procedure.

**2. SUMMARY OF METHOD**

- 2.1 The method involves calculating statistical parameters from three or more representative measurements, test results, or values for each specified element in a Lot or Sample. The arithmetic average (mean) value of the sample is calculated. As a measure of variability, the sample Standard Deviation is calculated. Using these results, the distance from the sample mean to each limit is divided by the standard deviation, which yields the Quality Index.
- 2.2 The incomplete beta function ratio, using sample sizes and quality indices as variables, is used in the computer version to calculate areas under the beta distribution. With variables typical for QL determinations, the beta distribution (Figure 71-1) is similar to the normal distribution (Figure 71-2).
- 2.3 The total area under the beta distribution outside the specification limits is the fraction defective, which is then multiplied by 100 to yield the percent defective; this subtracted from 100 gives the percent within limits.
- 2.4 Table 71-1 contains values for percent within limits as related to sample sizes and quality indices. The table was developed from mathematical calculations and is used in the manual method to estimate QL.

### 3. MANUAL PROCEDURE

- 3.1 Determine the arithmetic mean and standard deviation for the several test results from the lot for each element being evaluated. Compute these as shown in Equations 3.1 and 3.2.

$$\bar{X} = \frac{\sum X}{n} \quad \text{Equation 3.1}$$

$$s = \sqrt{\frac{\sum (X - \bar{X})^2}{n - 1}} \quad \text{Equation 3.2}$$

Where:

$\bar{X}$  = Sample mean,  
 $\Sigma$  = Summation of,  
 $X$  = Individual test value to  $X_n$ ,  
 $n$  = Total number of test values,  
 $s$  = Sample standard deviation.

- 3.2 Compute the upper-quality index ( $Q_u$ ) per Equation 3.3.

$$Q_u = \frac{T_u - \bar{X}}{s} \quad \text{Equation 3.3}$$

Where:

$Q_u$  = Upper quality index,  
 $T_u$  = Upper specification limits.

- 3.2.1 Determine  $P_u$  (percent within the upper specification limit which corresponds to a given  $Q_u$ ) from Table 71-1. If desired,  $P_u$  may be interpolated to the nearest 0.1. Where  $T_u$  is not specified,  $P_u$  will be 100.

- 3.3 Compute the lower quality index ( $Q_L$ ) per Equation 3.4.

$$Q_L = \frac{\bar{X} - T_L}{s} \quad \text{Equation 3.4}$$

Where:

$Q_L$  = Lower quality index,  
 $T_L$  = Lower specification limits.

- 3.3.1 Determine  $P_L$  (percent within the lower specification limit which corresponds to a given  $Q_L$ ) from Table 71-1. If desired,  $P_L$  may be interpolated to the nearest 0.1. Where  $T_L$  is not specified,  $P_L$  will be 100.
- 3.4 Compute QL (the total percent within specification limits) per Equation 3.5.

$$QL = (P_U + P_L) - 100 \quad \text{Equation 3.5}$$

- 3.5 The manual method for determining QL essentially conforms to the applicable portions of AASHTO Standard Recommended Practice R 9, Acceptance Sampling Plans for Highway Construction.
- 3.6 A sample calculation is provided at the end of this procedure demonstrating the calculation of Quality Level and Pay Factors using this manual procedure.

#### 4. COMPUTER ASSISTED PROCEDURE

- 4.1 The calculations for determining the Quality Level, may be performed by using the latest versions of the Departments' quality level programs.
- 4.2 In the quality level programs, the areas under the beta distribution are calculated from the incomplete beta function ratio by assigning the variables used in Equations 3.1 through 3.4. The procedure is as described in *Numerical Recipes in C<sub>1</sub>, Chapter 6*. A detailed discussion of the theories involved is provided by Willenbrock and Kopac in *TRR 691, Process Control in the Construction Industry<sub>2</sub>*.
- 4.3 All numbers from the calculations are carried to significant figures and round according to AASHTO Standard Recommended Practice R 11, using the Rounding Method.
- 4.4 Where contractual pay factors are based on the QL use the CDOT Application for Reporting (CAR) reports for obtaining the incentive/disincentive for the item. The quantity shown on the CAR report shall match the total quantity paid on the estimate. Differences in quantities shall be explained on the CDOT Form 474, Explanation of Exceptions.



**MATHEMATICAL PROCEDURE** - Adapted from *Resolution of beta-distribution equations for quality level analysis...*<sup>3</sup>

5.1 To evaluate the necessary quality parameters, the integral must be evaluated.

$$I_n = \frac{1}{B\left(\frac{n}{2} - 1, \frac{n}{2} - 1\right)} \int_0^g t^{\frac{n}{2} - 2} (1 - t)^{\frac{n}{2} - 2} dt \quad \text{Equation 5.1}$$

In Equation 5.1  $B(n/2-1, n/2-1)$  is generally referred to as the complete beta-function (or just the beta-function) with parameters  $n/2-1, n/2-1$ , and the integral is the incomplete beta-function. Together they form the beta distribution from a random variable. The beta function is defined by:

$$B\left(\frac{n}{2} - 1, \frac{n}{2} - 1\right) = \int_0^1 t^{\frac{n}{2} - 2} (1 - t)^{\frac{n}{2} - 2} dt, \quad \text{Equation 5.2}$$

and the upper limit in Equation 5.1 is given by:

$$g = \frac{1}{2} - \frac{Q\sqrt{n}}{2(n - 1)} \quad \text{Equation 5.3}$$

where Q is the quality index defined in Equations 3.3 and 3.4 and n is the sample size.

5.2 For small sample sizes no numerical integration is necessary as the integral may be economically evaluated in close form. In particular, we have:

$$I_3 = \frac{1}{2} + \frac{1}{p} \sin^{-1}(2g - 1) \quad \text{Equation 5.4}$$

$$I_4 = g \quad \text{Equation 5.5}$$

$$I_5 = \frac{1}{2} + \frac{1}{p} \sin^{-1}(2g - 1) + \frac{2}{p} \sqrt{g - g^2} (2g - 1) \quad \text{Equation 5.6}$$

$$I_6 = 3g^2 - 2g^3 \quad \text{Equation 5.7}$$

$$I_7 = \frac{1}{2} + \frac{1}{p} \sin^{-1}(2g - 1) - \frac{2}{3p} \sqrt{g - g^2} (2g - 1)(8g^2 - 8g - 3) \quad \text{Equation 5.8}$$

$$I_8 = 10g^3 - 15g^4 + 6g^5 \quad \text{Equation 5.9}$$

These expressions are small enough to be used with some hand calculators. As the value of n increases the calculations become more complex. With the availability of personal computers, we include the equation for information and recommend the use of personal computers.

TABLE 71-1

| Upper-Quality Index $Q_u$ or Lower Quality Index $Q_L$ |      |      |      |      |      |      |      |                    |                    |                    |                    |                    |                    |                     |                    |  |
|--|------|------|------|------|------|------|------|--------------------|--------------------|--------------------|--------------------|--------------------|--------------------|---------------------|--------------------|--|
| $P_u$ or $P_L$<br>%                                    |      |      |      |      |      |      |      | n=10<br>to<br>n=11 | n=12<br>to<br>n=14 | n=15<br>to<br>n=18 | n=19<br>to<br>n=25 | n=26<br>to<br>n=37 | n=38<br>to<br>n=69 | n=70<br>to<br>n=200 | n=201<br>to<br>n=x |  |
|  | n=3  | n=4  | n=5  | n=6  | n=7  | n=8  | n=9  |                    |                    |                    |                    |                    |                    |                     |                    |  |
| 100  | 1.16 | 1.50 | 1.79 | 2.03 | 2.23 | 2.39 | 2.53 | 2.65               | 2.83               | 3.03               | 3.20               | 3.38               | 3.54               | 3.70                | 3.83               |  |
| 99   |      | 1.47 | 1.67 | 1.80 | 1.89 | 1.95 | 2.00 | 2.04               | 2.09               | 2.14               | 2.18               | 2.22               | 2.26               | 2.29                | 2.31               |  |
| 98   | 1.15 | 1.44 | 1.60 | 1.70 | 1.76 | 1.81 | 1.84 | 1.86               | 1.91               | 1.93               | 1.96               | 1.99               | 2.01               | 2.03                | 2.05               |  |
| 97   |      | 1.41 | 1.54 | 1.62 | 1.67 | 1.70 | 1.72 | 1.74               | 1.77               | 1.79               | 1.81               | 1.83               | 1.85               | 1.86                | 1.87               |  |
| 96   | 1.14 | 1.38 | 1.49 | 1.55 | 1.59 | 1.61 | 1.63 | 1.65               | 1.67               | 1.68               | 1.70               | 1.71               | 1.73               | 1.74                | 1.75               |  |
| 95   |      | 1.35 | 1.44 | 1.49 | 1.52 | 1.54 | 1.55 | 1.56               | 1.58               | 1.59               | 1.61               | 1.62               | 1.63               | 1.63                | 1.64               |  |
| 94   | 1.13 | 1.32 | 1.39 | 1.43 | 1.46 | 1.47 | 1.48 | 1.49               | 1.50               | 1.51               | 1.52               | 1.53               | 1.54               | 1.55                | 1.55               |  |
| 93   |      | 1.29 | 1.35 | 1.38 | 1.40 | 1.41 | 1.42 | 1.43               | 1.44               | 1.44               | 1.45               | 1.46               | 1.46               | 1.47                | 1.47               |  |
| 92   | 1.12 | 1.26 | 1.31 | 1.33 | 1.35 | 1.36 | 1.36 | 1.36               | 1.37               | 1.37               | 1.39               | 1.39               | 1.40               | 1.40                | 1.40               |  |
| 91   | 1.11 | 1.23 | 1.27 | 1.29 | 1.30 | 1.30 | 1.31 | 1.31               | 1.32               | 1.32               | 1.33               | 1.33               | 1.33               | 1.34                | 1.34               |  |
| 90   | 1.10 | 1.20 | 1.23 | 1.24 | 1.25 | 1.25 | 1.26 | 1.26               | 1.26               | 1.27               | 1.27               | 1.27               | 1.28               | 1.28                | 1.28               |  |
| 89   | 1.09 | 1.17 | 1.19 | 1.20 | 1.20 | 1.21 | 1.21 | 1.21               | 1.21               | 1.22               | 1.22               | 1.22               | 1.22               | 1.22                | 1.23               |  |
| 88   | 1.07 | 1.14 | 1.15 | 1.16 | 1.16 | 1.16 | 1.17 | 1.17               | 1.17               | 1.17               | 1.17               | 1.17               | 1.17               | 1.17                | 1.17               |  |
| 87   | 1.06 | 1.11 | 1.12 | 1.12 | 1.12 | 1.12 | 1.12 | 1.12               | 1.12               | 1.12               | 1.12               | 1.12               | 1.12               | 1.13                | 1.13               |  |
| 86   | 1.04 | 1.08 | 1.08 | 1.08 | 1.08 | 1.08 | 1.08 | 1.08               | 1.08               | 1.08               | 1.08               | 1.08               | 1.08               | 1.08                | 1.08               |  |
| 85   | 1.03 | 1.05 | 1.05 | 1.04 | 1.04 | 1.04 | 1.04 | 1.04               | 1.04               | 1.04               | 1.04               | 1.04               | 1.04               | 1.04                | 1.04               |  |
| 84   | 1.01 | 1.02 | 1.01 | 1.01 | 1.00 | 1.00 | 1.00 | 1.00               | 1.00               | 1.00               | 1.00               | 1.00               | 0.99               | 0.99                | 0.99               |  |
| 83   | 1.00 | 0.99 | 0.98 | 0.97 | 0.96 | 0.96 | 0.96 | 0.96               | 0.96               | 0.96               | 0.96               | 0.96               | 0.95               | 0.95                | 0.95               |  |
| 82   | 0.97 | 0.96 | 0.95 | 0.94 | 0.93 | 0.93 | 0.93 | 0.92               | 0.92               | 0.92               | 0.92               | 0.92               | 0.92               | 0.92                | 0.92               |  |
| 81   | 0.96 | 0.93 | 0.91 | 0.90 | 0.90 | 0.89 | 0.89 | 0.89               | 0.89               | 0.88               | 0.88               | 0.88               | 0.88               | 0.88                | 0.88               |  |
| 80   | 0.93 | 0.90 | 0.88 | 0.87 | 0.86 | 0.86 | 0.86 | 0.85               | 0.85               | 0.85               | 0.85               | 0.84               | 0.84               | 0.84                | 0.84               |  |
| 79   | 0.91 | 0.87 | 0.85 | 0.84 | 0.83 | 0.82 | 0.82 | 0.82               | 0.82               | 0.81               | 0.81               | 0.81               | 0.81               | 0.81                | 0.81               |  |
| 78   | 0.89 | 0.84 | 0.82 | 0.80 | 0.80 | 0.79 | 0.79 | 0.79               | 0.78               | 0.78               | 0.78               | 0.78               | 0.77               | 0.77                | 0.77               |  |
| 77   | 0.87 | 0.81 | 0.78 | 0.77 | 0.76 | 0.76 | 0.76 | 0.75               | 0.75               | 0.75               | 0.75               | 0.74               | 0.74               | 0.74                | 0.74               |  |
| 76   | 0.84 | 0.78 | 0.75 | 0.74 | 0.73 | 0.73 | 0.72 | 0.72               | 0.72               | 0.71               | 0.71               | 0.71               | 0.71               | 0.71                | 0.71               |  |
| 75   | 0.82 | 0.75 | 0.72 | 0.71 | 0.70 | 0.70 | 0.69 | 0.69               | 0.69               | 0.68               | 0.68               | 0.68               | 0.68               | 0.68                | 0.67               |  |
| 74   | 0.79 | 0.72 | 0.69 | 0.68 | 0.67 | 0.66 | 0.66 | 0.66               | 0.66               | 0.65               | 0.65               | 0.65               | 0.65               | 0.64                | 0.64               |  |
| 73   | 0.76 | 0.69 | 0.66 | 0.65 | 0.64 | 0.63 | 0.63 | 0.63               | 0.62               | 0.62               | 0.62               | 0.62               | 0.62               | 0.61                | 0.61               |  |
| 72   | 0.74 | 0.66 | 0.63 | 0.62 | 0.61 | 0.60 | 0.60 | 0.60               | 0.59               | 0.59               | 0.59               | 0.59               | 0.59               | 0.58                | 0.58               |  |
| 71   | 0.71 | 0.63 | 0.60 | 0.59 | 0.58 | 0.57 | 0.57 | 0.57               | 0.57               | 0.56               | 0.56               | 0.56               | 0.56               | 0.55                | 0.55               |  |
| 70   | 0.68 | 0.60 | 0.57 | 0.56 | 0.55 | 0.55 | 0.54 | 0.54               | 0.54               | 0.53               | 0.53               | 0.53               | 0.53               | 0.53                | 0.52               |  |
| 69   | 0.65 | 0.57 | 0.54 | 0.53 | 0.52 | 0.52 | 0.51 | 0.51               | 0.51               | 0.50               | 0.50               | 0.50               | 0.50               | 0.50                | 0.50               |  |
| 68   | 0.62 | 0.54 | 0.51 | 0.50 | 0.49 | 0.49 | 0.48 | 0.48               | 0.48               | 0.48               | 0.47               | 0.47               | 0.47               | 0.47                | 0.47               |  |
| 67   | 0.59 | 0.51 | 0.47 | 0.47 | 0.46 | 0.46 | 0.46 | 0.45               | 0.45               | 0.45               | 0.45               | 0.44               | 0.44               | 0.44                | 0.44               |  |
| 66   | 0.56 | 0.48 | 0.45 | 0.44 | 0.44 | 0.43 | 0.43 | 0.43               | 0.42               | 0.42               | 0.42               | 0.42               | 0.41               | 0.41                | 0.41               |  |
| 65   | 0.52 | 0.45 | 0.43 | 0.41 | 0.41 | 0.40 | 0.40 | 0.40               | 0.40               | 0.39               | 0.39               | 0.39               | 0.39               | 0.39                | 0.39               |  |
| 64   | 0.49 | 0.42 | 0.40 | 0.39 | 0.38 | 0.38 | 0.37 | 0.37               | 0.37               | 0.36               | 0.36               | 0.36               | 0.36               | 0.36                | 0.36               |  |
| 63   | 0.46 | 0.39 | 0.37 | 0.36 | 0.35 | 0.35 | 0.35 | 0.34               | 0.34               | 0.34               | 0.34               | 0.34               | 0.33               | 0.33                | 0.33               |  |
| 62   | 0.43 | 0.36 | 0.34 | 0.33 | 0.32 | 0.32 | 0.32 | 0.32               | 0.31               | 0.31               | 0.31               | 0.31               | 0.31               | 0.31                | 0.31               |  |
| 61   | 0.39 | 0.33 | 0.31 | 0.30 | 0.30 | 0.29 | 0.29 | 0.29               | 0.29               | 0.29               | 0.28               | 0.28               | 0.28               | 0.28                | 0.28               |  |
| 60   | 0.36 | 0.30 | 0.28 | 0.27 | 0.27 | 0.27 | 0.26 | 0.26               | 0.26               | 0.26               | 0.26               | 0.26               | 0.26               | 0.25                | 0.25               |  |
| 59   | 0.32 | 0.27 | 0.25 | 0.25 | 0.24 | 0.24 | 0.24 | 0.24               | 0.23               | 0.23               | 0.23               | 0.23               | 0.23               | 0.23                | 0.23               |  |
| 58   | 0.29 | 0.24 | 0.23 | 0.22 | 0.21 | 0.21 | 0.21 | 0.21               | 0.21               | 0.21               | 0.20               | 0.20               | 0.20               | 0.20                | 0.20               |  |
| 57   | 0.25 | 0.21 | 0.20 | 0.19 | 0.19 | 0.19 | 0.18 | 0.18               | 0.18               | 0.18               | 0.18               | 0.18               | 0.18               | 0.18                | 0.18               |  |
| 56   | 0.22 | 0.18 | 0.16 | 0.16 | 0.16 | 0.16 | 0.16 | 0.16               | 0.16               | 0.15               | 0.15               | 0.15               | 0.15               | 0.15                | 0.15               |  |
| 55   | 0.18 | 0.15 | 0.14 | 0.13 | 0.13 | 0.13 | 0.13 | 0.13               | 0.13               | 0.13               | 0.13               | 0.13               | 0.13               | 0.13                | 0.13               |  |
| 54   | 0.14 | 0.12 | 0.11 | 0.11 | 0.11 | 0.10 | 0.10 | 0.10               | 0.10               | 0.10               | 0.10               | 0.10               | 0.10               | 0.10                | 0.10               |  |
| 53   | 0.11 | 0.09 | 0.08 | 0.08 | 0.08 | 0.08 | 0.08 | 0.08               | 0.08               | 0.08               | 0.08               | 0.08               | 0.08               | 0.08                | 0.08               |  |
| 52   | 0.07 | 0.06 | 0.06 | 0.05 | 0.05 | 0.05 | 0.05 | 0.05               | 0.05               | 0.05               | 0.05               | 0.05               | 0.05               | 0.05                | 0.05               |  |
| 51   | 0.04 | 0.03 | 0.03 | 0.03 | 0.03 | 0.03 | 0.03 | 0.03               | 0.03               | 0.03               | 0.03               | 0.03               | 0.03               | 0.03                | 0.02               |  |
| 50   | 0.00 | 0.00 | 0.00 | 0.00 | 0.00 | 0.00 | 0.00 | 0.00               | 0.00               | 0.00               | 0.00               | 0.00               | 0.00               | 0.00                | 0.00               |  |

NOTE: When  $Q_u$  or  $Q_L$  falls between table values, estimate  $P_u$  or  $P_L$  to the closest 0.10.

TABLE 71-1

| Upper-Quality Index $Q_U$ or Lower Quality Index $Q_L$ |       |       |       |       |       |       |       |            |            |            |            |            |            |             |           |  |
|--|-------|-------|-------|-------|-------|-------|-------|------------|------------|------------|------------|------------|------------|-------------|-----------|--|
| $P_U$ or $P_L$<br>%                                    |       |       |       |       |       |       |       | n=10       | n=12       | n=15       | n=19       | n=26       | n=38       | n=70        | n=201     |  |
|  | n=3   | n=4   | n=5   | n=6   | n=7   | n=8   | n=9   | to<br>n=11 | to<br>n=14 | to<br>n=18 | to<br>n=25 | to<br>n=37 | to<br>n=69 | to<br>n=200 | to<br>n=x |  |
| 50   | 0.00  | 0.00  | 0.00  | 0.00  | 0.00  | 0.00  | 0.00  | 0.00       | 0.00       | 0.00       | 0.00       | 0.00       | 0.00       | 0.00        | 0.00      |  |
| 49   | -0.04 | -0.03 | -0.03 | -0.03 | -0.03 | -0.03 | -0.03 | -0.03      | -0.03      | -0.03      | -0.03      | -0.03      | -0.03      | -0.03       | -0.02     |  |
| 48   | -0.07 | -0.06 | -0.06 | -0.05 | -0.05 | -0.05 | -0.05 | -0.05      | -0.05      | -0.05      | -0.05      | -0.05      | -0.05      | -0.05       | -0.05     |  |
| 47   | -0.11 | -0.09 | -0.08 | -0.08 | -0.08 | -0.08 | -0.08 | -0.08      | -0.08      | -0.08      | -0.08      | -0.08      | -0.08      | -0.08       | -0.08     |  |
| 46   | -0.14 | -0.12 | -0.11 | -0.11 | -0.11 | -0.10 | -0.10 | -0.10      | -0.10      | -0.10      | -0.10      | -0.10      | -0.10      | -0.10       | -0.10     |  |
| 45   | -0.18 | -0.15 | -0.14 | -0.13 | -0.13 | -0.13 | -0.13 | -0.13      | -0.13      | -0.13      | -0.13      | -0.13      | -0.13      | -0.13       | -0.13     |  |
| 44   | -0.22 | -0.18 | -0.16 | -0.16 | -0.16 | -0.16 | -0.16 | -0.16      | -0.16      | -0.15      | -0.15      | -0.15      | -0.15      | -0.15       | -0.15     |  |
| 43   | -0.25 | -0.21 | -0.20 | -0.19 | -0.19 | -0.19 | -0.18 | -0.18      | -0.18      | -0.18      | -0.18      | -0.18      | -0.18      | -0.18       | -0.18     |  |
| 42   | -0.29 | -0.24 | -0.23 | -0.22 | -0.21 | -0.21 | -0.21 | -0.21      | -0.21      | -0.21      | -0.20      | -0.20      | -0.20      | -0.20       | -0.20     |  |
| 41   | -0.32 | -0.27 | -0.25 | -0.25 | -0.24 | -0.24 | -0.24 | -0.24      | -0.23      | -0.23      | -0.23      | -0.23      | -0.23      | -0.23       | -0.23     |  |
| 40   | -0.36 | -0.30 | -0.28 | -0.27 | -0.27 | -0.27 | -0.26 | -0.26      | -0.26      | -0.26      | -0.26      | -0.26      | -0.26      | -0.25       | -0.25     |  |
| 39   | -0.39 | -0.33 | -0.31 | -0.30 | -0.30 | -0.29 | -0.29 | -0.29      | -0.29      | -0.29      | -0.28      | -0.28      | -0.28      | -0.28       | -0.28     |  |
| 38   | -0.43 | -0.36 | -0.34 | -0.33 | -0.32 | -0.32 | -0.32 | -0.32      | -0.31      | -0.31      | -0.31      | -0.31      | -0.31      | -0.31       | -0.31     |  |
| 37   | -0.46 | -0.39 | -0.37 | -0.36 | -0.35 | -0.35 | -0.35 | -0.34      | -0.34      | -0.34      | -0.34      | -0.34      | -0.33      | -0.33       | -0.33     |  |
| 36   | -0.49 | -0.42 | -0.40 | -0.39 | -0.38 | -0.38 | -0.37 | -0.37      | -0.37      | -0.36      | -0.36      | -0.36      | -0.36      | -0.36       | -0.36     |  |
| 35   | -0.52 | -0.45 | -0.43 | -0.41 | -0.41 | -0.40 | -0.40 | -0.40      | -0.40      | -0.39      | -0.39      | -0.39      | -0.39      | -0.39       | -0.39     |  |
| 34   | -0.56 | -0.48 | -0.45 | -0.44 | -0.44 | -0.43 | -0.43 | -0.43      | -0.42      | -0.42      | -0.42      | -0.42      | -0.41      | -0.41       | -0.41     |  |
| 33   | -0.59 | -0.51 | -0.47 | -0.47 | -0.46 | -0.46 | -0.46 | -0.45      | -0.45      | -0.45      | -0.45      | -0.44      | -0.44      | -0.44       | -0.44     |  |
| 32   | -0.62 | -0.54 | -0.51 | -0.50 | -0.49 | -0.49 | -0.48 | -0.48      | -0.48      | -0.48      | -0.47      | -0.47      | -0.47      | -0.47       | -0.47     |  |
| 31   | -0.65 | -0.57 | -0.54 | -0.53 | -0.52 | -0.52 | -0.51 | -0.51      | -0.51      | -0.50      | -0.50      | -0.50      | -0.50      | -0.50       | -0.50     |  |
| 30   | -0.68 | -0.60 | -0.57 | -0.56 | -0.55 | -0.55 | -0.54 | -0.54      | -0.54      | -0.53      | -0.53      | -0.53      | -0.53      | -0.53       | -0.52     |  |
| 29   | -0.71 | -0.63 | -0.60 | -0.59 | -0.58 | -0.57 | -0.57 | -0.57      | -0.57      | -0.56      | -0.56      | -0.56      | -0.56      | -0.55       | -0.55     |  |
| 28   | -0.74 | -0.66 | -0.63 | -0.62 | -0.61 | -0.60 | -0.60 | -0.60      | -0.59      | -0.59      | -0.59      | -0.59      | -0.59      | -0.58       | -0.58     |  |
| 27   | -0.76 | -0.69 | -0.66 | -0.65 | -0.64 | -0.63 | -0.63 | -0.63      | -0.62      | -0.62      | -0.62      | -0.62      | -0.62      | -0.61       | -0.61     |  |
| 26   | -0.79 | -0.72 | -0.69 | -0.68 | -0.67 | -0.66 | -0.66 | -0.66      | -0.66      | -0.65      | -0.65      | -0.65      | -0.65      | -0.64       | -0.64     |  |
| 25   | -0.82 | -0.75 | -0.72 | -0.71 | -0.70 | -0.70 | -0.69 | -0.69      | -0.69      | -0.68      | -0.68      | -0.68      | -0.68      | -0.68       | -0.67     |  |
| 24   | -0.84 | -0.78 | -0.75 | -0.74 | -0.73 | -0.73 | -0.72 | -0.72      | -0.72      | -0.71      | -0.71      | -0.71      | -0.71      | -0.71       | -0.71     |  |
| 23   | -0.87 | -0.81 | -0.78 | -0.77 | -0.76 | -0.76 | -0.76 | -0.75      | -0.75      | -0.75      | -0.75      | -0.74      | -0.74      | -0.74       | -0.74     |  |
| 22   | -0.89 | -0.84 | -0.82 | -0.80 | -0.80 | -0.79 | -0.79 | -0.79      | -0.78      | -0.78      | -0.78      | -0.78      | -0.77      | -0.77       | -0.77     |  |
| 21   | -0.91 | -0.87 | -0.85 | -0.84 | -0.83 | -0.82 | -0.82 | -0.82      | -0.82      | -0.81      | -0.81      | -0.81      | -0.81      | -0.81       | -0.81     |  |
| 20   | -0.93 | -0.90 | -0.88 | -0.87 | -0.86 | -0.86 | -0.86 | -0.85      | -0.85      | -0.85      | -0.85      | -0.84      | -0.84      | -0.84       | -0.84     |  |
| 19   | -0.96 | -0.93 | -0.91 | -0.90 | -0.90 | -0.89 | -0.89 | -0.89      | -0.89      | -0.88      | -0.88      | -0.88      | -0.88      | -0.88       | -0.88     |  |
| 18   | -0.97 | -0.96 | -0.95 | -0.94 | -0.93 | -0.93 | -0.93 | -0.92      | -0.92      | -0.92      | -0.92      | -0.92      | -0.92      | -0.92       | -0.92     |  |
| 17   | -1.00 | -0.99 | -0.98 | -0.97 | -0.96 | -0.96 | -0.96 | -0.96      | -0.96      | -0.96      | -0.96      | -0.96      | -0.95      | -0.95       | -0.95     |  |
| 16   | -1.01 | -1.02 | -1.01 | -1.01 | -1.00 | -1.00 | -1.00 | -1.00      | -1.00      | -1.00      | -1.00      | -1.00      | -0.99      | -0.99       | -0.99     |  |
| 15   | -1.03 | -1.05 | -1.05 | -1.04 | -1.04 | -1.04 | -1.04 | -1.04      | -1.04      | -1.04      | -1.04      | -1.04      | -1.04      | -1.04       | -1.04     |  |
| 14   | -1.04 | -1.08 | -1.08 | -1.08 | -1.08 | -1.08 | -1.08 | -1.08      | -1.08      | -1.08      | -1.08      | -1.08      | -1.08      | -1.08       | -1.08     |  |
| 13   | -1.06 | -1.11 | -1.12 | -1.12 | -1.12 | -1.12 | -1.12 | -1.12      | -1.12      | -1.12      | -1.12      | -1.12      | -1.12      | -1.13       | -1.13     |  |
| 12   | -1.07 | -1.14 | -1.15 | -1.16 | -1.16 | -1.16 | -1.16 | -1.17      | -1.17      | -1.17      | -1.17      | -1.17      | -1.17      | -1.17       | -1.17     |  |
| 11   | -1.09 | -1.17 | -1.19 | -1.20 | -1.20 | -1.21 | -1.21 | -1.21      | -1.21      | -1.22      | -1.22      | -1.22      | -1.22      | -1.22       | -1.22     |  |
| 10   | -1.10 | -1.20 | -1.23 | -1.24 | -1.25 | -1.25 | -1.26 | -1.26      | -1.26      | -1.27      | -1.27      | -1.27      | -1.28      | -1.28       | -1.28     |  |
| 9  | -1.11 | -1.23 | -1.27 | -1.29 | -1.30 | -1.30 | -1.31 | -1.31      | -1.32      | -1.32      | -1.33      | -1.33      | -1.33      | -1.34       | -1.34     |  |
| 8  | -1.12 | -1.26 | -1.31 | -1.33 | -1.35 | -1.36 | -1.36 | -1.36      | -1.37      | -1.37      | -1.39      | -1.39      | -1.40      | -1.40       | -1.40     |  |
| 7  | -1.13 | -1.29 | -1.35 | -1.38 | -1.40 | -1.41 | -1.42 | -1.43      | -1.44      | -1.44      | -1.45      | -1.46      | -1.46      | -1.47       | -1.47     |  |
| 6  | -1.13 | -1.32 | -1.39 | -1.43 | -1.46 | -1.47 | -1.48 | -1.49      | -1.50      | -1.51      | -1.52      | -1.53      | -1.54      | -1.55       | -1.55     |  |
| 5  | -1.14 | -1.35 | -1.44 | -1.49 | -1.52 | -1.54 | -1.55 | -1.56      | -1.58      | -1.59      | -1.61      | -1.62      | -1.63      | -1.63       | -1.64     |  |
| 4  | -1.14 | -1.38 | -1.49 | -1.55 | -1.59 | -1.61 | -1.63 | -1.65      | -1.67      | -1.68      | -1.70      | -1.71      | -1.73      | -1.74       | -1.75     |  |
| 3  | -1.15 | -1.41 | -1.54 | -1.62 | -1.67 | -1.70 | -1.72 | -1.74      | -1.77      | -1.79      | -1.81      | -1.83      | -1.85      | -1.86       | -1.87     |  |
| 2  | -1.15 | -1.44 | -1.60 | -1.70 | -1.76 | -1.81 | -1.84 | -1.86      | -1.91      | -1.93      | -1.96      | -1.99      | -2.01      | -2.03       | -2.05     |  |
| 1  | -1.15 | -1.47 | -1.67 | -1.80 | -1.89 | -1.95 | -2.00 | -2.04      | -2.09      | -2.14      | -2.18      | -2.22      | -2.26      | -2.29       | -2.31     |  |
| 0  | -1.16 | -1.50 | -1.79 | -2.03 | -2.23 | -2.39 | -2.53 | -2.65      | -2.83      | -3.03      | -3.20      | -3.38      | -3.54      | -3.70       | -3.83     |  |

NOTE: When  $Q_U$  or  $Q_L$  falls between table values, estimate  $P_U$  or  $P_L$  to the closest 0.10.

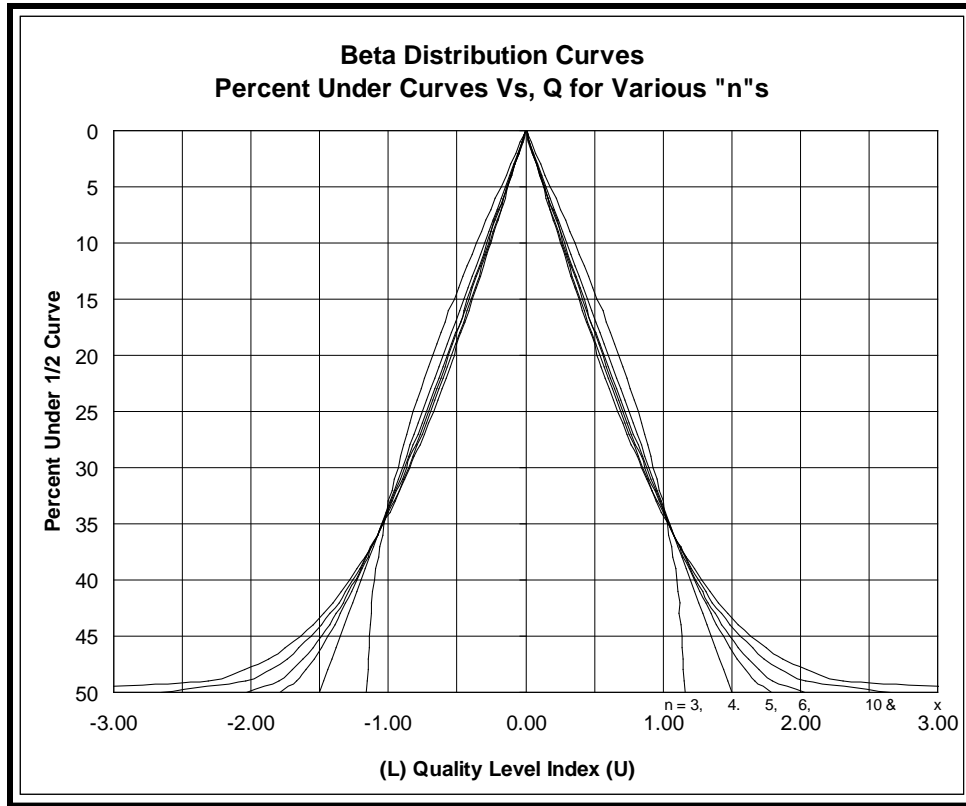


Figure 71-1

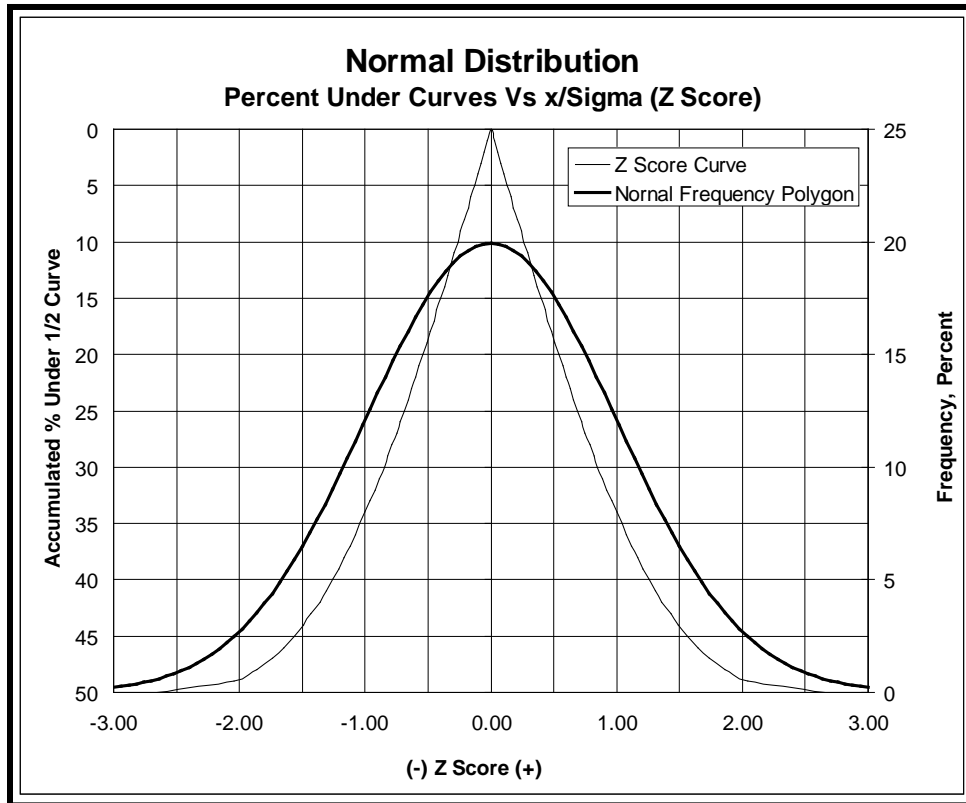


Figure 71-2

**Footnotes:**

1. Numerical Recipes in C, the Art of Scientific Computing; by W. H. Press, B.P. Flannery, S. A. Teukolsky and W.T. Vetterling. Cambridge University Press, The Pitt Bldg, Trumpington Street, CB2 1RP, 40 West 20th St., New York, NY 10011. Copyright 1988.
2. Development of a Highway Acceptance Plan, by Jack H. Willenbrock, Pennsylvania State University and Peter A. Kopac, Federal Highway Administration. TRR 691, Process Control in the Construction Industry, National Academy of Sciences, Washington, D.C. 1978.
3. Resolution of Beta-Distribution Formulas for Quality Level Analysis, a report to the Colorado Department of Transportation from the Colorado Workshop on Mathematical Problems in Industry, prepared by F. Jay Bourland, Department of Mathematics, Colorado State University, and Alistair Fitt, Department of Mathematics, University of Southampton.

## Determining Quality Level and Pay Factor Sample Calculation for Close Approximation - Manual Procedure

### To Solve for Quality Level:

This example will demonstrate the manual calculation of the Quality Level for asphalt density testing. With a nuclear gauge, the following test results were obtained: 92.5, 93.4, 94.8, 95.2, and 96.4. Using the density specification of 92 to 96 percent compaction.

Use Equations 3.1 and 3.2, to solve for the arithmetic mean and the standard deviation.

The arithmetic mean: 94.46  
Standard Deviation: 1.532

With those known, use Equations 3.3 and 3.4 to solve for the upper-quality index ( $Q_U$ ) and the lower quality index ( $Q_L$ ).

$$Q_U = \frac{96 - 94.46}{1.532} = 1.005 \qquad Q_L = \frac{94.46 - 92}{1.532} = 1.606$$

These values are then used to find percent within the upper specification limit ( $P_U$ ) and the percent within the lower specification limit ( $P_L$ ).

To find  $P_U$ , enter Table 71-1 at the column  $n = 5$ . Read down to find that 1.005 falls between 1.01 and 0.98. Therefore, interpolation must be done to find where  $P_U$  falls between 83 and 84.

$$\frac{X - 83}{1.005 - 0.98} = \frac{84 - 83}{1.01 - 0.98}$$

Solve for X

$$X = 83.83$$

Therefore,  $P_U = 83.83$

To find  $P_L$ , enter Table 71-1 at the column  $n = 5$ . Read down to find that 1.606 falls between 1.67 and 1.60. Therefore, interpolation must be done to find where  $P_L$  falls between 98 and 99.

$$\frac{X - 98}{1.606 - 1.60} = \frac{99 - 98}{1.67 - 1.60}$$

Solve for X

$$X = 98.09$$

Therefore,  $P_L = 98.09$

$P_U$  and  $P_L$  are plugged into Equation 3.5 to find the Quality Level ( $Q_L$ ).

$$Q_L = (83.83 + 98.09) - 100 = 81.92$$

$$Q_L = 81.9$$

### To Solve for Pay Factor:

Equations used to calculate Pay Factor are in the Revision of Sections 105 and 106, for both Quality of Hot Mix Asphalt (HMA) and Voids Acceptance of Hot Mix Asphalt, of the Standard Specifications.

#### When Pn is from 3 to 9 or greater than 200

$$P_n = 5 \quad Q_L = 81.9$$

Go to Table 105-3

Go to the formula for Pn = 5

$$0.25529 + 1.48268(Q_L/100) - 0.67759(Q_L/100)^2$$

$$0.25529 + 1.48268(81.9/100) - 0.67759(81.9/100)^2 = 1.015$$

Maximum PF for Pn = 5 is 1.030

Choose the smallest PF

$$PF = 1.015$$

#### When Pn is equal to or greater than 10 and less than 201

Example using Formula 1 when the number of tests equals 13:

$$P_n = 13 \quad Q_L = 81.9$$

Formula (1)

$$PF = \frac{(PF_1 + PF_2)}{2} + \left[ \frac{(PF_2 + PF_3)}{2} - \frac{(PF_1 + PF_2)}{2} \right] \times \frac{(P_{n_2} - P_{n_x})}{(P_{n_2} - P_{n_3})}$$

Use Table 105-3 to solve for PF<sub>1</sub>, PF<sub>2</sub>, and PF<sub>3</sub> of Formula 1. Use Table 105-3 to find P<sub>n2</sub>, P<sub>n3</sub>, and P<sub>nx</sub> of Formula 1.

PF<sub>1</sub> = Formula for Pn = 10 to 11

$$0.15344 + 1.50104(81.9/100) - 0.58896(81.9/100)^2 = 0.988$$

Maximum PF for Pn = 10 to 11 is 1.045

Choose smallest PF

$$PF_1 = 0.988$$

PF<sub>2</sub> = Formula for Pn = 12 to 14

$$0.07278 + 1.64285(81.9/100) - 0.65033(81.9/100)^2 = 0.982$$

Maximum PF for Pn = 12 to 14 is 1.045

Choose smallest PF

$$PF_2 = 0.982$$

PF<sub>3</sub> = Formula for Pn = 15 to 18

$$0.07826 + 1.55649(81.9/100) - 0.56616(81.9/100)^2 = 0.973$$

Maximum PF for Pn = 15 to 18 is 1.050

Choose smallest PF

$$PF_3 = 0.973$$

Pn<sub>2</sub> = Lowest Pn in 12 to 14

$$Pn_2 = 12$$

Pn<sub>3</sub> = Lowest Pn in 15 to 18

$$Pn_3 = 15$$

Pn<sub>x</sub> = 13

$$PF = \frac{(0.988 + 0.982)}{2} + \left[ \frac{(0.982 + 0.973)}{2} - \frac{(0.988 + 0.982)}{2} \right] \times \frac{(12 - 13)}{(12 - 15)} = 0.9825$$

Maximum PF for Pn = 12 to 14 is 1.045

Choose smallest PF

$$PF = 0.9825$$



### To Solve for Element Average Pay Factor:

At times, for instance, when the material is greater than 2V out, a separate process is started. This example will show how to determine an Average Pay Factor for an element that is represented by 3 different processes. Let's say the following Pay Factors were calculated:

$$PF_1 = 1.011 \text{ for } 10,000 \text{ tons}$$

$$PF_2 = 0.694 \text{ for } 500 \text{ tons}$$

$$PF_3 = 1.022 \text{ for } 10,500 \text{ tons}$$

$$PFA = \frac{[10,000(1.011) + 500(0.694) + 10,500(1.022)]}{10,000 + 500 + 10,500}$$

$$PFA = 1.009$$

### To Solve for Composite Pay Factor:

When each of the Element Pay Factors of an item has been calculated, the Composite Pay Factor is then found using the W Factor of the Standard Specials. The Composite Pay Factor is the total pay factor for an item, such as HMA. For example, the weights for the item HMA are:

|                 |      |
|-----------------|------|
| Gradation       | 20 % |
| Asphalt Content | 30 % |
| Asphalt Density | 50 % |

Let's say each element was calculated to have the following Average Pay Factors:

$$\text{Gradation} \quad 1.014$$

$$\text{Asphalt Content} \quad 1.026$$

$$\text{Asphalt Density} \quad 1.009$$

$$PFC = \frac{[.20(1.014) + .30(1.026) + .50(1.009)]}{.20 + .30 + .50}$$

$$PFC = 1.015$$

This Composite Pay Factor is then applied to calculate the incentive or disincentive. For example, if 21,000 tons of HMA were put down at a cost of \$30/ton:

$$(1.015 - 1)(21,000)(30) = \$9,450$$

The total incentive for this job would be \$9,450.

### When Paying Binder Separately

Binder can be paid for separately from the rest of the HMA. To calculate an incentive or a disincentive, the total cost of the binder and HMA must be found. An example follows that uses the following values:

|     |                           |           |
|-----|---------------------------|-----------|
| 403 | HMA (GR SX) (76)          | \$55/Ton  |
| 411 | Asphalt Cement (PG 58-40) | \$150/Ton |

|                |               |
|----------------|---------------|
| 1,000 tons mix | 5.35% asphalt |
| 1,000 tons mix | 5.30% asphalt |
| 1,000 tons mix | 5.35% asphalt |
| 1,000 tons mix | 5.32% asphalt |
| 720 tons mix   | 5.00% asphalt |

$$\frac{(1000)(5.35) + (1000)(5.30) + (1000)(5.35) + (1000)(5.32) + (720)(5.00)}{1000 + 1000 + 1000 + 1000 + 720} = 5.28\%$$

5.28% asphalt for 4,720 tons of mix

Solve for total cost of AC:

$$(4720 \text{ tons mix})(.0528 \text{ percent asphalt}) = 249.22 \text{ tons AC}$$

$$(249.22 \text{ tons AC})(\$150/\text{ton}) = \$37,383.00$$

Now solve for the Price/Ton for the combination of HMA and binder.

$$\text{Unit Price HMA (\$/ton)} + \frac{\text{Total Cost of AC (\$)}}{\text{Total tons HMA}}$$

$$\$55/\text{ton} + \frac{\$37,383}{4,720 \text{ tons HMA}} = \$62.92/\text{ton}$$

\$62.92 is the cost per ton for the **entire** mix, both HMA, and AC. This value is used to calculate the incentive or disincentive.

{Page Intentionally Left Blank}

## Colorado Procedure 74-21

*Standard Practice for*

### Operating Inertial Profilers and Evaluating Pavement Profiles

(This procedure modifies AASHTO R 57-14. The AASHTO R 57-14 is to be used in conjunction with this procedure.)

#### 1. SCOPE

1.1 This test method describes the procedures for operating and verifying the calibration of a profiler. This method also describes the evaluation procedures for the profiles that are generated to determine payment adjustments.

1.2 **This test method is identical to AASHTO R 57 with the following exceptions.**

#### 2. REFERENCED DOCUMENTS

Add the following to Section 2:

2.4 *Colorado Procedures:*

CP 78 Certification of High-Speed Profilers.

#### 5. EQUIPMENT

Delete Subsections 5.1, 5.3.1.1 and 5.3.1.1.1 and replace each with the following:

5.1 The inertial profiler shall meet the equipment requirements of CP 78. The inertial profiler shall be currently certified per CP 78.

5.3.1.1. Distance Calibration

5.3.1.1.1. The distance calibration shall be 1056 feet long and shall be on a relatively flat, straight section of pavement.

Add the following to Section 5:

5.4 The operator of the profiling equipment shall have a Current CDOT Profiler Operator Certification. The operator must be the driver of the vehicle and operate the data collection system. |

## 6. TEST PROCEDURE

Delete Steps 4 & 6 of Table 1 and replace with the following:

Step 4. Collect measurements in the direction of traffic. A lane will be tested at least one run. A lane may be retested only if the triggering system fails. The Contractor shall use automated triggering for the start and stop locations, and for the areas to be excluded. The locations of the triggers shall be painted on the pavement so that the Contractor can use the same trigger locations when the final profile is completed or when retesting is required. Triggers for starting and stopping a profile and the locations of exclusions shall be collected automatically during the test and may not be added before or after the collection of the profile. GPS triggering shall not be allowed for smoothness acceptance of data collection.

Step 6. Within 24 hours after each profile is collected, the Contractor shall submit the data electronically along with a Smoothness Acceptance Data Submittal form to the Department at [DOT\\_Profiles@state.co.us](mailto:DOT_Profiles@state.co.us) and the Project Engineer.

Add the following to Section 6:

6.1.1 The names of the files shall be in the following format:

PPPPP\_HHHHHH\_DDDDD\_LLL\_MMM\_TTT

Where:

P - is the 5 digit Contract IDs, formally known as the project subaccount number

H - is the highway number. Example I-25, SH-287, or US-40.

D - is the official highway direction, not the apparent direction of travel. Odd highway numbers are north and south, and even highway number is east and west.

L - is the lane number.

M - is additional information to identify the lane. This is useful if a lane is tested in sections to identify each section.

T - is an "initial" or "final" test.

6.1.2 Files submitted not following the above file naming convention may be rejected and require retesting if the location of the run cannot be determined.

6.1.3 Files shall be submitted using the PPF file format and the profiler's native file format and shall indicate locations of exclusions. The ERD file format is not acceptable. CCP Unit may request data formats not listed above.

6.1.4 Initial and Final runs shall have the same file name other than the initial or final designation.

6.5 A Smoothness Acceptance Data Submittal form shall be submitted with the electronic data to the Project. A minimum of one data submittal form per day shall be submitted. The data submittal form shall contain the following for each run:

- Project Number
- Project Code (Contract ID)
- Region
- Profiler Certification Identification Number
- Profiler Operator's name
- Highway number
- Pavement type (PCCP or HMA)
- Smoothness Category
- Date Runs were performed on; designate runs as "Initial" or "Final"
- Contact information and signature of CDOT representative on-site during the performance of HSP runs
- Location and description of 1056 LF Distance Calibration site
- Ambient temperature on-site at the start and end of HSP runs
- Lane number (Lanes are numbered from the left to the right in the direction of travel)
- Direction of travel
- File names
- Run Number (1<sup>st</sup>, 2<sup>nd</sup> or 3<sup>rd</sup>)
- Time each run was completed
- Location of exclusions (In miles from the beginning of the test)
- Description of each trigger.

A Smoothness Acceptance Data Submittal form is attached at the end of this procedure. An electronic copy of the Smoothness Acceptance Data Submittal form in MS Excel or .pdf format may be obtained by e-mail. [dot\\_profiles@state.co.us](mailto:dot_profiles@state.co.us).

## 8. DATA ANALYSIS

8.1 The Department will analyze the data with the profiler manufacturer's software or the the latest version of ProVAL.



## Colorado Procedure 75-08

### *Standard Practice for*

## Stratified Random Sampling of Materials

### 1. SCOPE

- 1.1 This practice covers the random selection of materials to be sampled and tested.
- 1.2 This Standard may involve hazardous materials, operations, and equipment. This Standard does not purport to address all of the safety problems associated with its use. It is the responsibility of the user of this Standard to establish appropriate safety and health practices before use.

### 2. REFERENCED DOCUMENTS

- 2.1 *ASTM Standard:*  
D 3665 Standard Practice for Random Sampling of Construction Materials.

### 3. SIGNIFICANCE AND USE

- 3.1 The sampling and testing procedures to be followed are specified in the procedures of the tests required.
- 3.2 The sampling of materials is one of the most critical steps in materials testing. If the material to be tested to determine conformity to specifications is not chosen randomly, the tests will not reflect the true characteristics of the material being evaluated. Most specifications require samples to be taken using a stratified random process. Stratified random requires that one random sample is selected from each sub-lot or the quantity represented by the minimum sampling frequency. Stratified random sampling ensures that samples are selected uniformly throughout the entire production process.
- 3.3 Random sampling ensures that all produced material will have an equal chance of being selected for testing. No material is excluded from the chance of being selected unless it is specified in the test specification.
- 3.4 It is the nature of random testing that some of the samples will represent below-average material, just as they will sometimes represent above-average material.
- 3.5 Random number schedules should be predetermined using an established random process. CDOT has developed a random schedule program that can be used for sampling all construction materials. The *Random Schedule* program is included in the Asphalt03 and Voids03 computer programs. Random number schedules used for sampling should not be shared with the supplier before the sample is taken. Contractors can generate their random number schedules as needed using the computer program. Extra samples may be taken for the contractor's use at the time of sampling.



- 3.6 Stratified random sampling is called for in most of the CDOT specifications. However, some specifications have a minimum sampling frequency of one per day. Regardless of the quantity produced that day one sample is still required. A predetermined random sampling schedule has no way of knowing what the daily production will be. It is the responsibility of the tester to ensure that the minimum sampling frequency is met in these cases. Other specifications require that a minimum number of samples to be taken regardless of the produced quantity. In these cases, the planned quantity is divided by the number of required samples to determine the sampling frequency. A stratified random schedule should be generated using the new sampling frequency.

#### **4. CDOT RANDOM SCHEDULE PROGRAM**

- 4.1 CDOT random schedule program is contained in both the Asphalt03 and Voids03 computer programs, found under Tools. It is written in Microsoft Excel and can be used to generate a random sampling schedule for all materials.

#### **5. GENERATING A RANDOM SCHEDULE**

- 5.1 Open the *Random Schedule* program. Enable the macros when asked. Instructions for using the program are included in the Instructions worksheet. Read through the instructions before using the program. The program requires that Excel's Analysis ToolPak - VBA be installed before the macros will run properly. Follow the instructions on the Instructions worksheet to do this.
- 5.2 Move to the "Rand Nos" worksheet. Enter the project information into the green shaded cells. Click the "Clear No's" button to clear the worksheet. Click the "Generate Random Numbers" button to generate a set of random numbers. Click the "Print" button to print the random number schedule.
- 5.2.1 The random schedule program has the option of generating offset random numbers. Offset numbers are used to find a random transverse location. For example, the correct random location for a mat density test is the combination to two random numbers, the longitudinal (along the length of the pavement) and transverse (across the width of the pavement). The generation of transverse numbers can be turned off by changing the cell for generating offset numbers to "No". The "Transverse-Convert" worksheet contains a table that can help you convert the transverse random number into feet and inches based on the width of the pavement.
- 5.2.2 The random schedule program can only generate up to 70 numbers at one time. To generate numbers over 70 follow the instructions in the "Instructions" worksheet.
- 5.3 Repeat the steps in Subsection 5.2 to generate a random schedule for all materials and test elements for the project.

#### **6. COMPLETING THE RANDOM SCHEDULE FORM**

- 6.1 On the project, sample as close as possible to the values represented on the sampling schedule. Fill in the "Taken At" column of the random schedule form as samples are being selected. Major deviations from the sampling schedule should be noted and explained on the form or add pages as needed.

## Colorado Procedure 76-20

### *Standard Practice for*

### **Verification of Equipment Used to Field Test Bituminous Mixtures**

#### **1. SCOPE**

- 1.1 This method of test covers the verification of equipment used to field test bituminous mixtures and provides documentation that the equipment verification has been done.

#### **2. REFERENCED DOCUMENTS**

##### 2.1 *Colorado Procedures*

CP 31 Sieve Analysis of Aggregates

CP 51 Determining the Maximum Specific Gravity of Bituminous Mixtures

CP 81 Density of In-Place Bituminous Pavement by the Nuclear Method

CP 85 Asphaltic Cement Content of Asphalt Concrete Mixtures by the Nuclear Method

#### **3. TERMINOLOGY**

- 3.1 *Daily Verification* - Verification procedures that are carried out each day the laboratory equipment is used for testing. The verification is documented once per month.
- 3.2 *Weekly Verification* - Verification procedures which are carried out approximately once per week while the laboratory equipment is being used for testing. The verification is documented once per month.
- 3.3 *Monthly Verification* - Verification procedures which are carried out approximately once per month while the laboratory equipment is being used for testing. The verification is documented.
- 3.4 *Annual Verification* - Verification procedures which are carried out approximately once per year or each time the materials test trailer is moved. This may be done at the same time as the equipment is being calibrated. The verification is documented.

#### **4. APPARATUS**

- 4.1 *Thermometers* - Alcohol or mercury-filled glass thermometers or calibrated digital thermometers capable of reading 250°F by 2°F (121°C by 1°C) and 77°F by 2°F (25°C by 1°C).

#### **5. PROCEDURE**

- 5.1 The following verification procedures are to be routinely carried out. If there is any question about the calibration of equipment, the verification procedures relating to the equipment must be carried out immediately.
- 5.2 If the verification procedure indicates that a problem exists, the problem must be addressed before further testing is conducted using the equipment.

**6. DAILY EQUIPMENT VERIFICATION**

- 6.1 Verify daily that the Nuclear Moisture/ Density (M/D) Gauge meets the standardization check on a reference standard block as specified in CP 81. Record on CDOT Form 746.
- 6.2 Verify daily that the Nuclear Asphalt Content (AC) Gauge meets the standard background test as specified in CP 85. Record on CDOT Form 772.

**7. WEEKLY EQUIPMENT VERIFICATION**

- 7.1 Verify weekly that the oil in the vacuum pump used in CP 51 is not contaminated with water. Examine the desiccating crystals and oven-dry them when necessary.
- 7.2 Verify that the #200 (75  $\mu$ m) sieve screen used for aggregate washes in CP 31 is free from holes and is tight.
- 7.3 Verify that the sieves used for gradations in CP 31 shall have tight screen mesh, cannot move, with no permanent deformation in the screen, and that there are no obvious defects, such as holes or broken solder in any of the screens. Also, ensure that the nested sieves fit together tightly enough to prevent loss of material during sieving and have a reasonably easy fit with the next sieve in the nest of sieves.
- 7.4 Verify that all scales are level.

**8. MONTHLY EQUIPMENT VERIFICATION**

- 8.1 Verify monthly that the mercury in the manometer used to measure the vacuum applied to samples in CP 51 is free of air bubbles.
- 8.2 Oven-dry the desiccating agent in the vacuum pump setup in CP 51 (indicating silica gel, 6-16 mesh, VWR).
- 8.3 Verify the weights of the flasks used to measure the maximum specific gravity in CP 51. The weights are measured with the flasks full of 77°F  $\pm$  1°F (25.0°C  $\pm$  0.5°C) water and covered by the same cover plate that is used during the test. If you are using temperatures other than 77°F (25°C) in the Rice test, prepare a chart of flask weight vs. water temperature containing at least 5 points, which span all of the temperatures you will be using.
- 8.4 Verify monthly that the Nuclear Asphalt Content (AC) Gauge meets the statistical stability test and the drift test as specified in CP 85.

**9. ANNUAL EQUIPMENT VERIFICATION**

- 9.1 Verify scale readings using a reference weight or weight set.
- 9.2 Verify the time that aggregate sieving is done by running the sieving adequacy test defined in CP 31.



{Page Intentionally Left Blank}

## Colorado Procedure 77-18

### *Standard Procedure for*

## Determination of Macro-Texture of a Pavement Surface

### 1. SCOPE

- 1.1 This test method describes the means to evaluate the macro-texture of an HMA or PCCP pavement surface.
- 1.2 This CP may involve hazardous materials, operations, and equipment. This CP does not purport to address all of the safety problems associated with the CP's use. The CP user's responsibility is to establish appropriate safety and health practices and determine the applicability of regulatory limitations before use.

### 2. REFERENCE

- 2.1 *AASHTO Standards:*  
M 247-07, Type 1 Glass Beads Used In Traffic Paints
- 2.2 *ASTM Standards:*  
E 1094-04 Pharmaceutical Glass or ISO Standard 6706 Plastic Laboratory Ware - Graduated Measuring Cylinders
- 2.3 *CP Standards:*  
FMM Appendix L, Random Sampling

### 3. TERMINOLOGY

- 3.1 Terms and abbreviations shall be as per the CDOT Standard Specifications and the Field Materials Manual.

### Method A – Milled HMA Surface

### 4. SIGNIFICANCE AND USE

- 4.1 This CP is used to evaluate the macro-texture of a milled HMA pavement surface.

### 5. APPARATUS

- 5.1 *Filler:* Type 1 glass beads per AASHTO M 247-07.
- 5.2 *Spreader:* A flat, stiff, hard disk made from methyl methacrylate (Plexiglas) with a thickness of 0.5 ± 0.1 in., with a diameter of 8 ± 2 in. and a round handle affixed in the center used to spread the filler.

- 5.3 *Graduate*: A conical or cylindrical shape graduate, Type 1, Class B, or better, 250 ml capacity conforming to the volume and accuracy requirements of ASTM E 1094-04 or ISO Standard 6706 used to measure the volume of filler for the test.
- 5.4 *Brushes*: A stiff wire brush and a soft-bristle brush used to clean the pavement.
- 5.5 *Container*: A small container with a secure and easily removable cover used to store at least 200 ml of filler.
- 5.6 *Screen*: A shield used to protect the test area from air turbulence created from wind or traffic.

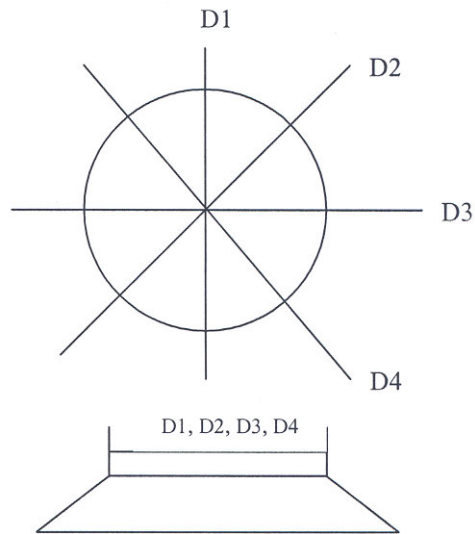
## 6. LABORATORY PREPARATION

- 6.1 Prepare one container for each sample location.
- 6.2 Fill the graduate with  $200 \pm 2$  ml of filler.
- 6.3 Gently tap the side of the graduate to level the surface of the filler.
- 6.4 Place the measured volume of filler in the container.
- 6.5 Label the container with type and quantity of filler.

## 7. PROCEDURE

- 7.1 Randomly determine a sample location on the milled pavement surface following the CP 75 Random Sampling, to test the macro-texture.
- 7.2 Inspect the sample location and ensure it is a dry, homogeneous site, free of unique or localized features such as cracks, joints, stripping, and patching.
- 7.3 If localized features are present, move up-station at the same transverse offset until a suitable site is found.
- 7.4 Gently clean an area of about 1 foot by 1 foot for the sample location using the stiff wire brush to remove any, residue, debris, or loosely bonded material. Be careful not to dislodge bonded material. After using the stiff wire brush, gently brush the sample location with the soft bristle brush to remove any remaining debris.
- 7.5 Place the screen on the milled pavement surface to protect the sample location from air turbulence.
- 7.6 Hold the container with filler above the pavement at the sample location at a height not greater than 4 in.
- 7.7 Pour the measured volume of filler from the container onto the milled pavement surface into a conical pile.
- 7.8 Place the spreader lightly on top of the conical pile of filler being careful not to compact the filler.

- 7.9 Move the spreader in a slow, circular motion to disperse the filler in a circular area and to create a defined crest around the perimeter. An alteration of the circular pattern is unacceptable and should be minimized.
- 7.10 Continue spreading the filler until it is well dispersed and the spreader rides on top of the high points, of the milled pavement surface.
- 7.11 Measure and record the diameter of the circular area four times, at intervals of 45° and to the nearest 0.1 in., as shown in Figure 1.



**FIGURE 1: Typical Measuring Pattern**

- 7.12 Measure the diameter of the circular area from the top (crest) of the slope on one side, through the center, and to the top (crest) of the slope on the other side of the circular area.
- 7.13 Calculate the average diameter of the circular area covered by the filler.
- 7.14 Determine the macro-texture thickness of the milled pavement surface by using the Cross-reference table on the bottom of the Macro-Texture Report form for Method A. Report the result to three decimal places.
- 7.15 Remove the filler material from the location using the soft bristle brush and repeat Subsections 7.5 through 7.14.
- 7.16 Determine the average macro-texture thickness by adding the two results determined in Subsection 7.14 and dividing by 2. Report the result to three decimal places.



## Method B – PCCP Surface

### 8. SIGNIFICANCE AND USE

8.1 This method is used to evaluate the macro-texture of a PCCP surface.

### 9. APPARATUS

9.1 *Filler:* Type 1 glass beads per AASHTO M 247-11.

9.2 *Spreader:* A flat, stiff hard disk with a thickness of  $1.0 \pm 0.5$  in., with a diameter of  $4 \pm 2$  in.

9.3 *Graduate:* A conical or cylindrical shape graduate, Type 1, Class B, or better, 250 ml capacity conforming to the volume and accuracy requirements of ASTM E 1094-04 or ISO Standard 6706 used to measure the volume of filler for the test.

9.4 *Brushes:* A stiff wire brush and a soft-bristle brush used to clean the pavement.

9.5 *Container:* A small container with a secure and easily removable cover used to store at least 50 ml of filler.

9.6 *Screen:* A shield used to protect the test area from air turbulence created from wind or traffic.

### 10. LABORATORY PREPARATION

10.1 Prepare one container for each sample location.

10.2 Fill the graduate with  $25 \pm 2$  ml of filler.

10.3 Gently tap the side of the graduate to level the surface of the filler.

10.4 Place the measured volume of filler in the container.

10.5 Label the container with type and quantity of filler.

### 11. PROCEDURE

11.1 Randomly determine a sample location on the pavement surface per CP 75 Random Sampling procedure, to test the macro-texture.

11.2 Gently clean an area of about 1 foot by 1 foot for the sample location using the stiff wire brush to remove any, residue, debris, or loosely bonded material. Be careful not to dislodge bonded material. After using the stiff wire brush, gently brush the sample location with the soft bristle brush to remove any remaining debris.

- 11.3 Place the screen on the pavement surface to protect the sample location from air turbulence.
- 11.4 Hold the container with filler above the pavement at the sample location at a height not greater than 4 in.
- 11.5 Pour the measured volume of filler from the container onto the milled pavement surface into a conical pile.
- 11.6 Place the spreader lightly on top of the conical pile of filler being careful not to compact the filler.
- 11.7 Move the spreader in a slow, circular motion to disperse the filler in a circular area and to create a defined crest around the perimeter. An alteration of the circular pattern is unacceptable and should be minimized
- 11.8 Continue spreading the filler until it is well dispersed and the spreader rides on top of the high points of the pavement surface.
- 11.9 Measure and record the diameter of the circular area four times, at intervals of 45° and to the nearest 0.1 in., as shown in Figure 1.
- 11.10 Calculate the average diameter of the circular area covered by the filler.
- 11.11 Determine the macro-texture thickness of the pavement surface by using the cross-reference table on the bottom of the Macro-Texture Report Form for Method B. Report the result to three decimal places.
- 11.12 Repeat Subsections 11.2 through 11.11 two more times on areas within the selected PCCP panel.
- 11.13 Remove the filler material from the locations and properly dispose of the material.

**12. CALCULATIONS**

12.1 Calculate the average diameter of the circular area covered by the filler.

$$Da = (D1 + D2 + D3 + D4) / 4$$

Where:

Da = Average diameter of the filler area, inches  
D1, D2, D3, D4 = Diameters of the filler area, in.

$$\text{Area (in}^2\text{)} = \pi Da^2/4$$

Calculate the volume of filler in cubic inches (in.<sup>3</sup>)

$$V (\text{in.}^3) = V (\text{ml}) / 16.387 \text{ ml/in.}^3$$

Calculate Macro-Texture Depth (inches):

Depth: Volume of the filler (in<sup>3</sup>) divided by Area of the filler (in.<sup>2</sup>).

Example:

Da = 8.0 inches

$$\text{Area} = \pi Da^2/4 \rightarrow \pi 8.0^2/4 = 50.265 \text{ in.}^2$$

Volume of filler = 25 ml → Converting ml to cubic inches = 25/16.387 = 1.525 in.<sup>3</sup>

Depth = 1.525 in.<sup>3</sup>/50.265 in.<sup>2</sup> = 0.030 in.

12.2 Calculate the Average Texture Depth (ATD) of the selected PCCP panel by adding the individual macro-texture depth results and dividing by three.

12.3. Report the ATD to the nearest 0.001 inches.

**13. REPORT**

13.1 Report the following information:

Project Rep.  
Date of Report  
Project number  
Contract ID  
Name of the prime contractor and representative  
Test #  
Date of test  
Station or Milepost of sample location  
The offset of the sample location  
The diameter of the filler area, D1, D2, D3, D4  
The average diameter of the filler area  
Macro-texture Depth

**MACRO-TEXTURE REPORT (METHOD A)**

Project Rep.: \_\_\_\_\_

Date of Report: \_\_\_\_\_

Project No: \_\_\_\_\_

Contract ID: \_\_\_\_\_

Milling Contractor: \_\_\_\_\_

Prime Contractor: \_\_\_\_\_

Milling Rep.: \_\_\_\_\_

Prime Rep.: \_\_\_\_\_

| Test #    | Date | Sta | Offset | Dia. D1 (in) | Dia. D2 (in) | Dia. D3 (in) | Dia. D4 (in) | Dia. Avg (in) | Macro Texture |
|-----------|------|-----|--------|--------------|--------------|--------------|--------------|---------------|---------------|
|           |      |     |        |              |              |              |              |               |               |
| Average = |      |     |        |              |              |              |              |               |               |
|           |      |     |        |              |              |              |              |               |               |
| Average = |      |     |        |              |              |              |              |               |               |
|           |      |     |        |              |              |              |              |               |               |
| Average = |      |     |        |              |              |              |              |               |               |
|           |      |     |        |              |              |              |              |               |               |
| Average = |      |     |        |              |              |              |              |               |               |

**MACRO-TEXTURE THICKNESS BASED ON 200 ML OF FILLER AND AVERAGE DIAMETER**

| Average Diameter (inches) | Macrotexture Thickness (inches) | Average Diameter (inches) | Macrotexture Thickness (inches) | Average Diameter (inches) | Macrotexture Thickness (inches) |
|---------------------------|---------------------------------|---------------------------|---------------------------------|---------------------------|---------------------------------|
| 7.1                       | 0.308                           | 8.8                       | 0.201                           | 10.5                      | 0.141                           |
| 7.2                       | 0.300                           | 8.9                       | 0.196                           | 10.6                      | 0.138                           |
| 7.3                       | 0.292                           | 9.0                       | 0.192                           | 10.7                      | 0.136                           |
| 7.4                       | 0.284                           | 9.1                       | 0.188                           | 10.8                      | 0.133                           |
| 7.5                       | 0.276                           | 9.2                       | 0.184                           | 10.9                      | 0.131                           |
| 7.6                       | 0.269                           | 9.3                       | 0.180                           | 11.0                      | 0.128                           |
| 7.7                       | 0.262                           | 9.4                       | 0.176                           | 11.1                      | 0.126                           |
| 7.8                       | 0.255                           | 9.5                       | 0.172                           | 11.2                      | 0.124                           |
| 7.9                       | 0.249                           | 9.6                       | 0.169                           | 11.3                      | 0.122                           |
| 8.0                       | 0.243                           | 9.7                       | 0.165                           | 11.4                      | 0.120                           |
| 8.1                       | 0.237                           | 9.8                       | 0.162                           | 11.5                      | 0.117                           |
| 8.2                       | 0.231                           | 9.9                       | 0.159                           | 11.6                      | 0.115                           |
| 8.3                       | 0.226                           | 10.0                      | 0.155                           | 11.7                      | 0.113                           |
| 8.4                       | 0.220                           | 10.1                      | 0.152                           | 11.8                      | 0.112                           |
| 8.5                       | 0.215                           | 10.2                      | 0.149                           | 11.9                      | 0.110                           |
| 8.6                       | 0.210                           | 10.3                      | 0.146                           | 12.0                      | 0.108                           |
| 8.7                       | 0.205                           | 10.4                      | 0.144                           | 12.1                      | 0.106                           |

### MACRO-TEXTURE REPORT (METHOD B)

Project Rep.: \_\_\_\_\_

Date of Report: \_\_\_\_\_

Project No: \_\_\_\_\_

Contract ID: \_\_\_\_\_

Milling Contractor: \_\_\_\_\_

Prime Contractor: \_\_\_\_\_

Milling Rep.: \_\_\_\_\_

Prime Rep.: \_\_\_\_\_

| Test #    | Date | Station | Offset | Dia. D1 (in) | Dia. D2 (in) | Dia. D3 (in) | Dia. D4 (in) | Average Dia. (in) | Texture Depth |
|-----------|------|---------|--------|--------------|--------------|--------------|--------------|-------------------|---------------|
|           |      |         |        |              |              |              |              |                   |               |
|           |      |         |        |              |              |              |              |                   |               |
|           |      |         |        |              |              |              |              |                   |               |
| Average = |      |         |        |              |              |              |              |                   |               |

| Test #    | Date | Station | Offset | Dia. D1 (in) | Dia. D2 (in) | Dia. D3 (in) | Dia. D4 (in) | Average Dia. (in) | Texture Depth |
|-----------|------|---------|--------|--------------|--------------|--------------|--------------|-------------------|---------------|
|           |      |         |        |              |              |              |              |                   |               |
|           |      |         |        |              |              |              |              |                   |               |
|           |      |         |        |              |              |              |              |                   |               |
| Average = |      |         |        |              |              |              |              |                   |               |

| Test #    | Date | Station | Offset | Dia. D1 (in) | Dia. D2 (in) | Dia. D3 (in) | Dia. D4 (in) | Average Dia. (in) | Texture Depth |
|-----------|------|---------|--------|--------------|--------------|--------------|--------------|-------------------|---------------|
|           |      |         |        |              |              |              |              |                   |               |
|           |      |         |        |              |              |              |              |                   |               |
|           |      |         |        |              |              |              |              |                   |               |
| Average = |      |         |        |              |              |              |              |                   |               |

#### MACRO-TEXTURE DEPTH BASED ON 25 ML OF FILLER AND AVERAGE DIAMETER

| Average Diameter (Inches) | Macrotexture Depth (Inches) | Average Diameter (Inches) | Macrotexture Depth (Inches) | Average Diameter (Inches) | Macrotexture Depth (Inches) | Average Diameter (Inches) | Macrotexture Depth (Inches) |
|---------------------------|-----------------------------|---------------------------|-----------------------------|---------------------------|-----------------------------|---------------------------|-----------------------------|
| 5                         | 0.078                       | 6.5                       | 0.046                       | 8                         | 0.030                       | 9.5                       | 0.022                       |
| 5.1                       | 0.075                       | 6.6                       | 0.045                       | 8.1                       | 0.030                       | 9.6                       | 0.021                       |
| 5.2                       | 0.072                       | 6.7                       | 0.043                       | 8.2                       | 0.029                       | 9.7                       | 0.021                       |
| 5.3                       | 0.069                       | 6.8                       | 0.042                       | 8.3                       | 0.028                       | 9.8                       | 0.020                       |
| 5.4                       | 0.067                       | 6.9                       | 0.041                       | 8.4                       | 0.028                       | 9.9                       | 0.020                       |
| 5.5                       | 0.064                       | 7                         | 0.040                       | 8.5                       | 0.027                       | 10                        | 0.019                       |
| 5.6                       | 0.062                       | 7.1                       | 0.039                       | 8.6                       | 0.026                       | 10.1                      | 0.019                       |
| 5.7                       | 0.060                       | 7.2                       | 0.037                       | 8.7                       | 0.026                       | 10.2                      | 0.019                       |
| 5.8                       | 0.058                       | 7.3                       | 0.036                       | 8.8                       | 0.025                       | 10.3                      | 0.018                       |
| 5.9                       | 0.056                       | 7.4                       | 0.035                       | 8.9                       | 0.025                       | 10.4                      | 0.018                       |
| 6                         | 0.054                       | 7.5                       | 0.035                       | 9                         | 0.024                       | 10.5                      | 0.018                       |
| 6.1                       | 0.052                       | 7.6                       | 0.034                       | 9.1                       | 0.023                       | 10.6                      | 0.017                       |
| 6.2                       | 0.050                       | 7.7                       | 0.033                       | 9.2                       | 0.023                       | 10.7                      | 0.017                       |
| 6.3                       | 0.049                       | 7.8                       | 0.032                       | 9.3                       | 0.022                       | 10.8                      | 0.017                       |
| 6.4                       | 0.047                       | 7.9                       | 0.031                       | 9.4                       | 0.022                       | 10.9                      | 0.016                       |

## Colorado Procedure 78-21

### *Standard Practice for*

## Certification of Inertial Profilers and Operators

### 1. SCOPE

- 1.1 This test method describes the procedures for certifying high-speed profilers for use on CDOT projects.

### 2. REFERENCED DOCUMENTS

- 2.1 International Cybernetics Corp. SurPRO 3500 User's Manual.
- 2.2 *AASHTO Standards:*  
M 328-10 Standard Equipment Specification for Inertial Profiler

### 3. EQUIPMENT

- 3.1 International Cybernetics Corporation's (ICC) SurPRO 3500.
- 3.2 Inertial Profiler
- 3.2.1 The Inertial Profiler shall meet the specifications of AASHTO M 328 except that profilers used to measure the smoothness on concrete pavement shall use approved line lasers with at least a 3 in. wide footprint. Line lasers shall be aligned transversely to the pavement. Inertial profilers may be Light Weight Profilers (LWP) or High-Speed Profilers (HSP).
- 3.2.2 The HSP or LWP shall use the following operation parameters:
- 3.2.2.1 Shall have two height sensors spaced at  $70 \pm 1$  inch. Profilers with 1 laser may be used for Process Control testing only.
- 3.2.2.2 The sample interval at which relative profile elevations are reported shall be less than or equal to one inch.
- 3.2.2.3 The algorithm for filtering the profile data shall use a cutoff wavelength of 300 ft.
- 3.2.2.4 The profiler shall be capable of automated triggering using reflective tape affixed to the pavement or traffic cones to start & stop data collection and indicate locations of exclusions. GPS triggering shall not be used.
- 3.2.2.5 Profilers used for Smoothness Acceptance Testing shall be capable of collecting profiles at a speed of at least 15 mph. LWPs may operate at a speed less than 15 mph for Process Control testing only.

#### **4. OPERATOR CERTIFICATION**

4.1 Operators shall attend the CDOT Profiler Operator Certification. The CDOT Profiler Operator Certification will include the following:

4.1.1 A course on the CDOT smoothness specification and basic profiler operations. |

4.1.1.1 Pass a written test on the CDOT smoothness specification with a score of at least 80%.

4.1.2 The operator will demonstrate proficiency in the operation of his profiler by successfully demonstrating the following:

- Height sensor calibration checks. (CDOT garage)
- Accelerometer calibration checks (CDOT garage)
- Distance calibration
- Bounce test. (CDOT garage)
- Setting triggering and collecting a profile with the triggering.
- Data submittal

4.2 The CDOT Profiler Operator Certification will expire on June 30th of the following year. |

#### **5. REFERENCE SITE SELECTION**

5.1 The Department will select a site to perform the Profiler Certification with the following requirements:

5.1.1 Shall be relatively straight, level, and smooth.

5.1.2 Shall have a sufficient distance for two consecutive 0.1-mile sections and sufficient distance to safely start & stop with a 300 ft. lead-in. |

5.1.3 The 0.1-mile sections shall have an average IRI value between 30 & 90 in/mile.

5.1.4 Shall be on a surface where the surface texture will have a minimal impact on data collection.

5.1.5 Shall be free of cracks in the traveled wheel paths.

5.1.6 Shall be on a relatively stable base with minimal traffic.

#### **6. REFERENCE VALUE DETERMINATION**

6.1 The device for determining the reference values shall be an ICC SurPRO 3500.

6.2 The reference site will be painted with a dot at least every 10 feet in the wheel paths.

6.3 The reference device will perform one closed-loop and two open loop data collection runs for each wheel path in the intended direction of travel. |

- 6.4 ProVAL will be used to determine the cross-correlation value for the closed-loop run in each wheel path. A minimum cross-correlation value of 0.95 will be required to accept each wheel path.
- 6.5 If the cross-correlation values for a wheel path are less than 0.95 it shall be retested according to Subsection 6.3.
- 6.6 The profile from one of the three reference runs for each 0.1-mile section for each wheel path will be used as the reference values for the certification. These values will not be shared with the participants.

## **7. PROFILER CERTIFICATION PROCEDURE**

- 7.1 Before the profilers start collecting certification data, the profiler's subsystems shall pass the manufacturer's calibrations checks for the height sensor, accelerometer, and bounce test. These checks will be performed at the CDOT Central Lab.
- 7.2 Before the profilers start collecting certification data, the profiler's distance measuring instrument shall be calibrated following the manufacturer's procedures using the distance calibration site at the profiler certification site.
- 7.3 The operator shall install the triggers appropriate for their profiler's triggering system at the beginning and end of the certification course if the already installed triggers do not trigger their profiler. GPS triggering shall not be allowed.
- 7.4 The operator shall collect twelve profiles in the intended direction of travel at a minimum speed of at least 15 MPH.
- 7.5 The operator shall provide the Department the raw data files and data files that can be opened in ProVAL (ERD or PPF).
- 7.6 Data files for the twelve profiles shall be submitted to the Department on a thumb drive immediately after the completion of the twelve profiles. The media may not be returned to the operator.
- 7.6.1 Filenames shall be in the following format:  
COMPANY NAME\_Run\_XX.PPF(or ERD)
- 7.7 The data files will be analyzed by the Department.

## **8. ACCEPTANCE DETERMINATION**

- 8.1 Repeatability of the profiler will be evaluated using ProVAL. ProVAL will determine the cross-correlation value for the 1<sup>st</sup> 10 profiles in each wheel path. A minimum cross-correlation value of 0.92 will be required to pass.



- 8.2 Accuracy of the profiler will be evaluated using ProVAL. Each of the 10 profiles will be compared to the reference profile for each wheel path. The accuracy score for each profile in each wheel path will be averaged. Both wheel paths shall have an average accuracy score of at least 0.90.

NOTE 1: Details of the procedures for evaluation of profiles for repeatability and accuracy are detailed in AASHTO M 328

- 8.3 Passing the repeatability and accuracy requirements is required to pass the certification criteria.
- 8.4 If the criteria in Section 8.1 or 8.2 are not met, then the 11<sup>th</sup> profile will be substituted for the 1<sup>st</sup> profile, and the analysis will be re-run.
- 8.5 If the analysis in Section 8.4 does not meet the criteria in Section 8.1 or 8.2, the 11<sup>th</sup> and 12<sup>th</sup> profile will be substituted for the 1<sup>st</sup> and 2<sup>nd</sup> profile and the analysis will be re-run.
- 8.6 If the analysis in Section 8.5 does not meet the criteria in Section 8.1 or 8.2; the profiler's subsystems will need to be rechecked and 12 new profiles collected according to Section 7.
- 8.7 A profiler will only be allowed 2 trials. Profilers that fail to meet the certification criteria shall require repair and/or maintenance from the manufacturer. The profiler will not be allowed to attempt certification until a written statement describing the maintenance or repairs is submitted to the Department. This shall also include documentation that the profiler can pass the repeatability requirement.

## 9. CERTIFICATION

- 9.1 After a profiler is determined to be acceptable, a Certificate will be issued listing:
- Profiler serial number
  - Profiler VIN #
  - Profiler Make & Model
  - Height sensor serial numbers
  - Accelerometer serial numbers
  - Certification Date
  - Expiration Date
- 9.2 The certification will expire on June 30th of the following year. |
- 9.3 A list of certified profilers and operators is posted on CDOT's web at <https://www.codot.gov/business/designsupport/matgeo/pave-smooth-testing>

**10. SUSPENSION OF CERTIFICATION**

**Note 2:** This Section is used when a Contractor's profiler fails to meet the Smoothness Verification Testing acceptance criteria.

- 10.1 The Contractor's profiler shall collect three profiles at a site chosen by the Department. The site will meet the requirements of Section 5.
- 10.2 CDOT profiler will collect three profiles at the site.
- 10.3 The data files for the three profiles shall be submitted to the CDOT in a thumb drive. The media will not be returned to the Contractor.
- 10.4 The Department will determine an average MRI for each 0.1-mile section using the Department's profiler's results.
- 10.5 The Contractor's Profiler's results will be compared to the Department's results.
- 10.6 The Contractor's Profiler will retain its certification if the average MRI for each 0.1-mile section does not vary from the Department's MRI values by more than 6.0 in/mile.
- 10.7 If the Contractor's profiler fails to meet the criteria in Subsection 10.6, the Contractor's profiler will be allowed to collect three additional profiles and then it will be re-evaluated.
- 10.8 If the Contractor's profiler fails to meet the criteria in Subsection 10.6 a second time, the Contractor's profiler's Certification will be suspended.
- 10.9 The Contractor's profiler shall be repaired and/or adjusted/calibrated by the manufacturer.
- 10.10 If the Contractor wants to have his profiler recertified after repairs have been made before the next annual certification, all costs associated with the recertification shall be borne by the Contractor.

{Page Intentionally Left Blank}

## Colorado Procedure 79-20

### *Standard Practice for*

## Evaluating MIT Scan Images for Uncut Dowel Baskets

### 1. SCOPE

- 1.1. This practice is used to determine the acceptance of dowel bars in PCCP when dowel bars are installed with metallic dowel baskets and the shipping braces are not cut before concrete placement. Dowels placed with metallic dowel baskets that have the shipping braces or with the non-metallic basket will be accepted using the joint score.
- 1.2. Uncut shipping braces on metallic dowel basket interferes with the MIT Scan and creates ghost bars, uninterpretable data, or missing bars.
- 1.3. Materials Bulletin 2011-1 provides general guidance on the operation of the MIT Scan-2. The Materials Bulletin can be located at:  
  
<https://www.codot.gov/business/designsupport/materials-and-geotechnical/materials-bulletins/2011-1-July%2014-2011/view>
- 1.4. This practice shows example MIT Scan-2 image maps and a corresponding picture of the dowel basket alignment without concrete. The example images show only one lane of pavement with 5 bars per wheel path spaced 1 foot apart. Two bars in the center of the lane are not installed per CDOT standard plans
- 1.5. This CP provides examples of the most common dowel basket alignments. Further assistance can be obtained by contacting the Concrete and Physical Properties Lab.

**2. DOWEL BAR BASKET IMAGES**

2.1 Figure 79-1 shows a properly aligned dowel basket under the MIT Scan-2 tracks. Figure 79-2 shows the corresponding MIT Scan-2 image map. This joint would be accepted without requiring corrective work.



Figure 79-1

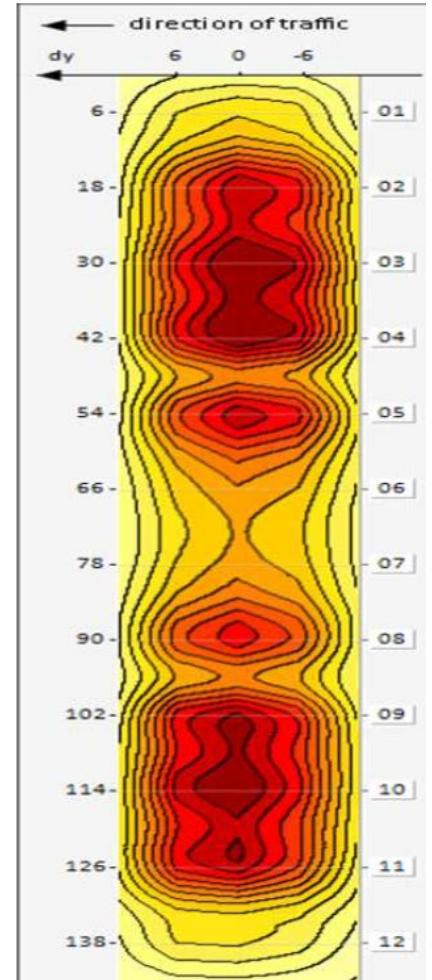


Figure 79-2



2.2 Figure 79-3 shows a basket that is not centered on the saw cut joint but otherwise aligned. The saw cut is indicated by the black line on the MIT Scan-2 tracks. Figure 79-4 shows the corresponding MIT Scan-2 image map. Further investigation of this joint with cores or a pachometer should be conducted to determine if the minimum 6 inches of embedment on each side of the joint is achieved. If 6 inches of embedment on each side of the joint is not achieved, the joint is rejected and requires corrective work.



Figure 79-3

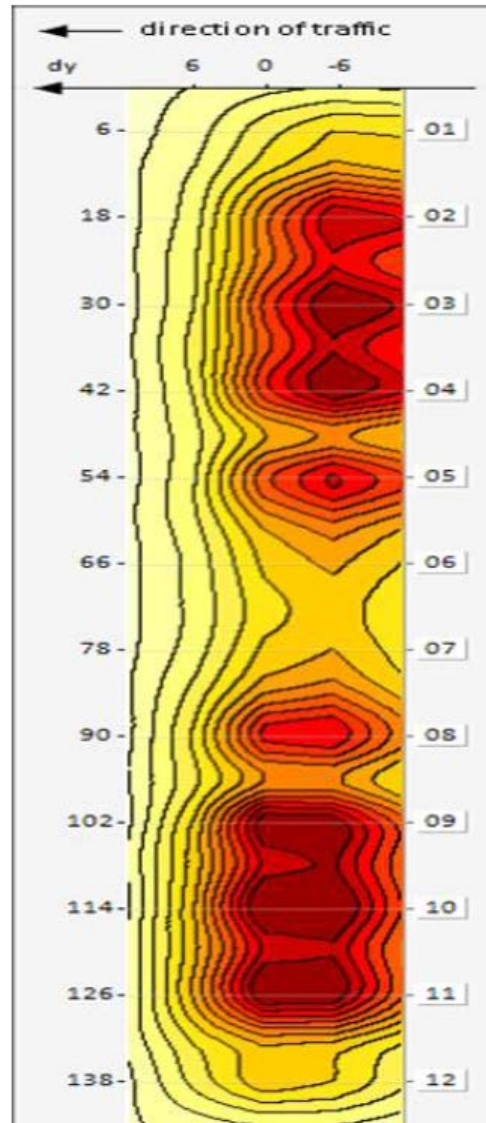


Figure 79-4

2.3 Figure 79-5 shows a skewed basket to the saw cut joints. The saw cut is indicated by the black line on the MIT Scan-2 tracks. Figure 79-6 shows the corresponding MIT Scan-2 image map. This joint should be further evaluated to determine if the saw cut is skewed and the basket is properly aligned or if the saw cut is correct and the basket is skewed. If the saw cut is skewed and the bars are properly aligned and each bar has the minimum embedment on each side of the saw cut, the joint can be accepted, otherwise, it is rejected and corrective work must be performed. If the saw cut is correct, this would be a locked joint and would require corrective work if adjacent joints are also locked.



Figure 79-5

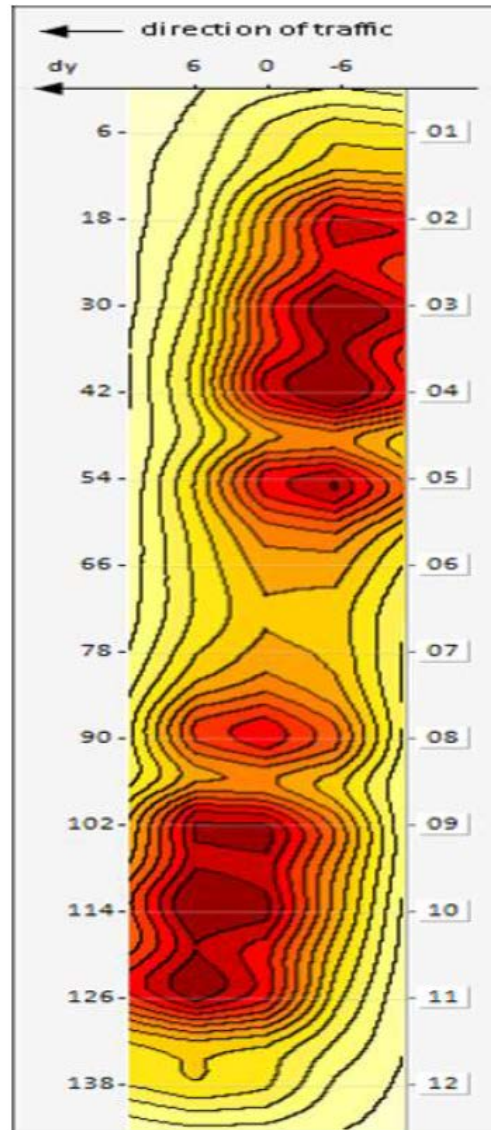


Figure 79-6



2.4 Figure 79-7 shows a basket that has been tilted. Figure 79-8 shows the corresponding MIT Scan-2 image map. This joint should be further evaluated by coring or a pachometer to determine the overall rotational misalignment of each bar. A joint score can be used to determine the acceptability of the joint using the criteria in subsection 412.13 and if corrective work is required. A single joint like this can be left in place without corrective work if the adjacent joints are correct and there is the required minimum cover above and below the dowel bars. Otherwise the joint requires corrective work.



Figure 79-7

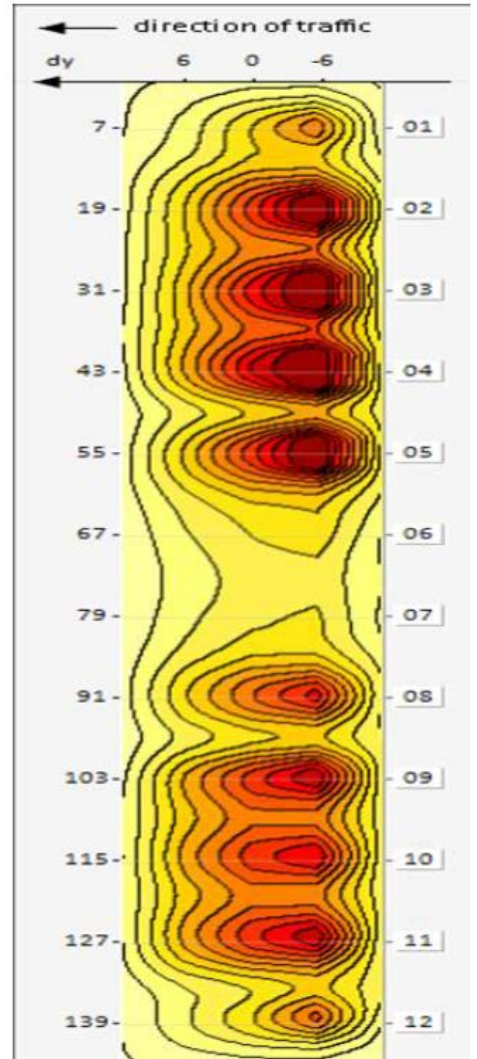


Figure 79-8



2.5 Figure 79-9 shows a basket that is deeper on one end than the other, but is otherwise aligned. Figure 79-10 shows the corresponding MIT Scan-2 image map. This joint should be further evaluated by coring or a pachometer to determine if there is the required minimum cover above and below the dowel bars. If there is the proper cover above and below the dowel bars, the joint can be accepted, otherwise, corrective work would be required.



Figure 79-9

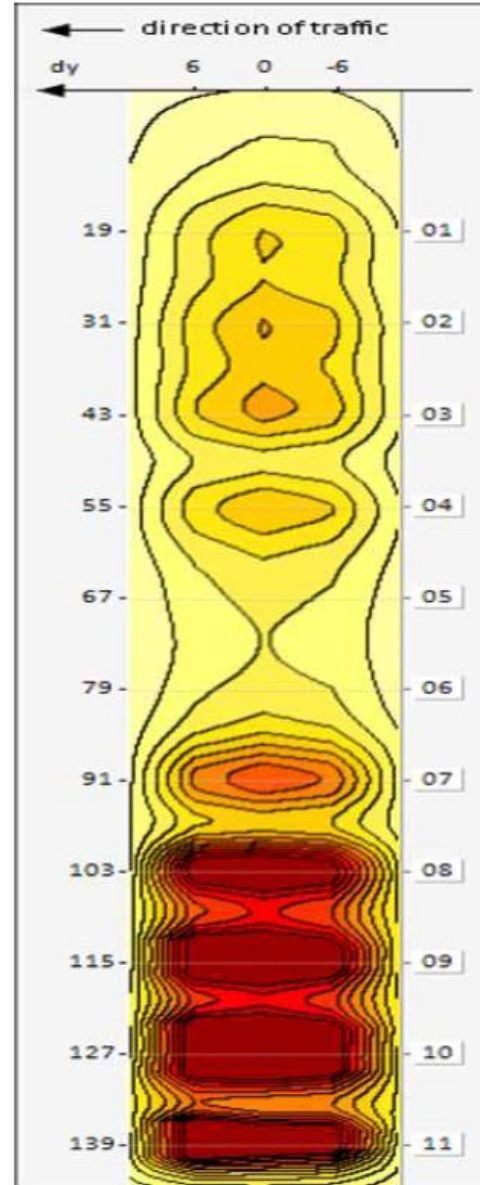


Figure 79-10

2.6 Figure 79-11 shows a basket that is only on one wheel path. Figure 79-12 shows the corresponding MIT Scan-2 image map. The top half of the MIT Scan-2 image map shows what a joint with no bars would look like. This joint requires corrective work to install the missing bars



Figure 79-11

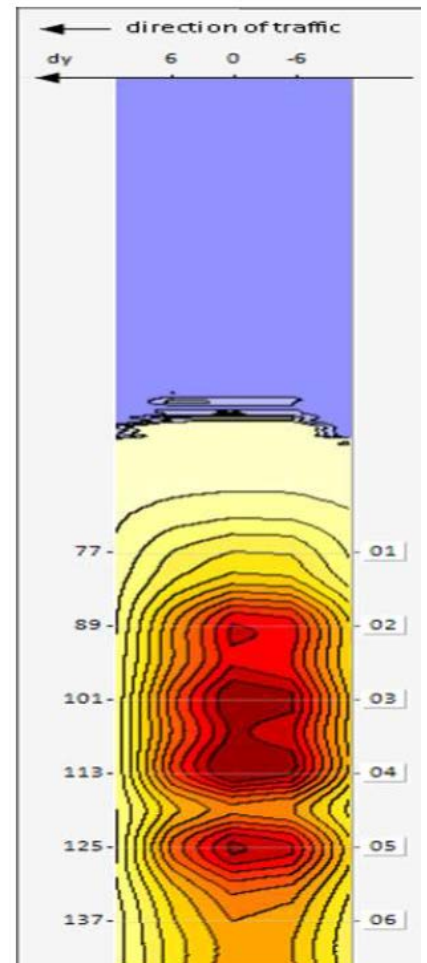


Figure 79-12

{Page Intentionally Left Blank}

## Colorado Procedure 80-13

*Standard Method of Test for*

### **In-Place Density and Moisture Content of Soil and Soil-Aggregate by the Nuclear Method**

#### **1. SCOPE**

1. This test method describes the procedure for determining the in-place density and moisture of soil and soil-aggregate by use of nuclear moisture/density gauges. This procedure is to be used to measure densities at depths of 4, 6 & 8 inches only. Interferences (conditions that can provide incorrect measurements) of the nuclear test are discussed in AASHTO T 310-01.

#### **2. REFERENCED DOCUMENTS**

##### *Colorado Procedures:*

CP 15 Certification of Consultant Nuclear Moisture/Density Gauges

CP 25 Calculation of Percent Relative Compaction of Soils and Soil-Rock Mixtures

CP 75 Stratified Random Sampling of Materials

CP-L 5302 Calibration of CDOT Nuclear Moisture / Density Gauges

#### **3. SIGNIFICANCE**

- 3.1 The test method described is used for the in-place determination of the density and water content of soil and soil-aggregate.
- 3.2 The test method is used for acceptance testing of compacted soil and soil-aggregate.
- 3.3 Test results may be affected by chemical composition, sample heterogeneity, and, to a lesser degree, material density, and the surface texture of the material being tested. The test also exhibits spatial bias in that the gauge is more sensitive to water contained in the material close to the surface.

#### **4. APPARATUS**

- 4.1 *Nuclear Moisture/Density (M/D) Gauge* – The M/D gauge shall meet the requirements of CP 15 or CP-L 5302.
- 4.2 *Reference Standard* – A block of material used for checking gauge operation, correction of source decay, and to establish conditions for a reproducible reference count rate.
- 4.3 *Site Preparation Device* – A plate, straightedge, or other suitable leveling tools, which may be used for planing the test site to the required smoothness, and for guiding the drive pin to prepare a perpendicular hole.

- 4.4 *Drive Pin* – A pin not to exceed the diameter of the source rod by more than 1/8<sup>th</sup> of an inch.
- 4.5 *Drive Pin Extractor* – A tool that may be used to remove the drive pin in a vertical direction so that the pin will not distort the hole in the extraction process.

## 5. HAZARDS

- 5.1 The gauge utilizes radioactive material that may be hazardous to the health of the user unless proper precautions are taken. Users of the gauge must become familiar with applicable safety procedures and government regulations.

## 6. CALIBRATION / CERTIFICATION

- 6.1 Calibration Certification of the gauge shall be per CP 15 or CP-L 5302.

## 7. STANDARDIZATION

- 7.1 All Nuclear Moisture/Density (M/D) Gauges are subject to long-term aging of the radioactive sources, detectors, and electronic systems, which may change the relationship between count rates and the material density and water content. To offset this aging, gauges are calibrated as a ratio of the measurement count rate to a count rate made on a reference standard.
- 7.2 Standardization of the gauge on the reference standard is required at the start of each day's use, after the gauge has been turned off, or when a gauge's readings are in question. A permanent record of this data shall be retained. The standardization shall be performed with the gauge at least 33 ft away from other nuclear gauges and clear of large masses of water, hydrogenous material, or other items that may affect the reference count rates. Standard counts should be taken in the same environment as the actual measurement counts.
- 7.3 Turn the gauge on and allow it to stabilize according to the manufacturer's recommendations.
- 7.4 Place the gauge on the reference standard as recommended by the gauge manufacturer, and perform a four-minute standard count.
- 7.5 Compare the standard count obtained in Subsection 7.4 to the average of the previous 4 days' standard counts. If the density standard count is not within 1% of the density 4-day average or the moisture standard count is not within 2% of the moisture 4-day average rerun the standard count. If the above conditions are not met contact your On-site Radiation Safety Officer or contact the gauge manufacturer for further guidance. Record the standard counts on CDOT Form 746 and 427.

## 8. PROCEDURE

- 8.1 Using CP 75 Random Sampling procedures, select both longitudinal and transverse test locations where the test position is at least 6 inches from any vertical projection.
- 8.2. Prepare the test site in the following manner:

- 8.2.1. Remove all loose and disturbed material, and remove additional material as necessary to expose the top of the material to be tested.
- 8.2.2. Prepare a horizontal area, sufficient in size to accommodate the gauge by planing the area to a smooth condition to obtain maximum contact between the gauge and material being tested.
- 8.2.3. The maximum void beneath the gauge shall not exceed 1/8<sup>th</sup> of an inch. Use minus #4 native fines to fill these voids and smooth the surface with the site preparation device. The depth of the filler shall not exceed 1/8<sup>th</sup> of an inch. The area covered by the fill shall not exceed 10% of the test site.
- 8.2.4. Using the hole-forming device, make a hole, perpendicular to the prepared surface. The depth of the hole shall be at least 2 inches deeper than the selected test depth and aligned such that the insertion of the probe will not cause the gauge to tilt from the plane of the prepared area.
- 8.2.5. Remove the hole-forming device carefully to prevent the distortion of the hole, damage to the surface, or loose material falling into the hole.
- 8.3. Proceed with testing in the following manner:
  - 8.3.1. Place the gauge on the material to be tested and align the source rod directly above the hole.
  - 8.3.2. Lower the source rod into the hole to the desired test depth. Pull back gently on the gauge towards the operator so that the source rod is in direct contact with the backside of the hole. Enter the depth of measurement on the scaler.

**Note 1:** Failure to enter the actual depth of the reading into the scaler will yield incorrect density results.
  - 8.3.3. Keep all other radioactive sources at least 33 feet away from the gauge to avoid affecting the measurement.
  - 8.3.4. Perform four one-minute readings and record the dry density and percent moisture on CDOT Form 427.

**Note 2:** Most gauges report both wet & dry density and moisture content in PCF and percent moisture. It is important to record the correct reading from the gauge.
  - 8.3.5. Obtain a sample of the soil or soil-aggregate as required in CP 23 or CP 25. The sample should be collected from beneath the M/D gauge, between the hole and the end of the gauge. The depth of the sample shall be 2 inches deeper than the test depth.
- 8.4. A percent moisture check shall be run at least once for each soil classification or soil-aggregate (rock) type on the project.
  - 8.4.1. Using, a minimum 500g portion of the sample obtained for CP 23 or CP 25 to determine the moisture content according to AASHTO T 265.
  - 8.4.2. The gauge's percent moisture is valid if it is  $\pm$  1% of the moisture content determined by AASTHO T 265.

- 8.4.3 If the gauge's percent moisture is not within 1% then AASHTO T265 shall be used for determining the MC at each location. The Wet density from the gauge will be recorded and the dry density calculated for determining percent compaction.

$$D_D = \frac{W_D}{1 + \frac{M}{100}}$$

Where:

$D_D$  = Dry Density, lbs/ft<sup>3</sup>

$W_D$  =Wet Density, lbs/ft<sup>3</sup>

$M$  =percent moisture from T 265.

**Note 3:** This check is to make sure that the chemical composition of the soil or soil-aggregate mixture does not interfere with the gauge's moisture content determination.

## 9. CALCULATIONS

- 9.1 Average the gauge readings obtained in Subsection 8.3.4.

## 10. REPORT

- 10.1 CDOT Form 746, Nuclear Moisture/Density Gauge Log.

<https://www.codot.gov/library/forms/cdot0746.pdf/view>

- 10.2 CDOT Form 427, Nuclear Soils-Moisture/Density Test.

<https://www.codot.gov/library/forms/cdot0427.pdf/view>

## Colorado Procedure 81-18

### *Standard Method of Test for*

## Density and Percent Compaction of HMA Pavement by the Nuclear Method

### 1. SCOPE

- 1.1 This method covers the determination of the total density of hot mix asphalt pavement in- place by use of nuclear gauges. The test method used to determine the density of in-place hot mix asphalt pavements is the backscatter method, whereby the source is lowered into near contact with the compacted roadway surface. The direct transmission and air gap methods are not used to test the in-place density of bituminous pavements.
- 1.2 The nuclear equipment referenced in this method is the Surface Moisture/Density (M/D) Gauge and the Thin Layer Density Gauge. This procedure applies equally to both types of gauges, except as noted.
- 1.3 The following applies to all specified limits in this standard: To determine conformance with these specifications, an observed value or a calculated value shall be rounded off "to the nearest unit" in the last right-hand place of figures used in expressing the limiting value, following the rounding-off method of AASHTO R 11, Recommended Practice For Indicating Which Places Of Figures Are To Be Considered Significant In Specified Limiting Values.

### 2. REFERENCED DOCUMENTS

#### 2.1 *Colorado Procedures:*

CP 15 Certification of Consultant Nuclear Moisture / Density Gauges

CP 75 Stratified Random Sampling of Materials

CP 82 Field Correction of the In-Place Measurement of Density of Bituminous Pavement by the Nuclear Method

CP-L 5302 Calibration of CDOT Nuclear Moisture/Density Gauges

CP-L 5304 Calibration of CDOT Nuclear Thin Layer Density Gauges

### 3. SIGNIFICANCE

- 3.1 The method described is used for the in-place determination of the density of HMA.
- 3.2 This method is used for the acceptance testing of HMA.
- 3.3 Test results may be affected by chemical composition, sample heterogeneity, and the surface texture of the material being tested. The techniques also exhibit spatial bias in that the apparatus is more sensitive to certain regions of the material under test.



**4. APPARATUS**

- 4.1 *Nuclear Moisture/Density (M/D) or Thin Lift Gauge* - The M/D or Thin-Layer gauge shall meet the requirements of CP 15 or CP-L 5302.

**5. HAZARDS**

- 5.1 The gauge utilizes radioactive material that may be hazardous to the health of the user unless proper precautions are taken. Users of the gauge must become familiar with applicable safety procedures and government regulations.

**6. CALIBRATION/CERTIFICATION**

- 6.1 Calibration/Certification of M/D gauges shall be per CP-L 5302 or CP 15.
- 6.2 Calibration/Certification of Thin Layer Density shall be per CP-L 5304 or CP 15.

**7. STANDARDIZATION**

- 7.1 All Nuclear Gauges are subject to long-term aging of the radioactive sources, detectors, and electronic systems, which may change the relationship between count rates and the material density and water content. To offset this aging, gauges are calibrated as a ratio of the measurement count rate to a count rate made on a reference standard.
- 7.2 Standardization of the gauge on the reference standard is required at the start of each day's use, after the gauge has been turned off, or when a gauge's readings are in question. A permanent record of this data shall be retained. The standardization shall be performed with the gauge at least 33 ft away from other nuclear gauges and clear of large masses of water, hydrogenous material, or other items that may affect the reference count rates. Standard counts should be taken in the same environment as the actual measurement counts.
- 7.3 Turn the gauge on and allow it to stabilize according to the manufacturers' recommendations.
- 7.4 Place the gauge on the reference standard as recommended by the gauge manufacturer, and perform a four-minute standard count.
- 7.5 Compare the standard count obtained in Subsection 7.4 to the average of the previous 4 days' standard counts. If the density standard count is not within 1% of the density 4-day average, rerun the standard count. If the above conditions are not met, contact your On-site Radiation Safety Officer, follow your company's procedures, or contact the gauge manufacturer for further guidance. Record the standard counts on CDOT Form 746 and 428.

## 8. PROCEDURE

- 8.1 Using CP 75, select both longitudinal and transverse test locations where the gauge in test position will be at least 6 in. away from any vertical projection. Mark these test locations using a pavement marking pen. The gauge test site shall be an area 8 in. by 13 in. centered over the marked test location. The long axis of the test site must be parallel to the direction of the paver and rollers.

**Note 1:** When selecting a test location, include all areas 1 foot or more away from confined or unconfined longitudinal joints. Do not include locations closer than 1 foot to longitudinal joints.

- 8.2 Prepare the gauge test site in the following manner:

8.2.1 Remove all loose and disturbed material from the roadway surface.

8.2.2 Prepare the gauge test site to accommodate the gauge so that the gauge remains level and steady. "Rocking of the gauge may be caused by a non-level surface or by asphaltic aggregate particles becoming cemented to the bottom of the gauge. Obtain maximum contact between the gauge and material being tested. If rocking cannot be corrected, the test site may be moved a few centimeters to level the gauge.

8.2.3 The maximum void beneath the gauge shall not exceed 1/8 in. If necessary, use the minimum possible amount of native fines or fine sand to fill these voids and smooth the surface with a rigid plate or other suitable tools.

**Note 2:** The placement of the gauge on the surface of the material to be tested is critical to the successful determination of density. The optimum condition is total contact between the bottom surface of the gauge and the surface of the material being tested. This is not possible in all cases and to correct surface irregularities use of sand or similar material as a filler will be necessary. The depth of the filler should not exceed 1/8 in. and the total area filled should not exceed 10 percent of the bottom area of the gauge. Several trial seatings may be required to achieve these conditions.

- 8.3 Proceed with the test in the following manner:

8.3.1 Place the gauge on the 8 in. by 13 in. gauge test site. Mark two corners of the gauge test site using a pavement marking pen.

8.3.2 Keep all other radioactive sources at least 33 ft. away from the gauge to avoid affecting the measurement.

8.3.3 Tilt the gauge away from the operator slightly. Extend the source rod from the "SAFE" position to the "Backscatter" position, which is the position in which the tip of the source rod attains near contact with the pavement surface. Tilting the gauge will ensure that the index handle trigger of the source rod is securely engaged in the notch on the index rod. Ensure that the source rod is firmly seated against the bottom of the notch, which places the source into near contact with the roadway surface.

- 8.3.4 Seat the gauge firmly, keeping the base in contact with the prepared gauge test site.
- 8.3.5 Set the count time to one-minute. Perform two one-minute readings and record the wet density on CDOT Form #428. Turn the gauge 180 degrees and align the gauge over the gauge test site. Perform and record two additional one-minute readings.

**Note 3:** Most gauges report both wet and dry density. It is important to record the correct reading from the gauge.

- 8.3.6 If a core sample is required, follow CP 82. Obtain the core or cores for CP 82 from the central longitudinal axis of the gauge test site.

**Note 4:** If the entire bituminous pavement, that is the old existing asphalt roadway plus the planned overlay, will be less than 4 inches thick, underlying subgrade density variations can cause nuclear gauge test inconsistencies.

## 9. CALCULATIONS

- 9.1 Average of the four nuclear gauge readings obtained in Subsection 8.3.5.
- 9.2 Calculate the adjusted wet density value by adding the field density to the correction factor derived through CP 82. Calculate the percent density by dividing the adjusted field density by the laboratory maximum mixture density (i.e. the maximum specific gravity multiplied by 62.4).

## 10. REPORT

- 10.1 CDOT Form 746, Nuclear Moisture/Density Gauge Log.

<https://www.codot.gov/library/forms/cdot0746.pdf/view>

- 10.2 CDOT Form 428, Nuclear Asphalt-Density Test.

<https://www.codot.gov/library/forms/cdot0428.pdf/view>

## Colorado Procedure 82-20

### *Standard Method of Test for*

## **Field Correction of the In-Place Measurement of Density of Bituminous Pavement by the Nuclear Method**

### **INTRODUCTION**

This method covers the determination of a correction factor which is used to adjust the density readings of in-place bituminous pavement generated by a nuclear surface gauge to core sample densities. A common misconception exists that a calibrated nuclear gauge can and will provide the correct in-place density of a bituminous pavement. However, no two design mixes are identical when placed on a project because the environment and roadway structure are unique; therefore, a standard calibration for bituminous pavements is impossible. Correlating the in-place nuclear density to the in-place core sample density allows for the development of a correction factor that should be valid until the ingredients in the bituminous pavement change or the underlying material changes. Principles of the nuclear test are discussed in the AASHTO T 310 Appendix, as are some of the advantages and disadvantages of the test. Surface nuclear gauges utilize radioactive materials, which may be hazardous to the health of users unless proper precautions are taken.

### **1. SCOPE**

- 1.1 This method describes the procedures for determining a correction factor to be applied to the in-place measurement, by nuclear methods, of pavement densities. This factor corrects for the varying effects of materials, roadway structure, and environment.
- 1.2 This procedure should be used on each project as specified in the contract. This procedure may also be used whenever variations in conditions bring the Moisture/Density Gauge or Thin Layer Density Gauge readings into question.
- 1.3 The values stated in English units are to be regarded as the standard.

### **2. REFERENCED DOCUMENTS**

#### 2.1 *Colorado Procedures*

- CP 44 Bulk Specific Gravity and Percent Relative Compaction of Compacted Bituminous Mixtures Using Saturated Surface-Dry Specimens
- CP 51 Determining the Maximum Specific Gravity of Bituminous Mixtures
- CP 75 Stratified Random Sampling of Materials
- CP 81 Density of In-Place Bituminous Pavement by Nuclear Method

### 3. APPARATUS

- 3.1 Any tool suitable for removing intact a core of compacted pavement for the full depth of the course or courses. A diamond bit core drill is suitable for this purpose. The core drill must have a diameter of greater than 4 in. (100 mm) and should be equipped to core and retrieve specimens approximately 4 or 6 in. (100 to 150 mm) in diameter.
- 3.2 A rigid plate or suitable container large enough to hold the sample without distortion after it is removed from the pavement.
- 3.3 Surface Moisture/Density Gauge or Thin Layer Density Gauge as specified in CP 81.
- 3.4 Apparatus as specified in CP 51 (Determining the Maximum Specific Gravity of Bituminous Mixtures) and CP 44 (Bulk Specific Gravity of Compacted Bituminous Mixtures Using Saturated Surface-Dry Specimens).

### 4. PROCEDURE

- 4.1 Using CP 75, select and record seven longitudinal and transverse test locations where the gauge in test position will be at least 6 in. away from any vertical projection. Mark these test locations using a pavement marking pen. The gauge test site shall be an area 8 in. by 13 in. centered over the marked test location. The long axis of the test site must be parallel to the direction of the paver and rollers.

**Note 1:** When selecting a test location, include all areas 1 foot or more away from confined or unconfined longitudinal joints. Do not include locations closer than 1 foot to longitudinal joints.

**Note 2:** If the existing pavement depth plus the depth of the planned first lift will be less than 4 in., the nuclear gauge may be affected by variations in the density of the subbase. Thin layer density gauges and cores are not affected by these variations in subbase densities.

**Note 3:** A visual examination of the existing pavement should be conducted before paving begins so that heavily distressed areas may be avoided when selecting test locations in Subsection 4.1. These areas may affect gauge readings, may not be representative of the roadway in general or may lose their continuity once extracted.

- 4.2 Obtain nuclear gauge density readings at each test location according to CP 81 for either the nuclear gauge #1 or #2 values.

**Note 4:** CP 81 contains essential details concerning the safety, calibration, and standardization of nuclear gauges.

- 4.3 Take a core sample from the center of the gauge test site at each test location. This core shall be provided to CDOT for the determination of the nuclear asphalt density correction.

- 4.3.1 Any additional cores should be taken along the longitudinal axis as close as possible to the original core location.

**Note 5:** The Contractor shall provide cores from each location to CDOT as witnessed by the CDOT tester. If the core is damaged during the coring process, a new gauge test site as close as possible to the original test site along the longitudinal centerline axis of the original test site shall be chosen. The direction of the new test site shall be randomly selected by the CDOT tester. Repeat Subsections 4.1 to 4.3 at the new test site. Once the bulk specific gravity test (CP 44) has been started on a core, the contractor shall no longer have the option of requesting a new test site at that location.

- 4.4 When the nominal maximum size aggregate in the pavement is 1 in. or less, a 4 in. diameter bit or larger shall be used. When the nominal maximum size aggregate is over 1 in., a 6-inch diameter bit shall be used. When the coring operation has been completed, carefully remove the sample by use of the core retriever. Mark each core to allow identification of the test site. Care should be exercised that the sample is not distorted, bent, cracked, or in any way changed from its physical condition as it was before removal from the pavement.
- 4.5 Separate the core below the layer for which the correction factor is being determined.
- 4.6 Determine the specific gravity of the core samples in accordance with CP 44.

## 5. DETERMINATION OF CORRECTION FACTOR

- 5.1 Calculate the average specific gravity of the seven pavement cores taken from the roadway. Convert the average specific gravity to density by multiplying the specific gravity by 62.4.
- 5.2 Using CP 81, calculate the average in-place density from the seven sites using the nuclear gauge.
- 5.3 Calculate the correction factor to be used for measurements of density readings from the same project as follows:

$$A = B - C$$

Where:

A = Correction factor determined for a specific gauge and pavement,

B = Average density of pavement cores,

C = Average density reading from the nuclear gauge.

**Note 6:** This correction factor shall be added after the four wet density readings are recorded and averaged. The correction factor must be used on the same nuclear gauge and the same pavement as tested during the compaction test section.

**6. REPORT**

6.1 The results are reported on the following CDOT forms:

6.1.1 CDOT Form 746 - Nuclear Moisture/ Density Gauge Log.

6.1.2 CDOT Form 428 - Nuclear Asphalt-Density Test.

6.1.3 CDOT Form 469 - Nuclear Asphalt-Density Correction.

## Colorado Procedure 85-13

*Standard Method of Test for*

### **Asphalt Cement Content of Asphalt Mixtures by the Nuclear Method**

(This procedure is based upon AASHTO T 287-06. AASHTO T 287-06 or any subsequent revision may not be used in place of this procedure.)

#### **1. SCOPE**

- 1.1 This method covers the determination of the asphalt cement content of asphalt concrete mixtures with a nuclear asphalt content gauge.
- 1.2 The values stated in English units are to be regarded as the standard. The metric equivalents of English units may be approximate.
- 1.3 This test method involves potentially hazardous materials, operation, and equipment. This method does not address the safety concerns associated with its use. All operators will be trained in radiation safety before operating nuclear gauges.

#### **2. REFERENCED DOCUMENTS**

##### 2.1 Colorado Procedures:

- CP 30 Sampling of Aggregates
- CP 32 Reducing Field Samples of Aggregate to Testing Size
- CP 41 Sampling Hot Mix Asphalt
- CP 43 Determining Moisture (Water) or Volatile Distillates Content of Bituminous Paving Mixtures
- CP 55 Reducing Field Samples of Hot Mix Asphalt to Testing Size

##### 2.2 Colorado Laboratory Procedures:

- CP-L 5115 Preparing and Determining the Density of Bituminous Mixture Test Specimens Compacted by the Superpave Gyration Compactor

##### 2.3 AASHTO Procedures:

- T 40 Sampling Bituminous Materials

##### 2.4 Manufacturer's Instruction Manual

#### **3. SIGNIFICANCE AND USE**

- 3.1 This method is used for rapidly determining the asphalt content of asphalt paving mixtures. Testing can be completed in a matter of minutes so that adjustments, if necessary, can be made in the asphalt metering system with a limited amount of HMA production. The procedure is useful in the determination of asphalt content only, as it does not provide extracted aggregate for gradation analysis.



- 3.2 This procedure determines the asphalt binder content of a test sample by comparing the measured asphalt binder content with previously established correlation data. The asphalt binder content is expressed as a percentage of the mass of the asphalt mixture.
- 3.3 Accurate results are dependent upon the proper correlation of the nuclear gauge to the material being tested. This procedure is sensitive to the type and gradation of the aggregate, hydrated lime, and the percentage and source of the asphalt binder.
- 3.4 This procedure measures the total amount of hydrogen in a sample, including hydrogen present in the form of water. Unless the test sample is completely free of moisture, the percentage of moisture must be determined as outlined in Subsection 10.2, and correction shall be made to compensate for the moisture.
- 3.5 This procedure may be used with reclaimed asphalt pavement (RAP) incorporated into the mixture, if approved by the Region Materials Engineer, provided that the RAP is of uniform gradation, asphalt content, and asphalt type. When RAP is used, the RAP should be mixed in the correlation samples at the same rate that will be used in the asphalt concrete mixture being tested.

#### 4. APPARATUS

- 4.1 Nuclear Asphalt-Content (AC) Gauge.
- 4.1.1 Variability of the AC Gauge at 6 percent asphalt content shall be no greater than 0.05 percent for a 4-minute count.
- 4.1.2 The variability of the AC Gauge is determined from the slope of the correlation curve and the standard deviation of the count rate. Variability is calculated as follows:

$$V = \frac{s.d.}{s}$$

Where:

- V = AC Gauge variability, in percent asphalt,  
 s.d. = Standard Deviation, in counts per automatically timed period,  
 s = Slope, in counts per percent asphalt.

The standard deviation is calculated from 20 individual automatically timed readings (per manufacturer's instructions for operation of the equipment). Counts are taken on a sample with asphalt cement content within  $\pm 0.5$  percent of the mix design.

- 4.1.3 The range of control mix shall be between 2 and 14 percent asphalt cement by weight.
- 4.2 Sample Pans - Three or more stainless-steel pans. Dimensions as specified by the gauge manufacturer. Sample pans with excessive asphalt cement residue, visible damage, or deformity shall not be used. When cleaning agents are used on the sample pans they shall be washed with water and dried before use.

**Note 1:** The residue left by the cleaning agents may contain hydrogen that can affect nuclear gauge readings.

- 4.3 Balance - Capable of weighing to 15 kg (33 lb), readable to 0.1 g.
- 4.4 Oven - Capable of heating to 350°F ± 5° (177°C ± 3°).
- 4.5 Straightedge - Steel, approximately 18 in. (450 mm) in length.
- 4.6 Plywood - 3/4 in. (20 mm) or heavier, or metal plate 3/8 in. (10 mm) or heavier having an area slightly larger than the top of the sample pans or wooden survey stake longer than the width of the sample pan.
- 4.7 Assorted spoons, spatulas, and mixing bowls.
- 4.8 Thermometer - Temperature range of 50°F to 500°F (10°C to 300°C).

## 5. PRECAUTIONS

- 5.1 The nuclear asphalt-content gauge may be sensitive to outside influence and therefore:
  - 5.1.1 Any other source of neutron radiation shall be kept at least 33 ft (10 m) from the equipment.
  - 5.1.2 The space within 3 foot of the AC gauge shall be kept free of hydrogenous materials such as coffee cups, water, oil, WD40, asphalt, or plastic materials.
  - 5.1.3 All personnel shall be kept at least 3 feet away from the AC gauge during testing.
  - 5.1.4 The AC gauge shall not be located within 3 ft of any water supply tanks, fuel tanks, or other liquid containers subject to fluctuating liquid levels.
- 5.2 Moving the AC gauge to a different location may cause a change in the background radiation measurements. New background measurements and possibly a new correlation will be necessary before use.

## 6. SAMPLING

- 6.1 Obtain samples of aggregate per CP 30. Reduce samples of aggregate to testing size according to CP 32.
- 6.2 Obtain samples of asphalt binder per AASHTO T 40.
- 6.3 Obtain samples of the freshly produced HMA per CP 41. Reduce samples of HMA to testing size according to CP 55.

## 7. STANDARDIZATION

- 7.1 All nuclear devices are subject to long-term aging of the radioactive source, detectors, and other electronic systems, which may change the relationship between count rate and asphalt content. Because of this aging, new correlation curves shall be run each construction season. Changes in the surroundings of the asphalt content gauge (Subsection 5.1.1 to 5.2) may also produce increases or decreases in the count rate. To minimize these effects, background counts must be taken at least once per day.

- 7.2 Turn the Asphalt Content Gauge on and allow a 20-minute warm-up period before using the gauge. Perform a background test of at least 8 minutes with an empty chamber and record the background count on the Nuclear Asphalt Content Gauge Log.

For Troxler gauges a variation of less than or equal to 1 percent from the previous background count is acceptable. If the variation is greater than 1 percent, check for conditions identified in Subsection 5.1.1 to 5.2 and repeat the test. If the variation remains, follow Subsection 7.4.

For CPN gauges a CHI value (acronym from gauge display) of  $1.00 \pm 0.25$  is acceptable. If the CHI value is outside the range check for conditions identified in Subsection 5.1.1 to 5.2 and then repeat the test. If the CHI value remains outside the range follow Subsection 7.4.

- 7.3 Verify gauge stability by performing a statistical stability test on all new or repaired AC Gauges before use and once per month when the gauge is in use. A failing statistical stability test should be repeated after ensuring that the chamber is empty and checking for the conditions identified in Subsections 5.1.1 to 5.2. If the test still fails, follow Subsection 7.4.

- 7.4 If an AC Gauge has failed either the background test or the statistical stability test, contact the On-Site Radiation Safety Officer, or contact the manufacturer of the gauge for guidance.

**Note 2:** If the equipment is being used either continuously or intermittently during the day, it is best to leave the power on during the day to prevent having to repeat the background count. This may also provide more stable and consistent results.

## 8. CORRELATION PAN PREPARATION

- 8.1 This method is sensitive to the type of aggregate, percentage, and source of asphalt cement, aggregate gradation, and all additives, including hydrated lime. Accordingly, a correlation must be developed for each mix type. The correlation will be established with three or more points. A baseline dry aggregate count must also be taken to determine whether changes in aggregate properties are affecting the asphalt cement content determinations.

- 8.1.1 Sample the aggregate at the plant per Subsection 6.1. The aggregate shall be oven-dried at  $300^{\circ}\text{F} \pm 15^{\circ}$  ( $149^{\circ}\text{C} \pm 8^{\circ}$ ) to constant weight. The aggregate may be a composite generated from individual components by the percentage of weight according to the mix design or a cold feed combined aggregate sample (without hydrated lime added) from an HMA production facility. The cold feed combined aggregates' conformance to the mix design gradation targets shall be verified before correlation. Enough aggregate shall be obtained for a minimum of one dry aggregate and three mix samples. Approximately 65 lb (30 kg) total will be required.

- 8.1.2 Hydrated lime, if required by the mix design, shall be added to the aggregate in the laboratory.

### 8.2 Dry Aggregate Count:

- 8.2.1 A dry aggregate count should be made often enough to ensure that changes in aggregate do not occur unnoticed (approximately once per week). If a change greater than  $\pm 0.5$  percent occurs, a new correlation shall be run.

- 8.2.2 Place the dry hot aggregate in a tared sample pan in two equal layers.

- 8.2.3 Use a spatula to distribute the aggregate uniformly so that the coarse and fine aggregate does not segregate.
- Note 3:** Too much spading can cause the fines to migrate to the bottom, resulting in excessive sample weight.
- 8.2.4 Raise and drop the pan approximately one inch, four times. Be sure that the pan bottom strikes evenly.
- 8.2.5 Fill the pan with the second layer slightly above the top rim.
- 8.2.6 Raise and drop the pan approximately one inch, four times.
- 8.2.7 Place a straightedge firmly across the rim and use a sawing motion to strike off the surface of the sample so that it is flush with the rim. Gaps between the straight edge and the sample shall be filled with fine aggregate and the sample leveled. Do not compact the sample. Obtain and record the temperature and weight of the sample.
- 8.2.8 Obtain a 16-minute sample count following the gauge manufacturer's instructions. This count will be used to determine if changes occur in the aggregate used during construction.
- 8.3 There are two methods used to prepare the sample pans used for correlation. Method A is used when each laboratory prepares and tests the pans. Method B is used when the sample pans are prepared in the Contractor's lab and then used for the correlation curve generation in a CDOT lab. The Region Materials Engineer will designate which method will be used.

#### Method A

- 8.3.1 Heat all bowls, sample pans, tools, aggregate, and asphalt binder to the mixing temperature listed in CP-L 5115 for the asphalt binder being used. An initial or "butter" mix is required to condition the mixing equipment. Mix a minimum of three asphalt concrete samples to cover the approximate range of the design asphalt content. Mix one at the design asphalt content, one at 1.0 percent above and one at 1.0 percent below, or at other percentages as required to cover the range of expected use. Use the same source, grade, and type of asphalt binder that will be used in the asphalt concrete mixture to be tested. All elements of the mix design must be utilized, including hydrated lime.
- Note 4:** It is recommended that the design optimum asphalt content sample be mixed and placed in the sample pan first to determine the test weight for all samples.
- 8.3.2 Fill the sample pan one-half full, evenly distributing the sample in the pan.
- 8.3.3 Level the asphalt concrete mixture with a trowel or spatula.
- 8.3.4 Fill the remainder of the pan so that the asphalt concrete mixture is mounded above the top of the pan. Record the weight of the asphalt concrete mixture in the pan. This is the weight that all correlation and test samples will be measured.

- 8.3.5 Use a metal plate, plywood, or survey stake to consolidate the asphalt concrete mix until it is even with the top edge of the pan. Make sure that excessive voids are not visible in the corners of the pan. All specimens shall be compacted at a temperature between 250°F - 300°F (121°C - 149°C).

**Note 5:** For AC gauges that do not have temperature compensation capability, obtain and record the temperature of the sample. This is the temperature  $\pm 10^\circ\text{F}$  ( $\pm 6^\circ\text{C}$ ) at which all samples and correlation pans will be measured.

- 8.3.6 Prepare the remainder of the correlation sample pans following the procedures of 8.3.1 thru 8.3.5. Use the same weight of asphalt concrete mixture in each pan.

#### **Method B**

- 8.3.7 CDOT personnel will witness the Contractor's laboratory prepare the correlation sample pans following the procedures of 8.3.1 through 8.3.6.

- 8.3.8 When CDOT personnel cannot witness the Contractor's laboratory prepare the correlation sample pans; CDOT personnel will prepare a sample at optimum AC content following the procedures of 8.3.1 thru 8.3.5.

- 8.3.8.1 After procedures 9.1 through 9.5 the CDOT prepared sample pan will be tested following the procedures of 10.9 and 10.10. If the gauge result varies by more than 0.20% from the optimum AC content, a new gauge correlation is required.

### **9. CORRELATION GENERATION:**

- 9.1 Follow the gauge manufacturer's procedures to start a new correlation.

**Note 6:** Most gauge manufacturers use the term calibration instead of correlation for preparing a correlation curve.

- 9.2 Place the sample pan in the gauge and set the count time for a 16-minute count. Proceed following the manufacturer's instructions for the operation of the equipment and the sequence of operation.

- 9.3 Repeat Subsection 9.2 for the remainder of the correlation samples.

- 9.4 Prepare a correlation curve by plotting the correlation asphalt concrete mixture sample readings versus asphalt content on linear graph paper, choosing convenient scale factors for counts and asphalt content. Connect the points with a straight line. On most gauges, the equation (slope and intercept) for this line is generated internal to the gauge. A correlation will be considered acceptable if the correlation factor is greater than or equal to 0.9990.

$$\text{Correlation Factor} = \sqrt{1 - \frac{\sum i(Y_i - \hat{Y}_i)^2}{\sum i(Y_i - \bar{Y})^2}}$$

Where:

$Y_i$  = Actual percent asphalt values for each sample,

$\hat{Y}_i$  = Calculated percent asphalt values from the curve,

$\bar{Y}$  = Mean value of the actual percentages asphalt

$i$  = Number of correlation samples.

- 9.5 After procedure 9.4 perform an additional background count to compare with the original background count performed in Subsection 7.2. A variation of greater than 1.0 percent from the previous background count is unacceptable.

**Note 7:** The formula to calculate the slope and intercept of a straight line is

$$Y = mx + b$$

The slope,  $m$ , is calculated using the following equation.

$$\text{Slope}(m) = \frac{y_2 - y_1}{x_2 - x_1}$$

The intercept,  $b$ , is calculated using the following equation.

$$b = y_1 - mx_1$$

Where for Troxler Gauges:

$x_1$  = Measured count of Point 1/1000,

$x_2$  = Measured count of Point 2/1000,

$y_1$  = Percent AC of Point 1,

$y_2$  = Percent AC of Point 2.

Where for CPN Gauges:

$x_1$  = Percent AC of Point 1,

$x_2$  = Percent AC of Point 2,

$y_1$  = Measured count of Point 1,

$y_2$  = Measured count of Point 2.

**10. DETERMINING ASPHALT CONTENT OF HMA SAMPLES**

- 10.1 Sample the HMA per Section 6.3.
- 10.2 The sample portion to be tested should provide approximately 17.6 lb. (8 kg) per test unit.
- 10.3 The test sample shall be checked for moisture content. The percentage moisture determined must be subtracted from the asphalt content percentage as indicated by the nuclear AC gauge. Determine the amount of moisture in the mixture per CP 43 and CP 55.
- 10.4 Adjust the test sample temperature to 250°F - 300°F (121°C - 149°C).
- 10.5 Fill the sample pan one-half full; evenly distribute the sample in the pan.
- 10.6 Level the asphalt concrete mixture with a trowel or spatula.
- 10.7 Fill the remainder of the pan until the weight of the asphalt concrete mixture in the pan is equal to plus or minus 5 grams of the mass of mix in the samples used for correlation in Subsection 8.3.4. Record the weight of the asphalt concrete mixture in the pan.
- 10.8 Use a metal plate, plywood, or survey stake to compact the asphalt concrete mix until it is even with the top of the pan.

**Note 8:** For AC gauges that do not have temperature compensation capability, obtain and record the temperature of the sample. The starting test temperature shall be 180°F to 290°F (82°C to 143°C) and within  $\pm 10^\circ\text{F}$  ( $\pm 6^\circ\text{C}$ ) of the correlation temperature.

- 10.9 Place the sample in the gauge. Set the gauge to take a single 16-minute count. Follow the manufacturer's instructions to obtain sample asphalt content.
- 10.10 Correct asphalt content for moisture content.

**11. REPORT**

- 11.1 The results are reported on the following CDOT forms:

- 11.1.1 CDOT Form 772, Nuclear Asphalt-Content Gauge Log.

<https://www.codot.gov/library/forms/cdot0772.pdf/view>

- 11.1.2 CDOT Form 599, Nuclear Asphalt-Content Correlation.

<https://www.codot.gov/library/forms/cdot0599.pdf/view>

- 11.1.3 CDOT Form 106, Asphalt Tests.

<https://www.codot.gov/library/forms/cdot0106.pdf/view>

## Chapter 200

### Soils – 21

**This chapter is not part of the Project specifications but is a guide for project personnel in interpreting CDOT specifications, understanding ASTM, AASHTO, and Colorado test procedures, and for completing CDOT forms.**

Pavement and structures built on the soils rely on engineered soil properties because soils are the foundation for transportation construction. Soil placement is vital to construction quality. The quality of the pavement mix, design, and construction is meaningless if the soils below the pavement settle, heave, or slide.

Soil and embankment inspectors and testers need to understand basic information about soils, testing procedures to classify soils, and how different soil types behave when they are used as an engineered material (i.e. compaction, drainage, stability, etc.). Testers working on a CDOT project are required to be certified with or under the guidance of a tester certified with the Western Alliance for Quality Transportation Construction (WAQTC) and CDOT's Soils, Excavation, & Embankment Inspection. Because these certifications cover testing in detail, this chapter provides a summary of basic soil mechanics, laboratory testing procedures, and field testing procedures used to determine soil and engineering properties used during construction. Additional information can be found in the WAQTC Embankment & Base In-Place Density Participant Workbook and the CDOT Soils, Excavation, & Embankment Inspection Manual.

#### GENERAL SOIL PROPERTIES

There are three divisions of particle sizes that are determined from a gradation analysis: gravel, sand (coarse and fine), and fines (silt and clay). Sand and gravel are granular soils that are non-cohesive with particles that are visible to the naked eye. Soils composed primarily of sand and gravel have high strength, a high porosity (i.e. good drainage), and are not prone to long-term post-construction settlement. These soils are also easier to work with to gain adequate compaction during construction. Soils composed primarily of sand; however, are highly erodible.

Natural deposits of granular soils are described based on their in-situ density using the following terms: very loose, loose, medium dense, dense, and very dense. The denser the soil deposit, the higher the strength. This information is collected with field tests during a subsurface exploration program.

Silt and clay are classified as "fines" and pass the No. 200 sieve for a gradation analysis. These particles are not distinguishable by the naked eye. The terms used to describe silty and clayey soils refer to their "consistency" or "cohesiveness": very soft, soft, medium stiff, stiff, very stiff, and hard.

Silt is the coarser portion of the fines content (particle sizes varying from 0.002 mm to 0.075 mm). Soils composed primarily of silt are non-cohesive and are characterized by low plasticity. Soils composed primarily of silt are also highly erodible.

Clay is cohesive and can have high variability in plasticity, depending on the mineralogy of the clay particles present. Clay represents particles smaller than 0.002 mm, or 2 microns ( $\mu\text{m}$ ) in a soil sample. The cohesion of clay soil is an indication of its strength, and softer clay soils are characterized by a lower cohesion or lower strength. This information is also collected with field tests during a subsurface exploration program.



Both silt and clay soils are characterized by low permeability (i.e. water does not flow through these soils quickly and they do not drain well). They have lower strength than sand and gravel, and they can be prone to long-term post-construction settlement. These soils are more difficult to work with during construction to achieve adequate compaction. Because of their low permeability, it is more difficult to moisture condition these soils uniformly to achieve near-optimum moisture conditions for adequate compaction. Silts and clays are also more sensitive to frost heave.

An elevated presence of fines within sandy or gravelly soils results in a decrease in strength, a decrease in permeability, and an increase in the likelihood of post-construction settlement. The percentage of fines and granular material determined in the soils and fills shall meet the project specifications.

#### **LABORATORY TESTS**

The following summarizes the testing that may be required during construction. Refer to the plans and specifications for your project to determine what tests are required.

#### **Gradation**

A gradation analysis is a method used to quantitatively determine the distribution of particle sizes in soils, aggregate, or soil-aggregate mixtures. Colorado Procedure (CP) 21, Mechanical Analysis of Soils, describes the procedure to run this test. This test is also referred to as a grain size analysis, particle size analysis, or sieve analysis. A sufficient amount of soil needs to be sampled to run a representative gradation test. The minimum mass of material required is dependent on the Nominal Maximum Size of aggregate or particle in the sample. The Nominal Maximum Size is defined as the smallest sieve opening through which the entire amount of specimen passes.

#### **Atterberg Limits**

The Atterberg limits define the range of moisture contents in which soil behaves as a plastic. As the moisture content of clayey soil increases, the material behavior will change from a solid to a semi-solid, to plastic, and eventually to a liquid. The specific moisture contents that need to be determined for AASHTO M-145 soil classification are:

- Plastic Limit (PL) and Plasticity Index of Soils - AASHTO T 90
- Liquid Limit (LL) of Soils - AASHTO T 89

The plastic limit of a soil is the lowest water content at which the soil remains plastic. The liquid limit is the moisture content at which the soil behavior changes from a plastic to a liquid state. The range of moisture contents that a soil behaves as plastic is referred to as the plasticity index (PI), and is taken as the difference between the liquid limit moisture content and the plastic limit moisture content ( $PI = LL - PL$ ).

Soils that do not exhibit plastic behavior (clean granular soils) will have a value of zero for the PI, are referred to as Non-Plastic (NP) and will have No Value (NV) prescribed for their liquid limit and plastic limit. Soils with higher clay content are characterized by higher liquid limits and higher plasticity indices. If the soil can be rolled into 1/8 inch (3 mm) diameter threads after moisture is added then the material is considered plastic. If the material cannot be easily rolled, it is likely non-plastic.

## AASHTO Soil Classification

The inspector needs to familiarize themselves with this soil classification system. Project specifications will often require specific soil types to be used for various types of backfill (i.e. retaining wall backfill, embankment fill, pipe bedding, etc.).

The AASHTO Soil Classification system classifies soils into eight major groups based on their grain size distribution and Atterberg limits. These groups are designated A-1 through A-8. Soils that fall within the lower-numbered groups are granular (sands and gravels), contain less than 35 percent fines, and tend to be either non-plastic or low plasticity (A-1, A-2, and A-3 soils). Soils that classify within the higher numbered groups have higher fines content (silt and clay-sized particles) and are generally characterized by higher plasticity (A-4, A-5, A-6, and A-7 soils). Peat classifies as an A-8 soil and is characterized by an organic content of 15 percent or more.

To classify a soil using AASHTO M-145, gradation information and the Atterberg limits of the soil must be determined (see Soil Classification Table in Forms section of this chapter). The sieves used for this classification system must include the No. 10, No. 40, and No. 200 sieves. To use this classification system, an individual can determine the correct soil classification by the process of elimination.

In addition to the major groups and subgroups listed above, additional classification using the liquid limit, plasticity index, and percent fines can be conducted to determine a soil's partial group index. A partial group index is a number placed in parentheses after an AASHTO group number: e.i. A-6 (5) indicates an A-6 group soil with a partial group index of 5. This number indicates the percent fines a soil contains, the level of plasticity of the fines, and indicates the quality of the soil as subgrade material. Higher partial group indices indicate poorer quality soil (i.e. an A-6 with a partial group index of 30 is a poorer quality soil than an A-6 with a partial group index of 5).

## Unstable Soils as Determined by R-Value

Soil shall be analyzed for resistance to deformation (stability). The testing shall be Resistance R-Value and Expansion Pressure of Compacted Soils or Aggregates using Hveem Stabilometer per AASHTO T 190. Soil is unstable when the following criteria are met (see FIGURE 200-1):

- The decrease of R-value from 400 psi to 300 psi is 10 or greater, and
- The optimum moisture of AASHTO T 99 or T 180 is greater than the exudation moisture at 300 psi.

The statement: "This material meets the criteria as 'unstable'" will be written in the notes section on Soils Test Report in CAR for CDOT Form 323.

The use of unstable soil in projects should be minimized and carefully monitored. Potential remediation alternatives for unstable soil may include the following:

- Construction of a test section and proof rolling to verify construction methods.
- The unstable soil should be compacted at a moisture content of 1% to 2% below optimum moisture.
- Mechanical improvement, including the use of geosynthetics such as geotextile or geo-grid.
- Chemical treatment such as cement, fly ash, or cement/fly ash combination.

Region Materials should be contacted when unstable soils are encountered on a project.

### **Swelling Soils/Heaving Bedrock**

Swelling soils are clay-rich soils that exhibit a volume change with increases or decreases to their moisture content. These soils are derived from weathering of certain claystone bedrock formations. Heaving bedrock operates by the same mechanism but is differentiated because the swelling occurs from intact bedrock layers rather than from unconsolidated soil deposits. This expansion can increase the volume of a deposit by more than 20 percent and the swelling action can exert thousands of pounds of force onto overlying structures.

Once a pavement or structure is placed over and expansive soil, natural evaporation is restricted which can cause moisture to build up in the subsurface. Also, if pavement cracks develop through time and allow water infiltration into the subsurface, an increase in moisture content can occur. The underlying soils expand causing buckling and differential heave to occur in the overlying structures.

Problems due to swelling soils and heaving bedrock most often occur in cut areas where dry claystone bedrock or residual soils are exposed and in transitions from cut to fill areas. Swelling soils can cause problems in, fill areas if soils with expansion potential are used as embankment fill.

Remedial measures to address swelling soil include:

- The crown of the roadway is generally sloped to promote runoff and eliminate ponding water.
- Construct drainage ditches below the subgrade level in low areas and are graded to allow rapid runoff of surface water.
- Over-excavation and replacement of potential expansive layers.
- Chemical treatment of the subgrade soils with lime, fly ash, or combinations of these materials.

It should be noted that chemical soil treatment by the use of lime or other cement agents can result in a different type of heave for soils characterized by a high sulfate content. Sulfate can react with the lime (or other calcium-based products) resulting in the growth of ettringite and/or thaumasite crystals in the soil. The growth of these crystals in the soil also results in volume expansion and heave to overlying structures. Soils shall be tested and meet the chemical requirements per Subsection 203.03 of the Standard Specifications.

The soil inspector needs to be aware of swelling soils that are encountered within a corridor; and what, if any, mitigation measures were specified to address these soils during construction. The Region Materials Engineer should be contacted when expansive soils are encountered on a project. Table 200-1 presents suggested treatment depths of the subgrade where swelling soils are present.

### **SOIL SURVEYS & SIMILARIZATION**

There are two types of soil surveys: Preliminary Soil Surveys and Soil Surveys of Constructed Roadbeds. The preliminary soil surveys are conducted before new alignments and most road widening projects as part of the pavement design process. The purpose of soil surveys is to identify the various soil types within the existing and proposed roadway at elevations above and below the profile grade. The extent of each soil type is noted and each type is identified by the AASHTO classification method. The condition of subsoils upon which embankments will be constructed is evaluated. This involves moisture content, density, groundwater distribution, and other material properties that may impact the pavement before, during, and after construction. Detailed information on Preliminary Soil Surveys procedures and applications can be found in the Pavement Design Manual.

Soil Surveys of Constructed Roadbeds are to be performed per the OA Frequency Guide and CP 24-16. A sample should be taken for each soil encountered except for the material that may be used as topsoil. If the same soil is found in more than one hole, it may be **Similarized** to a soil already sampled. Similarization is the process of combining or eliminating samples from nearby locations that exhibit similar physical properties such as color, grain size, gradation, plasticity, roundness, etc. Similarizing increases productivity and efficiency while reducing cost for sample shipment and laboratory analysis. Care should be exercised in similarizing soils and additional samples should be taken where doubt exists. Similarization will be limited to one mile. Soil samples taken in each boring will be visually classified and similarized in the Region by certified inspectors and testers before submittal for laboratory analysis.

### **RIPPABILITY**

Some bedrock can be broken down by the process of ripping. Ripping is the process of drawing a heavy metal tooth through the bedrock by a piece of construction equipment. The measurement of how easy it is to rip down the rock by a certain piece of equipment is the rippability. The rippability is different for different types of bedrock and how the bedrock was formed. To assist in determining what equipment should be used for ripping the bedrock on a project, references are available such as the Caterpillar® Handbook of Ripping or similar manuals. These manuals associate construction equipment with seismic velocities to help plan what equipment should be used.

### **ITEM 203, EMBANKMENT**

The foundation soils and the materials used to construct embankments must be properly constructed to improve stability, increase the strength of the soils, reduce the likelihood of post-construction settlement, and increase the long term performance of the roadway. Embankment strength is dependent upon three basic conditions:

1. Compaction
2. Moisture Content
3. Soil Characteristics

**Embankment material must be accurately classified using the AASHTO method and that soil samples tested truly represent the material being used in construction.**

Proper compaction of embankments is necessary to provide a stable base for roadway pavement. It must be understood that the foundation soil directly beneath the embankment has to be strong enough to support it. Insufficient strength of foundation soil could cause damage by shear failure, slip outs, or displacement of underlying soft material by outward plastic flow. Highly compressible soil in the foundation could result in excessive settlement.

Compaction is by definition, the densification of soil by removal of air/void space through mechanical energy. To adequately compact any soil with conventional construction equipment, water must be regulated within the soil to maximize the degree of compaction that can be achieved. Water allows soil particles to slip over one another and move into a denser configuration. If too much water is added, the soil begins to behave as a liquid. The soil will simply pump or deform with compactive effort, and an increase to densification can no longer be achieved. The moisture content at which the maximum density of soil can be attained is referred to as the "optimum moisture content". When soil is compacted at its optimum moisture content, it can be compacted to its maximum density.

Optimum moisture and maximum density values are determined according to either AASHTO T 99 (Standard) or AASHTO T 180 (Modified) as called for in the plans or specifications. It is the responsibility of the Engineer to assure the optimum moisture and maximum density of the in-place embankment material meet the requirements in Subsection 203.07 of the Standard Specifications.

### **Construction Procedure Summary**

Roadway embankment material must be placed in horizontal layers. Material placed in lifts shall not exceed 8 inches for soil and rock embankment and 18 inches for rock fill. Rocks larger than the lift thickness shall be separated to allow for compaction equipment to operate in between the rocks. Rocky material should be uniformly distributed throughout the embankment to assure thorough consolidation.

### **Field Equipment**

The type of compaction equipment to be used by the Contractor is optional unless otherwise specified on the plans. The Contractor, however, must meet density and percent moisture requirements. Common types of compaction equipment used are:

- **Sheep-foot Roller** - Used with cohesive (clayey and silty) soils.
- **Smooth-Wheel Rollers** - Used with base coarse materials and for finishing operations.
- **Vibratory Rollers** - Used with granular (sandy and gravelly) soils.

When "Roller Hours" is specified on a project, estimated yardage (volume) shall be documented on the CP 80aa Template in Site Materials Manager. The estimated yardage (volume) shall be placed in the appropriate section of the template and shall be marked "for information only". In-place density tests should be taken for documentation when practical. A brief statement on the type, weight (mass), and effectiveness of the roller should be included under "Remarks" along with the "Roller Hours".

### **Field Tests**

Field testing shall be performed per the OA and IA Frequency Guide Schedules as stated in this Field Materials Manual. Changes in embankment material may require additional testing. The results of these field tests must be recorded and retained in project files.

### **Zero Air Voids Density**

The Zero Air Voids Density Tabulation shown in this Chapter represents the dry density that would be obtained at the various moisture contents if there were no air voids present( i.e., when all voids between soil particles are filled with moisture). At a given moisture content and specific gravity, the zero air voids density represents the maximum density that can be obtained in the given soil.

Report the in-place dry density and the in-place moisture from the test results on CP 80aa. These results should be checked against the zero air voids density. For cohesive materials (clays and silts), a specific gravity of 2.70 may be used while 2.65 may be used for non-cohesive materials (sands and gravels). The in-place dry density should never exceed the zero air voids density of a material's in-place moisture and specific gravity as presented in the Zero Air Voids Density Tabulation (Table 200-2). If it does, some of the data is erroneous. To avoid using incorrect density values, the tester should check the Zero Air Voids Density Tabulation (Table 200-2) whenever a percent relative compaction figure of 105% or more is calculated.

**ITEM 206, STRUCTURE BACKFILL**

Section 206 of the Standard Specifications lists four classes of Structure Backfill in subsection 206.02:

- Structural Backfill Class 1, which is graded, granular material meeting the requirements of subsection 703.08 (a).
- Structural Backfill Class 2 which shall be composed of suitable material developed on the project meeting the requirements of subsection 703.08 (b).
- Flow-Fill, which is a self-leveling, low strength concrete material as outlined in subsection 206.02(a)2.
- Imported Structural Backfill for Pipes, as outlined in subsection 206.02(a)3.

Field personnel shall indicate which method of determining maximum density (AASHTO T 99 or T 180) applies to the material submitted. The moisture and density required for Class 1 Structure Backfill will meet Subsection 206.03 of the Standard Specifications. More information on Structure Backfill, Class 1 appears in Chapter 300 of this Manual.

The moisture and density required for Class 2 Structure Backfill shall conform to Subsection 206.03 and unless otherwise designated, the type of compaction shall be the same as that specified for the project. In the event a Contractor elects to substitute aggregate base course for Class 2 Structure Backfill, the maximum density determination and percent relative compaction will be the same as for Class 1 Structure Backfill per Subsection 206.03. The CDOT Tester and Project Engineer should discuss the compaction requirements if this type of substitution is being considered.

Structural Backfill shall meet the chemical testing requirements for sulfates, chlorides, pH, and resistivity per Subsection 206.02.

**Note: When using Class 2 Structure Backfill that is composed of an appreciable amount of plus No. 4 material, Subsection 206.03 on uniform distribution and placement of maximum 6-inch layers should be strictly adhered to.** See also Subsection 703.08, paragraph (b) for further requirements when plus No. 4 material is present. This is very important in order not to cause any damage to the structure. Class 1 Backfill material should be used if there is any doubt about placing Class 2 material in the required 6-inch lift. The use of "too rocky to test" in place of the actual testing should be used very sparingly; therefore, it may apply when more than 50% of the material is retained on the  $\frac{3}{4}$ " sieve. Almost all Class 2 Backfill should be tested.

**ITEM 206, FILTER MATERIAL**

A protective filter is a pervious material that will allow the free infiltration of water but will prevent the entrance of soil into the filter. Specifications 206, 605, and 703 should be referenced concerning soil and drain material properties and placement. Much of the problem of selecting the right aggregate(s) for drainage systems stems from the need of satisfying two conflicting requirements:

- The aggregates must have pores that are large enough to permit water to flow readily through the layer.
- Drainage layers in contact with the soil must be fine enough to prevent the trench soil from washing through the pores of the aggregate that would result in clogging of the system. Usually, the pores will not clog if the 15% size of the filter is not more than 5 times the 85% size of the soil.

Meeting both requirements with one material sometimes can be nearly impossible. If it should become necessary to choose between one requirement or the other, the aggregate pore size should have precedence. One solution in difficult cases is the use of graded filters having two or more layers. One layer or zone of aggregate should be fine enough to hold the soil in place. Also, one or more than one, of the coarser layers may be used to provide the needed water removing capacity. Graded filters of two or more layers are very common in dams. However, a desire to simplify construction has led to the widespread use of a single layer for most pavement drainage. Further guidance can be found in the Pavement Design Manual, Regional Materials Residency, or the Regional Hydraulic Engineer. Table 200-3 presents recommended filter classes.

### Region Soil Survey Sampling Checklist – Calendar Year 2020

#### Soil Survey of Constructed Roadbeds

(Refer to CP 24 for details)

#### **New & Widened Roadways and Sampling of Boring Materials**

1. Borings will be drilled in the final subgrade before pavement overlay.
2. A minimum of one boring per 1,000 linear feet of completed 2-lane roadway will be done.
3. A minimum depth of 2 feet below the finished subgrade is required.
4. Take one sample per soil type containing at least 33 lbs. (15 kg) of minus No. 4 screen materials for **classification**.

#### **Materials Ownership and Documentation**

1. **Field** or **Region Lab** will use CP 20, CP 21, and Form 564 to complete the soil classification.
2. **Field** or **Region** will follow CP 24 and mathematically scalp the gradation on the appropriate sieve and determine if there are significant variations in the material from the preliminary soil survey.
3. **If there are significant variations from the preliminary soil survey**, all +3/8, plus No. 4 screen, and minus #4 screen materials will be separated and retained in separate bags.
4. The sample material should be submitted through Site Manager Materials with a Form 157 requesting an R-value will be sent to the Region Lab (\*) or Central Lab.
5. The soil classification on Form #564 will also be sent to the Region Lab or Central Lab.
6. If **no** significant variations are found, record on Form 219 for project documentation.

#### Borrow Pits

(Refer to Standard Specifications for Road & Bridge Construction for details)

**Contractor Source:** The cost of complying with Section 106.02,(b)*Contractor Source* requirements, including sampling, testing, and corrective action by the Contractor, shall be included in the work.

**CDOT reserves the right to verify the contractor's source.**

#### **Materials Ownership, Sampling, and Forms (FMM QA Schedule)**

1. If embankment will support concrete pavement or be chemically stabilized, during production one soil sample per 2,000 yds<sup>3</sup> or fraction thereof will be tested for sulfate from the designated source by CDOT project or Region personnel.
2. Results will be documented on Forms 157 and 323.

3. During the qualification of a borrow source, one 5 lb. sample of soil, per soil type, will be submitted to the Chemical Unit of the Central Laboratory for sulfate content.

**Notes:**

1. Region Lab/Soils Program will perform the classification of soils.
2. Chemical Unit will perform chemical analysis of soil samples for sulfates.
3. Chemical Unit will provide the Project with the chemical analysis on the qualification of borrow sources.
4. For the preliminary soil survey, the Chemical Unit will provide the Region Materials Program with the chemical analysis reports and forward the results to the Soils Program.
5. The Soils Program will input the chemical results onto the electronic Form 555, and forward the completed preliminary soil survey to the Region Materials Program.
6. Chemical Unit will perform chemical analysis of soil samples for corrosion tests and will provide test results to the Region for pipe material type selection.

(\*) If the Region Lab can perform AASHTO T 190 then no sample needs to be sent to the Central Lab.

**Region Soil Survey Drilling Checklist**

**Reconnaissance of Drill Site**

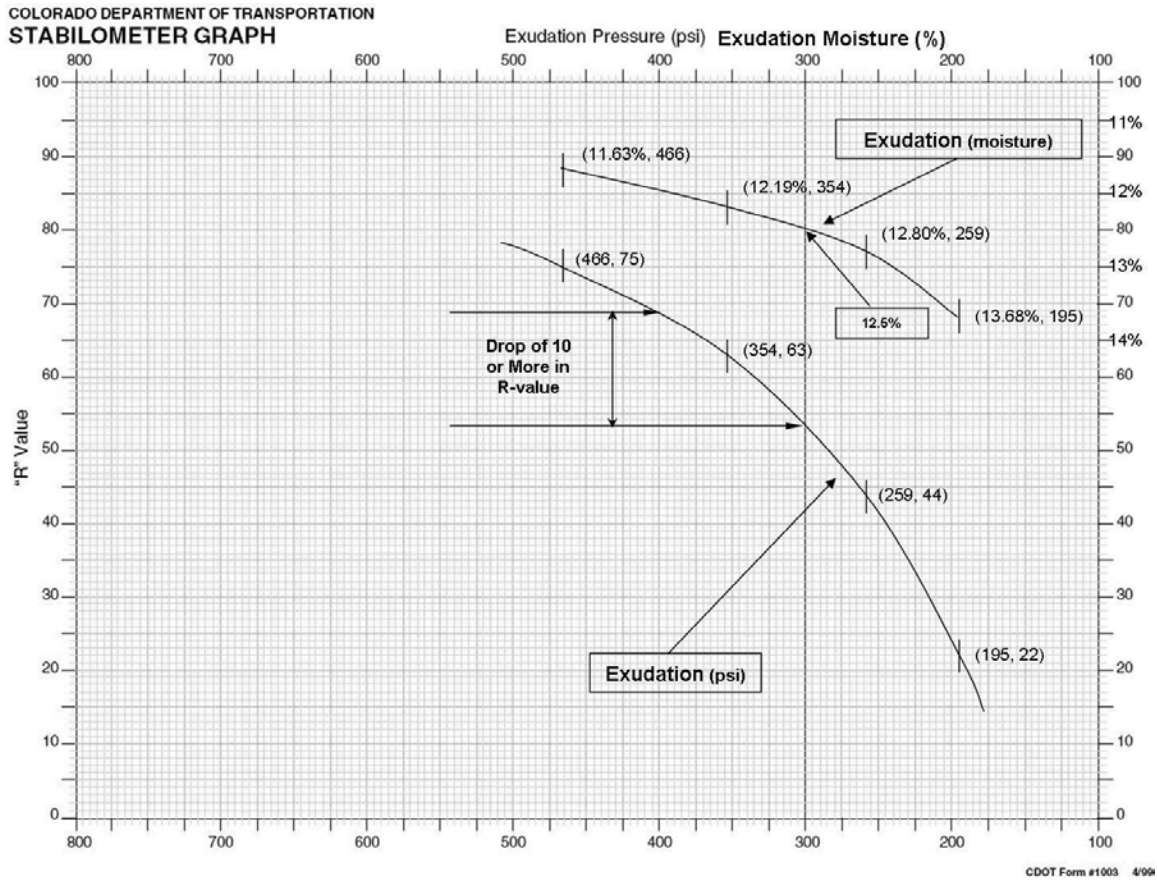
|   | <u>Yes</u>               | <u>No</u>                | <u>N/A</u>               |
|---|--------------------------|--------------------------|--------------------------|
| 1. Was a reconnaissance survey of the area to be drilled performed? | <input type="checkbox"/> | <input type="checkbox"/> | <input type="checkbox"/> |
| 2. Have landowner clearances and locates been obtained?             | <input type="checkbox"/> | <input type="checkbox"/> | <input type="checkbox"/> |
| 3. Have temporary easements been obtained?                          | <input type="checkbox"/> | <input type="checkbox"/> | <input type="checkbox"/> |
| 4. Have drilling methods been determined?                           | <input type="checkbox"/> | <input type="checkbox"/> | <input type="checkbox"/> |
| 5. Have roadway conditions and types of pavement been noted?        | <input type="checkbox"/> | <input type="checkbox"/> | <input type="checkbox"/> |
| 6. Have rock outcrops been noted?                                   | <input type="checkbox"/> | <input type="checkbox"/> | <input type="checkbox"/> |
| 7. Have survey cross-sections or profiles been performed?           | <input type="checkbox"/> | <input type="checkbox"/> | <input type="checkbox"/> |
| 8. Is there drilling for the existing roadway?                      | <input type="checkbox"/> | <input type="checkbox"/> | <input type="checkbox"/> |
| 9. Is there drilling for new or extension of the roadway surface?   | <input type="checkbox"/> | <input type="checkbox"/> | <input type="checkbox"/> |
| 10. Have structures and culverts been identified?                   | <input type="checkbox"/> | <input type="checkbox"/> | <input type="checkbox"/> |
| 11. Has the Soil Survey Field Report, Form 554 been completed?      | <input type="checkbox"/> | <input type="checkbox"/> | <input type="checkbox"/> |
| 12. Have sulfate/corrosion resistance samples been taken?           | <input type="checkbox"/> | <input type="checkbox"/> | <input type="checkbox"/> |

**If suspicious material is encountered during drilling**

- **Stop Drilling**
- **Do not move the drill rig**
- **Secure area and provide traffic control if necessary**
- **Contact Region Environmental and/or Region Safety Coordinator**



**FIGURES AND TABLES**



**FIGURE 200-1**

**TABLE 200-1. SUGGESTED TREATMENT BELOW NORMAL SUBGRADE ELEVATION FOR PROJECTS**

| Plasticity Index | Depth of Treatment            |                             |
|------------------|-------------------------------|-----------------------------|
|                  | Interstate And Primary System | Secondary And State Systems |
| 10 to 20         | 2 feet                        | 2 feet                      |
| 20 to 30         | 3 feet                        | 2 feet                      |
| 30 to 40         | 4 feet                        | 3 feet                      |
| 40 to 50         | 5 feet                        | 3 feet                      |
| *Over 50         | 6 feet                        | 4 feet                      |

**TABLE 200-2. ZERO AIR VOIDS DENSITY TABULATION**

| Moisture,<br>% of Dry Wt. | Dry Density (ZAVD) |                   |                    |                   |                    |                   |
|---------------------------|--------------------|-------------------|--------------------|-------------------|--------------------|-------------------|
|                           | @ 2.65 SP. GR.     |                   | @ 2.70 SP. GR.     |                   | @ 2.75 SP. GR.     |                   |
|                           | lb/ft <sup>3</sup> | kg/m <sup>3</sup> | lb/ft <sup>3</sup> | kg/m <sup>3</sup> | lb/ft <sup>3</sup> | kg/m <sup>3</sup> |
| 9.0                       | 133.5              | 2138.4            | 135.5              | 2170.5            | 137.6              | 2204.1            |
| 9.5                       | 132.1              | 2116.0            | 134.1              | 2148.1            | 136.1              | 2180.1            |
| 10.0                      | 130.7              | 2093.6            | 132.7              | 2125.6            | 134.6              | 2156.1            |
| 10.5                      | 129.4              | 2072.8            | 131.3              | 2103.2            | 133.2              | 2133.6            |
| 11.0                      | 128.3              | 2055.1            | 129.9              | 2080.8            | 131.7              | 2109.6            |
| 11.5                      | 126.7              | 2029.5            | 128.6              | 2060.0            | 130.3              | 2087.2            |
| 12.0                      | 125.5              | 2010.3            | 127.3              | 2039.1            | 129.0              | 2066.4            |
| 12.5                      | 124.2              | 1989.5            | 126.0              | 2018.3            | 127.7              | 2045.5            |
| 13.0                      | 123.0              | 1970.3            | 124.7              | 1997.5            | 126.4              | 2024.7            |
| 13.5                      | 121.8              | 1951.0            | 123.5              | 1978.3            | 125.1              | 2003.9            |
| 14.0                      | 120.6              | 1931.8            | 122.3              | 1959.0            | 123.9              | 1984.7            |
| 14.5                      | 119.5              | 1914.2            | 121.1              | 1939.8            | 122.7              | 1965.4            |
| 15.0                      | 118.3              | 1895.0            | 120.0              | 1922.2            | 121.5              | 1946.2            |
| 15.5                      | 117.2              | 1877.3            | 118.8              | 1903.0            | 120.3              | 1927.0            |
| 16.0                      | 116.1              | 1859.7            | 117.7              | 1885.4            | 119.2              | 1909.4            |
| 16.5                      | 115.1              | 1843.7            | 116.6              | 1867.7            | 118.0              | 1890.2            |
| 17.0                      | 114.0              | 1826.1            | 115.5              | 1850.1            | 117.0              | 1874.1            |
| 17.5                      | 113.0              | 1810.1            | 114.4              | 1832.5            | 115.8              | 1854.9            |
| 18.0                      | 112.0              | 1794.0            | 113.4              | 1816.5            | 114.8              | 1838.9            |
| 18.5                      | 111.0              | 1778.0            | 112.4              | 1800.5            | 113.7              | 1821.3            |
| 19.0                      | 110.0              | 1762.0            | 111.4              | 1784.4            | 112.7              | 1805.3            |
| 19.5                      | 109.0              | 1746.0            | 110.4              | 1768.4            | 111.7              | 1789.2            |
| 20.0                      | 108.1              | 1731.6            | 109.4              | 1752.4            | 110.7              | 1773.2            |
| 20.5                      | 107.2              | 1717.2            | 108.5              | 1738.0            | 109.7              | 1757.2            |
| 21.0                      | 106.2              | 1701.1            | 107.5              | 1722.0            | 108.8              | 1742.8            |
| 21.5                      | 105.3              | 1686.7            | 106.6              | 1707.6            | 107.8              | 1726.8            |
| 22.0                      | 104.5              | 1673.9            | 105.7              | 1693.1            | 106.9              | 1712.4            |
| 22.5                      | 103.6              | 1659.5            | 104.8              | 1678.7            | 106.0              | 1697.9            |
| 23.0                      | 102.7              | 1645.1            | 103.9              | 1664.3            | 105.1              | 1683.5            |
| 23.5                      | 101.9              | 1632.3            | 103.1              | 1651.5            | 104.2              | 1669.1            |
| 24.0                      | 101.1              | 1619.5            | 102.2              | 1637.1            | 103.4              | 1656.3            |
| 24.5                      | 100.3              | 1606.6            | 101.4              | 1624.3            | 102.5              | 1641.9            |
| 25.0                      | 99.5               | 1593.8            | 100.6              | 1611.4            | 101.7              | 1629.1            |
| 25.5                      | 98.7               | 1581.0            | 99.8               | 1598.6            | 100.9              | 1616.2            |
| 26.0                      | 97.9               | 1568.2            | 99.0               | 1585.8            | 100.1              | 1603.4            |
| 26.5                      | 97.2               | 1557.0            | 98.2               | 1573.0            | 99.3               | 1590.6            |
| 27.0                      | 96.4               | 1544.2            | 97.4               | 1560.2            | 98.5               | 1577.8            |
| 27.5                      | 95.7               | 1533.0            | 96.7               | 1549.0            | 97.7               | 1565.0            |
| 28.0                      | 94.9               | 1520.1            | 96.0               | 1537.8            | 97.0               | 1553.8            |
| 28.5                      | 94.2               | 1508.9            | 95.2               | 1524.9            | 96.2               | 1541.0            |
| 29.0                      | 93.5               | 1497.7            | 94.5               | 1513.7            | 95.5               | 1529.7            |
| 29.5                      | 92.8               | 1486.5            | 93.8               | 1502.5            | 94.7               | 1516.9            |
| 30.0                      | 92.1               | 1475.3            | 93.1               | 1491.3            | 94.0               | 1505.7            |
| 30.5                      | 91.4               | 1464.1            | 92.4               | 1480.1            | 93.3               | 1494.5            |
| 31.0                      | 90.8               | 1454.5            | 91.7               | 1468.9            | 92.6               | 1483.3            |
| 31.5                      | 90.1               | 1443.2            | 91.0               | 1457.7            | 91.9               | 1472.1            |
| 32.0                      | 89.5               | 1433.6            | 90.4               | 1448.1            | 91.3               | 1462.5            |
| 32.5                      | 88.8               | 1422.4            | 89.7               | 1436.8            | 90.6               | 1451.3            |
| 33.0                      | 88.2               | 1412.8            | 89.1               | 1427.2            | 90.0               | 1441.6            |
| 33.5                      | 87.5               | 1401.6            | 88.5               | 1417.6            | 89.3               | 1430.4            |
| 34.0                      | 87.0               | 1393.6            | 87.8               | 1406.4            | 88.7               | 1420.8            |
| 34.5                      | 86.4               | 1384.0            | 87.2               | 1396.8            | 88.1               | 1411.2            |
| 35.0                      | 85.8               | 1374.4            | 86.6               | 1387.2            | 87.4               | 1400.0            |
| 35.5                      | 85.2               | 1364.8            | 86.0               | 1377.6            | 86.8               | 1390.4            |

**TABLE 200-3. RECOMMENDED FILTER CLASSES**

| Sieve Size or Designation  | Percentage of soil passing designated sieves (1) |                      |              |
|--|--|----------------------|--------------|
|  | Use Class 1, B or C (2)                          | Use Class B or C (2) | Use Class C  |
| No. 10<br>No. 40   | less than 85, &<br>less than 25                  | less than 85         | more than 85 |
| (1) Based on the minus 3 inch (75 mm) portion of the soil adjacent to the filter material.<br>(2) To drain large quantities of water, use the most open grading recommended. |  |                      |              |

This table is based on the following criteria: The  $D_{15}$  size of the filter should not be more than five times the  $D_{85}$  size of the soil.

### DEFINITIONS

**Alluvial Fan** - Deposit formed at the base of a steep valley or canyon wall by steep gradient tributary action. The material usually consists of heterogeneous angular rock and soil.

**Angle of Internal Friction** - An angle whose tangent is equal to the frictional shear strength of soil divided by the confining stress exerted on that soil. Cohesion-less soils tend to exhibit high Angle of Internal Friction ( $\phi$ ) values.

**Boulders** - All rocks larger than 10 inches in diameter.

**Clay** - A very fine-grained soil, which passes the No. 200 screen and has a Plastic Index of 11 or more.

**Cobbles** - Rocks, which range from 3 to 10 inches in diameter.

**Cohesion** - The capacity of sticking or adhering together. That part of a soils' shear strength, which does not depend on inter-particle friction. Cohesion is the major factor contributing to the shear strength of clay soils.

**Compaction** - The process of increasing the density of a material by mechanical means, such as tamping, rolling, vibration, etc.

**Consolidation** - The process of decreasing the thickness of a soil layer by applying a vertical load.

**Degree of Saturation** - The ratio of the volume of water to the void volume in a given soil mass.

**Density** - The mass of a substance per unit volume, usually expressed in pounds per cubic foot (pcf).

**Embankment** - A raised structure, consisting of soil, aggregate, or rock. Usually, the material is compacted and is used to support roadway pavement.

**Erosion** - The removal and transportation of soil or rock by water, ice, and gravity.

**Escarpment** - A steep face terminating highlands abruptly

**Glacial Moraine** - Deposit of heterogeneous material left by glacial action. Material ranges in size from clay to large boulders.

**Gradation** - Indicates the range and relative distribution of particles in soil or aggregate.

**Gravel** - A granular material, which is retained on the No. 10 screen and has a maximum particle size of 3 inches.

**Hygroscopic Moisture** – Hygroscopic material is soil that readily absorbs water usually from the atmosphere; therefore hygroscopic moisture is the moisture absorbed from the atmosphere. In most cases, the water can be removed from the material by heating.

**Internal Friction** - The property of individual soil particles to resist movement along adjacent surface areas.

**Land forms** - Distinct shapes of the earth's surface that have been formed by erosion and deposition of rock or soil. Common examples are stream terraces, alluvial fans, glacial moraines, and sand dunes.

**Liquid Limit** - The moisture content at which a soil changes from the plastic state of consistency to the liquid state of consistency.

**Loess Deposit** - A homogeneous, un-stratified accumulation of windblown silt with subordinate amounts of very fine-grained sand.

**Maximum Density** - The unit dry weight (pounds per cubic foot, (pcf)) of a soil compacted at optimum moisture and at a specific compactive effort.

**Optimum Moisture** - Percent moisture of a soil, which will yield a maximum dry unit weight for a specified compactive effort.

**Permeability** - The rate at which a material allows transmission of water.

**pH** – A measure of the activity of hydrogen ions in a solution. When in balance (pH 7) the soil is said to be neutral. The pH scale covers a continuum ranging from 0 (very acidic) to 14 (very alkaline or basic).

**Plastic Index** - The numerical difference between the liquid limit and the plastic limit of a soil.

**Plasticity** - Property of material to be remolded without crumbling under certain moisture conditions.

**Plastic Limit** - The moisture content at which a soil changes from the semi-solid state of consistency to the plastic state of consistency.

**Poorly Graded** - Particles sizes of a soil mass that are not evenly distributed.

**Pore Water Pressure** - The stress imparted by water against soil particles within a saturated soil mass.

**Porosity** - The ratio of void space of a material to the total volume of its mass, usually expressed as a percent.

**Rock** - Any naturally formed consolidated aggregate or mass of minerals, which cannot be excavated by manual methods alone. (Pieces of rock, which pass the No. 4 screen, are considered soil particles.)

**Sand** - A granular soil, which passes the No. 10 screen and is retained on the No. 200 screen.

**Sand Dunes** - Ridges of mounds formed by windblown sand. These deposits of sand consist of clean, uniform sand grains.

**Silt** - A very fine-grained soil, which passes the No. 200 screen and has a Plastic Index of 10 or less.

**Residual Soil** - Material that is produced by the weathering of bedrock and accumulates or remains in contact with parent rock.

**Similarization** - The process of combining or eliminating samples from nearby locations that exhibit similar physical properties such as color, grain size, gradation, plasticity, roundness, etc. Similarization will be limited to one mile. Soil samples taken in each boring will be visually classified and similarized in the Region by certified inspectors and testers before submittal for laboratory analysis.

**Soil** - A loosely cemented, heterogeneous, earthen material, which is composed of particles surrounded by voids of various sizes. Voids may be filled with air, water, and gas, or any combination of the same. Particles of soil are produced by physical or chemical disintegration of rock.

**Specific Gravity (Absolute)** - The ratio of the unit weight of solid matter in the soil to that of distilled water at 68°F (20°C).

**Specific Gravity (Apparent)** - The ratio of the weight of soil particles (including permeable and impermeable voids) to that of water.

**Specific Gravity (Bulk)** - The ratio of the weight of a specific volume of soil particles to the same volume of water.

**Stream Terrace** - Mostly granular material, which has been deposited by stream action to form a level, topped surface with an escarpment on one side.

**Stratified** - Soil deposited in layers with different and distinct characteristics.

**Swelling Soil** - Material, which exhibits the ability to increase in volume with an increase in water content. Soils with high swell potential usually contain montmorillonite.

**Testable Material** - Soils and rock mixtures having 50% or more by weight, at field moisture content, of minus 4 material and the top size material being less than 6 inches in diameter.

**Transported Soil** - Accumulation of material, which has been transported from its parent rock by water, wind, or ice.

**Void Ratio** - The ratio of the volume of void space to the total volume of the particles within a mass.

**CDOT Materials Forms - Applicable for Soils**

<https://www.codot.gov/library/forms/form-numbers-broken-down>

**Materials Forms, Instructions & Examples Chapter**

**NOTE: The example forms are still in development, as they are completed they will be entered into the chapter. Use the relevant example forms from the The electronic version of the 2018 FMM.**

| Form | Title  | Page |
|------|--|------|
| 157  | Field Report for Sample Identification or Materials Documentation.....     |      |
| 24   | Moisture - Density Relation .....  |      |
| 212  | Field Report on Compaction of Earthwork .....                              |      |
| 219  | Soil Survey of the Completed Roadbed .....                                 |      |
| 323  | Laboratory Report on Item 203 (Embankment or Borrow).....                  |      |
| 548  | Nomograph - to Correct for Percent Rock .....                              |      |
| 564  | Soils and Aggregates Sieve Analysis When Splitting on the No.4 Sieve ..... |      |
| 584  | Moisture - Density Relation Graph .....                                    |      |
| 626  | Field Laboratory Test Results.....   |      |
| 1003 | Stabilometer Graph .....   |      |
| 1007 | Gradation Chart .....  |      |
| 1030 | Stabilometer Test.....   |      |
| 1045 | Gradation Worksheet .....  |      |
| 1297 | Moisture - Density Report – [computer <i>output</i> ].....                 |      |
|      | Soil Classification Tables .....   |      |
|      | Note: Text, not Examples.....  |      |
| 554  | Soil Survey Field Report .....   |      |
| 157  | Field Report for Sample Identification or Materials Documentation.....     |      |

{Page Intentionally Left Blank}

## Chapter 300

### Bases - 21

**This chapter is not part of the Project's specifications but is a guide for project personnel in interpreting CDOT specifications, understanding ASTM, AASHTO, and Colorado Procedures (CPs) for testing, and for completing CDOT forms.**

The design and construction of a pavement structure may include one or more base courses. A base course is a layer of material below the wearing surface of a pavement. Bases may be constructed of gravels, mixtures of soil and aggregate, mixtures of asphalt and aggregate, mixtures of cement and aggregate or soil, or other innovative materials. Bases may be made of unbound materials, such as gravel, or bound materials, such as lime treated subgrade.

Base courses under concrete pavements provide a drainage layer, reduce pumping, provide protection against frost damage, and provide support for the heavy equipment used for placing concrete pavements. There is some increase in structural capacity when a base is placed under a concrete pavement, but it is typically not a significant amount.

Base courses under flexible pavements provide a significant increase in structural capacity. Pavement design of flexible pavement depends on the wheel loads being distributed over a greater area as the depth of the pavement structure increases. There are the added benefits of improved drainage and protection against frost damage.

#### **ITEM 206 STRUCTURE BACKFILL**

#### **ITEM 304 AGGREGATE BASE COURSE**

Compaction of unbound bases is important for the stability of the pavement it supports. The maximum dry density is established in the laboratory before construction. During construction measurements of the base dry density is compared to the maximum dry density. The requirements for compaction of aggregate base course (ABC) are shown in Subsection 304.06 of the Standard Specifications for Road and Bridge Construction. Structure Backfill has similar requirements as shown in Subsection 206.03.

Two methods to determine the maximum dry density of soils are AASHTO T 99 and AASHTO T 180. AASHTO T 99 is similar to ASTM D 698 and is commonly referred to as the Proctor Test, as it was first proposed by R. R. Proctor in 1933. AASHTO T 99 uses a 5.5 lb. rammer dropped from 12 in. When a 4 in. mold is used, three layers are compacted with 25 blows on each layer. When a 6 in. mold is used, three layers are compacted with 56 blows on each layer. AASHTO T 99 results in a compactive effort of 12,400 ft-lbf/ft<sup>3</sup>. AASHTO T 180 is similar to ASTM D 1557 and is commonly referred to as the Modified Proctor Test. AASHTO T 180 uses a 10 lb. rammer dropped from 18 in. When a 4 in. mold is used, five layers are compacted with 25 blows on each layer. When a 6 in. mold is used, five layers are compacted with 56 blows on each layer. This results in a compactive effort of 56,000 ft-lbf/ft<sup>3</sup>. Comparing compactive efforts, AASHTO T 180 produces four and a half times the compactive effort than a sample receives compacted according to AASHTO T 99.

AASHTO T 99 is the appropriate standard for compaction of cohesive soils, particularly if there is the potential for swelling when saturated. AASHTO T 180 is appropriate for granular soils, such as aggregate base course and Structure Backfill, Class 1.



There are four methods of determining moisture-density relationships by AASHTO T 180:

- Method A uses a 4 in. mold and the fraction of the soil passing a No. 4 sieve. AASHTO states that this is applicable to soil mixtures that have 40% or less retained on a No. 4 sieve.
- Method B uses a 6 in. mold and the fraction of the soil passing a No. 4 sieve. AASHTO states that this is applicable to soil mixtures that have 40% or less retained on a No. 4 sieve.
- Method C uses a 4 in. mold and the fraction of the soil passing a 3/4 in. sieve. AASHTO states that this is applicable to soil mixtures that have 30% or less retained on a 3/4 in. sieve.
- Method D uses a 6 in. mold and the fraction of the soil passing a 3/4 in. sieve. AASHTO states that this is applicable to soil mixtures that have 30% or less retained on a 3/4 in. sieve.

The Gradation requirements for Class 1 Structure Backfill and ABC are shown in Subsections 703.08 and 703.03 respectively. A review of the Gradation requirements shows that many granular materials will meet the Gradation requirements and exceed the limits of application stated in AASHTO T 180.

Colorado has developed a rock correction formula in Colorado Procedure 23 (CP 23) when AASHTO T 180 is used:

$$MDD = (P_f \times D_f + P_c \times 0.95 D_c) / 100$$

The standard practice within the Department follows:

- 110 lbs. of granular material are sampled and sent to the laboratory before construction begins. This would typically require two standard sample bags.
- The material is separated into two fractions, material retained on a No. 4 sieve and material passing a No. 4 sieve.
- The specific gravity and absorption of the material retained on a No. 4 sieve is determined according to AASHTO T 85 Specific Gravity and Absorption of Coarse Aggregate.
- The maximum dry density and optimum moisture of the material passing a No. 4 sieve is determined according to AASHTO T 180, Method A.
- For bases with crushed concrete or reclaimed asphalt pavement (RAP), an accurate specific gravity determination is difficult to make. For these materials T 180, Method D is used.
- Method D may be used if more than 30% of the material is retained on the No. 4 sieve, but has 30% or less of the material retained on the 3/4 inch sieve. When Method D is used, use the above procedure but substitute the 3/4 inch sieve for the No. 4 sieve.

During construction, the control of compaction follows according to the plans, specifications, and the Frequency Guide Schedule for Minimum Materials Sampling, Testing, and Inspection. Each field test must include a separation of the sample into the two fractions, material retained on a No. 4 sieve, and material passing a No. 4 sieve. Percent relative compaction is determined according to CP 25. CP 23 is used to correct the maximum dry density and optimum moisture for soil-rock mixtures with more than 5% material retained on a No. 4 sieve.

**ITEM 308 PORTLAND CEMENT & FLY ASH**

Sources of Portland cement and/or fly ash are listed on the Department's Approved Product List. To verify a specific cementitious material that may be considered for a project check if the supplier/manufacturer of the cement or fly ash is on the Approved Products List at the web site address of:

<https://www.codot.gov/business/apl>

If a manufacturer wants to add a cement or fly ash source use the same web site and follow the instructions within Notice to Manufacturers: <https://www.codot.gov/business/apl/manufacturers.html> and also follow all references within CP 11:

**CDOT Materials Forms - Applicable for Bases**

<https://www.codot.gov/library/forms/form-numbers-broken-down>

**Materials Forms, Instructions & Examples Chapter**

**NOTE: The example forms are still in development, as they are completed they will be entered into the chapter. Use the relevant example forms from the The electronic version of the 2018 FMM.**

| Form | Title   |
|------|---|
| 157  | Field Report for Sample Identification or Materials Documentation                     |
| 6    | Field Tests of Base Aggregate, Fillers, Paving and Miscellaneous Aggregates           |
| 38   | Aggregate Test Report - [ <i>computer output</i> ] SiteManager                        |
| 194  | Structure Backfill Density Report   |
| 564  | Soils and Aggregate Sieve Analysis When Splitting On the No. 4 Sieve                  |
| 565  | Sieve Analysis For Aggregate Not Split On the No. 4 Sieve                             |
| 633  | Sample Tag (Sacks)  |
| 1126 | Stabilometer Record of Item 304 Aggregate Base Course                                 |
| 1296 | Granular Materials Moisture – Density Report - [ <i>computer output</i> ] SiteManager |

|   |               |  |                           |   |  |
|---|---------------|--|---------------------------|---|--|
| <b>COLORADO DEPARTMENT OF TRANSPORTATION<br/>FIELD REPORT FOR SAMPLE IDENTIFICATION<br/>OR MATERIALS DOCUMENTATION</b>  |               |  | FS# = (Contract ID-Seq.#) |   |  |
|   |               |  | Region                    |   |  |
|   |               |  | Contract ID               | Date Submitted  |  |
|   |               |  | Project No.               |   |  |
| Project Location  |               |  |                           |   |  |
| Material Type   |               | Field Lab phone  | Cell Phone                |   |  |
| Material Code (LIMS)  | Item          | Class  | Grading                   | Special Provisions <input type="checkbox"/> yes   |  |
| Previously used on Project No.:   |               | Previous CDOT Form #157 F/S No.(s):  |                           | <input type="checkbox"/> CDOT Form #633 (sack)<br><input type="checkbox"/> CDOT Form #634 (can) |  |
| ● Sample Identification: Quantity & Unit of material submitted, describe tests required, precise location sample remove from (Stationing), etc.<br>● Materials Documentation: Field inspected (describe appearance, weight/dimensions, model/serial number), COC &/or CTR provided etc. |               |  |                           |   |  |
|   |               |  |                           |   |  |
|   |               |  |                           |   |  |
|   |               |  |                           |   |  |
|   |               |  |                           |   |  |
|   |               |  |                           |   |  |
| Central Lab use only:   |               |  |                           |   |  |
| Sample ID (#1)  |               | Sample ID (#2)   |                           | Sample ID (#3)  |  |
| Sample ID (#4)  |               | Sample ID (#5)   |                           | Sample ID (#6)  |  |
| APL/QML Acceptance: APL Ref. No.  | Product name: |  |                           | Date checked:   |  |
| APL/QML Acceptance: APL Ref. No.  | Product name: |  |                           | Date checked:   |  |
| Preliminary <input type="checkbox"/> Construction <input type="checkbox"/> Maintenance <input type="checkbox"/> Emergency <input type="checkbox"/>  |               |  |                           | Date needed   |  |
| Contractor  |               |  | Supplier                  |   |  |
| Sampled from<br><small>(Pit, roadway, windrow, stock, etc.)</small>   |               |  | Pit name or owner         |   |  |
| Quantity represented  |               | Previous quantity  |                           | Total quantity to date  |  |
| Sample submitted:<br><input type="checkbox"/> Yes <input type="checkbox"/> No   |               | Shipped specified quantity to:<br><input type="checkbox"/> Central lab <input type="checkbox"/> Region lab <input type="checkbox"/> Consultant lab |                           | Date  |  |
| Sampled or inspected by (print name)  |               | Title  |                           | E-mail  |  |
| Supervisor (Pro./Res./Mets. Engr./Maint. Supt.) (print name)  |               | Title  |                           | Residency   |  |

Distribution: Chemical Lab: [cdot\\_chemlab@state.co.us](mailto:cdot_chemlab@state.co.us)  
 Concrete Lab: [cdot\\_conc.lab@state.co.us](mailto:cdot_conc.lab@state.co.us)  
 Flexible Pavement: [cdot\\_flex.lab@state.co.us](mailto:cdot_flex.lab@state.co.us)  
 Physical Properties: [cdot\\_phpr.lab@state.co.us](mailto:cdot_phpr.lab@state.co.us)  
 Soils Lab: [cdot\\_soils.lab@state.co.us](mailto:cdot_soils.lab@state.co.us)  
 Region Labs: Send completed form with sample

Previous editions are obsolete and may not be used. CDOT Form #167 04/18

Project File: SMM – Upload completed form into the attachment icon on the sample record





|  |   |
|--|---|
| <b>COLORADO DEPARTMENT OF TRANSPORTATION<br/>SOILS AND AGGREGATES SIEVE ANALYSIS<br/>WHEN SPLITTING ON THE No. 4 SIEVE</b> | Contract ID                                 |
|  | Project No.                                 |
|  | Item <span style="float:right">Class</span> |

|                    |         |                |                       |      |                 |          |               |                          |
|--------------------|---------|----------------|-----------------------|------|-----------------|----------|---------------|--------------------------|
| Pit name           |         |                | Station               |      |                 | Test no. | Sample weight | Date                     |
| Sieve              | Wet wt. | Dry wt.        | Individual percentage |      | Percent passing | Specs    | Sample ID     |                          |
|                    |         |                |                       |      |                 |          | Liquid limit  | Moisture correction      |
|                    |         |                |                       |      |                 |          | Plastic limit | Plus #4 moisture sample  |
|                    |         |                |                       |      |                 |          | Plastic index | Wet weight               |
|                    |         |                |                       |      |                 |          | Soil class.   | Dry weight               |
|                    |         |                |                       |      |                 |          | "R" value     | Loss                     |
|                    |         |                |                       |      |                 |          |               | % moisture               |
| + #4               |         |                |                       |      |                 |          | Sampled by    | Minus #4 moisture sample |
| - #4               |         |                |                       | #    |                 |          |               | Wet weight               |
| Total              |         |                |                       | #    |                 |          |               | Dry weight               |
|                    |         |                |                       | #200 |                 |          | Tested by     | Loss                     |
|                    |         |                |                       | #200 |                 |          |               | % moisture               |
| Minus #4 wash      |         |                |                       |      |                 |          |               |                          |
| Wet weight (grams) | Sieve   | Weight (grams) | Individual percentage |      | Percent passing |          |               |                          |
|                    | #       |                |                       |      |                 |          |               |                          |
|                    | #       |                |                       |      |                 |          |               |                          |
| Dry weight (grams) | #200    |                |                       |      |                 |          |               |                          |
|                    | - #200  |                |                       |      |                 |          |               |                          |
|                    | Total   |                |                       |      |                 |          |               |                          |

NOTE: Save all material until calculations are completed in case a check is necessary

|                    |         |                |                       |      |                 |          |               |                          |
|--------------------|---------|----------------|-----------------------|------|-----------------|----------|---------------|--------------------------|
| Pit name           |         |                | Station               |      |                 | Test no. | Sample weight | Date                     |
| Sieve              | Wet wt. | Dry wt.        | Individual percentage |      | Percent passing | Specs    | Sample ID     |                          |
|                    |         |                |                       |      |                 |          | Liquid limit  | Moisture correction      |
|                    |         |                |                       |      |                 |          | Plastic limit | Plus #4 moisture sample  |
|                    |         |                |                       |      |                 |          | Plastic index | Wet weight               |
|                    |         |                |                       |      |                 |          | Soil class.   | Dry weight               |
|                    |         |                |                       |      |                 |          | "R" value     | Loss                     |
|                    |         |                |                       |      |                 |          |               | % moisture               |
| + #4               |         |                |                       |      |                 |          | Sampled by    | Minus #4 moisture sample |
| - #4               |         |                |                       | #    |                 |          |               | Wet weight               |
| Total              |         |                |                       | #    |                 |          |               | Dry weight               |
|                    |         |                |                       | #200 |                 |          | Tested by     | Loss                     |
|                    |         |                |                       | #200 |                 |          |               | % moisture               |
| Minus #4 wash      |         |                |                       |      |                 |          |               |                          |
| Wet weight (grams) | Sieve   | Weight (grams) | Individual percentage |      | Percent passing |          |               |                          |
|                    | #       |                |                       |      |                 |          |               |                          |
|                    | #       |                |                       |      |                 |          |               |                          |
| Dry weight (grams) | #200    |                |                       |      |                 |          |               |                          |
|                    | - #200  |                |                       |      |                 |          |               |                          |
|                    | Total   |                |                       |      |                 |          |               |                          |

Previous editions are obsolete and may not be used.

| Colorado Department of Transportation<br>Sieve Analysis for Aggregates CP31<br>Atterberg Limits T89 and T90 |        |   |                           |            | Contract ID: _____ Region: _____  |                       |
|---|--------|---|---------------------------|------------|---|-----------------------|
| Material Description:   |        |   |                           |            | Project Number: _____   |                       |
| Prime Contractor:   |        |   |                           |            | Project Location: _____   |                       |
| Sample ID SMM: _____  |        |   | Lab Ref Number SMM: _____ |            | Do not use this form for Item 203 - Soils or Item 206 - Structure Backfill Class 2, use Form 564 Split over the #4 - CP 21  |                       |
| Class: _____  |        |   |                           |            | Test No: _____  |                       |
| Test Date: _____  |        |   |                           |            |   |                       |
| Gradation Specimen Dry Weight (SDW):  |        | Washed Dry Weight (WDW):                        |                           |            | Sample Information  |                       |
| Sieve   | Weight | Percent Retained                                | Percent Passing           | Specs      | Sampled From: _____<br>Supplier Ticket No: _____<br>Time Sampled: _____<br>Station: _____<br>Lane: _____<br>Quantity Sample Represents: _____<br>Sampling witnessed by: _____<br>Sample Tested By: _____  |                       |
| 6"  |        |   |                           |            | <b>Sample % Moisture and Dry Weight</b><br><br>Pan ID: _____<br>Pan Weight (g): _____ A<br>Pan & Sample - Wet Weight (g): _____ B<br>Pan & Sample - Dry Weight (g): _____ C<br>Sample - Wet Weight (g): _____ D=(B-A)<br>Sample - Dry Weight (g): _____ E=(C-A)<br>Moisture Loss (g): _____ F=(D-E)<br>Moisture Content (MC) %: _____ G=(F/E) x 100<br>Specimen Dry Weight: <span style="border: 1px solid black; padding: 2px;">        </span> E<br><br>If gradation sample and moisture sample are the same sample, use the dry weight (SDW) in the sieve analysis calculations. |                       |
| 4"  |        |   |                           |            |   |                       |
| 3"  |        |   |                           |            |   |                       |
| 2½"   |        |   |                           |            |   |                       |
| 2"  |        |   |                           |            |   |                       |
| 1½"   |        |   |                           |            |   |                       |
| 1"  |        |   |                           |            |   |                       |
| ¾"  |        |   |                           |            |   |                       |
| ½"  |        |   |                           |            |   |                       |
| ⅜"  |        |   |                           |            |   |                       |
| 5/16"   |        |   |                           |            |   |                       |
| ¼"  |        |   |                           |            |   |                       |
| #4  |        |   |                           |            |   |                       |
| #8  |        |   |                           |            |   |                       |
| #16   |        |   |                           |            |   |                       |
| #30   |        |   |                           |            |   |                       |
| #50   |        |   |                           |            |   |                       |
| #100  |        |   |                           |            |   |                       |
| #200  |        |   |                           |            |   |                       |
| - #200  |        | (WDW - TSW) ÷ WDW x 100 = % Diff (Spec: ≤ 0.3%) |                           |            |   |                       |
| Total Sieved WT (TSW):  |        | _____ ÷ _____ x 100 = _____ %                   |                           |            |   |                       |
| Wet Weight ÷ (100 + MC %) x 100 = Specimen Dry Weight<br>Wet WT. _____ ÷ (100 + _____) x 100 = _____ SDW    |        |   |                           |            | If a split moisture sample is used to determine dry mass of gradation sample, use calculation to determine dry weight.  |                       |
| Atterberg Limits:    Liquid Limit T89    Plastic Limit T90  |        |   |                           |            |   |                       |
| Tin ID: _____   |        |   | Place IA Stamp Here:      |            |   |                       |
| Mass of Tin: _____  |        |   |                           |            |   |                       |
| Mass of Tin + Wet Soil: _____   |        |   |                           |            |   |                       |
| Mass of Tin + Dry Soil: _____   |        |   | Number of Blows           | Multiplier | IA Sample ID: _____   |                       |
| Moisture Content %: _____   |        |   | 22                        | 0.9850     | Electronic Signature of IA Personnel  |                       |
| Number of Blows: _____  |        |   | 23                        | 0.9900     |   |                       |
| Plasticity Index  |        |   | Specifications            | 24         | 0.9950  | Sample Remarks: _____ |
| Liquid Limit %: _____   |        |   |                           | 25         | 1.0000  |                       |
| Plastic Limit %: _____  |        |   |                           | 26         | 1.0050  |                       |
| Plasticity Index: _____   |        |   |                           | 27         | 1.0090  |                       |
| LL % = Moisture Content @ number of blows X multiplier  |        |   |                           | 28         | 1.0140  |                       |

Previous editions are obsolete and may not be used.

CDOT Form #565

|   |                        |                              |               |
|---|------------------------|------------------------------|---------------|
| Contract ID   |                        | Region                       | Material Code |
| Sample ID   |                        |                              | FS #          |
| Test #  | Proj Special Provision | <input type="checkbox"/> YES | Lab Ref #     |
| Item #  | Cell #                 | Sample                       | of            |
| E-mail  |                        |                              |               |
| Colorado Dept of Transportation 4670 N. Holly St.<br>Denver CO 80216-6408 |                        |                              |               |
| CDOT Form 633 8/19  |                        |                              |               |

|   |        |        |
|---|--------|--------|
| Contract ID   |        | Region |
| Sample ID   |        |        |
| FS #  | Test # |        |
| Station   | Depth  |        |
| Item #  | Sample | of     |
| <b>Detach Stub and Submit with Sample</b>                                 |        |        |
| Colorado Dept of Transportation 4670 N. Holly<br>St. Denver CO 80216-6408 |        |        |
| CDOT Form 633 8/19  |        |        |



|   |           |        |   |                |                  |        |       |
|---|-----------|--------|---|----------------|------------------|--------|-------|
| <b>COLORADO DEPARTMENT OF TRANSPORTATION</b><br><b>STABILOMETER RECORD OF</b><br><b>ITEM 304 ABC</b>  |           |        |   | Contract ID    |                  | Region |       |
|   |           |        |   | Project No.    |                  |        |       |
|   |           |        |   | Proj. location |                  |        |       |
| Pit name  |           | Date   | Sample ID   |                |                  | Lab #  |       |
| Represents  |           |        | LL  | PL             | PI               | SE     | Class |
| GRADATION   |           |        | Stabilometer "R" value:   |                |                  |        |       |
| As run  |           | Set up | % moisture at   |                | lbs. per cu. ft. |        |       |
| Seive size  | % passing | Scalp  | % Moisture - #4 Material _____ X<br>Weight of - #4 Material _____ =<br>Weight of H <sub>2</sub> O _____ +<br>Initial H <sub>2</sub> O added _____ =<br>Total initial H <sub>2</sub> O _____ (A) |                |                  |        |       |
| 4"  |           |        | COMPACTION  |                |                  |        |       |
| 3"  |           |        | Cylinder #  |                |                  |        |       |
| 2½"   |           |        | H <sub>2</sub> O added (B)  |                |                  |        |       |
| 2"  |           |        | Exudation pressure, lbs   |                |                  |        |       |
| 1½"   |           |        | Exudation pressure, PSI   |                |                  |        |       |
| 1"  |           |        | Ht. of briquette (H)  |                |                  |        |       |
| ¾"  |           |        | Wt. cylinder & wet sample   |                |                  |        |       |
| ½"  |           |        | Cylinder tare   |                |                  |        |       |
| ⅜"  |           |        | Wet wt. of sample (W <sub>w</sub> )   |                |                  |        |       |
| #4  |           |        | <sup>1</sup> Weight of H <sub>2</sub> O (C)   |                |                  |        |       |
| #8  |           |        | <sup>2</sup> Dry wt. (D)  |                |                  |        |       |
| #16   |           |        | <sup>3</sup> % Moisture (M)   |                |                  |        |       |
| #50   |           |        | <sup>4</sup> Density  |                |                  |        |       |
| #100  |           |        | Height correction by wt.  |                |                  |        |       |
| #200  |           |        | STABILOMETER  |                |                  |        |       |
| Set up weights  |           |        | Total load  | PSI            |                  |        |       |
| -¾" + ½"  |           |        | 1000  | 80             |                  |        |       |
| -½" + ⅜"  |           |        | 2000  | 160            |                  |        |       |
| -⅜" + #4  |           |        | Displacement turns  |                |                  |        |       |
| - #4  |           |        | "R" value   |                |                  |        |       |
| <sup>1</sup> (A) + (B) = (C)<br><sup>2</sup> (Ww) - (C) = (D)<br><sup>3</sup> (C) ÷ (D) = (M)<br><sup>4</sup> (W <sub>w</sub> ) x 30.3<br>(100 + M) x H |           |        | Drainage  |                |                  |        |       |
|   |           |        | Exp. pressure dial reading  |                |                  |        |       |

Previous editions are not obsolete and may not be used.

CDOT Form #1126 4/14

## Chapter 400

### Asphalt - 21

**This chapter is not part of the Project specifications but is a guide for project personnel in interpreting CDOT specifications, understanding ASTM, AASHTO, and Colorado test procedures, and for completing CDOT forms.**

#### Bituminous Mixtures & Binders

Bituminous materials are used by CDOT for a variety of purposes. The bituminous material (normally referred to as asphalt cement or binder) may be combined with aggregate to bind the aggregate together and thus form a durable pavement. Binder may also be sprayed on a surface to protect the surface. Binders at room temperature are too viscous (stiff) to mix with aggregate or to be sprayed. Mixing is achieved by reducing viscosity by one of three approaches: Hot Mix Asphalt (HMA) is produced by heating the binder, to reduce viscosity, then combining the hot binder with hot, dry aggregate. Until 2004 HMA was referred to as HBP or Hot Bituminous Pavement by CDOT. Colorado changed to be consistent with the current national terminology. A second method for lowering viscosity to improve mixing involves combining binder with water and emulsifier to produce an emulsion. In the third approach, asphalt cement is combined with solvent to produce lower viscosity material called cutback asphalt. Cutback can be readily mixed with aggregate. Heating, emulsification, or solvents may also be used to facilitate spraying of a binder.

#### HMA

Of the three mixing approaches, HMA provides the strongest and most durable pavements. Combining hot asphalt cement with hot dry aggregate provides the strongest bond between the binder and aggregate. However, drying the aggregate plus heating the aggregate and binder requires considerable energy. In addition, the HMA must be transported, placed and compacted before it becomes too cool for proper compaction.

#### Emulsions

Emulsions can be stored and used at lower temperatures than binder for use in HMA. Emulsions can also be used with wet, cool aggregate. These emulsion properties allow energy savings and more flexibility in application.

#### Cutbacks

Cutbacks contain solvents, which could be used for fuel, petrochemicals, or some other more effective use of a non-renewable resource. A more serious problem with cutbacks is that the solvents can be absorbed through the skin or may be breathed after evaporation. Many solvents used in cutbacks present health hazards and some solvents are highly flammable and thus are a fire hazard. Solvents in cutbacks also contribute to air pollution and the formation of ozone. Health, safety, and environmental regulations have eliminated almost all use of cutbacks for highway construction by CDOT.

**ITEM 403 - HOT MIX ASPHALT**

*Superpave* - The Strategic Highway Research Program (SHRP) was established by Congress in 1987 as a five-year research program to improve the performance and durability of U.S. roads and to make those roads safer for both motorists and highway workers. \$50 million of the SHRP research funds were used for the development of performance based asphalt specifications that directly relate laboratory analysis with field performance.

Superpave (Superior Performing Asphalt Pavements) is a product of the SHRP asphalt research. The Superpave system represents an improved system for specifying asphalt binders and mineral aggregates, developing asphalt mix designs, and analyzing and establishing pavement performance prediction. The Superpave binder specifications and mix design system include various test equipment, test methods, and materials criteria.

Superpave is a performance-based system. The tests and analysis have direct relationships to field performance.

**ITEM 403 - SUPERPAVE MIX DESIGN**

One outcome of the SHRP research was the development of the Superpave gyratory compactor (SGC). The SGC compacts mixtures at an angle of 1.25°, which has been determined to better simulate field compaction.

Mixes that are designed with the SGC take into account the amount of traffic the roadway is expected to experience throughout its design life. Binder selection is based on climate, traffic loading, and traffic flow. The asphalt content that yields 4% air voids at the design number of gyration,  $N_{\text{design}}$ , becomes the target asphalt content.

An excellent discussion of the Superpave mix design can be found in the Asphalt Institute Manual SP-2, *Superpave Mix Design*. When using the 0.45 Power-Chart, CDOT defines the maximum density gradation line as a straight line passing from the origin to one sieve size larger than the nominal maximum aggregate size.

**ITEM 411 - PERFORMANCE GRADED BINDERS (PG BINDERS)**

The asphalt cements under the Superpave system are called binders because the intent of the specifications was to address both modified and unmodified asphalt cements. One feature of the Superpave binder specification is that all of the binders have to meet the same criteria, but the temperature at which they meet the criteria is related to the climate in the project area. For instance, using the Superpave specifications binders can be chosen to address low temperature cracking in the high mountains, or rut resistance in the eastern plains with the same test values, but the test temperature would be different to reflect the different project climates. For example, a performance binder designation listed as PG 58-28 would mean that the binder will meet the high service temperature requirements (rutting) up to a pavement temperature of 58°C and that the binder will meet the low temperature requirements down to a pavement service temperature of -28°C. The recommended pavement service temperatures for all Colorado weather stations can be found in CDOT's Pavement Design Manual along with instructions for the selection of PG binders.

**Some of the tests and equipment in the Superpave system are as follows:**

*Dynamic Shear Rheometer (DSR)* - Used to measure rut resistance properties at high pavement service temperatures, and fatigue cracking properties at intermediate service temperatures.

*Bending Beam Rheometer (BBR)* - Used to measure binder properties at low temperatures to determine if a binder has the required properties for resistance to thermal cracking.

*Direct Tension Device (DTD)* - Used to measure binder strength at low temperatures to determine resistance to low temperature cracking.

*Rolling Thin Film Oven (RTFO)* - Used to simulate the aging, which occurs to the asphalt binder in the mixing plant. Most of the rut resistance measurements are made on the binder in this condition.

*Pressure Aging Vessel (PAV)* - Used to age asphalt binder in the lab to simulate the aging, which takes place in the pavement after 5 to 7 years. Most of the measurements to determine fatigue and thermal cracking resistance are made on samples following this aging procedure.

An excellent discussion of the background and testing of PG binders is found in the Asphalt Institute Manual SP-1, *Superpave Asphalt Binder Specification*.

**ITEM 403 - HOT MIX ASPHALT****European Rutting Machines**

Rutting and stripping data from project produced mixes is being gathered to identify good and poor performing mixes, as well as to develop specifications to help determine and produce better performing mixes for Colorado.

Two different pieces of equipment are being used in the Central Laboratory to measure rutting potential, the Hamburg Wheel-Tracking Device and the French Rutting Tester. The Hamburg Device also provides a severe test for stripping. As reflected in the Schedule for Sampling and Testing (Item 403), the choice of which rut tester to use is determined by the Region Materials Engineer.

The following are descriptions of the two rutting devices.

**Hamburg Wheel-Tracking Device (HWTD)**

The Hamburg Wheel-Tracking Device was obtained following the European Tour in 1990 by CDOT and has been used in a large quantity of research concerning stripping by CDOT. The HWTD was manufactured by Helmut-Wind Inc. of Hamburg Germany and is a very severe test for stripping and rutting of an asphalt mix.

A pair of samples (lab compacted slabs or field cores of 10" diameter) is tested simultaneously. The slabs/cores are submerged under water with the temperature varying from 45°F to 55°C (113°F to 131°F) depending on the PG binder. A steel wheel, 47 mm (1.85 in) wide, loads the samples with 705 N (158 lbs) and the wheel makes 50 passes over each sample per minute. The maximum velocity of the wheel is 340 mm/sec (1.1 ft/sec) in the center of the sample. Each sample is loaded for 10,000 passes or until 15 mm of deformation occurs. Approximately 3 1/2 hours are required for a test.

The results from the HWTD include the creep slope, stripping slope, and the stripping inflection point. The creep slope relates to rutting from plastic flow. It is the inverse of the rate of deformation in the linear region of the deformation curve, after post compaction effects have ended and before the onset of stripping. The stripping slope is the inverse of the rate of deformation in the linear region of the deformation curve, after stripping begins and until the end of the test. It is the number of passes required to create a 1 mm impression from stripping and is related to moisture damage. The stripping inflection point is the number of passes at the intersection of the creep slope and the stripping slope. It is also related to moisture damage.<sup>1</sup>

The CDOT specification is a maximum impression of 4 mm after 10,000 passes. The Figure 400-1 shows a plot of a Hamburg sample.

### **French Rutting Tester (FRT)**

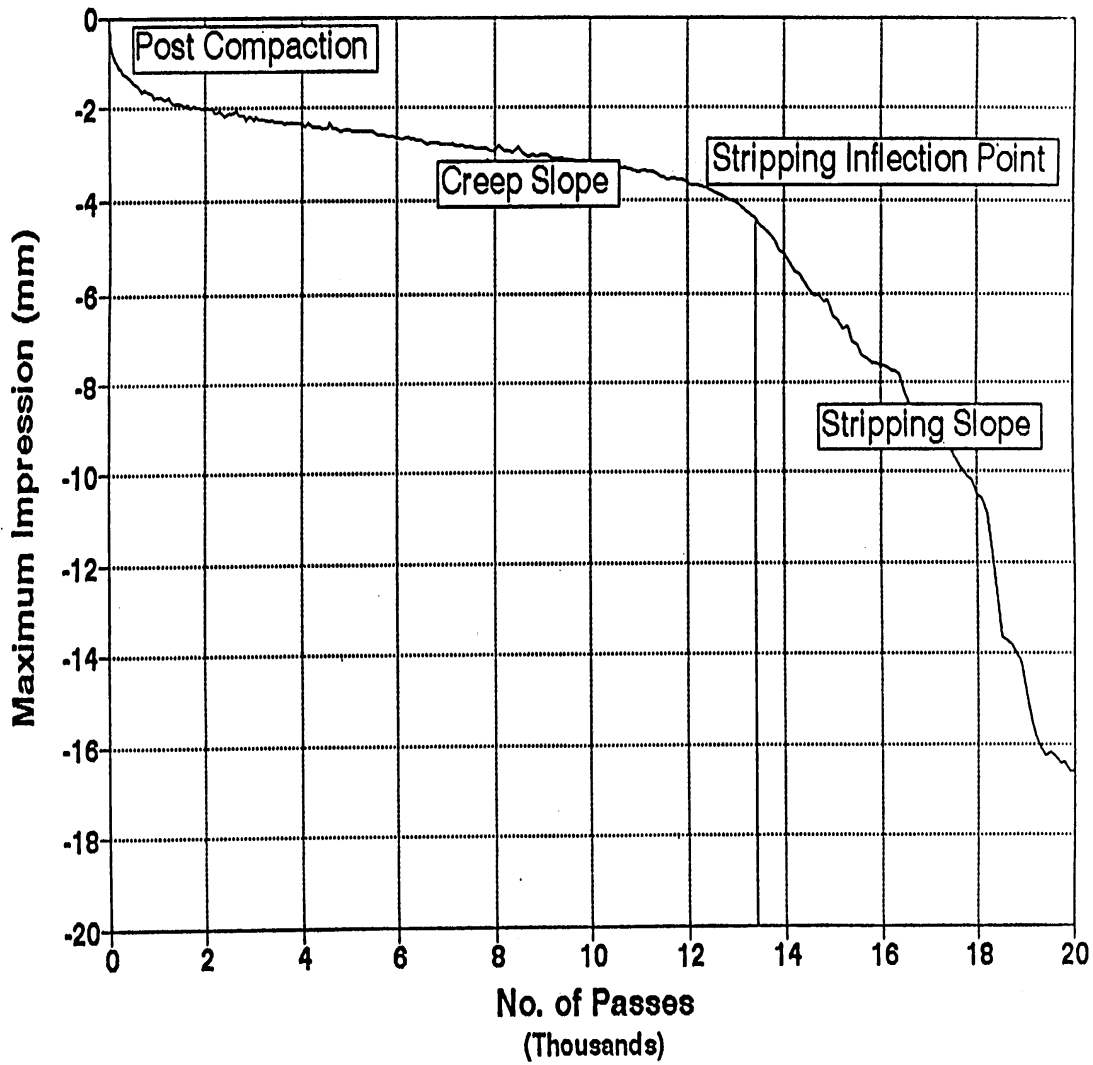
The French Rutting Tester was also obtained following the European Tour in 1990, and has been used extensively to predict rutting. The research on 33 pavements with known rutting performance has shown that this equipment is excellent at predicting rutting from plastic flow. The FRT test slabs 500 mm by 180 mm (19.7 x 7.1 inches), which can be 20 to 100 mm thick (0.8 to 3.9 inches).

Two slabs can be tested simultaneously. The slabs are loaded by a pneumatic tire inflated to 87 psi (0.6 Mpa). The tire loads the sample at 1 cycle per second (one cycle is two passes).

The entire chamber is heated to a temperature range between 113°F to 140°F (45°C to 60°C), depending on the PG binder.

FRT tests can be made on lab compacted slabs, or field slabs of 8" x 20" cut from the roadway. The rut depth is calculated as the difference between the original slab height and the slab height after testing is completed. It is reported in millimeters. The CDOT specification is less than 5 mm rutting in 10,000 cycles.

The FRT has been shown to be a very good predictor of rut susceptibility from plastic flow when the test temperature is adjusted to the conditions found in the project area.



Definition of the Hamburg Wheel-Tracking Results.

FIGURE 400-1

**Asphalt Mixture Performance Test (AMPT)**

A Pooled Fund Study Launched in 2008 by the FHWA offered the State Agencies the opportunity to obtain and therefore train on using the AMPT which is used to evaluate Superpave mixtures. The AMPT was developed to specifically perform three types of tests.

1. Dynamic Modulus
2. Repeated Load Test
3. Creep Test: (Measures flow time and flow number used to evaluate rutting and fatigue cracking.)

Reference Material:

AASHTO TP 79

AASHTO PP 60

AASHTO PP 61

Report:

Dynamic Modulus:  $E^* = \frac{\text{Peak Stress}}{\text{Peak Strain}}$

Phase Angle: The time lag between stress and strain.

**ITEM 411 - ASPHALT MATERIALS**

**Acceptance Procedure for Asphalt Cements / Performance Graded Asphalt Binders, Liquid Asphalt Materials, Emulsified Asphalts, and Asphalt Rejuvenating Agents.** Wherever the word Asphalt Cements is used, it is construed to mean either, Asphalt Cements or Performance Graded Asphalt Binders.

It is the responsibility of project personnel to set up a predetermined random sampling schedule. All samples, whether QA or IA, are to be submitted to the Central Laboratory and accompanied by the appropriate form.

**Note: All sample containers must be properly labeled (CDOT Form 634) with the following:**

Contract ID  
Field Sheet #  
Sample ID  
Material Type  
Lot #  
Material Code  
Can #  
Lab Ref. #

Asphalt and binder acceptance/verification (QA) samples shall be taken at the contractor's plant.

Samples of these materials will normally be taken by the Contractor's personnel in the presence of the CDOT project personnel or their designated agent for acceptance/verification.

**Note:** Reference to Independent Assurance sampling and testing has been deleted.

Samples shall be taken from the pipeline(s) through which the material is flowing by insertion of a sampling device or other similar efficient method immediately prior or before discharge into the HMA final mixing area or apparatus. The sampling device should be conveniently located for sampling access by contractor's project personnel. See AASHTO T 40 for additional information about sampling of AC type material. Note: The sampling device would normally be located in the line from the storage tank to the HMA plant mixing area.

### **Random Sampling and the Lot System**

Statistical methods are employed to evaluate quality assurance of materials because it is impractical, if not impossible, to test all the materials incorporated into a highway project. To meet the requirements of the CDOT statistical acceptance procedure the following method will be utilized:

Normally, samples 1 through 5 will be designated Lot No. 1, samples 6 through 10 will be designated Lot No. 2, samples 11 through 15 will be designated Lot No. 3, etc. At the discretion of the Project Engineer, a lot may be assigned as stated in the "Establishing Lots and Process Control on the Project" in the Appendix Chapter and also they may refer to the CP 75, Stratified Random Sampling of Materials, and the section "Sampling and Testing Definitions."

In the Central Laboratory a sample from each lot will be randomly selected to represent that lot. If the tested sample conforms to specification requirements, the lot is acceptable. If the tested sample fails to meet specification requirements, then the other samples of that lot will be tested.

The test results for the lot will then be analyzed by the Project Engineer for acceptance at full contract price, price reduction, or rejection according to Subsection 105.03 of the Standard Specifications.

Do not use the price reduction formulas shown in Subsection 105.03 of the Standard Specifications on metric projects unless the specific metric notation is included.

### **Reporting Project Acceptance/Verification Samples for Undiluted Emulsion**

Under this program, the field tester will continue to collect a COC for the material delivered to the project and file it in the project files. The tester will fill in the pertinent field data on CDOT Form 411, PG Binder/Emulsion Submittal Form.

### **Asphalt Emulsion Overview**

Binder and water do not normally mix well. Even if thoroughly mixed, the droplets of binder quickly recombine (coalesce) to become separate from the water. The mixture of binder and water are made more permanent by using an emulsifier to suspend the binder droplets within the water. The emulsifier bonds to the surface of the binder droplets, causing them to repel each other and thus not coalesce.

Emulsions are manufactured to yield a viscosity low enough for the emulsion to disperse throughout an aggregate or be sprayed on a surface. After application, the emulsion sets or breaks as the asphalt droplets coalesce, the water evaporates, and the binder coats the aggregate or sprayed surface. Time required for the emulsion to break is influenced by many factors including: emulsion characteristics, temperature, humidity, aggregate gradation, and aggregate surface properties.



## Emulsion Production

Emulsions are produced by mixing binder with water containing an emulsifier in a colloid mill. The mill contains a moving rotor and a stationary stator separated by a small gap. The mill creates small droplets of binder, kept separate by the emulsifier, and dispersed in the water. This process is augmented by heating both the binder and the water. In some cases the water is heated above boiling, requiring the process to take place under pressure. Additional additives may be added during the process to modify the properties of the emulsion or the residual binder left after curing. Polymers and adhesion promoters are added to improve the performance of the residual binder. For example, polymers improve binder properties such as cohesion, resistance to cracking at low temperatures, and resistance to flow at high temperatures. Thickeners and several other chemicals may be added to improve the properties of the emulsion. For the most part, these chemicals stabilize emulsion viscosity or reduce settlement.

**TABLE 400-1**

| <b>COMPARISON OF EMULSION PROPERTIES</b> |                                      |                             |
|--|--------------------------------------|-----------------------------|
| <b>Property</b>                          | <b>Anionic Emulsion</b>              | <b>Cationic Emulsion</b>    |
| Breaking Time                            | Long                                 | Short                       |
| Adhesion of Deposited Bitumen            | Bad, except on calcareous aggregates | Excellent on all aggregates |
| Condition of Aggregate                   | Must be dry                          | Must be wet                 |

## Emulsion Testing

Testing of emulsions serves several purposes. Some of the tests such as charge and reactivity are used to classify emulsions. Classification allows the user to choose the right emulsion for the intended application. Other tests ensure that the storage and handling of the emulsion will not be a problem. Still other tests evaluate performance related properties of the emulsion. Some of these performance related test results are also used in classification. Tests can be conducted on the emulsion or on the binder that remains when the water is removed. The common tests conducted on emulsions used by CDOT are the following:

### 1. Particle Charge

Emulsions are classified as anionic (negatively charged) or cationic (positively charged) depending on the charge of the particles surrounding the binder droplets. Particle charge is determined by inserting electrodes into the emulsion, applying a current, and noting which electrode is coated by binder. Emulsion charge can influence how the emulsion residue coats aggregate of certain mineral composition.

## **2. Reactivity**

Emulsions are classified as rapid-setting, medium-setting, or slow-setting based on how quickly they set or break. Rapid-setting emulsions set quickly when applied to clean, relatively large aggregate, such as chips used in chip seals. Medium-setting emulsions set more slowly when applied to clean relatively large aggregate. Medium-setting emulsions can be mixed with aggregates low in fines such as open-graded mixes. Slow-setting emulsions set slowly when combined with aggregates containing substantial amounts of fines. These emulsions can be used to produce cold mixes using uniformly graded aggregates similar to those used in HMA.

Reactivity can be measured in several ways. The emulsion can be mixed with standard aggregates and the amount of coating determined. Coalescence when exposed to fine quartz sand or cement also indicates reactivity. In another reactivity test, solutions that cause emulsions to break are added in increments. The amount of solution required to cause coalescence or breaking indicates reactivity and is called “demulsibility”.

## **3. Sieve Test**

The sieve test determines if there are large particles in the emulsion, which could clog spray nozzles. The amount of binder retained on the No. 20 sieve is determined. The maximum allowed amount is normally 0.1%.

## **4. Storage Stability**

If the density of the binder droplets is different from the water density, the droplets will tend to float to the top or settle to the bottom (more typical). If this is excessive, the non-uniformity can cause construction problems. Glass cylinders are filled with emulsion and allowed to sit for 24 hours. Samples are obtained from the top and bottom of the cylinder and the residue percentage compared to the percentage for the entire cylinder. The percentage of binder residue for the top and bottom cannot vary from the overall by more than 1%.

## **5. Emulsion Viscosity**

The viscosity of the emulsion affects handling and use. The emulsion must be pumpable and flow easily through pipes. It must also coat aggregate effectively, without being too thick to coat or so thin that it runs off too quickly.

Emulsion viscosity is measured by determining the time required for flow of the emulsion out of a cup with a standard opening. The test is called Saybolt Furo1. The temperature for this test is determined by the class of emulsion and relates to the temperature of typical use of a given class.

## **Examination of Emulsion Residue**

The percentage and properties of the residue remaining when the water is removed from the emulsion are critical to performance. There must be an adequate amount of binder with the correct physical properties for the emulsion to perform well. The water may be removed by evaporation or by distillation. CDOT determines the percent residue and obtains residue for testing by evaporation. If the emulsion fails any test, this process is repeated using distillation for water removal. The CDOT approach parallels the AASHTO standards, which allow evaporation for acceptance only.

Penetration is determined for binder residue of all emulsions. Ductility is determined for binder residue of all non-polymerized emulsions. Toughness and tenacity are usually determined for polymerized cationic emulsions. The float test is conducted only on high float emulsions. For polymerized, high-float emulsions, the ductility and elastic recovery are determined.

### **1. Binder Content**

The emulsion must have an adequate amount of residual binder remaining after the water evaporates. This residue does the job, the water is just a carrier, which evaporates or runs off. Normally, minimum binder residue is 57% for slow-setting emulsions and 65% for both rapid-setting and medium-setting emulsions.

### **2. Penetration**

The penetration test is a measure of the consistency of binder. This test measures the depth of penetration of a standard, loaded needle in a fixed time. Stiff binders have a lower penetration because the needle penetrates less.

### **3. Solubility in Trichloroethylene**

Solubility in trichloroethylene is a measure of the purity of the binder. The soluble portion of the binder provides the cementing properties. The insoluble portion is composed of salts, free carbon, or minerals, which do not help in binding. In this test, the binder is dissolved in trichloroethylene and filtering separates the soluble and insoluble portions.

### **4. Ductility**

Ductility is a measure of the ability of a binder to be extended into a fine thread. A standard sized briquette is extended under controlled conditions until the thread breaks. The elongation when the thread breaks is the ductility. Binders with inadequate ductility are too brittle and result in mixtures that are more susceptible to cracking, raveling, or poor bonding.

### **5. Elastic Recovery**

Elastic recovery is a test used by CDOT (CP-L 2211) to measure the elasticity of the residue for polymerized, anionic emulsions. The Methods A and B prescribe elongating the specimen to specified lengths, and at a specified rate. The sample is then cut either immediately, or after five minutes, and allowed to recover for a one-hour period. Percent of elongation recovered by this contraction is the elastic recovery. Failure of this test indicates the polymer is ineffective.

## 6. Toughness & Tenacity

The toughness and tenacity test is used by CDOT (CP-L 2210) to measure stretching properties imparted to the residue of cationic emulsion by polymers. A tension head is lowered into a heated sample of the binder and the combination is cooled in a water bath to a standard temperature. The head is then pulled upward until the binder forms a long, thin thread, which finally breaks. The areas under two portions of the stress-strain curve are used to calculate the toughness and tenacity. Failure of this test indicates the polymer is ineffective.

## 7. Float Test

The float test measures the ability of a binder to resist softening at a high temperature (60°C). In this test, a hole in a small test “boat” is plugged with the binder being tested. The boat is floated on a hot water bath causing the plug of asphalt to soften, allowing entry of water, which sinks the boat. The time in seconds, required for the boat to sink, is the float test result. High float emulsions must have a minimum float time of 1200 seconds (20 minutes).

### Classification Nomenclature for Emulsions

The series of letters and numbers used to classify emulsions contain a wealth of information about the properties of the emulsion. These properties determine the appropriate use for each emulsion.

For example, consider the emulsions classified as:

**a - “CSS-1h”**

**b - “HFMS-2sP”**

- **a - C** in this location would indicate a cationic emulsion. All cationic emulsions start with a “C”, if there is not a “C”, the emulsion is anionic or non-ionic.
- **b - HF** indicates the float properties of the emulsion. All high float emulsions must pass the float test. No letter C in this location would indicate that this is not a cationic emulsion; hence b above is an anionic emulsion.
- **a - SS** indicates a slow setting emulsion. An **RS** in this location would indicate a rapid setting emulsion and a **MS** in this location would indicate a medium setting emulsion, such as b listed above.
- The **1** or **2** following the **SS** and the **MS** in the above examples give an indication of the emulsion viscosity (Saybolt-Furol). **2** indicates a higher viscosity than a **1**.
- **h** indicates the binder residue is hard, as measured by the penetration test on the residue. **s** indicates the binder residue is soft and no letter indicates a penetration range between an **s** and an **h**.
- **P** indicates the binder is polymerized. No **P** at the end indicates a non-polymer modified binder.
- **R** indicates the binder is modified with latex. No **R** at the end indicates a non-latex modified binder.

## **Emulsion Applications**

### **Tack Coats**

Tack coats are used on lower lifts of HMA to provide a bond to the HMA layer above and to avoid slippage. Slippage can cause severe distress for pavements, so an effective tack coat is critical. CDOT specifies CSS-1h and SS-1h for tack coats. Other asphalt emulsions may be used for tack coats. However, it is very important that the tack coat results in sufficient residual binder to provide a good bond. In addition, there should not be an excessive delay between application of the tack coat and paving. During the delay traffic can pick up the binder or track dirt on the binder, which will reduce bonding. Pave as soon as possible after the emulsion has set to prevent contamination (dust, dirt, etc.) or pickup by tires.

### **Prime Coats**

Prime coats are used on aggregate base courses to provide good adhesion to the HMA layer placed above. Property requirements for prime coats are in the Specification Book. (The material to be used for prime coats is specified in the project plans, and historically both cutback and emulsified asphalts have been used. Emulsions are becoming the most common because of the environmental problems with cutback asphalts.)

### **Chip Seals**

A chip seal (cover coat) consists of a spray bar application of emulsion, topped by chips dropped by a spreader. Light, pneumatic tire rolling seats the chips. The chips are clean, 3/8" aggregate. Single-sized, hard aggregates are desirable for chip seals. A fog seal, applied after the chip seal has completely cured, provides a uniform appearance and better chip retention. CRS-2P and HFRS-2P emulsions are used for chip seals. The rapid set (RS) grabs the chip quickly and the polymer (P) in the binder holds the chip better. It is desirable to use the same emulsion for the fog coat that was used in the chip seal for better compatibility and chip retention.

### **Cold In-Place Recycling**

Cold in-place recycling consists of: 1) roto-milling off the surface of an existing pavement, 2) adding additional binder to the millings, 3) mixing and then spreading the combination on the surface, and finally 4) compacting to an adequate density. HMA is normally placed over the cold in-place recycle layer. Emulsions are used to add the binder since this is a cold process. HFMS-2sP is normally used for cold in-place recycle. The soft binder(s) helps soften the hard oxidized existing pavement and the polymer (P) helps with adhesion and crack resistance.

## Specification Requirements for Emulsion Properties

Specifications for properties of emulsions used by CDOT are found in three locations:

### 1. Standard Specifications

Specifications for some commonly used emulsions are found in tables in Subsection 702.03 of the Specification Book as modified by the Standard Special Provisions. These include: seal coats, prime coats, penetrating priming stabilizers, recycling agents, and rejuvenating agents.

### 2. AASHTO (American Association of State Highway and Transportation Officials)

AASHTO standards apply for all non-polymer emulsions used by CDOT. These are referenced in the Specification Book, Standard Special Provision, or Project Special Provisions. Note that some of the references include modifications of the AASHTO standards.

### 3. Maintenance Bid Table

Each year, binder suppliers bid for the privilege of supplying binders for CDOT maintenance use (Maintenance Bid). Bids are based on binder property specifications provided by CDOT. Non-polymer emulsions are based on reference to AASHTO. Property specifications for polymer emulsions are defined in detail in the Maintenance Bid. These specifications are now organized into a table. An example of that table follows. Note that this table is revised each year. Specific requirements for a particular year should be determined by obtaining a copy of the Maintenance Bid for that year.

## Examples of Emulsion Property Tables

The following pages include examples of emulsion property tables. These are examples only and should not be used to determine specification compliance. Property requirements for non-polymer emulsions should be obtained by reference to the applicable year of AASHTO. Property requirements for emulsions used by CDOT Maintenance should be obtained by reference to the applicable Maintenance Bid.

**Colorado DOT Emulsion Requirements\***

| Property                                 | Cationic  |                               |                               |          | Anionic |           | AASHTO |
|--|-----------|-------------------------------|-------------------------------|----------|---------|-----------|--------|
|  | CSS-1h    | CQS-1hL                       | CQS-1hP                       | CRS-2    | AEP     | SS-1h     |        |
| <i>Tests on Emulsion:</i>                |           |                               |                               |          |         |           |        |
| Temp, °C                                 | 25        | 25                            | 25                            | 50       | 50      | 25        | T-59   |
| Viscosity<br>Sabolt- Furol, s            | min       | 20                            | 15                            | 50       | 20      | 20        |        |
|  | max       | 100                           | 100                           | 450      | 150     | 100       |        |
| Storage stability, 24 hr,<br>% max       | 1         | 1                             | 1                             | 1        |         | 1         | T-59   |
| Particle Charge                          | Positive  | Positive                      | Positive                      | Positive |         |           | T-59   |
| Sieve test, % max                        | 0.1       | 0.1                           | 0.1                           | 0.1      |         | 0.1       | T-59   |
| Residue by distillation, %<br>min        | 57        | 62                            | 62                            | 65       | 65      | 57        | T-59   |
| <i>Tests on residue:</i>                 |           |                               |                               |          |         |           |        |
| Penetration, 25°C, 100g,<br>5s, min      | 40        | 40                            | 40                            | 70       |         | 40        | T-49   |
| Penetration, 25°C, 100g,<br>5s, max      | 120       | 150                           | 150                           | 150      |         | 120       |        |
| Ductility, 25°C, 5 cm/min,<br>cm, min    | 40        | 50                            | 50                            | 40       |         | 40        | T-51   |
| Solubility, in<br>trichloroethylene% min | 97.5      | 97.5                          | 97.5                          | 97.5     | 97.5    | 97.5      | T-44   |
| Typical Use                              | Tack Coat | Slurry Seal & Micro-surfacing | Slurry Seal & Micro-surfacing | MTCE     | Prime   | Tack Coat |        |

\* Partial list of requirements for quick reference only. Refer to AASHTO M140 and M 208 for complete requirements.

**TABLE 400-2**

**Note:** The TABLE 400-3 that existed on this page prior to the 2017 FMM has been deleted in its entirety.

### **Colorado DOT Specifications for Polymer Modified Emulsions**

Polymerized emulsions shall be an emulsified blend of polymerized asphalt, water, and emulsifiers. The asphalt cement shall be polymerized prior to emulsification and shall contain a minimum of three (3.0) percent polymer by weight of asphalt cement. The emulsion standing undisturbed for a minimum of 24 hours shall show no white, milky separation but shall be smooth and homogeneous throughout. The emulsion shall be pumpable and suitable for application through a distributor. The emulsified blend shall conform to the requirements listed in the table of properties below. The "Standard" column of the table lists the American Association of State Highway and Transportation Officials (AASHTO) or Colorado Procedure-Laboratory standard that defines the procedure for the test on that line. For example: T 59 is an AASHTO standard and CP-L 2211 is a Colorado Procedure-Laboratory (CP-L) standard. CP-Ls are found in the Colorado Department of Transportation's (CDOT's) Laboratory Manual of Test Procedures.

### **Footnotes for Table 400-4**

<sup>1</sup> CP-L 2212 is a rapid evaporation test for determining percent residue of an emulsion and providing material for tests on residue. CP-L 2212 is for acceptance only. If the percent residue or any test on the residue fails to meet specifications, the tests will be repeated using the distillation test in accordance with AASHTO T 59 to determine acceptability.

<sup>2</sup> For high float emulsions the distillation and evaporation tests will in be in accordance with AASHTO T 59 or CP-L 2112 respectively with modifications to include  $205^{\circ}\text{C} \pm 5^{\circ}$  ( $400^{\circ}\text{F} \pm 10^{\circ}$ ) maximum temperature to be held for 15 minutes.

<sup>3</sup> When CRS-2P is used for chip seals, compatibility of the aggregate (chips) and the emulsion may be determined for information in accordance with CP-L 2213. This test is a visual estimate of the coating of the aggregate by the emulsion binder after mixing of the emulsion and aggregate.



**Properties for CDOT Polymer Modified Emulsions**

| Property   | CRS-2R <sup>3</sup> | CRS-2P <sup>3</sup> | HFMS-2P         | HFMS-2Sp         | Standard         |
|--|---------------------|---------------------|-----------------|------------------|------------------|
| <i>Tests on emulsion:</i>                                    |                     |                     |                 |                  |                  |
| Viscosity, Sabolt- Furol<br>@ 50 <sup>o</sup>                | min                 | 50                  | 50              | 50               | T-59             |
|  | max                 | 450                 | 450             | 450              |                  |
| at 50°C, s   |                     |                     |                 |                  |                  |
| Storage stability, 24 hr, % max                              | 1.0                 | 1.0                 | 1.0             | 1.0              | T-59             |
| Particle Charge Test   | Positive            | Positive            | Positive        |                  | T-59             |
| Sieve Test, % Max  | 0.10                | 0.10                | 0.10            | 0.10             | T-59             |
| Demulsibility, 0.02 N CaCl <sub>2</sub> , %<br>min           |                     | 40                  |                 |                  | T-59             |
| Oil Distillate by volume, % max<br>or range                  | 3.0                 | 3.0                 | 3.0             | 1.0-7.0          | T-59             |
| Residue by distillation/<br>evaporation <sup>1</sup> , % min | 65                  | 65                  | 65 <sup>2</sup> | 65 <sup>2</sup>  | T-59<br>CPL-2212 |
| <i>Tests on residue:</i>                                     |                     |                     |                 |                  |                  |
| Penetration, 25°C, 100g, 5s, min                             | 70                  | 70                  | 70              | 150              | T-49             |
| Penetration, 25°C, 100g, 5s,<br>max                          | 150                 | 150                 | 150             | 300              |                  |
| Ductility, 25°C, 5 cm/min, cm,<br>min                        |                     |                     | 75              |                  | T-51             |
| Solubility, in<br>trichloroethylene% min                     | 97.5                | 97.5                | 97.5            | 97.5             | T-44             |
| Elastic Recovery<br>Min.                                     | Test Temp<br>°C     |                     | 58              | 50               | CPL-2211         |
|  |                     |                     | 25              | 4                |                  |
| Float Test, 60°C, s min                                      |                     |                     | 1200            | 1200             | T-50             |
| Toughness, in-lbs, min                                       | 90                  | 70                  |                 |                  | CPL-2210         |
| Tenacity, in-lbs, min  | 45                  | 45                  |                 |                  | CPL-2210         |
| Typical Use  | Chipseal            | Chipseal<br>3       | MTCE            | In-place Recycle |                  |

**TABLE 400-4**



**Straight Bill Of Lading -**  
 Short Form Original - Not Negotiable  
 Asphalt

**BOL Number:** \_\_\_\_\_  
**MoT:** TRUCK  
**Transaction Loader:** \_\_\_\_\_

The property described below, in apparent good order, except as noted (contents and condition of contents of packages unknown), marked, consigned, and destined as indicated below, which said carrier (the word carrier being understood throughout the contract as meaning any person or corporation in possession of the property under the contract) agrees to carry to its usual place delivery at said destination, if on its route, otherwise to deliver to another carrier on the route to said destination. It is mutually agreed, as to each carrier, of all or any of said property over all or any portion of said route to destination, and as to each party at any time interested in all or any of said property, that every service to be performed hereunder shall be subject to all the terms and conditions of the Uniform Domestic Straight Bill of Lading set forth(1) in Uniform Freight Classifications in effect on the date hereof, if this is a rail or a rail-water shipment, or (2) in the applicable motor carrier classification or tariff if this is a motor carrier shipment.

**Shipper's Info:** Ship Date: \_\_\_\_\_ Time In: \_\_\_\_\_ Time Out: \_\_\_\_\_  
 HollyFrontier Refining and Marketing LLC Carrier: \_\_\_\_\_ Planned Order \_\_\_\_\_  
 300 MORRIE AVENUE Vehicle: \_\_\_\_\_ Tare Weight: \_\_\_\_\_  
 CHEYENNE, WY 82007 Trailer Customer PO \_\_\_\_\_ Gross Weight: \_\_\_\_\_  
 Ship-to Info: Incoterms \_\_\_\_\_ Net Weight: \_\_\_\_\_  
 Consignee Signature: \_\_\_\_\_

Cert Num: \_\_\_\_\_  
 Seals 1 & 2: \_\_\_\_\_  
 Seals 3 & 4: \_\_\_\_\_

The loader by signing this Bill-of-Lading hereby certifies that transport was loaded as specifies.  
 (Signature of Loader) \_\_\_\_\_

**Items:-**

| Item | Material | Material Description | Weight | UoM | Net Qty | UoM    | Temp | Gravity | Tank |
|------|----------|----------------------|--------|-----|---------|--------|------|---------|------|
| 10   | 100030   | 1 T/T                | STO    | UG6 | 6.00    | TK1-52 |      |         |      |

UN3257, ELEVATED TEMPERATURE LIQUID, N.O.S., (ASPHALT), 9, III

ASPHALT, PG 58-28, 4961605

**For Transportation Emergency -** Spill, Leak, Fire, Exposure, or Accident, call 800-424-9300, In District of Columbia 202-483-7616, Chemtrec Account: CCN201319 In Mexico call 703-527-3887

The driver by signing this Bill-of-Lading hereby certifies that transport was loaded as specifies. The carrier certifies that the cargo tank supplied for this shipment is a proper container for the transportation of this commodity as described by shipper.

Driver Name: \_\_\_\_\_ Driver Signature: \_\_\_\_\_

This is to certify that the here-in named materials are properly classified, described, packaged, marked, and labeled, and are in proper condition for transportation according to the applicable regulations of the department of transportation.

KELLI WILBER

If the shipment moves between two ports by a carrier by water, the law requires that the bill of lading shall state whether it is "carrier's or shipper's weight".  
 NOTE: Where the rate is dependent on the value, shippers are required to state specifically in the writing the agreed or declared value of the property. The agreed or declared value of the property is hereby specifically stated by the shipper to be not exceeding.

## CDOT Materials Forms - Applicable for Flexible Pavements, Bituminous, Eurolab

<https://www.codot.gov/library/forms/form-numbers-broken-down>

### Materials Forms, Instructions & Examples Chapter

**NOTE: The CDOT forms are still in development, as they are completed they will be entered into the chapter. Use the relevant example forms from the Electronic version of the 2018 FMM.**

| Form | Title   |
|------|---|
| 157  | Field Report for Sample Identification or Materials Identification                              |
| 6    | Field Tests of Base Aggregates, Fillers, Paving and Miscellaneous Aggregates                    |
| 43   | Job Mix Formula [ <i>computer output</i> ] SiteManager  |
| 58   | Field Report of Asphalt Content & Maximum Specific Gravity of Hot Mix Asphalt                   |
| 67   | Asphalt Cement Results and Final Quantity [ <i>computer output</i> ] SiteManager                |
| 69   | Field Report of Hot Mix Asphalt Density   |
| 106  | Asphalt Tests   |
| 360  | Project Produced Hot Mix Asphalt [ <i>computer output</i> ] SiteManager                         |
| 411  | PG Binder / Emulsion Submittal Form   |
| 429  | Laboratory Design for HMA - Superpave Gyrotory Compactor [ <i>computer output</i> ] SiteManager |
| 582  | Hot Mix Asphalt Density Test  |
| N/A  | Ignition Furnace Correction Factor Worksheet (Laboratroy Worksheet)                             |
| 626  | Field Laboratory Test Results   |
| 634  | Sample Label (cans)   |
| 1094 | Asphalt Mix Design Graph  |
| 1290 | Longitudinal Joint Data   |
| 1304 | HMA Sample Submittal  |
| 1346 | HMA Segregation Data  |

|   |      |  |                           |   |                |  |
|---|------|--|---------------------------|---|----------------|--|
| <b>COLORADO DEPARTMENT OF TRANSPORTATION<br/>FIELD REPORT FOR SAMPLE IDENTIFICATION<br/>OR MATERIALS DOCUMENTATION</b>  |      |  | FS# = (Contract ID-Seq.#) |   |                |  |
|   |      |  | Region                    |   | Date Submitted |  |
|   |      |  | Contract ID               |   | Project No.    |  |
|   |      |  | Project Location          |   |                |  |
| Material Type   |      | Field Lab phone  |                           | Cell Phone  |                |  |
| Material Code (LIMS)  | Item | Class  | Grading                   | Special Provisions <input type="checkbox"/> yes   |                |  |
| Previously used on Project No.:   |      | Previous CDOT Form #157 F/S No.(s):  |                           | <input type="checkbox"/> CDOT Form #633 (sack)<br><input type="checkbox"/> CDOT Form #634 (can) |                |  |
| ● Sample Identification: Quantity & Unit of material submitted, describe tests required, precise location sample remove from (Stationing), etc.<br>● Materials Documentation: Field inspected (describe appearance, weight/dimensions, model/serial number), COC &/or CTR provided etc. |      |  |                           |   |                |  |
|   |      |  |                           |   |                |  |
|   |      |  |                           |   |                |  |
|   |      |  |                           |   |                |  |
|   |      |  |                           |   |                |  |
|   |      |  |                           |   |                |  |
|   |      |  |                           |   |                |  |
| Central Lab use only:   |      |  |                           |   |                |  |
| Sample ID (#1)  |      | Sample ID (#2)   |                           | Sample ID (#3)  |                |  |
| Sample ID (#4)  |      | Sample ID (#5)   |                           | Sample ID (#6)  |                |  |
| APL/QML Acceptance: APL Ref. No.  |      | Product name:  |                           | Date checked:   |                |  |
| APL/QML Acceptance: APL Ref. No.  |      | Product name:  |                           | Date checked:   |                |  |
| Preliminary <input type="checkbox"/>  |      | Construction <input type="checkbox"/>  |                           | Maintenance <input type="checkbox"/>  |                |  |
| Emergency <input type="checkbox"/>  |      |  |                           | Date needed   |                |  |
| Contractor  |      |  | Supplier                  |   |                |  |
| Sampled from<br><small>(Pit, roadway, windrow, stock, etc.)</small>   |      |  | Pit name or owner         |   |                |  |
| Quantity represented  |      | Previous quantity  |                           | Total quantity to date  |                |  |
| Sample submitted:<br><input type="checkbox"/> Yes <input type="checkbox"/> No   |      | Shipped specified quantity to:<br><input type="checkbox"/> Central lab <input type="checkbox"/> Region lab <input type="checkbox"/> Consultant lab |                           | Date  |                |  |
| Sampled or inspected by (print name)  |      | Title  |                           | E-mail  |                |  |
| Supervisor (Pro./Res./Mats. Engr./Maint. Supt.) (print name)  |      | Title  |                           | Residency   |                |  |

Distribution: Chemical Lab: [cdot\\_chemlab@state.co.us](mailto:cdot_chemlab@state.co.us)  
 Concrete Lab: [cdot\\_conc.lab@state.co.us](mailto:cdot_conc.lab@state.co.us)  
 Flexible Pavement: [cdot\\_flex.lab@state.co.us](mailto:cdot_flex.lab@state.co.us)  
 Physical Properties: [cdot\\_phpr.lab@state.co.us](mailto:cdot_phpr.lab@state.co.us)  
 Soils Lab: [cdot\\_solis.lab@state.co.us](mailto:cdot_solis.lab@state.co.us)  
 Region Labs: Send completed form with sample

Previous editions are obsolete and may not be used. CDOT Form #167 04/18

Project File: BMM – Upload completed form into the attachment icon on the sample record







| <b>COLORADO DEPARTMENT OF<br/>TRANSPORTATION<br/>ASPHALT TESTS</b>  |         |  |         | Contract ID  |        | Date Submitted                    |        |                   |
|---|---------|--|---------|--|--------|-----------------------------------|--------|-------------------|
|   |         |  |         | Project No.  |        |                                   |        |                   |
|   |         |  |         | Project Location   |        |                                   |        |                   |
|   |         |  |         | AC gauge No:   |        | Correlation No:                   |        | Correlation temp. |
| Supplier:   |         | Item / Material Code:  |         | Grading:   |        | Course:                           |        |                   |
| Form 43 No:   |         | Background cat.:   |         | AT No:   |        | MV: INFO:                         |        |                   |
| Sample ID (AC Test)   |         | Sample ID (Gradation Test)                                     |         | Sieve analysis   |        |                                   |        |                   |
| Date:   | Time:   | Date:  | Time:   | $\left[ \frac{\text{Wet wt.}}{\text{Dry wt.}} \left( 100 + \frac{\% \text{ moisture}}{100} \right) \right] \times 100 = \text{Dry wt. (before wash)}$  |        |                                   |        |                   |
| Tone:   | Tickel: | Tone:  | Tickel: |  |        |                                   |        |                   |
| Station:  | Lane:   | Station:   | Lane:   |  |        |                                   |        |                   |
| Asphalt content test #:   |         | Gradation Test #:  |         | Sieve Weight   | Weight | % Ret.                            | % Pass | Spec              |
| Job Mix % AC:   |         | Pan ID:  |         | 1  |        |                                   |        |                   |
| Meas. count:  |         | Tare:  |         | 3/4  |        |                                   |        |                   |
| Gauge % AC:   |         | Wet wt.:   |         | 1/2  |        |                                   |        |                   |
| % Moisture:   |         | Dry wt.:   |         | 3/8  |        |                                   |        |                   |
| Corr. % AC:   |         | Loss:  |         | #4   |        |                                   |        |                   |
|   |         | % Moisture:  |         | #8   |        |                                   |        |                   |
| Dry aggregate count:  |         |  |         | #16  |        |                                   |        |                   |
| CDOT Form 43 Max. specific gravity:   |         |  |         | #30  |        |                                   |        |                   |
| Maximum Specific Gravity  |         |  |         | #50  |        |                                   |        |                   |
| Flask ID:   |         |  |         | #100   |        |                                   |        |                   |
| Mass of Dry Specimen (g):   |         |  |         | #200   |        |                                   |        |                   |
| Mass of flask, water & lid (g):   |         |  |         | minus #200   |        |                                   |        |                   |
| Mass of filled flask, specimen & lid (g):   |         |  |         | Total Sieve wt. (TSW)<br><br>Dry weight (after wash): <input style="width: 50px;" type="text"/><br><br>$\% \text{ difference} = (\text{Dry wt.} - \text{TSW}) / \text{Dry wt.} \times 100 = \text{_____} \%$ |        |                                   |        |                   |
| Temperature of water in flask (F°):   |         |  |         |  |        |                                   |        |                   |
| (A+D)-E:  |         |  |         |  |        |                                   |        |                   |
| Specific Gravity A/(A+D-E):   |         |  |         |  |        |                                   |        |                   |
| Temperature of water must be 77°F, if not, correct results using Equation 2 in CP 51  |         | SPECS: Individual flask SpG must be within 0.011 of each other |         |  |        |                                   |        |                   |
| Average Specific Gravity:   |         |  |         | Fractured Faces (FF)   |        | Moisture correction for Aggregate |        |                   |
| Comments:<br><br><br><br>Sampled by: (print name) _____ Date _____<br>Tested By: (Print Name) _____ Date _____<br>Company _____ |         |  |         | A) Total weight:   |        | Pan ID:                           |        |                   |
|   |         |  |         | B) Fractured Aggregate:  |        | Tare:                             |        |                   |
|   |         |  |         | (B/A) x 100 = _____ % FF   |        | Wet weight:                       |        |                   |
|   |         |  |         |  |        | Dry weight:                       |        |                   |
|   |         |  |         |  |        | Loss:                             |        |                   |
|   |         | % Moisture:  |         |  |        |                                   |        |                   |
|   |         |  |         | CDOT Form 43 % Aggregate Absorption  |        |                                   |        |                   |



**COLORADO DEPARTMENT OF TRANSPORTATION  
PG BINDER/EMULSION SUBMITTAL**

| Contract ID  | Material Type<br><small>Binder Grade      Emulsion Type</small> |                       | Refinery Code<br><small>See Page 2 For Code</small> | Lot No.  | Region | FS# = (Contract ID-Seq.#)<br>----- |   |  |
|--|---|-----------------------|---|--|--------|------------------------------------|---|--|
|  | PG  | -                     |   |  |        |                                    |   |  |
| Project number   |   | Project Location      |   | Bid Plan Quantity  |        | Date submitted                     |   |  |
|  |   |                       |   | <input type="checkbox"/> T<br><input type="checkbox"/> G |        |                                    |   |  |
| SMM/LIMS<br>Sample ID  | Can #   | Tons<br>or<br>gallons | Emulsion<br>Batch Date                              | Date sampled   |        |                                    | Previous sheet: total tons or gallons (a)                   | Submitted by: (print name)   |
|  |   |                       |   | M  | D      | Y                                  | <input type="checkbox"/> T or <input type="checkbox"/> G    |  |
|  |   |                       |   |  |        |                                    | This sheet: total tons or gallons (b)                       | Cell Phone:  |
|  |   |                       |   |  |        |                                    | <input type="checkbox"/> T or <input type="checkbox"/> G    | Email (Project Tester):  |
|  |   |                       |   |  |        |                                    | Total: (a+b)  | CDOT Project Engineer <input type="checkbox"/> Consultant PE <input type="checkbox"/>      |
|  |   |                       |   |  |        |                                    | <input type="checkbox"/> T or <input type="checkbox"/> G    | Name: _____  |
|  |   |                       |   |  |        |                                    | <input type="checkbox"/> <b>Final lot for this material</b> | IA Tester Name:  |
|  |   |                       |   |  |        |                                    |   | Special provisions applicable:<br>yes <input type="checkbox"/> no <input type="checkbox"/> |
| Remarks  |   |                       |   |  |        |                                    | Can Number witness by IA                                    |  |
|  |   |                       |   |  |        |                                    | Can # _____   |  |
| Send completed form to: <a href="mailto:cdot_bit.lab@state.co.us">cdot_bit.lab@state.co.us</a> |   |                       |   |  |        |                                    | Place IA stamp here:  |  |
|  |   |                       |   |  |        |                                    | Electronic Signature of IA Personnel                        |  |

Distribution: Project File

Previous editions of this form are obsolete and may not be used.

CDOT Form 411 06/19

**INSTRUCTIONS:**

Form shall be emailed to [cdot\\_bit.lab@state.co.us](mailto:cdot_bit.lab@state.co.us) when complete for the lot. Complete the Form, use Save As, name the Form to identify it with Field Sheet # - Lot #. Example C18180 - 4022 Lot 1.

**Contract ID** - Enter the number assigned to the project (previously referred to as the project code).

**Material Type** - Grade of the material such as PG 58-28.

**Refinery name and location** - See list below for Code.

|                                 |                 | CODE  |                               |                    | CODE   |
|---------------------------------|-----------------|-------|-------------------------------|--------------------|--------|
| Aggregate Ind. / West Central   | Sedalia, CO     | AGISC | Sinclair Wyoming Refining Co. | Sinclair, WY       | SINSIN |
| Cobitco Inc.                    | Denver, CO      | COBIT | Suncor Energy – Commodity     | Commerce City, CO  | SUNCCC |
| Ergon Asphalt & Emulsions, Inc. | El Dorado, KS   | ERGED | Suncor Energy –Emulsion /BKEP | Commerce City, CO  | SUNCCF |
| Ergon Asphalt & Emulsion, Inc.  | Woods Cross, UT | ERGWC | Suncor Energy –Polymer /BKEP  | Commerce City, CO  | SUNCCP |
| HollyFrontier Refinery          | Cheyenne, WY    | HFRWY | Suncor Energy –Commodity      | Fruita, CO         | SUNFR  |
| Holly R&M, LLC                  | Albuquerque, NM | HANM  | Suncor Energy-BKEP            | Grand Junction, CO | SUNGJ  |
| Jebro Incorporated              | Cheyenne, WY    | JEBCH | Suncor Energy-BKEP            | Pueblo, CO         | SUNPU  |
| Jebro Incorporated              | Sioux City, IA  | JEBSC | Western States Asphalt        | Cheyenne, WY       | WSA    |
| Peak Asphalt, LLC               | Rawlins, WY     | PEAKR | Western Emulsions             | Woods Cross UT     | WEWC   |
| Peak Asphalt, LLC               | Woods Cross, UT | PEAKW | Western Emulsions             | N. Salt Lake UT    | WENSL  |

**Lot No.** - The number of the lot represented. See the Field Materials Manual, Ch 400 and Appendix.

**Date Submitted** - This is the date the samples are submitted, not the date the samples were obtained.

**SMM / LIMS Sample ID** - This cell is used for projects utilizing Site Manager for sample submittal. Each sample must have its own sample id. Leave this cell blank if project is not a Site Manager Materials project.

**Can #** - All projects will use the Can# column. Can numbers must run sequentially for each binder type or emulsion. **Example** - If project quantity is 25,000 tons of HMA (PG 64-22), can numbers will be from Can #1 to Can #25. Project has 95,125 gallons of emulsion, sample each load, can numbers would be from 1-19 approximately, assuming 19 loads delivered.

**Tons or gallons** - Binder - One sample per 1000 Tons of HMA or SMA produced.  
Emulsion - Gallons - Sample each load, record the gallons from the bill of lading.

**Emulsion Batch Date** - From the Bill of Lading, record the date the material was made.  
Note 1: Independent Assurance (IA) samples - Please note on form #411 and on form #634 (sample label for cans) which can # is also the IA sample. IA samples must be indicated on this form.  
Note 2: All sample containers must be properly labeled utilizing CDOT Form #634.

|                      |                      |
|----------------------|----------------------|
| <b>Contract ID</b>   | <b>Field Sheet #</b> |
| <b>Sample ID</b>     |                      |
| <b>Material Type</b> | <b>Lot #</b>         |
| <b>Material Code</b> | <b>Can #</b>         |
| <b>Lab Ref. #</b>    |                      |

**Instructions for SMM/LIMS sample creation  
Basic Sample Data tab**

- 1) Sample Type must be Quality Acceptance
- 2) Material code begins with 702.01 for binders, and 702.03 through 702.05 for emulsions  
Must use material code from the OA Checklist for the project
- 3) The Lab Reference Number cell must be the last four digits of the Field Sheet number followed by LT#. This is the lot number, Ex= 1234LT6

**Additional Sample Data tab**

- 1) Use the Seal Number cell to designate the Lot #, Can #, & number of samples in the lot  
LT5C17of5= lot#5, can#17, and 5 cans submitted in this lot

**Field sheet with IA witnessed sample**

Lab Reference Number cell shall be last four digits of the field sheet, followed by LT#IA, Ex=1234LT6IA  
Seal Number cell shall be LT#C#IA. This is the Lot # followed by can # that was witnessed by the IA

|  |  |                  |         |             |
|--|--|------------------|---------|-------------|
| <b>COLORADO DEPARTMENT OF TRANSPORTATION</b><br>Bulk Specific Gravity and Percent Relative Compaction of<br><b>HMA / SMA CP 44</b> |  | Project no.      | Region  | Contract ID |
|  |  | Project Location |         |             |
|  |  | Form #43 No.     | Grading |             |

|                                |  |  |  |
|--------------------------------|--|--|--|
| Sample ID                      |  |  |  |
| Test number                    |  |  |  |
| Station                        |  |  |  |
| Distance Rt. or Lt. of CL      |  |  |  |
| Course                         |  |  |  |
| Date placed                    |  |  |  |
| Date retrieved (sampled)       |  |  |  |
| Pan Number                     |  |  |  |
| Pan Weight                     |  |  |  |
| Weight in H <sub>2</sub> O (C) |  |  |  |
| Sat. surf. dry wt. (B)         |  |  |  |
| Dry weight in air (A)          |  |  |  |
| Pan & Core-dry@ Constant mass  |  |  |  |
| Bulk Specific Gravity          |  |  |  |
| Ave. Daily Rice                |  |  |  |
| % Relative Compaction          |  |  |  |
| Sample ID (for IAT)            |  |  |  |
| IA Test #                      |  |  |  |

|                                |  |  |                      |
|--------------------------------|--|--|----------------------|
| Sample ID                      |  |  | Place IA stamp here: |
| Test number                    |  |  |                      |
| Station                        |  |  |                      |
| Distance Rt. or Lt. of CL      |  |  |                      |
| Course                         |  |  |                      |
| Date placed                    |  |  |                      |
| Date retrieved (sampled)       |  |  |                      |
| Pan Number                     |  |  |                      |
| Pan Weight                     |  |  |                      |
| Weight in H <sub>2</sub> O (C) |  |  |                      |
| Sat. surf. dry wt. (B)         |  |  |                      |
| Dry weight in air (A)          |  |  |                      |
| Pan & Core-dry@ Constant mass  |  |  |                      |
| Bulk Specific Gravity          |  |  |                      |
| Ave. Daily Rice                |  |  |                      |
| % Relative Compaction          |  |  |                      |
| Sample ID (for IAT)            |  |  |                      |
| IA Test #                      |  |  |                      |

|   |                        |                      |
|---|------------------------|----------------------|
| Bulk Specific Gravity = $\frac{A}{B-C}$ |                        |                      |
| Sampled by (print name)                 | Tested by (print name) | Company Name or CDOT |

Previous editions are obsolete and may not be used.

CDOT Form #582 4/18

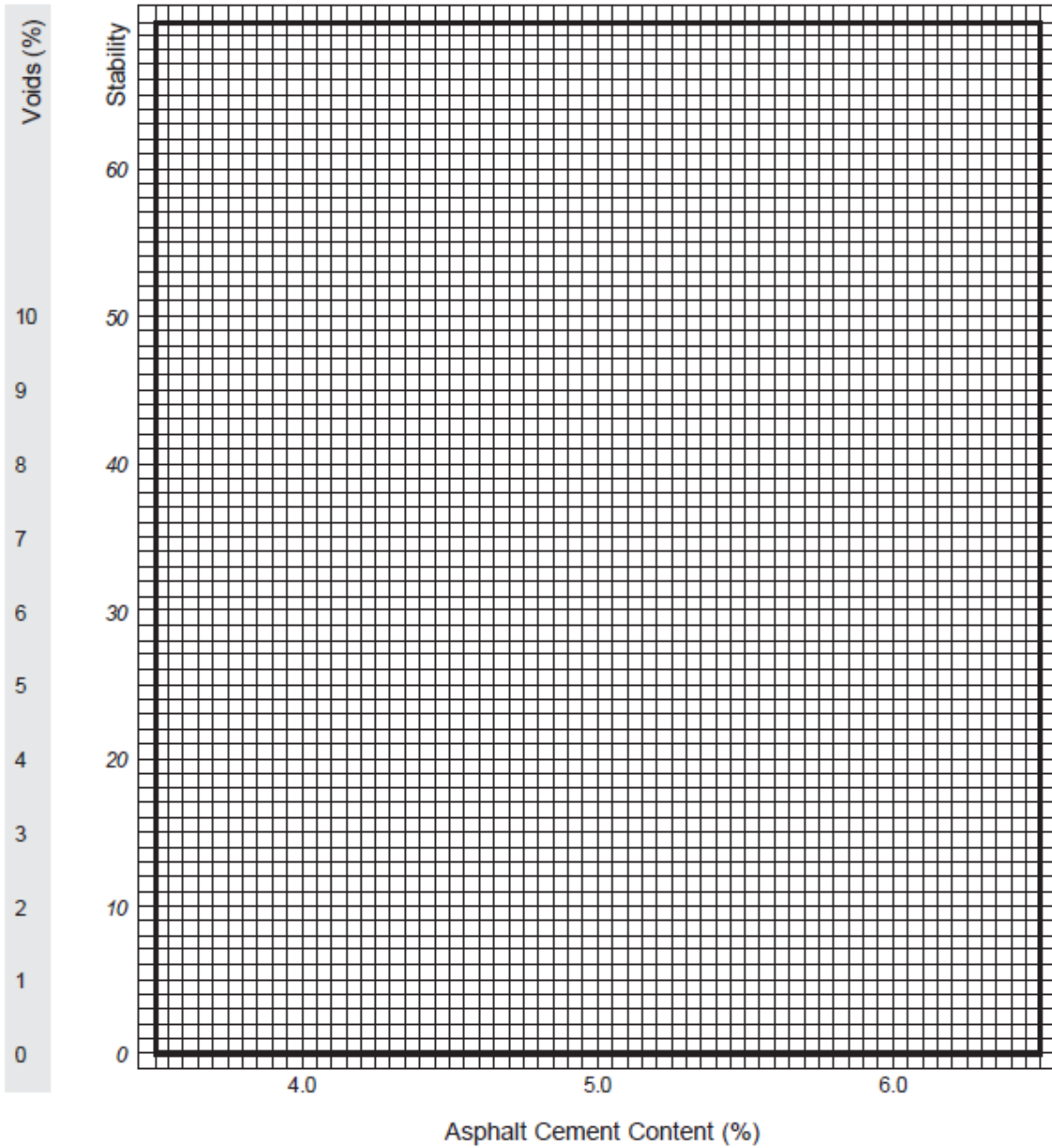
|  |  |  |  |  |  |       |                |  |
|--|--|--|--|--|--|-------|----------------|--|
| <b>COLORADO DEPARTMENT OF TRANSPORTATION<br/>FIELD LABORATORY TEST RESULTS</b> |  |  |  |  | Project No.                                      |       | Contract ID    |  |
|  |  |  |  |  | Project Location                                 |       |                |  |
| Contractor/Supplier:   |  |  |  |  | Item   | Class | Lot            |  |
| Attention:   |  |  |  |  |  |       |                |  |
| TEST NO.   |  |  |  |  | Item Description                                 |       |                |  |
| DATE   |  |  |  |  |  |       |                |  |
| STATION  |  |  |  |  |  |       |                |  |
| LOCATION   |  |  |  |  | Specs  |       | Failing Test # |  |
| QUANTITY   |  |  |  |  |  |       |                |  |
| Sieve  |  |  |  |  |  |       |                |  |
| Sieve  |  |  |  |  |  |       |                |  |
| Sieve  |  |  |  |  |  |       |                |  |
| Sieve  |  |  |  |  |  |       |                |  |
| Sieve  |  |  |  |  |  |       |                |  |
| Sieve  |  |  |  |  |  |       |                |  |
| Sieve  |  |  |  |  |  |       |                |  |
| Sieve  |  |  |  |  |  |       |                |  |
| Sieve  |  |  |  |  |  |       |                |  |
| Sieve  |  |  |  |  |  |       |                |  |
| Sieve  |  |  |  |  |  |       |                |  |
| Sieve  |  |  |  |  |  |       |                |  |
| L.L.   |  |  |  |  |  |       |                |  |
| P.I.   |  |  |  |  |  |       |                |  |
| % Bitumen  |  |  |  |  |  |       |                |  |
| Max SpG  |  |  |  |  |  |       |                |  |
| Voids  |  |  |  |  |  |       |                |  |
| VMA  |  |  |  |  |  |       |                |  |
| % Rel. Comp.   |  |  |  |  |  |       |                |  |
| % Moisture   |  |  |  |  |  |       |                |  |
| Slump  |  |  |  |  |  |       |                |  |
| % Air  |  |  |  |  |  |       |                |  |
| Flex/Cyl PSI   |  |  |  |  |  |       |                |  |
| Other:   |  |  |  |  |  |       |                |  |
| Note: Record "Test No." of the corresponding Sample ID (SM/LIMS).              |  |  |  |  | Remarks (below):                                 |       |                |  |
| CDOT Representative (print name)   |  |  |  |  | CDOT Representative Electronic Signature         |       |                |  |
| Contractor's Representative (print name)                                       |  |  |  |  | Contractor's Representative Electronic Signature |       |                |  |

Previous editions are obsolete and may not be used.

CDOT Form #626 6/18

|  |             |                        |
|--|-------------|------------------------|
| Region   | Contract ID | Field Sheet #          |
| Sample ID  |             |                        |
| Material Type  | Lot #       | Can #                  |
| Laboratory Reference #   |             |                        |
| Contact information:   |             |                        |
| Comments:  |             |                        |
| Colorado Department of Transportation<br>4670 N. Holly St. Denver CO. 80216-6408 |             | CDOT Form 634<br>08/19 |

|   |                |                 |
|---|----------------|-----------------|
| <b>COLORADO DEPARTMENT OF TRANSPORTATION<br/>ASPHALT MIX DESIGN GRAPH</b> | Project no.    | Contract ID     |
|   | Proj. location | Field sheet no. |



Previous editions are obsolete and may not be used.

CDOT Form #1094 4/14

|   |  |  |                   |  |  |  |                |
|---|--|--|-------------------|--|--|--|----------------|
| <b>COLORADO DEPARTMENT OF TRANSPORTATION<br/>HMA SAMPLE SUBMITTAL</b>   |  | Contract ID  |                   | Project No.  |  | FS# = (Contract ID-Seq#)   |                |
|   |  | Project Location   |                   |  |  | Region   | Date Submitted |
| Prime Contractor  |  | HMA Supplier   |                   | Reference previously used Contract ID & Form #43 No.:  |  | Special Provisions Applicable:<br><input type="radio"/> YES <input type="radio"/> NO   |                |
| Pit Names   |  | Form #43 Number  |                   | Form #43 Date  | Contact Person (QA Tester)                     | Contact phone #  |                |
| Item #  | Acceptance Method<br><input type="radio"/> Voids <input type="radio"/> Gradation | Test No.   | Sample Represents |  | Total Quantity Placed<br>of this mix to date - |  | Plan Quality   |
| Sampled From (CP 41)<br><input type="radio"/> Plant <input type="radio"/> Auger<br><input type="radio"/> Windrow <input type="radio"/> Roadway    |  | Grading<br><input type="radio"/> S <input type="radio"/> SMA<br><input type="radio"/> SX <input type="radio"/> SG<br><input type="radio"/> ST <input type="radio"/> RCI<br><input type="radio"/> Other _____ |                   | Gyrations<br><input type="radio"/> 50 <input type="radio"/> 100<br><input type="radio"/> 75 <input type="radio"/> 125<br><input type="radio"/> Other _____   |  | Binder<br><input type="radio"/> PG58-28 <input type="radio"/> PG64-28<br><input type="radio"/> PG58-34 <input type="radio"/> PG70-28<br><input type="radio"/> PG64-22 <input type="radio"/> PG76-28<br><input type="radio"/> Other _____ |                |
| AC & Belt Cut CPL 5120C/CP 85C<br><input type="radio"/> Yes <input type="radio"/> NO  |  |  |                   | Tests - Required as indicated<br><input type="checkbox"/> CP 31HMAaa<br><input type="checkbox"/> CP 48aa <input type="checkbox"/> CPL 5106<br><input type="checkbox"/> CP 51 <input type="checkbox"/> CPL 5115<br><input type="checkbox"/> CP 85 <input type="checkbox"/> CPL 5120 |  | <input type="checkbox"/> CPL 5109 Region Labs<br>Every 10,000 Tons<br><br><input type="checkbox"/> CPL 5109 Central Lab<br>1st 10,000 Tons only  |                |
| Sample ID: VMA/ Voids & or AC/Rice  |  | Sample ID Region Lab   |                   | Place IA stamp here:   |  | Sample ID for Central Lab / Flex Lab:  |                |
| Sample ID: Gradation Accp: CP31 HMA   |  | Sample ID Region Lab (CPL 5109)  |                   |  |  | Sample Type must be Information only.  |                |
| QA tested at:<br><input type="radio"/> Region <input type="radio"/> Field<br><input type="radio"/> Region Mobile <input type="radio"/> Consultant |  | Sample represents:<br>Check Testing <input type="checkbox"/><br>Mix Verification <input type="checkbox"/><br>1 Per 10,000 Ton <input type="checkbox"/>   |                   | Electronic Signature of IA Personnel<br>   |  | Sample ID for Central Lab / Euro Lab:  |                |
| Sample ID for IA  |  |  |                   |  |  | Sample Type must be Quality Acceptance<br><input type="checkbox"/> Hamburg Rutter CPL 5112<br><input type="checkbox"/> French Rutter CPL 5114  |                |
| Number of Cans Submitted  |  | Sample Location Information  |                   |  |  |  |                |
| Central Lab: _____  | Region Lab: _____  | Ticket #   | Time sampled      | Station  | Lane   | Daily Tons @ Sample  |                |
| Flex Lab: _____   | Region Mobile: _____   | Witnessed by   | Date sampled      | Via (state, contractor or courier)   |  | Date Shipped   | Shipped by     |
| Project Tester (print name)   |  | Title  |                   | E-mail Address   |  |  |                |
| Supervisor (print name)   |  | Title  |                   | E-mail Address   |  |  |                |

**Distribution:**  Flex Lab: cdot\_flex.lab@state.co.us  
 Euro Lab: cdot\_euro.lab@state.co.us  
 Region Lab or Region Mobile Lab  
 Project File: Upload completed form onto the ProjectShare folder

Previous editions are obsolete and may not be used.

CDOT Form #1304 04/2020





{Page Intentionally Left Blank}

## Chapter 500 Structures - 21

**This chapter is not part of the Project specifications but is a guide for project personnel in interpreting CDOT specifications, understanding ASTM, AASHTO, and Colorado test procedures, and for completing CDOT forms.**

### ITEM 502, PILING

Acceptable welding rods for splicing H piles and pipe piles are E7016 and E7018. These identifying numbers will be found on the electrodes and their container. Welding is usually performed at the project construction site.

There is a standard special revision to Section 502 of the Standard Specifications, for Piling, requiring the use of a Pile Driving Analyzer (PDA) when piling is to be driven on a project.

### ITEM 503, DRILLED SHAFTS

Inspectors shall maintain drilling and construction records on Form 1333. Drilling progress and cuttings should be watched. For example, a slow advance rate in wet sand may indicate sloughing of the boring requiring casing or slurry to stabilize the hole. Record the use of any slurry including type, properties, quantity, and disposal. Concrete properties shall be tested and recorded to ensure a proper pour. The concrete volume and depth should be recorded at regular intervals throughout the pour to help map the shaft for voids or collapse.

### ITEM 504, SOIL NAIL WALLS

Drainage during construction is very important. Saturation of the wall face and retained materials before completion of the wall and drainage features may lead to wall distress. Be aware of the geology and site conditions. Work should stop and the design engineer should be contacted if a significant change in conditions is observed during excavation. Verification and proof testing shall be completed and recorded per the plans. Care needs to be taken during the installation of the toe drain at the base of the completed wall. Over excavation at the toe for the drain installation may result in wall distress.

### ITEM 506, GABIONS AND SLOPE MATTRESS

#### Gabions

A necessary feature of the rock basket is the weave of the wire fabric, which must "give" in all directions and not unravel if a wire should break. Field personnel will inspect for compliance with the Non-Raveling Construction requirement in Subsection 712.09 of the Standard Specifications.

### ITEM 509, STRUCTURAL STEEL

#### Fabrication

The Staff Bridge Fabrication Inspectors are responsible for the testing, inspection, and documentation of shop fabricated structural steel bridges. They will obtain and review mill test reports, welding procedure

reports, and welder qualifications, and assure compliance with project specifications. This will be documented on the final inspection report issued for shop fabricated structural steel bridges.

### **Field Welding**

If any field welding of fabricated structural steel components becomes necessary, the Bridge Design Inspection Unit should be consulted for guidance and assistance. They will also guide in determining defective welds that are not detectable by visual inspection.

### **Shear Studs**

Shear studs are usually inspected during the shop fabrication of structural steel bridges.

Field welded shear studs are inspected by striking the stud with a hammer until it is bent to 45°. Two studs per 100 will be tested. The studs tested that show no sign of failure should be left in the bent position. Studs bent during handling should be left in the bent position. Any studs that are broken off should be replaced by field welding. Additional studs should be tested when a failure occurs. Contact the Staff Bridge Fabrication Inspectors for assistance when excessive failures occur.

### **Bolts**

Rotational capacity tests are required at the job site. Refer to the CDOT Construction Manual. Document the results of this test in Project Files.

## **ITEM 509, STRUCTURAL STEEL (GALVANIZED) MISCELLANEOUS**

Field inspection in some cases cannot be accomplished on a piece-by-piece basis, as it arrives on the project, depending on the size and configuration of the material. Therefore, it is possible for field personnel, during installation to find places that are not adequately galvanized. It is allowable to touch up inadequate or damaged galvanizing with one full brush coat of zinc-rich paint meeting the requirements of the Department of Defense DOD-P-21035A, according to 509.27(h) of the Standard Specifications. A Certificate of Compliance is required indicating that the zinc-rich paint meets the above specification.

## **ITEM 510, STRUCTURAL PLATE STRUCTURES (GALVANIZED)**

Not pre-tested, but field inspected. A word of caution regarding the storage of galvanized structural plate. Zinc will convert into "white rust" rapidly when it becomes wet in the absence of air.

A rapid loss of zinc may occur when curved sheets are stacked together in such a way that water can get between the sheets and not drain. It is possible to lose the entire protective coating of zinc over large areas in a short time under the right conditions of moisture and warmth. To prevent this, the sheets should be stored under cover or stacked so water will drain away rather than be trapped between the sheets.

## **ITEM 515, WATERPROOFING MEMBRANE**

### **Bridge Deck, All Types**

Section 515 of the CDOT's Standard Specifications describe the types of waterproofing membranes which may be used as protection from de-icing salt on concrete bridge decks. Also, the CDOT Standard Specification gives detailed application procedures for membrane types, the protective covering, and hot mix asphalt overlay. These requirements must be strictly adhered to obtain the best possible waterproofing system.

**CDOT Materials Forms - Applicable for Structures  
Located within  
Materials Forms, Instructions & Examples Chapter**

| <b>Form</b> | <b>Title</b>  |
|-------------|---|
| 157         | Field Report for Sample Identification or Materials Documentation |

|   |      |  |                           |   |                |  |
|---|------|--|---------------------------|---|----------------|--|
| <b>COLORADO DEPARTMENT OF TRANSPORTATION<br/>FIELD REPORT FOR SAMPLE IDENTIFICATION<br/>OR MATERIALS DOCUMENTATION</b>  |      |  | FS# = (Contract ID-Seq.#) |   |                |  |
|   |      |  | Region                    |   | Date Submitted |  |
|   |      |  | Contract ID               |   | Project No.    |  |
|   |      |  | Project Location          |   |                |  |
| Material Type   |      |  | Field Lab phone           |   | Cell Phone     |  |
| Material Code (LIMS)  | Item | Class  | Grading                   | Special Provisions <input type="checkbox"/> yes   |                |  |
| Previously used on Project No.:   |      | Previous CDOT Form #157 F/S No.(s):  |                           | <input type="checkbox"/> CDOT Form #633 (sack)<br><input type="checkbox"/> CDOT Form #634 (can) |                |  |
| ● Sample Identification: Quantity & Unit of material submitted, describe tests required, precise location sample remove from (Stationing), etc.<br>● Materials Documentation: Field inspected (describe appearance, weight/dimensions, model/serial number), COC &/or CTR provided etc. |      |  |                           |   |                |  |
|   |      |  |                           |   |                |  |
|   |      |  |                           |   |                |  |
|   |      |  |                           |   |                |  |
|   |      |  |                           |   |                |  |
|   |      |  |                           |   |                |  |
| Central Lab use only:   |      |  |                           |   |                |  |
| Sample ID (#1)  |      | Sample ID (#2)   |                           | Sample ID (#3)  |                |  |
| Sample ID (#4)  |      | Sample ID (#5)   |                           | Sample ID (#6)  |                |  |
| APL/QML Acceptance: APL Ref. No.  |      | Product name:  |                           | Date checked:   |                |  |
| APL/QML Acceptance: APL Ref. No.  |      | Product name:  |                           | Date checked:   |                |  |
| Preliminary <input type="checkbox"/>  |      | Construction <input type="checkbox"/>  |                           | Maintenance <input type="checkbox"/>  |                |  |
| Emergency <input type="checkbox"/>  |      |  |                           | Date needed   |                |  |
| Contractor  |      |  | Supplier                  |   |                |  |
| Sampled from<br><small>(Pit, roadway, windrow, stock, etc.)</small>   |      |  | Pit name or owner         |   |                |  |
| Quantity represented  |      | Previous quantity  |                           | Total quantity to date  |                |  |
| Sample submitted:<br><input type="checkbox"/> Yes <input type="checkbox"/> No   |      | Shipped specified quantity to:<br>_____ <input type="checkbox"/> Central lab _____ <input type="checkbox"/> Region lab _____ <input type="checkbox"/> Consultant lab |                           | Date  |                |  |
| Sampled or inspected by (print name)  |      | Title  |                           | E-mail  |                |  |
| Supervisor (Pro./Res./Mats. Engr./Maint. Supt.) (print name)  |      | Title  |                           | Residency   |                |  |

Distribution: Chemical Lab: [cdot\\_chemlab@state.co.us](mailto:cdot_chemlab@state.co.us)  
 Concrete Lab: [cdot\\_conc.lab@state.co.us](mailto:cdot_conc.lab@state.co.us)  
 Flexible Pavement: [cdot\\_flex.lab@state.co.us](mailto:cdot_flex.lab@state.co.us)  
 Physical Properties: [cdot\\_phpr.lab@state.co.us](mailto:cdot_phpr.lab@state.co.us)  
 Soils Lab: [cdot\\_soils.lab@state.co.us](mailto:cdot_soils.lab@state.co.us)  
 Region Labs: Send completed form with sample

Previous editions are obsolete and may not be used. CDOT Form #157 04/18  
 Project File: SMM – Upload completed form into the attachment icon on the sample record

## Chapter 600

### Concrete & Item 600 - 21

**This chapter is not part of the Project specifications but is a guide for project personnel in interpreting CDOT specifications, understanding ASTM, AASHTO, and Colorado test procedures, and for completing CDOT forms.**

#### ITEM 601, STRUCTURAL CONCRETE

##### Concrete Design Mixes

All concrete placed on the project shall conform to a design mix, which has been approved according to CP 62. The design mix is defined by the proportions and sources of all ingredients in the concrete.

The Contractor (or Supplier) will establish and is responsible for the concrete design mix proportions and source of all ingredients for each class of concrete used. The Region Materials Engineer (RME) or the Concrete & Physical Properties (CPP) Unit may verify any or all properties of the submitted mix design before approval. When a trial mix check is requested, aggregate sources will be sampled by the Contractor and the samples submitted to the CPP Unit.

The concrete Table 601-1 in Section 601 of the Standard Specification or the Special Provisions for the project gives the data for each class of concrete. The column "Concrete Class" lists each class of concrete and the required field compressive strength.

When a concrete mix design is approved, a CDOT Form 1373 will be issued for the project.

Standard approved mix designs will be placed on the Pre-Approved Concrete Mix Designs list:  
<https://www.codot.gov/business/apl/concrete-mix-designs>

Mix designs are approved for two years from the date the mix was trialed or when the aggregate was sampled, whichever occurs first.

**Concrete mix designs are to be submitted to the Concrete & Physical Properties Unit at:**  
[dot\\_concretemixdesigns@state.co.us](mailto:dot_concretemixdesigns@state.co.us).

#### REFERENCING PRE-APPROVED MIX DESIGNS

Projects may choose to reference existing pre-approved concrete mix designs. The concrete mix designs used on CDOT projects are to be referenced in the following manner:

1. Mixes must be reviewed and approved by the CPP Unit or RME before use.
2. Cross-reference the contractor's mix design number with the CDOT mix design number on the Pre-Approved Concrete Mix Design list.
3. Document the Concrete Mix Design on a CDOT Form 1188, listing the CDOT mix number.

Upon approval of the concrete mix design, The mix design will be assigned to the project in SMM/LIMS and a CDOT Form 1373 can be printed from CAR for the project.

### **REVIEW OF CONTRACTOR'S MIX DESIGN**

All concrete mix designs shall be reviewed and approved by CCP Unit or RME per CP 62 before placement

### **AGGREGATES**

A minimum of three 60 lb. sacks of the coarse (1-1/2 in. to 3/4 in.); three 60 lb. sacks of intermediate (3/4 in. to plus #4); and three 60 lb. sacks of sand (minus #4) per class of concrete are required when mix design checks are performed.

One additional sack of each aggregate will be required for Class H, HT S50, and P mixes.

### **Aggregate Tests Required for Design Mixes**

The following test will be performed by the Contractor:

1. specific gravity
2. absorption
3. organic impurities in sand
4. sieve analysis
5. sand equivalent
6. L.A. abrasion
7. percent passing the No. 200 sieve
8. fineness modulus
9. unit weight and voids in aggregate
10. potential alkali reactivity
11. Soundness by the sodium sulfate method.

### **COMPRESSIVE STRENGTH TESTING**

The determination of the compressive strength of concrete shall be done per ASTM C 39. This method consists of applying a compressive axial load to molded cylinders or cores at a rate within the prescribed range until failure occurs. The compressive strength of the specimen is calculated by dividing the maximum load attained during the test by the cross-sectional area of the specimen. The following details, from the test procedure, are noted:

1. The initial cure of specimens is per AASHTO T 23 as modified.
2. Testing machine. Calibration of the testing machine shall be performed at least annually, but not to exceed 13 months. Recalibration is required upon installation or relocation of the machine, or whenever there is reason to doubt the accuracy of test results. The diameter of the sphere of the top-loading head on the machine shall be at least 75% of the diameter of the specimen to be tested.

3. Concrete specimens shall not be tested if any individual cylinder diameter differs from other diameters of the same cylinder by more than 2%. No cylinder shall depart from perpendicularity to the axis by more than 0.5°; top of the cylinder may not deviate by more than 1/16 inch in 12 inches. When neoprene caps are used, each end of the cylinder shall be planed within 0.125 inches across any diameter and no depression in the concrete surface deeper than 0.125 inches is tolerated. The diameter used for calculating the cross-sectional area of the cylinder shall be determined to the nearest 0.01 inches by averaging two diameters measured at right angles about the mid-height of the specimen. Core length shall be measured to the nearest 0.05 inch.
4. Procedure. Test the cylinders as molded in the field. The loading rate shall be within the range of 20 to 50 psi/second. During the first half of the anticipated load, a higher rate of loading is allowed. When using neoprene caps an additional three to five seconds of the load is applied to ensure completion of the test and avoidance of premature breaks.
5. Neoprene Pads. Only one side of the pad shall be used when testing the cylinders. Each pad shall not be used to test more than 100 cylinders. Record the number of tests for each pad. The neoprene pad's shore hardness shall be the following for the specified compressive strengths:
  - 50 for 1500 – 6000 psi
  - 60 for 2500 – 7000 psi
  - 70 for 4000 – 7000 psi

A 60 durometer pad is recommended for testing all classes of concrete except for Class S50 which requires sulfur capping or end grinding.

The neoprene pads shall be removed from the retaining rings and inspected after each test.

## **QUALITY ASSURANCE PROGRAM FOR CDOT CONCRETE CYLINDER TESTING**

### **Introduction**

This defines a quality assurance program for testing concrete cylinders. This program assures the conformance of CDOT equipment and procedures to ASTM Standards by the following:

1. Equipment checks using a standard checklist.
2. Procedure checks using a standard checklist.
3. Inter-Lab (Round Robin) testing with all labs testing replicate specimens at the same time.
4. Training offered by the Concrete Unit of Staff Materials & Geotechnical Branch.
5. ACI certification of CDOT employees.

Cylinders shall be tested with equipment that has been checked and found to be in conformance with ASTM criteria. Testing shall be conducted by an employee who is certified as an ACI Concrete Laboratory Testing Tech I or ACI Concrete Strength Testing Technician.



## Equipment

The cylinder testing equipment will be examined, using the equipment checklist, a minimum of once a year, or when the equipment is moved. The person checking the equipment must meet one of the following criteria:

1. Examined by CCRL (Cement and Concrete Reference Laboratory) for procedures and equipment.
2. Trained by the Concrete Unit of Staff Materials & Geotechnical Branch.

## Procedures

The person will be observed conducting the test by a proctor using the procedures checklist a minimum of once a year. The proctor checking the procedures must be certified as an ACI Concrete Laboratory Testing Tech I or ACI Concrete Strength Testing Technician.

## Inter-Lab Testing (Round Robin)

The Concrete Unit will mold replicate cylinders and distribute these to each Region. All cylinders will be tested at approximately the same time. The Concrete Unit will compile the results and distribute a brief report. Excessive deviations will be investigated by the Region.

## Training

The Concrete Unit will conduct training for Region personnel who perform concrete cylinder testing. Classes will be approximately 4 hours and will normally have four trainees per class.

## ACI Certification

American Concrete Institute (ACI) offers one-day certifications. These certifications include testing of concrete cylinders and a complete battery of tests conducted on concrete aggregate and concrete. ACI Certifications are offered through the Colorado Ready Mixed Concrete Association. CRMCA may be contacted at 303-290-0303 or <http://www.crmca.org/>

## Documentation

Region Materials Laboratories will maintain documentation on equipment calibration, equipment checks, procedure checks, employee training, employee ACI certification, and Inter-Lab results.

The Concrete Unit of the Central Laboratory will maintain documentation of equipment and procedure checks conducted by the Concrete Unit and Inter-Lab results.

**Equipment and Documentation Checklist for  
Compression Testing of Concrete Cylinders**

Date \_\_\_\_\_ Location

Inspection Team

**Compression Machine**

Mfg. & Model

Capacity

Installation Date

Calibration Date

Calibration interval did not exceed 13 months or calibrated since moved.

Loading head free moving (4° in any direction).

Head diameter: [A minimum dimension of at least 3% greater than the diameter of the specimen, to be tested.

Head radius > radius of the sphere.

**Other Equipment Noted and Available**

Condition of neoprene pads and extrusion controllers.

The water temperature of cylinder storage area (73.4°F ± 3°).

Temperature recording device operating.

Water saturated with lime.

**Documentation / Records on File**

Compression machine calibration documentation immediately available.

Water temperature, neoprene pad durometer, and neoprene pad usage recorded (100 uses per pad maximum).

Diameter, load, and psi of cylinders recorded.

2020 FMM

**Procedure Checklist for  
Compression Testing of Concrete Cylinders**

Date \_\_\_\_\_ Location \_\_\_\_\_

**Proctor** \_\_\_\_\_

Proctor Credentials \_\_\_\_\_

Employee Observed \_\_\_\_\_

Employee Training and Certification \_\_\_\_\_

**Procedure**

- \_\_\_\_\_ Remove the specimen from moist storage, maintain moisture.
- \_\_\_\_\_ Measure diameter to nearest 0.01 in by averaging two diameters measured at right angles to each other, using calipers, at mid-height of the specimen.
- \_\_\_\_\_ Wipe clean bearing surfaces of upper and lower blocks.
- \_\_\_\_\_ Center the cylinder to the spherical head.
- \_\_\_\_\_ Bring top block to bear gently and uniformly on the specimen while rotating the movable portion by hand.
- \_\_\_\_\_ Load the cylinder (20 to 50 psi/sec. for hydraulically operated machines).
- \_\_\_\_\_ Take cylinders to failure (additional 3-5 seconds may be required to ensure completion of break).
- \_\_\_\_\_ Record the maximum load.
- \_\_\_\_\_ Calculate the compressive strength and report to the required precision (nearest 10 psi)

**Comments:** \_\_\_\_\_  
\_\_\_\_\_  
\_\_\_\_\_  
\_\_\_\_\_  
\_\_\_\_\_

## **UNIT WEIGHT, YIELD, AND GRAVIMETRIC AIR CONTENT OF CONCRETE**

### **AASHTO T 121**

The unit weight of the concrete is determined by AASHTO T 121.

Refer to AASHTO T 121 for full details of the test procedure and calculations for determining the following: Unit weight (pounds per cubic foot), yield (volume of concrete produced per batch), relative yield (ratio of the actual volume to the volume as designed for the batch), and air content (percentage of voids in the concrete).

### **EXCESSIVE WATER DEMAND**

Water-cement ratios, which exceed the specified maximum may result from one of the following:

1. Incorrect batch weights, due to mathematical errors or scales out of adjustment.
2. Stockpiles of aggregate drying to less than a saturated surface-dry condition, requiring more water than the design. Water added to the batch to bring the aggregates to SSD shall not be included in the w/cm ratio calculation.

It is the Contractor's responsibility to maintain water-cement ratios at or below the specified maximum.

## **MAKING AND CURING CONCRETE CYLINDERS IN THE FIELD**

### **Acceptance (QA) Cylinders**

Test cylinders made for determination of compliance with strength specifications are referred to as "acceptance cylinders". These cylinders are tested at 28 days after casting for all classes of concrete.

Acceptance cylinders made at the job site shall be made and cured per AASHTO T 23 except that the initial cure shall be in a water tank with a temperature of  $73.4^{\circ}\text{F} \pm 3^{\circ}$ .

When a Class 2 lab trailer is not specified and when approved by the Region Materials Engineer cylinders may be cured in accordance with AASHTO T23. The curing temperature shall be  $70^{\circ}\text{F} \pm 10^{\circ}$ . The minimum and maximum temperature of the curing shall be recorded.

### **Information Cylinders**

Test cylinders made for determining form removal time or when a structure may be put into service are referred to as "information cylinders". Information cylinders are no longer allowed. Maturity meters shall be used.

## **Numbering and Marking Cylinders**

See the instructions and examples of CDOT Form 82 in this chapter for the correct method of numbering cylinders. Mark the identifying number and information on the cylinders with a water-proof marking. Do not scratch numbers on the end of the cylinders as it will affect test results.

Any OA (QA) strength specimens (cylinders and beams) that will not be exclusively secured by CDOT require the use of an additional marking. Central Lab has sample tags that are placed on the inside and outside of the molds and bond to the concrete specimen. These sample tags are serialized/barcoded and have a felt-like backing. The serial number shall be scanned and recorded and then verified before transport to the CDOT lab to make sure the strength specimen cast was not swapped out by the contractor. This is highly unlikely, but FHWA has identified this as a possible opportunity for fraud. These tags are not required when specimens are cast and secured in a CDOT facility the contractor does not have access to.

## **DOCUMENTATION AND TRANSFER OF CONCRETE TEST CYLINDERS**

### **Field sheet Numbering System**

The CDOT Form #82, Concrete Cylinder Transmittal, is used to document and provide information for concrete cylinders submitted for compressive strength testing. SMM/LIMS sample ID shall be recorded on the CDOT Form #82.

### **Concrete Cylinder Transport**

Concrete specimens being transported before 48 hours after molding are left in the molds. Upon arrival at the designated testing facility, cylinders are removed from the molds and stored in a suitable curing area. Specimens to be transported after 48 hour age are removed from the molds in  $24 \pm 8$  hours. Curing shall be in saturated limewater @  $73.4^{\circ}\text{F} \pm 3^{\circ}$  until the time of transport. During transportation, the specimens must be protected and kept moist with cushioning material in padded boxes or suitable protective containers. Moisture loss shall be prevented by wrapping the specimens in plastic, wet sand, or burlap. The project tester or designated project representative will be responsible for the proper transfer of the specimens. The cylinders shall be removed from the molds and marked with the project number, cylinder set number, and break date.

For concrete mix designs with 15% or more Class F fly ash, it is recommended that the cast cylinders remain in the initial curing condition for the majority of the allowed 48 hour time. Concrete with 15% or more Class F fly ash can develop strength slower and transporting them sooner can lead to low break strengths.

### **Reporting Test Results**

The cylinder test information is entered in a reporting program from the CDOT Form #82, Concrete Cylinder Transmittal Report. Compressive test results and cylinder measurements are performed on the specified break dates with compressive strength test results reported on CDOT Form #192, Report of Concrete Tests. Reports are obtained through CARS. It is the responsibility of the Engineer in charge of the laboratory to ensure the proper testing and reporting of compressive strength test results.

## TECHNICAL COMPLAINTS

Questions or problems should be directed to the Concrete / Physical Properties Unit Program Manager at 303-398-6542. The evaluation process will include an investigation ensuring that correct procedures were adhered to in the following areas:

1. Paperwork
2. Testing procedures
3. Machine Calibration and settings

A verbal reply will be issued, written replies upon request.

## AIR ENTRAINMENT

### Definition

Air entrainment is the introduction of air that causes the development of a system of microscopic air bubbles in concrete during mixing.

### Measurement

Determination of air content at the job site shall be made per AASHTO T 152 and the apparent air content reported. Do not correct the air meter reading for air in the aggregate, but report total percent air.

The following may affect the quantity and quality of entrained air in concrete.

#### 1. Fly Ash

Fly Ash may substantially change the amount of air-entraining admixture required to produce the required air content. Fly ash with a high loss of ignition (LOI) has a high content of carbon and it usually causes the greatest air reduction.

#### 2. Temperature

Rising temperatures generally require increased amounts of air-entraining agents.

#### 3. Water

An increase in the water-cement ratio may increase the air content of the concrete. Contaminants present in many water sources, especially streams, can cause highly variable air content in the water.

#### 4. Mixing

A normal dosage of A.E.A. that does not produce adequate air entrainment may indicate inadequate mixing. Trucks with worn blades will not entrain satisfactory amounts of air within the specified number of mixing revolutions. However, prolonged mixing may increase concrete temperature and further reduce air content. The addition of more air-entraining agent to a truck on the job site is allowed.

#### 5. Cement

The ability of the mortar to entrain air will decrease with the increase of the fineness of the cement, and with an increase in the cement content of the mortar.

**6. Fine Aggregate**

Changes in the sand may alter the volume of air entrainment in the mortar. An increase in the quantity of very fine particles (minus No. 30 plus No. 100 sieve) will tend to increase the volume of air in the mortar.

**7. Pumping Concrete**

Pumping concrete may reduce the air content of the concrete. Several factors in the pump configuration may influence the quantity of air loss. It is the responsibility of the Contractor to ensure that the air content leaving the pump be within the specified limits.

**ADMIXTURES**

*Pre-Approved Acceptance.* Admixtures are required to conform to applicable AASHTO or ASTM specifications. When using an admixture, attention should be given to the instruction provided by the manufacturer. The amount shown on the laboratory design mix is merely a guide and may require adjustment.

Check the Approved Products List at <https://www.codot.gov/business/apl> for approved admixtures.

**Surface Retarders**

To produce exposed aggregate textures, surface retarders may be used. Sample panels may be constructed on the job site using the design mix and surface retarder if required by contract documents. This will not only provide a measure of the effectiveness of the retarder but will give a preview of the color and texture of the final result. It is important, as with other admixtures, to follow the manufacturer's instruction. Sample panels, if required, should be a minimum of 2' X 2' for 3/4" exposed coarse aggregate. If a larger sized coarse aggregate is required, the panel dimensions should be increased. Most surface retarders require an initial curing period before removal of the matrix.

**Workability Agents and Pumping Aids**

Improved workability is important for concrete placed in heavily reinforced members or placed by pumping or tremie methods. Frequently, increasing the cement content or the amount of fine aggregate will give the desired workability. One of the best workability agents is entrained air. It acts as a "lubricant" and is especially effective in improving workability and preventing segregation.

Finely divided materials are also used as admixtures to improve the workability of mixes deficient in material passing the No. 50 and No. 100 sieves. These materials may be chemically inert or pozzolanic. Inert materials include ground quartz, ground limestone, hydrated lime, and talc. Pozzolans include fly ash, volcanic glass, silica fume, diatomaceous earth, and some clays and shales heat-treated or raw.

Fly ash from an approved source may be used as a cement replacement in all classes of concretes, provided a design mix has been run using the substitution. Class C Fly Ash shall not be used in concrete that may be subjected to sulfate exposure in soil or water.

**Monomolecular Film Coatings / Water Fog Sprays**

Monomolecular Film Coatings may be applied to concrete slabs or other flatwork as a method to effectively retard surface evaporation. When placing bridge deck concrete or roadway concrete pavement, a film coating shall never be used ahead of the finishing machine.

Accordingly, its usage shall be subject to the established construction guidelines, per approval of the Engineer. A monomolecular film coating may be used after the finishing operation to prevent evaporation until the wet curing material is in place. The film shall be applied as a fine mist in small quantities. Once applied to a surface, the surface may not be reworked. There is no reason to delay wet curing, Any minor scoring of the surface is preferential to drying of the surface.

#### **Preformed Expansion Joint Material**

Damage may occur during shipping, handling, and/or storage on the project. Therefore, immediately before use, project personnel shall inspect the material for physical damage, dryness, bleaching, etc. Any portion of a shipment may be rejected before use at the direction of project personnel.

#### **ITEM 602, REINFORCING STEEL (EPOXY COATED)**

NOTE: Only producers of epoxy-coated reinforcing steel, under CP 11, that are on CDOT's Qualified Manufacturers List can be used: [www.codot.gov/business/apl](http://www.codot.gov/business/apl)

*COC Acceptance.* Bars shall meet the requirements of Subsection 709.01 before coating. Epoxy coated bars shall meet the requirements of the latest edition of AASHTO M 284.

Coated bars shall be tied with coated tie wires and placed on plastic supports or fully coated steel supports.

Field-inspect epoxy-coated steel carefully. Document field inspection and attach mill test reports to the CDOT Form 157. Retain all copies in the field Project Files.

#### **ITEM 602, REINFORCING STEEL**

**Note:** Only Reinforcing Steel Mills, under CP 11, that are on CDOT's Qualified Manufacturers List can be used: [www.codot.gov/business/apl](http://www.codot.gov/business/apl)

Field inspections, by the Engineer, should indicate that the reinforcing steel is clean and if Epoxy-Coated, that the coating is not chipped, cracked, or scratched. The steel should also be checked for proper size and grade using the information listed below.

The CDOT Staff Bridge Branch uses several different strengths of reinforcing steel for design purposes. It is necessary to watch the bar list on the bridge plans for higher strength grades, find their exact locations on the bridge plans, and be sure the correct steel is being used in that location.

Grade 60 has a yield strength of 60,000 psi and has either a "60" on the bar or a single continuous longitudinal line through at least five spaces offset from the center of the bar-side. This grade may be substituted on an equal basis for Grade 40 without prior approval. However, make note of this in the project records if substitution is made.

The metric equivalent to Grade 60 is Grade 420. It has either a "4" on the bar or a single continuous longitudinal line through at least five spaces offset from the center of the bar-side.

Grade 75 has a yield strength of 75,000 psi and has either a "75" on the base or two continuous longitudinal lines through at least five spaces offset each direction from the center of the bar.

The metric equivalent to Grade 75 is Grade 520. It has either a "5" on the base or two continuous longitudinal lines through at least five spaces offset each direction from the center of the bar.



Metric markings are being phased out by the Concrete Reinforcing Steel Institute (CRSI) to reduce confusion and the chance of errors/delays from the construction supply chain.

Information on bar markings at CRSI website:

<http://www.crsi.org/index.cfm/steel/identification>

CSRI Plant Identification Guide for Concrete Reinforcing Bars available at CRSI website or.

<http://intranet/best-dot/MAC/mac-resources>

An effort should be made to note in the project diary and on appropriate CDOT forms the grades of reinforcing steel used and especially note when different grades were used in special locations.

Concrete blocks or chairs for support of reinforcing steel need not be tested or documented unless there is reason to believe they lack conformance with CRSI recommended practices.

Certain items contain reinforcing steel, which is not included in the quantities of Item 602. These include precast, concrete bridge caissons, drop inlets, manholes, sign footings, slope and ditch pavements, and dowels in concrete pavement. When totaling up the payment quantity for these items, be sure the steel for these items is not included in reporting Item 602.

## **WIRE MESH**

Wire mesh: Field-inspect. Document in the Project Files.

The term "gage" is used by the metal industry to denote a nominal dimension. This table defines those dimensions. Galvanized sheet steel is, of course, thicker than bare sheet steel. This difference is caused by the application of a double surface coating of zinc representing 2 to 2.5 oz. per sq. ft.

Wire gage is the diameter of the finished product whether galvanized or bare. The galvanizing on the wire may vary from a thin film to as much as 2 oz. per sq. ft. of area. In the case of chain link fence wire, a 2 oz. the coating may contribute as much as 0.007 in. to the diameter.

The figures in Table 600-1 pertain to actual thicknesses and diameters but may vary because of the manufacturer's tolerances. For example, culvert sheets may be 0.006 to 0.009 in. undersize. Multi-plate sheets may be as much as 0.012 in. undersize. The wire can vary as much as  $\pm 0.005$  in. from the given diameter. To determine spelter thickness, consider 1 oz. per sq. ft. of zinc coating to be 0.0017 in. thick.

**TABLE OF GAGE MEASUREMENTS  
TABLE 600-1**

| SHEET STEEL   |               | WIRE GAGE     |       | SHEET STEEL |           | WIRE GAGE |       |
|---------------|---------------|---------------|-------|-------------|-----------|-----------|-------|
| Bare          | Galv          | Diameter      |       | Bare        | Galv      | Diam.     |       |
| <u>Inches</u> | <u>Inches</u> | <u>Inches</u> |       | <u>mm</u>   | <u>mm</u> | <u>mm</u> |       |
| .2758         | .280          | 1             | .283  | 7.005       | 7.112     | 1         | 7.188 |
| .2451         | .249          | 3             | .244  | 6.225       | 6.325     | 3         | 6.197 |
| .2145         | .218          | 5             | .207  | 5.448       | 5.537     | 5         | 5.258 |
| ---           | ---           | 6             | .192  | ---         | ---       | 6         | 4.877 |
| .1838         | .188          | 7             | .177  | 4.668       | 4.775     | 7         | 4.496 |
| .1793         | ---           | 7             | .170  | 4.554       | ---       | 7         | 4.318 |
| .1644         | .168          | 8             | .162  | 4.176       | 4.267     | 8         | 4.115 |
| ---           | ---           | 9             | .148  | ---         | ---       | 9         | 3.759 |
| .1345         | .138          | 10            | .135  | 3.416       | 3.505     | 10        | 3.429 |
| ---           | ---           | 11            | .120  | ---         | ---       | 11        | 3.048 |
| .1046         | .109          | 12            | .105  | 2.657       | 2.769     | 12        | 2.667 |
| ---           | ---           | 12            | .099  | ---         | ---       | 12        | 2.515 |
| .0747         | .079          | 14            | .080  | 1.897       | 2.007     | 14        | 2.032 |
| ---           | ---           | 14            | .076  | ---         | ---       | 14        | 1.930 |
| .0598         | .064          | 16            | .0625 | 1.152       | 1.626     | 16        | 1.588 |
| .0478         | .052          | 18            | .0475 | 1.214       | 1.321     | 18        | 1.207 |
| .0359         | .040          | 20            | .0348 | 0.912       | 1.016     | 20        | 0.884 |
| .0299         | .034          | 22            | .0286 | 0.760       | 0.864     | 22        | 0.726 |

ITEM 603 Culverts & Sewers  
 604 Manholes, Inlets, Meter Vaults  
 624 Drainage Pipe

### **CORRUGATED METAL PIPE**

Final acceptance is based on field inspection by Project Personnel.

### **SPELTER DAMAGE REPAIR**

Zinc-rich paint conforming to the Department of Defense DOD-P-21035A should be used for repainting damaged spelter. A Certificate of Compliance is required that indicates that the zinc-rich paint meets the above-referenced specification.

### **CONCRETE CULVERT PIPE**

**Note:** Only Precast Concrete Manufacturers, under CP 11, that are on CDOT's Qualified Manufacturers List can be used:

<https://www.codot.gov/business/apl/qualified-manufacturers-list.html>

Inspection of the individual pieces of the lot is left to the supplier and the field personnel. The field inspection is to be done per AASHTO M 170.

After final pay quantities are known, document them on a CDOT Form 157.

**VITRIFIED CLAY PIPE**

The project field personnel should field-inspect the pipe and document information in the Project Files.

**PIPE JOINT SEALING COMPOUND**

Most joints will require some type of sealing material. The choice is limited to either performed plastic sealing compound or bituminous mastic. Both must meet AASHTO M 198 specifications. Portland cement grout is not allowed. Rubber gaskets are required for siphon and sanitary sewers and also may be used without further approval on storm sewers and culverts.

The performed plastic sealing compound is supplied with removable paper strips between layers. A primer is required. Instructions require the primer to dry hard before applying the joint sealer. It is strongly recommended that the primer be applied by the contractor at the Jobsite rather than by the pipe manufacturer in his plant. This helps keep dirt off the primer surface and coats any chipped surfaces. Cold and wet weather require special installation procedures.

On the CDOT Form 157 that accompanies the sample list trade name, manufacturer, and any analysis or specification data found on the label.

**ITEM 604, MANHOLES**

Manholes will have stamped on each section the date of manufacture and name or trademark of the fabricator. Inspect these sections for the same characteristics listed and explained under Concrete Culvert Pipe. Document in the Project Files that the material was field-inspected and is acceptable, and add a statement to the effect that the material was in good condition when installed.

**ITEM 606, GUARDRAIL****Treated Timber Posts & Galvanized Steel Posts**

Project personnel will inspect all posts upon arrival on the project regardless of their source. This inspection will be documented on CDOT Form 157, an example of which appears at the end of this chapter. See Special Notice to Contractors for additional information.

Final acceptance is based on field-inspection by project personnel.

**Type 3 W-Beam Guard Rail**

When either the weathering steel or galvanized steel arrives on the job, it must be stored in such a way that water will not get in between the stacked rails. Water in a confined area, as it would be between these rails, causes a rapid loss of galvanizing in the form of white rust and definite kind of rusting in the weathering steel that leads to flaking and pitting, as well as an uneven rust pattern. The acceptance documentation can be done on the same CDOT Form 157 as used for acceptance of the posts.

**ITEM 606, END ANCHORAGE**

For individual components of end anchors and types, refer to the M & S Standards for a description of parts on each type. Further details are shown in the Standard Specifications, Section 710, and Subsection 710.09. The acceptance documentation can be done on the same CDOT Form 157 as used for acceptance/verification of the posts. List the above information on the CDOT Form 157.

**ITEM 607, FENCES****Treated Timber Posts**

Project personnel will inspect posts and note the source, field-inspect for compliance, and document on CDOT Form 157

**ITEM 613, LIGHTING\*****Luminaires**

Many manufacturers of luminaires that comply with our specifications are "nationally known brands". It must be understood that they also manufacture luminaires that do not meet our specification and therefore, it is necessary to check the ratings of the luminaires furnished against the requirements of the plans and specifications. Document this inspection on a CDOT Form 157. See Special Notice to Contractors for additional information.

**Metal Light Standards (pole and arms)\***

Many suppliers are capable of providing approved standards. Because the standards received on the job were made by a company previously approved, does not imply that they meet the requirements of the plans and specifications, since they also supply poles and arms in other sizes and to other specifications. It is necessary to check all features against the requirements of the plans and specifications. Document this inspection on a CDOT Form 157. See Special Notice to Contractors.

\* See the Schedule for Item 613

**ITEM 614, TRAFFIC CONTROL DEVICES****Sign Posts**

Structural Steel: These posts have the break-away feature which requires the bolts to be torqued. The upper, or fuse plate bolts, are normally shop tightened. Therefore, field checking of these fuse plate bolts should be necessary. The lower or break-away bolts are tightened more than the required torque so that during shipment and erection, the two parts stay attached. Therefore, it is necessary after erection, for the contractor to loosen these break-away bolts and retighten them with a torque wrench to the torque values shown on the plans (Standard Drawing S-614-5). Be careful not to over-tighten them. It is very important to burr the threads of the break-away bolts to prevent the nuts from loosening. **Be sure to check the torque of all bolts because if they are not tightened properly, the sign will not function as designed.** Document in Project Files.

**Flashing Yellow Beacons**

Be sure that all features required by the standard drawing and the specifications are met by the models supplied.

**Anchor Bolts for Sign Bridge Structure**

The anchor bolts for wide flange posts and sign structures that go into these footings are part of the sign structure but are shipped ahead of them. Small structure anchor bolts and regular bolts should be field inspected and documented in Project Files. See Special Notice to Contractors.

**ITEM 615, WATER CONTROL DEVICES**

Drawing M-615-A requires the use of a joint sealer meeting Federal Specification SS-S-168 or approved equivalent to make the adjustable elbows watertight.

**ITEM 618, POST TENSIONING GROUT**

Each project will collect a sample and send it to the Central Lab before use. The Chemical Lab will test the 1<sup>st</sup> sample from particular grout and send that result to each project that sends a sample for that grout until the test results are greater than 6 months old. Then the next sample submitted after the 6 months would be tested. The grout submittal shall comply with Section 618.09.

**ITEM 624, DRAINAGE PIPE**

There are several different types of drainage pipe materials available, each with different abrasion and corrosive resistant characteristics. To take economic advantage of this, ten different classes have been defined and the available drainage pipe materials designated as useable or not useable for each class, so the contractor can select the most economical material.

Most projects will have no corrosive problems. However, when they are encountered, they should be recognized during the soil survey. The decision on what Class of pipe to use is detailed in the CDOT Pipe Material Selection. The Soils Survey portion of Chapter 200 gives details on what to look for and when to suspect the existence of a corrosive condition.

**CDOT Materials Forms - Applicable for Concrete**

<https://www.codot.gov/library/forms/form-numbers-broken-down>

**Materials Forms, Instructions & Examples Chapter**

**Note: The CDOT forms are still in development, as they are completed they will be entered into the chapter. Use the relevant example forms from the electronic version of the 2018 FMM.**

| Form  | Title   |
|-------|---|
| 1188  | Concrete Mix Submittal<br>[preceded by Contractor's supplemental documentation] |
| 1373  | Concrete Mix Design Report – [ <i>computer output</i> ]                         |
| 157   | Field Report for Sample Identification or Materials Documentation               |
| 46    | Concrete Truck Mixer Inspection Certification                                   |
| 82    | Concrete Specimen Transmittal   |
| 156   | Concrete Test Results Summary   |
| 192   | Report of Concrete Tests – [ <i>computer output</i> ]                           |
| 193   | Inspection- Quality Assurance Acceptance Report – [ <i>computer output</i> ]    |
| 196-A | Physical Test Report – [ <i>computer output</i> ]                               |
| 199   | Concrete Core Tests – [ <i>computer output</i> ]                                |
| 276   | Report of Concrete Placed   |
| 281   | Concrete Batched and Placed   |
| 389   | Field Report for Joint Sealant Testing  |
| 626   | Field Laboratory Test Results   |
| 1372  | Reinforcing Bar Physical Test Report – [ <i>computer output</i> ]               |
| 1375  | Concrete Field Tests Report – [ <i>computer output</i> ]                        |

{Page Intentionally Left Blank}

## Chapter 700

### Paints - 21

This chapter is not part of the Project specifications but is a guide for project personnel in interpreting CDOT specifications, understanding ASTM, AASHTO, and Colorado test procedures, and for completing CDOT forms.

#### ITEM 708, PAINTS

##### General:

This specification covers ready-mixed paint. Paint shall be easily mixed. The mixed paint shall be free from agglomerates, skins and foreign matter and shall be of suitable consistency for the method of application. Paint shall have satisfactory spreading qualities and give a smooth, continuous coating free from breaks or sags. Paint shall be able to withstand one year of storage without detrimental deterioration. In a 3/4 full, tightly closed container, paint shall show no skinning after 48 hours.

Color where designated by number refers to Federal Standard 595B. All proportions specified herein shall be by weight.

**Structural Steel Bridge Paint** - All structural steel shall be painted as follows:

*Inorganic Zinc-Rich Polyurethane System.* The primer shall be an approved inorganic zinc-rich primer conforming to the requirements of Table I of the STEEL STRUCTURES PAINTING COUNCIL SPECIFICATION NO. 20 (SSPC-PAINT 20) (Nov. 1, 1982). The vehicle of this primer shall be SSPC-Paint 20, Type I-C.

The primer shall be applied according to the manufacturer's recommendations with a minimum dry film thickness of 80 micrometers (3 mils).

The manufacturer shall certify in writing to the Engineer that the SSPC-SP 6 steel cleaning is compatible with the primer used.

The topcoat shall be an approved high-build polyurethane enamel with a minimum dry film thickness of 80 micrometers (3 mils). To prevent bubbling, a mist coat shall be applied prior to application of the topcoat.

##### **Epoxy Coaters for Reinforcing Steel**

All steel reinforcing bars and steel dowel bars shall be painted in accordance with CP 11 Part II, Sub-Part 2: Epoxy-Coated Steel Reinforcing Bars and Epoxy-Coated Steel Dowel Bars Section 13, copied below:

#### **13. FABRICATION & JOBSITE HANDLING**

13.1 The coated bars to be fabricated by the Fabricator or field fabricated by the Contractor after application of the coating shall meet the following:

13.1.1 Contact points, such as drive rollers, shear contacts, mandrels and backup barrels on benders shall be protected with a suitable covering to minimize damage during the fabrication process.



- 13.1.1 The Fabricator shall be responsible for repair to the coating due to damage during shipment, storage, or fabrication at the Fabricator's facility.
- 13.1.3 The Contractor shall be responsible for repair to the coating due to damage during shipment, storage, fabrication, or placement at the construction jobsite.
- 13.2 Coating damaged due to fabrication or handling shall be repaired with patching material. The patching or repairing shall be performed in accordance with the written recommendations of the patching material Supplier.
- 13.3 Patching or repair material shall be compatible with the coating, inert in concrete, and feasible for repairs. The patching or repair material shall conform to AASHTO M 317 - Standard Specification for Epoxy-Coated Reinforcing Bars: Handling Requirements for Fabrication and Job Site

## Chapter 800

### Radiation Safety & Nuclear Gauge Operation - 21

**This chapter is not part of the Project specifications but is a guide for project personnel in interpreting CDOT specifications, understanding ASTM, AASHTO, and Colorado test procedures, and for completing CDOT forms.**

**Note:** Chapter 800 has been deleted. A copy of Chapter 800 will be located with each Nuclear Gauge. Additional copies will be located with each Region Radiation Safety Officer and the Region Safety Officer.

## Materials Forms – Instructions & Examples-21

### 1. SCOPE

- 1.1 The 2019 CDOT Field Materials Manual changed its format with regard to the examples of Materials Forms. Previously the Materials Forms were placed in each applicable chapter. It was decided to change this approach and now place all forms in one chapter in sequential order. The reasoning behind this change was to make it easier for those using these forms to find them especially with many of these materials testers being new users of these forms.

**Note 1:** The CDOT Materials Form updates to electronic version are currently being developed. As they are completed they will be added to the CDOT Forms webpage. You will have to download the CDOT Form to your computer to use the electronic version of the CDOT Form. The old versions of the CDOT Materials Forms (Examples) have been deleted. If it is beneficial to retain copies of all or select pages from the FMM, you can download the examples of the forms for your reference only.

**Note 2:** For consultants using the CDOT Forms be sure to open the form using the "Edge" Browser. You may encounter Font issues if you do not open with the "Edge" Browser.

- 1.2 SiteManager® Materials Projects do not need to use these forms because information can be entered directly into the required test templates. However, if a tester decides to use the form itself the data entry has been designed to mirror in most cases the template.
- 1.3 Non- SiteManager® Projects may use these forms whether they are Design-Build Projects, CDOT Maintenance Projects, Local Agency Projects, or other.

### 2. FINDING CDOT FORMS

- 2.1 All but two of the referenced forms can be found on the CDOT Forms Catalog. The web links are listed on the second page.  
The two that cannot be obtained on-line are special use "forms", the CDOT Form 633 and the 634.
- 2.2 CDOT Form 633, Sample Tag, which is placed on sample sacks.
- 2.3 CDOT Form 634, Sample Label, which is placed on sample cans.
- 2.4 The CDOT Form 633 Sample Tags and 634 Labels are available by contacting the CDOT Materials Forms Manager at [edward.trujillo@state.co.us](mailto:edward.trujillo@state.co.us) or call 303-398-6566 or by contacting the Materials & Geotechnical Branch Program Assistant at 303-398-6502. Both individuals are located at 4670 North Holly Street in Denver, Colorado.

**3. Instructions for Manually Developing the Field Sheet Numbers for CDOT Forms**

The CDOT Materials Forms that utilize a Field Sheet # are: 6, 58, 69, 82, 83, 84, 157, 212, 411, 554, & 1304. An example of the manually developed Field Sheet Number is shown below. It is a combination of the Project's Contract ID, a hyphen, and a sequential number. This process was effective as of 3-13-2017.

|  |
|--|
| FS# = (Contract ID-Seq.#)<br>_____ - _____ |
|--|

- Step 1.) Create an excel spreadsheet to document the project's sequential numbers.**
- Step 2.) Reserve 0001 to 0099 for **the Region's use.****
- Step 3.) Sequential Numbering for the project shall begin at 0100, **unless directed by the RME.****
- Step 4.) As the number is assigned, designate that number has been used by date.**

Groups of numbers can be developed based on Items (Example 1) or sequentially (Example 2).

**Example of grouping by Item**

| Item 203     |           | Item 206 CL 1 |           | Item 403 SX(75) |           |
|--------------|-----------|---------------|-----------|-----------------|-----------|
| Sequential # | Date Used | Sequential #  | Date Used | Sequential #    | Date Used |
| 0100         |           | 0200          |           | 0400            |           |
| 0101         |           | 0201          |           | 0401            |           |
| 0102         |           | 0202          |           | 0402            |           |
| 0103         |           | 0203          |           | 0403            |           |
| 0104         |           | 0204          |           | 0404            |           |
| 0105         |           | 0205          |           | 0405            |           |
| 0106         |           | 0206          |           | 0406            |           |
| 0107         |           | 0207          |           | 0407            |           |
| 0108         |           | 0208          |           | 0408            |           |
| 0109         |           | 0209          |           | 0409            |           |
| 0110         |           | 0210          |           | 0410            |           |
| 0111         |           | 0211          |           | 0411            |           |
| 0112         |           | 0212          |           | 0412            |           |
| 0113         |           | 0213          |           | 0413            |           |
| 0114         |           | 0214          |           | 0414            |           |
| 0115         |           | 0215          |           | 0415            |           |
| 0116         |           | 0216          |           | 0416            |           |
| 0117         |           | 0217          |           | 0417            |           |
| 0118         |           | 0218          |           | 0418            |           |
| 0119         |           | 0219          |           | 0419            |           |
| 0120         |           | 0220          |           | 0420            |           |
| 0121         |           | 0221          |           | 0421            |           |

**Example of numbering sequentially**

| Sequential # | Date Used | Sequential # | Date Used | Sequential # | Date Used |
|--------------|-----------|--------------|-----------|--------------|-----------|
| 0100         |           | 0116         |           | 0132         |           |
| 0101         |           | 0117         |           | 0133         |           |
| 0102         |           | 0118         |           | 0134         |           |
| 0103         |           | 0119         |           | 0135         |           |
| 0104         |           | 0120         |           | 0136         |           |
| 0105         |           | 0121         |           | 0137         |           |
| 0106         |           | 0122         |           | 0138         |           |
| 0107         |           | 0123         |           | 0139         |           |
| 0108         |           | 0124         |           | 0140         |           |
| 0109         |           | 0125         |           | 0141         |           |
| 0110         |           | 0126         |           | 0142         |           |
| 0111         |           | 0127         |           | 0143         |           |
| 0112         |           | 0128         |           | 0144         |           |
| 0113         |           | 0129         |           | 0145         |           |
| 0114         |           | 0130         |           | 0146         |           |
| 0115         |           | 0131         |           | 0147         |           |

## List of CDOT Forms

FORM #TITLE

REVISION DATE

| FORM #  | TITLE  | REVISION DATE |
|---------|--|---------------|
| 6       | Field Tests of Base Aggregates, Fillers, Paving and Misc. Aggregates.....                      | 11/17         |
| 24      | Moisture-Density Relation .....  | 4/19          |
| 30      | Certified Nuclear Gauge Label .....  | 01/20         |
| 46      | Concrete Truck Mixer Inspection Certification .....  | 3/14          |
| 58      | Field Report of AC and Max Sp Gr (RICE) of Hot Mix Asphalt .....                               | 4/17          |
| 69      | Field Report of Hot Mix Asphalt Density .....  | 11/17         |
| 82      | Concrete Cylinders Compressive Strength.....   | 2/18          |
| 83      | Concrete Beams Flexural Strength.....  | 2/20          |
| 84      | Concrete Cylinders Split Tensile .....   | 4/18          |
| 105     | Speed Memo .....   | 2/17          |
| 106     | Asphalt Binder Content by Nuclear.....   | 4/20          |
| 107     | Asphalt Binder Content by Ignition.....  | 5/18          |
| 156     | Concrete Test Results Summary .....  | 4/14          |
| 157     | Field Report for Sample Identification or Materials Documentation .....                        | 4/19          |
| 193     | Inspection – Quality Assurance Acceptance Report <b>(Report)</b> [ <i>computer output</i> ] .. | 0/00          |
| 194     | Structure Backfill Density Report .....  | 3/14          |
| 211     | Materials Documentation Request .....  | 6/14          |
| 212     | Field Report on Compaction of Earthwork.....   | 11/17         |
| 219     | Soil Survey of the Completed Roadbed.....  | 2/16          |
| 250     | Materials Documentation Record .....   | 7/17          |
| 266     | Inspector’s Progress Report .....  | 4/17          |
| 276     | Report of Concrete Placed .....  | 4/14          |
| 281     | Concrete Batched and Placed .....  | 4/14          |
| 323     | Laboratory Report on Item 203 (Embankment or Borrow) .....                                     | 5/14          |
| 334     | Penetrometer Log .....   | 4/14          |
| 379     | Project Independent Assurance Sampling Schedule.....   | 5/19          |
| 389     | Field Report for Joint Sealant Testing .....   | 4/14          |
| 411     | PG Binder/ Emulsion Submittal.....   | 11/19         |
| 417     | CP-17, Process Documentation Worksheet .....   | 1/18          |
| 427     | Nuclear Soils Moisture/Density Test.....   | 7/19          |
| 428     | Nuclear Asphalt Density Test .....   | 5/18          |
| 469     | Nuclear Asphalt Density Correction .....   | 2/17          |
| 473-SMM | Letter of Final Materials Certification .....  | 5/19          |
| 473-LA  | Letter of Final Materials Certification for a LA Projects .....                                | 5/19          |
| 473-M   | Letter of Final Materials Certification for a Maintenance Projects.....                        | 5/19          |
| 474     | Explanation of Exceptions .....  | 8/19          |
| 520     | Report on Central Laboratory to Region Lab Inspection.....                                     | 4/14          |
| 548     | Nomograph - To Correct for Percent Rock.....   | 5/14          |
| 549     | Leak Test Envelope.....  | 01/20         |
| 554     | Soils Survey Field Report.....   | 11/17         |
| 555     | Preliminary Soil Survey .....  | 12/16         |
| 564     | Soils and Aggregate Sieve Analysis When Splitting on the No. 4 Sieve.....                      | 5/14          |
| 565     | Sieve Analysis for Aggregates Not Split on the No. 4 Sieve .....                               | 6/18          |

**Note 1:** Personalizing or altering the originators CDOT Forms is not authorized.

**Note 2:** Forms that are serialized, that is Forms with unique Field sheet numbers, (Number is in **Bold**) must utilize the protocol on page 2 of this chapter. Any form with a false or duplicate Serial / Field Sheet Number will not be processed.

**Note 3:** All forms are available on the Forms Catalog. The web link to view or obtain these forms are listed below. Most of the CDOT forms are Adobe PDF fillable forms, that can either be filled in on your computer or you may wish to print the blank forms for field completion.

### List of CDOT Forms

| FORM #      | TITLE   | REVISION DATE |
|-------------|---|---------------|
| 582         | Hot Mix Asphalt Density Test.....                           | 5/18          |
| 583         | Thin Lift Compaction Test Section - Density.....            | 12/19         |
| 584         | Moisture-Density Relation Graph .....                       | 4/14          |
| 595         | Pre-Approved Product Evaluation Request & Summary.....      | 12/19         |
| 599         | Nuclear Asphalt Content Correlation.....                    | 01/20         |
| 626         | Field Laboratory Test Results .....                         | 6/18          |
| 633         | Sample Tag (for Sacks) .....                                | 11/19         |
| 634         | Sample Label (for Cans) .....                               | 11/19         |
| 723         | Nuclear Equipment Moisture/ Density Calibration Sheet.....  | 01/20         |
| 746         | Nuclear Moisture/Density Gauge Log .....                    | 01/20         |
| 772         | Nuclear Asphalt Content Gauge Log .....                     | 01/20         |
| 774         | Nuclear Gauge Operator Identification (Card).....           | 1/20          |
| 1003        | Stabilometer Graph.....                                     | 6/20          |
| 1007        | Gradation Chart .....                                       | 4/20          |
| 1030        | Stabilometer Test.....                                      | 4/20          |
| 1045        | Gradation Worksheet.....                                    | 4/14          |
| 1074        | Equipment Inspection Decal .....                            | 12/00         |
| 1094        | Asphalt Mix Design Graph.....                               | 4/14          |
| 1126        | Stabilometer Record of Item 304 ABC .....                   | 4/14          |
| 1151        | Nuclear Equipment Statistical Stability / Drift Test.....   | 01/20         |
| 1188        | Concrete Mix Submittal .....                                | 11/19         |
| 1199        | Finals Materials Documentation Checklist (Page 1 & 2) ..... | 7/14          |
| 1247        | Nuclear Gauge Property Decal.....                           | 4/20          |
| 1290        | Longitudinal Joint Data .....                               | 6/18          |
| <b>1304</b> | HMA Sample Submittal.....                                   | 11/19         |
| 1322        | CP 16, Pre-Testing Meeting Agenda.....                      | 4/14          |
| 1323        | CP 16, Weekly Meeting Agenda .....                          | 4/14          |
| 1324        | CP 16, Evaluation of Materials Testing.....                 | 12/19         |
| 1333        | Inspector's Report of Caisson Installation .....            | 4/17          |
| 1334        | Geological Boring Log.....                                  | 8/14          |
| 1346        | HMA Segregation Data.....                                   | 4/14          |

<https://www.codot.gov/library/forms>

<https://www.codot.gov/library/forms/materials-forms-serialized>

<https://www.codot.gov/library/forms/form-numbers-broken-down>

{Page Intentionally Left Blank}



## Electronic Documentation - 21

CDOT is transitioning toward accepting all submittals, forms, project records and supporting documents in electronic format. This Manual reflects technology as of 7/01/2020. Users should work in partnership with CDOT staff to continue to advance this effort in between Manual updates.

### 1. Description of Bentley Software Tools and Adobe Sign

#### Adobe Sign

Adobe Sign is the electronic signature and professional seal software selected by CDOT and required for use on Project Records including Change Modification Orders (CMO), which facilitates automated workflows including the ability to route Project Records for acknowledgements, electronically sealing and/or signing. Adobe Sign is not the eSignature program selected for use on document requiring a CDOT Controller or State Controller signature (contracts).

#### Deliverables Management

CDOT uses a series of tools in the Bentley suite for design, construction and engineering documents. One of them is ProjectWise Deliverables Management. This is a cloud-based service that streamlines how a project team works with transmittals, submittals, and Requests for Information (RFI). It provides improved visibility into these processes and also retains confidentiality when legally required.

ProjectWise Deliverables Management is utilized to ensure that documents are submitted, completed and processed on schedule. Functions include: ensuring delivery to correct parties, enabling faster reviews and responses, automating an audit trail thereby increasing accountability with detailed recordkeeping, connecting entire supply chain through a secure cloud platform and leveraging project dashboards to monitor workflows and evaluate project performance. ProjectWise Deliverables Management is capable of handling reference files used in design.

#### Project Share

The Cloud-based software tool hosted in the Bentley / Microsoft Azure Cloud used for document collaboration. Project Share connects to and synchronizes with ProjectWise Explorer, such that files placed in a Project Share folder, which is synchronized with ProjectWise Explorer, are automatically copied to the same folder in ProjectWise Explorer. Note that Project Share is not used for DGN reference files in design.

### **ProjectWise Explorer**

Bentley ProjectWise Explorer is the Electronic Document Management System (EDMS) for archiving all electronic Project Records set forth in the CDOT Record File Plans.

## **2. Definitions (Please also use the Definitions in the PDs if they are necessary for your Manual. The PDs are available in Word format in the Workshop Documents folder)**

**Adobe Acrobat DC.** The software selected by CDOT and required for use in order to create and/or modify a PDF (portable document format) Project Record, to retain a record in an ISO Compliant format. By using Adobe Acrobat DC tools, the software “Smart Scans” Project Records to meet state and federal legal requirements prior to archiving in ProjectWise Explorer.

**Adobe Sign.** The electronic signature and professional seal software selected by CDOT and required for use on Project Records including Change Modification Orders (CMO), which facilitates automated workflows including the ability to route Project Records for acknowledgements, electronically sealing and/or signing.

**Electronic Document Management System.** (“EDMS”) ProjectWise Explorer which has been selected by CDOT as the EDMS for CDOT Project Records.

**Form 950 “Project Closure”.** This CDOT form provides notice of financial closure of the project. It includes notification to the FHWA that the project is closed and includes an electronically generated Project Record retention date.

**ISO Compliant.** A Record retained in a format approved by the International Organization for Standardization, a worldwide federation of national standards which refers to the ISO 19005 series of standards with PDF/A-1 approved as a minimum. Archiving an electronic Record in an ISO Compliant format ensures that it can be read in one hundred years, regardless of the hardware or software used to create the record. An ISO Compliant Record replaces microfilm as a method of archiving.

**Naming Convention.** A thread of acronyms that allows the CDOT Project Record to be correctly named and located in the ProjectWise Explorer locally-hosted or cloud-based EDMS.

**Project Records.** Engineering, Design, Specialty Group, and Construction Records pertaining to CDOT projects, including change modification orders (CMO). See § 24-80-101(1), C.R.S. "Record" shall also mean information that is inscribed on a tangible medium or that is stored in an electronic or other medium. See § 24-71.3-102(13), C.R.S. For further clarification, see relevant CDOT Records File Plans pertaining to Project Records.

**Project Share.** The Cloud-based software tool hosted in the Bentley / Microsoft Azure Cloud used for document collaboration. Project Share connects to and synchronizes with ProjectWise Explorer, such that files placed in a Project Share folder, which is synchronized with ProjectWise Explorer, are automatically copied to the same folder in ProjectWise Explorer.

**ProjectWise Explorer** The Bentley software system utilized by the Department for archiving Project Records.

**Record File Plan.** CDOT's internal governing document developed by each division, program, or unit which contain the state and federal legal retention requirements for CDOT Records pertaining to the specific Records. Record File Plans include the correct location in ProjectWise Explorer for each Project Record.

**Smart Scanning.** The term CDOT uses to meet state and federal retention requirements for CDOT Project Records by utilizing Adobe Acrobat to make Project Records searchable, page aligned, and compressed. It also means archived in an ISO Compliant format. Note that some mediums, such as video files and image files cannot be archived in an ISO Compliant format. In this case, the files shall be retained in their original format.

### 3. **Language for CDOT Legal Requirements Regarding Record Retention**

CDOT's legal requirements to retain project records extend not only to CDOT employees but also the consultants, contractors and local agencies who work on CDOT project records. As a public agency, CDOT is legally required under state and federal law to retain certain Project Records for specified time periods. These time periods are set forth in the CDOT Record File Plans.

**4. Language for Compliance with Procedural Directive 21.1 “Requirements for the Retention of Records for Specified Design, Construction, Engineering, and Specialty Groups (Paper and Electronic)” effective June 20, 2019.**

**General Reference to PD:**

CDOT’s requirements for Project Records are set forth in Procedural Directive (“PD”) 21.1 “Requirements for the Retention of Records for Specified Design, Construction, Engineering, and Specialty Groups (Paper and Electronic)” effective June 20, 2019.

The requirements of Procedural Directive (PD) 21.1 apply to CDOT employees and to contractors, consultants and local agencies who develop, transfer, augment, or are in any way involved with or responsible for CDOT records. It applies to all CDOT projects including local agency, P3, Innovative, Design-Build and CMGC projects.

**Applicability**

Procedural Directive 21.1 shall apply to all divisions, offices, and regions of CDOT engineers and project staff who develop, handle, or receive records. It also applies to all projects, including but not limited to capital engineering projects, local agency, P3, Innovative, Design-Build (DB) and Construction Management General Contracting projects (CMGC). It applies to all consultants, contractors and local agencies who develop, transfer, augment, or are in any way involved with or responsible for CDOT records.

**Archiving Project Records in ProjectWise.**

All active and future Project Records shall be archived in Project Share / ProjectWise Explorer Electronic Document Management System on an ongoing basis rather than at the conclusion of the project.

Phases or milestones from scoping to project closure shall be established for archiving purposes. Record File Plans indicate the correct archive location for these records. They are located in the Governing Documents folder under “5 – Record File Plans”. For external users, a link to this file is included in all project share sites.

**CDOT’s EDMS for Project Records**

Bentley ProjectWise Explorer is the Electronic Document Management System (EDMS) for archiving all electronic Project Records set forth in the CDOT Record File Plans.

If project consultants are using Aconex, the PM and CDOT Resident Engineer must develop a phased approach to migrate records into ProjectWise Explorer on an ongoing basis within 45 days of the project final acceptance.

### **Record Retention Schedules for Project Records**

CDOT's Record File Plans contain a list of the public records that are required to be retained, as well as the electronic folder in ProjectWise Explorer where they will be archived. A link to the CDOT Record File Plans is made available in each Bentley Project Share site. This link will provide access for consultants, contractors and local agencies to CDOT Record File Plans.

CDOT's project records are created and retained in electronic format unless the record has a retention period of 3.5 years or less from the Form 950 closure date. If the retention period is shorter, the Project Engineer along with the Region Finals Administrator shall make the determination to retain documents in paper form.

Project Records that are subject to the following categories must be retained for seven years from the Form 950 close date (may be longer if FEMA requirements apply):

- Major project (CMGC, DB, P3 or other innovative contract projects)
- Subject of internal or external audit
- Litigation hold
- Emergency funded

Project Records must be archived according to milestones established by the project engineer on an ongoing basis rather than at the conclusion of the project.

### **Smart Scanning (ISO Compliant Requirement)**

Properly archiving Project Records means that they will be preserved in digital PDF format so that they can be read with original fidelity in one hundred years regardless of the hardware or software used to create them. This ensures that CDOT's most critical records with long-term or permanent retention requirements may be retained in digital form rather than paper or microfilm.

Project Records with retention periods longer than 3.5 years must be "Smart Scanned" prior to archiving. Training on Smart Scanning is available by registering through the Transportation Engineering Training Program ("TETP") website located here: <https://www.codot.gov/programs/tetp> Smart Scanning makes the Project Record searchable, compressed, page aligned, and in compliance with International Standard Organization's ("ISO") standard PDF/A-1b.

Project Records which do not need to be Smart Scanned are the following:

- (1) Project Records approved by the Project Engineer and CDOT Finals Administrator to be submitted in paper form. The CDOT Finals Administrator and Project Engineer may determine that Project Records with a retention period of 3.5 years or less from the CDOT Form 950 closure date can be provided to CDOT in paper form.
- (2) Videos, photos, image files, and other media formats which cannot be converted to PDF. Certain files are unable to be Smart Scanned and must be placed in ProjectWise Explorer in their original formats.

### **Paper Record Retention**

If paper Project Records have a retention period of 3.5 years or less from the Form 950 project closure date, they may be scanned and retained electronically or retained in paper format until they have met their retention period. A Destruction Form shall then be completed. Once approved, the records may then be shredded or disposed of.

Project Records in paper form are now retained by the Regions for archiving until the Records meet their retention period. Headquarters no longer receives a copy.

### **Naming Conventions for File Names**

Use standard naming conventions (PD 21.1 Appendix "A") and as noted in Record File Plans. For questions on naming conventions, ask CDOT Finals Administrators.

### **Adobe Sign: CDOT's Electronic Signature Software for Project Records.**

Unless otherwise notified by the Chief Engineer, Adobe Sign is CDOT's approved electronic workflow signature software for "Project Records." This includes the use of Adobe Sign for sealing with the professional engineer seal (see Procedural Directive 508.1 below, which sets forth requirements for sealing). Adobe Sign may not be utilized for any document which requires a signature from the CDOT Controller or State Controller.

For all Project Records that do not require a CDOT Controller/State Controller signature, Adobe Sign shall be used for both eSignatures and eSeals on Project Records. Note that Adobe Sign is permissible for use on contract modification orders ("CMO") given that CMOs do not require a signature by the Office of the State Controller. Adobe Sign work flows for Project Records will significantly cut down time routing paper records for signature, and will automatically archive the signed Project Record in ProjectWise.

### **Local Agency Records**

On Local Agency projects with CDOT oversight, Local Agencies follow their own record retention schedules that adhere to the Inter-Governmental Agreement with CDOT. However, specific documents in the CDOT Record File Plans are required to be retained by CDOT and must be provided to the CDOT Local Agency Coordinator by the local agency or its representative. CDOT uses Bentley Project Share for this purpose so that the Local Agency can transmit the project record to the CDOT Local Agency Coordinator using the project-specific Project Share site. The Local Agency Coordinator will then archive the project record utilizing the synchronization function in Project Share, and the document will automatically be archived in the correct ProjectWise Explorer folder.

### **CDOT Responsibilities:**

#### **Resident Engineers:**

- Must ensure that their staff are trained to properly archive records in the correct location and format.
- Include a provision requiring compliance with PD 21.1 in all task orders.
- Provide a copy of PD 21.1 with the Notice to Proceed.

#### **Project Managers:**

- Must fill out all attribute fields known at the time of project creation and thereafter when modifications occur. Attribute fields are filled out in SAP CJ20N (and, when launched, On Track).

#### **Finals Administrators:**

- Responsible for creating three electronic plan sets in PWZ Explorer: Award Set with watermark, Record Set with watermark, As-Constructed Plan with watermark.

#### **Records Coordinators**

- Records Coordinators are selected by their Appointing Authority to handle Project Records. Their responsibilities are set forth in PD 51.1 and in the Overview of Records Management and Records Coordinator Certification available through SAP/My Learning.

#### **Engineering Contracts:**

- Must include in contracts that PWZ Explorer is CDOT's EDMS for Project Records.
- Standards and Specifications Unit must include relevant requirements of PD 21.1 in project special provisions by January 2020 (deadline extended to July 30, 2020).

## 5. **Procedural Directive (PD) 508.1 “Requirements for the Use of the Professional Engineer’s Seal”**

### **General Description**

PD 508.1 defines the procedures for the use of the Professional Engineer seal by CDOT employees, consultants, contractors and local agencies who perform engineering work for CDOT.

All CDOT, local agency and consulting Engineers must utilize electronic sealing (rather than mechanical sealing on paper) by January 2020 unless an exception request and approval is granted by the Chief Engineer.

Beginning January 2021, no exemptions will be granted to the electronic sealing requirements.

### **Applicability**

The requirements of PD 508.1 apply to CDOT employees and to contractors, consultants and local agencies who develop, transfer, augment, or are in any way involved with or responsible for CDOT records. It applies to all CDOT projects including local agency, P3, Innovative, Design-Build and CMGC projects. PD 508.1 must be read together with PD 21.1. Sealed Project Records must be retained in ProjectWise Explorer in conformance with the CDOT Record File Plans.

Engineering designs, Record Sets and Contract Modification Orders, contract drawings and specifications for CDOT projects prepared by COOT employees or by contractors or consultants who perform work for CDOT, or by local agencies who perform work for projects with COOT oversight and/or funding or federal funding passed through CDOT, shall be Sealed in accordance with Procedural Directive 508.1.

### **Legal Requirements for Sealing**

CDOT’s Sealing requirements are dictated by and adhere to the Sealing requirements for licensed engineers set forth in the AES Board Rules, 4 CCR 730-1, which have the effect of law. The AES Board Rules dictate which documents require a Seal. The AES Board Rules have the effect of law. These include Record Sets, Contract Modification Orders, VECP’s M&S Standards and changes thereto.

To limit the scope of responsibility to one or more disciplines, a statement must be included adjacent to the Seal which limits responsibility to those portions of work done, such as: "My responsibility with respect to this standard plan revision is limited to-----"

Transmittal and storage of all CDOT project records shall adhere to the requirements of Procedural Directive 21.1 and CDOT's Record File Plans. The Sealed Record Set is required to be deposited in CDOT's ProjectWise Explorer. This will constitute the official record and will be retained permanently.



## **Responsibilities**

### **Engineer in Responsible Charge:**

- Must seal respective documents for work within their scope of work, including local agencies. Must ensure that all seals are obtained on the record set. This includes the limitation of scope for each seal.
- The Engineer in Responsible Charge on a local agency project with COOT oversight is required to Seal all documents within the scope of their work. They shall be responsible for depositing the Seal Record Set into ProjectWise within 45 days of the award.

### **CDOT Resident Engineer:**

- Is responsible for ensuring that all documents requiring Seals are obtained within 45 days of award of the construction project and archived in the correct PWZ Explorer folder.

## **Exclusions from Sealing Requirements**

- **Manufactured Components.** Engineers may specify manufactured components (e.g., impact attenuators, products on the Approved Product List ("APL")), which are exempted by statute as part of design documents. Manufactured components for the purposes of this Procedural Directive shall consist of such items as a pump, motor, steel beam or other types of items that are manufactured in multiple units for selection and use in projects which must be designed by Engineers. Systems of manufactured components which are specific to a particular use or application must also be designed by an Engineer. The Engineer may show the manufactured component on the drawing or document and is responsible for the correct selection and specification of the manufactured component but is not responsible for the proper design and manufacture of the manufactured component.
- **Stormwater Management Plans**  
Stormwater Management Plans (SWMPs) and Erosion/Sediment Control Plans are excluded from the Seal requirement. Stormwater Management Plan sheets that do not contain engineering information (e.g. hydrology, hydraulics) are not considered "engineering drawings"; therefore, Sealing by a professional engineer is not required. Engineering features (e.g., ditches, storm sewer and permanent water quality facilities) required for the management of stormwater on the project shall be included in the plans on separate sheets as details with the associated information which would require Sealing in accordance with this Directive.

## Job Safety Analysis (JSA) – Materials Index - 21

The following documents are intended to assist with the safe implementation and interpretation of the AASHTO, ASTM, CDOT Miscellaneous, Colorado Procedures, and Colorado Procedures for Laboratory Testing.

Job Safety Analysis (JSA) documents are posted on CDOT's Materials and Geotechnical web site at the address of <http://www.codot.gov/business/designsupport/materials-and-geotechnical/manuals/jsa> The JSA's shall be reviewed and updated.

Questions or perceived errors should be directed to the applicable Region Materials Engineer or Program Manager within the Central Laboratory. The following test methods and procedures have applicable JSAs or are under development.

### AASHTO Test Methods:

- R 28
- T 59
- T 84
- T 85
- T 90
- T 96
- T190
- T 240
- T 313
- T 331
- T 334

### ASTM Test Methods:

- A 370 (Rebar)
- A 370 (Strand)
- C 39
- C 78
- C 114
- C 138 / C 231
- C 143
- C 151
- C 185
- C 452
- C 496
- C 535
- C 617
- C 1260
- D 244

**CDOT Miscellaneous:**

- Continuous Sampler Penetration
- FWD Testing
- Hard Rock Coring
- Soil (Auger) Drilling
- Soil Profile
- Standard Penetration Test

**CP Test Methods:**

- CP 20
- CP 21
- CP 30
- CP 31
- CP 31A / CP 31B
- CP 32
- CP 34 / CP 35
- CP 34
- CP 37
- CP 41A
- CP 41B
- CP 41C
- CP 43
- CP 44
- CP 45
- CP 46
- CP 51
- CP 53
- CP 55
- CP 58
- CP 61
- CP 66
- CP 67
- CP 68
- CP 77
- CP 80
- CP 81
- CP 82
- CP 85

**CP-L Test Methods:**

- CP-L 2103
- CP-L 2104
- CP-L 2212
- CP-L 3101(Deleted Replaced with AASHTO T 190)
- CP-L 3103
- CP-L 4209
- CP-L 4211
- CP-L 4301
- CP-L 4302
- CP-L 5106
- CP-L 5109
- CP-L 5115
- CP-L 5120
- CP-L 5301
- CP-L 5302 / CP-L 5304
- CP-L 5303
- CP-L 5305

{Page Intentionally Left Blank}

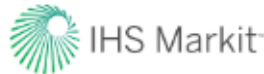
## IHS Engineering Workbench Instructions-21

As of April 23 2020, IHS has changed the log-in process for current users.

**Step 1:** log-in to CDOT Intranet and go to the AASHTO and ASTM Standards and Specifications page.

**Step 2:** enter your CDOT E-mail address

**Step 3:** enter your pass word if you have forgotten your password then click on "forgot Password" follow the next step below.



IHS Markit is committed to optimizing security for the protection of our customers, employees, partners, and products. We recently updated our access security; As a result, starting April 23<sup>rd</sup>, you will see a slight adjustment to the way you log-in.

Due to security best practices, you will need to reset your password the next time you login.

Here is a preview of the new login page:



Upon your first time logging in after the update occurring April 23<sup>rd</sup>, please feel free to select the following options to further ease your login experience:

1. Select "Save email" upon entering e-mail
2. Select "Keep me logged in" upon entering password (if applicable)

For more information, please visit or share our [Resource Page](#) for FAQs and a short tutorial. Please contact [IHS Markit Customer Care](#) if you need any assistance or for further questions.

Thank you for your cooperation and assistance.

**IHS Markit**

Copyright © 2020 IHS Markit. All rights reserved.

[PRIVACY POLICY](#) | [TERMS OF USE](#) | [DISCLAIMER](#) | [CONTACT US](#)

This email was sent to: [edward.trujillo@state.co.us](mailto:edward.trujillo@state.co.us). Update your [email preferences](#) or [unsubscribe](#). Please do not reply.

**Step 4: you will be sent a Verification Code highlight and copy and paste onto the verification code box that has been given and then build a new password and check box "Remember Me" and click on "keep me logged in".**



## Password Reset

We have received a request to reset the password for your IHS Markit account [\[edward.trujillo@state.co.us\]](mailto:edward.trujillo@state.co.us).

To reset your password, copy and paste the Verification Code below:

**Verification Code:** 3d39508b-8963-4582-aedd-42053c1e028a

If you have received this email in error, or have any other questions, contact Customer Care at: <https://ihsmarkit.com/about/contact-us.html>

Thank you,

[IHS Markit Customer Care](#)

---

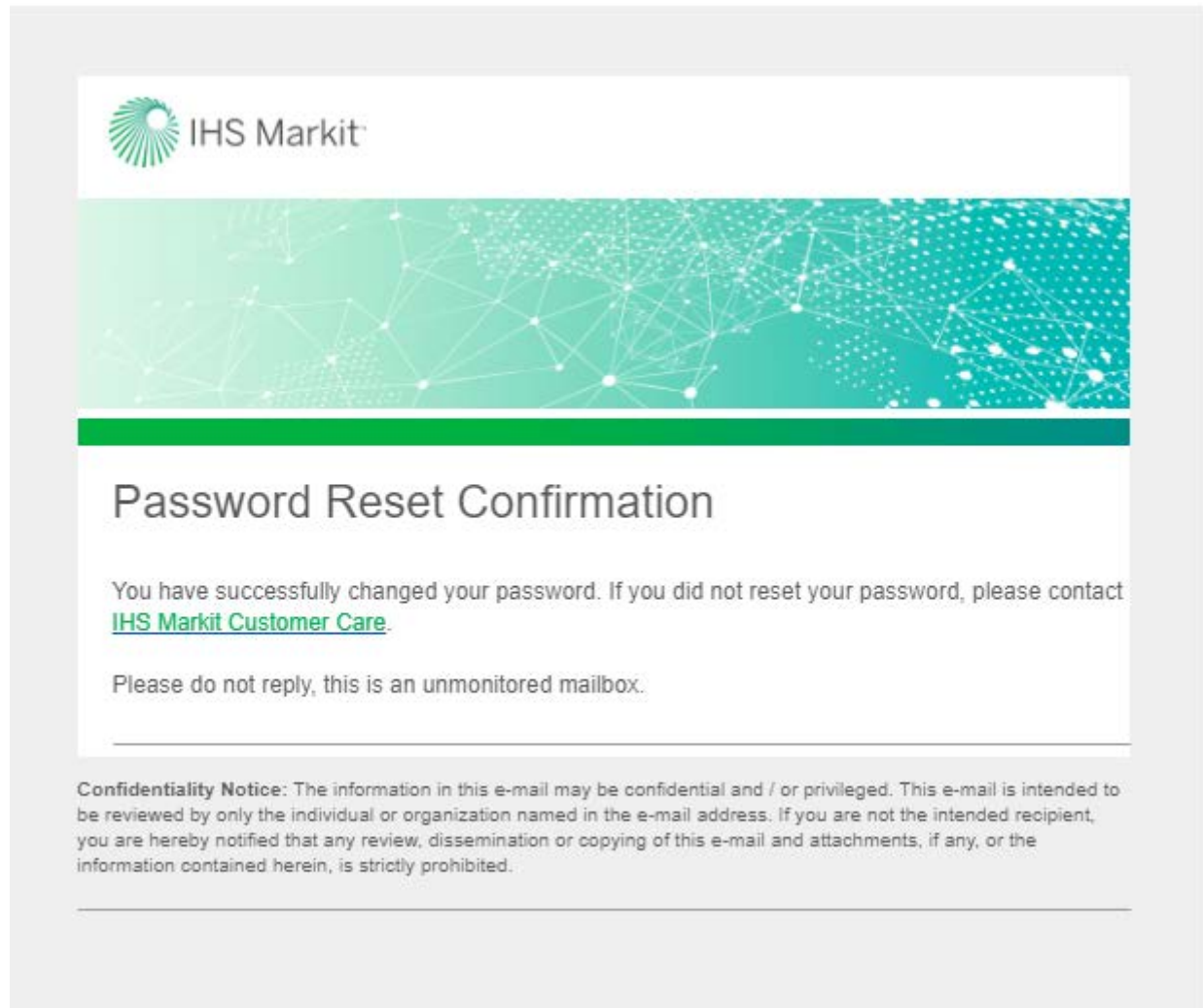
**Confidentiality Notice:** The information in this e-mail may be confidential and / or privileged. This e-mail is intended to be reviewed by only the individual or organization named in the e-mail address. If you are not the intended recipient, you are hereby notified that any review, dissemination or copying of this e-mail and attachments, if any, or the information contained herein, is strictly prohibited.

---

**Step 5: you will receive a Password Reset Confirmation and remember your password for future reference.**

**If you have problems contact HIS Markit Customer Care using the following link:**

<https://ihsmarkit.com/about/contact-us.html>





## For First Time Registration:

<https://login.ihserc.com>



[Home](#) | [Subscriber Login](#) | [How To Subscribe](#) | [Standards Store](#)

### Account Login

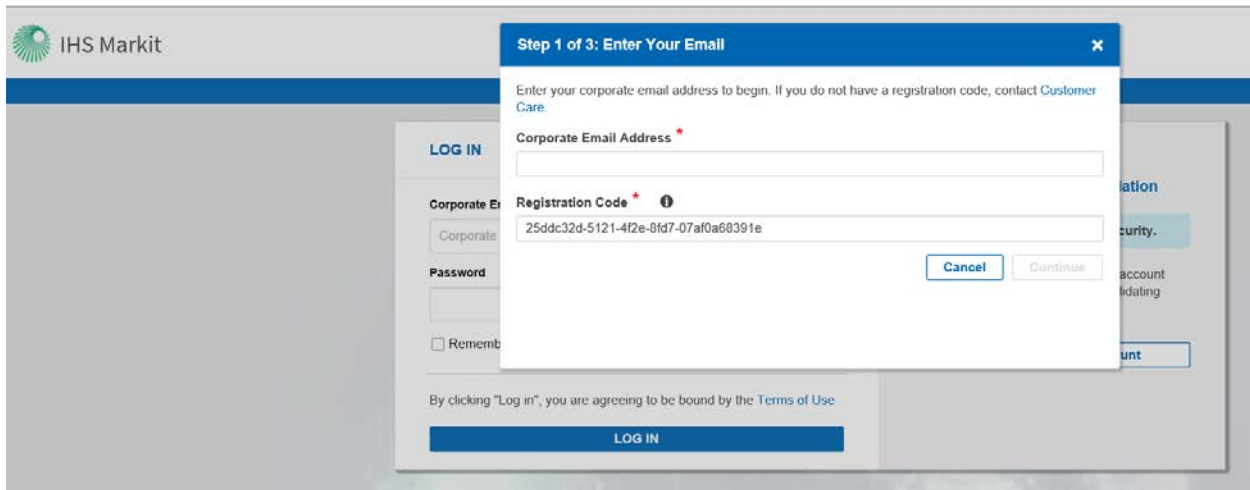
Use this login to access products from the Engineering Division including: IHS Standards Expert, HAYSTACK®, 4DOnline Parts Universe, CatalogXpress®, Fasteners eCatalog, AV-DATA®, and more.

**Account Login name:**

**Account Password:**

[Your IP](#) | [Privacy](#) | [Legal](#) | [Terms and Conditions](#)

Enter the Account Login name and click on Submit button. Kindly note that entering Account Login Name: - CODOT77 will link the you to Sub Account ID: - 5971061001; proper linkage.



The screenshot displays the IHS Markit login interface. A modal window titled "Step 1 of 3: Enter Your Email" is overlaid on the login form. The modal contains the following text and fields:

- Header: Step 1 of 3: Enter Your Email
- Instruction: Enter your corporate email address to begin. If you do not have a registration code, contact Customer Care.
- Field: Corporate Email Address (empty)
- Field: Registration Code (pre-filled with 25ddc32d-5121-4f2e-8fd7-07af0a68391e)
- Buttons: Cancel, Continue

The background login form includes:

- LOG IN button
- Corporate Email field (with Corporate dropdown)
- Password field
- Remember me checkbox
- Terms of Use link
- LOG IN button

Clicking on Register or Validate Account would enable the Registration Code to be populated automatically.

Kindly refer to Page 2 onwards on the SAM FAQ PDF file attached for further information. As a gentle reminder, corporate e-mail address refers to your own e-mail address.

Upon successful validation, you may now access IHS Engineering Resource Center via the link provided below: -

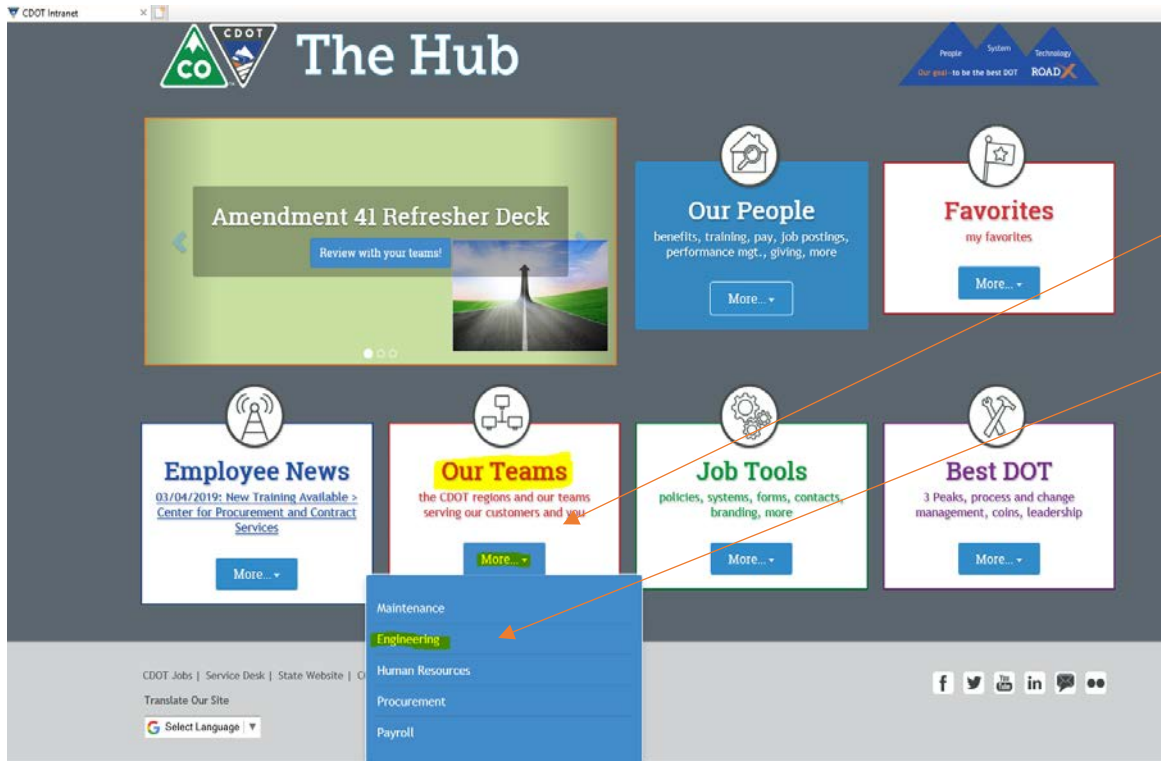
<https://login.ihsmarkit.com/>

Contact Ed Trujillo [Edward.trujillo@state.co.us](mailto:Edward.trujillo@state.co.us) 303-398-6566 if you need further assistance.

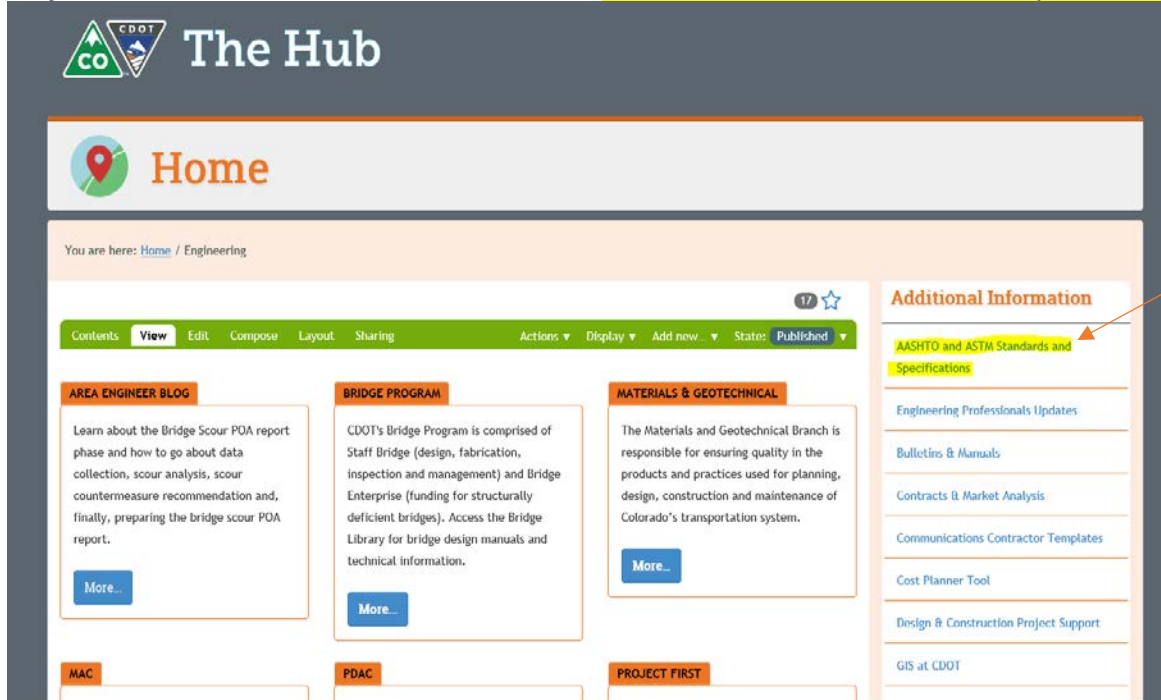
**Instructions for registered users through the CDOT INTRANET:**

**Step 1.** Go to the CDOT INTERNAL Web Page and click on the "Our Teams/More" button.

**Step 2.** Click on **Engineering Button**.



**Step 3.** Go to Additional Information and Click on **AASHTO and ASTM Standard and Specifications.**



**Step 4. Click on How to Subscribe and then Subscriber Login to creat a [User ID #] and then click on HIS Engineering Workbench to look up procedures.**

Engineering — CDOT Intranet | IHS Main Menu

Home | [Subscriber Login](#) | [How To Subscribe](#) | [Standards Store](#)

IHS Markit

### Main Menu

Welcome, **Edward** [User ID: 2405949]  
→ [Subscriber Logout](#)  
→ [Missing personal data?](#)

Account: Colorado Department of Transportation  
Account ID: 5971061001  
Session: 44382200  
Your IP: 63.225.17.34

**Select a Service from your current subscription:**

- > **IHS Engineering Workbench**
- > [Support and Training](#)

The IHS Web site, the database services, and other information provided through this Web site are made available to users subject to the Subscriber's compliance without modification of the IHS Internet Terms and Conditions and notices contained herein. By accessing or using this site or the IHS database services, the Subscriber agrees to be bound by the IHS Internet Terms and Conditions and notices.

[Privacy](#) | [Legal](#) | [Terms and Conditions](#)

**Step 4**

**Information on how to us the HIS program:**

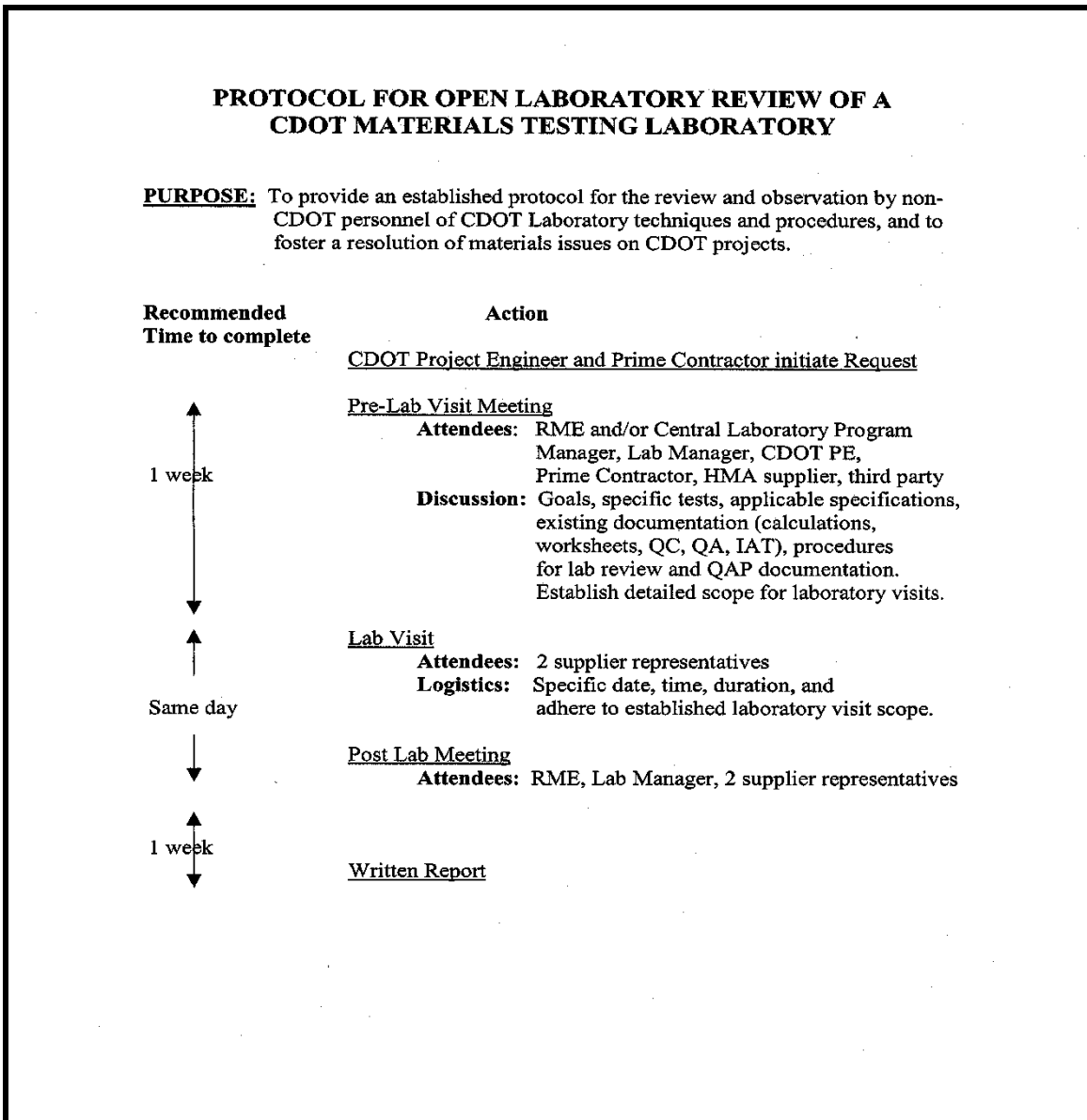
Click on link to get more information and watch a video tour.

<https://cdn.ihs.com/www/pdf/IHS-Engineering-Workbench-Quick-Start-Guide-for-Early-Visibility.pdf>

## Inspections: CDOT Central Laboratory of the Regions - 20

### TABLE OF CONTENTS

- I. Protocol for Open Laboratory Review of a CDOT Materials Testing Laboratory
- II. Protocol for the Inspection of Region Materials Laboratories by the Central Materials Laboratory
- III. Protocol for Round Robin Materials Testing of CDOT Region & Consultant Laboratories
- IV. Protocol for the Audit of Region Materials IA Sampling and Testing Program by the Central Materials Laboratory
- V. Protocol for the Audit of Region Materials Finals Materials Review and Acceptance Process by the Central Materials Laboratory
- VI. Protocol for the Audit of Local Agency Finals Materials Review and Acceptance Process by the Central Materials Laboratory



## **Protocol for the Inspection of Region Materials Laboratories by the Central Materials Laboratory - 15**

**AUTHORITY:** The Code of Federal Regulations (CFR) requires that for all State DOTs the Central Laboratories be AASHTO accredited and all laboratories conducting acceptance tests must be qualified. CDOT implements this requirement by having the Central Laboratory inspect Region Materials Laboratories, and by having Region laboratories inspect project (Field) laboratories. The Central Laboratory may also inspect project (Field) labs. This program is documented in the QA Procedures Chapter, Subsection 9.2.1.2, in the Field Materials Manual, which is reviewed and approved by the FHWA.

**OVERVIEW:** Each year a team from the Central Laboratory inspects each Region Materials Laboratory. Checklists are filled out during these inspections recording equipment condition, calibration, serial number, etc. A report is written documenting the results of the inspection. Checklists are included as attachments to the Final Report

**TEAM MEMBERSHIP:** The Concrete & Physical Properties Program will lead the inspection team. The team will be comprised of personnel from the Asphalt Pavement, Soils, and Concrete / Physical Properties programs. The Program Manager may delegate leadership to a PE I or Scientist II or higher within that Program. Experienced technicians from each Program are also on the team. The Team Leader and the other Program Managers will agree on the selection of technicians for the team.

**SCHEDULING INSPECTIONS:** The Team Leader schedules the inspections with the Regions at mutually convenient times and dates. Mobile Lab Trailers will not be inspected if they have been removed from active service. These trailers will be inspected after they are returned to service.

**INSPECTION CHECKLISTS:** Each of the three Programs is responsible for developing and maintaining worksheets that associate with the CDOT Form #520 to assist in and document the inspection. **CONDUCT OF INSPECTIONS:** The team inspects the laboratory equipment and may observe the conduct of tests using appropriate checklists. Any equipment, which is not properly calibrated, correlated, does not meet applicable standards, or is not in good working condition, is noted. Each technician focuses on equipment appropriate to their specialty area. General use equipment such as balances and ovens are also checked.

**REPORTING OF INSPECTION RESULTS:** The Team Leader will write the reports documenting the results of the Region's inspection. The report lists non-conformities in equipment and procedures, recommends any action needed to address problems or non-conformities, and reports the latest round robin results. Draft reports will be distributed to the Region Materials Engineers for comments prior to distribution. Each Final Report, with the attachments, is then distributed. The Reports will be distributed by June 30<sup>th</sup>. Region Materials Engineers will submit a written response to the Central Laboratory Branch Manager within one month of receiving the lab inspection report. Round robin testing must be performed and scores of 2, 1, or 0 must be addressed. The procedures that each individual lab within the Region is qualified to perform will be listed on the MAC website under Lab Accreditations.

**DISTRIBUTION LIST:**

- RTD - Direct Recipient
- Director of Project Support
- Region Materials Engineer
- FHWA
- Chief Engineer
- Central Laboratory - Documentation Unit

**Colorado Department of Transportation**

**Report of Central Laboratory to Region Lab Inspection**

This inspection is designed to cover apparatus and documentation used in CDOT Region Laboratories. Equipment was inspected according to applicable CDOT, ASTM and AASHTO specifications.

|        |  |          |  |  |  |  |      |  |
|--------|--|----------|--|--|--|--|------|--|
| Region |  | Location |  |  |  |  | Date |  |
|--------|--|----------|--|--|--|--|------|--|

| Region personnel present during inspection | Central Laboratory personnel present during inspection |
|--|--|
|  |  |
|  |  |
|  |  |
|  |  |
|  |  |

| General Lab   | Rating |
|---|--------|
| 1. Lab cleanliness & housekeeping? (Good/Fair/Poor)   |        |
| 2. Equipment cleanliness & functionality? (Good/Fair/Poor)                                      |        |
| 3. Region Quality System Manual present, current & complete? (Y/N)                              |        |
| 4. Tester Certifications present and complete? (Y/N)  |        |
| 5. Current CDOT Field Materials Manual, Laboratory Manual of Test Procedure & CDOT Forms? (Y/N) |        |

**Comments**

| General Lab Equipment |   | Applicable | Passed |
|-----------------------|---|------------|--------|
| Procedure             | Description   | (Y/N)      | (Y/N)  |
| A-1                   | Sieve Check   |            |        |
| A-2                   | Sieving Adequacy Check                                    |            |        |
| G-1                   | Verification of Balance                                   |            |        |
| G-2                   | Standardization of Oven Temperature                       |            |        |
| G-3                   | Calibrated Thermometer Check                              |            |        |
| G-4                   | Standardization of Liquid-in-Glass / Digital Thermometers |            |        |

**Comments**



| <b>Asphalt Laboratory Equipment</b> |  | Applicable | Passed |
|-------------------------------------|--|------------|--------|
| Procedure                           | Description  | (Y/N)      | (Y/N)  |
| HMA-1                               | Standardization of Low Temperature Oven or Freezer               |            |        |
| HMA-2                               | Superpave Gyratory Compactor Mold Check                          |            |        |
| HMA-3                               | Superpave Gyratory Compactor Ram Head Check                      |            |        |
| HMA-4                               | Troxler Gyratory Compactor True Mold Angle Check                 |            |        |
| HMA-5                               | Troxler Gyratory Compactor Pressure Check                        |            |        |
| HMA-7                               | Troxler Gyratory Compactor Height Calibration and Rotation Check |            |        |
| HMA-8                               | Vacuum System Check  |            |        |
| HMA-9                               | Standardization of Water Baths                                   |            |        |
| HMA-10                              | Stabilometer Check   |            |        |
| HMA-11                              | United Press Load Cell Check                                     |            |        |
| <b>Comments</b>                     |  |            |        |

| <b>Concrete Laboratory Equipment</b> |                                   | Applicable | Passed |
|--------------------------------------|-----------------------------------|------------|--------|
| Procedure                            | Description                       | (Y/N)      | (Y/N)  |
| C-1                                  | Type B Air Meter Check            |            |        |
| C-2                                  | Flexural Strength Apparatus Check |            |        |
| C-3                                  | Sulfur Mortar Check               |            |        |
| C-4                                  | Capping Plate Check               |            |        |
| C-5                                  | Compression Machine Check         |            |        |
| C-6                                  | Mortar Cube Bearing Block Check   |            |        |
| C-7                                  | Concrete Hand Tools Check         |            |        |
| C-8                                  | Neoprene Pad Check                |            |        |
| C-9                                  | Volumetric Air Meter Check        |            |        |
| C-10                                 | Slump Cone Check                  |            |        |
| C-11                                 | Splitting Tensile Apparatus Check |            |        |
| C-12                                 | Strike-Off Plate Check            |            |        |
| C-13                                 | Cube Mold And Tamper Check        |            |        |
| C-14                                 | Beam Mold Check                   |            |        |
| C-15                                 | Moist Room Check                  |            |        |
| C-16                                 | Water Storage Tank Check          |            |        |
| C-17                                 | Cylinder Mold Evaluation          |            |        |
| <b>Comments</b>                      |                                   |            |        |

| Soils Laboratory Equipment |   | Applicable | Passed |
|----------------------------|---|------------|--------|
| Procedure                  | Description                                     | (Y/N)      | (Y/N)  |
| S-1                        | Liquid Limit Equipment Check                    |            |        |
| S-2                        | Compaction Mold Check                           |            |        |
| S-3                        | Compaction Rammer Check                         |            |        |
| S-4                        | Straightedge Check                              |            |        |
| S-5                        | R-Value Mold Check                              |            |        |
| S-6                        | Fine Aggregate Splitter Check                   |            |        |
| S-7                        | Coarse Aggregate Splitter Check                 |            |        |
| S-8                        | Metal Follow er & Standard Metal Specimen Check |            |        |
| S-9                        | Rubber Disk and Filter Paper Check              |            |        |
| N/A                        | Sulfate Test Equipment                          |            |        |
| N/A                        | Chloride Test Equipment                         |            |        |
| N/A                        | pH test Equipment                               |            |        |
| N/A                        | Soil Resistivity Equipment                      |            |        |
| N/A                        | Nuclear MD Gauges Calibrated                    |            |        |

**Comments**

| Physical Properties Laboratory Equipment |   | Applicable | Passed |
|--|---|------------|--------|
| Procedure                                | Description                                       | (Y/N)      | (Y/N)  |
| PP-1                                     | Fine Aggregate Angularity Equipment Check         |            |        |
| PP-2                                     | Coarse Aggregate Specific Gravity Equipment Check |            |        |
| PP-3                                     | Fine Aggregate Specific Gravity Equipment Check   |            |        |
| PP-4                                     | Micro Deval Equipment Check                       |            |        |
| PP-5                                     | LA Abrasion Equipment Check                       |            |        |
| PP-6                                     | Sand Equivalent Equipment Check                   |            |        |

**Comments**

|                          |   |  |  |
|--------------------------|---|--|--|
| Distribution:            |   |  |  |
| <input type="checkbox"/> | Materials and Geotechnical Branch Manager   |  |  |
| <input type="checkbox"/> | Materials and Geotechnical Program Managers |  |  |
| <input type="checkbox"/> | Region Materials Engineer                   |  |  |

## Equipment Calibration, Verification, and Check Information

| <i>Testing Area</i> | <i>Items(s)</i>   | <i>Calibration/Verification Interval</i>  | <i>Calibration/Verification Procedure</i> |
|---------------------|---|---|---|
| General             | Balances, Scales and Weights  | 12 Mo.                                    | Certified Contractor or G-1               |
| General             | Test Thermometers   | 12 Mo.                                    | Certified Contractor or G-3 & G-4         |
| General             | Sieves  | 12 Mo.                                    | A-1                                       |
| General             | Mechanical Shakers  | 12 Mo.                                    | A-2                                       |
| General             | Oven  | 12 Mo.                                    | G-2                                       |
| Concrete/PP Unit    | Air Meters  | 3 Mo.                                     | ASTM C 231                                |
| Concrete/PP Unit    | Capping Material  | 3 Mo.                                     | AASHTO T 231                              |
| Concrete/PP Unit    | Compression Testing Machine   | 12 Mo.                                    | Certified Contractor<br>ASTM C 39         |
| Concrete/PP Unit    | Beam Apparatus  | 12 Mo.                                    | Certified Contractor<br>AASHTO T 97       |
| Concrete/PP Unit    | Conical Mold & Tamper   | 24 Mo.                                    | ASTM C 128                                |
| Concrete/PP Unit    | Single Use Molds  | Once per shipment.                        | AASHTO M 205                              |
| Concrete/PP Unit    | Beam Molds  | 12 Mo                                     | AASHTO T 23                               |
| Concrete/PP Unit    | L.A. Machine  | 24 Mo.                                    | AASHTO T 96                               |
| Concrete/PP Unit    | Moist Room  | Verify Temp with<br>Recording Thermometer | ASTM C 511                                |
| Concrete/PP Unit    | Slump Cones   | 12 Mo.                                    | ASTM C 143                                |
| Concrete/PP Unit    | Steel Balls   | 24 Mo.                                    | AASHTO T 96                               |
| Concrete/PP Unit    | Unit Weight Measures  | 12 Mo.                                    | ASTM C 29                                 |
| Concrete/PP Unit    | Unbonded Caps   | Each Shipment                             | ASTM C 1231                               |
| Concrete/PP Unit    | M/D Gauge, Calibration Checks   | 12 Mo.                                    | CP-L 5303                                 |
| Flex. Pvmt          | Compression Testing Machine   | 12 Mo.                                    | Certified Contractor or<br>HMA-11         |
| Flex. Pvmt          | Molds, Superpave  | 12 Mo.                                    | HMA-2                                     |
| Flex. Pvmt          | Superpave Gyratory Compactor, Verify<br>Ram Pressure, Angle of Gyration,<br>Frequency of Gyration, LVDT | 12 Mo.                                    | HMA-4, 5, 7                               |
| Flex. Pvmt          | Superpave Gyratory Compactor, Verify<br>Ram Head and Base Plate   | 12 Mo.                                    | HMA-2 & 3                                 |
| Flex. Pvmt          | Superpave Gyratory Compactor<br>Calibration Load Cell   | 12 Mo.                                    | Certified Contractor                      |
| Flex Pvmt           | Water Bath  | 12 Mo                                     | HMA-9                                     |
| Flex. Pvmt          | Vacuum System   | 12 Mo.                                    | HMA-8                                     |
| Flex. Pvmt          | Molds, Followers, Calibration<br>Cylinders  | 12 Mo.                                    | HMA-10                                    |
| Flex. Pvmt          | Ignition Oven Internal Scale  | 12 Mo.                                    | Certified Contractor<br>or G-1            |
| Flex. Pvmt          | Vacuum / Pressure Measuring Gauges  | 12 Mo.                                    | Certified Contractor<br>or HMA-8          |
| Soils Unit          | California Kneading Compactor   | 12 Mo.                                    | Certified Contractor                      |
| Soils Unit          | Compression or Loading Device   | 12 Mo.                                    | Certified Contractor                      |
| Soils Unit          | Grooving Tool   | 12 Mo.                                    | AASHTO T 89                               |
| Soils Unit          | Hydrometers   | 24 Mo.                                    | AASHTO T 88                               |
| Soils Unit          | Liquid Limit Device   | 12 Mo.                                    | AASHTO T 89                               |
| Soils Unit          | Manual Hammer   | 12 Mo.                                    | AASHTO T 99 /<br>AASHTO T 180             |
| Soils Unit          | Mechanical Compactor (Hammer)   | 12 Mo                                     | AASHTO T 99/<br>AASHTO T 180              |
| Soils Unit          | Metal Follower  | 12 Mo.                                    | CP-L 3101                                 |
| Soils Unit          | Molds   | 12 Mo.                                    | AASHTO T 99/AASHTO<br>T 180 / CP-L 3101   |
| Soils Unit          | Standard Metal Specimen   | 12 Mo.                                    | CP-L 3101                                 |
| Soils Unit          | Straight edge   | 6 Mo.                                     | AASHTO T 99 /<br>AASHTO T 180             |
| Soils Unit          | R-Value Equipment   | 12Mo.                                     | CP-L 3101                                 |
| Soils Unit          | Vacuum System   | 24 Mo.                                    | AASHTO T 100                              |

**Calibration, Verification, and Check of Equipment Inventory**

Region Lab: \_\_\_\_\_

| Equipment                          | Manufacturer | Model | Serial No. | Equip. No. | Date Purchased | Date in Service | Condition Received |
|------------------------------------|--------------|-------|------------|------------|----------------|-----------------|--------------------|
| <b>Soils Equipment</b>             |              |       |            |            |                |                 |                    |
|                                    |              |       |            |            |                |                 |                    |
|                                    |              |       |            |            |                |                 |                    |
|                                    |              |       |            |            |                |                 |                    |
|                                    |              |       |            |            |                |                 |                    |
|                                    |              |       |            |            |                |                 |                    |
|                                    |              |       |            |            |                |                 |                    |
|                                    |              |       |            |            |                |                 |                    |
|                                    |              |       |            |            |                |                 |                    |
|                                    |              |       |            |            |                |                 |                    |
| <b>Flexible Pavement Equipment</b> |              |       |            |            |                |                 |                    |
|                                    |              |       |            |            |                |                 |                    |
|                                    |              |       |            |            |                |                 |                    |
|                                    |              |       |            |            |                |                 |                    |
|                                    |              |       |            |            |                |                 |                    |
|                                    |              |       |            |            |                |                 |                    |
|                                    |              |       |            |            |                |                 |                    |
|                                    |              |       |            |            |                |                 |                    |
|                                    |              |       |            |            |                |                 |                    |
|                                    |              |       |            |            |                |                 |                    |
|                                    |              |       |            |            |                |                 |                    |
| <b>Concrete</b>                    |              |       |            |            |                |                 |                    |
|                                    |              |       |            |            |                |                 |                    |
|                                    |              |       |            |            |                |                 |                    |
|                                    |              |       |            |            |                |                 |                    |
|                                    |              |       |            |            |                |                 |                    |
|                                    |              |       |            |            |                |                 |                    |
|                                    |              |       |            |            |                |                 |                    |
|                                    |              |       |            |            |                |                 |                    |
|                                    |              |       |            |            |                |                 |                    |
|                                    |              |       |            |            |                |                 |                    |
|                                    |              |       |            |            |                |                 |                    |
| <b>Aggregates</b>                  |              |       |            |            |                |                 |                    |
|                                    |              |       |            |            |                |                 |                    |
|                                    |              |       |            |            |                |                 |                    |
|                                    |              |       |            |            |                |                 |                    |
|                                    |              |       |            |            |                |                 |                    |
|                                    |              |       |            |            |                |                 |                    |
|                                    |              |       |            |            |                |                 |                    |
|                                    |              |       |            |            |                |                 |                    |
|                                    |              |       |            |            |                |                 |                    |
|                                    |              |       |            |            |                |                 |                    |
|                                    |              |       |            |            |                |                 |                    |



## Protocol for Round Robin Materials Testing of CDOT Region & Consultant Laboratories - 18

### SCOPE:

Round robins are conducted every year in the winter. It provides all participating labs the opportunity to look at their procedures and results in relation to other test labs

### PARTICIPANTS:

The Lab Manager contacts all of the previous year's participants to find their interest in the round robin. New labs may also be invited to participate. The Regions are contacted for information about consultant test labs that should be included. With a clear idea of the number of participants and the quantity of samples that will be needed, the various laboratories obtain enough materials for the round robin testing.

### MATERIALS:

#### ***Flexible Pavement:***

A typical project mix design is chosen for the Round Robin. Flexible Pavement personnel sample aggregates for the testing. A binder supplier is contacted to supply the binder. The mix design is run in the Flexible Pavement Unit to be sure that material changes will not affect the mix design. Slight gradation changes may be made to produce a reasonable mix, and the final mix design is produced. Alternatively, a Plant Mixed Sample may be sampled and distributed.

#### ***Soils:***

A typical soil sample is chosen for the Round Robin. Soils lab personnel acquire soils for the testing. .

#### ***Concrete & Physical Properties:***

A concrete mix is chosen for the round robin. A local concrete supplier is contacted to supply the mix.

Along with the concrete sample, samples for CP 37 *Plastic Fines in Graded Aggregates and Soils by the Sand Equivalent Test* and CP-L4102 *Specific Gravity and Absorption of Fine Aggregate* will be distributed.

### SAMPLE PREPARATION:

#### ***Flexible Pavement:***

Laboratory Mixed Sample Procedure: Flexible Pavement personnel run the aggregates through the Physical Properties Lab. Aggregate and binder are reduced for the ignition oven correction factor that is run by each lab. Flex personnel then mix the Hot Mix Asphalt (HMA) to within 1 gram of the mix design binder content. Mixing times and temperatures are tightly controlled and kept constant between cans of mix. Samples are distributed, with the correction factor materials, to each round robin participant.

Plant Mixed Sample Procedure: Material from a project with a desired mix design is selected. The appropriate quantity is sampled from an approved location per CP 41 and placed in sample cans. The HMA samples are shipped to the Central Lab for evaluation. Samples are distributed, with the correction factor materials, to each round robin participant.

Required round robin tests may include:

- AC content (CP-L 5120)
- Gradation from burn-off (CP-L 5120)
- Maximum specific gravity (CP 51)
- Bulk specific gravity (CP 44)
- Air voids (CP-L 5115)
- Stability (CP-L 5106)
- Tensile strength ratio (CP-L 5109)

Directions and a worksheet for reporting results are also provided. The directions specify heating times and temperatures, CPs and CP-Ls to use, what samples to split out of each can, and a phone number for questions.

Alternate methods of round robin sample preparation may be implemented, with the approval of the MAC. Alternate methods may include unmixed samples, samples provided as individual aggregate components with a batch sheet, samples procured from a third party, samples delivered as individual test sizes, or a variation thereof.

**Soils:**

Soils lab personnel split the field material over the #4 screen and process the coarse aggregates. Soil and aggregates are recombined for the mechanical analysis. A moisture content sample is packaged separately and included with the material for Atterburg Limits. Ten pound samples of minus #4 material are split for proctor density. For the R-Value test, a 4800-gram sample of minus #4 will be provided. When a sulfate content test sample is requested, a 500 gram sample of minus #40 material and/or a vial of sulfate solution will be provided. The sulfate sample will be tested using CP-L 2103. Directions and a worksheet for reporting results are provided. The directions specify the test methods to be used, the accuracy used in reporting results, and a phone number to call with questions.

**Concrete & Physical Properties:**

Cylinders will be cast and cured according to AASHTO T 23 *Making and Curing Concrete Test Specimens in the Field*. The cylinders will be cured at the Central Laboratory and distributed to the participants. The participants will cure the cylinders and break the cylinders on the designated date according to ASTM C 39 *Compressive Strength of Cylindrical Concrete Specimens*.

The fine aggregate is sampled in accordance to AASHTO T 2 *Sampling Aggregates* from the stockpile and reduced in accordance to AASHTO T 248 *Reducing Samples of Aggregate to Testing Size* to approximately 1,500-gram samples.

**NOTIFICATION OF RESULTS:**

Round Robin Participants receive an electronic report. A lab's rating is determined through application of standard deviations to the data average. The AMRL method is followed. Scores that are greater than 3 standard deviations from the mean will not be used to calculate the statistics. The rating system is described as follows:

Rating 5 is for test results within  $\pm 1.0$  standard deviation.

Rating 4 is for test results between  $\pm 1.0$  to  $\pm 1.5$  standard deviations

Rating 3 is for test results between  $\pm 1.5$  to  $\pm 2.0$  standard deviations.

Rating 2 is for test results between  $\pm 2.0$  to  $\pm 2.5$  standard deviations.

Rating 1 is for test results between  $\pm 2.5$  to  $\pm 3.0$  standard deviations.

Rating 0 is for test results greater than  $\pm 3.0$  standard deviations.

The best possible AMRL rating is 5, and the worst possible rating is 0. Any CDOT lab with an AMRL rating that is 2 or less is judged to be marginal and needs to be either addressed or investigated during the lab inspection.

**REPORT:**

Participants receive an electronic round robin report. The report contains the following: cover sheet with CDOT logo, author's address, and the year and type of round robin results.

## Table of Contents:

- Introduction,
- General sampling and testing procedures that are used,
- Data evaluation section that explains the AMRL rating system that was used,
- The results section briefly describes what tests were run and what two standard deviations includes (95.5 % of the test results),
- State what procedural differences exist from last year's round robin,
- The acknowledgment thanks all that helped with the round robin,
- Tables with test results and ratings for all labs, although the labs are only identified through the sample numbers that they received.
- Graphs of the distribution of test results for each test performed and a scatter plot if applicable.

**MISCELLANEOUS:**

If a participating lab has one or more individual test ratings of two or less, they may obtain a 2<sup>nd</sup> sample for retesting after the report has been distributed. New test material may be provided so that the lab may rerun the material, if the material is not time sensitive. Only their original results will be used in the round robin report.

All lab results will be kept confidential. The latest round robin results will be included in the Region Lab Inspection Report.

Inviting all labs doing CDOT work may be impractical, as much work is needed to sample the materials.



It's possible that Region Mobile labs won't be up and running in the winter when the round robin material is distributed. Material for the Mobile labs is still sent out. When the lab is operating, the round robin material will be tested and the results will be submitted to the Central Laboratory to be compared to the round robin data and for inclusion in the Region Materials Inspection Report. While it would then be too late to include the Mobile lab's data in the round robin report, the Region could look at the round robin data to gain feedback about their equipment and procedures.

**DISTRIBUTION:**

1. Reports to industry are sent to the management of industry labs.
2. Reports to CDOT Regions are sent to the Region Materials Engineer for review and internal distribution.
3. Program Managers retain reports concerning their Unit.
4. The Documentation Unit receives an electronic copy for file retention and posting on the web site.

## **Protocol for the Audit of Region Materials IA Sampling and Testing Program by the Central Materials Laboratory- 21**

**AUTHORITY:**

The Code of Federal Regulations (23 CFR Part 637) require that for all State DOTs (SHA) an Independent Assurance Program be implemented. The “Independent Assurance samples and tests or other procedures shall be performed by qualified testing personnel employed by the SHA or its designated agent” (637.205 Policy). The Central Materials Laboratory ensures compliance by performing triennial audits of the Regions’ IA programs. The QA Program Chapter, Subsection 6.11.1, of the Field Materials Manual, which is reviewed and approved by the FHWA, documents this Inspection.

**OVERVIEW:**

Every two years a team from the Central Laboratory and the FHWA reviews the Independent Assurance Program established by the Region. A report is written documenting the results of the audit.

**TEAM MEMBERSHIP:**

The team will consist of the Pavement Design Program Manager and the Documentation Unit Representative. The Program Manager may delegate leadership to another Professional Engineer within the Unit. The FHWA may provide a representative to accompany and participate in the audit.

**SCHEDULING AUDITS:**

The Team Leader contacts each of the Region Materials Engineers and schedules the audits at mutually convenient times and dates. The RME should ensure the availability of the Region’s IA Tester(s). It is advisable to avoid the busiest months of the construction season, and to schedule in conjunction with the Final Materials Review and Acceptance Process Audit.

**AUDIT QUESTIONNAIRE:**

The Documentation Unit will develop and distribute a questionnaire to assist in the investigation of the CDOT Independent Assurance program. This document may include issues raised at the previous IA Testers Meeting.

**CONDUCT OF AUDITS:**

The team shall distribute the questionnaire to the Region Materials Engineer (RME) and the IA Tester(s) approximately four weeks prior to the scheduled audit date. Two weeks will be allowed for the completion and return of the questionnaires. The Region’s questionnaire will be reviewed with the IA Tester(s) and the RME at the time of the audit to ensure accuracy and a complete understanding of all applicable activities.

**REPORTING OF AUDIT RESULTS:**

The Team Leader shall write a report documenting the results of each Region’s audit. Each Region’s report provides an overall assessment of the Region’s independent assurance program and identifies any deficiencies. Innovative features, which improve the effectiveness of the program, should also be noted. Draft reports will be distributed to the Region Materials Engineers for comments prior to them being submitted to the MAC for approval. Each Final Report, with the questionnaire, is then distributed. The Reports must be written and distributed by June 30<sup>th</sup>.

**DISTRIBUTION LIST:**

FHWA - Direct Recipient  
Chief Engineer  
Director of Project Support  
Region Transportation Director  
Program Engineer  
Resident Engineer  
Region Materials Engineer

## **Protocol for the Audit of Region Materials Final Materials Review and Acceptance Process by the Central Materials Laboratory - 21**

### **AUTHORITY:**

The Code of Federal Regulations (23 CFR Part 637) require that for all State DOTs (SHA) a quality assurance program shall provide for an acceptance program and an independent assurance (IA) program. The Central Materials Laboratory ensures compliance by performing triennial audits of the Region's project documentation. A review of required CDOT Forms and Documents within the completed Project's File is mandated to ensure compliance with the Documentation Chapter of the Field Materials Manual.

### **OVERVIEW:**

Every two years a team from the Central Laboratory and the FHWA perform a Quality Audit. This is divided into two parts, a questionnaire and randomly selecting a minimum of three CDOT projects that have been completed during the previous three years within each of the Regions. A report is written documenting the results of the audit.

### **TEAM MEMBERSHIP:**

The team will consist of the Pavement Design Program Manager and the Documentation Unit Representative. The Program Manager may delegate leadership to another Professional Engineer within the Unit. The FHWA will be invited, and may provide a representative to accompany and participate in the audit.

### **SCHEDULING AUDITS:**

The Team Leader contacts each Region Materials Engineer and schedules the audits at mutually convenient times and dates. The RME should ensure the availability of the Region's Materials Documentation Coordinator and/or the Region's Finals Engineer, if applicable. It is advisable to avoid the busiest months of the construction season, and to schedule in conjunction with the IA Sampling and Testing Program Audit.

### **AUDIT QUESTIONNAIRE:**

The Documentation Unit will develop and distribute a questionnaire to assist in the investigation of the CDOT finals materials documentation program.

### **AUDIT CHECKLIST:**

The Documentation Unit will develop and maintain a checklist to assist in and document the audit.

### **CONDUCT OF AUDITS:**

The team shall distribute the questionnaire to the Region Materials Engineer (RME) and the Finals Materials Documentation Coordinator approximately four weeks prior to the scheduled audit date. Two weeks will be allowed for the completion and return of the questionnaires. The Region's questionnaire will be reviewed with the Finals Materials Documentation Coordinator, Finals Engineer, and the Region Materials Engineer at the time of the audit to ensure accuracy and a complete understanding of all applicable activities. The CDOT Project Files will be reviewed to ensure compliance with the Finals Materials Documentation Checking Procedure as stated in each of the Documentation chapters of the FMM. Review of all documentation from throughout the duration of the project is acceptable. Review of the Management of Consultant Materials Testing (CP 16) is optional based on the Region.

**REPORTING OF AUDIT RESULTS:**

The Team Leader shall write a report documenting the results of each Region's audit. Each Region's report provides an overall assessment of the Region's Final Materials Review and Acceptance Process and identifies any deficiencies. Innovative features, which improve the effectiveness of the program, should also be noted. Draft reports will be distributed to the Region Materials Engineers for comments prior to them being submitted to the MAC for approval. Each Final Report is then distributed. The Reports must be written and distributed by June 30<sup>th</sup>.

**NOTE:** In accordance with the Documentation – CDOT Maintenance and Local Agency Chapter CDOT MTCE Projects will be included in 2018. A Maintenance Protocol for Audit will be written.

**DISTRIBUTION LIST:**

- FHWA - Direct Recipient
- Chief Engineer
- Director of Project Support
- Region Transportation Director
- Program Engineer
- Resident Engineer
- Region Materials Engineer

## **Protocol for the Audit of Local Agency Final Materials Review and Acceptance Process by the Central Materials Laboratory - 21**

**AUTHORITY:** The Code of Federal Regulations (23 CFR Part 637) require that for all State DOTs (SHA) a quality assurance program shall provide for an acceptance program and an independent assurance (IA) program. The Central Materials Laboratory ensures compliance by performing triennial audits of the Region's project documentation. A review of required CDOT Forms and Documents within the completed Project's File is mandated to ensure compliance with the Documentation Chapter of the Field Materials Manual.

**OVERVIEW:** Every two years a team from the Central Laboratory and the FHWA perform a Quality Audit. This is divided into two parts, a questionnaire and randomly selecting a minimum of two local agency projects that have been completed during the previous three years within each of the Regions. A report is written documenting the results of the audit.

**TEAM MEMBERSHIP:** The team will consist of the Pavement Design Program Manager and the Documentation Unit Representative. The Program Manager may delegate leadership to another Professional Engineer within the Unit. The FHWA will be invited, and may provide a representative to accompany and participate in the audit.

**SCHEDULING AUDITS:** The Team Leader contacts each Region Materials Engineer and schedules the audits at mutually convenient times and dates. The RME should ensure the availability of the Region's Local Agency Coordinator and any applicable staff involved in the process. It is advisable to avoid the busiest months of the construction season, and to schedule in conjunction with the IA Sampling and Testing Program Audit and the Final Materials Review and Acceptance Process Audit.

**AUDIT QUESTIONNAIRE:** The Documentation Unit will develop and distribute a questionnaire to assist in the investigation of the CDOT local agency program.

**AUDIT CHECKLIST:** The Documentation Unit will develop and maintain a checklist to assist in and document the audit of the actual project.

**CONDUCT OF AUDITS:** The team shall distribute the questionnaire to the Local Agency Coordinator approximately four weeks prior to the scheduled audit date. Two weeks will be allowed for the completion and return of the questionnaires. The Region's questionnaire will be reviewed with the Local Agency Coordinator and the Region Materials Engineer at the time of the audit to ensure accuracy and a complete understanding of all applicable activities. The local agencies' project files will be reviewed to ensure compliance with the Finals Materials Documentation Checking Procedure as stated in the Documentation chapter of the CDOT Field Materials Manual. The intent is to also ensure compliance with CDOT's Local Agency Manual – Addendum for Materials Testing & Documentation.

**REPORTING OF AUDIT RESULTS:** The Team Leader shall write a report documenting the results of each Region's audit. Each Region's report provides an overall assessment of the Region's Local Agency Review and Acceptance Process and identifies any deficiencies. Innovative features, which improve the effectiveness of the program, should also be noted. Draft reports will be distributed to the Region Materials Engineers and Local Agency Coordinators for comments prior to them being submitted to the MAC for approval. Each Final Report is then distributed. The Reports must be written and distributed by June 30<sup>th</sup>.

**DISTRIBUTION LIST:**

FHWA - Direct Recipient  
Chief Engineer  
Director of Project Support  
Region Transportation Director  
Program Engineer  
Resident Engineer

## Appendix - Table of Contents –21

| Appendix Title  | Page   |
|---|--------|
| A1 Materials Advisory Committee (MAC) Charter .....           | 2      |
| A2 Independent Assurance (IA) Testers Committee Charter ..... | 6      |
| A3 Flexible Pavement Operators' Group (FPOG) Charter .....    | 9      |
| <br>B Task Force Management Guide .....                       | <br>12 |
| C Personnel Roster, Staff Materials & Region Materials .....  | 16     |
| D Definitions.....  | 20     |
| E Acronyms.....   | 25     |
| F Significant Publications.....                               | 29     |
| G Colorado Procedures - Laboratory <i>Numeric Order</i> ..... | 30     |
| H Metric Conversion Tables.....                               | 32     |
| I Materials Testing Accuracy Criteria.....                    | 35     |
| J Laboratory Test Time.....                                   | 38     |
| K Establishing Lots or Process Control on the Project .....   | 40     |
| L Random Sampling.....  | 40     |
| M Sample Processing Procedure.....                            | 41     |
| N Use of Laboratory Check Tests on More Than One Project..... | 41     |



## Appendix A1 - Materials Advisory Committee (MAC) Charter - 21

### PURPOSE

To oversee the Field Materials Manual, the Laboratory Manual of Test Procedures, Pavement Design Manual, MAC Task Forces and Task Groups. To review and approve all changes in the Schedules and test procedures in these manuals. To develop, review, approve, and propose to the Specification Committee specifications addressing materials problems and needs. To develop and implement programs, procedures, and policies to maintain the quality and statewide uniformity of materials incorporated into CDOT construction projects.

### MEMBERSHIP

| <b>Voting Members:</b>                   | <b>Votes</b> |
|--|--------------|
| CDOT Materials Engineer (Chairman)       | 1            |
| Region Materials Engineers (*) .....     | 6            |
| Central Laboratory Program Managers (**) | 2            |
| Applied Research and Innovation Branch   | 0            |
| Total Vote .....                         | 9            |

(\*) There are 6 RMEs for the 5 Regions.

(\*\*) Two of the 6 Program Managers from the Central Materials Laboratory, designated by the Materials & Geotechnical Branch Manager or per the respective specialty area.

### Advisory members:

Representatives from Central Laboratory Program Subject Matter Experts, Standards & Specifications, Area Engineers, Staff Maintenance, FHWA, etc.

### MEETINGS

Every two months, in odd months, on the 2nd Wednesday of the month (if possible). The meeting facilitation responsibilities will rotate among the five Regions. The host Region Materials Engineer (RME) will make arrangements for and preside at the meeting.

- The order of the Regions will be established through consensus between the MAC Chairman and the RMEs.
- The CDOT Materials Engineer will designate a person to be the Secretary of the MAC: to assist the Host Region, to create and distribute the Agenda, to take notes at the Meetings, write the Minutes, distribute the Minutes and the Executive Summary, and maintain the MAC on Teams web site.

### SCOPE

1. Review and approve changes to the following:
  - Quality Assurance Procedures
  - Documentation, Project Materials to Final Materials [for SiteManager / LIMS, for Design-Build, for CDOT Maintenance & Local Agency]
  - Special Notice to Contractors

Owner Acceptance (OA) Frequency Guide Schedule for Minimum Materials Sampling, Testing, and Inspection

Independent Assurance (IA) Frequency Guide Schedule for Evaluation of OA Sampling & Testing Colorado Procedures (CP's)

Chapters, 200 – 800, Inspections

Job Safety Analysis (JSA), Materials

Colorado Procedures - Laboratory (CP-L's)

MAC Task Force Charters

2. Provide oversight for the Field Materials Manual, Laboratory Manual of Test Procedures, Pavement Design Manual, materials research, Pavement Management System implementation, and sampling & testing of maintenance material.
3. Review, discuss, develop, and approve specifications addressing materials problems or needs. Specifications approved by the MAC are then forwarded to the Specification Committee for consideration.

### **GUIDELINES FOR MATERIALS ADVISORY COMMITTEE (MAC) MEETINGS**

**Overview** - The focus of MAC meetings will be to conduct the responsibilities of the MAC as designated under the **Purpose** and **Scope** Sections of the Materials Advisory Committee Charter.

**Conduct of Meeting** - The host Region Materials Engineer (RME) will preside over the meeting and act as the meeting facilitator. The agenda topics will be handled in order and discussion shall remain focused on the topic as presented in the Agenda. Additional topics added after the meeting agenda has been distributed, will be discussed after the meeting agenda items have been addressed if time permits. Discussion on each topic will move toward a swift and efficient resolution of the problem with the Host acting as a facilitator if necessary. If substantial work is anticipated to resolve specific items, a task group can be formed to develop an action plan, which will resolve the question. When discussion on any topic begins to stray from the topic or significantly exceeds the allotted time for that topic, the presiding RME shall push for a resolution or move to the next Agenda item.

**Who Attends** - Attendance will be **Voting** and **Advisory** members of the Committee, as shown in the Charter. Guests (Contractors, suppliers, etc.) will attend only if invited by a MAC member for a specific Agenda topic only.

**Guests** that come for one topic and then leave shall be assigned a time slot, most likely after lunch. Guests invited for an *Education and Research* topic may be scheduled during lunch to maximize efficient time utilization. The guests' schedule will be taken into consideration. Discretion will be used when an excessive amount of time, minor importance, or more than one topic is requested. In some instances, guests may be placed at the end of the agenda.

**Guests, Uninvited:** The Open Meetings Law (C.R.S. 24-6-401) does not apply to advisory committees or other internal work groups at CDOT. There is no right for non-invitees to attend such meetings. Policy clarified at November 2017 MAC Meeting.

**Agenda Topics** - Only persons eligible to be voting members of the MAC may place topics on the agenda. Anyone else must work through these members to establish an agenda topic. The presenter of each topic shall lead the discussion on their topic and ask for a vote if necessary.

**Agenda Topic Votes** - Only Voting members of the MAC may “Make a Motion” or “Second a Motion”. Only voting members may participate in E- Votes (Votes by E- Mail). Votes require 6 in affirmation. *Abstaining from a vote is not a passive act. Except in illness a voting members who is missing must designate a proxy in advance to the MAC Secretary. The individual attending for the voting member should not designate themselves.*

**Appropriate Topics & Discussion** - Topics will normally address items listed under **Purpose** and **Scope** of the MAC Charter. Topics for the upcoming meeting need to be submitted during the Topic Solicitation period. Each agenda item will be given a number. Topics that are brief updates without the possibility of discussion can be posted in the Agenda without discussion and stipulated as “Non-Verbal”.

**Documents Referenced for Topics** - All referenced documents will be provided to the MAC Secretary as stipulated prior to the Meeting for distribution and presentation on the day of the MAC.

**Agenda & Meeting Organization** - The priority / order of the Agenda is:

- 1) The **Minutes** from the previous MAC Meeting will be approved by Vote.
- 2) The **Agenda** for the current MAC Meeting will be accepted or amended, if necessary, by the membership.
- 3) The **E-Vote Summaries** from between the MAC Meetings will be announced by the Facilitator. The intent is to read the e-vote into the Minutes not to further discuss the issue. If the topic needs any discussion it shall be an Old Business Agenda item.
- 4) **Task Force Business.** Task Forces need to inform the Committee of their current status. Informational updates with discussion and votes are frequently necessary. An update is required at a minimum of once per year.

Task Group Business. Task Groups being internal and of very limited scope need to inform the Committee of their current status within the applicable Old Business topic.

- 5) **Old Business.** This will include items that were on the last MAC agenda as either New Business or Additional Business. This will also include Old Business items that were not resolved at the previous MAC meeting because additional data needed to be gathered, or because it is long term in implementation. Items not discussed during the previous three MAC meetings (6 months) shall be considered new business if the topic is resumed.
- 6) **Education & Research.** Guest speakers, video presentations, etc. will occasionally be on the Agenda to assist in the sharing of relevant current information. If possible all Education & Research topics will immediately follow the lunch break at approximately 12:00.
- 7) **New Business.** This will be prioritized by the MAC Chairman based on the importance of the agenda item and associated with related topics.
- 8) **Additional Business.** Items that are received after the deadline for submittal. Unless these are “emergency” items, they will be placed at the end of the agenda and discussed in a priority order as time permits. Low priority items may be postponed and added to the next MAC’s agenda.

*MAC Meeting Minutes and Executive Summary* - The MAC Secretary will develop the draft version of the Minutes within two weeks after the date of the Meeting. Although distributed to all Meeting Attendees there should always be a response from the topic presenters, the MAC Facilitator, and the MAC Chairman. The MAC Chairman should develop an Executive Summary. The MAC Secretary may distribute and post the final version of the MAC Meeting Minutes and the Executive Summary.

## **Appendix A - Independent Assurance (IA) Testers Committee Charter - 14**

### **PURPOSE**

To review and aid in the development of the Independent Assurance (IA) Program and the Frequency Schedule for Independent Assurance Evaluation in the Field Materials Manual.

To receive and review procedures for testing materials used in the Field and recommend any necessary changes for implementation to the Materials Advisory Committee.

To establish and maintain statewide consistency between Quality Assurance and Independent Assurance Testers.

To establish and maintain consistency in the use of the Field Materials Manual.

### **MEMBERSHIP**

#### **Voting Members:**

A member of the Documentation Unit of Staff Materials and one IA tester from each of the six Regions will be allowed to vote. Regions with more than one IA Tester shall share a vote.

#### **Advisory Members:**

FHWA and CDOT employees with experience or expertise in the tests performed by Field personnel or the Central Laboratory.

### **MEETINGS**

Meetings will be on an annual basis and usually in January. The meeting will be held at a time close to the Materials Advisory Committee (MAC) meeting. If requested by the Committee, additional meetings may be required. The Pavement Design Program Engineer will host the meeting each calendar year. A member of the Documentation Unit will assist the Host, to create and distribute the Agenda, to take notes at the meetings, and produce and distribute the Minutes.

### **SCOPE**

To share information and ideas related to sampling and testing of material incorporated into CDOT projects.

To review new ideas, develop and approve (by simple majority) suggested changes to the Field Materials Manual, specifications, or procedures addressing materials problems or needs. Suggested changes will be forwarded to the MAC for consideration.

### **GUIDELINES FOR THE INDEPENDENT ASSURANCE TESTERS COMMITTEE MEETINGS**

**Overview** The focus of the IAT Meeting will be to conduct the responsibilities of the IAT Committee as designated under the **Purpose** and **Scope** sections of the Independent Assurance Tester Committee Charter.

**Conduct of Meeting** - The Chairperson will preside over the meeting. The agenda topics will be handled in order and discussion shall remain focused on the current topic. Additional topics added after the meeting agenda has been distributed, will be discussed after the meeting agenda items have been addressed if time permits. Discussion on each topic will move toward a swift and efficient resolution of the problem. If substantial work is anticipated to resolve specific items, a task force can be formed to develop an action plan, which will resolve the question. When discussion on any topic begins to stray from the topic, the Chairperson shall push for a resolution or move to the next agenda item.

**Who Attends** - Attendance will be **Voting** and **Advisory** members of the Committee, as shown in the Charter. Guests (Contractors, suppliers, etc.) will attend only if invited by an IAT member for a specific Agenda topic.

**Agenda Topics** - Only persons eligible to be voting members of the IAT Committee may place topics on the agenda. Anyone else must work through these members to establish an agenda topic. The presenter of each topic shall lead the discussion on their topic and ask for a vote if necessary.

**Agenda Topic Votes** - Only Voting members of the IAT may "Make a Motion" or "Second a Motion". Only voting members may participate in E- Votes (Votes by E- Mail).

**Appropriate Topics & Discussion** - Topics will normally address items listed under **Purpose** and **Scope** of the IAT Charter. Topics that are informational and require no decision, such as updates, shall generally be avoided. These can be handled by E-Mail.

**Prioritization of IAT Agenda Items** - Agenda items for the upcoming meeting need to be submitted at least 20 calendar days prior to the meeting. Each agenda item will be given a number. The priority for the Agenda is:

1. The **Minutes** from the previous IAT meeting will be approved by vote.
2. The **Agenda** for the current IAT meeting will be approved by vote.
3. The **E-Votes Summary** will be submitted for IAT Minute inclusion.
4. Matters considered "**emergency**" items as determined by the Chairperson shall have the top priority.
5. **Task Group Business**. Task Groups need to inform the Committee of current status. Informational updates with discussion and votes are frequently necessary.
6. **Guests** that come for one topic and then leave shall be assigned a time slot, most likely after lunch. The guests' schedule will be taken into consideration. Discretion will be used when an excessive amount of time, minor importance, or more than one topic is requested. In some instances guests may be placed at the end of the agenda.
7. **Old Business**. This will include items that were on the last IAT agenda but were not addressed because of lack of time. This will also include items that were not resolved at the previous IAT meeting because additional data needed to be gathered. Items not addressed at the last IAT meeting shall be considered new business.

8. **Education & Research.** Guest speakers, video presentations, etc. will occasionally be on the Agenda to assist in the sharing of relevant current information.
1. **New Business.** This will be prioritized by the Chairperson based on the importance of the agenda item and then associated with related topics.
2. **Additional Business.** Items that are **received after the deadline** for submittal. Unless these are “emergency” items, they will be placed at the end of the agenda and discussed as time permits

**Appendix A - Flexible Pavement Operators Group (FPOG) Charter - 18**

**PURPOSE**

To review needed changes in the testing of flexible pavement and to share information with other flexible pavement testers. To review and aid in the development of Colorado Procedures (CPs) and Colorado Procedures - Laboratory (CP-Ls) that pertain to flexible pavement.

**MEMBERSHIP**

**Voting Members:**

A member of the Flexible Pavement Unit of Staff Materials designated by the Asphalt Program Manager and one representative designated by each Region Materials Engineer (RME) from each of the Regions will be allowed to vote.

| <b>Voting Members:</b>                   | <b>Votes</b> |
|--|--------------|
| Flexible Pavement Unit (Staff Materials) | 1            |
| <u>Region Labs</u>                       | <u>6</u>     |
| Total Votes                              | 7            |

Note 1: There are six RMEs for the 5 Regions.

**Advisory Members:**

A Flexible Pavement Engineer and, as needed, CDOT employees with flexible pavement experience.

**MEETINGS**

The MAC authorized the FPOG to meet up to four times per year, ideally between September and March. The meetings will take place in Glenwood Springs or Denver. Regions will rotate hosting the meeting. The host Region will provide a Chairman to preside at the meeting and to make arrangements for the meeting. The Flexible Pavement advisory member will serve as Secretary to assist the Host Region, to create and distribute the Agenda, to take notes at the meetings, and produce and distribute the Minutes.

**SCOPE**

To share information and ideas related to the testing of flexible pavements  
To review ideas and approve (by simple majority) suggested changes to the following:

- Colorado Procedures (CPs)
- Colorado Procedures - Laboratory (CP-Ls)

The Flexible Pavement advisory member then presents these approved changes to the Asphalt Program Manager for the MAC’s consideration.



## **GUIDELINES FOR FLEXIBLE PAVEMENT OPERATORS' GROUP (FPOG) MEETINGS**

**Overview** - The focus of FPOG meetings will be to conduct the responsibilities of the FPOG as designated under the **Purpose** and **Scope** sections of the Flexible Pavement Operators' Group Charter.

**Conduct of Meeting** - The Chairman from the host Region will preside over the meeting. The agenda topics will be handled in order and discussion shall remain focused on the current topic. Additional topics added after the meeting agenda has been distributed, will be discussed after the meeting agenda items have been addressed if time permits. Discussion on each topic will move toward a swift and efficient resolution of the problem. If substantial work is anticipated to resolve specific items, a task force can be formed to develop an action plan, which will resolve the question. When discussion on any topic begins to stray from the topic, the Chairman shall push for a resolution or move to the next agenda item.

**Who Attends** - Attendance will be **Voting** and **Advisory** members of the FPOG, as shown in the Charter. The RME from the host Region is encouraged to attend. Guests (Contractors, suppliers, etc.) will attend only if invited by a FPOG member for a specific Agenda topic.

**Agenda Topics** - Any FPOG member may place topics on the agenda. Anyone else must work through these members to establish an agenda topic. The presenter of each topic shall lead the discussion on their topic and ask for a vote if necessary.

**Agenda Topic Votes** – Only Voting members of the FPOG may “Make a Motion” or “Second a Motion”. Only voting members may participate in E- Votes (Votes by E- Mail).

*Appropriate Topics & Discussion* - Topics will normally address items listed under **Purpose** and **Scope** of the FPOG Charter. Topics that are informational and require no decision, such as updates, shall generally be avoided. These can be handled by E-Mail.

**Prioritization of FPOG Agenda Items** - Agenda items for the upcoming meeting need to be submitted at least 10 calendar days prior to the meeting to the Flexible Pavement advisory member at Staff Materials. Each agenda item will be given a number. The priority for the Agenda is:

1. The **Minutes** from the previous FPOG meeting will be approved by vote.
2. The **Agenda** for the current FPOG meeting will be approved by vote.
3. The **E-Vote Summary** will be submitted for FPOG Minute inclusion.
4. Matters considered "**emergency**" items as determined by the Chairman shall have the top priority.
5. **Task Force Business.** Task Forces need to inform the Flexible Pavement Operators' Group of current status. Informational updates with discussion and votes are frequently necessary.
6. **Guests** that come for one topic and then leave shall be assigned a time slot, most likely after lunch. The guests' schedule will be taken into consideration. Discretion will be used when an excessive amount of time, minor importance, or more than one topic is requested. In some instances guests may be placed at the end of the agenda.

7. **Old Business.** This will include items that were on the last FPOG agenda but were not addressed because of lack of time. This will also include items that were not resolved at the previous FPOG meeting because additional data needed to be gathered. Items not addressed at the last FPOG meeting shall be considered new business.
8. **Education & Research.** Guest speakers, video presentations, etc. will occasionally be on the Agenda to assist in the sharing of relevant current information.
9. **New Business.** This will be prioritized by the Chairman based on the importance of the agenda item and associated with related topics.
10. **Additional Business.** Items that are **received after the deadline** for submittal. Unless these are “emergency” items, they will be placed at the end of the agenda and discussed as time permits.

## Appendix B- Task Force Management Guide

**OVERVIEW** The activities of a task force must be managed to accomplish the purpose of the task force. Keep the focus on the purpose of the task force and accomplish the tasks necessary to achieve this purpose with a series of action items. Various materials committees (MAC, AIF Steering, CDOT-ACPA Co-op, etc.) establish the purpose of each task force. At the first meeting of the task force make sure that this purpose is clearly understood by all task force members. Avoid expanding the purpose or scope of the task force without first consulting the committee that established the task force. The committee may decide that new problems identified by the task force are low priority or should be addressed by another task force.

**PROBLEM SOLVING** The activities of a task force are basically problem solving. Keep in mind the steps in problem solving, which are:

- Identify the problem
- Generate solutions
- Evaluate the advantages and disadvantages of each solution and make a decision
- Implement the solution
- Consider evaluating the solution one or two years later to make additional tweaks

**PRIORITIES** At the first meeting the task force should clarify priorities. Often there is an urgent need for a quick fix to the current specification followed by a longer-term effort to gather information and affect a more permanent reworking of the specification. As the work of the task force progresses make sure that the list of priorities is kept up-to-date.

**IMPLEMENTATION TIMELINES** Give consideration to timelines at which the final products will impact CDOT projects. The schedule of the Specification Committee is:

| Specification Committee Schedule |                    |
|----------------------------------|--------------------|
| Meeting Dates                    | Quarterly Releases |
| March                            | February           |
| June                             | May                |
| September                        | August             |
| December                         | November           |

Generally speaking, items approved by the MAC at its September Meeting, will be able to impact projects the following construction season. If urgent changes are needed, then items approved at the November MAC may make it into projects. This is possible, but not desirable. Items approved at the January MAC Meeting and beyond will not impact CDOT projects until the following construction season.

**SCHEDULING** It is not advisable to have meetings during the busy summer construction season for CDOT or industry representatives. However, after considering the implementation needs and the importance of the changes, meetings in the summer months may occur. Be sure to check with the CDOT and Industry Co-chairs for guidance on summer meetings.

It is in everyone's best interest to have as complete and comprehensive a product as possible. However, that is not realistic in many cases. It is often better to make incremental improvements. Several task forces have come up with an improved product. After experimenting with it on projects, the lessons learned are documented and a "Part 2" effort can be undertaken.

**AGENDA** Distribute a detailed agenda at least a week before each meeting. Start the agenda with a reminder of the date, time, and place of the meeting. Include a description of any decisions that need to be made with each topic. The last topic is establishing the date, time, and place of the next meeting.

**SUPPORTING INFORMATION** Distribute information to be discussed at least a week before the meeting so members have time to study that information. This information may be test data, research reports, etc. You shouldn't expect task force members to digest information just received and immediately make decisions.

**CONDUCT OF THE MEETING** As the person conducting the meeting, make sure that the discussion follows the agenda. New topics that arise may be discussed at the end of the meeting. Keep the discussion focused on the purpose of the task force. Try to base decisions on data. Sometimes data will indicate that a perceived problem does not exist. Try to draw out input from the quiet members of the task force. They may have valuable ideas. In addition, it is important to have buy-in by all task force members into whatever decisions the task force makes. Avoid having aggressive task force members dominate the discussion. The products of the task force should not only be workable but also should be a consensus that both industry and CDOT can be comfortable with. Within CDOT it is critical that task force products have statewide buy-in. A recurring problem with CDOT standards is lack of uniformity of statewide application that undermines the integrity and credibility of these standards.

Keep in mind that the Materials Advisory Committee and Specification Committee must approve any specification changes desired by the task force. The task force must develop the rationale and data needed to convince these technical committees.

Get commitments from task force member to do what needs to be done, to accomplish the purpose of the task force (action items). At the end of the meeting, review these action items. Define clearly who will do what by when. Finally, determine the date, time and place of the next meeting, if possible.

**MINUTES** Someone should take notes at the meeting and produce detailed minutes. It is best for the note taker to not be the person conducting the meeting. It's too much for one person. Good minutes help avoid rehashing the same items at each meeting. Include in the minutes, decisions made on each topic. It is also good to describe areas of disagreement and any action that will be taken to resolve the disagreement. Include action items, listing who will do what by when. The final item in the minutes is the date, time, and place of the next meeting. Distribute minutes to task force members within two weeks of the meeting. It's often good to send minutes to your supervisor to keep them informed and to let them know what you're up to.

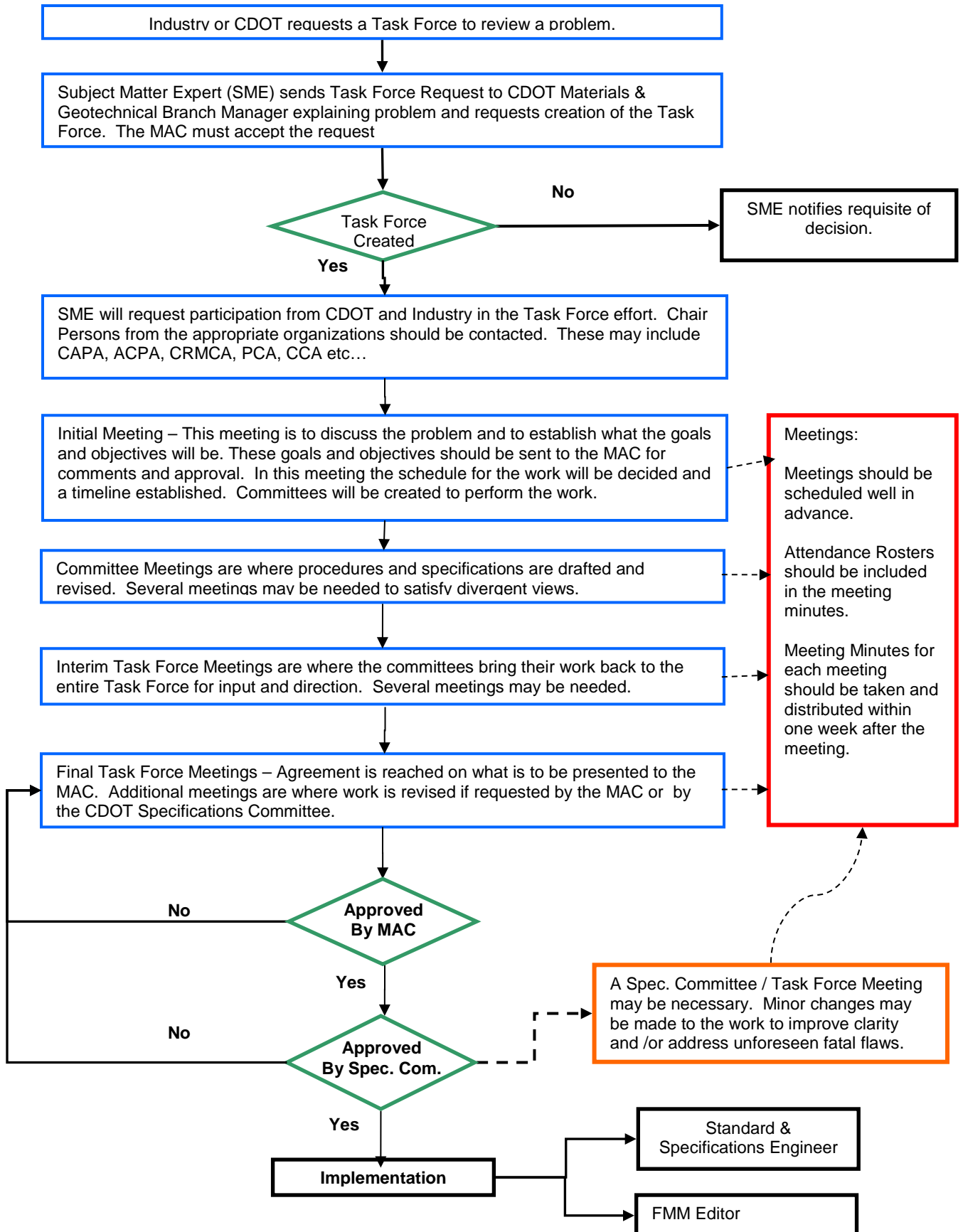
**DOCUMENT TASK FORCE RESULTS** Document the findings and changes made by the task force. This will be useful in the future to clarify the rationale behind CDOT specifications and standards. Documentation should include the purpose of the task force, problems identified, data collected, references reviewed, and finally changes made to CDOT specifications and standards. The MAC secretary shall maintain copies of this final report documenting task force results.

Some examples of successful products have been:

- Specifications and standards that are forwarded to the Specification Committee,
- Project selection guidelines that are forwarded to the Materials Advisory Committee and included in the Pavement Design Manual,
- Colorado procedures and practices that are forwarded to the Materials Advisory Committee and included in the Field Materials Manual,
- Research needs statements that are forwarded to the Research Branch for consideration as a formal research problem statement or a quick study, or

Information that is important enough to be shared broadly within CDOT is forwarded to the Project Development Area Engineers for distribution as a Construction Bulletin.

**The Task Force Process and Best Practices**



## Appendix C - Personnel Roster, Staff Materials & Region Materials - 21

| <u>Office/ Name</u>   | <u>Title</u>  | <u>Telephone</u>                    |
|---|---|-------------------------------------|
| <b>Materials &amp; Geotechnical Branch</b>  |   |                                     |
| Wieden, Craig   | Materials & Geotechnical Engineer   | 303-398-6501                        |
| Gonzalez, Norma   | Program Assistant<br>FAX  | 303-398-6502<br>303-398-6504        |
| <b>Asphalt Pavement Program</b>   |   |                                     |
| Stanford, Michael   | Asphalt Pavement Engineer   | 303-398-6576                        |
| Vacant  | Asphalt Support Engineer  | 303-398-6525                        |
| Lam, Johnny   | Flexible Pavement & European Lab Manager  | 303-398-6533                        |
| Stephenson, Gregg   | Bituminous - Chemical Lab Manager   | 303-398-6531                        |
| <b>Concrete Pavement Program &amp; etc., Soils &amp; Physical Properties Labs</b> |   |                                     |
| Prieve, Eric  | Concrete & Phy Prop. Engineer   | 303-398-6542<br>(Cell) 303-204-8926 |
| Niculae, Valentino  | Concrete Support Engineer   | 303-398-6549                        |
| Brown, Clay   | Concrete Pavement Lab Manager   | 303-398-6541<br>(Cell) 303-204-8926 |
| Tchouban, Bryan   | Soils Lab Manager   | 303-398-6590                        |
| Smith, Paul   | CDOT Radiation Safety Officer (RSO),<br>Pavement Deflection Technician [FWD],<br>& M/D Gauge Calibration Tech | 303-398-6547<br>(Cell) 303-319-9557 |
| Jiron, Kelvin   | High Speed Profiler (HSP)   | 303-398-6548                        |
| <b>Pavement Design Program</b>  |   |                                     |
| Perkins, Melody   | Pavement Design Engineer  | 303-398-6562                        |
| Vacant  | Pavement Design Support Engineer  | 303-398-6562                        |
| Keith Uren  | Pavement Design Support Engineer  |                                     |
| Brooks, Kyle  | SiteManager Materials Trainer, QC/IA Program Manager  | 303-398-6528                        |
| Clark, Cheryle  | SiteManager Materials / LIMS Support  | 303-398-6564                        |
| Trujillo, Ed  | Materials Publication Manager,<br>MAC Secretary, Product Evaluation Coordinator (PEC)                         | 303-398-6566                        |
| Hernandez, Tony   | Materials Documentation Manager<br>(Accreditations & Form #250s)  | 303-398-6563                        |
| <b>Office/ Name Title Telephone</b>   |   |                                     |
| <b><u>Pavement Management Program</u></b>   |   |                                     |
| Conroy, Laura   | Pavement Management Engineer  | 303-398-6579                        |
| Farrokhyar, Ali   | Project Level Pavement Management   | 303-398-6577                        |
| Scoville, Janeth  | Pavement Management   | 303-398-6580                        |
| Chavez, Eric  | Network Level Pavement Manager  | 303-398-6565                        |

**Soils & Geotechnical Program**

|                      |                                       |      |              |
|----------------------|---------------------------------------|------|--------------|
| Thomas, David        | Program Manager                       |      | 303-398-6604 |
|                      |                                       | Cell | 303-807-7457 |
| Nasiatka, Dave       | Geotechnical Engineer                 |      | 303-398-6586 |
|                      |                                       | Cell | 303-895-6485 |
| Russell, Christopher | Geotechnical Engineer (Soils and PDA) |      | 303-398-6587 |
|                      |                                       | Cell | 720-308-5462 |
| Tarsar, Madeline     | Geotechnical Engineer                 |      | 303-398-6606 |
| Pomeroy, Jamie       | Geotechnical Engineer                 |      | 303-398-6512 |
| Zak, Steven          | Drill Crew Foreman                    |      | 303-365-7142 |
|                      |                                       | Cell | 720-793-4767 |

**Geohazards Program**

|                   |                       |      |              |
|-------------------|-----------------------|------|--------------|
| Ortiz, Ty         | Program Manager       |      | 303-398-6601 |
|                   |                       | Cell | 303-921-2634 |
| Group, Robert     | Engineering Geologist |      | 303-398-6589 |
| Taylor, D. (Beau) | Engineering Geologist |      | 303-398-6588 |
| Oester, Nicole    | Engineering Geologist |      | 303-398-6603 |

**Central Materials Laboratory, 4670 North Holly Street, Unit A, Denver CO 80216- 6408**

---

| <b><u>Office/ Name</u></b> | <b><u>Title</u></b> | <b><u>Location</u></b> | <b><u>Telephone</u></b> |
|----------------------------|---------------------|------------------------|-------------------------|
|----------------------------|---------------------|------------------------|-------------------------|

**Region 1, North & Central Programs / Independent Assurance**

|                 |                                 |             |              |
|-----------------|---------------------------------|-------------|--------------|
| Henry, Stephen  | Region Materials Engineer       | North Holly | 303-398-6703 |
| Mize, Issa      | Asst. Region Materials Engineer | North Holly | 303-398-6701 |
| Jones, Macy     | Pavement Designer               | North Holly | 303-398-6801 |
| Ryal, Travis    | Pavement Designer               | North Holly | 303-398-6507 |
| Kelly, Brian M. | IA / Lab Manager                | North Holly | 303-398-6704 |
| Collins, Robert | IA / Lab Technician             | North Holly | 303-398-6706 |
| Robertson, Lane | IA / Lab Technician             | North Holly | 303-398-6705 |
| FAX             |                                 |             | 303-398-6781 |

| <b><u>Office/ Name</u></b> | <b><u>Title</u></b> | <b><u>Location</u></b> | <b><u>Telephone</u></b> |
|----------------------------|---------------------|------------------------|-------------------------|
|----------------------------|---------------------|------------------------|-------------------------|

**Region 1, South & West Programs / OA**

|                       |                                 |             |              |
|-----------------------|---------------------------------|-------------|--------------|
| Chang, James          | Region Materials Engineer       | North Holly | 303-398-6702 |
|                       |                                 | (Cell)      | 303-883-0500 |
| Hussain, Shamshad     | Asst. Region Materials Engineer | North Holly | 303-398-6802 |
|                       |                                 | (Cell)      | 303-916-0890 |
| Kevin Moore           | Pavement Design                 | North Holly | 303-398-6803 |
| Gallegos, Michael     | Region 1 Lab Manager            | North Holly | 303-398-6805 |
|                       |                                 | (Cell)      | 303-918-6134 |
| Jones, Robert "Brett" | Region 1 Lab Technician         | North Holly | 303-398-6806 |
| Young, Ronald         | Region 1 Lab Technician         | North Holly | 303-398-6807 |
|                       | Region 1 Lab Technician         | North Holly |              |
| FAX                   |                                 |             | 303-398-6781 |

**Region 1 Materials Laboratory, 4670 North Holly Street, Unit B & C, Denver CO 80216- 6408**



**Region 2**

|                          |   |              |             |              |
|--------------------------|---|--------------|-------------|--------------|
| Pieper, Jody             | Region Materials Engineer                                     | 5615 Wills   |             | 719-562-5532 |
|                          |   |              | (Cell)      | 719-248-2323 |
| Mero, Jeri               | Asst. Region Materials Engineer                               | 5615 Wills   |             | 719-562-5509 |
|                          |   |              | (Cell)      | 719-248-2323 |
| Bergles, Robert "Buster" | Region 2 Lab Manager  | 5615 Wills   |             | 719-546-5778 |
|                          |   |              | (Cell)      | 719-251-7834 |
| Raebel, Richard "Rick"   | Materials Document. Coordinator/<br>Region 2 Pavement Manager | 5615 Wills   |             | 719-546-5787 |
|                          |   |              | (Cell)      | 719-251-9112 |
| Smith, Chuck             | IAT Lab   | 5615 Wills   |             | 719-546-5776 |
|                          |   |              | (Cell)      | 719-251-7825 |
| Armendariz, Mike         | Region 2 Lab Technician                                       | 5615 Wills   |             | 719-546-5776 |
|                          | Mobile Lab Technician   |              |             | 719-546-5776 |
| Vela, Derek              | Region 2 Lab Technician                                       | 5615 Wills   |             | 719-546-5776 |
| Schreiber, Mike          | Colorado Springs Lab  | *            |             | 719-227-3230 |
|                          |   |              | (Cell)      | 719-688-2089 |
| Story, Daniel "Dan"      | Lamar Lab   | 2402 S. Main |             | 719-336-3228 |
|                          |   |              | (Microwave) | 719-688-5447 |
|                          |   |              | (Cell)      | 719-688-2095 |
| Materials Lab FAX        |   |              |             |              |
| Colorado Springs FAX     |   | *            |             | 719-227-3298 |
| Lamar FAX                |   | 2402 S. Main |             | 719-546-5701 |

**Region 2 Materials Laboratory (Pueblo) 5615 Wills Blvd., Pueblo Colorado, 81008**

**\* Region 2 (Colorado Springs) 1480 Quail Lake Loop, Colorado Springs Co. 80906**

**Region 2 (Lamar) 2402 S. Main, Lamar Co. 81052**

**Region 3**

|                 |                                 |             |        |              |
|-----------------|---------------------------------|-------------|--------|--------------|
| Golden, Coulter | Region Materials Engineer       | 2328 G Road |        | 970-683-7561 |
|                 |                                 |             | (Cell) | 970-596-0752 |
| Moore, Babaft   | Asst. Region Materials Engineer | 2328 G Road |        | 970-683-7563 |
|                 |                                 |             | (Cell) | 719-661-2444 |
| Mulumba, Jolene | Pavement Manager                | 2328 G Road |        | 970-683-7567 |
|                 |                                 |             | (Cell) | 970-642-8379 |
| Kelly, Jen      | IAT Lab                         | 2328 G Road |        | 970-683-7562 |
|                 |                                 |             | (Cell) | 970-200-2880 |
| Phipps, Darren  | IAT Lab                         | 2328 G Road |        | 970-683-7566 |
|                 |                                 |             | (Cell) | 970-623-9612 |

**Office/ Name****Title****Location****Telephone**

|                |   |             |        |              |
|----------------|---|-------------|--------|--------------|
| Rosedahl, Andy | Region 3 Lab                                    | 2328 G Road |        | 970-683-7570 |
|                |   |             | (Cell) | 970-250-4769 |
| Rowell, Dawn   | Region 3 Lab                                    | 2328 G Road |        | 970-683-7572 |
| Walz, Chance   | Region 3 Lab                                    | 2328 G Road |        | 970-683-7571 |
|                |   |             | (Cell) | 970-986-9635 |
| Morgan, Cindy  | Finals Administrator /<br>Materials Coordinator | 2328 G Road |        | 970-683-7575 |
|                |   |             | (Cell) | 970-270-2724 |
| Morrison, Mary | Data Technician                                 | 328 G Road  |        | 970-683-7560 |
| FAX            |   |             |        | 970-683-7579 |

**Region 3 2328 G Road, Grand Junction Co. 81501**

**Region 3 (Materials Lab) 2328 G Road, Grand Junction Co. 81505**

**Region 4**

|                 |                                 |          |                     |
|-----------------|---------------------------------|----------|---------------------|
| DeWitt, Gary    | Region Materials Engineer       | Region 4 | 970-350-2379        |
|                 |                                 |          | (Cell) 970-381-1446 |
| Heimmer, Steve  | Asst. Region Materials Engineer | Region 4 | 970-350-2380        |
| Strome, Gary    | Asst. Region Materials Engineer | Region 4 | 970-350-2382        |
|                 |                                 |          | (Cell) 970-381-3447 |
| Moore, Brandon  | Pavement Manager                | Region 4 | 970-350-2383        |
|                 |                                 |          | (Cell) 970-290-8252 |
| Gonser, Steve   | Lab Manager                     | Region 4 | 970-350-2384        |
| Cloephil, Brett | Lab Technician                  | Region 4 | 970-350-2385        |
| Folino, Dante   | Lab Technician                  | Region 4 | 970-350-2246        |
|                 |                                 |          | (Cell) 720-877-5381 |
| Mayhew, Todd    | IAT Lab                         | Region 4 | 970-350-2334        |
|                 |                                 |          | (Cell) 970-380-0123 |
| Davila, Paul    | IAT Lab                         | Region 4 | 970-350-2381        |
|                 |                                 |          | (Cell) 970-397-2894 |
| FAX             |                                 | Region 4 | 970-350-2390        |

**Region 4 3971 W. Service Rd., Evans Co. 80620-2623**

---

**Region 5**

|                 |                           |         |                     |
|-----------------|---------------------------|---------|---------------------|
| Webb, Tim       | Region Materials Engineer | Durango | 970-385-1625        |
|                 |                           |         | (Cell)              |
| Kemp, Beaux     | Pavement Management       | Durango | 970-385-1627        |
|                 | Pavement Management       |         | (Cell)              |
| Murphy, Patrick | IA Lab Manager            | Durango | 970-385-1624        |
|                 |                           |         | (Cell) 970-759-5300 |
| Maertín, Lisa   | Lab Technician            | Durango | 970-385-1628        |
| Ramirez, Jacob  | IAT Lab                   | Alamosa | 719-587-6520        |
|                 |                           |         | (Cell) 719-588-3031 |
| FAX             |                           | Durango | 970-385-1610        |
| FAX             |                           | Alamosa | 719-587-6521        |

**Region 5 20581 US Highway 160 Durango Co. 81301**  
**Region 5 (Alamosa) 1205 West Ave. Alamosa, Co. 81101**

## Appendix D - Definitions-21

**NOTE:** Definitions applicable to a specific material may be found in the respective chapter.

**Acceptance Program** - All factors that comprise CDOT's determination of the quality of the product as specified in the contract requirements. These factors include verification sampling, testing, and inspection.

**Accredited Laboratory** - A laboratory that is accredited by the AASHTO Accreditation Program.

**Anionic** - Negatively charged, i.e. emulsions

**Batch** - A unit or subdivision of a lot, such as a mixer load of concrete, a batch of bituminous mix, or a square yard of base course.

**Bias** - Constant error in one direction, which causes the average test result to be offset from the true average value.

**Calibration** - The act or process of determining the relationship between a set of standard units of measure and the output of an instrument or test procedure

**Cationic** - Positively charged, i.e. emulsions

**Central Laboratory Check Samples and Tests.** Random representative samples submitted to CDOT's Central and/or Region Laboratory to additionally evaluate quality of field produced products and materials, and to perform tests not within the capabilities of the Field and/or Region Laboratories.

**Check Sample** - A Replicate Sample, usually from Project Samples or Verification Samples, which is submitted to the Central or Region Laboratory for an independent check. Independent checks on HBP include: Hveem Stability (CP-L 5105), Lottman (CP-L 5109), and Air Voids (CP-L 5105). For Superpave mixes S, SX, and SG independent checks include: volumetric properties at  $N_{design}$  and Hveem Stability (CP-L 5106). The purpose of these samples is for the Central or Region Laboratory to verify acceptability and quality of field produced material and to perform tests that are not within the capabilities of the field.

**Coefficient of Variation** - The Standard Deviation divided by the mean.

$$CV = \frac{\sigma}{\bar{X}}$$

**Comparative Sample** - One of several samples resulting from a closely controlled small Batch or increment which has been thoroughly mixed and then reduced by quartering or splitting into a number of Replicate Samples. For CDOT purposes the Central Laboratory will make Groups of Comparative Samples on various materials. One or more will be sent to each participating Region Laboratory for testing to determine acceptability of procedures, methods, and equipment.

**Control Chart** - Chart or graph, usually conspicuously displayed in the field materials laboratory where an up-to-date plot of Control and Verification Test results is kept.

**Control Sample** - A sample taken during the process from any of the components for a manufactured (constructed) product before being incorporated into the final mixture, or a sample taken from the final mixture or product before the material has reached its final position and condition in the completed construction.

**Correlation** - A statistical relation between two or more variable such that systematic changes in the value of one variable are accompanied by systematic changes in the other.

**Designated Agent** - An employee or employees of the State, local agency, or a consultant or independent laboratory which is employed, paid by, and / or directly accountable to CDOT or a public agency excluding the contractors' or vendors' personnel.

**F-test** - Compares the population variances.

**Group** - Replicate Test Specimens taken from the same Batch Sample.

**Independent Assurance Program (IA)** - Refer to Definitions (Section 3) within the Quality Assurance Procedures Chapter.

**Independent Assurance Sampling-Testing and Witnessing of Testing or Sampling** - A sample taken and tested, or a sample that is witnessed only at a random location or time, the point to be designated by: Region Laboratory personnel, or project personnel, or CDOT's designated agent not associated with Project Verification Sampling and Testing; or the Contractor's (or his representative) not associated with Project Quality Control Sampling and Testing; or by an FHWA Engineer. The person who designates the point for sampling and who performs the actual test may physically do the sampling or project testing personnel may do the sampling in the presence of the IA person. Certain specified IA samples may be witnessed only. These samples are to be taken in the presence of both the project and IA personnel. These samples shall be taken by contractor's personnel or his representative. For more details and information, see the CDOT, Quality Assurance Program for Construction and Materials Sampling and Testing.

**Lot** - An isolated quantity of material from a single source. A measured amount of construction material assumed to be produced by the same process.

**Mix Verification Testing** – After the mix design has been approved and production commences, the Department will perform a minimum of three volumetric verification tests to verify that the field produced HMA conforms to the approved mix design.

**Nominal** – Representative value of a measurable property determined under a set of conditions, by which a product may be described.

**Nominal Maximum** - The size of aggregate in the smallest sieve opening through which the entire amount of specification aggregate is permitted to pass.

**Note:** For Item 403, Nominal Maximum size should be defined as: one sieve size larger than the first sieve to retain more than ten percent of the aggregate.

**Nominal Value** – A value assigned for convenient designation; existing in name only. An example being "2 by 4" lumber and one-inch pipe.

**Owner Acceptance** – Refer to Definitions (Section 3) within the Quality Assurance Procedures Chapter.

**Owner Verification Testing** – Refer to Definitions (Section 3) within the Quality Assurance Procedures Chapter.

**Practice** – A definitive procedure for performing one or more specific operations or functions that does not produce a test result.

**Precision** - A generic concept related to the closeness of agreement between test results obtained under prescribed like conditions from the measurement process being evaluated.

**Process Control** – Refer to Definitions (Section 3) within the Quality Assurance Procedures Chapter.

**Professional Engineer Seals** – Obtained or used by license holders in the State of Colorado and shall be capable of leaving an impression representation on the engineering work. For size and type specifications, see Subsection 5.5.1 of the Bylaws and Rules from the Colorado State Board of Licensure for Professional Engineers and Professional Land Surveyors.

**Professional Engineer Stamps** – Obtained or used by license holders in the State of Colorado and shall be capable of leaving a permanent ink impression. The permanent inked impression can be done with a variety of stamps including the traditional rubber stamp and pad, self-inking and pre-inked stamp all leaving a permanent inked impression. For size and type specifications, see Subsection 5.5.1 of the Bylaws and Rules from the Colorado State Board of Licensure for Professional Engineers and Professional Land Surveyors.

**Proficiency Samples** - Homogeneous samples that are distributed and tested by two or more laboratories.

**Quality Assurance (QA)** - Refer to Definitions (Section 3) within the Quality Assurance Procedures Chapter.

**Quality Control (QC)** - Refer to Definitions (Section 3) within the Quality Assurance Procedures Chapter.

**Qualified Laboratories** - Refer to Definitions (Section 3) within the Quality Assurance Procedures Chapter.

**Random Sample** - A sample drawn from a Lot in which each increment in the lot has an equal probability of being chosen.

**Random Sample, Stratified** - When a Lot is subdivided into approximately equal Sub-lots and samples are selected from each sub-lot by a Random process.

**Reasonable Conformance** - When construction and materials substantially comply with the plans and specifications. Clearly stated acceptance plans assist the Project Engineer in making his decision as to reasonable conformance.

**Recycled Pavement** – When used in the context of cold in-place recycled pavement or hot in-place recycled pavement, the asphaltic material is reworked within the foot-print of the roadway without removing it off site.

**Repeatability** - The range within which repeated measurements are made by the same operator on the same apparatus on Replicate Test Specimens. Essentially, the precision of the test.

**Replicate Samples or Test Specimens** - Multiple Samples or Test Specimens as nearly identical as possible, under the stated conditions, usually from a thoroughly mixed larger sample that has been reduced in size by quartering or splitting.

**Reproducibility** - The range within which check measurements by different operators on different apparatus should agree under definitely stated conditions. Usually performed on Test Specimens from Replicate Samples.

**Sample** - A small part of a Sub-lot or Batch, which represents the whole. A sample may be divided into several Test Specimens.

**Split Sample** - A sample taken and evenly divided to be tested by two or more individuals or laboratories.

**Standard Deviation (s)** - A measure of the dispersion of measurements from their average; the square root of the quantity of individual deviations from the mean, squared, summed, and divided by the number of samples minus 1.

$$s = \sqrt{\frac{\sum(\bar{X} - X)^2}{n - 1}}$$

**Standardization** - The adjustment of an instrument, prior to use, to an arbitrary reference value, or to a device that has been calibrated.

**State personnel** - An employee or employees of CDOT.

**Sub-lot** - The largest, clearly identifiable subdivision of a Lot. Usually specified in the Field Materials Manual Sampling Schedule as the largest quantity that may be represented by a single sample.

**System Basis, IA** - A system where the minimum frequency is based on a unit of material production and/or a unit of time.

**t-test** - Compares the population means.

**Test Method** – A definitive procedure for the identification, measurement, and evaluation of one or more qualities, characteristics, or properties of a material, product, system or service that produces a test result.

**Test Portion** – The part of a material sample required for testing.

**Test Specimen** - That part of a material Sample that is prepared and tested. Usually obtained by reducing the sample by quartering, splitting, or taking an aliquot (usually a liquid portion removed from the whole) quantity.

**Variation** - Differences, due to any cause, in measured values of a measurable characteristic.

**Vendor** - A supplier of materials incorporated into the project, which is not the contractor. May or may not be the Manufacturer.

**Verification Sampling and Testing** - Sampling and testing performed to validate the quality of the product for acceptance.

**Verification Sample** - A sample used to make a decision as to the acceptability of the material being sampled. Reasonable Conformance and amount of payment will be based on this sample. The specifications designate the point of verification sampling. Refer to the Schedule.

**Viscosity** - Low viscosity = more fluid, High viscosity = more stiff

**Witness** – To witness is to observe an act of work, verifying that the work was performed and performed correctly. After observation, witness is to testify by written and verbal communication protocols to CDOT Engineer in charge.

## Appendix E – Acronyms-21

|        |  |
|--------|--|
| 3R     | Resurfacing, Restoration, Rehabilitation                           |
| AAP    | AASHTO Accreditation Program                                       |
| AASHTO | American Association of State Highway and Transportation Officials |
| ABC    | Aggregate Base Course  |
| AC     | Asphalt Content  |
| ACI    | American Concrete Institute  |
| ACPA   | American Concrete Pavement Association                             |
| ACPA   | American Concrete Pipe Association                                 |
| AI     | Asphalt Institute  |
| AIF    | Asphalt Industry Forum   |
| AMPT   | Asphalt Materials Performance Test                                 |
| AMRL   | AASHTO Materials Reference Laboratory                              |
| APA    | Asphalt Pavement Analyzer  |
| APL    | Approved Product List  |
| AQL    | Asphalt Quality Level  |
| AV     | APL – QML Verification   |
| ARA    | Asphalt Rejuvenating Agent   |
| ARF    | Access Request Form  |
| ASTM   | American Society of Testing and Materials                          |
| ATSSA  | American Traffic Safety Services Association                       |
| BMP    | Best Management Practices  |
| CAGE   | Colorado Association Geotechnical Engineers                        |
| CAPA   | Colorado Asphalt Pavement Association                              |
| CAR    | CDOT Application for Reporting                                     |
| CBC    | Concrete Box Culvert   |
| CCA    | Colorado Contractors Association                                   |
| CCRL   | Cement and Concrete Reference Laboratory                           |
| CDOT   | Colorado Department of Transportation                              |
| CDPHE  | Colorado Department of Public Health and Environment               |
| CFR    | Code of Federal Regulations  |
| CIP    | Complete-in-Place  |
| CIPR   | Cold-in-Place Recycle  |
| CIR    | Cold-in-Place Recycle  |
| COC    | Certificate of Compliance  |
| CM/GC  | Construction Manager / General Contractor                          |
| CMO    | Contract Modification Order  |
| CP     | Colorado Procedure   |
| CP-L   | Colorado Procedure – Laboratory                                    |
| CPM    | Counts Per Minute  |



|        |   |
|--------|---|
| CQL    | Concrete Quality Level                              |
| CRS    | Colorado Revised Statutes                           |
| CRSI   | Concrete Reinforcing Steel Institute                |
| CTP    | Check Testing Program                               |
| CTR    | Certified Test Reports                              |
| CTS    | Compaction Test Section                             |
| D/A    | Dust to Asphalt                                     |
| DMS    | Dynamic Message Sign                                |
| DRB    | Dispute Resolution Board                            |
| DSR    | Dynamic Shear Rheometer                             |
| EIS    | Environmental Impact Statement                      |
| EOR    | Engineer of Record                                  |
| EPA    | Environmental Protection Agency                     |
| EPE    | Expert Product Evaluator                            |
| FAA    | Fine Aggregate Angularity                           |
| FAPG   | Federal Aid Policy Guide                            |
| FDR    | Full Depth Reclamation                              |
| FHWA   | Federal Highway Administration                      |
| FIPI   | Finding In the Public Interest                      |
| FIR    | Field Inspection Review                             |
| FMM    | Field Materials Manual                              |
| FOR    | Final Office Review                                 |
| FPOG   | Flexible Pavement Operators Group                   |
| FQC    | Field Quality Control                               |
| FWD    | Falling Weight Deflectometer                        |
| HAZMAT | Hazardous Material                                  |
| HBP    | Hot Bituminous Pavement                             |
| HIPR   | Hot-in-Place Recycle                                |
| HIR    | Hot-in-Place Recycle                                |
| HITEC  | Highway Innovative Technology Evaluation Center     |
| HMA    | Hot Mix Asphalt                                     |
| HSP    | High Speed Profiler                                 |
| IA     | Independent Assurance Program                       |
| IAT    | Independent Assurance Sampling and Testing          |
| I/D P  | Incentive/Disincentive Payment                      |
| IGA    | Inter-Governmental Agreement                        |
| IRI    | International Roughness Index                       |
| JMF    | Job Mix Formula                                     |
| JSA    | Job Safety Analysis                                 |
| LabCAT | Laboratory for Certification of Asphalt Technicians |
| LA     | Local Agency  |

|        |  |
|--------|--|
| LACA   | Local Agency Certification Acceptance                            |
| LCCA   | Life Cycle Cost Analysis   |
| LIMS   | Laboratory Information Management System                         |
| LMTP   | Laboratory Manual of Test Procedures                             |
| LOI    | Loss on Ignition   |
| LOS    | Level of Service   |
| LPA    | Local Public Agency  |
| MAC    | Materials Advisory Committee                                     |
| MCR    | Minor Contract Revision  |
| MLOS   | Maintenance Level of Service                                     |
| MOA    | Memorandum of Agreement  |
| MOU    | Memorandum of Understanding                                      |
| MQL    | Moving Quality Level   |
| MRI    | Mean Roughness Index   |
| MSDS   | Materials Safety Data Sheets                                     |
| MUTCD  | Manual on Uniform Traffic Control Devices                        |
| NCAT   | National Center for Asphalt Technology                           |
| NCHRP  | National Cooperative Highway Research Program                    |
| NDT    | Non-Destructive Testing  |
| NEPA   | National Environmental Protection Act                            |
| NHS    | National Highway System  |
| NICET  | National Institute for Certification of Engineering Technologies |
| NIST   | National Institute of Standards and Technology                   |
| NOV    | Notice of Violation  |
| NPCA   | National Precast Concrete Association                            |
| NPS    | Non-Project Specific   |
| NTPEP  | National Transportation Product Evaluation Program               |
| OA     | Owner Acceptance   |
| OGFC   | Open Grade Friction Course                                       |
| OIT    | Office of Information Technology                                 |
| OVT    | Owner Verification Testing                                       |
| PC     | Process Control  |
| PCCP   | Portland Cement Concrete Pavement                                |
| PEC    | Product Evaluation Coordinator                                   |
| PF     | Pay Factor   |
| PG     | Performance Graded   |
| PPM    | Parts Per Million  |
| ProMIS | Project Management Information System                            |
| PS&E   | Plans, Specifications and Estimate                               |
| PSI    | Preliminary Site Investigation                                   |
| PSP    | Project Special Provision  |

|           |  |
|-----------|--|
| QA        | Quality Assurance  |
| QAP       | Quality Assurance Plan   |
| QC        | Quality Control  |
| QCP       | Quality Control Plan   |
| QIC       | Quality Implementation Council                                       |
| QL        | Quality Level  |
| QML       | Qualified Manufacturers List   |
| QPM       | Quality Pavement Management  |
| RAP       | Reclaimed Asphalt Pavement (previously Recycled)                     |
| RAS       | Reclaimed Asphalt Shingles   |
| RE        | Resident Engineer  |
| RECP      | Rolled Erosion Control Product                                       |
| RMAEC     | Rocky Mountain Asphalt Education Center                              |
| RME       | Region Materials Engineer  |
| ROD       | Record of Decision   |
| ROW       | Right of Way   |
| RSAR      | Roadway Surface Accomplishment Report                                |
| RSO       | Radiation Safety Officer   |
| RTD       | Region Transportation Director                                       |
| RTFO      | Rolling Thin Film Oven   |
| SHRP      | Strategic Highway Research Program                                   |
| SMA       | Stone Matrix Asphalt   |
| SME       | Subject Matter Expert  |
| SMM       | SiteManager® Materials   |
| SOW       | Scope of Work  |
| SpG       | Specific Gravity   |
| SSD       | Saturated Surface Dry  |
| SSP       | Standard Special Provision   |
| SUPERPAVE | Superior Performing Asphalt Pavements                                |
| TCLP      | Toxicity Characteristic Leaching Procedure                           |
| TCP       | Traffic Control Plan   |
| TRM       | Turf Reinforcement Mat   |
| VCA       | Voids in Coarse Aggregate  |
| VFA       | Voids Filled with Asphalt  |
| VMA       | Voids in the Mineral Aggregate                                       |
| VMA       | Viscosity Modifying Admixture  |
| VTM       | Voids in Total Mix   |
| WASHTO    | Washington Association of State Highway and Transportation Officials |
| WAQTC     | Western Alliance for Quality Transportation Construction             |
| WCTG      | Western Cooperative Test Group                                       |
| WMA       | Warm Mix Asphalt   |

## Appendix F - Significant Publications-21

- AASHTO, Guide for Design of Pavement Structures
- American Concrete Institute
- Asphalt Institute, Performance Graded Asphalt Binder Specifications and Testing Superpave Series No. 1 (SP-1)
- Asphalt Institute, Superpave Level 1 Mix design
- Asphalt Institute, Superpave Series No. 2 (SP-2)
- Department of Natural Resources, Construction Materials Rules and Regulations
- CDOT, Construction Manual
- CDOT, Cost Data Books
- CDOT Field Materials Manual (FMM)
- CDOT Independent Assurance Manual (IA)
- CDOT, Local Agency Manual
- CDOT, Life Cycle Cost Analysis State-of-the-Practice
- CDOT, M & S Standards
- CDOT, Pavement Design Manual (PDM)
- CDOT, Pipe Material Selection Guide
- CDOT, Laboratory Manual of Test Procedures (LMTP)
- CDOT, Standard Specifications for Road and Bridge Construction
- Metropolitan Government Pavement Engineers Council (MGPEC) Pavement Design Standards and Construction Specification Manual
- Portland Cement Association, Design and Control of Concrete Mixes, Thirteenth Edition

## **Appendix G - Colorado Procedures - Laboratory Numeric Order-20**

### **CP-Ls 2100      Chemical Unit Testing**

- CP-L 2103    Determining the Sulfate Ion Content in Water or Water-Soluble Sulfate Ion Content in Soil
- CP-L 2104    Determining the Chloride Ion Content in Water or Water-Soluble Chloride Ion Content in Soil

### **CP-Ls 2200      Bituminous Testing**

- CP-L 2202    Test of Protective Covering for Bridge Deck Waterproofing Membrane
- CP-L 2203    Pliability and Thickness of Prefabricated Reinforced Membrane
- CP-L 2210    Determining Toughness and Tenacity of Rubberized Asphaltic Materials
- CP-L 2211    Elastic Recovery
- CP-L 2212    Residue by Evaporation of Asphalt Emulsion
- CP-L 2213    Coating of Bitumen-Aggregate Mixtures
- CP-L 2214    Verification of Binder Acidity
- CP-L 2215    Effect of Heat and Air on a Moving Film of Asphalt

### **CP-Ls 3100      Soils Testing**

- CP-L 3101    DELETED > Replaced by AASHTO T 190 on 01-14-2016
- CP-L 3102    DELETED > Replaced by CP-L 3101 on 01-14-2013
- CP-L 3103    Specific Gravity of Soils
- CP-L 3104    Determining the Durability of Shales for Use as Embankments
- CP-L 3105    Grain Size Analysis of Soil for AASHTO Classification
- CP-L 3106    Grain Size Analysis of Soil for Unified Soil Classification System
- CP-L 3107    Determining the Resilient Modulus of Cohesive (Type 2) Soils

### **CP-Ls 3200      Geology Testing**

- CP-L 3201    Continuous Penetration Test

### **CP-Ls 4100      Concrete Testing**

- CP-L 4101    Preparing Concrete Blocks for Testing Sealants, for Joints and Cracks
- CP-L 4102    Specific Gravity and Absorption of Fine Aggregate
- CP-L 4103    Unrestrained Shrinkage of Concrete

### **CP-Ls 4200      Physical Properties Testing**

- CP-L 4209    Physical Testing of Quicklime, Hydrated Lime, and Limestone
- CP-L 4211    Resistance of Coarse Aggregate to Degradation by Abrasion in the Micro-Deval Apparatus
- CP-L 4215    Determination of Percent Moisture in Rock Salt
- CP-L 4216    Determination of Salt Content of Sanding Materials

**CP-Ls 4300** CP-L 4301 Surface Abrasion Resistance of Polyester Concrete  
 CP-L 4302 Methods of Test for Bonding Strength of Polyester Concrete to Concrete

**CP-Ls 5100 Flexible Pavement Testing**

CP-L 5100 HMA Testing Troubleshooting Guide  
 CP-L 5101 Verification of Laboratory Equipment Used to Test Bituminous Mixtures  
 CP-L 5106 Resistance to Deformation of Bituminous Mixtures by Means of Hveem Apparatus  
 CP-L 5109 Resistance of Compacted Bituminous Mixture to Moisture Induced Damage  
  
 CP-L 5110 Resilient Modulus Test ( $M_R$ )  
 CP-L 5111 Determining the Percent of Recycling Agent to Use for Cold Recycling of Asphalt Concrete  
 CP-L 5112 Hamburg Wheel-Track Testing of Compacted Bituminous Mixtures  
 CP-L 5114 French Rut Testing of Compacted Bituminous Mixtures  
 CP-L 5115 Preparing and Determining the Density of Bituminous Mixture Test Specimens Compacted by the Superpave Gyrotory Compactor  
 CP-L 5116 Linear Kneading Compaction of Bituminous Mixtures  
 CP-L 5117 Superpave Design for Hot Mix Asphalt  
 CP-L 5120 Determination of the Asphalt Binder Content of Bituminous Mixtures by the Ignition Method  
 CP-L 5140 Mix Design for Hot In-Place Recycling of Asphalt Pavements  
 CP-L 5145 Contractor Asphalt Mix Design Approval Procedures Utilizing RAP Millings from the Same Project  
 CP-L 5150 Adjusting Moisture Requirement to Hydrate Lime in Asphalt Mixes

**CP-Ls 5300 Nuclear Unit Testing**

CP-L 5301 Leak Wipe Procedure for Nuclear Gauges  
 CP-L 5302 Calibration of CDOT Nuclear Moisture / Density Gauges  
 CP-L 5303 Calibration Check of CDOT Nuclear Moisture / Density Gauges  
 CP-L 5304 Calibration of CDOT Nuclear Thin Layer Density Gauges  
 CP-L 5305 Leak Wipe Analysis for Nuclear Gauges  
 CP-L 5306 Certification of Consultant Nuclear Moisture / Density and Thin Layer Density Gauges

**Note:** CP-Ls 5900 series, Inspection, was transferred to the Staff Bridge Branch for their posting prior to the printing of the 2005 Laboratory Manual of Test Procedures publication.

### Appendix H - Metric Conversion Tables-20

**Conversion Factors - U.S. to Metric S.I.**

| Quantity           | U.S.        | Metric Unit (SI)                     | Multiply by  |
|--------------------|-------------|--------------------------------------|--------------|
| <b>Length</b>      | mile        | kilometer (km)                       | 1.609 344    |
|                    | yard        | meter (m)                            | 0.914 4      |
|                    | foot        | meter (m)                            | 0.304 8      |
|                    | foot        | millimeter (mm)                      | 304.8        |
|                    | inch        | millimeter (mm)                      | 25.4         |
| <b>Area</b>        | acre        | Hectares (ha)                        | 0.404 685 6  |
|                    | square yard | square meter (m <sup>2</sup> )       | 0.836 127 36 |
|                    | square foot | square meter (m <sup>2</sup> )       | 0.092 903 04 |
|                    | square inch | square millimeter (mm <sup>2</sup> ) | 645.16       |
| <b>Volume</b>      | cubic yard  | cubic meter (m <sup>3</sup> )        | 0.764 555    |
|                    | cubic foot  | cubic meter (m <sup>3</sup> )        | 0.028 316 8  |
|                    | cubic inch  | cubic millimeter (mm <sup>3</sup> )  | 16 387.064   |
|                    | gallon      | Liter (L)                            | 3.785 41     |
| <b>Mass</b>        | ton         | metric ton (t)                       | 0.907 184    |
|                    | pound       | kilogram (kg)                        | 0.453 592    |
|                    | ounce       | gram (g)                             | 28.3495      |
| <b>Temperature</b> | °Fahrenheit | °Celsius                             | (°F-32) 5/9  |
| <b>Pressure</b>    | psi         | kilopascals (kPa)                    | 6.894 76     |

**Conversion Factors - Metric S.I. to U.S.**

| Quantity      | Metric Unit (SI) | U.S. | Multiply by |
|---------------|------------------|------|-------------|
| <b>Length</b> | kilometer (km)   | mile | 0.621 371   |
|               | meter (m)        | yard | 1.093 6     |
|               | meter (m)        | foot | 3.280 84    |
|               | millimeter (mm)  | foot | 0.003 28    |
|               | millimeter (mm)  | inch | 0.039 37    |

|                    |                                      |             |                 |
|--------------------|--------------------------------------|-------------|-----------------|
| <b>Area</b>        | Hectares (ha)                        | acre        | 2.471 054       |
|                    | square meter (m <sup>2</sup> )       | square yard | 1.195 99        |
|                    | square meter (m <sup>2</sup> )       | square foot | 10.763 91       |
|                    | square millimeter (mm <sup>2</sup> ) | square inch | 0.001 55        |
| <b>Volume</b>      | cubic meter (m <sup>3</sup> )        | cubic yard  | 1.307 95        |
|                    | cubic meter (m <sup>3</sup> )        | cubic foot  | 35.314 72       |
|                    | cubic millimeter (mm <sup>3</sup> )  | cubic inch  | 0.000 061       |
|                    | Liter (L)                            | gallon      | 0.264 172       |
| <b>Mass</b>        | metric ton (t)                       | ton         | 1.102 31        |
|                    | kilogram (kg)                        | pound       | 2.204 62        |
|                    | gram (g)                             | ounce       | 0.035 274       |
| <b>Temperature</b> | °Celsius                             | °Fahrenheit | (°C x 1.8) + 32 |
| <b>Pressure</b>    | kilopascals (kPa)                    | psi         | 0.145 038       |

**Metric Decimal Prefixes**

| <b>Prefix</b> | <b>Magnitude</b> | <b>Expression</b>      |
|---------------|------------------|------------------------|
| kilo          | 10 <sup>3</sup>  | 1000 (one thousand)    |
| milli         | 10 <sup>-3</sup> | 0.001 (one thousandth) |

For a more information on Metric S.I. units see CDOT’s *Metric Conversion Manual*. Other good references include AASHTO R1-91 and ASTM E 380-92.

---

**Sieve Sizes, English versus Metric**

| <b><u>English</u></b> | <b><u>Metric</u></b> |
|-----------------------|----------------------|
| 3"                    | 76.2 mm              |
| 2 ½ "                 | 63.5 mm              |
| 2 "                   | 50.8 mm              |
| 1 ½ "                 | 38.1 mm              |
| 1 "                   | 25.4 mm              |
| ¾ "                   | 19.0 mm              |
| ½ "                   | 12.7 mm              |
| ⅜ "                   | 9.51 mm              |
| # 4                   | 4.75 mm              |
| # 8                   | 2.36 mm              |
| # 16                  | 1.18 mm              |
| # 30                  | 600 mu               |
| # 50                  | 300 mu               |
| # 100                 | 150 mu               |
| # 200                 | 75 mu                |



## Appendix I - Materials Testing Accuracy Criteria-20

The following table is the official testing accuracy criteria for the Colorado Department of Transportation and shall be strictly adhered to.

|                                 | MEASURE TO NEAREST         | REPORT TO NEAREST                                  |   |
|---------------------------------|----------------------------|--|---|
| <b>SOILS</b>                    | Sieve Analysis             |  |   |
|                                 | (Except -#200) .....       | 1.0 g .....  | 1%  |
|                                 | Minus No. 200.....         | 0.1 g .....  | 0.1%  |
|                                 | Atterberg Limits .....     | 0.01 g .....                                       | 1%  |
|                                 | Density .....              | ---- .....   | 0.1 lb/ft <sup>3</sup> (1 kg/m <sup>3</sup> ) |
|                                 | Relative Compaction .....  | 0.1 lb/ft <sup>3</sup> (1 kg/m <sup>3</sup> )..... | 0.1% <span style="color: red;"> </span>       |
|                                 | Moisture Content           |  |   |
|                                 | D/M Gauge.....             | 0.1 lb/ft <sup>3</sup> (1 kg/m <sup>3</sup> )..... | 0.1%  |
|                                 | Dry Weight.....            | 0.1 g .....  | 0.1%  |
|                                 | <b>BASE AGGREGATES</b>     | Sieve Analysis                                     |   |
| (Except -#200) .....            |                            | 1.0 g .....  | 1%  |
| Minus No. 200.....              |                            | 0.1 g .....  | 0.1%  |
| Atterberg Limits .....          |                            | 0.1 g .....  | 1%  |
| Density .....                   |                            | ---- .....   | 0.1 lb/ft <sup>3</sup> (1 kg/m <sup>3</sup> ) |
| Relative Compaction .....       |                            | 0.1 lb/ft <sup>3</sup> (1 kg/m <sup>3</sup> )..... | 0.1% <span style="color: red;"> </span>       |
| Moisture Content                |                            |  |   |
| D/M Gauge.....                  |                            | 0.1 lb/ft <sup>3</sup> (1 kg/m <sup>3</sup> )..... | 0.1%  |
| Dry Weight.....                 |                            | 0.1 g .....  | 0.1%  |
| <b>CONCRETE</b>                 |                            | Sieve Analysis                                     |   |
|                                 | (Except -#200) .....       | 1.0 g .....  | 1%  |
|                                 | Minus No. 200.....         | 0.1 g .....  | 0.1%  |
|                                 | (*)Sand Equivalent .....   | 0.1 .....  | 1 (*)   |
|                                 | Moisture in Aggregate..... | 0.1 g .....  | 0.1%  |
|                                 | Air Content .....          | ---- .....   | 0.1%  |
|                                 | Fineness Modulus .....     | ---- .....   | 0.01  |
|                                 | Slump .....                | ---- .....   | 1/4 inch (5 mm)                               |
|                                 | Compressive Strength ..... | 1 psi (0.01 MPa) .....                             | 10 psi (0.1 MPa)                              |
|                                 | Flexural Strength .....    | 1 psi (0.01 MPa) .....                             | 5 psi (0.05 MPa)                              |
|                                 | Thickness .....            | 0.05 in (1.3 mm) .....                             | 0.1 in (2.5 mm)                               |
|                                 | <b>BITUMINOUS PVMT.</b>    | Moisture in Mix .....                              | 0.1 g .....                                   |
| Sieve Analysis                  |                            |  |   |
| (Except -#200) .....            |                            | 1.0 g .....  | 1%  |
| Minus No. 200.....              |                            | 0.1 g .....  | 0.1%  |
| Asphalt Content                 |                            |  |   |
| (CP-L 5120).....                |                            | 0.1 g .....  | 0.01%   |
| (CP 85).....                    |                            | 1.0 g .....  | 0.01%   |
| Hveem Stability .....           |                            | ---- .....   | 1   |
| Voids in Mineral Aggregate..... |                            | ---- .....   | 0.1%  |
| Air Voids .....                 |                            | ---- .....   | 0.1%  |
| Lottman TSR .....               |                            | ---- .....   | 1%  |
| Lottman Wet TS.....             |                            | 1 lb.f (1 N) .....                                 | 1 psi (1 KPa)                                 |
| Lottman Dry TS.....             |                            | 1 lb.f (1 N) .....                                 | 1 psi (1 KPa)                                 |
| Filler.....                     |                            | 0.1 g .....  | 0.1%  |
| Specific Gravity.....           |                            | 0.1 g .....  | 0.001   |
| Specific Gravity                |                            |  |   |
| D/M Gauge.....                  |                            | ---- .....   | 0.001   |
| Relative Compaction .....       |                            | 0.01 .....   | 0.1%  |

(\* )Report to the next highest whole number per CP 37.

## **UNDERSTANDING CALCULATIONS AND ROUNDING IN MS EXCEL**

### **UNDERSTANDING THE DIFFERENCE BETWEEN DISPLAYED VALUES AND UNDERLYING VALUES**

A Microsoft Excel® numeric cell entry can maintain precision to only a maximum of 15 digits. This means you can enter numbers longer than 15 digits into a cell, but Excel converts any digits after 15 to zeros.

The values that appear in formatted cells are called *displayed values*; the values that are stored in cells and appear in the formula bar are called *underlying values*. The number of digits that appear in a cell, its displayed value, depends on the width of the column and any formatting that you have applied to the cell. When performing calculations, Excel always uses the underlying value, not the displayed value.

### **UNDERSTANDING THE ROUND FUNCTION**

MS Excel® ROUND function rounds a number to a specified number of decimal places, rounding digits less than 5 down and digits greater than or equal to 5 up. For example, the formula =ROUND(123.4567,3) returns 123.457. The number 123.457 is now the underlying value. Therefore, when performing calculations, the rounding function changes the values of the numbers that are operate on.

### **UNDERSTANDING CDOT FORMS**

CDOT paper worksheet forms were made to conserve space and paper. The forms may have one or more test methods/procedures incorporated into the forms. Because of space limitations, it is not referenced to which method/procedure the test results are being reported. It is up to the material tester to determine which test methods/procedures are being tested to and documented. Rounding, of intermediate results, is to be performed if the result is referencing a specific stand-alone test method/procedure that was reported previously. For example, if a moisture content has a designated AASHTO or ASTM test method/procedure, the results were rounded and documented previously. The following calculations on the form are to use the rounded moisture content. Then the final reported result is to be rounded and reported. If the moisture content was not reported previously, but was calculated as an intermediate result, then use the underlying value.

Caution is needed when developing computerized worksheets using MS Excel® from CDOT forms. Each stand-alone AASHTO, ASTM, CDOT CP or CPL has a rounded reported result. Computerized worksheets are to be analyzed that incorporate stand-alone test methods/procedures or if the intermediate result (underlying value) is to be used.

### **ROUNDING OF TEST DATA FOR DETERMINING CONFORMANCE WITH SPECIFICATIONS**

When calculating a test result from observed values and test data, rounding of intermediate values and quantities shall be avoided. As far as practicable with the calculating device used, carry out all calculations with the observed values exactly and round only the final result, which is reported as specified. Any final results used in further calculations shall be considered an intermediate quantity and the unrounded value is used.

**EXAMPLE:**

Find final results for Moisture Content, Dry Density and Percent Compaction:

A = Observed wet weight of the moisture sample  
= 182.4 gr.

B = Observed dry weight of the moisture sample  
= 166.8 gr.

MD = Moisture/density relationship  
= 115.4 pcf

WD = Observed wet density value  
= 119.3 pcf

MC = Moisture Content (%)

DD = Dry density (pcf)

C = compaction (%)

$$MC = \frac{(A - B) * 100}{B} = \frac{(182.4 - 166.8) * 100}{166.8} = 9.4\%$$

Unrounded is 9.35252

$$DD = \frac{(WD * 100)}{(100 + MC)} = \frac{(119.3 * 100)}{(100 + 9.35252)} = 109.1 \text{ pcf}$$

Unrounded is 109.09671

$$C = \frac{DD}{MD} = \frac{109.09671}{115.4} = 94.53 \rightarrow 95\%$$

% compaction, a passing test

Recalculated using rounded MC:

$$DD = \frac{(WD * 100)}{(100 + MC)} = \frac{(119.3 * 100)}{(100 + 9.4)} = 109.0 \text{ pcf}$$

Unrounded is 109.04936

Recalculated using rounded DD:

$$C = \frac{DD}{MD} = \frac{109.0}{115.4} = 94.45 \rightarrow 94\%$$

% compaction less than 95 thus, a failing test

**Caution** When you change the precision of the calculations in a workbook by using the displayed (formatted) values, Excel permanently changes any constant values on the worksheets in the workbook. If you later choose to calculate with full precision, the original underlying values cannot be restored. It is advised to use full precision. If it is desired to use precision as displayed follow these default settings for the Excel workbook.

Excel 2007 & more current:

1. Click the **Office Button**, click **Excel Options**, and then click the **Advance** tab in the left column.
2. Under **When calculating this workbook**, select the **Set precision as displayed** check box.

### Appendix J - Laboratory Test Time-21

Time listed is the interval from sample submittal at the Materials and Geotechnical Branch to the issuance of a report. Time spent while the sample is in transit is not included. Time spent while the report is in transit is not included. Test Time does not include weekends or state holidays.

| ITEM NO. | DESCRIPTION  | TEST TIME<br>(WORKING DAYS) |
|----------|--|-----------------------------|
| 203      | <b>EMBANKMENT</b>  |                             |
|          | Gradation, Atterberg Limits, Moisture-Density Curve, Specific Gravity, R Value, and Classification .....                               | 16                          |
|          | (This test time excludes a preliminary soil survey with more than 10 samples. Call for actual turnaround time.)                        |                             |
|          | Sulfate testing.....   | 5                           |
|          | Chloride testing.....  | 15                          |
|          | Soil Resistivity testing.....  | 6                           |
|          | pH testing.....  | 5                           |
|          | Pipe Type Material Selection testing.....  | 15                          |
| 206      | <b>STRUCTURE BACKFILL, BED COURSE &amp; FILTER MATERIAL</b>  |                             |
|          | Class 1: Gradation, Atterberg limits, Moisture-Density Curve and Specific Gravity .....  | 13                          |
|          | Class 2: Gradation, Atterberg Limits, Moisture-Density Curve and Specific Gravity .....  | 14                          |
|          | Bed Course: Gradation .....  | 5                           |
|          | Filter Materials: Gradation .....  | 5                           |
|          | Sulfate testing per the Schedule .....   | 5                           |
|          | Chloride testing.....  | 15                          |
|          | Soil Resistivity testing.....  | 6                           |
|          | pH testing.....  | 5                           |
| 301      | Deleted  |                             |
| 304      | <b>AGGREGATE BASE COURSE</b>   |                             |
|          | Gradation, Atterberg Limits, Moisture-Density Curve .....  | 15                          |
|          | Gradation, Atterberg Limits, Moisture-Density Curve, Abrasion .....  | 16                          |
|          | Gradation, Atterberg Limits, Moisture-Density Curve, and R-Value .....   | 20                          |
|          | Gradation, Atterberg Limits, Moisture-Density Curve, Abrasion and R-Value .....  | 21                          |
| 307      | <b>HYDRATED LIME &amp; LIME TREATED SUBGRADE</b>   |                             |
|          | Hydrated Lime: Gradation .....   | 5                           |
|          | Lime Treated Subgrade: Gradation, Atterberg Limits, PH, Optimum Lime Content, Moisture-Density Curve, and Unconfined Compression ..... | 20                          |

| ITEM NO. | DESCRIPTION   | TEST TIME<br>(WORKING DAYS) |
|----------|---|-----------------------------|
| 403      | <b>HOT MIX ASPHALT PAVEMENT</b>   |                             |
|          | Asphalt Content, Gradation, Stability, Lottman .....  | 7                           |
|          | Gradation, Atterberg Limits, Specific Gravity .....   | 10                          |
|          | Gradation, Atterberg Limits, Specific Gravity, Abrasion,<br>Fractured Faces .....                               | 12                          |
|          | EuroLab: French and /or German Wheel Tracking Devices.....  | 9                           |
| 409      | <b>COVER COAT MATERIAL</b>  |                             |
|          | Gradation, Abrasion, Fractured Faces .....  | 6                           |
| 411      | <b>BITUMEN</b>  |                             |
|          | Asphalt Cement (not performance graded), Emulsion .....   | 5                           |
|          | Performance Graded Asphalt Binder, Verification Testing .....   | 3                           |
|          | Performance Graded Asphalt Binder, Complete Testing .....   | 6                           |
| 412      | <b>PORTLAND CEMENT CONCRETE PAVEMENT</b>  |                             |
|          | Aggregate Gradation & Abrasion .....  | 6                           |
|          | Compressive Strength of Information Cylinders .....   | *                           |
|          | Compressive Strength at 7 Days.....   | *                           |
|          | Compressive Strength at 28 Days.....  | *                           |
|          | Compressive Strength of Drilled Cores.....  | *                           |
|          | Flexural Strength at 28 Days.....   | *                           |
|          | Mix Design, Review .....  | 3                           |
|          | Sand Equivalent.....  | 5                           |
|          | Note: * = The number of stipulated days plus 1 day for the report.  |                             |
| 504      | <b>MECHANICALLY STABILIZED EARTH WALLS</b>  |                             |
|          | Gradation, Atterberg Limits, Moisture-Density Curve,<br>Classification, Specific Gravity, and Direct Shear..... | 14                          |
| 506      | <b>RIPRAP</b>   |                             |
|          | Specific Gravity.....   | 3                           |
| 515      | <b>WATERPROOFING MEMBRANE</b>   |                             |
|          | Various Laboratory Tests.....   | 11                          |
| 601      | <b>STRUCTURAL CONCRETE</b>  |                             |
|          | Aggregate, Gradation & Abrasion .....   | 6                           |
|          | Aggregate Soundness with Sodium Sulfate.....  | 10                          |
|          | Compressive Strength of Information Cylinders .....   | 1 *                         |
|          | Compressive Strength at 7 Days.....   | 5 *                         |
|          | Compressive Strength at 28 Days.....  | 20 *                        |
|          | Compressive Strength of Drilled Cores.....  | 2 *                         |
|          | Mix Design, Review .....  | 3 *                         |
|          | Note: * = The number of stipulated days plus 1 day for the report.  |                             |
| 602      | <b>REINFORCING STEEL</b>  |                             |
|          | Prestressing Strand.....  | 6                           |

## **Appendix K - Establishing Lots or Process Control on the Project-20**

A lot is any well-defined quantity of material produced by essentially the same process through continuous production.

The standard size lot consists of 5 samples, but a lot may include as few as 3 or as many as 7 samples due to changes in production or when total quantities require more or less than 5 tests.

Establishing lots is not difficult when the production process and materials sources are uniform. When production begins under good process control and there is little need for plant adjustment, the first 5 samples should be used to establish the quantity represented by the first lot. Thereafter, each lot should contain 5 samples. More than a single day's run may be included if there is no significant change in the production process or raw material.

When the production process is erratic or out-of-control, establishing lots becomes a problem.

Often, the first few samples at the beginning of the production run will be erratic or off-target, and several major adjustments may be required before production is resumed. In such cases, these first few samples should be Lot No. 1. Then, after production levels out, 5 sample lots are to be used.

After the 5 sample lots have become routine, only a major production change or a quantity of material for which more or less than 5 samples are required should be cause for altering the number of tests.

## **Appendix L - Random Sampling-20**

The most important factor in obtaining information for the purpose of enforcing specifications is the action of sampling. It must be understood that unless the samples are chosen by probability sampling, the statistical methods may not be entirely applicable. Stratified Random Sampling should be used for this process. This is a method of random sampling that causes the samples to be spread more uniformly throughout the lot.

A predetermined schedule for random sampling should be developed for each project. If requested, the Central Laboratory will supply a schedule for random sampling. A random sampling schedule can also be developed using ASTM D 3665 and/or ASTM E 105 prior to start of testing. See also CP 75.

It is realized that where scattered piecework is being done, such as tapers and gores, it may not always be possible to strictly conform to the above procedure. Judgment must be used and a reasonable attempt made to select samples without bias. Bituminous materials ordinarily shipped to the project in tank trucks are sampled in a slightly different manner than for most other materials. See Chapter 400 of the Field Materials Manual for a detailed description of the sampling and acceptance verification plan.

The location or time of sampling must be selected by a random method. This means the location or time of sampling must be predetermined without bias, such as by the use of a table of random numbers. Every load, ton, or square yard in the sub-lot must have an equal probability of being chosen. This means the sample location or time chosen must be accessible. It is not possible to obtain a probability sample from a stockpile of aggregates because samples cannot be taken from the interior of the pile. To sample such material properly, it must be sampled at randomly determined intervals either as it is placed in the pile or removed from the pile.

## Appendix M - Sample-Processing Procedure-20

Samples which are received, tested, and reported by the CENTRAL LABORATORY, are processed in the following manner:

### IDENTIFICATION

All materials and samples must be logged-in. Samples must be identified as to DATE RECEIVED, ITEM NUMBER, CONTRACT ID, PROJECT NUMBER, and NUMBER OF SAMPLES.

### SELECTION

The selection of samples is handled by field project personnel. Staff Materials is responsible for the testing of samples submitted by field personnel. The only exceptions to this are samples of asphalt cement and liquid asphalt. In this case, one sample out of five is selected at random. If this sample meets specifications, the other four are discarded. If not, the other four samples are tested and reported.

### CONDITIONING-

Samples which require conditioning will be conditioned per the appropriate test procedure.

### STORAGE

Samples will be stored in the proper environment prior to testing. An example of this is concrete cylinders, which must be stored (cured) in a 100% humidity environment.

### RETENTION

Samples of all materials will be retained at least 2 weeks or until all issues are resolved. There is no retention of concrete cylinders.

### DISPOSAL

All materials which are not hazardous will be placed in the large roll-on / roll-off trash receptacle immediately behind the Laboratory. Materials which are hazardous will be handled per Staff Materials procedure for handling hazardous materials.

## Appendix N - Use of Laboratory Check Tests on More Than One Project-20

Results of Laboratory Check Tests can be used and referenced to more than one project if the RME allows it and if the following criteria are met:

The source (pit, plant, supplier and design mix) of material must be the same.

Construction must occur at approximately the same time on each project.

Example: Placing asphalt pavements on two separate projects from the same supplier. (Asphalt cement, portland cement, ARA additives, etc.)

Document the referenced laboratory check test on a CDOT Form #157 listing:

- The Project Number from which the tests was referenced.
- Check Test ID Number (unique for this activity)
- The plant where the material was produced.
- All of the ingredients in the product.
- The date the material was placed (on both projects).
- The Design Mix Number (if applicable).