

TABLE OF CONTENTS – 12

Introduction: (1) Cover Page; (2) Introduction; (3) Dedication / List of Annual FMM Revisions, Additions & Deletions; (4) Acknowledgement; (5) Review / Comment Form; (6) Comment and Correction Form

Table of Contents:

QA Procedures: Quality Assurance Procedures for Construction and Materials Sampling and Testing

Documentation: Documentation – Project Materials and Finals Materials

Contractors, Special Notice Special Notice to Contractors

Schedule (Quality Assurance) Frequency Guide Schedule for Minimum Materials Sampling, Testing, and Inspection

Schedule (Independent Assurance) Frequency Schedule for Independent Assurance Evaluation

CP 10s Colorado Procedures 10s

- CP 10 Qualification of Testing Personnel and Laboratories
- CP 11 Quality Management Plans and the Qualified Manufacturers List (QML)
 - Asphalt Binder
 - Asphalt Emulsion
 - Hydraulic Cement
 - Fly Ash and Pozzolan
 - Hydrated Lime
 - Steel Reinforcing Bars and Steel Dowel Bars
 - Epoxy-Coated Steel Reinforcing Bars & Epoxy-Coated Steel Dowel Bars
 - Precast Concrete Structures
- CP 12A Contractor's Hot Mix Asphalt Quality Control Notebook
- CP 12B Contractor's PCCP Quality Control Notebook
- CP 13 Check Testing
- CP 14 F and t- test Statistical Method for HMA Voids Acceptance
- CP 15 Certification of Consultant Nuclear Moisture/Density Gauges
- CP 16 Management of CDOT & Consultant Materials Testing
- CP 17 Hot Mix Asphalt Test Results Verification and Dispute Resolution

CP 20s Colorado Procedures 20s - Soils

- CP 20 Dry Preparation of Disturbed Soil Samples for Test
- CP 21 Mechanical Analysis of Soils
- CP 23 Determining Maximum Dry Density and Optimum Moisture of the Total Sample of Soil-Rock Mixture
- CP 24 Soil Surveys of Constructed Roadbeds
- CP 25 Calculation of Percent Relative Compaction of Soils and Soil-Rock Mixtures

CP 30s Colorado Procedures 30s - Bases

- CP 30 Sampling of Aggregates
- CP 31 Sieve Analysis of Aggregates
- CP 32 Reducing Field Samples of Soil and Aggregate to Testing Size
- CP 33 Total Evaporable Moisture Content and Surface Moisture Content of Aggregate by Drying
- CP 37 Plastic Fines in Graded Aggregates and Soils by Sand Equivalent Test

TABLE OF CONTENTS

CP 40s	Colorado Procedures 40s – Pavements
CP 41	Sampling Hot Mix Asphalt
CP 42	Estimation of Asphalt Content in HMA Through Back Calculations Using Gse
CP 43	Determining Moisture (Water) or Volatile Distillates Content of HMA
CP 44	Bulk Specific Gravity and Percent Relative Compaction of Compacted Bituminous Mixtures Using Saturated Surface-Dry Specimens
CP 45	Determining Percent of Particles with Two or More Fractured Faces
CP 46	Determination of Gradation of Aggregate in a Core from Asphalt Pavement
CP 47	Rejuvenating Agent Evaluation Procedure
CP 48	Determination of the Voids in the Mineral Aggregate (VMA)
CP 50s	Colorado Procedures 50s - Pavements
CP 50	Calculation of Dust to Asphalt Ratio of Bituminous Mixes
CP 51	Determining the Maximum Specific Gravity of HMA
CP 52	Contractor Asphalt Mix Design Approval Procedures
CP 53	Determining Maximum Density of Cold In-Place Recycled Pavement
CP 54	Approval of Asphalt Mix Designs Using Plant Produced Material
CP 55	Reducing Field Samples of Hot Mix Asphalt to Testing Size
CP 56	Guidelines for Using Maximum Specific Gravity (Rice) of Project-Produced HMA to Change the Target Specific Gravity for Compaction Compliance
CP 57	Determining the “Free Moisture” in Cold In-Place Recycled Pavement
CP 58	Detecting and Measuring Temperature Segregation of HMA
CP 59	Contractor Non-Standard Asphalt Mix Approval
CP 60s	Colorado Procedures 60s
CP 60	Deleted (06-30-2008)
CP 61	Sampling Freshly Mixed Concrete
CP 62	Contractor Concrete Mix Design Approval Procedures
CP 65	Evaluating Low Strength Test Results of Concrete Cylinders
CP 66	Measuring Texture Depth of Portland Cement Concrete Using a Tire Tread Depth Gauge
CP 67	Determining Adhesion of Joint Sealant to Concrete Pavement
CP 68	Determining Portland Cement Concrete Pavement Thickness
CP 69	Estimating the In-Place Concrete Strength by a Maturity Method
CP 70s	Colorado Procedures 70s
CP 70	Deleted 7-01-2011
CP 71	Determining Quality Level (Percent Within Tolerance Limits)
CP 72	Deleted 7-01-2011
CP 73	Deleted 7-01-2011
CP 74	Operating Profilers and Evaluating Pavement Profiles
CP 75	Stratified Random Sampling of Materials
CP 76	Verification of Equipment Used to Field Test Bituminous Mixtures
CP 77	Determination of Macro-Texture of Planed Hot Mix Pavement
CP 78	Certification of High Speed Profilers

TABLE OF CONTENTS

CP 80s	Colorado Procedures 80s - Nuclear	
	CP 80	In-Place Density and Moisture Content of Soil and Soil-Aggregate by the Nuclear Method
	CP 81	Density and Percent Relative Compaction of In-Place Bituminous Pavement by the Nuclear Method
	CP 82	Field Correction of the In-Place Measurement of Density of Bituminous Pavement by the Nuclear Method
	CP 85	Asphalt Cement Content of Asphalt Mixtures by the Nuclear Method
Chapter 200	Soils	
		Region Soil Survey Sampling Checklist3
	Item 203	Compaction 9
	Item 206	Structure Backfill 10
	Item 206	Filter Material 12
		Definitions 17
		CDOT Forms – Soils Examples Index 19
		Classification of Soils and Soil-Aggregate Mixtures 53
		Procedure for Preliminary Survey: Overview 57
		Soil Survey 59
		CDOT Forms - #554 & #555 Examples 67
		Soil Identification and Description 72
		Rock Identification and Description 73
		Rock Classification Table 74
		Determination of Need for Culvert Protection 75
		Liquid Limit Determination from Blow Counts and Water Contents 76
		Partial Group Index for Liquid Limit & Plastic Index 77
Chapter 300	Bases	
	Item 206	Structure Backfill, Class 1 1
	Item 304	Aggregate Base Course 1
	Item 308	Portland Cement and Fly Ash 4
		CDOT Forms – Bases Examples Index 5
Chapter 400	Asphalt	
	Item 403	Hot Mix Asphalt 1
	Item 403	Superpave Mix Design 2
	Item 411	Performance Graded Binders 2
	Item 403	Hot Mix Asphalt, European Rutting Machines 2
	Item 411	Bituminous Materials 5
		CDOT Forms – Asphalt Examples Index 16
Chapter 500	Structures/Steel/Miscellaneous	
	Item 502	Piling 1
	Item 506	Gabions and Slope Mattress 1
	Item 509	Structural Steel 1
	Item 509	Structural Steel (Galvanized) 1
	Item 510	Structural Plate (Galvanized) 2
	Item 515	Waterproofing Membrane (Bridge Deck) 2
		CDOT Forms – Structures Examples Index 3

TABLE OF CONTENTS

Chapter 600	Concrete & Item 600	
	Item 601	Structural Concrete 1
	Item 602	Reinforcing Steel (Epoxy Coated)..... 9
	Item 602	Reinforcing Steel..... 9
	Item 603	Culverts 10
	Item 604	Sewers Pipe..... 10
	Item 617	Culvert Pipe..... 10
	Item 624	Corrosion Resistant Culvert..... 10
	Item 604	Manholes 11
	Item 606	Guard Rail..... 11
	Item 606	End Anchors 12
	Item 607	Fences 12
	Item 613	Lighting 12
	Item 614	Traffic Control Devices..... 12
	Item 615	Water Control Devices..... 12
	Item 624	Corrosion Resistant Culverts 12
		CDOT Forms – Concrete Examples Index 14
Chapter 700	Paints	
	Item 708	Paints (Zinc Rich Paint) 1
		CDOT Forms – Paints Examples..... 2
Chapter 800	Radiological Safety & Nuclear Gauge Operation	
		General CDOT Nuclear Information..... 1
		Sample Documents 4
		Nuclear Gauge Photographic & Reference Information 5
		CDOT Forms – Nuclear Examples Index..... 14
	Job Safety Analysis Index	
		Table of Contents..... 1
	AASHTO – ASTM Online	
		Accessing AASHTO Online for the First Time..... 1
		Accessing ASTM Online..... 4
	QC & QA Software	
		Quality Control & Quality Assurance Software 1
	Inspections & Round Robins, Central / Regions	
		Protocol for Open Laboratory Review of a CDOT Materials Testing Laboratory . 1
		Protocol for Inspection of Region Materials Laboratories by the Central Materials Laboratory..... 2
		Report on Central Laboratory Region Laboratory Inspection (Form #520)..... 3
		Calibration and Verification of Equipment Inventory..... 9
		Summary of Tester Qualifications..... 10
		Equipment Calibration, Verification and Check Information 11
		Protocol for Round Robin Materials Testing of CDOT Region & Consultant Laboratories..... 12

TABLE OF CONTENTS

Protocol for Audit of Region Materials IA Sampling and Testing Program by the Central Materials Laboratory	15
Protocol for Audit of Region Materials Final Materials Review and Acceptance Process by the Central Materials Laboratory	16

Appendix

A - Materials Advisory Committee (MAC) Charter	2
A - Independent Assurance (IA) Testers Committee Charter	4
A - Flexible Pavement Operator's Group (FPOG) Charter	6
B - Task Force Management Guide	8
C - Personnel Roster, Staff & Region Materials	11
D - Definitions	15
E - Acronyms	19
F - Significant Publications	23
G- Colorado Procedures - Laboratory <i>Numeric Order</i>	24
H - Metric Conversion Tables	26
I - Materials Testing Accuracy Criteria	28
J - Laboratory Test Time	31
K - Establishing Lots or Process Control on the Project	33
L - Random Sampling	34
M- Sample Processing Procedure	35
N - Use of Laboratory Check Tests on More Than One Project	36
O - CDOT Forms – Materials Related	37

Miscellaneous

(This tab is deliberately left empty for the notes from the FMM's owner.)

MATERIALS PAY ITEMS

NUMERICAL LIST

Item No	Description	Item No	Description
203	Compaction	506	Riprap (Gabions) and Slope Mattress
206	Structure Backfill	507	Slope and Ditch Paving
206	Filter Material	508	Timber Structures
206	Bed Course Material	509	Structural Steel
207	Topsoil	509	Structural Steel (Galvanized)
208	Silt Fence	510	Structural Plate Structures
209	Watering	512	Bearing Device
212	Seeding and Sodding	513	Drain Pipe
213	Mulching	514	Pipe Railing
214	Planting	515	Waterproofing Membrane
215	Transplanting	516	Damproofing
216	Soil Retention System	517	Waterproofing
217	Soil Sterilization	518	Expansion Devices and Waterstops
301	Plant Mix Bituminous Base Course	601	Structural Concrete
304	Aggregate Base Course	602	Reinforcing Steel
306	Reconditioning	603	Culverts
307	Lime Treated Subgrade	604	Sewers, Manholes, Inlets, and Meter Vaults
307	Hydrated Lime	605	Underdrains
307	Mineral Fillers	606	Guard Rail
308	Portland Cement Treated Base	607	Fences
308	Portland Cement, Fly Ash	608	Sidewalks
309	Lean Concrete Base	609	Curbing
310	Process Asphalt Mat	610	Median Cover Material
403	Hot Bituminous Pavement	611	Cattle Guard
405	Hot In-Place Recycle	612	Markers
406	Cold Bituminous Pavement (Recycle)	613	Lighting
408	Hot Poured Joint and Crack Sealer	614	Traffic Control Devices
409	Seal Coat	615	Water Control Devices
409	Cover Coat Material	616	Siphons
411	Bituminous Materials	617	Culvert Pipe
412	Portland Cement Concrete Pavement	618	Prestressed Concrete Structures
420	Geotextiles	619	Water Lines
501	Steel Sheet Piling	622	Rest Areas and Buildings
502	Piling	623	Sprinkler System
503	Drilled Caissons	624	Corrosion Resistant Culverts
504	Cribbing	627	Pavement Marking
504	MSE Walls	641	Shotcrete
		708	Paints

MATERIALS PAY ITEMS

ALPHABETICAL LIST

Description	Item No	Description	Item No
Aggregate Base Course	304	Piling	502
Anchor Bolts	613	Piling (Steel Sheet).....	501
Arch Pipe (Plate).....	510	Pipe (Culvert)	617
Asphalt Cement	411	Pipe (Drain)	513
Bearing Device	512	Pipe Railing	514
Bed Course Material	206	Plant Mix Bituminous Base Course	301
Bituminous Base (Plant Mix).....	301	Planting	214
Bituminous Materials	411	Plate Pipe (Structural)	510
Caissons (Drilled)	503	Polyethylene Sheeting.....	610
Cattle Guard	611	Portland Cement	308
Cold Bituminous Pavement (Recycle)	406	Portland Cement Concrete Pavement.....	412
Compaction.....	203	Preformed Bridge Compression Joint Sealer	518
Concrete (Structural)	601	Prestressed Concrete Structures	618
Concrete Units (Prestressed)	618	Process Asphalt Mat	310
Copper (Sheet)	511	Railing (Pipe).....	514
Corrosion Resistant Culverts	624	Reconditioning.....	306
Cover Coat Material	409	Reinforcing Steel.....	602
Cover Material (Median)	610	Rest Areas and Buildings	622
Cribbing	504	RipRap	506
Culverts.....	603	Seal Coat.....	409
Culvert Pipe	617	Seeding and Sodding	212
Curbing	609	Sewers, Manholes, Inlets, and Meter Vaults .	604
Damproofing	516	Shotcrete	641
Drain Pipe	513	Sidewalks	608
Drilled Caissons.....	503	Silt Fence	208
Emulsion	411	Soil Retention System	216
Expansion Devices and Waterstops.....	518	Siphons	616
Filter Material	206	Slope and Ditch Paving	507
Gabions	506	Slope Mattress	506
Galvanized Structural Steel	509	Sprinkler System	623
Geotextiles.....	420	Steel (Reinforcing).....	602
Guard Rail.....	606	Steel Sheet Piling	501
Hot Bituminous Pavement	403	Steel (Structural)	509
Hot In-Place Recycle	405	Structural Concrete	601
Hot Poured Joint and Crack Sealer	408	Structural Plate Pipe.....	510
Humus	214	Structural Steel.....	509
Hydrated Lime.....	307	Structural Steel Galvanized.....	510
Inlets	604	Structure Backfill	206
Joint Seal (Preformed).....	518	Topsoil.....	207
Lean Concrete Base	309	Timber Structures	508
Lighting	613	Traffic Control Devices.....	614
Lime Treated Subgrade	307	Trash Guards	616
Liquid Asphalt	411	Underdrains.....	605
MSE Wall.....	504	Water Control Devices	615
Manholes	604	Watering.....	209
Markers	612	Water Lines	619
Median Cover Material.....	610	Waterproofing.....	517
Mineral Fillers, Etc.	307	Waterproofing Membrane	515
Mulching (Straw).....	213		
Mulching (Wood Cellulose).....	213		
PG Binder	411		
Paints.....	708		
Pavement Marking.....	627		

{This page was intentionally left blank.}

FIELD MATERIALS MANUAL 2012

AS REVISED

To be used on projects advertised after July 1, 2011



**Colorado Department
of Transportation**

{This page was intentionally left blank.}

2012 CDOT Field Materials Manual Introduction

The purpose of this manual is to provide an official guide to CDOT Field forces for the sampling and testing of materials on construction projects and the subsequent documentation. It is not the intent to publish a complete summary of all sampling and testing methods and procedures. Further relevant information may be found in either the applicable AASHTO or ASTM manuals. Published herein are some select AASHTO Procedures concerning materials testing that may not be readily available to Field personnel.

The Manual is published in dual units using the Standard English units and the International System of Units (SI Modernized Metric).

The testing frequency as shown in the Quality Assurance (QA) Schedule (Frequency Guide Schedule for Minimum Materials Sampling, Testing, and Inspection) is considered to be the minimum necessary to have the degree of control desired. The Sampling and Testing Procedures have in many cases been modified to make them more applicable to Field testing conditions. Further unauthorized modifications should not be attempted. If a valid reason exists, a shortage of tests can be explained and the work accepted. However, improper test procedures cannot be explained nor accepted.

The testing frequency for Independent Assurance Sampling and Testing is to be established by the Region Materials Engineer according to the Independent Assurance (IA) Schedule (Frequency Schedule for Independent Assurance Evaluation).

It is not our intention to discourage efforts to find better or faster methods of testing. Many of the Colorado Procedures are the result of suggestions from field materials personnel. However, before using a procedure other than that listed, it must be approved by the Materials Advisory Committee (MAC) and the FHWA. In addition, the procedure used must be the same as that specified in the project specifications. If this rule is not followed, the acceptance or rejection action cannot be supported and may result in legal rulings against the Division in cases of litigation.

The Frequency Guide Schedule for Minimum Materials Sampling, Testing, and Inspection current at the time of contract advertisement shall apply during the full course of that particular project.

We realize the critical importance of materials and the associated personnel, whether they are Quality Control (QC), Quality Assurance (QA), or Independent Assurance (IA) to any construction project. It is our intent to create a Field Materials Manual (FMM) that always reflects the most current and best procedures, and is as user friendly as possible. Please take the time to review and read this publication, and provide us with either the Review / Comment Form or the Comment / Correction Form at any time.

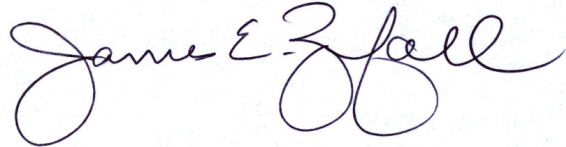

Jim Zufall
CDOT Materials Engineer

- NOTE 1:** CDOT Internal Web Address: <http://internal/infoexchg/organizations.cfm> (see Manual /...)
CDOT External Web Address: <http://www.dot.state.co.us/DesignSupport/> (see Manuals)
- NOTE 2:** **Materials Advisory Committee (MAC) information:** <http://internal/MAC/>
- NOTE 3:** **Materials Bulletins:** Same address as Note 1 with Construction and Design Bulletins.
- NOTE 4:** General correspondence (letters and envelopes), large packages, bulk mail samples of materials, and nuclear gauges should be addressed to or delivered to:
4670 North Holly Street, Unit A, Denver, CO 80216-6408
- NOTE 5:** If you have any questions concerning this manual please contact:
Editor @ (303) 398-6566 or the Assistant Editor @ (303) 398-6563.

2012 CDOT Field Materials Manual Dedication

Front Cover: The scenes on the cover of the 2012 CDOT Field Materials Manual are contributed from CDOT's 100 Years of Colorado State Transportation History. The photographs are: 1918, Million Dollar Highway, US 550 (top center); 1915, Denver to Colorado Springs, US 85 (center); 1921, Monarch Pass, US 50 (bottom left); 1940s, Denver to Colorado Springs, US 85 (bottom right); 1954, Colorado Department of Highways Headquarters Building corner stone (spine).

Special Thanks to: Jim Wickland for creating the front cover design.
Tony Hernandez for assisting in numerous tasks such as example replacement and page numbering complications.

FMM Documents: A special thanks are extended to the members and participants of the MAC meetings and the associated task forces who are constantly striving to improve testing methodology and CDOT specifications so that the roads in Colorado are progressively built better and are safer for the motoring public.

Listed Revisions, Additions & Deletions

Changes from the 2011 FMM: Changes in the text from the previous year will have a solid black side-bar in either the left or right applicable margin. If there are significant changes to a Colorado Procedure (CP) then the year after the CP number will be the same as the year for the Manual. The list below is not inclusive.

- QA Program Chapter: Changes to Subsection 9.2.1, 9.4.1
- Documentation Chapter: Changes to Sections 3, 6, 7, Note 3
- Special Notice to Contractors: Changes to Sections: 4, and Subsection 7.3.d
- QA Schedule and IA Schedule: as always have been revised, but black-bars in the margins are not feasible due to space constraints.
- CP 10: misc
- CP 11: misc
- CP 14: Total re-write
- CP 16: Section 4
- CP 17: Subsection 5.1, 5.6 – 5.9
- CP 31: Note 1
- CP 33: New
- CP 51: Subsection 3.6
- CP 52: Section 2
- CP 59: New to the FMM, was a Materials Bulletin as an interim CP
- CP 62: Subsection 2.1.1, 5.2.1, 5.2.2
- CP 69: Subsection 8.3 was deleted
- CP 70, CP 72, CP 73: All three were Deleted
- CP 74: Subsection 1.2, 2.4, 8.1
- CP 85: various changes from Subsection 8.3.4 to the end
- Chapter 200, Chapter 600, Chapter 800: various changes
- Job Safety Analysis: replaces the tab entitled Safety Manual, lists all current JSAs
- Inspections: misc.
- Appendix: misc.

Any errors that may still exist within this manual are solely the oversight of the Editor.

2012 Field Materials Manual (FMM)

Colorado Procedure Review/Comment Form

Mail or Fax to: Colorado Department of Transportation
Materials & Geotechnical Branch
Documentation Unit
4670 North Holly Street, Unit A
Denver, Colorado 80216-6408
FAX: (303) 398-6504

Name _____ Phone No. (_____) _____ Date _____
Company or CDOT Office _____

CP No. _____ **Section No.** _____

Comments : _____

CP No. _____ **Section No.** _____

Comments : _____

CP No. _____ **Section No.** _____

Comments : _____

CP No. _____ **Section No.** _____

Comments : _____

CP No. _____ **Section No.** _____

Comments : _____

Thank you for your help in making the CDOT Field Materials Manual a better publication by notifying us of errors or points of confusion that require clarity.

Quality Assurance Procedures for Construction and Materials Sampling and Testing – 12

1. PURPOSE

1.1 To prescribe policies, procedures, and guidelines to assure the quality of materials on all Colorado Department of Transportation construction projects are in accordance with 23 CFR and the FHWA Stewardship Agreement.

2. REFERENCES

2.1 AASHTO R 9 – Standard Recommended Practice for Acceptance Sampling Plans for Highway Construction

2.2 AASHTO R 10 – Standard Recommended Practice for Definition of Terms for Specifications and Procedures

2.3 AASHTO R 18 – Standard Recommended Practice for Establishing and Implementing a Quality System for Construction Materials Testing Laboratories

2.4 AASHTO R 25 – Standard Recommended Practice for Technician Training and Qualification Programs

2.5 AASHTO R 38 – Standard Practice for Quality Assurance of Standard Manufactured Materials

2.6 AASHTO R 44 – Standard Practice for Independent Assurance (IA) Programs

2.7 ASTM D 3665 – Standard Practice for Random Sampling of Construction Materials

2.8 ASTM E 177 – Standard Practice for Use of the Terms Precision and Bias in ASTM Test Methods

2.9 Title 23 Code of Federal Regulations (CFR), Part 637, Subpart B, Quality Assurance Procedures for Construction

3. DEFINITIONS

3.1 *Acceptance Program* - All factors that

comprise CDOT's determination of the quality of the product as specified in the contract requirements. These factors include verification sampling, testing, and inspection and may include results of quality control sampling and testing.

3.2 *Accredited Laboratory* - A laboratory which is recognized by a formal accrediting body as meeting quality system requirements including demonstrated competence to perform standard test procedures. Accredited by the AASHTO Accreditation Program (AAP).

3.3 *Central Laboratory Samples and Tests* - Random representative samples submitted to CDOT's Central and/or Region Laboratory to additionally evaluate quality of field produced products and materials, and to perform tests not within the capabilities of the Field and/or Region Laboratories.

3.4 *Designated Agent* - An employee or employees of a state, local agency, consultant, or independent laboratory, which is employed, paid by, and/or directly accountable to CDOT, or a public agency, excludes the contractors' or vendors' personnel.

3.5 *Independent Assurance (IA) Program* - Activities that are an unbiased and are an independent evaluation of all the sampling and testing (or inspection) procedures used in the acceptance (QA) program. [IA provides an independent verification of the reliability of the acceptance (or verification) data obtained by the agency and the data obtained by the contractor. The results of IA testing or inspection are not to be used as a basis of acceptance.] Beyond evaluating sampling and testing procedures the IA program also includes testing equipment, and in some cases the witnessing of certain specified samples and sampling techniques used in the acceptance program.

3.6 *IA Project Basis* – Based on quantity, may provide an easier way to monitor compliance and ensure that all materials are covered on an individual project. This is the normal sampling and testing frequency, per the IA Schedule, for Item 403 [Hot Mix Asphalt (HMA)].

3.7 *IA System Basis* – Typically administered Region wide. It is personnel-related rather than project-related and therefore allows easier tracking of individuals. This approach is usually applied on a time-based, rather than on a quantity-based frequency. This is an alternate sampling and testing frequency, per the IA Schedule, for Item 403 [Hot Mix Asphalt (HMA)] where the minimum frequency is based on an expanded unit of material production and a unit of time.

3.8 *IA Combination Basis* – To maximize the effectiveness of the IA program, the RME may choose to utilize both the Project and System Basis within their Region. Based on the number, size, location, or construction phasing of HMA projects, the RME will have the option of choosing either the Project Basis or the System Basis for every project within their Region. If the Combination Basis is used, the RME will document the field tester's name(s) and the quantity of HMA used for each project.

3.9 *Proficiency Samples* - Homogeneous samples that are distributed and tested by two or more laboratories. The test results are compared to assure that the laboratories are obtaining the same results. (i.e. as part of laboratory accreditation or round robin testing).

3.10 *Qualified Laboratories* – Laboratories that are capable as defined by appropriate programs established or recognized by each Agency. [Accredited Laboratories are considered Qualified; however, a Qualified Laboratory need not be Accredited.] Laboratories that participate in a qualification program, approved by CDOT, which shall include provisions for checking testing equipment and maintaining records of all equipment calibrations and verification checks. All testing equipment used to conduct testing shall conform to the standards specified in the testing procedure.

3.11 *Qualified Sampling & Testing Personnel* - Personnel who are capable of performing sampling and testing as defined by appropriate programs approved by CDOT.

3.12 *Quality Assurance (QA)* - All those planned and systematic actions necessary to provide confidence that a product or facility will perform satisfactorily in service; or making sure the quality of a product is what it should be.

3.13 *Quality Control (QC)* – The system used by a Contractor / vendor to monitor, assess and adjust their production or placement processes to ensure that the final product will meet the specified level of quality. Quality Control includes sampling, testing, inspection, and corrective action (where required) to maintain continuous control of a production or placement process (and to fulfill contract requirements).

3.14 *Random Sample* - A sample drawn from a lot in which each increment in the lot has an equal probability of being chosen. All samples used for quality control and verification sampling and testing shall be random samples.

3.15 *Stewardship Agreement* – FHWA has stewardship and oversight responsibilities on Federal-aid programs. CDOT has assumed all project approval authority on National Highway System (NHS) projects, excluding the Interstate.

3.16 *State Personnel* - An employee or employees of CDOT.

3.17 *Vendor* - A supplier of project-produced material that is not the contractor. A vendor may or may not be the Manufacturer, but the distributor of a product.

3.18 *Verification Sampling and Testing* - Sampling and testing performed to validate the quality of the product for acceptance (as per the QA Frequency Guide Schedule). The Quality Assurance (QA) tester performs this activity.

NOTE 1: Additional relevant definitions are located in the FMM Appendix.

4. POLICY

4.1 *Quality Assurance Program* – It is the policy of CDOT to have a quality assurance program which will assure that materials, products, and workmanship incorporated in CDOT construction projects, and Local Agency projects, are in conformity with the requirements of the approved plans and specifications, including any approved changes. The program must meet the criteria in 23 CFR, Subsection 637.207 and the FHWA Stewardship Agreement.

4.2 *CDOT Capabilities* - CDOT shall maintain an adequate, qualified staff to administer its

Quality Assurance Program. CDOT shall also maintain a Central Laboratory. CDOT's Central Laboratory shall meet the requirements in Sub-section 637.209 (a) (2) of 23 CFR.

4.3 *Independent Assurance (IA) Program* - Independent Assurance samples and tests (and observations) or other procedures shall be performed by qualified sampling and testing personnel employed by CDOT or by contract its designated agent, which would be employed by an AASHTO Accredited Laboratory.

4.4 *Verification sampling and testing* - The verification sampling and testing are to be performed by qualified testing personnel employed by CDOT or its designated agent (employed by a Qualified Laboratory), excluding the contractor and vendor. Also referred to as Quality Assurance (QA) testing.

4.4.1 *Random Samples* – All samples used for verification sampling and testing shall be random samples. Additional samples may be taken at any point in the production for verification of quality, but these will not be used for statistical evaluation.

4.4.2 The results of these tests will be used in the acceptance decision as specified in the contract requirements and all approved changes.

4.5 It will be the responsibility of the Region Materials Engineer (RME), under the direction of the Region Transportation Director (RTD), to implement those portions of the Quality Assurance Program applicable to CDOT Regions.

5. SCOPE OF THE QUALITY ASSURANCE (QA) PROGRAM

5.1 The Quality Assurance (QA) Program will provide for:

5.1.1 Acceptance Program.

5.1.1.1 Frequency Guide Schedule for verification sampling and testing which will give general guidance to personnel responsible for the program and allow adaptation to specific project conditions and needs.

5.1.1.2 Identification of the specific location in the construction or production operation at which verification sampling and testing is to be

accomplished.

5.1.1.3 Identification of specific attributes to be inspected which will reflect the quality of the finished product.

5.1.2 Independent Assurance (IA) Program.

5.1.3 Project Materials Certification.

5.1.3.1 Retention of sampling and testing records.

5.2 Quality Assurance (QA) Program Evaluation Checks:

5.2.1 Inspection and Accreditation of CDOT's Central Laboratory performed annually by the National Reference Laboratory, AASHTO Designation R 18.

5.2.2 Independent Assurance (IA) Sampling & Testing Program Review, conducted biennially by the Central Laboratory and the FHWA (Subsection 7.11).

6. ACCEPTANCE PROGRAM

6.1 Project Verification Sampling and Testing:

6.1.1 Project verification (QA) sampling and testing will be accomplished and documented on all CDOT construction projects according to the edition of the CDOT Field Materials Manual (FMM) in effect at the time of project advertisement.

6.1.1.1 The Field Materials Manual contains schedules, tables, nomographs, examples, etc. that aid in completing project verification sampling, testing, inspection, and proper documentation.

6.1.1.2 Subsections of the Field Materials Manual contain guidelines for using the CDOT Statistical Sampling and Acceptance Plan.

6.1.2 The results of all project verification (QA) tests will be made available to the FHWA Operations Engineer at the project or residency office when requested.

7. INDEPENDENT ASSURANCE (IA) PROGRAM

7.1 The CDOT Materials Engineer will act in an advisory capacity to the Region Materials

Engineer in carrying out this program, and either he or his designee will be the liaison with other CDOT Divisions, other organizations, consultants, designated accredited laboratories, and the FHWA.

7.2 The IA Program is an internal program to be administered and performed by CDOT personnel or by designated agents from an AASHTO accredited laboratory. This program is to be applied to all CDOT construction projects and Local Agency construction projects regardless of whether they are on the NHS or not.

7.3 Following the guidelines and instructions in the "Frequency Guide Schedule for Independent Assurance Evaluation", the Region Materials Engineer will assign an individual from the Region Materials Laboratory to develop the CDOT Form #379, *Project Independent Assurance Sampling Schedule*. This person will determine the material items and number of tests required on every project. An initial review will be performed by the Region Materials Engineer's designee, to ensure independence between development and approval. The Region Materials Engineer, or his designee, will approve the CDOT Form #379 prior to distribution to the Project Engineer. Ideally the initial review and the approval will not be performed by the RME.

7.3.1 Where more than one sampling location is permitted, the IA Tester reserves the right to further designate the sampling location.

7.3.2 IA System Basis Sampling and Testing on Item 403, if used instead of the Project Basis, should be noted on the Form #379. (Additional information can be obtained in the Frequency Schedule for Independent Assurance Evaluation, Item 403.)

7.3.3 Sampling, witnessing, testing and equipment checks on a project will be performed by the IA Tester, whether CDOT personnel or CDOT's designated agent, who have no direct responsibility for project verification (QA) sampling and testing, using equipment other than that assigned to the project. (See Notes 5, 6, and 7 on the "Frequency Schedule for Independent Assurance Evaluation".) The IA equipment should be independent of the QA process unless otherwise noted on the CDOT Form #379.

7.3.4 All personnel performing sampling, observations, and testing on CDOT or Local Agency projects will be qualified personnel as noted in Section 8, *Sampling and Testing Personnel Qualifications*, and/or CP 10, *Qualification of Testing Personnel and Laboratories*.

7.3.5 Project Materials Lab (test trailer) inspections performed prior to construction commencing will review the existence of required equipment and their calibrations, as well as test procedures and the general organization of the field laboratory. This information will be documented on the CDOT Form # 379, listed as Item 620.03, and will show the date of the inspection(s). The inspection will be guided by CP 10 and will utilize the Field Lab & Personnel Qualification Checklist.

7.4 For projects on the NHS, the Local Agency Contract Administration Checklist has been developed to ensure that all required aspects of a project approved for Federal funding have been addressed and a responsible party assigned for each task. The local agency must use: an AASHTO Accredited Laboratory, qualified personnel for testing and observations, perform the verification equipment checks, and follow all applicable sections of this Quality Assurance Procedures Chapter, and the IA Program Section in particular.

7.4.1 For Local Agency projects not on the NHS, CDOT requires Independent Assurance testing. The Local Agency shall use its established, documented procedures to independently verify the adequacy of testing equipment and personnel.

7.5 State personnel, or designated agents employed by an AASHTO designated accredited laboratory, performing IA Sampling and Testing will be limited to witnessing no more than 20% of the QA tests performed. This is defined as no more than 20% of each individual test element. Witnessing more than this limit has the potential of involving the IA tester in too much of the day-by-day project level responsibilities and activities of the QA tester.

7.5.1 Project inspections performed during construction will check the project (QA) equipment to assure the equipment is adequate for the designated procedure. The equipment will also be checked at that time for the required calibration, if

applicable, and that proper documentation of the verification checks are on file. The inspection will be guided by CP 10 and the Field Lab & Personnel Qualification Checklist.

7.5.1.1 An appropriate statement on the applicable report form used for tested or observed IA samples will be made to this effect: **"Equipment used for the above sampling, testing, and evaluation was inspected by me and found to essentially comply with the requirements of the Procedure used."**

7.5.1.2 If any discrepancies to the project equipment are found by the IA Tester, they should be documented and reported to the Project Engineer at the earliest opportunity with a description of the repair or replacement needed. Appropriate notations should be made on the applicable reporting test form or on a separate memo, if required.

7.6 The IA System Basis for Sampling and Testing may be used in a Region. The testing and sampling frequency will be based on either a unit of production or on a unit of time. (Additional information can be obtained in the Frequency Schedule for Independent Assurance Evaluation, Item 403.) If it is used throughout the Region, it should last for the entire calendar year. If it is used for a project, it should be used for the entire project and last for its duration.

7.6.1 The Annual Report on Program Wide Independent Assurance Testing of Hot Mix Asphalt Materials using the System Basis will be developed by the Central Laboratory and sent to the FHWA summarizing the results of the IA System Based program, per CFR 23, Subsection 637.207 (2) (iv), for the previous calendar year.

7.6.1.1 Distribution List:
FHWA - Direct Recipient
Chief Engineer
Director of Staff Services
Regional Transportation Director
Region Materials Engineer

7.7 On CDOT projects the QA testing equipment will be evaluated by using equipment verification checks, testing split samples of verification or proficiency samples, or any combination of methods.

7.8 On CDOT projects the QA testing personnel will be evaluated by observation of sampling and testing procedures, along with testing splits of verification or proficiency samples, or any combination of the methods.

7.9 A prompt comparison will be made of test results obtained from the QA tester being evaluated and the Independent Assurance (IA) tester, using the guidelines enumerated in the CDOT Field Materials Manual's Frequency Schedule for Independent Assurance Evaluation and Table One – Comparison Precision Guide; and then documented as required.

7.9.1 Field reviews of IA samples will be documented by signing and dating entries on the applicable test reports by the IA tester.

7.9.2 Split-sample test results that agree within the limits of the Comparison Precision Guide from the Frequency Schedule for Independent Assurance Evaluation (Table One) will not require any comments on the reporting form. Minor Differences do not need to be investigated.

7.9.3 If split-sample test results have "Significant" Differences, the Region Materials Engineer or his designee will conduct an investigation to determine the probable cause of the difference.

7.9.3.1 This investigation may be as simple as having all testing personnel run their retained splits of the samples. If, after comparing results of the retained splits, Significant Differences still exist, the Region Materials Engineer must conduct a thorough investigation into the sampling, testing, and equipment used to perform the tests. The results of this investigation must be documented on the appropriate CDOT form listed in the Schedule. The statement must reference the exact "difference", the cause of this difference, and the corrective action. If the investigation results are too lengthy, a separate memo may be required.

7.9.3.2 Prompt and appropriate action will be taken by the Project Engineer to correct or improve sampling and/or testing methods if the need is indicated.

7.9.4 The Project Engineer makes acceptance decisions based on verification (QA) sampling and testing, and factors relating to the quality of the material or product. What should not be

incorporated into these statements is a recommendation for an acceptance decision at full price. IA testing is not for the purpose of verifying quality, but meant to evaluate personnel and check equipment. However, these test results may be used by the Project Engineer to support his decisions.

7.10 When all IA sampling and testing on the project is completed per the Form # 379, the Region Materials Engineer will certify through his Final Review that: **“The Independent Assurance Sampling Schedule for this project has been substantially followed and the test results of the IA samples are in reasonably close agreement with the project acceptance (QA) sample test results.”**

7.10.1 Exceptions to this statement have been previously commented on and documented when the test results were reported or are explained on this form or on an attached sheet. The Form #379 may include supplemental attachments.

7.11 A review of each CDOT Region’s IA Sampling and Testing Program will be performed every two years, at a minimum, by Central Laboratory Personnel and the FHWA. The purpose of the review will be verification of compliance with 23 CFR, Part 637, Quality Assurance Procedures for Construction, and the applicable Sections of the CDOT Field Materials Manual.

7.11.1 The **Biennial Independent Assurance Sampling and Testing Program Review** with the Region Materials Engineer will be conducted to check IA program compliance, document problems, document current inclusion of LA projects into the program, and observe Region-by-Region uniformity. A minimum of two weeks notice will be given to the Region Materials Engineer. Information on inspections is located in the Inspection (Central-to-Region) Chapter.

7.11.2 The findings and recommendations of the review will be discussed with the CDOT Materials Engineer and will be reported to the FHWA.

7.11.3 Distribution List:
FHWA - Direct Recipient
Chief Engineer
Director of Staff Services
Regional Transportation Director
Region Materials Engineer

8. SAMPLING and TESTING PERSONNEL QUALIFICATIONS

8.1 The Code of Federal Regulations (23 CFR) requires that persons conducting tests used in the acceptance decision or in IA inspections be qualified. This includes employees of CDOT and designated agents conducting verification (QA) testing, QC testing used in the acceptance decision (QC-For-Pay) by contractor and vendor employees, and IA testing by employees of CDOT or designated agents of CDOT. The requirements that must be met for an employee to be qualified are defined in CP 10 of this manual.

9. LABORATORY QUALIFICATION PROGRAM

9.1 23 CFR requires that laboratories conducting tests used in the acceptance decision or laboratories conducting IA testing be qualified. This includes CDOT and designated agent laboratories conducting verification tests plus contractor and vendor laboratories conducting QC testing used in the acceptance decision. These laboratories are inspected by the Region Materials Laboratory or a designated agent selected by the Region Materials Laboratory before project testing begins. The procedures for conducting inspections are described in CP 10 of this manual.

9.2 23 CFR requires that the CDOT Central Laboratory be accredited by AASHTO. Designated agents conducting IA sampling, testing, and inspections for CDOT must also be accredited by AASHTO. The detailed accreditation requirements are in CP 10 of this manual.

9.2.1 Qualifications:

9.2.1.1 Central Laboratory and designated agents: The CDOT Central Laboratory and designated agents shall be AASHTO accredited.

9.2.1.2 **Annual Region Materials Laboratory Inspections:** Central Laboratory personnel shall perform an inspection of each CDOT Region Materials Laboratory annually.

The CDOT Region Materials Laboratories are:

- Region 1: Denver & HMA Mobile Lab
- Region 2: Pueblo & HMA Mobile Lab
- Region 3: Grand Junction & HMA Mobile Lab
- Region 4: Evans & HMA Mobile Lab

- Region 5: Durango, Alamosa & HMA Mobile Lab
- Region 6: Denver

Other permanent laboratories within the Regions are considered Project/Field Laboratories.

9.2.1.3 The Annual Region Materials Laboratory Inspections protocol is located in the Inspection (Central-to-Region) Chapter.

9.2.2 Equipment Verification Checks: All laboratories performing IA testing shall conduct verification checks at the minimum frequencies required by the test procedure, equipment operating guides, or Verification schedule included in the Field Materials Manual's Inspections Chapter. The results of the equipment verification checks shall be recorded on CDOT Form #520 and retained for a period of seven years. When testing HMA, the appropriate calibration checks specified in CP-L 5101 shall be used.

9.3 Verification Testing: CDOT Laboratories or their designated agent shall be allowed to perform verification testing if they meet the following requirements. All requirements include the verification of testing equipment function, review of equipment maintenance, and review of the records of all equipment calibrations and verifications.

9.3.1 Annual Inspection:

9.3.1.1 CDOT Laboratories: The Region Materials Laboratory shall conduct a check of project testing Field Laboratory equipment. The Central Laboratory may also conduct random Field Laboratory equipment inspections during project construction. The Resident Engineers, in cooperation with the Region Materials Engineer, shall be responsible for assuring that CDOT owned project testing equipment is acceptable for verification (QA) sampling and testing.

9.3.1.2 Designated Agent Laboratories: The Region Materials Laboratory or their designated agent shall conduct a check of project testing laboratory equipment. The Central Laboratory may also conduct random Field Laboratory equipment inspections during project construction. The Region Materials Engineer shall be responsible for assuring that project testing equipment is acceptable for verification (QA) sampling and testing.

9.3.2 Equipment Verification Checks: All laboratories performing verification (QA) testing shall conduct equipment verification checks on all testing equipment used. The results of the verification checks shall be recorded on CDOT Form #520 and retained for a period of seven years. When testing HMA, the appropriate verification checks specified in CP-L 5101 shall be used.

9.3.3 If the actual laboratory in which the verification tests are performed holds current AASHTO accreditation, it shall be exempt from the requirements of Subsection 9.3.1 and 9.3.2.

9.4 **Round Robins** are conducted every year during the winter season. It provides all participating laboratories the opportunity to look at their test procedures and test results in relation to other labs.

9.4.1 The Round Robin protocol is located in the Inspection (Central-to-Region) Chapter.

10. LABORATORY ACCREDITATION

10.1 CDOT's Central Laboratory must be accredited. 23 CFR Part 637 requires that designated agent laboratories conducting IA testing be accredited. Accreditation requirements are detailed in CP 10 of this manual.

10.2 Central Laboratory Inspection. The CDOT's Central Laboratory will be inspected periodically by the AASHTO Accreditation Program utilizing laboratory assessment and proficiency sample services provided by AMRL and CCRL.

10.2.1 The AMRL and CCRL statistical reports and the report on Central Laboratory inspection will be reviewed by the CDOT Materials Engineer and Central Laboratory Program Managers, and copies will be furnished to the FHWA.

10.2.2 Any deficiencies in Central Laboratory procedures or equipment will be corrected at the earliest opportunity, and corrective actions documented where directed and furnished to the appropriate National Standards Reference Laboratory, and with copies furnished to the FHWA.

10.2.3 Any AASHTO Proficiency Sample(s) which have a rating of less than 3 (>2.0 Standard

Deviations), will be reviewed by the CDOT Materials Engineer and Central Laboratory Program Managers. The cause of the low ratings will be investigated and corrective action will be taken to prevent future occurrences. These actions will be reported, in writing, to AASHTO – AMRL-CCRL, with copies furnished to the FHWA, within 60 days of the date of AMRL-CCRL inspection.

11. PROJECT MATERIALS CERTIFICATION

11.1 A CDOT Form #250 “Materials Documentation Record” will be developed by the Documentation Unit of the Materials and Geotechnical Branch for all projects regardless if they are administered by CDOT or by a local agencies. On Design/Build projects the Engineer shall send the list of pay items and approximate quantities furnished by the Contractor to the Documentation Unit of CDOT Materials & Geotechnical Branch as soon as it is received.

11.2 The CDOT Form #250 will list the minimum sampling and testing requirements for each product or material bid item, for both Verification (QA) tests and laboratory check tests. The original Form #250 will remain in the Staff Materials project file with duplicate copies being distributed to the Region Materials Engineer, Resident Engineer, Project Engineer, or the Region’s Local Agency Coordinator.

11.3 The Engineer will document actions taken by project personnel concerning acceptance decisions based on verification (QA) sampling and testing. Acceptance decisions include price reductions, corrective actions or removals, dispute resolution, etc.

11.4 The results of laboratory check tests will be evaluated using the same criteria detailed in Table One of the IA Schedule. They will be reported to the project personnel as follows:

11.4.1 Meets Acceptance Decision Criteria based on verification (QA) sampling and testing.

11.4.2 Minor Difference from Acceptance Decision Requirements: No further action required.

11.4.3 Significant Differences from Acceptance Decision Requirements: Further action is required.

11.4.3.1 When laboratory check test results do not agree with the contract requirements, whether the check tests are performed at the Central or Region Laboratory, project personnel will be notified by telephone, and the reports, by hard (paper) copy or computer reporting, will be forwarded as soon as possible.

11.4.3.2 The Project Engineer will investigate these Significant Differences and attempt to determine why the verification tests did not correlate with the check tests. The Engineer will determine and document the reason for the deviation or difference, and any corrective action taken.

11.5 The Project Engineer will document all project materials sampling and testing through the completion of the CDOT Form #250 and by signing and dating the last page.

11.6 The Region Materials Engineer will furnish the Project Engineer with a completed and signed copy of the CDOT Form #379, *Project Independent Assurance Sampling Schedule*. The responsibility for the review and completion of the CDOT Form #379 will reside with the Region Materials Engineer, as per Subsection 7.3 and 7.10.

11.7 In order to make the Final Materials Certification process more efficient it has been decentralized; therefore, the Final Materials Certification for each project is to be completed by Region personnel.

11.7.1 Final Materials Certification. The Documentation Chapter of the Field Materials Manual provides specific guidelines for the completion of this aspect of the program.

11.8 The Project Engineer reviews and signs the developed CDOT Form # 473, *Letter of Final Materials Certification*, both Page 1 and 2.

11.9 The Resident Engineer certifies on the CDOT Form #473, *Letter of Final Materials Certification*: **The results of the tests on the acceptance samples indicate that the material incorporated in the construction work, and the construction operations controlled by sampling and testing, were in conformity with the approved plans and specifications; and such results compare favorably with the results of the Independent Assurance**

sampling and testing. The signed Form #473 includes the following attachments:

11.9.1 A copy of the Explanation of Exceptions, Form #473 Page 2.

11.9.2 A copy of the Project Independent Assurance Sampling Schedule, Form #379.

11.9.3 A copy of the Final Materials Documentation Checklist, (Project Closure), Form #1199 Page 1.

11.9.4 A copy of the Finals Materials Documentation Checklist, (Review or Audit), Form #1199 Page 2.

11.9.5 A copy of the CP 16, Evaluation of Materials Testing, Form #1324 (when applicable).

11.10 The Letter of Final Materials Certification (Form # 473) will be distributed per the instructions in the Documentation Chapter of this Manual. If any part of the CDOT Form #250 is used to explain exceptions or deviations of product or materials, that part must be attached to the completed Form #473 Page 2, Explanation of Exceptions. If any of the last five sections [Documentation for Added Materials Items, Documentation for Deleted Materials Items, Summary of Laboratory Check Test Deviations, Summary of Sampling and Testing Deviations, and Summary of Project Price Reduction Documentation] contain information then these pages must also be attached.

11.10.1 The Explanation of Exceptions will address all materials deviations from the plans and specifications and the subsequent action taken, as well as any comparison differences between Quality Assurance test results and Independent Assurance test results, and any missing tests.

11.11 The Region review process for a completed construction project's materials documentation is that each Region will follow the guidelines as defined in the Documentation Chapter. It is essential to follow both the Residency-to-Residency Final Materials Documentation Review and the Region Final Materials Documentation Audit of the current Field Materials Manual.

11.12 The CDOT Materials Engineer will establish a Materials Documentation Quality

Review Team to audit each Region's Finals Materials Review and Acceptance Process.

11.12.1 The Materials Documentation Quality Review Team will consist of representatives from the Central Materials Laboratory and the FHWA, if they choose to participate, meeting with the CDOT Region Materials Engineer and the Finals Materials Engineer and/or the Finals Materials Documentation Coordinator.

11.12.2 A review of each CDOT Region's Finals Materials Documentation Process will be performed every two years, at a minimum. The review will utilize both a questionnaire and the audit of two randomly selected completed CDOT projects. LA projects will be randomly selected and included in the audit. Additional reviews may be scheduled as deficiencies are identified and to accommodate contract dollar volume per Region.

11.12.2.1 The **Biennial Finals Materials Documentation Review and Acceptance Process Audit** with the Region Materials Engineer is to ensure compliance with the requirements of the Documentation Chapter of the Field Materials Manual and to identify areas for potential improvement. A minimum of two weeks notice will be given to the Region Materials Engineer.

11.12.2.2 The findings and recommendations of the audit will be discussed with the CDOT Materials Engineer and will be reported to the FHWA.

11.12.2.3 Distribution List:
FHWA - Direct Recipient
Chief Engineer
Director of Staff Services
Regional Transportation Director
Program Engineer
Resident Engineer
Region Materials Engineer

12. MAINTAIN QA PROGRAM REQUIREMENTS

12.1 It will be the responsibility of the CDOT Materials & Geotechnical Branch to maintain and periodically update the QA program as required.

12.2 The CDOT Materials Advisory Committee (MAC) will meet, as required, to review the Quality Assurance Program and recommend revisions to the CDOT Materials & Geotechnical Branch.

13. FIELD MATERIALS DOCUMENTATION

13.1 It is the responsibility of the Project Engineer to accept or reject materials and/or products based on documentation submitted at the project level. The Central Laboratory personnel will act only in an advisory capacity to the project personnel in determining the acceptability of a product or material unless otherwise stated.

13.2 All materials Forms must have the appropriate project number and the project code easily identified on them:

13.2.1 Project Number: The Alpha-Numeric identifier.

13.2.2 Project Code: The five digit numeric designator (previously referred to as the sub-account number).

NOTE 2: As accounting processes change, the project information identifiers may also change. Personnel should be aware of the most current method.

13.3 All document and reporting Forms must be dated and signed by the appropriate and specified personnel.

13.4 In order to comply with adequate field documentation as stated in the CDOT Construction Manual, project field work sheets should be handled in the following manner:

13.4.1 The first Form will have a printed name and signature.

13.4.2 Thereafter the Form can be initialed by the same person.

13.4.3 If at any time the project personnel are changed, the above process will be started over.

13.4.4 The final worksheet in any series of testing for any pay item will have the last Form signed, rather than initialed.

13.5 Where predominately computer forms or worksheets are being used on a project, sufficient information will be available in the project records to determine the responsible party performing the sampling, testing, documentation, and record keeping.

14. DISTRIBUTION OF MATERIALS RECORDS and RETENTION OF SAMPLING and TESTING RECORDS

14.1 All originating materials (original document) records for construction projects are to be kept in the project file in the Region. These include, but are not limited to, COCs, CTRs, and all Forms that document test results for acceptance of materials or products used on construction projects.

14.2 These records may be made available to the public through a written request on CDOT Form #1092, *Public Records Inspection Request*.

14.3 The appropriate Forms (such as CDOT Form #157) that aid in the identification of samples and provide instructions for testing of samples will be attached to each individual sample submittal form, addressed to the appropriate laboratory.

14.4 The Central Laboratory personnel will provide acceptance details on products and materials that are stated in the Frequency Guide Schedule for Sampling and Testing or other applicable documents that state the Central Laboratory is directly involved.

14.4.1 Do not send copies of product or materials forms, or associated documentation to any Staff branch unless it is specified on the Form distribution or specifically addressed to do such in the Field Materials Manual.

14.5 Copies of product and/or materials reports for acceptance decisions and IA reports will be retained for all CDOT projects at the designated Region office for the period specified in CDOT's Records Retention Procedural Directive.

15. TRAINING PROGRAMS and SEMINARS for CDOT PERSONNEL

15.1 Region Materials Training Programs. Formal training courses in materials sampling and testing will be conducted in each Region as needed, by the Region Materials Engineer for new state personnel assigned to construction projects.

15.2 Annual refresher courses will be conducted on an as needed basis in each Region by the Region Materials Engineer for CDOT personnel involved with construction products and

materials sampling and testing.

15.3 Statewide Materials Training Programs: The Central Laboratory will conduct training programs on an as needed basis in specific areas of materials engineering properties intended to address statewide concerns. This may include sampling of materials and testing procedures. Central Laboratory personnel are also available to participate in Region training programs when requested.

15.4 Materials engineering conferences may be scheduled by the Central Laboratory. Participants may include representatives from Region Materials and Region Construction Offices as well as Central Laboratory Program Managers and personnel from other Staff Branches. Each Region Materials Engineer may submit items during the construction year for the agenda.

15.5 The Concrete Unit of the Central Laboratory will define, coordinate, and support a program for CDOT personnel to assure the accuracy and conformance of compressive strength testing of concrete cylinders. The program shall include equipment checks, procedure checks, inter-lab testing, training, and ACI certification. The details of this program are in Chapter 600 of the Field Materials Manual.

15.6 The Nuclear Unit of the Central Laboratory will present the *School of Radiological Safety and Nuclear Gauge Operation* on a biennial basis for re-certification of materials testers, or annually as needed for new employees.

16. TERMINOLOGY AND ABBREVIATIONS

16.1 Titles having a masculine gender, such as he, his, him, are utilized for the sake of brevity and are intended to refer to persons of either sex.

16.2 Whenever an abbreviation is used, it is to be construed to be the same as the respective expression.

16.3 Whenever an acronym is used, it is to be construed to be the same as the respective expression.

16.4 Whenever the title, the Engineer, is mentioned it refers to the Chief Engineer of the Department acting directly or through an

authorized representative, who is responsible for engineering and administrative supervision of the project.

16.5 The Staff Materials & Geotechnical Branch, Staff Materials, the CDOT Materials Lab, and the Central Laboratory are all synonymous with respect to this publication.

17. EXAMPLES

17.1 Examples of the CDOT Form #250 (first and last three pages only), #379, #473 (Page 1 & 2), and #1199 (Page 1 & 2) referenced in this chapter can be found in the Documentation Chapter.

17.2 An example of CDOT Form #520 referenced in this chapter can be found in the Inspections (Central to Region) Chapter.

17.3 An example of CDOT Form #1092 is not provided in this Manual; however it may be obtained through the CDOT Forms Catalog.

{This page was intentionally left blank.}

Documentation – Project Materials to Final Materials - 12

1. SCOPE

The intent of this chapter is to provide the Region personnel guidance from the beginning of the project to the closure of the materials portion of the project files. The materials documentation on a project needs to be accurate, complete, and processed within 120 days after final acceptance to ensure that the quality of the project is maintained and to avoid legal and contractual conflicts.

2. GENERAL REQUIREMENTS

The procedures referenced are to be followed as indicated for both CDOT projects and for Local Agency projects. The materials documentation procedure begins at the Materials and Geotechnical Branch in the Documentation Unit with the creation of the *Materials Documentation Record*, CDOT Form #250, and at the Region Materials Laboratory with the creation of the *Project Independent Assurance Sampling Schedule*, CDOT Form #379. Final Materials Documentation is to be prepared and reviewed as provided in this chapter. Details on Documentation procedures for individual items are contained in the applicable Sections of this Manual and they cover most situations encountered, but exceptions may require special attention.

3. LOCAL AGENCY (LA) PROJECTS

When projects are funded with Federal and Local Agency funds, an Inter-Governmental Agreement (IGA) is required between CDOT and the Local Agency to define project scope, project responsibilities, detailed funding amounts, encumbered project funds, and payment obligations. The State of Colorado administers, oversees, or monitors the Federal-Aid Local Agency (LA) Transportation Projects.

3.1 Local Agency Contract Administration Checklist will:

3.1.1 Designate that the Documentation Unit of the CDOT Materials & Geotechnical Branch is responsible for the development of the CDOT Form #250, *Materials Documentation Record*.

The checklist will also designate who is the responsible individual for updating the Form #250 as work progresses, and who is the responsible individual required to sign the "Reviewed and Approved By" upon completion of the project.

3.1.2 Designate that the applicable CDOT Region Materials Engineer's (RME) staff is responsible for the development of the CDOT Form #379 *Project Independent Assurance Sampling Schedule*. The CDOT RME will sign the "Approved By". The checklist will designate who is the responsible individual for completing the Form #379 throughout the project, and who is the responsible individual required to sign the "Final Review By" upon completion of the project.

On National Highway System (NHS) projects the Independent Assurance Sampling, Testing and Witnessing shall be accomplished by CDOT personnel or its designated agent employed by an AASHTO Accredited Laboratory.

3.1.3 Designate who is the responsible individual for the development of the CDOT Form #473, *Letter of Final Materials Certification* and *Letter of Materials Certification Explanation of Exceptions (Pages 1 and 2)*. The checklist will designate the responsible individual required to sign the "Approved by" for the Local Agency Project Engineer / Project Manager. The applicable CDOT Resident Engineer will sign the "Approved by".

3.2 Construction administration, inspection, materials testing, and documentation for LA projects shall follow this Field Materials Manual, and the latest version of the Local Agency Manual.

3.2.1 The Local Agency should utilize Section 4 as much as is applicable in the organization and completion of their project materials documentation.

3.3 The Local Agency should utilize Section 7 for the Distribution of their Finals Materials Documentation.

4. CDOT PROJECTS – RESPONSIBILITIES & PROCEDURES

The Project Engineer, as the representative of the Chief Engineer, is responsible for Materials Documentation on his Project. The Project Engineer should take measures to ensure that Documentation Procedures of the Department and the Region are followed. All referenced documentation activities within the *Before Construction*, *During Construction*, and *After Construction* sections are the responsibility of the Project Engineer or his designee.

4.1 Before Construction:

1. Review the Project Plans and check the Project Special Provisions for any modified testing procedures.
2. Review the developed CDOT Form #250. This will enable the Project Engineer to be aware of the types and frequencies of tests that the project quality assurance (QA) tester will be performing.
3. Review the developed CDOT Form #379. This will enable the Project Engineer to be aware of the frequency of the independent assurance (IA) tests that will be performed.
4. Set up the Project Material Books. Ensure that the format is as described in the Organizational Guide for Project Material Books in Section 14.
5. Review the Special Notice to Contractors. Make note of the applicable acceptance level for the materials being incorporated into the project.
6. Ensure items and testing frequencies included in other work are accounted for in the Form #250, the Form #379, or for Pre-inspection. (For example, Structural Backfill has been included with the MSE wall.)
7. Develop list of Pre-inspected Items.
8. Collect submitted list of proposed materials suppliers from the Contractor. Ensure that all steel and iron products permanently incorporated in the work are domestically produced in accordance with Section 4 of the Special Notice to Contractors.
9. Evaluate the Contractor's materials suppliers list against the requirements of CP 11, the **Qualified Manufacturers List (QML)**, and the **Approved Products List (APL)** on the web.

www.coloradodot.info/business/apl

10. Identify sources of undesigned materials.
11. Set up Random Sampling Schedules (CP 75).
12. Assure Concrete Mix Design Approval, if required.
13. Assure Asphalt Job Mix Formula Approval, if required.
14. Schedule and participate in pre-testing meeting. Use CP 16, Pre-Testing Meeting Agenda (CDOT Form #1322), if applicable.
15. CDOT Forms must be the most recent revisions as referenced in the FMM Appendix and located on the web.
www.dot.state.co.us/FormsMgmt/

4.2 During Construction

NOTE 1: Detailed information on the completion and distribution of the CDOT Form #250, #379, #1199 (Page 1), and #211 is presented on pages 7 thru 9.

1. Sample and Test according to the Random Sample Schedule (CP 75).
 2. Ensure that the Engineer and Inspectors have communicated with the QA tester: activities, production, materials or product deliveries, Contract Modification Orders (CMO), altered quantities, and additional items not considered on the Form #250.
- NOTE 2:** The Project Engineer needs to communicate the field-adjusted quantities from the CMOs and the Minor Contract Revisions (MCRs) to the Region Materials Engineer (RME) and the IA Tester.
3. Complete on a daily basis the sampling and testing documentation (worksheets & reports).
 4. File on a daily basis all materials acceptance documents such as Certified Test Reports (CTRs), Certificates of Compliance (COCs), references to the applicable pages from the CDOT APL, etc.
 5. File, within appropriate tabbed sections of the project binder(s) on a daily basis, all completed paperwork.
 6. Submit required samples to the Region Materials Laboratory in accordance with the Frequency Guide (QA) Schedule.
 7. Submit required samples to the Central Laboratory in accordance with the Frequency Guide (QA) Schedule.

8. Inform Region Materials Laboratory IA Tester of any upcoming IA sampling and testing per the Form #379.
9. Ensure that all required information is added to the Form #250 as testing progresses. It is very important to complete the applicable portions of the last five sections [Documentation for Added Materials Items, Documentation for Deleted Materials Items, Summary of Laboratory Check Test Deviations, Summary of sampling and Testing Deviations, and Summary of Project Price Reduction Documentation] at the time this information becomes available.
10. Perform Price Adjustment Calculations prior to Estimates in accordance with Sections 105.03 to 105.07 of the Standard Specifications.
11. On a monthly basis monitor quantities from Progress Estimates.
12. Make sure Price Adjustments are on the Progress Estimates.
13. On a daily basis keep an updated list of Exceptions to Specifications.
14. Write explanations for each Exception and keep it in the project file as they occur. This will facilitate the completion of the Form #473, Explanation of Exception, at the end of the project.
15. Participate in weekly materials testing meetings as necessary utilizing CP 16, Weekly Meeting Agenda (CDOT Form #1323).

4.3 After Construction

NOTE 3: The project personnel are to review 100% of the Items and materials documents at this time. To provide an indication that the review is being performed an actual check mark (✓) in pencil be placed on all of the applicable documents being reviewed.

1. Sort and arrange all documents within the Project Materials Books sequentially by Item number and then by date (most recent first behind the applicable tab) for ease of review. [The first tabbed section will be the documents as referenced in the Table of Documentation Distribution-1 with all of the documents in the order shown. This will not only aid in the closure process but also facilitate the review and audit process.]

2. Use the Finals Materials Documentation Checklist, (Project Closure) CDOT Form #1199 Page 1, to document that the subsequent steps have been followed. A black check mark (✓) is to be placed within all verification boxes or click on the applicable box if it is being completed on the computer.
3. Compare final quantities from the latest Progress Estimate to the Form #250 final quantities. Write the Progress Estimate Number (date) used on Page 1 of the CDOT Form #1199.
4. Verify that the Field Sheet / Serial Numbers on the Form #250 match the project documents.
5. Document on the Form #250 the total number of tests taken by the QA Tester.
6. Verify that any shortages of required tests as indicated on the Form #250 are explained.
7. Independent Assurance Tests (IATs):
 - 7.1 Verify that the Field Sheet / Serial Numbers on the Form #379 match the project documents and all tests agree with field acceptance tests, and if applicable, shortages and exceptions are explained.
 - 7.2 Ensure the correct number of tests on the CDOT Form #379. Indicate if Project Basis or System Basis.
 - 7.3 Ensure that IA Witness tests did not exceed 20% of actual testing for each test element.
 - 7.4 Ensure that Independent (IA) / Acceptance (QA) / Check Test differences are explained.
 - 7.5 Ensure that the Form #379 has a Final Review By signature of the RME and then has been returned to the Project Engineer.
8. Make sure all Pre-Inspected items have a Form #193, when applicable.
9. Make sure a Line Item exists for each Price Adjustment. A separate Line Item is preferred, if a lump sum method is used, submit a detailed explanation.
10. Make sure there is a brief explanation for material accepted at full price, Percent of reduction in contract price (P) less than 3, is noted on the field form(s) when submitted.

NOTE: Reference to P is addressed in Standard Specifications, Section 105.03.
11. Check all Price Reduction Calculations, P greater than or equal to 3.
12. Check explanation for all material repaired or replaced, P greater than 25.

13. Check all of the input values for accuracy on Quality Control / Quality Assurance (QC/QA) projects with incentive/disincentive specifications.
14. Send a copy of the final QC/QA data to the RME and to the Staff Materials Pavement Design Program (QC/QA Manager) on a computer disk or by E-mail. (Personnel Roster is in the Appendix). Verification of receipt by Staff Materials is required to be retained in the file with the QC/QA data. On the Form #1199 write the date sent to the QC/QA Manager.
15. Complete CP 16, Evaluation of Materials Testing (CDOT Form #1324) for all consultants.
16. The Project Engineer or the Finals Materials Documentation Coordinator (if so designated by the RTD) is responsible for initially developing the *Letter of Final Materials Certification*, CDOT Form #473. This includes the Explanation of Exceptions (Form #473 Page 2) which should have been maintained throughout the project in accordance with *During Construction #14*.
17. Prior to the submission of the last Progress Estimate, the Project Engineer shall have all the documentary evidence needed to show that the contractor has complied with the requirements of the Contract Plans and Specifications for all materials used in accordance with the CDOT Field Materials Manual - Quality Assurance Procedures for Construction and Materials Sampling and Testing chapter.
18. Ensure that all required documents from the Contractor have been received: such as: Buy America Certificate, CTRs, COCs, etc so that upon Final Acceptance the Finals Materials Documentation review and audit process can be completed within 120 days.
19. Collect the Contractor's QC Notebook for HMA and PCCP as per CP 12A and CP 12B respectively.
20. 100% of the Project Material Books are to be immediately forwarded to the Region Final Materials Documentation Coordinator.

5. INDEPENDENT REVIEW REQUIREMENT [i.e. RESIDENCY – TO – RESIDENCY FINAL MATERIALS DOCUMENTATION REVIEW]

The Region Finals Materials Documentation Coordinator in cooperation with

each of the Resident Engineers will distribute the Materials Documentation to a different Residency for their review upon receiving the last Progress Estimate. Cross-residency reviews provide a greater degree of independence and critical evaluation.

The Region Finals Materials Documentation Coordinator will prepare the CDOT Form #1199 Page 2, Finals Materials Documentation Checklist, (Review or Audit) and list the four major items. The Items of work that involve the four largest amounts of money as indicated by the original contract shall be considered Major Items. Major Item #1 will be the most expensive and Major Item #4 will be the fourth most expensive. Using the Form #1199 the Finals Materials Documentation Coordinator will randomly select one of the listed Major Items for the reviewer to check completely. The actual review process utilizing the Form #1199 for the Review is similar to that used for the Project Closure; however, there are some modifications because the Project Engineer or designee is performing a 100% check.

NOTE 4: To verify the steps performed by a reviewer, it is required that an actual check mark (✓) in blue ink be placed on all of the applicable documents being reviewed.

1. Compare final quantities from the latest Progress Estimate to the Form #250 final quantities. Verify the number of the Progress Estimate used on Page 1 of the CDOT Form #1199. If a more recent Progress Estimate has been issued it should be used and noted.
2. Verify that the Field Sheet / Serial Numbers on the Form #250 match the project documents.
3. Verify on the Form #250 the total number of tests taken by the QA Tester.
4. Verify that any shortages of required tests as indicated on the Form #250 are explained.
5. Independent Assurance Tests (IATs):
 - 5.1 Verify that the Field Sheet / Serial Numbers on the Form #379 match the project documents and all tests agree with field acceptance tests, and if applicable, shortages and exceptions are explained.
 - 5.2 Ensure the correct number of tests on the CDOT Form #379. Indicate if System Basis or not.

- 5.3 Ensure that IA Witness tests did not exceed 20% of actual testing for each test element.
- 5.4 Ensure that Independent (IA) / Acceptance (QA) / Check Test differences are explained.
- 5.5 Ensure that Form #379 has a Final Review By signature of the RME and then returned to the Project Engineer for its inclusion with the Form #473.
6. Make sure all Pre-Inspected items have a Form #193, when applicable.
7. Make sure a Line Item exists for each Price Adjustment. A separate Line Item is preferred, if a lump sum method is used, submit a detailed explanation.
8. Make sure there is a brief explanation for material accepted at full price, Percent of reduction in contract price (P) less than 3, is noted on the field form(s) when submitted.
NOTE: Reference to P is addressed in Standard Specifications, Section 105.03.
9. Check all Price Reduction Calculations, P greater than or equal to 3.
10. Check explanation for all material repaired or replaced, P greater than 25.
11. Check all of the input values for accuracy on QC/QA projects with incentive/disincentive specifications.
12. Ensure that a verification of receipt for the final QC/QA data being sent to the RME and to the Staff Materials Pavement Design Program (QC/QA Manager) is on file. If it is not included in the file then send a copy of the QC/QA data to guarantee that it has been received. On the Form #1199 write the date sent to the QC/QA Manager.
13. Verify the completion of CP 16, Evaluation of Materials Testing (CDOT Form #1324) for all consultants.
14. Verify that the Letter of Final Materials Certification, CDOT Form #473 has an Approved By signature of the Project Engineer. This includes the Explanation of Exceptions (Form #473 Page 2). See the instructions for the Form #473 to ensure that the Explanation of Exceptions meets the requirements for completeness.
15. As part of the final Progress Estimate, the Project Engineer has included all the documentary evidence needed to show that the contractor has complied with the requirements of the Contract Plans and Specifications for all materials used in accordance with the CDOT Field Materials Manual - Quality Assurance Procedures for

Construction and Materials Sampling and Testing chapter. The CDOT Form #325, Final Estimate Data, is to be included in this process. If there is a delay obtaining the Form #325 then it will be included as soon as it is developed and signed.

If unresolved differences are identified in the complete check of the first randomly selected Major Item a second randomly selected Major Item will be checked completely. If unresolved differences are found in the second Major Item checked then both of the remaining two Major Items will be checked completely. If the existence of discrepancies or continued unresolved differences remains, a meeting will need to be scheduled between the Reviewer, the project's Resident Engineer, and the Project Engineer.

The completion of the Form #473 is required within 120 days after final acceptance in order to achieve a timely closure of the project. The Letter of Final Materials Certification is to have an Approved By signature of the Resident Engineer beneath the signature of the Project Engineer. The Explanation of Exceptions, Form #473 Page 2 may be edited as necessary; however, the one provided by the Project Engineer must accompany the edited version so that the RE is aware of the changes. The CDOT Form #473, Letter of Final Materials Certification, is a requirement for the closure of each construction project.

6. REGION FINAL MATERIALS DOCUMENTATION AUDIT

It is recommended that the audit of every fifth (5th) project from within the entire Region be performed in conjunction with and by the same Residency performing the Residency-to-Residency Review. The Finals Materials Documentation Coordinator will monitor all projects based on the Acceptance Date. The Finals Materials Documentation Coordinator will select, on a totally random basis, one of the three remaining Major Items and indicate that this item is to be audited. The item is to be reviewed fully in addition to the randomly selected Item from the four Major Items listed on the Form #1199 Page 2. This is to ensure that Region personnel become familiar with all aspects of project materials documentation on

all items. The results of the audit are to be documented by the Region Finals Materials Documentation Coordinator and communicated to the RME. Complete within the 120 days.

**7. Table of Documentation Distribution - 1
LA Project Finals Materials Documentation Packet**

Document Order	Distribution				
	#1	#2	#3	#4	#5
Form #473, Page 1	X	X		X	X
Form #473, Page 2, Explanation of Exceptions supporting documents (letters, CMOs, MCRs, etc)	X	X		X	X
Form #250 (all pages)	X	X		X	X
Form #379	X	X		X	X
Form #1199, Page 2	X	X		X	X
Form #1199, Page 1	X	X		X	X
Random Sample Schedule	X	X		X	

Distribution:

#1	CDOT Resident Engineer	Original
#2	LA Project Engineer / Project Manager	Copy
#3	CDOT Region Materials Engineer	Copy (Only if requested)
#4	CDOT Local Agency Coordinator	Copy
#5	Documentation Unit, Staff Materials & Geotechnical Branch	Copy

**Table of Documentation Distribution - 2
CDOT Project Finals Materials Documentation Packet**

Document Order	Distribution						
	#1	#2	#3	#4	#5	#6	#7
Form #473, Page 1	X	X	X	X	X	X	X
Form #473, Page 2, Explanation of Exceptions supporting documents (letters, CMOs, MCRs, etc)	X	X	X	X	X	X	X
Form #325, Page 1 & 2	X	X		X		X	
Final Estimate or last Progress Estimate	X	X		X		X	
Form #250 (all pages)	X	X	X	X		X	X
Form #379	X	X	X	X	X	X	X
Form #1199, Page 2	X	X	X	X	X	X	X
Form #1199, Page 1	X	X	X	X		X	X
Random Sample Schedule	X	X	X	X			
Price Reduction Calculation	X	X		X			
QC Data	X	X		X			
QA Data		X	X	X			
Buy America Certificate	X	X		X		X	
Roadway Surface Accomplishment Report (RSAR)	X	X	X	X			
Evaluation of Materials Testing, Form #1324 (per CP16)	X	X	X	X		X	X

Distribution:

#1	Resident Engineer	Original
#2	Project Engineer	Copy (Only if requested)
#3	Region Materials Engineer	Copy
#4	Region Finals Engineer	Copy
#5	FHWA (Oversight Projects Only)	Copy
#6	Documentation Unit, Staff Materials & Geotechnical Branch	Copy
#7	Records Center	Copy

8. CDOT FORM #211 – Completion Instructions [Materials Documentation Request]

The Final Materials Documentation Project Closeout and the Final Materials Documentation Review or Audit activities will discover that occasionally required documents will be missing. Individuals performing the closeout, review or audit should use this form or comparable e-mails to allow for a paper trail in the effort to obtain the missing documents. The original project personnel may have misplaced or lost a field materials worksheet or report. The Contractor may have not forwarded required COCs or CTRs. Because time is critical always indicate a due date and follow through immediately if that date has passed. If e-mail queries are being used, write on the "Subject:" CDOT Materials Documentation Request or CDOT Form #211. Staple the resolution Form #211s or e-mails to the CDOT Form #1199s.

NOTE 5: The CDOT Forms #250, #379, #473, and both #1199s that have been referenced are integral to the Materials Documentation process, both at the project level and at the review and audit level. Therefore, the subsequent explanation of each of the form's requirements is addressed at this point.

9. CDOT FORM #250 – Completion Instructions [Materials Documentation Record]

The Project Engineer is responsible for the initial review of the Form #250 and contacting the Staff Materials & Geotechnical Branch if there is a problem with the form. Ensuring the proper completion of the Form #250 and then applying the signature to Reviewed and Approved by is the Project Engineer's responsibility. If a consultant tester is utilized on the project a professional engineer with the consulting company must sign and place his PE stamp on the last page of the Form #250.

Completion of the CDOT Form #250 will include the following as substantiating documentation:

1. Entering Final Materials Quantities.
2. Inclusion of Quantities added by Contract Modification Order(s) on CDOT Form #90.
3. Breakout and inclusion of Quantities not listed separately in the Bid Schedule (e.g. –

quantities included in Lump Sum Items, etc.).

4. Verification that minimum testing frequencies have been accomplished.
5. Explanation of Exceptions for Material Specification Deviations.
6. Documentation of Exceptions, for comparison differences between Quality Assurance (QA) Test results and Independent Assurance (IA) Test results.
7. Documentation of Exceptions for Price Reductions when P is greater than or equal to 3. Specification deviations that have a price reduction factor (P) of less than 3 require that the exception be noted on the submittal sheet referenced in the Field Materials Manual – QA Schedule. A copy of the calculations should be attached.
8. Documentation of Exceptions for remedial action when P is greater than 25.
9. Documentation of Exceptions for an insufficient number of tests.

NOTE 6: If the Guidelines for Test Frequency Reduction are utilized then reference it specifically, do not just state "waived by the Project Engineer".

10. Documentation of Exceptions for a lack of tests for Items included in Lump Sum Payments.
11. Documentation of Exceptions for a lack of tests for Items included in extra work.

Distribution:

Note: Submit the entire completed copy, not just the first and last page.

10. CDOT FORM #379 –Completion Instructions [Project Independent Assurance Sampling Schedule]

The Project Engineer is responsible for ensuring that the Region Materials Engineer's IA Staff are kept informed throughout the course of the project. The QA Procedure Chapter, Subsection 7.5.1.2 and throughout Subsection 7.9 describes the exact responsibilities that the Project Engineer has with regard to the Form #379.

The Region Materials Engineer will assign an individual from the Region Materials Laboratory to develop the CDOT Form #379, *Project Independent Assurance Sampling*

Schedule. Either the Region Materials Engineer, or his designee, will perform the initial review to provide independence between development and review. The Region Materials Engineer, or his designee, will approve the CDOT Form #379 prior to distribution to the Project Engineer. The RME or his designee will send a copy of the #379 to the appropriate Project Engineer, even if a copy has been sent to the project (QA) tester. When all of the Form #379 IA sampling and testing on the project is completed, the RME will certify it through his Final Review and then forward the signed Form #379 to the Project Engineer.

Completion of the CDOT Form #379 will include:

1. The actual number of tests completed.
2. An Explanation of Exceptions for comparison differences between Quality Assurance (QA) Test results and Independent Assurance (IA) Test results, as defined in Section 7.9 of the QA Procedures chapter.
3. An Explanation of Exceptions for an insufficient number of tests.
4. The Field Sheet / Serial Numbers from the CDOT Forms correlated to the applicable CDOT Form Number and the test dates.
5. The completion of the statement "*All equipment was independent except as noted.*".

11. CDOT FORM #473–Completion Instructions [Letter of Final Materials Certification, Page 1 & 2]

The Project Engineer is responsible for ensuring that the Letter of Final Materials Certification, CDOT Form #473 is developed. This includes the Explanation of Exceptions (Form #473 Page 2) which should have been maintained throughout the project. The Region's Finals Materials Documentation Coordinator may be designated by the RTD to initially prepare the Form #473 Page 1. The Project Engineer applies the first Approved By signature to the form because it is his project and he would be aware of all issues associated with his project. The Resident Engineer for the project applies his signature under Approved By on the Form #473 because of his ultimate responsibility and authority. He may edit the Explanation of Exceptions (Page 2) as necessary, after the completion of the Final Materials Documentation Review.

Explanation of Exceptions (Page 2):

[Examples only, not all inclusive.]

- Missing documents such as CTRs, COCs, Buy America, Asbestos management Certification
- Section 9 (Form #250) and Section 10 (Form #379) have specific Exceptions that should be placed in this document.
- The last five sections from the form #250 [Documentation for Added Materials Items, Documentation for Deleted Materials Items, Summary of Laboratory Check Test Deviations, Summary of Sampling and Testing Deviations, and Summary of Project Price Reduction Documentation] may be attached.

Completion of the CDOT Form #473 will include:

1. The creation of Explanation of Exceptions is a compilation of recorded and documented explanations from throughout the project and also those recorded on the Form #250.
2. All issues that were referenced on the CDOT Form #1199 Page 1 and Page 2 were reviewed.
3. All CDOT forms and documents are assembled in the required order stipulated in Table Documentation-1. These are to be physically attached with pages stabled together as much as is possible.

12. CDOT FORM # 1199, Page 1 – Completion Instructions [Final Materials Documentation Checklist, (Project Closure)]

The CDOT Form #1199 Page 1 is a checklist to be used by the Project Engineer. The Project Engineer should utilize this form in the process of completing the #473 as both a guide and a means of documenting that specific issues were addressed and the required supplemental documentation was included in the finals packet.

It is understood that a subsequent Progress Estimate may be created after the Project Engineer has attempted to close out the project; therefore, the latest Progress Estimate number is to be recorded.

Thoroughly compare the latest Progress Estimate with the Form #250 to ensure that the materials quantities are correct. Verify that the form numbers and their respective serial

numbers match the project documents. Verify that the required tests match the tests reported (those actually performed). This process is repeated utilizing the Form #379.

Ensure that all of the supplemental documents referenced in the lower half of the Form #1199 are completed and available for inclusion in the final packet.

The Finals Materials Documentation Checklist for Project Closure is to be signed and dated by the Project Engineer or his designee.

13. CDOT FORM # 1199, Page 2 – Completion Instructions [Final Materials Documentation Checklist, (Review or Audit)]

The CDOT Form #1199 Page 2 is a checklist to be used in the Residency-to-Residency Review and in the Region Final Materials Documentation Audit. The Resident Engineer's reviewer or the Finals Materials Documentation Coordinator should utilize this form in the process of reviewing and auditing the submitted project files from the Project Engineer.

As stated in the Residency-to-Residency Finals Materials Documentation Review instructions and in the Region Finals Materials Documentation Audit instructions this activity is not meant to repeat the 100% project files check performed by the Project Engineer. Reviewing more than the one Major Item is to be reserved for responding to discrepancies and problems discovered in the review process.

Utilize the directions from Page 1 with respect to comparing the Final Estimate with the Form #250. Verify the testing with respect to the Form #379. Ensure that all of the supplemental documents referenced in the lower half of the Form #1199 were completed and included in the final packet.

The Final Materials Documentation Checklist for the Review or Audit is to be signed and dated by the Reviewer or the Finals Materials Documentation Coordinator.

14. ORGANIZATIONAL GUIDE FOR PROJECT MATERIAL BOOKS

SCOPE

The Field Materials Manual includes the "Frequency Guide Schedule for Minimum Sampling, Testing, and Inspection. This is the essential document to use when determining which CDOT forms to use as worksheets, which CDOT forms to collect as test reports, and what materials acceptance documents are required.

Utilize this Organizational Guide for Project Materials Books in both initially establishing the binders and maintaining them throughout the project. It is not inclusive of every materials Item, but it references the primary Items that you will encounter. It is critical to follow the Item numbering in sequential order to aid in locating project paperwork. Since this is a work in progress, contact the FMM editor with corrections or suggested additions.

Check Project Specials and Project Standard Revisions for additional paperwork that may be required.

Each bullet represents a subsection within the item and therefore needs to be properly divided. Sheet dividers or tabs properly identified will help to delineate the paperwork for ease in locating forms used as worksheets and test reports. Place the most recent or newest documents behind the applicable tab.

– **Core Project Documents**

- Form #250 in its entirety, even though a copy could be divided with the respective Item pages within each tab.
- Form #379.
- Random Sample Schedule.
- All documents listed in the Table of Documentation Distribution will be located here at the closure of the project.

– **203 Embankment**

- Soil Classification (Form #564) / Curves (Form #24) / Computer Moisture / Density with rock correction printouts with curve numbers on it.
Each curve will have all of the above stapled / attached together. Make an extra copy of the computer moisture / density curve to go with the gauge book.
- Soil Classifications (Form #564s) for your completed roadway soil survey data. (1 per 1000 ft. or change of soils.) Get these tests done as fast as you can so they can be submitted for an R-value in case there is a stability problem.
- #157s – This is for the samples sent to the Central / Region Laboratory for an R-value to complete your soil survey. Attach the test results from the Lab, to the corresponding #157 serial number. Note: For faster R-value results, attach a copy of your Form #564 (soil classification) that you completed above for that sample.
- Form #212s (Densities) – with the field test worksheets (in chronological order by date and test number) stapled / attached to this. Make sure your classifications match what is on your computer moisture / density curve. Project Engineer must sign this form when it is completed. You do not wait to the end of the project to fill this out. This form can be filled in and submitted weekly, bi-weekly, monthly, or however your Project Engineer may want this information to be submitted for signature. Communication between you and the Project Engineer is very important.
- Form #219 – completed Roadbed Soil Survey. You fill this in from the test results you receive from the #157 samples submitted. When this is completed, sign it and have it signed also by the Project Engineer. Then submit this to Region Lab, as soon as possible, for final approval. You will get a signed copy back, when it is approved, for your file.
- Sulfate testing for preliminary roadway soil survey data (1 per 1000 ft. or change of soils.) will use the preliminary soil survey Form #555. Soils sampled for sulfate testing will be identified for each soil layer and boring on this form. Additional information will be submitted on the Form # 157 identifying the test bore number, number and type (soil or water) of tests being submitted. The completed soil survey will include the sulfate percentage for each sample submitted.
- Sulfate testing for imported embankment (1 per 2000 yd³ or change in soils) will use the Laboratory Report on Item 203 (Embankment or Borrow) Form # 323.
- Corrosion tests for pipe material type selection will be submitted on the Form # 157 and Form #555 identifying the test bore or location number, number and type (soil or water) of tests being submitted.

– **206 Structural Backfill**

Class 1

- #157s – Sample submitted to Central / Region Laboratory for a gradation compliance check and a moisture / density curve. Attach the Lab test results to the corresponding #157 serial number.
- (Gradations) Form #6s that have the field gradation test worksheets (Form #565s) stapled / attached that are represented on that form in chronological order by test number and date.
- (Density) Form #6s that have the field density worksheets (Form #427s) stapled / attached that are represented on that form in chronological order by test number and date.

Class 2

- Classification (Form #564) / Curve (Form #24) / Computer printout of Moisture / Density Curve with rock correction.
All of this needs to be attached together with a Curve number on it (if there are several curves). Make an extra copy of the computer printout to go in the gauge book.
- Form #212 (Densities). Same as per Item 203.

Flow fill

You only need the #157 filled out for each Flow-Fill Mix Design used. Do not submit this mix design to the Central Laboratory. This stays in project records. Keep batch tickets.

Filter Material or Bed Course

You only need the Form #6. Attach field test sheets (Form #565s) to this form and get it signed by the project engineer.

Form #194

Structural Backfill Density Report is a summary to be filled out at the end of the project when you have the correct number of cross pipes / side drain pipes / minor structure / and major structure with their quantities broken out by the type of backfill. You will get this data from your Project Engineer, as well as the Project Plans and As-Builts.

Item 207

You will need to have a section for the test results and the #157 that was filed to delineate if it was a Contractor's Source, and this documentation should be accompanied by the Certified Test Reports (CTRs) the Contractor should submit with samples of the material. Check and document that the one the lab used was the one approved for use.

If the Material used was generated on project, document on a #157 and have the Project Engineer sign the #157.

Item 208

You should file a #157 for each of the items that you are documenting. Silt fence, Erosion Bales, and the Miscellaneous Items that were used. Make sure the materials have the proper documentation, and if applicable are on the Approved Products List (APL). It is helpful to print the applicable Form #595 with the information on the product found on the APL and file it behind the #157 for that item.

Item 209

You should document if the Landscaping water used was potable, or if a CTR was submitted and approved for use.

- If Magnesium Chloride is used for a Dust Palliative, document on a #157 and file the Certificate of Compliance (COC) behind it.
- If an Asphaltic material was used for a Dust Palliative, follow Item 403/411 requirements, and document.
- Embankment Moisture Control should be documented per specification.

Item 212

You should have separated areas for the seed, sod, and fertilizer. File the COCs behind the #157 documenting the quantities approved and that each meets CDOT Standards. Make sure you have copies of the Seed tickets filed behind the #157 and COC. Fertilizer should meet requirements of Standard Specification Subsection 212.02.

Item 213

There should be separate sections for Wood Cellulose, Mulch Tackifier, and Straw or Hay used.

- Wood Cellulose Fiber should be located on the APL, document, and file APL document behind #157.
- The Mulch Tackifier should be located on the APL, document, and file APL document behind #157.
- Straw and Hay should be accompanied by a COC stating material is "Weed Free." File behind #157 documenting that it was acceptable.

Item 214

You need separate sections for Plants, Humus, and Fertilizer.

- Plants are accepted by COCs, document on #157, and file COC behind the #157.
- Humus are approved by HQ Staff Landscape Architect. Document on #157 and file any paperwork given by HQ behind your #157.
- Fertilizer should be accepted by COC. File with #157 stating material meets requirements.

Item 215

- Plants are accepted by the Right-Of-Way Engineer, document on #157 his acceptance.
- Fertilizer should be accepted by COC. File with #157 stating material meets requirements.

Item 216

Soil Retention Blanket should be weighed, and measured, and document on #157, that the material is acceptable.

Item 217

This material is accepted by Staff Landscape Architect, document on #157 their acceptance and any paperwork from HQ should follow your #157.

Item 304

- #157s are for the samples sent to Central / Region Laboratories for R-value, Moisture / Density curve, gradation verification, LA Abrasion, etc. Follow "Guide Schedule for Minimum Materials Sampling, Testing and Inspection." Attach the test results with the appropriate #157 serial number that you receive back from the Lab.
- Form #6 (Gradations / Atterberg Limits) with the attached field test worksheets attached to this form. Project Engineer needs to sign this form.
- Form #6 (Densities) with the attached field test worksheets attached to this form. Project Engineer needs to sign this form.

The above section applies to all types of aggregate base courses (ABC). If you have several different types of ABC you need the three (3) sections for each type.

Item 306

Follow Item 203 requirements for documentation for this item, follow schedule of Item 306 for frequency of tests needed.

Item 307 Hydrated Lime

- #157 for each shipment (one per source, 1 per 100 ton, 2nd 100 ton, etc.).
- Keep shipment invoices listing “Date, BOL / COC number, tons shipped, and accumulative total”. This will help you know when to ship the samples you took per truck represents 100 tons or fraction thereof for testing. Basically, every 4 samples (1 per truck @ 25 tons per truck) you need to ship all of this to the Central Lab.

Item 307

There should be separate sections for the following:

1. Lime Treated Sub-Grade
 - a. Density reports on the Form #212
 - b. #157 documenting the Moisture Density Curves, (copy of curves should be kept in Nuclear Gauge book for field use).
 - c. Section should be kept for “depth” of lime treatment measurements.
 - d. Check schedule for lime samples to be submitted to HQ for testing, file results behind #157.
2. Quick Lime
 - a. CTRs and #157 documenting percent purity, source, and supplier. See “notes” under this item for calculations.
3. Mineral Fillers
 - a. Document gradations on Form #6.
 - b. Submit samples to Central Lab for testing every 500 tons, file results behind #157.
 - c. Document the Source, Supplier, and any other required information on #157 or other documents required by provisions.

Item 308

1. Portland Cement Treated Base
 - a. Densities should be recorded on Form #6.
 - b. Gradations should be recorded on Form #6.
 - c. Atterberg Limits should be recorded on proper forms and worksheets and filed.
 - d. Moisture and Density Curves should be filed behind #157 for each blend of soil and Cement.
2. Portland Cement and Fly Ash
 - a. Product must be on the APL. Print the information and file behind #157 that the product is acceptable.
 - b. File behind a #157 if the Engineer requested Bill of Lading and CTRs from supplier. File results behind #157.

Item 310

Document as per the Project Contract.

Item 403 HMA

- #157's – This is the aggregate sent in to check the mix design in the beginning, information samples sent to SuperLab, 1st 10K, 2nd 10K, etc. (Remember to send in a 25-lb belt sample from the plant along with a can of asphalt binder along with your 1st Rep. Sample to Region and Central Lab.
- Form #43 (Bottom mat)
- Stat. and drift test done on AC gauge prior to Calibration for the above Form #43. Calibration (Form #599).
- Check Testing Computations along with the worksheets from both testers.
- Random test sampling form.

- Form #1304, to be accompanied with the HMA sample submittal.
- % AC calculations with moisture correction calculations (Form #106). In numerical order. Remember to do your rice calculations and make sure they meet the $\pm .011$ tolerance between the split samples.
- Gradation tests with fractured face calculations on the worksheet (Form #106). In numerical order.
- Form #469 – Density correction sheet with the gauge core readings and the actual core specific gravity calculation attached to the form.
- Form #428 worksheets in numerical order. Remember that the first 7 densities are from the 7 cores of the compaction test section (CTS) representing the 1st 500 tons. You can attach a copy of the bulk specific gravity calculations you got from the cores divided by the max. sp.gr. to get the density and attach it to a Form #428 sheet.
- Form #1290 Longitudinal Joint density worksheets
- QC/QA computer run that has been checked and signed.

Repeat the same bookkeeping for the top mat of HMA also. These need to be separated especially if it is with a different asphalt binder.

405 Hot-In-Place Recycle

- Document in-place densities on Form #69 or computer generated report, and a specific gravity test result for each density on Form #69.
- Asphalt Rejuvenating Agent, follow Item 411 requirements.

406 Cold Bituminous Pavement (recycle)

- In-place densities should be reported on Form #69.
- Gradations should be reported on Form #6.
- Free moisture should be documented on applicable forms, suggest using Form #6.
- Hveem Stability and Lottmans should be documented and results filed behind #157.
- Asphalt Rejuvenating Agent and Asphalt Emulsion should follow Item 411 for documentation.

408 Joint and Crack Sealant

- Hot Poured (HMA only)
 - Document on #157 that material is on APL, file APL review sheet behind #157. ENSURE BATCH NUMBERS MATCH!
- Silicone (PCCP only)
 - Document on #157 that material is on APL, file APL review sheet behind #157.

409 Cover Coat Material

- Submit samples per Field Materials Manual to Central Lab, and file results behind #157 used to submit samples.
- Report Gradations on Form #6.
- Report Fractured Faces on Form #6.

411 and test results Asphalt Binders and Emulsions

- Keep a Bill of Lading / COCs daily total of all material shipped with a running accumulative total, just like you do for Item 307.

- Forms #411. (Separate the Form #411 by type of binder if you have several on the project.) Even if you do not ship in a sample (i.e., like emulsion, and it is pre-approved), you still need to put the quantity on the correct form number for that item.

412 Portland Cement Concrete Pavement

Follow frequency outlined in the Project Documents and the Field Materials Manual. Have separate sections as listed below:

- Form #1373, Concrete Mix Design Report.
- Air Contents, temperatures, yields, slumps, and water cement ratios should be recorded on Form #156. This should be signed by Project Engineer as soon as reasonable to keep him/her up to date with test results.
- Compressive and Flexural Strengths results should be filed behind the Form #82s that samples were turned in with for testing.
- Sand Equivalent test results should be filed behind #157.
- Pull Test for Tie bars (if applicable) should be filed behind #157.
- Tining and Saw Cut Depth test results should be filed behind #157.
- Pull Tests for Joint Sealants should be reported on Form #389.
 Note: Flexural strengths conducted by Contractor should be filed behind #157 or other applicable Forms.
- Portland Cement, follow Item 308 requirements.
- Joint Sealant, follow Item 408 requirements.
- Contraction Joint Plastic Strip: Field inspect and document on #157 that product is acceptable.
- Reinforcing Steel, Dowels, Tie Bar: follow Item 602.
- Other Items not listed, document as necessary.

420 Geosynthetics

- Geosynthetics, which includes Geomembranes, are accepted by COC. File copies behind a #157 stating material is acceptable and note that batch numbers match.
- Geotextiles are located on the New York State Approved Products List. Cross reference this list and document behind a #157 stating material is acceptable and note that batch numbers match.
- Geogrids are accepted on a project by project basis. Geogrids that are used in conjunction with MSE walls need to be reviewed by Staff Bridge Design & Management Branch for acceptability. Geogrids that are used in conjunction with embankment and roadway need to be reviewed by the Soils / Rockfall Program of the Staff Materials & Geotechnical Branch for acceptability. Document behind a #157 stating material is acceptable and note that batch numbers match.
- When Performance Graded Binders or Asphalt Cement is used, follow Section 411 requirements.

501 Steel Sheet Piling

- Sheet Piling is accepted by COC and Mill Tests Reports. File copies of each behind a #157 stating that the materials meet the specifications, and list the heat numbers, reference the mill test reports that are attached, and that the material is acceptable for use.
- Reinforced Sheet Metal Piling Tips should be on a separate #157, with the same information as above.

502 Piling

- Sheet Piling is accepted by COC and Mill Tests Reports. File copies of each behind a #157 stating that the materials meet the specifications, and list the heat numbers, reference the mill test reports that are attached, and that the material is acceptable for use.
- Reinforced Sheet Metal Piling Tips should be approved by the Soils / Rockfall Program of the Materials and Geotechnical Branch at CDOT, document this acceptance on #157.

503 Drilled Caissons

- Concrete should be documented same as Item 601 of the Schedule.
- Reinforcing materials should be documented same as Item 602 of the Schedule.

504 Cribbing

- Steel Cribbing should be accepted by CTR and Mill Tests. Document on #157 that material is acceptable and file all appropriate test results behind #157.
- Concrete Cribbing should be documented same as Item 601 of the Schedule.
- Timber Cribbing should be documented same as Item 508 of the Schedule.

504 Mechanically Stabilized Earth Wall

- Have the following sections to delineate the acceptance of the wall.
 - Foundation Soils should be submitted to the Central Laboratory for Direct Shear, Friction Angles, and possibly Moisture / Density Curves. File test results behind each #157 for each type of material that is encountered. THIS SHOULD BE DONE RIGHT AWAY, AND BEFORE WALL IS BEING BUILT.
 - Other Tests results should be recorded similar to Item 203, if applicable.
 - Structure Backfill should be documented the same as Item 206.
 - Reinforcing Elements are accepted by COCs, file behind #157.
 - Facing Elements are accepted by COCs, file behind #157.
 - Treated Timbers should be documented per Item 508 of the Schedule.
 - All other miscellaneous items should be documented as applicable.

506 Rip Rap

- Test and record the specific gravity of the material, document on #157 that material was tested and indicate general sizes and other applicable information.
- Bed Course Materials follow Item 206 instructions.
- Gabions and Slope Mattress are COC accepted. Document on #157 that the material is acceptable.
- Concrete and Reinforced Concrete, follow the Item 601 and 602 instructions.

507 through 518

- Follow the applicable directions for each item for documentation.

601 Structural Concrete

- Mix Design Review Sheet (#1188), the approved mix designs should be filed behind the copy of the Form #1188.
- Form #1373, Concrete Mix Design Report
- Form #82s with the 28 day compressive or flexural strength test results recorded on the CDOT Form #192 attached.
- Form #156s Signed by Project Engineer
- Form #157s for curing compound, water, and other incidental items.
- Price Reductions and explanations of deviations.
- Copy of the Structural Concrete Pre-Pour conference agenda.

Do this for each class of concrete (i.e., Class A, B, D, etc.)

607 Fences

Follow applicable directions for each sub-category as it is listed in the Field Materials Manual.

- For Masonry Sound Barrier Walls, call HQ or designer for copies of the Universal Building Code sections covering the requirements for testing and sampling masonry walls. File test reports behind applicable forms relating to each test. (I.E. Prisms, grout, and mortar).

641 Shotcrete

- Mix Design Review Sheet (#1188), the approved mix designs should be filed behind the copy of the Form #1188.
- Form #1373, Concrete Mix Design Report
- Form #82s with the 28 day compressive test results recorded on the CDOT Form #192 attached.
- Form #156s Signed by Project Engineer
- Form #157s for curing compound, water, and other incidental items.
- Form #276 report of concrete placed.
- Price Reductions and explanations of deviations.
- Copy of the Contractor's Quality Control Plan.

NOTE 1: File the remaining Items by Item Number. Use the Field Materials Manual to determine what paperwork is appropriate for that item. Any items not listed above should have adequate explanation in the Field Materials Manual.

NOTE 2: The "Special Notice to Contractors" describes in detail what is needed on both the COC and CTR. Look at this Notice to determine if a COC or CTR may be accepted.

COLORADO DEPARTMENT OF TRANSPORTATION MATERIALS DOCUMENTATION REQUEST	Project No. IM 0253-151	Project Code (SA#) 11925
	Region 4	Date 10/5/02
	Proj. location I-25, SH 7 to WCR 16	

To: **Fidel Gonzales** Address: **1050 Lee Hill rd.**
Boulder, Co.
80302

Upon reviewing the above project for Materials Certification purposes, during the Finals Materials Documentation Checking Procedure, the following items were found to have shortages in materials documentation. Please review these shortages and reply by **10/10/02**.
Please return the original Form #211, for tracking purposes, with the missing documentation by **11/15/02**.

Item	Description	Materials documentation needed	Date received
203	Form # 212	Field Report on Compaction of Earthwork	

Signed Rose Mc Donald	Title E.I.T. III	Date 10/5/02
---------------------------------	----------------------------	------------------------

- Distribution:**
- Resident Engineer
 - Project Engineer
 - Project Tester
 - Materials Project Files

CDOT Form #211 3/04

Colorado Department of Transportation
CDOT Form #250, 7/09
Version 10.4

MATERIALS DOCUMENTATION RECORD

Estimated Field Requirements for Minimum Materials
Sampling, Testing, and Inspection and Record of Field
and Central Laboratory Documentation of Materials.

Project Code:
Project Number:
Location:
Region:
Date:
Contractor:



PROJECT TO BE TESTED AND DOCUMENTED PER THE 2010 FIELD MATERIALS MANUAL

Comply with the Buy America requirements in Section 4 of the Special Notice to Contractors in the Field Materials Manual.

Forward to the Staff Bridge Fabrication Inspectors Unit the list of materials suppliers and subcontractors upon receipt from the contractor.

Attach additional sheets to this form if more space is needed for documentation.

All samples are to be selected using a stratified random sampling schedule. See Colorado Procedure 75 for details on stratified random sampling. Generate and print all random sampling schedules needed before the work begins. Use the random schedule program contained in the Asphalt03 or Voids03 computer programs to generate schedules. Contact the Pavement Design program if you have questions at 303 398-6563.

Tests designated for the Central Lab can be performed in the Field Lab or the Region Lab if adequate facilities and equipment are available.

All CDOT Forms referenced on the Form #250 are to be the most current versions. Verify the revision dates with those listed in the Appendix to the Field Materials Manual and with those listed on the CDOT Form Catalog at www.dot.state.co.us/FormsMgmt/, and then use the most recent.

The CDOT Form #250 is to be used in conjunction with the QA Schedule of the CDOT Field Materials Manual and all referenced Sections or Subsections of the Standard Specifications for Road and Bridge Construction.

Please reference the Guidelines for Test Frequency Reduction on the last two pages of Q/A Schedule in CDOT's Field Materials Manual for guidance on small quantities.

LOCAL AGENCY PROJECTS

All documentation issues should be through your CDOT Local Agency Coordinator.

All Local Agency Projects shall use the CDOT Form #250 as developed by the Documentation Unit of CDOT's Materials and Geotechnical Branch.

All Local Agency Projects shall use the CDOT Form #379 as developed by the applicable CDOT Region Materials Engineer.

All Local Agency Projects shall use the CDOT Field Materials Manual referenced on the Form #250 for specific guidance on documentation of project files.

The Field Materials Manual is available for viewing at the CDOT External Web Address: <http://www.dot.state.co.us/DesignSupport/> (see Manuals). The QA Program Chapter, the Documentation Chapter, and the Special Notice to Contractors Chapter provide guidance and justification.

Colorado Department of Transportation
CDOT Form #250, 7/09
Version 10.4

MATERIALS DOCUMENTATION RECORD

Estimated Field Requirements for Minimum Materials
Sampling, Testing, and Inspection and Record of Field
and Central Laboratory Documentation of Materials.

Project Code:
Project Number:
Location:
Region:
Date:
Contractor:



ADDED MATERIALS ITEMS, DOCUMENTATION FOR:
Attach additional sheets to this form if more space is needed for documentation.

C/MO/MCR NUMBER	DATE	ITEM NUMBER	DESCRIPTION	TYPE OF TESTS	TESTS REQUIRED	FINAL QUANTITY	TESTS REPORTED	PROJECT ACCEPTANCE TEST REPORTED	# OF CHECK TESTS REQUIRED AND SUBMITTED
									CDOT Form #s, FS#s

DELETED MATERIALS ITEMS, DOCUMENTATION FOR:
Attach additional sheets to this form if more space is needed for documentation.

C/MO/MCR NUMBER	DATE	ITEM NUMBER	DESCRIPTION	TYPE OF TESTS	EXPLANATION

Colorado Department of Transportation
CDOT Form #250, 7/09
Version 10.4

MATERIALS DOCUMENTATION RECORD

Project Code:
Project Number:
Location:
Region:
Date:
Contractor:



Estimated Field Requirements for Minimum Materials
Sampling, Testing, and Inspection and Record of Field
and Central Laboratory Documentation of Materials.

SUMMARY OF SAMPLING AND TESTING DEVIATIONS
Deviations from sampling and testing requirements must be fully documented on the CDOT Form #473 Explanation of Exceptions (page 2).

ITEM NUMBER	TEST ELEMENT OR ACCEPTANCE	EXPLANATION

SUMMARY OF LABORATORY CHECK TEST DEVIATIONS
Fully document and explain all laboratory check test deviations on CDOT Form #473 Explanation of Exceptions (page 2)

ITEM NUMBER	DESCRIPTION	MEMO DATE	CDOT Form #157 FS#

Document Significant Independent Assurance differences as per 11.4 of the QA Procedures in the Field Materials Manual.

SUMMARY OF PROJECT PRICE REDUCTION DOCUMENTATION
Fully document and explain all price reductions on CDOT Form #473 Explanation of Exceptions (page 2)

ITEM NUMBER	DESCRIPTION	PRICE REDUCTION AMOUNT	CALCULATIONS #266 / #105 DATES	CMO / MCR NUMBERS	LINE ITEM NO. ON FINAL ESTIMATE

Colorado Department of Transportation
CDOT Form #250, 7/09
Version 10.4

MATERIALS DOCUMENTATION RECORD

Estimated Field Requirements for Minimum Materials
Sampling, Testing, and Inspection and Record of Field
and Central Laboratory Documentation of Materials.

Project Code:
Project Number:
Location:
Region:
Date:
Contractor:



Isolated relatively small quantities of concrete, reinforcing steel, wire mesh, bolts etc. which are paid for incidentally shall be field inspected to determine conformance with specifications and Document in Project Records. If any questions arise concerning the proper documentation of materials during construction, contact the Documentation Unit of the Central Laboratory in Denver @ 303-398-6563.

FIELD DOCUMENTATION ENTERED BY: _____

DATE: _____

REVIEWED AND APPROVED BY: _____

DATE _____

Signature/Title _____

Signature/Title _____

Print Name _____

Print Name _____

Distribution: (includes the entire and completed CDOT Form #250)
Resident Engineer
Region Materials Engineer
Region Finals Engineer
Documentation Unit (Materials and Geotechnical Branch)
FHWA (Oversight Projects only)

End

Ref # ITOR184-12WB140

COLORADO DEPARTMENT OF TRANSPORTATION PROJECT INDEPENDENT ASSURANCE SAMPLING SCHEDULE		Project Code		Project No.		Page		System Basis	
		11925		IM 0253-151		1 of 1		N (Y or N)	
		Project Engineer				Resident Engineer			
		Corey Stewart				David A. Forsyth			
Project Location									
I-25, SH 7 to WCR 16									
Item # Quantity	Identification & Test Performed	#of Samples		CDOT Form #	Field Sheet #	Date M / D / Y	Field Tester (QA)	Indep. Assur. Tester (IA)	
		Req.	Actual						
403 13500	HMA GR SX(75) PG 64-22	3							
	% Asphalt	1	58	42631	6/24/03	F. Gonzales	Mike Ellis		
	Max Specific Gravity	1	58	42631	6/24/03	F. Gonzales	Mike Ellis		
	Hveem Stability	1	58	42631	6/24/03	F. Gonzales	Mike Ellis		
	Air Voids	1	58	42631	6/24/03	F. Gonzales	Mike Ellis		
	VMA	1	58	42631	6/24/03	F. Gonzales	Mike Ellis		
	% Compaction	1	69	39376	6/24/03	F. Gonzales	Mike Ellis		
	Joint Density	1	69/1290	39377	6/24/03	F. Gonzales	Mike Ellis		
412 3000 sy	PCCP	1							
	Compressive Strength	1	82	109965	7/4/03	F. Gonzales	Mike Ellis		
	Slump	1	82	109965	7/4/03	F. Gonzales	Mike Ellis		
	Air Content	1	82	109965	7/4/03	F. Gonzales	Mike Ellis		
	Sand Equivalent	1	82	109965	7/4/03	F. Gonzales	Mike Ellis		
Project Mat'l's Lab Inspected By: Steve Gonser		Date: 5/12/03							
In accordance with Item 620.03 and CP 10.									
Developed By: Mike Ellis		Date: 3/4/03							
<p>The above schedule is an estimate of CDOT Independent Assurance samples required on this project. The number of samples recommended is also the number of each type of test for the specific item in the <i>Frequency Schedule for Independent Assurance Evaluation</i> unless otherwise noted.</p> <p>All equipment was independent except as noted:</p>									
Initial Review By: Rose Mc Donald		Date: 3/9/03		Approved By: Gary Dewitt		Date: 3/10/03			
Distribution:		POST:		The independent assurance sampling schedule for this project has been substantially followed and the test results of the IA samples are in reasonably close agreement with the project acceptance sample test results. (Exceptions to this statement have been previously commented on and documented when the test results were reported or are explained on this form or on an attached sheet.					
PRE:		w/ Form #473		Final Review By: (Region Materials Engineer) _____ Date: _____					
___ Region Materials Engineer		w/ Form #473							
___ Resident Engineer		w/ Form #473							
___ Project Engineer		w/ Form #473							
___ Project Tester		N/A							
___ Doc. Unit, Central Lab		w/ Form #473							

COLORADO DEPARTMENT OF TRANSPORTATION LETTER OF FINAL MATERIALS CERTIFICATION	Project No. IM 0253-151	Page 1 of 2
	Project Code (SA#) 11925	Acceptance date 4/16/04
	Proj. location I-25, SH 7 to WCR 16	
	Contractor Kraemer and Sons	

This is to Certify that:

The results of the tests on the acceptance samples indicate that the material incorporated in the construction work, and the construction operations controlled by sampling and testing, were in conformity with the approved plans and specifications; and such results compare favorably with the results of the Independent Assurance sampling and testing.

All results from the Independent Assurance sampling and testing are within tolerance limits of the results of sampling and testing that are used in the acceptance program.

Yes No Independent Assurance Testing of Hot Mix Asphalt Materials used the System Approach.

Exceptions to the plans and specifications are explained on page 2 of this Form #473. The referenced documents below are attached to this form.

- Yes No Explanation(s) of Exceptions, Form # 473 Page 2, attached.
- Yes No Explanation of Exceptions, Supplemental Documents attached.
- Yes No Project Independent Assurance Sampling Schedule, Form #379, attached.
- Yes No Finals Materials Documentation Checklist, (Project Closure) Form #1199, page 1, attached.
- Yes No Finals Materials Documentation Checklist, (Review or Audit) Form #1199, page 2, attached.

Approved by: Project Engineer (signed) Corey Stewart	Title: P. E. I	Date: 4/16/04
Approved by: Resident Engineer (signed) David A. Forsyth	Title: P. E. II	Date: 5/22/04

Distribution:

OVERSIGHT PROJECTS

- o: Resident Engineer (included with Project Final Documentation)
- xc: Region Materials Engineer
- Region Finals Engineer
- FHWA Division Administrator
- Documentation Unit, Materials & Geotechnical Branch
- Central Files

NON-OVERSIGHT PROJECTS

- o: Resident Engineer (included with Project Final Documentation)
- xc: Region Materials Engineer
- Region Finals Engineer
- Documentation Unit, Materials & Geotechnical Branch
- Central Files

COLORADO DEPARTMENT OF TRANSPORTATION LETTER OF FINAL MATERIALS CERTIFICATION EXPLANATION OF EXCEPTIONS	Project No. IM 0253-151	Page 2 of 2
	Project Code (SA#) 11925	Acceptance date 4/20/09
	Proj. location I-25, SH 7 to WCR 16	
	Contractor Kraemer and Sons	

(Attach to Form #473 Page 1)

- (1) There was a 22,134.12 incentive for item 403 Grading S(100), CDOT Mix # 147004 and a 1,833.01 incentive for Joint Density for a total incentive payment of 23,134.14 on this project.
- (2) Item # 612-Deliniators : No CTR recieved after reported efforts.
- (3) Item # 208-Erosion Bales : No COC recieved due to small quantities (Field Inspected).

Note : These are examples only and do not reflect acutual problems associated with this project.

COLORADO DEPARTMENT OF TRANSPORTATION FINAL MATERIALS DOCUMENTATION CHECKLIST, (PROJECT CLOSURE)			
Project number IM 0253-151		Project code (SA#) 11925	Acceptance Date 4/20/04
Proj. location I-25, SH 7 to WCR 16			Region 4
Contractor Kraemer and Sons	Project Engineer Corey Stewart	Resident Engineer David A. Forsyth	
<input checked="" type="checkbox"/> Project Basis	<input type="checkbox"/> System Basis	<input checked="" type="checkbox"/> Progress Estimate number: 14	(latest issued)
In order for materials documentation to be complete, the following items need to be checked 100%:			
<input checked="" type="checkbox"/> Final Quantities between Progress Estimate and CDOT Form #250 agree. (If different, it is noted)			
<input checked="" type="checkbox"/> Field Sheet/Serial number(s) on CDOT Form #250 match project documents, of the item(s) checked.			
<input checked="" type="checkbox"/> Tests required and tests reported on the Form # 250 agree. (If different, it is noted.)			
yes	no		
<input checked="" type="checkbox"/>		If IA tests are involved, Field Sheet/Serial number(s) on CDOT Form #379 match project documents and all test(s) agree with field acceptance tests, and if applicable, shortages and exceptions are explained.	
<input checked="" type="checkbox"/>		Ensure the correct number of tests on the CDOT Form #379.	
<input checked="" type="checkbox"/>		IA Witness tests did not exceed 20% of actual testing, for each test element.	
<input checked="" type="checkbox"/>		Independent (IA)/Acceptance (QA)/Check Test differences are explained.	
<input checked="" type="checkbox"/>		Form #250 signed by the Project Engineer and Form #379 signed by the Region Materials Engineer.	
NOTE: The following materials records are required to be attached to complete the finals materials documentation process, if applicable for this project:			
<input checked="" type="checkbox"/>		Letters, CMOs, MCRs, field sheets, etc. if used as the primary documentation within the Explanation of Exceptions	
<input checked="" type="checkbox"/>		Progress Estimate (latest issued)	
<input checked="" type="checkbox"/>		Random Sample Schedule	
<input checked="" type="checkbox"/>		Price reduction calculations.(with supporting documentation)	
<input checked="" type="checkbox"/>		QC/QA Data for Item: . (reference applicable Items)	
<input checked="" type="checkbox"/>		Buy America Certificate, for steel products.	
<input checked="" type="checkbox"/>		Asbestos Management Certificate.	
<input checked="" type="checkbox"/>		Roadway Surface Accomplishment Report (RSAR).	
	<input checked="" type="checkbox"/>	Evaluation of Materials Testing, Form #1324 (per CP 16).	
Review notes:			
This is to certify that the review of the materials documentation indicates the documentation is complete and accurate.			
Signed: Tom Scholz		Title: E/PS Tech III	Date: 4/20/04
Distribution: <input type="checkbox"/> Resident Engineer, (included with Project Final Documentation) <input type="checkbox"/> Region Finals Engineer <input type="checkbox"/> Project Engineer <input type="checkbox"/> FHWA (Oversight Projects Only) <input type="checkbox"/> Region Materials Engineer <input type="checkbox"/> Documentation Unit, Materials & Geotechnical Branch			

**COLORADO DEPARTMENT OF TRANSPORTATION
FINAL MATERIALS DOCUMENTATION CHECKLIST, (REVIEW or AUDIT)**

Project number IM 0253-151	Project code (SA#) 11925	Acceptance Date 4/20/04
--------------------------------------	------------------------------------	-----------------------------------

Residency Finals Review or Region Finals Audit Progress Estimate number: **14**

Major Item 1.) 203	Major Item 2.) 206
Major Item 3.) 403	Major Item 4.) 506

1.)	2.)	3.)	4.)	In order for materials documentation to be complete, the following items need to be checked:
<input checked="" type="checkbox"/>	<input checked="" type="checkbox"/>	<input checked="" type="checkbox"/>	<input checked="" type="checkbox"/>	Final Quantities between Progress Estimate and CDOT Form #250 agree. (If different, it is noted)
<input checked="" type="checkbox"/>	<input checked="" type="checkbox"/>	<input checked="" type="checkbox"/>	<input checked="" type="checkbox"/>	Field Sheet/Serial number(s) on CDOT Form #250 match project documents, of the item(s) checked.
<input checked="" type="checkbox"/>	<input checked="" type="checkbox"/>	<input checked="" type="checkbox"/>	<input checked="" type="checkbox"/>	Tests required and tests reported on the Form # 250 agree. (If different, it is noted.)

yes	no	
<input checked="" type="checkbox"/>	<input type="checkbox"/>	If IA tests are involved, Field Sheet/Serial number(s) on CDOT Form #379 match project documents and all test(s) agree with field acceptance tests, and if applicable, shortages and exceptions are explained.
<input checked="" type="checkbox"/>	<input type="checkbox"/>	Ensure the correct number of tests on the CDOT Form #379.
<input checked="" type="checkbox"/>	<input type="checkbox"/>	IA Witness tests did not exceed 20% of actual testing, for each test element.
<input checked="" type="checkbox"/>	<input type="checkbox"/>	Independent (IA)/Acceptance (QA)/Check Test differences are explained.
<input checked="" type="checkbox"/>	<input type="checkbox"/>	Form #250 signed by the Project Engineer and Form #379 signed by the Region Materials Engineer.
NOTE: The following materials records are required to be attached to complete the finals materials documentation process, if applicable for this project:		
<input checked="" type="checkbox"/>	<input type="checkbox"/>	Letters, CMOs, MCRs, field sheets, etc. if used as the primary documentation within the Explanation of Exceptions
<input checked="" type="checkbox"/>	<input type="checkbox"/>	CDOT Form #325, Final Estimate Data. (If not yet developed, indicate this in Review Notes.)
<input checked="" type="checkbox"/>	<input type="checkbox"/>	Progress Estimate. <i>Note if a more recent version was used since the Project Closure.</i>
<input checked="" type="checkbox"/>	<input type="checkbox"/>	Random Sample Schedule
<input checked="" type="checkbox"/>	<input type="checkbox"/>	Price reduction calculations.(with supporting documentation)
<input checked="" type="checkbox"/>	<input type="checkbox"/>	QC/QA Data for Item: . (reference applicable Items)
<input checked="" type="checkbox"/>	<input type="checkbox"/>	Buy America Certificate, for steel products.
<input checked="" type="checkbox"/>	<input type="checkbox"/>	Asbestos Management Certificate.
<input checked="" type="checkbox"/>	<input type="checkbox"/>	Roadway Surface Accomplishment Report (RSAR).
<input checked="" type="checkbox"/>	<input type="checkbox"/>	Evaluation of Materials Testing, Form #1324 (per CP 16).

Review notes:

This is to certify that the review of the materials documentation indicates the documentation is complete and accurate.		
Signed: James Keenan	Title: E/PS Tech III	Date: 5/03/04

{This page was intentionally left blank.}

Special Notice to Contractors - 12

1. SCOPE

1.1 It is the intent of this chapter to provide guidelines to the Contractor or Sub-Contractor, so that they can properly present their materials for inclusion in the construction project.

1.2 The Contractor shall follow the procedures listed below to ensure the proper inspection, sampling, testing, and certification of materials and products incorporated into all construction projects.

1.3 "Prequalification of Bidders" (Standard Specifications, Subsection 102.01) is synonymous with any reference to the CDOT "Pre-Qual List". A Prime Contractor requiring additional information regarding bidding can go to <http://www.dot.state.co.us/Bidding/index.htm>.

1.4 The Qualified Manufacturers List (QML) is used for suppliers of Steel Reinforcing Bars & Steel Dowel Bars, Epoxy-Coated Steel Reinforcing Bars & Epoxy-Coated Steel Dowel Bars, and Precast Concrete Structures. These products are required to be selected off the QML. All relevant details for the proper submittal of specified Standard Manufactured Materials and Fabricated Structural Materials are found in CDOT's Field Materials Manual under CP 11, Quality Management Plans for the Qualified Manufacturers List or the Approved Products List.

2. PROVIDE NOTIFICATION OF MATERIALS SOURCES AND SUPPLIERS

2.1 In accordance with Subsection 106.01 of the Standard Specifications: The Contractor shall submit a formal list of material sources and suppliers to the Engineer at least two weeks prior to delivery; however, it is preferable that the list be presented at the Pre-Construction Meeting.

2.2 The list shall include: item to be supplied, quantity, a reference to the level of acceptance required by CDOT (per Section 7, Designated Products and Assemblies), company name and address supplying the material, and contact person (if the material is to be pre-inspected or if a problem exists with the material

delivered). The submitted list shall indicate, immediately after the item being supplied, the applicable acceptance level required:

- (A) Pre-Inspection (PI)
- (B) Certified Test Report (CTR)
- (C) Certificate of Compliance (COC)
- (D) Pre-Approved (per APL)

2.3 All required product or material documentation shall be provided at the point and time of delivery to the construction project. Failure to provide the required documents, such as CTRs and COCs, may result in rejection of the materials. Failure to utilize the QML or APL may result in rejection of the materials.

3. DESIGN/BUILD PROJECTS - MATERIALS DOCUMENTATION RECORD, CDOT FORM #250

3.1 Two weeks before construction of any element of work the Contractor shall furnish the Engineer a schedule of items, approximate quantities to be incorporated into the project, and a reference to the method of acceptance required by CDOT (per Section 7, Designated Products and Assemblies). This information is to include the item of work with its placement location and dates. The Contractor shall immediately notify the Engineer, in writing, if the items of work or quantities are revised.

3.2 At the completion of the project, the Contractor shall furnish the Engineer with a completed CDOT Form #250 - Materials Documentation Record listing items utilized to construct the project and the approximate quantity of each item.

4. BUY AMERICA REQUIREMENTS

4.1 In accordance with Subsection 106.11 of the Standard Specifications as referenced in 23 CFR Part 635.410:

- A. Regulations require the use of domestic steel and iron in Federally funded construction projects. All foreign steel and iron materials and products are covered by Buy America regardless of the percentage they comprise in a

manufactured product or the form they may take. (See 'C' for minimum use & waiver information.)

- B. All manufacturing processes are defined as "processes required to change the raw ore or scrap metal into the finished, in-place steel or iron product". Manufacturing begins with the initial melting and mixing, and continues through the coating stage. Any process which modifies the chemical content, the physical size or shape, or the final finish is considered a manufacturing process.
- C. Buy America will not prevent a minimal use of foreign steel or iron provided the total project delivery cost of all such steel and iron which includes the cost of delivering the steel and iron to the project, does not exceed one-tenth of one percent of the total contract cost or \$2,500, whichever is greater. With prior concurrence from FHWA Headquarters, the FHWA Division Administrator may grant a waiver of the Buy America requirements for specific projects. When domestic steel products are available, meeting the contractor's schedule should not be the basis for requesting a Buy America waiver.
- D. The Contractor shall maintain on file the certifications that every process, including the application of a coating, performed on steel or iron products either has or has not been carried out in the United States of America. These certifications shall create a chain of custody, and the lack of these certifications will be justification for rejection of the steel or iron product.
- E. Prior to the permanent incorporation into the project of the steel or iron products, the Contractor shall certify in writing that the documentation is on file and the steel or iron products are in compliance with this requirement. (An example of what is required on a Certificate of Contractor's Compliance to Buy America Clause is on page 12 of this chapter. An original signature is required on the Certificate for the Project Files copy.)

NOTE 1: Section 106.8 of the CDOT Construction Manual contains specific information on Buy America Requirements. For more information see Construction Bulletin 2010.

5. ASBESTOS MANAGEMENT CERTIFICATE

- 5.1 This certificate is no longer required.

6. QUALITY MANAGEMENT PLANS FOR THE QUALIFIED MANUFACTURERS LIST OR THE APPROVED PRODUCTS LIST

6.1 CP 11 specifies requirements and procedures for a certification system that shall be applicable to all referenced manufacturers, as well as suppliers and contractors within certain industries. Certifying a Manufacturer's Quality Management Plan is not an automatic acceptance of any particular product, but an acknowledgement that the Manufacturer has taken steps to ensure that their quality controls meet the applicable Industry standards. Manufacturers whose Quality Management Plans are acceptable will be placed on the Qualified Manufacturers List (QML). Only Manufacturers listed on the QML will be eligible to provide the referenced products to a CDOT project.

6.2 The following Standard Manufactured Materials as referenced in CP 11 require an annual submission of a Quality Management Plan along with a sample for evaluation.

- Part I, Standard Manufactured Materials
 - Sub-Part 1. Asphalt Binder
 - Sub-Part 2. Asphalt Emulsion
 - Sub-Part 3. Hydraulic Cement
 - Sub-Part 4. Fly Ash
 - Sub-Part 5. Hydrated Lime

These products are located on the APL.

6.3 The following Fabricated Structural Materials as referenced in CP 11 require an annual submission of a Quality Management Plan.

- Part II, Fabricated Structural Materials
 - Sub-Part 1. Steel Reinforcing Bars & Steel Dowel Bars

Sub-Part 2. Epoxy-Coated Steel Reinforcing Bars & Epoxy-Coated Steel Dowel Bars

Sub-Part 3. Precast Conc. Structures
The QML is located within CDOT's Approved Products List (APL) web site, at www.coloradodot.info/business/APL.

6.4 The respective QML web site pages are updated regularly. All pages will have at least one revision referencing acceptability for the new calendar year.

7. DESIGNATED PRODUCTS AND ASSEMBLIES

7.1 The majority of materials submitted for inclusion on CDOT projects will fall within one of four methods of product acceptance for their sampling and testing. CDOT always retains the right through its Quality Assurance (QA) Program to obtain samples for additional testing and require supplemental documentation.

7.2 If the material or product is not referenced within the four methods of product acceptance then the materials or products must be fabricated or supplied in accordance with the requirements of the applicable Colorado Department of Transportation specifications, plans, and standards. An example of processed materials not found in the following four methods are Aggregate Base Course (ABC), Hot Mix Asphalt (HMA), and Concrete (PCCP). An example of a manufactured product treated uniquely is the Dynamic Message Signs (DMS) which are completely bid on projects or through state awards.

7.3.a. PRE-INSPECTION (PI):

Pre-Inspection is when representatives from the Colorado Department of Transportation visit a manufacturer's facility to perform an initial review of the company's quality control plan and employee certifications, as well as subsequent inspection visitations during the manufacturing of the product. Inspection arrangements should be made by contacting the CDOT Staff Bridge Fabrication Inspectors at (303) 757-9193 a minimum of 10 days prior to the beginning of fabrication. Failure to give notification may result in delays to the project and/or rejection of materials or products.

NOTE 2: Bearing Devices and Expansion Devices are inspected randomly at the discretion of the Staff Bridge Fabrication Inspectors.

Products needing Pre-Inspection:

Bearing Devices (Type III) - Bridge^A
Expansion Device, Modular - Bridge^A
(0-6", through, 0-24")
Prestressed Concrete Units - Bridge^A
Structural Steel - Bridge^A

CDOT Form #193 is to be provided with the above referenced products.

7.3.b. CERTIFIED TEST REPORT (CTR):

The Certified Test Report method of acceptance is when a manufacturer is required to submit the actual test results performed on the material being provided. A CTR shall contain the actual results of tests for the chemical analysis, heat treatment, and/or mechanical properties per the drawing and/or specification. The contract will designate products and assemblies that can be incorporated in the work, if accompanied by Certified Test Reports. The word preceding the "Test Report" may vary between different industries, such as Certified, Mill, Metallurgical, Laboratory; however, they are all considered equivalent.

In accordance with Subsection 106.13 of the Standard Specifications and the requirements of this document, each CTR shall include:

- 1) Department's project number,
- 2) Manufacturer's name,
- 3) Address of manufacturing facility,
- 4) Laboratory name & address,
- 5) Name of product or assembly,
- 6) Complete description of the material,
- 7) Model, catalog, stock no. (if applicable),
- 8) Lot, heat, or batch number identifying the material delivered,
- 9) Date(s) of the laboratory testing,
- 10) All test results that are required so as to verify that the material furnished conforms to all applicable Department specifications. Test results shall be from tests conducted on samples taken from the same lot, heat, or batch.
- 11) The following certification, signed by a person having legal authority to act

for the Contractor: [Example on page 5]

The Certified Test Report shall be a legible copy or an original document and shall include the Contractor's original signature. The signature (including corporate title) on the Certified Test Report, under penalty of perjury, shall be of a person having legal authority to act for the manufacturer or the independent testing laboratory. It shall state that the test results show that the product or assembly to be incorporated into the project has been sampled and passed all specified tests in conformity to the plans and specifications for this project. One legible copy or original document of the fully signed Certified Test Report shall be furnished to the Engineer prior to installation of the material. Failure to comply may result in delays to the project and/or rejection of the materials.

Each product or assembly delivered to the project must contain the lot, heat, or batch number identical to that on the accompanying Certified Test Report. Products or assemblies furnished on the basis of Certified Test Reports may be sampled and tested by the Department and if determined that the material does not meet the applicable specifications, the material will be rejected or accepted according to Subsection 105.03.

An example of what is required on a CTR is on page 13 of this chapter.

Below is a partial list of products or categories that **require a Certified Test Report:**
Bearing Devices (Type III) - Bridge^A
Cribbing
Mechanical Fasteners (Field) ^A
Glass Beads (for pavement marking)
Overhead Sign Structures ^A
Top Soil
Traffic Signal Structures ^A
Welded Wire Reinforcement

7.3.c. CERTIFICATE OF COMPLIANCE (COC):

The Certificate of Compliance method of acceptance is when a manufacturer is required to submit a document certifying that the material being provided meets all required Department specifications. A COC shall reference the required specifications for the chemical analysis,

heat treatment, and/or mechanical properties per the drawing and/or specification, but not the actual test results. The contract will designate products and assemblies that can be incorporated in the work, if accompanied by Certificates of Compliance.

In accordance with Subsection 106.12 of the Standard Specifications and the requirements of this document, the certificate shall include:

- 1) Department's project number,
- 2) Manufacturer's name,
- 3) Address of manufacturing facility,
- 4) Laboratory name & address,
- 5) Name of product or assembly,
- 6) Complete description of the material,
- 7) Model, catalog, stock no.(if applicable),
- 8) Lot, heat, or batch number identifying the material delivered,
- 9) Date(s) of the laboratory testing,
- 10) Listing of all applicable specifications required by the Department for this particular product or assembly. Certificates shall reference the actual tests conducted on samples taken from the same lot, heat, or batch, and shall include a statement that the product or assembly to be incorporated into the project was fabricated in accordance with and meets the applicable specifications.
- 11) The following certification, signed by a person having legal authority to act for the Contractor: [Example on page 5]

The original Certificate of Compliance shall include the Contractor's original signature. The original signature (including corporate title) on the Certificate of Compliance, under penalty of perjury, shall be of a person having legal authority to act for the manufacturer. It shall state that the product or assembly to be incorporated into the project has been sampled and passed all specified tests in conformity to the plans and specifications for this project. One legible copy of the fully signed Certificate of Compliance shall be furnished to the Engineer prior to installation of material. The original shall be provided to the Engineer before payment for the represented item will be made.

Each product or assembly delivered to the project must contain the lot, heat, or batch

number identical to that on the accompanying Certificate of Compliance. Products or assemblies furnished on the basis of Certificates of Compliance may be sampled and tested by the Department and if determined that the material does not meet the applicable specifications, the material will be rejected or accepted according to Subsection 105.03.

An example of what is required on a COC is on page 14 of this chapter.

Below is a partial list of products or categories that **require** a **Certificate of Compliance**:

NOTE 3: If the Plans do not specifically reference a Certified Test Report (Mill Test Report) and the product category is not listed on the Approved Products List within the Pre-Approved level of acceptance, then a COC will be required.

- Bearing Devices (Type I, II ^{A,B})
- Bridge Deck Forms, Permanent Steel ^A
- Bridge Rail, Steel ^A
- Concrete Box Culverts, Precast
- Dampproofing, Asphalt
- Dust Palliative, Asphaltic or Magnesium Chloride
- Erosion Bales ^D

- Expansion Joint Material, Preform. Filler
- Flumes (all types)
- Gabions and Slope Mattress
- Gaskets
- Guard Rail - End Anchors
- Guard Rail Metal ^A
- Guard Rail Posts - Metal ^A
- Guard Rail - Precast
- Guard Rail Posts - Timber Blocks and Posts ^A
- Hay ^D
- Headgates
- Inlets, Grates and Frames (Prefab)
- Interior Insulation
- Lighting
- Light Standards, High Mast
- Light Standards, Metal
- Luminaires (Inclusive)
- Manholes, Rings and Covers (Prefab)
- AEP (Asphalt Emulsion Prime)
- MSE Wall - Elements ^{A,C}
- Pedestrian Bridge ^A
- Piling ^A
- Pipes - all material compositions
- Rest Area Materials (construction of)
- Retaining Wall Blocks
- Seed ^C
- Sign Panels
- Sprinkler System(s)
- Steel Sign Posts
- Steel Sheet Piling ^A
- Straw ^D
- Structural Glazed Tile and Ceramic Tile
- Structural Plate Structures ^A
- Structural Steel Galvanized ^A
- Treated Timber

Example of stamp or affixed sticker to be placed on Certified Test Reports (CTRs), per Subsection 7.2 B (11).

I herby certify under penalty of perjury that the material listed in this Certified Test Report represents _____ (quantity and units) of pay item _____ (pay item # and description) that will be installed in conformance with the plans and specifications on Project Number _____ .	
_____	_____
Contractor	Date

Example of stamp or affixed sticker to be placed on Certificates of Compliance (COCs), per Subsection 7.2 C (11).

I herby certify under penalty of perjury that the material listed in this Certificate of Compliance represents _____ (quantity and units) of pay item _____ (pay item # and description) that will be installed in conformance with the plans and specifications on Project Number _____ .	
_____	_____
Contractor	Date

NOTE 4:

- A Mill Test Report shall be included.
- B Certified Test Report(s) on components must accompany the material or product.
- C Certified Test Report shall be included.
- D Contractor may obtain a current list of Weed Free Forage Crop Producers by contacting the Colorado Department of Agriculture at (303) 239-4149.

7.3.d. PRE-APPROVED (APL):

The Pre-Approved method of acceptance is when a manufacturer is required to submit all relevant documentation on their product in advance of any specific project. A primary requirement to be considered for the Approved Products List (APL) is that the material retains a very high level of uniformity and consistency in its production quality (i.e. not project specific).

The submittal of Product literature /Tech Data Sheet (TDS), Certificates of Compliance, Certified Test Reports, Materials Safety Data Sheets (MSDS), etc., as well as product samples for specific categories combine all previous methods of acceptance into one. A Manufacturer whose product is not currently on the APL should read and follow the instructions within the Notice to Manufacturers on the APL web site.

Product evaluation can take a minimum of four months to in excess of a year for some product categories. If CDOT specifications need to be altered or created for a product's acceptance then it could take even longer.

In accordance with CDOT's Procedural Directive 1401.1, a manufacturer's product is evaluated within CDOT to determine its acceptability on CDOT construction projects, as defined by CDOT specifications, plans and standards. For additional information on the APL or the web site contact the Product Evaluation Coordinator within the Staff Materials & Geotechnical Branch at 303-398-6566.

Locate products on the web site through *APL Search*, and then use the referenced Category, the Manufacturer's name, or the Product name. A category search requires that the drop-down menus be used. Web site

address: www.coloradodot.info/business/APL .

APL User Guidance

1. If three or more products are listed for any applicable category then one of these products shall be selected. If the category is unpopulated a COC will be required for the product actually used. If the category is under-populated a COC will be required for the product actually used if not from the APL. CDOT's Subject Matter Expert (SME) for the applicable category shall be contacted for assistance. A CTR may be requested if the Project Engineer deems it appropriate. Contact the CDOT Product Evaluation Coordinator at 303-398-6566 with any questions.

2. Products that are evaluated on a batch or lot basis and subsequently posted on the APL web site will not be posted indefinitely. On February 1st of each calendar year batches or lots older than two complete years will be automatically removed or they will be removed sooner if informed that the batch or lot has expired. Specifically this refers to (1) single component, hot-applied, elastomeric membranes for bridge decks, (2) hot poured, joint/crack sealant, and (3) asphalt plug joints.

3. Asphalt Binder and Asphalt Emulsions: Approved asphalt binders and emulsions will remain on the APL for only the calendar year they were submitted before being removed. Approved binders and emulsions are only valid for the calendar year in which they were tested and approved, as per CP 11. The year is incorporated into the product name.

4. Environmental Erosion Control and Sediment Control Category: All questions regarding erosion control and sediment control materials, both the current specifications and the products, should be directed to the CDOT Staff Environmental Branch SME. Tom Boyce at 303-512-4053.

5. Traffic Control Pavement Marking Material Sub-Category: All questions regarding pavement marking materials, both the current specifications and the products, should be directed the CDOT Staff Traffic Branch SME. K.C. Matthews at 303-757-9543.

6. Geosynthetics and Geotextiles:
Materials Bulletin (2008 Number 1) dated
January 25, 2008 is posted at:

<http://www.dot.state.co.us/DesignSupport/Materials%20Bulletins/Materials%20Bulletins.htm>

This Materials Bulletin clarifies the terminology and application of geosynthetics as specified in the standard specifications and the standard special provision (SSP), *Revision of Sections 208, 420, 605, and 712 – Geosynthetics and Geotextiles*. For New York State web site navigation refer to (NYDOT APL Instructions) at <http://internal/infoexchg/organizations.cfm>.

7. Concrete Mix Designs:

On the APL website there is a folder listing concrete mix designs that have been pre-approved. When a concrete mix is placed on the APL, it meets the most current CDOT Standard Specifications; however, it may not meet a CDOT project's Special Provisions. CP 62 is the procedure for approving all concrete mixes for use on a CDOT project.

8. Non-Standard HMA Mixes:

On the APL website there is a folder listing non-standard HMA mixes that have been pre-approved for use on CDOT Projects. Use of a non-standard HMA mix on a Project shall be approved by the Project Engineer.

9. Contractors are required to submit a Certificate of Compliance to the project engineer documenting the selection of the CDOT APL and/or QML products that they wish to include for project incorporation. (Refer to example on Page 15).

10. APL Quality Assurance Program:

Upon selecting the sub-category or base-category the Product ID (PID), Product Name, Manufacturer, and Comments will be displayed.

(a) By clicking on the PID / Form #595 the Pre-Approved Product Evaluation Request & Summary will be displayed. This will provide the customer with both a mini product data sheet and the information necessary for additional product analysis for specific utilization.

(b) From a Quality Assurance (QA) perspective, it is highly recommended that the **Comments – Add** field be selected so that a database can be generated for products that work best in specific situations. In those rare occasions, bad or flawed products can be removed from the APL. Only comments from the Contractor, applicable sub-contractor, and the project personnel representing the Department will be accepted.

(c) If a product fails to perform to within minimum quality expectations contact the CDOT Product Evaluation Coordinator immediately via e-mail as listed in the APL web site.

DISCLAIMER: The Colorado Department of Transportation (CDOT) is not obligated to any manufacturer to use any of their products listed in the Approved Products List (APL). The APL simply documents that the listed products have been reviewed, tested, and evaluated against CDOT standards, and were found to be acceptable to be used in CDOT projects. Acceptance is based on product quality; however, price or availability may be the determining factor by a contractor or sub-contractor on the CDOT project.

The product shall be removed from the APL if Product Performance comments indicate that field performance is unacceptable to CDOT quality standards or if the product varies from the data as originally submitted. Additional disclaimer information can be found within the APL web site.

<u>APL Category</u>	<u>APL Sub-Category</u>	<u>APL Base Category</u>
Adhesive:	Anchoring, Lateral:	Acrylic Cementitious Epoxy Polyester
	Anchoring, Overhead: Bonding:	N/A Epoxy
Asphalt:	Asphalt Release Agent:	Truck Bed Only Truck & Equipment
	Binder:	
	Emulsion:	
	Hydrated Lime: Roadway Patching:	N/A Pre-Mixed [Bagged]
Bridge Structures:	Geocomposite Drain:	N/A
	Thin Bonded Overlay:	Epoxy Non-Epoxy
	Structural Wrapping Repair	N/A
Concrete:	Admixture:	Air Entraining
		Water-Reducing
		Retarding
		Accelerating
		Water-Reducing & Retarding
		Water-Reducing & Accelerating
		Water-Reducing, High Range
		Water-Reducing, High Range & Retard.
		Extended Set-Control
		Specific Performance
Concrete Corrosion Inhibitor		
Miscellaneous		
Curing Compound:	Type 1 [Clear, Wax Based]	
	Type 1 [Clear, Resin Based]	
	Type 2 [White Pigmented, Wax Based]	
	Type 2 [White Pigmented, Resin Based]	
Cement:	Portland Cement, ASTM C 150	
	Blended Cement, ASTM C 595	
	Hydraulic Cement, ASTM C 1157	
Pozzolan:	Fly Ash, Class C	
	Fly Ash, Class F	
	Fly Ash, Class N	
	Silica Fume	
Fiber:	Macro Fiber	
	Micro Fiber	
Grout:	General Purpose [Non-Shrink]	
	Post-Tensioned Cable	
Repair/Patching:	Rapid Set, Horizontal	
	Rapid Set, Vertical & Overhead	
	Bonding Agent	
Drainage:	Culvert Pipe: Manholes & Inlets:	Culvert Lining [Repair]
		Manhole Riser
		Trench Drain
		Plastic Drains

<u>APL Category</u>	<u>APL Sub-Category</u>	<u>APL Base Category</u>
Drainage	Storm Water Separator:	Regular Flow Hydrodynamic High Flow Hydrodynamic
Environmental:	Sound Wall:	Absorptive Reflective
Environ., Erosion Control:	Soil Retention Covering:	SRB [Biodegradable Class 1] SRB [Photodegradable Class 1] SRB [Biodegradable Class 2] SRB [Photodegradable Class 2] TRM [Class1] TRM [Class 2] TRM [Class 3] Bonded Fiber Matrix Mulch Tackifier Soil Binder Spray-on-Mulch Blanket
	Mulch:	Hydraulic Wood Cellulose Fiber
	Soil Conditioner:	N/A
	Geogrid:	N/A
Environ., Sediment Control:	Vegetation Control	Structural
	Ditch Control:	Erosion Log Silt Berm Silt Dike
	Perimeter / TOS Control:	Erosion Log
	Inlet / Outlet Protection:	Storm Drain Inlet Protection
	Catch Basin Insert:	N/A
	Dewatering Device:	Dewatering Filter Bag
	Concrete Washout Structure:	Pre-Fabricated
<hr/>		
Paint / Coating:	Anti-Graffiti:	N/A
	Concrete Corrosion Inhibitor:	N/A
	Epoxy Coating:	N/A
	Structural Concrete Coating:	N/A
	Structural Steel Paint:	N/A
	Wire Coating:	N/A
<hr/>		
Pedestrian Safety:	ADA Truncated Dome:	N/A
<hr/>		
Right-of-Way Structure:	Mailbox Support System:	N/A
	Utility Enclosure:	N/A
	Pole Base Hardware:	N/A
<hr/>		
Roadway Safety:	Cable Barrier:	N/A
	Guardrail W-Beam:	Guardrail Synthetic Blockout Guardrail End Treatment
	Crash Cushion:	Guardrail Median Terminal Barrier End Terminal Impact Attenuator, Permanent Sand Barrel Impact Attenuator
<hr/>		
Sealant [Joint & Crack]:	Asphaltic Plug Joint:	N/A
	Hot Poured, Joint/Crack:	ASTM D 6690, Type II ASTM D 6690, Type IV ASTM D 5078

<u>APL Category</u>	<u>APL Sub-Category</u>	<u>APL Base Category</u>
Sealant [Joint & Crack]:	Silicone, Joint:	Non-Sag Self-Leveling
	Pre-Formed Joint Filler:	N/A
	Loop Detector Slot:	One Component Two Component
<hr/>		
Soil / Geotechnical:	Stabilization:	Chemical, Liquid
	Void Elimination:	Polyurethane Foam, High Density
<hr/>		
Traffic Control:	Portable Changeable Message:	Trailer Mount Vehicle Mount
	Arrow Board:	Type A
		Type B
		Type C
		Type D
	Speed Notification:	Radar/Message Trailer
		Speed Display Trailer
		Speed Display Device
	Traffic Control Enhancement:	AFAD
		Flashing Beacon
		Warning Light
		Raised Island, Temporary
Rumble Strip, Temporary		
Glare Screen		
Channelizing Device:		Cone Tubular Marker Vertical Panel Drum Barricade, Type 1 Barricade, Type 2 Barricade, Type 3 Direction Indicator Barricade Longitudinal Channelizing Device Opposing Traffic Lane Divider
Delineator:	Flexible Post	
	Flexible, Multiple Hit Post	
Reflective Element:	Guardrail Mount	
	Barrier (Solid Wall) Marker	
	Guardrail & Post Marker	
Post Anchoring:	Delineator Post Marker	
	Linear Reflector Strip	
	Mechanical System	
Traffic Barrier, Temporary:	Polyurethane Foam, Backfill	
	N/A	
	Impact Attenuator, Temporary	
Crash Cushion, Temporary:	Truck Mounted Attenuator (TMA)	
	Trailer Mounted Attenuator	
Sign Stand:	N/A	
Pavement Marking Material:	Preformed Plastic Tape, Type I, Perm.	
	Preformed Plastic Tape, Type II, Perm.	
	Preformed Plastic Tape, Type III, Perm.	
	Thermoplastic, Hot Applied	
	Thermoplastic, Preformed	
	Epoxy Paint, Yellow Epoxy Paint, White	

<u>APL Category</u>	<u>APL Sub-Category</u>	<u>APL Base Category</u>
	Pavement Marking Material:	Methyl Methacrylate Raised Flexible Marker Recessed Pavement Marker
Traffic Control:	Sign Sheeting:	ASTM D 4956, Type IV ASTM D 4956, Type V ASTM D 4956, Type VI ASTM D 4956, Type VI [Roll-up & Cone Collar] ASTM D 4956, Type VII ASTM D 4956, Type VII, Fluorescent ASTM D 4956, Type VIII ASTM D 4956, Type VIII, Fluorescent ASTM D 4956, Type IX ASTM D 4956, Type IX, Fluorescent ASTM D 4956, Type X ASTM D 4956, Type X, Fluorescent ASTM D 4956, Type XI ASTM D 4956, Type X, Fluorescent Films / Miscellaneous
<hr/>		
Waterproofing:	Concrete Sealer:	Alkyl-alkoxy Silane Non-Alkyl-alkoxy Silane Penetrating Epoxy
	Elastomeric Membrane:	Micro-Subsurface Repair Single Component, Hot Applied Non-Asphaltic
<hr/>		

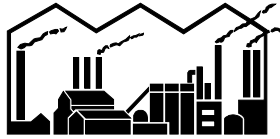

Western Construction Inc.

13369 W. Rocky Rd. Smallville, Colorado 91130
Phone 999-123-4567

CERTIFICATE OF CONTRACTOR'S COMPLIANCE TO BUY AMERICA CLAUSE

All steel and/or iron products permanently incorporated into the CDOT Federal Aid Project Number _____, with a project location of _____, were produced or manufactured in the United States of America, Puerto Rico, District of Columbia, or in any of the territories and possessions of the United States of America, except as listed below:

_____ No Exception

_____ Minor Exceptions: Value less than 1/10 of 1% of the total contract cost or \$ 2,500.00 whichever is greater. Documentation is in our Project Files.

Certifications that every process, including the application of a coating, performed on steel or iron products stating that it has or has not been carried out in the United States of America is on file. This certification creates a chain of custody that includes every supplier, distributor, fabricator, and manufacturer that handles the steel or iron product.

Our actions were in full compliance with Colorado DOT's Standard Specifications for Road and Bridge Construction, Section 106.11

Western Construction Inc.

John Doe

John Doe
President

I, _____, as secretary of Western Construction, Inc., hereby affirm that the foregoing certificate was signed this _____ day of _____, 20____ by John Doe, who is duly constituted as President of Western Construction Inc. and who is authorized to bind the Corporation to this Certificate.

EXAMPLE

(Per requirements of Subsection 4.1)
(Original Signatures Required, No Facsimiles Accepted)

American Glass Bead Inc.

Desert Ray, Tx. 76660
Phone: (254)562-2541
Fax: (254)562-2542
www.agbi.com

CERTIFIED TEST REPORT

Colorado Department of Transportation (CDOT) project number: MTCE 03-022

Name of Product: AASHTO M 247 Type 1 Colorado Spec Glass Beads

*Product Code: AGBI- 0123

Product Batch Number: 021805

*Product date of manufacturing: Feb. 18, 2005

*Quantity Shipped: 44000 Pounds

* Date of Shipment: TBA

Laboratory Information:

*AGBI Inc.: HWY 40 & FCR 145

*Testing Date: 2/18/05

* Samples Tested: Samples are from Batch # 021805

AASHTO Designation M 247

*AASHTO M 247 Type 1 Colorado Spec

Test Results: Gradation (ASTM Standard D 1214)

Sieve Designation	Specification for AASHTO M 247 Mass Percent Passing (Type 1)	Test Result
No. 20 (0.850 mm)	100	100
No. 30 (0.600 mm)	75-95	86.9
No. 40 (0.425 mm)	-	-
No. 50 (0.300 mm)	15-35	24.2
No. 80 (0.180 mm)	-	-
No. 100 (0.150 mm)	0-5	.7

AASHTO M 247 Type 1

Test Results: Other Properties

Element / Method	Specification for AASHTO M 247 Specification Limit	Test Result
Roundness/ASTM D 1155	70% min	71.4%
Crushing Resistance ASTM D 1213	Retained 0.425-mm (No. 40) sieve 133N (30 lbs.) min.	Passing
Refractive Index (Ref: TTB1325C Section 4.3.3)	1.50 min	1.52
Moisture Resistance	Non-Moisture absorption & Free flowing	Passing
Flotation	90% of all beads shall float in xylene	n/a

Certification of Material: The referenced material meets or complies with the AASHTO M 247 Type 1 Colorado Specification.

Billy Gibbons

18 Feb, 2005

Billy Gibbons / Quality Control

Date

EXAMPLE

[Per requirements of Section 7]
(Original Signatures Required,
Legible copy Accepted)

I hereby certify under penalty of perjury that the material listed in this Certified Test Report represents _____ (quantity and units) of pay item _____ (pay item # and description) that will be installed in conformance with the plans and specifications on Project No. _____.

Contractor

Date

North-By-Northwest, Inc.
9876 S. Eva-Marie Blvd.
Grant, South Dakota 54321
Phone 999-123-4567

Certificate of Compliance

Product Name: Universal Bridge Deck Expansion Joint
Model: .UBDEJ-101
Lot: 135-02

Description: Pre-formed Silicone gland, that can be bonded directly to an Elastomeric concrete joint interface with a single component silicone-locking adhesive.

Material Testing Specifications:

<u>Property</u>	<u>Test Method</u>	<u>Mean Value</u>
Durometer (Shore A)	ASTM D 2240	55
Tensile (psi)	ASTM D 412	650 psi
Elongation (%)	ASTM D 412	382 %
Tear (die B ppi)	ASTM D 624	88 ppi
Compression Set At 350°F 22 hrs.	ASTM D 395	30 %
Operating Temperature Range		-60° F to 450° F
Specific Gravity		1.51

State Specification Reference:

Colorado DOT Standard Specifications for Road and Bridge Construction,
Section 412.13 (c). Project plans as required.

CDOT Project Number NH 0507-123

The above referenced tests were performed within our laboratory on March 14th 2002.
All tests passed and the minimum required values were exceeded. Applicable laboratory test reports are available upon your request.

North-By-Northwest, Inc.

John Doe

John Doe
Manager, Quality Assurance

Date: 22 June 2002

I hereby certify under penalty of perjury that the material listed in this Certificate of Compliance represents _____ (quantity and units) of pay item _____ (pay item # and description) that will be installed in conformance with plans and specification on Project Number _____.

Contractor

Date

EXAMPLE

[Per requirements of Section 7]
(Original Signatures Required,
Legible copy Accepted)

BlueBerry Shortcake Construction Inc.

411 N. Southland Rd. East Westville, Colorado 91130
Phone 999-123-4567

CERTIFICATE OF CONTRACTOR'S COMPLIANCE FOR APL / QML SELECTION

Date: _____

CDOT Project No.: _____

CDOT Project Location: _____

CDOT Project Code: _____

The following material was selected from the CDOT Approved Products List in accordance with the project plans, the 2011 Standard Specifications for Road and Bridge Construction, and the 2012 Field Materials Manual.

QML Part/Sub-Part: _____

APL Category: _____

APL Sub-Category: _____

APL Base Category: _____

APL Reference No.: _____

Product Name: _____

Manufacturer: _____

Date of Web Site Review & Selection: _____

BlueBerry Shortcake Construction Inc.

Veronica Dee

Veronica Dee
Construction Manager

I hereby certify under penalty of perjury that the material listed in this Certificate of Compliance represents _____ (quantity and units) of pay item _____ (pay item # and description) that will be installed in conformance with plans and specification on Project Number _____.

Contractor

Date

EXAMPLE

(Per requirements of Subsection 7.3.d)
(Original Signatures Required, No Facsimiles Accepted)

{This page was intentionally left blank.}

FREQUENCY GUIDE SCHEDULE for Minimum Materials Sampling, Testing, and Inspection

PAY ITEM	TYPE OF TEST	PROJECT VERIFICATION SAMPLING & TESTING FREQUENCY	PROCEDURES		REMARKS	POINT OF VERIFICATION FOR QUALITY DETERMINATION	CENTRAL LAB	
			PROJECT VERIFICATION SAMPLING	PROJECT VERIFICATION TESTING			TEST FREQUENCY	SAMPLE SIZE
203 EMBANKMENT	IN-PLACE DENSITY	1 per 2000 cu yds (1500 m ³) or fraction thereof of testable material as described in Subsection 203.07 of CDOT Standard Specifications. DENSITY: 1 per 500 cu yds (375 m ³) when within 100 ft (30 m) of Bridge Approach(s).		T 191 CP 23 CP 25 CP 80	CP 25, Subsection 3.4.8, for 1-point check requirements. Report on CDOT Form #212; including where roller hours only are specified. See FMM (Chapter 200) for further details.	In the compacted lift.		
	MOISTURE-DENSITY CURVE	1 per soil type.		T 99 or T 180	Report on CDOT Form #24.		Moisture-Density Curve and Soil-Survey shall be performed on the soil found at the proposed profile grade in the Field Lab or the Region Lab. 1 - R value test, per general soil type. (per CP-L 3101 & CP-L 3102) (see NOTE 1)	33 lb. (15 kg) -#4 If the criteria are met for CP 24, Section 4.1, use Form #564 to classify the material. Keep the material segregated & submit the -#4, +#4, and +3/8" rock.
	SOIL-SURVEY (CLASSIFICATION)	1 per 1000 lin. ft. (300 m) of two-lane roadway or fraction thereof.	CP 24	CP 20 CP 21	Use AASHTO M 145 for soil classification. Report on CDOT Form #219.	In the top 2 ft. (600 mm) of the finished subgrade.		
203 BORROW	WATER-SOLUBLE SULFATE	1 per 2000 cu yds (1500 m ³) or fraction thereof. Minimum 1 per source.	CP 30	CP-L 2103	Report on CDOT Form #323. See Chapter 200, Soil Survey / Preliminary Soil Profile	From uncompacted lift or stockpile.	1 water-soluble sulfate test. (see NOTE 1)	5 lb. (3 kg) per soil type.

NOTE 1: Tests can be performed in the Field Lab or the Region Lab if adequate facilities and equipment are available.

CP = Colorado Procedures

CP-L = Colorado Procedures – Laboratory

T = AASHTO Procedures

C = ASTM Procedures

FREQUENCY GUIDE SCHEDULE for Minimum Materials Sampling, Testing, and Inspection

PAY ITEM	TYPE OF TEST	PROJECT VERIFICATION SAMPLING & TESTING FREQUENCY	PROCEDURES		REMARKS	POINT OF VERIFICATION FOR QUALITY DETERMINATION	CENTRAL LAB	
			PROJECT VERIFICATION SAMPLING	PROJECT VERIFICATION TESTING			TEST FREQUENCY	SAMPLE SIZE
206 STR. BACKFILL (CLASS 1)	GRADATION	1 per 200 cu yds (150 m ³) or fraction thereof.	CP 30	CP 31	Report on CDOT Form #6.	In-Place, before compaction.	1 per source, per project.	110 lb. (45 kg) See Chap. 300
	ATTERBERG LIMITS	1 per 200 cu yds (150 m ³) or fraction thereof.		T 89 T 90			1 per source, per project.	
	IN-PLACE DENSITY	1 per 200 cu yds (150 m ³) or fraction thereof. Minimum 1 per structure in roadbed.		T 191 CP 80	Report on CDOT Form #6.	In the compacted lift.		
	MOISTURE-DENSITY CURVE	If in roadbed, 1 per source.		T 180	Report on CDOT Form #24.		1 per source, per project.	
	SULFATE	1 per source, per project.		CP-L 2103	Report on CDOT Form #323.		1 per source, per project. (see NOTE 1)	
206 STR. BACKFILL (CLASS 2)	IN-PLACE DENSITY	1 per 200 cu yds (150 m ³) or fraction thereof. Minimum 1 per structure in roadbed.		T 191 CP 80	Report on CDOT Form #6. See FMM, Chap. 200, Item 206 Structure Backfill, Note on rocky material.	In the compacted lift.		55 lb. (25 kg)
	SULFATE	1 per 200 cu yds (150 m ³) or fraction thereof. Minimum 1 per source.		CP-L 2103	Report on CDOT Form #323.		1 per source, per project.	
	MOISTURE-DENSITY CURVE	If in roadbed, 1 per source.		T 99 or T 180	Report on CDOT Form #24.		1 per source, per project. (see NOTE 1)	

NOTE 1: Tests can be performed in the Field Lab or the Region Lab if adequate facilities and equipment are available.

CP = Colorado Procedures

CP-L = Colorado Procedures – Laboratory

T = AASHTO Procedures

C = ASTM Procedures

FREQUENCY GUIDE SCHEDULE for Minimum Materials Sampling, Testing, and Inspection

PAY ITEM	TYPE OF TEST	PROJECT VERIFICATION SAMPLING & TESTING FREQUENCY	PROCEDURES		REMARKS	POINT OF VERIFICATION FOR QUALITY DETERMINATION	CENTRAL LAB	
			PROJECT VERIFICATION SAMPLING	PROJECT VERIFICATION TESTING			TEST FREQUENCY	SAMPLE SIZE
206 BED COURSE MATERIAL	GRADATION	1 per 200 cu yds (150 m ³) or fraction thereof.	CP 30	CP 31	Report on CDOT Form #6.	In-Place.	1 per source, per project.	55 lb. (25 kg)
	SULFATE	1 per 200 cu yds (150 m ³) or fraction thereof. Minimum 1 per source.		CP-L 2103	Report on CDOT Form #323.		1 per source, per project. (see NOTE 1)	
206 FILTER MATERIAL	GRADATION	1 per 200 cu yds (150 m ³) or fraction thereof for each Class.	CP 30	CP 31	Report on CDOT Form #6. See FMM, Chapter 200 for further details.	In-Place.	1 per source, per project.	55 lb. (25 kg)

NOTE 1: Tests can be performed in the Field Lab or the Region Lab if adequate facilities and equipment are available.

FREQUENCY GUIDE SCHEDULE for Minimum Materials Sampling, Testing, and Inspection

206 FLOW FILL	Submit to project files a Flow-Fill mix design that documents adherence to the Specifications.
207 TOPSOIL	<p>Contractor Source(s): <i>Acceptance Method: CTR.</i> The Contractor shall provide the Engineer with one copy of Certified Test Reports documenting: pH, % organic, soluble salts, nutrient and micro-nutrient requirements as specified in the Contract Documents. The tests shall be in accordance with the "Method of Soil Analysis conducted by the Colorado State University Soil Testing Laboratory" or a Certified Soils laboratory. A list of qualified laboratories is available by contacting the Landscape Architect's office at (303) 757-9174. Field inspect and document on CDOT Form #157 that the material is acceptable, retain all copies in the Project Files.</p>
208 EROSION CONTROL	<p>Note: Reference the Special Notice to Contractors 7.3 D: Information regarding environmental products and the APL.</p> <p>Silt Fence: <i>Acceptance Method: Pre-Approved (with Contractor's COC for Documentation).</i> Field inspect and document on CDOT Form # 157 that the material is acceptable, retain all copies in the Project Files.</p> <p>Erosion Bales: <i>Acceptance Method: COC.</i> The Contractor shall provide the Engineer a Certificate of Compliance that is furnished by the supplier. The Engineer will inspect the shipment upon arrival on the project site and before unloading any of the material or removing any of the required identification tags or special markings, he will examine the Certificate for the required information. Note; the Certificate shall state the material being delivered is "Weed Free". Document the details of this field inspection, noting that the inspection and certificate details were completed prior to unloading. Field inspect and document on CDOT Form # 157 that the material is acceptable, retain all copies in the Project Files. (See the Special Notice to Contractors for more information.)</p> <p>Miscellaneous: Follow specified Item requirements for the specified material. Refer to Standard Specification Subsection 208.02. Field inspect and document on CDOT Form #157 that the material is acceptable, retain all copies in the Project Files.</p>
209 WATERING	<p>Landscaping Water: <i>Acceptance Method: Contractor's COC or CTR.</i> If potable, Document on CDOT Form #157, retain all copies in the Project Files. When in doubt obtain Certified Test Reports, furnished by the Contractor. Refer to Standard Specifications Subsection 209.02.</p> <p>Dust Palliative (Magnesium Chloride): <i>Acceptance Method: COC.</i> The Contractor shall provide one copy of a Certificate of Compliance. (See Item 403-411 for Asphaltic Material.) Field inspect and document on CDOT Form #157 that the material is acceptable, retain all copies in the Project Files.</p> <p>Embankment Moisture (water) Control: <i>Acceptance Method: N/A</i> Sampling not required unless chemical content and quality are in doubt. Refer to Standard Specifications Subsection 209.02. If water quality test results are required, follow instructions for Landscaping Water above. Field inspect and document on CDOT Form #157 that the material is acceptable, retain all copies in the Project Files.</p>

FREQUENCY GUIDE SCHEDULE for Minimum Materials Sampling, Testing, and Inspection

<p style="text-align: center;">212</p> <p style="text-align: center;">SEEDING AND SODDING</p>	<p>Seed: <i>Acceptance Method: COC.</i> Package must bear label containing analysis and germination data. A Certificate of Compliance must accompany shipments stating that the analysis has been performed within 6 months prior to date of delivery on project. State on CDOT Form #157: (1) the materials has been field inspected and is acceptable, (2) C.O.C. is attached for project file, (3) lot numbers on the C.O.C. correspond with the lot numbers on seed package. Refer to Standard Specifications Subsection 212.02.</p> <p>Sod: <i>Acceptance Method: Contractor's COC.</i> The Contractor shall submit to the Engineer a sample of sod 6½ ft X 2 ft (2 m X 50 cm) for a comparison standard. Field inspect for compliance with Standard Specifications Subsection 212.02 or other contract documents. Document on CDOT Form #157.</p> <p>Fertilizer: <i>Acceptance Method: COC.</i> Compliance with Standard Specifications Subsection 212.02. Field inspect and document on CDOT Form #157 that the material is acceptable, retain all copies in the Project Files.</p>
<p style="text-align: center;">213</p> <p style="text-align: center;">MULCHING</p>	<p>Note: Reference the Special Notice to Contractors 7.3 D: Information regarding environmental products and the APL.</p> <p>Hay or Straw: <i>Acceptance Method: COC.</i> See Item 208 of this Schedule, and follow the requirements for Erosion Bales. See Special Notice to Contractors for more information. Field inspect and document on CDOT Form #157 that the material is acceptable, retain all copies in the Project Files.</p> <p>Wood Cellulose: <i>Acceptance Method: COC.</i> Field inspect and document on CDOT Form #157 that the material is acceptable, retain all copies in the Project Files.</p> <p>Mulch Tackifier: <i>Acceptance Method: Pre-Approved (with Contractor's COC for Documentation).</i> Field inspect and document on CDOT Form #157 that the material is acceptable, retain all copies in the Project Files.</p>
<p style="text-align: center;">214</p> <p style="text-align: center;">PLANTING</p>	<p>Plants: <i>Acceptance Method: COC.</i> Plants from out-of-state sources are to conform to the requirements of Standard Specifications Subsection 214.02 or contract documents. Field inspect and document on CDOT Form #157 that the material is acceptable, retain all copies in the Project Files.</p> <p>Humus: <i>Acceptance Method: N/A.</i> >> Contact Staff Landscape Architect at CDOT Headquarters (303) 757-9174 for approval of humus material. Field inspect and document on CDOT Form #157 that the material is acceptable, retain all copies in the Project Files.</p> <p>Fertilizer: <i>Acceptance Method: COC.</i> Field inspect and document on CDOT Form #157 that material is acceptable, retain all copies in the Project Files. See Standard Specifications Subsection 214.02(d).</p>
<p style="text-align: center;">215</p> <p style="text-align: center;">TRANS- PLANTING</p>	<p>Plants: <i>Acceptance Method: N/A</i> Selected by Engineer from within ROW. Document in Project Records.</p> <p>Fertilizer: <i>Acceptance Method: COC.</i> Field inspect and document on CDOT Form #157 that the material is acceptable, retain all copies in the Project Files. See Standard Specifications Subsection 215.03</p>

FREQUENCY GUIDE SCHEDULE for Minimum Materials Sampling, Testing, and Inspection

<p style="text-align: center;">216</p> <p style="text-align: center;">SOIL RETENTION COVERING</p>	<p>Note: Reference the Special Notice to Contractors 7.3 D: Information regarding environmental products and the APL.</p> <p>Soil Retention Covering: <i>Acceptance Method: Pre-Approved (with Contractor's COC for Documentation).</i> Weigh and measure as applicable, inspect, and note any special requirements. Field inspect and document on CDOT Form #157 that the material is acceptable, retain all copies in the Project Files.</p>
<p style="text-align: center;">217</p> <p style="text-align: center;">HERBICIDE TREATMENT</p>	<p><i>Acceptance Method: N/A</i></p> <p>Contact Staff Landscape Architect at CDOT Headquarters (303) 757-9542 for approval of material used as Herbicide Treatment. Field inspect and document on CDOT Form #157 that the material is acceptable, retain all copies in the Project Files.</p>

FREQUENCY GUIDE SCHEDULE for Minimum Materials Sampling, Testing, and Inspection

PAY ITEM	TYPE OF TEST	PROJECT VERIFICATION SAMPLING & TESTING FREQUENCY	PROCEDURES		REMARKS	POINT OF VERIFICATION FOR QUALITY DETERMINATION	CENTRAL LAB	
			PROJECT VERIFICATION SAMPLING	PROJECT VERIFICATION TESTING			TEST FREQUENCY	SAMPLE SIZE
304 AGGREGATE BASE COURSE	GRADATION	1 per 2000 tons (2000 t), or 1 per 1000 cu. yds. (765 M ³) or fraction thereof on each Class.	CP 30	CP 31	Report on CDOT Form #6.	Immediately after pugmill mixing or from windrow.	1 per source, per project.	55 lb (25 kg) for Gradation Only.
	ATTERBERG LIMITS	1 per 2000 tons (2000 t), or 1 per 1000 cu. yds. (765 M ³) or fraction thereof on each Class.		T 89 T 90			1 per source, per project.	110 lb. (50 kg) of minus 3/4" (19.0 mm) is required for full testing (moisture density curve). or 55 lbs.(25 kg) in addition to other test samples.
	IN-PLACE DENSITY	1 per 2000 tons (2000 t), or 1 per 1000 cu. yds. (765 M ³) or fraction thereof.		T 191 CP 80	Report on CDOT Form #6.	In the compacted lift.	1 R-value test per Class. (see NOTE 1)	
	MOISTURE-DENSITY CURVE	1 per source		T 180	Report on CDOT Form #24.		1 per source, per project.	
	LA ABRASION	1 per source		T 96	LA Abrasion required for Class 4,5,6,7		1 per source, per project. (NOTE 1)	
306 RECONDITIONING	IN-PLACE DENSITY	1 per 5000 sq. yds. (4000 m ²) or fraction thereof. 1 per 2500 sq. yds. (2000 m ²) or fraction thereof for each shoulder (when shoulders only are specified).		T 191 CP 23 CP 80	Report on CDOT Form #212.	In the compacted lift.		
	MOISTURE-DENSITY CURVE	1 per soil type.		T 99 T 180	Report on CDOT Form #24.		May be done at the Field or Region Lab if proper equipment is available.	

NOTE 1: Tests can be performed in the Field Lab or the Region Lab if adequate facilities and equipment are available.

CP = Colorado Procedures

CP-L = Colorado Procedures – Laboratory

T = AASHTO Procedures

C = ASTM Procedures

FREQUENCY GUIDE SCHEDULE for Minimum Materials Sampling, Testing, and Inspection

PAY ITEM	TYPE OF TEST	PROJECT VERIFICATION SAMPLING & TESTING FREQUENCY	PROCEDURES		REMARKS	POINT OF VERIFICATION FOR QUALITY DETERMINATION	CENTRAL LAB	
			PROJECT VERIFICATION SAMPLING	PROJECT VERIFICATION TESTING			TEST FREQUENCY	SAMPLE SIZE
307 LIME TREATED SUBGRADE	IN-PLACE DENSITY	1 per 10 000 sq. yds. (8 000 m ²) or fraction thereof; or as specified in the Contract.		T 191 CP 23 CP 80	Report on CDOT Form #212.	In the compacted lift.	The Region shall retain a Designated agent Laboratory to perform the required tests, if proper equipment is not available.	Process control test: Schedules for minimum sampling and testing conducted by the Contractor are listed in Standard Specification Section 307, Table 307-1. Cost shall be included in the bid price.
	GRADATION	1 per 10 000 sq. yds. (8 000 m ²) or fraction thereof.	CP 30	CP 31	1" – 100% passing #4 – 60% passing Dry sieving after final mixing.			
	ATTERBERG LIMITS	1 per 10 000 sq. yds. (8 000 m ²) or fraction thereof.		T 89 T 90	Reduce by ½ original PI.			
	MOISTURE-DENSITY CURVE	1 per soil type.		T 99 T 180	Moisture content of mixture at the start of compaction shall be at 2 ± 1% above optimum moisture content.			
	UNCONFINED COMPRESSIVE STRENGTH	1 per 10 000 sq. yds. (8 000 m ²) or fraction thereof.		D 5102 (Proc. B)	Tests shall be conducted on samples cured in moist environment for 5 days @ 100 F.			
	THICKNESS ACCEPTANCE	1 per 3 000 sq. yds. (2 400 m ²) or fraction thereof.		C 174	When measurement is <0.5", 2 additional cores shall be taken in that lot and the average of 3 cores will determine the thickness of that lot.			
	SWELL TEST	1 per 10 000 sq. yds. (8 000 m ²) or fraction thereof.		D 4546 (Meth. B)	½% or less with 200 psf surcharge pressure.	From the compacted roadway.		
	pH	1 per 10 000 sq. yds. (8 000 m ²) or fraction thereof.	CP 30	G 51	pH will be determined after % lime has been established based on unconfined compressive strength pH.			
	SULFATE	1 per soil type.		CP-L 2103	Water soluble sulfate content in soil shall be less than 0.2% by dry soil weight.			

FREQUENCY GUIDE SCHEDULE for Minimum Materials Sampling, Testing, and Inspection

<p style="text-align: center;">307</p> <p style="text-align: center;">HYDRATED LIME</p>	<p>Hydrated Lime: <i>Acceptance Method: Pre-Approved (with Contractor's COC for Documentation)* and CTR.</i> Information available at www.coloradodot.info/business/APL/ . Field inspect and document on CDOT Form #157 that the material is acceptable, retain all copies in the Project Files. The Contractor shall provide the Engineer with one copy of Certified Test Reports that is furnished by the supplier for Chemical Tests, as per AASHTO M 303. Immediately attach one copy of the Certified Test Reports and send to the Region Materials Engineer for review and comments. Immediately obtain a 5 lbs sample (1/2 of a standard lard can) according to AASHTO T 218 and submit to the Central Laboratory for gradation verification testing.</p> <p>NOTE 1: Minimum of one sample per source per project required. NOTE 2: Retain one copy of the Certified Test Reports along with the Form #157 for Project Files. Thereafter; one sample per 100 tons (100 t) of lime, for gradation only.</p> <p>NOTE 3: ALL VERIFICATION AND ACCEPTANCE GRADATION SAMPLES WILL BE SUBMITTED TO THE CENTRAL LABORATORY FOR TESTING. No verification gradation samples are to be run in the field except for information only.</p> <p>Quicklime: <i>Acceptance Method: CTR.</i> Test results are to document the percent purity. No sample required. (NOTE: number of tons of quicklime x 1.32 = tons of hydrated lime.)</p> <p>* Document the lime source on CDOT Form #157, (include sufficient information on the CDOT Form #157 so that the supplier and source are easily identified).</p>
<p style="text-align: center;">MINERAL FILLERS</p>	<p>For project acceptance, test for gradation according to CP 31 at 1 per 100 tons (100 t) or fraction thereof used, and report on CDOT Form #6. Submit 10 lb. (5 kg) sample to Central Laboratory at a frequency of 1 per 500 tons (500 t) or fraction thereof, for gradation check sample.</p> <p>Document lime or mineral filler source on CDOT Form #157, (include sufficient information on the CDOT Form #157 so that the supplier and source are easily identified).</p> <p>The above frequency is only applicable when mineral fillers are required by the plans.</p> <p>For Stone Matrix Asphalt (SMA) project acceptance, test for gradation according to CP 31 at 1 per 10,000 tons (10 000t) of SMA mix or fraction thereof used. Report on CDOT Form #6. Submit 10 lb. (5kg) sample to Central Laboratory.</p>

FREQUENCY GUIDE SCHEDULE for Minimum Materials Sampling, Testing, and Inspection

<p style="text-align: center;">308</p> <p style="text-align: center;">PORTLAND CEMENT OR FLY ASH</p>	<p>Portland Cement or Fly Ash utilized for treated subgrade:</p> <p><i>Acceptance Method: Pre-Approved (with Contractor's COC for Documentation).</i> Information available at www.colorado.dot.info/business/APL/. Field inspect and document on CDOT Form #157 that the material is acceptable, retain all copies in the Project Files.</p> <p>Established through a Project Special.</p> <p>Randomly sampled and tested on a project-by-project basis. If the source of cement or fly ash has changed from that in the approved mix design, contact the Concrete Unit of the Central Laboratory at (303) 398-6542.</p> <p>Upon request of the Engineer, the Contractor shall furnish a Bill of Lading, a manufacture's report stating the results of tests made on samples of the material taken during production or transfer, and certifying (with a COC) that the cement conforms to applicable requirements of ASTM C 150, C 1157, or C 595 and fly ash conforms to the applicable requirements of ASTM C 618. Review and Document on CDOT Form # 157 in the Project Files.</p>
<p style="text-align: center;">310</p> <p style="text-align: center;">FULL DEPTH RECLAMATION</p>	<p>Full Depth Reclamation:</p> <p>Established through a Project Special. Testing and sampling as specified in the contract.</p> <p>Density is performed at 1 per 4000 sq. yds. and Gradation is performed as required.</p>

FREQUENCY GUIDE SCHEDULE for Minimum Materials Sampling, Testing, and Inspection

PAY ITEM	TYPE OF TEST	PROJECT VERIFICATION SAMPLING & TESTING FREQUENCY	PROCEDURES		REMARKS	POINT OF VERIFICATION FOR QUALITY DETERMINATION	CENTRAL LAB	
			PROJECT VERIFICATION SAMPLING	PROJECT VERIFICATION TESTING			TEST FREQUENCY	SAMPLE SIZE
403 HOT MIX ASPHALT (HMA)	ASPHALT CONTENT	1 per 1 000 tons (1 000 t) or fraction thereof of mix produced (or as specified in the contract).	CP 41 CP 55	CP 85 CP-L 5120	Mix Design as per CP 52; CDOT Form #43 required <u>before</u> mix is produced. Report Asphalt Content on Form #58 and Form #360	Plant discharge, at/or behind paver. For Central Lab Correction Factor, sample aggregate from belt and Binder from Contractors tank.	CHECK TEST: Minimum of each 10k or fraction thereof. 1 can is submitted to Central Lab & one to the Region Lab.	65 lb (30 kg)
	AGGREGATE MOISTURE	Aggregate: 1 per 2 000 tons (2 000 t) or fraction thereof of mix produced (or as specified in the contract).	CP 30	CP 60 (Meth. B)	Report on Form #6 the results from Form #565 or #106. Compare to the % absorption (SSD) on the Form #43.	Aggregate from the cold feed.	Also needed for Central Lab Correction Factor when new 10K submitted. If Mix Design changes, submit Correction Factor when next 10K submitted. Submit Correction Factor at beginning of each Paving Season.	25 lb (Agg) 1 qt (binder)
	GRADATION	Aggregate: 1 per 2 000 tons (2 000 t) or fraction thereof of mix produced (or as specified in the contract).	CP 30	CP 31	Report Gradation on CDOT Form #6.	Aggregate from the cold feed, pugmill discharge, extraction, or product of CP-L 5120.		100 lb (45 kg) (Agg)
	MICRO DEVAL	1 per 10,000 tons (10 000 t) as specified in the Contract.	CP 30	CP-L 4211	Mix Design as per CP 52.	Aggregate from the cold feed.		65 lb (30kg)
	FRACTURED FACES AND VOID CONTENT FINE AGGREGATE	1 per 10,000 tons (10 000 t) of mix or fraction thereof.	CP 30	CP 45 T 304 A	Report on CDOT Form #58.			
	IN-PLACE DENSITY	Top two lifts of Item 403: 1 per 500 tons (500 t) or fraction thereof of mix placed. All other lifts: 1 per 1000 tons (1000 t) or fraction thereof of mix placed (or as specified in the contract).		CP 44 CP 81	Report on CDOT Form #69.	In the compacted lift.		
	THERMAL SEGREGATION	As specified in the contract.		CP 58	Report on CDOT Form #1346.	Behind paver.		
	LONGITUDINAL JOINT DENSITY	1per 5000 Linear Ft. of Joint		CP 44	Report on CDOT Form #1290.			
	(Testing Continued on the next page.)							

FREQUENCY GUIDE SCHEDULE for Minimum Materials Sampling, Testing, and Inspection

PAY ITEM	TYPE OF TEST	PROJECT VERIFICATION SAMPLING & TESTING FREQUENCY	PROCEDURES		REMARKS	POINT OF VERIFICATION FOR QUALITY DETERMINATION	CENTRAL LAB	
			PROJECT VERIFICATION SAMPLING	PROJECT VERIFICATION TESTING			TEST FREQUENCY	SAMPLE SIZE
403 HOT MIX ASPHALT (HMA)	THEORETICAL MAX. SP. GRAVITY	1 per 1 000 tons (1 000 t). Minimum of 1 test per day if less than 1 000 tons placed in a day.	CP 41 CP 55	CP 51 CP 56	Report on CDOT Form #69.	Plant discharge, at/or behind paver.	CHECK TEST: Minimum of each 10k or fraction thereof.	9 lb (4 kg) minimum
	HVEEM STABILITY	As specified in contract.	CP 41 CP 55	CP-L 5106	Report on Computer accept. form, or equivalent, or CDOT Form # 360 (see all test items).	Plant discharge, windrow, at/or behind paver.		
	AIR VOIDS	As specified in contract.	CP 41 CP 55	CP 44 CP-L 5115		Plant discharge, windrow, at/or behind paver.	Above test frequency for: Hveem Stability, Air Voids, VMA, and Lottman. Central Lab will run the Lottman test on first 10K. Lottman tests on 10k samples after the first 10K sample will be run if requested by the Region.	
	VOIDS IN MINERAL AGGREGATE	As specified in contract.	CP 41 CP 55	CP 48		Plant discharge, windrow, at/or behind paver.		
	LOTTMAN	As specified in contract.	CP 41 CP 55	CP-Ls 5109 & 5115		Plant discharge, windrow, at/or behind paver.		
	HAMBURG WHEEL-TRACKING	As specified in contract. (100 or 125 gyrations)	CP 41	CP-L 5112	Submit sample to the EuroLab Unit of the Central Lab. Applicable with superpave gyratory compaction designs with 100 or 125 design revolutions <u>only</u> .	Plant discharge, windrow, at/or behind paver.		65 lb (30 kg) for the Hamburg test
	FRENCH RUTTING-TESTER	As specified in contract. (100 or 125 gyrations)	CP 41	CP-L 5114		Plant discharge, windrow, at/or behind paver.		65 lb (30 kg) for the French test.
	PAVEMENT SMOOTHNESS	As specified in contract. Within 14 days after completion of paving.		CP 74	Testing shall be performed by the Contractor and will be witnessed by the Engineer. Data will be transferred to a CD or flash drive and immediately transferred to the Engineer after testing. Data will be immediately transferred to the Central Lab for analysis.			The Central Lab will perform pavement smoothness verification testing. The minimum testing will be statewide, once per certified profiler performing work and 25% of profiles submitted for a certified profiler.
(Testing Continued on the next page.)								

FREQUENCY GUIDE SCHEDULE for Minimum Materials Sampling, Testing, and Inspection

403	HOT MIX ASPHALT (HMA)	<p>NOTE: Subsidiary Item: Asphalt cement / performance graded (PG) binders, follow Item 411 of the Schedule.</p> <p>Incidental Items (non-pay): Portland Cement: <i>Acceptance Method: Pre-Approved (with Contractor's COC for Documentation).</i> Follow Item 308 of Schedule.</p> <p>Hydrated Lime: <i>Acceptance Method: Pre-Approved (with Contractor's CTR for Documentation).</i> The Contractor shall provide the Engineer with one copy of Certified Test Reports that is furnished by the supplier for Chemical Tests, per AASHTO M 303. Immediately attach one copy of the Certified Test Reports and send to the Region Materials Engineer for review and comments. Immediately obtain a 6 ½ lbs sample according to AASHTO T 218 and submit to the Central Laboratory for gradation verification testing. NOTE: Minimum of one sample per source per project required. NOTE: Retain one copy of the Certified Test Reports along with the Form #157 for Project Files. Testing must include CP-L 4209. Thereafter; one sample per 100 tons (100 t) of lime, for gradation only. See Item 307 of Schedule.</p> <p>Mineral Filler for SMA – Follow the procedure as stated for Hydrated Lime (immediately above).</p> <p>NOTE: Mix Design as per CP 52, Submit a 50 lbs (25 kg) representative sample of each aggregate for testing of aggregate specific gravity, absorption, and plastic index. If Los Angeles (LA) Abrasion or Micro-Deval is also requested for the large aggregate, submit 60 lbs (27 kg) of the large aggregate. Be sure to document on the CDOT Form #157 which tests are requested.</p> <p>NOTE: QC/QA Computer Test reports are acceptable Documentation for Asphalt Content, Gradation, In-Place Density, Longitudinal Joint Density, Maximum Specific Gravity, Air Voids, and Voids in Mineral Aggregate.</p>
------------	------------------------------	--

PAY ITEM	TYPE OF TEST	PROJECT VERIFICATION SAMPLING & TESTING FREQUENCY	PROCEDURES		REMARKS	POINT OF VERIFICATION FOR QUALITY DETERMINATION	CENTRAL LAB	
			PROJECT VERIFICATION SAMPLING	PROJECT VERIFICATION TESTING			TEST FREQUENCY	SAMPLE SIZE
405 HOT-IN-PLACE RECYCLE	IN-PLACE DENSITY	1 per 5 000 sq yds (4 000 m ²) total mix or fraction thereof (or as specified in the contract).	CP 41 (Meth. C)	CP 81	Document on CDOT Form #69.	Roadway behind paver & after rolling.		
	MAX. SP. GRAVITY (RICE)	Minimum, 1 per each density test.	CP 41 (Meth. C)	CP 51	Document on CDOT Form #58.			
	ASPHALT Rejuvenating Agent	See Item 411.						

FREQUENCY GUIDE SCHEDULE for Minimum Materials Sampling, Testing, and Inspection

PAY ITEM	TYPE OF TEST	PROJECT VERIFICATION SAMPLING & TESTING FREQUENCY	PROCEDURES		REMARKS	POINT OF VERIFICATION FOR QUALITY DETERMINATION	CENTRAL LAB	
			PROJECT VERIFICATION SAMPLING	PROJECT VERIFICATION TESTING			TEST FREQUENCY	SAMPLE SIZE
406 COLD ASPHALT PAVEMENT (RECYCLE)	IN-PLACE DENSITY	1 per 5000 sq yds (4000 m ²) or fraction thereof.	CP 41 * (Meth. C)	CP 53 CP 81	Report on CDOT Form #69, Form #6 or computer report. *To obtain material for CP 53.	Windrow or roadway, after rolling in finished roadway. For cationic emulsions, sample after rolling in the finished roadway.		
	GRADATION	1 per 20,000 sq yds (16 000 m ²) or fraction thereof.	CP 41	CP 31	Report on CDOT Form #6. Use sieve sizes as required.			
	HVEEM STABILITY	1 per 20,000 sq yds (16 000 m ²) or fraction thereof.	CP 41	CP-L 5111	For information only!			
	FREE MOISTURE	1 per day or as specified in the contract.		CP 57				
	ASPHALT Rejuvenating Agent	See Item 411.						
	Asphalt Emulsion	See Item 411						
409 COVER COAT MATERIAL	GRADATION	1 per 200 tons (200 t) or fraction thereof.	* CP 30	* CP 31	* NOTE: Report on CDOT Form #6. Submit 66 lb (30 kg) sample of field-produced aggregate to the Central Lab before use. Performance Graded Binder / Asphalt: Follow instructions in Item 411.	Spreader or the last stockpile prior to placement.	1 per project.	33 lb (15 kg)
	LA ABRASION	See ITEM 304						
	FRACTURED FACES	1 per 2500 tons (2500 t) or fraction thereof.	CP 30	CP 45	Document on CDOT Form # 6.			
408 SEALANT JOINT/CRACK	Joint & Crack Sealant, Hot Poured: Acceptance Method: <i>Pre-Approved (per each batch/lot) (with Contractor's COC for Documentation).</i> Information available at www.coloradodot.info/business/APL/ . Field inspect and document on CDOT Form #157 that the material is acceptable, retain all copies in the Project Files. Tested for compliance with ASTM D 6690 (Type II or Type IV).							

FREQUENCY GUIDE SCHEDULE for Minimum Materials Sampling, Testing, and Inspection

<p>403 - 411</p> <p>ASPHALT MATERIALS</p>	<p>BINDERS AND EMULSIONS: <i>Acceptance Method: Pre-Approved (Contractor's COC for Documentation) @ www.coloradodot.info/business/APL/</i></p> <p>NOTE: Normally, samples 1 thru 5 will be designated Lot No. 1, samples 6 thru 10 will be designated Lot No. 2, samples 11 thru 15 will be designated Lot No. 3, etc. At the discretion of the Project Engineer, a lot may be assigned as stated in the "Establishing Lots On The Project" Appendix of the FMM.</p> <p>ASPHALT CEMENT / PERFORMANCE GRADED (PG) ASPHALT BINDER:</p> <ul style="list-style-type: none"> Project acceptance samples of Asphalt Cement / Performance Graded Binders will be taken at the Contractor's HMA plant. Samples will be 1 qt. (1 liter) in size, and will be sampled in accordance with AASHTO T 40. Procedures and Type of Test: PG Binders will be tested according to the test procedures referenced in AASHTO MP1 and, as a minimum one sample per lot will be tested for Dynamic Shear Rheometer (DSR) (original). <p>BINDER - When Paid with HMA Mix: Project Verification Sampling frequency: 1 sample per 1000 tons (1000 t) of HMA mix, or fraction thereof, or as specified in the project plans, when binder (PG) is included in the bid price of Item 403 HMA. A complete set of tests to show compliance with the required specifications will be performed at the rate of 1 set of tests per 20,000 tons (20 000 t) of HMA mix, with a minimum of 1 complete set of tests per project. The correlation sample that is taken when the IA sample is taken must be marked as a correlation sample on the Form #411.</p> <p>BINDER - When Paid as Item 411: Project Verification Sampling frequency: 1 sample per 1000 tons of mix or fraction thereof, or as specified in the project plans, when bid pay Item is 411 - Asphalt Cement / PG Binder. A complete set of tests to show compliance with the required specifications will be performed at the rate of 1 set of tests per 15,000 tons of mix, with a minimum of 1 complete set of tests per project. For Asphalt cement or binder used in other than HMA Mixes, the sampling rate will be one sample per truck load of Binder. Submit <u>all samples</u> to the Central Laboratory where one sample per lot will be randomly tested. Report all sample information on CDOT Form #411 for PG Binder. All samples are tested as per Item 411 specifications.</p> <p>EMULSIFIED ASPHALT: <i>Acceptance Method: Pre-Approved (with Contractor's COC for Documentation).</i> Refer to Item 702.03. Unless otherwise specified, the Contractor shall provide the Project Engineer with one copy of a Certificate of Compliance that is furnished by the supplier to be attached to the CDOT Form #157. List the information on the form, and note the material is acceptable. Retain in the Project Files.</p> <p>EMULSIFIED ASPHALT FOR USE WITH ITEMS 406 & 409: One sample per truckload of Emulsified Asphalt. Submit all samples in the lot to the Central Laboratory. Sample in accordance with AASHTO T 40. Sample size 2 qt. (2 liter). Submit on CDOT Form #411. See note above for lot information. Fog Coat: Will be calculated on percent residue test.</p> <p>ASPHALT MATERIALS FOR COLD IN-PLACE RECYCLING, ITEM 406: One sample per truckload or 6,000 gallons (23 000 L). Acceptance samples may be taken from the line between the truck and recycling equipment, or at the truck. Sample according to AASHTO T 40. Sample size: one liter in non-metallic container. Submit all samples to the Central Lab. Submit on CDOT Form #411.</p> <p>ASPHALT REJUVENATING AGENT (ARA): <i>Acceptance Method: Pre-Approved (with Contractor's COC for Documentation).</i> Refer to Item 702.04. Submit one sample per project. Include supplier / refinery information; type and grade. Submit on CDOT Form #411.</p> <p>DUST PALLIATIVE, ASPHALTIC: Follow instructions for Emulsified Asphalt for Tack Coat Item 407.</p> <p>ASPHALT EMULSION for PRIME COAT (AEP) (any grade): <i>Acceptance Method: COC.</i> The Contractor shall provide the Project Engineer with one copy of a Certificate of Compliance that is furnished by the supplier to be attached to the CDOT Form #411. List the information on the form, and note the material is acceptable. Retain in the Project Files.</p>	<p>Point of Verification for Quality Determination</p> <p>< HMA Plant.</p> <p>< Storage tank or delivery conveyance.</p> <p>< At Project site.</p> <p>< At Project site.</p>
---	---	---

FREQUENCY GUIDE SCHEDULE for Minimum Materials Sampling, Testing, and Inspection

PAY ITEM	TYPE OF TEST	PROJECT VERIFICATION SAMPLING & TESTING FREQUENCY	PROCEDURES		REMARKS	POINT OF VERIFICATION FOR QUALITY DETERMINATION	CENTRAL LAB	
			PROJECT VERIFICATION SAMPLING	PROJECT VERIFICATION TESTING			TEST FREQUENCY	SAMPLE SIZE
412 PCCP COMPRESSIVE STRENGTH	AIR CONTENT	Minimum 1 per day then 1 per 5,000 sq. yds.	CP 61	T 152	Report weight on CDOT Form #82 during placement, and yield on CDOT Form #156.	Per CP 61	Cylinders are tested in Central Lab, but may be tested in the Field or Region Lab if adequate equipment is available.	
	UNIT WEIGHT / YIELD	Minimum 3 per mix design.	CP 61	T 121		Per CP 61		
	SLUMP		CP 61	T 119				
	COMPRESSIVE STRENGTH		CP 61	C 39 T 23	1 set of 5 cylinders, (Test 2 at 7 days and 3 at 28 days, or 56 days for Class H & HT) or as specified in the contract. Transmit cylinders on CDOT Form #82. Report on CDOT Form #192. Information cylinders may be cast at the discretion of the Proj Engineer.	Per CP 61		
	SAND EQUIVALENT		CP 30	CP 37		Stockpile or Plant.		
	WATER CEMENTITIOUS RATIO	1 st three loads each day, then 1 per 2000 cu. yds. (1520 m ³), or fraction thereof.			W/C = $\frac{\text{(weight water)}}{\text{(wt cement + wt flyash)}}$	Batch ticket.		
412 PCCP FLEXURAL STRENGTH	AIR CONTENT / YIELD	Minimum 1 per day then 1 per 5,000 sq. yds. Minimum 3 per mix design.	CP 61	T 152		Per CP 61	Beams are tested at the Contractor's Quality Control Lab	
	SLUMP		CP 61	T 119				
	FLEXURAL STRENGTH	1 per 10 000 sq. yds. per mix. Minimum of 3 per process.	CP 61	T 97	1 set of 4 beams, tested at 28 days.	Per CP 61		
	WATER CEMENTITIOUS RATIO	1 st three loads each day, then 1 per 2000 cu. yds. (1520 m ³), or fraction thereof.			W/C = $\frac{\text{(weight water)}}{\text{(wt cement + wt flyash)}}$	Batch ticket.		

FREQUENCY GUIDE SCHEDULE for Minimum Materials Sampling, Testing, and Inspection

PAY ITEM	TYPE OF TEST	PROJECT VERIFICATION SAMPLING & TESTING FREQUENCY	PROCEDURES		REMARKS	POINT OF VERIFICATION FOR QUALITY DETERMINATION	CENTRAL LAB	
			PROJECT VERIFICATION SAMPLING	PROJECT VERIFICATION TESTING			TEST FREQUENCY	SAMPLE SIZE
412 PORTLAND CEMENT CONCRETE PAVEMENT COMPRESSIVE STRENGTH OR FLEXURAL STRENGTH	THICKNESS	Min. 1 per day, per mix. If the project total is <50,000 sq. yds. then a minimum of 10 tests. If the project total is ≥50,000 sq. yds. then 1 per 5,000 sq.yds	T 24	T 148	Average of 3 specimens / test. Report thickness on CDOT Form #157. None required on bridge approach slabs.	Hardened concrete.		
	PULL TEST for JOINT SEALANTS	Minimum of 6 transverse and 6 longitudinal joint locations for the first 2500 linear feet (760 m) of concrete roadway; 3 transverse and 3 longitudinal joints thereafter.		CP 67	Replace joint failures. Report on CDOT Form #389. Document in Project Files. Witness by Engineer.	Installed in hardened concrete joint.		
	DOWEL BAR PLACEMENT	As specified in the plans.			Witness by Engineer.	Joint.		
	PULL TEST for TIE BARS	As specified in Standard Specification Section 412.13 (a).			If stabbed or drilled into the pavement. Witness by Engineer.	Hardened concrete.		
	TINING DEPTH	1 per 528 ft (160 m) linear feet or fraction thereof in each lane and shoulder wider than 8 feet.		CP 66	Summarize and report tining depth on CDOT Form #157. Witness by Engineer.	Hardened concrete.		
	SAW CUT DEPTH	1 per 528 ft (160 m), linear feet, of each longitudinal joint and 1 transverse joint in a section of 528 ft (160 m) or fraction thereof.		CP 66	Summarize and report saw cut depth on CDOT Form #157. Witness by Engineer.	Hardened concrete.		
<p>Slump may not exceed the Lab design by more than 1.5 inches. When compressive or flexural strength specimens are cast the tests for slump, unit weight, air content, and yield shall be made on the same sample at the same time.</p> <p>Compressive Strength specimens shall be initially cured by full immersion in saturated limewater at 73.4°F ± 3°, with lime concentrations as per AASHTO M 201. Water temperature shall be recorded by a continuous recording thermometer, calibrated every six months; or a maximum-minimum thermometer read and recorded twice a day on CDOT Form #82. When a field trailer is not available the curing tank shall be buried or insulated if necessary.</p> <p>INCIDENTAL ITEMS (non-pay) Portland Cement: Acceptance Method: Pre-Approved (with Contractor's COC for Documentation). Follow Item 701 of Schedule. Joint Sealant with Backer Rod, Silicone: Acceptance Method: Pre-Approved (with Contractor's COC for Documentation). Follow Item 412.18 of Schedule. Contraction Joint Plastic Strip: Acceptance Method: Field inspect and document on CDOT Form #157 that the material is acceptable, retain all copies in the Project Files. Reinforcing Steel, Dowels, Tie Bars: Acceptance Method: Follow Item 602 of Schedule. Incidental Items not listed above (non-pay): Acceptance Method: Follow Item 601 of Schedule.</p>								

FREQUENCY GUIDE SCHEDULE for Minimum Materials Sampling, Testing, and Inspection

420 GEO- SYNTHETIC	<p>Geosynthetics: <i>Acceptance Method: Pre-Approved (with Contractor's COC for Documentation).</i></p> <p>Geomembranes. Field inspect and document on CDOT Form #157 that the material is acceptable, retain all copies in the Project Files. Reference CDOT Materials Bulletin 2008 No 1.</p>
420 GEO- TEXTILES	<p>Geotextiles: <i>Acceptance Method: Pre-Approved (with Contractor's COC for Documentation).</i>* The physical, mechanical, and endurance properties that must be met , or exceeded, by the Geotextile being manufactured must be in compliance with AASHTO M 288, Geotextile Specification for Highway Applications. This Specification covers Geotextile fabrics for use in subsurface drainage, separation, stabilization, erosion control, temporary silt fence, and paving fabrics. Reference CDOT Materials Bulletin 2008 No 1.</p> <p>Materials shall be selected from the New York Department of Transportation's Approved Products List of Geosynthetic materials that meet the National Transportation Product Evaluation Program (NTPEP) and AASHTO M 288. The web address to ensure product acceptability is www.dot.state.ny.us/ Go to Site Index, Approved List of Materials and Equipment, Geosynthetics for Highway Construction, Geotextiles. Field inspect and document on CDOT Form #157 that the material is on the New York State APL.</p>
420 GEOGRIDS	<p>Geogrids for Embankment & Roadway: <i>Acceptance Method: COC or CTR.</i> Evaluated on a project-by-project basis by the Soils / Rockfall Program of the Materials and Geotechnical Branch at (303) 398-6587. After the specific material recommended for use has been evaluated, if approved for use, then field inspect and document on CDOT Form #157 that the material complies with the project specifications. Certified Test Reports or Certificates of Compliance may be required to be retained in the Project Files.</p> <p>Geogrids for Mechanically Stabilized Earth (MSE) Walls: <i>Acceptance Method: COC or CTR.</i> Evaluated on a project-by-project basis by the Bridge Design and Management Branch at (303) 512-4072. After the specific material recommended for use has been evaluated, if approved for use, then field inspect and document on CDOT Form #157 that the material complies with the project specifications. Certified Test Reports or Certificates of Compliance may be required to be retained in the Project Files.</p>
501 STEEL SHEET PILING	<p>Sheet Piling: <i>Acceptance Method: COC.</i> The contractor shall provide the Engineer with one copy of a Certificate of Compliance and Mill Test Reports (furnished by the supplier) showing compliance with Standard Specification Subsection 501.02 (or 501.03 as applicable) and to be retained with CDOT Form # 157, retain in Project Files. State on CDOT Form #157 that: (1) the material has been field inspected and is acceptable; (2) the Mill Test Reports are on file; and, (3) the heat numbers on piling correspond with the numbers on the Mill Test Reports.</p> <p>Reinforced Sheet Piling Tips: Documentation is the same as for Sheet Piling.</p>
502 PILING	<p>Steel Piling, Steel Pipe Piling, and Steel Shell Piling: <i>Acceptance Method: COC.</i> Follow the instructions in Item 501 of Schedule, except that the material shall comply with Standard Specifications Subsection 502.02.</p> <p>Reinforced Piling Tips: Contact the Soils / Rockfall Program of the Materials and Geotechnical Branch at (303) 398-6586.</p>

FREQUENCY GUIDE SCHEDULE for Minimum Materials Sampling, Testing, and Inspection

503 DRILLED CAISSONS	<p>Concrete: Follow instructions in Item 601 of Schedule.</p> <p>Reinforcing Steel: Follow instructions in Item 602 of Schedule. NOTE: Do not include quantities listed in Item 602 when reporting.</p>
504 CRIBBING	<p>Steel Cribbing: <i>Acceptance Method: CTR.</i> The Contractor shall provide the Engineer with one copy of Certified Test Reports / Mill Test Reports (furnished by supplier), attach and document on CDOT Form #157, retain in Project Files. State on CDOT Form #157: (1) the material has been field inspected and is acceptable.</p> <p>Concrete Cribbing: Follow Items 601 and 602.</p> <p>Timber Cribbing: See Item 508.</p>
504 MECH. STABILIZED EARTH WALL	<p>Reinforcement Elements: <i>Acceptance Method: COC.</i> Field inspect and document on CDOT Form #157 that the material is acceptable, retain all copies in the Project Files.</p> <p>Facing Elements: <i>Acceptance Method: COC.</i> Field inspect and document on CDOT Form #157 that the material is acceptable, retain all copies in the Project Files.</p> <p>Treated Timbers: See Item 508 and document acceptance of the material as stated.</p> <p>Structure Backfill: See Item 203, 206, 304 or contract documents as appropriate for gradation, atterberg limits, and density testing. Submit a 55 Lb. (22 kg) sample to Central Lab for direct shear testing [AASHTO T 236] to verify material's friction angle. Submit the compaction method and percent relative compaction if friction angle is required. Submit one sample per source.</p> <p>Foundation Soil: Submit a 55 lb. (22kg) sample to Central Laboratory for direct shear testing [AASHTO T 236] to verify material's friction angle. Submit one sample per 500 feet (150 meters) of wall length if the foundation soil type is unchanged. Submit the compaction method and percent relative compaction if friction angle is required. Otherwise, submit one sample for each soil type encountered. If the soil type is the same material as the Structure Backfill, then no additional samples will be required for testing.</p> <p>Misc Items: Document all items in Project Files.</p>
506 RIPRAP	<p>Riprap: Field inspect stone to determine compliance with specifications or contract documents, on size, durability, placement, etc. Determine specific gravity (bulk, saturated-surface dry) where specified in accordance with AASHTO T 85 or CP 23. Document on CDOT Form #157 for each pay item and show quantity represented and that the material has been field inspected and is acceptable. Bed Course Material: Follow instructions in Item 206 of Schedule.</p> <p>Gabions and Slope Mattress: <i>Acceptance Method: COC.</i> Wire mesh and fabricated baskets. Note that the baskets and wire mesh material has been field inspected and is accepted on the CDOT Form #157. See Chapter 500 for further details.</p> <p>Concrete and Concrete Reinforced: Follow instructions in Item 601 and 602 of Schedule.</p>

FREQUENCY GUIDE SCHEDULE for Minimum Materials Sampling, Testing, and Inspection

507 SLOPE AND DITCH PAVING	<p>Concrete and Concrete Reinforced: Follow instructions in Item 601 and 602 of Schedule. See Chapter 600 for more information. Note: Initial water cure of cylinders as per Item 601, or as directed by the Engineer.</p> <p>Welded Wire Mesh: <i>Acceptance Method: COC.</i> Field inspect and document on CDOT Form #157 that the material is acceptable, retain all copies in the Project Files. Refer to Standard Specifications Subsection 709.01.</p> <p>Dry Rubble: Determine specific gravity (bulk, saturated-surface dry) where specified according to AASHTO T 85 or CP 23. *</p> <p>Grouted Rubble: Determine specific gravity (bulk, saturated-surface dry) where specified according to AASHTO T 85 or CP 23. *</p> <p>Mortar: <i>Acceptance Method: Pre-Approved (with Contractor's COC for Documentation).</i> Field inspect and document on CDOT Form #157 that the material is acceptable, retain all copies in the Project Files.</p> <p>Asphalt: Field test for asphalt content and gradation; 1 each per 500 tons (500 t) or fraction thereof. No Central Laboratory samples required. Report on CDOT Form #6 and #58, or computer printouts are acceptable. Include bitumen quantity in Item 403 (Patching) quantities. Follow Item 411 of Schedule.</p> <p>* Document dry rubble and components of grouted rubble in Project Files.</p>
508 TIMBER STRUCTURES	<p>Treated Timber: <i>Acceptance Method: COC.</i> The Contractor shall provide the Engineer with one copy of the Certificate of Compliance (furnished by the supplier) and a copy of treating report(s) or retention assay. Field inspect and document on CDOT Form #157 that the material is acceptable, retain all copies in the Project Files.</p> <p>Timber for Cattle Guards: Follow instructions in Item 611 of Schedule.</p> <p>Untreated Timber: Field inspect and document on CDOT Form #157 that the material is acceptable, retain all copies in the Project Files.</p>
509 STRUCTURAL STEEL	<p>Steel Structures: <i>Acceptance Method: Pre-Inspected.</i> See Special Notice to Contractors for details. Final Inspection Report (CDOT Form #193) will be distributed by the Staff Bridge Fabrication Inspectors after all fabrication is complete and all mill test reports are received from the fabricator. This report will include high strength shop bolts, shop painting and galvanizing. The Staff Bridge Fabrication Inspectors will determine that the structural steel meets all physical and chemical requirements.</p> <p>Field painting: Field inspect for conformance with Standard Specifications Subsections 509.29. Paint reporting procedure is outlined in Item 708 of Schedule.</p> <p>Isolated small quantities of structural steel and structural steel-galvanized should be field inspected and reported on CDOT Form #157, and state that the material is acceptable.</p> <p>Structural Steel - Galvanized: The requirements are the same as for non-galvanized steel.</p>
510 STR. PLATE STRUCTURE	<p>Structural Plate Structures: <i>Acceptance Method: CTR.</i></p> <p>The contractor shall provide the Engineer with one copy of Certified Test Reports (furnished by supplier) attached to the CDOT Form #157, retain in Project Files. State on CDOT Form #157 (1) the material has been field inspected and is acceptable, (2) identification numbers on mill test reports corresponds with heat numbers on plates. State on the CDOT Form #157 that the high strength bolts were field inspected and bear high strength bolt markings.</p>

FREQUENCY GUIDE SCHEDULE for Minimum Materials Sampling, Testing, and Inspection

512 BEARING DEVICE	<p>Type I & II: <i>Acceptance Method: COC.</i> Contractor shall provide one copy of Certificate of Compliance and including Certified Test Reports on components. Copies of this Certificate of Compliance are to be attached to the CDOT Form #157, retain in Project Files. State on CDOT Form #157: (1) the material has been field inspected and is acceptable.</p> <p>Type III: <i>Acceptance Method: CTR.</i> The contract will list the products and manufacturers specifically approved by the Bridge Design and Management Branch. Field inspect and document on CDOT Form #157 that the material is acceptable, retain all copies in the Project Files.</p>
513 DRAIN PIPE	<p>Note: Item 513 has been deleted and incorporated into Item 624.</p>
514 PIPE RAILING	<p>Pedestrian & Bikeway Railing: Steel, Aluminum, Timber (any type). <i>Acceptance Method: CTR.</i></p> <p>The contractor shall provide the Engineer with one copy of Certified Test Reports (furnished by supplier) to be filed in the Project Files with the CDOT Form #157. Field inspect and document on CDOT Form #157 that the material is acceptable, retain all copies in the Project Files.</p>
515 WATERPROOFING MEMBRANE	<p>Prefabricated, Reinforced Membrane: <i>Acceptance Method: COC.</i> Field inspect and document on CDOT Form #157 that the material is acceptable, retain all copies in the Project Files.</p> <p>Single Component, Hot Applied, Elastomeric Membrane: <i>Acceptance Method: Pre-Approved (per each batch/lot) (with Contractor's COC for Documentation)</i> Information available at www.coloradodot.info/business/APL/. Field inspect and document on CDOT Form #157 that the material is acceptable, retain all copies in the Project Files.</p> <p>Protective Covering (Roofing paper): <i>Acceptance Method: COC.</i> Field inspect and document on CDOT Form #157 that the material is acceptable, retain all copies in the Project Files.</p> <p>Concrete Sealer: <i>Acceptance Method: Pre-Approved (with Contractor's COC for Documentation).</i></p> <p>Information available at www.coloradodot.info/business/APL/ . Field inspect and document on CDOT Form #157 that the material is acceptable, retain all copies in the Project Files.</p>

FREQUENCY GUIDE SCHEDULE for Minimum Materials Sampling, Testing, and Inspection

<p style="text-align: center;">516</p> <p style="text-align: center;">DAMP- PROOFING</p>	<p>Asphalts: <i>Acceptance Method: COC.</i></p> <p>Materials for damp-proofing with asphalt shall conform to the requirements ASTM D 449. The contractor shall provide the Engineer with one copy of Certificate of Compliance (furnished by supplier). Field inspect and document on CDOT Form #157 that the material is acceptable, retain all copies in the Project Files.</p>
<p style="text-align: center;">517</p> <p style="text-align: center;">WATER- PROOFING</p>	<p>Waterproofing Materials: <i>Acceptance Method: COC.</i></p> <p>Field inspect and document on CDOT Form #157 that the material is acceptable, retain all copies in the Project Files.</p>
<p style="text-align: center;">518</p> <p style="text-align: center;">EXPANSION DEVICES</p>	<p>Asphaltic Plug Joints: <i>Acceptance Method: Pre-Approved (per each batch/lot) (with Contractor's COC for Documentation).</i> Information available at www.coloradodot.info/business/APL/ . Field inspect and document on CDOT Form #157 that the material is acceptable, retain all copies in the Project Files. If verification testing is requested by the Engineer, submit one box of specimen with a CDOT Form #157 to the Central Lab.</p> <p>Waterstops: <i>Acceptance Method: COC.</i> Complies with the Standard Specifications Subsection 518.02. Field inspect and document on CDOT Form #157 that the material is acceptable, retain all copies in the Project Files.</p> <p>Asphaltic Expansion Devices: <i>Acceptance Method: COC.</i> Complies with the Standard Specifications Subsection 518.03. Field inspect and document on CDOT Form #157 that the material is acceptable, retain all copies in the Project Files.</p> <p>Elastomeric Expansion Devices: <i>Acceptance Method: COC.</i> Complies with the Standard Specifications Subsection 518.04. Field inspect and document on CDOT Form #157 that the material is acceptable, retain all copies in the Project Files.</p> <p>Modular Expansion Devices: <i>Acceptance Method: COC.</i> Complies with the Standard Specifications Subsection 518.05. Field inspect and document on CDOT Form #157 that the material is acceptable, retain all copies in the Project Files.</p> <p>Elastomeric Concrete End Dam: <i>Acceptance Method: COC.</i> Complies with the Standard Specifications Subsection 518.06. Field inspect and document on CDOT Form #157 that the material is acceptable, retain all copies in the Project Files.</p>

FREQUENCY GUIDE SCHEDULE for Minimum Materials Sampling, Testing, and Inspection

PAY ITEM	TYPE OF TEST	PROJECT VERIFICATION SAMPLING & TESTING FREQUENCY	PROCEDURES		REMARKS	POINT OF VERIFICATION FOR QUALITY DETERMINATION	CENTRAL LAB	
			PROJECT VERIFICATION SAMPLING	PROJECT VERIFICATION TESTING			TEST FREQUENCY	SAMPLE SIZE
601	AIR CONTENT (#1) UNIT WEIGHT (#1)	The first three batches at the beginning of a day's production, then one random test per five batches.	CP 61	T 152	Report on CDOT Form #82 and Form #156.	Per CP 61.		
	SLUMP (#1)	1 per set of cylinders.	CP 61	T 119		Per CP 61.		
	COMPRESSIVE STRENGTH	One set (5) cylinders per 100 cu yds (75 m ³) or fraction thereof. (Test 2 at 7 days and 3 at 28 days). For Class H and HT concrete, one set of (8) cylinders per 100 cu yds (75 m ³) or fraction thereof. Test 2 at 7 days, 3 at 28 days, and 3 at 56 days).	CP 61	C 39 T 23 (#2)	Submit cylinders on CDOT Form #82. Report on CDOT Form #192. Information cylinders may be cast at the discretion of Project Engineer and cured at the structure.		Cylinders are tested in the Central Lab, but may be tested in the Field or Region Laboratory if adequate equipment is available.	
STRUCTURAL CONCRETE	<p>1. NOTE (#1): Slump, air content, and Unit Wt. tests are required for each set of cylinders for all Classes of concrete. Except for Class BZ concrete the maximum specified slump is the Lab mix design slump plus 1.5 inches.</p> <p>2. NOTE (#2): Specimens shall be initially cured by full immersion in saturated limewater, with lime concentrations as per AASHTO M 201. Water temperature shall be recorded by a continuous recording thermometer, calibrated every six months; or a maximum-minimum thermometer read and recorded, twice a day, on the CDOT Form #82. When a field trailer is not available the curing tank shall be buried or insulated if necessary.</p> <p>INCIDENTAL ITEMS (non-pay) Cementitious Materials: Follow instructions in Item 701 of the Schedule. Reinforcing Steel: Follow instructions in Item 602 of the Schedule.</p> <p>Water, Non-Potable: <i>Acceptance Method: CTR.</i> If non-potable obtain Certified Test Reports from the Contractor (furnished by the supplier) before using, and document on the CDOT Form #157, and retain in Project Files. The test shall be in accordance with AASHTO T 26. If potable, document on CDOT Form #157. Water, Potable: <i>Acceptance Method: COC.</i></p> <p>Air Entraining Agents and Chemical Admixtures: <i>Acceptance Method: Pre-Approved (with Contractor's COC for Documentation).</i> The Contractor may change the brand of admixture as approved by the Engineer. Amounts of admixture needed to achieve the desired physical properties, may be adjusted once the quantities have been established in the trial mix. Information available at www.coloradodot.info/business/APL/. Only approved products may be used. Report all additives and dosages on batch ticket (CDOT Form #281 or equivalent). Plant computer printout batch ticket is acceptable.</p> <p>(Continued on next page.)</p>							

FREQUENCY GUIDE SCHEDULE for Minimum Materials Sampling, Testing, and Inspection

<p>601</p> <p style="writing-mode: vertical-rl; transform: rotate(180deg);">STRUCTURAL CONCRETE</p>	<p>INCIDENTAL ITEMS (non-pay)</p> <p>Other Additives: Contact Central Laboratory at (303) 398- 6542 for sampling, testing, and documentation information before use.</p> <p>Curing Compounds: <i>Acceptance Method: Pre-Approved (with Contractor's COC for Documentation).</i> Information available at www.coloradodot.info/business/APL/ . Tabulate the quantity of material used on the project. If you have questions or problems, call (303) 398-6542</p> <p>Epoxy Adhesive: <i>Acceptance Method: Pre-Approved (with Contractor's COC for Documentation).</i> Information available at www.coloradodot.info/business/APL/. For bonding fresh concrete to old concrete.</p> <p>Expansion Joint Material, Preformed Filler: <i>Acceptance Method: Pre-Approved (with Contractor's COC for Documentation).</i> Information available at www.coloradodot.info/business/APL/. Field inspect and document on CDOT Form #157 that the material is acceptable, retain all copies in the Project Files.</p> <p>Cementitious Grouts: <i>Acceptance Method: Pre-Approved (Contractor's COC for Documentation).</i> Information available at www.coloradodot.info/business/APL/.</p> <p>Class 5 Masonry Finish: <i>Acceptance Method: Pre-Approved (Contractor's COC for Documentation).</i> Information available at www.coloradodot.info/business/APL/.</p> <p>Structural Concrete Coating (Acrylic): <i>Acceptance Method: Pre-Approved (with Contractor's COC for Documentation).</i> Information available at www.coloradodot.info/business/APL/. Field inspect and document on CDOT Form #157 that the material is acceptable, retain all copies in the Project Files.</p> <p>Bridge Deck Forms; Permanent (left in-place) Steel: <i>Acceptance Method: CTR.</i> The contractor shall provide the Engineer with one copy of Certified Test Reports that are furnished by supplier to be filed with CDOT Form #157. State on CDOT Form #157: (1) the material has been field inspected and is acceptable, (2) Certified Test Reports are on file.</p>
<p>602</p> <p style="writing-mode: vertical-rl; transform: rotate(180deg);">REINFORCING STEEL</p>	<p>Reinforcing Steel (black bar) & Epoxy Coated Reinforcing Steel (green bar): <i>Acceptance Method: COC.</i> In accordance with CP 11 the Contractor shall only use qualified manufacturer sources of reinforcing steel found on the QML at www.coloradodot.info/business/APL/ .</p> <p>Each shipment will be accompanied by shipping invoices and Mill Test Reports. The Contractor shall provide the Engineer with one copy of Mill Test Reports. These reports are to be retained in the Project Files during construction. Document on a CDOT Form #157: (1) that the steel mill is on the QML (2) the material has been field inspected and is acceptable, (3) Mill Test Reports are on file, and (4) a tabulation of the quantity used on project.</p> <p>One sample of reinforcing steel shall be submitted to the Central Lab from each approved source. The sample shall consist of three straight 3-4 foot long pieces of the same grade and size. The bar size will be a size #10 or smaller.</p> <p>Epoxy Coating: <i>Acceptance Method: Pre-Approved (with Contractor's COC for Documentation).</i> Information available at www.coloradodot.info/business/APL/.</p> <p>Steel Chairs: <i>Acceptance Method: COC.</i> Field inspect and document on CDOT Form #157 that the material is acceptable, retain all copies in the Project Files.</p>

FREQUENCY GUIDE SCHEDULE for Minimum Materials Sampling, Testing, and Inspection

<p style="text-align: center;">603</p> <p style="writing-mode: vertical-rl; transform: rotate(180deg);">CULVERTS, SEWERS AND CULVERT PIPE</p>	<p>Corrugated Steel Pipe (CSP) and End Sections. Corrugated Aluminum Pipe (see note). Bonded CSP. Bituminous Coated CSP and Precoated CSP: <i>Acceptance Method: COC.</i> Field inspect for visible defects. Tabulate final quantities. Total quantities must equal or exceed final project quantities. Field inspect and document on CDOT Form #157 that the material is acceptable, retain all copies in the Project Files.</p> <p>Cast-in-Place Concrete Pipe: Follow instructions in Item 601 of Schedule. NOTE: T 23, Initial water cure as per Item 601, or as directed by the Engineer.</p> <p>Concrete Pipe and Precast Concrete Box Culvert: <i>Acceptance Method: COC.</i> In accordance with CP 11 the Contractor shall only use qualified manufacturer sources of precast concrete products found on the web site at www.coloradodot.info/business/APL/. Field inspect for visible defects. Tabulate final quantities on CDOT Form #157. Total quantities must equal or exceed final project quantities. Field inspect and document on CDOT Form #157 that the material is acceptable, retain all copies in the Project Files.</p> <p>Thermoplastic Pipe: <i>Acceptance Method: COC.</i> Pipe types can include PVC, (PE) Polyethylene. <u>Must have Steel End Section or as approved by the Engineer.</u> Field inspect and document on CDOT Form #157 that the material is acceptable, retain all copies in the Project Files.</p> <p>Vitrified Clay Pipe: <i>Acceptance Method: COC.</i> Field inspect and document on CDOT Form #157 that the material is acceptable, retain all copies in the Project Files.</p> <p>Gaskets: <i>Acceptance Method: COC.</i> Field inspect and document on CDOT Form #157 that the material is acceptable, retain all copies in the Project Files.</p> <p>Pipe Joint-Sealing Compounds: <i>Acceptance Method: COC.</i> Field inspect and document on CDOT Form #157 that the material is acceptable, retain all copies in the Project Files.</p> <p>NOTE: See the M Standards for proper types of End Sections when using Aluminum pipe.</p>
<p style="text-align: center;">604</p> <p style="writing-mode: vertical-rl; transform: rotate(180deg);">MANHOLES AND INLETS</p>	<p>Manholes, Inlets, and Precast Concrete Units (Prefabricated): <i>Acceptance Method: COC.</i> In accordance with CP 11 the Contractor shall only use qualified manufacturer sources of precast concrete products found on the web site at www.coloradodot.info/business/APL/.</p> <p>Field Fabricated: <u>Concrete</u>, follow Item 601. Note: Initial water cure as per Item 601, or as directed by the Engineer. <u>Reinforcing Steel</u>, follow Item 602. Field inspect and document on CDOT Form #157 that the material is acceptable, retain all copies in the Project Files.</p> <p>Clay or Shale Brick, Concrete Brick, Concrete Masonry Blocks: <i>Acceptance Method: COC.</i> Must meet individual specifications though not paid for separately. Field inspect and document on CDOT Form #157 that the material is acceptable, retain all copies in the Project Files.</p> <p>Inlet Grates and Frames, Manhole Rings, Covers, and Steps: <i>Acceptance Method: COC.</i> Must meet individual specifications though not paid for separately. Field inspect and document on CDOT Form #157 that the material is acceptable, retain all copies in the Project Files.</p>

FREQUENCY GUIDE SCHEDULE for Minimum Materials Sampling, Testing, and Inspection

605	SUBSURFACE DRAINS	<p>Corrugated Metal Pipe: <i>Acceptance Method: COC.</i> Field inspect and document on CDOT Form #157 that the material is acceptable, retain all copies in the Project Files.</p> <p>Vitrified Clay Pipe: <i>Acceptance Method: COC.</i> Follow instructions in Item 603.</p> <p>Plastic Pipe: <i>Acceptance Method: COC.</i> Field inspect and document on CDOT Form #157 that the material is acceptable, retain all copies in the Project Files.</p> <p>Bedding and Filter Materials: Follow instructions in Item 206 of Schedule. See Chapter 200 for filter material information.</p>
606	GUARDRAIL / BRIDGE RAIL	<p>Type 3 and Type 6: Treated Timber Posts and Blocks. <i>Acceptance Method: COC.</i> The Contractor shall provide one copy of a Certificate of Compliance and Mill Test Reports (furnished by the supplier). POSTS MUST BE FIELD INSPECTED (size, straightness, overall quality, visible defects, etc). Document on CDOT Form #157. List source, quantity, and sizes.</p> <p>Guardrail Blockouts, Synthetic. <i>Acceptance Method: Pre-Approved (Contractor's COC for Documentation).</i> Information available at www.coloradodot.info/business/APL/.</p> <p>Steel Posts for Type 3 and Type 6 (All types) - Document same as Guardrail below.</p> <p>Hardware and End Anchors - <i>Acceptance Method: COC.</i> List each pay item type on CDOT Form # 157. Field inspect and document on CDOT Form #157 that the material is acceptable, retain all copies in the Project Files.</p> <p>Rail - <i>Acceptance Method: COC.</i> Contractor shall provide the Engineer with one copy of a Certificate of Compliance and Mill Test Reports (furnished by supplier) to be filed with CDOT Form #157. Field inspect and document on CDOT Form #157 that the material is acceptable, retain all copies in the Project Files.</p> <p>Type 7, Precast: <i>Acceptance Method: COC.</i> In accordance with CP 11 the Contractor shall only use qualified manufacturer sources of precast concrete products found on the web site at www.coloradodot.info/business/APL/. The Contractor shall provide a copy of a Certificate of Compliance (furnished by the supplier), document on CDOT Form #157.</p> <p>Type 7, Cast-in-Place: Follow Item 601 of Schedule, except test frequency for cylinders shall be 1 per 1000 linear feet (300 m). NOTE: Initial water cure as per Item 601, or as directed by the Engineer.</p> <p>Reinforcing Steel - Follow Item 602 of Schedule.</p> <p>Incidental Items (non-pay) - Follow instructions in Section 601 of this Schedule.</p> <p>Light Weight Aggregates - Follow Section 601 of this Schedule, except that Central Laboratory sample size shall be one full sack.</p> <p>Glare Screens: <i>Acceptance Method: Pre-Approved (Contractor's COC for Documentation).</i> Information available at www.coloradodot.info/business/APL/.</p> <p>Type 10M, Type H and Type R: <i>Acceptance Method: CTR.</i> The Contractor shall furnish the Engineer with one copy of Certified Test Reports (furnished by the supplier) including Mill Test Reports to be filed with CDOT Form #157. Field inspect and document on CDOT Form #157 that the material is acceptable, retain all copies in the Project Files.</p>

FREQUENCY GUIDE SCHEDULE for Minimum Materials Sampling, Testing, and Inspection

<p>607</p> <p style="writing-mode: vertical-rl; transform: rotate(180deg);">FENCES</p>	<p>Barbed Wire: <i>Acceptance Method: COC.</i> Each roll shall be tagged with legible markings bearing the following information. ASTM Designation A 121, Design No., Class of Coating, Length of Roll and Name of Manufacturer. Field inspect and document on CDOT Form #157 that the material is acceptable, retain all copies in the Project Files.</p> <p>Woven Wire: <i>Acceptance Method: COC.</i> Each roll shall be tagged with legible markings bearing the following information. ASTM Designation A 116, Design No., Class of Coating. Length of Roll, and Name of Manufacturer and document this information on CDOT Form #157.</p> <p>Gates, Wire Ties, Wire Stays, Clips, Clamps, Staples, and Miscellaneous Fittings: Field inspect and document on CDOT Form #157 that the material is acceptable, retain all copies in the Project Files.</p> <p>Chain Link Fabric: <i>Acceptance Method: COC.</i> Field inspect and document on CDOT Form # 157 that the material is acceptable, retain all copies in the Project Files.</p> <p>Steel Posts, Steel Pipe Railing: <i>Acceptance Method: COC.</i> Make random check of weight, length, and coating. Field inspect and document on CDOT Form #157 that the material is acceptable, retain all copies in the Project Files.</p> <p>Timber Posts (Treated): <i>Acceptance Method: COC.</i> POSTS MUST BE FIELD INSPECTED (size, straightness, etc.). Document on CDOT Form #157 listing source, number, and sizes.</p> <p>Timber Posts (Untreated): <i>Acceptance Method: COC.</i> Field inspect. Document on CDOT Form #157 listing source, number, and sizes.</p> <p>Sound Barrier Wall: <i>Acceptance Method: Pre-Approved (with Contractor's COC for Documentation).</i> Information available at www.coloradodot.info/business/APL/ . Reflective Sound Barrier Walls and Absorptive Sound Barrier Walls are placed on the APL solely based on the acoustic qualities. The Contractor shall provide the Engineer with one copy of Certified Test Reports (furnished by the supplier) to validate the structural values required of the wall. Field inspect and document on CDOT Form #157 that the material is acceptable, retain all copies in the Project Files.</p>
--	---

FREQUENCY GUIDE SCHEDULE for Minimum Materials Sampling, Testing, and Inspection

PAY ITEM	TYPE OF TEST	PROJECT VERIFICATION SAMPLING & TESTING FREQUENCY	PROCEDURES		REMARKS	POINT OF VERIFICATION FOR QUALITY DETERMINATION	CENTRAL LAB	
			PROJECT VERIFICATION SAMPLING	PROJECT VERIFICATION TESTING			TEST FREQUENCY	SAMPLE SIZE
608 SIDEWALKS AND BIKEWAYS (PCCP)	AIR CONTENT	1 per 1000 sq yd. (840 m ²) or fraction thereof.	CP 61	T 152 T 199	Report on CDOT Form #156.	Per CP 61.	See Item 601.	See Item 601.
	SLUMP	One per set of cylinders.	CP 61	T 119		Per CP 61.		
	COMPRESSIVE STRENGTH	1 set (5) cylinders per 1000 sq. yds. (840 m ²) or fraction thereof.	CP 61	C 39 T 23	Submit cylinders on CDOT Form # 82. Report on CDOT Form #192. Information cylinders may be cast at the discretion of the Project Engineer. Initial water cure as per Item 601, or as directed by the Engineer.			
<p>NOTE: At the start of each day's production, the first load of concrete will be tested for air content. If the test meets specifications, then revert to the testing frequency above. Slump and air content tests are required for each set of cylinders for all Classes of concrete. The maximum specified slump is the Lab mix design slump plus 1.5 inches.</p> <p>Incidental Items (non-pay): Follow instructions in Item 601 of Schedule.</p>								
SIDEWALKS AND BIKEWAYS (HMA)	ASPHALT CONTENT	1 per project if plan quantity is more than 2 500 tons, or fraction Thereof greater than 500 tons.	CP 41 CP 55	CP 85 CP-L 5120	Mix Design as per CP 52; CDOT Form #43 required <u>before</u> mix is produced. Report Asphalt Content on Form #58.	See Item 403	See Item 403	See Item 403
	GRADATION	1 per project if plan quantity is more than 2 500 tons, or fraction Thereof greater than 500 tons.	CP 30	CP 31	Report Gradation on CDOT Form #6	See Item 403		
	IN-PLACE DENSITY	1 per project if plan quantity is more than 2 500 tons, or fraction Thereof greater than 500 tons.		CP 44 CP 81	Report on CDOT Form #69	See Item 403		

FREQUENCY GUIDE SCHEDULE for Minimum Materials Sampling, Testing, and Inspection

PAY ITEM	TYPE OF TEST	PROJECT VERIFICATION SAMPLING & TESTING FREQUENCY	PROCEDURES		REMARKS	POINT OF VERIFICATION FOR QUALITY DETERMINATION	CENTRAL LAB	
			PROJECT VERIFICATION SAMPLING	PROJECT VERIFICATION TESTING			TEST FREQUENCY	SAMPLE SIZE
609 CURB AND GUTTER (PCCP)	AIR CONTENT	1 per 2000 lin. ft. (600 m) or fraction thereof.	CP 61	T 152 T 199	Report on CDOT Form #156.	Per CP 61.	See Item 601.	See Item 601.
	SLUMP	One per set of cylinders.	CP 61	T 119		Per CP 61.		
	COMPRESSIVE STRENGTH	1 set (5) Cylinders per 2000 lin. ft. (600 m) or fraction thereof. (Test 2 at 7 days and 3 at 28 days).	CP 61	C 39 T 23	Submit cylinders on CDOT Form #82. Report on CDOT Form #192. Information cylinders may be cast at the discretion of the Project Engineer. Initial water cure as per Item 601, or as directed by the Engineer.			
<p>NOTE: At the start of each day's production, the first load of concrete will be tested for air content. If the test meets specifications, then revert to the testing frequency above. Slump and air content tests are required for each set of cylinders for all Classes of concrete. The maximum specified slump is the Lab mix design slump plus 1.5 inches.</p> <p>Incidental Items (non-pay): Follow instructions in Item 601 of Schedule.</p>								
CURB AND GUTTER (HMA)	ASPHALT CONTENT	1 per project if plan quantity is more than 2 500 tons, or fraction Thereof greater than 500 tons.	CP 41 CP 55	CP 85 CP-L 5120	Mix Design as per CP 52; CDOT Form #43 required <u>before</u> mix is produced. Report Asphalt Content on Form #58.	Plant discharge, at/or behind paver. For Central Lab Correction Factor, sample aggregate from belt and Binder from Contractors tank.	See Item 403	See Item 403
	GRADATION	1 per project if plan quantity is more than 2 500 tons, or fraction Thereof greater than 500 tons.	CP 30	CP 31	Report Gradation on CDOT Form #6	Aggregate from the cold feed, pugmill discharge, extraction, or product of CP-L 5120.		

FREQUENCY GUIDE SCHEDULE for Minimum Materials Sampling, Testing, and Inspection

610	MEDIAN COVER MATERIAL	<p>Decorative Concrete and Patterned Concrete: Follow instructions in Item 608 of this Schedule.</p> <p>Median Edging (Patterned Concrete): Follow instructions in Item 609 of Schedule. NOTE: Submit a Median Cover Material mix design documenting adherence to Special Provisions or contract documents. NOTE: Initial water cure as per Item 601, or as directed by the Engineer.</p> <p>Aggregate: Sample according to CP 30 and test for gradation according to CP 31. Test frequency 1 per 1000 tons (1000 t) or fraction thereof. Report on CDOT Form #6. Points of Acceptance: In stockpile or placed layer.</p> <p>Stone: Paid by ton (metric ton). Field inspect for compliance with Special Provisions or contract documents. Field inspect and document on CDOT Form #157 that the material is acceptable, retain all copies in the Project Files.</p> <p>Herbicide Treatment: Follow instructions in Item 217 of this Schedule. Use under the aggregate or under the stone.</p>
611	CATTLE GUARD	<p>Precast Cattle Guard Boxes: <i>Acceptance Method: COC.</i> In accordance with CP 11 the Contractor shall only use qualified manufacturer sources of precast concrete products found on the web site at www.coloradodot.info/business/APL/. The Contractor shall provide a copy of a Certificate of Compliance (furnished by the supplier), document on CDOT Form #157.</p> <p>Concrete, Reinforcing Steel, Structural Steel and Treated Timber: Follow instructions for 601 and 602 of this Schedule. Field inspect and document on CDOT Form #157 that the material is acceptable, retain all copies in the Project Files.</p>
612	DELINEATORS & REFLECTORS	<p>Delineators: Steel Posts: <i>Acceptance Method: COC.</i> Make random check of weight, length, and condition of coating. Field inspect and document on CDOT Form #157 that the material is acceptable, retain all copies in the Project Files.</p> <p>Reflectors : <i>Acceptance Method: Pre-Approved (with Contractor's COC for Documentation).</i> Field inspect and document on CDOT Form #157 that the material is acceptable, retain all copies in the Project Files. Information available at www.coloradodot.info/business/APL/.</p> <p>Delineators: Flexible Posts - <i>Acceptance Method: Pre-Approved (with Contractor's COC for Documentation).</i> Field inspect and document on CDOT Form #157 that the material is acceptable, retain all copies in the Project Files. Information available at www.coloradodot.info/business/APL/.</p> <p>Median Barrier Reflectors: <i>Acceptance Method: Pre-Approved (with Contractor's COC for Documentation).</i> Field inspect and document on CDOT Form #157 that the material is acceptable, retain all copies in the Project Files. Information available at www.coloradodot.info/business/APL/.</p>

FREQUENCY GUIDE SCHEDULE for Minimum Materials Sampling, Testing, and Inspection

613	<p>Luminaire: <i>Acceptance Method: COC.</i> The contractor shall provide the Engineer with one copy of a Certificate of Compliance (furnished by supplier) to be filed with CDOT Form #157. Field inspect and document on CDOT Form #157 that the material is acceptable, retain all copies in the Project Files.</p> <p>Wiring: <i>Acceptance Method: COC.</i> Field inspect for compliance with plans and specifications. Document in Project Files.</p> <p>Anchor Bolts: <i>Acceptance Method: CTR.</i> The Contractor shall provide the Engineer with one copy of Certified Test Reports (furnished by supplier) to be filed with CDOT Form #157. Field inspect and document on CDOT Form #157 that the material is acceptable, retain all copies in the Project Files.</p> <p>Metal or Plastic Conduit: Field inspect and document on CDOT Form #157 that the material is acceptable, retain all copies in the Project Files.</p> <p>* Light Standards, High Mast: <i>Acceptance Method: COC.</i> Includes poles, luminaries, rings, lowering devices, electrical components. Field inspect and document on CDOT Form #157 that the material is acceptable, retain all copies in the Project Files.</p> <p>Break away couplers and bases: Field inspect and document on CDOT Form #157 that the material is acceptable, retain all copies in the Project Files.</p> <p>Light Standards, Precast Concrete: <i>Acceptance Method: COC.</i> Field inspect and document on CDOT Form #157 that the material is acceptable, retain all copies in the Project Files.</p> <p>* Light Standards, Metal (poles and arms): <i>Acceptance Method: COC.</i> Field inspect and document on CDOT Form #157 that the material is acceptable, retain all copies in the Project Files.</p> <p>Hardware for Metal Light Standards: Field inspect and document on CDOT Form #157 that the material is acceptable, retain all copies in the Project Files.</p> <p>* Note: When light standards (poles and arms) are paid for under Item 613, a Certificate of Compliance for all structural components including light standards, bases, couplers, anchor bolts, luminaries, and other attachments shall state that the components will safely resist the higher of a 90 miles per hour wind velocity or the wind velocity specified in the plans or specifications or contract documents. The Certificate of Compliance shall state that static tests have been performed. If the Certified Test Reports are not in the Project File with CDOT, it must be attached to the Certificate of Compliance. The test procedure for aluminum parts shall satisfy the requirements of the Aluminum Association, Inc., "Specifications for Aluminum Structures" Section 8, except that no reduction factors for live load and dead load will be permitted. The Certificate of Compliance for breakaway couplers and bases shall state that production lot samples have been tested and meet the breakaway requirements of the AASHTO Standard Specifications for Structural Supports for Highway Signs, Luminaries, and Traffic Signals, Section 7.</p> <p>NOTE: For any concrete cast-in-place, if cylinders are fabricated, then initial water cure as per Item 601, or as directed by the Engineer.</p>
------------	--

LIGHTING

FREQUENCY GUIDE SCHEDULE for Minimum Materials Sampling, Testing, and Inspection

614	<p>Sign Panels: <i>Acceptance Method: COC.</i> The Contractor shall provide the Engineer with one copy of a Certificate of Compliance (furnished by supplier) to be filed with CDOT Form #157. After arrival on the project, field inspect fabricated panels for correct sign wording, legend and workmanship. Field inspect and document on CDOT Form #157 that the material is acceptable, retain all copies in the Project Files.</p> <p>Retroreflective Sign Sheeting: <i>Acceptance Method: Pre-Approved (Contractor's COC for Documentation).</i> Information available at www.coloradodot.info/business/APL/.</p> <p>Sign Posts - Steel, Wide Flange (WF): <i>Acceptance Method: COC.</i> The contractor shall provide the Engineer with one copy of a Certificate of Compliance (furnished by supplier) to be filed with CDOT Form #157. Field inspect and document on CDOT Form #157 that the material is acceptable, retain all copies in the Project Files.</p> <p>U2 Type: Make random check of weight, coating, and length for plan requirements. Square Tube Posts may be used as alternate. See Standard Drawing for post sizes. Field inspect and document on CDOT Form #157 that the material is acceptable, retain all copies in the Project Files.</p> <p>Timber: Field inspect and document on CDOT Form #157 that the material is acceptable, retain all copies in the Project Files.</p> <p>Overhead Sign Structures: <i>Acceptance Method: CTR.</i> The Contractor shall provide the Engineer with one copy of a Certified Test Report(s) and Certified Mill Test Reports for all steel materials incorporated into the structure (furnished by supplier). Field inspect and document on CDOT Form #157 that the material is acceptable, retain all copies in the Project Files.</p> <p>Traffic Signal Structure(s): <i>Acceptance Method: CTR.</i> The contractor shall provide the Engineer with one copy of a Certified Test Report(s) and Certified Mill Test Reports for all steel materials incorporated into the structure (furnished by supplier). Field inspect and document on CDOT Form #157 that the material is acceptable, retain all copies in the Project Files.</p> <p>Anchor Bolts: <i>Acceptance Method: CTR.</i> The contractor shall provide the Engineer with one copy of a Certified Test Report (furnished by supplier). Field inspect and document on CDOT Form #157 that the material is acceptable, retain all copies in the Project Files.</p> <p>Concrete Footings: Concrete and Reinforcing steel. For large quantities, if cast-in-place cylinders may be required, document per Item 601. If Cast-in-Place, initial water cure as per Item 601, or as directed by the Engineer. See the end of the Schedule for small quantities. Field inspect and document on CDOT Form #157 that the material is acceptable, retain all copies in the Project Files.</p> <p>Construction Traffic Control Signage & Devices: <i>Acceptance Method: Pre-Approved (Contractor's COC for Documentation).</i> Information available at www.coloradodot.info/business/APL/. Verify in APL Traffic Control Sub-Categories.</p> <p>Lighting Fixtures, Flashing Yellow Beacons, Traffic Signal Systems: Field inspect for compliance with plans and specifications and if in doubt, contact Region Traffic Signal Technician / Foreman. Field inspect and document on CDOT Form #157 that the material is acceptable, retain all copies in the Project Files.</p> <p>Messenger Cables, Electrical Conduit, Pull Boxes, Direct Burial Cable, Vehicle Detector Wire Loop, Grounding and Bonding, Miscellaneous Hardware, and Barricades: Field inspect and document on CDOT Form #157 that the material is acceptable, retain all copies in the Project Files.</p> <p>Breakaway Sign Structures: <i>Acceptance Method: COC.</i> Field inspect and document on CDOT Form #157 that the material is acceptable, retain all copies in the Project Files.</p>
------------	---

TRAFFIC CONTROL DEVICES

FREQUENCY GUIDE SCHEDULE for Minimum Materials Sampling, Testing, and Inspection

<p>615</p> <p style="writing-mode: vertical-rl; transform: rotate(180deg);">WATER CONTROL DEVICES</p>	<p>Headgates and Parshall Measuring Flumes: <i>Acceptance Method: COC.</i> The Contractor shall provide the Engineer with one copy of a Certificate of Compliance (by supplier). Field inspect and document on CDOT Form #157 that the material is acceptable, retain all copies in the Project Files.</p> <p>Embankment Protectors: Follow instructions in Item 603 of Schedule. Follow individual Item specification for any other type.</p>
<p>616</p> <p style="writing-mode: vertical-rl; transform: rotate(180deg);">SIPHONS</p>	<p>Siphon Pipe (metal and concrete), Siphon Drain Pipe: Follow instructions in Item 603 of Schedule.</p> <p>Trash Guards, Drain Valves, Valve Boxes: Field inspect and document on CDOT Form #157 that the material is acceptable, retain all copies in the Project Files. See Standard Specifications Subsection 712.06 and 716.07.</p> <p>Gaskets: Follow instructions in Item 603 of Schedule.</p>
<p>618</p> <p style="writing-mode: vertical-rl; transform: rotate(180deg);">PRESTRESSED CONCRETE STRUCTURES</p>	<p>Prestressed Concrete Unit: <i>Acceptance Method: Pre-Inspected.</i> A final report (CDOT Form #193) will be issued by the Staff Bridge Fabrication Inspectors stating that the units comply with the specifications and that the Material reports are on file at CDOT. Call the CDOT Staff Bridge Fabrication Inspectors at (303) 757-9193 for information.</p> <p>Prestressed and Pre-Inspected Girder members (units) will bear a CDOT stamp. Girder members will be stamped by CDOT personnel or the designated agent, when Quality Assurance determines that the contract requirements have been met.</p> <p>CDOT's Staff Bridge Fabrication Inspectors will notify the Project Engineer or project personnel of any release of girder members planned before the 28-day normal release schedule or specified in the contract documents.</p> <p>Post-Tensioned Members: *All components must meet individual specifications. Post-tensioning data must be documented in Project Files. Concrete - follow instructions in Item 601 of Schedule: <u>except</u> that one set (5) of cylinders are required for each concrete placement. Concrete usually is cast-in-place. <u>See note in Item 601</u> for curing instructions.</p> <p>Reinforcing Steel: Follow instructions in Item 602 of Schedule.</p> <p>Field Post-Tension Elements: *Strand, wire, and bars may be pretested. If not pretested contact Central Laboratory immediately and submit samples at the required frequencies. The Contractor shall provide the Project Engineer with one copy of Mill Test Reports. These reports are to be filed with the CDOT Form #157: (1) the material has been field inspected and is acceptable, (2) Mill Test Reports are filed, and (3) a tabulation of the quantity used on the project.</p> <p>* Sampling Frequency: Strand 1-per Heat Number (Sample 5.5' (1.7 m) long, minimum). Include a copy of the Mill Test Report attached with the CDOT Form #157. Wire 1-per 5 ton (5 t) or fraction thereof (sample 30" (760 mm) long). Bars 1 per 5 ton (5 t) or fraction thereof (sample 42" (1070 mm) long).</p>

FREQUENCY GUIDE SCHEDULE for Minimum Materials Sampling, Testing, and Inspection

<p>619</p> <p style="writing-mode: vertical-rl; transform: rotate(180deg);">WATER LINES</p>	<p>Cast Iron and Copper Pipe: <i>Acceptance Method: COC.</i> Field inspect and document on CDOT Form #157 that the material is acceptable, retain all copies in the Project Files.</p> <p>Welded Steel Pipe: Field inspect and document on CDOT Form #157 that the material is acceptable, retain all copies in the Project Files. Welding is performed in field as per AWS, D-1.1.</p> <p>Standard Galvanized Pipe: <i>Acceptance Method: COC.</i> Field inspect and document on CDOT Form #157 that the material is acceptable, retain all copies in the Project Files.</p> <p>Thermoplastic Pipe: <i>Acceptance Method: COC.</i> Field inspect PVC or PE pipe for pressure rating, brand name, and NSF rating upon arrival and before use. It is very important that you must carefully check for NSF rating on pipe when plastic pipe is used for potable and city waterline and domestic consumption. Field inspect and document on CDOT Form #157 that the material is acceptable, retain all copies in the Project Files.</p> <p>Valves and Valve Boxes: <i>Acceptance Method: COC.</i> Field inspect and document on CDOT Form #157 that the material is acceptable, retain all copies in the Project Files.</p>
<p>622</p> <p style="writing-mode: vertical-rl; transform: rotate(180deg);">REST AREAS AND BUILDINGS</p>	<p>Precast Concrete Units, Light Poles, Picnic Tables, and Septic Tanks: <i>Acceptance Method: COC.</i> Follow Certificate of Compliance procedure.</p> <p>Structural Glazed Tile, Ceramic Tile, Interior Insulation, Copper Pipe, Cast Iron Pipe, Perforated Drain Pipe: <i>Acceptance Method: COC.</i> The Contractor shall provide the Engineer with one copy of a COC (furnished by supplier). Field inspect and document on CDOT Form #157 that the material is acceptable, retain all copies in the Project Files.</p> <p>Roofing Asphalt: <i>Acceptance Method: COC.</i> The Contractor shall provide the Engineer with one copy of a Certificate of Compliance (furnished by the supplier) stating conformance to ASTM D 312, Type I and III. List all information on CDOT Form # 411 that the material is acceptable and retain all copies in the Project Files.</p> <p>Brick, Concrete Brick, Concrete Block: Check manufacturer, style, number, and color. The contractor shall provide the Engineer with one copy of a Certified Analysis to be filed with CDOT Form #157, retained in Project File. State on CDOT Form #157 that the material has been inspected and is acceptable, and that the Certified Analysis is on file. If no Certified Analysis is available, submit 5 brick or block per 10,000 or fraction thereof to the Central Laboratory before use.</p> <p>Mortar Sand: Submit one 33 lb (15 kg) sample to Central Laboratory before use. Report on CDOT Form #157.</p> <p>Masonry Cement: Must be commercial brand in good condition. Field inspect and document on CDOT Form #157 that the material is acceptable, retain all copies in the Project Files.</p> <p>Leaching Field Aggregate: Field inspect and field test to determine compliance with plans and specifications. One field sieve analysis required for each 100 cubic yards (75.3 m³) or fraction thereof. Report on CDOT Form #6.</p> <p>ALL ITEMS NOT INCLUDED ABOVE: FIELD INSPECT ACCORDING TO SECTION 622 INSPECTION GUIDELINES OF THE CDOT CONSTRUCTION MANUAL. REPORT ON CDOT FORM #157. REPORT AS MANY ITEMS AS PRACTICAL ON A SINGLE CDOT FORM #157. ATTACH ADDITIONAL SHEETS TO THIS FORM IF NECESSARY. RETAIN IN PROJECT FILE.</p>

FREQUENCY GUIDE SCHEDULE for Minimum Materials Sampling, Testing, and Inspection

623 IRRIGATION SYSTEM	<p>Irrigation System: <i>Acceptance Method: COC.</i> The Contractor shall provide the Engineer with one copy of a Certificate of Compliance (furnished by supplier) to be filed with CDOT Form #157. Field inspect and document on CDOT Form #157 that the material is acceptable, retain all copies in the Project Files.</p>
624 DRAINAGE PIPE	<p>Drainage Pipe: <i>Acceptance Method: COC.</i> See Item 603 of the schedule.</p> <p>Note: Item 513 that was discontinued is incorporated into this Section.</p>
627 PAVEMENT MARKING	<p>Glass Beads: <i>Acceptance Method: CTR.</i> The Contractor shall provide the Engineer with one copy of Certified Test Reports for Glass Beads (furnished by the supplier) to be filed with CDOT #157.</p> <p>Pavement Marking, All Types: <i>Acceptance Method: Pre-Approved (with Contractor's COC for Documentation).</i> Information available at www.coloradodot.info/business/APL/ .</p> <p>NOTE: Field inspect and document on CDOT Form # 157 that the material is acceptable, retain all copies in the Project Files.</p>
628 PEDESTRIAN BRIDGES	<p>Pedestrian Bridges: <i>Acceptance Method: COC.</i></p> <p>Established through a Project Special.</p> <p>The Contractor shall provide the Engineer one copy of a Certificate of Compliance (furnished by the supplier, if applicable) and Mill Test Reports. Individual components should be inspected and documented where possible. Follow the schedule for the appropriate item, (e.g. concrete, timber, etc.) If the bridge is: Pay Item 628 CIP, and you are unable to identify component parts, or if it is precast or prefabricated at an off-site location, then field inspect for adherence to the plans and specifications or special provisions, as applicable. Document on appropriate CDOT forms, or on a CDOT Form # 157, listing what material items can be readily identified.</p>

FREQUENCY GUIDE SCHEDULE for Minimum Materials Sampling, Testing, and Inspection

PAY ITEM	TYPE OF TEST	PROJECT VERIFICATION SAMPLING & TESTING FREQUENCY	PROCEDURES		REMARKS	POINT OF VERIFICATION FOR QUALITY DETERMINATION	CENTRAL LAB	
			PROJECT VERIFICATION SAMPLING	PROJECT VERIFICATION TESTING			TEST FREQUENCY	SAMPLE SIZE
641 SHOTCRETE	COMPRESSIVE STRENGTH	1 per day if less than 50 cu. yds are placed. Once per every 50 cu. yds or fraction thereof.	C 1140	C 1140 (3 @ 28 days)	Coring of shotcrete panels shall be performed by the contractor. If 28-day strengths are below specified strength, three additional cores will be tested at 56 days.	Panels shall be field cured. Cores for 28-day strengths removed 25-27 days after casting. Cores for 56-day strengths removed 53-55 days after casting.		
	AIR CONTENT	The 1 st three batches at the beginning of a day's production, then 1 per every 50 cu. yds or fraction thereof.	CP 61	T 152	Only for the wet process.	Tested at the point of delivery.		

708 PAINTS	<p>Structural Steel Bridge Paint: <i>Acceptance Method: COC.</i> Inorganic Zinc-Rich Polyurethane System. The Contractor shall provide the Engineer one copy of a Certificate of Compliance (furnished by the supplier or manufacturer) stating that the material complies with Standard Specifications Section 708 and specific requirements stated in the project plans. This information to be filed with the CDOT Form #157. Retain in Project Files.</p>							
	<p>Structural Concrete Coating: <i>Acceptance Method: Pre-Approved (Contractor's COC for Documentation).</i> Information available at www.coloradodot.info/business/APL/.</p>							

FREQUENCY GUIDE SCHEDULE for Minimum Materials Sampling, Testing, and Inspection

Guidelines for Test Frequency Reduction

SCOPE: Some relaxation in inspection and testing procedures may be permitted under certain conditions. Reduced engineering control may be particularly applicable to small quantities of intermittently delivered material on large projects and for contracts covering small projects.

It is intended that the reduced engineering control of sampling and testing procedures be permitted only for relatively small quantities of material that will not adversely affect the Traffic carrying capacity of a completed facility. **Such procedures are not to be permitted in concrete for major structures, permanent mainlines of ramp pavements, or other structurally critical items.**

Reduced inspection and testing frequencies are permissible only under the provisions outlined herein. Utilization of these Guidelines will be at the discretion of the Project Engineer and the Region Materials Engineer. The Project Engineer will determine the feasibility of reducing any phase of engineering control on his project. His decision should be documented in the project diary and with supplemental documentation as outlined below.

SAMPLING AND TESTING OF SMALL QUANTITIES:

The materials listed below may be accepted without further sampling and testing on the basis of visual examination, provided the source has recently furnished or is currently furnishing similar material found to be satisfactory under normal CDOT sampling and testing procedures.

The maximum quantities of material, which may be accepted by the above method, are:

Item 203 - Compaction:

Project Acceptance Test: 500 cubic yards (380 m³) or less, visually inspect and document in Project Files.

Item 206 - Structure Backfill:

50 cubic yards (35 m³) or less, visually inspect and document in Project Files. Central Laboratory Check Samples: 200 cubic yards (150 m³) or less, field test and document in Project Files.

Item 206 - Filter Material:

Project Acceptance Tests: 50 cubic yards (35 m³) or less, visually inspect and document in Project Files. Central Laboratory Check Samples: 200 cubic yards (150 m³) or less, field test and document in Project Files.

Item 206 - Bed Course Material:

Project Acceptance Tests: 100 cubic yards (70 m³) or less, visually inspect and document in Project Files. Central Laboratory Check Samples: 200 cubic yards (150 m³) or less, field test and document in Project Files.

Item 304 - Aggregate Base Course:

Project Acceptance Tests: Gradation, Atterberg limits and compaction 500 tons (500 t) or less, visually inspect and document in Project Files.

Item 403 - Hot Mix Asphalt:

All tests, 500 tons (500 t) or less, visually inspect and document in Project Files. Central Laboratory Check / Assurance Samples: 1000 tons (1000 t) or less, no sample; 2000 tons (2000 t), one sample; greater than 2000 tons (2000 t), and 1 per 10,000 tons (10 000 t) or fraction there of (see Schedule).

Item 409 - Cover Coat Material:

50 tons (50 t) or less, visually inspect and document in Project Files. Central Laboratory Check Sample: 200 tons (200 t) or less, no sample.

Item 411 - Asphalt Materials PG Binder:

AC-25 tons (25 t) or less, no sample. MC - 3000 gallons (11 000 L) or less, no sample. Emulsion - 3000 gallons (11 000 L) or less, no sample and document in Project Files.

FREQUENCY GUIDE SCHEDULE for Minimum Materials Sampling, Testing, and Inspection

Item 412 - Portland Cement Concrete Pavement:

Slump, air content, and compressive strength, 1000 square yards (800 m²) or less combining all thicknesses, visually inspect and document in Project Files.

Item 601 - Structural Concrete:

50 cubic yards (35 m³) or less for all Classes of concrete, visually inspect and document in Project Files.

Item 608 - Sidewalks and Bikeways:

250 square yards (200 m²) or less combining all thicknesses of sidewalks, visually inspected and document in the Project Files.

Item 609 - Curb and Gutter:

500 linear feet (150 m) or less for all Classes of concrete or HMA in the curbing, visually inspect and document in the Project Files.

SAMPLING AND TESTING OF LARGE QUANTITIES:

When a project has an unusually **large** quantity on any items it may be desirable to reduce the testing frequency. The following guidelines are suggested when considering test frequency reduction.

1. Region Materials Engineer, in cooperation with the Project Engineer, should analyze the item or items considered for reduction. The analysis should take into consideration the following:
 - a. The effect of reducing test frequency when analyzing a lot for price reduction. The minimum testing frequencies listed in the Frequency Guide Schedule for Minimum Materials Sampling, Testing, and Inspection.
 - b. Overall importance to the finished project should be considered because a reduction in test frequency could possibly allow some out of specification material to be incorporated into the project.
 - c. A source being used to supply material that has a **proven record** of supplying specification material.
2. When the determination is made that a reduced testing frequency is warranted, the Region Materials Engineer should submit a written request to the Materials and Geotechnical Branch Manager for approval. After approval has been obtained from the Materials and Geotechnical Branch Manager, testing will begin using the normal frequency until good control is established. As soon as five consecutive tests indicate no deviation from specification, reduced test frequencies can begin. If a test indicates deviation from specification, normal frequency will be immediately reinstated until five consecutive tests are within specifications. It is not the intent of these guidelines to suggest that a reduction in testing frequency be made on all projects where a large quantity occurs on an item. **This should only be used in isolated cases where it would be impractical to take the normal number of tests.**

FREQUENCY SCHEDULE for INDEPENDENT ASSURANCE EVALUATION

ITEM	DESCRIPTION	TYPE OF TEST REQUIRED	MINIMUM SAMPLING FREQUENCY	FORM #	REMARKS
203	EMBANKMENT	% Compaction	1 per 100 000 cu yds (75 000 m ³), or a fraction thereof greater than 25 000 cu yds. None required if plan quantity is less than 25 000 cu yds (20 000 m ³).	212	Use the same location for % Compaction. Verify curve selection.
206	STRUCTURE BACKFILL (Class I)	Gradation % Compaction	1 per 10 000 cu yds (7500 m ³), or a fraction thereof greater than 1 000 cu yds. None required if plan quantity is less than 1 000 cu yds (750 m ³).	6	Split the gradation sample. Use the same location for % Compaction. Verify curve selection.
206	STRUCTURE BACKFILL (Class II)	% Compaction	1 per 10 000 cu yds (7500 m ³), or a fraction thereof greater than 1 000 cu yds. None required if plan quantity is less than 1 000 cu yds (750 m ³).	212	Use the same location for % Compaction. Verify curve selection.
206	FILTER MATERIAL	Gradation	1 per 2 000 cu yds. (1500 m ³), or a fraction thereof greater than 200 cu yds. None required if plan quantity is less than 1 000 cu yds (750 m ³).	6	Split the gradation sample.
304	AGGREGATE BASE COURSE	Gradation % Compaction	1 per 20 000 tons (20 000 t), (10 000 cu. yds.) or a fraction thereof greater than 2 000 tons (2 000 t), (1 000 cu. yds.). None required if plan quantity is less than 10 000 tons (10 000 t), (5 000 cu. yds.).	6	Split the gradation sample. Use the same location for % Compaction. Verify curve selection.
306	RECONDITIONING	% Compaction	1 per 50 000 sq yds. (40 000 m ²), or a fraction thereof greater than 5 000 sq yds. (4 000 m ²). None required if plan quantity is less than 25 000 sq yds. (20 000 m ²).	212	Use the same location for % Compaction. Verify curve selection.

FREQUENCY SCHEDULE for INDEPENDENT ASSURANCE EVALUATION

ITEM	DESCRIPTION	TYPE OF TEST REQUIRED	MINIMUM SAMPLING FREQUENCY	FORM #	REMARKS
307	LIME TREATED SUB-GRADE	% Compaction	1 per 50 000 sq yds. (42 000 m ²), or a fraction thereof greater than 5 000 sq yds. (4 200 m ²). None required if plan quantity is less than 25 000 sq yds. (20 000 m ²).	212	Use the same location for % Compaction. Verify curve selection.
308	PORTLAND CEMENT TREATED BASE [Project Special]	Gradation % Compaction	1 per 50 000 tons (50 000 t) or a fraction thereof greater than 5 000 tons (5 000 t). None required if plan quantity is less than 5 000 tons (5000 t).	6	Split the gradation sample. Use the same location for % Compaction. Verify curve selection.
310	PROCESS ASPHALT MAT [Project Special]	% Compaction	1 per Project or as determined by the RME.	69	Use the same location for % Compaction. Verify curve selection.
403	HOT MIX ASPHALT - GRADATION ACCEPTANCE PROJECT Basis	% Asphalt Maximum Specific Gravity Gradation	1 per 10 000 tons (10 000 t), or a fraction thereof greater than 2 500 tons (2 500 t). None required if plan quantity is less than 2 500 tons (2 500 t).	360 and /or 58 and 6	Split the HMA sample.
		% Compaction Joint Density		69	Use the same location for % Compaction. Take an adjacent core for joint density.
403	HOT MIX ASPHALT - GRADATION ACCEPTANCE SYSTEM Basis	% Asphalt Maximum Specific Gravity Gradation	1 per 25 000 tons (25 000 t), or a fraction thereof greater than 2 500 tons (2 500 t), and perform at a minimum one IA every two months on each HMA project tester and their equipment. None required if plan quantity is less than 2 500 tons (2 500 t).	360 and /or 58 and 6	Split the HMA sample.
		% Compaction Joint Density		69	Use the same location for % Compaction. Take an adjacent core for joint density.

FREQUENCY SCHEDULE for INDEPENDENT ASSURANCE EVALUATION

ITEM	DESCRIPTION	TYPE OF TEST REQUIRED	MINIMUM SAMPLING FREQUENCY	FORM #	REMARKS
403	HOT MIX ASPHALT - VOIDS ACCEPTANCE PROJECT Basis	% Asphalt Maximum Specific Gravity Hveem Stability Air Voids Voids in Mineral Aggregate % Compaction Joint Density	1 per 10 000 tons (10 000 t), or a fraction thereof greater than 2 500 tons (2 500 t). None required if plan quantity is less than 2 500 tons (2 500 t).	360 and /or 58	Split the HMA sample.
				69	Use the same location for % Compaction. Take an adjacent core for joint density.
403	HOT MIX ASPHALT - VOIDS ACCEPTANCE SYSTEM Basis	% Asphalt Maximum Specific Gravity Hveem Stability Air Voids Voids in Mineral Aggregate % Compaction Joint Density	1 per 25 000 tons (25 000 t), or a fraction thereof greater than 2 500 tons (2 500 t), and perform at a minimum one IA every two months on each HMA project tester and their equipment. None required if plan quantity is less than 2 500 tons (2 500 t).	360 and /or 58	Split the HMA sample.
				69	Use the same location for % Compaction. Take an adjacent core for joint density.
405	HOT-IN-PLACE RECYCLE	% Compaction Maximum Specific Gravity	1 per 50 000 sq yds. (40 000 m ²), or a fraction thereof greater than 5 000 sq yds. (4 000 m ²). None required if plan quantity is less than 25 000 sq yds. (20 000 m ²)	69	Use the same location for % Compaction. Split the HMA sample.
406	COLD ASPHALT PAVEMENT (RECYCLE)	% Compaction	1 per 50 000 sq yds. (40 000 m ²), or a fraction thereof greater than 5 000 sq yds. (4 000 m ²). None required if plan quantity is less than 25 000 sq yds. (20 000 m ²).	69	Use the same location for % Compaction.

FREQUENCY SCHEDULE for INDEPENDENT ASSURANCE EVALUATION

ITEM	DESCRIPTION	TYPE OF TEST REQUIRED	MINIMUM SAMPLING FREQUENCY	FORM #	REMARKS
403/ 411	ASPHALT CEMENT/ PERFORMANCE GRADED ASPHALT BINDER & BITUMINOUS MATERIAL	Determined by Central Laboratory	Asphalt Cement / Performance Graded Binder & Emulsion for Chip Seal Coats and Cold-In-Place Recycling: Project acceptance sampling will be witnessed by the Region IA Tester, and documented on CDOT Form #411. Project Basis: 1 per 20 000 tons (20 000 t), or a fraction thereof greater than 2 500 tons (2 500 t) per binder type. None required if plan quantity is less than 2 500 tons (2 500 t). System Basis: A minimum of one per two months per tester or one per binder grade. None required if plan quantity is less than 2 500 tons (2 500 t).	67	Take an adjacent can for binder testing. (See Chapter 400 for details)
409	COVER COAT MATERIAL - AGGREGATE	Gradation	1 per 5 000 tons (5 000 t), or a fraction thereof greater than 500 tons (500 t). None required if plan quantity is less than 1 200 tons (1 200 t). 1 per 285 000 sq yds (230 000 m ²). None required if plan quantity is less than 62 500 sq yds (50 000 m ²).	6	Split the gradation sample.
409/ 411	COVER COAT MATERIAL - EMULSION	Determined by Central Laboratory	1 per 5 000 tons (5 000 t), or a fraction thereof greater than 500 tons (500 t). None required if plan quantity is less than 1 200 tons (1 200 t). Note: Verify if the sample is diluted or undiluted in the field.	67	Take an adjacent can for emulsion testing.

FREQUENCY SCHEDULE for INDEPENDENT ASSURANCE EVALUATION

ITEM	DESCRIPTION	TYPE OF TEST REQUIRED	MINIMUM SAMPLING FREQUENCY	FORM #	REMARKS
412	PORTLAND CEMENT CONCRETE PAVEMENT (Compressive Strength Alternative)	Compressive Strength Slump Air Content Sand Equivalent	1 set of cylinders per 50 000 sq yds. (40,000 m ²), or a fraction thereof greater than 5 000 sq yds. (4 000 m ²) for all thicknesses. None required if total plan quantity for all thicknesses is less than 5 000 sq yds. (4 000 m ²).	82 &/or 192	May use the same sampling container or a split sample. Split the sand equivalent sample.
	(Flexural Strength Alternative)	Flexural Strength	1 set of beams per 50 000 sq yds. (40,000 m ²), or a fraction thereof greater than 5 000 sq yds. (4 000 m ²) for all thicknesses. None required if total plan quantity for all thicknesses is less than 5 000 sq yds. (4 000 m ²).	157, 82 &/or 192	May use the same sampling container or a split sample.
503	DRILLED CAISSONS	Compressive Strength Slump	1 set of cylinders per 2 000 cu yds. (1 500 m ³), or a fraction thereof greater than 200 cu yds (150 m ³). None required if plan quantity is less than 500 cu yds. (380 m ³).		May use the same sampling container or a split sample.
507	SLOPE AND DITCH PAVING (Concrete)	Compressive Strength Slump Air Content	1 per 2 000 cu yds. (1 500 m ³), or a fraction thereof greater than 200 cu yds (150 m ³). None required if plan quantity is less than 500 cu yds. (380 m ³).		May use the same sampling container or a split sample.
601	STRUCTURAL CONCRETE	Compressive Strength Slump Air Content	1 per 2 000 cu yds. (1 500 m ³), or fraction thereof greater than 500 cu yds for each Class. No tests required if the quantity is less than 500 cu yds for each class. <u>Exception</u> : 1 test minimum if the total quantity of all classes is greater than 500 cu yds (380m ³).		May use the same sampling container or a split sample.

FREQUENCY SCHEDULE for INDEPENDENT ASSURANCE EVALUATION

ITEM	DESCRIPTION	TYPE OF TEST REQUIRED	MINIMUM SAMPLING FREQUENCY	REMARKS
606	GUARDRAIL (Cast In-Place)	Compressive Strength Slump Air Content	1 per 10 000 linear feet (3000 m) or a fraction thereof greater than 1 000 linear feet (300 m). None required if plan quantity for all classes is less than 3 000 linear feet (900 m).	May use the same sampling container or a split sample.
608	SIDEWALKS (Concrete)	Compressive Strength Slump Air Content	1 per 10 000 sq yds. (8 000 m ²), or a fraction thereof greater than 1 000 sq yds. (800 m ²). None required if total plan quantity for all classes and for all thicknesses is less than 1 500 sq yds. (1 250 m ²)	May use the same sampling container or a split sample.
	(HMA)	Gradation AC Content	1 per project. None required if total plan quantity is less than 2 500 tons (2 500 t).	Split the HMA sample.
609	CURB AND GUTTER (Concrete)	Compressive Strength Slump Air Content	1 per project. None required if plan quantity is less than 10 000 linear ft. (3 000 m).	May use the same sampling container or a split sample.
	(HMA)	None	None	
610	STRUCTURAL CONCRETE (Median Cover Mat'l)	Compressive Strength Slump Air Content	1 set of cylinders per 90 000 sq ft. (8 361 m ²), or a fraction thereof greater than 9 000 sq ft. (800 m ²) for each class. None required if total plan quantity is less than 10 000 sq ft. (929 m ²).	May use the same sampling container or a split sample.
618	PRESTRESSED CONCRETE UNITS (Cast In-Place)	Compressive Strength Slump Air Content	1 per 2 000 cu yds. (1 500 m ³), or a fraction thereof greater than 200 cu yds. (150 m ³). None required if plan quantity is less than 500 cu yds. (380 m ³).	May use the same sampling container or a split sample.

INDEPENDENT ASSURANCE (IA) SAMPLING

- NOTE 1 -** When all Items subject to Independent Assurance Sampling on a particular project have quantities less than the minimums set forth in the (QA) Frequency Guide Schedule for Minimum Materials Sampling, Testing, and Inspection, no IA Samples are required. However, on such projects the Region Materials Engineer will fill in the heading on a CDOT Form #379 and write across the face of this form a statement to the effect that “*No independent assurance samples were taken because of the small quantities involved.*” This will fulfill Independent Assurance requirements on this project.
- NOTE 2 -** Independent Assurance Sampling shall be accomplished at the Point of Verification or Acceptance listed for each Item in the (QA) Frequency Guide Schedule for Minimum Materials Sampling, Testing, and Inspection in the Field Materials Manual.
- NOTE 3 - **Gradation:**** Gradation tests shall be split with the field tester and run independently by personnel who have no direct responsibility for verification sampling and testing.
- NOTE 4 - **Compaction:**** Compaction tests using a Nuclear Moisture/Density (M/D) Gauge require that a Standard Count be made prior to the test as a check on the gauge. If the sand replacement method (AASHTO T 191) is used, documentation of sand calibration must be retained in the Project Files. If the calibration is not on file, a calibration will be required before the compaction test is performed.
- NOTE 5 - **Asphalt Content:**** When a Nuclear Asphalt Content Gauge is used, the Slope - Y Intercept shall be verified as the calibration. Independent Assurance tests shall be split with the field tester and run independently by personnel who have no direct responsibility for verification sampling and testing.
- NOTE 6 -** The Maximum Specific Gravity of project-produced mix is used to determine the target density for compaction compliance (see CP 51 & CP 56). Tests shall be split with the field tester and run independently by personnel who have no direct responsibility for acceptance/verification and testing.
- Nominal Maximum – (for Table One usage)** The size of aggregate in the smallest sieve opening through which the entire amount of Specification aggregate is permitted to pass. For Item 403, the Nominal Maximum size should be defined as one sieve size larger than the first sieve to retain more than ten percent of the aggregate.

INDEPENDENT ASSURANCE (IA) SAMPLING

TABLE IA – 1, Comparison Precision Guide

Element	Type of Test	Minor Difference	Significant Difference
Gradation	Sieve Analysis per CP 31		
	Nominal Maximum	≤ 1%	> 1%
	1-1/2" to # 8	≤ 5%	> 5%
	#16 to #50	≤ 4%	> 4%
	#100	≤ 3%	> 3%
Sieve Analysis per CP 31	#200	≤ 3%	> 3%
	NOTE: # 200 (Item 409 per CP 31B)	≤ 0.5%	> 0.5%
Asphalt Content	Asphalt Content Gauge per CP 85	≤ 0.20%	> 0.20%
	Ignition Method per CP-L 5120	≤ 0.35%	> 0.35%
	Asphalt Content Gauge vs. Ignition Method	≤ 0.35%	≤ 0.35%
Maximum Specific Gravity	Flask per CP 51	≤ 0.019	> 0.019
Asphalt Compaction	M/D Gauge per CP 81	≤ 2.0%	> 2.0%
	Cores per CP 44	≤ 2.0%	> 2.0%
Asphalt Compaction at Longitudinal Joints	M/D Gauge per CP 81	≤ 2.0%	> 2.0%
	Cores per CP 44	≤ 2.0%	> 2.0%
Air Voids	Per CP-L 5115	≤ 1.2%	> 1.2%
Voids in Mineral Aggregate	Per CP 48	≤ 1.2%	> 1.2%
Hveem Stability	Per CP-L 5106	≤ 7	> 7

INDEPENDENT ASSURANCE (IA) SAMPLING

TABLE IA – 1, Comparison Precision Guide (continued)

Element	Type of Test	Minor Difference	Significant Difference
Sand Equivalent	Sand Equivalent per CP 37	≤ 5 points	> 5 points
Slump	Cone per AASHTO T 119	≤ 1/2"	> 1/2"
Air Content	Air Meter per AASHTO T 152	≤ 0.5%	> 0.5%
Compressive Strength	Compressive Strength per ASTM C 39	Average QA within ±10% of average IA	Average QA test result >10% of average IA test result
Flexural Strength	Flexural Strength per AASHTO T 97	Average QA within ±10% of average IA	Average QA test result >10% of average IA test result
Soil Compaction	M/D Gauge per CP 80	≤ 2.0%	> 2.0%
Aggregate Base Compaction	M/D Gauge per CP 80	≤ 2.0%	> 2.0%

NOTE: Data based on Empirical Bayesian Statistics and is subject to change as the database increases. Table 1 was revised for the 2007 FMM based on data from the 2003, 2004, and 2005 construction season.

INDEPENDENT ASSURANCE (IA) SAMPLING

{This page was intentionally left blank.}

Colorado Procedure 10 -12

Standard Practice for

Qualification of Testing Personnel and Laboratories

1. INTRODUCTION

1.1 This procedure defines the requirements for qualification of people and laboratories. Specifically, all persons and all laboratories conducting tests used in mix design or acceptance must be qualified. Laboratories conducting Independent Assurance (IA) inspections for CDOT must be accredited and the people conducting these inspections must be certified.

2. SAMPLING AND TESTING PERSONNEL QUALIFICATIONS

2.1 All persons conducting or supervising tests used in mix design, acceptance, or IA must be qualified. The personnel conducting or supervising tests for the contractor's QC Program must be qualified. This includes mix design testing, verification testing by CDOT and designated agents (private laboratories), testing conducted by contractors and vendors and used in the acceptance decision (QC-For-Pay), and IA testing by CDOT and designated agents. The requirements to be qualified are stated below.

2.2 The person with overall responsibility for the sampling and testing on construction projects (the Project Engineer or Resident Engineer for CDOT and the Quality Control Supervisor if non-CDOT) shall be a registered Professional Engineer in the State of Colorado or possess a National Institute for Certification of Engineering Technologies (NICET) Level III Certificate in Highway Materials or Construction Materials with the soil, concrete, and asphalt sub-fields.

2.2.1 Pursuant to Section 12-25-102(10) of the Colorado Revised Statutes all mix designs shall be sealed by a registered Professional Engineer in the State of Colorado.

2.3 Persons performing sampling and testing used in the mix design, acceptance decision, QC, or IA testing shall be qualified by meeting the requirements listed in Table 10-1 and possessing current certifications.

2.3.1 To operate a nuclear device, CDOT personnel must possess a current certificate indicating that they have satisfactorily completed CDOT's School of Radiological Safety and Nuclear Gauge Operation. Non-CDOT operators of nuclear gauges must be certified as required by their company's Radioactive Materials License, issued by the Colorado Department of Public Health and Environment.

2.4 *New Employees:* New employees not qualified in accordance with Subsection 2.3 may conduct acceptance tests under the direct, day-to-day, supervision of an employee that is qualified (in accordance with 2.3) to conduct those tests. The maximum time period of supervised testing by any one non-qualified employee for each item is indicated in Subsection 2.4.2. Additional conditions that must be met are listed in Subsection 2.4.1. Note that these provisions do not apply to nuclear testing.

2.4.1 *Qualified Supervisor:* The qualified supervisor shall train the new employee, if needed, and then confirm in writing that this employee is capable of performing the tests in accordance with the standards. This written confirmation shall contain the following: identity and signature of the qualified supervisor, name and previous experience of the new employee, the time spent training the new employee, the tests for which the new employee is qualified, and the date the new employee will begin mix design or acceptance testing. The written confirmation shall be delivered to and approved by the Region Materials Engineer before the new employee performs mix design or acceptance tests. The qualified supervisor shall be present on the testing site at least once each day the new employee is conducting tests to closely oversee and check the work of the new employee. The qualified supervisor shall co-sign each test report and worksheet produced by the new employee. The close day-to-day supervision shall continue until the new employee is qualified by meeting the requirements of Subsection 2.3.

2.4.2 Time Limits for Acceptance Testing by Non-qualified New Employees:

2.4.2.1 *Soils Testing*: A maximum of 2 calendar months of continuous testing before qualification is required. Accumulation of time is not allowed.

2.4.2.2 *HMA Testing*: A maximum of two calendar months of continuous testing before qualification is required. Accumulation of time is not allowed. Inexperienced employees (less than one year of documented experience) performing testing on HMA shall successfully complete the Asphalt Construction QC/QA Technician Education course provided by the Rocky Mountain Asphalt Education Center (303-741-6148) before seeking certification.

2.4.2.3 *Concrete Testing*: A maximum of six calendar months of continuous testing before qualification is required. Accumulation of time is not allowed.

3. LABORATORY QUALIFICATION PROGRAM

3.1 The purpose of the Laboratory Qualification Program is to verify that laboratories conducting testing used in mix design or the acceptance decision are qualified. All laboratories conducting tests used in mix design or the acceptance decision must be qualified before construction of items requiring testing by that lab. Testing used in the acceptance decision includes verification testing by CDOT and designated agents of CDOT, plus QC testing by contractors and vendors.

3.2 All laboratories conducting testing used in mix design or the acceptance decision must meet the following requirements. CDOT and designated agent laboratories conducting verification testing, and contractors and vendors conducting QC testing used in the acceptance decision are included.

3.2.1 Laboratory Inspections:

3.2.1.1 *CDOT Laboratories*: The Region Materials Engineer or his designee shall conduct an inspection of each project laboratory before mix design or verification testing begins. The Central Laboratory may conduct random Field Laboratory inspections during project construction. The inspection shall be documented using the *Field Lab & Personnel Qualification Checklist* and any supplemental lists deemed necessary. The Region Materials Engineer, his designee, or the

Central Laboratory Inspection Coordinator shall indicate on the checklist whether or not the laboratory is qualified. If the laboratory has been determined to not be qualified, the deficiencies will be corrected to the satisfaction of the Region Materials Engineer. Project construction involving items subject to mix design or verification testing shall not begin until the laboratory conducting these tests is determined to be qualified. The Resident Engineer, in cooperation with the Region Materials Engineer, shall be responsible for assuring that CDOT owned project testing equipment is acceptable for mix design or verification sampling and testing.

3.2.1.2 *Designated Agent Laboratories*: All designated agent laboratories shall be part of the AASHTO accreditation program such as AASHTO Materials Reference Laboratory (AMRL) or Cement and Concrete Reference Laboratory (CCRL) in all of the tests performed. The Region Materials Engineer shall conduct or direct a designated representative to conduct an inspection of each designated agent laboratory used in verification testing before testing begins. The Central Laboratory may conduct random Field Laboratory inspections during project construction. The inspection shall be documented using the *Field Lab & Personnel Qualification Checklist* and any supplemental lists deemed necessary. The Region Materials Engineer, his designated representative, or the Central Laboratory Inspection Coordinator shall indicate on the checklist whether or not the laboratory is qualified. If the laboratory is determined to not be qualified, the deficiencies will be corrected to the satisfaction of the Region Materials Engineer. Project construction involving items subject to verification testing shall not begin until the laboratory conducting these tests is determined to be qualified. A designated agent may not conduct an inspection for qualification of its own laboratory. The laboratory shall participate in the CDOT round robin program for the required tests and achieve a score of 3.0 or better. Scores below a 3.0 will require approved corrective action and possible retesting.

3.2.1.3 *Contractor and Vendor Laboratories*: The Region Materials Engineer or his designated representative may conduct an inspection of each Contractor or vendor laboratory before QC testing used in the mix design or acceptance decision begins. If the inspection is performed it shall be documented using the *Field Lab & Personnel Qualification*

Checklist and any supplemental lists deemed necessary. The checklist shall indicate if the laboratory is qualified in all required tests. If the laboratory is determined to not be qualified, the deficiencies will be corrected to the satisfaction of the Region Materials Engineer. If the Contractor or vendor laboratory is used for mix design testing and is not AASHTO accredited, the laboratory shall participate in the CDOT round robin program for the required tests and achieve a score of 3.0 or better. Scores below a 3.0 will require approved corrective action and possible retesting. Testing conducted before the laboratory is determined to be qualified may not be used in the acceptance decision. Contractor or vendor laboratories used in QC-For-Pay projects shall be qualified in accordance with this subsection.

3.2.2 Calibration Checks: All laboratories performing mix design, verification testing, or QC testing used in acceptance shall conduct calibration checks at the minimum frequencies required by the test procedure, equipment operating guides, or Calibration Schedule included in the Field Materials Manual's Inspections (Central > Region) Chapter. The results of these calibration checks shall be documented on the appropriate forms and retained for a period of seven years. The calibration check documentation shall be made available to the Region Materials Engineer or the Project Engineer upon request.

3.2.3 Lab Personnel Qualifications: All laboratories performing mix design, verification testing, or QC testing used in the acceptance decision shall maintain documentation of the qualification of all laboratory personnel. This documentation shall indicate that all laboratory personnel are qualified for all the tests they conduct. This documentation shall be current and available at all times for review by the Project Engineer and the Region Materials Engineer.

3.3 If the laboratory performing the mix design, verification testing, or QC used in the acceptance decision is AASHTO accredited in the tests performed, it may be exempted from the above requirements for inspection and calibration checks.

4. INDEPENDENT ASSURANCE (IA) LABORATORY REQUIREMENTS

4.1 The CDOT Central Laboratory, the Region Materials Laboratories, and designated

agent laboratories conducting Independent Assurance (IA) inspections and testing shall conform to the following requirements.

4.1.1 Central Lab and Designated Agents: The CDOT Central Lab and designated agents conducting IA testing shall be AASHTO accredited in accordance with the requirements of Section 5.

4.1.2 Region Materials Labs: An inspection of each Region Materials Laboratory shall be made annually by personnel from the Central Materials Laboratory, as per Subsection 9.2.1.2 of the QA Procedures Chapter. Equipment Verification Checks will be made on equipment used for IA testing including ovens, scales, and balances.

4.1.3 All laboratories performing IA testing shall conduct equipment verification checks twice a year on all equipment used in IA testing during that period. The results of those checks shall be in accordance with AASHTO R 18 and documented on the appropriate forms and retained for a period of seven years.

5. ACCREDITATION

5.1 CDOT Central Laboratory and Designated Agent Inspection: The CDOT Central Lab and designated agents conducting IA testing for CDOT will be inspected periodically by National Reference Laboratories (AMRL and/or CCRL) and will maintain accreditation by the AASHTO Accreditation Program.

5.1.1 The test procedures covered by the designated agent accreditation shall include all IA tests that the designated agent will conduct or observe for CDOT.

5.1.2 AASHTO Materials Reference Laboratory (AMRL) and Cement and Concrete Reference Laboratory (CCRL) Inspection Reports:

5.1.2.1 All AMRL and CCRL inspection reports from inspections conducted on the Central Materials Laboratory will be retained and made available to the FHWA upon request.

5.1.2.2 All AMRL and CCRL inspection reports from inspections conducted on designated agents that conduct IA testing for CDOT will be retained and made available to CDOT upon request.

5.1.3 Deficiencies Identified in AMRL or CCRL Inspection Reports:

5.1.3.1 Deficiencies indicated in the AMRL or CCRL inspection reports for inspections conducted on the CDOT Central Materials Laboratory or on designated agents conducting IA testing for CDOT will be corrected at the earliest opportunity and documentation of the corrective action sent to AMRL or CCRL.

5.1.4 Proficiency Samples Ratings:

5.1.4.1 CDOT Central Laboratory or designated agent laboratory AASHTO Proficiency Samples with a rating of less than 3 (2 Standard Deviations) will be investigated to determine the cause of the low ratings and corrective action taken to prevent future occurrences. These corrections will be reported, in writing, to AMRL or CCRL within 60 days of the receipt of the deficient rating.

5.2 Local Agencies shall have IA inspections conducted by an AASHTO accredited laboratory in accordance with the conditions of Subsection 7.4 of the Quality Assurance Procedures Chapter of the Field Material Manual (FMM). The local agency must confirm that the Accredited Laboratory meets all appropriate criteria.

6. INSTRUCTIONS FOR USE OF THE – FIELD LAB & PERSONNEL QUALIFICATION CHECKLIST

GENERAL

6.1 Lab Cleanliness & Housekeeping - The field-testing lab is generally clean and organized to the point where it will not affect test results.

6.2 Equipment Cleanliness & Functionality - The field-testing equipment is clean and in good working order, with no broken or partially repaired parts that would have a detrimental effect on the test results.

6.3 Calibration Checks & Personnel Qualification - Documentation of the calibration checks must be readily available in the field-testing lab, being both complete and up-to-date. This includes calibration checks of scales, ovens, water baths (concrete & bulk), and thermometers. Equipment verification such as sieve examinations, measurements of air meters, slump cones, cylinder molds, beam

molds, etc. should also be documented. The qualifications of each person in the lab who conduct the tests are documented, being both current and available.

6.4 Scales, Accurate & Level - Verify scales have been checked with a reference weight in accordance with AASHTO M 231 and are level on the testing face.

6.5 Ovens, Accurate Temperatures (140°, 230°, 275°, & 300°F) - Verify that oven thermostats are maintaining the temperature of the 140°F ± 5° (60°C ± 2.8°) oven, 230°F ± 9° (110°C ± 5°) oven, 275°F ± 5° (135°C ± 2.8°) oven, and the 300°F ± 5° (149°C ± 2.8°) oven.

6.6 Thermometer(s) Accurate - Conforming to the requirements of ASTM. The thermometers shall be capable of reading 77°F by 0.2°F (25°C by 0.1°C), 140°F by 0.2°F (60°C by 0.1°C), 230°F by 1°F (110°C by 0.5°C), 275°F by 2°F (135°C by 1°C), and 300°F by 2°F (149°C by 1°C).

6.7 Sieves - In good repair, and checked with comparator. Sieves conform to ASTM E 11 and have been checked with a certified comparator in accordance with ASTM E 11. Verify that there are no visible holes, dents, wire marks, etc. in the sieves or any sagging of the sieve.

6.8 Current and Updated CDOT Materials Forms. CDOT Form #250 (Materials Documentation Record) and Form #379 (Project Independent Assurance Sampling Schedule) are filled out and complete as of the date of the inspection.

6.9 Equipment and Lab Facility supplied by the Contractor meet the M Standards (M-620-11 or M-620-12) or the specification for the project for which the lab is being supplied.

6.10 Aggregate splitter complies with ASTM C 702 for the correct number of opening and the size of openings. Splitter does not have visible signs of excessive wear, i.e., splitter openings broken, dented, welds detached, etc.

6.11 Shaker - Sieving Adequacy Test Performed. Verify the correct aggregate sieving time by running the sieving adequacy test defined in CP 31, ASTM C 136, and AASHTO T 27. Verify that the sieve shaker can hold an entire set of sieves, (10 + catch pan).

CONCRETE

6.12 Curing tanks for concrete cylinders and beams contains lime-water at the correct temperature, $73^{\circ}\text{F} \pm 1.8^{\circ}$ ($23^{\circ}\text{C} \pm 1^{\circ}\text{C}$) in accordance with ASTM C 31. Verify the recording thermometer is present and is correct in accordance with ASTM C 31.

6.13 Verify that all Concrete Testing Equipment meets the appropriate requirements: Air meter (ASTM C 231), Slump Cone (ASTM C 143), Unit Weight (ASTM C 138), Cylinder Molds (ASTM C 31), and Beam Molds (ASTM C 78).

6.14 Verify that the Concrete Compression Machine has been calibrated for concrete cylinders, ASTM C 39, and for beams (if tested), ASTM C 78, and has a current (yearly) certified calibration sticker on the machine. Verify that the neoprene pads meet ASTM C 1231 and have been checked for wear and logged for the number of breaks on each pair of pads (maximum of 100 uses per pad). Verify the loading rate of the Concrete Compression Machine and that it meets the ASTM C 39. Verify that calibration records for the Concrete Compression Machine are available and up to date in accordance with ASTM E 4.

ASPHALT

6.15 Verify that a square splitting pan and square sided scoop are being used for asphalt sampling and splitting in accordance with CP 55.

6.16 Verify that CP 51 is being followed for determination of Maximum Specific Gravity (Rice). Verify that manometer is free of air bubbles, vacuum pump oil is free of water, desiccating crystals are free of moisture, flasks have been calibrated in accordance with CP 51 and "D" weights have been logged. Verify that vacuum pump pressure can be maintained at 28 ± 2 mm of mercury.

6.17 Verify that CP 44 is being followed for determination of Bulk Specific Gravity. Bulk tank is at the correct temperature, $77^{\circ}\text{F} \pm 1.8^{\circ}$ ($25^{\circ}\text{C} \pm 1^{\circ}$). Suspension line is of the smallest possible diameter at the water surface (and there are no knots at the surface).

NUCLEAR

6.18 Verify that nuclear gauges are stored and secured properly as required by the Radioactive Materials License. Verify that the Caution Radioactive Materials placard, the Notice to Employees document, and the Nuclear Incident Procedure sheet (filled out with responsible individual(s) names and phone numbers) are posted correctly. That the daily gauge logs are filled out and current, and the Moisture / Density Gauge has been calibrated as specified. Consultant M/D Gauges will be certified within the last 12 months and CDOT M/D Gauges will be calibrated within the last 24 months. Verify that Statistical Stability and Drift tests have been run before the start of the project and whenever requested by the Project Engineer.

SOILS

6.19 Verify that soils and base course equipment meet the corresponding AASHTO requirements and that the correct hammers and molds, designated in AASHTO T 99 and T 180, are used. Verify that the atterberg limit equipment is calibrated properly and is within specification in accordance with AASHTO T 89 and T 99. Verify that the #4 riddle meets the AASHTO E 11 standards by using a comparator, micrometer, or other calibrated measuring device. Verify that compaction base is of sufficient mass (> 90 kg) and a suitable area for compaction is available in accordance with AASHTO T 99 and T 180.

AASHTO Test Designation	ASTM Test Designation	CDOT Test Designation	Test Description	ACI Concrete Field Testing Technician Grade I	ACI Aggregate Testing Technician - Level 1	ACI Aggregate Testing Technician - Level 2	ACI Concrete Lab. Testing Tech. Grade I (G) - Level 1 (L) – Both (B)	ACI Concrete Lab. Testing Tech. Grade II (G) - Level 2 (L) – Both (B)	ACI Concrete Strength Testing Technician	WAQTC Embankment & Base	LABCAT A	LABCAT B	LABCAT C	LABCAT E
T 246		CPL 5106	Hveem Stability										X	
T 283		CPL 5109	Resistance to Moisture Induced Damage										X	
	C 1231		Unbonded Caps for Concrete Cylinders				B		X					
	C 39		Compressive Strength of Cylindrical Concrete Specimens				B		X					
	C 617		Capping Cylindrical Concrete Specimens				B		X					
	C 1064		Temperature of Freshly Mixed Hydraulic-Cement Concrete	X										
	C 172		Sampling Freshly Mixed Concrete	X										
	C 143		Slump of Hydraulic-Cement Concrete	X										
	C 138		Density, Yield and Air Content (Gravimetric) of Concrete	X										
	C 231		Air Content of Freshly Mixed Concrete by Pressure Method	X										
	C 31		Making and Curing Concrete Test Specimens in the Field	X										
	C 42		Obtaining and Testing Drilled Cores and Sawed Beams					B						
	C 78		Flexural Strength of Concrete (Using Simple Method with Third-Point Loading)				L	G	X					
T 224		CP-23	Correction for Coarse Particles in the Soil Compaction Test							X				
T 310		CP 80	In-Place Density and Moisture Content of Soil and Soil-Aggregate by Nuclear Methods (Shallow Depth)							X				
T 89			Determining the Liquid Limits of Soils							*				
T 90			Determining the Plastic Limit and Plasticity Index of Soils							*				
T 99 T 180			Moisture Density Relations of Soils							X				

* Included as part of Excavation & Embankment (Soil Inspector) Certification

{This page was intentionally left blank.}

Field Lab & Personnel Qualification Checklist – 11

Project No. _____ Project Code _____

Project Location: _____

Consultant/Field Tester _____ Project Engineer _____

Qualified Laboratory? Yes No General Impression _____

Region Inspection of Project Field Lab Region Inspection of Contractor Lab

Region Inspection of Consultant Lab

GENERAL

- 6.1 Lab Cleanliness & Housekeeping. (Good/Fair/Poor) _____
- 6.2 Equipment Cleanliness & Functionality. (Good/Fair/Poor)..... _____
- 6.3 Calibration Checks & Personnel Qualification, Documents present & complete.(Y/N/NA) _____
- 6.4 Scales-Accurate & Level. (Y/N/NA)..... _____
- 6.5 Ovens-Accurate Temperatures (140°, 230°, 275°, 300EF). (Y/N/NA) _____
- 6.6 Thermometer(s)-Accurate. (Y/N/NA)..... _____
- 6.7 Sieves - Good repair, and checked w/ comparator. (Y/N/NA) _____
- 6.8 Current CDOT Materials Forms. (Y/N/NA)..... _____
Forms up-to-date (# 250 & # 379, and all others). (Y/N/NA)..... _____
- 6.9 Equipment & Lab facility supplied by Contractor meet Specifications. (Y/N/NA)..... _____
- 6.10 Aggregate Splitter - Correct # of openings. (Y/N/NA) _____
Correct size openings. (Y/N/NA) _____
- 6.11 Shaker-sieving adequacy performed. (Y/N/NA)..... _____
Holds full set of sieves (10 + catch pan). (Y/N/NA)..... _____

Comments: _____

CONCRETE Applicable. (Y/N) _____

- 6.12 Concrete curing water at correct temperature. (Y/N/NA) _____
Recording thermometer present and operating. (Y/N/NA)..... _____
- 6.13 Concrete Testing Equipment:
 - Air Meter Calibrated. (Y/N/NA) _____
 - Slump Cone Dimensions are accurate. (Y/N/NA)..... _____
 - Strike off plate for Unit Wts is accurate. (Y/N/NA)..... _____
 - Approved Cylinder/Beam Molds. (Y/N/NA)..... _____
- 6.14 Concrete Compression Machine:
 - Calibrated for Cylinders/Beams. (Y/N/NA) _____
 - Neoprene Pads checked/logged. (Y/N/NA)..... _____
 - Correct Loading Rate. (Y/N/NA)..... _____
 - Calibration records present. (Y/N/NA)..... _____

Comments: _____

ASPHALT Applicable. (Y/N)

- 6.15 Square Splitting Pan for Asphalt. (Y/N/NA).....
- Square Sided Scoop for Asphalt. (Y/N/NA).....
- 6.16 Maximum Specific Gravity (RICE) set up. (Y/N/NA)
- Manometer free of air. (Y/N/NA)
- Pump oil free of water. (Y/N/NA).....
- Desiccating crystals free of water. (Y/N/NA)
- Flasks calibrated and logged. (Y/N/NA)
- Vacuum Pump Pressure at 28 ± 2 mm Hg. (Y/N/NA)
- 6.17 Bulk Specific Gravity Equipment:
 - Tank at Correct Temperature. (Y/N/NA).....
 - Suspension line of smallest diameter. (Y/N/NA).....

Comments:

NUCLEAR Applicable. (Y/N)

- 6.18 Nuclear Gauge Stored Properly & Secured. (Y/N/NA).....
- Caution Radioactive Materials placard posted correctly. (Y/N/NA).....
- Nuclear Incident Procedures filled out. (Y/N/NA)
- Daily Gauge Logs filled out. (Y/N/NA)
- M/D Gauge Certified. (Y/N/NA)
- Stat & Drift Test performed. (Y/N/NA)

Comments:

SOILS Applicable. (Y/N).....

- 6.19 Soils & Base Equipment:
 - Hammers & Molds within specification. (Y/N/NA).....
 - Atterburg equipment within specification. (Y/N/NA).....
 - #4 Riddle within specification. (Y/N/NA)
 - Compaction base of sufficient mass (>90 Kg). (Y/N/NA)

Comments:

PERSONNEL

Tester 1 (Name / Title)	Required (Y or N)	Certification	Expiration MM-DD-YY
		ACI Concrete Field Testing Technician Grade I	
		ACI Aggregate Testing Technician – Level 1	
		ACI Aggregate Testing Technician – Level 2	
		ACI Concrete Laboratory Testing Technician Grade I or ACI Concrete Lab. Testing Tech. Level 1	
		ACI Concrete Laboratory Testing Technician Grade II or ACI Concrete Lab. Testing Tech. Level 2	
		ACI Concrete Strength Testing Technician	
		WAQTC Embankment & Base	
		LabCAT A	
		LabCAT B	
		LabCAT C	
		LabCAT E	

Tester 2 (Name / Title)	Required (Y or N)	Certification	Expiration MM-DD-YY
		ACI Concrete Field Testing Technician Grade I	
		ACI Aggregate Testing Technician – Level 1	
		ACI Aggregate Testing Technician – Level 2	
		ACI Concrete Laboratory Testing Technician Grade I or ACI Concrete Lab. Testing Tech. Level 1	
		ACI Concrete Laboratory Testing Technician Grade II or ACI Concrete Lab. Testing Tech. Level 2	
		ACI Concrete Strength Testing Technician	
		WAQTC Embankment & Base	
		LabCAT A	
		LabCAT B	
		LabCAT C	
		LabCAT E	

Comments: _____

Inspected by: _____ **Date** _____ **Region** _____ **Materials Lab**

Approved by: _____ **Date** _____
 Project Engineer

- Distribution: () Region Materials Engineer - Original
 () Resident Engineer
 () Project Engineer
 () Field Lab Tester

{This page was intentionally left blank.}

Colorado Procedure 11-12

Standard Practice for

Quality Management Plans for the Qualified Manufacturers List or the Approved Products List

1. SCOPE

1.1 This Standard specifies requirements and procedures for a certification system that shall be applicable to all referenced manufacturers, as well as suppliers and contractors within certain industries. Certifying a Manufacturer's Quality Management Plan is not an automatic acceptance of any particular product, but an acknowledgement that the Manufacturer has taken steps to ensure that their quality controls meet the applicable Industry standards. A Quality Management Plan, a Quality Control Plan, and a Quality System Manual are deemed synonymous for this standard.

1.2 Manufacturers whose Quality Management Plans are acceptable will be placed on the Qualified Manufacturers List (QML) or their products will be eligible to be placed on the Approved Products List (APL). Only Manufacturers required to be listed on the QML will be eligible to provide the referenced products to a CDOT project. The QML is located within CDOT's Approved Products List (APL) web site, at www.coloradodot.info/business/APL/.

2. REFERENCED INDUSTRIES

2.1 With respect to this Standard there are two materials classes. This Colorado Procedure will be divided into two parts to correlate to these materials classes. Part I will be Standard Manufactured Materials of which upon acceptance of the manufacturer's Quality Control Plans the individual products submitted will be placed on the APL. Part II will be Fabricated Structural Materials of which upon acceptance of the manufacturer's Quality System Manual the individual production facilities will be placed on the QML. Each Part will be divided into Sub-Parts, which are a grouping of products or Manufacturers that have a certain commonality. Within each Sub-Part of this Colorado Procedure there will be instructions and guidance for the Manufacturers to become certified so that they can submit their manufactured products for inclusion in CDOT projects.

3. TABLE OF CONTENTS

Part I.	Standard Manufactured Materials	
	Sub-Part 1.	Asphalt Binder
	Sub-Part 2.	Asphalt Emulsion
	Sub-Part 3.	Hydraulic Cement
	Sub-Part 4.	Fly Ash
	Sub-Part 5.	Hydrated Lime
Part II.	Fabricated Structural Materials	
	Sub-Part 1.	Steel Reinforcing Bars & Steel Dowel Bars
	Sub-Part 2.	Epoxy-Coated Steel Reinforcing Bars & Epoxy-Coated Steel Dowel Bars
	Sub-Part 3.	Precast Concrete Structures
	Sub-Part 4.	Corrugated Steel Pipe (Under Development)

4. PRODUCT ACCEPTANCE

4.1 The majority of materials submitted for inclusion on CDOT projects will fall within one of four levels of product acceptance for their sampling and testing. CDOT always retains the right through its Quality Assurance (QA) Program to obtain samples for additional testing and require supplemental documentation.

4.2 The four levels of product acceptance are: Pre-Inspected (PI), Certified Test Report (CTR), Certificate of Compliance (COC), and Pre-Approved (through the APL).

4.3 A Manufacturer being placed on the QML is a completely separate activity from how their product(s) are accepted on a CDOT project. The specifics on product acceptance are addressed in the Special Notice to Contractors chapter and with additional reference in the Quality Assurance Schedule.

5. DECERTIFICATION

5.1 Certification may be withdrawn from suppliers when one or more of the following conditions exist:

5.1.1 Failure to consistently supply material of a specific grade meeting specifications for three (3) acceptance samples as determined by CDOT test results.

5.1.2 Failure to regularly participate in two (2) WCTG or equal "Round-Robins."

5.1.3 Inadequate maintenance of required records.

5.1.4 Improper documentation of shipments.

5.1.5 A visit by CDOT's Representative to a supplier's facility reveals significant quality control problems.

5.1.6 Failure to maintain an acceptable quality control program.

5.1.7 Failure to comply with any additional decertification requirements found in the applicable Sub-Part of this Standard.

5.2 Notification of Decertification will be in writing.

6. QUALIFYING FOR RECERTIFICATION

6.1 If a supplier has been decertified and seeks to be recertified, then the Supplier Certification Requirements must be fulfilled, as per Section 6 of the applicable Sub-Part of this Standard.

Part I, Sub-Part 1:

Asphalt Binder - 12

(Certifying Suppliers and Contractors)

1. REFERENCED DOCUMENTS

- 1.1 CDOT Standard Specifications
 - Table 702-1, Superpave Performance Graded Binders
- 1.2 AASHTO Standards:
 - R 29 Practice for Grading or Verifying the Performance Grade of an Asphalt Binder
 - T 40 Method of Sampling Bituminous Materials
 - R 18 AASHTO Accreditation Program
- 1.3 ASTM Standards:
 - D 8 Definitions of Terms Relating to Materials for Roads and Pavements
- 1.4 WCTG Bylaws

2. TERMINOLOGY

- 2.1 Binder - An asphalt based cement that is produced from petroleum residue either with or without the addition of non-particulate organic modifiers.
- 2.2 PG - Performance Graded, as in Superpave Performance Graded Binders.
- 2.3 Supplier - A Supplier shall be defined as one who produces, controls, and supplies the final binder product to satisfy the PG binder grade specified in Table 702-1 of the Standard Specifications and/or other appropriate CDOT specifications. A Supplier shall be a refinery, a terminal, an HMA producer, or any facility that holds product for more than 30 days from the date of delivery for unmodified binders or 7 days from the date of delivery for a modified binder regardless of binder quantity. If no modification is made to the PG binder grade after its initial production at the refinery, the refinery shall be the supplier and must provide certification. If there is any grade modification of the PG binder

at the terminal, the terminal becomes the supplier and must provide the certification. If an HMA producer blends binder of different grades or binders from different suppliers at the facility, the HMA producer becomes the supplier and must provide the certification to verify the grade of the stored binder and must meet CP 11 requirements for an approved supplier. No PG binder will be produced or blended to specification at the hot mix asphalt (HMA) plant.

2.4 Contractor – The company who places the HMA on the project under contract with CDOT.

2.5 WCTG – Western Cooperative Test Group, a government / industry association.

3. SIGNIFICANCE AND USE

3.1 This Standard specifies requirements and procedures for a certification system that shall be applicable to all suppliers and contractors providing performance graded (PG) binders. The requirements and procedures shall apply to materials that meet the requirements of CDOT specifications for PG binders. These provisions initially apply to the refinery manufacturing the PG binder and/or to terminals where binders are mixed. These provisions subsequently apply to the Contractor, after delivery of the PG binder to the Contractor, for use in hot mix asphalt (HMA) on CDOT projects.

3.2 This Standard specifies procedures intended to minimize disruption of PG binder shipments. This is accomplished by a certification system that evaluates quality control and specification compliance tests performed by the Supplier and the HMA Contractor according to their quality control plans.

4. SAMPLING

4.1 All test samples required by this standard shall be obtained in accordance with AASHTO T 40. A supplier may propose an

alternate method of sampling that will ensure the sampling of a non-segregated product.

5. TESTING REQUIREMENTS

5.1 All specification compliance testing required for this Standard shall be performed by a laboratory currently covered by AMRL accreditation. Any satellite laboratory of a Supplier that performs required testing under this Standard will be identified in the submitted Supplier Quality Control Plan (Section 7) and shall be approved by CDOT.

5.2 All laboratories performing routine Quality Control testing shall participate in WCTG round robin testing or an approved equal.

6. SUPPLIER CERTIFICATION REQUIREMENTS

6.1 The Supplier shall submit to CDOT for approval a complete Quality Control Plan that complies with the requirements of Section 7. If the Quality Control Plan is rejected, the Supplier may modify the plan based on the critique provided and then resubmit it to CDOT for approval.

6.2 Once the Supplier's Quality Control Plan is approved by CDOT, the Supplier shall submit to the CDOT Product Evaluation Coordinator a completed copy of CDOT Form #595 (Pre-Approved Product Evaluation Request & Summary) for each performance graded binder. The Form #595 can be located at: www.coloradodot.info/business/APL/ within the Notice to Manufacturers. The Form #595 is designed as a PDF Writeable form, which must be completed by the Supplier. The completed form shall be returned to CDOT's Product Evaluation Coordinator as an e-mail attachment.

6.2.1 The Form #595 "Product name" field shall identify the submitted performance grade binder and the construction year of the submittal (i.e. "PG 76 -28 (2011)").

6.2.2 The Form #595 will serve as the request to CDOT for authorization to ship PG binder as referenced within this Colorado Procedure.

6.3 The Supplier shall forward to CDOT the initial testing data for the performance grade binder identified in the Form #595 and a copy of

the MSDS. The Supplier shall also obtain and provide a split sample for the CDOT Central Laboratory from the first production run of the performance graded binder identified on the Form #595. This will be concurrent with the first shipments of the construction season when the performance graded binder is being made for the first time that season.

6.3.1 If the submitted sample required in Subsection 6.3 fails the verification testing and is rejected by CDOT, then the Supplier may submit to CDOT a new test sample with a new CDOT Form #595, updated initial test data, and an MSDS. If CDOT rejects this second submittal then the Supplier may resubmit again. However, this third submittal for the same Product name (binder grade for that calendar year) shall include, in addition to all requirements in Subsection 6.3, a test report from an independent AMRL accredited laboratory.

6.4 The Supplier shall allow CDOT to visit the production and/or shipping site during normal business hours to perform an audit by observing the Supplier's quality control activities, to inspect the facilities, and to obtain samples for test.

6.5 The Supplier shall follow the procedures described in the CDOT approved quality control plan.

6.6 The Supplier shall establish a continuing test record for every test required for each PG binder included in the written request as prepared to satisfy the requirements of Subsection 6.1.

6.7 The Supplier shall submit to CDOT all reports required by this standard in a format approved by CDOT.

6.8 The Supplier shall have a satisfactory record of compliance with CDOT project specifications. Decisions by CDOT concerning this requirement shall be based on the test results furnished by the supplier and satisfactory results when the splits and field tests are compared with supplier tests.

7. SUPPLIER QUALITY CONTROL PLAN (MINIMUM REQUIREMENTS)

7.1 The Supplier's Quality Control Plan shall identify the following:

7.1.1 Facility type (refinery, terminal, HMA producer).

7.1.2 Facility location (actual physical address).

7.1.3 Name and telephone number of the person responsible for quality control at the facility.

7.1.4 Quality control tests and testing frequency to be performed on each PG binder.

7.1.5 Name and location of the laboratory performing quality control tests on the PG binder that is shipped.

7.2 The Supplier's Quality Control Plan shall include a declaration stating that if a test result indicates that a shipment of PG binder is not in compliance with the purchase specifications, the Supplier shall:

- (1) Identify the material in the shipment,
- (2) Immediately cease the shipment until the material complies with the specification,
- (3) Immediately notify CDOT regarding the shipment in question,
- (4) Immediately notify the Contractors scheduled to use the material from the shipment in question,
- (5) Notify CDOT prior to resuming shipment; and
- (6) Implement any mutually agreed upon procedures for the disposition of the material.

7.3 The Supplier's quality control plan shall describe method and frequency for initial testing, specification compliance testing, and quality control testing for guiding the manufacturer.

7.3.1 **Initial Testing** - For each grade of PG binder to be supplied, specification compliance testing shall be initially performed and the results of that testing provided to CDOT, accompanied by a sample of the material represented by the test results. Specification compliance testing shall confirm that the PG binder conforms to all requirements of Table 702-1 of the Standard Specifications. This will be concurrent with the first shipments of the construction season when the performance grade binder is being made for the first time that season. If, during the course of a construction project, the binder used changes such that

future binder supply to a project will come from a different refinery, different terminal, or be a different formulation that could potentially affect mix properties, the Supplier shall notify the Contractor and CDOT Project Engineer in writing at least 5 working days before shipment. If the Supplier is changing terminal location and both locations utilize the same formulation, the Supplier shall notify the Contractor and CDOT Project Engineer prior to use on the project and the one point check per CP 52 may be waived with concurrence from the RME.

7.3.2 **Specification Compliance Testing** - Specification compliance testing shall be run on a routine basis and the results submitted to CDOT at a minimum of once per month.

7.3.3 **Quality Control Testing for Guiding the Manufacturer** - Tests to determine conformance with Table 702-1 of the Standard Specifications tests shall be conducted as needed for quality control. The Quality Control Plan shall indicate the frequency of this testing. Non-Table 702-1 tests, of the Standard Specifications, may be used for guiding the manufacturer. The use of non-Table 702-1 tests does not preclude the need to meet Table 702-1 requirements or to run complete Table 702-1 tests as indicated in the Quality Control Plan.

7.4 The Supplier's quality control plan shall include a statement that the Supplier will prepare and maintain summary reports for all quality control and specification compliance tests performed, and will submit them to CDOT on request.

7.5 The Supplier's quality control plan shall provide an outline of the procedure to be followed for checking transport vehicles before loading to prevent contamination of shipments. The outline shall include a statement that the Transport Vehicle Inspection Report, signed by the designated inspector, shall be maintained in the Supplier's records and will be made available to CDOT on request.

7.6 If the supplier's facility has the capability of introducing any additives to the binder at the point of load-out, then the QC plan shall outline the procedures to control, monitor, and report on the exact amount of additive. Only CDOT approved additives shall be allowed at load-out.

7.7 If the Supplier's facility has acid, alkaline, or recycled engine oil bottom modification equipment in place for producing acid, alkaline, or recycled engine oil bottom modified binders for sale in non-CDOT markets, the Supplier's Quality Control Plan shall include a description of the precautions that will be taken to prevent acid, alkaline, or recycled engine oil bottom modified binders from being inadvertently shipped to CDOT.

8. CDOT EVALUATION PROCEDURE

8.1 CDOT will verify that the Supplier's quality control plan is adequate. CDOT may visit the shipping site when required.

8.2 CDOT will notify the Supplier whether or not the Supplier's application for Certified Binder Supplier status has been granted. The notification shall include a list of the PG binder(s) covered.

8.3 CDOT may verify that the Supplier's specification compliance testing laboratory is currently covered by AASHTO accreditation.

8.4 CDOT may verify that the Supplier's specification compliance testing laboratory participates in the WCTG round robin testing program or an equal program.

8.5 CDOT may perform split sample testing in accordance with Section 11.

8.6 CDOT will perform quality assurance testing.

8.7 CDOT may inspect the operations of the Supplier's facility including those related to the PG binder shipments if required.

8.8 CDOT will post the Supplier's approved binder type with the associated Supplier's facility name on CDOT's Approved Products List. Reference to the web site is at www.coloradodot.info/business/APL/.

9. REQUIREMENTS FOR SHIPPING PG BINDER BY AN APPROVED SUPPLIER

9.1 The Supplier's Quality Control Plan as approved by CDOT (Section 8) shall be implemented.

9.2 Each shipment shall be accompanied by two copies of the bill of lading, which shall include:

- (1) The name and location of the Supplier, as stated in the Supplier's Quality Control Plan,
- (2) The performance grade of material,
- (3) The quantity of material shipped,
- (4) The type and quantity of any approved additive introduced at load-out,
- (5) The date of shipment,
- (6) A certificate of compliance (COC) certifying the material meets specification requirements. The COC statement will certify the material was manufactured and tested in accordance with CDOT's approved Quality Control Plan (Section 7) and, therefore meets State requirements and,
- (7) A statement certifying that the transport vehicle was inspected before loading and was found acceptable for the material shipped. The COC statement will certify the material was manufactured and tested in accordance with the CDOT approved Quality Control Plan (Section 7) and, therefore, meets State requirements.

9.3 If the specification compliance test results do not conform to PG binder specifications, the Supplier shall remove the non-compliant material from the shipping queue as per Subsection 7.2.

10. SPLIT SAMPLE TESTING

10.1 CDOT may request split sample testing. The test results will be exchanged as soon as they are available.

10.2 If the split sample test data is not within the precision specified for that particular test a review of both sampling and testing procedures will be conducted by both the supplier and CDOT. If precision statements are not available, the test results should not differ by more than two standard deviations of the latest available WCTG Round Robin test results for that test.

11. REPORT AND DATA SHEETS

11.1 Supplier Reports - The Supplier shall prepare the reports described in Subsections 6.1, 6.2, 6.3, 6.6, 6.7, 7.2, 7.4, 7.5, 9.2, and 9.3.

12. DECERTIFICATION

12.1 Certification may be withdrawn from suppliers when one or more of the following additional conditions exist:

12.1.1 Acid, alkaline, or recycled engine oil bottom modification are discovered in the binder.

13. FIELD QUALITY CONTROL OF PERFORMANCE GRADED ASPHALT BINDER(S)

13.1 The field quality control of the binder shall be the responsibility of the Contractor. Prior to accepting deliveries of binder, the Contractor shall submit a Field Quality Control (FQC) Plan for binder addressing all key elements as listed in Section 14. This FQC Plan will be included within the Contractor's quality control plan for asphalt concrete. The FQC Plan shall be submitted at least 10 days prior to commencing paving operations. The purpose of the FQC Plan is to describe proper handling techniques for the binder to maintain specification conformance of binder properties during transportation, storage, and production operations. The Engineer will review the FQC Plan, and paving operations will not begin until the FQC Plan has been approved in writing.

13.2 The contents of the binder FQC Plan shall be project specific and shall be kept current to the production and mixture operations employed at any time. Prior to executing any change to binder handling, the FQC Plan shall be revised to incorporate the change. Engineer approval of the revised FQC Plan, in writing, will be required before the change is made to binder handling. Failure to keep the FQC Plan current may affect subsequent decisions by the Engineer, such as those made to address correction of failed material.

13.3 The Contractor shall confirm and document that the Supplier that manufactures the binder and the specific binder is on CDOT's

Approved Products List as referenced in Subsection 8.8.

13.4 The Contractor shall indicate, in writing, what steps will be taken to ensure that the FQC Plan is followed and what action will be taken to correct the situation if it is found that the plan is not being followed.

14. MINIMUM REQUIREMENTS FOR THE CONTRACTOR'S BINDER FIELD QUALITY CONTROL PLAN

14.1 The FQC Plan shall identify all subcontractors responsible for handling the binder. This will include the firm hauling the binder unless that firm is the binder supplier or is employed by the binder supplier.

14.2 The responsibilities of each party having a role in executing the FQC Plan shall be identified.

14.3 The FQC Plan shall describe how changes in grade or supplier of the binder, used in the paving mix, will be implemented. The change must not result in mixing of different binders. If mixing does occur, the mixed binder shall not be incorporated into the paving mix placed on the project. The Contractor shall inform the Engineer in advance of any change in grade or supplier of the binder.

14.4 The anticipated mode of binder delivery shall be described. The process of tank inspection, prior to initial filling, will be described. The tanks on the project site must be completely empty and free of contaminants to avoid contamination of the binder delivered to the project.

14.5 Any special handling or storage requirements of the binder shall be fully described. These shall comply with the manufacturer's recommendations for that grade of binder. The FQC Plan shall conform to these special requirements.

14.6 As detailed by the binder supplier, based on the type of asphalt used to produce the specific grade (i.e. Blended asphalt, Modified asphalt, etc.), any potential limitations of the binder relative to prolonged storage, exposure to prolonged and/or elevated heating, susceptibility to stratification and/or separation, etc. shall be

fully described. The Contractor's FQC Plan shall describe how these limitations of the binder shall be addressed.

14.7 If agitation is used in binder storage tanks, the capacity and methods of agitation within the storage tank(s) shall be described.

14.8 Provisions to avoid damage to binder during the suspension of paving operations shall be described. These provisions will detail limits to storage times and corresponding temperature limits.

14.9 The binder rotation FQC Plan shall be described. (i.e. First-in / First-out basis).

14.10 Any on-site sampling and testing shall be described with respect to sampling location, tests to be conducted, and control limits for test results. On-site sampling methods and facilities

shall be fully described. It is a good practice for the Contractor to obtain and retain samples of binder when delivered to the project. These samples can be tested if binder problems occur. These test results can help isolate the cause of problems with binder properties. Binder performance test requirements are contained in Table 702-1 of the Standard Specifications.

14.11 The FQC Plan shall describe methods for identifying the binder contained in each storage tank. Clear and consistent labeling of each tank shall be included in these methods.

14.12 The binder temperatures in the tanks shall be routinely monitored, at a minimum of once per day. Procedures and equipment for this monitoring shall be described. Results of this monitoring shall be made available to the Engineer upon request.

CP 11, Asphalt Binder Supplier Certification Checklist - 2012

Supplier Name: _____ Date: _____
 Refinery Name: _____ Refinery Location: _____
 Supplier Lab: _____ Supplier Lab Location: _____
 PG Binder: _____

Yes / No

Subsection

- 5.1 Does supplier's lab have current AMRL accreditation?..... _____
- 5.2 Do the labs performing routine QC testing participate in WCTG Round Robin testing or equal?..... _____
- 6.1 QC Plan submitted to CDOT? _____
- 6.2 Completed CDOT Form #595 sent to CDOT as an e-mail attachment?..... _____
- 6.3 Initial test data supplied? _____
- 6.3 MSDS supplied?..... _____
- 6.3 Split sample provided to CDOT once per construction season?..... _____

SUPPLIER QC PLAN:

Subsection

- 7.1.1 Facility type listed? _____
- 7.1.2 Facility location listed?..... _____
- 7.1.3 Name of person responsible for QC at the facility listed? _____
- 7.1.4 List of QC tests and frequency to be used on PG binder?..... _____
- 7.1.5 Name & location of lab performing these tests listed? _____
- 7.2 Does Plan state that, if a shipment is not within specification, the supplier shall:
 - (1) Identify the material in the shipment? _____
 - (2) Immediately cease shipment until material complies with the specification? _____
 - (3) Immediately notify CDOT regarding the shipment in question? _____
 - (4) Immediately notify the Contractors scheduled to use the material from the shipment in question?..... _____
 - (5) Notify CDOT prior to resuming shipment? _____
 - (6) Implement any mutually agreed upon procedures for the disposition of the material? _____
- 7.3 Does plan describe the method and frequency for initial testing, QC testing, and specification compliance testing?..... _____
- 7.3.1 Results of specification compliance testing supplied to CDOT along with a sample? _____
- 7.3.1 Results confirm that the PG binder conforms to Table 702-1? _____
- 7.3.2 Plan states that specification compliance testing is performed routinely and results submitted to CDOT monthly?..... _____
- 7.3.3 Plan indicates frequency of testing to determine conformance with Table 702-1?..... _____
- 7.4 Plan states that supplier will maintain summary reports for all QC & Spec Compliance tests performed, and will submit to CDOT upon request?..... _____

[Continued on the next page.]

Yes / No

Subsection

- 7.5 Plan contains an outline of the procedure for checking transport vehicles before loading to prevent contamination? _____
- 7.5.1 Outline includes statement that the transport vehicle inspection report, signed by the designated inspector, shall be maintained in the supplier's records, and will be made available to CDOT upon request? _____
- 7.6 If the Supplier has equipment in place for acid, alkaline, or recycled engine oil bottom modification of binder, are precautions described that will be taken to prevent acid, alkaline, or recycled engine oil bottom modified binders from being shipped to CDOT?..... _____

CP 11, Asphalt Contractor Field Quality Control Checklist - 2012

Contractor Name: _____ Date: _____
Project Number: _____
Project Code: _____
Project Location: _____

FIELD QUALITY CONTROL OF PERFORMANCE GRADED ASPHALT BINDER (S)

Yes / No

Subsection

- 13.1 Was the Contractor's Field Quality Control (FQC) Plan submitted 10 days prior to paving? _____
- 13.2 Is the binder FQC plan specific to this Project? _____
- 13.2 Does the binder FQC plan apply to current binder handling? _____

Does the Contractor's Binder Field Quality Control Plan Address the Following:

Subsection

- 14.1 List of the subcontractors handling the binder?..... _____
- 14.2 Responsibilities of the parties executing the binder FQC Plan? _____
- 14.3 How grade changes will be handled?..... _____
- 14.4 Delivery mode and tank inspection before filling? _____
- 14.5 Special handling and suppliers recommended handling? _____
- 14.6 Limitations on the type of binder with respect to handling? _____
- 14.7 Method of agitating binder in the tank (if any)? _____
- 14.8 Binder handling during paving delays? _____
- 14.9 Binder rotation plan (i.e. First-in / First-out)? _____
- 14.10 On-site sampling plan (if any)? _____
- 14.11 Binder identification plan (tank labeling)? _____
- 14.12 Binder temperature monitoring (minimum once per day)? _____

{This page was intentionally left blank.}

Part I, Sub-Part 2:

Asphalt Emulsion - 12

(Certifying Suppliers and Contractors)

1. REFERENCED DOCUMENTS

- 1.1 CDOT Standard Specifications:
Section 702, Bituminous Materials
Table 702-2 to Table 702-7
- 1.2 AASHTO Standards:
T 40 Method of Sampling Bituminous
Materials
R 18 AASHTO Accreditation Program
- 1.3 ASTM Standards:
D 8 Definitions of Terms Relating to
Materials for Roads and Pavements

2. TERMINOLOGY

- 2.1 Emulsion – A binder that is emulsified with water in a colloid mill.
- 2.2 Supplier - A Supplier shall be defined as one who produces the final product or who makes the blend or modification that alters the properties of the PG binder specified in Section 702 of the Standard Specifications and/or other appropriate CDOT specifications. A Supplier shall be a refinery, a terminal, or an emulsion producer. If no modification is made to the emulsion after its initial production at the refinery, the refinery shall be the supplier and must provide certification. If there is any modification of the emulsion at the terminal, the terminal becomes the supplier and must provide the certification. No emulsion will be produced or blended to specification at the hot mix asphalt (HMA) plant.
- 2.3 Contractor – The company who places the emulsion on the project under contract with CDOT.

3. SIGNIFICANCE AND USE

- 3.1 This standard specifies requirements and procedures for a certification system that shall be applicable to all suppliers and contractors providing asphalt emulsions. The requirements and procedures shall apply to materials that meet the requirements of CDOT specifications for emulsions. These provisions initially apply to the refinery manufacturing the emulsion and/or to the terminals where emulsions are modified. These provisions subsequently apply to the Contractor, after delivery of the emulsion to the Contractor, for use on CDOT projects.
- 3.2 This standard specifies procedures intended to minimize disruption of emulsion shipments. This is accomplished by a certification system that evaluates quality control and specification compliance tests performed by the Supplier and the Contractor according to their quality control plans.

4. SAMPLING

- 4.1 All test samples required by this standard shall be obtained in accordance with AASHTO T 40. A supplier may propose an alternate method of sampling that will ensure the sampling of a non-segregated product.

5. TESTING REQUIREMENTS

- 5.1 All certification testing required for this standard shall be performed by a laboratory currently covered by AMRL accreditation. Any satellite laboratory of a Supplier that performs required testing under this standard will be identified in the submitted Supplier Quality Control Plan (Section 7) and shall be approved by CDOT.

6. SUPPLIER CERTIFICATION REQUIREMENTS

6.1 The Supplier shall submit to CDOT for approval a complete Quality Control Plan that complies with the requirements of Section 7. If the Quality Control Plan is rejected, the Supplier may modify the plan based on the critique provided and then resubmit it to CDOT for approval.

6.2 Once the Supplier's Quality Control Plan is approved by CDOT, the Supplier shall submit to the CDOT Product Evaluation Coordinator a completed copy of CDOT Form #595 (Pre-Approved Product Evaluation Request & Summary) for each emulsion. The Form #595 can be located within Notice to Manufacturers at: www.coloradodot.info/business/APL/ . The Form #595 is designed as a PDF Writeable form, which must be completed by the Supplier. The completed form shall be returned to CDOT's Product Evaluation Coordinator as an e-mail attachment.

6.2.1 The Form #595 "Product name" field shall identify the submitted emulsion and the construction year of the submittal (i.e. "CRS-2P (2011)").

6.2.2 The Form #595 will serve as the request to CDOT for authorization to ship emulsion as referenced within this Colorado Procedure.

6.3 The Supplier shall forward to CDOT the initial testing data for the emulsion identified on the Form #595 and a copy of the MSDS. The Supplier shall also obtain and provide a split sample for the CDOT Central Laboratory from the first production run of the emulsion identified on the Form #595. This will be concurrent with the first shipments of the construction season when the emulsion is being made for the first time that season.

6.3.1 If the submitted sample required in Subsection 6.3 fails the verification testing and is rejected by CDOT, then the Supplier may submit to CDOT a new test sample with a new CDOT Form #595, updated initial test data, and an MSDS. If CDOT rejects this second submittal then the Supplier may resubmit again. However, this third submittal for the same Product name (emulsion type for that calendar year) shall include, in addition to all requirements in

Subsection 6.3, a test report from an independent AMRL accredited laboratory.

6.4 The Supplier shall allow CDOT to visit the production and/or shipping site during normal business hours to perform an audit by observing the Supplier's quality control activities, to inspect the facilities, and to obtain samples for test.

6.5 The Supplier shall follow the procedures described in the CDOT approved quality control plan.

6.6 The Supplier shall establish a continuing test record for every test required for each emulsion included in the written request as prepared to satisfy the requirements of Subsection 6.1.

6.7 The Supplier shall submit to CDOT all reports required by this standard in a format approved by CDOT.

6.8 The Supplier shall have a satisfactory record of compliance with CDOT project specifications. Decisions by CDOT concerning this requirement shall be based on the test results furnished by the supplier and satisfactory results when the splits and field tests are compared with supplier tests.

7. SUPPLIER QUALITY CONTROL PLAN (MINIMUM REQUIREMENTS)

7.1 The Supplier's Quality Control Plan shall identify the following:

7.1.1 Facility type (refinery, terminal).

7.1.2 Facility location (actual physical address).

7.1.3 Name and telephone number of the person responsible for quality control at the facility.

7.1.4 Quality control tests and testing frequency to be performed on each type of emulsion.

7.1.5 Name and location of the laboratory performing quality control tests on the emulsion that is shipped.

7.2 The Supplier's Quality Control Plan shall include a declaration stating that if a test result indicates that a shipment of emulsion is not in compliance with the purchase specifications, the Supplier shall:

- (1) Identify the material in the shipment,
- (2) Immediately cease the shipment until the material complies with the specification,
- (3) Immediately notify CDOT regarding the shipment in question,
- (4) Immediately notify the Contractors scheduled to use the material from the shipment in question,
- (5) Notify CDOT prior to resuming shipment; and
- (6) Implement any mutually agreed upon procedures for the disposition of the material.

7.3 The Supplier's quality control plan shall describe method and frequency for initial testing, specification compliance testing, and quality control testing for guiding the manufacturer.

7.3.1 **Initial Testing** - For each type of emulsion to be supplied, specification compliance testing shall be initially performed and the results of that testing provided to CDOT, accompanied by a sample of the material represented by the test results. Specification compliance testing shall confirm that the emulsion conforms to all requirements of Section 702 of the Standard Specifications. This will be concurrent with the first shipments of the construction season when the emulsion is being made for the first time that season.

7.3.2 **Specification Compliance Testing** - Specification compliance testing shall be run on a routine basis and the results submitted to CDOT at a minimum of once per month.

7.3.3 **Quality Control Testing for Guiding the Manufacturer** - Tests to determine conformance with Section 702 of the Standard Specifications tests shall be conducted as needed for quality control. The Quality Control Plan shall indicate the frequency of this testing. Non-Section 702 tests, of the Standard Specifications, may be used for guiding the manufacturer. The use of non-Section 702 tests does not preclude the need to meet Section 702 requirements or to run complete Section 702 tests as indicated in the Quality Control Plan.

7.4 The Supplier's quality control plan shall include a statement that the Supplier will prepare and maintain summary reports for all quality control and specification compliance tests performed, and will submit them to CDOT on request.

7.5 The Supplier's quality control plan shall provide an outline of the procedure to be followed for checking transport vehicles before loading to prevent contamination of shipments. The outline shall include a statement that the Transport Vehicle Inspection Report, signed by the designated inspector, shall be maintained in the Supplier's records and will be made available to CDOT on request.

8. CDOT EVALUATION PROCEDURE

8.1 CDOT will verify that the Supplier's quality control plan is adequate. CDOT may visit the shipping site when required.

8.2 CDOT will notify the Supplier whether or not the Supplier's application for Certified Emulsion Supplier status has been granted. The notification shall include a list of the types of emulsions covered.

8.3 CDOT may verify that the Supplier's specification compliance testing laboratory is currently covered by AASHTO accreditation.

8.4 CDOT may verify that the Supplier's specification compliance testing laboratory participates in a round robin testing program.

8.5 CDOT may perform split sample testing in accordance with Section 10.

8.6 CDOT will perform quality assurance testing.

8.7 CDOT may inspect the operations of the Supplier's facility including those related to the emulsion shipments if required.

8.8 CDOT will post the Supplier's approved emulsion type with the associated Supplier's facility name on CDOT's Approved Products List. Reference to the web site is at www.coloradodot.info/business/APL/.

9. REQUIREMENTS FOR SHIPPING EMULSIONS BY AN APPROVED SUPPLIER

9.1 The Supplier's Quality Control Plan as approved by CDOT (Section 8) shall be implemented.

9.2 Each shipment shall be accompanied by two copies of the bill of lading, which shall include:

- (1) The name and location of the Supplier, as stated in the Supplier's Quality Control Plan,
- (2) The type of emulsion,
- (3) The quantity of material shipped,
- (4) The date of shipment,
- (5) A certificate of compliance (COC) certifying the material meets specification requirements. The COC statement will certify the material was manufactured and tested in accordance with the CDOT approved Quality Control Plan (Section 7) and, therefore, meets state requirements (example in Chapter 400), and,
- (6) A statement certifying that the transport vehicle was inspected before loading and was found acceptable for the material shipped. The COC statement will certify the material was manufactured and tested in accordance with CDOT's approved Quality Control Plan (Section 7) and, therefore, meets state requirements.

9.3 If the specification compliance test results do not conform to emulsion specifications, the Supplier shall remove the non-compliant material from the shipping queue as outlined in Subsection 7.2.

10. SPLIT SAMPLE TESTING

10.1 CDOT may request split sample testing. The test results will be exchanged as soon as they are available.

10.2 If the split sample test data is not within the precision specified for that particular test a review of both sampling and testing procedures will be conducted by both the supplier and CDOT.

11. REPORT AND DATA SHEETS

11.1 Supplier Reports - The Supplier shall prepare the reports described in Subsections 6.1, 6.2, 6.3, 6.6, 6.7, 7.2, 7.4, 7.5, 9.2, and 9.3.

12. RECERTIFICATION

12.1 If a supplier has been decertified and seeks to be recertified, the supplier must fulfill the requirements for certification, as per Section 6.

13. FIELD QUALITY CONTROL OF EMULSION(S)

13.1 The field quality control of the emulsion shall be the responsibility of the Contractor. Prior to accepting deliveries of emulsion, the contractor shall submit a Field Quality Control (FQC) Plan for emulsion addressing all key elements as listed in Section 14. This FQC Plan will be included within the Contractor's quality control plan for asphalt concrete. The FQC Plan shall be submitted at least 10 days prior to commencing paving operations. The purpose of the FQC Plan is to describe proper handling techniques for the emulsion to maintain specification conformance of emulsion properties during transportation, storage, and production operations. The Engineer will review the FQC Plan, and the paving operations will not begin until the FQC Plan has been approved in writing.

13.2 The contents of the emulsion FQC Plan shall be project specific and shall be kept current to the production and mixture operations employed at any time. Prior to executing any change to emulsion handling, the FQC Plan shall be revised to incorporate the change.

Engineer approval of the revised FQC Plan, in writing, will be required before the change is made to emulsion handling. Failure to keep the FQC Plan current may affect subsequent decisions by the Engineer, such as those made to address a correction of failed material.

13.3 The Contractor shall confirm and document that the Supplier that manufactures the emulsion and the specific emulsion is on

CDOT's Approved Products List as referenced in Subsection 8.8.

13.4 The Contractor shall indicate, in writing, what steps will be taken to ensure that the FQC Plan is followed and what action will be taken to correct the situation if it is found that the plan is not being followed.

14. MINIMUM REQUIREMENTS FOR THE CONTRACTOR'S EMULSION FIELD QUALITY CONTROL PLAN

14.1 The FQC Plan shall identify all subcontractors responsible for handling the emulsion. This will include the firm hauling the emulsion unless that firm is the emulsion supplier or is employed by the emulsion supplier.

14.2 The responsibilities of each party having a role in executing the FQC Plan shall be identified.

14.3 The FQC Plan shall describe how changes in type or supplier of the emulsion, used on the paving job, will be implemented. The change must not result in mixing of different emulsions. If mixing does occur, the mixed emulsion shall not be incorporated in the project. The Contractor shall inform the Engineer in advance of any change in type or supplier of the emulsion.

14.4 The anticipated mode of emulsion delivery shall be described. The process of tank inspection, prior to initial filling, will be described. The tanks on the project site must be completely empty and free of contaminants to avoid contamination of the emulsion delivered to the project.

14.5 Any special handling or storage requirements of the emulsion shall be fully described. These shall comply with the manufacturer's recommendations for that type of emulsion. The FQC Plan shall conform to these special requirements.

14.6 As detailed by the emulsion supplier, based on the type of materials used to produce the specific emulsion, any potential limitations of the emulsion relative to prolonged storage, exposure to prolonged and/or elevated heating, susceptibility to stratification and/or separation, etc. shall be fully described. The Contractor's FQC Plan shall describe how these limitations of the emulsion shall be addressed.

14.7 If agitation is used in emulsion storage tanks, the capacity and methods of agitation within the storage tank(s) shall be described.

14.8 Provisions to avoid damage to emulsion during the suspension of paving operations shall be described. These provisions will detail limits to the storage times and corresponding temperature limits.

14.9 The emulsion rotation FQC Plan shall be described. (First-in / First-out basis, for example).

14.10 Any on-site sampling and testing shall be described with respect to sampling location, tests to be conducted, and control limits for test results. On-site sampling methods and facilities shall be fully described. It is a good practice for the Contractor to obtain and retain samples of emulsion when delivered to the project. These samples can be tested if emulsion problems occur. These test results can help isolate the cause of emulsion problems. Emulsion performance test requirements are contained in Section 702 of the Standard Specifications.

14.11 The FQC Plan shall describe methods for identifying the emulsion contained in each storage tank. Clear and consistent labeling of each tank shall be included in these methods.

14.12 The emulsion temperatures in the tanks shall be routinely monitored, at a minimum of once per day. Procedures and equipment for this monitoring shall be described. Results of this monitoring shall be made available to the Engineer upon request.

{This page was intentionally left blank.}

CP 11, Asphalt Emulsion Supplier Certification Checklist - 2012

Supplier Name: _____ Date: _____
 Refinery Name: _____ Refinery Location: _____
 Supplier Lab: _____ Supplier Lab Location: _____
 Emulsion Type: _____

Yes/ No

Subsection

- 5.1 Does supplier's lab have current AMRL accreditation? _____
- 6.1 QC plan submitted to CDOT? _____
- 6.2 Completed CDOT Form #595 sent to CDOT as an e-mail attachment? _____
- 6.3 Initial test data supplied? _____
- 6.3 MSDS supplied? _____
- 6.3 Split sample provided to CDOT once per construction season? _____

SUPPLIER QC PLAN:

Subsection

- 7.1.1 Facility type listed? _____
- 7.1.2 Facility location listed? _____
- 7.1.3 Name of person responsible for QC at the facility is listed? _____
- 7.1.4 List of QC tests & frequency to be used on emulsion? _____
- 7.1.5 Name & location of lab performing these tests is listed? _____
- 7.2 Does Plan state that, if a shipment is not within specification, the supplier shall:
 - (1) Identify the material in the shipment? _____
 - (2) Immediately cease shipment until material complies with the specification? _____
 - (3) Immediately notify CDOT regarding the shipment in question? _____
 - (4) Immediately notify the Contractors scheduled to use the material from the shipment in question? _____
 - (5) Notify CDOT prior to resuming shipment? _____
 - (6) Implement any mutually agreed upon procedures for the disposition of the material? _____
- 7.3 Does plan describe the method and frequency for initial testing, QC testing, and specification compliance testing? _____
- 7.3.1 Results of specification compliance testing supplied to CDOT along with a sample? _____
- 7.3.1 Results confirm that the Emulsion conforms to Section 702? _____
- 7.3.2 Plan states that specification compliance testing is performed routinely and results are submitted to CDOT monthly? _____
- 7.3.3 Plan indicates frequency of testing to determine conformance with Section 702? _____
- 7.4 Plan states that supplier will maintain summary reports for all QC and Spec Compliance tests performed, and will submit to CDOT upon request? _____
- 7.5 Plan contains an outline of the procedure for checking transport vehicles before loading to prevent contamination? _____
- 7.5.1 Outline includes statement that the transport vehicle inspection report, signed by the designated inspector, shall be maintained in the supplier's records, and will be made available to CDOT upon request? _____

CP 11, Asphalt Contractor Field Quality Control Checklist - 2012

Contractor Name: _____ Date: _____
Project Number: _____
Project Code: _____
Project Location: _____

FIELD QUALITY CONTROL OF EMULSION(S)

<u>Subsection</u>	<u>Yes/ No</u>
13.1 Was the Contractor's Field Quality Control (FQC) Plan submitted 10 days prior to paving?	_____
13.2 Is the emulsion FQC plan specific to this Project?	_____
13.2 Does the emulsion FQC plan apply to current emulsion handling?.....	_____

Does the Contractor's Emulsion Field Quality Control Plan Address the Following:

<u>Subsection</u>	
14.1 List of the subcontractors handling the emulsion?.....	_____
14.2 Responsibilities of the parties executing the emulsion FQC Plan?	_____
14.3 How emulsion type changes will be handled?	_____
14.4 Delivery mode and tank inspection before filling?	_____
14.5 Special handling and suppliers recommended handling?	_____
14.6 Limitations on the type of emulsion with respect to handling?.....	_____
14.7 Method of agitating emulsion in the tank (if any)?	_____
14.8 Emulsion handling during paving delays?.....	_____
14.9 Emulsion rotation plan (i.e. First-in / First-out)?.....	_____
14.10 On-site sampling plan (if any)?	_____
14.11 Emulsion identification plan (tank labeling)?.....	_____
14.12 Emulsion temperature monitoring (minimum once per day)?	_____

Part I, Sub-Part 3:

Hydraulic Cement – 12

1. REFERENCED DOCUMENTS

1.1 ASTM Standards:

ASTM C 150 Standard Specification for Portland Cement

ASTM C 183 Standard Practice for Sampling and the Amount of Testing of Hydraulic Cement

ASTM C 219 Standard Terminology Relating to Hydraulic Cement

ASTM C 595 Standard Specification for Blended Hydraulic Cement

ASTM C 1157 Standard Performance Specification for Hydraulic Cement

2. TERMINOLOGY

2.1 See ASTM C 219 Standard Terminology Relating to Hydraulic Cement.

2.2 Supplier – In this Standard, a *Cement Supplier* shall be defined as one who manufactures hydraulic cement.

2.3 Supplier – In this Standard, a *Concrete Supplier* shall be defined as one who manufactures concrete mix. Among the ingredients of a concrete mix is hydraulic cement.

2.4 Contractor – The company under contract with CDOT to produce products using hydrated cement.

3. SIGNIFICANCE AND USE

3.1 This Standard specifies requirements and procedures for a certification system that shall be applicable to all Cement Suppliers providing hydraulic cement. These provisions apply to the plant manufacturing the hydraulic cement. These provisions apply to the Contractor, after delivery of the hydraulic cement to the Contractor, for use on CDOT projects.

3.2 This Standard specifies procedures intended to minimize disruption of hydraulic cement shipments. This is accomplished by a certification system that evaluates quality control and specification compliance tests performed by the Cement Supplier according to their quality control plans.

4. SAMPLING

4.1 All test samples shall be obtained in accordance with ASTM C 183. The use of a random sampling procedure is mandatory to the establishment of a valid quality assurance program.

5. TESTING REQUIREMENTS

5.1 Testing shall be performed by a laboratory currently accredited by the Cement and Concrete Reference Laboratory (CCRL). Any satellite laboratory of a Cement Supplier that performs required testing under this Standard shall be identified in the submitted Quality Control Plan (Section 7).

6. SUPPLIER CERTIFICATION REQUIREMENTS

6.1 Cement Suppliers shall submit to the CDOT Product Evaluation Coordinator (PEC), CDOT Form #595, Pre-Approved Product Evaluation Request & Summary for each type of hydraulic cement intended for use on CDOT projects. Instructions for completing and submitting the CDOT Form #595 can be located within the Notice to Manufacturers at: www.coloradodot.info/business/APL/.

6.2 In addition to completing CDOT Form #595, the following shall be supplied to the PEC:

6.2.1 A brief outline of the procedures used to evaluate the finished product including sampling and testing frequency and the sample preparation employed, including chemical analysis methods used such as X-ray, atomic absorption spectroscopy, and/or wet chemistry.

6.2.2 The results of all applicable chemical and/or physical tests required by ASTM C 150, C 595, or C 1157 on the most recent 40 samples (20 pairs) tested. The results shall be submitted in the format outlined in ASTM C 183, in particular the table entitled "Test Data" with the critical limits calculated as described.

6.2.3 A copy of the CCRL certification for the laboratory performing testing.

6.2.4 A copy of the Cement Supplier's Quality Control Plan, which complies with the requirements of Section 7, if one has not been supplied to CDOT for previously submitted products.

6.3 A sample of the proposed hydraulic cement shall be shipped to the PEC at the Materials and Geotechnical Branch, 4670 North Holly Street, Unit A, Denver, Colorado 80216-6408.

6.4 The Cement Supplier shall allow CDOT to visit the production and/or shipping site during normal business hours to observe the Cement Supplier's quality control activities, to inspect the facilities, and to obtain samples for tests.

6.5 The Cement Supplier shall follow the procedures described in the CDOT approved quality control plan.

6.6 The Cement Supplier shall establish a continuing test record for every test required and for each Type of hydraulic cement included in the written request as prepared to satisfy the requirements of Subsection 6.1.

6.7 The Cement Supplier shall submit to CDOT all reports required by this standard in a format approved by CDOT.

6.8 The Cement Supplier shall have a satisfactory record of compliance with CDOT project specifications. Decisions by CDOT concerning this requirement shall be based on the test results furnished by the Cement Supplier's tests.

7. SUPPLIER QUALITY CONTROL PLAN (MINIMUM REQUIREMENTS)

7.1 The Cement Supplier's Quality Control Plan shall identify the following:

7.1.1 Facility location (actual physical address).

7.1.2 Name and telephone number of a person at each production facility, responsible for quality control of the material shipped to CDOT projects.

7.1.3 Quality control tests and testing frequency to be performed on each hydraulic cement.

7.1.4 Name and location of the laboratory performing quality control tests on the hydraulic cement.

7.2 The Cement Supplier's Quality Control Plan shall include a declaration stating that if a test result indicates that a shipment of hydraulic cement does not comply with the purchase specifications, the Cement Supplier shall:

7.2.1 Identify the material in the shipment,

7.2.2 Immediately cease the shipment until the material complies with the specification,

7.2.3 Immediately notify CDOT regarding the shipment in question,

7.2.4 Immediately notify the Contractors and Concrete Suppliers scheduled to use the material from the shipment in question, notify CDOT prior to resuming shipment; and implement any mutually agreed upon procedures for the disposition of the material.

7.3 The Cement Supplier's Quality Control Plan shall describe method and frequency for initial testing and quality control testing.

7.3.1 **Initial Testing** - For each type of hydraulic cement to be supplied, testing shall be performed and the results provided to CDOT, accompanied by a sample of the material represented by the test results.

7.3.2 **Quality Control Testing** – Tests to determine conformance with applicable ASTM standards shall be conducted as needed for quality control. The Cement Supplier's Quality Control Plan shall indicate the frequency of this testing.

7.4 The Cement Supplier's Quality Control Plan shall include a statement that the Cement Supplier will prepare and maintain summary reports for all quality control tests performed, and will submit them to CDOT on request.

7.5 The Cement Supplier's Quality Control Plan shall provide an outline of the procedure to be followed for checking transport vehicles before loading to prevent contamination of shipments. The outline shall be maintained in the Cement Supplier's records and will be made available to CDOT on request.

8. CDOT EVALUATION PROCEDURE

8.1 CDOT will verify that the Cement Supplier's Quality Control Plan is adequate. CDOT may visit the shipping site when required.

8.2 CDOT will notify the Cement Supplier whether or not the Cement Supplier's application has been granted.

8.3 CDOT may verify that the Cement Supplier's testing laboratory is currently CCRL accredited.

8.4 CDOT may perform split sample testing in accordance with Section 10.

8.5 CDOT may sample and perform testing on random samples.

8.6 CDOT may inspect the operations of the Cement Supplier's facility, including those related to shipments if required.

8.7 Products approved for use will be posted on the CDOT APL.

9. REQUIREMENTS FOR SHIPPING HYDRAULIC CEMENT BY AN APPROVED SUPPLIER

9.1 The Cement Supplier's Quality Control Plan as approved by CDOT (Section 7) shall be implemented.

9.2 Each shipment shall be accompanied by two copies of the bill of lading, which shall include:

9.2.1 The name and location of the Cement Supplier,

9.2.2 The Type of hydraulic cement shipped,

9.2.3 The quantity of material shipped,

9.2.4 The date of shipment,

9.2.5 A certificate of compliance (COC) certifying that the material meets specification requirements and,

9.2.6 A statement certifying that the transport vehicle was inspected before loading, and was found acceptable for the material shipped.

9.3 If the test results do not conform to the applicable ASTM standards, the Cement Supplier shall remove the non-compliant material from the shipping queue as outlined in Subsection 7.2.

10. SPLIT SAMPLE TESTING

10.1 CDOT may request split sample testing. The test results will be exchanged as soon as they are available.

10.2 If the split sample test data is not within the precision specified for that particular test a review of both sampling and testing procedures will be conducted by both the Cement Supplier and CDOT.

11. REPORT AND DATA SHEETS

11.1 Cement Supplier Reports - The Cement Supplier shall prepare the reports described in Subsections 6.1, 6.2, 9.2, and 9.3.

{This page was intentionally left blank.}

Part I, Sub-Part 4:

Fly Ash - 12

1. REFERENCED DOCUMENTS

1.1 ASTM Standards:

ASTM C 219 Standard Terminology Relating to Hydraulic Cement

ASTM C 311 Standard Test Methods for Sampling and Testing Fly Ash or Natural Pozzolans for Use in Portland Cement Concrete.

ASTM C 618 Standard Specification for Coal Fly Ash and Raw or Calcined Natural Pozzolan for Use in Concrete.

2. TERMINOLOGY

2.1 See ASTM C 219 Standard Terminology Relating to Hydraulic Cement.

2.2 Supplier, Fly Ash – In this Standard, a *Fly Ash Supplier* shall be defined as one who provides fly ash for use on CDOT projects.

2.3 Supplier, Concrete – In this Standard, a *Concrete Supplier* shall be defined as one who manufactures concrete mix. Fly ash may be among the ingredients of a concrete mix.

2.4 Contractor – The company under contract with CDOT to produce products using fly ash.

3. SIGNIFICANCE AND USE

3.1 This Standard specifies procedures intended to minimize disruption of fly ash shipments. This is accomplished by a certification system that evaluates quality control and specification compliance tests performed by the Fly Ash Supplier according to their quality control plans.

3.2 This Standard specifies requirements and procedures for a certification system that shall be applicable to all fly ash suppliers providing fly ash. The requirements and procedures shall apply to materials that meet the requirements of CDOT specifications for fly ash.

These provisions apply to the plant producing the fly ash. These provisions apply to the Contractor, after delivery of the concrete mix to the Contractor, for use on CDOT projects.

4. SAMPLING

4.1 All test samples shall be obtained in accordance with ASTM C 311. The use of a random sampling procedure is mandatory to the establishment of a valid quality assurance program.

5. TESTING REQUIREMENTS

5.1 Testing shall be performed by a laboratory currently accredited by the Cement and Concrete Reference Laboratory (CCRL). Any satellite laboratory of a Fly Ash Supplier that performs required testing under this Standard shall be identified in the submitted Quality Control Plan (Section 7).

6. SUPPLIER CERTIFICATION REQUIREMENTS

6.1 Fly Ash Suppliers shall submit to the CDOT Product Evaluation Coordinator (PEC), the CDOT Form #595, Pre-Approved Product Evaluation Request & Summary for each source and Class of fly ash intended for use on CDOT projects. Instructions for completing CDOT Form #595 can be found at www.coloradodot.info/business/APL/ within the Notice to Manufacturers.

6.2 In addition to completing the CDOT Form #595, the following shall be supplied to the PEC:

6.2.1 A brief outline of the procedures used to evaluate the finished product including; sampling and testing frequency and the sample preparation employed, including chemical analysis methods used such as X-ray, atomic absorption spectroscopy, and/or wet chemistry.

6.2.2 The results of all applicable chemical and/or physical tests required by ASTM C 618 on the most recent 40 samples (20 pairs) tested. The results shall be submitted in the format outlined in ASTM C 311, in particular the table entitled "Test Data" with the critical limits calculated as described.

6.2.3 A copy of the CCRL certification for the laboratory performing testing.

6.2.4 A copy of the Fly Ash Supplier's Quality Control Plan, which complies with the requirements of Section 7, if one has not been supplied to CDOT for previously submitted products.

6.3 A sample of the proposed fly ash shall be shipped to the PEC at the Materials and Geotechnical Branch, 4670 North Holly Street, Unit A, Denver, Colorado 80216-6408.

6.4 The Fly Ash Supplier shall allow CDOT to visit the production and/or shipping site to observe the Fly Ash Supplier's quality control activities, to inspect the facilities, and to obtain samples for tests.

6.5 The Fly Ash Supplier shall follow the procedures described in the CDOT approved quality control plan.

6.6 The Fly Ash Supplier shall establish a continuing test record for every test required for each Type of fly ash included in the written request as prepared to satisfy the requirements of Subsection 6.1.

6.7 The Fly Ash Supplier shall submit to CDOT all reports required by this standard in a format approved by CDOT.

6.8 The Fly Ash Supplier shall have a satisfactory record of compliance with CDOT project specifications. Decisions by CDOT concerning this requirement shall be based on the test results furnished by the Fly Ash Supplier and satisfactory results when the splits and field tests are compared with Fly Ash Supplier tests.

7. SUPPLIER QUALITY CONTROL PLAN (MINIMUM REQUIREMENTS)

7.1 The Fly Ash Supplier's Quality Control Plan shall identify the following:

7.1.1 Facility location.

7.1.2 Name and telephone number of a person at each production facility, responsible for quality control of material shipped to CDOT projects.

7.1.3 Quality control tests and testing frequency to be performed on each fly ash.

7.1.4 Name and location of the laboratory performing quality control tests on the fly ash.

7.2 The Fly Ash Supplier's Quality Control Plan shall include a declaration stating that if a test result indicates that a shipment of fly ash does not comply with the purchase specifications, the Fly Ash Supplier shall:

7.2.1 Identify the material in the shipment,

7.2.2 Immediately cease the shipment until the material complies with the specification,

7.2.3 Immediately notify CDOT regarding the shipment in question,

7.2.4 Immediately notify the Contractors and Concrete Suppliers scheduled to use the material from the shipment in question,

7.2.5 Notify CDOT prior to resuming shipment; and

7.2.6 Implement any mutually agreed upon procedures for the disposition of the material.

7.3 The Fly Ash Supplier's Quality Control Plan shall describe method and frequency for initial testing and quality control testing.

7.3.1 **Initial Testing** – For each fly ash product to be supplied, testing shall be performed and the results of that testing provided to CDOT, accompanied by a sample of the material represented by the test results.

7.3.2 **Quality Control Testing** – Tests to determine conformance with ASTM C 618 shall be conducted as needed for quality control. The Supplier's Quality Control Plan shall indicate the frequency of this testing.

7.4 The Fly Ash Supplier's Quality Control Plan shall include a statement that the Fly Ash Supplier will prepare and maintain summary reports for all quality control tests performed, and will submit them to CDOT on request.

7.5 The Fly Ash Supplier's Quality Control Plan shall provide an outline of the procedure to be followed for checking transport vehicles before loading to prevent contamination of shipments. The outline shall be maintained in the Fly Ash Supplier's records and will be made available to CDOT on request.

8. CDOT EVALUATION PROCEDURE

8.1 CDOT will verify that the Fly Ash Supplier's Quality Control Plan is adequate. CDOT may visit the shipping site when required.

8.2 CDOT will notify the Fly Ash Supplier whether or not the Fly Ash Supplier's application has been granted.

8.3 CDOT may verify that the Fly Ash Supplier's testing laboratory is currently CCRL accredited.

8.4 CDOT may perform split sample testing in accordance with Section 10.

8.5 CDOT may sample and perform testing on random samples.

8.6 CDOT may inspect the operations of the Fly Ash Supplier's facility including those related to shipments if required.

8.7 Products approved for use will be posted on the CDOT APL.

9. REQUIREMENTS FOR SHIPPING FLY ASH BY AN APPROVED SUPPLIER

9.1 The Fly Ash Supplier's Quality Control Plan as approved by CDOT (Section 7) shall be implemented.

9.2 Each shipment shall be accompanied by two copies of the bill of lading, which shall include:

9.2.1 The name and location of the Fly Ash Supplier and the plant producing the fly ash,

9.2.2 The class of fly ash,

9.2.3 The quantity of material shipped,

9.2.4 The date of shipment,

9.2.5 A statement certifying the material meets specification requirements (COC) and,

9.2.6 A statement certifying that the transport vehicle was inspected before loading and was found acceptable for the material shipped.

9.3 If the test results do not conform to ASTM C 618 specifications, the Fly Ash Supplier shall remove the non-compliant material from the shipping queue as outlined in Subsection 7.2.

10. SPLIT SAMPLE TESTING

10.1 CDOT may request split sample testing. The test results will be exchanged as soon as they are available.

10.2 If the split sample test data is not within the precision specified for that particular test a review of both sampling and testing procedures will be conducted by both the Fly Ash Supplier and CDOT.

11. REPORT AND DATA SHEETS

11.1 Fly Ash Supplier Reports - The Fly Ash Supplier shall prepare the reports described in Subsections 6.1, 6.2, and 9.2.

{This page was intentionally left blank.}

Part I, Sub-Part 5:

Hydrated Lime - 12

1. REFERENCED DOCUMENTS

1.1 AASHTO Standards:

AASHTO M 303 - Lime for Asphalt Mixtures

AASHTO R 38 – Quality Assurance of Standard Manufactured Materials

1.2 ASTM Standards:

ASTM C 25 - Standard Test Methods for Chemical Analysis of Limestone, Quicklime, and Hydrated Lime

ASTM C 50 - Standard Practice for Sampling, Inspection, Packing, and Marking of Lime and Limestone Products

ASTM C 110 - Standard Test Methods for Physical Testing of Quicklime, Hydrated Lime, and Limestone

ASTM C 207 - Standard Specification for Hydrated Lime for Masonry Purposes

ASTM C 977 - Standard Specification for Hydrated Lime for Soil Stabilization

2. TERMINOLOGY

2.1 See ASTM C 51 Standard Terminology Relating to Lime and Limestone (as used by the Industry).

2.2 Supplier – In this Standard, a *Supplier* shall be defined as one who manufactures hydrated lime.

2.3 Contractor – The company under contract with CDOT to produce products using hydrated lime.

3. SIGNIFICANCE AND USE

3.1 This Standard specifies procedures

intended to minimize disruption of hydrated lime shipments. This is accomplished by a certification system that evaluates quality control and specification compliance tests performed by the Supplier on samples obtained prior to shipment.

3.2 This Standard specifies requirements and procedures for a certification system that shall be applicable to all Suppliers providing hydrated lime. These provisions apply to the plant manufacturing the hydrated lime. These provisions apply to the Contractor, after delivery of the hydrated lime to the Contractor, for use on CDOT projects.

4. SAMPLING

4.1 All test samples required by this Standard shall be obtained in accordance with ASTM C 50. The use of a random sampling procedure is mandatory to the establishment of a valid quality assurance program.

5. TESTING REQUIREMENTS

5.1 Laboratories that perform the required testing under this Standard shall list qualifications in the submitted Supplier Quality Control Plan. Any satellite laboratory of a Supplier that performs required testing under this Standard shall be identified in the submitted Supplier Quality Control Plan (Section 7).

6. SUPPLIER REQUIREMENTS

6.1 Suppliers shall submit to the CDOT's Product Evaluation Coordinator (PEC) the CDOT Form #595, Pre-Approved Product Evaluation Request & Summary for each source of hydrated lime intended for use on CDOT projects. Instructions for completing the Form #595 can be found in Notice to Manufacturers at www.coloradodot.info/business/APL/.

6.2 In addition to completing CDOT Form #595, the following shall be supplied to the PEC:

6.2.1 A brief outline of the procedures used to evaluate the finished product including; sampling and testing frequency, and the sample preparation employed, including chemical analysis methods used.

6.2.2 The results of all applicable chemical and/or physical tests required by AASHTO M 303, ASTM C 110, ASTM C 207 or ASTM C 977 on the most recent 20 samples tested. The results shall be submitted in a tabular format with the critical limits indicated.

6.2.3 A copy of the Supplier's Quality Control Plan, which complies with the requirements of Section 7. Any changes to the supplier's Quality Control plans shall require an updated plan sent to the PEC.

6.3 A sample of the proposed hydrated lime shall be shipped to the PEC at the Materials and Geotechnical Branch, 4670 North Holly Street, Unit A, Denver, Colorado 80216-6408.

6.4 During normal business hours, the Supplier shall allow CDOT to visit the production and/or shipping site to observe the Supplier's quality control activities, to inspect the facilities, and to obtain samples for tests.

6.5 The Supplier shall follow the procedures described in the CDOT approved quality control plan.

6.6 The Supplier shall establish a continuing test record for every test required for hydrated lime included in the written request as prepared to satisfy the requirements of Subsection 6.2.

6.7 The Supplier shall submit to CDOT all reports required by this standard in a format approved by CDOT.

6.8 The Supplier shall have a satisfactory record of compliance with CDOT project specifications. Decisions by CDOT concerning this requirement shall be based on the test results furnished by the Supplier and satisfactory results when the splits and field tests are compared with Supplier tests.

7. SUPPLIER QUALITY CONTROL PLAN (MINIMUM REQUIREMENTS)

7.1 The Supplier's Quality Control Plan shall identify the following:

7.1.1 Facility location.

7.1.2 Name and telephone number of a person at each production facility, responsible for quality control of material shipped to CDOT projects.

7.1.3 Quality control tests and testing frequency to be performed on each hydrated lime product.

7.1.4 Name and location of the laboratory performing quality control tests on the hydrated lime.

7.2 The Supplier's Quality Control Plan shall include a declaration stating that if a test result indicates that a shipment of hydrated lime does not comply with the purchase specifications, the Supplier shall:

7.2.1 Identify the material in the shipment,

7.2.2 Immediately cease the shipment until the material complies with the specification,

7.2.3 Immediately notify CDOT regarding the shipment in question,

7.2.4 Immediately notify the Contractors scheduled to use the material from the shipment in question,

7.2.5 Notify CDOT prior to resuming shipment; and

7.2.6 Implement any mutually agreed upon procedures for the disposition of the material.

7.3 The Supplier's Quality Control Plan shall describe method and frequency for initial and quality control testing.

7.3.1 **Initial Testing** - For each hydrated lime product to be supplied, testing shall be initially performed by the supplier and the results of those tests shall be provided to CDOT, accompanied by a sample of the material represented by the test results.

7.3.2 **Quality Control Testing** – Tests to determine conformance with Subsection 712.03 of the Standard Specifications shall be conducted as needed for quality control. The Supplier's Quality Control Plan shall indicate the frequency of this testing.

7.4 The Supplier's Quality Control Plan shall include a statement that the Supplier will prepare and maintain summary reports for all quality control tests performed, and will submit them to CDOT on request.

7.5 The Supplier's Quality Control Plan shall provide an outline of the procedure to be followed for checking transport vehicles before loading to prevent contamination of shipments. The outline shall be maintained in the Supplier's records and will be made available to CDOT on request.

8. CDOT EVALUATION PROCEDURE

8.1 CDOT will verify that the Supplier's Quality Control Plan is adequate. CDOT may visit the shipping site when required.

8.2 CDOT will notify the Supplier whether or not the Supplier's application has been granted.

8.3 CDOT may perform split sample testing in accordance with Section 10.

8.4 On a random basis, CDOT may request a sample for testing the supplier's product.

8.5 CDOT may inspect the operations of the Supplier's facility including those related to shipments if required.

8.6 CDOT will post the Supplier's approved hydrated lime with the associated Supplier's facility name on CDOT's Approved Products List. Reference to the web site is at: www.coloradodot.info/business/APL/.

9. REQUIREMENTS FOR SHIPPING HYDRATED LIME BY AN APPROVED SUPPLIER

9.1 The Supplier's Quality Control Plan as approved by CDOT (Section 7) shall be implemented.

9.2 Each shipment shall be accompanied by two copies of the bill of lading, which shall include:

9.2.1 The name and location of the Supplier,

9.2.2 The Type of material shipped,

9.2.3 The quantity of material shipped,

9.2.4 The date of shipment,

9.2.5 A certificate of compliance (COC) certifying the material meets specification requirements. The COC statement will certify the material was manufactured and tested in accordance with CDOT's approved Quality Control Plan (Section 7) and, therefore meets State requirements and,

9.2.6 A statement certifying that the transport vehicle was inspected before loading and was found acceptable for the material shipped.

9.3 If the test results do not conform to Standard Specification Subsection 712.03, the Supplier shall remove the non-compliant material from the shipping queue as outlined in Subsection 7.2.

10. SPLIT SAMPLE TESTING

10.1 CDOT may request split sample testing. The test results will be exchanged as soon as they are available.

10.2 If the split sample test data is not within the precision specified for that particular test a review of both sampling and testing procedures will be conducted by both the Supplier and CDOT.

11. REPORT AND DATA SHEETS

11.1 Supplier Reports - The Supplier shall prepare the reports described in Subsections 6.1, 6.2 and 9.2.

Part II, Sub-Part 1:

Steel Reinforcing Bars and Steel Dowel Bars - 12

SCOPE: This sub-part provides procedures for being included on the Qualified Manufacturer List (QML) as a Fabricator of steel reinforcing bars and dowel bar for CDOT projects. CDOT will only accept steel reinforcing bars and dowel bars from a Fabricator on the QML.

CDOT will accept steel reinforcing bar suppliers who have both participated in AASHTO's NTPEP (National Transportation Product Evaluation Program) audit program of steel rebar and have received evaluation results deemed acceptable to CDOT. A letter must be addressed to CDOT's Product Evaluation Coordinator (PEC) requesting that the facility be placed on the CDOT's QML. A copy of the NTPEP Certificate of Compliance as well as any applicable documentation from the audit reports is required. CDOT may request additional information if necessary and may decertify a supplier for failing to meet CDOT expectations.

1. REFERENCED DOCUMENTS

Where applicable, the latest edition of the following standards shall be considered a part of these requirements.

1.1 CDOT Standard Specifications for Road and Bridge Construction:

- Section 412.13 – Joints
- Section 602 – Reinforcing Steel
- Section 709.01 – Reinforcing Steel
- Section 709.03 – Dowel Bars and Tie Bars

1.2 AASHTO Standards:

AASHTO M 31 – Standard Specification for Deformed and Plain Carbon Steel Bars for Concrete Reinforcement

AASHTO R 38 – Standard Practice for Quality Assurance of Standard Manufactured Materials

AASHTO T 244 – Standard Method of Test for Mechanical Testing of Steel Products

AASHTO M 55 – Standard Method of Test for Steel Welded Wire Reinforcement, Plain, for Concrete

AASHTO M 221 – Standard Method of Test for Steel Welded Wire Reinforcement, Deformed, for Concrete

1.3 ASTM Standards:

ASTM A 184 – Standard Specification for Welded Deformed Steel Bar Mats for Concrete Reinforcement

ASTM A 370 – Standard Test Methods and Definitions for Mechanical Testing of Steel Products

ASTM A 615 – Standard Specification for Deformed and Plain Billet-Steel Bars for Concrete Reinforcement

ASTM A 706 – Low-Alloy Steel Deformed and Plain Bars for Concrete Reinforcement

ASTM A 996 – Standard Specification for Rail-Steel and Axle-Steel Deformed Bars for Concrete Reinforcement

ASTM D 3665 – Standard Practice for Random Sampling of Construction Material

2. TERMINOLOGY

2.1 See AASHTO M 31 and ASTM A 370 for terminology related to steel reinforcing bars and dowel bars.

2.2 Coating Application Plant – The one who produces a protective coated steel reinforcing bar and a protective coated dowel bar.

2.3 Contractor – The company under contract with CDOT to produce products using steel reinforcing bars and dowel bars.

2.4 Deformed bar – Steel bar with protrusions; a bar that is intended for use as reinforcement in reinforced concrete construction.

2.5 Fabricator – The company, which cuts and bends steel reinforcing bars either coated or uncoated and/or assembles dowel bar baskets. The company may also provide uncut lengths of steel bar to the construction project site. Each plant constitutes a separate company.

2.6 Plain bar – Steel bar without protrusions; a bar that is intended for use as a dowel bar in transverse joints of concrete pavement construction.

2.7 Supplier – In this sub-part supplier shall be defined as one who produces or mills uncoated deformed steel reinforcing bars and steel plain bars used by the Fabricator.

2.8 Uncoated bar – Steel bar without protective coating.

2.9 Cement and Concrete Reference Laboratory (CCRL) Laboratory Inspection Program – Provides a comprehensive account of how procedures, practices, equipment and facilities compare with ASTM standards requirements. The CCRL laboratory inspector: checks critical equipment dimensions and operating characteristics, watches a technician demonstrate test procedures, and reviews the quality system when covered by appropriate ASTM standards.

3. SIGNIFICANCE AND USE

3.1 This Standard specifies requirements that should be followed by the Supplier in implementing an effective Quality Control (QC) system. This is accomplished by a certification system that evaluates quality control practices and specification compliance tests performed by the Supplier according to their quality control plans.

3.2 This Standard specifies requirements and procedures for a certification system that shall be applicable to all Suppliers providing steel reinforcing bars and dowel bars.

3.2.1 This Standard covers the responsibilities of the Supplier from point of delivery of steel reinforcing bars and dowel bars to the Fabricators plant, construction project site, and/or Coating Application Plant.

4. SAMPLING

4.1 All number and frequency of test samples required by this Standard shall be in accordance with AASHTO M 31 and ASTM A 996 (as a minimum) and the enhanced Manufacturer QC program. It is expected that the QC tests are to be tied to critical production processes as well as to the final product.

4.2 In addition, the QC program required by this Standard shall use stratified random sampling techniques. Stratified random sampling should be performed in accordance with ASTM D 3665. The use of a stratified random sampling procedure is mandatory to the establishment of a valid QC program. All random QC sample locations shall be properly documented.

NOTE 1: Determination of random locations (or timing) is universally applied to a construction site or to a Fabricator production line. ASTM D 3665 covers a flowing stream of material that can be applied to the production line of steel reinforcing bars and dowel bars.

5. TESTING REQUIREMENTS

5.1 An internal designated testing location and/or facility of a Supplier that performs the required testing under this Standard shall be identified in the submitted Quality System Manual (QSM) (per Section 9).

5.1.1 A copy of the certification of national accreditation program such as CCRL shall be reproduced in the submitted Quality System Manual (QSM) (per Section 9).

5.2 Testing required for this Standard shall be performed by qualified Supplier personnel through appropriate QC programs or appropriate training programs.

5.3 As a minimum, the Supplier's programs used shall include the following;

5.3.1 Training in AASHTO or ASTM test procedures.

5.3.2 Demonstration of proficiency in each Supplier's QC test.

5.3.3 Demonstration of ability to properly document Supplier's QC test results.

5.3.4 Demonstrate the ability to interpret all the test results.

6. SUPPLIER REQUIREMENTS

6.1 Uncoated bar Suppliers shall be on CDOT's Qualified Manufacturers List (QML) prior to use by the Fabricator. The QML can be found at the following web address www.coloradodot.info/business/APL/.

6.2 The uncoated bar Supplier shall provide an annual certification that all steel products delivered to the Fabricator and/or Coating Application Plant / Fabricator and permanently incorporated in the work shall have occurred in the United States of America.

7. CERTIFICATION

7.1 This section details the required documentation and samples to be submitted to the CDOT by the Supplier requesting to be added to the QML.

7.2 A brief outline of the procedures used to evaluate the finished product including: sampling and testing frequency, sample preparation methods, chemical analysis methods, and physical testing methods.

7.3 The results of all applicable chemical and/or physical tests required by ASTM A 615 on the most recent 40 samples (20 pairs) tested. The results shall be submitted in the format outlined in ASTM A 370.

7.4 A copy of the CCRL certification for the laboratory performing testing.

7.5 A copy of the reinforcing steel Supplier's Quality System Manual, which complies with the requirements of Section 9.

7.6 A sample of the proposed reinforcing steel at least 3 foot in length shall be shipped to

the Concrete and Physical Properties Program at the Materials and Geotechnical Branch, 4670 N. Holly Street, Unit A, Denver, CO 80216-6408.

7.7 The reinforcing steel Supplier shall allow CDOT to visit the production and/or shipping site to observe the reinforcing steel Supplier's quality control activities, to inspect the facilities, and to obtain samples for tests.

7.8 The reinforcing steel Supplier shall follow the procedures described in the CDOT approved quality system manual.

7.9 The reinforcing steel Supplier shall establish a continuing test record for every test required for each Type of reinforcing steel included in the written request.

7.10 The reinforcing steel Supplier shall submit to CDOT all reports required by this standard in a format approved by CDOT.

7.11 The reinforcing steel Supplier shall have a satisfactory record of compliance with CDOT project specifications. Decisions by CDOT concerning this requirement shall be based on the test results furnished by the Reinforcing Steel Supplier and satisfactory results when field samples are tested.

8. DECERTIFICATION

8.1 CDOT may decertify the Fabricator when conditions exist as specified on page 2 of CP 11 (Section 5 – Decertification).

NOTE 2: The term Supplier and Fabricator are interchangeable when reading Section 5 – Decertification on page 2.

9. SUPPLIER'S QUALITY SYSTEM MANUAL (MINIMUM REQUIREMENTS)

9.1 On an annual basis, at a minimum of one month prior to producing steel reinforcing bars and dowel bars for a CDOT project, one copy of the Supplier's Quality System Manual (QSM) shall be submitted for review and approval to CDOT's Product Evaluation Coordinator either at 303-398-6566 or within the Staff Materials & Geotechnical Branch at 4670 North Holly Street,

Unit A, Denver, Colorado 80216. In lieu of a may be submitted. The PDF'ed manual submittal must be complete and whole. CDOT's approval of the QSM is intended only to indicate that the QSM is in conformance with the minimum QC requirements set forth in this Standard. Once the Supplier is approved and on the QML, the QSM provisions will remain in effect for a period of one year, unless revisions are determined to be necessary by the Quality Control Manager or requested by CDOT, or if the Supplier is decertified. If any changes are made to the QSM, an updated copy shall be submitted to CDOT for review and approval. In lieu of a full updated copy, submittals of updates are acceptable. Updates shall be in the same format as the manual and are to be inserted into the manual to replace outdated pages. The updates may be in PDF format. The updated pages will have the date of update issuance and is to be recorded in a table of revisions. Guidelines for preparing a QSM are documented in AASHTO R 38.

9.2 The Supplier's QSM may be maintained in electronic format. However, one or more copies of the QSM shall be maintained by the Supplier's QC Manager in a printed and bound format. The QSM shall be available to all of the Supplier's employees. Each document in the QSM shall indicate its preparation date and all pages of the QSM shall be numbered. If a document is revised, the date of revision shall be indicated on the document and recorded in a table of revisions.

9.3 The Supplier's QSM shall be formatted to provide numbered sections which meet the following order, format and content:

9.3.1 Supplier's quality policy or mission Statement endorsed by the company's Chief Executive Officer.

9.3.1.1 The quality policy / mission statement shall indicate support of top management to enforce the QC requirements contained in the QSM.

9.3.2 The QSM shall include the address and telephone numbers of applicable personnel at the supplier facility.

9.3.3 The QSM shall include a brief listing and description of all the steel reinforcing bars and dowel bars being fabricated at the facility.

hard copy QSM, an electronic PDF document

9.3.4 The QSM shall present and define any significant terms used throughout the QSM.

9.3.5 For all fabricated items addressed in the QSM, the applicable AASHTO, ASTM, specification shall be identified.

9.3.6 The QSM shall present the personnel structure established to implement the Supplier's quality system. The specific roles and responsibilities of all QC personnel shall be documented as follows:

9.3.6.1 The QSM shall contain an organizational chart. The chart shall indicate a clear separation between the QC personnel and the production personnel. The QC Manager shall be allowed direct access to top management, independent from production.

9.3.6.2 Each facility shall have a Quality Control Manager who has the overall responsibility for implementing the requirements of the QSM. The QC Manager shall review the established QC system annually in order to satisfy this requirement, or if changes in the fabrication process(s) occur, or whenever technical or CDOT information indicate a trend in reduced quality.

9.3.6.3 Each facility shall have at least one Quality Control Technician to perform QC sampling, testing, and inspection. At least one QC Technician shall be on-site during production. The QC Technicians shall be familiar with the tests they perform and have sufficient authority to assure corrective actions are carried out when necessary. The QSM shall indicate the line of authority of the QC Technicians, which shall demonstrate their authority to require corrective action. The QSM shall designate the QC Technicians at the facility and laboratory involved in the production or testing of the steel reinforcing bars and dowel bars.

9.4 The QSM shall contain a description of the qualifications required and attained, as well as the years of experience for each QC Manager and QC Technician. All QC sampling, testing, QSM shall also include periodic auditing of each QC Technician's ability to satisfactorily perform the required tests. Retraining shall be provided when the test method is revised.

9.5 The QSM shall provide for specific training for frontline production personnel in the safe and correct operating procedures implemented to ensure the required quality of all steel reinforcing bars and dowel bars.

9.6 The Supplier shall maintain its own accredited or qualified laboratory to perform QC testing. The Supplier shall provide backup QC testing personnel and any necessary backup laboratory equipment. The QSM shall include the address and telephone numbers of the designated backup personnel. The Supplier's internal designated testing location and/or facility shall meet the minimum accreditations or qualifications obtained through CCRL:

9.7 The QSM shall contain an inventory of the necessary equipment used for sampling and testing along with associated calibration equipment used for each required test procedure. The QSM shall assign a unique identification number to each piece of testing equipment. The QSM inventory for each necessary piece of equipment shall include the following information:

9.7.1 The name of each necessary piece of equipment, date placed in service, manufacturer, model and serial number. The QSM shall include the location where the instructions for use and operation of each necessary piece of equipment is stored if not included in the QSM.

9.7.1.1 For each necessary piece of equipment, the QSM shall include the interval of calibration or verification, a reference to the calibration or verification procedures used, and the location where the current calibration or verification records are stored. The QSM shall describe the methods of calibration and verification procedures that are performed at the specified intervals.

9.7.2 The QSM shall contain a copy of the signed certification that all steel products permanently incorporated into the manufactured product shall have occurred in the United States of America.

10.5 CDOT may perform quality assurance testing.

10.6 CDOT may visit the Fabricator's site when required. CDOT may inspect the operations of

9.8 The QSM shall describe the procedure and frequency for inspection and selection of material samples during production. Sampling shall be performed on a stratified random procedure in accordance with ASTM D 3665. All random QC sample locations shall be properly documented and these procedures shall be included in the QSM.

9.9 The QSM shall contain descriptions and examples of the test report forms used by the Supplier. The QSM shall identify the individuals responsible for maintaining all test records and reports along with the location where the reports are stored.

9.9.1 The test reports shall be maintained and available for inspection for a minimum of three years.

9.10 The QSM shall contain a description of the procedures used to identify and document all material or test results that do not conform to specification requirements. The QSM shall contain provisions for resolving non-conforming material or test results.

9.11 The QSM shall describe procedures used to properly handle, store, and ship steel reinforcing bars and dowel bars.

10. CDOT EVALUATION PROCEDURE

10.1 Suppliers producing steel reinforcing bars and dowel bars shall meet the minimum industry standards.

10.2 Suppliers shall submit the required documentation and samples described in Section 7.

10.3 Within two months after submitting all required information, CDOT will notify the Supplier whether or not the manufacturing facility's application for the Qualified Manufacturer List has been granted.

10.4 CDOT may perform split sample testing in accordance with Section 11.

the Fabricator's facility including those related to shipments if required.

10.5 CDOT will post the Fabricator's name and approved plant on CDOT's Qualified

Manufacturer List (QML) in the web site at www.coloradodot.info/business/APL/.

10.6 Failure in one or more Sections or Subsections listed in this Standard may result in decertification of the plant and the plant will be removed from the QML. The Supplier may apply for reinstatement on the QML.

12.3 If the specification compliance test results do not conform to Subsection 709.01 and 709.03 of the CDOT Standard Specifications, the Fabricator shall remove the non-compliant material from the shipping queue.

11. SPLIT SAMPLE TESTING

11.1 CDOT may request split sample testing. A split sample is a sample taken and evenly divided to be tested by two or more individuals or laboratories. The test results will be exchanged as soon as they are available.

11.2 If the split sample test data is not within the agreed to precision for that particular test a review of both sampling and testing procedures will be conducted by both the Supplier and CDOT.

12. REQUIREMENTS FOR SHIPPING STEEL REINFORCING BARS AND DOWEL BARS BY AN APPROVED FABRICATOR

12.1 The steel reinforcing bars and dowel bars Supplier's QSM as approved by CDOT shall be implemented.

12.2 Each shipment shall be accompanied by two copies of the bill of lading, which shall include:

12.2.1 The name and location of the steel reinforcing bars and dowel bars Fabricator and the Supplier producing the steel reinforcing bars and dowel bars,

12.2.2 The size and grade of steel reinforcing bars and dowel bars conforming to specified specification,

12.2.3 Bars shall be separated and tagged with the Supplier's heat identification number,

12.2.4 The quantity of material shipped,

12.2.5 The date of shipment,

12.2.6 A copy of the mill test reports.

Part II, Sub-Part 2:

Epoxy-Coated Steel Reinforcing Bars and Epoxy-Coated Steel Dowel Bars - 12

SCOPE: This sub-part provides procedures for being included on the Qualified Manufacturers List (QML) as a producer of epoxy-coated steel reinforcing bars and epoxy-coated steel dowel bars for CDOT projects. CDOT will only accept epoxy-coated steel reinforcing bars and epoxy-coated steel dowel bars by a Manufacturer on the QML.

1. REFERENCED DOCUMENTS

Where applicable, the latest edition of the following standards shall be considered a part of these requirements.

1.1 CDOT Standard Specifications for Road and Bridge Construction:

- Section 412.13 – Joints
- Section 602 – Reinforcing Steel
- Section 709.01 – Reinforcing Steel
- Section 709.03 – Dowel Bars and Tie Bars

1.2 AASHTO Standards:

AASHTO M 31 – Standard Specification for Deformed and Plain Carbon Steel Bars for Concrete Reinforcement

AASHTO M 254 – Standard Specification for Corrosion-Resistant Coated Dowel Bars

AASHTO M 284 – Standard Specification for Epoxy-Coated Reinforcing Bars: Materials and Coating Requirements

AASHTO M 317 – Standard Specification for Epoxy-Coated Reinforcing Bars: Handling Requirements for Fabrication and Job Site

AASHTO R 38 – Standard Practice for Quality Assurance of Standard Manufactured Materials

AASHTO T 253 – Standard Method of Test for Coated Dowel Bars

1.3 ASTM Standards:

ASTM A 615 – Standard Specification for Deformed and Plain Billet-Steel Bars for Concrete Reinforcement

ASTM A 775 – Standard Specification for Epoxy-Coated Steel Reinforcing Bars

ASTM D 3665 – Standard Practice for Random Sampling of Construction Material

ASTM D 3963 – Standard Specification for Fabrication and Jobsite Handling of Epoxy-Coated Steel Reinforcing Bars

1.4 Concrete Reinforcing Steel Institute (CRSI):

Epoxy Coating Plant Certification Manual

2. TERMINOLOGY

2.1 See AASHTO M 284 for terminology related to epoxy-coated steel reinforcing bars.

2.2 Coated bar – Steel bar with protective epoxy coating applied by the electrostatic spray method.

2.3 Contractor – The company under contract with CDOT to produce products using epoxy-coated steel reinforcing bars and epoxy-coated steel dowel bars.

2.4 Deformed bar – Steel bar with protrusions; a bar that is intended for use as reinforcement in reinforced concrete construction.

2.5 Fabricator – The company, which cuts and bends steel reinforcing bars either coated or uncoated and/or assembles dowel bar baskets.

2.6 Manufacturer – The company, which produces epoxy-coated steel reinforcing bars and epoxy-coated steel dowel bars. Each epoxy-coated applicator plant constitutes a separate company.

2.7 Plain bar – Steel bar without protrusions; a bar that is intended for use as a dowel bar in transverse joints of concrete pavement construction.

2.8 Supplier – In this sub-part it shall be defined as one who provides materials used in the manufacturing of epoxy-coated steel reinforcing bars and epoxy-coated steel dowel bars. Uncoated steel reinforcing bars, uncoated dowel bars, and powder coating are among the materials provided to the Manufacturer.

2.9 Uncoated bar – Steel bar without protective epoxy coating.

3. SIGNIFICANCE AND USE

3.1 This Standard specifies requirements that should be followed by the Manufacturer in implementing an effective Quality Control (QC) system. This is accomplished by a certification system that evaluates quality control practices and specification compliance tests performed by the Manufacturer according to their quality control plans.

3.2 This Standard specifies requirements and procedures for a certification system that shall be applicable to all Manufacturers providing epoxy-coated steel reinforcing bars and epoxy-coated steel dowel bars. These provisions initially apply to the plant manufacturing the epoxy-coated steel reinforcing bars and epoxy-coated steel dowel bars.

3.2.1 This Standard covers the responsibilities of the Manufacturer from point of delivery of uncoated deformed or plain bars at the applicator plant to point of delivery on the construction project site and/or Fabricator plant.

3.3 This Standard applies to Fabricators that use epoxy-coated bars. The Fabricator shall conform to the requirements of ASTM D 3963 for fabrication of bars and dowel bar assemblies after the application of the epoxy-coating.

3.3.1 This Standard covers the responsibilities of the Fabricator from point of delivery of epoxy-coated steel reinforcing bars and epoxy-coated steel dowel bars at the Fabricators plant to point of delivery on the construction project site.

3.3.2 This Standard covers the responsibilities of the Fabricator from point of delivery of uncoated bars to point of delivery of the Manufacturers application site.

3.3.3 This Standard subsequently covers epoxy-coated steel reinforcing bars and epoxy-coated steel dowel bars for use on CDOT projects. The Contractor shall conform to the requirements of ASTM D 3963 for job site handling of epoxy-coated bars.

4. SAMPLING

4.1 All number and frequency of test samples required by this Standard shall be in accordance with AASHTO M 284 (as a minimum) and the enhanced Manufacturer QC program. It is expected the QC tests are to be tied to critical production processes as well as to the final product.

NOTE 1: AASHTO M 284 specifies the number and frequency of tests for coating thickness, continuity, flexibility, and adhesion. For example, an enhanced Manufacturer QC program that exceeds the minimum set forth in AASHTO M 284 would document the method of determination of an additional randomly selected bar to test the bar surface temperature before applying the coating.

4.2 In addition, the QC program required by this Standard shall use stratified random sampling techniques. Stratified random sampling should be performed in accordance with ASTM D 3665. The use of a stratified random sampling procedure is mandatory to the establishment of a valid QC program. All random QC sample locations shall be properly documented.

NOTE 2: Determination of random locations (or timing) is universally applied to a construction site or to a Manufacturer's production line. ASTM D 3665 covers a flowing stream of material that can be applied to the production line of epoxy-coated bars.

5. TESTING REQUIREMENTS

5.1 An internal designated testing location and/or facility of a Manufacturer that performs

the required testing under this Standard shall be identified in the submitted Quality System Manual (QSM) (per Section 9).

5.2 Testing required for this Standard shall be performed by qualified Manufacturers personnel through appropriate QC programs or appropriate training programs.

5.3 As a minimum, the Manufacturers programs used shall include the following;

5.3.1 Training in AASHTO, ASTM, or CRSI test procedures.

5.3.2 Demonstration of proficiency in each Manufactures QC test.

5.3.3 Demonstration of ability to properly document Manufactures QC test results.

5.3.4 Demonstrate the ability to interpret all the test results.

6. SUPPLIER REQUIREMENTS

6.1 Uncoated bar Suppliers shall be on CDOT's Qualified Manufacturers List (QML) prior to use by the Manufacturer. The QML can be found at the following web address: www.coloradodot.info/business/APL/.

6.2 Uncoated bar Suppliers shall follow the procedures described in the CDOT approved quality control plan as required in CP 11 Part I, Sub-Part 6.

6.3 The uncoated bar Supplier shall provide an annual certification that all steel products delivered to the Manufacturer and permanently incorporated in the work shall have occurred in the United States of America.

6.4 Suppliers of epoxy powder shall be on CDOT's Approved Product List (APL). The APL along with instruction for completing CDOT Form #595, Pre-Approved Product Evaluation Request & Summary, can be found at the following web address: www.coloradodot.info/business/APL/.

7. CURRENTLY CERTIFIED MANUFACTURERS

7.1 A Manufacturer, which has been certified for the past three consecutive years under the Concrete Reinforcing Steel Institute (CRSI) certification plant program, will be placed on CDOT's QML after submitting all of the following:

- The certificate from the current year and the preceding three consecutive years of evaluations from CRSI,
- The inspection report from the current year and the preceding three consecutive years of evaluations from CRSI,
- The Quality System Manual as outlined in Section 9 of this Standard.

7.2 A Manufacturer, which has been certified for less than three consecutive years under the CRSI certification plant program will be on probation and placed on the QML after submitting all of the following:

- The certificate from the current year along with any preceding years of evaluations from CRSI,
- The inspection report from the current year along with any preceding years of evaluations from CRSI,
- The Quality System Manual as outlined in Section 9 of this Standard.

7.2.1 The probation period will be for three consecutive years after being placed on the QML.

8. DECERTIFICATION

8.1 This section applies to Manufacturers that are classified under Subsection 7.1. If the Manufacturer becomes decertified by CRSI certification plant program after being placed on the QML, the Manufacturer will be removed from the QML until successfully completing and submitting to CDOT the requirements within this Standard. Decertification is the final ruling after the CRSI dispute process has been completed. The Manufacturer may apply for reinstatement on the QML no sooner than six months after removal from the QML. The probationary period will be for one year after being placed back on the QML with Subsections 7.2, 8.2, and 8.3 of this Standard being applied.

8.2 This section applies to Manufacturers that are classified under Subsection 7.2. If the Manufacturer becomes decertified by CRSI certification plant program after being placed on the QML, the Manufacturer will be removed from the QML until successfully completing and submitting to CDOT the requirements within this Standard. The Manufacturer may apply for reinstatement on the QML no sooner than three years after removal from the QML.

8.3 CDOT may decertify the Manufacturer when conditions exist as specified in Section 5 - Decertification within the Introduction of the CP 11 Page 2.

NOTE 3: The term Supplier and Manufacturer are interchangeable when reading Section 5 – Decertification from page 2.

9. MANUFACTURER'S QUALITY SYSTEM MANUAL (MINIMUM REQUIREMENTS)

9.1 On an annual basis, at a minimum of one month prior to producing epoxy-coated steel reinforcing bars and epoxy-coated steel dowel bars for a CDOT project, one copy of the Manufacturer's Quality System Manual (QSM) shall be submitted for review and approval to CDOT's Product Evaluation Coordinator (303) 398-6566 within the Staff Materials & Geotechnical Branch at 4670 North Holly Street, Unit A, Denver, Colorado 80216-6408. In lieu of a hard copy QSM, a PDF format document may be submitted. The PDF manual submittal must be complete and whole. CDOT's approval of the QSM is intended only to indicate that the QSM is in conformance with the minimum QC requirements set forth in this Standard. Once the Manufacturer is approved and on the Qualified Manufacturers List (QML), the QSM provisions will remain in effect for a period of one year, unless revisions are determined to be necessary by the Quality Control Manager or requested by CDOT, or if the Manufacturer is decertified. If any changes are made to the QSM, an updated copy shall be submitted to CDOT for review and approval. In lieu of a full updated copy, submittals of updates are acceptable. Updates shall be in the same format as the manual and are to be inserted into the manual to replace outdated pages. The updates may be in PDF format. The updated pages will have the date of update issuance and

is to be recorded in a table of revisions. Guidelines for preparing a QSM may be available from the Concrete Reinforcing Steel Institute (CRSI). Guidelines are also documented in AASHTO R 38.

9.2 The Manufacturer's QSM shall include the latest edition of CRSI Plant Certification Manual.

9.3 The Manufacturer's QSM may be maintained in electronic format. However, one or more copies of the QSM shall be maintained by the Manufacturer's QC Manager in a printed and bound format (3-ring or other). The QSM shall be available to all of the Manufacturer's employees. Each document in the QSM shall indicate its preparation date and all pages of the QSM shall be numbered. If a document is revised, the date of revision shall be indicated on the document and recorded in a table of revisions.

9.4 The Manufacturer's QSM shall be formatted to provide numbered sections which meet the following order, format, and content:

9.4.1 Manufacturer's quality policy or mission Statement endorsed by the company's Chief Executive Officer.

9.4.1.1 The quality policy / mission statement shall indicate support of top management to enforce the QC requirements contained in the QSM.

9.4.2 The QSM shall include the address and telephone numbers of applicable personnel at the manufacturing facility. If applicable, the QSM shall include the address and telephone numbers of responsible personnel of the Fabricators.

9.4.3 The QSM shall include a brief listing and description of all the epoxy-coated deformed and plain bars being manufactured at the facility.

9.4.4 The QSM shall present and define any significant terms used throughout the QSM.

9.4.5 For all manufactured items addressed in the QSM, the applicable AASHTO, ASTM, or CDOT specification shall be identified.

9.4.6 The QSM shall present the personnel structure established to implement the

Manufacturer's quality system. The specific roles and responsibilities of all QC personnel shall be documented as follows:

9.4.6.1 The QSM shall contain an organizational chart. The chart shall indicate a clear separation between the QC personnel and the production personnel. The QC Manager shall be allowed direct access to top management, independent from production.

9.4.6.2 Each facility shall have a Quality Control Manager who has the overall responsibility for implementing the requirements of the QSM. The QC Manager shall review the established QC system annually in order to satisfy this requirement, or if changes in the manufacturing process(s) occur, or whenever technical or CDOT information indicate a trend in reduced quality.

9.4.6.3 Each facility shall have at least one Quality Control Technician to perform QC sampling, testing, and inspection. At least one QC Technician shall be on-site during production. The QC Technicians shall be familiar with the tests they perform and have sufficient authority to assure corrective actions are carried out when necessary. The QSM shall indicate the line of authority of the QC Technicians, which shall demonstrate their authority to require corrective action. The QSM shall designate the QC Technicians at the facility and laboratory involved in the production or testing of the epoxy-coated steel reinforcing bars and epoxy-coated steel dowel bars.

9.5 The QSM shall contain a description of the qualifications required and attained, and years of experience for each QC Manager and QC Technician. All QC sampling, testing, and inspection personnel shall be trained. Plants certified by CRSI shall have at least one QC Manager and at least one QC Technician who are capable of performing and correctly interpreting all the tests required by CRSI Plant Certification Manual. The QSM shall also include periodic auditing of each QC Technician's ability to satisfactorily perform the required tests. Retraining shall be provided when the test method is revised.

9.6 The QSM shall provide for specific training for frontline production personnel in the safe and correct operating procedures implemented to ensure the required quality of all epoxy-coated

steel reinforcing bars and epoxy-coated steel dowel bars.

9.7 The Manufacturer shall maintain its own qualified internal designated testing location and/or facility to perform QC testing. The Manufacturer shall provide backup QC testing personnel and any necessary backup laboratory equipment. The QSM shall include the address and telephone numbers of a designated backup personnel. The Manufacturer's internal designated testing location and/or facility shall meet the minimum accreditations or qualifications obtained through one or more of the following programs:

9.7.1 The manufacturing industry's Concrete Reinforcing Steel Institute Certification Plant Program.

9.7.2 National accreditation programs such as AASHTO Accreditation Program or American Association for Laboratory Accreditation.

9.8 The QSM shall contain an inventory of the necessary equipment used for sampling and testing along with associated calibration equipment used for each required test procedure. The QSM shall assign a unique identification number to each piece of testing equipment. The QSM inventory for each necessary piece of equipment shall include the following information:

9.8.1 The name of each necessary piece of equipment, date placed in service, Manufacturer, model and serial number. The QSM shall include the location where the instructions for use and operation of each necessary piece is stored if not included in the QSM.

9.8.1.1 For each necessary piece of equipment, the QSM shall include the interval of calibration or verification, a reference to the calibration or verification procedures used, and the location where the current calibration or verification records are stored. The QSM shall describe the methods of calibration and verification procedures that are performed at the specified intervals.

9.9 The QSM shall identify all types of Supplier delivered materials used for the production of epoxy-coated steel reinforcing bars and epoxy-coated steel dowel bars.

9.9.1 The QSM shall contain a copy of the signed certification from the steel Supplier that all steel products permanently incorporated into the manufactured product shall have occurred in the United States of America.

9.9.2 The QSM shall contain a description of the specification requirements for all Supplier delivered materials.

9.9.3 The QSM shall contain a description of the certification and test reports delivered by the Supplier and a location where these records are stored.

9.9.4 The QSM shall include all QC testing of the supplied materials and shall contain a statement that no raw materials shall be used unless they are on the APL or they have been tested and meet all appropriate CDOT, AASHTO, or ASTM specifications.

9.9.5 All Supplier delivered materials shall be properly stored to prevent damage, contamination, or other alterations prior to use in production. The QSM shall include procedures for the adequate storage of supplied materials.

9.10 The QSM shall describe the procedure and frequency for inspection and selection of material samples during production. Sampling shall be performed on a stratified random procedure in accordance with ASTM D 3665. All random QC sample locations shall be properly documented and these procedures shall be included in the QSM.

9.11 The QSM shall contain descriptions and examples of the test report forms used by the Manufacturer. The QSM shall identify the individual(s) responsible for maintaining all test records and reports along with the location where the reports are stored.

9.11.1 The test reports shall be maintained and available for inspection for a minimum of three years.

9.12 The QSM shall contain a description of the procedures used to identify and document all material or test results that do not conform to specification requirements. The QSM shall contain provisions for resolving non-conforming material or test results.

9.13 The QSM shall describe procedures used to properly handle, store, and ship epoxy-coated steel reinforcing bars and epoxy-coated steel dowel bars.

10. CDOT EVALUATION PROCEDURE

10.1 Manufacturing facilities producing epoxy-coated steel reinforcing bars and epoxy-coated steel dowel bars shall meet the minimum industry standards, and be annually inspected and certified by CRSI. A copy of the certification shall be submitted to CDOT as part of the QML process.

10.2 Initially the Manufacturer shall submit a representative sample of epoxy-coated steel reinforcing bars and epoxy-coated steel dowel bars, test result documentation, and QSM to CDOT's Product Evaluation Coordinator (303) 398-6566 within the Staff Materials & Geotechnical Branch at 4670 North Holly Street, Unit A, Denver, Colorado 80216-6408.

10.2.1 A representative sample of an epoxy-coated steel reinforcing bar at least 3 foot in length and an epoxy-coated steel dowel bar 18 inches long shall be shipped.

10.2.2 The results of all applicable chemical and/or physical tests required by AASHTO M 284 on the most recent 20 samples tested. The results shall be submitted in the format outlined in AASHTO M 284 and as documented in the Manufacturer's QSM.

10.2.3 One copy of the Manufacturer's Quality System Manual shall be submitted.

10.3 CDOT will verify that the Manufacturer's QSM is adequate.

10.4 Within two months after submitting all required information, CDOT will notify the Manufacturer whether or not the manufacturing facility's application for the Qualified Manufacturers List has been granted.

10.5 CDOT may perform split sample testing in accordance with Section 11.

10.6 CDOT may perform quality assurance testing.

10.7 CDOT may visit the Manufacturer's site when required. CDOT may inspect the operations of the Manufacturer's facility including those related to shipments if required.

10.8 CDOT will post the Manufacturer's name and approved plant on CDOT's Qualified Manufacturers List in the web site: www.coloradodot.info/business/APL/.

10.9 Failure in one or more Sections or Sub-sections listed in this Standard may result in an accelerated inspection program. Any additional failures to meet these minimum requirements shall result in the decertification of the plant and the plant will be removed from the QML. The Manufacturer may apply for reinstatement on the QML no sooner than stipulated in Section 8 of this Standard.

11. SPLIT SAMPLE TESTING

11.1 CDOT may request split sample testing. A split sample is a sample taken and evenly divided to be tested by two or more individuals or laboratories. The test results will be exchanged as soon as they are available.

11.2 If the split sample test data is not within the agreed to precision for that particular test a review of both sampling and testing procedures will be conducted by both the Manufacturer and CDOT.

12. REQUIREMENTS FOR SHIPPING EPOXY-COATED STEEL REINFORCING BARS AND EPOXY-COATED STEEL DOWEL BARS BY AN APPROVED MANUFACTURER

12.1 The epoxy-coated steel reinforcing bars and epoxy-coated steel dowel bars Manufacturer's QSM as approved by CDOT shall be implemented.

12.2 Each shipment shall be accompanied by two copies of the bill of lading, which shall include:

12.2.1 The name and location of the epoxy-coated steel reinforcing bars and epoxy-coated steel dowel bars Manufacturer and the plant producing the epoxy-coated steel reinforcing bars and epoxy-coated steel dowel bars,

12.2.2 The size and grade of epoxy-coated steel reinforcing bars and epoxy-coated steel dowel bars conforming to CDOT specification,

12.2.3 Certifications for the powder coating,

12.2.4 The quantity of material shipped,

12.2.5 The date of shipment,

12.2.6 A copy of the mill test reports.

12.3 If the specification compliance test results do not conform to Subsection 709.01 and 709.03 specifications, the Manufacturer shall remove the non-compliant material from the shipping queue.

13. FABRICATION AND JOBSITE HANDLING

13.1 The coated bars to be fabricated by the Fabricator or field fabricated by the Contractor after application of the coating shall meet the following:

13.1.1 Contact points, such as drive rollers, shear contacts, mandrels and backup barrels on benders shall be protected with a suitable covering to minimize damage during the fabrication process.

13.1.2 The Fabricator shall be responsible for repair to the coating due to damage during shipment, storage, or fabrication at the Fabricator's facility.

13.1.3 The Contractor shall be responsible for repair to the coating due to damage during shipment, storage, fabrication, or placement at the construction jobsite.

13.2 Coating damaged due to fabrication or handling shall be repaired with patching material. The patching or repairing shall be performed in accordance with the written recommendations of the patching material Supplier.

13.3 Patching or repair material shall be compatible with the coating, inert in concrete, and feasible for repairs. The patching or repair material shall conform to AASHTO M 317.

Part II, Sub-Part 3:

Precast Concrete Structures - 11

SCOPE: This sub-part provides procedures for being included on the Qualified Manufacturers List (QML) as a fabricator of precast (**not prestressed**) concrete structures for CDOT projects. The precast concrete structures may include, but are not limited to: inlets, manholes, junction boxes, box culverts, modular bridges (3-sided box culvert), pipes, cattle guards, and Type 7 barrier. CDOT will only accept precast concrete structures by a manufacturer on the QML.

1. REFERENCED DOCUMENTS

Where applicable, the latest edition of the following standards shall be considered a part of these requirements.

1.1 CDOT Standard Specifications for Road and Bridge Construction:

- Section 601 – Structural Concrete
- Section 603 – Culverts and Sewers
- Section 604 – Manholes, Inlets, and Vaults
- Section 606 – Guardrail
- Section 611 – Cattle Guards
- Section 617 – Culvert Pipe
- Section 701 – Hydraulic Cement
- Section 703 – Aggregates
- Section 709 – Reinforcing Steel and Wire Rope
- Section 711 – Concrete Curing Materials and Admixtures
- Section 712 - Miscellaneous

1.2 CDOT Standard Plans (M & S Standards):

- M-601-1 Single Concrete Box Culvert
- M-601-2 Double Concrete Box Culvert
- M-601-3 Triple Concrete Box Culvert
- M-601-10 Headwalls for Pipe Culverts
- M-603-2 Reinforced Concrete Pipe
- M-603-3 Precast Concrete Box Culvert,
- M-603-10 Concrete and Metal End Sections,
- M-604-10 Inlet, Type C
- M-604-11 Inlet, Type D
- M-604-12 Inlet, Type R
- M-604-13 Inlet, Type 13
- M-604-20 Manholes
- M-604-25 Vane Grate Inlet with Frame and Concrete Apron
- M-606-14 Precast Type 7 Concrete Barrier
- M-611-1 Cattle Guard

- 1.3 AASHTO Standards:
- M 6 Fine Aggregate for Portland Cement Concrete
- M 43 Sizes of Aggregate for Road and Bridge Construction
- M 55 Steel Welded Wire Reinforcement, Plain, for Concrete
- M 86 Standard Specification for Concrete Sewer, Storm Drain, and Culvert Pipe
- M 157 Ready-Mixed Concrete
- M 170 Standard Practice for Reinforced Concrete Culvert, Storm Drain, and Sewer Pipe
- M 206 Reinforced Concrete Arch Culvert, Storm Drain, and Sewer Pipe
- M 207 Reinforced Concrete Elliptical Culvert, Storm Drain, and Sewer Pipe
- M 221 Steel Welded Wire Reinforcement, Deformed, for Concrete
- M 242 Reinforced Concrete D-Load Culvert, Storm Drain, and Sewer Pipe
- M 284 Epoxy-Coated Reinforcing Bars: Materials and Coating Requirements
- R 38 Quality Assurance of Standard Manufactured Materials

- 1.4 ASTM Standards:
- C 361 Standard Specification for Reinforced Concrete Low-Head Pressure Pipe
- C 923 Standard Specification for Resilient Connectors between Reinforced Concrete Manhole Structures, Pipes, and Laterals
- C 936 Standard Specification for Joints for Concrete Pipe, Manholes, and Precast Box Sections using Preformed Flexible Joint Sealants
- C 1017 Standard Specification for Chemical Admixtures for Use in Producing Flowing Concrete
- C 1478 Standard Specification for Storm Drain Resilient Connectors between Reinforced Concrete Storm Sewer Structures, Pipes, and Laterals
- D 3665 Standard Practice for Random Sampling of Construction Materials

2. TERMINOLOGY

- 2.1 See AASHTO M 262 Standard Terminology Relating to Concrete Pipe.

2.2 Conventional mix – In this Standard it shall be defined as a Class of concrete in Section 601 of CDOT's Standard Specifications for Road and Bridge Construction.

2.3 Dry Cast – In this Standard it shall be defined as zero slump concrete most often used for pipes, box culverts, and manholes.

2.4 Manufacturer – A company which manufactures and supplies Standard Manufactured Materials for the Prime Contractor, Sub-contractor, or CDOT.

2.5 Prime Contractor – The company under contract with CDOT to produce products using precast concrete structures.

2.6 Quality System Manual (QSM) – A written document that describes the overall internal quality control operating procedures of a Manufacturer. The QSM documents the internal policies for achieving quality and the assignment of responsibility and accountability for quality control within the Manufacturer's organization. It shall describe the minimum quality control requirements expected of material suppliers who are involved with the Manufacturer's product.

2.7 Self-Compacting (leveling) Concrete – In this Standard it shall be defined as a very high slump concrete where the spread is measured using a slump cone. The spread is usually between 22 to 32 inches in diameter. In addition, the mix usually contains a superplasticizer and a viscosity-modifying admixture (VMA). This concrete is usually used for manholes and inlets

2.8 Supplier – In this Standard it shall be defined as one who provides materials used in the manufacturing of precast concrete structures. Cement, fly ash, welded wire reinforcement (WWR), and epoxy coated reinforcing bar are among the materials provided to the manufacturer.

2.9 Wet Cast – In this Standard it shall be defined as anything other than zero slump concrete. This concrete is usually used for manholes and inlets.

3. SIGNIFICANCE AND USE

3.1 This procedure specifies requirements that should be followed by the Manufacturer in implementing an effective Quality Control (QC) system. This is accomplished by a certification system that evaluates quality control practices and specification compliance tests performed by the Manufacturer according to their quality control plans.

3.2 This Standard specifies requirements and procedures for a certification system that shall be applicable to all Manufacturers providing precast concrete structures. These provisions initially apply to the plant manufacturing the precast concrete structures. These provisions subsequently apply to the Contractor, after delivery of the precast concrete structure to the Contractor, for use on CDOT projects.

4. SAMPLING

4.1 All test samples required by this Standard shall be obtained using stratified random sampling techniques. Stratified random sampling should be performed in accordance with ASTM D 3665. The use of a stratified random sampling procedure is mandatory to the establishment of a valid QC program. All random QC sample locations shall be properly documented.

5. TESTING REQUIREMENTS

5.1 Testing required for this Standard shall be performed by certified personnel or in accredited laboratories through appropriate QC Certification programs. Any satellite laboratory of a Manufacturer that performs required testing under this Standard shall be identified in the submitted Quality System Manual (QSM) (Section 9).

5.2 As a minimum, the certification program used shall include the following;

5.2.1 Training in AASHTO, ASTM, or ACI test procedures.

5.2.2 Demonstration of proficiency in each required test.

5.2.3 Demonstration of ability to properly document test results.

6. SUPPLIER REQUIREMENTS

6.1 Cement, fly ash, and concrete admixture suppliers shall be on CDOT's Approved Product List (APL) prior to use by the manufacturer. The APL along with instruction for completing CDOT Form #595, Pre-Approved Product Evaluation Request & Summary, can be found at the following web address: www.coloradodot.info/business/APL/. The Form #595 is designed as a PDF Writeable form, which must be completed by the supplier or their Product Representative. The completed form shall be returned to CDOT's Product Evaluation Coordinator as an e-mail attachment.

6.2 The cement and fly ash suppliers shall follow the procedures described in the CDOT approved quality control plan as required in CP 11 Part I, Sub-Part 3 and 4 respectively.

6.3 The steel supplier shall provide an annual certification that all steel products delivered to the manufacturer and permanently incorporated in the work shall have occurred in the United States of America.

7. CURRENTLY CERTIFIED MANUFACTURERS

7.1 A manufacturer, regardless of their current casting process, which has been certified for the past three consecutive years under the American Concrete Pipe Association (ACPA) for all pipe products, dry cast box culverts, and manholes, or under the National Precast Concrete Association (NPCA) for all pipe products, manholes, modular bridges, and other wet cast products, will be placed on the QML after submitting all of the following:

- The certificate from the current year and the preceding three consecutive years of evaluations from NPCA or ACPA,
- The score summary sheets from the current year and the preceding three consecutive years of evaluations from NPCA or ACPA,
- The Quality System Manual as outlined in Section 9 of this Standard.

7.2 A manufacturer, regardless of their current casting process, which has been certified for less than three consecutive years under the American Concrete Pipe Association (ACPA) for all pipe products, dry cast box culverts, and manholes or under the National Precast Concrete Association (NPCA) for manholes, modular bridges, and other wet cast products will be on probation and placed on the QML after submitting all of the following:

- The certificate from the current year along with any preceding years of evaluations from NPCA or ACPA,
- The score summary sheets from the current year along with any preceding years of evaluations from NPCA or ACPA,
- The Quality System Manual as outlined in Section 9 of this Standard.

7.2.1 The probation period will be for three consecutive years after being placed on the QML.

8. DECERTIFICATION

8.1 If the manufacturer becomes decertified after being placed on the QML, the manufacturer will be removed from the QML until successfully completing and submitting to CDOT the requirements within this Standard. The manufacturer may apply for reinstatement on the QML no sooner than six months after removal from the QML.

8.2 If the manufacturer becomes decertified due to a structural failure of a product during the probationary period, the manufacturer will be removed from the QML until successfully completing and submitting to CDOT the requirements within this Standard. A structural failure will be determined by the Engineer in accordance with the FHWA Report Number FHWA-IP-86-2 "Culvert Inspection Manual." The manufacturer may apply for reinstatement on the QML no sooner than three years after removal from the QML.

9. MANUFACTURER'S QUALITY SYSTEM MANUAL (MINIMUM REQUIREMENTS)

9.1 On an annual basis, at a minimum of one month prior to producing any precast concrete structure for a CDOT project, one copy

of the Manufacturer's Quality System Manual (QSM) shall be submitted for review and approval to CDOT's Product Evaluation Coordinator (303) 398-6566 within the Staff Materials & Geotechnical Branch at 4670 North Holly Street, Unit A, Denver, Colorado 80216-6408. CDOT's approval of the QSM is intended only to indicate that the QSM is in conformance with the minimum QC requirements set forth in this Standard. Once the manufacturer is approved and on the Qualified Manufacturers List (QML), the QSM provisions will remain in effect for a maximum period of one calendar year, unless revisions are determined to be necessary by the Quality Control Manager or requested by CDOT, or if the manufacturer is decertified. If any changes are made to the QSM, an updated copy shall be submitted to CDOT for review and approval. Guidelines for preparing a QSM may be available from the National Precast Concrete Association (NPCA) or the American Concrete Pipe Association (ACPA).

9.2 The Manufacturer's QSM may be maintained in electronic format. However, one or more copies of the QSM shall be maintained by the Manufacturer's QC Manager in a printed and bound format (3-ring or other). The QSM shall be available to all of the Manufacturer's employees. Each document in the QSM shall indicate its preparation date and all pages of the QSM shall be numbered. If a document is revised, the date of revision shall be indicated on the document and recorded in a table of revisions.

9.3 The Manufacturer's QSM shall be formatted to provide numbered sections which meet the following order, format, and content:

9.3.1 Manufacturer's quality policy or mission Statement endorsed by the company's Chief Executive Officer.

9.3.1.1 The quality policy / mission statement shall indicate support of top management to enforce the QC requirements contained in the QSM.

9.3.2 The QSM shall include the address and telephone numbers of applicable personnel at the manufacturing facility.

9.3.3 The QSM shall include a brief listing and description of all the precast products being manufactured at the facility.

9.3.4 The QSM shall present and define any significant terms used throughout the QSM.

9.3.5 For all manufactured items addressed in the QSM, the applicable AASHTO, ASTM, or CDOT specification shall be identified.

9.3.6 The QSM shall present the personnel structure established to implement the Manufacturer's quality system. The specific roles and responsibilities of all QC personnel shall be documented as follows:

9.3.6.1 The QSM shall contain an organizational chart. The chart shall indicate a clear separation between the QC personnel and the production personnel. The QC Manager shall be allowed direct access to top management, independent from production.

9.3.6.2 Each facility shall have a Quality Control Manager who has the overall responsibility for implementing the requirements of the QSM. At least one QC Manager shall be on-site during production. The QC Manager shall review the established QC system annually in order to satisfy this requirement, or if changes in the manufacturing process(s) occur, or whenever technical or CDOT information indicate a trend in reduced quality.

9.3.6.3 Each facility shall have at least one Quality Control Technician to perform QC sampling, testing, and inspection. At least one QC Technician shall be on-site during production. The QC Technicians shall be familiar with the tests they perform and have sufficient authority to assure corrective actions are carried out when necessary. The QSM shall indicate the line of authority of the QC Technicians, which shall demonstrate their authority to require corrective action. The QSM shall designate the certified QC Technicians at the facility and laboratory involved in the production or testing of the precast concrete structures.

9.4 The QSM shall contain a description of the certifications required and attained and years of experience for each QC Manager and QC Technician. All QC sampling, testing, and

inspection personnel shall be certified by ACI Concrete Field Technician Level 1 or higher. Plants certified by NPCA shall have at least one QC Manager and at least one QC Technician who has successfully completed the NPCA's Production and Quality School or ACPA's approved equivalent. The QSM shall also include periodic auditing of each QC technician's ability to satisfactorily perform the required tests. Retraining shall be provided when the test method is revised.

9.5 The QSM shall provide for specific training for frontline production personnel in the safe and correct operating procedures implemented to ensure the required quality of all precast concrete structures.

9.6 The Manufacturer shall maintain its own accredited or qualified laboratory to perform QC testing. The QSM shall include the address and telephone numbers of a designated backup accredited or qualified laboratory. The laboratory shall meet the minimum accreditations or qualifications obtained through one or more of the following programs depending on the casting process:

9.6.1 For "dry" cast plant laboratories:

9.6.1.1 National accreditation programs such as AASHTO Accreditation Program or American Association for Laboratory Accreditation.

9.6.1.2 Either the Manufacturing industry's American Concrete Pipe Association's Q-Cast program or the National Precast Concrete Association Certification program.

9.6.2 For "conventional", "wet", or "Self-Compacting" cast plant laboratories:

9.6.2.1 National accreditation programs such as AASHTO Accreditation Program or American Association for Laboratory Accreditation.

9.6.2.2 The Manufacturing industry's National Precast Concrete Association Certification program.

9.7 The QSM shall contain an inventory of the major equipment used for sampling and testing along with associated calibration equipment used for each required test procedure. The QSM shall assign a unique

identification number to each piece of testing equipment. The QSM inventory for each major piece of equipment shall include the following information:

9.7.1 The name of each major piece of equipment, date placed in service, manufacturer, model and serial number. The QSM shall include the location where the instructions for use and operation of each major piece is stored if not included in the QSM.

9.7.1.1 For each major piece of equipment, the QSM shall include the interval of calibration or verification, a reference to the calibration or verification procedures used, and the location where the current calibration or verification records are stored. The QSM shall describe the methods for ensuring that the calibration and verification procedures are performed at the specified intervals.

9.8 The QSM shall identify all types of supplier delivered materials used for the production of precast concrete structures.

9.8.1 The QSM shall contain a copy of the signed certification from the steel supplier that all steel products permanently incorporated into the manufactured product shall have occurred in the United States of America.

9.8.2 The QSM shall contain a description of the specification requirements for all supplier delivered materials.

9.8.3 The QSM shall contain a description of the certification and test reports delivered by the supplier and a location where these records are stored.

9.8.4 The QSM shall include all QC testing of the supplied materials and shall contain a statement that no raw materials shall be used unless they are on the APL or they have been tested and meet all appropriate CDOT, AASHTO, or ASTM specifications.

9.8.5 All supplier delivered materials shall be properly stored to prevent damage, contamination, or other alterations prior to use in production. The QSM shall include procedures for the adequate storage of supplied materials.

9.9 The QSM shall describe the procedure and frequency for inspection and selection of material samples during production. Sampling shall be performed on a stratified random procedure in accordance with ASTM D 3665. All random QC sample locations shall be properly documented and these procedures shall be included in the QSM.

9.10 The QSM shall contain descriptions and examples of the test report forms used by the manufacturer. The QSM shall identify the individual(s) responsible for maintaining all test records and reports along with the location where the reports are stored.

9.10.1 The test reports shall be maintained and available for inspection for a minimum of three years.

9.11 The QSM shall contain a description of the procedures used to identify and document all material or test results that do not conform to specification requirements. The QSM shall contain provisions for resolving non-conforming material or test results.

9.12 The QSM shall include drawings, with dimensions, of the forms used to produce precast concrete structures for CDOT.

9.12.1 Drawings and dimensions for precast modular concrete bridges will not be required with the QSM. However, they shall be submitted to Staff Bridge in accordance with Subsection 105.02 of the Standard Specifications.

9.13 The QSM shall describe the method used to permanently mark the precast concrete structure in accordance with the appropriate AASHTO or ASTM standard.

9.14 The QSM shall describe procedures used to properly handle, store, and ship precast concrete structures.

10. CERTIFICATE OF COMPLIANCE

10.1 The manufacturer shall prepare a standard Certificate of Compliance (COC) for each precast concrete structure delivered to a CDOT project. The COC shall contain all of the required information as stipulated in the CDOT Special Notice to Contractors. The COC shall include all necessary information to properly identify each precast concrete structure represented by the COC.

11. MANUFACTURING FACILITY INSPECTION AND CERTIFICATION

11.1 Manufacturing facilities producing precast pipe and box culvert shall meet the minimum industry standards, and be annually inspected and certified by the ACPA. Manufacturing facilities producing manholes shall meet the minimum industry standards, and be annually inspected and certified by either the ACPA or the NPCA. Manufacturing facilities producing precast pipe, modular bridges, and other precast concrete structures shall meet the minimum industry standards, and be annually inspected and certified by the NPCA. A copy of the certification shall be submitted to CDOT as part of the QML process.

11.2 Failure in one or more Sections or Subsections listed in this Standard may result in an accelerated inspection program. Any additional failures to meet these minimum requirements shall result in the decertification of the plant and the plant will be removed from the QML. The manufacturer may apply for reinstatement on the QML no sooner than six months after removal from the QML as stipulated in Section 8 of this Standard.

11.3 Within two months after submitting all required information, CDOT will notify the manufacturer of precast concrete structures whether or not the manufacturing facility's application for the Qualified Manufacturers List has been granted.

11.4 At any time, CDOT may inspect the operations or perform quality assurance testing.

Colorado Procedure 11-12

Standard Practice for

Quality Management Plans for the Qualified Manufacturers List or the Approved Products List

1. SCOPE

1.1 This Standard specifies requirements and procedures for a certification system that shall be applicable to all referenced manufacturers, as well as suppliers and contractors within certain industries. Certifying a Manufacturer's Quality Management Plan is not an automatic acceptance of any particular product, but an acknowledgement that the Manufacturer has taken steps to ensure that their quality controls meet the applicable Industry standards. A Quality Management Plan, a Quality Control Plan, and a Quality System Manual are deemed synonymous for this standard.

1.2 Manufacturers whose Quality Management Plans are acceptable will be placed on the Qualified Manufacturers List (QML) or their products will be eligible to be placed on the Approved Products List (APL). Only Manufacturers required to be listed on the QML will be eligible to provide the referenced products to a CDOT project. The QML is located within CDOT's Approved Products List (APL) web site, at www.coloradodot.info/business/APL/.

2. REFERENCED INDUSTRIES

2.1 With respect to this Standard there are two materials classes. This Colorado Procedure will be divided into two parts to correlate to these materials classes. Part I will be Standard Manufactured Materials of which upon acceptance of the manufacturer's Quality Control Plans the individual products submitted will be placed on the APL. Part II will be Fabricated Structural Materials of which upon acceptance of the manufacturer's Quality System Manual the individual production facilities will be placed on the QML. Each Part will be divided into Sub-Parts, which are a grouping of products or Manufacturers that have a certain commonality. Within each Sub-Part of this Colorado Procedure there will be instructions and guidance for the Manufacturers to become certified so that they can submit their manufactured products for inclusion in CDOT projects.

3. TABLE OF CONTENTS

Part I.	Standard Manufactured Materials	
	Sub-Part 1.	Asphalt Binder
	Sub-Part 2.	Asphalt Emulsion
	Sub-Part 3.	Hydraulic Cement
	Sub-Part 4.	Fly Ash
	Sub-Part 5.	Hydrated Lime
Part II.	Fabricated Structural Materials	
	Sub-Part 1.	Steel Reinforcing Bars & Steel Dowel Bars
	Sub-Part 2.	Epoxy-Coated Steel Reinforcing Bars & Epoxy-Coated Steel Dowel Bars
	Sub-Part 3.	Precast Concrete Structures
	Sub-Part 4.	Corrugated Steel Pipe (Under Development)

4. PRODUCT ACCEPTANCE

4.1 The majority of materials submitted for inclusion on CDOT projects will fall within one of four levels of product acceptance for their sampling and testing. CDOT always retains the right through its Quality Assurance (QA) Program to obtain samples for additional testing and require supplemental documentation.

4.2 The four levels of product acceptance are: Pre-Inspected (PI), Certified Test Report (CTR), Certificate of Compliance (COC), and Pre-Approved (through the APL).

4.3 A Manufacturer being placed on the QML is a completely separate activity from how their product(s) are accepted on a CDOT project. The specifics on product acceptance are addressed in the Special Notice to Contractors chapter and with additional reference in the Quality Assurance Schedule.

5. DECERTIFICATION

5.1 Certification may be withdrawn from suppliers when one or more of the following conditions exist:

5.1.1 Failure to consistently supply material of a specific grade meeting specifications for three (3) acceptance samples as determined by CDOT test results.

5.1.2 Failure to regularly participate in two (2) WCTG or equal "Round-Robins."

5.1.3 Inadequate maintenance of required records.

5.1.4 Improper documentation of shipments.

5.1.5 A visit by CDOT's Representative to a supplier's facility reveals significant quality control problems.

5.1.6 Failure to maintain an acceptable quality control program.

5.1.7 Failure to comply with any additional decertification requirements found in the applicable Sub-Part of this Standard.

5.2 Notification of Decertification will be in writing.

6. QUALIFYING FOR RECERTIFICATION

6.1 If a supplier has been decertified and seeks to be recertified, then the Supplier Certification Requirements must be fulfilled, as per Section 6 of the applicable Sub-Part of this Standard.

Part I, Sub-Part 1:

Asphalt Binder - 12

(Certifying Suppliers and Contractors)

1. REFERENCED DOCUMENTS

- 1.1 CDOT Standard Specifications
 - Table 702-1, Superpave Performance Graded Binders
- 1.2 AASHTO Standards:
 - R 29 Practice for Grading or Verifying the Performance Grade of an Asphalt Binder
 - T 40 Method of Sampling Bituminous Materials
 - R 18 AASHTO Accreditation Program
- 1.3 ASTM Standards:
 - D 8 Definitions of Terms Relating to Materials for Roads and Pavements
- 1.4 WCTG Bylaws

2. TERMINOLOGY

- 2.1 Binder - An asphalt based cement that is produced from petroleum residue either with or without the addition of non-particulate organic modifiers.
- 2.2 PG - Performance Graded, as in Superpave Performance Graded Binders.
- 2.3 Supplier - A Supplier shall be defined as one who produces, controls, and supplies the final binder product to satisfy the PG binder grade specified in Table 702-1 of the Standard Specifications and/or other appropriate CDOT specifications. A Supplier shall be a refinery, a terminal, an HMA producer, or any facility that holds product for more than 30 days from the date of delivery for unmodified binders or 7 days from the date of delivery for a modified binder regardless of binder quantity. If no modification is made to the PG binder grade after its initial production at the refinery, the refinery shall be the supplier and must provide certification. If there is any grade modification of the PG binder

at the terminal, the terminal becomes the supplier and must provide the certification. If an HMA producer blends binder of different grades or binders from different suppliers at the facility, the HMA producer becomes the supplier and must provide the certification to verify the grade of the stored binder and must meet CP 11 requirements for an approved supplier. No PG binder will be produced or blended to specification at the hot mix asphalt (HMA) plant.

2.4 Contractor – The company who places the HMA on the project under contract with CDOT.

2.5 WCTG – Western Cooperative Test Group, a government / industry association.

3. SIGNIFICANCE AND USE

3.1 This Standard specifies requirements and procedures for a certification system that shall be applicable to all suppliers and contractors providing performance graded (PG) binders. The requirements and procedures shall apply to materials that meet the requirements of CDOT specifications for PG binders. These provisions initially apply to the refinery manufacturing the PG binder and/or to terminals where binders are mixed. These provisions subsequently apply to the Contractor, after delivery of the PG binder to the Contractor, for use in hot mix asphalt (HMA) on CDOT projects.

3.2 This Standard specifies procedures intended to minimize disruption of PG binder shipments. This is accomplished by a certification system that evaluates quality control and specification compliance tests performed by the Supplier and the HMA Contractor according to their quality control plans.

4. SAMPLING

4.1 All test samples required by this standard shall be obtained in accordance with AASHTO T 40. A supplier may propose an

alternate method of sampling that will ensure the sampling of a non-segregated product.

5. TESTING REQUIREMENTS

5.1 All specification compliance testing required for this Standard shall be performed by a laboratory currently covered by AMRL accreditation. Any satellite laboratory of a Supplier that performs required testing under this Standard will be identified in the submitted Supplier Quality Control Plan (Section 7) and shall be approved by CDOT.

5.2 All laboratories performing routine Quality Control testing shall participate in WCTG round robin testing or an approved equal.

6. SUPPLIER CERTIFICATION REQUIREMENTS

6.1 The Supplier shall submit to CDOT for approval a complete Quality Control Plan that complies with the requirements of Section 7. If the Quality Control Plan is rejected, the Supplier may modify the plan based on the critique provided and then resubmit it to CDOT for approval.

6.2 Once the Supplier's Quality Control Plan is approved by CDOT, the Supplier shall submit to the CDOT Product Evaluation Coordinator a completed copy of CDOT Form #595 (Pre-Approved Product Evaluation Request & Summary) for each performance graded binder. The Form #595 can be located at: www.coloradodot.info/business/APL/ within the Notice to Manufacturers. The Form #595 is designed as a PDF Writeable form, which must be completed by the Supplier. The completed form shall be returned to CDOT's Product Evaluation Coordinator as an e-mail attachment.

6.2.1 The Form #595 "Product name" field shall identify the submitted performance grade binder and the construction year of the submittal (i.e. "PG 76 -28 (2011)").

6.2.2 The Form #595 will serve as the request to CDOT for authorization to ship PG binder as referenced within this Colorado Procedure.

6.3 The Supplier shall forward to CDOT the initial testing data for the performance grade binder identified in the Form #595 and a copy of

the MSDS. The Supplier shall also obtain and provide a split sample for the CDOT Central Laboratory from the first production run of the performance graded binder identified on the Form #595. This will be concurrent with the first shipments of the construction season when the performance graded binder is being made for the first time that season.

6.3.1 If the submitted sample required in Subsection 6.3 fails the verification testing and is rejected by CDOT, then the Supplier may submit to CDOT a new test sample with a new CDOT Form #595, updated initial test data, and an MSDS. If CDOT rejects this second submittal then the Supplier may resubmit again. However, this third submittal for the same Product name (binder grade for that calendar year) shall include, in addition to all requirements in Subsection 6.3, a test report from an independent AMRL accredited laboratory.

6.4 The Supplier shall allow CDOT to visit the production and/or shipping site during normal business hours to perform an audit by observing the Supplier's quality control activities, to inspect the facilities, and to obtain samples for test.

6.5 The Supplier shall follow the procedures described in the CDOT approved quality control plan.

6.6 The Supplier shall establish a continuing test record for every test required for each PG binder included in the written request as prepared to satisfy the requirements of Subsection 6.1.

6.7 The Supplier shall submit to CDOT all reports required by this standard in a format approved by CDOT.

6.8 The Supplier shall have a satisfactory record of compliance with CDOT project specifications. Decisions by CDOT concerning this requirement shall be based on the test results furnished by the supplier and satisfactory results when the splits and field tests are compared with supplier tests.

7. SUPPLIER QUALITY CONTROL PLAN (MINIMUM REQUIREMENTS)

7.1 The Supplier's Quality Control Plan shall identify the following:

7.1.1 Facility type (refinery, terminal, HMA producer).

7.1.2 Facility location (actual physical address).

7.1.3 Name and telephone number of the person responsible for quality control at the facility.

7.1.4 Quality control tests and testing frequency to be performed on each PG binder.

7.1.5 Name and location of the laboratory performing quality control tests on the PG binder that is shipped.

7.2 The Supplier's Quality Control Plan shall include a declaration stating that if a test result indicates that a shipment of PG binder is not in compliance with the purchase specifications, the Supplier shall:

- (1) Identify the material in the shipment,
- (2) Immediately cease the shipment until the material complies with the specification,
- (3) Immediately notify CDOT regarding the shipment in question,
- (4) Immediately notify the Contractors scheduled to use the material from the shipment in question,
- (5) Notify CDOT prior to resuming shipment; and
- (6) Implement any mutually agreed upon procedures for the disposition of the material.

7.3 The Supplier's quality control plan shall describe method and frequency for initial testing, specification compliance testing, and quality control testing for guiding the manufacturer.

7.3.1 **Initial Testing** - For each grade of PG binder to be supplied, specification compliance testing shall be initially performed and the results of that testing provided to CDOT, accompanied by a sample of the material represented by the test results. Specification compliance testing shall confirm that the PG binder conforms to all requirements of Table 702-1 of the Standard Specifications. This will be concurrent with the first shipments of the construction season when the performance grade binder is being made for the first time that season. If, during the course of a construction project, the binder used changes such that

future binder supply to a project will come from a different refinery, different terminal, or be a different formulation that could potentially affect mix properties, the Supplier shall notify the Contractor and CDOT Project Engineer in writing at least 5 working days before shipment. If the Supplier is changing terminal location and both locations utilize the same formulation, the Supplier shall notify the Contractor and CDOT Project Engineer prior to use on the project and the one point check per CP 52 may be waived with concurrence from the RME.

7.3.2 **Specification Compliance Testing** - Specification compliance testing shall be run on a routine basis and the results submitted to CDOT at a minimum of once per month.

7.3.3 **Quality Control Testing for Guiding the Manufacturer** - Tests to determine conformance with Table 702-1 of the Standard Specifications tests shall be conducted as needed for quality control. The Quality Control Plan shall indicate the frequency of this testing. Non-Table 702-1 tests, of the Standard Specifications, may be used for guiding the manufacturer. The use of non-Table 702-1 tests does not preclude the need to meet Table 702-1 requirements or to run complete Table 702-1 tests as indicated in the Quality Control Plan.

7.4 The Supplier's quality control plan shall include a statement that the Supplier will prepare and maintain summary reports for all quality control and specification compliance tests performed, and will submit them to CDOT on request.

7.5 The Supplier's quality control plan shall provide an outline of the procedure to be followed for checking transport vehicles before loading to prevent contamination of shipments. The outline shall include a statement that the Transport Vehicle Inspection Report, signed by the designated inspector, shall be maintained in the Supplier's records and will be made available to CDOT on request.

7.6 If the supplier's facility has the capability of introducing any additives to the binder at the point of load-out, then the QC plan shall outline the procedures to control, monitor, and report on the exact amount of additive. Only CDOT approved additives shall be allowed at load-out.

7.7 If the Supplier's facility has acid, alkaline, or recycled engine oil bottom modification equipment in place for producing acid, alkaline, or recycled engine oil bottom modified binders for sale in non-CDOT markets, the Supplier's Quality Control Plan shall include a description of the precautions that will be taken to prevent acid, alkaline, or recycled engine oil bottom modified binders from being inadvertently shipped to CDOT.

8. CDOT EVALUATION PROCEDURE

8.1 CDOT will verify that the Supplier's quality control plan is adequate. CDOT may visit the shipping site when required.

8.2 CDOT will notify the Supplier whether or not the Supplier's application for Certified Binder Supplier status has been granted. The notification shall include a list of the PG binder(s) covered.

8.3 CDOT may verify that the Supplier's specification compliance testing laboratory is currently covered by AASHTO accreditation.

8.4 CDOT may verify that the Supplier's specification compliance testing laboratory participates in the WCTG round robin testing program or an equal program.

8.5 CDOT may perform split sample testing in accordance with Section 11.

8.6 CDOT will perform quality assurance testing.

8.7 CDOT may inspect the operations of the Supplier's facility including those related to the PG binder shipments if required.

8.8 CDOT will post the Supplier's approved binder type with the associated Supplier's facility name on CDOT's Approved Products List. Reference to the web site is at www.coloradodot.info/business/APL/.

9. REQUIREMENTS FOR SHIPPING PG BINDER BY AN APPROVED SUPPLIER

9.1 The Supplier's Quality Control Plan as approved by CDOT (Section 8) shall be implemented.

9.2 Each shipment shall be accompanied by two copies of the bill of lading, which shall include:

- (1) The name and location of the Supplier, as stated in the Supplier's Quality Control Plan,
- (2) The performance grade of material,
- (3) The quantity of material shipped,
- (4) The type and quantity of any approved additive introduced at load-out,
- (5) The date of shipment,
- (6) A certificate of compliance (COC) certifying the material meets specification requirements. The COC statement will certify the material was manufactured and tested in accordance with CDOT's approved Quality Control Plan (Section 7) and, therefore meets State requirements and,
- (7) A statement certifying that the transport vehicle was inspected before loading and was found acceptable for the material shipped. The COC statement will certify the material was manufactured and tested in accordance with the CDOT approved Quality Control Plan (Section 7) and, therefore, meets State requirements.

9.3 If the specification compliance test results do not conform to PG binder specifications, the Supplier shall remove the non-compliant material from the shipping queue as per Subsection 7.2.

10. SPLIT SAMPLE TESTING

10.1 CDOT may request split sample testing. The test results will be exchanged as soon as they are available.

10.2 If the split sample test data is not within the precision specified for that particular test a review of both sampling and testing procedures will be conducted by both the supplier and CDOT. If precision statements are not available, the test results should not differ by more than two standard deviations of the latest available WCTG Round Robin test results for that test.

11. REPORT AND DATA SHEETS

11.1 Supplier Reports - The Supplier shall prepare the reports described in Subsections 6.1, 6.2, 6.3, 6.6, 6.7, 7.2, 7.4, 7.5, 9.2, and 9.3.

12. DECERTIFICATION

12.1 Certification may be withdrawn from suppliers when one or more of the following additional conditions exist:

12.1.1 Acid, alkaline, or recycled engine oil bottom modification are discovered in the binder.

13. FIELD QUALITY CONTROL OF PERFORMANCE GRADED ASPHALT BINDER(S)

13.1 The field quality control of the binder shall be the responsibility of the Contractor. Prior to accepting deliveries of binder, the Contractor shall submit a Field Quality Control (FQC) Plan for binder addressing all key elements as listed in Section 14. This FQC Plan will be included within the Contractor's quality control plan for asphalt concrete. The FQC Plan shall be submitted at least 10 days prior to commencing paving operations. The purpose of the FQC Plan is to describe proper handling techniques for the binder to maintain specification conformance of binder properties during transportation, storage, and production operations. The Engineer will review the FQC Plan, and paving operations will not begin until the FQC Plan has been approved in writing.

13.2 The contents of the binder FQC Plan shall be project specific and shall be kept current to the production and mixture operations employed at any time. Prior to executing any change to binder handling, the FQC Plan shall be revised to incorporate the change. Engineer approval of the revised FQC Plan, in writing, will be required before the change is made to binder handling. Failure to keep the FQC Plan current may affect subsequent decisions by the Engineer, such as those made to address correction of failed material.

13.3 The Contractor shall confirm and document that the Supplier that manufactures the binder and the specific binder is on CDOT's

Approved Products List as referenced in Subsection 8.8.

13.4 The Contractor shall indicate, in writing, what steps will be taken to ensure that the FQC Plan is followed and what action will be taken to correct the situation if it is found that the plan is not being followed.

14. MINIMUM REQUIREMENTS FOR THE CONTRACTOR'S BINDER FIELD QUALITY CONTROL PLAN

14.1 The FQC Plan shall identify all subcontractors responsible for handling the binder. This will include the firm hauling the binder unless that firm is the binder supplier or is employed by the binder supplier.

14.2 The responsibilities of each party having a role in executing the FQC Plan shall be identified.

14.3 The FQC Plan shall describe how changes in grade or supplier of the binder, used in the paving mix, will be implemented. The change must not result in mixing of different binders. If mixing does occur, the mixed binder shall not be incorporated into the paving mix placed on the project. The Contractor shall inform the Engineer in advance of any change in grade or supplier of the binder.

14.4 The anticipated mode of binder delivery shall be described. The process of tank inspection, prior to initial filling, will be described. The tanks on the project site must be completely empty and free of contaminants to avoid contamination of the binder delivered to the project.

14.5 Any special handling or storage requirements of the binder shall be fully described. These shall comply with the manufacturer's recommendations for that grade of binder. The FQC Plan shall conform to these special requirements.

14.6 As detailed by the binder supplier, based on the type of asphalt used to produce the specific grade (i.e. Blended asphalt, Modified asphalt, etc.), any potential limitations of the binder relative to prolonged storage, exposure to prolonged and/or elevated heating, susceptibility to stratification and/or separation, etc. shall be

fully described. The Contractor's FQC Plan shall describe how these limitations of the binder shall be addressed.

14.7 If agitation is used in binder storage tanks, the capacity and methods of agitation within the storage tank(s) shall be described.

14.8 Provisions to avoid damage to binder during the suspension of paving operations shall be described. These provisions will detail limits to storage times and corresponding temperature limits.

14.9 The binder rotation FQC Plan shall be described. (i.e. First-in / First-out basis).

14.10 Any on-site sampling and testing shall be described with respect to sampling location, tests to be conducted, and control limits for test results. On-site sampling methods and facilities

shall be fully described. It is a good practice for the Contractor to obtain and retain samples of binder when delivered to the project. These samples can be tested if binder problems occur. These test results can help isolate the cause of problems with binder properties. Binder performance test requirements are contained in Table 702-1 of the Standard Specifications.

14.11 The FQC Plan shall describe methods for identifying the binder contained in each storage tank. Clear and consistent labeling of each tank shall be included in these methods.

14.12 The binder temperatures in the tanks shall be routinely monitored, at a minimum of once per day. Procedures and equipment for this monitoring shall be described. Results of this monitoring shall be made available to the Engineer upon request.

CP 11, Asphalt Binder Supplier Certification Checklist - 2012

Supplier Name: _____ Date: _____
 Refinery Name: _____ Refinery Location: _____
 Supplier Lab: _____ Supplier Lab Location: _____
 PG Binder: _____

Yes / No

Subsection

- 5.1 Does supplier's lab have current AMRL accreditation?..... _____
- 5.2 Do the labs performing routine QC testing participate in
WCTG Round Robin testing or equal?..... _____
- 6.1 QC Plan submitted to CDOT? _____
- 6.2 Completed CDOT Form #595 sent to CDOT as an e-mail attachment?..... _____
- 6.3 Initial test data supplied? _____
- 6.3 MSDS supplied?..... _____
- 6.3 Split sample provided to CDOT once per construction season?..... _____

SUPPLIER QC PLAN:

Subsection

- 7.1.1 Facility type listed? _____
- 7.1.2 Facility location listed?..... _____
- 7.1.3 Name of person responsible for QC at the facility listed? _____
- 7.1.4 List of QC tests and frequency to be used on PG binder?..... _____
- 7.1.5 Name & location of lab performing these tests listed? _____
- 7.2 Does Plan state that, if a shipment is not within specification, the supplier shall:
 - (1) Identify the material in the shipment? _____
 - (2) Immediately cease shipment until material complies with the specification? _____
 - (3) Immediately notify CDOT regarding the shipment in question? _____
 - (4) Immediately notify the Contractors scheduled to use the material
from the shipment in question?..... _____
 - (5) Notify CDOT prior to resuming shipment? _____
 - (6) Implement any mutually agreed upon procedures for the disposition of the material? _____
- 7.3 Does plan describe the method and frequency for initial testing,
QC testing, and specification compliance testing?..... _____
- 7.3.1 Results of specification compliance testing supplied to CDOT
along with a sample? _____
- 7.3.1 Results confirm that the PG binder conforms to Table 702-1? _____
- 7.3.2 Plan states that specification compliance testing is performed
routinely and results submitted to CDOT monthly?..... _____
- 7.3.3 Plan indicates frequency of testing to determine conformance with Table 702-1?..... _____
- 7.4 Plan states that supplier will maintain summary reports for
all QC & Spec Compliance tests performed, and will submit to CDOT upon request?..... _____

[Continued on the next page.]

Yes / No

Subsection

- 7.5 Plan contains an outline of the procedure for checking transport vehicles before loading to prevent contamination? _____
- 7.5.1 Outline includes statement that the transport vehicle inspection report, signed by the designated inspector, shall be maintained in the supplier's records, and will be made available to CDOT upon request? _____
- 7.6 If the Supplier has equipment in place for acid, alkaline, or recycled engine oil bottom modification of binder, are precautions described that will be taken to prevent acid, alkaline, or recycled engine oil bottom modified binders from being shipped to CDOT?..... _____

CP 11, Asphalt Contractor Field Quality Control Checklist - 2012

Contractor Name: _____ Date: _____
Project Number: _____
Project Code: _____
Project Location: _____

FIELD QUALITY CONTROL OF PERFORMANCE GRADED ASPHALT BINDER (S)

Yes / No

Subsection

- 13.1 Was the Contractor's Field Quality Control (FQC) Plan submitted 10 days prior to paving? _____
- 13.2 Is the binder FQC plan specific to this Project? _____
- 13.2 Does the binder FQC plan apply to current binder handling? _____

Does the Contractor's Binder Field Quality Control Plan Address the Following:

Subsection

- 14.1 List of the subcontractors handling the binder?..... _____
- 14.2 Responsibilities of the parties executing the binder FQC Plan? _____
- 14.3 How grade changes will be handled?..... _____
- 14.4 Delivery mode and tank inspection before filling? _____
- 14.5 Special handling and suppliers recommended handling? _____
- 14.6 Limitations on the type of binder with respect to handling? _____
- 14.7 Method of agitating binder in the tank (if any)? _____
- 14.8 Binder handling during paving delays? _____
- 14.9 Binder rotation plan (i.e. First-in / First-out)? _____
- 14.10 On-site sampling plan (if any)? _____
- 14.11 Binder identification plan (tank labeling)? _____
- 14.12 Binder temperature monitoring (minimum once per day)? _____

{This page was intentionally left blank.}

Part I, Sub-Part 2:

Asphalt Emulsion - 12

(Certifying Suppliers and Contractors)

1. REFERENCED DOCUMENTS

- 1.1 CDOT Standard Specifications:
Section 702, Bituminous Materials
Table 702-2 to Table 702-7
- 1.2 AASHTO Standards:
T 40 Method of Sampling Bituminous
Materials
R 18 AASHTO Accreditation Program
- 1.3 ASTM Standards:
D 8 Definitions of Terms Relating to
Materials for Roads and Pavements

2. TERMINOLOGY

- 2.1 Emulsion – A binder that is emulsified with water in a colloid mill.
- 2.2 Supplier - A Supplier shall be defined as one who produces the final product or who makes the blend or modification that alters the properties of the PG binder specified in Section 702 of the Standard Specifications and/or other appropriate CDOT specifications. A Supplier shall be a refinery, a terminal, or an emulsion producer. If no modification is made to the emulsion after its initial production at the refinery, the refinery shall be the supplier and must provide certification. If there is any modification of the emulsion at the terminal, the terminal becomes the supplier and must provide the certification. No emulsion will be produced or blended to specification at the hot mix asphalt (HMA) plant.
- 2.3 Contractor – The company who places the emulsion on the project under contract with CDOT.

3. SIGNIFICANCE AND USE

3.1 This standard specifies requirements and procedures for a certification system that shall be applicable to all suppliers and contractors providing asphalt emulsions. The requirements and procedures shall apply to materials that meet the requirements of CDOT specifications for emulsions. These provisions initially apply to the refinery manufacturing the emulsion and/or to the terminals where emulsions are modified. These provisions subsequently apply to the Contractor, after delivery of the emulsion to the Contractor, for use on CDOT projects.

3.2 This standard specifies procedures intended to minimize disruption of emulsion shipments. This is accomplished by a certification system that evaluates quality control and specification compliance tests performed by the Supplier and the Contractor according to their quality control plans.

4. SAMPLING

4.1 All test samples required by this standard shall be obtained in accordance with AASHTO T 40. A supplier may propose an alternate method of sampling that will ensure the sampling of a non-segregated product.

5. TESTING REQUIREMENTS

5.1 All certification testing required for this standard shall be performed by a laboratory currently covered by AMRL accreditation. Any satellite laboratory of a Supplier that performs required testing under this standard will be identified in the submitted Supplier Quality Control Plan (Section 7) and shall be approved by CDOT.

6. SUPPLIER CERTIFICATION REQUIREMENTS

6.1 The Supplier shall submit to CDOT for approval a complete Quality Control Plan that complies with the requirements of Section 7. If the Quality Control Plan is rejected, the Supplier may modify the plan based on the critique provided and then resubmit it to CDOT for approval.

6.2 Once the Supplier's Quality Control Plan is approved by CDOT, the Supplier shall submit to the CDOT Product Evaluation Coordinator a completed copy of CDOT Form #595 (Pre-Approved Product Evaluation Request & Summary) for each emulsion. The Form #595 can be located within Notice to Manufacturers at: www.coloradodot.info/business/APL/. The Form #595 is designed as a PDF Writeable form, which must be completed by the Supplier. The completed form shall be returned to CDOT's Product Evaluation Coordinator as an e-mail attachment.

6.2.1 The Form #595 "Product name" field shall identify the submitted emulsion and the construction year of the submittal (i.e. "CRS-2P (2011)").

6.2.2 The Form #595 will serve as the request to CDOT for authorization to ship emulsion as referenced within this Colorado Procedure.

6.3 The Supplier shall forward to CDOT the initial testing data for the emulsion identified on the Form #595 and a copy of the MSDS. The Supplier shall also obtain and provide a split sample for the CDOT Central Laboratory from the first production run of the emulsion identified on the Form #595. This will be concurrent with the first shipments of the construction season when the emulsion is being made for the first time that season.

6.3.1 If the submitted sample required in Subsection 6.3 fails the verification testing and is rejected by CDOT, then the Supplier may submit to CDOT a new test sample with a new CDOT Form #595, updated initial test data, and an MSDS. If CDOT rejects this second submittal then the Supplier may resubmit again. However, this third submittal for the same Product name (emulsion type for that calendar year) shall include, in addition to all requirements in

Subsection 6.3, a test report from an independent AMRL accredited laboratory.

6.4 The Supplier shall allow CDOT to visit the production and/or shipping site during normal business hours to perform an audit by observing the Supplier's quality control activities, to inspect the facilities, and to obtain samples for test.

6.5 The Supplier shall follow the procedures described in the CDOT approved quality control plan.

6.6 The Supplier shall establish a continuing test record for every test required for each emulsion included in the written request as prepared to satisfy the requirements of Subsection 6.1.

6.7 The Supplier shall submit to CDOT all reports required by this standard in a format approved by CDOT.

6.8 The Supplier shall have a satisfactory record of compliance with CDOT project specifications. Decisions by CDOT concerning this requirement shall be based on the test results furnished by the supplier and satisfactory results when the splits and field tests are compared with supplier tests.

7. SUPPLIER QUALITY CONTROL PLAN (MINIMUM REQUIREMENTS)

7.1 The Supplier's Quality Control Plan shall identify the following:

7.1.1 Facility type (refinery, terminal).

7.1.2 Facility location (actual physical address).

7.1.3 Name and telephone number of the person responsible for quality control at the facility.

7.1.4 Quality control tests and testing frequency to be performed on each type of emulsion.

7.1.5 Name and location of the laboratory performing quality control tests on the emulsion that is shipped.

7.2 The Supplier's Quality Control Plan shall include a declaration stating that if a test result indicates that a shipment of emulsion is not in compliance with the purchase specifications, the Supplier shall:

- (1) Identify the material in the shipment,
- (2) Immediately cease the shipment until the material complies with the specification,
- (3) Immediately notify CDOT regarding the shipment in question,
- (4) Immediately notify the Contractors scheduled to use the material from the shipment in question,
- (5) Notify CDOT prior to resuming shipment; and
- (6) Implement any mutually agreed upon procedures for the disposition of the material.

7.3 The Supplier's quality control plan shall describe method and frequency for initial testing, specification compliance testing, and quality control testing for guiding the manufacturer.

7.3.1 Initial Testing - For each type of emulsion to be supplied, specification compliance testing shall be initially performed and the results of that testing provided to CDOT, accompanied by a sample of the material represented by the test results. Specification compliance testing shall confirm that the emulsion conforms to all requirements of Section 702 of the Standard Specifications. This will be concurrent with the first shipments of the construction season when the emulsion is being made for the first time that season.

7.3.2 Specification Compliance Testing - Specification compliance testing shall be run on a routine basis and the results submitted to CDOT at a minimum of once per month.

7.3.3 Quality Control Testing for Guiding the Manufacturer - Tests to determine conformance with Section 702 of the Standard Specifications tests shall be conducted as needed for quality control. The Quality Control Plan shall indicate the frequency of this testing. Non-Section 702 tests, of the Standard Specifications, may be used for guiding the manufacturer. The use of non-Section 702 tests does not preclude the need to meet Section 702 requirements or to run complete Section 702 tests as indicated in the Quality Control Plan.

7.4 The Supplier's quality control plan shall include a statement that the Supplier will prepare and maintain summary reports for all quality control and specification compliance tests performed, and will submit them to CDOT on request.

7.5 The Supplier's quality control plan shall provide an outline of the procedure to be followed for checking transport vehicles before loading to prevent contamination of shipments. The outline shall include a statement that the Transport Vehicle Inspection Report, signed by the designated inspector, shall be maintained in the Supplier's records and will be made available to CDOT on request.

8. CDOT EVALUATION PROCEDURE

8.1 CDOT will verify that the Supplier's quality control plan is adequate. CDOT may visit the shipping site when required.

8.2 CDOT will notify the Supplier whether or not the Supplier's application for Certified Emulsion Supplier status has been granted. The notification shall include a list of the types of emulsions covered.

8.3 CDOT may verify that the Supplier's specification compliance testing laboratory is currently covered by AASHTO accreditation.

8.4 CDOT may verify that the Supplier's specification compliance testing laboratory participates in a round robin testing program.

8.5 CDOT may perform split sample testing in accordance with Section 10.

8.6 CDOT will perform quality assurance testing.

8.7 CDOT may inspect the operations of the Supplier's facility including those related to the emulsion shipments if required.

8.8 CDOT will post the Supplier's approved emulsion type with the associated Supplier's facility name on CDOT's Approved Products List. Reference to the web site is at www.coloradodot.info/business/APL/.

9. REQUIREMENTS FOR SHIPPING EMULSIONS BY AN APPROVED SUPPLIER

9.1 The Supplier's Quality Control Plan as approved by CDOT (Section 8) shall be implemented.

9.2 Each shipment shall be accompanied by two copies of the bill of lading, which shall include:

- (1) The name and location of the Supplier, as stated in the Supplier's Quality Control Plan,
- (2) The type of emulsion,
- (3) The quantity of material shipped,
- (4) The date of shipment,
- (5) A certificate of compliance (COC) certifying the material meets specification requirements. The COC statement will certify the material was manufactured and tested in accordance with the CDOT approved Quality Control Plan (Section 7) and, therefore, meets state requirements (example in Chapter 400), and,
- (6) A statement certifying that the transport vehicle was inspected before loading and was found acceptable for the material shipped. The COC statement will certify the material was manufactured and tested in accordance with CDOT's approved Quality Control Plan (Section 7) and, therefore, meets state requirements.

9.3 If the specification compliance test results do not conform to emulsion specifications, the Supplier shall remove the non-compliant material from the shipping queue as outlined in Subsection 7.2.

10. SPLIT SAMPLE TESTING

10.1 CDOT may request split sample testing. The test results will be exchanged as soon as they are available.

10.2 If the split sample test data is not within the precision specified for that particular test a review of both sampling and testing procedures will be conducted by both the supplier and CDOT.

11. REPORT AND DATA SHEETS

11.1 Supplier Reports - The Supplier shall prepare the reports described in Subsections 6.1, 6.2, 6.3, 6.6, 6.7, 7.2, 7.4, 7.5, 9.2, and 9.3.

12. RECERTIFICATION

12.1 If a supplier has been decertified and seeks to be recertified, the supplier must fulfill the requirements for certification, as per Section 6.

13. FIELD QUALITY CONTROL OF EMULSION(S)

13.1 The field quality control of the emulsion shall be the responsibility of the Contractor. Prior to accepting deliveries of emulsion, the contractor shall submit a Field Quality Control (FQC) Plan for emulsion addressing all key elements as listed in Section 14. This FQC Plan will be included within the Contractor's quality control plan for asphalt concrete. The FQC Plan shall be submitted at least 10 days prior to commencing paving operations. The purpose of the FQC Plan is to describe proper handling techniques for the emulsion to maintain specification conformance of emulsion properties during transportation, storage, and production operations. The Engineer will review the FQC Plan, and the paving operations will not begin until the FQC Plan has been approved in writing.

13.2 The contents of the emulsion FQC Plan shall be project specific and shall be kept current to the production and mixture operations employed at any time. Prior to executing any change to emulsion handling, the FQC Plan shall be revised to incorporate the change.

Engineer approval of the revised FQC Plan, in writing, will be required before the change is made to emulsion handling. Failure to keep the FQC Plan current may affect subsequent decisions by the Engineer, such as those made to address a correction of failed material.

13.3 The Contractor shall confirm and document that the Supplier that manufactures the emulsion and the specific emulsion is on

CDOT's Approved Products List as referenced in Subsection 8.8.

13.4 The Contractor shall indicate, in writing, what steps will be taken to ensure that the FQC Plan is followed and what action will be taken to correct the situation if it is found that the plan is not being followed.

14. MINIMUM REQUIREMENTS FOR THE CONTRACTOR'S EMULSION FIELD QUALITY CONTROL PLAN

14.1 The FQC Plan shall identify all subcontractors responsible for handling the emulsion. This will include the firm hauling the emulsion unless that firm is the emulsion supplier or is employed by the emulsion supplier.

14.2 The responsibilities of each party having a role in executing the FQC Plan shall be identified.

14.3 The FQC Plan shall describe how changes in type or supplier of the emulsion, used on the paving job, will be implemented. The change must not result in mixing of different emulsions. If mixing does occur, the mixed emulsion shall not be incorporated in the project. The Contractor shall inform the Engineer in advance of any change in type or supplier of the emulsion.

14.4 The anticipated mode of emulsion delivery shall be described. The process of tank inspection, prior to initial filling, will be described. The tanks on the project site must be completely empty and free of contaminants to avoid contamination of the emulsion delivered to the project.

14.5 Any special handling or storage requirements of the emulsion shall be fully described. These shall comply with the manufacturer's recommendations for that type of emulsion. The FQC Plan shall conform to these special requirements.

14.6 As detailed by the emulsion supplier, based on the type of materials used to produce the specific emulsion, any potential limitations of the emulsion relative to prolonged storage, exposure to prolonged and/or elevated heating, susceptibility to stratification and/or separation, etc. shall be fully described. The Contractor's FQC Plan shall describe how these limitations of the emulsion shall be addressed.

14.7 If agitation is used in emulsion storage tanks, the capacity and methods of agitation within the storage tank(s) shall be described.

14.8 Provisions to avoid damage to emulsion during the suspension of paving operations shall be described. These provisions will detail limits to the storage times and corresponding temperature limits.

14.9 The emulsion rotation FQC Plan shall be described. (First-in / First-out basis, for example).

14.10 Any on-site sampling and testing shall be described with respect to sampling location, tests to be conducted, and control limits for test results. On-site sampling methods and facilities shall be fully described. It is a good practice for the Contractor to obtain and retain samples of emulsion when delivered to the project. These samples can be tested if emulsion problems occur. These test results can help isolate the cause of emulsion problems. Emulsion performance test requirements are contained in Section 702 of the Standard Specifications.

14.11 The FQC Plan shall describe methods for identifying the emulsion contained in each storage tank. Clear and consistent labeling of each tank shall be included in these methods.

14.12 The emulsion temperatures in the tanks shall be routinely monitored, at a minimum of once per day. Procedures and equipment for this monitoring shall be described. Results of this monitoring shall be made available to the Engineer upon request.

{This page was intentionally left blank.}

CP 11, Asphalt Emulsion Supplier Certification Checklist - 2012

Supplier Name: _____ Date: _____
Refinery Name: _____ Refinery Location: _____
Supplier Lab: _____ Supplier Lab Location: _____
Emulsion Type: _____

Yes/ No

Subsection

- 5.1 Does supplier's lab have current AMRL accreditation? _____
- 6.1 QC plan submitted to CDOT? _____
- 6.2 Completed CDOT Form #595 sent to CDOT as an e-mail attachment? _____
- 6.3 Initial test data supplied? _____
- 6.3 MSDS supplied? _____
- 6.3 Split sample provided to CDOT once per construction season? _____

SUPPLIER QC PLAN:

Subsection

- 7.1.1 Facility type listed? _____
- 7.1.2 Facility location listed? _____
- 7.1.3 Name of person responsible for QC at the facility is listed? _____
- 7.1.4 List of QC tests & frequency to be used on emulsion? _____
- 7.1.5 Name & location of lab performing these tests is listed? _____
- 7.2 Does Plan state that, if a shipment is not within specification, the supplier shall:
 - (1) Identify the material in the shipment? _____
 - (2) Immediately cease shipment until material complies with the specification? _____
 - (3) Immediately notify CDOT regarding the shipment in question? _____
 - (4) Immediately notify the Contractors scheduled to use the material from the shipment in question? _____
 - (5) Notify CDOT prior to resuming shipment? _____
 - (6) Implement any mutually agreed upon procedures for the disposition of the material? _____
- 7.3 Does plan describe the method and frequency for initial testing, QC testing, and specification compliance testing? _____
- 7.3.1 Results of specification compliance testing supplied to CDOT along with a sample? _____
- 7.3.1 Results confirm that the Emulsion conforms to Section 702? _____
- 7.3.2 Plan states that specification compliance testing is performed routinely and results are submitted to CDOT monthly? _____
- 7.3.3 Plan indicates frequency of testing to determine conformance with Section 702? _____
- 7.4 Plan states that supplier will maintain summary reports for all QC and Spec Compliance tests performed, and will submit to CDOT upon request? _____
- 7.5 Plan contains an outline of the procedure for checking transport vehicles before loading to prevent contamination? _____
- 7.5.1 Outline includes statement that the transport vehicle inspection report, signed by the designated inspector, shall be maintained in the supplier's records, and will be made available to CDOT upon request? _____

CP 11, Asphalt Contractor Field Quality Control Checklist - 2012

Contractor Name: _____ Date: _____
Project Number: _____
Project Code: _____
Project Location: _____

FIELD QUALITY CONTROL OF EMULSION(S)

<u>Subsection</u>	<u>Yes/ No</u>
13.1 Was the Contractor's Field Quality Control (FQC) Plan submitted 10 days prior to paving?	_____
13.2 Is the emulsion FQC plan specific to this Project?	_____
13.2 Does the emulsion FQC plan apply to current emulsion handling?.....	_____

Does the Contractor's Emulsion Field Quality Control Plan Address the Following:

<u>Subsection</u>	
14.1 List of the subcontractors handling the emulsion?.....	_____
14.2 Responsibilities of the parties executing the emulsion FQC Plan?	_____
14.3 How emulsion type changes will be handled?	_____
14.4 Delivery mode and tank inspection before filling?	_____
14.5 Special handling and suppliers recommended handling?	_____
14.6 Limitations on the type of emulsion with respect to handling?.....	_____
14.7 Method of agitating emulsion in the tank (if any)?	_____
14.8 Emulsion handling during paving delays?.....	_____
14.9 Emulsion rotation plan (i.e. First-in / First-out)?.....	_____
14.10 On-site sampling plan (if any)?	_____
14.11 Emulsion identification plan (tank labeling)?.....	_____
14.12 Emulsion temperature monitoring (minimum once per day)?	_____

Part I, Sub-Part 3:

Hydraulic Cement – 12

1. REFERENCED DOCUMENTS

1.1 ASTM Standards:

ASTM C 150 Standard Specification for Portland Cement

ASTM C 183 Standard Practice for Sampling and the Amount of Testing of Hydraulic Cement

ASTM C 219 Standard Terminology Relating to Hydraulic Cement

ASTM C 595 Standard Specification for Blended Hydraulic Cement

ASTM C 1157 Standard Performance Specification for Hydraulic Cement

2. TERMINOLOGY

2.1 See ASTM C 219 Standard Terminology Relating to Hydraulic Cement.

2.2 Supplier – In this Standard, a *Cement Supplier* shall be defined as one who manufactures hydraulic cement.

2.3 Supplier – In this Standard, a *Concrete Supplier* shall be defined as one who manufactures concrete mix. Among the ingredients of a concrete mix is hydraulic cement.

2.4 Contractor – The company under contract with CDOT to produce products using hydrated cement.

3. SIGNIFICANCE AND USE

3.1 This Standard specifies requirements and procedures for a certification system that shall be applicable to all Cement Suppliers providing hydraulic cement. These provisions apply to the plant manufacturing the hydraulic cement. These provisions apply to the Contractor, after delivery of the hydraulic cement to the Contractor, for use on CDOT projects.

3.2 This Standard specifies procedures intended to minimize disruption of hydraulic cement shipments. This is accomplished by a certification system that evaluates quality control and specification compliance tests performed by the Cement Supplier according to their quality control plans.

4. SAMPLING

4.1 All test samples shall be obtained in accordance with ASTM C 183. The use of a random sampling procedure is mandatory to the establishment of a valid quality assurance program.

5. TESTING REQUIREMENTS

5.1 Testing shall be performed by a laboratory currently accredited by the Cement and Concrete Reference Laboratory (CCRL). Any satellite laboratory of a Cement Supplier that performs required testing under this Standard shall be identified in the submitted Quality Control Plan (Section 7).

6. SUPPLIER CERTIFICATION REQUIREMENTS

6.1 Cement Suppliers shall submit to the CDOT Product Evaluation Coordinator (PEC), CDOT Form #595, Pre-Approved Product Evaluation Request & Summary for each type of hydraulic cement intended for use on CDOT projects. Instructions for completing and submitting the CDOT Form #595 can be located within the Notice to Manufacturers at: www.coloradodot.info/business/APL/.

6.2 In addition to completing CDOT Form #595, the following shall be supplied to the PEC:

6.2.1 A brief outline of the procedures used to evaluate the finished product including sampling and testing frequency and the sample preparation employed, including chemical analysis methods used such as X-ray, atomic absorption spectroscopy, and/or wet chemistry.

6.2.2 The results of all applicable chemical and/or physical tests required by ASTM C 150, C 595, or C 1157 on the most recent 40 samples (20 pairs) tested. The results shall be submitted in the format outlined in ASTM C 183, in particular the table entitled "Test Data" with the critical limits calculated as described.

6.2.3 A copy of the CCRL certification for the laboratory performing testing.

6.2.4 A copy of the Cement Supplier's Quality Control Plan, which complies with the requirements of Section 7, if one has not been supplied to CDOT for previously submitted products.

6.3 A sample of the proposed hydraulic cement shall be shipped to the PEC at the Materials and Geotechnical Branch, 4670 North Holly Street, Unit A, Denver, Colorado 80216-6408.

6.4 The Cement Supplier shall allow CDOT to visit the production and/or shipping site during normal business hours to observe the Cement Supplier's quality control activities, to inspect the facilities, and to obtain samples for tests.

6.5 The Cement Supplier shall follow the procedures described in the CDOT approved quality control plan.

6.6 The Cement Supplier shall establish a continuing test record for every test required and for each Type of hydraulic cement included in the written request as prepared to satisfy the requirements of Subsection 6.1.

6.7 The Cement Supplier shall submit to CDOT all reports required by this standard in a format approved by CDOT.

6.8 The Cement Supplier shall have a satisfactory record of compliance with CDOT project specifications. Decisions by CDOT concerning this requirement shall be based on the test results furnished by the Cement Supplier's tests.

7. SUPPLIER QUALITY CONTROL PLAN (MINIMUM REQUIREMENTS)

7.1 The Cement Supplier's Quality Control Plan shall identify the following:

7.1.1 Facility location (actual physical address).

7.1.2 Name and telephone number of a person at each production facility, responsible for quality control of the material shipped to CDOT projects.

7.1.3 Quality control tests and testing frequency to be performed on each hydraulic cement.

7.1.4 Name and location of the laboratory performing quality control tests on the hydraulic cement.

7.2 The Cement Supplier's Quality Control Plan shall include a declaration stating that if a test result indicates that a shipment of hydraulic cement does not comply with the purchase specifications, the Cement Supplier shall:

7.2.1 Identify the material in the shipment,

7.2.2 Immediately cease the shipment until the material complies with the specification,

7.2.3 Immediately notify CDOT regarding the shipment in question,

7.2.4 Immediately notify the Contractors and Concrete Suppliers scheduled to use the material from the shipment in question, notify CDOT prior to resuming shipment; and implement any mutually agreed upon procedures for the disposition of the material.

7.3 The Cement Supplier's Quality Control Plan shall describe method and frequency for initial testing and quality control testing.

7.3.1 **Initial Testing** - For each type of hydraulic cement to be supplied, testing shall be performed and the results provided to CDOT, accompanied by a sample of the material represented by the test results.

7.3.2 **Quality Control Testing** – Tests to determine conformance with applicable ASTM standards shall be conducted as needed for quality control. The Cement Supplier's Quality Control Plan shall indicate the frequency of this testing.

7.4 The Cement Supplier's Quality Control Plan shall include a statement that the Cement Supplier will prepare and maintain summary reports for all quality control tests performed, and will submit them to CDOT on request.

7.5 The Cement Supplier's Quality Control Plan shall provide an outline of the procedure to be followed for checking transport vehicles before loading to prevent contamination of shipments. The outline shall be maintained in the Cement Supplier's records and will be made available to CDOT on request.

8. CDOT EVALUATION PROCEDURE

8.1 CDOT will verify that the Cement Supplier's Quality Control Plan is adequate. CDOT may visit the shipping site when required.

8.2 CDOT will notify the Cement Supplier whether or not the Cement Supplier's application has been granted.

8.3 CDOT may verify that the Cement Supplier's testing laboratory is currently CCRL accredited.

8.4 CDOT may perform split sample testing in accordance with Section 10.

8.5 CDOT may sample and perform testing on random samples.

8.6 CDOT may inspect the operations of the Cement Supplier's facility, including those related to shipments if required.

8.7 Products approved for use will be posted on the CDOT APL.

9. REQUIREMENTS FOR SHIPPING HYDRAULIC CEMENT BY AN APPROVED SUPPLIER

9.1 The Cement Supplier's Quality Control Plan as approved by CDOT (Section 7) shall be implemented.

9.2 Each shipment shall be accompanied by two copies of the bill of lading, which shall include:

9.2.1 The name and location of the Cement Supplier,

9.2.2 The Type of hydraulic cement shipped,

9.2.3 The quantity of material shipped,

9.2.4 The date of shipment,

9.2.5 A certificate of compliance (COC) certifying that the material meets specification requirements and,

9.2.6 A statement certifying that the transport vehicle was inspected before loading, and was found acceptable for the material shipped.

9.3 If the test results do not conform to the applicable ASTM standards, the Cement Supplier shall remove the non-compliant material from the shipping queue as outlined in Subsection 7.2.

10. SPLIT SAMPLE TESTING

10.1 CDOT may request split sample testing. The test results will be exchanged as soon as they are available.

10.2 If the split sample test data is not within the precision specified for that particular test a review of both sampling and testing procedures will be conducted by both the Cement Supplier and CDOT.

11. REPORT AND DATA SHEETS

11.1 Cement Supplier Reports - The Cement Supplier shall prepare the reports described in Subsections 6.1, 6.2, 9.2, and 9.3.

{This page was intentionally left blank.}

Part I, Sub-Part 4:

Fly Ash - 12

1. REFERENCED DOCUMENTS

1.1 ASTM Standards:

ASTM C 219 Standard Terminology Relating to Hydraulic Cement

ASTM C 311 Standard Test Methods for Sampling and Testing Fly Ash or Natural Pozzolans for Use in Portland Cement Concrete.

ASTM C 618 Standard Specification for Coal Fly Ash and Raw or Calcined Natural Pozzolan for Use in Concrete.

2. TERMINOLOGY

2.1 See ASTM C 219 Standard Terminology Relating to Hydraulic Cement.

2.2 Supplier, Fly Ash – In this Standard, a *Fly Ash Supplier* shall be defined as one who provides fly ash for use on CDOT projects.

2.3 Supplier, Concrete – In this Standard, a *Concrete Supplier* shall be defined as one who manufactures concrete mix. Fly ash may be among the ingredients of a concrete mix.

2.4 Contractor – The company under contract with CDOT to produce products using fly ash.

3. SIGNIFICANCE AND USE

3.1 This Standard specifies procedures intended to minimize disruption of fly ash shipments. This is accomplished by a certification system that evaluates quality control and specification compliance tests performed by the Fly Ash Supplier according to their quality control plans.

3.2 This Standard specifies requirements and procedures for a certification system that shall be applicable to all fly ash suppliers providing fly ash. The requirements and procedures shall apply to materials that meet the requirements of CDOT specifications for fly ash.

These provisions apply to the plant producing the fly ash. These provisions apply to the Contractor, after delivery of the concrete mix to the Contractor, for use on CDOT projects.

4. SAMPLING

4.1 All test samples shall be obtained in accordance with ASTM C 311. The use of a random sampling procedure is mandatory to the establishment of a valid quality assurance program.

5. TESTING REQUIREMENTS

5.1 Testing shall be performed by a laboratory currently accredited by the Cement and Concrete Reference Laboratory (CCRL). Any satellite laboratory of a Fly Ash Supplier that performs required testing under this Standard shall be identified in the submitted Quality Control Plan (Section 7).

6. SUPPLIER CERTIFICATION REQUIREMENTS

6.1 Fly Ash Suppliers shall submit to the CDOT Product Evaluation Coordinator (PEC), the CDOT Form #595, Pre-Approved Product Evaluation Request & Summary for each source and Class of fly ash intended for use on CDOT projects. Instructions for completing CDOT Form #595 can be found at www.coloradodot.info/business/APL/ within the Notice to Manufacturers.

6.2 In addition to completing the CDOT Form #595, the following shall be supplied to the PEC:

6.2.1 A brief outline of the procedures used to evaluate the finished product including; sampling and testing frequency and the sample preparation employed, including chemical analysis methods used such as X-ray, atomic absorption spectroscopy, and/or wet chemistry.

6.2.2 The results of all applicable chemical and/or physical tests required by ASTM C 618 on the most recent 40 samples (20 pairs) tested. The results shall be submitted in the format outlined in ASTM C 311, in particular the table entitled "Test Data" with the critical limits calculated as described.

6.2.3 A copy of the CCRL certification for the laboratory performing testing.

6.2.4 A copy of the Fly Ash Supplier's Quality Control Plan, which complies with the requirements of Section 7, if one has not been supplied to CDOT for previously submitted products.

6.3 A sample of the proposed fly ash shall be shipped to the PEC at the Materials and Geotechnical Branch, 4670 North Holly Street, Unit A, Denver, Colorado 80216-6408.

6.4 The Fly Ash Supplier shall allow CDOT to visit the production and/or shipping site to observe the Fly Ash Supplier's quality control activities, to inspect the facilities, and to obtain samples for tests.

6.5 The Fly Ash Supplier shall follow the procedures described in the CDOT approved quality control plan.

6.6 The Fly Ash Supplier shall establish a continuing test record for every test required for each Type of fly ash included in the written request as prepared to satisfy the requirements of Subsection 6.1.

6.7 The Fly Ash Supplier shall submit to CDOT all reports required by this standard in a format approved by CDOT.

6.8 The Fly Ash Supplier shall have a satisfactory record of compliance with CDOT project specifications. Decisions by CDOT concerning this requirement shall be based on the test results furnished by the Fly Ash Supplier and satisfactory results when the splits and field tests are compared with Fly Ash Supplier tests.

7. SUPPLIER QUALITY CONTROL PLAN (MINIMUM REQUIREMENTS)

7.1 The Fly Ash Supplier's Quality Control Plan shall identify the following:

7.1.1 Facility location.

7.1.2 Name and telephone number of a person at each production facility, responsible for quality control of material shipped to CDOT projects.

7.1.3 Quality control tests and testing frequency to be performed on each fly ash.

7.1.4 Name and location of the laboratory performing quality control tests on the fly ash.

7.2 The Fly Ash Supplier's Quality Control Plan shall include a declaration stating that if a test result indicates that a shipment of fly ash does not comply with the purchase specifications, the Fly Ash Supplier shall:

7.2.1 Identify the material in the shipment,

7.2.2 Immediately cease the shipment until the material complies with the specification,

7.2.3 Immediately notify CDOT regarding the shipment in question,

7.2.4 Immediately notify the Contractors and Concrete Suppliers scheduled to use the material from the shipment in question,

7.2.5 Notify CDOT prior to resuming shipment; and

7.2.6 Implement any mutually agreed upon procedures for the disposition of the material.

7.3 The Fly Ash Supplier's Quality Control Plan shall describe method and frequency for initial testing and quality control testing.

7.3.1 **Initial Testing** – For each fly ash product to be supplied, testing shall be performed and the results of that testing provided to CDOT, accompanied by a sample of the material represented by the test results.

7.3.2 **Quality Control Testing** – Tests to determine conformance with ASTM C 618 shall be conducted as needed for quality control. The Supplier's Quality Control Plan shall indicate the frequency of this testing.

7.4 The Fly Ash Supplier's Quality Control Plan shall include a statement that the Fly Ash Supplier will prepare and maintain summary reports for all quality control tests performed, and will submit them to CDOT on request.

7.5 The Fly Ash Supplier's Quality Control Plan shall provide an outline of the procedure to be followed for checking transport vehicles before loading to prevent contamination of shipments. The outline shall be maintained in the Fly Ash Supplier's records and will be made available to CDOT on request.

8. CDOT EVALUATION PROCEDURE

8.1 CDOT will verify that the Fly Ash Supplier's Quality Control Plan is adequate. CDOT may visit the shipping site when required.

8.2 CDOT will notify the Fly Ash Supplier whether or not the Fly Ash Supplier's application has been granted.

8.3 CDOT may verify that the Fly Ash Supplier's testing laboratory is currently CCRL accredited.

8.4 CDOT may perform split sample testing in accordance with Section 10.

8.5 CDOT may sample and perform testing on random samples.

8.6 CDOT may inspect the operations of the Fly Ash Supplier's facility including those related to shipments if required.

8.7 Products approved for use will be posted on the CDOT APL.

9. REQUIREMENTS FOR SHIPPING FLY ASH BY AN APPROVED SUPPLIER

9.1 The Fly Ash Supplier's Quality Control Plan as approved by CDOT (Section 7) shall be implemented.

9.2 Each shipment shall be accompanied by two copies of the bill of lading, which shall include:

9.2.1 The name and location of the Fly Ash Supplier and the plant producing the fly ash,

9.2.2 The class of fly ash,

9.2.3 The quantity of material shipped,

9.2.4 The date of shipment,

9.2.5 A statement certifying the material meets specification requirements (COC) and,

9.2.6 A statement certifying that the transport vehicle was inspected before loading and was found acceptable for the material shipped.

9.3 If the test results do not conform to ASTM C 618 specifications, the Fly Ash Supplier shall remove the non-compliant material from the shipping queue as outlined in Subsection 7.2.

10. SPLIT SAMPLE TESTING

10.1 CDOT may request split sample testing. The test results will be exchanged as soon as they are available.

10.2 If the split sample test data is not within the precision specified for that particular test a review of both sampling and testing procedures will be conducted by both the Fly Ash Supplier and CDOT.

11. REPORT AND DATA SHEETS

11.1 Fly Ash Supplier Reports - The Fly Ash Supplier shall prepare the reports described in Subsections 6.1, 6.2, and 9.2.

{This page was intentionally left blank.}

Part I, Sub-Part 5:

Hydrated Lime - 12

1. REFERENCED DOCUMENTS

1.1 AASHTO Standards:

AASHTO M 303 - Lime for Asphalt Mixtures

AASHTO R 38 – Quality Assurance of Standard Manufactured Materials

1.2 ASTM Standards:

ASTM C 25 - Standard Test Methods for Chemical Analysis of Limestone, Quicklime, and Hydrated Lime

ASTM C 50 - Standard Practice for Sampling, Inspection, Packing, and Marking of Lime and Limestone Products

ASTM C 110 - Standard Test Methods for Physical Testing of Quicklime, Hydrated Lime, and Limestone

ASTM C 207 - Standard Specification for Hydrated Lime for Masonry Purposes

ASTM C 977 - Standard Specification for Hydrated Lime for Soil Stabilization

2. TERMINOLOGY

2.1 See ASTM C 51 Standard Terminology Relating to Lime and Limestone (as used by the Industry).

2.2 Supplier – In this Standard, a *Supplier* shall be defined as one who manufactures hydrated lime.

2.3 Contractor – The company under contract with CDOT to produce products using hydrated lime.

3. SIGNIFICANCE AND USE

3.1 This Standard specifies procedures

intended to minimize disruption of hydrated lime shipments. This is accomplished by a certification system that evaluates quality control and specification compliance tests performed by the Supplier on samples obtained prior to shipment.

3.2 This Standard specifies requirements and procedures for a certification system that shall be applicable to all Suppliers providing hydrated lime. These provisions apply to the plant manufacturing the hydrated lime. These provisions apply to the Contractor, after delivery of the hydrated lime to the Contractor, for use on CDOT projects.

4. SAMPLING

4.1 All test samples required by this Standard shall be obtained in accordance with ASTM C 50. The use of a random sampling procedure is mandatory to the establishment of a valid quality assurance program.

5. TESTING REQUIREMENTS

5.1 Laboratories that perform the required testing under this Standard shall list qualifications in the submitted Supplier Quality Control Plan. Any satellite laboratory of a Supplier that performs required testing under this Standard shall be identified in the submitted Supplier Quality Control Plan (Section 7).

6. SUPPLIER REQUIREMENTS

6.1 Suppliers shall submit to the CDOT's Product Evaluation Coordinator (PEC) the CDOT Form #595, Pre-Approved Product Evaluation Request & Summary for each source of hydrated lime intended for use on CDOT projects. Instructions for completing the Form #595 can be found in Notice to Manufacturers at www.coloradodot.info/business/APL/.

6.2 In addition to completing CDOT Form #595, the following shall be supplied to the PEC:

6.2.1 A brief outline of the procedures used to evaluate the finished product including; sampling and testing frequency, and the sample preparation employed, including chemical analysis methods used.

6.2.2 The results of all applicable chemical and/or physical tests required by AASHTO M 303, ASTM C 110, ASTM C 207 or ASTM C 977 on the most recent 20 samples tested. The results shall be submitted in a tabular format with the critical limits indicated.

6.2.3 A copy of the Supplier's Quality Control Plan, which complies with the requirements of Section 7. Any changes to the supplier's Quality Control plans shall require an updated plan sent to the PEC.

6.3 A sample of the proposed hydrated lime shall be shipped to the PEC at the Materials and Geotechnical Branch, 4670 North Holly Street, Unit A, Denver, Colorado 80216-6408.

6.4 During normal business hours, the Supplier shall allow CDOT to visit the production and/or shipping site to observe the Supplier's quality control activities, to inspect the facilities, and to obtain samples for tests.

6.5 The Supplier shall follow the procedures described in the CDOT approved quality control plan.

6.6 The Supplier shall establish a continuing test record for every test required for hydrated lime included in the written request as prepared to satisfy the requirements of Subsection 6.2.

6.7 The Supplier shall submit to CDOT all reports required by this standard in a format approved by CDOT.

6.8 The Supplier shall have a satisfactory record of compliance with CDOT project specifications. Decisions by CDOT concerning this requirement shall be based on the test results furnished by the Supplier and satisfactory results when the splits and field tests are compared with Supplier tests.

7. SUPPLIER QUALITY CONTROL PLAN (MINIMUM REQUIREMENTS)

7.1 The Supplier's Quality Control Plan shall identify the following:

7.1.1 Facility location.

7.1.2 Name and telephone number of a person at each production facility, responsible for quality control of material shipped to CDOT projects.

7.1.3 Quality control tests and testing frequency to be performed on each hydrated lime product.

7.1.4 Name and location of the laboratory performing quality control tests on the hydrated lime.

7.2 The Supplier's Quality Control Plan shall include a declaration stating that if a test result indicates that a shipment of hydrated lime does not comply with the purchase specifications, the Supplier shall:

7.2.1 Identify the material in the shipment,

7.2.2 Immediately cease the shipment until the material complies with the specification,

7.2.3 Immediately notify CDOT regarding the shipment in question,

7.2.4 Immediately notify the Contractors scheduled to use the material from the shipment in question,

7.2.5 Notify CDOT prior to resuming shipment; and

7.2.6 Implement any mutually agreed upon procedures for the disposition of the material.

7.3 The Supplier's Quality Control Plan shall describe method and frequency for initial and quality control testing.

7.3.1 **Initial Testing** - For each hydrated lime product to be supplied, testing shall be initially performed by the supplier and the results of those tests shall be provided to CDOT, accompanied by a sample of the material represented by the test results.

7.3.2 **Quality Control Testing** – Tests to determine conformance with Subsection 712.03 of the Standard Specifications shall be conducted as needed for quality control. The Supplier's Quality Control Plan shall indicate the frequency of this testing.

7.4 The Supplier's Quality Control Plan shall include a statement that the Supplier will prepare and maintain summary reports for all quality control tests performed, and will submit them to CDOT on request.

7.5 The Supplier's Quality Control Plan shall provide an outline of the procedure to be followed for checking transport vehicles before loading to prevent contamination of shipments. The outline shall be maintained in the Supplier's records and will be made available to CDOT on request.

8. CDOT EVALUATION PROCEDURE

8.1 CDOT will verify that the Supplier's Quality Control Plan is adequate. CDOT may visit the shipping site when required.

8.2 CDOT will notify the Supplier whether or not the Supplier's application has been granted.

8.3 CDOT may perform split sample testing in accordance with Section 10.

8.4 On a random basis, CDOT may request a sample for testing the supplier's product.

8.5 CDOT may inspect the operations of the Supplier's facility including those related to shipments if required.

8.6 CDOT will post the Supplier's approved hydrated lime with the associated Supplier's facility name on CDOT's Approved Products List. Reference to the web site is at: www.coloradodot.info/business/APL/.

9. REQUIREMENTS FOR SHIPPING HYDRATED LIME BY AN APPROVED SUPPLIER

9.1 The Supplier's Quality Control Plan as approved by CDOT (Section 7) shall be implemented.

9.2 Each shipment shall be accompanied by two copies of the bill of lading, which shall include:

9.2.1 The name and location of the Supplier,

9.2.2 The Type of material shipped,

9.2.3 The quantity of material shipped,

9.2.4 The date of shipment,

9.2.5 A certificate of compliance (COC) certifying the material meets specification requirements. The COC statement will certify the material was manufactured and tested in accordance with CDOT's approved Quality Control Plan (Section 7) and, therefore meets State requirements and,

9.2.6 A statement certifying that the transport vehicle was inspected before loading and was found acceptable for the material shipped.

9.3 If the test results do not conform to Standard Specification Subsection 712.03, the Supplier shall remove the non-compliant material from the shipping queue as outlined in Subsection 7.2.

10. SPLIT SAMPLE TESTING

10.1 CDOT may request split sample testing. The test results will be exchanged as soon as they are available.

10.2 If the split sample test data is not within the precision specified for that particular test a review of both sampling and testing procedures will be conducted by both the Supplier and CDOT.

11. REPORT AND DATA SHEETS

11.1 Supplier Reports - The Supplier shall prepare the reports described in Subsections 6.1, 6.2 and 9.2.

Part II, Sub-Part 1:

Steel Reinforcing Bars and Steel Dowel Bars - 12

SCOPE: This sub-part provides procedures for being included on the Qualified Manufacturer List (QML) as a Fabricator of steel reinforcing bars and dowel bar for CDOT projects. CDOT will only accept steel reinforcing bars and dowel bars from a Fabricator on the QML.

CDOT will accept steel reinforcing bar suppliers who have both participated in AASHTO's NTPEP (National Transportation Product Evaluation Program) audit program of steel rebar and have received evaluation results deemed acceptable to CDOT. A letter must be addressed to CDOT's Product Evaluation Coordinator (PEC) requesting that the facility be placed on the CDOT's QML. A copy of the NTPEP Certificate of Compliance as well as any applicable documentation from the audit reports is required. CDOT may request additional information if necessary and may decertify a supplier for failing to meet CDOT expectations.

1. REFERENCED DOCUMENTS

Where applicable, the latest edition of the following standards shall be considered a part of these requirements.

1.1 CDOT Standard Specifications for Road and Bridge Construction:

- Section 412.13 – Joints
- Section 602 – Reinforcing Steel
- Section 709.01 – Reinforcing Steel
- Section 709.03 – Dowel Bars and Tie Bars

1.2 AASHTO Standards:

AASHTO M 31 – Standard Specification for Deformed and Plain Carbon Steel Bars for Concrete Reinforcement

AASHTO R 38 – Standard Practice for Quality Assurance of Standard Manufactured Materials

AASHTO T 244 – Standard Method of Test for Mechanical Testing of Steel Products

AASHTO M 55 – Standard Method of Test for Steel Welded Wire Reinforcement, Plain, for Concrete

AASHTO M 221 – Standard Method of Test for Steel Welded Wire Reinforcement, Deformed, for Concrete

1.3 ASTM Standards:

ASTM A 184 – Standard Specification for Welded Deformed Steel Bar Mats for Concrete Reinforcement

ASTM A 370 – Standard Test Methods and Definitions for Mechanical Testing of Steel Products

ASTM A 615 – Standard Specification for Deformed and Plain Billet-Steel Bars for Concrete Reinforcement

ASTM A 706 – Low-Alloy Steel Deformed and Plain Bars for Concrete Reinforcement

ASTM A 996 – Standard Specification for Rail-Steel and Axle-Steel Deformed Bars for Concrete Reinforcement

ASTM D 3665 – Standard Practice for Random Sampling of Construction Material

2. TERMINOLOGY

2.1 See AASHTO M 31 and ASTM A 370 for terminology related to steel reinforcing bars and dowel bars.

2.2 Coating Application Plant – The one who produces a protective coated steel reinforcing bar and a protective coated dowel bar.

2.3 Contractor – The company under contract with CDOT to produce products using steel reinforcing bars and dowel bars.

2.4 Deformed bar – Steel bar with protrusions; a bar that is intended for use as reinforcement in reinforced concrete construction.

2.5 Fabricator – The company, which cuts and bends steel reinforcing bars either coated or uncoated and/or assembles dowel bar baskets. The company may also provide uncut lengths of steel bar to the construction project site. Each plant constitutes a separate company.

2.6 Plain bar – Steel bar without protrusions; a bar that is intended for use as a dowel bar in transverse joints of concrete pavement construction.

2.7 Supplier – In this sub-part supplier shall be defined as one who produces or mills uncoated deformed steel reinforcing bars and steel plain bars used by the Fabricator.

2.8 Uncoated bar – Steel bar without protective coating.

2.9 Cement and Concrete Reference Laboratory (CCRL) Laboratory Inspection Program – Provides a comprehensive account of how procedures, practices, equipment and facilities compare with ASTM standards requirements. The CCRL laboratory inspector: checks critical equipment dimensions and operating characteristics, watches a technician demonstrate test procedures, and reviews the quality system when covered by appropriate ASTM standards.

3. SIGNIFICANCE AND USE

3.1 This Standard specifies requirements that should be followed by the Supplier in implementing an effective Quality Control (QC) system. This is accomplished by a certification system that evaluates quality control practices and specification compliance tests performed by the Supplier according to their quality control plans.

3.2 This Standard specifies requirements and procedures for a certification system that shall be applicable to all Suppliers providing steel reinforcing bars and dowel bars.

3.2.1 This Standard covers the responsibilities of the Supplier from point of delivery of steel reinforcing bars and dowel bars to the Fabricators plant, construction project site, and/or Coating Application Plant.

4. SAMPLING

4.1 All number and frequency of test samples required by this Standard shall be in accordance with AASHTO M 31 and ASTM A 996 (as a minimum) and the enhanced Manufacturer QC program. It is expected that the QC tests are to be tied to critical production processes as well as to the final product.

4.2 In addition, the QC program required by this Standard shall use stratified random sampling techniques. Stratified random sampling should be performed in accordance with ASTM D 3665. The use of a stratified random sampling procedure is mandatory to the establishment of a valid QC program. All random QC sample locations shall be properly documented.

NOTE 1: Determination of random locations (or timing) is universally applied to a construction site or to a Fabricator production line. ASTM D 3665 covers a flowing stream of material that can be applied to the production line of steel reinforcing bars and dowel bars.

5. TESTING REQUIREMENTS

5.1 An internal designated testing location and/or facility of a Supplier that performs the required testing under this Standard shall be identified in the submitted Quality System Manual (QSM) (per Section 9).

5.1.1 A copy of the certification of national accreditation program such as CCRL shall be reproduced in the submitted Quality System Manual (QSM) (per Section 9).

5.2 Testing required for this Standard shall be performed by qualified Supplier personnel through appropriate QC programs or appropriate training programs.

5.3 As a minimum, the Supplier's programs used shall include the following;

5.3.1 Training in AASHTO or ASTM test procedures.

5.3.2 Demonstration of proficiency in each Supplier's QC test.

5.3.3 Demonstration of ability to properly document Supplier's QC test results.

5.3.4 Demonstrate the ability to interpret all the test results.

6. SUPPLIER REQUIREMENTS

6.1 Uncoated bar Suppliers shall be on CDOT's Qualified Manufacturers List (QML) prior to use by the Fabricator. The QML can be found at the following web address www.coloradodot.info/business/APL/.

6.2 The uncoated bar Supplier shall provide an annual certification that all steel products delivered to the Fabricator and/or Coating Application Plant / Fabricator and permanently incorporated in the work shall have occurred in the United States of America.

7. CERTIFICATION

7.1 This section details the required documentation and samples to be submitted to the CDOT by the Supplier requesting to be added to the QML.

7.2 A brief outline of the procedures used to evaluate the finished product including: sampling and testing frequency, sample preparation methods, chemical analysis methods, and physical testing methods.

7.3 The results of all applicable chemical and/or physical tests required by ASTM A 615 on the most recent 40 samples (20 pairs) tested. The results shall be submitted in the format outlined in ASTM A 370.

7.4 A copy of the CCRL certification for the laboratory performing testing.

7.5 A copy of the reinforcing steel Supplier's Quality System Manual, which complies with the requirements of Section 9.

7.6 A sample of the proposed reinforcing steel at least 3 foot in length shall be shipped to

the Concrete and Physical Properties Program at the Materials and Geotechnical Branch, 4670 N. Holly Street, Unit A, Denver, CO 80216-6408.

7.7 The reinforcing steel Supplier shall allow CDOT to visit the production and/or shipping site to observe the reinforcing steel Supplier's quality control activities, to inspect the facilities, and to obtain samples for tests.

7.8 The reinforcing steel Supplier shall follow the procedures described in the CDOT approved quality system manual.

7.9 The reinforcing steel Supplier shall establish a continuing test record for every test required for each Type of reinforcing steel included in the written request.

7.10 The reinforcing steel Supplier shall submit to CDOT all reports required by this standard in a format approved by CDOT.

7.11 The reinforcing steel Supplier shall have a satisfactory record of compliance with CDOT project specifications. Decisions by CDOT concerning this requirement shall be based on the test results furnished by the Reinforcing Steel Supplier and satisfactory results when field samples are tested.

8. DECERTIFICATION

8.1 CDOT may decertify the Fabricator when conditions exist as specified on page 2 of CP 11 (Section 5 – Decertification).

NOTE 2: The term Supplier and Fabricator are interchangeable when reading Section 5 – Decertification on page 2.

9. SUPPLIER'S QUALITY SYSTEM MANUAL (MINIMUM REQUIREMENTS)

9.1 On an annual basis, at a minimum of one month prior to producing steel reinforcing bars and dowel bars for a CDOT project, one copy of the Supplier's Quality System Manual (QSM) shall be submitted for review and approval to CDOT's Product Evaluation Coordinator either at 303-398-6566 or within the Staff Materials & Geotechnical Branch at 4670 North Holly Street,

Unit A, Denver, Colorado 80216. In lieu of a may be submitted. The PDF'ed manual submittal must be complete and whole. CDOT's approval of the QSM is intended only to indicate that the QSM is in conformance with the minimum QC requirements set forth in this Standard. Once the Supplier is approved and on the QML, the QSM provisions will remain in effect for a period of one year, unless revisions are determined to be necessary by the Quality Control Manager or requested by CDOT, or if the Supplier is decertified. If any changes are made to the QSM, an updated copy shall be submitted to CDOT for review and approval. In lieu of a full updated copy, submittals of updates are acceptable. Updates shall be in the same format as the manual and are to be inserted into the manual to replace outdated pages. The updates may be in PDF format. The updated pages will have the date of update issuance and is to be recorded in a table of revisions. Guidelines for preparing a QSM are documented in AASHTO R 38.

9.2 The Supplier's QSM may be maintained in electronic format. However, one or more copies of the QSM shall be maintained by the Supplier's QC Manager in a printed and bound format. The QSM shall be available to all of the Supplier's employees. Each document in the QSM shall indicate its preparation date and all pages of the QSM shall be numbered. If a document is revised, the date of revision shall be indicated on the document and recorded in a table of revisions.

9.3 The Supplier's QSM shall be formatted to provide numbered sections which meet the following order, format and content:

9.3.1 Supplier's quality policy or mission Statement endorsed by the company's Chief Executive Officer.

9.3.1.1 The quality policy / mission statement shall indicate support of top management to enforce the QC requirements contained in the QSM.

9.3.2 The QSM shall include the address and telephone numbers of applicable personnel at the supplier facility.

9.3.3 The QSM shall include a brief listing and description of all the steel reinforcing bars and dowel bars being fabricated at the facility.

hard copy QSM, an electronic PDF document

9.3.4 The QSM shall present and define any significant terms used throughout the QSM.

9.3.5 For all fabricated items addressed in the QSM, the applicable AASHTO, ASTM, specification shall be identified.

9.3.6 The QSM shall present the personnel structure established to implement the Supplier's quality system. The specific roles and responsibilities of all QC personnel shall be documented as follows:

9.3.6.1 The QSM shall contain an organizational chart. The chart shall indicate a clear separation between the QC personnel and the production personnel. The QC Manager shall be allowed direct access to top management, independent from production.

9.3.6.2 Each facility shall have a Quality Control Manager who has the overall responsibility for implementing the requirements of the QSM. The QC Manager shall review the established QC system annually in order to satisfy this requirement, or if changes in the fabrication process(s) occur, or whenever technical or CDOT information indicate a trend in reduced quality.

9.3.6.3 Each facility shall have at least one Quality Control Technician to perform QC sampling, testing, and inspection. At least one QC Technician shall be on-site during production. The QC Technicians shall be familiar with the tests they perform and have sufficient authority to assure corrective actions are carried out when necessary. The QSM shall indicate the line of authority of the QC Technicians, which shall demonstrate their authority to require corrective action. The QSM shall designate the QC Technicians at the facility and laboratory involved in the production or testing of the steel reinforcing bars and dowel bars.

9.4 The QSM shall contain a description of the qualifications required and attained, as well as the years of experience for each QC Manager and QC Technician. All QC sampling, testing, QSM shall also include periodic auditing of each QC Technician's ability to satisfactorily perform the required tests. Retraining shall be provided when the test method is revised.

9.5 The QSM shall provide for specific training for frontline production personnel in the safe and correct operating procedures implemented to ensure the required quality of all steel reinforcing bars and dowel bars.

9.6 The Supplier shall maintain its own accredited or qualified laboratory to perform QC testing. The Supplier shall provide backup QC testing personnel and any necessary backup laboratory equipment. The QSM shall include the address and telephone numbers of the designated backup personnel. The Supplier's internal designated testing location and/or facility shall meet the minimum accreditations or qualifications obtained through CCRL:

9.7 The QSM shall contain an inventory of the necessary equipment used for sampling and testing along with associated calibration equipment used for each required test procedure. The QSM shall assign a unique identification number to each piece of testing equipment. The QSM inventory for each necessary piece of equipment shall include the following information:

9.7.1 The name of each necessary piece of equipment, date placed in service, manufacturer, model and serial number. The QSM shall include the location where the instructions for use and operation of each necessary piece of equipment is stored if not included in the QSM.

9.7.1.1 For each necessary piece of equipment, the QSM shall include the interval of calibration or verification, a reference to the calibration or verification procedures used, and the location where the current calibration or verification records are stored. The QSM shall describe the methods of calibration and verification procedures that are performed at the specified intervals.

9.7.2 The QSM shall contain a copy of the signed certification that all steel products permanently incorporated into the manufactured product shall have occurred in the United States of America.

10.5 CDOT may perform quality assurance testing.

10.6 CDOT may visit the Fabricator's site when required. CDOT may inspect the operations of

9.8 The QSM shall describe the procedure and frequency for inspection and selection of material samples during production. Sampling shall be performed on a stratified random procedure in accordance with ASTM D 3665. All random QC sample locations shall be properly documented and these procedures shall be included in the QSM.

9.9 The QSM shall contain descriptions and examples of the test report forms used by the Supplier. The QSM shall identify the individuals responsible for maintaining all test records and reports along with the location where the reports are stored.

9.9.1 The test reports shall be maintained and available for inspection for a minimum of three years.

9.10 The QSM shall contain a description of the procedures used to identify and document all material or test results that do not conform to specification requirements. The QSM shall contain provisions for resolving non-conforming material or test results.

9.11 The QSM shall describe procedures used to properly handle, store, and ship steel reinforcing bars and dowel bars.

10. CDOT EVALUATION PROCEDURE

10.1 Suppliers producing steel reinforcing bars and dowel bars shall meet the minimum industry standards.

10.2 Suppliers shall submit the required documentation and samples described in Section 7.

10.3 Within two months after submitting all required information, CDOT will notify the Supplier whether or not the manufacturing facility's application for the Qualified Manufacturer List has been granted.

10.4 CDOT may perform split sample testing in accordance with Section 11.

the Fabricator's facility including those related to shipments if required.

10.5 CDOT will post the Fabricator's name and approved plant on CDOT's Qualified

Manufacturer List (QML) in the web site at www.coloradodot.info/business/APL/.

10.6 Failure in one or more Sections or Sub-sections listed in this Standard may result in decertification of the plant and the plant will be removed from the QML. The Supplier may apply for reinstatement on the QML.

12.3 If the specification compliance test results do not conform to Subsection 709.01 and 709.03 of the CDOT Standard Specifications, the Fabricator shall remove the non-compliant material from the shipping queue.

11. SPLIT SAMPLE TESTING

11.1 CDOT may request split sample testing. A split sample is a sample taken and evenly divided to be tested by two or more individuals or laboratories. The test results will be exchanged as soon as they are available.

11.2 If the split sample test data is not within the agreed to precision for that particular test a review of both sampling and testing procedures will be conducted by both the Supplier and CDOT.

12. REQUIREMENTS FOR SHIPPING STEEL REINFORCING BARS AND DOWEL BARS BY AN APPROVED FABRICATOR

12.1 The steel reinforcing bars and dowel bars Supplier's QSM as approved by CDOT shall be implemented.

12.2 Each shipment shall be accompanied by two copies of the bill of lading, which shall include:

12.2.1 The name and location of the steel reinforcing bars and dowel bars Fabricator and the Supplier producing the steel reinforcing bars and dowel bars,

12.2.2 The size and grade of steel reinforcing bars and dowel bars conforming to specified specification,

12.2.3 Bars shall be separated and tagged with the Supplier's heat identification number,

12.2.4 The quantity of material shipped,

12.2.5 The date of shipment,

12.2.6 A copy of the mill test reports.

Part II, Sub-Part 2:

Epoxy-Coated Steel Reinforcing Bars and Epoxy-Coated Steel Dowel Bars - 12

SCOPE: This sub-part provides procedures for being included on the Qualified Manufacturers List (QML) as a producer of epoxy-coated steel reinforcing bars and epoxy-coated steel dowel bars for CDOT projects. CDOT will only accept epoxy-coated steel reinforcing bars and epoxy-coated steel dowel bars by a Manufacturer on the QML.

1. REFERENCED DOCUMENTS

Where applicable, the latest edition of the following standards shall be considered a part of these requirements.

1.1 CDOT Standard Specifications for Road and Bridge Construction:

- Section 412.13 – Joints
- Section 602 – Reinforcing Steel
- Section 709.01 – Reinforcing Steel
- Section 709.03 – Dowel Bars and Tie Bars

1.2 AASHTO Standards:

AASHTO M 31 – Standard Specification for Deformed and Plain Carbon Steel Bars for Concrete Reinforcement

AASHTO M 254 – Standard Specification for Corrosion-Resistant Coated Dowel Bars

AASHTO M 284 – Standard Specification for Epoxy-Coated Reinforcing Bars: Materials and Coating Requirements

AASHTO M 317 – Standard Specification for Epoxy-Coated Reinforcing Bars: Handling Requirements for Fabrication and Job Site

AASHTO R 38 – Standard Practice for Quality Assurance of Standard Manufactured Materials

AASHTO T 253 – Standard Method of Test for Coated Dowel Bars

1.3 ASTM Standards:

ASTM A 615 – Standard Specification for Deformed and Plain Billet-Steel Bars for Concrete Reinforcement

ASTM A 775 – Standard Specification for Epoxy-Coated Steel Reinforcing Bars

ASTM D 3665 – Standard Practice for Random Sampling of Construction Material

ASTM D 3963 – Standard Specification for Fabrication and Jobsite Handling of Epoxy-Coated Steel Reinforcing Bars

1.4 Concrete Reinforcing Steel Institute (CRSI):

Epoxy Coating Plant Certification Manual

2. TERMINOLOGY

2.1 See AASHTO M 284 for terminology related to epoxy-coated steel reinforcing bars.

2.2 Coated bar – Steel bar with protective epoxy coating applied by the electrostatic spray method.

2.3 Contractor – The company under contract with CDOT to produce products using epoxy-coated steel reinforcing bars and epoxy-coated steel dowel bars.

2.4 Deformed bar – Steel bar with protrusions; a bar that is intended for use as reinforcement in reinforced concrete construction.

2.5 Fabricator – The company, which cuts and bends steel reinforcing bars either coated or uncoated and/or assembles dowel bar baskets.

2.6 Manufacturer – The company, which produces epoxy-coated steel reinforcing bars and epoxy-coated steel dowel bars. Each epoxy-coated applicator plant constitutes a separate company.

2.7 Plain bar – Steel bar without protrusions; a bar that is intended for use as a dowel bar in transverse joints of concrete pavement construction.

2.8 Supplier – In this sub-part it shall be defined as one who provides materials used in the manufacturing of epoxy-coated steel reinforcing bars and epoxy-coated steel dowel bars. Uncoated steel reinforcing bars, uncoated dowel bars, and powder coating are among the materials provided to the Manufacturer.

2.9 Uncoated bar – Steel bar without protective epoxy coating.

3. SIGNIFICANCE AND USE

3.1 This Standard specifies requirements that should be followed by the Manufacturer in implementing an effective Quality Control (QC) system. This is accomplished by a certification system that evaluates quality control practices and specification compliance tests performed by the Manufacturer according to their quality control plans.

3.2 This Standard specifies requirements and procedures for a certification system that shall be applicable to all Manufacturers providing epoxy-coated steel reinforcing bars and epoxy-coated steel dowel bars. These provisions initially apply to the plant manufacturing the epoxy-coated steel reinforcing bars and epoxy-coated steel dowel bars.

3.2.1 This Standard covers the responsibilities of the Manufacturer from point of delivery of uncoated deformed or plain bars at the applicator plant to point of delivery on the construction project site and/or Fabricator plant.

3.3 This Standard applies to Fabricators that use epoxy-coated bars. The Fabricator shall conform to the requirements of ASTM D 3963 for fabrication of bars and dowel bar assemblies after the application of the epoxy-coating.

3.3.1 This Standard covers the responsibilities of the Fabricator from point of delivery of epoxy-coated steel reinforcing bars and epoxy-coated steel dowel bars at the Fabricators plant to point of delivery on the construction project site.

3.3.2 This Standard covers the responsibilities of the Fabricator from point of delivery of uncoated bars to point of delivery of the Manufacturers application site.

3.3.3 This Standard subsequently covers epoxy-coated steel reinforcing bars and epoxy-coated steel dowel bars for use on CDOT projects. The Contractor shall conform to the requirements of ASTM D 3963 for job site handling of epoxy-coated bars.

4. SAMPLING

4.1 All number and frequency of test samples required by this Standard shall be in accordance with AASHTO M 284 (as a minimum) and the enhanced Manufacturer QC program. It is expected the QC tests are to be tied to critical production processes as well as to the final product.

NOTE 1: AASHTO M 284 specifies the number and frequency of tests for coating thickness, continuity, flexibility, and adhesion. For example, an enhanced Manufacturer QC program that exceeds the minimum set forth in AASHTO M 284 would document the method of determination of an additional randomly selected bar to test the bar surface temperature before applying the coating.

4.2 In addition, the QC program required by this Standard shall use stratified random sampling techniques. Stratified random sampling should be performed in accordance with ASTM D 3665. The use of a stratified random sampling procedure is mandatory to the establishment of a valid QC program. All random QC sample locations shall be properly documented.

NOTE 2: Determination of random locations (or timing) is universally applied to a construction site or to a Manufacturer's production line. ASTM D 3665 covers a flowing stream of material that can be applied to the production line of epoxy-coated bars.

5. TESTING REQUIREMENTS

5.1 An internal designated testing location and/or facility of a Manufacturer that performs

the required testing under this Standard shall be identified in the submitted Quality System Manual (QSM) (per Section 9).

5.2 Testing required for this Standard shall be performed by qualified Manufacturers personnel through appropriate QC programs or appropriate training programs.

5.3 As a minimum, the Manufacturers programs used shall include the following;

5.3.1 Training in AASHTO, ASTM, or CRSI test procedures.

5.3.2 Demonstration of proficiency in each Manufactures QC test.

5.3.3 Demonstration of ability to properly document Manufactures QC test results.

5.3.4 Demonstrate the ability to interpret all the test results.

6. SUPPLIER REQUIREMENTS

6.1 Uncoated bar Suppliers shall be on CDOT's Qualified Manufacturers List (QML) prior to use by the Manufacturer. The QML can be found at the following web address: www.coloradodot.info/business/APL/.

6.2 Uncoated bar Suppliers shall follow the procedures described in the CDOT approved quality control plan as required in CP 11 Part I, Sub-Part 6.

6.3 The uncoated bar Supplier shall provide an annual certification that all steel products delivered to the Manufacturer and permanently incorporated in the work shall have occurred in the United States of America.

6.4 Suppliers of epoxy powder shall be on CDOT's Approved Product List (APL). The APL along with instruction for completing CDOT Form #595, Pre-Approved Product Evaluation Request & Summary, can be found at the following web address: www.coloradodot.info/business/APL/.

7. CURRENTLY CERTIFIED MANUFACTURERS

7.1 A Manufacturer, which has been certified for the past three consecutive years under the Concrete Reinforcing Steel Institute (CRSI) certification plant program, will be placed on CDOT's QML after submitting all of the following:

- The certificate from the current year and the preceding three consecutive years of evaluations from CRSI,
- The inspection report from the current year and the preceding three consecutive years of evaluations from CRSI,
- The Quality System Manual as outlined in Section 9 of this Standard.

7.2 A Manufacturer, which has been certified for less than three consecutive years under the CRSI certification plant program will be on probation and placed on the QML after submitting all of the following:

- The certificate from the current year along with any preceding years of evaluations from CRSI,
- The inspection report from the current year along with any preceding years of evaluations from CRSI,
- The Quality System Manual as outlined in Section 9 of this Standard.

7.2.1 The probation period will be for three consecutive years after being placed on the QML.

8. DECERTIFICATION

8.1 This section applies to Manufacturers that are classified under Subsection 7.1. If the Manufacturer becomes decertified by CRSI certification plant program after being placed on the QML, the Manufacturer will be removed from the QML until successfully completing and submitting to CDOT the requirements within this Standard. Decertification is the final ruling after the CRSI dispute process has been completed. The Manufacturer may apply for reinstatement on the QML no sooner than six months after removal from the QML. The probationary period will be for one year after being placed back on the QML with Subsections 7.2, 8.2, and 8.3 of this Standard being applied.

8.2 This section applies to Manufacturers that are classified under Subsection 7.2. If the Manufacturer becomes decertified by CRSI certification plant program after being placed on the QML, the Manufacturer will be removed from the QML until successfully completing and submitting to CDOT the requirements within this Standard. The Manufacturer may apply for reinstatement on the QML no sooner than three years after removal from the QML.

8.3 CDOT may decertify the Manufacturer when conditions exist as specified in Section 5 - Decertification within the Introduction of the CP 11 Page 2.

NOTE 3: The term Supplier and Manufacturer are interchangeable when reading Section 5 – Decertification from page 2.

9. MANUFACTURER'S QUALITY SYSTEM MANUAL (MINIMUM REQUIREMENTS)

9.1 On an annual basis, at a minimum of one month prior to producing epoxy-coated steel reinforcing bars and epoxy-coated steel dowel bars for a CDOT project, one copy of the Manufacturer's Quality System Manual (QSM) shall be submitted for review and approval to CDOT's Product Evaluation Coordinator (303) 398-6566 within the Staff Materials & Geotechnical Branch at 4670 North Holly Street, Unit A, Denver, Colorado 80216-6408. In lieu of a hard copy QSM, a PDF format document may be submitted. The PDF manual submittal must be complete and whole. CDOT's approval of the QSM is intended only to indicate that the QSM is in conformance with the minimum QC requirements set forth in this Standard. Once the Manufacturer is approved and on the Qualified Manufacturers List (QML), the QSM provisions will remain in effect for a period of one year, unless revisions are determined to be necessary by the Quality Control Manager or requested by CDOT, or if the Manufacturer is decertified. If any changes are made to the QSM, an updated copy shall be submitted to CDOT for review and approval. In lieu of a full updated copy, submittals of updates are acceptable. Updates shall be in the same format as the manual and are to be inserted into the manual to replace outdated pages. The updates may be in PDF format. The updated pages will have the date of update issuance and

is to be recorded in a table of revisions. Guidelines for preparing a QSM may be available from the Concrete Reinforcing Steel Institute (CRSI). Guidelines are also documented in AASHTO R 38.

9.2 The Manufacturer's QSM shall include the latest edition of CRSI Plant Certification Manual.

9.3 The Manufacturer's QSM may be maintained in electronic format. However, one or more copies of the QSM shall be maintained by the Manufacturer's QC Manager in a printed and bound format (3-ring or other). The QSM shall be available to all of the Manufacturer's employees. Each document in the QSM shall indicate its preparation date and all pages of the QSM shall be numbered. If a document is revised, the date of revision shall be indicated on the document and recorded in a table of revisions.

9.4 The Manufacturer's QSM shall be formatted to provide numbered sections which meet the following order, format, and content:

9.4.1 Manufacturer's quality policy or mission Statement endorsed by the company's Chief Executive Officer.

9.4.1.1 The quality policy / mission statement shall indicate support of top management to enforce the QC requirements contained in the QSM.

9.4.2 The QSM shall include the address and telephone numbers of applicable personnel at the manufacturing facility. If applicable, the QSM shall include the address and telephone numbers of responsible personnel of the Fabricators.

9.4.3 The QSM shall include a brief listing and description of all the epoxy-coated deformed and plain bars being manufactured at the facility.

9.4.4 The QSM shall present and define any significant terms used throughout the QSM.

9.4.5 For all manufactured items addressed in the QSM, the applicable AASHTO, ASTM, or CDOT specification shall be identified.

9.4.6 The QSM shall present the personnel structure established to implement the

Manufacturer's quality system. The specific roles and responsibilities of all QC personnel shall be documented as follows:

9.4.6.1 The QSM shall contain an organizational chart. The chart shall indicate a clear separation between the QC personnel and the production personnel. The QC Manager shall be allowed direct access to top management, independent from production.

9.4.6.2 Each facility shall have a Quality Control Manager who has the overall responsibility for implementing the requirements of the QSM. The QC Manager shall review the established QC system annually in order to satisfy this requirement, or if changes in the manufacturing process(s) occur, or whenever technical or CDOT information indicate a trend in reduced quality.

9.4.6.3 Each facility shall have at least one Quality Control Technician to perform QC sampling, testing, and inspection. At least one QC Technician shall be on-site during production. The QC Technicians shall be familiar with the tests they perform and have sufficient authority to assure corrective actions are carried out when necessary. The QSM shall indicate the line of authority of the QC Technicians, which shall demonstrate their authority to require corrective action. The QSM shall designate the QC Technicians at the facility and laboratory involved in the production or testing of the epoxy-coated steel reinforcing bars and epoxy-coated steel dowel bars.

9.5 The QSM shall contain a description of the qualifications required and attained, and years of experience for each QC Manager and QC Technician. All QC sampling, testing, and inspection personnel shall be trained. Plants certified by CRSI shall have at least one QC Manager and at least one QC Technician who are capable of performing and correctly interpreting all the tests required by CRSI Plant Certification Manual. The QSM shall also include periodic auditing of each QC Technician's ability to satisfactorily perform the required tests. Retraining shall be provided when the test method is revised.

9.6 The QSM shall provide for specific training for frontline production personnel in the safe and correct operating procedures implemented to ensure the required quality of all epoxy-coated

steel reinforcing bars and epoxy-coated steel dowel bars.

9.7 The Manufacturer shall maintain its own qualified internal designated testing location and/or facility to perform QC testing. The Manufacturer shall provide backup QC testing personnel and any necessary backup laboratory equipment. The QSM shall include the address and telephone numbers of a designated backup personnel. The Manufacturer's internal designated testing location and/or facility shall meet the minimum accreditations or qualifications obtained through one or more of the following programs:

9.7.1 The manufacturing industry's Concrete Reinforcing Steel Institute Certification Plant Program.

9.7.2 National accreditation programs such as AASHTO Accreditation Program or American Association for Laboratory Accreditation.

9.8 The QSM shall contain an inventory of the necessary equipment used for sampling and testing along with associated calibration equipment used for each required test procedure. The QSM shall assign a unique identification number to each piece of testing equipment. The QSM inventory for each necessary piece of equipment shall include the following information:

9.8.1 The name of each necessary piece of equipment, date placed in service, Manufacturer, model and serial number. The QSM shall include the location where the instructions for use and operation of each necessary piece is stored if not included in the QSM.

9.8.1.1 For each necessary piece of equipment, the QSM shall include the interval of calibration or verification, a reference to the calibration or verification procedures used, and the location where the current calibration or verification records are stored. The QSM shall describe the methods of calibration and verification procedures that are performed at the specified intervals.

9.9 The QSM shall identify all types of Supplier delivered materials used for the production of epoxy-coated steel reinforcing bars and epoxy-coated steel dowel bars.

9.9.1 The QSM shall contain a copy of the signed certification from the steel Supplier that all steel products permanently incorporated into the manufactured product shall have occurred in the United States of America.

9.9.2 The QSM shall contain a description of the specification requirements for all Supplier delivered materials.

9.9.3 The QSM shall contain a description of the certification and test reports delivered by the Supplier and a location where these records are stored.

9.9.4 The QSM shall include all QC testing of the supplied materials and shall contain a statement that no raw materials shall be used unless they are on the APL or they have been tested and meet all appropriate CDOT, AASHTO, or ASTM specifications.

9.9.5 All Supplier delivered materials shall be properly stored to prevent damage, contamination, or other alterations prior to use in production. The QSM shall include procedures for the adequate storage of supplied materials.

9.10 The QSM shall describe the procedure and frequency for inspection and selection of material samples during production. Sampling shall be performed on a stratified random procedure in accordance with ASTM D 3665. All random QC sample locations shall be properly documented and these procedures shall be included in the QSM.

9.11 The QSM shall contain descriptions and examples of the test report forms used by the Manufacturer. The QSM shall identify the individual(s) responsible for maintaining all test records and reports along with the location where the reports are stored.

9.11.1 The test reports shall be maintained and available for inspection for a minimum of three years.

9.12 The QSM shall contain a description of the procedures used to identify and document all material or test results that do not conform to specification requirements. The QSM shall contain provisions for resolving non-conforming material or test results.

9.13 The QSM shall describe procedures used to properly handle, store, and ship epoxy-coated steel reinforcing bars and epoxy-coated steel dowel bars.

10. CDOT EVALUATION PROCEDURE

10.1 Manufacturing facilities producing epoxy-coated steel reinforcing bars and epoxy-coated steel dowel bars shall meet the minimum industry standards, and be annually inspected and certified by CRSI. A copy of the certification shall be submitted to CDOT as part of the QML process.

10.2 Initially the Manufacturer shall submit a representative sample of epoxy-coated steel reinforcing bars and epoxy-coated steel dowel bars, test result documentation, and QSM to CDOT's Product Evaluation Coordinator (303) 398-6566 within the Staff Materials & Geotechnical Branch at 4670 North Holly Street, Unit A, Denver, Colorado 80216-6408.

10.2.1 A representative sample of an epoxy-coated steel reinforcing bar at least 3 foot in length and an epoxy-coated steel dowel bar 18 inches long shall be shipped.

10.2.2 The results of all applicable chemical and/or physical tests required by AASHTO M 284 on the most recent 20 samples tested. The results shall be submitted in the format outlined in AASHTO M 284 and as documented in the Manufacturer's QSM.

10.2.3 One copy of the Manufacturer's Quality System Manual shall be submitted.

10.3 CDOT will verify that the Manufacturer's QSM is adequate.

10.4 Within two months after submitting all required information, CDOT will notify the Manufacturer whether or not the manufacturing facility's application for the Qualified Manufacturers List has been granted.

10.5 CDOT may perform split sample testing in accordance with Section 11.

10.6 CDOT may perform quality assurance testing.

10.7 CDOT may visit the Manufacturer's site when required. CDOT may inspect the operations of the Manufacturer's facility including those related to shipments if required.

10.8 CDOT will post the Manufacturer's name and approved plant on CDOT's Qualified Manufacturers List in the web site: www.coloradodot.info/business/APL/.

10.9 Failure in one or more Sections or Sub-sections listed in this Standard may result in an accelerated inspection program. Any additional failures to meet these minimum requirements shall result in the decertification of the plant and the plant will be removed from the QML. The Manufacturer may apply for reinstatement on the QML no sooner than stipulated in Section 8 of this Standard.

11. SPLIT SAMPLE TESTING

11.1 CDOT may request split sample testing. A split sample is a sample taken and evenly divided to be tested by two or more individuals or laboratories. The test results will be exchanged as soon as they are available.

11.2 If the split sample test data is not within the agreed to precision for that particular test a review of both sampling and testing procedures will be conducted by both the Manufacturer and CDOT.

12. REQUIREMENTS FOR SHIPPING EPOXY-COATED STEEL REINFORCING BARS AND EPOXY-COATED STEEL DOWEL BARS BY AN APPROVED MANUFACTURER

12.1 The epoxy-coated steel reinforcing bars and epoxy-coated steel dowel bars Manufacturer's QSM as approved by CDOT shall be implemented.

12.2 Each shipment shall be accompanied by two copies of the bill of lading, which shall include:

12.2.1 The name and location of the epoxy-coated steel reinforcing bars and epoxy-coated steel dowel bars Manufacturer and the plant producing the epoxy-coated steel reinforcing bars and epoxy-coated steel dowel bars,

12.2.2 The size and grade of epoxy-coated steel reinforcing bars and epoxy-coated steel dowel bars conforming to CDOT specification,

12.2.3 Certifications for the powder coating,

12.2.4 The quantity of material shipped,

12.2.5 The date of shipment,

12.2.6 A copy of the mill test reports.

12.3 If the specification compliance test results do not conform to Subsection 709.01 and 709.03 specifications, the Manufacturer shall remove the non-compliant material from the shipping queue.

13. FABRICATION AND JOBSITE HANDLING

13.1 The coated bars to be fabricated by the Fabricator or field fabricated by the Contractor after application of the coating shall meet the following:

13.1.1 Contact points, such as drive rollers, shear contacts, mandrels and backup barrels on benders shall be protected with a suitable covering to minimize damage during the fabrication process.

13.1.2 The Fabricator shall be responsible for repair to the coating due to damage during shipment, storage, or fabrication at the Fabricator's facility.

13.1.3 The Contractor shall be responsible for repair to the coating due to damage during shipment, storage, fabrication, or placement at the construction jobsite.

13.2 Coating damaged due to fabrication or handling shall be repaired with patching material. The patching or repairing shall be performed in accordance with the written recommendations of the patching material Supplier.

13.3 Patching or repair material shall be compatible with the coating, inert in concrete, and feasible for repairs. The patching or repair material shall conform to AASHTO M 317.

Part II, Sub-Part 3:

Precast Concrete Structures - 11

SCOPE: This sub-part provides procedures for being included on the Qualified Manufacturers List (QML) as a fabricator of precast (**not prestressed**) concrete structures for CDOT projects. The precast concrete structures may include, but are not limited to: inlets, manholes, junction boxes, box culverts, modular bridges (3-sided box culvert), pipes, cattle guards, and Type 7 barrier. CDOT will only accept precast concrete structures by a manufacturer on the QML.

1. REFERENCED DOCUMENTS

Where applicable, the latest edition of the following standards shall be considered a part of these requirements.

1.1 CDOT Standard Specifications for Road and Bridge Construction:

- Section 601 – Structural Concrete
- Section 603 – Culverts and Sewers
- Section 604 – Manholes, Inlets, and Vaults
- Section 606 – Guardrail
- Section 611 – Cattle Guards
- Section 617 – Culvert Pipe
- Section 701 – Hydraulic Cement
- Section 703 – Aggregates
- Section 709 – Reinforcing Steel and Wire Rope
- Section 711 – Concrete Curing Materials and Admixtures
- Section 712 - Miscellaneous

1.2 CDOT Standard Plans (M & S Standards):

- M-601-1 Single Concrete Box Culvert
- M-601-2 Double Concrete Box Culvert
- M-601-3 Triple Concrete Box Culvert
- M-601-10 Headwalls for Pipe Culverts
- M-603-2 Reinforced Concrete Pipe
- M-603-3 Precast Concrete Box Culvert,
- M-603-10 Concrete and Metal End Sections,
- M-604-10 Inlet, Type C
- M-604-11 Inlet, Type D
- M-604-12 Inlet, Type R
- M-604-13 Inlet, Type 13
- M-604-20 Manholes
- M-604-25 Vane Grate Inlet with Frame and Concrete Apron
- M-606-14 Precast Type 7 Concrete Barrier
- M-611-1 Cattle Guard

- 1.3 AASHTO Standards:
- M 6 Fine Aggregate for Portland Cement Concrete
- M 43 Sizes of Aggregate for Road and Bridge Construction
- M 55 Steel Welded Wire Reinforcement, Plain, for Concrete
- M 86 Standard Specification for Concrete Sewer, Storm Drain, and Culvert Pipe
- M 157 Ready-Mixed Concrete
- M 170 Standard Practice for Reinforced Concrete Culvert, Storm Drain, and Sewer Pipe
- M 206 Reinforced Concrete Arch Culvert, Storm Drain, and Sewer Pipe
- M 207 Reinforced Concrete Elliptical Culvert, Storm Drain, and Sewer Pipe
- M 221 Steel Welded Wire Reinforcement, Deformed, for Concrete
- M 242 Reinforced Concrete D-Load Culvert, Storm Drain, and Sewer Pipe
- M 284 Epoxy-Coated Reinforcing Bars: Materials and Coating Requirements
- R 38 Quality Assurance of Standard Manufactured Materials

- 1.4 ASTM Standards:
- C 361 Standard Specification for Reinforced Concrete Low-Head Pressure Pipe
- C 923 Standard Specification for Resilient Connectors between Reinforced Concrete Manhole Structures, Pipes, and Laterals
- C 936 Standard Specification for Joints for Concrete Pipe, Manholes, and Precast Box Sections using Preformed Flexible Joint Sealants
- C 1017 Standard Specification for Chemical Admixtures for Use in Producing Flowing Concrete
- C 1478 Standard Specification for Storm Drain Resilient Connectors between Reinforced Concrete Storm Sewer Structures, Pipes, and Laterals
- D 3665 Standard Practice for Random Sampling of Construction Materials

2. TERMINOLOGY

- 2.1 See AASHTO M 262 Standard Terminology Relating to Concrete Pipe.

2.2 Conventional mix – In this Standard it shall be defined as a Class of concrete in Section 601 of CDOT's Standard Specifications for Road and Bridge Construction.

2.3 Dry Cast – In this Standard it shall be defined as zero slump concrete most often used for pipes, box culverts, and manholes.

2.4 Manufacturer – A company which manufactures and supplies Standard Manufactured Materials for the Prime Contractor, Sub-contractor, or CDOT.

2.5 Prime Contractor – The company under contract with CDOT to produce products using precast concrete structures.

2.6 Quality System Manual (QSM) – A written document that describes the overall internal quality control operating procedures of a Manufacturer. The QSM documents the internal policies for achieving quality and the assignment of responsibility and accountability for quality control within the Manufacturer's organization. It shall describe the minimum quality control requirements expected of material suppliers who are involved with the Manufacturer's product.

2.7 Self-Compacting (leveling) Concrete – In this Standard it shall be defined as a very high slump concrete where the spread is measured using a slump cone. The spread is usually between 22 to 32 inches in diameter. In addition, the mix usually contains a superplasticizer and a viscosity-modifying admixture (VMA). This concrete is usually used for manholes and inlets

2.8 Supplier – In this Standard it shall be defined as one who provides materials used in the manufacturing of precast concrete structures. Cement, fly ash, welded wire reinforcement (WWR), and epoxy coated reinforcing bar are among the materials provided to the manufacturer.

2.9 Wet Cast – In this Standard it shall be defined as anything other than zero slump concrete. This concrete is usually used for manholes and inlets.

3. SIGNIFICANCE AND USE

3.1 This procedure specifies requirements that should be followed by the Manufacturer in implementing an effective Quality Control (QC) system. This is accomplished by a certification system that evaluates quality control practices and specification compliance tests performed by the Manufacturer according to their quality control plans.

3.2 This Standard specifies requirements and procedures for a certification system that shall be applicable to all Manufacturers providing precast concrete structures. These provisions initially apply to the plant manufacturing the precast concrete structures. These provisions subsequently apply to the Contractor, after delivery of the precast concrete structure to the Contractor, for use on CDOT projects.

4. SAMPLING

4.1 All test samples required by this Standard shall be obtained using stratified random sampling techniques. Stratified random sampling should be performed in accordance with ASTM D 3665. The use of a stratified random sampling procedure is mandatory to the establishment of a valid QC program. All random QC sample locations shall be properly documented.

5. TESTING REQUIREMENTS

5.1 Testing required for this Standard shall be performed by certified personnel or in accredited laboratories through appropriate QC Certification programs. Any satellite laboratory of a Manufacturer that performs required testing under this Standard shall be identified in the submitted Quality System Manual (QSM) (Section 9).

5.2 As a minimum, the certification program used shall include the following;

5.2.1 Training in AASHTO, ASTM, or ACI test procedures.

5.2.2 Demonstration of proficiency in each required test.

5.2.3 Demonstration of ability to properly document test results.

6. SUPPLIER REQUIREMENTS

6.1 Cement, fly ash, and concrete admixture suppliers shall be on CDOT's Approved Product List (APL) prior to use by the manufacturer. The APL along with instruction for completing CDOT Form #595, Pre-Approved Product Evaluation Request & Summary, can be found at the following web address: www.coloradodot.info/business/APL/. The Form #595 is designed as a PDF Writeable form, which must be completed by the supplier or their Product Representative. The completed form shall be returned to CDOT's Product Evaluation Coordinator as an e-mail attachment.

6.2 The cement and fly ash suppliers shall follow the procedures described in the CDOT approved quality control plan as required in CP 11 Part I, Sub-Part 3 and 4 respectively.

6.3 The steel supplier shall provide an annual certification that all steel products delivered to the manufacturer and permanently incorporated in the work shall have occurred in the United States of America.

7. CURRENTLY CERTIFIED MANUFACTURERS

7.1 A manufacturer, regardless of their current casting process, which has been certified for the past three consecutive years under the American Concrete Pipe Association (ACPA) for all pipe products, dry cast box culverts, and manholes, or under the National Precast Concrete Association (NPCA) for all pipe products, manholes, modular bridges, and other wet cast products, will be placed on the QML after submitting all of the following:

- The certificate from the current year and the preceding three consecutive years of evaluations from NPCA or ACPA,
- The score summary sheets from the current year and the preceding three consecutive years of evaluations from NPCA or ACPA,
- The Quality System Manual as outlined in Section 9 of this Standard.

7.2 A manufacturer, regardless of their current casting process, which has been certified for less than three consecutive years under the American Concrete Pipe Association (ACPA) for all pipe products, dry cast box culverts, and manholes or under the National Precast Concrete Association (NPCA) for manholes, modular bridges, and other wet cast products will be on probation and placed on the QML after submitting all of the following:

- The certificate from the current year along with any preceding years of evaluations from NPCA or ACPA,
- The score summary sheets from the current year along with any preceding years of evaluations from NPCA or ACPA,
- The Quality System Manual as outlined in Section 9 of this Standard.

7.2.1 The probation period will be for three consecutive years after being placed on the QML.

8. DECERTIFICATION

8.1 If the manufacturer becomes decertified after being placed on the QML, the manufacturer will be removed from the QML until successfully completing and submitting to CDOT the requirements within this Standard. The manufacturer may apply for reinstatement on the QML no sooner than six months after removal from the QML.

8.2 If the manufacturer becomes decertified due to a structural failure of a product during the probationary period, the manufacturer will be removed from the QML until successfully completing and submitting to CDOT the requirements within this Standard. A structural failure will be determined by the Engineer in accordance with the FHWA Report Number FHWA-IP-86-2 "Culvert Inspection Manual." The manufacturer may apply for reinstatement on the QML no sooner than three years after removal from the QML.

9. MANUFACTURER'S QUALITY SYSTEM MANUAL (MINIMUM REQUIREMENTS)

9.1 On an annual basis, at a minimum of one month prior to producing any precast concrete structure for a CDOT project, one copy

of the Manufacturer's Quality System Manual (QSM) shall be submitted for review and approval to CDOT's Product Evaluation Coordinator (303) 398-6566 within the Staff Materials & Geotechnical Branch at 4670 North Holly Street, Unit A, Denver, Colorado 80216-6408. CDOT's approval of the QSM is intended only to indicate that the QSM is in conformance with the minimum QC requirements set forth in this Standard. Once the manufacturer is approved and on the Qualified Manufacturers List (QML), the QSM provisions will remain in effect for a maximum period of one calendar year, unless revisions are determined to be necessary by the Quality Control Manager or requested by CDOT, or if the manufacturer is decertified. If any changes are made to the QSM, an updated copy shall be submitted to CDOT for review and approval. Guidelines for preparing a QSM may be available from the National Precast Concrete Association (NPCA) or the American Concrete Pipe Association (ACPA).

9.2 The Manufacturer's QSM may be maintained in electronic format. However, one or more copies of the QSM shall be maintained by the Manufacturer's QC Manager in a printed and bound format (3-ring or other). The QSM shall be available to all of the Manufacturer's employees. Each document in the QSM shall indicate its preparation date and all pages of the QSM shall be numbered. If a document is revised, the date of revision shall be indicated on the document and recorded in a table of revisions.

9.3 The Manufacturer's QSM shall be formatted to provide numbered sections which meet the following order, format, and content:

9.3.1 Manufacturer's quality policy or mission Statement endorsed by the company's Chief Executive Officer.

9.3.1.1 The quality policy / mission statement shall indicate support of top management to enforce the QC requirements contained in the QSM.

9.3.2 The QSM shall include the address and telephone numbers of applicable personnel at the manufacturing facility.

9.3.3 The QSM shall include a brief listing and description of all the precast products being manufactured at the facility.

9.3.4 The QSM shall present and define any significant terms used throughout the QSM.

9.3.5 For all manufactured items addressed in the QSM, the applicable AASHTO, ASTM, or CDOT specification shall be identified.

9.3.6 The QSM shall present the personnel structure established to implement the Manufacturer's quality system. The specific roles and responsibilities of all QC personnel shall be documented as follows:

9.3.6.1 The QSM shall contain an organizational chart. The chart shall indicate a clear separation between the QC personnel and the production personnel. The QC Manager shall be allowed direct access to top management, independent from production.

9.3.6.2 Each facility shall have a Quality Control Manager who has the overall responsibility for implementing the requirements of the QSM. At least one QC Manager shall be on-site during production. The QC Manager shall review the established QC system annually in order to satisfy this requirement, or if changes in the manufacturing process(s) occur, or whenever technical or CDOT information indicate a trend in reduced quality.

9.3.6.3 Each facility shall have at least one Quality Control Technician to perform QC sampling, testing, and inspection. At least one QC Technician shall be on-site during production. The QC Technicians shall be familiar with the tests they perform and have sufficient authority to assure corrective actions are carried out when necessary. The QSM shall indicate the line of authority of the QC Technicians, which shall demonstrate their authority to require corrective action. The QSM shall designate the certified QC Technicians at the facility and laboratory involved in the production or testing of the precast concrete structures.

9.4 The QSM shall contain a description of the certifications required and attained and years of experience for each QC Manager and QC Technician. All QC sampling, testing, and

inspection personnel shall be certified by ACI Concrete Field Technician Level 1 or higher. Plants certified by NPCA shall have at least one QC Manager and at least one QC Technician who has successfully completed the NPCA's Production and Quality School or ACPA's approved equivalent. The QSM shall also include periodic auditing of each QC technician's ability to satisfactorily perform the required tests. Retraining shall be provided when the test method is revised.

9.5 The QSM shall provide for specific training for frontline production personnel in the safe and correct operating procedures implemented to ensure the required quality of all precast concrete structures.

9.6 The Manufacturer shall maintain its own accredited or qualified laboratory to perform QC testing. The QSM shall include the address and telephone numbers of a designated backup accredited or qualified laboratory. The laboratory shall meet the minimum accreditations or qualifications obtained through one or more of the following programs depending on the casting process:

9.6.1 For "dry" cast plant laboratories:

9.6.1.1 National accreditation programs such as AASHTO Accreditation Program or American Association for Laboratory Accreditation.

9.6.1.2 Either the Manufacturing industry's American Concrete Pipe Association's Q-Cast program or the National Precast Concrete Association Certification program.

9.6.2 For "conventional", "wet", or "Self-Compacting" cast plant laboratories:

9.6.2.1 National accreditation programs such as AASHTO Accreditation Program or American Association for Laboratory Accreditation.

9.6.2.2 The Manufacturing industry's National Precast Concrete Association Certification program.

9.7 The QSM shall contain an inventory of the major equipment used for sampling and testing along with associated calibration equipment used for each required test procedure. The QSM shall assign a unique

identification number to each piece of testing equipment. The QSM inventory for each major piece of equipment shall include the following information:

9.7.1 The name of each major piece of equipment, date placed in service, manufacturer, model and serial number. The QSM shall include the location where the instructions for use and operation of each major piece is stored if not included in the QSM.

9.7.1.1 For each major piece of equipment, the QSM shall include the interval of calibration or verification, a reference to the calibration or verification procedures used, and the location where the current calibration or verification records are stored. The QSM shall describe the methods for ensuring that the calibration and verification procedures are performed at the specified intervals.

9.8 The QSM shall identify all types of supplier delivered materials used for the production of precast concrete structures.

9.8.1 The QSM shall contain a copy of the signed certification from the steel supplier that all steel products permanently incorporated into the manufactured product shall have occurred in the United States of America.

9.8.2 The QSM shall contain a description of the specification requirements for all supplier delivered materials.

9.8.3 The QSM shall contain a description of the certification and test reports delivered by the supplier and a location where these records are stored.

9.8.4 The QSM shall include all QC testing of the supplied materials and shall contain a statement that no raw materials shall be used unless they are on the APL or they have been tested and meet all appropriate CDOT, AASHTO, or ASTM specifications.

9.8.5 All supplier delivered materials shall be properly stored to prevent damage, contamination, or other alterations prior to use in production. The QSM shall include procedures for the adequate storage of supplied materials.

9.9 The QSM shall describe the procedure and frequency for inspection and selection of material samples during production. Sampling shall be performed on a stratified random procedure in accordance with ASTM D 3665. All random QC sample locations shall be properly documented and these procedures shall be included in the QSM.

9.10 The QSM shall contain descriptions and examples of the test report forms used by the manufacturer. The QSM shall identify the individual(s) responsible for maintaining all test records and reports along with the location where the reports are stored.

9.10.1 The test reports shall be maintained and available for inspection for a minimum of three years.

9.11 The QSM shall contain a description of the procedures used to identify and document all material or test results that do not conform to specification requirements. The QSM shall contain provisions for resolving non-conforming material or test results.

9.12 The QSM shall include drawings, with dimensions, of the forms used to produce precast concrete structures for CDOT.

9.12.1 Drawings and dimensions for precast modular concrete bridges will not be required with the QSM. However, they shall be submitted to Staff Bridge in accordance with Subsection 105.02 of the Standard Specifications.

9.13 The QSM shall describe the method used to permanently mark the precast concrete structure in accordance with the appropriate AASHTO or ASTM standard.

9.14 The QSM shall describe procedures used to properly handle, store, and ship precast concrete structures.

10. CERTIFICATE OF COMPLIANCE

10.1 The manufacturer shall prepare a standard Certificate of Compliance (COC) for each precast concrete structure delivered to a CDOT project. The COC shall contain all of the required information as stipulated in the CDOT Special Notice to Contractors. The COC shall include all necessary information to properly identify each precast concrete structure represented by the COC.

11. MANUFACTURING FACILITY INSPECTION AND CERTIFICATION

11.1 Manufacturing facilities producing precast pipe and box culvert shall meet the minimum industry standards, and be annually inspected and certified by the ACPA. Manufacturing facilities producing manholes shall meet the minimum industry standards, and be annually inspected and certified by either the ACPA or the NPCA. Manufacturing facilities producing precast pipe, modular bridges, and other precast concrete structures shall meet the minimum industry standards, and be annually inspected and certified by the NPCA. A copy of the certification shall be submitted to CDOT as part of the QML process.

11.2 Failure in one or more Sections or Subsections listed in this Standard may result in an accelerated inspection program. Any additional failures to meet these minimum requirements shall result in the decertification of the plant and the plant will be removed from the QML. The manufacturer may apply for reinstatement on the QML no sooner than six months after removal from the QML as stipulated in Section 8 of this Standard.

11.3 Within two months after submitting all required information, CDOT will notify the manufacturer of precast concrete structures whether or not the manufacturing facility's application for the Qualified Manufacturers List has been granted.

11.4 At any time, CDOT may inspect the operations or perform quality assurance testing.

Colorado Procedure 12A-09

Standard Practice for

Contractor's Hot Mix Asphalt Quality Control Notebook

1. SCOPE

1.1 This Standard describes the best practice to be used when developing appropriate worksheets and forms in a QC notebook.

1.2 The requirements such as, but not limited to: the sample size, specimen size, number of specimens, interpretation of results, reporting significant digits, and precision statements are in the specific test method.

1.3 This practice is to be used when quantities exceed 500 tons of Item 403.

2. GENERAL QC NOTEBOOK REQUIREMENTS

2.1 The following information shall be included on each page of a worksheet or form:

- (1) Project number, code, and location
- (2) Item number and grading
- (3) Supplier's name and address
- (4) Name of the laboratory performing the test
- (5) CDOT Form #43 HMA mix design number
- (6) Date, location, and time the sample was taken or the beginning of the test
- (7) Name of the person taking the sample and performing the test
- (8) Test number
- (9) Quantity of material placed to date at the time of taking the sample
- (10) Type of test performed
- (11) Specification limits
- (12) Remarks area

3. SAMPLE LOCATION WORKSHEET

3.1 The following shall be included on the sample location worksheet:

- (1) Temperature of the mix at the time sampled
- (2) Sampling method (plant, windrow, etc.)

4. PERCENT ASPHALT CEMENT CONTENT WORKSHEET

4.1 When using the asphalt cement content gauge to determine percent asphalt cement in the specimen, the following shall be included on the worksheet:

- (1) Base weight
- (2) HMA sample location or lift
- (3) Test temperature (if applicable)
- (4) Background count
- (5) Measured count
- (6) Gauge measured percent AC
- (7) Percent moisture as determined from Subsection 5.1
- (8) Corrected percent AC
- (9) Dry aggregate count (if applicable)

4.2 When using the ignition oven to determine percent asphalt cement in the specimen, the following shall be included on the worksheet:

- (1) Weight of the baskets
- (2) Weight of each basket and HMA before ignition from both the external and internal scales
- (3) Weight of each basket and HMA after ignition
- (4) Weight of HMA before ignition
- (5) Weight of HMA after ignition
- (6) Lost HMA weight due to ignition
- (7) Percent uncorrected AC in HMA
- (8) Asphalt correction factor
- (9) Corrected percent AC

5. PERCENT MOISTURE WORKSHEET

5.1 When determining the percent moisture in a HMA specimen, the following shall be included on the worksheet:

- (1) Weight of the tare (if applicable)
- (2) Wet and dry weights of the specimen
- (3) Weight of lost moisture
- (4) Percent moisture

6. SIEVE ANALYSIS WORKSHEET

6.1 When performing a sieve analysis and determining the aggregate gradation, the following shall be included on the worksheet:

- (1) Weight of the tare (if applicable)
- (2) Wet weight of material before washing
- (3) Dry weight of material before washing
- (4) Weight of moisture lost due to drying
- (5) Percent moisture
- (6) Weight retained on the applicable sieve size
- (7) Percent retained on the applicable sieve size
- (8) Percent passing the applicable sieve size
- (9) Total weight sieved
- (10) Dry weight after washing
- (11) Percent difference between item 9 and 10

7. MAXIMUM SPECIFIC GRAVITY WORKSHEET

7.1 When determining the maximum specific gravity, the water temperature calibration for each flask shall be developed and in the contactors files. When determining the maximum specific gravity, the following shall be included on the worksheet:

- (1) Weight of each flask
- (2) Weight of each sample and flask
- (3) Weight of each sample
- (4) Weight of each flask filled with water and the lid
- (5) Weight of each flask filled with the sample, water, and lid
- (6) Temperature of the water
- (7) Maximum specific gravity
- (8) Average maximum specific gravity

8. AIR VOIDS and VMA WORKSHEET

8.1 When determining the air voids of a laboratory compacted specimen, the following shall be included on the worksheet:

- (1) Total weight of the specimen in air
- (2) Weight of the surface-dry specimen in air
- (3) Weight of the specimen in water
- (4) Percent water absorbed by volume
- (5) Bulk specific gravity of the specimen
- (6) Average maximum specific gravity as determined from Subsection 7.1
- (7) Percent air voids

8.2 When determining the voids in the mineral aggregate of a laboratory compacted HMA specimen, the following shall be included on the worksheet:

- (1) Bulk specific gravity of the aggregate as determined from Subsection 8.1 steps 1 through 4
- (2) Percent of aggregate based on the total weight of the mix
- (3) Percent of voids in the mineral aggregate based on bulk volume

9. HOT MIX ASPHALT DENSITY WORKSHEET

9.1 When determining the density of the compacted HMA mat using a moisture-density gauge, the following shall be included on the worksheet:

- (1) Station and distance from centerline (right or left)
- (2) Daily maximum specific gravity
- (3) Standard count
- (4) Measured count or wet density for each reading
- (5) Average of the measured counts or wet densities
- (6) Ratio of the average density count and the standard count (if applicable)
- (7) Field specific gravity
- (8) Correction factor determined from CDOT Form #469 (if applicable)
- (9) Adjusted field specific gravity
- (10) Percent relative compaction

9.2 When determining the density of the compacted HMA mat using cores, the following shall be included on the worksheet:

- (1) Date specimen was retrieved
- (2) Dry weight in air
- (3) Weight of the saturated surface dried specimen
- (4) Weight of the specimen in water
- (5) Bulk specific gravity of the specimen
- (6) Daily maximum specific gravity
- (7) Percent relative compaction

10. LONGITUDINAL JOINT WORKSHEET

10.1 When determining the longitudinal joint density of the compacted HMA mat using cores, the following shall be included on the worksheet:

- (1) Date the lift was placed
- (2) Date the specimen was retrieved
- (3) Average lift thickness
- (4) Dry weight in air
- (5) Weight of the saturated surface dried specimen
- (6) Weight of the specimen in water
- (7) Bulk specific gravity of the specimen
- (8) Maximum specific gravity in accordance with specifications
- (9) Percent relative compaction at the longitudinal joint

11. FREE MOISTURE FOR PERCENT LIME WORKSHEET

11.1 When determining the percent free moisture specified for hydrated lime used in HMA, the following shall be included on the worksheet:

- (1) Weight of the tare
- (2) Wet and dry weights of the specimen
- (3) Weight of lost moisture
- (4) Percent moisture
- (5) Percent absorption (from the mix design)
- (6) Percent surface (free) moisture

{This page was intentionally left blank.}

Colorado Procedure 12B-09

Standard Practice for

Contractor's Portland Cement Concrete Paving Quality Control Notebook

1. SCOPE

1.1 This Standard describes the best practice to be used when developing appropriate worksheets and forms in a QC notebook.

1.2 The requirements such as, but not limited to: the sample size, specimen size, number of specimens, interpretation of results, reporting significant digits, and precision statements are in the specific test method.

1.3 This practice is to be used when quantities exceed 1000 square yards of Item 412.

2. GENERAL QC NOTEBOOK REQUIREMENTS

2.1 The following information shall be included on each page of a worksheet or form:

- (1) Project number or code
- (2) Item number and grading or class
- (3) Supplier's name and address
- (4) Name of the laboratory performing the test
- (5) Date, location, and time the sample was taken or the beginning of the test
- (6) Type of test performed
- (7) Sampling method
- (8) Name of the person taking the sample and performing the test
- (9) Sample ID Number
- (10) Quantity of material placed to date at the time of taking the sample
- (11) Specification limits
- (12) Remarks area

3. TILING DEPTH WORKSHEET

3.1 When determining the tiling depth, the following shall be included on the worksheet:

- (1) 10 consecutive texture groove depth readings
- (2) Average groove depth

4. SIEVE ANALYSIS WORKSHEET

4.1 When performing a sieve analysis and determining the aggregate gradation, the following shall be included on the worksheet:

- (1) Weight of the tare
- (2) Wet weight of material before washing
- (3) Dry weight of material before washing
- (4) Weight of moisture lost due to drying
- (5) Percent moisture
- (6) Dry weight after washing
- (7) Weight retained on the applicable sieve size
- (8) Percent passing the applicable sieve size
- (9) Total weight sieved
- (10) Percent difference between number 6 & 9
- (11) Test Date

5. WATER CEMENTITIOUS RATIO WORKSHEET

5.1 When determining the water cementitious ratio the following shall be included on the worksheet:

- (1) CDOT Form #1373 mix design number
- (2) Weight of Cement
- (3) Weight of Flyash
- (4) Weight of total cementitious
- (5) Moisture content of each aggregate
- (6) Absorption of each aggregate
- (7) Free moisture of each aggregate
- (8) Weight of batch water
- (9) Weight of total water
- (10) Water cementitious ratio

6. JOINT SEALANT PULL TEST WORKSHEET

6.1 When determining the joints pull test, the following shall be included on the worksheet:

- (1) Method Used
- (2) Pass / Fail

7. COMPRESSIVE STRENGTH WORKSHEET

7.1 When determining the compressive strength of a molded cylinder the following shall be included on the worksheet:

- (1) CDOT Form #1373 mix design number
- (2) Time of initial cure
- (3) Minimum & maximum temperature of curing facility
- (4) Age of specimen
- (5) 2 diameter measurements & average diameter or established diameter
- (6) Cross sectional area
- (7) Cylinder cap type
- (8) Maximum load
- (9) Fracture type (if necessary)
- (10) Compressive strength of each cylinder
- (11) Average compressive strength
- (12) Slump of the fresh concrete
- (13) Air temperature at the time of sampling
- (14) Temperature of the fresh concrete
- (15) Air content of the fresh concrete
- (16) Unit weight of the fresh concrete including the following:
 - a. Pot tare weight
 - b. Pot volume
 - c. Weight of pot & concrete
- (17) Yield of the fresh concrete

7.2 When determining the compressive strength of a core the following shall be included on the worksheet:

- (1) CDOT Form #1373 mix design number
- (2) Age of specimen
- (3) 2 diameter measurements & average diameter or established diameter
- (4) Cross sectional area
- (5) Core length
- (6) L/D ratio & correction factor
- (7) Core cap type
- (8) Maximum load
- (9) Fracture type
- (10) Compressive strength of each core
- (11) Average compressive strength

8. FLEXURAL STRENGTH WORKSHEET

8.1 When determining the flexural strength the following shall be included on the worksheet:

- (1) CDOT Form #1373 mix design number
- (2) Time of initial cure
- (3) Minimum & maximum temperature of curing facility

- (4) Age of specimen
- (5) 3 width measurements & average width
- (6) 3 height measurements & average height
- (7) Span length
- (8) Maximum load
- (9) Distance between fracture & nearest support
- (10) Modulus of rupture of each beam
- (11) Average modulus of rupture
- (12) Slump of the fresh concrete
- (13) Air temperature at the time of sampling
- (14) Temperature of the fresh concrete
- (15) Air content of the fresh concrete
- (16) Unit weight of the fresh concrete including the following:
 - d. Pot tare weight
 - e. Pot volume
 - f. Weight of pot & concrete
- (17) Yield of the fresh concrete

9. PAVEMENT THICKNESS WORKSHEET

9.1 When determining the pavement thickness, the following shall be included on the worksheet:

- (1) Thickness
- (2) Difference in thickness from plan thickness

10. FRACTURED FACES WORKSHEET

10.1 When determining the fractured faces the following shall be included on the worksheet:

- (1) Mass of sample
- (2) Mass of particles with 2 or more fractured faces
- (3) Percent by mass of particles with 2 or more fractured faces
- (4) Date Tested

11. SAND EQUIVALENT WORKSHEET

11.1 When determining the equivalency the following shall be included on the worksheet:

- (1) Type of shaker
- (2) Age of stock solution
- (3) Clay reading of each specimen
- (4) Sand reading of each specimen
- (5) Sand equivalent of each specimen
- (6) Average sand equivalent
- (7) Date Tested

Colorado Procedure 13-10

Standard Procedure for

Check Testing

1. SCOPE

1.1 The purpose of check testing is to compare the testing equipment and personnel that will be used according to the contract. With the successful completion of check testing within acceptable limits, both the Engineer and the Contractor should have confidence in test results. This procedure can be used at any time the Engineer needs to determine a level of confidence in test results between two or more sets of testing equipment and personnel.

2. REFERENCED DOCUMENTS

CDOT Quality Assurance Program for Construction and Materials Sampling and Testing.

An Investigative Study of the CDOT Asphalt Mixture Design Procedure, October 1993, Aguirre Engineers, Inc.

Spring 1998 Round Robin Results, October 1998, by Bob LaForce, CDOT.

Sixth Annual Report: HBP QC&QA Projects Constructed in 1997 Under QPM2 Specifications, May 1998, by Bud A. Brakey, CDOT.

HBP QA/QC Pilot Projects Constructed in 1993, May 1994, by Bud A. Brakey, CDOT.

HBP Pilot Void Acceptance Projects in Region 2 in 1997, May 1998, by Bud A. Brakey, CDOT.

ASTM C 39, Compressive Strength of Cylindrical Concrete Specimens.

AASHTO T 97, Flexural Strength of Concrete Using Simple Beam with Third-Point Loading.

AASHTO T 99 The Moisture-Density Relations of Soils Using a 2.5 kg Rammer and a 305 mm Drop.

Surface Moisture-Density Gauges, November 1992, Troxler Electronic Laboratories, Inc.

Gyratory Task Force, MAC Minutes of 03/08/00

3. DEFINITIONS

3.1 Base Data - The historical standard deviation (σ) between two operators performing a test on split samples of the same material. This is shown in Column 1 of Table 13-1.

3.2 Maximum Difference - The expected difference between two operators performing a test on split samples of the same material (δ) is calculated by multiplying σ by 1.96. This is shown in Column 2 of Table 13-1.

3.3 Acceptable Check Test Limit - The limit for check tests is the maximum difference between the averages of the absolute values of differences of five tests performed by two different operators on split samples (δ') and is calculated by dividing δ by the square root of five. This is shown in Column 3 of Table 13-1. For any given element and number of tests (n) greater than 1 performed on a split sample, the acceptable check test limit can be calculated by dividing Column 2 of Table 13-1 by the square root of n .

3.4 Check Test Limit / HMA In-Place Density - Since seven split samples are used to correlate nuclear gauges on HMA pavements, the acceptable limit for check tests is the difference between the averages of the absolute values of the differences of seven tests performed by two different operators on split samples and is calculated by dividing δ (Column 2) by the square root of seven. This is shown in the row In-Place Density HMA and at the Column 3 of Table 13-1.

4. APPARATUS, SAMPLING AND TESTING PROCEDURES

4.1 Apparatus, sampling and testing procedure are described in the specified procedure for the subject tests. Samples used in check testing do not need to be from random samples nor do they need to represent any certain project or location. Samples should be split samples or as close to identical as possible. Samples are split according to splitting procedures for the subject material. If tests are to be taken on

material in-place, then the tests shall be taken at the same place.

5. PROCEDURE

5.1 The subject test is performed on at least five split samples. In the case of in-place density of HMA pavements, seven test locations are used.

5.2 Calculate the absolute values of the differences between test results on each sample.

5.3 Calculate the average of the absolute values determined in 5.2.

5.4 Results of 5.3 are compared to acceptable limits for check tests as shown in Column 3 of Table 13-1.

5.5 Column 3 of Table 13-1 shows the acceptable limits for check tests of some materials used in roadway construction. Other values for the acceptable limits for check tests can be derived by following the procedure used to derive values for Table 13-1 and stated in the Definitions.

Example: Check Testing Program results and calculations for Asphalt Content

Split Sample "n"	QC Tester	QA Tester	Absolute Value of Difference QC _n - QA _n
1	6.03%	6.19%	0.16%
2	6.15%	5.97%	0.18%
3	6.09%	6.20%	0.11%
4	5.92%	6.25%	0.33%
5	6.20%	6.11%	0.09%

- A. Compare each |QC_n - QA_n| with appropriate value from Column 2 of Table 13-1**
Each |QC_n - QA_n| < 0.49% (Column 2 for Asphalt Content), so each test is within the necessary range.
- B. Calculate Average of Absolute Value of Differences:**
(0.16% + 0.18% + 0.11% + 0.33% + 0.09%) / 5 = 0.17%
- C. Compare value from "B" with appropriate value in Column 3 of Table 13-1**
0.17% < 0.22% (from Column 3 for Asphalt Content); therefore, results of the Check Testing Program for this element are acceptable.

NOTE 1: The values in Table 13-1 were reviewed at the 2008 FMM Meeting for accuracy and intent. There is no direct correlation between Table 13-1 and the Table IA-1, IA Comparison Precision Guide.

NOTE 2: Compressive Strength and Flexural Strength Elements (Procedures) are performed in accordance with Standard Specification Subsection 106.06 (d).

TABLE 13-1
Acceptable Limits of Two Laboratory Test Precision

Element (Procedure)	Column 1	Column 2	Column 3
	σ (Two operators split sample)	δ (Maximum difference split sample)	δ' (Acceptable Check Test Limit)
Asphalt Content [Nuclear Method] (CP 85)	0.25%	0.49%	0.22%
Asphalt Content [Ignition Method] (CP-L 5120)	0.25%	0.49%	0.22%
HMA #4 Sieve (CP 31)	2.04%	4.00%	1.79%
HMA #8 Sieve (CP 31)	1.92%	3.76%	1.68%
HMA #200 Sieve (CP 31)	0.56%	1.10%	0.49%
HMA Voids in the Mineral Aggregate (CP 48)	0.40%	0.78%	0.35%
HMA Air Voids (CP 44)	0.37%	0.73%	0.32%
HMA Hveem Stability (CP-L 5106)	3.9	7.7	3.4
HMA Maximum Specific Gravity (CP 51)	.009	.018	.008
In-Place Density HMA (CP 81)	0.77%	1.51%	0.57%
Longitudinal Joint Density (ASTM D 2726)	1.10 %	2.20 %	.83 %
Compressive Strength PCCP (ASTM C 39)	192 psi (1324 KPa)	376 psi (2592 KPa)	168 psi (1158 KPa)
Sand Equivalent (CP 37)	3 points	7 points	5 points
Flexural Strength PCCP (ASTM C 78)	44 psi (303 KPa)	86 psi (593 KPa)	39 psi (269 KPa)
In-Place Density Soils (CP 80)	0.34 pcf (5450 g/m ³)	0.67 pcf (10 700 g/m ³)	0.30 pcf (4770 g/m ³)
In-Place Soil Moisture (CP 80)	0.45 pcf (7210 g/m ³)	0.89 pcf (14 100 g/m ³)	0.40 pcf (6320 g/m ³)
Moisture Density Relation, (AASHTO T 99, Density)	1.6 pcf (25 600 g/m ³)	3.1 pcf (50 200 g/m ³)	1.4 pcf (22 500 g/m ³)
Moisture Density Relation, (AASHTO T 99, Moisture)	0.8 pcf (12 800 g/m ³)	1.6 pcf (25 100 g/m ³)	0.7 pcf (11 200 g/m ³)

FIELD MANAGEMENT OF TEST RESULTS
ASPHALT CHECK TESTING

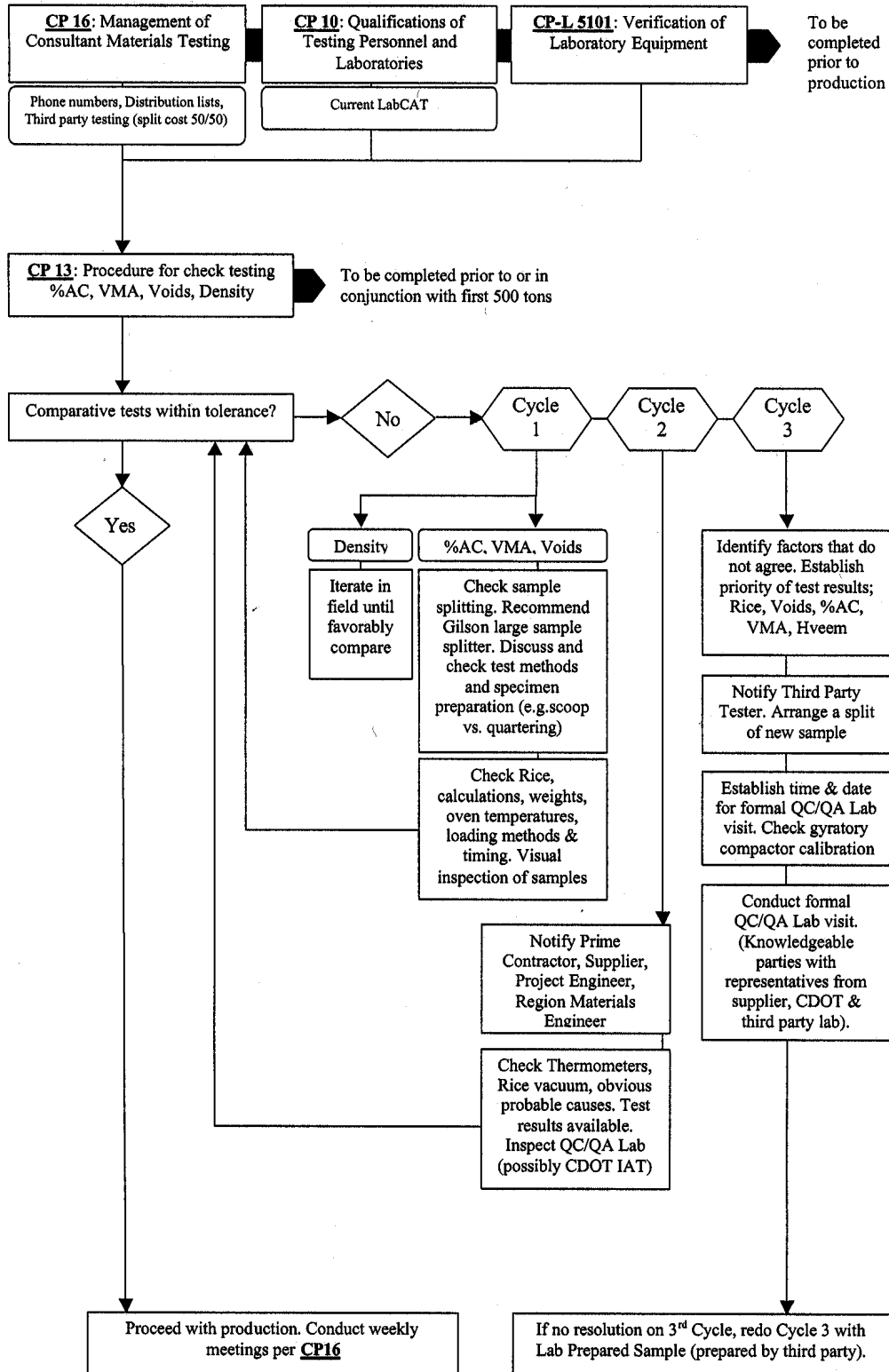

Colorado Procedure 14-12

Standard Practice for

F and t-test Statistical Method

1. SCOPE

1.1 Use this procedure as required by the project specifications to provide a method of comparing two independent data sets of multiple test results (e.g. Contractor's Quality Control and the Department's Acceptance test results, Contractor's Quality Control and CDOT Verification test results, CDOT and Contractor's Verification test results, etc.) to determine if the materials tested come from the same population. This statistical procedure employs estimation and hypothesis testing using F-test and t-tests to make the comparisons.

1.2 Compare two populations that are assumed normally distributed by calculating and comparing the population means (arithmetic averages) and variances (standard deviation x standard deviation). The F-test compares the population variances while the t-test compares the population means.

1.3 Select all samples using random or stratified random procedures. Perform all testing and measuring in accordance with standard acceptable practices. All sampling and testing will be in accordance with applicable specifications.

1.4 The following sections provide reference materials, the mathematical equations, combined manual and computer-assisted calculations, and completely automated procedure using computer software to calculate the F-test and t-test statistics.

2. REFERENCED DOCUMENTS

- 2.1 *Colorado Procedures:*
CP 41 Sampling Hot Mix Asphalt
CP 55 Reducing Field Samples of Hot Mix Asphalt to Testing Size.
CP 61 Sampling Freshly Mixed Concrete

2.2 *Other References:*

AASHTO R 9-97 "Standard Recommended Practice for Acceptance Sampling Plans for Highway Construction".

Implementation Manual for Quality Assurance, 1996, AASHTO Highway Subcommittee on Construction.

Statistical Reasoning, 1985, Gary Smith.

Probability and Statistics, 1975, Murray R. Spiegel.

Elementary Statistics, 1976, Robert R. Johnson.

Probability and Statistics for Engineers and Scientists, 1972, Ronald E. Walpole and Raymond H. Myers.

3. DEFINITION OF TERMS, SYMBOLS, AND EQUATIONS

3.1 Equations and Definitions

$$\bar{X} = \sum x_i / n \quad \text{Eq. 3.1}$$

Where \bar{X} is the sample mean or average.

\sum = summation symbol

x_i = any individual test value ($i = 1, 2, 3, \dots, n$)

n = total number of tests (sample size)

$$S = \sqrt{\frac{\sum(Xi - \bar{X})^2}{n - 1}} \quad \text{Eq. 3.2}$$

Where S is the standard deviation

n-1 = degree of freedom

$$V = S^2 \quad \text{Eq. 3.3}$$

Where V is the sample variance

$$F = (V_1/V_2) \text{ or } (V_2/V_1) \quad \text{Eq. 3.4}$$

Where F is the ratio of the variance from each data set (larger variance divided by the smaller variance) depending on which ratio yields a value equal to or greater than 1. This is called the F distribution.

$$S_p = \sqrt{\frac{(n_1 - 1)S_1^2 + (n_2 - 1)S_2^2}{(n_1 + n_2 - 2)}} \quad \text{Eq. 3.5}$$

Where S_p is a weighted average of the sample variances each weighted by the degrees of freedom.

$$t = (\bar{X} - \mu) / (S_p / \sqrt{n_c + S_p / n_a})^{1/2} \quad \text{Eq. 3.6}$$

Where t is the statistic used to compare the mean of a sampled population to some fixed, known value.

μ = Mean from the contractor's population

S_p = Variance of the pooled data

n_c = Number of tests in the contractor's population

n_a = Number of tests in CDOT's population

α = level of significance or critical region. This is the probability of incorrectly deciding the data sets are different when they actually come from the same population. In either the construction

or the manufacturing industry, α is the risk of rejecting a good material or product. The critical region, α in the F and t probability distribution curves is equivalent to the rejection area. Since the total area bounded by either the F or t distribution curve is equal to 1, the acceptance region is $1 - \alpha$. For example, when $\alpha = 0.05$, there is a probability of 95 percent that the two data sets are from the same population.

α_{critical} = is the maximum value in the F distribution and t statistic for the level of significance and the degree of freedom for the contractor and CDOT at which the comparison between the two sample populations should not be exceeded. If the t statistic is less than the critical value, the hypothesis is that they came from the same population.

The two-tailed test determines if the population parameters (variances or averages) are either equal or not equal. All the values of α obtained from this procedure are based on the two-tails of the distribution curve.

4. SUMMARY OF METHOD

4.1 The method involves calculating sample statistics from three or more representative measurements, test results, or values, for each specified element in a lot or sample. The specimen will be independent samples. The statistical variables to be calculated include the mean, standard deviation, variance, F and t values, and the α_{critical} value. The following sections summarize the F-test and t-test method to be employed in this procedure.

4.2 Determine the appropriate population parameters and sample statistics to be used in estimation and hypothesis testing (F & t-tests). For the F-test calculation, test the assumption that the population variances are equal against the assumption that they are not equal (use a two-tailed F-test). For the t-test calculation, assume the population variances are equal and test the assumption that the population means are equal against the assumption that they are not equal (use a two-tailed t-test).

4.3 Choose a level of significance or critical region (α) for each of the F-test and t-test calculations. AASHTO R 9 provides suggested critical values of α_{critical} used in the highway construction industry. CDOT typically uses α_{critical} values of 0.10, 0.05, 0.01, and 0.005. In

this procedure, use α_{critical} values as specified in the project specifications.

4.4 Calculate all the required variables in the appropriate F-test and t-test equations and compare the calculated α_{critical} with the level of significance chosen in the previous subsection.

4.5 Conclude that the measurements, test results, or test values come from the same population if the calculated α -value is less than the α_{critical} at the selected level of significance. Conclude that the measurements, test results, or test values do not come from the same population if the calculated α -value is less than the α_{critical} value at the selected level of significance.

5. COMPUTER-ASSISTED PROCEDURE

5.1 Any applicable computer software with statistical functions may be used to conduct F-test and t-test calculations. The Microsoft Excel statistical function FTEST can be used to calculate the α_{critical} value for the F-test while the Microsoft Excel statistical function TTEST can be used to calculate the α_{critical} value for the t-test. The FTEST function has the command format FTEST [array1, array2]. Array1 is the first data set and array2 is the second data set. The FTEST function directly calculates the two-tailed α_{critical} value. Compare this value with the selected level of significance. Conclude that the test data are from the same population if the result of the FTEST calculation is less than the selected level of significance. Proceed to conducting a t-test

assuming equal population variances if the result of the FTEST calculation is less than the selected level of significance.

5.2 The Microsoft Excel TTEST function has the command format TTEST [array1, array2, tails, type]. Array1 is the first data set and array2 is the second data set. The tails parameter specifies the number of distribution tails and type refers to the kind of t-test to perform. The type can be 1 (paired t-test), 2 (two-sample equal variance) and 3 (two-sample unequal variance). Type 3 is not used in this procedure because the test data sets are automatically concluded to be not from the same population if the sample variances are found to be unequal. The t-test directly calculates the α_{critical} value, given the required values of the variables in the TTEST function. Compare this value with the selected level of significance. Conclude that the test data are from the same population if the result of the TTEST calculation is less than the selected level of significance. Conclude that the test data are not from the same population if the result of TTEST calculation is greater than the selected level of confidence.

5.3 The Department has software to perform F-test and t-test analysis. The software calculates the F-test and t-test values and compares them with the selected level of significance. The software automatically indicates if the test data are either from the same population or not using appropriate label or designation.

6. SAMPLE CALCULATIONS F-test and t-test

6.1 Independent Samples (Non-paired Observations)

This example will demonstrate the procedures to conduct F-test and t-test calculations for independent samples.

Problem Statement:

Using the ignition furnace method to determine the asphalt content of a mix, the following test results were obtained for independent sample populations A and B:

Test Number	Population A	Population B
1	4.65	4.75
2	4.84	4.79
3	4.59	4.74
4	4.75	4.41

5	4.63	4.77
6	4.75	4.58
7	4.58	4.81
8	4.82	
9	4.86	
10	4.60	
11	4.77	
12	4.65	
13	4.80	

Using F-test and t-test, determine if sample A and sample B are from the same population.

Solution:

- a) Select the level of significance (α) at which to evaluate the F test and t test. Use the level specified in the project special provisions. Assuming that $\alpha = 0.01$ is specified, determine the F-value using Eq. 3.4 which comes from Eq. 3.3 (variance), Eq. 3.2 (standard deviation), and Eq. 3.1 (mean) in each data set.

	<u>Sample A</u>	<u>Sample B</u>
Arithmetic Average	4.71	4.69
Standard Deviation	0.1013	0.1457
Variance	0.010260	0.021224

F-value (larger variance is divided by smaller variance, $0.021224 / 0.010260$)	2.07
Degrees of freedom, n-1, (numerator, 7-1)	6
Degrees of freedom, n-1, (denominator, 13-1)	12

- b) From AASHTO R 9, Table X2.1, the α_{critical} value for the F test using 6 degrees of freedom in the numerator and 13 degrees of freedom in the denominator translates into α_{critical} of 5.76.
- c) Compare this calculated α_{critical} value with the F-value. Since the α_{critical} is greater than the calculated value ($5.76 > 2.07$), **conclude that the sample variances are equal and proceed to conducting a t-test.**
- d) Calculate the arithmetic averages (\bar{X}_1 and \bar{X}_2) and variances (S_1^2 and S_2^2) for each data set. Calculate the pooled variance, S_p for both data sets using Eq. 3.5. Calculate the absolute t-value using Eq. 3.6. The sample size for sample A is $n = 13$ and the sample size for sample B is $n = 7$.

Arithmetic Average (\bar{X}_1 or \bar{X}_2)	4.71	4.69
Variance (S_1^2 or S_2^2)	0.01026	0.02122
Pooled Variance (S_p)	0.11796	

Calculating the absolute value of t yields: $(4.69 - 4.71) / ((0.11796/14) + (0.11796/7))^{1/2} = 0.126$

- e) From AASHTO R 9, Table X2.2, the α_{critical} value is $= 2.878$. Since the α_{critical} is greater than the calculated value ($2.878 > 0.126$), **conclude that the two data sets are from the same population.**

Colorado Procedure 15-08

Standard Practice for

Certification of Consultant Nuclear Moisture/Density Gauges

1. SCOPE

An engineering consulting company contracted to perform materials testing for the Department must have their designated nuclear moisture/density gauges certified in the calibration bay located at CDOT's Central Materials Laboratory. Nuclear M/D gauges used for quality control testing by the contractor or the contractor's agent will not be certified on the Department's calibration blocks.

2. REFERENCED DOCUMENTS

CP-L 5306, Certification of Consultant Nuclear Moisture / Density and Thin Layer Density Gauges

Statistical Stability Test and Drift Test, CDOT Form #1151

QA Certified Nuclear Gauge – Consultant Nuclear Gauge Assignment Document, CDOT

CDOT Certified Nuclear Gauge Label, CDOT Form #30

3. REQUIREMENTS

3.1 The company must contact the Staff Materials & Geotechnical Branch at (303) 398-6547 to make an appointment to certify their M/D gauge. It is recommended that an adequate amount of time, i.e., at least two months, be allowed to ensure that the gauge is available when the contract commences.

3.2 The company must provide Staff Materials with a current copy of The Notice to Proceed and the referenced Task Order. Documentation provided must include project number, project code (sub-account number), location, contract commencement date, and the contract expiration date or work duration time frame.

3.3 The company must ensure that the gauge requiring certification is clean and is in no need of

maintenance or repairs. Cleaning, maintenance, and repairs will not be performed by CDOT Staff Materials personnel.

3.4 The company is required to have one gauge certified for the contracted project, plus one additional gauge certified as an emergency replacement. If the company has two contracted projects with the Department, three certified gauges would be required, that is, one M/D gauge for each project plus one emergency replacement gauge.

3.5 The company must have a recently performed passing Statistical Stability Test and Drift Test, CDOT Form #1151, for their gauge when they arrive for the certification.

3.6 The company employee who will be performing the certification procedure shall be capable of running the basic operations of the gauge and must have a personnel monitoring device, a calculator, and a minimum of 3 hours of available time. Arrival must be at the time of the appointment, and rescheduling will be required if the operator and gauge are not in the calibration room, commencing with the certification within 30 minutes of the established time.

NOTE: CDOT requires personnel monitoring devices be worn by an individual within proximity to its nuclear gauges. If the company's policy is to not require personnel monitoring devices of its employees, per current Colorado Department of Public Health & Environment directives, then a letter stating that CDOT will be held harmless from any exposure to CDOT nuclear gauges must be provided and signed by the company's Radiation Safety Officer.

3.7 A gauge passing the calibration will be certified with a label stating "CDOT QA/QC CERTIFIED NUCLEAR GAUGE" (CDOT Form #30).

3.8 The company will receive a QA Certified Nuclear Gauge certificate. It must be completed, signed by the company's designated Radiation

Safety Officer and returned as soon as possible. If the nuclear gauge is assigned to a different project from the one listed on the QA Certified Nuclear Gauge certificate at anytime during the certification period, then Staff Materials must be informed in writing.

3.9 The certification is valid for no more than 12 months.

3.10 The company must inform CDOT Staff Materials if any repairs take place on the gauge within this acceptance period.

<h2 style="margin: 0;">STATE OF COLORADO</h2>	
<p>DEPARTMENT OF TRANSPORTATION Materials and Geotechnical Branch Nuclear/Deflection Laboratory 4670 N Holly Street, Unit A Denver, Colorado 80216 303-398-6547</p>	
<h3 style="margin: 10px 0;">QA Certified Nuclear Gauge Consultant Nuclear Gauge Assignment</h3>	
<p>Consultant Name _____ Address _____ _____ _____</p>	
<p>The above named entity will be utilizing Gauge No _____ (Certification Date _____) under contract with the Colorado Department of Transportation, or the entity was sub-contracted to perform testing by the contracted engineering consulting company of _____</p>	
<p>Project No. _____ Project Code (SA#) _____ Location _____ Contract Commences _____ Expires _____</p>	
<p>Gauge Serial Number: _____ Gauge Model _____ Certified By: _____ Expiration Date _____</p>	
<p>The following conditions that must be met to use the above gauge on a CDOT project:</p> <ol style="list-style-type: none">1. Radioactive material shall be used by individuals, designated as users by the R.S.O.2. Personnel monitoring devices capable of detecting both gamma and neutron radiation may not be required. However, CDOT must be informed in writing as to the Licensee's policy and the individual tester must comply for the duration of the contract.3. Each sealed source containing radioactive material shall be tested for leakage and/or contamination in accordance with RH 4.16 of the State of Colorado <i>Rules and Regulations Pertaining to Radiation Control</i>.4. Radioactive material shall be stored and used in a manner that will preclude use by unauthorized personnel.5. The nuclear gauge and its associated DOT Type "A" carrying case will meet marking and labeling requirements. The carrying case must be capable of meeting the requirements of a DOT Type "A" transport container.6. If a nuclear gauge is to be stored in a CDOT facility, the Consultant shall provide the Project Engineer a copy of the Consultant's Nuclear Incident Procedures to be posted in the facility.	
<p>Signature _____ Designated Radiation Safety Officer (RSO) Emergency Notification Telephone No.(s): 1) _____ 2) _____ <small>(rev. 4/07)</small></p>	<p>Date _____</p>

Colorado Procedure 16-12

Standard Practice for

Management of CDOT & Consultant Materials Testing

1. SCOPE

This procedure contains a summary of the responsibilities and the process for developing the consultant materials testing contract and administering task orders. Also contained in this procedure are examples of the forms for management and evaluation of consultant materials testing on CDOT projects.

2. SUMMARY OF RESPONSIBILITIES AND PROCESSES

The Region Materials Engineer develops the non-project specific (NPS) materials testing consulting contract that is then reviewed for approval by the Program Engineer and Region Transportation Director. The contract is distributed to interested consultants as a part of a request for proposals. Proposals are reviewed by Region Engineers and then the Consultants are selected. Resident Engineers write task orders to provide consultant materials testing for specific projects. The business office tracks expenditures and assists in the paperwork involved in administering the NPS contracts and the task orders written under each contract. The Region Materials Engineer reviews and retains copies of consultant evaluations and coordinates solving of problems with consultant testing.

3. MANAGEMENT AND EVALUATION OF CDOT & CONSULTANT MATERIALS TESTING

3.1 CP 16, Pre-Testing Meeting Agenda – CDOT & Consultant Materials Testing (CDOT Form #1322)

This form is used to guide discussion and document results of a pre-testing meeting. This meeting allows the key people involved in the testing to discuss and define each of the issues involved in consultant testing. Each item should be discussed and the results of that discussion written on the form. Pre-testing meetings have been a valuable tool to avoid problems by promoting communication on important issues before testing begins.

3.2 CP 16, Weekly Meeting Agenda – CDOT & Consultant Materials Testing (CDOT Form #1323)

This form is used to guide discussion and document results of a meeting held each week, if needed, to determine if the consultant testing is going smoothly. These meetings allow early identification and resolution of problems. Key issues addressed at the weekly meetings are distribution of test results, documentation of testing, proper test procedures, and how failing tests are handled. If the consultant testing is going well, then brief and informal meetings between the CDOT head tester and the consultant tester, or skipping some of these meetings, may be appropriate. If there are substantial problems then a formal meeting including the Project Engineer and the supervisor of the consultant materials tester may be needed. Use the form to document all meetings, however brief.

3.3 CP 16, Evaluation of Materials Testing – Consultant Materials Testing (CDOT Form #1324)

This form is used to evaluate the consultant after consultant testing on the project is completed. This evaluation is normally conducted by the Project Engineer. The contractor, consultant, and head tester should be interviewed prior to completing this form. A final meeting with the consultant to discuss strengths and weaknesses is also recommended. A copy of the completed evaluation form is part of the Finals packet and must be sent to the Region Materials Engineer and the Documentation Unit of the Central Materials Laboratory. This central record of evaluations will support statewide review of consultant performance.

4. CONSULTANT PERFORMANCE EVALUATION

The CDOT Consultant Performance Evaluation, CDOT Form #313, is a general evaluation of consultants performing any services for the Department.

Senate Bill 07 228 requires that all state contracts greater than \$100,000 that were signed, or changed, after July 1, 2009 must have Contractor

evaluations and ratings performed. The final evaluation rating will be posted to the Contract Management Systems (CMS) public website at <http://contractsweb.state.co.us>. All CDOT guidance documents, which include instructions, procedures, forms, email language, memorandums and other information related to contractor performance evaluation, are posted on the Purchasing web page located at [//internal/Puchasing/PurchasingDocuments.cfm](http://internal/Puchasing/PurchasingDocuments.cfm).

These evaluations are separate from the CP 16, Evaluation of Materials Testing (CDOT Form #1324). All of forms are required to be completed.

COLORADO DEPARTMENT OF TRANSPORTATION CP 16, PRETESTING MEETING AGENDA The purpose of this meeting is to clarify the expectations of CDOT for the consultant materials tester and to review some of the common issues that arise during typical projects. This form shall be used for consultants and may be used when CDOT is performing the testing.	Project No.:	
	Project code:	
	Proj. name/location:	
	Region:	Residency:

Attendance: It is recommended that the following people be in attendance:

CDOT Project Engineer:	Consultant materials tester's supervisor:
CDOT head tester:	Contractor quality control tester:
Region Laboratory representative (if available):	Contractor representative(s):
Consultant materials tester:	Supplier representative(s):
It is recommended this meeting occur one week prior to the need for testing. If some of the issues brought up at the meeting are not initially resolved, then there will be time to address them.	

1) Test result distribution:

Payment to the contractor is dependent on test results of materials. Therefore, it is critical that test results are distributed before the next day of production . Computer printout of the Moving Quality Level (MQLs) needs to be sent as well.					
Have all forms for reporting test results been provided to the consultant materials tester and contractor? <input type="checkbox"/> yes <input type="checkbox"/> no			Test results will be distributed by:		
Test results will be distributed to:		FAX:		CDOT Form #626*	
				yes no	
				yes no	
1)				<input type="checkbox"/> <input type="checkbox"/>	
2)				<input type="checkbox"/> <input type="checkbox"/>	
3)				<input type="checkbox"/> <input type="checkbox"/>	
4)				<input type="checkbox"/> <input type="checkbox"/>	
5)				<input type="checkbox"/> <input type="checkbox"/>	
*When test results fail, a CDOT Form #626 (Field Laboratory Test Results) shall be sent to the above people that request it.					
**When QLs (Quality Levels) and pay factors are calculated, they shall be sent to the above people that request it.					
What mix designs have been submitted and approved?					
Who is authorized to sign the Form #626?			Who will calculate the QLs and pay factors?		
Who will distribute the QLs and pay factors?			How often will the QLs and pay factors be distributed?		
Which versions of software will be used to calculate pay factors?					
Does the consultant have this software installed? <input type="checkbox"/> yes <input type="checkbox"/> no			Does the contractor have copies of this software? <input type="checkbox"/> yes <input type="checkbox"/> no		
Who from the contractor will be responsible for maintaining the MQLs?					

2) Special reports

In some instances that involve a long testing procedure (volumetrics, cylinders, etc.), the results need to be distributed no later than the day after the test is completed. The following protocol should be used for the distribution of these tests.		
	Distributed by	Distributed when
Concrete cylinder breaks:		
Asphalt volumetrics:		
Rice:		

3) Procedural review

These are common areas of concern for testing materials on CDOT projects. It is recommended to review these during this meeting. All Laboratory correlations have been performed. <input type="checkbox"/> Yes <input type="checkbox"/> No				
Forms:	Does the consultant materials tester have the Form #250? <input type="checkbox"/>	Does the consultant materials tester have the Form #379? <input type="checkbox"/>	Does the consultant materials tester have the Confidential Random Sampling Schedule? <input type="checkbox"/>	
Concrete: Time constraints and procedures for making cylinders and beams (CP 61)				
Acceptance cylinders and/or beams:		Field cured cylinders:		
Sampling location within load:		Special requirements:		
Sampling method (CP 61):				
Location of water tank for initial cure (first 24 hours):		Bridge Deck Curing Measures (thermocouples etc.):		
Weekend pours (sampling and handling after 24 hours):		Maturity meter calibrations for fast track paving, completed by?		
Location of cure (after 24 hours):				
Transportation (how and when):				
Asphalt:	Gradation	AC/Rice	Binder	Density
Sample location:				
Sample taken by:				
Sample witnessed by:				
Sample method:				
Sample split by:				
Sample delivered by:				
Test location:				
Tested by:				
Review sample size:	Aggregate:	Binder:	HBP:	
Special sampling requirements:				

4) Protocol for failing tests

During production of materials, it is possible that test results of materials could fail. It is desirable to understand the protocol that will be followed when this happens. Typical actions could include: meeting, coring, retest, third party testing, check testing program, price reduction, test saved splits, etc.	
Concrete:	
Slump:	Air:
Compressive Strength (CP 65):	Yield:
Flexural Strength:	How will the QLs and pay factor be handled?
Asphalt:	
Density:	Gradation:
Asphalt Content:	Stability:
Volumetrics:	Binder:
How will the QLs and pay factor be handled?	
Soils:	
Density:	Moisture:
Soil Bearing Value:	Soil type:
Soil Profile:	

5) Head tester commitments

The CDOT head tester will assist the consultant materials tester with a limited amount of help. This assistance will be scheduled between the two testers. This will include: review of the Field Materials Manual, setting up the book for project documentation, reviewing the book throughout the project, new CDOT tests and protocols, and one copy of the project plans and specifications.		
The CDOT head tester will not assist in training the consultant materials tester in test procedures or protocol. Consultants will provide cylinder molds (Jatco), asphalt binder cans, and 3 ring binders (all shall be new). Current copies of the specification book, Field Materials Manual, and other publications/materials needed for the project will also be provided by the consultant.		
Head tester:	Phone:	FAX:

6) Protocol for switching consultant materials testers

It is desirable for the consultant materials tester to be the same throughout the entire project. However, it is understood that situations arise that create the need for the consultant to switch the tester. This should be minimized. When a switch does occur, the following protocol is required for a smooth transition.	
If known in advance - A reduced check testing program (at least 3 samples) needs to be performed. The replacement tester needs to spend at least one day on the project with the original tester.	
If not known in advance - A reduced check testing program (at least 3 samples) needs to be performed within one week. Additionally, the replacement tester's supervisor needs to be present for at least one full day or night of testing with the replacement tester and until the replacement tester is familiar with the project.	
Short term (only 1 or 2 days) - The replacement tester's supervisor needs to be present for the days or nights of testing with the replacement tester until the original tester returns.	
Any additional supervision costs incurred as a result of switching consultant materials testers will not be charged to the project.	
Materials consultant tester's immediate supervisor is:	Supervisor's phone number:

7) Equipment charges

The same equipment (nuclear moisture/density gauge, air meter, etc.) needs to be used throughout the project. When a tester is switched, the new tester needs to use equipment that was used previously on the project. If the equipment breaks down or is replaced, it has to be calibrated or correlated appropriately before use.
--

8) Check testing program

The check testing program needs to be completed before production begins.	
Check testing started on:	Check testing completed on:
What was the average of the differences in each of the tests?	
Gradation:	Rice:
Asphalt content:	Density:
Did it correlate?	If not, then what is the next step?

9) Independent Assurance Tests

The Form #379 indicates the number of Independent Assurance Tests (IAT) that are required. It is the responsibility of the materials consultant to schedule these tests. It is necessary to schedule the tests a minimum of 24 hours in advance. To schedule the test contact:	
Contact:	Phone:
Additionally, the tests should be scheduled (when possible) during a large or typical production operation - not the end of a job or small quantity. If there are problems with the test results, it is better to schedule the IAT sooner rather than later.	

10) Qualified laboratory

The consultant laboratory needs to be qualified in order to perform verification testing. The equipment serial numbers to be used on the project will also be documented and given to the head tester. In order to get the laboratory inspected, so that it may become qualified, contact:	
Contact:	Phone:
Date laboratory was qualified:	By:
AASHTO accredited laboratories will be considered qualified.	

11) Certified personnel

Do the testers have the appropriate certifications for concrete testing (ACI Lab Tech I, Lab Tech II or Field Tech I), Asphalt testing (LabCAT Level A, Level B or Level C), and soils (WAQTC, Embankment and Base)?	
Tester:	Certifications:

12) Resolution of testing issues

Issues may develop on the project between the contractor, consultant, and/or CDOT as a result of test results or test procedures. It is recommended that the issues be dealt with appropriately. The CDOT Head Tester or Project Engineer should deal with all issues that arise from the testers. The consultant tester should not try to resolve issues with the contractor. If the problem is not resolved, then the two supervisors should meet. Every effort should be made to resolve the issue at the lowest possible level.

13) Materials consultant supervisor

The materials consultant tester project supervisor is:	Supervisor's phone number:
--	----------------------------

14) Weekly meetings

The purpose of weekly meetings is to ensure that an adequate job is being performed. If there are any issues, they need to be addressed. This meeting can be a regularly scheduled meeting or can occur sporadically depending on the progress on the project and the consultant's expertise.			
Attendance: CDOT representative, consultant tester, and contractor representative.		Where:	
Day:		Time:	
Who will attend?	Name	Company	Phone
1)			
2)			
3)			
4)			
5)			

COLORADO DEPARTMENT OF TRANSPORTATION CP 16, WEEKLY MEETING AGENDA The purpose of weekly meetings is to ensure that an adequate job is being performed. If there are any issues, they need to be addressed. This shall be used for Consultants and may be used when CDOT is performing the testing.	Project No.:	
	Project code:	
	Proj. name/location:	
	Date:	Region:

Attendance:

Name	Company	Phone
1)		
2)		
3)		
4)		
5)		

1) Test result distribution

Is everyone receiving their test results?
Are there any issues?

2) Special reports

Are test results for tests that take over 1 day being distributed timely?

3) Paperwork and documentation (Is the paperwork and documentation up to date for:)

Acceptance testing:
IATs:
COCs and CTRs (Obtained for the files):

4) Procedural review

Are there any questions about the procedures being used?
--

5) Protocol for failing tests

Have there been any failing tests?
If so, what actions have been taken?

6) Head tester commitments

Has the head tester provided the necessary assistance?
Has the consultant requested assistance in areas not required?

7) Protocol for switching consultant materials testers

Has the consultant materials tester been switched?
If so, how was the switch handled?

8) Equipment changes

Has the same equipment been used throughout the project?
If equipment was changed, was it properly correlated or calibrated?

9) Check testing

Is the check testing program complete?
Is the check testing program up to date?

10) Independent Assurance Tests

Have the Independent Assurance tests been scheduled?
--

11) Miscellaneous

Are other pre-testing meeting checklist items complete?

COLORADO DEPARTMENT OF TRANSPORTATION CP 16, EVALUATION OF MATERIALS TESTING The contractor, consultant and head tester should be interviewed prior to completing this form. There should be a final meeting with the consultant to review strengths and weaknesses.	Project No.:	
	Project code:	
	Proj. name/location:	
	Region:	Residency:

Name of consultant company:	Name of consultant tester:	Quality of work/total rating:
-----------------------------	----------------------------	-------------------------------

Factor:	Ratings: ((5) very good, (4) good, (3) average, (2) below average, (1) poor)
1) Test result distribution	
2) Paperwork and documentation	
3) Following test procedures	
4) Following protocol for failing tests	
5) Adequacy of personnel, supervision and management	
6) Switching of testers	
7) Equipment changes and problems	
8) Scheduling of IATs	
9) Accurate billings	
10) Weekly meetings were attended	
11) Final paperwork	
12) Total Score: [$\frac{\text{total score}}{\text{total score}} + (11 - \text{any N/As}) = \text{Quality of work/total rating}$]	0

Comments on referenced Evaluation factors:

Rater: (Project Engineer)	Date:
Reviewer: (Region Materials Engineer)	Date:

Copy distribution: Project Engineer - Original
 Consultant
 Region Materials Engineer
 Central Laboratory - Documentation Unit

{This page was intentionally left blank.}

Colorado Procedure 17-12

Standard Practice for

Hot Mix Asphalt Test Result Verification and Dispute Resolution

1. SCOPE

1.1 The purpose of this Hot Mix Asphalt (HMA) Test Result Verification and Dispute Resolution Procedure is to establish a process to address questions over acceptance test result differences between the Contractor and the Colorado Department of Transportation (CDOT) in the properties and pay for HMA. Outliers will be addressed using the 2v process listed in the Revision of Sections 105 and 106 of the Standard Special Provisions.

2. REFERENCED DOCUMENTS

- 2.1 CDOT Field Materials Manual
- 2.2 CDOT Lab Manual of Test Procedures
- 2.3 AASHTO Test Procedures
- 2.4 ASTM Test Procedures

3. DEFINITIONS

- 3.1 Check Testing – as defined in CP 13.
- 3.2 Blind Split Sample – Sample submitted by the Engineer to the CDOT Materials and Geotechnical Branch to resolve differences in test results between QA testing and QC testing in accordance with this procedure. This sample shall be a split sample, in accordance with procedures in the CP 55, Method E.

4. REQUIRED CONDITIONS

- 4.1 The Check Testing provisions of the Contract must have been satisfactorily completed in accordance with CP 13.
- 4.2 If the check testing has not been satisfactorily completed in accordance with the contract, no challenge of the QA results will be allowed.

TABLE 17-1: Required Test Result Differences to Qualify for Dispute Resolution Testing

Element	Type of Test	Difference Between Test Results
Gradation: #8 and larger Sieves	CP 31	≥ 5 %
#16 to #100 Sieves	CP 31	≥ 3 %
#200 Sieve	CP 31	≥ 2.0 %
Asphalt Content	CP 85 CP-L 5120	≥ 0.27 % ≥ 0.27 %
Asphalt Compaction	CP 81 CP 44	≥ 1.5 % ≥ 1.5 %
Asphalt Compaction Longitudinal Joints	CP 44	≥ 1.5%
Air Voids	CP-L 5115	≥ 0.7 %
Voids in Mineral Aggregate	CP 48	≥ 0.7 %

4.3 Test result differences shall be larger than the tolerances listed in Table 17-1 or no dispute will be allowed.

4.4 If a documented split sample for dispute resolution is not submitted to the Engineer, dispute resolution testing will not be allowed.

4.5 For any disputed property, the following steps will be followed:

4.5.1 Level 1 – Test Result Questioned

Affected parties will immediately notify the Engineer and describe the issue in writing.

- Project and Contractor personnel will perform an investigation, review data, and possibly retest samples.
- All Level 1 tasks must be completed within 3 working days from the time written notification is received.

4.5.2 Level 2 – Issue Not Resolved by Level 1

Engineer and Contractor personnel will perform an investigation and review data to determine if the questioned sample is an isolated sample (test differences outside of multi-lab precision).

- QC and QA must be complete and up-to-date.
- If the dispute is a result of a bias between the QC and Acceptance test results, the bias should be resolved through check testing (CP 13) before determining if Level 3 should be used.
- All Level 2 tasks must be completed within 8 working days from the time written notification is received.

4.5.3 Level 3 – Issue Not Resolved by Level 2

- Blind split sample will be submitted to the CDOT Staff Materials Lab within 18 working days from the time written notification is received.
- Sample testing shall be completed by Staff Materials or third party lab within 5 working days of sample receipt.
- CDOT and Contractor Personnel will review findings of the third party lab and resolve within 5 working days.
- Third Party results entered into pay program.

5. SUBMISSION OF BLIND SAMPLE

5.1 The Contractor will provide and the Engineer will retain a split sample of sufficient quantity from each acceptance test as required by the test procedure to perform dispute resolution testing, except for cores used for density. (See Section 6) When materials are sampled for AC content correlation or correction in accordance with CP 85 or CP-L 5120, sufficient quantity as required by the test procedure shall be split out and retained for the dispute resolution laboratory. All samples will be retained by the Engineer.

5.2 If third party testing is required in accordance with CP 17, a blind split samples will be sent to the CDOT Materials and Geotechnical Branch. The blind split samples will either be tested by the CDOT Materials and Geotechnical Branch or forwarded to a consultant laboratory in accordance with the selection made by the contractor. The test results from the blind split samples will be used in the pay factor calculation in place of the test results that are questioned.

5.3 When a volumetric property is questioned, all volumetric properties shall be retested and the new values used for the calculation of dispute resolution pay factors. Recent QC data for aggregate bulk specific gravity may also be requested and evaluated during dispute testing.

5.4 For gradation disputes, the percent passing all specified sieves shall be retested and included in the calculation of dispute resolution pay factors.

5.5 All properties will be tested using the method used for project acceptance. For example, if acceptance testing for percent AC content is based on the nuclear AC gauge, the dispute resolution sample shall be tested using a nuclear AC gauge.

5.6 The dispute resolution blind split sample shall be confidentially submitted only to the Materials and Geotechnical Branch, Asphalt Program Manager by the Engineer using a CDOT Form #1304. Samples shall be submitted only when the decision has been formally made at the project to conduct dispute testing. The CDOT Form #1304 shall contain the following information:

- Project Subaccount
- Form #43 number for the sample
- Date of the Form #43
- Name and title of sample submitter
- Project contact information for reporting test results.
- List of required tests
- Independent lab who will test (either “Central Lab” or “Private Lab”)

- Witness information, if applicable (see Subsection 7.1)

5.7 The sample can shall contain a sufficient quantity of material as required by the test procedures to run the requested specified tests.

5.8 The blind sample shall be identified only by the CDOT Form # 1304 Field Sheet Number when provided by the CDOT Asphalt Program Manager to the independent lab for testing. The independent lab that will test the sample shall not be provided any details on the dispute sample project and shall not contact the project. Necessary project-specific testing information shall be provided after testing has been completed.

5.9 The project staff indicated on the Form #1304 shall be the only contact point for information and test result distribution by the CDOT Asphalt Program Manager.

6. DENSITY DISPUTES

6.1 As addressed in the Specification, disputes involving mat and longitudinal joint density, shall be resolved using roadway cores. The cores shall be taken by the Contractor within the time required by the specification.

6.2 Where cores are used for density acceptance, for example, SMA or Longitudinal Joints, dispute resolution will not be allowed unless companion QC cores were taken at the same time and with the edge of the core within six inches of the acceptance cores. Dispute resolution cores will also be taken within six inches of the edge of the acceptance cores.

6.3 Where acceptance for density was made using a nuclear density gauge, dispute resolution cores will be taken at the same location as the density measurements.

7. WITNESSING SAMPLE TESTING

7.1 The Contractor or his representative may witness the testing of the disputed sample if tested

by the Materials and Geotechnical Branch. One testing witness will be allowed and shall be identified in writing along with his qualifications prior to the testing. The CDOT Asphalt Program Manager will schedule the testing time and will notify the designated witness. Witnessing of testing shall be by visual observation only, no comments or discussion of the testing with the technicians performing the tests will be allowed. Questions on the testing procedures shall be directed to the CDOT Flexible Pavement Laboratory Manager after completion of testing. If the witness has any formal comments on the tests, they shall be submitted in writing to the Engineer with a copy also sent to the CDOT Asphalt Program Manager prior to scheduled distribution of the test results.

8. RESPONSIBILITY FOR TESTING EXPENSE

8.1 For single property disputes such as asphalt content on a gradation acceptance project, the lab whose result is furthest from the dispute resolution lab will pay for testing.

8.2 For disputes where more than a single property is affected by the retest, the lab furthest from the dispute resolution lab on the property questioned will pay for the testing, but the entire test result will be entered into the pay calculations for the material represented by that sample. For example:

8.2.1 Gradation - The test results for the disputed sieve will be used to determine who is furthest, but the entire gradation will be entered into the pay formula.

8.2.2 Volumetric properties - VMA, Air Voids and percent AC will be entered into the formula, while payment for testing will be determined based on the results for the single property disputed.

8.3.1 In case of a tie, the testing cost will be divided equally between both parties.

8.4 The costs for testing is shown in Table 17-2. An administrative cost of \$230 per sample will be charged in addition to the costs shown.

TABLE 17-2
Costs for Third Party Testing

Test	Cost
AC Ignition Correction	\$318
AC Nuclear Correction	\$373
AC Content by Ignition	\$109
AC Content by Nuclear	\$86
Gradation	\$115
Mixture Volumetrics (Rice, Air Voids, VMA)	\$338
Core Bulk Specific Gravity	\$32

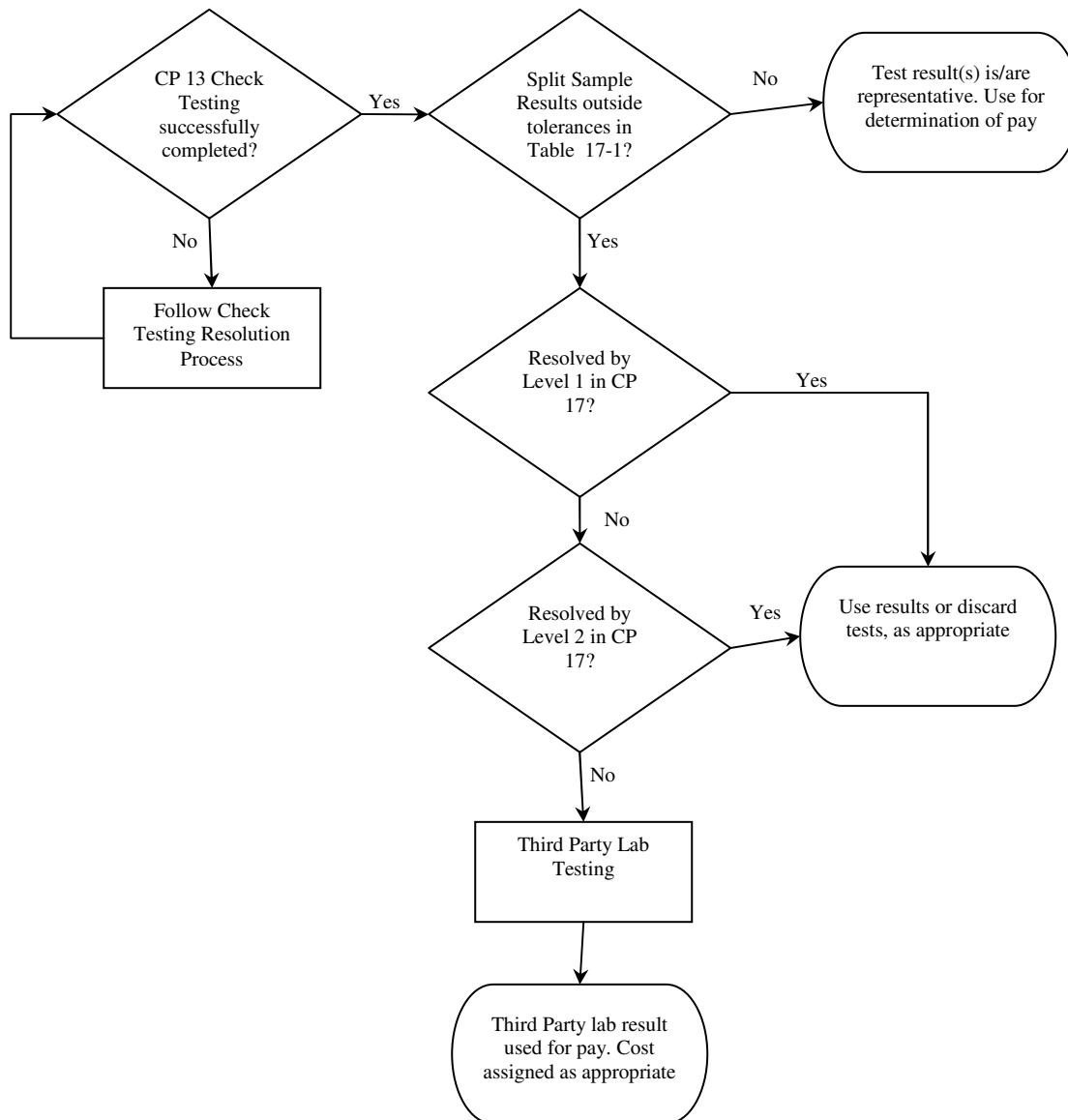

{This page was intentionally left blank.}

Colorado Procedure 20-08

Standard Practice for

Dry Preparation of Disturbed Soil Samples for Test

1. SCOPE

1.1 This procedure describes the dry preparation of soil and soil aggregate samples for mechanical analysis, liquid and plastic limits, and moisture density relations test.

2. REFERENCED DOCUMENTS

2.1 AASHTO Procedures:

- T 89 Determining the Liquid Limit of Soil
- T 90 Determining the Plastic Limit and Plasticity Index of Soil
- T 99 Moisture-Density Relations of Soils Using a 2.5-kg Rammer and a 305-mm Drop
- T 180 Moisture-Density Relations of Soils Using a 4.54-kg Rammer and a 457-mm Drop
- M 92 (ASTM E 11)
- M 145 Classification of Soils and Soil-Aggregate Mixtures for Highway Construction Purposes

2.2 ASTM Procedures:

- E 11 Standard Specifications for Wire Cloth and Sieves for Testing Purposes

2.3 Colorado Procedures:

- CP 21 Mechanical Analysis of Soils
- CP 32 Reducing Field Samples of Soils and Aggregate to Testing Size

3. APPARATUS

3.1 *Scales* – Scale of suitable capacity and sensitive to .01 lb (.01 kg).

3.2 *Balance* – Balance of suitable capacity and sensitive to 0.1 g.

3.3 *Sieves* – Series of sieves conforming to AASHTO M 92 of the following sizes: No. 4, No. 10, and No. 40.

3.4 *Drying Apparatus* – Oven or other suitable device.

3.5 *Sample Splitter* – Riffle type sample splitter to reduce sample to test portion size in accordance with CP 32.

3.6 *Pulverizing Apparatus* – Either a mortar and rubber covered pestle, or a mechanical device consisting of a power driven rubber covered mauler and a mortar suitable for breaking up the aggregations of soil particles without reducing the size of the individual grains.

4. SAMPLE SIZE

4.1 The amounts of material required to perform the individual tests are as follows:

4.1.1 Mechanical Analysis (CP 21) – For the mechanical analysis, material passing the No. 4 is required in the amount of approximately 500 g. The total portion of the sample retained on the No. 4 shall be used for gradation.

NOTE 1: When the mechanical analysis is to be used to determine the soil classification in accordance with AASHTO M 145, material retained on the 3-in. (75 mm) sieve shall not be included in the gradation of the material retained on the No. 4 sieve.

4.1.2 Liquid Limit (AASHTO T 89) and Plastic Limit (AASHTO T 90) – For the liquid and plastic limit tests, material passing the No. 40 sieve is required in total amounts of 100 to 300 g.

4.1.3 For Moisture Density Relations (AASHTO T 99 and T 180) test the following minimum amounts of material as required.

<u>Method</u>	<u>Passing Sieve</u>	<u>Minimum Quantity</u>
A	No. 4	10 lb. (4.5 kg)
B	No. 4	16 lb. (7.3 kg)
C	3/4 in. (19.0 mm)	12 lb. (5.4 kg)
D	3/4 in. (19.0 mm)	25 lb. (11.3 kg)

5. PREPARATION OF TEST SAMPLES

5.1 The sample shall be dried in air or by use of a drying apparatus that does not exceed 140°F (60°C). When sufficiently dry, break up the aggregations and separate the material into two fractions using a No. 4 sieve. Care shall be taken when processing the material through the No. 4 sieve to avoid reducing the natural size of the individual particles. Material retained on the No. 4 sieve shall be thoroughly cleaned using the apparatus described in Subsection 3.6 and a wire brush when necessary. The minus No. 4 material removed shall be combined with the material previously processed through the No. 4 sieve, and added to the total weight (mass) of the material passing the No. 4 sieve, uncorrected for hygroscopic moisture. (See NOTE 1).

5.2 Test Specimen for Mechanical Analysis – The total fraction of the sample retained on the No. 4 sieve as prepared in 5.1 shall be set aside for use in the sieve analysis of the plus No. 4 material in CP 21. Immediately after weighing the total amount of material passing the No. 4 sieve as prepared in 5.1, select by use of a sample splitter, a representative specimen weighing (with a mass of) approximately 500g for the washed sieve analysis in CP 21 and another representative specimen weighing (with a mass of) approximately 250g for a moisture specimen to correct the total weight (mass) of the minus No. 4 fraction and to correct the weight (mass) of the specimen selected for the washed sieve analysis to oven dry weight (mass).

5.3 Test Specimen for Liquid and Plastic Limits Tests (T 89, T 90) – By use of a sample splitter, select a representative portion of minus No. 4 material as prepared in Subsection 5.1 which will provide approximately 100g to 300g of minus No. 40 material when processed as follows:

5.3.1 The aggregations of soil particles shall be maulled using a rubber covered pestle or a power driven rubber covered mauler and mortar. Separate the specimen on the No. 10 sieve and alternately grind and sieve the material until the plus No. 10 particles appear clean. Discard the material retained on the No. 10 sieve. Alternately maul and sieve the material retained on the No. 40 sieve until only a small quantity passes the sieve and the retained particles appear clean. Discard the material retained on the No. 40 sieve. The thoroughly mixed minus No. 40 material shall be

used for the liquid and plastic limits tests.

NOTE 2: When mauling material with a pulverizing apparatus it shall be done in such a manner as to break up the aggregations without fracturing the individual grains.

5.4 Moisture Density Relations Test - By use of a sample splitter select a representative portion of minus No. 4 material as prepared in Subsection 5.1. Prepare the plus No. 4 material according to the procedure described in AASHTO T 99 or T 180 Method C or D. The minimum weight (mass) requirement shall be as shown for the applicable method in Subsection 4.1.3.

Colorado Procedure 21-08

Standard Method of Test for

Mechanical Analysis of Soils

1. SCOPE

1.1 This method describes the procedure for the quantitative determination of the distribution of particle size in soils and soil aggregate mixtures.

2. REFERENCED DOCUMENTS

- 2.1 *AASHTO Procedures:*
M 92 (ASTM E 11)
M 145 Classification of Soils and Soil-Aggregate Mixtures for Highway Construction Purposes
- 2.2 *Colorado Procedures:*
CP 20 Dry Preparation of Disturbed Soil Samples for Test

3. APPARATUS

- 3.1 *Balance* – A balance sensitive to within 0.1 gram.
- 3.2 *Container* – A pan or vessel with sufficient capacity to contain the specimen when covered with water.
- 3.3 *Washing Device* (Optional) – Any approved device designed to facilitate the removal of material finer than the No. 200 sieve from the test specimen. The device shall be capable of producing a result equivalent to that described in Subsection 5.2.2 and Note 2.
- 3.4 *Sieves* – A series of sieves of the following sizes conforming to AASHTO M 92: 3-in. (75 mm), 1-in. (25.0 mm), 3/4-in. (19.0 mm), No. 4, No. 10, No. 40, and No. 200.
- 3.5 *Drying Equipment* – Hot plate, stove, or oven.

4. TEST SPECIMEN

4.1 The test specimen shall be prepared in accordance with CP 20, Subsections 5.1 and 5.2.

5. PROCEDURE

5.1 Sieve Analysis of Plus No. 4 Material – The total fraction of the sample retained on the No. 4 sieve as prepared in CP 20, Subsection 5.1, shall be separated into a series of sizes by the use of the 3-in. (75 mm), 1-in. (25.0 mm), 3/4-in. (19.0 mm), 3/8-in. (9.5 mm), and the No. 4 sieves. The sieving operation shall be conducted in such a manner so as to keep the particles moving continuously over the surface of the sieve. Care shall be taken not to overload the sieves. Sieving shall continue until not more than 1% by weight (mass) of the residue passes any sieve during 1 minute. When mechanical sieving is used the thoroughness of sieving shall be checked occasionally by using the method as described above.

5.1.1 Weigh and record the portion of the specimen retained on each sieve. It is permissible to record the accumulated weights (masses) as the contents of each successive sieve are added to the fractions previously deposited on the scale pan.

NOTE 1: For the purpose of soil classification in accordance with AASHTO M 145, material retained on the 3 in. (75 mm) sieve shall not be included in the total weight (mass) of the specimen. The approximate maximum size shall be noted and reported on CDOT Form #219. When there is an appreciable amount of plus 3 in. (75 mm) material the percentage should be estimated and included in the notes on CDOT Form # 219.

5.2 Sieve Analysis of Minus, No. 4 Material – The minus No. 4 specimen for moisture determination, as prepared by CP 20, Subsection 5.2, shall after weighing be dried to a constant

weight (mass) at $230^{\circ}\text{F} \pm 9^{\circ}$ ($110^{\circ}\text{C} \pm 5^{\circ}$). When cool (room temperature) and dry, weigh, calculate, and record the percent moisture.

5.2.1 The minus No. 4 specimen for the washed sieve analysis as prepared by CP 20, Subsection 5.2, shall, after weighing, be placed in a container and covered with water for a sufficient length of time to assure complete separation of the material finer than the No. 200 sieve from the coarser particles. A small amount of organic wetting agent may be added to the water to facilitate wetting.

5.2.2 Transfer the soaked specimen from the container onto a nest of two sieves of which the top "breaker" sieve is a No. 8 or No. 10 and the bottom sieve is a No. 200. Wash the specimen over the "breaker" sieve until the material retained on the sieve is clean. Transfer the clean retained material to a suitable container and set aside. Wash the material passing the "breaker" sieve over the No. 200 sieve, using any method or device, which will assure the removal of that portion of the specimen, which is finer than the No. 200 sieve size. When clean, transfer the material remaining on the No. 200 sieve to the container with the material retained on the "breaker" sieve and dry to a constant weight (mass) at $230^{\circ}\text{F} \pm 9^{\circ}$ ($110^{\circ}\text{C} \pm 5^{\circ}$).

NOTE 2: Washing over the No. 200 sieve by decantation, using a pinched hose or by mechanical or automatic washing devices, shall be performed in such a manner so as not to reduce the individual particle size. Manipulation of the material on the No. 200 sieve will be permitted, provided direct force or pressure is not applied to the sieve. The specimen shall be considered clean when the water washed through the sieve and caught in a clean white pan shows only a negligible amount of material passing the sieve.

5.2.3 When cool (room temperature), separate the specimen into a series of sizes by the use of the No. 10, No. 40, and No. 200 sieves. The sieving shall be conducted as described in Subsection 5.1.

5.2.4 Weigh and record the material retained on each sieve. This may be done either individually or accumulatively as in Subsection 5.1.1.

6. CALCULATIONS

6.1 Using the percent moisture as determined in Subsection 5.2, correct the original moist weight (mass) of the total minus No. 4 material and the moist weight (mass) of the minus No. 4 specimen selected for the washed sieve analysis to dry weight (mass) as follows:

$$\frac{\text{Dry Weight (Mass)}}{\text{Wet Weight (Mass)}} = \frac{\text{wet weight (mass)}}{100 + \% \text{moisture in specimen}} \times 100$$

6.2 After correcting the total moist weight (mass) of the minus No. 4 fraction to dry weight (mass), calculate the percentage of material retained on each sieve larger than the No. 4 sieve and the total percentage of material passing the No. 4 sieve by dividing each by the total combined dry weight (mass) of both the plus and minus No. 4 fractions. Convert percent retained to percent passing each sieve and total percent passing the No. 4 sieve. (See Note 1)

6.3 Calculate the percentages retained on the No. 10, No. 40, and No. 200 sieves from the washed sieve analysis specimen by dividing the weight (mass) retained on each sieve by the total dry weight (mass) of the minus No. 4 sieve analysis specimen before washing. Convert percent retained to percent passing each sieve.

6.4 Calculate the percent passing each sieve on a total sample basis by multiplying the percent passing each sieve of the washed sieve analysis specimen by the percent passing the No. 4 sieve of the total sample divided by 100.

7. RECORD

7.1 CDOT Form #564, Soils and Aggregates Sieve Analysis When Splitting on the No. 4 Sieve.

7.2 CDOT Form #219, Soil Survey of the Completed Roadbed.

Colorado Procedure 23-10

Standard Method of Test for

Determining Maximum Dry Density and Optimum Moisture of the Total Sample of Soil-Rock Mixture

1. SCOPE

1.1 This method of test is intended for determining the maximum dry density and optimum moisture content of the total sample of soil-rock mixture on which the maximum dry density and optimum moisture content of the minus No. 4 material has been determined, and correcting this density and moisture for the percentage of rock in the soil-rock mixture. The percentage of rock is determined using material obtained from the immediate vicinity of the density test.

2. REFERENCED DOCUMENTS

- 2.1 *AASHTO Procedures:*
- T 85 Specific Gravity and Absorption of Coarse Aggregate
 - T 99 Moisture-Density Relations of Soils Using a 2.5-kg Rammer and a 305-mm Drop
 - T 180 Moisture-Density Relations of Soils Using a 4.54-kg Rammer and a 457-mm Drop
 - T 191 Density of Soil In-Place by the Sand-Cone Method
- 2.2 *Colorado Procedures:*
- CP-L 3104 Determining the Durability of Shales for Use as Embankments

3. APPARATUS

- 3.1 *Balance* - Capacity of 2500g or more and sensitive to 0.1g.
- 3.2 *Drying Equipment* - Stove or oven.

4. PROCEDURE

4.1 Determine the maximum dry density and the optimum moisture content of the minus No. 4 material in accordance with AASHTO T 99 or T 180, Method A.

4.2 Determine the bulk specific gravity of the rock fraction of the sample as follows:

4.2.1 Obtain a representative sample of material from the immediate vicinity of the density test. The depth of the sample hole should be between 5 to 10 inches (125 to 250 mm). Process the sample over the No. 4 sieve to obtain a 1.5 to 2.0 kg specimen of minus 3 in. (75 mm) plus No. 4 rock.

4.2.2 Determine the bulk specific gravity of the plus #4 material using AASHTO T 85.

4.3 Weigh the entire soil-rock mixture from the density test hole as described in T 191 or from a hole directly below the nuclear moisture / density gauge test site. Dry the entire specimen to a constant weight (mass) at $230^{\circ}\text{F} \pm 9^{\circ}$ ($110^{\circ}\text{C} \pm 5^{\circ}$) and determine the moisture content and dry weight (mass) of the entire specimen. Separate the material by using a No. 4 sieve and weigh the fraction retained. Calculate the percentage retained as follows:

$$\text{Percent Plus No. 4 (rock)} = \frac{\text{Dry wt. of + No. 4}}{\text{Dry wt. of total specimen}} \times 100$$

5. CALCULATIONS

5.1 The maximum dry density and optimum moisture content of the minus No. 4 material determined in accordance with AASHTO T 99 or T 180, Method A, shall be corrected for the percentage of plus No. 4 rock in the density test by the following formulas or by use of the nomographs provided in Chapter 200.

$$\text{Corrected Maximum Dry Density} = \frac{P_f \times D_f + P_c \times 0.9D_c}{100}$$

$$\text{Corrected Optimum Moisture Content} = \frac{M_f \times P_f + M_c \times P_c}{100}$$

7.2 CDOT Form #584, Moisture - Density Relation Graph.

Where:

- P_f = Percent fine particles by weight (minus No. 4);
- P_c = Percent coarse particles by weight (plus No. 4);
- D_f = Maximum dry density of fine particles (minus No. 4), pcf;
- D_c = 62.4 x bulk specific gravity (G_m) (oven dry basis) of coarse particles, pcf.;
- P_c = Percent coarse particles by weight (plus No. 4);
- M_f = Moisture content of the fine particles (minus No. 4);
- M_c = Moisture content of the coarse particles (plus No. 4).

6. LIMITATION FOR USE OF CP 23

6.1 CP 23 shall not be used when the plus No. 4 fraction of the sample consists of cinders or other light porous rock since an accurate specific gravity determination is difficult to make on this type of material. For these materials AASHTO T 99 or T 180 Method C or D shall be used.

6.2 The plus No. 4 fraction of the sample shall be determined to be Rock-like (Durable) or Soil-like (Non-durable) either visually, by experienced field personnel, or in the Central Laboratory., according to CP-L 3104.

If the plus No. 4 fraction is classified as Non-durable then CP 23 will not apply and the total sample shall be treated as minus No. 4 material for moisture / density determination.

NOTE 1: Non-durable plus No. 4 material will usually be found in soils with a classification of A-6 or A-7.

7. RECORD

7.1 CDOT Form #24, Moisture - Density Relation.

Colorado Procedure 24-05

Standard Practice for

Soil Surveys of Constructed Roadbeds

1. SCOPE

1.1 This procedure provides the substantiation for the cover placed and the data required to justify changes from plan cover. A soil survey of the constructed roadbed consists of the following:

1.1.1 Obtaining representative samples of all soil types, the determination of soil profiles, and the significant soil layers to a depth of two feet (600 mm).

1.1.2 The classification and extent of each soil type.

2. EQUIPMENT

2.1 The amount and type of equipment required for making a survey depends on the type of material in the roadbed. Refer to the Soil Survey / Preliminary Soil Profile Section within Chapter 200 for additional information.

3. SUB-GRADE INVESTIGATION

3.1 Soil identification, sampling, and testing provide the fundamental framework of the complete survey. This emphasizes the necessity of using care in identifying and sampling soils. Laboratory tests are of little or no value if the samples selected are not representative of the materials to be considered.

3.2 Make a sufficient number of investigations to assure all significant variations in soil types are determined. A minimum of one investigation per 1,000 linear ft. (300 m) is required. Make all investigations to a depth of at least two feet (600 mm) below the finished sub-grade elevation. Number the investigations consecutively as the survey moves progressively forward. For vertical changes in the same test hole use suffixes A, B, etc. Take a new sample for every change in soil type. An investigation may include referencing a sample to one previously taken. Referencing samples should be done by those who are thoroughly experienced in soils technology. Show

the limits of all investigations consecutively with no breaks except for bridges. In areas where several soil types are so intermixed that no limits can be determined, show the various tests with separate numbers, with no suffixes, and show the limits for this area. Stabilization will be based on the least desirable soil in the area.

3.2.1 When the Pavement Stabilization is based on a design R Value that equals 5; the Region Materials Engineer in cooperation with the Resident Engineer and the Staff Soils Engineer may elect to eliminate the requirement for the Final Soil Survey of the Constructed Roadbed. This decision should be evaluated and documented on a project-by-project basis.

3.3 Place the soil sample for laboratory analysis in tightly woven sacks. A minimum of 25 lbs. (10 to 12 kg) of minus No. 4 material is required for classification, stabilometer and expansion pressure tests. Additional material, in the approximate amount of the plus No. 4 material contained in the sample, is required when a soil rock mixture is sampled. For field laboratory gradation and Atterberg limits, approximately 15 lbs. (10 kg) of minus No. 4 material is required.

4. COVER DETERMINATIONS

4.1 The field laboratory will conduct gradation and Atterberg Limits to classify soils for the substantiation of cover placed. Keep graded material segregated until it is determined there are no significant variations in the material from the preliminary soil survey. If significant variations of the material from the preliminary soil survey are determined, the segregated material should be sent with the Form #564 to either the Central or Region Laboratory for R-value tests.

4.2 The Central Laboratory or Region Laboratory will determine the R-Value on soils submitted for cover determinations. Use the R-Value as instructed in the current CDOT Pavement Design Manual. When available, Structural Coefficients should be taken from the pavement stabilization plan contained in the plan sheets. In

the field, soils may be referenced to samples of similar soils from the same or adjacent projects.

4.3 Reference R-Values on soil by comparing the classification, Atterberg Limits, and the "as run" gradation reported on CDOT Form #555 with the field sample which has been mathematically "scalped" on the same sieve as the laboratory sample. Only experienced materials personnel should attempt to reference soil to determine R-Values.

5. REPORTING

5.1 Report the Soil Survey on CDOT Form #219. Leave Sample No. blank. No serial number is required. Date and project number are sufficient for identification. A CDOT Form #219 will not be required for overlay projects or projects where there has not been any change in the top two feet (600 mm) of sub-grade as shown by the preliminary soil survey.

5.2 Document on CDOT Form #219 any significant variation from the cover required by the as-constructed soil survey. Areas, which contain mixtures of soil types, shall have sufficient cover to satisfy the lowest R-Value of the material in the area.

5.3 Submit a CDOT Form #219 on all newly completed roadbeds and roadbeds that are modified resulting in soil changes in the top two feet (600 mm).

5.3.1 Main-line roadbed includes each side of the median on divided highways.

5.3.2 All service roads and interchanges.

5.3.3 Widening (each side if applicable).

5.3.4 All work sections of old roadbeds.

5.3.5 Identify and report each of the above separately on CDOT Form #219. See Chapter 200 for an example of CDOT Form #219.

5.4 When change orders are required to document changes in cover requirements, support them with a CDOT Form #219 for the portion affected. Route the change orders through the Region Materials Engineer's office so the supporting data on CDOT Form #219 may be checked.

6. RECORD

6.1 CDOT Form #555, Preliminary Soil Survey.

6.2 CDOT Form #219, Soil Survey of the Completed Roadbed.

Colorado Procedure 25-10

Standard Practice for

Calculation of Percent Relative Compaction of Soils and Soil-Rock Mixtures

1. SCOPE

1.1 This procedure describes the method for calculating percent relative compaction of soils and soil-rock mixtures.

NOTE 1: For calculation details, refer to the examples of CDOT Form #31 (Chapter 200) or CDOT Form #427 (Chapter 800) in this Field Materials Manual.

2. REFERENCED DOCUMENTS

2.1 AASHTO Procedures:

- T 99 Moisture-Density Relations of Soils Using a 2.5-kg Rammer and a 305-mm Drop
- T 180 Moisture-Density Relations of Soils Using a 4.54-kg Rammer and a 457-mm Drop
- T 191 Density of Soil In-Place by the Sand-Cone Method

2.2 Colorado Procedures:

- CP 80 In-Place Density and Moisture Content of Soil and Soil-Aggregate by the Nuclear Method

3. PROCEDURE

3.1 Calculate percent relative compaction by dividing the dry density of the material from the test site by its maximum dry density, and multiply this quotient by 100. The maximum dry density shall be as defined in the applicable paragraph of this procedure.

3.2 Following the determination of the in-place density, obtain a representative sample of the material directly beneath the nuclear moisture / density gauge to a depth not to exceed 2 inches greater than the depth being tested. The sample should be of sufficient size

to obtain at least 7 lbs. (3.2 kg) of air dried minus No. 4 material. When employing AASHTO T 191, the material excavated from the test hole may be used.

3.3 Determine the percent plus No. 4 in the material obtained in Subsection 3.2. If there is 5% or more plus No. 4 material, a rock correction must be applied to the maximum dry density of the material obtained in this procedure.

3.4 Use the minus No. 4 portion from the material described in Subsection 3.2 to determine the maximum wet density according to AASHTO T 99 or T 180, whichever is applicable.

NOTE 2: Some drying or the addition of extra moisture may be necessary to bring the soil moisture into the general range of 6% below optimum to optimum. The percent moisture may be used from the nuclear moisture / density test if the material contains no more than 5% plus No. 4 material, and if the moisture is maintained essentially identical to the test site moisture content.

3.4.1 Using the percent moisture from either the nuclear test data or from a representative moisture specimen taken from the material in the compaction cylinder, calculate the dry density of the material from the compaction cylinder using the formula:

Where:

$$D_D = \frac{W_W * MF}{M + 100} \times 100$$

- D_D = Dry weight (mass) of compacted soil, lb/ft³ (kg/m³),
- W_W = Wet weight (mass) of compacted soil, lb (kg)
- MF = Mold Factor (30 for a 4" mold or 13.33 for a 6" mold)
- M = percent moisture.

3.4.2 Using the dry density figure from the material compacted into the cylinder and the percent moisture figure of this same material, plot the location of these coordinates on the appropriate moisture density relation curve (determined by AASHTO T 99 and T 180) previously run by project personnel or provided to project personnel by the Region Laboratory or the Central Laboratory.

NOTE 3: This moisture density relation curve must pertain to soil from the same project or a project in the immediate vicinity of the one being tested. If the soil being tested has not been classified previously, it must be classified and only a curve from soils of similar classification shall be used for the trial plot. If the one point data determined in Subsections 3.4 and 3.4.1 does not plot within at least 2.0 lb/ft^3 (32 kg/m^3) at the specimen's moisture content, of an applicable moisture density curve, try additional appropriate curves meeting the aforementioned criteria. If an applicable curve is not found, refer to Subsection 3.4.5 of this procedure.

3.4.3 Select the moisture density relation curve, which this point falls upon or the curve that is within 2.0 lb/ft^3 (32 kg/m^3) of this point at the moisture content of the specimen.

3.4.4 The maximum dry density for this particular material shall be as determined from the dry density curve selected in Subsection 3.4.3.

3.4.5 If the data from the one point test from Subsection 3.4 does not plot within 2.0 lb/ft^3 (32 kg/m^3) of any appropriate moisture density relation curve described in Subsection 3.4.2, use the material collected in Subsection 3.2 to perform a complete moisture density relation test according to AASHTO T 99 or T 180, whichever is applicable. Use the maximum dry density from this data to calculate the percent relative compaction.

3.4.6 If a Family of Curves is available, use the data from the one point test as described in Subsections 3.4 through 3.4.1 to select the proper moisture density relation curve and thus determine the proper maximum dry density for soil being tested.

3.4.7 By knowing the origin of the hauled material, being able to visually identify soil types,

and by referring to preliminary soil profile data as well as compacted curve data determined from soils on the project, the tester may use engineering judgment to select the proper moisture density relation curve and use the maximum dry density from this curve to determine percent relative compaction.

NOTE 4: This arbitrary selection should only be attempted by experienced personnel, and only when working with uniform soil classifications.

3.4.8 When using the method of compaction curve selection described in Subsection 3.4.7, a minimum of one, one-point test shall be performed for every 5 relative compaction determinations made for each major soil classification.

NOTE 5: Subsection 3.4.8 is required to verify and document that there has not been subtle or unnoticed changes in soil characteristics.

3.4.9 For soil containing 5% or more plus No. 4 material, the maximum dry density of minus No. 4 fraction shall be determined as described in this procedure. The corrected maximum dry density shall be used to calculate percent relative compaction. To correct the maximum dry density use the instructions for CDOT Form #31 (Chapter 200) and CDOT Form #427 (Chapter 800).

4. RECORD

4.1 CDOT Form #31, In-Place Moisture and Density Determination by the Sand Method.

4.2 CDOT Form #427, Nuclear Soils Moisture / Density Test.

Colorado Procedure 30-09

Standard Practice for

Sampling of Aggregates

(This procedure is based upon AASHTO T 2-91. AASHTO T 2-91 or any subsequent revision may not be used in place of this procedure.)

1. SCOPE

1.1 These methods are intended to apply to the sampling of aggregates used in acceptance and quality control from the points of acceptance designated in the Schedule for Minimum Materials Sampling, Testing, and Inspection for the following items:

- Item 206 - Structure Backfill, Filter Material, Bed Course Material
- Item 304 - Aggregate Base Course
- Item 308 - Aggregate for Portland Cement Treated Base
- Item 403 - Aggregates for Hot Mix Asphalt
- Item 409 - Cover Coat Material
- Item 412 - Aggregate for Portland Cement Concrete Pavement
- Item 601 - Aggregate for Structural Concrete
- Item 608 - Aggregate for Concrete Sidewalk, Bituminous Sidewalk, Concrete Bikeways and Bituminous Bikeways
- Item 609 - Aggregate for Concrete Curbing and Bituminous Curbing
- Item 610 - Aggregate for Median Cover Material

NOTE 1: Sampling plans and the acceptance and control tests vary with the type of construction in which the material is used.

1.2 The values stated in English units are to be regarded as the standard. The values in parentheses are provided for information purposes only.

1.3 This standard may involve hazardous materials, operations and equipment. This standard does not purport to address all of the safety problems associated with its use. It is the responsibility of the user of this standard to establish appropriate safety and health practices and determine the applicability of regulatory limitations prior to use.

2. REFERENCED DOCUMENTS

- 2.1 *Colorado Procedure:*
CP 75 Stratified Random Sampling of Materials

3. SIGNIFICANCE AND USE

3.1 Sampling is equally as important as the testing, and the sampler shall use every precaution to obtain samples that will show the nature and condition of the materials which they represent.

3.2 Samples of all aggregates used in HMA and being tested by the Colorado Department of Transportation (CDOT) or its representative shall be taken by the contractor or his representative with an authorized representative of CDOT present during the sampling procedure. Samples of all non-HMA aggregates being tested by CDOT or its representative shall be taken by or, at CDOT's option, witnessed by an authorized representative of CDOT. The CDOT representative present shall take immediate possession of all samples taken. CDOT reserves the right to designate the locations to be sampled and the procedure to be used.

4. SECURING SAMPLES

4.1 *General* - Where practicable, a minimum of one sample per stockpile to be tested for quality shall be obtained from the finished product. Samples from the finished product to be tested for abrasion loss shall not be subject to further crushing or manual reduction in particle size in preparation for the abrasion test, unless the size of the finished product is such that it requires further reduction for testing purposes.

4.2 *Sampling Equipment*. The contractor shall provide suitable equipment needed for proper sampling.

4.3 Procedure:

4.3.1 *Sampling from a Flowing Aggregate Stream* - Samples shall be selected from all of the material produced using CP 75. Use extreme care to avoid segregation when sampling. Sampling the initial discharge or the final few tons from a bin or conveyor belt increases the chances of obtaining segregated material and should be avoided.

4.3.1.1 *Belt Discharge:*

4.3.1.1.1 *Belt Discharge using Hand Tools* - If it is safe and practical to sample directly from the belt discharge, hand tools may be used. Obtain one or more approximately equal increments, selected at random. Combine to form a field sample whose mass equals or exceeds the minimum recommended in Subsection 4.4.2. Take each increment from the entire cross section of the material as it is being discharged using a container at least 12 in. (30 cm) in diameter (or minimum lateral dimension) and having sufficient capacity to hold the sample increment. Make several quick passes through different sections of the material rather than one slow pass. A sampling platform or other means are required to enable the sampler to safely stand within 2 ft. (0.6 meters) of the belt discharge.

4.3.1.1.2 *Belt Discharge using an Automatic Belt Sampler* - Belt discharge samples may be taken using an automatic belt sampler designed to cut the full discharge of the belt without loss of any portion of the material. Take one or more field samples whose combined mass equals or exceeds the minimum recommended in Subsection 4.4.2.

4.3.1.1.3 *Belt Discharge using Power Equipment* - A belt discharge sample may be taken by positioning a front-end loader bucket, truck, or similar equipment beneath the belt discharge. The material obtained shall be placed in a separate, small sampling pile and sampled according to Subsection 4.3.3.2. Obtain a field sample whose mass equals or exceeds the minimum recommended in Subsection 4.4.2.

4.3.1.2 *Bin Discharge* - Test results obtained using bin discharge samples shall not be used for acceptance.

4.3.1.3 *Dry Batch* - When sampling a dry batch,

an initial dry batch must be wasted. A second batch may then be sampled as follows. A front-end loader bucket, truck, or similar equipment is positioned under the pugmill to obtain a large sample in one increment. Sample the material according to Subsection 4.3.3.2. Extreme care must be used to avoid segregation and loss of dust sized particles from the sample.

4.3.2 *Sampling from the Stopped Conveyor Belt* Samples shall be selected from all of the material being produced by CP 75. Obtain one or more approximately equal increments and combine to form a field sample whose mass equals or exceeds the minimum recommended in Subsection 4.4.2. Stop the conveyor belt while the sample increments are being obtained. To obtain each increment, insert two templates, the shape of which conforms to the shape of the belt into the aggregate stream on the belt, and space them such that the material contained between them will yield an increment of the required weight. Carefully scoop all material between the templates into a suitable container and collect the fines on the belt with a brush and dustpan and add to the container.

4.3.3 *Sampling from Stockpiles* - When sampling from stockpiles, it may be difficult to obtain representative samples. Sampling from stockpiles should only be done by or under the direction of experienced personnel. When sampling stockpiles of coarse or coarse and fine aggregates, power equipment, when available, should be utilized as described in Subsections 4.3.3.1 and 4.3.3.2. For general guidance in sampling from stockpiles, see Subsections 4.3.3.1 or 4.3.3.3. When sampling Cover Coat Material from the stockpile, the sample shall be taken from the last stockpile prior to delivery to the spreader. The material will be sampled by the random sampling procedure as it is being delivered to the stockpile, or as it is being removed and hauled to the spreader. This will assure that all portions of the material will be sampled.

4.3.3.1. When using power equipment, develop a separate, small sampling pile composed of materials drawn from various levels and locations in the main pile as follows. Remove material from the sides of stockpiles to expose a representative face for sampling. Judgment must be used to determine the number and locations of areas in the big pile to sample in order to represent the stockpile as accurately as possible. The number

of portions required will depend on the size of the stockpile, the method of stockpiling, and the visual degree of segregation. Channel the faces thus exposed from bottom to top and sample the material obtained according to Subsection 4.3.3.2.

4.3.3.2 The power equipment should combine the material obtained in a separate small sampling pile. Flatten the pile to form a pad having depth that is not thicker than approximately 1 ft. (0.3 meters). Use a flat, square end shovel and sample the pad from at least three locations, sampling through the full depth of the pad if possible. Several increments shall be combined to compose a field sample whose mass equals or exceeds the minimum recommended in Subsection 4.4.2.

4.3.3.3 Where power equipment is not available, samples from stockpiles should be made up of at least two sets of three increments (180 degrees apart) taken from the top third, at the midpoint, and at the bottom third of the volume of the pile. Place a board or metal shelf vertically into the pile just above the sampling point to prevent loose aggregate from sliding into the sampling area and to aid in preventing segregation. Remove approximately 6 inches (15 cm) of surface material. Use a flat, square end shovel or scoop with sides for sampling. In sampling stockpiles of fine aggregate (3/8 in. (minus 9.5 mm)), the outer layer, which may have become segregated, should be removed and the sample taken from the material beneath. The use of sampling tubes has proven to be satisfactory. Sampling tubes approximately 1 1/4 in. (30 mm) minimum in width by 6 ft. (2 m) in length may be inserted into the pile at random locations to extract a minimum of five increments of material to form the sample. Several increments shall be combined to compose a field sample whose mass equals or exceeds the minimum recommended in Subsection 4.4.2.

4.3.4 *Sampling from Roadway (Bases and Sub-bases)* - Select material to be sampled from all of the material produced (e.g. A station or tonnage) by utilizing CP 75. Obtain at least three approximately equal increments, selected at random from the unit being sampled, and combine to form a field sample whose mass equals or exceeds the minimum recommended in Subsection 4.4.2. Using a flat, square end scoop or shovel, take all sample increments from the roadway for the full depth of the material, wherever possible, taking care to exclude any underlying

material.

4.3.5 *Sampling Aggregates from Processed Windrows* - Select material to be sampled from all of the material produced using CP 75. For processed material containing sufficient moisture to maintain a near vertical face, remove material from one side toward the center to the full depth until a representative face is exposed. Channel the face just exposed from bottom to top and obtain a sample whose mass equals or exceeds the minimum recommended in Subsection 4.4.2 by combining portions from at least three equally spaced locations on the exposed face. Use a flat, square end shovel and, exercising care, remove the portions making sure that particles do not roll off the shovel.

4.3.6 *Sampling Aggregates from a Cover Coat Material Spreader* - Samples shall be taken at the last possible location prior to placement on the pavement. With the spreader stopped, samples will be taken from a minimum of three of the individual chip spreader gates as the aggregate is falling from the spreader to the sample container placed on the pavement. These samples will be combined into one sample whose mass equals or exceeds the minimum requirements shown in Subsection 4.4.2. If there is a belt transfer device on the spreader, the Engineer may approve obtaining a representative sample from the belt when the machine is at rest as detailed in Subsection 4.3.2. If neither of these sampling methods are possible, the Engineer may allow random sampling from the stockpile as detailed in Subsection 4.3.3.

4.4 Number and Mass of Field Samples:

4.4.1 The minimum number of field samples required is specified in the CDOT Field Materials Manual under the Schedule for Minimum Materials Sampling, Testing, and Inspection.

4.4.2 The minimum mass for lab samples is given in the CDOT Field Materials Manual in the Schedule for Minimum Materials Sampling, Testing, and Inspection. The minimum mass for field samples is given in Table 30-1. The sample must be large enough to include representative portions of each component of the material. The mass must be predicated on the type and number of tests to which the material is to be subjected and with sufficient material obtained to provide for the proper execution of these tests.

TABLE 30-1: Size of Field Samples

Nominal Maximum Size of Aggregates ^A		Approximate Minimum Mass of Field Samples, lbs. (kg)	
Fine Aggregate:			
No. 8	(2.36 mm)	10	(5)
No.4	(4.75 mm)	10	(5)
Coarse Aggregate:			
3/8 in.	(9.5 mm)	15	(7)
2 in.	(12.5 mm)	20	(10)
3/4 in.	(19.0 mm)	25	(12)
1 in.	(25.0 mm)	30	(15)
1 2 in.	(37.5 mm)	40	(20)
2 in.	(50. mm)	45	(22)
2 2 in.	(63. mm)	50	(25)
3 in.	(75. mm)	55	(27)
3 2 in.	(90. mm)	60	(30)

^A For processed aggregate, the nominal maximum size is defined in the Appendix to the CDOT Field Materials Manual.

5. SHIPPING SAMPLES

5.1 Transport aggregates in bags or other containers so constructed as to preclude loss or contamination of any part of the sample, or damage to the contents from mishandling during shipment. Do not ship more than 60 lbs. (30 kg) per bag to allow for easier handling of samples. When moisture content is being measured in the aggregate sample, the representative sample must be stored in a sealed container that will prevent any moisture loss.

5.2 Shipping containers for aggregate samples shall have suitable individual identification attached and enclosed so that field reporting, laboratory logging, and test reporting may be facilitated. **Utilization of CDOT Form #633, Sample Tag (for Sacks), is required for all submitted samples.**

Colorado Procedure 31-12

Standard Method of Test for

Sieve Analysis of Aggregates

(This procedure modifies AASHTO T 11 and T 27. The current AASHTO T 11 and T 27 are to be used with this procedure.)

1. SCOPE

1.1 This method covers the determination of the particle size distribution of fine and coarse aggregate

2. REFERENCED DOCUMENTS

- 2.1 AASHTO Standards:
- T 11 Materials Finer than the No. 200 Sieve in Mineral Aggregates by Washing
 - T 27 Sieve Analysis of Fine and Coarse Aggregates
- 2.2 Colorado Procedures:
- CP 32 Reducing Field Samples of Soil and Aggregate to Testing Size

3. PROCEDURE

3.1 AASHTO T 11 and T 27 shall be used to determine the sieve analysis of fine and coarse aggregates with the following exceptions:

3.1.1 The minimum test sample mass shall be that in Table 31-1.

3.1.2 A split moisture sample may be used to accelerate the test procedure using the following procedure:

3.1.2.1 Following CP 32 split the material into two approximately equal samples.

3.1.2.2 Dry one of the samples to a constant mass using a hot plate or a 230°F +/- 9° oven to determine its moisture content.

3.1.2.3 Determine the dry weight of the second

sample using the following equation:

$$W_{Dry} = \frac{W_{Wet}}{100+MC} \times 100$$

Where

W_{Dry} = Dry weight (mass) of 2nd sample
 W_{Wet} = Wet weight of 2nd sample
 MC = Moisture content of 1st sample

3.1.2.4 Determine the sieve analysis on the 2nd sample using AASHTO T 11 and T 27.

Table 31-1

Aggregate Nominal Maximum Size Square Opening, Inches	Minimum Weight (Mass) of Test Sample, Pounds (kg)
< 3/8	0.66 (0.30)
3/8	2.2 (1.0)
1/2	3.3 (1.5)
3/4	4.4 (2.0)
1	5.5 (2.5)
1 1/2	11.0 (5.0)
2	16.0 (7.5)
2 1/2	22.0 (10.0)
3	27.5 (12.5)
3 1/2	33.0 (15.0)

NOTE 1: Nominal maximum size is as defined in the Appendix of the Field Materials Manual.

{This page was intentionally left blank.}

Colorado Procedure 32-03

Standard Practice for

Reducing Field Samples of Soil and Aggregate to Testing Size

(This procedure is based upon AASHTO T 248-89. AASHTO T 248-89 or any subsequent revision may not be used in place of this procedure.)

1. SCOPE

1.1 These methods cover the reduction of field samples of soil and aggregate to the appropriate size for testing employing techniques that are intended to minimize variations in measured characteristics between the test samples selected and the field sample. CP 55 is used for the reduction of samples of HMA to test size.

1.2 The values stated in acceptable English units are to be regarded as the standard.

2. REFERENCED DOCUMENTS

- 2.1 *AASHTO Standards:*
T 2 Sampling Aggregates
T 84 Specific Gravity and Absorption of Fine Aggregate
- 2.2 *Colorado Procedures:*
CP 20 Dry Preparation of Disturbed Soil Samples for Test
CP 30 Sampling of Aggregates
CP 55 Reducing Field Samples of Hot Mix Asphalt to Testing Size
CP-L 4102 Specific Gravity and Absorption of Fine Aggregate

3. SIGNIFICANCE AND USE

3.1.1 The necessity for selecting representative samples and reducing them to test specimen size is emphasized in many test procedures. Using the proper equipment for the type of material to be reduced in size is important. However, unless used correctly, the final test specimen will not necessarily be representative of the total sample.

3.1.2 Specifications for aggregates indicate the sampling portions of the material required for testing. Other factors being equal, larger samples will tend to be more representative of the total aggregate source. These methods provide for reducing the large sample obtained in the field to a convenient size for conducting a variety of tests to describe the material and to measure its quality in such a manner that the smaller portion is most likely to be a true representation of the field sample, and thus of the total aggregate source. The individual test methods indicate the minimum weights of material to be tested.

3.2 Under certain circumstances, reduction in size of the field sample prior to testing is not recommended. Substantial differences between the selected test samples sometimes cannot be avoided, as for example, in the case of an aggregate having relatively few large size particles in the field sample. The laws of chance dictate that these few particles may be unequally distributed among the reduced size test samples. Similarly, if the test sample is being examined for certain contaminants occurring as a few discrete fragments in only small percentages, caution should be used in interpreting results from the reduced size test sample. Chance inclusion or exclusion of only one or two particles in the selected sample may importantly influence interpretation of the characteristics of the field sample. In these cases, the entire field sample should be tested.

3.3 Failure to carefully follow the procedures in these methods could result in providing a non-representative sample to be used in subsequent testing.

4. SELECTION OF METHOD

4.1 The use of a riffle sample splitter is always preferable to hand quartering. A riffle splitter should be used whenever one exists with the proper sized openings. The splitter openings should be sufficiently wide to permit easy passage of the largest particles in the sample. When splitters with adjustable openings are used, the width of the openings should be adjusted to approximately 1-1/2 times the size of the largest particle in the sample.

4.2 Fine Aggregate - Field samples of fine aggregate that are drier than the saturated-surface-dry condition (Note 1) shall be reduced in size by a mechanical splitter according to Method A. Field samples having free moisture on the particle surfaces may be reduced in size by quartering according to Method B or by treating it as a miniature stockpile as described in Method C.

4.2.1 If the use of Method B or Method C is desired, and the field sample does not have free moisture on the particle surfaces, the sample may be first moistened to achieve this condition, and then it should be thoroughly mixed prior to the sample reduction being performed.

NOTE 1: The method of determining the saturated-surface-dry condition is described in AASHTO T 84. As a quick approximation, if the fine aggregate retains a balled shape when molded in the hand, it may be considered to be wetter than saturated-surface-dry.

4.2.2 If use of Method A is desired and the field sample has free moisture on the particle surfaces, the entire field sample may be dried to at least the surface-dry condition, using temperatures that do not exceed those specified for any of the tests contemplated, and then the sample reduction performed. Alternatively, if the moist field sample is very large, a preliminary split may be made using a mechanical splitter having wide chute openings 1 1/2 in. (38 mm) or more to reduce the sample to not less than 5000g. The portion obtained is then dried, and the reduction to test sample size is completed using Method A.

4.3 *Coarse Aggregates and Mixtures of Coarse and Fine Aggregates* - Reduce the sample using a mechanical splitter in

accordance with Method A (preferred method) or by quartering in accordance with Method B. The miniature stockpile Method C is not permitted for coarse aggregates or mixtures of coarse and fine aggregates.

NOTE 2: Past experience has shown that when adjustable splitter openings are adjusted too wide or too narrow improper splitting will occur (see Subsection 6.1).

5. SAMPLING

5.1 The field sample of aggregate shall be taken in accordance with CP 30 or as required by individual test methods. When tests for sieve analysis only are contemplated, the size of the field sample listed in CP 30 is usually adequate. When additional tests are to be conducted, the tester shall satisfy himself that the initial size of the field sample is adequate to accomplish all intended tests.

5.2 Soil samples to be reduced to test specimen size shall be prepared in accordance with CP 20.

METHOD A - MECHANICAL SPLITTER

6. APPARATUS

6.1 *Sample Splitter* - Sample splitters shall have an even number of equal width chutes, but not less than a total of eight for coarse aggregate, or twelve for fine aggregate, which discharge alternatively to each side of the splitter. For coarse aggregate and mixed aggregate the minimum width of the individual chutes shall be approximately 50 percent larger than the largest particles in the sample to be split (Note 3). For dry fine aggregate in which the entire sample will pass the 3/8 in. (9.5-mm) sieve, a splitter having chutes 1/2 to 3/4 in. (12.5 to 20 mm) wide shall be used. The splitter shall be equipped with a minimum of two collection pans, having a width equal to or slightly less than the overall assembly of chutes in the splitter to hold the two halves of the sample following the splitting. It shall also be equipped with a hopper, a flat scoop, or straight-edged pan which has a width equal to or slightly less than the overall width of the assembly of chutes, by which the sample may be fed at a controlled

rate to the chutes. The splitter and accessory equipment shall be so designed that the sample will flow smoothly without restriction or loss of material (Figure 32-1). A splitter brush should be used to clean the chutes of adhering fines.

NOTE 3: Mechanical splitters are commonly available in sizes adequate for coarse aggregates in which the largest particle does not exceed 1 1/2 in. (37.5 mm).

7. PROCEDURE

7.1.a Riffle Splitters Without Control Flow Hoppers - After placing the sample in a large flat-bottomed mixing pan, mix the sample thoroughly by turning the entire sample over three times. Using a flat scoop equal in length to the overall width of the riffles (feeder pan) remove the material from the mixing pan and uniformly distribute the material in the scoop so that when it is introduced to the splitter equal amounts of material will flow through each chute. Pour half of the sample through the riffles in a manner to allow the material to flow freely through the chutes without clogging any riffle. Reverse the ends of the feeder pan and pour the other half through the splitter. Continue this process until the entire sample has been introduced to the splitter.

7.1.b Riffle Splitters With Control Flow Hoppers - Place the entire sample in the closed hopper and uniformly distribute it from edge to edge. Using the handle, slowly release the material from the hopper through the chutes in a manner to allow the material to flow freely through the chutes without clogging any riffles. The first split is only to assist in mixing the sample. Remove both catch pans. Uniformly distribute the material in the first of the pans and pour it into the closed hopper by pouring half of the sample into the closed hopper, then reversing the ends of the pan, pouring the remaining half into the closed hopper. Repeat this process with the second pan. Place the emptied pans beneath the splitter under the riffles. With the material uniformly distributed in the closed hopper and using the handle, slowly release the material through the chutes as noted above.

7.2 Reintroduce the portion of the sample from alternating receptacles into the splitter as

noted in Subsections 7.1.a or 7.1.b as many times as necessary to reduce the sample to at least the minimum size required for the intended test. Clean the riffles and the splitter with a brush after each split. Retain the portion from the other receptacle in case it becomes necessary to re-run the test.

METHOD B - QUARTERING

8. APPARATUS

8.1 Apparatus shall consist of a straight-edge scoop, or a flat, square end shovel; a broom or brush; and a canvas blanket at least 6 by 8 ft (2 by 2.5 m).

9. PROCEDURE

9.1 The field sample shall be placed on a canvas blanket laid on a clean, hard, level surface. Mix the material thoroughly by turning the entire sample over three times. With the last turning, shovel the entire sample into a conical pile by depositing each full shovel on top of the preceding one. Alternatively lift each corner of the canvas and pull it over the sample toward the diagonally opposite corner causing the material to be rolled. Carefully flatten the conical pile to a uniform thickness and diameter by pressing down the apex with a shovel so that each quarter sector of the resulting pile will contain the material originally in it. The diameter should be approximately four to eight times the thickness. Divide the flattened mass into four equal quarters with a shovel or trowel. If the surface beneath the blanket is uneven, insert a stick or pipe beneath the blanket and under the center of the pile, then lift both ends of the stick, dividing the sample into two equal parts. Remove the stick leaving a fold of the blanket between the divided portions. Insert the stick under the center of the pile at right angles to the first division and again lift both ends of the stick, dividing the sample into four equal parts. Remove two diagonally opposite quarters, being careful to clean the fines from the blanket. Brush the cleared spaces clean and include the material in the sample. Successively mix and quarter the remaining material until the sample is reduced to the desired size (Figure 32-2). Save the remaining two quarters in case a retest is necessary.

METHOD C - SELECTION BY SCOOP

[Damp Fine (minus 3/8 in. (9.5 mm)) Aggregate Only]

10. APPARATUS

10.1 Apparatus shall consist of a small, flat, square end scoop with sides and a large flat-bottomed mixing pan.

11. PROCEDURE

11.1 Place the field sample of damp fine aggregate in the mixing pan where there will be

neither loss of material nor the accidental addition of foreign material. Mix the material thoroughly by turning the entire sample over three times. Flatten the sample in the pan to a uniform depth. Obtain a sample for each test by selecting at least three increments of material at random locations from the miniature stockpile, using a small flat square end scoop. Insert the scoop to the full depth of the material. Every attempt should be made to minimize the loss of particles over the sides of the scoop. Combine the portions to obtain a test specimen having the required weight. Save the remaining portion of the sample until tests are completed.

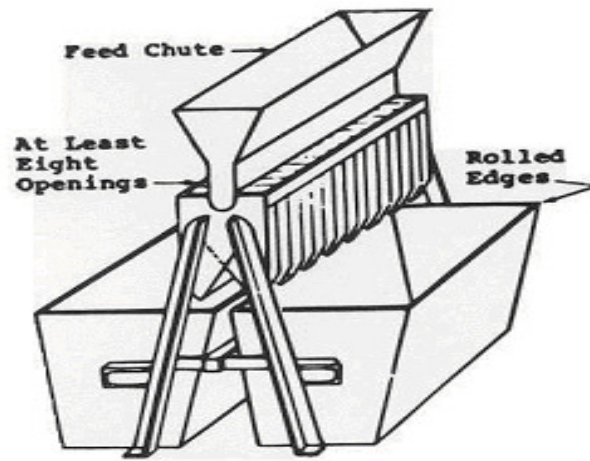

Riffle Sample Splitter

(a) Large Sample Splitter for Coarse Aggregate

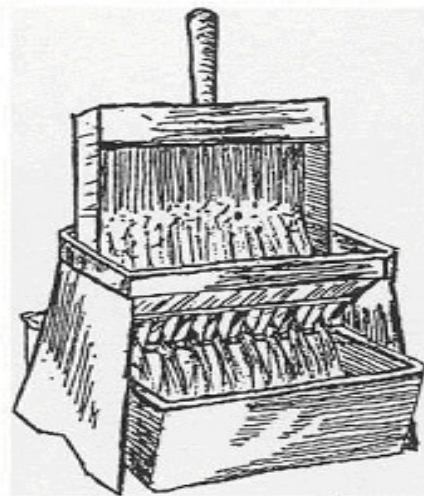

(b) Small Sample Splitters For Fine Aggregate

NOTE: May be constructed as either closed or open type. Closed type is preferred.

FIGURE 32-1 Sample splitters (Riffles)

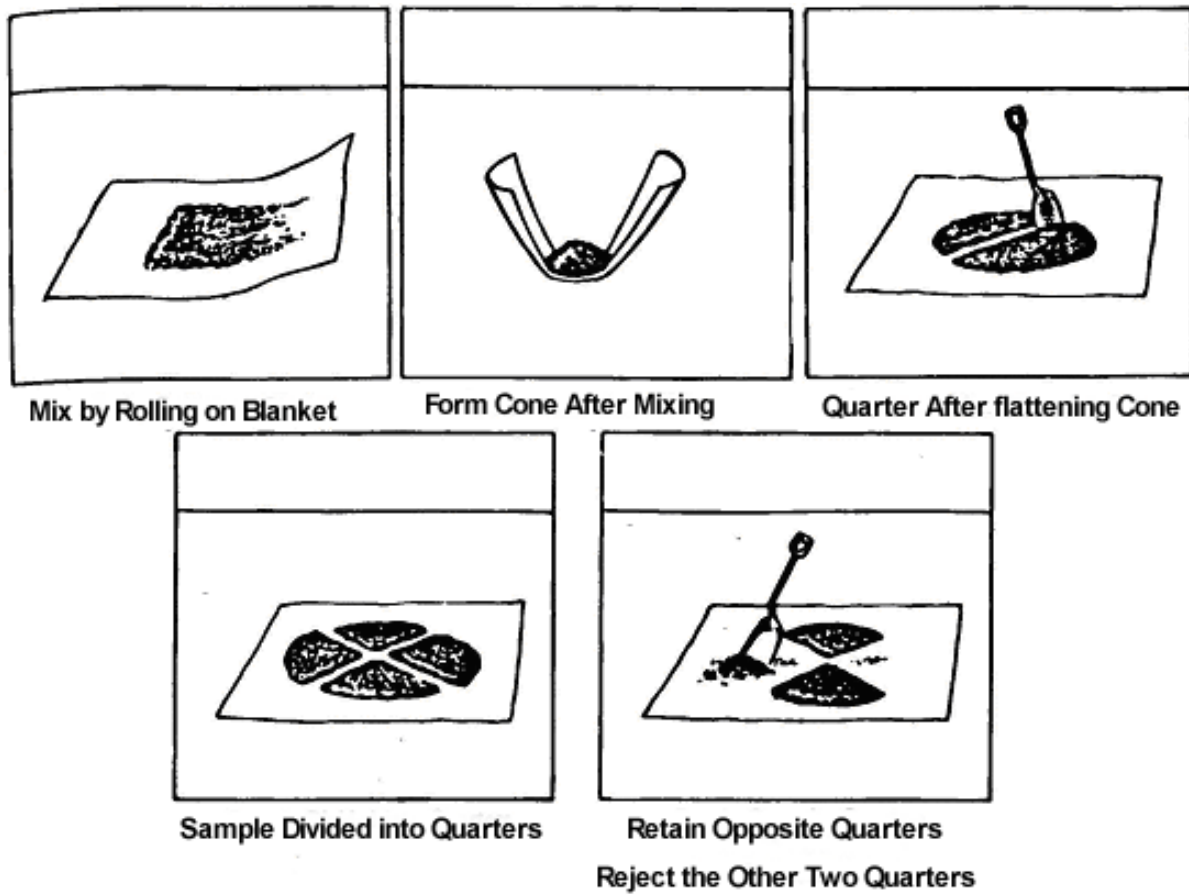

FIGURE 32-2 Quartering on a Canvas Blanket

Colorado Procedure 37-09

Standard Test Method for

Plastic Fines in Graded Aggregates and Soils by Sand Equivalent Test

(This test method is based upon AASHTO T 176-02. AASHTO T 176-02 or any subsequent revision may not be used in place of this procedure.)

1. SCOPE

1.1. This test is for the determination of the proportion of fine dust or claylike material in graded aggregates and soils.

2. APPARATUS

2.1 A graduated plastic cylinder, rubber stopper, irrigator tube, weighted foot assembly and siphon assembly, all conforming to their respective specifications and dimensions shown in Figure 37-1. Fit the siphon assembly to a 1 gallon bottle of working calcium chloride solution placed on a shelf 36 +/- 1 inch above the working surface. In lieu of the specified 1 gallon bottle, a glass or plastic vat having a larger capacity may be used provided the liquid level of the working solution is maintained between 36 to 46 inches above the work surface.

2.2 A tinned measure, having a capacity of 85 +/- 5 mL (3 oz), approximately 57 mm (2.25 in) in diameter.

2.3 A wide-mouth funnel approximately 4 inches in diameter at the mouth.

2.4 A clock or watch reading in minutes and seconds.

2.5 A mechanical shaker, powered by an electric motor, having a throw of 8.00 +/- 0.04 in. (203.2 +/- 1.0mm) and operating at 175 +/- 2 cycles per minute. The shaker shall be securely affixed to a firm and level mount.

2.6 Stock Solution – The materials listed in Subsections 2.6.1, 2.6.2, or 2.6.3 may be used to prepare the stock solution. A fourth alternative is not to use any biocide provided

the time of storage of stock solution is not sufficient to promote the growth of fungi.

2.6.1 Stock solution with formaldehyde:

2.6.1.1 Anhydrous Calcium Chloride, 454g of technical grade.

2.6.1.2 USP Glycerin, 2050g (1640 mL).

2.6.1.3 Formaldehyde, (40 volume percent solution) 47g (45 mL).

2.6.1.4 Dissolve the 454g of calcium chloride in 1.89 L of distilled water. Cool and filter it through ready pleated rapid filtering paper. Add the 2050g of glycerin and the 47g of formaldehyde to the filtered solution, mix well and dilute to 3.78 L.

2.6.2 Stock solution with glutaraldehyde:

2.6.2.1 Calcium Chloride Dihydrate, 577g of A.C.S. grade.

2.6.2.2 USP Glycerin, 2050g (1640 mL).

2.6.2.3 1.5-Pentanedial (Glutaraldehyde), 50 percent solution in water 59g (53 mL).

NOTE 1: 1.5-pentanedial, also known as glutaraldehyde, glutaric dialdehyde, and trade name UCARCIDE 250, may be obtained as Glutaraldehyde Solution 50 percent.

2.6.2.4 Dissolve the 577g of calcium chloride dehydrate in 1.89 L of distilled water. Cool and add the 2050g of glycerin and the 59g of glutaraldehyde to the solution, mix well and dilute to 3.78 L.

2.6.3 Stock solution with Kathon CG/ICP:

2.6.3.1 Calcium Chloride Dihydrate, 577g of A.C.S. grade.

2.6.3.2 USP Glycerin, 2050g (1640 mL).

2.6.3.3 Kathon CG/ICP, 563g (53 mL).

2.6.3.4 Dissolve the 577g of calcium chloride dehydrate in 1.89 L of distilled water. Cool and add the 2050g of glycerin and the 63g of Kathon CG/ICP to the solution, mix well and dilute to 3.78 L.

2.7. Working calcium chloride solution: Prepare by diluting 85 +/- 5 ml of the stock calcium chloride solution to 3.8L (1 gal.) with distilled water. The working solution shall be discarded if organic growth is present. The working solution shall be discarded after 30 days.

2.8 A straightedge or spatula, suitable for striking off the excess soil from the tin measure.

2.9. A thermostatically controlled drying oven capable of providing a temperature up to 60°C (140°F).

2.10. A non-absorbent plastic quartering or splitting sheet or non-absorbent pan.

2.11 Optional handle for irrigation tube – A 25-mm diameter wooden dowel to aid in pushing the irrigation tube into firm materials.

3. CONTROL

3.1. The temperature of the working solution should be maintained at 22°C +/- 3° (72°F +/- 5°) during the performance of the test. If field conditions prevent the maintenance of the temperature range frequent samples should be submitted to a laboratory where proper temperature can be maintained. A correction curve may be established for each material being tested where proper temperature control is not possible. No general correction curve should be used on several materials even within a narrow range of values. Samples that meet the minimums and equivalent requirements at a solution temperature below the

recommended range need not be subject to reference testing.

4. SAMPLE PREPARATION

4.1. All materials being tested by this method shall pass the 4.75 mm (#4) sieve. Pulverize all aggregations of fine grained soil material to pass the 4.75 mm (#4) sieve and clean all fines from the particles retained on the 4.75 mm (#4) sieve. All aggregations passing the 4.75 mm (#4) sieve shall be tested.

4.2. Split or quarter to yield a representative sample of at least 1500g of material passing the 4.75 mm (#4) sieve. Extreme care should be used to ensure the test sample is truly representative of the original sample.

4.3. Dry the sample to constant mass at a temperature not to exceed 60°C (140°F).

4.3.1. Weigh the dried sample to the nearest 0.1g. Thoroughly mix 3 +/- 1% moisture into the material, cover and allow tempering for 45 +/- 15 minutes.

4.3.2. After the tempering period, place the material on the splitting sheet or pan. Mix the sample until it appears homogeneous forming a pile. Using the splitting sheet, mixing can be accomplished by pulling a corner of the sheet diagonally across the material toward the opposite corner causing the material to be rolled. Continue pulling the corners of the sheet across until the sample appears homogeneous. Finish mixing with the sample in a pile near the center of the splitting sheet. Using the pan, mixing can be accomplished by turning the entire sample over at least 3 times. Upon the final turning, form the material in a conical pile by depositing each scoopful on top of the proceeding one.

4.3.3. Fill three 85 ml tins by pushing them through the base of the pile while exerting pressure with the hand on the opposite side of the pile. Use enough pressure to cause the tins to fill to overflowing. Press the material firmly into the tins with the palm of the hand allowing the maximum amount of material to be placed in the tins. Using the

spatula, strike off the excess material to the top of the tins.

4.3.4 Each of the three tins prepared in Subsection 4.3.3 is an individual test sample.

5. PROCEDURE

5.1. Siphon 101.6 +/- 2.5 mm (4.0 +/- 0.1 in.) of the working solution into the graduated cylinder. Pour a prepared test sample into a graduated cylinder using the funnel to avoid spillage. Tap the bottom of the cylinder sharply with the heel of the hand several times to release air bubbles and promote thorough wetting of the sample.

5.2. Allow the sample to stand undisturbed for 10 +/- 1 minute. After the 10 minute soaking period, stopper the cylinder and loosen the material from the bottom of the cylinder by partially inverting the cylinder and shaking simultaneously.

5.3. After loosening the material place the cylinder into the shaker, set the timer and allow the machine to shake the sample for 45 +/- 1 second.

5.4. Following the shaking period place the cylinder upright on the work surface and remove the stopper.

5.5. Insert the irrigator tube in the cylinder and rinse the material from the cylinder walls as the irrigator is lowered. Force the irrigator through the material to the bottom of the cylinder by using a gentle stabbing and twisting motion while the working solution is flowing from the irrigator tip. Continue to apply the stabbing and twisting action of the irrigator to suspend the fine material until the level nears the 381mm (15 in.) mark. As the level nears the 381 mm (15 in.) mark, without stopping the flow, slowly raise the irrigator as to maintain the 381mm (15 in.) level. Adjust the final level to 381mm (15 in.). The final level, as judged by the bottom of the meniscus, shall be between the top two graduations of the cylinder but not above the 381mm (15 in.) mark.

NOTE 2: On certain soils, particularly crushed materials, the stabbing action may not be possible. For such materials, the irrigation method is as follows: Continue to apply the twisting action as the irrigator tube is slowly withdrawn. As the irrigator tube is withdrawn, it is essential that as many of the fines be flushed upward until the level reaches the 381mm (15in.) level.

5.6. Allow the cylinder and contents to stand undisturbed for 20 minutes +/- 15 seconds. Start timing immediately after withdrawing the irrigator tube.

5.7. At the end of the 20 minute settling period, read and record the top of the clay layer. This is referred to as the "clay reading". If no clear line is formed at the end of the 20 minute period, allow the sample to stand undisturbed until a reading can be obtained. Once the reading can be made, record the clay reading and the total sedimentation time.

If the sedimentation time exceeds 30 minutes, retest the material using 3 individual samples of the same material. Read and record the clay reading of the sample that takes the least amount of time to form a clear line. Do not record the readings from the other two samples.

5.8. Immediately after taking the clay reading, gently lower the weighted foot assembly into the cylinder. Do not allow the indicator to hit the mouth of the cylinder as it is lowered. As the foot comes to rest on the sand, tip the assembly toward the graduations until the indicator touches the inside of the cylinder. Subtract 254 mm (10 in.) from the level indicated by the top edge of the indicator and record this value as the sand reading.

5.9. If the clay or sand reading falls between the graduations, record the next higher graduation line as your reading. For example: The indicator level is 6.22. The recorded level would be 6.3.

5.10 Repeat Subsections 5.1 to 5.9 for each of the three samples prepared in Subsections 4.3.3.

6. CALCULATIONS

6.1. Calculate the sand equivalent for each of the three test samples to the nearest 0.1 using the following formula:

$$SE = \frac{\text{Sand Reading} \times 100}{\text{Clay Reading}}$$

If the sand equivalent is not a whole number, report as the next higher whole number.

For example:

$$SE = 3.3 \times 100 / 8 = 41.25$$

Report as 42

6.2. Average the three SE values obtained in 6.1 to the nearest 0.1. If the average sand equivalent is not a whole number, report as the next higher whole number.

For example:

$$(42 + 44 + 41) / 3 = 42.3$$

Report as 43

7. PRECAUTIONS

7.1. When performing this test the work surface must be free of vibration. During the sedimentation period vibration may cause the suspended material to settle at a greater rate than normal, resulting in false readings. The shaker shall not be mounted on the same surface as the cylinders during the sedimentation period.

7.2. Do not expose the cylinders to direct sunlight any more than necessary.

7.3. On occasion organic growth in the working solution container and tubing will need to be removed. Growth can be seen as a slimy substance in the solution or as grayish black deposits on the sides of the container and in the tubing. To remove the growth prepare a solution of sodium hypochlorite³ and water in equal amounts. Fill the container and allow about a liter to flow through the siphon assembly and irrigator tube. Refill the container and allow to stand overnight. After soaking allow the

solution to flow out through the siphon assembly and irrigator tube. Remove the siphon assembly and rinse both the container and assembly with clear water. Allow water to flow through the assembly and irrigator tube to rinse the solvent from the inside of the tubing.

7.4. Occasionally the holes on the tip of the irrigator tube can become clogged. This can be checked easily while filling the cylinder to the initial amount as in Subsection 5.1. If the particle can not be removed by any other method, carefully use a pin or small wire to dislodge the particle, taking care to not enlarge the opening.

7.5. Upon receipt of a new weighted foot assembly and before placing it in service, measure and adjust the height of the indicator to 256.5 mm (10.1 in.).

8. PRECISIONS AND BIAS

8.1 *Multi-laboratory Precision* – Using CDOT IAT test results; the standard deviation of the difference between values obtained on the same sample from different laboratories is 2.3 (d2s). Therefore, the results of two properly conducted tests from different laboratories on similar material should not differ by more than 5.0 with a 95% confidence limit.

8.2 *Bias* – The procedure in this test method has no bias because the value of sand equivalent is defined only in terms of the test method.

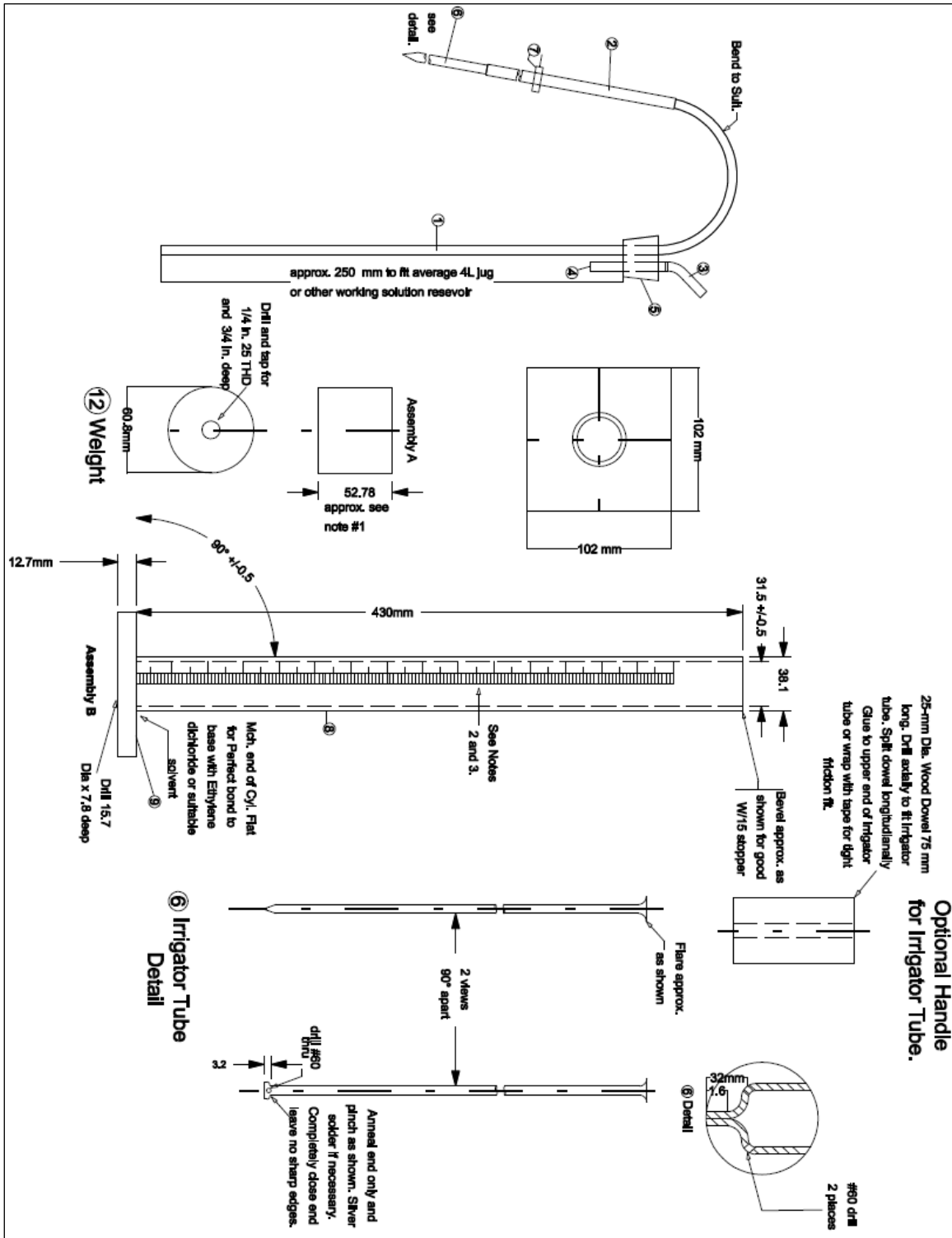

FIGURE 37-1

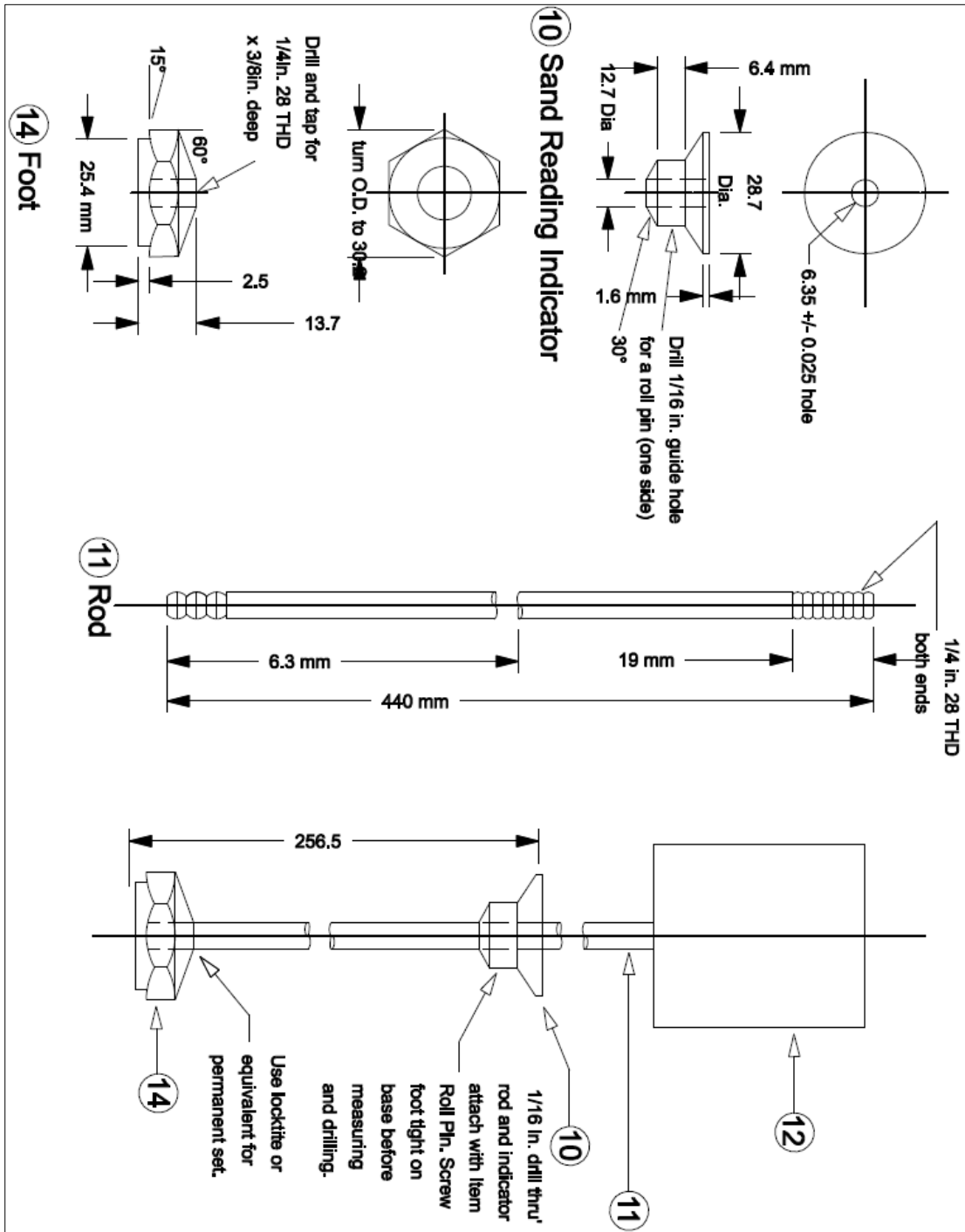

FIGURE 37-1 Continued

Assembly	No. Reg.	Description	Stock Size (mm)	Material	Heat Treatment
A	Siphon Assembly				
	1	Siphon Tube	6.4 dia. x 400	Copper Tube	
	2	Siphon Hose	4.8 I.D. x 200	Rubber Tube	
	3	Blow Hose	4.8 I.D. x 50.8	Rubber Tube	
	4	Blow Tube	6.4 dia. x 50.8	Copper Tube	
	5	Two-Hole Stopper	No. 6	Rubber	
	6	Irrigator Tube	6.4 O.D. 0.89 Wall x 500 Pinchcock, Day, BKH No.	Stainless Tube, Type 316	
	7	Clamp	21730 or Equivalent		
B	Graduate Assembly				
	8	Tube	38.1 O.D. x 430	Trans Acrylic Plastic	
	9	Base	12.7 x 102 x 102	Trans Acrylic Plastic	
C	Weighted Foot Assembly				
	10	Sand Reading Indicator	6.4 dia x 14.9	Nylon 101 Type 66	Annealed
	11	Rod	6.4 dia x 438.2	Brass	
	12	Weight	50.8 dia x 52.78	C.R.SH	
	13	Roll Pin	0.16 dia x 12.7	Steel	
	14	Foot	0.16 Hex x 13.7	Brass	
	15	Solid Stopper	No. 7	Rubber	

- Notes:
- 1 "C" Mounted Foot Assembly to Weight 1000+/- 5g
 - 2 Graduations on graduate to be 2.54 mm apart and every tenth mark to be numerically designated as shown. Every fifth line should be approximately 9.5 mm long. All other lines should be approximately 5.5 mm long. Depth to be 0.4 mm. Width to be 0.8 mm across the top.
 - 3 Accuracy of scale to be +/- 0.25 mm per 2.5 mm. Error at any point on scale to be +/- 0.75 mm of true distance to zero
 - 4 Glass or stainless steel may be substituted as a material type for the copper siphon and blow tubing

FIGURE 37-1 Continued

{This page was intentionally left blank.}

Colorado Procedure 41-08

Standard Practice for

Sampling Hot Mix Asphalt

(This procedure is based upon AASHTO T 168-91. AASHTO T 168-91 or any subsequent revisions may not be used in place of this procedure.)

1. SCOPE

1.1 This procedure covers sampling of hot mix asphalt (HMA) at points of manufacture, storage, or delivery.

1.1.1 Samples obtained by this procedure may be used for acceptance and quality control of hot mix asphalt (HMA).

1.2 This Standard may involve hazardous materials, operations, and equipment. This Standard does not purport to address all of the safety problems associated with its use. It is the responsibility of the user of this Standard to establish appropriate safety and health practices and determine the applicability of regulatory limitations prior to use.

1.3 The values stated in acceptable English units are to be regarded as the standard. The values in parentheses are provided for information purposes only.

2. REFERENCED DOCUMENTS

2.1 *Colorado Procedures:*

CP 75 Stratified Random Sampling of Materials

3. SIGNIFICANCE AND USE

3.1 *General:*

3.1.1 Sampling is equally as important as the testing, and the sampler shall use every precaution to obtain samples that will yield an acceptable estimate of the nature and conditions of the materials which they represent.

3.1.2 Care shall be taken in sampling to avoid segregation of the material being sampled. Care shall be taken also to prevent contamination by

dust or other foreign matter.

3.1.3 Samples to be used for acceptance or assurance testing shall be taken by the contractor or his representative. An authorized representative of the Colorado Department of Transportation shall be present during the sampling procedure. The CDOT Representative present shall take immediate possession of all samples taken. CDOT reserves the right to designate the method and location of material to be sampled.

4. PROCEDURE, GENERAL

4.1 *Sampling Equipment* - The contractor shall provide equipment needed for safe and appropriate sampling.

4.2 *Sample Handling* - Combine all sample increments. Place sample in a container with 3 to 4 gallon capacity, made of at least 30 gauge non-galvanized metal, having a "bail" type handle and a tight fitting lid.

4.3 *Sampling* - The procedures for selecting samples are described in CP 75. The material shall be sampled using stratified random sampling from all of the material delivered to the job site.

METHOD A - TUBE SAMPLER

5. APPARATUS

5.1 Tube sampler, with a minimum of 2-7/8 in. (73 mm) inside diameter, 16 gauge minimum thickness, and a length and diameter that are variable with desired test specimen size.

5.2 Tube sampler holder with a metal collar into which the sampler fits, with a 3 ft. (1 m) handle or a tube sampler holder with suitable arm arrangement to hold two tube samplers, which can

be positioned directly beneath the discharge opening.

5.3 Containers for transporting samples shall have 3 to 4 gallon capacity, be made of at least 30 gauge non-galvanized metal, have a "bail" type handle and a tight fitting lid.

6. PROCEDURE

6.1 Batch Plant and Storage Silos - Insert one or two tube samplers into the sampler holder arm while the arm is swung away from the discharge. Obtain one or more samples from the material being loaded into a single truck using one of the following methods: (1) during discharge of mixture, swing the arm holding the tube(s) through the discharge stream at a rate fast enough to obtain a representative sample filling the tube(s) or (2) prior to the discharge, center the sampling tube(s) directly under the discharge flow. After the mixture has been discharged, return the apparatus to the storage position away from the point of discharge and remove the tube(s). Strike off any material above the top rim of the tube sampler.

METHOD B - POINT OF DELIVERY

7. APPARATUS

7.1 Small flat scoop with vertical sides or square ended shovel.

7.2 Container for transporting samples shall have 3 to 4 gallon capacity, be made of at least 30 gauge non-galvanized metal, have a "bail" type handle and a tight fitting lid.

8. PROCEDURE

8.1 *Sampling from the Windrow Prior to Laydown* - Select three or more locations at random from the windrow. Samples of the windrow shall be secured at each location by removing material from one side of the windrow through the full depth to expose a face. Using the flat scoop, or a square shovel with sides, trench the exposed face from bottom to top, taking care to avoid segregation of particle sizes. Combine the samples from the different locations to obtain the required sample size as specified in Section 11.

8.2 *Sampling from Paving Machine Augers* - While the paver is in motion, observe the operation of the augers, which transport the mixture from the slat feeders to either side of the paver. These augers should be operating eighty percent or more of the time and be at least two-thirds covered with the mixture, if this is not the case, samples taken from the screws may be segregated and this method of sampling should not be used.

8.2.1 If the conditions of Subsection 8.2 are met, obtain at least three approximately equal increments of mixture ahead of the augers which transport the mixture from the slat feeders to either side of the paver as follows: insert the flat scoop or shovel into the mixture and remove the portion with minimal loss of the larger particles.

8.3 *Sampling from a Conveyor Belt* --CDOT does not utilize this sampling technique.

METHOD C - BEHIND PAVER

9. APPARATUS

9.1 Small flat scoop, square ended shovel with vertical sides, or sampling device similar to Figure 41-1.

9.2 Container for transporting samples shall have 3 to 4 gallon capacity, be made of at least 30 gauge non-galvanized metal, have a "bail" type handle and a tight fitting lid.

10. PROCEDURE

10.1 *Sampling from the Roadway Prior to Compaction* - Obtain at least three approximately equal increments, at a longitudinal location selected at random using CP 75, and combine to form a field sample whose quantity equals or exceeds the minimum recommended in Section 11.

10.1.1 Obtain all increments from the roadway immediately behind the machine for the full depth of the material, taking care to exclude any underlying material. Locate the sampling position across the width of the roadway using CP 75. When necessary, place templates on the existing roadway to exclude any underlying material. Clearly mark the specified area from which each increment or sample is to be removed. Templates, which are placed before the mixture is

spread, will be a definite aid in securing approximately equal increment weights.

10.2 *Sampling from Roadway after Compaction*
- Select the areas to be sampled using CP 75 from the material in place. Obtain at least three approximately equal increments selected from the area being sampled. Take all increments from the roadway through the full depth of the material, taking care to exclude any underlying material. Each increment shall be obtained by coring, sawing, or other methods in such a manner as to ensure a minimum disturbance of the material.

11. SIZE OF SAMPLE

11.1 *Number and Quantities of Field Samples:*

11.1.1 The number of field samples required is specified in the Schedule for Minimum Materials Sampling, Testing, and Inspection contained in the CDOT Field Materials Manual. The CDOT Field Materials Manual specifies the quantities of sample required for testing in the Central Laboratory and the Region Materials Laboratory. Project field tests will require a minimum sample size of 30 lbs (14 kg).

12. SHIPPING SAMPLES

12.1 Transport samples in a container with a 3 to 4 gallon capacity, made of at least 30 gauge non-galvanized metal, having a "bail" type handle and a tight fitting lid so constructed as to preclude loss or contamination of any part of the sample, or damage to the contents from mishandling during shipment.

12.2 Samples shall have individual identification attached providing the information required by the sample user. **Utilization of CDOT Form #633, Sample Tag (for Sacks), is required for all submitted samples.** This information is included on CDOT Form #157 or Form #1304 and a sample of these forms is shown in Chapter 400 of the CDOT Field Materials Manual.

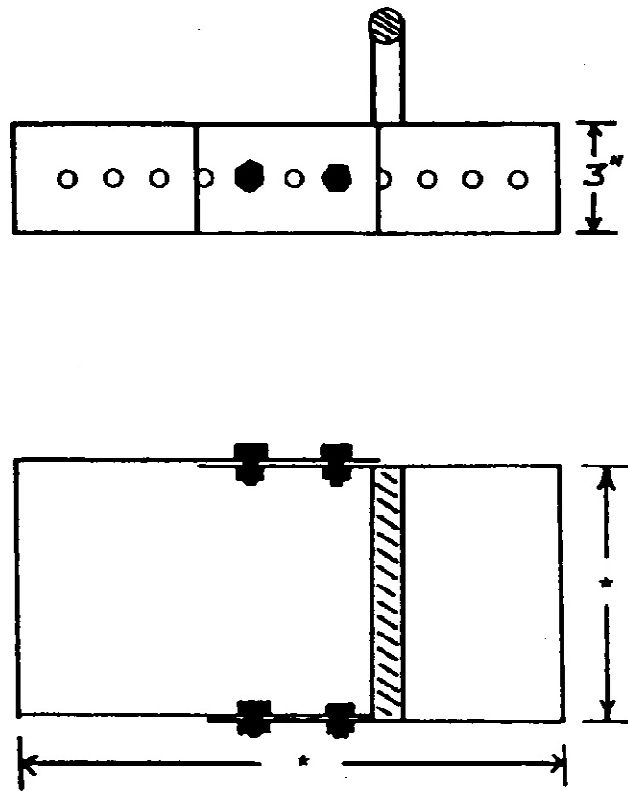

*Shape and area variable to accommodate sample size required.

Sampler is placed in the uncompacted lift directly behind paver and all material is removed.

FIGURE 41-1

Colorado Procedure 42-05

Standard Method of Test for

Estimation of Asphalt Content in Hot Mix Asphalt Through Back Calculations Using Gse

1. SCOPE

1.1 This is a Colorado investigative procedure that covers the quantitative estimation of the asphalt cement content of hot mix asphalt mixtures by calculating the value from the maximum specific gravity and the effective specific gravity of the aggregate. This procedure is not appropriate for determining percent asphalt content for payment.

2. REFERENCED DOCUMENTS

2.1 *Colorado Procedures:*

- CP 30 Sampling of Aggregates
- CP 32 Reducing Field Samples of Aggregate to Testing Size
- CP 41 Sampling Hot Mix Asphalt
- CP 51 Determining the Maximum Specific Gravity of Bituminous Mixtures
- CP 55 Reducing Field Samples of Hot Mix Asphalt to Testing Size

- CP-L 5115 Preparing and Determining the Density of Bituminous Mixture Test Specimens Compacted by the Superpave Gyration Compactor.

3. SIGNIFICANCE AND USE

3.1 Current procedures for determining the percent binder in hot mix asphalt are greatly affected by changes in the percent lime in the mix. If there is less lime in a mix than the nuclear gauge or ignition oven was correlated with, the mix will yield a low percent binder in the nuclear gauge and a high percent binder in the ignition oven. The reverse is true if there is more lime in the mix than the nuclear gauge or ignition oven was correlated with. This procedure can be used to further investigate the percent

binder in the mix. This procedure may yield questionable results when used with absorptive aggregates.

4. APPARATUS

- 4.1 CP 51, Subsections 3.1 – 3.8
- 4.2 Mixing bowl and mixing utensils.

5. PROCEDURE

5.1 Sample aggregates per CP 30. The aggregates should be representative of the aggregates in the asphalt mix; therefore pull the aggregate sample near the time the plant-produced hot mix asphalt is produced. Reduce the aggregates for mixing per CP 32. Utilizing CP 51 and the mix's nominal maximum aggregate size determine the minimum size of the aggregate sample needed for mixing.

5.2 Reduce the plant-produced hot mix asphalt per CP 55 and determine the maximum specific gravity per CP 51.

5.3 Mix the aggregates at the optimum percent binder. The required mixing temperature is in CP-L 5115.

5.4 Cure the lab produced mixture for 2-3 hours or, if you know how long the plant-produced material was cured, then cure the lab-produced sample for the same length of time. The cure time is particularly important for mixes with absorptive aggregates.

5.5 Determine the maximum specific gravity of the lab-produced mixture per CP 51.

6. CALCULATIONS

6.1 Determine the Gse of the lab-produced material as follows:

$$Gse = \frac{100 - Pb}{\frac{100}{Gmm} - Gb}$$

Where:

- Gse = Effective specific gravity of the aggregate,
Pb = Percent binder,
Gmm = Average maximum specific gravity,
Gb = Specific gravity of binder. (This value can be found in the mix design. If the value is unknown, use 1.03.)

6.2 Determine the percent binder of the plant-produced mix as follows:

$$Pb = 100 \times \frac{\left(\frac{Gse}{Gmm} - 1 \right)}{\left(\frac{Gse}{Gb} - 1 \right)}$$

Where:

- Pb = Percent binder of the Plant-produced mix,
Gse = Effective specific gravity of the aggregate from the lab-produced mix,
Gmm = Maximum specific Gravity of the field-produced mix,
Gb = Specific gravity of binder. (This value can be found in the mix design. If the value is unknown, use 1.03.)

Colorado Procedure 43-11

Standard Method of Test for

Determining Moisture (Water) or Volatile Distillates Content of HMA

1. SCOPE

1.1 This procedure covers two methods for the quantitative determination of moisture in Hot Mixture Asphalt (HMA).

1.2 The procedures are intended for the determination of moisture content or volatile fraction of the bitumen, in HMA.

1.3 The water content of a mixture is defined by this Standard as the ratio, expressed as a percentage of the mass of "pore" or "free" water in a given mass of material to the mass of the solid mixture.

1.4 The methods are intended to apply to samples of HMA used in verification and quality control from the points of acceptance designated in the Schedule for Minimum Materials Sampling, Testing, and Inspection.

1.5 This Standard may involve hazardous materials, operations, and equipment. This Standard does not purport to address all of the safety problems associated with its use. It is the responsibility of whoever uses this Standard to consult and establish appropriate safety and health practices and determine the applicability of regulatory regulations prior to use.

1.6 Unless otherwise specified in the Contract Documents, either method is acceptable for use.

2. REFERENCED DOCUMENTS

- 2.1 *Colorado Procedures:*
CP 41 Sampling Hot Mix Asphalt
CP 55 Reducing Field Samples of Hot Mix Asphalt to Testing Size
- 2.2 Manufacturer's instruction manual.
- 2.3 CDOT Standard Special Provisions and/or Project Special Provisions for Item 620

2.4 CDOT M & S Standards, Item 620

3. SIGNIFICANCE AND USE

3.1 These test methods are used for determining either the amount of moisture or the amount of volatile petroleum distillates in bituminous paving mixtures.

METHOD A

Determining Moisture or Volatile Petroleum Distillates Content of HMA by the Microwave Method

4. APPARATUS

- 4.1 *Microwave oven* - Having variable time and power controls.
- 4.2 *Pyrex dish* – (or similar microwave proof glass container) Capable of holding the entire test specimen being tested.
- 4.3 *Balance* - Having sufficient capacity and sensitivity to 0.1g.

5. TEST SPECIMEN

5.1 Sample the material in accordance with CP 41 and reduce it to test specimen size in accordance with CP 55.

6. SAFETY PRECAUTIONS

- 6.1 See the Manufacturer's Operator's Manual for the microwave oven.
- 6.2 Do not place any metallic containers or metallic material in any microwave oven at any time.

7. DETERMINE VARIABLE POWER SETTING

7.1 Set variable power control to approximately 50% power.

7.2 Place 550 +/- 50 ml (or 550 +/- 50 g) of tap water in a Pyrex (or similar microwave proof glass) container. Record temperature of water (T1). Set microwave oven timer for five minutes and heat the 500 ml of water. Record the water temperature (T2). The difference between temperature T1 and T2 should be 75°F ± 10° (42°C ± 6°). If the difference is too low (or high) increase (or decrease) the variable power control setting and repeat 7.2. This procedure will determine the power control setting to be used in Subsection 8.2.

8. PROCEDURE

8.1 Place the specimen in a clean, glass, dry, tared container and weigh to the nearest 0.1g. The weighed sample should be 550 +/- 50g for Grading S and SX mixtures. (Grading SG mixtures will require a minimum mass of 2000 grams for testing.)

8.2 Dry the specimen in the microwave oven using the variable power setting determined in Subsection 7.2. Continue to dry the test specimen until the mass of the specimen does not change after further heating for a 5-minute period. Care should be taken to avoid overheating of the specimen. An indication of overheating is blue smoke.

9. CALCULATIONS

9.1 Determine the percent moisture to the nearest 0.01% as follows:

$$\text{Percent Moisture} = \frac{A - B}{A} \times 100$$

Where:

A = Wet weight (mass) of test specimen,
B = Dry weight (mass) of test specimen.

10. RECORD

10.1 No CDOT Form is used, record on your own worksheet.

Method B

Determination Moisture of Bituminous Paving Mixtures by Convection Oven

11. APPARATUS

11.1 *Drying oven* - Thermostatically controlled forced draft oven meeting the requirements of Section 620 of the Standard Special Provisions.

11.2 *Specimen container* - Capable of holding the entire test specimen being tested.

11.3 *Balance* - Having sufficient capacity and sensitivity to 0.1g.

11.4 *Miscellaneous* - Knives, spatulas, scoops, tools, etc., as required in applicable CPs and CP-Ls.

12. TEST SPECIMEN

12.1 Sample the material in accordance with CP 41 and reduce it to test specimen size in accordance with CP 55.

12.2 The moisture content determination shall be done as soon as practicable after the original sample has been split down to test sample size.

12.2.1 If determining moisture content only, determine wet weight (mass) A in Subsection 14.1 as soon as the sample has been split.

12.2.2 If using it for moisture correction applied to the asphalt content, then determine wet weight (mass) A at the same time the asphalt content sample is done, i.e., during ignition oven asphalt content test.

13. PROCEDURE

13.1 Place the specimen in a clean, dry, tared container and weigh to the nearest 0.1g. The weighed sample mass shall not be less than 500 grams for grading S and SX mixtures. (Grading SG mixtures will require a minimum mass of 2000 grams for testing.)

13.2 Dry the specimen in the oven at the specified binder compaction temperature for that mixture, as per Table 43-1 for a minimum of 3 hours. Remove specimen and immediately weigh to the nearest 0.1g. No manipulation, i.e., stirring of the specimen, shall be permitted. Place specimen back in the oven and continue drying, checking mass of the specimen every ½ hour, ± 5 minutes. The specimen is considered dry when the loss in mass between two consecutive measurements is less than or equal to 0.05%.

TABLE 43-1

SuperPave Binder Grade	Lab Mixing Temp.	Lab Compaction Temp.
PG 58-28	310°F (154°C)	280°F (138°C)
PG 58-34	310°F (154°C)	280°F (138°C)
PG 64-22	325°F (163°C)	300°F (149°C)
PG 64-28	325°F (163°C)	300°F (149°C)
PG 70-28	325°F (163°C)	300°F (149°C)
PG 76-28	325°F (163°C)	300°F (149°C)

All temperatures in this table have a tolerance of ± 5°F (± 2.8°C)

14. CALCULATIONS

14.1 Determine the percent moisture to the nearest 0.01% as follows:

$$\text{Percent Moisture} = \frac{A - B}{A} \times 100$$

Where:

A = Wet weight (mass) of test specimen,
B = Dry weight (mass) of test specimen.

15. RECORD

15.1 No CDOT Form is used, record on your own worksheet.

{This page was intentionally left blank.}

Colorado Procedure 44-09

Standard Method of Test for

Bulk Specific Gravity and Percent Relative Compaction of Compacted Bituminous Mixtures Using Saturated Surface-Dry Specimens

(This procedure is based upon AASHTO T 166-93. AASHTO T 166-93 or any subsequent revisions may not be used in place of this procedure.)

1. SCOPE

1.1 These test methods cover the determination of bulk specific gravity of specimens of compacted bituminous mixtures as defined in ASTM E 1547, Terminology Relating to Industrial Chemicals.

1.2 The bulk specific gravity of the compacted bituminous mixtures may be used in calculating the unit weight of the mixture.

2. REFERENCED DOCUMENTS

- 2.1 *AASHTO Standards:*
M 231 Weighing Devices Used in the Testing of Materials
- 2.2 *ASTM Standards:*
D 2726 Test Method for Bulk Specific Gravity and Density of Compacted Bituminous Mixtures Using Saturated Surface-Dry Specimens
E 1547 Terminology Relating to Industrial Chemicals
- 2.3 *Colorado Procedures:*
CP 51 Determining the Maximum Specific Gravity of HMA
CP-L 5115 Preparing & Determining the Density of Bituminous Mixture Test Specimens Compacted by the Superpave Gyrotory Compactor

3. SIGNIFICANCE AND USE

3.1 This procedure covers and describes two test methods for determining bulk specific gravity in order to calculate the percent relative compaction of Hot Mix Asphalt.

4. TERMINOLOGY

4.1 Definitions:

4.1.1 *Constant Mass* – The mass at which further drying at either temperature as noted in Subsection 10.4 for two hours does not alter the mass by more than 0.05 percent.

5. TEST SPECIMENS

5.1 Test specimens may be either laboratory-molded bituminous mixtures or from the bituminous pavements. The mixtures may be surface or wearing course, or leveling course.

5.2 Size of Specimens--It is recommended, (1) that the diameter of cylindrically molded or cored specimens, or the length of the sides of sawed specimens, be at least equal to four times the maximum size of the aggregate; and (2) that the thickness of specimens be at least one-and-one-half times the maximum size of the aggregate.

5.3 Pavement specimens shall be taken from pavements with a core drill, a diamond or Carborundum saw, or by other suitable means.

5.4 Care shall be taken to avoid distortion, bending, or cracking of specimens during and after the removal from pavement or mold. Specimens shall be stored in a safe, cool place.

5.5 Specimens shall be free from foreign materials such as seal coat, tack coat, foundation material, soil, paper, or foil.

5.6 If desired, specimens may be separated from other pavement layers by sawing or other suitable means.

6. APPARATUS

6.1 *Balance* – Conforming to the requirements of AASHTO M 231, for the class of balance required for the principle sample weight of the sample being tested. The balance shall be equipped with suitable suspension apparatus and holder to permit weighing the specimen while suspended from the center of scale pan or balance.

6.2 *Suspension Apparatus* -- Wire suspending the container shall be the smallest practical size at the point where it penetrates the water's surface to minimize any possible effects of a variable immersed length. The suspension apparatus shall be constructed to enable the container to be immersed to a depth sufficient to cover it and the test sample during weighing without contacting the bottom of the water bath.

6.3 *Water Bath* -- For immersing the specimen in water while suspended under the balance, equipped with an overflow outlet for maintaining a constant water level.

6.4 *Damp Towel* -- Flannel or terry cloth towel.

6.5 *Oven* – If using Method B (Rapid Test), a forced draft oven capable of maintaining 230°F ± 9° (110°C ± 5°).

6.6 *CoreDry™* – If using Method C (CoreDry™ Test), a CoreDry unit from Instrotek® Inc.

METHOD A

7. PROCEDURE

7.1 Method A shall be used for laboratory compacted specimens only.

7.2 Laboratory compacted specimens, which have not been exposed to moisture, do not require additional drying. Cool the specimen to room temperature at 77°F ± 9° (25°C ± 5°). Samples must not feel warm to the touch. Record the dry mass A. If laboratory compacted specimens are wetted before the dry mass is determined, dry them as specified in Subsection 10.4 once the immersed mass and surface-dry mass have been determined. Immerse each specimen in water at 77°F ± 1.8° (25°C ± 1°) for 4 ± 1 minutes and record the immersed mass, C. Remove the specimen from the water, damp dry the specimen by blotting it as quickly as possible with a flannel cloth or terry cloth towel which has been thoroughly wetted and wrung out, then immediately determine the surface-dry mass, B. The objective of blotting is to remove all of the surface water without losing any water that has been absorbed into the sample. Any water that seeps from the specimen during the weighing operation is considered part of the saturated specimen.

NOTE 1: If desired, the sequence of testing operations may be changed to expedite the test results. For example, first the immersed mass (C) can be taken, then the surface-dry mass (B) and finally the dry mass (A).

8. CALCULATIONS

8.1 Calculate the bulk specific gravity of the specimens as follows (round and report the value to the nearest three decimal places):

$$\text{Bulk Specific Gravity} = \frac{A}{(B - C)}$$

Where:

- A = Mass (in grams) of sample in air,
- B = Mass (in grams) of surface-dry specimen in air,
- C = Mass (in grams) of sample in water.

8.2 Calculate the percent water absorbed by the specimen (on volume basis) as follows:

$$\text{Percent Water Absorbed by Volume} = \frac{(B - A)}{(B - C)} \times 100$$

9. RECORD

9.1 No CDOT Form, record on your own worksheet.

METHOD B (RAPID TEST)

10. PROCEDURE

10.1 Method B shall be used for pavement cores.

10.2 This procedure can be used for testing specimens, which are not required to be saved, and which contain substantial amounts of moisture. Specimens obtained by coring or sawing can be tested the same day by this method. Specimens obtained by coring or sawing shall be tested using Method B or C and shall not be tested using Method A.

10.3 The testing procedure to determine the immersed mass (C) and the surface dry mass (B) shall be the same as given in Section 7. The dry mass (A) of the specimen is determined last, as per Subsection 10.4.

10.4 Determine and record the weight of a large flat bottom drying pan and place the weighed specimen into the pan. For Forced Draft Ovens, place the pan and specimen in a 230°F ± 9° (110°C ± 5°) oven. For 5½ in. (140 mm) diameter or larger cores, or for porous or wet cores, leave the specimen in the oven until it can be easily separated into pieces not larger than 2 in. (50 mm) in diameter. Use extreme caution not to lose any portion of the original specimen while separating it. Replace the separated specimen in the oven. Document the start time. Dry all of the specimen(s) for 3 hours minimum and determine the weight at that time, (record the time). After an additional 2 hours of drying determine the weight at the time, (record the time if needed). The drying of the specimen can be stopped at this minimum of 5 total hours if constant mass is reached. Continue the drying and weighing at 2-hour intervals until constant mass is reached, up to the 24-hour maximum period. Determine the final weight of the heated specimens and use this weight as the dry mass A in the equation in Subsection 8.1.

METHOD C (COREDRY™ TEST)

11. PROCEDURE

11.1 Method C may be used for pavement cores in place of Method B.

11.2 This procedure can be used for testing specimens, which can be saved, and which contain substantial amounts of moisture. Specimens obtained by coring or sawing can be tested the same day by this method. Specimens obtained by coring or sawing shall be tested using Method B or C and shall not be tested using Method A.

11.3 The testing procedure to determine the immersed mass (C) and the surface dry mass (B) shall be the same as given in Section 7. The dry mass (A) of the specimen is determined last, as per Subsection 11.4.

11.4 Turn CoreDry™ to ON position. Allow the CoreDry™ to warm up and go through preparation cycles until the “System Ready” prompt appears. Allow cores to warm to room temperature and towel dry the surface of cores if there is free standing moisture on the surface. Place core on side on wire mesh in the vacuum chamber. Clean any ice or moisture out of moisture trap with a lint free cloth. Place lids on vacuum chamber and moisture trap and press START. CoreDry™ will cycle until drying is complete and chamber will pressurize so lids can be freely removed. If moisture is visible on core surface clean moisture trap and repeat drying process. Determine the final weight of the dried specimens and use this weight as the dry mass A in the equation in Subsection 8.1.

12. CALCULATIONS

12.1 Calculate the bulk specific gravity as shown in Subsection 8.1.

12.2 Calculate percent relative compaction as follows:

$$\text{Percent Relative Compaction} = \frac{\text{Bulk Sp. Gravity}}{\text{Max. Sp. Gravity}} \times 100$$

NOTE 2: Max. Sp. Gr. information in CP 51.

12.3 Calculate the percent air voids as follows:

$$\text{Air Voids} = 100 - \text{Percent Relative Compaction}$$

12.4 Calculate the VMA as follows:

$$\text{VMA} = 100 - \frac{G_{mb}P_s}{G_{sb}}$$

Where:

VMA = Voids in mineral aggregate in percent of bulk volume,

G_{sb} = Bulk specific gravity of the aggregate,

G_{mb} = Bulk specific gravity of compacted mix,

P_s = Aggregate, percent by total weight of mix.

13. PRECISION

13.1 Duplicate specific gravity results by the same operator should not be considered suspect unless they differ more than 0.020.

14. RECORD

14.1 No CDOT Form, record on your own worksheet.

Colorado Procedure 45-98

Standard Method of Test for

Determining Percent of Particles with Two or More Fractured Faces

1. SCOPE

1.1 This method describes the procedure for determining the percentage of crushed particles in an aggregate sample.

NOTE 1: If the test is performed in conjunction with a sieve analysis test such as CP 31, save the plus No. 4 portion and reduce, if desired, by splitting to the test size shown in Table 45-1 and proceed as in Subsection 5.2.

2. REFERENCED DOCUMENTS

2.1 *Colorado Procedures:*

CP 30	Sampling of Aggregates
CP-L 5120	Determination of the Asphalt Binder Content of Bituminous Mixtures by the Ignition Method

3. APPARATUS

3.1 *Balance* - Sufficient capacity and sensitive to 0.1 gram.

3.2 *Sieve, No. 4* - With square openings conforming to AASHTO M 92.

3.3 *Sample Splitter* - For the selection of a representative specimen.

3.4 *Drying Equipment* - An oven or hot plate capable of drying a sample completely.

4. SAMPLE AND TEST SPECIMEN SIZE

4.1 The minimum required weight (mass) of the total sample shall conform to the requirements of the Table as shown in CP 30 or CP-L 5120, if the test is to be determined on the residual aggregate.

4.2 The minimum weight (mass) of the total specimen shall be sufficient to yield a plus No. 4 test specimen conforming to the following table:

TABLE 45-1

SIZE OF PLUS NO. 4 TEST SPECIMEN

<u>Nominal Maximum Aggregate Size</u>	<u>Minimum Weight of Specimen, grams</u>
3/8 in. (9.5 mm), or under	100
1/2 in. (12.5 mm)	200
3/4 in. (19.0 mm), or over	300

5. PROCEDURE

5.1 Sieve the total unwashed specimen over the No. 4 sieve and discard the minus No. 4 material. Wash the retained material and dry at 230°F ± 9° (110°C ± 5°) if using a Forced Draft Oven. When dry, sieve it over a No. 4 sieve per Note 1.

5.2 Weigh the plus No. 4 specimen and then spread onto a work table large enough so the individual particles may be inspected.

5.3 Separate the particles with two or more fractured faces from those without. A rounded particle with a small chip broken off shall not be counted as having a fractured face. If the face constitutes at least one quarter of the maximum cross-sectional area of the rock particle, consider it a fractured face.

5.4 Weigh the particles with two or more fractured faces and record as "weight (mass) of fractured aggregate."

6. CALCULATIONS

6.1 Determine the percentage of particles with two or more fractured faces by dividing the weight (mass) of the fractured aggregate by the total weight (mass) of the plus No. 4 test specimen and calculate:

$$\text{Percent of Particles with two or more fractured faces} = \frac{\text{weight of fractured aggregate}}{\text{total weight of specimen}} \times 100$$

7. RECORD

7.1 No CDOT Form used, record on your own worksheet.

Colorado Procedure 46-08

Standard Method of Test for

Determination of Gradation of Aggregate in a Core from Asphalt Pavement

1. SCOPE

1.1 This Procedure is part of the process to determine if an area designated by the Engineer as questionable is segregated. Five, 10" cores are taken at random locations (CP 75) to represent the segregated area. This procedure removes the surface areas (containing cut aggregate) from each core. The material is then combined, split, asphalt cement is removed in the ignition oven, and finally gradation is determined. Key sieve sizes of this gradation are compared to average field gradation or CDOT Form #43 gradations to determine if the area is segregated as defined by the specification.

2. REFERENCED DOCUMENTS

- 2.1 *Colorado Procedure:*
CP 31 Sieve Analysis of Aggregates
CP 55 Reducing Field Samples of Hot Mix Asphalt to Testing Size
CP 75 Stratified Random Sampling of Materials
- 2.2 *Colorado Procedure – Laboratory:*
CP-L 5120 Determination of the Asphalt Binder Content of Bituminous Mixtures by the Ignition Method

3. APPARATUS

3.1 *Oven* - Capable of holding five pans with cores, a 6" ID template (core barrel, pipe section, etc) and capable of maintaining 230°F.

3.2 *Five Pans* - Each large enough to hold a 10" core.

3.3 *6" ID Template* - Core barrel, pipe section, etc.

4. PROCEDURE

4.1 Remove foreign material from the cores. Separate the lift to be tested from the other lift(s). Freezing of the cores and use of a chisel may facilitate this process.

4.2 Place each core in a separate pan and place all pans in a 230°F oven for two hours or until the core is soft enough for the following separation procedure. Heat a 6" ID (inside diameter) template. Remove each specimen and pan, one at a time. Remove the outer layer of each core in the following manner. Center the 6" ID template over the 10" core and pass the template vertically down the entire specimen. Maintain downward pressure on the core barrel with one hand and remove all the trimmed material with the other hand. Lift the core barrel to reveal the material. Place the material in the container to be used for combining and remixing.

4.3 Repeat this process with the other four cores. Mix the material from the five cores.

4.4 Following CP 55, split the combined material to result in two portions of appropriate size for ignition oven testing.

4.5 Remove asphalt cement in accordance with CP-L 5120.

4.6 Determine gradations in accordance with CP 31.

4.7 Apply aggregate gradations correction factors in accordance with CP-L 5120.

Colorado Procedure 47-90

Standard Method of Test for

Rejuvenating Agent Evaluation Procedure

1. SCOPE

1.1 The layout of a rejuvenating agent test area, application of the test rejuvenating agent, and determination of whether or not rejuvenating agent is needed.

1.2 Asphalt Rejuvenating Agents are composed of a petroleum resin-oil base uniformly emulsified with water. Rejuvenating Agents are used as an agent to counter roadway oxidation and add new life into the existing material. A Rejuvenating agent may need to be added to a pavement undergoing rehabilitation per the test.

2. APPARATUS

2.1 Covered applicator, keel, tape measure, paint brush, rejuvenating agent, camera (optional).

NOTE 1: The applicator should have a perforated top that allows a rapid dispersal of the rejuvenating agent. Measure and mark the applicator so that the markings will correspond to the desired rate of application for the test section in gal/sq.yd., i.e., .03, .05, .075, .10, .125, and .15 gal/sq. yd. (L/m^2 , i.e., .14, .23, .34, .45, .57, .68 L/m^2). See Figure 47-1.

3. LOCATION OF TEST SITES

3.1 A minimum of three locations should be selected for each project. It may be necessary to increase the number of test locations depending on the length of the projects.

3.2 Each test site should be two feet in length by two feet in width (0.6 m x 0.6 m). Approximately one-half of the area should be located in the outside wheel path, and approximately one-half should not be within the wheel path.

NOTE 2: The first test location should contain three test sites to determine the approximate amount of rejuvenating agent that may be required. The other test locations would require

one test site. Suggested starting rates are .05, .10, and .15 gal/sq.yd. (.23, .45, and .68 L/m^2).

4. PREPARATION

4.1 Dilute the full strength rejuvenating agent into to two parts of rejuvenating to one part water.

4.2 Pour the proper amount of diluted rejuvenating agent into the applicator and cover.

4.3 Pour enough rejuvenating agent into a container of sufficient size to hold the paint brush so that all of its bristles are covered. Let stand until the test site is prepared.

5. PROCEDURE

5.1 Mark each test site on the pavement.

5.2 Photograph each test site before rejuvenating agent is applied. (Optional)

5.3 Remove the paint brush from the container and wipe the excess rejuvenating agent back into the container.

5.4 Apply the rejuvenating agent to the test site as evenly as possible.

5.5 Use the paint brush to distribute the rejuvenating agent over the test site more uniformly.

5.6 Note the time of application and record the time and the rate of application on the pavement adjacent to the test site.

5.7 Let the rejuvenating agent stand undisturbed on the test site until it has penetrated. Record the time. If the rejuvenating agent fails to penetrate into the pavement in 20 minutes or less, try a smaller amount of rejuvenating agent. If this is not practical, then note that no rejuvenating agent is required for that test site.

NOTE 3: See Figure 47-2 A and B for examples of total penetration and partial penetration.

5.8 Photograph the test site after the test is completed. (Optional)

6. RECORD

6.1 No CDOT Form used, record on your own worksheet.

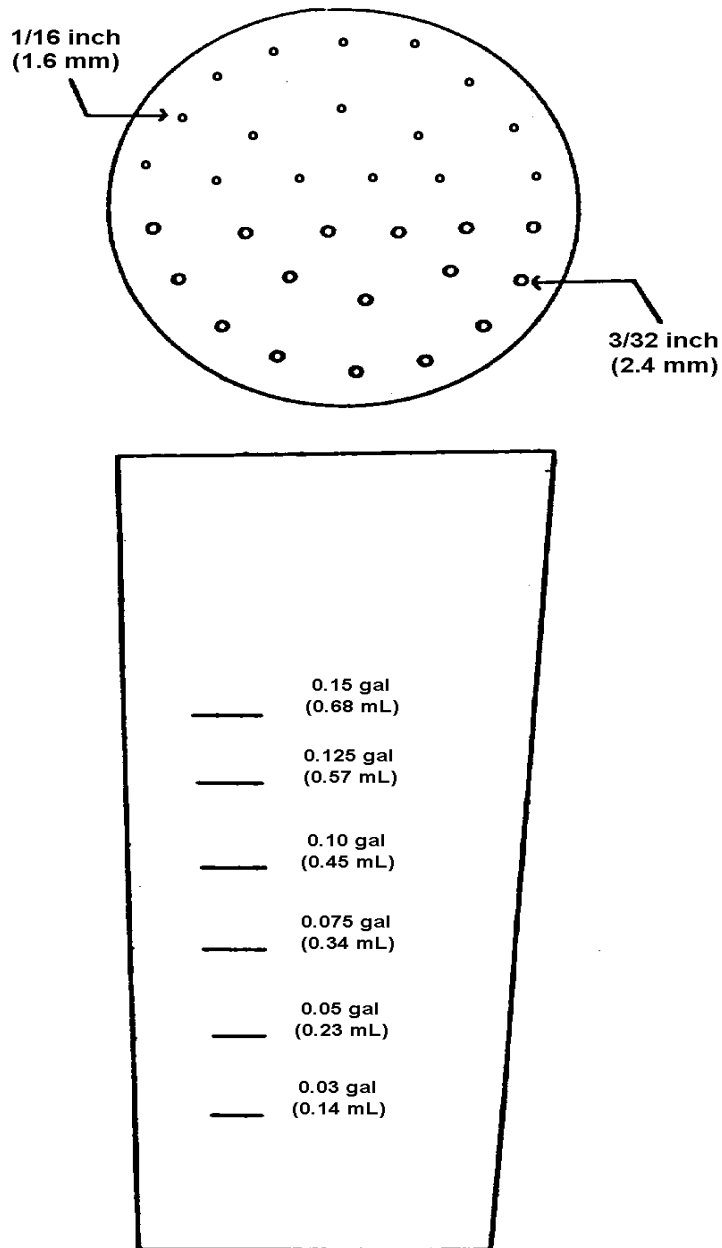

FIGURE 47-1



A. Total Penetration



B. Partial Penetration

Colorado Procedure 48-09

Standard Method of Test for

Determination of the Voids in the Mineral Aggregate (VMA)

1. SCOPE

1.1 Voids in the mineral aggregate (VMA) are the void spaces between the aggregate particles of the compacted mix. This void space includes the air voids and the effective asphalt content.

$$G_{sb} = \frac{P_1 + P_2 + \dots + P_n}{\frac{P_1}{G_1} + \frac{P_2}{G_2} + \dots + \frac{P_n}{G_n}}$$

Where:

P_1 = Percent by weight of aggregate 1, etc.,
 G_1 = Bulk specific gravity of aggregate 1, etc.

2. REFERENCED DOCUMENTS

2.1 *Colorado Procedures:*
CP 56 Guidelines for Using Maximum Specific Gravity (Rice) of Project-Produced HMA to Change the Target Specific Gravity for Compaction Compliance

3.3 When the total mix contains 20 percent or less of reclaimed asphalt pavement (RAP), the bulk specific gravity of the aggregate contained in the RAP shall be assumed to be the same as the effective specific gravity of the aggregate contained in the RAP for the purpose of the calculation in Subsection 3.2. The calculation for the effective specific gravity may be found in CP 56.

3. CALCULATION

3.1 VMA is computed as follows:

$$VMA = 100 - \frac{G_{mb} P_s}{G_{sb}}$$

Where:

VMA = Voids in mineral aggregate, in percent of bulk volume,

G_{sb} = Bulk specific gravity of the aggregate,

G_{mb} = Bulk specific gravity of compacted mix,

P_s = Aggregate, percent by total weight of mix.

NOTE 1: For more detailed information on VMA determination and related subjects, refer to the Asphalt Institute publication MS-4.

3.4 When hydrated lime is used in the mix, the G_{sb} value for the lime shall be 2.38.

3.2 When the total aggregate consists of separate fractions, the bulk specific gravity of the total aggregate is computed as follows:

{This page was intentionally left blank.}

Colorado Procedure 50-06

Standard Method of

Calculation of Dust to Asphalt Ratio of Bituminous Mixes

1. CALCULATIONS

The dust to asphalt (D/A) ratio is computed as follows:

$$DA = (P_{200} - 1) / P_{be}$$

Where:

DA = Dust to Asphalt Ratio,

P₂₀₀ = Aggregate content passing the 0.075-mm sieve, the percent by mass of aggregate,

P_{be} = Effective asphalt content, percent by total mass of mixture.

$$P_{be} = - (P_s \times G_b) \times \left(\frac{G_{se} - G_{sb}}{G_{se} \times G_{sb}} \right) + P_b$$

Where:

P_{be} = Effective asphalt content, percent by total mass of mixture,

P_s = Aggregate content, percent by total mass of mixture,

G_b = Specific gravity of asphalt,

G_{se} = Effective specific gravity of aggregate,

G_{sb} = Bulk specific gravity of aggregate,

P_b = Asphalt Content, percent by total mass of mixture.

{This page was intentionally left blank.}

Colorado Procedure 51-12

Standard Method of Test for

Determining the Maximum Specific Gravity of HMA

(This procedure is based upon AASHTO T 209-93. AASHTO T 209-93 or any subsequent revisions may not be used in place of this procedure.)

1. SCOPE

1.1 This method covers the determination of the maximum specific gravity of uncompacted bituminous paving mixtures.

2. REFERENCED DOCUMENT

- 2.1 *AASHTO Standards:*
- T 164 Quantitative Extraction of Bitumin from Bituminous Paving Materials
 - T 168 Sampling Bituminous Paving Mixtures.
- 2.2 *ASTM Standards:*
- E1 Specification for ASTM Thermometers
- 2.3 *Colorado Procedures:*
- CP 41 Sampling Hot Mix Asphalt
 - CP-L 5101 Verification of Laboratory Equipment used to Test Bituminous Mixtures
 - CP-L 5115 Preparing & Determining the Density of Bituminous Mixture Test Specimens Compacted by the Superpave Gyrotory Compactor
 - CP-L 5120 Determination of the Asphalt Binder Content of Bituminous Mixtures by the Ignition Method

3. APPARATUS

3.1 *Balance* - With ample capacity, and with sufficient sensitivity to enable maximum specific gravities of samples of uncompacted paving mixtures to be calculated to at least four significant figures; that is, to at least three decimal places.

NOTE 1: Since there are no more significant figures in the quotient (maximum specific gravity) than appear in either the dividend (the weight of the specimen in air) or in the divisor (the volume of the specimen), this means that the balance must have a sensitivity capable of providing both weight and volume values to at least four figures.

3.2 *Container* - Heavy walled volumetric flask, with the top sanded flat to provide a good seal with a cover plate, having a capacity of at least 2,000 ml. If containers other than heavy walled flasks are used, repeated weightings of the flask as specified in Subsection 4.1 must be within 0.2 grams of one another. Containers shall be sufficiently strong to withstand a partial vacuum and shall have covers as follows: for use with the flask, a rubber stopper with a hose connection. The hose opening shall be covered with a small piece of fine wire mesh to minimize the possibility of loss of fine material. The top surfaces of all containers shall be smooth and substantially plane.

3.3 *Thermometers* - Calibrated liquid-in-glass, total immersion type, of suitable range with gradations at least every 0.2°F (0.1°C) and a maximum scale error of 0.2°F (0.1°C) as prescribed in ASTM Specification E 1.

3.4 *Vacuum Pump or Water Aspirator* - Capable of developing a partial vacuum of 28 ± 2 mm of mercury (Hg) for evacuating air from the container.

3.5 *Water Bath* - Constant temperature water bath capable of maintaining a temperature of $77^{\circ}\text{F} \pm 1^{\circ}$ ($25^{\circ}\text{C} \pm 0.5^{\circ}$).

3.6 *Manometer or Vacuum Gauge* - Free of air bubbles, initially traceable to NIST, and be capable of measuring residual pressure down to 30 mm Hg or less.

3.7 *Needle Valve* - Capable of adjusting the

partial vacuum applied to the specimen to 28 ± 2 mm of mercury.

3.8 *Oven* – If using Section 8, capable of maintaining a temperature of $230^{\circ}\text{F} \pm 9^{\circ}$ ($110^{\circ}\text{C} \pm 5^{\circ}$). If short-term aging is required, an oven capable of maintaining 200°F (94°C).

4. CALIBRATION OF FLASK

4.1 Approximately once per month, accurately determine the mass of the flask filled with water at $77.0^{\circ}\text{F} \pm 1.0^{\circ}$ ($25.0^{\circ}\text{C} \pm 0.5^{\circ}$) and covered by the cover plate to be used for testing. Average the last three determinations of the weight of the flask, water, and cover plate and record this number. Alternatively, generate a curve as described in Subsection 6.5 and verify at least one point on this curve approximately once per month.

5. TEST SAMPLES

5.1 Field samples shall be obtained, as required by the Schedule, in accordance with CP 41, Sampling Hot Mix Asphalt.

5.2 The size of the test specimens shall be governed by the nominal maximum aggregate size of the mixture and conform to the mass requirement of Table 51-1. Split or quarter the field sample in accordance with CP 55 until the mass of the material required for the test is obtained. Two separately taken identical test specimens shall be obtained. The two specimens shall not be recombined at any time after they have been taken.

5.3 If laboratory or field produced specimens are to be compacted for voids analysis using CP-L 5115, the specimens used to determine the theoretical maximum specific gravity should be short-term aged using the same heating procedure as used for the specimens being compacted. Specimens, which have been held at a temperature above 200°F (94°C) for 1 or more hours after mixing, do not require additional aging.

Size of Aggregate		Mass of Specimens
in.	mm	specimens x grams
1 1/2	37.5	2 x 3000 g
1	25.0	2 x 1500 g
3/4	19.0	2 x 1000 g
1/2	12.5	2 x 750 g
3/8	9.5	2 x 500 g
No. 4	4.75	2 x 500 g

6. PROCEDURE

6.1 For each specimen, separate the particles of the specimen, taking care not to fracture the mineral particles, so that the particles of the fine aggregate portion are not larger than 1/4 in. (6.4 mm). If the mixture is not sufficiently soft to be separated manually, place it in a large flat pan and warm in an oven only until it can be so handled.

6.2 Cool the specimen to room temperature, place in the tared flask and weigh. Designate the net mass of specimen as A. Add sufficient water at approximately 77°F (25°C) so that the specimen is covered to a minimum depth of 1 in. (25 mm) and remains covered while it is agitated.

6.3 Remove entrapped air by subjecting the contents to a partial vacuum of 28 ± 2 mm Hg for 15 ± 2 minutes. Agitate the container and contents manually by vigorous shaking for 15 ± 5 seconds at intervals of about 2 minutes. Alternatively, a mechanical device, shown to be at least as effective at removing entrapped air as the manual method and shown to not result in stripping of the asphalt binder from the aggregate, may be used to agitate the container.

NOTE 2: If there are multiple broken or sawed uncoated aggregate surfaces or if uncoated fine material separates from the specimen and settles to the bottom of the flask once the test is complete, use the supplemental procedure described in Section 8.

TABLE 51-1:
Sample Mass for Various Nominal Maximum
Sizes of Aggregate.

Nominal Maximum	Number and Minimum
-----------------	--------------------

NOTE 3: The release of entrapped air may be facilitated by the addition of a suitable wetting agent such as Aerosol OT in concentration of 0.001 percent or 0.2 grams in 20 liters of water. This solution is then diluted to about 20:1 to make a wetting agent of which 5 to 10 ml may be added to each sample to give a final concentration of Aerosol OT of about 1 gram per 200,000 liters.

6.4 *Flask Determination* - Fill the flask with water, at a temperature of 77°F ± 1° (25°C ± 0.5°), being careful not to introduce air bubbles into the flask. Optionally, if air bubbles are seen in the flask, gently stir the specimen with a rod to dislodge any air bubbles that may still be trapped in the flask. Fill the flask to the top with water and cover the flask with the same cover plate used in the flask's calibration, making sure that there are no air bubbles beneath the flask's cover plate. Place the flask and contents into a 77°F ± 1° (25°C ± 0.5°) constant temperature water bath. Remove the flask from the water bath and dry the exterior of the flask completely. Check that no air bubbles have appeared beneath the flask's cover plate. Determine the weight of the flask, water, specimen, and cover plate 10 ± 1 minutes after completing Subsection 6.3.

6.5 In lieu of a constant temperature water bath, determine the temperature of the water within the flask immediately after weighing the flask, water, and specimen and make the appropriate density correction to 77°F (25°C) using the curve in Figure 51-1. In this case, the mass of the flask, water, and cover glass must be determined at the same temperature as the test temperature. This shall be done by plotting the mass of the flask, water, and cover plate for at least five approximately / equally spaced temperatures, which span the range of test temperatures to be used. Allow the flask and water to equilibrate at each temperature for at least one minute before measuring the water temperature and then weighing the flask, water, and cover plate. Alternatively, one point (using three trials) near the middle of the expected temperature range may be determined. The volume of the flask may then be calculated by subtracting the mass of the flask and cover glass, and then dividing the mass of the water by the density of the water at that temperature using the equation from FIGURE 51-1. A table may be constructed by multiplying the volume of the flask by the density of water and adding the

mass of the flask and cover glass for each temperature desired. This method may be used for containers which have a minimal change in volume over the temperature range to be expected, such as annealed glass flasks. At least one point on the resulting plot of mass vs. temperature should be verified monthly.

7. CALCULATION

7.1 Calculate the specific gravity of the specimen as follows:

7.1.1 *Flask Determination:*

$$\text{Specific Gravity} = \frac{A}{(A + D - E)}$$

[Equation 1]

Where:

- A = Mass of dry specimen in air, g,
- D = Mass of flask filled with water at 77°F (25°C), g,
- E = Mass of flask filled with water and specimen at 77°F (25°C), g.

7.2 Whenever water temperatures other than 77°F are used, use the following equation:

$$\text{Specific Gravity} = \frac{A}{(A + F) - (G + H)} \times \frac{dw}{0.9970}$$

[Equation 2]

Where:

- A = Mass of dry specimen in air, g,
- F = Mass of flask filled with water at test temperature, g, as read from the plot generated in Subsection 6.5,
- G = Mass of flask filled with water and specimen at test temperature, g,
- H = Correction for thermal expansion of bitumen, g. from Figure 51-2. **Note:** H may be assumed to be zero for test temperatures between 70°F and 90°F (21.1°C and 32.3°C),
- dw = Density of water at test temperature. Curve D in Figure 51-1, Mg/m³,

0.9970 = Density of water at 77°F (25°C).
Mg/m³.

The ratio (dw/0.9970) is Curve R in Figure 51-1.

NOTE 4: This general procedure for correcting for thermal effects should also be applicable to corresponding measurements made with other suitable containers.

7.3 *Repeatability* - If the specific gravities of the two specimens are not within 0.011 of each other, the results should be discarded, a new specimen obtained, and the specific gravity of the material retested.

8. SUPPLEMENTAL PROCEDURES FOR MIXTURES CONTAINING POROUS AGGREGATE NOT COMPLETELY COATED

METHOD A – DRY-BACK

8.1 Proceed as follows after completing Section 6.

8.1.1 Oven dry a filter paper and record its weight. Place the filter paper into a filter paper cone holder.

8.1.2 Drain the water from the specimen through the filter paper cone being careful not to lose any of the specimen. Allow the specimen to drain completely.

8.1.3 Weigh an empty pan sufficient in size to hold the test specimen while it dries in Subsection 8.2.

8.1.4 Empty the specimen from the filter paper into the pan from Subsection 8.1.3 and place the pan before an electric fan.

8.1.5 Oven dry the filter paper and any specimen which may still remain on the paper's surface at a temperature of 230°F ± 9° (110°C ± 5°) for more than 30 minutes. Subtract the weight of the filter paper used in Subsection 8.1.1 and record this weight.

8.2 Spread specimen before an electric fan to remove surface moisture. Weigh at 15-minute intervals and when the loss in mass is less than 0.5g for this interval, the specimen may be considered to be surface dry. This procedure requires about 2 hours and should be accompanied by intermittent stirring of the specimen. Conglomerations of mixture should be broken by hand. Care must be taken to prevent loss of particles of mixture.

8.3 To calculate the specific gravity of the specimen, the sum of the final surface-dry mass and the mass of any specimen remaining on the filter paper from Subsection 8.1.5 is substituted for A in the denominator of Equation 1 or 2.

METHOD B – ASPHALT CEMENT ADD-IN FOR CALCULATING THE EFFECTIVE SPECIFIC GRAVITY FOR RAP

8.4.1 Before Subsection 6.1, add in 2% to 3% virgin asphalt cement per CP-L 5120 Subsection 9.1, to the specimen.

8.4.2 After specimen has properly cooled proceed with Subsection 6.1.

8.5 For calculating effective specific gravity of the aggregates, the percent binder is the virgin binder added per this procedure and any binder that is already on the aggregate that is determined by CP-L 5120 or AASHTO T 164.

9. PRECISION

9.1 Criteria for judging the acceptability of specific gravity test results obtained by this method are given in Table 51-2 entitled "Specific Gravity Test Results." The figures given in column 2 are the standard deviations that have been found to be appropriate for the conditions of test described in column 1. The figures given in column 3 are the limits that should not be exceeded by the difference between the results of two properly conducted tests.

TABLE 51-2: Specific Gravity Test Results

Test and Type Index	Acceptable Standard Deviation (1S)	Range of Two Results (D2S)
Test results obtained without use of Section 8^a:		
Single-operator precision	0.0040	0.011
Multi laboratory precision	0.0064	0.019

^a **Basis of estimate:** 3 replicates, 5 materials, 5 laboratories.

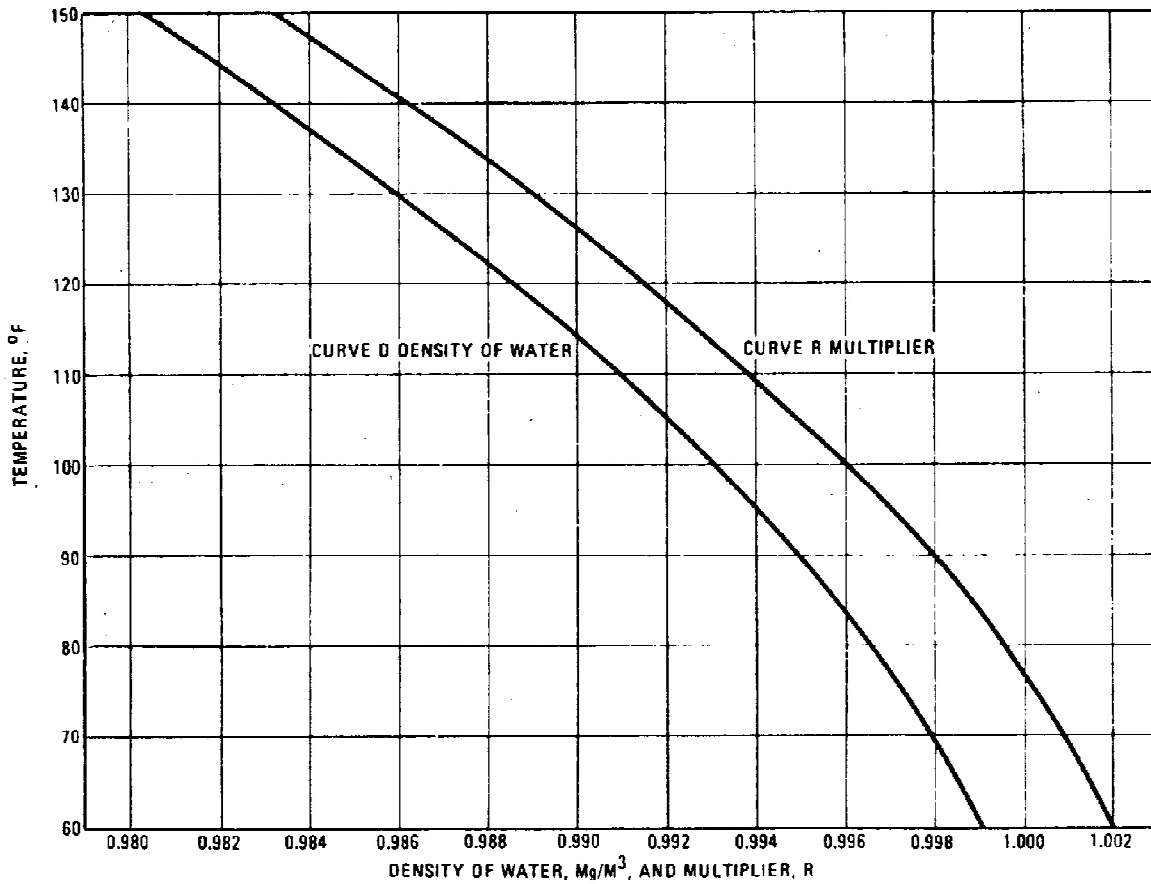

FIGURE 51-1 Curves D and R for Equation 2

The equation of curve D, the density of water from 60°F to 150°F is:
$$D = (1.001\ 402) + (0.000\ 029\ 42) \times T - (0.000\ 001\ 133) \times T^2$$

Where: T = Temperature in degrees Fahrenheit.

The equation for the multiplier R from 60°F to 150°F is:
$$R = (1.004\ 385) + (0.000\ 028\ 68) \times T - (0.000\ 001\ 129) \times T^2$$

Where: T = Temperature in degrees Fahrenheit.

(Please check all results against the graph for correctness.)

Curve R is the Ratio (dw / 0.9970)

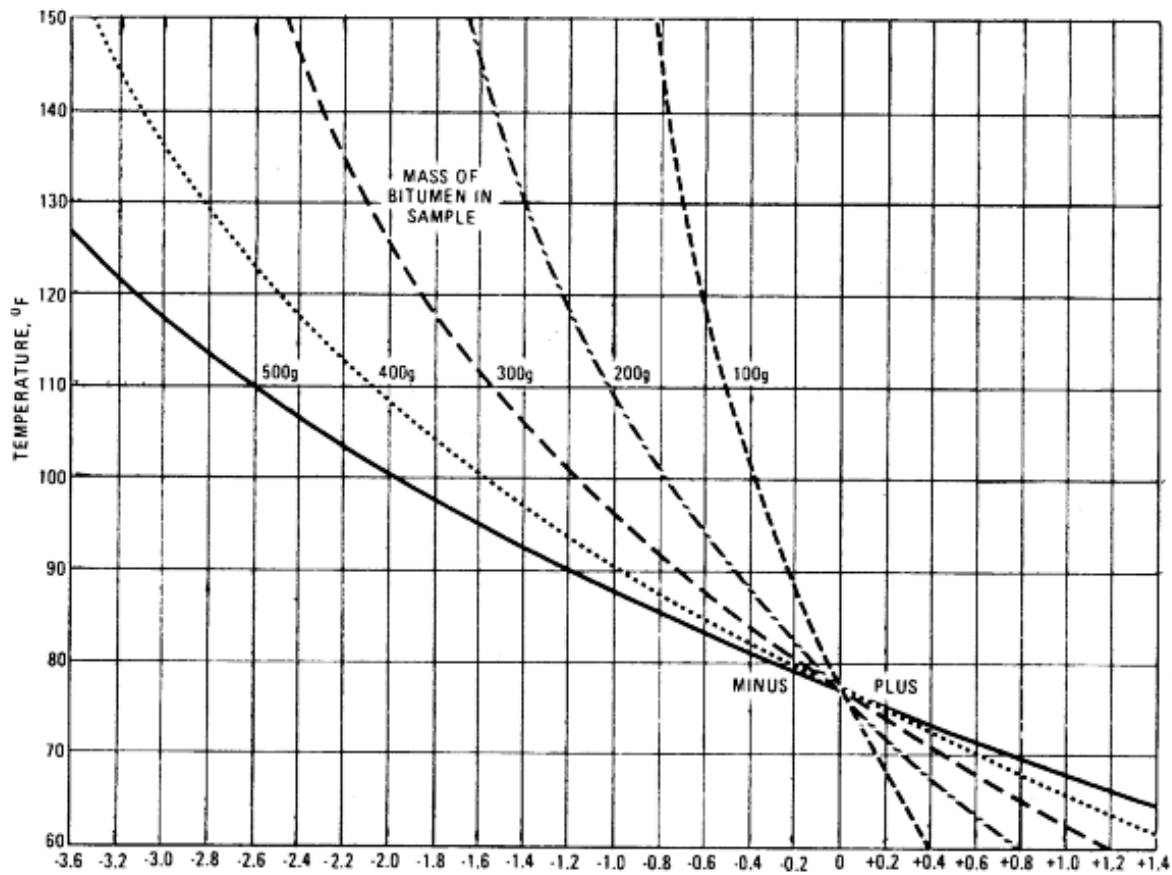

FIGURE 51-2 Correction Curves for Thermal Expansion of Bitumen, H, in Equation 3

The equation for the correction for the thermal expansion of bitumen, H, from 60°F to 150°F is:

$$H = [\text{grams bitumen}] \times [(0.022\ 71) - (0.000\ 386) \times T + (0.000\ 001\ 201) \times T^2]$$

Where: T = Temperature in degrees Fahrenheit.

(Please check all results against the graph for correctness.)

{This page was intentionally left blank.}

Colorado Procedure 52-12

Standard Practice for

Contractor Asphalt Mix Design Approval Procedures

1. SCOPE

1.1 This practice describes the procedures for asphalt mix design approval, the time required to perform the required tests, and the cost of the testing.

2. REFERENCED DOCUMENTS

2.1 *AASHTO Standards:*

- T 84 Specific Gravity & Absorption of Fine Aggregate
- T 85 Specific Gravity & Absorption of Coarse Aggregate
- T 90 Determining the Plastic Limit & Plasticity Index of Soils
- T 96 Resistance to Degradation of Small-Size Coarse Aggregate by Abrasion and Impact in the Los Angeles Machine

2.2 *Colorado Procedures:*

- CP 10 Qualification of Testing Personnel and Laboratories
- CP 30 Sampling of Aggregates
- CP 51 Determining the Maximum Specific Gravity of HMA

2.3 *Colorado Procedures – Laboratories:*

- CP-L 4211 Resistance of Coarse Aggregate to Degradation by Abrasion in the Micro-Deval Apparatus
- CP-L 5106 Resistance to Deformation of Bituminous Mixtures by Means of Hveem Apparatus
- CP-L 5109 Resistance of Compacted Bituminous Mixture to Moisture Induced Damage
- CP-L 5115 Preparing & Determining the Density of Bituminous Mixture Test Specimens Compacted by the Superpave Gyrotory Compactor
- CP-L 5145 Contractor Asphalt Mix Design Approval Procedures Utilizing RAP Millings from the Same Project

3. APPROVAL OF MIX DESIGNS

3.1 Asphalt mix designs shall be performed in conformance with CP-L 5115, CP-L 5106, and CP-L 5109 as well as other specified Colorado, AASHTO, and ASTM procedures. Mix designs for S and SX mixes will be done using 4-inch molds. Mix designs for SG mixes will be done using 6-inch molds. A complete mix design will be required for all mixtures placed on the project.

3.2 The Contractor must submit to the Engineer three copies of the asphalt mix design on CDOT Form #429, which contains all the information detailed in Subsection 4.2, and the aggregate samples, a minimum of 4 weeks prior to the anticipated paving start date. All asphalt mix designs shall be stamped by a registered Professional Engineer in the State of Colorado pursuant to Section 12-25-117 of the Colorado Revised Statutes. Mix designs shall have an original manual ink signature. Copied or faxed mix designs will not be accepted. As a minimum, the cover letter describing the asphalt mix design shall be stamped by a registered Professional Engineer in the State of Colorado. If the supporting documentation listed in Subsection 4.2 is not covered by the Engineer of Record, each supporting page shall be stamped by a registered Professional Engineer in the State of Colorado. The Region Materials Engineer (RME) must approve the Contractor's proposed asphalt mix design before paving may proceed. The Engineer may reject a mix design that appears to have errors. The Contractor shall use CDOT Form # 429 which may be obtained through the RME or through the Flexible Pavement Unit of the Central Laboratory.

3.2.1 To verify the asphalt mix design, the aggregates to be used shall be sampled in accordance with CP 30, in the presence of the Engineer, and will be tested by the Concrete/Physical Properties Unit of the CDOT Central Laboratory. The aggregates shall be tested for: Aggregate Specific Gravity and Absorption, (AASHTO T 84 & T 85) and Plastic Index (AASHTO T 90). The Engineer will

coordinate with the Region Materials Engineer to determine the need to run the Micro-Deval (CP-L 4211) and/or the Los Angeles Abrasion (AASHTO T 96).

NOTE 1: If the aggregate specific gravity of the contractor's asphalt mix design is not within 0.020 of the results from the CDOT Central Laboratory testing for the combined aggregates, the Contractor and CDOT Central Laboratory shall both recheck calculations, retest, and/or resample as needed until the resulting mix aggregate specific gravities agree to within 0.020. The contractor's aggregate specific gravity values will then be used to calculate the HMA mixture volumetric properties. After the Contractor develops the mix design he may use the aggregate test results from the CDOT Central Laboratory as listed in Subsection 3.2.1 for mix development.

3.3 The asphalt mix design cannot be approved when the laboratory trial, binder data, or aggregate data possess results are from tests performed more than one year in the past.

3.4 If all tests conform to the specifications, a CDOT Form #43 (Job Mix Formula) will be executed.

3.5 All mix design properties must satisfy Table 403-1 from the Project Special Provisions. The CDOT Form #43 will establish construction targets for Asphalt Content and all mix properties at Air Voids 1.0% below the mix design optimum.

3.6 The Form #43 shall be verified according to Section 106, (see Section 105 & 106 (Quality of Hot Mix Asphalt) in the Project Standard Special Provisions, part 8(d) Mix Verification testing.)

3.7 After an asphalt mix design is approved for use, binder changes shall be handled as follows:

3.7.1 If the Supplier remains the same, but the binder used changes, such that future binder supply to a project will come from a different refinery, different terminal, or be a different formulation that could potentially affect mix properties, a one point check at the Form #43 target AC content shall be done by the Contractor to verify that asphalt mix design properties are still valid. The one point check verification shall be reviewed and stamped by a registered Professional Engineer in the State of Colorado and shall be submitted to the Engineer. Production

shall not commence until one point verification is completed and is approved by the RME. A new mix design shall be required if the one point check is not accepted by the RME. If the supplier is changing terminal location and both locations utilize the same formulation, the one point check may be waived with concurrence from the RME.

3.7.2 If the Supplier or grade change, a new asphalt mix design shall be submitted for approval.

4. MIX DESIGN REQUIREMENTS

4.1 Labs and personnel providing asphalt mix designs shall comply with the requirements listed in CP 10.

4.2 It is recommended that a complete mix design consisting of test results from three trial blends (in accordance with Superpave Mix Design SP-2) be conducted when the materials sources used in the mix design have not been verified on past CDOT projects. A complete mix design must contain all of the following:

- (1) For each aggregate stockpile:
 - A. Aggregate source
 - B. Target gradation along with gradation results from at least the 10 most current samples. These samples shall have been sampled and tested within two months of submitting the mix design.
 - C. Atterberg limits
 - D. Los Angeles Abrasion
 - E. Statistical data for the Apparent Specific Gravity and Bulk Specific Gravity.
- (2) Reclaimed asphalt pavement (RAP) if used:
 - (A) Percent asphalt
 - (B) Aggregate Gradation
 - (C) Effective Specific Gravity (in lieu of the RAP aggregate specific gravity).
- (3) Combined Aggregate Properties:
 - A. Percentage of each aggregate used,
 - B. Combined Aggregate Gradation (See #9 below), both before and after RAP use,
 - C. Sand Equivalent,
 - D. Fine Aggregate Bulk Specific Gravity,

- Coarse Aggregate Bulk Specific Gravity,
 - E. Fine Aggregate Angularity,
 - F. Combined Aggregate Bulk Specific Gravity,
 - G. Fractured Faces,
 - H. Micro-Deval according to CP-L 4211
 - I. Effective Specific Gravity.
- (4) Source and grade of asphalt cement from a CDOT Certified Binder Supplier. Use the actual specific gravity of the asphalt cement in calculations.
- (5) Name and percentage of each additive.
- (6) For each asphalt content tested:
- A. Voids in Mineral Aggregate (VMA) @ N_{des} ,
 - B. Dust to Asphalt ratio,
 - C. Percent Voids Filled with Asphalt (VFA) @ N_{des} ,
 - D. Hveem Stability (@ N_{des}),
 - E. Maximum Theoretical Specific Gravity,
 - F. Bulk specific gravity @ N_{des} ,
 - G. Air voids, Voids in Total Mix (VTM) @ N_{des} .
- (7) Graphs of stability and air voids vs. asphalt content and VMA-VFA; Voids Filled with Asphalt vs. Asphalt content.
- (8) Lottman and wet/dry tensile strength at optimum asphalt content.
- (9) A 0.45 power plot of the proposed combined aggregate gradation, with maximum density line, restricted zone, and control points included.

5. CONTRACTOR CHECKS

5.1 If a contractor wishes to check a test result with CDOT, they should make arrangements with the Flexible Pavement Unit or Physical Properties Unit of the CDOT Staff Materials Laboratory, depending upon the properties (mix or aggregate) that are to be tested. The Unit will work one-on-one with the contractor, as time permits, to improve inter-lab agreement. The testing will not be a part of the mix design process.

6. COST OF MIX AGGREGATE TESTING

6.1 CDOT Staff Materials Laboratory will conduct one complete set of mix aggregate tests at no cost to the Contractor upon receipt of a completed asphalt mix design submittal from the Contractor. (See Subsection 3.2.1) The Contractor must pay \$500 per aggregate for each subsequent set of mix aggregate tests performed by the CDOT Central Laboratory. The Project Engineer will document the additional tests performed and the appropriate charges will be passed through to the Contractor.

7. TIME REQUIRED FOR AGGREGATE TESTS

7.1 Reference the Laboratory Test Time table located in the Appendix of the Field Materials Manual.

8. RECORD

8.1 CDOT Form #429 is used. It is available electronically from the Central Lab at 303-398-6528 or from the Region Materials Engineers. See Chapter 400 for an example and instructions on the use of this form.

8.2 All requests for mix design information shall be made under the Colorado Open Records Act and shall follow CDOT Procedural Directives 25.2, 51.2, and 51.3.

{This page was intentionally left blank.}

Colorado Procedure 53-09

Standard Method of Test for

Determining Maximum Density of Cold In-Place Recycled Pavement

(This procedure modifies AASHTO T 180. The current AASHTO T 180 is to be used in conjunction with this procedure.)

1. SCOPE

1.1 This test is intended for determining the maximum density of cold in-place recycled pavement using AASHTO T 180. Two alternate procedures are recommended as follows:

Method C - 4-inch (101.60 mm) mold, material passing a 3/4 in. (19.0 mm) sieve.

Method D - 6-inch (152.60 mm) mold, material passing a 3/4 in. (19.0 mm) sieve.

2. REFERENCED DOCUMENTS

- 2.1 *AASHTO Standards:*
T 119 Bulk Density ("Unit Weight") & Voids in Aggregate
T 180 Moisture-Density Relations of Soils Using a 4.54-kg (10-lb) Rammer and a 457-mm (18-in.) Drop
- 2.2 *Colorado Procedures:*
CP 41 Sampling Hot Mix Asphalt

2A. SAMPLING

2A.1 Obtain a sample from the windrow or roadway, after rolling in the finished roadway. For cationic emulsions, sample after rolling in the finished roadway. Follow CP 41, Method C. Prepare and compact the sample as described in Method C or Method D below.

METHOD C

8. SAMPLE

8.1 (Disregard - Drying of the sample.)

8.2 (Follow as modified.) Coarse material, which is retained on the 3/4 in. (19.0 mm) sieve, if any, may be discarded and replaced. (NOTE 8 from AASHTO T 180.)

NOTE 1: If it is advisable to maintain the same percentage of coarse material in the lab sample as in the original field sample, the material retained on the 3/4 in. (19.0 mm) sieve shall be replaced as follows: Sieve an adequate quantity of the representative material over the 2 in. (50 mm) and 3/4 in. (19.0 mm) sieves. Discard the coarse material retained on the 2 in. (50 mm) sieve. Remove the material passing the 2 in. (50 mm) sieve and retained on the 3/4 in. (19.0 mm) sieve and replace it with an equal mass of material passing the 3/4 in. (19.0 mm) sieve and retained on the No. 4 sieve. Take the material for replacement from the remaining portion of the sample.

8.3 (Follow as modified.) Select a representative sample, weighing (with mass of) approximately 6 lb. (2.7 kg) or more, of the material prepared as described in Subsection 8.2.

9. PROCEDURE

9.1 (Disregard - Addition of water to sample.)

9.2 (Follow per AASHTO T 180.) Form a specimen by compacting the prepared material in the 4 in. (101.60 mm) mold (with collar attached) in five approximately equal layers to give a total compacted depth of about 5 in. (125 mm). Compact each layer by applying 25 uniformly distributed blows from a rammer dropping free from a height of 18 in. (457 mm) above the elevation of the material when a sleeve-type rammer is used, or from 18 in. (457 mm) above the approximate elevation of each finally compacted layer when a stationary mounted type of rammer is used. During compaction, the mold

shall rest firmly on a dense, uniform, rigid and stable foundation. (See NOTE 2).

NOTE 2: Each of the following has been found to be a satisfactory base on which to rest the mold during compaction of the material: A block of concrete, weighing not less than 200 lb. (91 kg), supported by a relatively stable foundation; a sound concrete floor; and for field application, such surfaces as found in concrete box culverts, bridges, and pavements.

9.2.1 (Follow per AASHTO T 180.) Following compaction, remove the extension collar, carefully trim the compacted material even with the top of the mold by means of the straight edge, and weigh the mold and material to the nearest 0.01 lb (5g). For molds conforming to the tolerances given in Subsection 3.1 and masses recorded in pounds, multiply the mass of the compacted specimen and the mold, minus the mass of the mold, by 30, and record the result as the wet density, W , in pounds per cubic foot, of compacted material. For molds conforming to tolerances given in Subsection 3.1 and masses recorded in kilograms, multiply the mass of the compacted specimen and the mold, minus the mass of the mold, by 1060, and record the result as the wet density, W , in kilograms per cubic meter, of compacted material. For used molds out of tolerance by not more than 50 percent (Subsection 3.1), use the factor for the mold as determined in accordance with Section 8 (Calibration of Measure), AASHTO T 19.

9.3 (Follow as modified.) Remove the material from the mold and slice vertically through the center. Take a representative sample of the material from one of the cut faces, weigh immediately, and dry in an oven at 230°F (110°C) for at least 12 hours, or to a constant mass, to determine the moisture content. The moisture content sample shall weigh no less than 500g. Since this is for informational purposes, a microwave drying method may be used.

9.4 (Disregard - Addition of water to sample.)

METHOD D

10. SAMPLE

10.1 (Follow as modified.) Select the representative sample in accordance with Subsection 8.3, except that it shall weigh (have a

mass of) approximately 12 lb. (5 kg).

11. PROCEDURE

11.1 (Follow per AASHTO T 180.) Follow the same procedure as described for Method C in Section 9, except for the following: Form a specimen by compacting the prepared sample in the 6 in. (152.40 mm) mold (with collar attached) in five approximately equal layers, to give a total compacted depth of about 5 in. (127 mm), each layer being compacted by applying 56 uniformly distributed blows from the rammer. For molds conforming to tolerances in Subsection 3.1, and masses recorded in pounds, multiply the mass of the compacted specimen and the mold, minus the mass of the mold, by 13.33, and record the result as the wet density, W , in lb/ft³ of the compacted material. For molds conforming to tolerances in Subsection 3.1, and masses recorded in kilograms, multiply the mass of the compacted specimen and the mold, minus the mass of the mold, by 471, and record the result as the wet density, W , in kilograms per cubic meter, of compacted material. For used molds out of tolerance by not more than 50 percent (Subsection 3.1), use the factor for the mold, as determined in accordance with Section 8 (Calibration of Measure) AASHTO T 19.

12. CALCULATIONS

12.1 (Follow as modified.) The wet density, which was calculated in Subsections 9.2.1 or 11.1, will be the maximum density used for determining the percent relative compaction.

14. RECORD

14.1 No CDOT Form is used, record on your own worksheet.

Colorado Procedure 54-09

Standard Practice for

Approval of Asphalt Mix Designs Using Plant Produced Material

1. SCOPE

1.1 This procedure defines the process of approving asphalt mix designs using plant-produced material.

2. REFERENCED DOCUMENTS

2.1 AASHTO Standards:

- T 164 Quantitative Extraction of Asphalt Binder from Hot-Mix Asphalt (HMA) by the Ignition Method
- T 308 Determining the Asphalt Binder Content of Hot-Mix Asphalt (HMA) by the Ignition Method

2.2 Colorado Procedures:

- CP 85 Asphalt Cement Content of Asphalt Mixtures by the Nuclear Method
- CP-L 5120 Determination of the Asphalt Binder Content of Bituminous Mixtures by the Ignition Method

3. SAMPLING

3.1 The mixture proposed for use on the project shall be sampled by the Supplier in the presence of a CDOT witness. A split of the samples shall be submitted to the CDOT Region Materials Lab. Minimum sample size of the CDOT portion of the split is 60 lb. (30 kg) at each asphalt content. The Supplier must provide the source and gradation of each stockpile used in the mix, the blending percentages, and the combined bulk specific gravity of the aggregate.

4. ASPHALT MIX DESIGN APPROVAL

4.1 Any asphalt mix design may be approved using plant-produced material.

4.2 Three samples at asphalt cement contents approximately 0.7% apart shall be produced and sampled. Excess material produced in this process shall not be placed on CDOT projects. The Contractor will supply the asphalt cement contents of each of the three samples as determined by AASHTO T 164, AASHTO T 308, CP-L 5120 or CP 85. The Contractor shall also determine the gradation of each produced sample and provide the data to the Department.

4.3 At each asphalt cement content, the Contractor shall determine the theoretical maximum specific gravity, air voids, VMA, VFA, and stability. The Contractor shall provide graphs of these values.

4.4 If the test results indicate conformance with specifications, the optimum asphalt cement content will be determined and the Department will verify the mixture properties using the sampled material closest to optimum. The Lottman test will also be conducted using the sampled material closest to optimum.

4.5 If all test results conform to specifications, a CDOT Form #43 may be executed to establish the asphalt job mix formula.

{This page was intentionally left blank.}

Colorado Procedure 55-06

Standard Method of Test for

Reducing Field Samples of Hot Mix Asphalt to Testing Size

(This procedure is based upon AASHTO T 248-89. AASHTO T 248-89 or any subsequent revision may not be used in place of this procedure.)

1. SCOPE

1.1 These methods cover the reduction of field samples of hot mix asphalt (HMA), having a nominal maximum size equal to or less than 1.5 in. (37.5 mm), to the appropriate size for testing, employing techniques that are intended to minimize variations in measured characteristics between the test samples so selected and the field sample.

1.2 The values stated in English units are to be regarded as the standard.

2. REFERENCED DOCUMENTS

- 2.1 *Colorado Procedures:*
CP 41 Sampling Hot Mix Asphalt

3. SIGNIFICANCE AND USE

3.1 The necessity for selecting representative samples and reducing them to test specimen size is emphasized in many test procedures. Using the proper equipment for the type of material to be reduced in size is important. However, unless used correctly, the final test specimen will not necessarily be representative of the total sample.

3.2 Specifications for HMA require sampling portions of the material for testing. Other factors being equal, larger samples will tend to be more representative of the total supply. These methods provide for reducing the large sample obtained in the field to a convenient size for conducting a number of tests to describe the material. The reduction is done in a manner such that the smaller portion is most likely to be a representation of the field sample, and thus of the total supply. The individual test methods provide for minimum weights of material to be tested.

4. SAMPLING

4.1 The field sample of HMA shall be taken in accordance with CP 41, or as required by individual test methods. The user shall satisfy himself that the initial size of the field sample is adequate to accomplish all intended tests.

4.2 Before sample reduction, the field sample of HMA should be heated just until a temperature, which allows for the easy separation of particles is attained. HMA samples should not be reheated more than necessary to separate particles.

5. SAMPLE PREPARATION

HMA samples shall be prepared for the reduction required for Methods A, B, or D by using either Method 1 or 2.

5.1 Method 1

5.1.1 Apparatus

5.1.2 Apparatus shall consist of a small, flat, square-end scoop with sides and a large flat-bottomed mixing pan.

5.1.3 Procedure

5.1.4 Place the field sample of HMA into the mixing pan where there will be neither loss of material nor the accidental addition of foreign material. Mix the material thoroughly by turning the entire sample over three times. Flatten the sample in the pan to a uniform depth, which should be the same or lower than the sides of the scoop.

5.2 Method 2

5.2.1 Apparatus

5.2.2 Apparatus shall consist of a small, flat, square-end scoop with sides and a large flat-

bottomed mixing pan.

5.2.3 Procedure

5.2.4 Place the can containing the field sample of HMA into the mixing pan with the opening of the can resting downwards on the bottom of the pan. Elevate the can approximately 1 inch above the pan bottom. Move the can in a circular motion allowing a thin, uniform layer to form a trail behind the can. Try to distribute the material into two or more layers. If visible areas of segregation exist, mix the material thoroughly by turning the entire sample over onto itself using the scoop.

METHOD A - SELECTION BY SCOOP

6. APPARATUS

6.1 Apparatus shall consist of a small, flat, square-end scoop with sides and a putty knife.

7. PROCEDURE

7.1 Prepare the sample for reduction per Subsection 5.1 or Subsection 5.2.

7.2 Obtain a sample for each test by selecting at least three increments of material at random locations, using a small, flat, square-end scoop. Insert the scoop to the full depth of the material. Every attempt should be made to minimize the loss of particles, especially large aggregate particles, over the sides of the scoop. A putty knife may be used to separate the material in the scoop from the material in the pan and also to cut increments of material from the main body of material in the scoop. Do not shake the material in the scoop to add small, additional amounts of material to the specimen, as this may introduce segregated material to the specimen. Combine the portions to obtain a test specimen having the required weight. Save the remaining portion of the sample until the tests are completed.

METHOD B - QUARTERING

8. APPARATUS

8.1 Apparatus shall consist of a small, flat, square-end scoop with sides and a putty knife.

9. PROCEDURE

9.1 Prepare the sample for reduction per Subsection 5.1 or Subsection 5.2.

9.2 Divide the mixture into four equal quarters with a square scoop and remove two diagonally opposite quarters, including all fine material. Successively mix and quarter the remaining material until the sample is reduced to the desired size. Save the remaining portion of the sample until tests are completed.

METHOD C -MECHANICAL SPLITTER

10. APPARATUS

10.1 *Sample Splitter* - Sample splitters shall have an even number of equal width chutes, but not less than a total of eight for coarse aggregate, or twelve for fine-aggregate, which discharge alternatively to each side of the splitter. For HMA samples, the minimum width of the individual chutes shall be approximately 50 percent larger than the largest particles in the sample to be split (Note 1). The splitter shall be equipped with a minimum of two collection pans, having a width equal to or slightly less than the overall assembly of chutes in the splitter to hold the two halves of the sample following splitting. It shall also be equipped with a hopper, a flat scoop, putty knife or straight-edged pan which has a width equal to or slightly less than the overall width of the assembly of chutes, by which the sample may be fed at a controlled rate into the chutes. The splitter and accessory equipment shall be so designed that the sample will flow smoothly without restriction or loss of material. A splitter brush should be used to clean the chutes of adhering fines.

NOTE 1: Mechanical splitters are commonly available in sizes adequate for coarse aggregate having the largest particle not over 1½ in. (37.5 mm).

11. PROCEDURE

11.1 The riffle splitter must be clean and dry before use. Place the material into a large, flat-bottomed mixing pan. Mix the material thoroughly. Using a flat scoop equal in width to the overall length of the riffles, remove material from the pan and slowly pour the material into the riffle splitter,

first from one side and then the other. Alternatively, use a flat, square-end scoop to load the sample from the mixing pan into two extra splitter pans placed side-by-side. Slowly pour approximately half of the sample in the pan from one side and then reverse the ends of the pan and pour the remainder from the other side. A slight jarring action by the pan against the splitter helps keep the riffles from clogging. Uniformly distribute the sample from edge to edge, so that when it is introduced into the chutes, approximately equal amounts will flow through each chute. The rate at which the sample is introduced shall be such as to allow a free flow through the chutes into the receptacles below. Do not allow any of the riffles to become plugged since this will divert material to the two adjacent riffles and send too much material to the opposite receiving pan.

11.2 Reintroduce the portion of the sample from alternating receptacles into the splitter as many times as necessary to reduce the sample to the size specified for the intended test. Retain the portion of the material collected in the other receptacle at the last split until tests are completed.

NOTE 2: As an alternative to Subsection 11.2, further splitting to testing size can be achieved with Subsection 11.3.

11.3 After splitting the material into two or four equal measures (depending on the size of the field sample), leave the divided sample in the splitter pans and place in the oven. Use the flat, square-end scoop to obtain individual test samples of the required weight. Work from one end of the pan to the other. Insert the scoop to the full depth of the material. Every attempt should be made to minimize the loss of particles over the sides of the scoop. A putty knife may be used to separate the material in the scoop from the material in the pan and also to cut increments from the main body of material in the scoop. Do not shake the material in the scoop to add small, additional amounts to the specimen, as this may introduce segregated material to the specimen. Save the remaining portion of the sample until tests are completed.

METHOD D - SELECTION BY CROSS SECTION

12. APPARATUS

12.1 Apparatus shall consist of a small, flat, square-end scoop with square sides; a putty knife; and two slats having a height at least one inch taller than the sides of the splitting pan. The slats shall conform within one inch to the sides of the pan, so that material cannot fall from the vertical face into the sample being separated.

13. PROCEDURE

13.1 Prepare the sample for reduction per Subsection 5.1 or Subsection 5.2.

13.2 Obtain a sample for each test by pushing a dividing slat vertically through the entire width of the sample until it contacts the bottom of the pan. Next, place a second slat parallel to the first and push it vertically to the bottom of the pan. Remove all of the material between the slats. Take care to include all fines from the pan, the slat sides, and the utensil in the sample. Obtain additional samples by pushing one of the slats vertically into the remaining material and repeating the process. Save the remaining portion of the sample until tests are completed.

METHOD E - QUARTERMASTER MECHANICAL SPLITTER

14. APPARATUS

14.1 Apparatus shall consist of a Quartermaster mechanical splitter and a spatula.

15. PROCEDURE

15.1 This procedure may be used for combining and splitting large samples for testing between two labs.

15.2 Close the hopper doors. Place the HMA material into the hopper and level it out with a spatula. Place 4 empty buckets tightly in each corner with the handles facing outward, away from the splitter. Turn the Quartermaster handle to the left.

15.3 This Method shall not be used for further reductions in sample size.

{This page was intentionally left blank.}

Colorado Procedure 56-09

Standard Practice for

Guidelines for Using Maximum Specific Gravity (Rice) of Project-Produced HMA to Change the Target Specific Gravity for Compaction Compliance

1. SCOPE

1.1 During the production of Hot Mix Asphalt, changes may occur in the maximum specific gravity of the mix. This change may be detected, and target specific gravity corrected, by measuring the maximum specific gravity (CP 51) of the project-produced material.

2. REFERENCED DOCUMENTS

2.1 *AASHTO Standards:*

- T 84 Specific Gravity and Absorption of Fine Aggregate
- T 85 Specific Gravity and Absorption of Coarse Aggregate
- T 164 Quantitative Extraction of Asphalt Binder from Hot-Mix Asphalt (HMA) by the Ignition Method
- T 308 Determining the Asphalt Binder Content of Hot-Mix Asphalt (HMA) by the Ignition Method

2.2 *Colorado Procedures:*

- CP 55 Reducing Field Samples of Hot Mix Asphalt to Testing Size
- CP 85 Asphalt Cement Content of Asphalt Mixtures by the Nuclear Method
- CP-L 5120 Determination of the Asphalt Binder Content of Bituminous Mixtures by the Ignition Method

3. APPARATUS

3.1 For the determination of the maximum specific gravity, the equipment shall be in accordance with CP 51.

3.2 For the determination of the asphalt cement content, the equipment shall be in accordance with AASHTO T 164, AASHTO T 308, CP-L 5120 or CP 85.

4. SAMPLING

4.1 A portion of the sample from CP 85, or a split sample, shall be used for determining the maximum specific gravity (CP 51). Reduction to test size shall be in accordance with CP 55.

4.2 Measure and record the maximum specific gravity in accordance with CP 51.

4.3 Measure and record the asphalt cement content in accordance with AASHTO T 164, AASHTO T 308, CP-L 5120 or CP 85.

5. PROCEDURE

5.1 A test for maximum specific gravity may be run for information during nuclear asphalt content gauge correlation, and compared to the maximum specific gravity reported on the Form #43. This optional test yields information that compares the maximum specific gravity of materials on the project with materials used in the design.

5.2 The tests for maximum specific gravity should be performed as early during production as possible. The best time to start is during the compaction test section.

5.2.1 Average the results of three maximum specific gravity tests (6 values) from known asphalt cement contents from the field-produced material.

5.2.2 Average the results of three asphalt cement content tests from the field-produced material.

NOTE 1: If all the design criteria are within specification, and the plot of the point determined in Subsections 5.2.1 and 5.2.2 differs by more than 0.010 from the graph sent with the mix design of the asphalt cement content versus maximum specific gravity, then the target maximum specific

gravity for compaction shall be changed on the Form #43, as follows.

NOTE 2: If the maximum specific gravity is adjusted, it is possible that the aggregate specific gravity has changed. The Contractor or the Engineer may request that the individual aggregates be re-sampled and retested to determine a new aggregate specific gravity (AASHTO T 84 & T 85). The re-sampled individual aggregates will be split and the Contractor will keep one split for testing while the other split will be immediately given to the Engineer for possible testing. The new aggregate specific gravity will be entered on the new Form #43 and a new VMA target will be calculated. If the new VMA target does not meet the minimum requirements specified in the Revision of 403, work shall be suspended and the Contractor shall complete and submit a new mix design meeting all of the requirements at no additional cost to the Department.

6. CALCULATIONS

6.1 Determine the effective specific gravity of the aggregate, as follows:

$$G_{se} = \frac{100 - P_{ba}}{\frac{100}{G_{mm}} - \frac{P_{ba}}{1.03}}$$

Where:

- G_{se} = Effective specific gravity of the aggregate,
- G_{mm} = Average maximum specific gravity (from Subsection 5.2.1),
- P_{ba} = Average percent asphalt cement (from Subsection 5.2.2).

6.2 Determine the new target maximum specific gravity at optimum asphalt cement content, as follows:

(Note: Optimum asphalt cement content is from Form #43.)

$$G_{max} = \frac{100}{\frac{P_s}{G_{se}} + \frac{P_{bo}}{1.03}}$$

Where:

- G_{max} = New target maximum specific gravity at optimum asphalt cement content,
- P_s = Percent of aggregate at optimum asphalt cement content (100 minus optimum asphalt cement content),
- P_{bo} = Optimum asphalt cement content,
- G_{se} = Effective specific gravity (from Subsection 6.1).

6.3 The new target maximum specific gravity shall be reported on the Form #43. The Form #43 shall be dated when the contractor is notified of the new target. The Form #43 shall be signed by all of the involved parties.

NOTE 3: Following establishment of the new target maximum specific gravity, a new tolerance band of ± 0.01 shall be made and all further Rice values should be inside the tolerance band. If two consecutive maximum specific gravity values fall outside the 0.01 tolerance band, the next sample shall be taken immediately and a maximum specific gravity test performed. A new target maximum specific gravity based on three consecutive tests shall be specified on the Form #43, provided that all the design criteria are within specification. Aggregate specific gravity will again be determined in accordance with Note 2.

Example

Design = 5.1% A.C. and 2.507 Max. Sp. Gr.

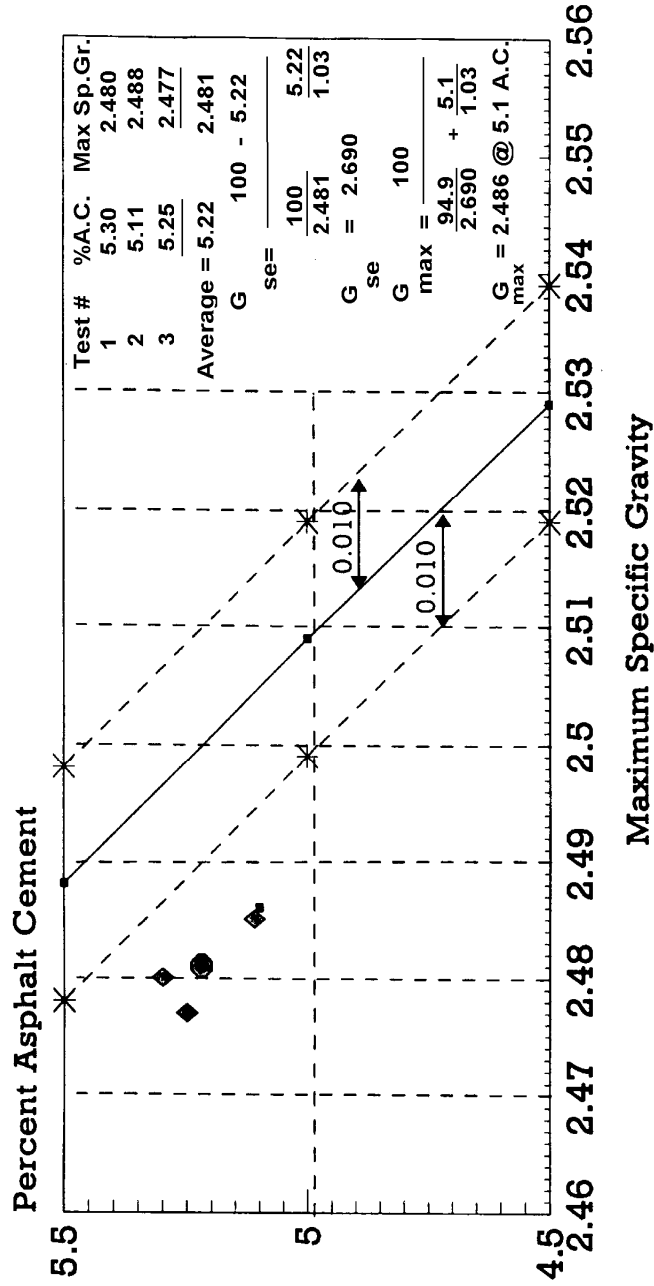

- ◆ CDOT Design
- Maximum Spec.
- ◆ Field Results
- Ave. Field Results
- ◆ Minimum Spec.
- New Max. Sp. Gr.

Field Sheet #

{This page was intentionally left blank.}

Colorado Procedure 57-95

Standard Method of Test for

Determining the "Free Moisture" in Cold In-Place Recycled Pavement

1. SCOPE

1.1 This procedure is to be used to determine the "free moisture" in cold in-place bituminous recycled pavement.

2. REFERENCED DOCUMENTS

2.1 Two alternate procedures are recommended as follows:

CP 43, Method A (Microwave Procedure)

CP 21 (Oven Dry Procedure)

NOTE 1: Use of a hot plate is not allowed, sample shall be dried to constant weight (mass) in an oven at 230°F ± 9° (110°C ± 5°) if CP 21 is used.

3. SAMPLING

3.1 Obtain a sample of the existing pavement from the roadway prior to cold in-place recycling. One sample per day of each pavement type being recycled should be sampled and tested.

NOTE 2: One sample per day needs to be taken to account for the variation in the in-place moisture of the existing pavement.

NOTE 3: Core samples are not recommended because of the excessive moisture introduced by the coring process.

3.2 Obtain a sample of the in-place recycled pavement, which has been compacted and is ready for either placement of the sealing emulsion or hot mix asphalt pavement overlay.

4. PROCEDURE

4.1 Determine the moisture content of the existing pavement sample by one of the procedures listed in Subsection 2.1.

4.2 Determine the moisture content of the cold in-place recycled sample by one of the procedures listed in Subsection 2.1.

5. CALCULATIONS

5.1 Calculate the percent "free moisture" as follows:

$$\text{Percent "free moisture"} = B - A$$

Where:

A = Percent moisture in Existing Pavement,
B = Percent moisture in Cold Recycled Material.

6. REPORTING

6.1 Report the "free moisture" to the nearest 0.1%.

6.2 Record the "free moisture" on the field density report for cold recycled pavement.

{This page was intentionally left blank.}

Colorado Procedure 58-07

Standard Method of Test for

Detecting and Measuring Temperature Segregation of HMA

1. SCOPE

1.1 This method describes the procedure for detecting and measuring temperature segregation of HMA using a handheld temperature device.

2. REFERENCED DOCUMENTS

2.1 CP 81 Density and Percent Relative Compaction of In-Place Bituminous Pavement by the Nuclear Method

3. APPARATUS

3.1 *Handheld Temperature Device* – An infrared temperature gun or infrared camera that is capable of measuring in one degree or finer increments between the temperatures of 150° to 400° F. For best clarity in readings, it is suggested that the temperature gun have a distance-to-spot size ratio (D:S) of 30:1 or greater.

3.2 Paint, grease crayon, or some other tool to mark locations to be tested for density.

3.3 Tape measure long enough to span the width of the paving area.

4. PROCEDURE

4.1 Mark the start of the area that will be examined. The tonnage of the area can be calculated in length by using 110 lbs/yd²/inch or can be found by tracking asphalt tickets. See Figure 58-1.

4.2 Scan the paving area with the hand-held temperature device looking for an area that is 25°F cooler than other areas across the width of the mat. Do not stand on or walk on the paving area. Stand adjacent to the paving area, behind the paver but ahead of the breakdown roller, and scan

slowly across the width of the mat excluding the outer one foot on each side of the mat. Move three feet forward and repeat scanning. Repeat as needed.

4.3 If an area is 25°F cooler than other areas across the width of the mat, mark the location on the edge of the mat and use a tape measure to locate the cooler area. Record on CDOT Form #1346.

4.4 Following finish rolling, locate the cooler area and find the density of the area per CP 81. Record on CDOT Form #1346.

5. REPORT

5.1 CDOT Form #1346, HMA Segregation Data, will serve as the report.

Figures 58-1 and 58-2 are on next page.

In Figure 58-1 below, the tester performed the temperature segregation check correctly. A start was established and 500 tons were checked for temperature segregation. Three cool areas were found in the 500 ton temperature segregation check.

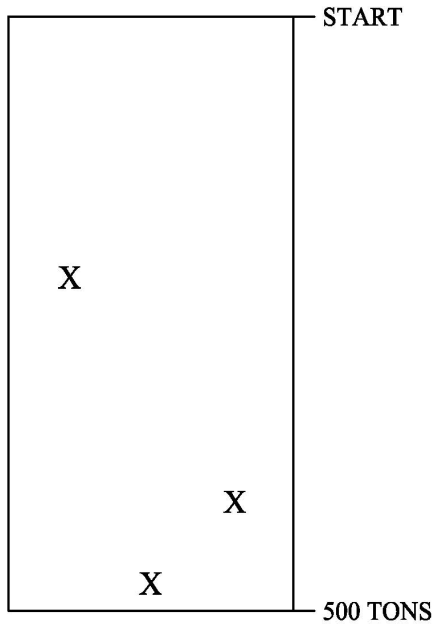

Figure 58-1 Temperature segregation study done correctly

In Figure 58-2 below, the tester did not perform the temperature segregation check correctly. A start was established and the tester went about 400 yards finding just two cool areas. He then restarted the temperature segregation check at the second cool area by establishing a new 500 ton test section. This resulted in finding five cool areas over the next 500 tons. This is incorrect.

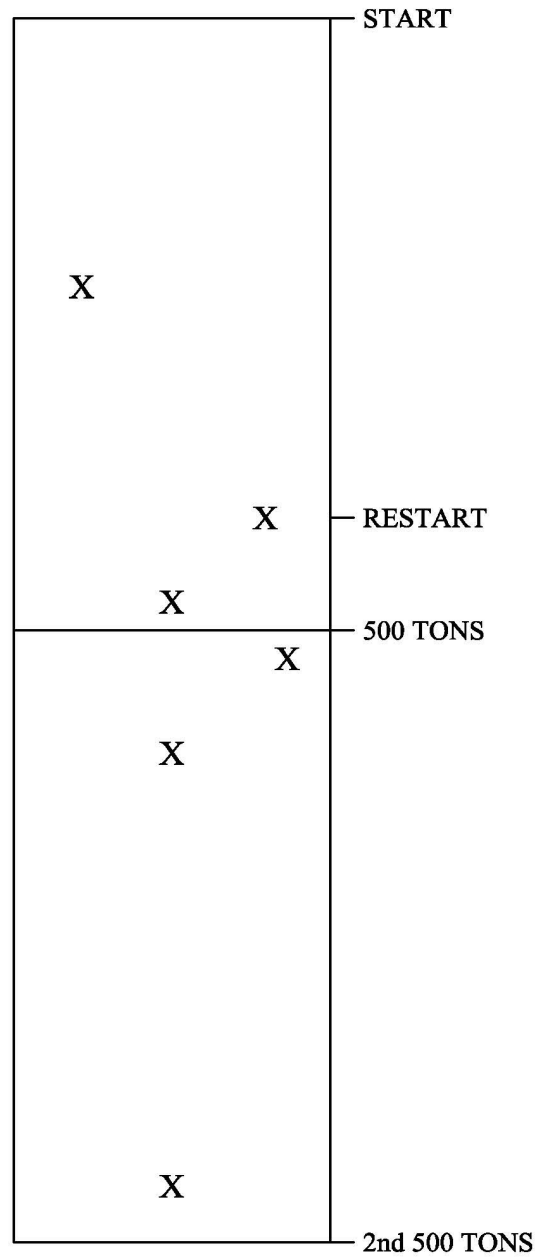

Figure 58-2 Temperature segregation study done incorrectly

Colorado Procedure 59-12

Standard Practice for

Contractor Non-Standard Asphalt Mix Approval

1. SCOPE

- 1.1 This practice describes the procedures for submitting Non-Standard Asphalt Mix (NSM) technologies.

2. REFERENCED DOCUMENTS

- 2.1 *CDOT Procedural Directives:*
PD 1401.1 Product Evaluation and Experimental Features
- 2.2 *Colorado Procedures:*
CP 52 Contractor Asphalt Mix Design Approval Procedures
- 2.3 AASHTO Procedure:
AASHTO R35 (Appendix to) *Special Mixture Design Considerations and Methods for Warm Mix Asphalt (WMA)*

3. APPROVAL OF NSM TECHNOLOGIES

3.1 NSM technologies shall be in conformance with CP 52, CDOT Specifications and other specified Colorado, AASHTO, and ASTM procedures. Significant variances from these specifications will require an Experimental Feature in accordance with PD 1401.1.

3.2 For Warm Mix Asphalt (WMA) mixtures using proposed aggregate blends with total absorption equal to or less than 1.3% mix designs shall be conducted without additives for approval and setting of production targets. For WMA mixtures using proposed aggregate blends with total absorption greater than 1.3% the mix designs shall be conducted in accordance with the Appendix to R35 referenced in Section 2.3 above. Regardless of mix design method, all WMA mixture and binder acceptance testing will be conducted according to existing CDOT HMA procedures, including established mixing and compaction temperatures. Proposed modifications

to production properties and handling processes for WMA mixtures shall be detailed. Binder grade selection shall be in accordance with existing CDOT Superpave criteria. WMA shall not be produced at plant temperatures more than 100°F below existing HMA Superpave mixing temperatures.

3.3 For WMA mixtures with more than 20% RAP, the plant production temperature shall be in excess of the documented grade of the “as recovered” RAP binder.

3.4 NSM approval is required for each NSM Technology and/or each Contractor intending to use an NSM mixture. If the NSM Technology is already approved for use by CDOT each Contractor must receive approval for supply of an NSM mixture based on their submittal.

3.5 Changes in NSM properties or formulations that result in changes to mixture properties will require new NSM submittal and approval.

3.6 Only approved NSM technologies will be allowed on CDOT Projects.

4. NSM SUBMITTAL REQUIREMENTS

4.1 All NSM submittals shall be submitted electronically to CDOT's Asphalt Program Manager. Acceptable formats include pdf, MS Excel, MS Word, PowerPoint, jpg and other compatible formats. Submittal shall be submitted in the order listed below. NSM must conform to the current CDOT HMA acceptance criteria. CDOT will determine if NSM Approval must be acquired for both the NSM Technology and the Contractor intending to supply the NSM.

4.2.1 NSM Technology Supplier - Submittals shall include:

- (1) A summary of the NSM Technology:
 - A. Process controls.
 - B. A detailed list of additive types and quantities.
 - C. Description of additives' influence on NSM.
 - D. Benefits of the NSM.
 - E. Equipment and plant requirements.

- (2) Performance History:
 - A. Product history.
 - B. Other projects, including those within Colorado, which utilized the NSM. Include site conditions, traffic, performance data and lab data on historical projects.
 - C. Research data on the NSM.
 - D. Sample specifications from other projects.
 - E. Approvals from other agencies.

- (3) Design Considerations:
 - A. Lab design practices with NSM technology.
 - B. Conformities and deviations from CDOT design and acceptance criteria. See CP 52 and Specifications for Road and Bridge Construction.

- (4) Production Considerations:
 - A. For WMA mixtures, provide a summary of anticipated differences in volumetric mix properties between the mix design values and the production target values.
 - B. For other NSM Mixtures provide field acceptance properties. Differences from current CDOT HMA requirements may trigger experimental feature process according to PD1401.1.
 - C. Sampling and testing requirements, including temperatures, laboratory handling, and variances from standard CDOT testing procedures. Detailed design, production, and testing requirements for use of the NSM shall be provided.
 - D. Acceptance criteria and justification if different than CDOT SuperPave requirements. Significant deviation from these criteria will require an experimental feature in accordance

with PD 1401.1.

- (5) Contacts:
 - A. NSM product manufacturer's representative name, email, and phone number.
 - B. Name, email, and phone number of NSM product manufacturer representative who will be available during construction.

4.2.2 NSM Contractor Submittals shall include:

- (1) Summary of Contractor's NSM Experience, if any. Contact names shall be included for owners of past projects.
- (2) Design Considerations:
 - A. Lab design practices with NSM technology.
 - B. Conformities and deviations from CDOT design and acceptance criteria. See CP 52 and Specifications for Road and Bridge Construction.

- (3) Production Considerations:
 - A. For WMA mixtures, provide a summary of anticipated differences in volumetric mix properties between the mix design values and the production target values. Mixture volumetric targets may be adjusted as approved by the RME. The contractor shall provide necessary data to support field volumetrics targets that are different from the HMA mix design values. At a minimum, three full volumetric samples will be produced at optimum AC (as determined from mix design without additive) with WMA additive to document impact on field volumetrics.
 - B. For other NSM Mixtures provide field acceptance properties. Differences from current CDOT HMA requirements may trigger experimental feature process according to PD1401.1.
 - C. Sampling and testing requirements, including temperatures, laboratory handling, and proposed variances from standard CDOT testing procedures. Detailed design, production, and testing requirements for use of the NSM shall be provided

- and approved prior to issue of the Form #43. Mixtures shall be tested for acceptance in accordance with established CDOT procedures.
- D. Acceptance criteria and justification if different than CDOT SuperPave requirements. Significant deviation from these criteria will require an experimental feature in accordance with PD 1401.1.
 - E. If the NSM produced on a project fails mixture verification, goes in to condition red, or if the asphalt plant fails to satisfy the NSM production controls outlined in the submittal for NSM approval, NSM production shall cease, written explanation shall be provided for the failures, and production may be required to revert to conventional HMA.

(5) Contacts:

- A. Contractor representative name, email, and phone number.
- B. NSM product manufacturer's representative name, email, and phone number.
- C. Name, email, and phone number of NSM product manufacturer's representative who will be available during construction.
- D. Mix Designer name, email, and phone number.

5. PRELIMINARY CDOT REVIEW PROCESS

5.1 Preliminary review of Contractor's NSM proposal will be performed by the CDOT Asphalt Program, in conjunction with Regional Material Engineers as needed.

5.2 CDOT may request additional information from Contractor.

5.3 Incomplete submittals may be rejected as unacceptable.

5.4 CDOT Asphalt Program will notify the Material Advisory Committee (MAC) of all NSM submittals processed.

5.5 If submittal package is not rejected during preliminary review, and when submittal package is deemed complete by the CDOT Asphalt Program, the NSM submittal will be sent to the MAC for

formal review.

5.6 Preliminary review is estimated to take two weeks, depending upon completeness of initial NSM submittal.

6. CDOT REVIEW PROCESS

6.1 Formal review of NSM submittals will be performed by the MAC. Review may take place at a regularly scheduled MAC meeting (MAC meetings are scheduled once every-other month) or at a separate formal meeting, depending upon schedule.

6.2 The MAC, via the CDOT Asphalt Program, may request additional information from the Contractor.

6.3 Submittal may be rejected by the MAC as unacceptable under NSM procedures.

6.4 The MAC will determine if the NSM falls under the jurisdiction of PD 1401.1. If so, the MAC will approve the NSM with recommendations for the experimental feature process. If the NSM is not under the jurisdiction of PD 1401.1, then the NSM will be approved with recommendation on scope of allowed project use.

6.5 The MAC will recommend whether the NSM is to be paid for under the existing HMA bid items or under a new NSM-specific bid item. For WMA mixtures, existing HMA bid items will be used.

6.6 The MAC will itemize any limitations to the use of the NSM on CDOT projects.

6.7 MAC review is estimated to take six weeks upon receipt of a complete NSM submittal.

7. SCHEDULE

7.1 Notification of NSM approval/rejection from CDOT may take a minimum of 8 weeks. This time frame may be significantly increased if additional information is requested from the Contractor, or if the submittal is delivered during peak construction/production season.

8. RECORD

8.1 All requests for NSM information shall be

made under the Colorado Open Records Act (CORA) and shall follow CDOT Procedural Directives 25.2, 51.2, and 51.3.

The Colorado Department of Transportation is subject to the provisions of the Colorado Open Records Act (C.R.S. 24-72-201, et seq.). Unless specifically excluded by the language of the act, all documents provided to or maintained by CDOT are considered to be a matter of public record.

Contractors submitting an NSM proposal to CDOT must identify the proposal as "Confidential" or "Available for Release". If, at any future date, a CORA request is made for any proposal identified as "Confidential", CDOT will notify the entity or individual making the request that the information is not available.

By identifying a proposal as "Confidential", the Contractor agrees to indemnify and hold harmless the Department and its employees from any legal action resulting from this decision to deny the documents, and to provide any necessary legal defense.

The NSM submittals shall include the following signed and checked statement:

Available for Release

Confidential

With this signature, I _____
(Name) with _____ (Business Name)
agrees to indemnify and hold harmless the Colorado Department of Transportation and its employees from any legal action which may result from its decision to withhold this document in response to requests made under the Colorado Open Records Act, and to provide any legal defense necessary if this decision is appealed.

8.2 All approved NSM technologies will be posted on the CDOT website.

8.3 All approved contractor users of an approved NSM technology will be posted on the CDOT website.

CP 59, NSM Technology Supplier Submittal Checklist

Supplier Name: _____ Date: _____
Contact Name: _____ Contact Phone Number: _____
Contact Email: _____

NSM Name: _____ NSM Type: _____

<u>Subsection</u>	<u>Yes/ No</u>
4.1 All material submitted electronically.....	_____
4.2.1 (1) Summary of the NSM technology	_____
Process controls.....	_____
Detailed list of additive types and quantities.....	_____
Description of additives influence.....	_____
NSM benefits.....	_____
Equipment and plant requirements	_____
MSDS sheets for additives	_____
4.2.1 (2) Performance history.....	_____
Product history	_____
Other projects utilizing NSM (includes site conditions and performance data)	_____
Research data.....	_____
Specifications used on other projects	_____
Approvals from other agencies	_____
4.2.1 (3) Design considerations.....	_____
Lab design practices	_____
Conformities and deviations from CDOT criteria	_____
4.2.1 (4) Production considerations.....	_____
Summary of anticipated differences between mix design values and production targets.....	_____
Field acceptance properties, including differences from CDOT HMA requirements	_____
Sampling and testing requirements.....	_____
Acceptance criteria and justification.....	_____
4.2.1 (5) Contacts.....	_____
Manufacturer representative name, email, and phone number	_____
On-site manufacturer representative name, email, and phone number	_____
8.1 Confidentiality statement.....	_____

CP 59, NSM Contractor Submittal Checklist

Contractor Name: _____ Date: _____
Contact Name: _____ Contact Phone Number: _____
Contact Email: _____

NSM Name: _____ NSM Type: _____

<u>Subsection</u>	<u>Yes/ No</u>
4.1 All material submitted electronically.....	_____
4.2.2 (1) Summary of contractor's experience with this technology.....	_____
4.2.2 (2) Design considerations.....	_____
Lab design practices	_____
Conformities and deviations from CDOT criteria	_____
4.2.2 (3) Production considerations.....	_____
Summary of anticipated differences between mix design values and production targets.....	_____
Field acceptance properties, including differences from CDOT HMA requirements	_____
Sampling and testing requirements, including design and production methods	_____
Acceptance criteria and justification.....	_____
Contingency plan if NSM fails during production.....	_____
4.2.2 (5) Contacts.....	_____
Contractor representative name, email, and phone number.....	_____
NSM manufacturer representative name, email, and phone number	_____
On-site NSM manufacturer representative name, email, and phone number	_____
Mix designer name, email, and phone number	_____
8.1 Confidentiality statement.....	_____

Colorado Procedure 61-10

Standard Practice for

Sampling Freshly Mixed Concrete

(This practice is based upon AASHTO T 141-05. AASHTO T 141-05 or any subsequent revisions may not be used in place of this procedure.)

1. SCOPE

1.1 This practice covers procedures for obtaining representative samples of fresh concrete on which tests are to be performed to determine compliance with specifications.

1.2 The values stated in ft lbs units are to be regarded as the standard.

1.3 This standard does not address all of the safety concerns, if any, associated with its use. It is the responsibility of the user of this standard to establish appropriate safety and health practices and to determine the applicability of regulatory limitations prior to use.

(Warning: Fresh hydraulic cementitious mixtures are caustic and may cause chemical burns to skin and tissue upon prolonged exposure.)

2. SIGNIFICANCE AND USE

2.1 This practice is intended to provide standard requirements and procedures for sampling freshly mixed concrete from different containers used in the transportation or placement of concrete. The detailed requirements as to materials, mixtures, air content, unit weight, temperature, number of specimens, slump, interpretation of results, and precision and bias are in specific test methods.

3. SAMPLING

3.1 The elapsed time shall not exceed 15 minutes between obtaining the first and final portions of the composite sample.

3.2 Transport the individual samples to the place where fresh concrete tests are to be performed and/or where test specimens are to be

molded. They shall be combined and remixed with a shovel, the minimum amount necessary to ensure uniformity and compliance with the maximum time limits specified in Subsection 3.3.

3.3 Start tests for slump, unit weight, temperature, and air content within 5 minutes after obtaining the final portion of the composite sample. Start molding specimens for strength tests within 15 minutes after fabricating the composite sample. Protect the sample from the sun, wind, and other sources of rapid evaporation, and from contamination.

4. PROCEDURE

4.1 *Size of Sample*— Make the samples to be used for strength tests a minimum of 1 cu. ft. Smaller samples are allowed for routine air content, unit weight, temperature, and slump tests. The size of the sample is dictated by the maximum nominal aggregate size.

4.2 The procedures used in sampling shall include the use of precautions that will assist in obtaining samples that are representative of the nature and condition of concrete sampled as follows:

4.2.1 *Sampling for PCCP* — Sample the concrete after it has been placed on grade. Obtain samples from at least five different portions of the pile and then combine into one sample for test purposes. Avoid contamination with subgrade material or prolonged contact with an absorptive subgrade.

4.2.2 *Sampling for concrete placed from a ready mix truck* — Sample the concrete by collecting two or more portions taken at regularly spaced intervals during discharge of the middle portion of the batch. Take the samples within the time limit specified in Section 3 and combine them into one sample for test purposes. Do not obtain samples

until after all of the water has been added to the mixer. No samples shall be taken before 10 % or after 90 % of the batch has been discharged. Due to the difficulty of determining the actual quantity of concrete discharged, the intent is to provide samples that are representative of widely separated portions, but not the beginning and the end of the load. Obtain a sample by repeatedly passing a receptacle through the entire discharge stream or by completely diverting the discharge into the sample container(s). Regulate the rate of discharge of the batch by the rate of revolution of the drum and not by the size of the gate opening.

4.2.3 *Sampling for piers, footings, walls and caissons* – Refer to Subsection 4.2.2.

4.2.4 *Sampling from concrete placed by pumps except for piers, footings, walls and caissons* — Sample the concrete by collecting two or more portions taken at regularly spaced intervals during discharge of the middle portion of the batch from the end of the pump. Take the samples within the time limit specified in Section 3 and combine them into one sample for test purposes. Do not obtain samples until after all of the water has been added to the mixer. No samples shall be taken before 10% or after 90% of the batch has been discharged. Due to the difficulty of determining the actual quantity of concrete discharged, the intent is to provide samples that are representative of widely separated portions, but not the beginning and the end of the load. Obtain a sample by completely diverting the discharge into the sample container(s) at the point of placement.

4.2.5 *Sampling from conveyer placed concrete* – Refer to Subsections 4.2.1 or 4.2.2.

4.2.6 *Sampling from crane & bucket placed concrete* – Refer to Subsections 4.2.1 or 4.2.2.

Colorado Procedure 62-12

Standard Practice for

Contractor Concrete Mix Design Approval Procedure

1. SCOPE

1.1 This practice describes the procedures for concrete mix design approval.

2. PRE-APPROVAL OF CONCRETE MIX DESIGNS

2.1 This process will place a Concrete Supplier's concrete mix on CDOT's Approved Products List (APL). The APL is located at http://www.dot.state.co.us/App_APL/.

2.1.1 Only standard mix designs will be placed on CDOT's APL. Project specific mix designs such as Class D (special) will not be added to CDOT's APL. Concrete mix design approval will follow the procedures listed in Section 5.

2.2 Concrete mix designs shall be performed in conformance with Colorado, AASHTO, and ASTM procedures.

2.3 The Concrete Supplier submits to the CDOT Central Materials Laboratory's Concrete & Physical Properties (CPP) Unit one copy of the concrete mix design, which contains all of the information detailed in Section 5.

2.3.1 All mix designs shall be stamped by a registered Professional Engineer in the State of Colorado pursuant to Section 12-25-117 of the Colorado Revised Statutes. Mix designs shall have an original manual ink signature. Copied or faxed mix designs will not be accepted.

2.3.2 The CPP Unit may verify any or all properties of the concrete mix design or individual component properties prior to mix design approval. The CPP Unit will notify the Concrete Supplier that a mix design will be verified. The Concrete Supplier will sample and submit the components to the CPP Unit.

2.3.3 If requested, all worksheets and other supporting information shall be submitted to the

CPP Unit for their review prior to mix design approval.

2.4 If all tests conform to the specifications, a Concrete Mix Design Report (CDOT Form #1373) will be created and sent to the Concrete Supplier.

2.5 The approved mix design will be placed on CDOT's APL.

2.5.1 A concrete mix placed on the APL is not guaranteed to be approved for use on a particular Project.

3. APPROVAL OF CONCRETE MIX DESIGNS SUBMITTED TO A PROJECT

3.1 This process will be used for Project specific concrete mix designs or concrete mix designs that are not on CDOT's APL.

3.2 Concrete mix designs shall be performed in conformance with Colorado, AASHTO, and ASTM procedures.

3.3 The Contractor submits to the Project Engineer two copies of the concrete mix design, which contains all the information detailed in Section 5, a minimum of three weeks prior to the anticipated concrete placement date. The Project Engineer will submit the Contractor's concrete mix design to the CPP Unit or Region Materials Engineer (RME) for review and approval along with CDOT Form #1188 and a copy of the Project's Index of Special Provisions.

3.3.1 All mix designs shall be stamped by a registered Professional Engineer in the State of Colorado pursuant to Section 12-25-117 of the Colorado Revised Statutes. Mix designs with electronic stamps and signatures will not be accepted. Copied or faxed mix designs will not be accepted.

3.3.2 The CPP Unit or RME may verify any or all properties of the concrete mix design or individual component properties prior to mix design approval.

The CPP Unit or RME will notify the Contactor that a mix design will be verified. The Contractor shall sample and submit the components to the CPP Unit or RME.

3.3.3 If requested, all worksheets and other supporting information shall be submitted to the CPP Unit or RME for their review prior to mix design approval.

3.4 If all tests conform to the specifications, a Concrete Mix Design Report (CDOT Form #1373) will be issued for the project.

3.4.1 A CDOT Form #1373 is only valid for the Project which it was issued to. If a concrete mix design is to be used on multiple Projects, the mix design, CDOT Form #1188 and a copy of the Project's Index of Special Provisions must be submitted for each Project.

3.5 When a standard mix design is approved by the CPP Unit the mix design will be placed on CDOT's Approved Products List and a CDOT Form #1373 will be sent to the Concrete Supplier.

3.6 When approved by the RME, the mix design will be forwarded to the CPP Unit for review.

4. USE OF PRE-APPROVED CONCRETE MIX DESIGNS ON PROJECTS

4.1 This process will be used when a Contractor wants to use a pre-approved concrete mix design listed on CDOT's APL on a Project.

4.2 The Contractor shall submit to the Project Engineer a letter stating his intent to use a pre-approved concrete mix design. The letter shall state at a minimum, the Concrete Supplier, the supplier's mix design number and CDOT's Concrete Mix Design Report (CDOT Form #1373) number a minimum of one week prior to the anticipated concrete placement date.

4.3 The Project Engineer will submit the Contractor's letter to the CPP Unit or RME for review and approval along with CDOT Form #1188 and a copy of the Project's Index of Special Provisions.

4.4 If a pre-approved concrete mix design conforms to the Project's specifications, a Concrete Mix Design Report (CDOT Form #1373) will be issued for the project.

4.4.1 A CDOT Form #1373 is only valid for the Project which it was issued to.

5. CONCRETE MIX DESIGN REQUIREMENTS

5.1 Labs and personnel providing mix designs shall comply with the requirements listed in CP 10.

5.2 A concrete mix design shall contain the following information:

5.2.1 Cover Letter – A cover letter including the following:

- Laboratory name & address
- Concrete supplier's name & address
- Concrete supplier's mix design number
- CDOT concrete class
- Date of trial batch testing
- Source of all mix design components
- Stamped & signed by a Professional Engineer registered in the State of Colorado

5.2.2 Mix Design Sheet – A mix design sheet identifying the following:

- Name of testing laboratory
- Concrete supplier's name & address
- Concrete supplier's mix design number
- Components of the mix design:
 - Aggregates – Source, grading, and pit name
 - Cement – Source, type, and plant
 - Pozzolan – Source, class, and plant
 - Silica Fume – Source and plant
 - Admixtures – Source and type
 - Water – Source.
- Mix design proportions and trial mix data in accordance with Standard Specification Section 601.05
- Stamped & signed by a Professional Engineer registered in the State of Colorado

5.2.3 Appendix – An appendix shall include all supporting data and documentation required in Section 601.05. This shall include, but is not limited to aggregate data and certified test reports. Any test report or supporting documentation that is used in this report from sources not covered by the Engineer of Record shall be stamped & signed by a Professional Engineer registered in the State of Colorado in charge for that work.

5.3 When the source of an admixture changes on a pre-approved mix design, the Concrete Supplier shall submit a letter stamped by the

Concrete Mix Design Engineer approving the changes to the existing mix design to the CPP Unit. The letter shall list all mix designs that will be affected by the change. If the change is approved by the CPP Unit, the affected mix designs on the APL will be changed to reflect the new admixture source.

6. RECORD

6.1 The RME or CPP Unit will issue a CDOT Form #1373 to the Project Engineer. See Chapter 600 of the CDOT Field Materials Manual for an example.

6.2 The Project Engineer will supply the Contractor the CDOT Form #1373 mix design number.

6.3 All requests for mix design information shall be made under the Colorado Open Records Act and shall follow CDOT Procedural Directives 25.2, 51.2, and 51.3.

7. REMOVAL OF A MIX DESIGN FROM THE APL

7.1 The CPP Unit may elect to test any or all components of a mix design on the APL.

7.2 The CPP Unit will request that a Project sample the mix design constituents from the batch plant. The sample will be sent to the CPP Unit for testing.

7.3 When a material does not meet CDOT mix design specifications, the Concrete Supplier will be notified.

7.3.1 The material will be re-sampled by the Project and sent to the CPP Unit for retesting.

7.3.2 Upon a second failure, any mix design using the material will be removed from the APL.

7.3.3 The CPP Unit will send notice to the Region Materials Engineers that a mix design(s) has been removed from the APL and any Projects using the mix design(s) should discontinue its use.

{This page was intentionally left blank.}

Colorado Procedure 65-01

Standard Practice for

Evaluating Low Strength Test Results of Concrete Cylinders

1. SCOPE

1.1 Field test procedures and strength test results for standard molded and cured cylinders shall be evaluated separately for each class of concrete. Such evaluation shall be conducted to determine if tests have been conducted in accordance with the AASHTO standards and/or approved CDOT procedures and specifications. When evaluating a single test consisting of three 28-day standard cured cylinders, if the compressive strength of any one cylinder differs from the average by more than 10%, that cylinder shall be discarded and the average strength determined using the strengths of the remaining two cylinders.

1.1.1 The evaluation process will include investigation to ensure that proper procedures were followed in the following areas:

- Molding
- Curing methods and temperatures
- Initial curing period
- Laboratory curing period
- Testing procedure
- Personnel qualifications

NOTE: Contact the Central Laboratory at (303) 398-6543 at least 48 hours before coring so that additional instruction can be given.

2. EVALUATION

2.1 Should cylinders fall below or be expected to fall below specified strength at any given age, a field investigation will be conducted as follows:

2.1.1 If test procedures outlined in Subsection 1.1 were not followed, results will be considered to be invalid and the tests shall be discarded. If cores are required, they will be at the expense of CDOT.

2.1.2 Supplier will furnish concrete batch weights (masses) of the suspected low strength concrete for comparison against approved mix design.

2.1.3 Delivery invoices will be supplied to verify job site water addition.

2.1.4 Evaluation of the concrete in question will be made based on Subsections 2.1.1, 2.1.2 and 2.1.3.

3. FOLLOW UP

3.1 Should evaluation based on Subsection 2.1.4 disclose reasons for low strength, standard price reduction shall be assessed or concrete removed as necessary and test results shall be considered valid.

3.2 After the investigation outlined in Subsection 1.1 is completed and no warranted reasons are found to have caused the low breaks, the concrete required for in-place investigation shall be tested by taking cores. Coring and testing shall be at the expense of the contractor.

4. CORING

4.1 This procedure describes the method used to obtain and evaluate cores from in-place concrete. This will be performed in accordance with the latest revision of AASHTO T 24 (ASTM C 42), with the exception that immediately after removal from the structure, cores will be cured at a temperature between 60° - 80°F (15° - 27°C) and at a relative humidity below 60% for the first 24 hours.

4.2 Cores taken for the determination of strength shall be of a standard size and within appropriate tolerance. Bits cut approximately 1/4" smaller than nominal OD (outside diameter). The 4 1/4" and 6 1/4" OD bits produce 4" and 6" cores widely used in highway materials testing.
[4" - 3.98 to 4.02 / 6" - 5.98 to 6.02]

5. APPARATUS

5.1 The apparatus shall be as described or referenced in AASHTO T 24 and ASTM C 42.

6. PROCEDURE

6.1 Where required and within 45 days after placement, cores with a diameter at least 3 times the nominal maximum size of the coarse aggregate used in the concrete shall be obtained in accordance with the latest revision of AASHTO T 24 (ASTM C 42). The cores shall be conditioned in accordance with Subsection 4.1. The cores will then be tested for compressive strength between 24 and 48 hours after removal.

6.2 At least 3 representative cores shall be taken from the concrete represented by each out-of-specification cylinder set or from groups of sets as defined by CDOT Standard Specifications 601.01.

6.3 Coring location shall be agreed to by the Engineer and Contractor and will be determined by the following priority schedule.

6.3.1 Identify suspect concrete location by correlating the total in-place concrete represented by the low strength to its relative position in the structure, e.g., bridge deck - Station 101 + 01, 6 feet from west end, 4 feet from west corner, 6 feet above pier cap.

6.3.2 If exact location is not readily apparent, identify approximate location and perform a rebound hammer evaluation in accordance with the latest revision of ASTM C 805, as follows:

6.3.2.1 Heavily textured, soft surfaces, surfaces with loose mortar, or masonry coatings shall be ground smooth with abrasive stone prior to testing.

6.3.2.2 Concrete being tested should have approximately the same moisture condition and surface finish. Direction of impact shall be the same.

6.3.2.3 Combination of Subsection 6.3.1 and Subsection 6.3.2.

6.4 Concrete in the area represented by a core test will be considered adequate if the average strength of the cores is equal to the specified strength. If the compressive strength, f'_c , of any one core differs from the average by more than 10% that core will be discarded and the

average will be determined using the compressive strengths of the remaining two cores.

6.5 Core holes shall be filled with low slump concrete or mortar.

6.6 Pay factor for strength shall be according to Table 601-3 of the CDOT Standard Specifications, and will be used to price reduce the cores or standard test cylinders, whichever are higher in strength.

Example 1:

Given: $f'_c = 3000$ psi
Concrete test cylinders averaged 2800 psi.

	<u>PSI</u>
Core 1	2900
Core 2	2850
Core 3	2450

Average compressive strength of 3 cores = 2730 psi.

Find: Is the concrete in the structure adequate under CDOT specifications?

Solution:

Test Evaluation:

$$f'_c = 3000 \text{ psi}$$

Average compressive strength of 3 cores - 2730 psi

Do any compressive strengths differ from the average by more than 10%?

10% of Average compressive strength = 273 psi

Core 1: $2900 - 2730 = 170$ psi, < 273 therefore OK

Core 2: $2850 - 2730 = 120$ psi, < 273 therefore OK

Core 3: $2730 - 2450 = 280$ psi, > 273 therefore - discard core and re-compute average compressive strength using two remaining cores.

New average compressive strength = 2875 psi

Use Table 601-3 to compute appropriate price reduction based on 2875 psi, since core strengths were higher than the cylinders strengths.

Example 2:
Price Reduction of Concrete

In this example calculation, a certain project has a pay item for 720 cubic yards of Concrete Class D (bridge). The contractor bid \$700 per cubic yards. To cover this quantity 8 sets of cylinders were molded and tested for compressive strength at 28 days. Some of the test results showed the concrete had less than the required 28-day compressive strength of 4500 psi. The project engineer has used all eight sets of cylinders to calculate the appropriate price reduction.

Test Number	Cylinder Strength psi	Cylinder Strength psi	Cylinder Strength psi	Average Cylinder Strength Psi
1	4510	4270	4580	4450
2	6200	6100	6250	6180
3	3800	4310	3840	3980
4	4210	4380	4060	4220
5	4040	3830	3790	3890
6	4130	4020	3930	4030
7	4710	4670	4790	4720
8	4960	5160	5200	5110

TABLE 65-1

The average strength of three 28-day cylinders is used to determine the acceptability of concrete placed in a structure. The break results of test numbers 1, 3, 4, 5 & 6 are below the required 28-day strength of 4500 psi for bridge decks. According to Section 601.17(c) of the *CDOT Standard Specification for Road and Bridge Construction* "The concrete will be considered acceptable when the running average of three consecutive strength tests is equal to or greater than the specified strength and no single test falls below the specified strength by more than 3.5 MPa (500 psi)."

Test Number	Average Cylinder Strength psi	Average of Three Consecutive Tests (psi)	Strength Below f_c' psi
1	4450	---	---
2	6180	---	---
3	3980	4870	520
4	4220	4793	280
5	3890	4030	610
6	4030	4047	470
7	4720	4213	---
8	5110	4620	---

TABLE 65-2

The table above shows that the running average of three consecutive tests fall below the required strength of 4500 psi, and the concrete placed will be price reduced according to the pay factors in Table 601-3 in Subsection 601.17. Test numbers 3, 4, 5, & 6 are represented in the low consecutive averages and will be price reduced. Test number 1 is considered acceptable and will not be price reduced because its running average with the next two tests is greater than the required strength, and it is not more than 500 psi below the

required strength.

To price reduce the low strength results you need to know the bid price for the concrete, and the quantity represented by each test. As stated above, the concrete was bid at \$700.00 per cubic yard. The contractor placed 720 cubic yards of Concrete Class D (bridge). The 720 cubic yards are represented by 8 sets of cylinders. Therefore, on this project the Engineer determined that each test represents 90 cubic yards. This is only an example and the quantity represented per test shall be determined by the Project Engineer. The formula for price reduction is:

$$PR = P \times (1 - PF) \times CY$$

Where:

- PR = Price Reduction,
- P = Bid Price of Concrete,
- PF = Pay Factor from Table 601-3 of Subsection 601.17,
- CY = Cubic Yards represented by the test.

Test Number	Average Strength Psi	Average of Three Consecutive Tests (psi)	Strength Below f'_c psi	Pay Factor Table 601-2E	Price Reduction
1	4450	---	---	---	---
2	6180	---	---	---	---
3	3980	4870	520	0.65	\$22,050.00
4	4220	4793	280	0.92	\$ 5,040.00
5	3890	4030	610	0.54	\$28,980.00
6	4030	4047	470	0.75	\$15,750.00
7	4720	4213	---	---	---
8	5110	4620	---	---	---
Total Price Reduction					\$71,820.00

TABLE 65-3

The Contractor has the option to obtain cores from the areas represented by tests 3, 4, 5 & 6 before the concrete is 45 days old. Coring will be in accordance to CP 65. In this case the contractor elected to obtain cores from the bridge deck. The following is a summary of the core break results:

Test Area	Core Strength psi	Core Strength psi	Core Strength psi	Average Core Strength psi
3	4230	4010	4100	4110
4	4630	4570	4510	4570
5	3690	3740	3700	3710
6	4270	4510	4400	4390

TABLE 65-4

The core strength results will replace the cylinder strength results if the core strengths are higher. In this case, cores from areas 3, 4 & 6 will replace the cylinder strength results for tests 3, 4 & 6. The following table shows the new price reductions:

Test Number	Average Cylinder Strength psi	Average Core Strength psi	Strength Below f_c' psi	Pay Factor Table 601-2E	Price Reduction
1	4450	---	---	---	---
2	6180	---	---	---	---
3	3980	4110	390	0.84	\$ 10,080.00
4	4220	4570	---	---	---
5	3890	3710	610	0.54	\$28,980.00
6	4030	4390	110	0.96	\$ 2,520.00
7	4720	---	---	---	---
8	5110	---	---	---	---
Total Adjusted Price Reduction					\$41,580.00

TABLE 65-5

{This page was intentionally left blank.}

Colorado Procedure 66-06

Standard Method of Test for

Measuring Texture Depth of Portland Cement Concrete Using a Tire Tread Depth Gauge

1. SCOPE

1.1 This method describes the procedure for measuring texture depth of fresh or hardened portland cement concrete by use of a tire tread depth gauge.

1.2 The values stated in SI units are to be regarded as the standard.

2. REFERENCED DOCUMENTS

2.1 AASHTO T 261-78 (1999): Discontinued.

3. APPARATUS

3.1 *Tire Tread Depth Gauge* – A tire tread depth gauge with 1-mm (1/32-in.) graduations. The gauge end may be modified to a shape suitable for the measurement.

3.2 Wire or stiff bristle brush, carborundum stone.

3.3 Steel straightedge approximately 6 by 25 by 300 mm (1/4 by 1 by 12 in.).

4. SELECTION OF TEST LOCATIONS

4.1 One test shall be identified by CDOT at a stratified random location transversely and longitudinally every 528 linear feet (160 m) or fraction thereof as specified in the testing schedule.

5. PROCEDURE

5.1 Document the nature and purpose of the measurement (inspection of new construction, condition survey, safety review, etc.); include the date of measurement, test location, the position within the lane (wheel path or outside wheel path), whether the concrete is fresh (plastic), hardened

without traffic, or approximate time that the pavement has been opened to traffic. Note whether the texture was construction by grinding or tining.

5.2 One test shall comprise of 10 consecutive texture depth groove readings. The reading location of each groove shall be in a line perpendicular to the grooves, starting at the point randomly located in accordance with Subsection 4.1.

5.3 The texture depth shall be measured from the original concrete surface. Any projections above the original surface shall be removed by brushing with a wire brush or carborundum stone as necessary to remove ridges adjacent to grooving, or with the steel straightedge prior to taking a measurement on hardened concrete. If measurements are made on fresh concrete, the depth gauge guide shall be pressed down to the level of the original concrete surface.

5.4 With the depth gauge guides in contact with the original concrete surface, the plunger is depressed until contact is made with the bottom of the groove in the concrete. The gauge is then removed without disturbing the plunger. The texture depth is read to the nearest 1-mm (1/32-in.) on the calibrated plunger. The plunger is then zeroed and the procedure is repeated until all measurements are completed.

6. CALCULATIONS

6.1 Calculate the average groove depth for each 528 linear feet (160 m) or fraction thereof to the nearest 1-mm (1/32-in.).

7. REPORT

7.1 The report shall indicate the 528 linear feet (160 m) identification and the average groove depth to the nearest 1-mm (1/32 in.).

{This page was intentionally left blank.}

Colorado Procedure 67-08

Standard Method of Test for

Determining Adhesion of Joint Sealant to Concrete Pavement

1. SCOPE

1.1 This procedure is designed to test the adhesion of the joint filler to the concrete pavement in sawed joints or routed cracks where backer rod is used.

2. TERMINOLOGY

2.1 *Adhesion* - The molecular attraction exerted between the surfaces of two different materials in contact (e.g. joint sealant and concrete surface).

2.2 *Cohesion* - The molecular attraction exerted between adjacent molecules of a single material (e.g. the joint sealant's ability to stay together by its own properties).

METHOD A: NON-SELF-LEVELING SEALANT

3. APPARATUS

3.1 Pulling hook conforming to Figure 67-1. The hook shall be made of a metal rod smaller than the joint width with a ninety (90) degree bend. The tip of the hook portion shall be flattened as shown in Figure 67-1, and the width shall be 1/16 inch (2 mm) less than the width of the sawed joint.

NOTE 1: M Standards show both 3/16" (4.8 mm) and 1/4" (6.4 mm) joint widths depending on location.

3.2 A spring scale capable of attachment to the pulling hook with a minimum capacity of 25 pounds (11.4 kg).

4. TEST CONDITIONS

4.1 Joint sealer shall have been in place for a minimum of ten (10) days prior to performing the pull test.

4.2 Weather conditions: Ambient temperature shall be at a minimum 70°F (21°C).

5. PROCEDURE

5.1 Embed hook into joint sealant as shown in Figure 67-2.

5.2 The tip of the pulling hook shall be embedded under the joint sealant a distance of 1½ inches (38 mm), to bend.

5.3 Attach spring scale to the handle of the pulling hook and pull vertically (steady pull, no jerking motion). The rate of pulling from the initial 0 pounds to twenty (20) pounds (90 N) is to be applied over 3 to 5 seconds.

5.4 When spring scale reaches 20 pounds (90 N), then hold for a minimum of one second.

5.5 If material fails in cohesion (tears) before reaching the 20 pound (90 N) force, without loss of adhesion to the sidewall, the application is acceptable. (NOTE: This is often the case with silicone joint sealers.)

5.6 If joint sealer pulls away from the sidewall prior to the 20 pound (90 N) applied force, the joint sealing application is considered failing.

6. FREQUENCY

6.1 If a failing joint is discovered, the tester shall isolate the failing area by testing all adjacent joints locations until passing joints are located.

6.2 Joints failing the pull test (CP 67 Method A) shall be removed, cleaned, and replaced at no additional cost to the project. Any joint that fails the pull test (CP 67 Method A) shall be removed the full width of the pavement or longitudinally between transverse joints.

FIGURE 67-1

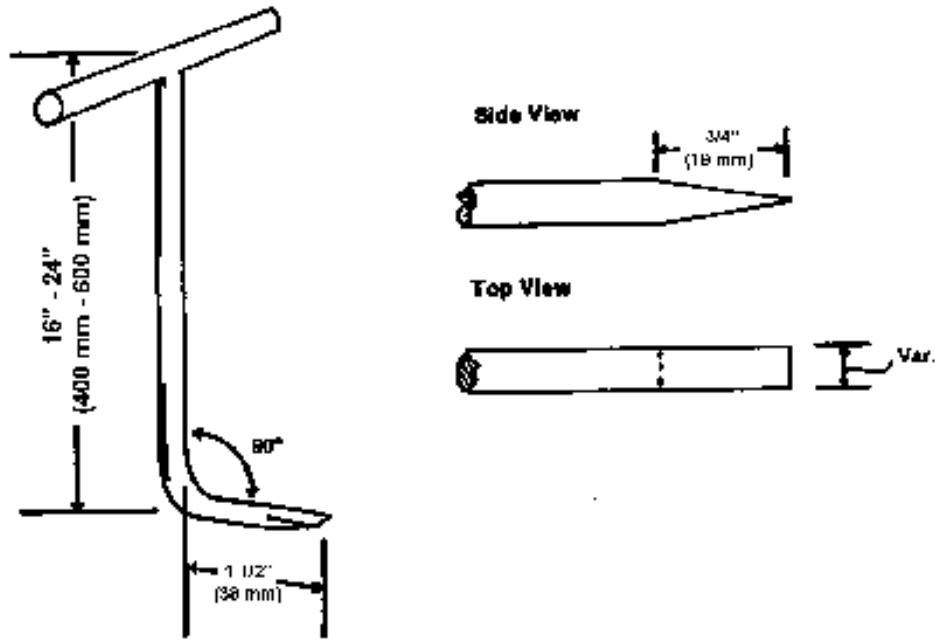
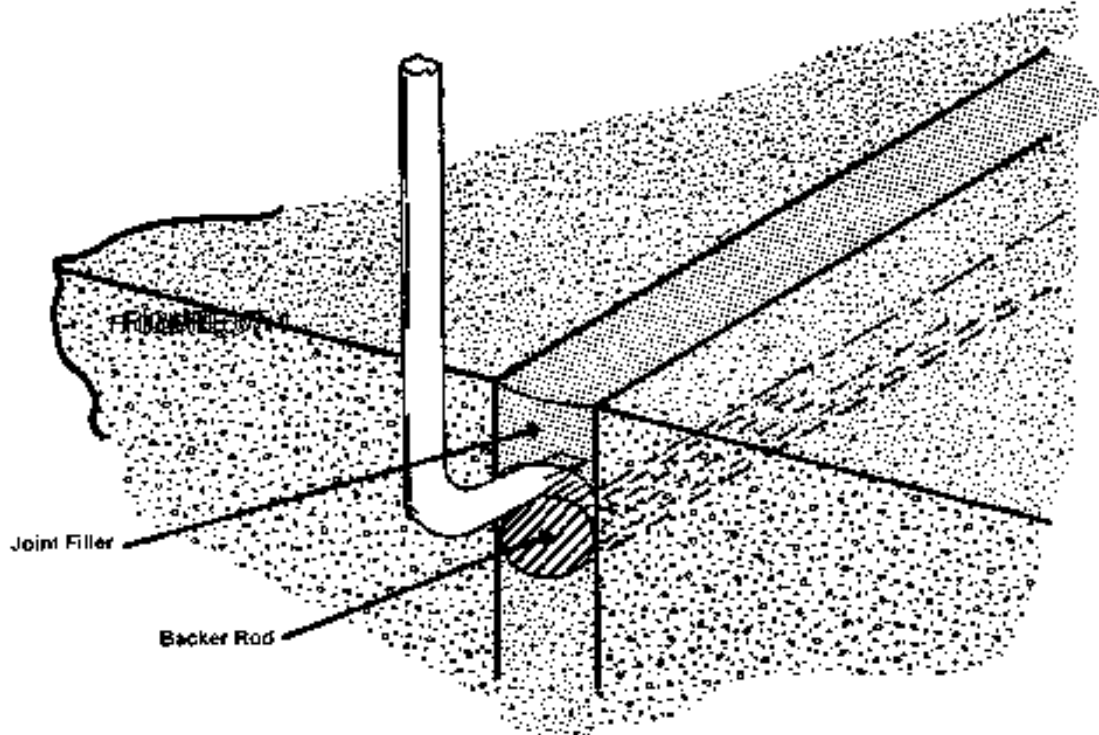

FIGURE 67-2



METHOD B: SELF-LEVELING SEALANT

7. APPARATUS

7.1 A sharp knife with a minimum 2" smooth blade such as a folding pocket knife. (Many knives are available, an example: Gerber Gator 3-1/8" blade, blade thickness .100")

NOTE 2: M Standards show both 3/16" (4.8 mm) and 1/4"(6.4 mm) joint widths depending on location.

8. TEST CONDITIONS

8.1 Joint sealant shall be fully cured (this is usually within 14 to 21 days of placement).

8.2 Weather conditions: The test shall be conducted at any ambient temperature.

9. PROCEDURE

9.1 Make a knife cut horizontally from one side of the joint to the other. (See Figure 67-3)

9.2 Make two vertical cuts approximately 2 inches long, at the sides of the joint, meeting the horizontal cut at the top of the two-inch cuts. (See Figure 67-3)

9.3 Make a 1" mark on the sealant tab (in the middle of the 2" piece cut in Subsection 9.2).

9.4 Grasp the two-inch piece of sealant (above the 1" mark) firmly between the fingers and pull at a 90E angle. (See Figure 67-5) Hold a ruler alongside the extending sealant. (See Figure 67-4) Try to pull the uncut sealant out of the joints.

9.5 If the 1" mark can be pulled 3 inches prior to tearing, the test is successful.

9.6 If adhesion is proper, the sealant should tear cohesively in itself before releasing adhesively from the substrate.

10. FREQUENCY

10.1 If a failing joint is discovered, the tester shall isolate the failing area by testing all adjacent joint locations until passing joints are located.

10.2 Joints failing the pull test (CP 67 Method B) shall be removed, cleaned, and replaced at no additional cost to the project. Any joint that fails the hand pull test (CP 67 Method B) shall be removed the full width of the pavement or longitudinally between transverse joints.

11. TROUBLESHOOTING

11.1 Adhesion may be adversely affected by:

- (1) Moisture in or on the substance during sealant application and cure.
- (2) Contaminated or weak surfaces.
- (3) Poor application technique.

12. REPAIR OF TEST AREA

12.1 Sealant may be replaced in the test area in the same manner it was originally installed (assuming good adhesion was obtained). Care should be taken to assure that the new sealant is in contact with the original, and that the original sealant surfaces are clean, so that a good bond between the new and old sealant will be obtained.

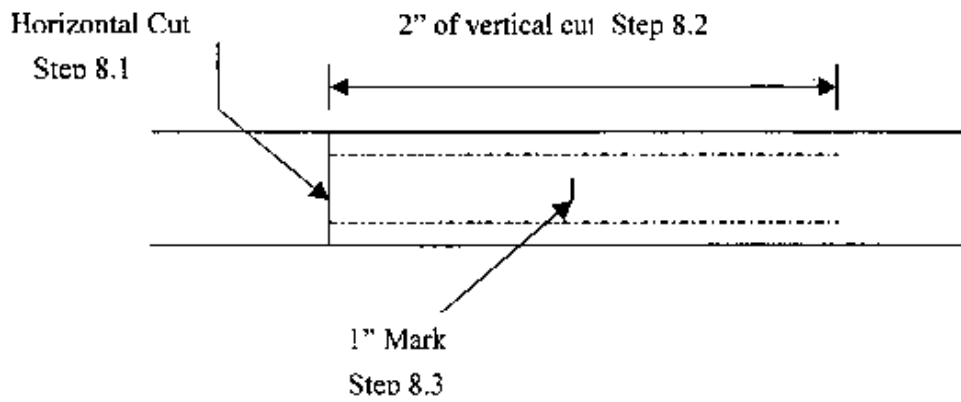

Joint (Plane View)

FIGURE 67-3 Joint Test preparation

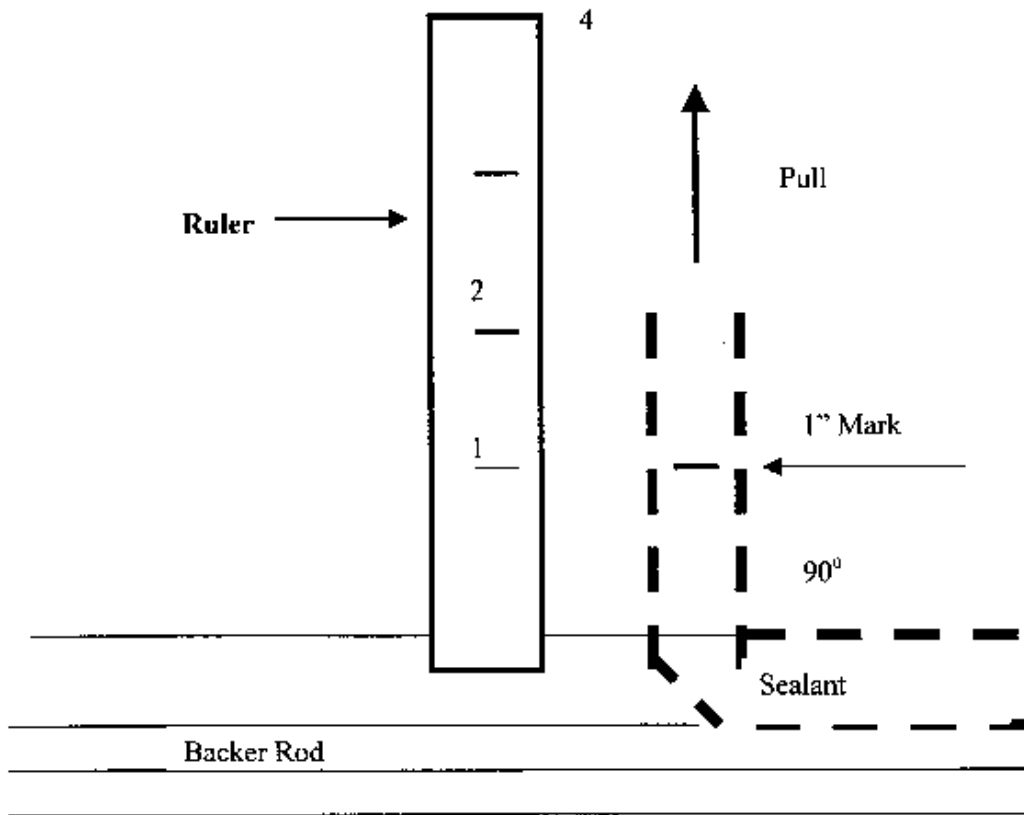

FIGURE 67-4 Pull Initiation

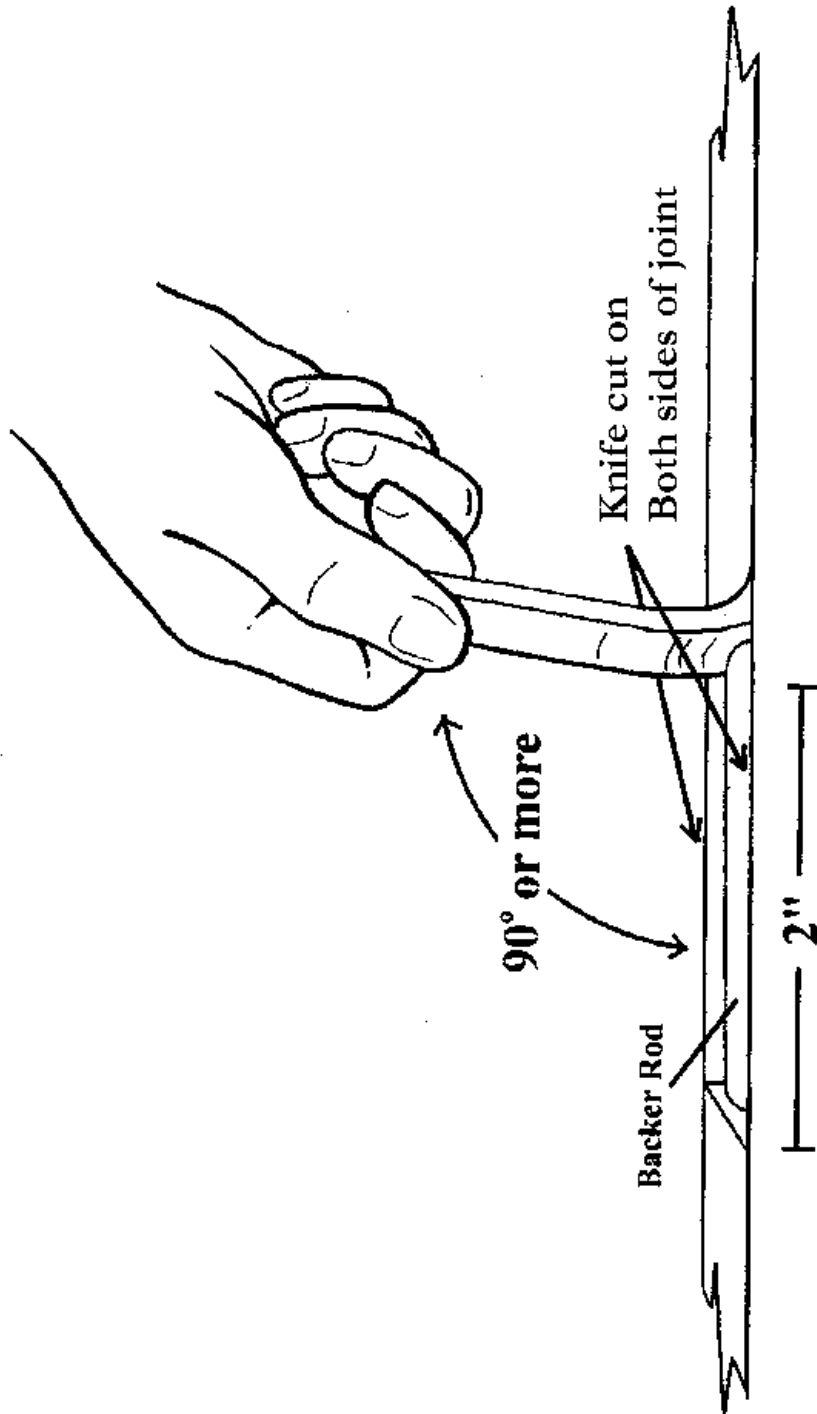

FIGURE 67-5

{This page was intentionally left blank.}

Colorado Procedure 68-01

Standard Practice for

Determining Portland Cement Concrete Pavement Thickness

1. SCOPE

1.1 This method describes the procedure for determining portland cement concrete pavement thickness, and when deficient, the average deficiency from specified thickness. The purpose is to document acceptable thickness and to establish the adjusted unit price for deficient thickness. Measuring the length of drilled concrete cores shall conform to AASHTO T 148 and core diameter shall conform to AASHTO T 24.

2. SAMPLING

2.1 Take thickness measurements of freshly finished plastic concrete pavement at a minimum frequency of one per 1250 linear feet (380 m) in each traffic lane. Where deviations in thickness from specified thickness are indicated, determine the average deficiency in thickness as outlined in Subsections 2.2 through 2.6 below.

2.2 Units to be measured will be considered to be 1250 linear feet (380 m) of pavement in each traffic lane. When the shoulder is 8 feet (2.5 m) or greater in width, it will be treated as a traffic lane.

2.3 Take one core at a random location in each unit where the measurement in the plastic concrete indicated deficiency in thickness. Measure the thickness of the core. When core thickness is deficient from the specified thickness by more than 0.2 in. (5 mm) but less than 1.0 in. (25 mm), take two additional cores at intervals not less than 300 ft (92 m). Determine the average thickness of the three cores. This thickness shall be used as the basis for any price reduction.

2.4 Group other areas such as intersections, entrances, cross-overs, ramps, etc. into 1000 sq. yd. (825 m²) units. Determine the thickness of each unit separately. Take one core at a random location in each 1000 sq. yd. (825 m²) unit, or fraction thereof, and measure its thickness. When such measurement is deficient from the specified thickness by more than 0.2 in. (5 mm), but less than 1.0 in. (25 mm), take two additional cores at

random locations within the unit, and determine the average thickness of the three cores. This thickness shall be used as the basis for any price reduction.

2.5 In calculating the average thickness of the pavement, measurements exceeding the specified thickness by more than 0.2 in. (5 mm) shall be considered as the specified thickness plus 0.2 in. (5 mm), and measurements showing deficiencies of more than 1.0 in. (25 mm) shall not be included in the average.

2.6 When the measurement of any core taken under Subsection 2.3 or 2.4 is more than 1.0 in. (25 mm) deficient in thickness, determine the actual thickness of the pavement in this area by taking exploratory cores. Take cores at not less than ten-foot (3 m) intervals parallel to the centerline in each direction from the affected location until a core is found, in each direction, which is not deficient by more than 1.0 in. (25 mm). Determine the extent of the deficient pavement for consideration of removal. Do not use exploratory cores in averages for adjusted unit price.

3. REPORTING

3.1 Tabulate and report all thickness measurements on CDOT Form #157.

3.2 Measurements from Subsections 2.2 through 2.6 shall be recorded and submitted with the monthly cost estimate when used to substantiate a price reduction.

{This page was intentionally left blank.}

Colorado Procedure 69-12

Standard Method for

Estimating the In-Place Concrete Strength by a Maturity Method

(This procedure modifies ASTM C 1074-04. The current ASTM C 1074 is to be used in conjunction with this procedure.)

1. SCOPE

1.1 This provides a procedure for estimating in-place concrete strength by means of the maturity method. The maturity index is expressed either in terms of the temperature-time factor or in terms of the equivalent age at a specified temperature.

1.2 This procedure is identical to ASTM C 1074 Estimating Concrete Strength by the Maturity Method, with the following exceptions:

8. PROCEDURE

Delete Subsection 8.4 from ASTM C 1074 and replace with the following Subsections and add 8.8:

8.4 Test the cylinders in pairs at times that yield compressive strengths in which at least three sets are at or below 2500 psi (17 MPa) and at least one set is above 2500 psi (17 MPa). Perform compression tests in accordance with Test Method C 39. If the range of the compressive strength of the two cylinders exceeds 10% of their average strength, test another cylinder and compute the average of three tests. If a test result is due to an obviously defective specimen, discard the test result.

8.4.1 When a strength other than 2500 psi is specified for opening a structure, at least three sets of cylinders shall be tested below the specified strength, and a least one set of cylinders shall be tested above the specified strength.

8.8 Testing to determine datum temperature or activation energy will not be required.

{This page was intentionally left blank.}

Colorado Procedure 70-12

Standard Practice for

Evaluation of Pavement Profiles, 0.1 inch (2.5 mm)

CP 70 was deleted after the 2011 Field Materials Manual. It is not to be effective after June 30, 2011.

{This page was intentionally left blank.}

Colorado Procedure 71-01

Standard Practice for

Determining Quality Level (Percent Within Tolerance Limits)

1. SCOPE

1.1 Use this procedure with Quality Assurance type specifications where Pay Factors or acceptance decisions are based on Quality Level (QL), defined as percent within specification (tolerance) limits. QL is a measure of quality of a lot or process.

1.2 QL represents the percentage of the population (lot or process) that falls above a single lower limit, below a single upper limit, or between the upper and lower limits of double-limit specifications.

1.3 For this procedure to be meaningful, select all samples by random or stratified random procedures. Perform all testing and measuring strictly in accordance with standard acceptable practices. When used for contractual purposes, perform all sampling and testing in accordance with the applicable specifications.

1.4 Manual, computer assisted, and mathematical procedures are described. Where contractual pay factors are based on QL, use only the computer assisted procedure.

2. SUMMARY OF METHOD

2.1 The method involves calculating statistical parameters from three or more representative measurements, test results, or values for each specified element in a lot or sample. The arithmetic average (mean) value of the sample is calculated. As a measure of variability, the sample Standard Deviation is calculated. Using these results, the distance from the sample mean to each limit is divided by the standard deviation, which yields the Quality Index.

2.2 The incomplete beta function ratio, using sample sizes and quality indices as

variables, is used in the computer version to calculate areas under the beta distribution. With variables typical for QL determinations, the beta distribution (Figure 71-1) is similar to the normal distribution (Figure 71-2).

2.3 The total area under the beta distribution outside the specification limits is the fraction defective, which is then multiplied by 100 to yield the percent defective; this subtracted from 100 gives the percent within limits.

2.4 Table 71-1 contains values for percent within limits as related to sample sizes and quality indices. The table was developed from mathematical calculations and is used in the manual method to estimate QL.

3. MANUAL PROCEDURE

3.1 Determine the arithmetic mean and standard deviation for the several test results from the lot for each element being evaluated. Compute these as shown in Equations 3.1 and 3.2.

$$\bar{X} = \frac{\sum X}{n} \quad \text{Equation 3.1}$$

$$s = \sqrt{\frac{\sum (X - \bar{X})^2}{n - 1}} \quad \text{Equation 3.2}$$

Where:

\bar{X} = Sample mean,
 \sum = Summation of,
 X = Individual test value to X_n ,
 n = Total number of test values,
 s = Sample standard deviation.

3.2 Compute the upper quality index (Q_u) per Equation 3.3.

$$Q_u = \frac{T_u - \bar{X}}{s} \quad \text{Equation 3.3}$$

Where:

Q_u = Upper quality index,
 T_u = Upper specification limits.

3.2.1 Determine P_u (percent within the upper specification limit which corresponds to a given Q_u) from Table 71-1. If desired, P_u may be interpolated to the nearest 0.1. Where T_u is not specified, P_u will be 100.

3.3 Compute the lower quality index (Q_L) per Equation 3.4.

$$Q_L = \frac{\bar{X} - T_L}{s} \quad \text{Equation 3.4}$$

Where:

Q_L = Lower quality index,
 T_L = Lower specification limits.

3.3.1 Determine P_L (percent within the lower specification limit which corresponds to a given Q_L) from Table 71-1. If desired, P_L may be interpolated to the nearest 0.1. Where T_L is not specified, P_L will be 100.

3.4 Compute QL (the total percent within specification limits) per Equation 3.5.

$$QL = (P_u + P_L) - 100 \quad \text{Equation 3.5}$$

3.5 The manual method for determining QL essentially conforms to the applicable portions of AASHTO Standard Recommended Practice R 9,

Acceptance Sampling Plans for Highway Construction.

3.6 A sample calculation is provided at the end of this procedure demonstrating the calculation of Quality Level and Pay Factors using this manual procedure.

4. COMPUTER ASSISTED PROCEDURE

4.1 The calculations for determining Quality Level may be performed by using the latest versions of the Departments quality level programs.

4.2 In the quality level programs, the areas under the beta distribution are calculated from the incomplete beta function ratio by assigning the variables used in Equations 3.1 through 3.4. The procedure is as described in *Numerical Recipes in C₁, Chapter 6*. A detailed discussion of the theories involved is provided by Willenbrock and Kopac in *TRR 691, Process Control in the Construction Industry₂*.

4.3 All numbers from the calculations are carried to significant figures and round according to AASHTO Standard Recommended Practice R 11, using the Rounding Method.

4.4 Where contractual pay factors are based on QL use the computer-assisted procedure only.

MATHEMATICAL PROCEDURE - Adapted from *Resolution of beta-distribution equations for quality level analysis...*₃

5.1 In order to evaluate the necessary quality parameters, the integral must be evaluated.

$$I_n = \frac{1}{B(\frac{n}{2} - 1, \frac{n}{2} - 1)} \int_0^g t^{\frac{n}{2} - 2} (1 - t)^{\frac{n}{2} - 2} dt \quad \text{Equation 5.1}$$

In Equation 5.1 $B(n/2-1, n/2-1)$ is generally referred to as the complete beta-function (or just the beta-function) with parameters $n/2-1, n/2-1$, and the integral is the incomplete beta-function. Together they form the beta distribution from a random variable. The beta function is defined by:

$$B(\frac{n}{2} - 1, \frac{n}{2} - 1) = \int_0^1 t^{\frac{n}{2} - 2} (1 - t)^{\frac{n}{2} - 2} dt, \quad \text{Equation 5.2}$$

and the upper limit in Equation 5.1 is given by:

$$g = \frac{1}{2} - \frac{Q\sqrt{n}}{2(n - 1)} \quad \text{Equation 5.3}$$

where Q is the quality index defined in Equations 3.3 and 3.4 and n is the sample size.

5.2 For small sample sizes no numerical integration is necessary as the integral may be economically evaluated in close form. In particular we have:

$$I_3 = \frac{1}{2} + \frac{1}{p} \sin^{-1} (2g - 1) \quad \text{Equation 5.4}$$

$$I_4 = g \quad \text{Equation 5.5}$$

$$I_5 = \frac{1}{2} + \frac{1}{p} \sin^{-1} (2g - 1) + \frac{2}{p} \sqrt{g - g^2} (2g - 1) \quad \text{Equation 5.6}$$

$$I_6 = 3g^2 - 2g^3 \quad \text{Equation 5.7}$$

$$I_7 = \frac{1}{2} + \frac{1}{p} \sin^{-1} (2g - 1) - \frac{2}{3p} \sqrt{g - g^2} (2g - 1)(8g^2 - 8g - 3) \quad \text{Equation 5.8}$$

$$I_8 = 10g^3 - 15g^4 + 6g^5 \quad \text{Equation 5.9}$$

These expressions are small enough to be used with some hand calculators. As the value of n increases the calculations become more complex. With the availability of personal computers, we include the equation for information and recommend the use of personal computers.

TABLE 71-1

Upper Quality Index Q_U or Lower Quality Index Q_L																						
P_U or P_L %	$n=3$		$n=4$		$n=5$		$n=6$		$n=7$		$n=8$		$n=9$		$n=10$ to $n=11$	$n=12$ to $n=14$	$n=15$ to $n=18$	$n=19$ to $n=25$	$n=26$ to $n=37$	$n=38$ to $n=69$	$n=70$ to $n=200$	$n=201$ to $n=x$
	100	1.16	1.50	1.79	2.03	2.23	2.39	2.53	2.65	2.83	3.03	3.20	3.38	3.54	3.70	3.83						
99		1.47	1.67	1.80	1.89	1.95	2.00	2.04	2.09	2.14	2.18	2.22	2.26	2.29	2.31							
98	1.15	1.44	1.60	1.70	1.76	1.81	1.84	1.86	1.91	1.93	1.96	1.99	2.01	2.03	2.05							
97		1.41	1.54	1.62	1.67	1.70	1.72	1.74	1.77	1.79	1.81	1.83	1.85	1.86	1.87							
96	1.14	1.38	1.49	1.55	1.59	1.61	1.63	1.65	1.67	1.68	1.70	1.71	1.73	1.74	1.75							
95		1.35	1.44	1.49	1.52	1.54	1.55	1.56	1.58	1.59	1.61	1.62	1.63	1.63	1.64							
94	1.13	1.32	1.39	1.43	1.46	1.47	1.48	1.49	1.50	1.51	1.52	1.53	1.54	1.55	1.55							
93		1.29	1.35	1.38	1.40	1.41	1.42	1.43	1.44	1.44	1.45	1.46	1.46	1.47	1.47							
92	1.12	1.26	1.31	1.33	1.35	1.36	1.36	1.36	1.37	1.37	1.39	1.39	1.40	1.40	1.40							
91	1.11	1.23	1.27	1.29	1.30	1.30	1.31	1.31	1.32	1.32	1.33	1.33	1.33	1.34	1.34							
90	1.10	1.20	1.23	1.24	1.25	1.25	1.26	1.26	1.26	1.27	1.27	1.27	1.28	1.28	1.28							
89	1.09	1.17	1.19	1.20	1.20	1.21	1.21	1.21	1.21	1.22	1.22	1.22	1.22	1.22	1.23							
88	1.07	1.14	1.15	1.16	1.16	1.16	1.17	1.17	1.17	1.17	1.17	1.17	1.17	1.17	1.17							
87	1.06	1.11	1.12	1.12	1.12	1.12	1.12	1.12	1.12	1.12	1.12	1.12	1.12	1.13	1.13							
86	1.04	1.08	1.08	1.08	1.08	1.08	1.08	1.08	1.08	1.08	1.08	1.08	1.08	1.08	1.08							
85	1.03	1.05	1.05	1.04	1.04	1.04	1.04	1.04	1.04	1.04	1.04	1.04	1.04	1.04	1.04							
84	1.01	1.02	1.01	1.01	1.00	1.00	1.00	1.00	1.00	1.00	1.00	1.00	0.99	0.99	0.99							
83	1.00	0.99	0.98	0.97	0.96	0.96	0.96	0.96	0.96	0.96	0.96	0.96	0.95	0.95	0.95							
82	0.97	0.96	0.95	0.94	0.93	0.93	0.93	0.92	0.92	0.92	0.92	0.92	0.92	0.92	0.92							
81	0.96	0.93	0.91	0.90	0.90	0.89	0.89	0.89	0.89	0.88	0.88	0.88	0.88	0.88	0.88							
80	0.93	0.90	0.88	0.87	0.86	0.86	0.86	0.85	0.85	0.85	0.85	0.84	0.84	0.84	0.84							
79	0.91	0.87	0.85	0.84	0.83	0.82	0.82	0.82	0.82	0.81	0.81	0.81	0.81	0.81	0.81							
78	0.89	0.84	0.82	0.80	0.80	0.79	0.79	0.79	0.78	0.78	0.78	0.78	0.77	0.77	0.77							
77	0.87	0.81	0.78	0.77	0.76	0.76	0.76	0.75	0.75	0.75	0.75	0.74	0.74	0.74	0.74							
76	0.84	0.78	0.75	0.74	0.73	0.73	0.72	0.72	0.72	0.71	0.71	0.71	0.71	0.71	0.71							
75	0.82	0.75	0.72	0.71	0.70	0.70	0.69	0.69	0.69	0.68	0.68	0.68	0.68	0.68	0.67							
74	0.79	0.72	0.69	0.68	0.67	0.66	0.66	0.66	0.66	0.65	0.65	0.65	0.65	0.64	0.64							
73	0.76	0.69	0.66	0.65	0.64	0.63	0.63	0.63	0.62	0.62	0.62	0.62	0.62	0.61	0.61							
72	0.74	0.66	0.63	0.62	0.61	0.60	0.60	0.60	0.59	0.59	0.59	0.59	0.59	0.58	0.58							
71	0.71	0.63	0.60	0.59	0.58	0.57	0.57	0.57	0.57	0.56	0.56	0.56	0.56	0.55	0.55							
70	0.68	0.60	0.57	0.56	0.55	0.55	0.54	0.54	0.54	0.53	0.53	0.53	0.53	0.53	0.52							
69	0.65	0.57	0.54	0.53	0.52	0.52	0.51	0.51	0.51	0.50	0.50	0.50	0.50	0.50	0.50							
68	0.62	0.54	0.51	0.50	0.49	0.49	0.48	0.48	0.48	0.48	0.47	0.47	0.47	0.47	0.47							
67	0.59	0.51	0.47	0.47	0.46	0.46	0.46	0.45	0.45	0.45	0.45	0.44	0.44	0.44	0.44							
66	0.56	0.48	0.45	0.44	0.44	0.43	0.43	0.43	0.42	0.42	0.42	0.42	0.41	0.41	0.41							
65	0.52	0.45	0.43	0.41	0.41	0.40	0.40	0.40	0.40	0.39	0.39	0.39	0.39	0.39	0.39							
64	0.49	0.42	0.40	0.39	0.38	0.38	0.37	0.37	0.37	0.36	0.36	0.36	0.36	0.36	0.36							
63	0.46	0.39	0.37	0.36	0.35	0.35	0.35	0.34	0.34	0.34	0.34	0.34	0.33	0.33	0.33							
62	0.43	0.36	0.34	0.33	0.32	0.32	0.32	0.32	0.31	0.31	0.31	0.31	0.31	0.31	0.31							
61	0.39	0.33	0.31	0.30	0.30	0.29	0.29	0.29	0.29	0.29	0.28	0.28	0.28	0.28	0.28							
60	0.36	0.30	0.28	0.27	0.27	0.27	0.26	0.26	0.26	0.26	0.26	0.26	0.26	0.25	0.25							
59	0.32	0.27	0.25	0.25	0.24	0.24	0.24	0.24	0.23	0.23	0.23	0.23	0.23	0.23	0.23							
58	0.29	0.24	0.23	0.22	0.21	0.21	0.21	0.21	0.21	0.21	0.20	0.20	0.20	0.20	0.20							
57	0.25	0.21	0.20	0.19	0.19	0.19	0.18	0.18	0.18	0.18	0.18	0.18	0.18	0.18	0.18							
56	0.22	0.18	0.16	0.16	0.16	0.16	0.16	0.16	0.16	0.15	0.15	0.15	0.15	0.15	0.15							
55	0.18	0.15	0.14	0.13	0.13	0.13	0.13	0.13	0.13	0.13	0.13	0.13	0.13	0.13	0.13							
54	0.14	0.12	0.11	0.11	0.11	0.10	0.10	0.10	0.10	0.10	0.10	0.10	0.10	0.10	0.10							
53	0.11	0.09	0.08	0.08	0.08	0.08	0.08	0.08	0.08	0.08	0.08	0.08	0.08	0.08	0.08							
52	0.07	0.06	0.06	0.05	0.05	0.05	0.05	0.05	0.05	0.05	0.05	0.05	0.05	0.05	0.05							
51	0.04	0.03	0.03	0.03	0.03	0.03	0.03	0.03	0.03	0.03	0.03	0.03	0.03	0.03	0.02							
50	0.00	0.00	0.00	0.00	0.00	0.00	0.00	0.00	0.00	0.00	0.00	0.00	0.00	0.00	0.00							

NOTE: When Q_U or Q_L falls between table values, estimate P_U or P_L to the closest 0.10.

TABLE 71-1

Upper Quality Index Q_U or Lower Quality Index Q_L																
P_U or P_L %								n=10 to n=11	n=12 to n=14	n=15 to n=18	n=19 to n=25	n=26 to n=37	n=38 to n=69	n=70 to n=200	n=201 to n=x	
	n=3	n=4	n=5	n=6	n=7	n=8	n=9									
50	0.00	0.00	0.00	0.00	0.00	0.00	0.00	0.00	0.00	0.00	0.00	0.00	0.00	0.00	0.00	0.00
49	-0.04	-0.03	-0.03	-0.03	-0.03	-0.03	-0.03	-0.03	-0.03	-0.03	-0.03	-0.03	-0.03	-0.03	-0.03	-0.02
48	-0.07	-0.06	-0.06	-0.05	-0.05	-0.05	-0.05	-0.05	-0.05	-0.05	-0.05	-0.05	-0.05	-0.05	-0.05	-0.05
47	-0.11	-0.09	-0.08	-0.08	-0.08	-0.08	-0.08	-0.08	-0.08	-0.08	-0.08	-0.08	-0.08	-0.08	-0.08	-0.08
46	-0.14	-0.12	-0.11	-0.11	-0.11	-0.10	-0.10	-0.10	-0.10	-0.10	-0.10	-0.10	-0.10	-0.10	-0.10	-0.10
45	-0.18	-0.15	-0.14	-0.13	-0.13	-0.13	-0.13	-0.13	-0.13	-0.13	-0.13	-0.13	-0.13	-0.13	-0.13	-0.13
44	-0.22	-0.18	-0.16	-0.16	-0.16	-0.16	-0.16	-0.16	-0.16	-0.15	-0.15	-0.15	-0.15	-0.15	-0.15	-0.15
43	-0.25	-0.21	-0.20	-0.19	-0.19	-0.19	-0.18	-0.18	-0.18	-0.18	-0.18	-0.18	-0.18	-0.18	-0.18	-0.18
42	-0.29	-0.24	-0.23	-0.22	-0.21	-0.21	-0.21	-0.21	-0.21	-0.21	-0.21	-0.20	-0.20	-0.20	-0.20	-0.20
41	-0.32	-0.27	-0.25	-0.25	-0.24	-0.24	-0.24	-0.24	-0.23	-0.23	-0.23	-0.23	-0.23	-0.23	-0.23	-0.23
40	-0.36	-0.30	-0.28	-0.27	-0.27	-0.27	-0.26	-0.26	-0.26	-0.26	-0.26	-0.26	-0.26	-0.26	-0.25	-0.25
39	-0.39	-0.33	-0.31	-0.30	-0.30	-0.29	-0.29	-0.29	-0.29	-0.29	-0.28	-0.28	-0.28	-0.28	-0.28	-0.28
38	-0.43	-0.36	-0.34	-0.33	-0.32	-0.32	-0.32	-0.32	-0.31	-0.31	-0.31	-0.31	-0.31	-0.31	-0.31	-0.31
37	-0.46	-0.39	-0.37	-0.36	-0.35	-0.35	-0.35	-0.34	-0.34	-0.34	-0.34	-0.34	-0.34	-0.33	-0.33	-0.33
36	-0.49	-0.42	-0.40	-0.39	-0.38	-0.38	-0.37	-0.37	-0.37	-0.36	-0.36	-0.36	-0.36	-0.36	-0.36	-0.36
35	-0.52	-0.45	-0.43	-0.41	-0.41	-0.40	-0.40	-0.40	-0.40	-0.39	-0.39	-0.39	-0.39	-0.39	-0.39	-0.39
34	-0.56	-0.48	-0.45	-0.44	-0.44	-0.43	-0.43	-0.43	-0.42	-0.42	-0.42	-0.42	-0.41	-0.41	-0.41	-0.41
33	-0.59	-0.51	-0.47	-0.47	-0.46	-0.46	-0.46	-0.45	-0.45	-0.45	-0.45	-0.44	-0.44	-0.44	-0.44	-0.44
32	-0.62	-0.54	-0.51	-0.50	-0.49	-0.49	-0.48	-0.48	-0.48	-0.48	-0.47	-0.47	-0.47	-0.47	-0.47	-0.47
31	-0.65	-0.57	-0.54	-0.53	-0.52	-0.52	-0.51	-0.51	-0.51	-0.50	-0.50	-0.50	-0.50	-0.50	-0.50	-0.50
30	-0.68	-0.60	-0.57	-0.56	-0.55	-0.55	-0.54	-0.54	-0.54	-0.53	-0.53	-0.53	-0.53	-0.53	-0.53	-0.52
29	-0.71	-0.63	-0.60	-0.59	-0.58	-0.57	-0.57	-0.57	-0.57	-0.56	-0.56	-0.56	-0.56	-0.55	-0.55	-0.55
28	-0.74	-0.66	-0.63	-0.62	-0.61	-0.60	-0.60	-0.60	-0.59	-0.59	-0.59	-0.59	-0.59	-0.58	-0.58	-0.58
27	-0.76	-0.69	-0.66	-0.65	-0.64	-0.63	-0.63	-0.63	-0.62	-0.62	-0.62	-0.62	-0.62	-0.61	-0.61	-0.61
26	-0.79	-0.72	-0.69	-0.68	-0.67	-0.66	-0.66	-0.66	-0.66	-0.65	-0.65	-0.65	-0.65	-0.64	-0.64	-0.64
25	-0.82	-0.75	-0.72	-0.71	-0.70	-0.70	-0.69	-0.69	-0.69	-0.68	-0.68	-0.68	-0.68	-0.68	-0.68	-0.67
24	-0.84	-0.78	-0.75	-0.74	-0.73	-0.73	-0.72	-0.72	-0.72	-0.71	-0.71	-0.71	-0.71	-0.71	-0.71	-0.71
23	-0.87	-0.81	-0.78	-0.77	-0.76	-0.76	-0.76	-0.75	-0.75	-0.75	-0.75	-0.74	-0.74	-0.74	-0.74	-0.74
22	-0.89	-0.84	-0.82	-0.80	-0.80	-0.79	-0.79	-0.79	-0.78	-0.78	-0.78	-0.78	-0.77	-0.77	-0.77	-0.77
21	-0.91	-0.87	-0.85	-0.84	-0.83	-0.82	-0.82	-0.82	-0.82	-0.81	-0.81	-0.81	-0.81	-0.81	-0.81	-0.81
20	-0.93	-0.90	-0.88	-0.87	-0.86	-0.86	-0.86	-0.85	-0.85	-0.85	-0.85	-0.84	-0.84	-0.84	-0.84	-0.84
19	-0.96	-0.93	-0.91	-0.90	-0.90	-0.89	-0.89	-0.89	-0.89	-0.88	-0.88	-0.88	-0.88	-0.88	-0.88	-0.88
18	-0.97	-0.96	-0.95	-0.94	-0.93	-0.93	-0.93	-0.92	-0.92	-0.92	-0.92	-0.92	-0.92	-0.92	-0.92	-0.92
17	-1.00	-0.99	-0.98	-0.97	-0.96	-0.96	-0.96	-0.96	-0.96	-0.96	-0.96	-0.96	-0.96	-0.95	-0.95	-0.95
16	-1.01	-1.02	-1.01	-1.01	-1.00	-1.00	-1.00	-1.00	-1.00	-1.00	-1.00	-1.00	-1.00	-0.99	-0.99	-0.99
15	-1.03	-1.05	-1.05	-1.04	-1.04	-1.04	-1.04	-1.04	-1.04	-1.04	-1.04	-1.04	-1.04	-1.04	-1.04	-1.04
14	-1.04	-1.08	-1.08	-1.08	-1.08	-1.08	-1.08	-1.08	-1.08	-1.08	-1.08	-1.08	-1.08	-1.08	-1.08	-1.08
13	-1.06	-1.11	-1.12	-1.12	-1.12	-1.12	-1.12	-1.12	-1.12	-1.12	-1.12	-1.12	-1.12	-1.12	-1.13	-1.13
12	-1.07	-1.14	-1.15	-1.16	-1.16	-1.16	-1.17	-1.17	-1.17	-1.17	-1.17	-1.17	-1.17	-1.17	-1.17	-1.17
11	-1.09	-1.17	-1.19	-1.20	-1.20	-1.21	-1.21	-1.21	-1.21	-1.22	-1.22	-1.22	-1.22	-1.22	-1.22	-1.23
10	-1.10	-1.20	-1.23	-1.24	-1.25	-1.25	-1.26	-1.26	-1.26	-1.27	-1.27	-1.27	-1.27	-1.28	-1.28	-1.28
9	-1.11	-1.23	-1.27	-1.29	-1.30	-1.30	-1.31	-1.31	-1.32	-1.32	-1.33	-1.33	-1.33	-1.34	-1.34	-1.34
8	-1.12	-1.26	-1.31	-1.33	-1.35	-1.36	-1.36	-1.36	-1.37	-1.37	-1.39	-1.39	-1.40	-1.40	-1.40	-1.40
7	-1.12	-1.29	-1.35	-1.38	-1.40	-1.41	-1.42	-1.43	-1.44	-1.44	-1.45	-1.46	-1.46	-1.47	-1.47	-1.47
6	-1.13	-1.32	-1.39	-1.43	-1.46	-1.47	-1.48	-1.49	-1.50	-1.51	-1.52	-1.53	-1.54	-1.55	-1.55	-1.55
5	-1.14	-1.35	-1.44	-1.49	-1.52	-1.54	-1.55	-1.56	-1.58	-1.59	-1.61	-1.62	-1.63	-1.63	-1.64	-1.64
4	-1.14	-1.38	-1.49	-1.55	-1.59	-1.61	-1.63	-1.65	-1.67	-1.68	-1.70	-1.71	-1.73	-1.74	-1.75	-1.75
3	-1.15	-1.41	-1.54	-1.62	-1.67	-1.70	-1.72	-1.74	-1.77	-1.79	-1.81	-1.83	-1.85	-1.86	-1.87	-1.87
2	-1.15	-1.44	-1.60	-1.70	-1.76	-1.81	-1.84	-1.86	-1.91	-1.93	-1.96	-1.99	-2.01	-2.03	-2.05	-2.05
1	-1.15	-1.47	-1.67	-1.80	-1.89	-1.95	-2.00	-2.04	-2.09	-2.14	-2.18	-2.22	-2.26	-2.29	-2.31	-2.31
0	-1.16	-1.50	-1.79	-2.03	-2.23	-2.39	-2.53	-2.65	-2.83	-3.03	-3.20	-3.38	-3.54	-3.70	-3.83	-3.83

NOTE: When Q_U or Q_L falls between table values, estimate P_U or P_L to the closest 0.10.

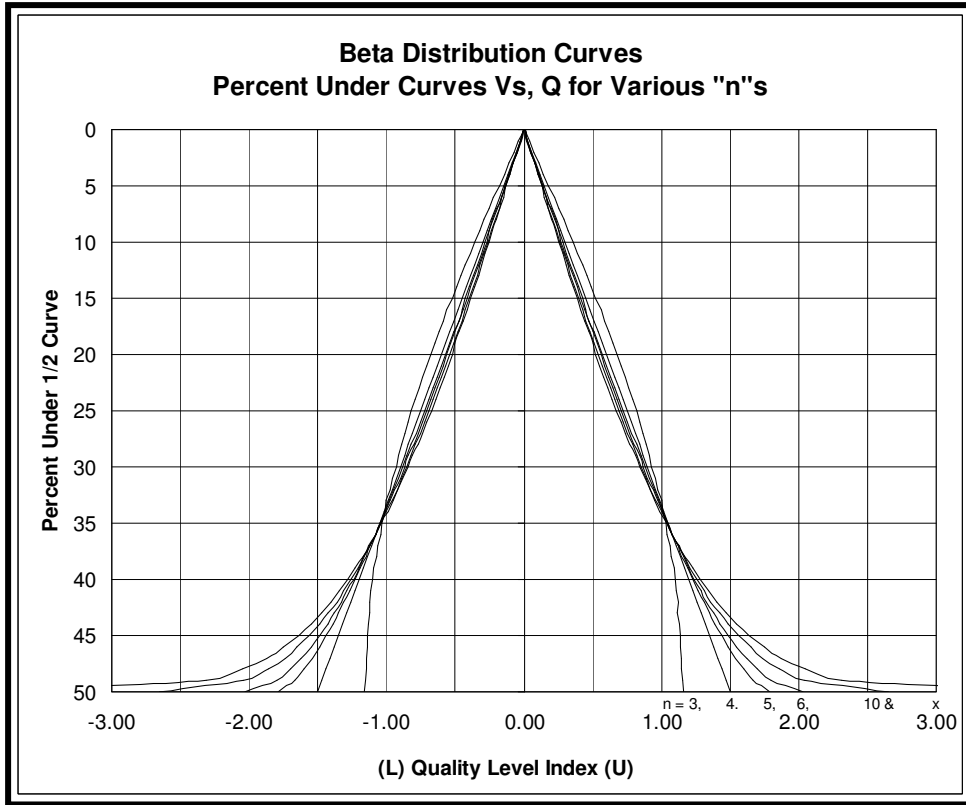

Figure 71-1

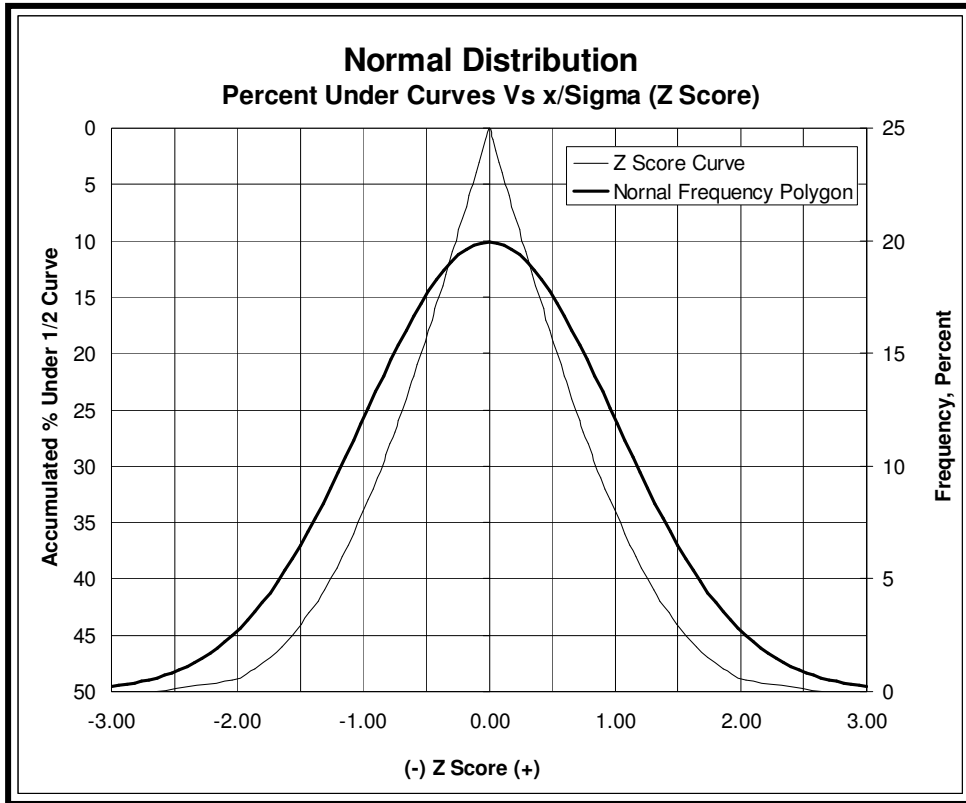

Figure 71-2

Footnotes:

1. Numerical Recipes in C, the Art of Scientific Computing; by W. H. Press, B.P. Flannery, S. A. Teukolsky and W.T. Vetterling. Cambridge University Press, The Pitt Bldg, Trumpington Street, CB2 1RP, 40 West 20th St., New York, NY 10011. Copyright 1988.
2. Development of a Highway Acceptance Plan, by Jack H. Willenbrock, Pennsylvania State University and Peter A. Kopac, Federal Highway Administration. TRR 691, Process Control in the Construction Industry, National Academy of Sciences, Washington, D.C. 1978.
3. Resolution of Beta-Distribution Formulas for Quality Level Analysis, a report to the Colorado Department of Transportation from the Colorado Workshop on Mathematical Problems in Industry, prepared by F. Jay Bourland, Department of Mathematics, Colorado State University and Alistair Fitt, Department of Mathematics, University of Southampton.

Determining Quality Level and Pay Factor

Sample Calculation for Close Approximation - Manual Procedure

To Solve for Quality Level:

This example will demonstrate the manual calculation of the Quality Level for asphalt density testing. With a nuclear gauge, the following test results were obtained: 92.5, 93.4, 94.8, 95.2, and 96.4. Using density specification of 92 to 96 percent compaction.

Use Equations 3.1 and 3.2, to solve for the arithmetic mean and the standard deviation.

Arithmetic mean: 94.46
Standard Deviation: 1.532

With those known, use Equations 3.3 and 3.4 to solve for the upper quality index (Q_U) and the lower quality index (Q_L).

$$Q_U = \frac{96 - 94.46}{1.532} = 1.005 \qquad Q_L = \frac{94.46 - 92}{1.532} = 1.606$$

These values are then used to find percent within the upper specification limit (P_U) and the percent within the lower specification limit (P_L).

To find P_U , enter Table 71-1 at the column $n = 5$. Read down to find that 1.005 falls between 1.01 and 0.98. Therefore, an interpolation must be done to find where P_U falls between 83 and 84.

$$\frac{X - 83}{1.005 - 0.98} = \frac{84 - 83}{1.01 - 0.98}$$

Solve for X

$$X = 83.83$$

Therefore, $P_U = 83.83$

To find P_L , enter Table 71-1 at the column $n = 5$. Read down to find that 1.606 falls between 1.67 and 1.60. Therefore, an interpolation must be done to find where P_L falls between 98 and 99.

$$\frac{X - 98}{1.606 - 1.60} = \frac{99 - 98}{1.67 - 1.60}$$

Solve for X

$$X = 98.09$$

Therefore, $P_L = 98.09$

P_U and P_L are plugged into Equation 3.5 to find the Quality Level (Q_L).

$$Q_L = (83.83 + 98.09) - 100 = 81.92$$

$$Q_L = 81.9$$

To Solve for Pay Factor:

Equations used to calculate Pay Factor are in the Revision of Sections 105 and 106, for both Quality of Hot Mix Asphalt (HMA) and Voids Acceptance of Hot Mix Asphalt, of the Standard Specifications.

When P_n is from 3 to 9 or greater than 200

$$P_n = 5 \qquad Q_L = 81.9$$

Go to Table 105-3

Go to formula for $P_n = 5$

$$0.25529 + 1.48268(Q_L/100) - 0.67759(Q_L/100)^2$$

$$0.25529 + 1.48268(81.9/100) - 0.67759(81.9/100)^2 = 1.015$$

Maximum PF for $P_n = 5$ is 1.030

Choose the smallest PF

$$PF = 1.015$$

When P_n is equal to or greater than 10 and less than 201

Example using Formula 1 when the number of tests equals 13:

$$P_n = 13 \qquad Q_L = 81.9$$

Formula (1)

$$PF = \frac{(PF_1 + PF_2)}{2} + \left[\frac{(PF_2 + PF_3)}{2} - \frac{(PF_1 + PF_2)}{2} \right] \times \frac{(P_{n_2} - P_{n_x})}{(P_{n_2} - P_{n_3})}$$

Use Table 105-3 to solve for PF_1 , PF_2 and PF_3 of Formula 1. Use Table 105-3 to find P_{n_2} , P_{n_3} and P_{n_x} of Formula 1.

$PF_1 =$ Formula for $P_n = 10$ to 11

$$0.15344 + 1.50104(81.9/100) - 0.58896(81.9/100)^2 = 0.988$$

Maximum PF for $P_n = 10$ to 11 is 1.045

Choose smallest PF

$$PF_1 = 0.988$$

PF₂ = Formula for Pn = 12 to 14

$$0.07278 + 1.64285(81.9/100) - 0.65033(81.9/100)^2 = 0.982$$

Maximum PF for Pn = 12 to 14 is 1.045

Choose smallest PF

$$PF_2 = 0.982$$

PF₃ = Formula for Pn = 15 to 18

$$0.07826 + 1.55649(81.9/100) - 0.56616(81.9/100)^2 = 0.973$$

Maximum PF for Pn = 15 to 18 is 1.050

Choose smallest PF

$$PF_3 = 0.973$$

Pn₂ = Lowest Pn in 12 to 14

$$Pn_2 = 12$$

Pn₃ = Lowest Pn in 15 to 18

$$Pn_3 = 15$$

Pn_x = 13

$$PF = \frac{(0.988 + 0.982)}{2} + \left[\frac{(0.982 + 0.973)}{2} - \frac{(0.988 + 0.982)}{2} \right] \times \frac{(12 - 13)}{(12 - 15)} = 0.9825$$

Maximum PF for Pn = 12 to 14 is 1.045

Choose smallest PF

$$PF = 0.9825$$

To Solve for Element Average Pay Factor:

At times, for instance when material is greater than 2V out, a separate process is started. This example will show how to determine an Average Pay Factor for an element that is represented by 3 different processes. Let's say the following Pay Factors were calculated:

PF₁ = 1.011 for 10,000 tons
PF₂ = 0.694 for 500 tons
PF₃ = 1.022 for 10,500 tons

$$\text{PFA} = \frac{[10,000(1.011) + 500(0.694) + 10,500(1.022)]}{10,000 + 500 + 10,500}$$

$$\text{PFA} = 1.009$$

To Solve for Composite Pay Factor:

When each of the Element Pay Factors of an item has been calculated, the Composite Pay Factor is then found using the W Factor of the Standard Specials. The Composite Pay Factor is the total pay factor for an item, such as HMA. For example, the weights for the item HMA are:

Gradation	20 %
Asphalt Content	30 %
Asphalt Density	50 %

Let's say each element was calculated to have the following Average Pay Factors:

Gradation	1.014
Asphalt Content	1.026
Asphalt Density	1.009

$$\text{PFC} = \frac{[.20(1.014) + .30(1.026) + .50(1.009)]}{.20 + .30 + .50}$$

$$\text{PFC} = 1.015$$

This Composite Pay Factor is then applied to calculate the incentive or disincentive. For example, if 21,000 tons of HMA were put down at a cost of \$30/ton:

$$(1.015 - 1)(21,000)(30) = \$9,450$$

The total incentive for this job would be \$9,450.

When Paying Binder Separately

Binder can be paid for separately from the rest of the HMA. To calculate an incentive or a disincentive, the total cost of the binder and HMA must be found. An example follows that uses the following values:

403	HMA (GR SX) (76)	\$55/Ton
411	Asphalt Cement (PG 58-40)	\$150/Ton

1000 tons mix	5.35% asphalt
1000 tons mix	5.30% asphalt
1000 tons mix	5.35% asphalt
1000 tons mix	5.32% asphalt
720 tons mix	5.00% asphalt

$$\frac{(1000)(5.35) + (1000)(5.30) + (1000)(5.35) + (1000)(5.32) + (720)(5.00)}{1000 + 1000 + 1000 + 1000 + 720} = 5.28\%$$

5.28% asphalt for 4720 tons of mix

Solve for total cost of AC:

$$(4720 \text{ tons mix})(.0528 \text{ percent asphalt}) = 249.22 \text{ tons AC}$$

$$(249.22 \text{ tons AC})(\$150/\text{ton}) = \$37,383.00$$

Now solve for the Price/Ton for the combination of HMA and binder.

$$\text{Unit Price HMA (\$/ton)} + \frac{\text{Total Cost of AC (\$)}}{\text{Total tons HMA}}$$

$$\$55/\text{ton} + \frac{\$37,383}{4,720 \text{ tons HMA}} = \$62.92/\text{ton}$$

\$62.92 is the cost per ton for the **entire** mix, both HMA and AC. This value is used to calculate the incentive or disincentive.

Colorado Procedure 72-12

Standard Practice for

**Evaluating Pavement Profiles for Profilograph Index using the
HSP (0.10 inch Blanking Band)**

CP 72 was deleted after the 2011 Field Materials Manual. It is not to be effective after June 30, 2011.

{This page was intentionally left blank.}

Colorado Procedure 73-12

Standard Practice for

Certification of California Style Profilographs

CP 73 was deleted after the 2011 Field Materials Manual. It is not to be effective after June 30, 2011.

{This page was intentionally left blank.}

Colorado Procedure 74-12

Standard Practice for

Operating Inertial Profilers and Evaluating Pavement Profiles

(This procedure modifies AASHTO R 7-10. The current AASHTO R 7 is to be used in conjunction with this procedure.)

1. SCOPE

1.1 This test method describes the procedures for operating and verifying the calibration of a profiler. This method also describes the evaluation procedures for the profiles that are generated to determine pay adjustments.

1.2 This test method is identical to AASHTO R 7 with the following exceptions.

2. REFERENCED DOCUMENTS

Add the following to Section 2:

2.3 *Colorado Procedures:*

CP 78 Certification of High Speed Profilers.

2.4 *Other Referenced Documents:*

FHWA's ProVAL Help File. ProVAL can be downloaded at <http://www.roadprofile.com>. ProVAL will be used for determining localized roughness.

5. EQUIPMENT

Delete Subsections 5.1, 5.3.1.1 and 5.3.1.1.1 and replace each with the following:

5.1 The inertial profiler shall meet the equipment requirements of CP 78. The inertial profiler shall be currently certified in accordance with CP 78.

5.3.1.1. Distance Calibration

5.3.1.1.1. The distance calibration shall be 1056 feet long and shall be on a relatively flat, straight section of pavement.

5.4 The operator of the profiling equipment shall have a Current LABCAT Level S (Smoothness) certification.

6. TEST PROCEDURE

Delete Steps 4 & 6 of Table 1 and replace with the following:

Step 4. Collect measurements in the direction of traffic. Three repeat runs will be collected for each lane. A lane shall only be tested three times. A lane may be retested only if the triggering system fails. The Contractor shall use automated triggering for the start and stop locations, and for the areas to be excluded. The locations of the triggers shall be painted on the pavement so that the Departments profiler can use the same trigger locations when the Contractor's profile data is verified.

Step 6. Immediately after data collection is complete, provide the Project Engineer with a CD or thumb drive with the data that was collected. Data shall be submitted in the manufacturer's native file format and a format readable by ProVAL. The CD or thumb drive will not be returned.

Add the following to Section 6:

6.3. A log sheet shall be submitted with the electronic data to the Project. The log sheet shall contain the following for each run:

- Project Number
- Project Code (sub-account number)
- Profiler Certification Identification Number
- Profiler Operator's name
- Highway number
- Lane number (Lanes are numbered from the left to the right in the direction of travel)
- Direction of travel

- File name
- Run Number (1st, 2nd or 3rd)
- Location of exclusions (In miles from the beginning of the test)

8. DATA ANALYSIS

8.1 The Department will analyze the data with the profiler manufacturer's software or the latest version of ProVAL.

Colorado Procedure 75-08

Standard Practice for

Stratified Random Sampling of Materials

1. SCOPE

1.1 This practice covers the random selection of materials to be sampled and tested.

1.2 This Standard may involve hazardous materials, operations, and equipment. This Standard does not purport to address all of the safety problems associated with its use. It is the responsibility of the user of this Standard to establish appropriate safety and health practices prior to use.

2. REFERENCED DOCUMENTS

2.1 *ASTM Standard:*
D 3665 Standard Practice for
Random Sampling of Construction
Materials.

3. SIGNIFICANCE AND USE

3.1 The sampling and testing procedures to be followed are specified in the procedures of the tests required.

3.2 The sampling of materials is one of the most critical steps in materials testing. If the material to be tested to determine conformity to specifications is not chosen randomly, the tests will not reflect the true characteristics of the material being evaluated. Most specifications require samples to be taken using a stratified random process. Stratified random requires that one random sample is selected from each subplot or the quantity represented by the minimum sampling frequency. Stratified random sampling ensures that samples are selected uniformly throughout the entire production process.

3.3 Random sampling ensures that all produced material will have an equal chance of being selected for testing. No material is excluded from the chance of being selected unless it is specified in the test specification.

3.4 It is the nature of random testing that some of the samples will represent below average material, just as they will sometimes represent above average material.

3.5 Random number schedules should be predetermined using an established random process. CDOT has developed a random schedule program that can be used for sampling all construction materials. The *Random Schedule* program is included in the Asphalt03 and Voids03 computer programs. Random number schedules used for sampling should not be shared with the supplier before the sample is taken. Contractors can generate their own random number schedules as needed using the computer program. Extra samples may be taken for the contractor's use at the time of sampling.

3.6 Stratified random sampling is called for in most of CDOT's specifications. However, some specifications have a minimum sampling frequency of one per day. Regardless of the quantity produced that day one sample is still required. A predetermined random sampling schedule has no way of knowing what the daily production will be. It is the responsibility of the tester to ensure that the minimum sampling frequency is met in these cases. Other specifications require that a minimum number of samples to be taken regardless of the produced quantity. In these cases the planned quantity is divided by the number of required samples to determine the sampling frequency. A stratified random schedule should be generated using the new sampling frequency.

4. CDOT's RANDOM SCHEDULE PROGRAM

4.1 CDOT's random schedule program is contained in both the Asphalt03 and Voids03 computer programs, found under Tools. It is written in Microsoft Excel and can be used to generate a random sampling schedule for all materials.

5. GENERATING A RANDOM SCHEDULE

5.1 Open the *Random Schedule* program. Enable the macros when asked. Instructions for using the program are included in the Instructions worksheet. Read through the instructions before using the program. The program requires that Excel's Analysis ToolPak - VBA be installed before the macros will run properly. Follow the instructions on the Instructions worksheet to do this.

5.2 Move to the "Rand Nos" worksheet. Enter the project information into the green shaded cells. Click the "Clear No's" button to clear the worksheet. Click the "Generate Random Numbers" button to generate a set of random numbers. Click the "Print" button to print the random number schedule.

5.2.1 The random schedule program has the option of generating offset random numbers. Offset numbers are used to find a random transverse location. For example, the correct random location for a mat density test is the combination to two random numbers, the longitudinal (along the length of the pavement) and transverse (across the width of the pavement). The generation of transverse numbers can be turned off by changing the cell for generating offset numbers to "No". The "Transverse_Convert" worksheet contains a table that can help you

convert the transverse random number into feet and inches based on the width of the pavement.

5.2.2 The random schedule program can only generate up to 70 numbers at one time. To generate numbers in excess of 70 follow the instructions in the "Instructions" worksheet.

5.3 Repeat the steps in Subsection 5.2 to generate a random schedule for all materials and test elements for the project.

6. COMPLETING THE RANDOM SCHEDULE FORM

6.1 On the project, sample as close as possible to the values represented on the sampling schedule. Fill in the "Taken At" column of the random schedule form as samples are being selected. Major deviations from the sampling schedule should be noted and explained on the form or on additional pages as needed.

Colorado Procedure 76-97

Standard Practice for

Verification of Equipment Used to Field Test Bituminous Mixtures

1. SCOPE

1.1 This method of test covers the verification of equipment used to field test bituminous mixtures and provides documentation that the equipment verification has been done.

2. REFERENCED DOCUMENTS

- 2.1 *Colorado Procedures*
CP 31 Sieve Analysis of Aggregates
CP 51 Determining the Maximum Specific Gravity of Bituminous Mixtures
CP 81 Density of In-Place Bituminous Pavement by the Nuclear Method
CP 85 Asphaltic Cement Content of Asphalt Concrete Mixtures by the Nuclear Method

3. TERMINOLOGY

3.1 *Daily Verification* - Verification procedures which are carried out each day the laboratory equipment is used for testing. The verification is documented once per month.

3.2 *Weekly Verification* - Verification procedures which are carried out approximately once per week while the laboratory equipment is being used for testing. The verification is documented once per month.

3.3 *Monthly Verification* - Verification procedures which are carried out approximately once per month while the laboratory equipment is being used for testing. The verification is documented.

3.4 *Annual Verification* - Verification procedures which are carried out approximately once per year or each time the materials test trailer is moved. This may be done at the same time as the equipment is being calibrated. The verification is documented.

4. APPARATUS

4.1 *Thermometers* - Alcohol or mercury filled glass thermometers or calibrated digital thermometers capable of reading 250°F by 2°F (121°C by 1°C) and 77°F by 2°F (25°C by 1°C).

5. PROCEDURE

5.1 The following verification procedures are to be routinely carried out. If there is any question about the calibration of equipment, the verification procedures relating to the equipment must be carried out immediately.

5.2 If the verification procedure indicates that a problem exists, the problem must be addressed before further testing is conducted using the equipment.

6. DAILY EQUIPMENT VERIFICATION

6.1 Verify daily that the Nuclear Moisture/Density (M/D) Gauge meets the standardization check on a reference standard block as specified in CP 81. Record on CDOT Form #746.

6.2 Verify daily that the Nuclear Asphalt Content (AC) Gauge meets the standard background test as specified in CP 85. Record on CDOT Form #772.

7. WEEKLY EQUIPMENT VERIFICATION

7.1 Verify weekly that the oil in the vacuum pump used in CP 51 is not contaminated with water. Examine the desiccating crystals and oven dry them when necessary.

7.2 Verify that the #200 (75 μm) sieve screen used for aggregate washes in CP 31 is free from holes and is tight.

7.3 Verify that the sieves used for gradations in CP 31 have screen mesh that is tight, cannot move, has no permanent deformation in the screen and that there are no obvious defects, such as holes or broken solder in any of the screens. Also ensure that the nested sieves fit together tightly enough to prevent loss of material during sieving and have a reasonably easy fit with the next sieve in the nest of sieves.

7.4 Verify that all scales are level.

8. MONTHLY EQUIPMENT VERIFICATION

8.1 Verify monthly that the mercury in the manometer used to measure the vacuum applied to samples in CP 51 is free of air bubbles.

8.2 Oven dry the desiccating agent in the vacuum pump setup in CP 51 (indicating silica gel, 6-16 mesh, VWR).

8.3 Verify the weights of the flasks used to measure the maximum specific gravity in CP 51. The weights are measured with the flasks full of $77^{\circ}\text{F} \pm 1^{\circ}$ ($25.0^{\circ}\text{C} \pm 0.5^{\circ}$) water and covered by the same cover plate that is used during the test. If you are using temperatures other than 77°F (25°C) in the Rice test, prepare a chart of flask weight vs. water temperature containing at least 5 points, which span all of the temperatures you will be using.

8.4 Verify monthly that the Nuclear Asphalt Content (AC) Gauge meets the statistical stability test and the drift test as specified in CP 85.

9. ANNUAL EQUIPMENT VERIFICATION

9.1 Verify scale readings using a reference weight or weight set.

9.2 Verify the time that aggregate sieving is done by running the sieving adequacy test defined in CP 31.

CP 76 - Checklist for Field Bituminous-Equipment Calibration

Photocopy this sheet and keep a dated record of each calibration procedure. Write any necessary notes on the back of this sheet or on additional sheets stapled to this one. Even though these activities are being verified daily or weekly, this checklist only needs to be completed monthly.

Tester _____

Date _____

Daily

- 6.1 Nuclear Moisture/Density Gauge Standardization Test
- 6.2 Nuclear Asphalt Content Gauge Background Test

Weekly

- 7.1 Vacuum pump oil isn't contaminated with water
- 7.2 #200 wash screen in good repair
- 7.3 Gradation screens in good repair
- 7.4 Scales level

Monthly

- 8.1 Manometer mercury free of air bubbles
- 8.2 Oven dry desiccating crystals
- 8.3 Weights of Rice flasks with water and lids
- 8.4 Nuclear Asphalt Content Gauge Statistical Stability

Annually

- 9.1 Scales accurate
- 9.2 Sieving adequacy

Notes :

{This page was intentionally left blank.}

Colorado Procedure 77-09

Standard Procedure for

Determination of Macro-Texture of Planed Hot Mix Asphalt Pavement

1. SCOPE

1.1 This test method describes the means to evaluate the macro-texture of a planed pavement surface.

1.2 This CP may involve hazardous materials, operations, and equipment. This CP does not purport to address all of the safety problems associated with the CP's use. The CP user's responsibility is to establish appropriate safety and health practices and determine the applicability of regulatory limitations prior to use.

2. REFERENCE

2.1 *AASHTO Standards:*
M 247-07, Type I Glass Beads Used In Traffic Paints

2.2 *ASTM Standards:*
E 1094-04 Pharmaceutical Glass or ISO Standard 6706 Plastic Laboratory Ware - Graduated Measuring Cylinders

2.3 *CP Standards:*
FMM Appendix, Random Sampling

3. TERMINOLOGY

3.1 Terms and abbreviations shall be in accordance with the Department's Standard Specifications, and Field Materials Manual.

4. SIGNIFICANCE AND USE

4.1 This CP is used to evaluate the macro-texture of a milled pavement surface.

5. APPARATUS

5.1 *Filler:* Type 1 glass beads in accordance with AASHTO M 247-07.

5.2 *Spreader:* A flat, stiff, hard disk made from methyl methacrylate (Plexiglas) with a thickness of 0.5 ± 0.1 in., diameter of 8 ± 2 in. and a round handle affixed in the center used to spread the filler.

5.3 *Graduate:* A conical or cylindrical shape graduate, Type 1, Class B or better, 250 ml capacity conforming to the volume and accuracy requirements of ASTM E 1094-04 or ISO Standard 6706 used to measure the volume of filler for the test.

5.4 *Brushes:* A stiff wire brush and a soft bristle brush used to clean the pavement.

5.5 *Container:* A small container with a secure and easily removable cover used to store 200 ml of filler.

5.6 *Screen:* A shield used to protect the test area from air turbulence created from wind or traffic.

6. LABORATORY PREPARATION

6.1 Prepare one container for each sample location.

6.2 Fill the graduate with 200 ± 2 ml of filler.

6.3 Gently tap the side of the graduate to level the surface of the filler.

6.4 Place the measured volume of filler in the container.

6.5 Label the container with type and quantity of filler.

7. PROCEDURE

7.1 Randomly determine a sample location on the milled pavement surface in accordance

with the Random Sampling appendices, to test the macro-texture.

7.2 Inspect the sample location and ensure it is a dry, homogeneous site, free of unique or localized features such as cracks, joints, stripping and patching.

7.3 If localized features are present, move up-station at the same transverse offset until a suitable site is found.

7.4 Gently clean an area of about 1 foot by 1 foot for the sample location using the stiff wire brush to remove any, residue, debris or loosely bonded material. Be careful not to dislodge bonded material. After using the stiff wire brush, gently brush the sample location with the soft bristle brush to remove any remaining debris.

7.5 Place the screen on the milled pavement surface to protect the sample location from air turbulence.

7.6 Hold the container with filler above the pavement at the sample location at a height not greater than 4 in.

7.7 Pour the measured volume of filler from the container onto the milled pavement surface into a conical pile.

7.8 Place the spreader lightly on top of the conical pile of filler being careful not to compact the filler.

7.9 Move the spreader in a slow, circular motion to disperse the filler in a circular area and to create a defined crest around the perimeter.

7.10 Continue spreading the filler until it is well dispersed and the spreader rides on top of the high points of the milled pavement surface.

7.11 Measure and record the diameter of the circular area four times, at intervals of 45° and to the nearest 0.1 in., as shown below.

7.12 Measure the diameter of the circular area from the top (crest) of the slope on one side, through the center, and to the top (crest) of the slope on the other side of the circular area.

7.13 Calculate the average diameter of the circular area covered by the filler.

7.14 Determine the macro-texture thickness of the milled pavement surface by using the

cross reference table on the bottom of the Macro-Texture Report form. Report the result to three decimal places.

7.15 Remove the filler material from the location using the soft bristle brush and repeat Subsections 7.5 through 7.14.

7.16 Determine the average macro-texture thickness by adding the two results determined in Subsection 7.14 and dividing by 2. Report the result to three decimal places.

8. CALCULATIONS

8.1 Calculate the average diameter of the circular area covered by the filler.

$$Da = (D1 + D2 + D3 + D4) / 4$$

Where:

Da = Average diameter of the filler area, in
D1, D2, D3, D4 = Diameters of the filler area, in
Macro-texture Thickness:

$$1 \text{ in.} = 2.54 \text{ cm}; 1 \text{ in.}^3 = 16.387 \text{ cm}^3 \text{ (cc) (ml)}$$

Thus: $200 \text{ ml} \rightarrow ((200 \text{ ml}) / (16.387 \text{ ml/in.}^3)) = 12.20 \text{ in.}^3$

Thickness: Volume / Area

Example:

$$Da = 8 \text{ in.}$$
$$\text{Area} = \pi r^2 \rightarrow \pi (8/2)^2 = 50.265 \text{ in.}^2$$
$$\text{Thickness} = 12.20 \text{ in.}^3 / 50.265 \text{ in.}^2 = 0.243 \text{ in.}$$

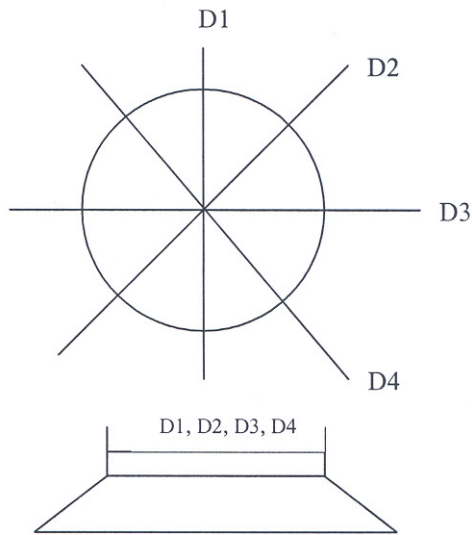

9. REPORT

9.1 Report the following information:

Date of test
Name of prime contractor and representative
Project number

Project Code
Diameter of filler area, D1, D2, D3, D4
Average diameter of filler area
Station or Milepost of sample location
Macro-texture Thickness
Offset of sample location
Name of milling contractor and representative

MACRO-TEXTURE REPORT

Project No: _____

Project Code: _____

Milling Contractor: _____

Prime Contractor: _____

Milling Rep.: _____

Prime Rep.: _____

Test #	Date	Sta	Offset	Dia. D1 (in)	Dia. D2 (in)	Dia. D3 (in)	Dia. D4 (in)	Dia. Avg (in)	Macro Texture
Average =									

Average =									

Average =									

Average =									

MACROTEXTURE THICKNESS BASED ON 200 ML OF FILLER AND AVERAGE DIAMETER

Average Diameter (inches)	Macrotexture Thickness (inches)	Average Diameter (inches)	Macrotexture Thickness (inches)	Average Diameter (inches)	Macrotexture Thickness (inches)
7.1	0.308	8.8	0.201	10.5	0.141
7.2	0.300	8.9	0.196	10.6	0.138
7.3	0.292	9.0	0.192	10.7	0.136
7.4	0.284	9.1	0.188	10.8	0.133
7.5	0.276	9.2	0.184	10.9	0.131
7.6	0.269	9.3	0.180	11.0	0.128
7.7	0.262	9.4	0.176	11.1	0.126
7.8	0.255	9.5	0.172	11.2	0.124
7.9	0.249	9.6	0.169	11.3	0.122
8.0	0.243	9.7	0.165	11.4	0.120
8.1	0.237	9.8	0.162	11.5	0.117
8.2	0.231	9.9	0.159	11.6	0.115
8.3	0.226	10.0	0.155	11.7	0.113
8.4	0.220	10.1	0.152	11.8	0.112
8.5	0.215	10.2	0.149	11.9	0.110
8.6	0.210	10.3	0.146	12.0	0.108
8.7	0.205	10.4	0.144	12.1	0.106

Colorado Procedure 78-12

Standard Practice for

Certification of High Speed Profilers

1. SCOPE

1.1 This test method describes the procedures for certifying high speed profilers for use on CDOT projects.

2. REFERENCED DOCUMENTS

2.1 International Cybernetics Corp. SurPRO 2000 User's Manual.

2.2 *AASHTO Standards:*

M 328-10 Standard Equipment Specification for Inertial Profiler

3. EQUIPMENT

3.1 International Cybernetics Corporation's SurPRO 2000.

3.2 High Speed Profiler

3.2.1 The High Speed Profiler (HSP) shall meet the specifications of AASHTO M 328 except that profilers used to measure the smoothness on concrete pavement shall use approved line lasers with at least a three inch wide foot print.

3.2.2 The HSP shall use the following operation parameters:

3.2.2.1 The height sensor spacing shall be 70 +/- 1 inch.

3.2.2.2 The sample interval at which relative profile elevations are reported shall be less than or equal to one inch.

3.2.2.3 The algorithm for filtering the profile data shall use a cutoff wavelength of 300 feet.

3.2.2.4 The HSP shall be capable of using automated triggering to start & stop data

collection.

4. OPERATOR REQUIREMENTS

4.1 The Operator shall be proficient in the operation of their profiler. It is recommended that the operator have a current LabCAT Level S Certification.

5. REFERENCE SITE SELECTION

5.1 The Colorado Department of Transportation will select a site to perform the HSP Certification with the following requirements:

5.1.1 Shall be relatively strait, level and smooth.

5.1.2 Shall have a sufficient distance for three consecutive 0.1mile sections and sufficient distance to safely start & stop with a 300 foot lead-in.

5.1.3 The 0.1 mile sections shall have an average IRI value between 30 & 90 in/mile.

5.1.4 Shall be on a surface where surface texture will have a minimal impact on data collection.

5.1.5 Shall be free of cracks in the traveled wheel paths.

5.1.6 Shall be on a relatively stable base with minimal traffic.

6. REFERENCE VALUE DETERMINATION

6.1 The device for determining the reference values shall be an ICC SurPRO 2000.

6.2 The reference site will be painted with a dot at least every 10 feet in the wheel paths.

6.3 The reference device will perform three closed loop data collection runs for each wheel path in the intended direction of travel.

6.4 ProVAL will be used to determine the cross correlation value for the closed loop run in each wheelpath. A minimum cross correlation value of 95 will be required to accept each wheelpath.

6.5 If the cross correlation values for a wheelpath are less than 95 it shall be retested according to section 6.3.

6.6 The IRI from the third run for each 0.1 mile section for each wheel path will be used as the reference values for the HSP certification. These values will not be shared with the participants.

7. CERTIFICATION PROCEDURE

7.1 Prior to the HSP collecting certification data, the HSP's distance measuring instrument shall be calibrated following the manufacturer's procedures.

7.2 The HSP operator shall perform ten runs in the intended direction of travel.

7.3 The HSP operator shall provide the Department the raw data files for ICC profilers or data files that can be opened in ProVAL for the other manufactures.

7.4 Data files for the ten runs shall be submitted to the Department on electronic media, such as a thumb drive or compact disk immediately after the completion of the ten runs. The media will not be returned to the operator.

7.5 The data files will be analyzed by the Department.

8. ACCEPTANCE DETERMINATION

8.1 An average and standard deviation of the ten runs will be determined for each 0.1 mile section for each wheel path.

8.2 The HSP will be considered acceptable when:

- The standard deviation for each 0.1 mile section does not exceed 3.0 in/mile.
- The average IRI for each 0.1 mile section does not vary from the reference

IRI values by more than 6.0 in/mile.

9. CERTIFICATION

9.1 After a HSP is determined to be acceptable, a Certificate will be issued listing:

- HSP serial number
- HSP VIN number
- HSP Make & Model
- Height sensor serial numbers
- Accelerometer serial numbers
- Certification Date
- Expiration Date

9.2 The certification will expire after one year.

9.3 A list of certified profilers is posted on CDOT's web site under Certified Pavement Smoothness Testing Devices at:
<http://www.dot.state.co.us/DesignSupport/>

10. SUSPENSION OF CERTIFICATION

NOTE 1: This Section is used when a Contractor's profiler fails to meet the Smoothness Verification Testing acceptance criteria.

10.1 The Contractor's profiler shall make three repeat runs at a site chosen by the Department. The site will meet the requirements of Section 5.

10.2 CDOT's profiler will make three runs of the site.

10.3 The data files for the three runs shall be submitted to the Department on electronic media, such as a thumb drive or compact disk. The media will not be returned to the Contractor.

10.4 The Department will determine an average HRI for each 0.1 mile section using the Department's profiler's results.

10.5 The Contractor's Profiler's results will be compared to the Department's results.

10.6 The Contractor's Profiler will retain its certification if the average HRI for each 0.1 mile section does not vary from the Department's HRI values by more than 6.0 in/mile.

10.7 If the Contractor's profiler fails to meet

the criteria in Subsection 10.6, the Contractor's profiler will be allowed to make three additional runs and then it will be re-evaluated.

10.8 If the Contractor's profiler fails to meet the criteria in Subsection 10.6 a second time, the Contractor's profiler's Certification will be suspended.

10.9 The Contractor's profiler shall be repaired and/or adjusted/calibrated by the manufacturer.

10.10 If the Contractor wants to have his profiler recertified after repairs have been made prior to the next annual certification, all costs associated with the recertification shall be borne by the Contractor.

{This page was intentionally left blank.}

Colorado Procedure 80-08

Standard Method of Test for

In-Place Density and Moisture Content of Soil and Soil-Aggregate by the Nuclear Method

(This procedure is based upon AASHTO T 310-01. AASHTO T 310-01 or any subsequent revision, or WAQTC TM7 may not be used in place of this procedure.)

1. SCOPE

1. This test method describes the procedure for determining the in-place density and moisture of soil and soil-aggregate by use of nuclear gauges. The density of the material is determined by the direct transmission method. The moisture of the material is determined only from measurements taken at the surface of the soil. The methods described are normally suitable to test depths of 2 to 12 inches. This procedure is to be used to measure densities at depths of 4, 6 & 8 inches only. Interferences (conditions that can provide incorrect measurements) of the nuclear test are discussed in AASHTO T 310-01.

1.2 *Density*- The total or wet density of the soil and soil-aggregate mixtures is determined by the attenuation of gamma radiation where the source is placed at a known depth up to 12 inches while the detector remains on the surface. The density in mass per unit volume of the material under test is determined by comparing the detected rate of gamma radiation with previously established calibration data.

1.3 *Moisture*- The moisture content of the soil and soil-aggregate mixtures is determined by thermalization or slowing of fast neutrons where the neutron source and thermal neutron detector remain at the surface. The water content in mass per unit volume of the material under test is determined by comparing the detection rate of thermalized neutrons with previously established calibration data.

1.4 The following applies to all specified limits in this standard: For the purposes of determining conformance with these specifications, an observed value or a calculated value shall be rounded off to the nearest unit in the last right hand place of figures used in expressing the limiting value, in accordance with the rounding-off method of AASHTO R 11, Recommended Practice for Indicating Which

Places of Figures are to be Considered Significant in Specified Limiting Figures.

2. REFERENCED DOCUMENTS

2.1 *Colorado Procedures:*

CP 15 Certification of Consultant Nuclear Moisture/Density Gauges

CP 25 Calculation of Percent Relative Compaction of Soils and Soil-Rock Mixtures

CP 75 Stratified Random Sampling of Materials

CP-L 5302 Calibration of CDOT Nuclear Moisture / Density Gauges

3. SIGNIFICANCE

3.1 The test method described is useful as a rapid, non-destructive technique for the in-place determination of the wet density and water content of soil and soil-aggregate.

3.2 The test method is used for quality control and acceptance testing of compacted soil and soil-aggregate for construction and for research and development. The non-destructive nature allows repetitive measurements at a single test location and statistical analysis of the results.

3.3 Test results may be affected by chemical composition, sample heterogeneity, and, to a lesser degree, material density and the surface texture of the material being tested. The test also exhibits spatial bias in that the gauge is more sensitive to water contained in the material in close proximity to the surface and less sensitive to water at greater depths.

4. APPARATUS

4.1 *Nuclear Moisture/Density (M/D) Gauge* - While the exact details of construction of the gauge may vary, the system shall consist of:

4.1.1. *A sealed source* - High-energy gamma radiation, such as Cesium-137.

4.1.2. *Gamma Detector* – Any type of gamma detector, such as a Geiger-Mueller tube.

4.1.3. *A sealed source* - Fast neutron radiation, such as Americium-241:Beryllium.

4.1.4. *Slow Neutron Detector* – Any type of slow neutron detector, such as Helium-3 tube.

4.2 *Reference Standard* – A block of material used for checking gauge operation, correction of source decay, and to establish conditions for a reproducible reference count rate.

4.3 *Site Preparation Device* – A plate, straightedge, or other suitable leveling tool, which may be used for planing the test site to the required smoothness, and for guiding the drive pin to prepare a perpendicular hole.

4.4 *Drive Pin* – A pin not to exceed the diameter of the source rod by more than an 1/8th of an inch.

4.5 *Drive Pin Extractor* – A tool that may be used to remove the drive pin in a vertical direction so that the pin will not distort the hole in the extraction process.

5. HAZARDS

5.1 The gauge utilizes radioactive material that may be hazardous to the health of the user unless proper precautions are taken. Users of the gauge must become familiar with applicable safety procedures and government regulations.

5.2 Effective user instruction together with routine safety procedures, such as source leak tests, recording and evaluation of personnel dosimetry, etc, are a recommended part of the operation and storage of the gauge.

6. CALIBRATION / CERTIFICATION

6.1 Calibration / Certification of the gauge

shall be in accordance to CP 15 or CP-L 5302.

7. STANDARDIZATION

7.1 All Nuclear Moisture/Density (M/D) Gauges are subject to long-term aging of the radioactive sources, detectors, and electronic systems, which may change the relationship between count rates and the material density and water content. To offset this aging, gauges are calibrated as a ratio of the measurement count rate to a count rate made on a reference standard.

7.2 Standardization of the gauge on the reference standard is required at the start of each day's use, after the gauge has been turned off, or when a gauge's readings are in question. A permanent record of this data shall be retained. The standardization shall be performed with the gauge at least 33 ft away from other nuclear gauges and clear of large masses of water, hydrogenous material, or other items which may affect the reference count rates. Standard counts should be taken in the same environment as the actual measurement counts.

7.3 Turn the gauge on and allow it to stabilize according to the manufacturers recommendations.

7.4 Place the gauge on the reference standard as recommended by the gauge manufacturer, and perform a four-minute standard count.

7.5 Compare the standard count obtained in Subsection 7.4 to the average of the previous 4 days standard counts. If the density standard count is not within 1% of the density 4-day average or the moisture standard count is not within 2% of the moisture 4-day average rerun the standard count. If the above conditions are not met contact your On-site Radiation Safety Officer, follow your company's procedures, or contact the gauge manufacturer for further guidance. Record the standard counts on CDOT Form # 746 and # 427.

8. PROCEDURE

8.1 Using CP 75, select both longitudinal and transverse test locations where the test position is at least 6 inches from any vertical projection.

8.2. Prepare the test site in the following manner:

8.2.1. Remove all loose and disturbed material, and remove additional material as necessary to expose the top of the material to be tested.

8.2.2. Prepare a horizontal area, sufficient in size to accommodate the gauge by planing the area to a smooth condition so as to obtain maximum contact between the gauge and material being tested.

8.2.3 The maximum void beneath the gauge shall not exceed $1/8^{\text{th}}$ of an inch. Use minus #4 native fines to fill these voids and smooth the surface with the site preparation device. The depth of the filler shall not exceed $1/8^{\text{th}}$ of an inch. The area covered by the fill shall not exceed 10% of the test site.

8.2.4. Using the hole-forming device, make a hole perpendicular to the prepared surface. The depth of the hole shall be at least 2 inches deeper than the selected test depth and aligned such that the insertion of the probe will not cause the gauge to tilt from the plane of the prepared area.

8.2.5 Remove the hole-forming device carefully to prevent the distortion of the hole, damage to the surface, or loose material falling into the hole.

8.3 Proceed with testing in the following manner:

8.3.1 Place the gauge on the material to be tested and align the source rod directly above the hole.

8.3.2 Lower the source rod into the hole to the desired test depth. Pull back gently on the gauge towards the operator so that the source rod is in direct contact with the back side of the hole. Enter the depth of measurement on the scaler.

NOTE 1: Failure to enter the actual depth of the reading into the scaler will yield incorrect density results.

8.3.3 Keep all other radioactive sources at least 33 feet away from the gauge to avoid affecting the measurement.

8.3.4 Perform four one-minute readings and record the dry density and percent moisture on CDOT Form #427.

NOTE 2: Most gauges report both wet & dry density and moisture content in PCF or percent moisture. It is important to record the correct reading from the gauge.

NOTE 3: Older model gauges do not report density or moisture content. Refer to the gauge manufacturer's instruction manual on how to obtain moisture content and density from the gauge.

8.3.5 Obtain a sample of the soil or soil-aggregate as required in Subsection 3.2 of CP 25, Calculation of Percent Relative Compaction of Soils and Soil Rock Mixtures. The collected sample should be collected from beneath the M/D gauge, between the hole and the end of the gauge where the detector tubes are located. The depth of sample shall be 2 to 10 inches.

9. CALCULATIONS

9.1 Average the gauge readings obtained in Subsection 8.3.4.

10. REPORT

10.1 CDOT Form #746, Nuclear Moisture/Density Gauge Log (Example in Chapter 800).

10.2 CDOT Form #427, Nuclear Soils Moisture/Density Test (Example in Chapter 800).

{This page was intentionally left blank.}

Colorado Procedure 81-10

Standard Method of Test for

Density and Percent Relative Compaction of In-Place Bituminous Pavement by the Nuclear Method

(This procedure is based upon AASHTO T 310-01 (Soil Density). AASHTO T 310-01 or any subsequent revision may not be used in place of this procedure.)

1. SCOPE

1.1 This method covers the determination of the total density of hot mix asphalt pavement in-place by use of nuclear gauges. The test method used to determine the density of in-place hot mix asphalt pavements is the backscatter method, whereby the source is lowered into near contact with the compacted roadway surface. The direct transmission and air gap methods are not used to test the in-place density of bituminous pavements..

1.2 The nuclear equipment referenced in this method is the Surface Moisture/Density (M/D) Gauge and the Thin Layer Density Gauge. This procedure applies equally to both types of gauges, except as noted.

1.3 The following applies to all specified limits in this standard: For the purposes of determining conformance with these specifications, an observed value or a calculated value shall be rounded off "to the nearest unit" in the last right-hand place of figures used in expressing the limiting value, in accordance with the rounding-off method of AASHTO R 11, Recommended Practice For Indicating Which Places Of Figures Are To Be Considered Significant In Specified Limiting Values.

2. REFERENCED DOCUMENTS

- 2.1 *Colorado Procedures:*
- CP 15 Certification of Consultant Nuclear Moisture / Density Gauges
 - CP 75 Stratified Random Sampling of Materials
 - CP 82 Field Correction of the In-Place Measurement of Density of Bituminous Pavement by the Nuclear Method

- CP-L 5302 Calibration of CDOT Nuclear Moisture/Density Gauges
- CP-L 5304 Calibration of CDOT Nuclear Thin Layer Density Gauges

3. SIGNIFICANCE

3.1 The method described is useful as a rapid, non-destructive technique for the in-place determination of density of HMA.

3.2 This method is suitable for control and acceptance testing of HMA for construction, as well as for use in research and development. Test results may be affected by chemical composition, sample heterogeneity, and the surface texture of the material being tested. The techniques also exhibit spatial bias in that the apparatus is more sensitive to certain regions of the material under test.

4. APPARATUS

4.1 *Nuclear Moisture/Density (M/D) or Thin Lift Gauge* - While the exact details of construction of the gauge may vary, at a minimum the system shall consist of:

4.1.1. *A sealed source* - High-energy gamma radiation, such as Cesium-137.

4.1.2. *Gamma Detector* - Any type of gamma detector, such as a Geiger-Mueller tube.

4.2 *Reference Standard* - A block of material used for checking gauge operation, correction of source decay, and to establish conditions for a reproducible reference count rate.

4.3 Any equipment that is used under the requirements of this method shall pass the

requirements for statistical stability and drift contained in CP-L 5302 and CP-L 5304.

5. HAZARDS

5.1 The gauge utilizes radioactive material that may be hazardous to the health of the user unless proper precautions are taken. Users of the gauge must become familiar with applicable safety procedures and government regulations.

5.2 Effective user instruction together with routine safety procedures, such as source leak tests, recording and evaluation of personnel dosimetry, etc, are a recommended part of the operation and storage of the gauge.

6. CALIBRATION / CERTIFICATION

6.1 Calibration for CDOT Moisture/Density (M/D) gauges follows CP-L 5302. Certification of non-CDOT Moisture/Density (M/D) gauges complies with CP 15, Certification of Consultant Nuclear Moisture/Density Gauges.

6.2 Calibration for CDOT Thin Layer Density gauges follows CP-L 5304. Certification of non-CDOT Thin Layer Density gauges complies with CP 15, Certification of Consultant Nuclear Moisture/Density Gauges.

7. STANDARDIZATION

7.1 All Nuclear Gauges are subject to long-term aging of the radioactive sources, detectors, and electronic systems, which may change the relationship between count rates and the material density and water content. To offset this aging, gauges are calibrated as a ratio of the measurement count rate to a count rate made on a reference standard.

7.2 Standardization of the gauge on the reference standard is required at the start of each day's use, after the gauge has been turned off, or when a gauge's readings are in question. A permanent record of this data shall be retained. The standardization shall be performed with the gauge at least 33 ft away from other nuclear gauges and clear of large masses of water, hydrogenous material, or other items which may affect the reference count rates. Standard counts

should be taken in the same environment as the actual measurement counts.

7.3 Turn the gauge on and allow it to stabilize according to the manufacturers recommendations.

7.4 Place the gauge on the reference standard as recommended by the gauge manufacturer, and perform a four-minute standard count.

7.5 Compare the standard count obtained in Subsection 7.4 to the average of the previous 4 days standard counts. If the density standard count is not within 1% of the density 4-day average, rerun the standard count. If the above conditions are not met contact your On-site Radiation Safety Officer, follow your company's procedures, or contact the gauge manufacturer for further guidance. Record the standard counts on CDOT Form #746 and #428.

8. PROCEDURE

8.1 Using CP 75, select both longitudinal and transverse test locations where the gauge in test position will be at least 6 in. away from any vertical projection. Mark these test locations using a pavement marking pen. The gauge test site shall be an area 8 in. by 13 in. centered over the marked test location. The long axis of the test site must be parallel to the direction of the paver and rollers.

NOTE 1: When selecting a test location, include all areas 1 foot or more away from confined or unconfined longitudinal joints. Do not include locations closer than 1 foot to longitudinal joints.

8.2 Prepare the gauge test site in the following manner:

8.2.1 Remove all loose and disturbed material from the roadway surface.

8.2.2 Prepare the gauge test site to accommodate the gauge so that the gauge remains level and steady. "Rocking of the gauge may be caused by a non-level surface or by asphaltic aggregate particles becoming cemented to the bottom of the gauge. Obtain maximum contact between the gauge and material being tested. If rocking cannot be corrected, the test site may be moved a few centimeters to level the

gauge.

8.2.3 The maximum void beneath the gauge shall not exceed 1/8 in. If necessary, use the minimum possible amount of native fines or fine sand to fill these voids and smooth the surface with a rigid plate or other suitable tool.

NOTE 2: The placement of the gauge on the surface of the material to be tested is critical to the successful determination of density. The optimum condition is total contact between the bottom surface of the gauge and the surface of the material being tested. This is not possible in all cases and to correct surface irregularities use of sand or similar material as a filler will be necessary. The depth of the filler should not exceed 1/8 in. and the total area filled should not exceed 10 percent of the bottom area of the gauge. Several trial seatings may be required to achieve these conditions.

8.3 Proceed with the test in the following manner:

8.3.1 Place the gauge on the 8 in. by 13 in. gauge test site. Mark two corners of the gauge test site using a pavement marking pen.

8.3.2 Keep all other radioactive sources at least 33 ft. away from the gauge to avoid affecting the measurement.

8.3.3 Tilt the gauge away from the operator slightly. Extend the source rod from the "SAFE" position to the "Backscatter" position, which is the position in which the tip of the source rod attains near contact with the pavement surface. Tilting the gauge will ensure that the index handle trigger of the source rod is securely engaged in the notch on the index rod. Ensure that the source rod is firmly seated against the bottom of the notch, which places the source into near contact with the roadway surface.

8.3.4 Seat the gauge firmly, keeping the base in contact with the prepared gauge test site.

8.3.5 Set the count time to one-minute. Perform two one-minute readings and record the wet density on CDOT Form #428. Turn the gauge 180 degrees and align the gauge over the gauge test site. Perform and record two additional one-minute readings.

NOTE 3: Most gauges report both wet and dry density. It is important to record the correct reading from the gauge.

NOTE 4: Older model gauges do not report density. Refer to the gauge manufacturer for instructions on how to obtain density from the gauge.

8.3.6 If a core sample is required, follow CP 82. Obtain the core or cores for CP 82 from the central longitudinal axis of the gauge test site.

NOTE 5: If the entire bituminous pavement, that is the old existing asphalt roadway plus the planned overlay, will be less than 4 inches thick, underlying subgrade density variations can cause nuclear gauge test inconsistencies.

9. CALCULATIONS

9.1 Average the four nuclear gauge readings obtained in Subsection 8.3.5.

9.2 Calculate the adjusted wet density value by adding the field density to the correction factor derived through CP 82. Calculate the percent density by dividing the adjusted field density by the laboratory maximum mixture density (i.e. the maximum specific gravity multiplied by 62.4).

10. REPORT

10.1 CDOT Form #746, Nuclear Moisture/Density Gauge Log (Example in Chapter 800).

10.2 CDOT Form #428, Nuclear Asphalt Density Test (Example in Chapter 800).

{This page was intentionally left blank.}

Colorado Procedure 82-08

Standard Method of Test for

Field Correction of the In-Place Measurement of Density of Bituminous Pavement by the Nuclear Method

INTRODUCTION

This method covers the determination of a correction factor which is used to adjust the density readings of in-place bituminous pavement generated by a nuclear surface gauge to core sample densities. A common misconception exists that a calibrated nuclear gauge can and will provide the correct in-place density of a bituminous pavement. However, no two design mixes are identical when placed on a project because the environment and roadway structure are unique; therefore, a standard calibration for bituminous pavements is impossible. Correlating the in-place nuclear density to the in-place core sample density allows for the development of a correction factor that should be valid until the ingredients in the bituminous pavement change or the underlying material changes. Principles of the nuclear test are discussed in the AASHTO T 310 Appendix, as are some of the advantages and disadvantages of the test. Surface nuclear gauges utilize radioactive materials, which may be hazardous to the health of users unless proper precautions are taken.

1. SCOPE

1.1 This method describes the procedures for determining a correction factor to be applied to the in-place measurement, by nuclear methods, of pavement densities. This factor corrects for the varying effects of materials, roadway structure, and environment.

1.2 This procedure should be used on each project as specified in the contract. This procedure may also be used whenever variations in conditions bring the Moisture/Density Gauge or Thin Layer Density Gauge readings into question.

1.3 The values stated in English units are to be regarded as the standard.

2. REFERENCED DOCUMENTS

- 2.1 *Colorado Procedures*
- | | |
|-------|--|
| CP 44 | Bulk Specific Gravity and Percent Relative Compaction of Compacted Bituminous Mixtures Using Saturated Surface-Dry Specimens |
| CP 51 | Determining the Maximum Specific Gravity of Bituminous Mixtures |
| CP 75 | Stratified Random Sampling of Materials |
| CP 81 | Density of In-Place Bituminous Pavement by Nuclear Method |

3. APPARATUS

3.1 Any tool suitable for removing intact a core of compacted pavement for the full depth of the course or courses. A diamond bit core drill is suitable for this purpose. The core drill must have a diameter of greater than 4 in. (100 mm) and should be equipped to core and retrieve specimens approximately 4 or 6 in. (100 to 150 mm) in diameter.

3.2 A rigid plate or suitable container large enough to hold the sample without distortion after it is removed from the pavement.

3.3 Surface Moisture/Density Gauge or Thin Layer Density Gauge as specified in CP 81.

3.4 Apparatus as specified in CP 51 (Determining the Maximum Specific Gravity of Bituminous Mixtures) and CP 44 (Bulk Specific Gravity of Compacted Bituminous Mixtures Using Saturated Surface-Dry Specimens).

4. PROCEDURE

4.1 Using CP 75, select and record seven longitudinal and transverse test locations where the gauge in test position will be at least 6 in. away from any vertical projection. Mark these test locations using a pavement marking pen. The gauge test site shall be an area 8 in. by 13 in. centered over the marked test location. The long axis of the test site must be parallel to the direction of the paver and rollers.

NOTE 1: When selecting a test location, include all areas 1 foot or more away from confined or unconfined longitudinal joints. Do not include locations closer than 1 foot to longitudinal joints.

NOTE 2: If the existing pavement depth plus the depth of the planned first lift will be less than 4 in., the nuclear gauge may be affected by variations in the density of the subbase. Thin layer density gauges and cores are not affected by these variations in subbase densities.

NOTE 3: A visual examination of the existing pavement should be conducted before paving begins so that heavily distressed areas may be avoided when selecting test locations in Subsection 4.1. These areas may affect gauge readings, may not be representative of the roadway in general, or may lose their continuity once extracted.

4.2 Obtain nuclear gauge density readings at each test location according to CP 81 for either the nuclear gauge #1 or #2 values.

NOTE 4: CP 81 contains essential details concerning the safety, calibration, and standardization of nuclear gauges.

4.3 Take a core sample from the center of the gauge test site at each test location. This core shall be provided to CDOT for the determination of the nuclear asphalt density correction.

4.3.1 Any additional cores should be taken along the longitudinal axis as close as possible to the original core location.

NOTE 5: The Contractor shall provide cores from each location to CDOT as witnessed by the CDOT tester. If the core is damaged during the coring process, a new gauge test site as close as possible to the original test site along the

longitudinal centerline axis of the original test site shall be chosen. The direction of the new test site shall be randomly selected by the CDOT tester. Repeat Subsections 4.1 to 4.3 at the new test site. Once the bulk specific gravity test (CP 44) has been started on a core, the contractor shall no longer have the option of requesting a new test site at that location.

4.4 When the nominal maximum size aggregate in the pavement is 1 in. or less, a 4 in. diameter bit or larger shall be used. When the nominal maximum size aggregate is over 1 in., a 6 inch diameter bit shall be used. When the coring operation has been completed, carefully remove sample by use of the core retriever. Mark each core to allow identification of the test site. Care should be exercised that the sample is not distorted, bent, cracked, or in any way changed from its physical condition as it was before removal from the pavement.

4.5 Separate the core below the layer for which the correction factor is being determined.

4.6 Determine the specific gravity of the core samples in accordance with CP 44.

5. DETERMINATION OF CORRECTION FACTOR

5.1 Calculate the average specific gravity of the seven pavement cores taken from the roadway. Convert the average specific gravity to density by multiplying the specific gravity by 62.4.

5.2 Using CP 81, calculate the average in-place density from the seven sites using the nuclear gauge.

5.3 Calculate the correction factor to be used for measurements of density readings from the same project as follows:

$$A = B - C$$

Where:

- A = Correction factor determined for a specific gauge and pavement,
- B = Average density of pavement cores,
- C = Average density reading from nuclear gauge.

NOTE 6: This correction factor is added to the nuclear gauge density determined on the same pavement using the same nuclear density gauge.

6. REPORT

6.1 The results are reported on the following CDOT forms:

6.1.1 CDOT Form #746 - Nuclear Moisture/Density Gauge Log (Example in Chapter 800).

6.1.2 CDOT Form #428 - Nuclear Asphalt Density Test (Example in Chapter 800).

6.1.3 CDOT Form #469 - Nuclear Asphalt Density Correction (Example in Chapter 800).

{This page was intentionally left blank.}

Colorado Procedure 85-12

Standard Method of Test for

Asphalt Cement Content of Asphalt Mixtures by the Nuclear Method

(This procedure is based upon AASHTO T 287-06. AASHTO T 287-06 or any subsequent revision may not be used in place of this procedure.)

1. SCOPE

1.1 This method covers the quantitative determination of the asphalt cement content of asphalt concrete mixtures by testing a sample with a nuclear asphalt content gauge.

1.2 The values stated in English units are to be regarded as the standard. The metric equivalents of English units may be approximate.

1.3 This test method involves potentially hazardous materials, operation and equipment. This method does not address all of the safety concerns associated with its use. All operators will be trained in radiation safety prior to operating nuclear gauges.

1.4 Equipment operators shall wear an approved form of radiation dosimetry (i.e., film badges or thermoluminescent dosimeter) capable of monitoring the occupational radiation exposure.

2. REFERENCED DOCUMENTS

2.1 Colorado Procedures:

- CP 30 Sampling of Aggregates
- CP 32 Reducing Field Samples of Aggregate to Testing Size
- CP 41 Sampling Hot Mix Asphalt
- CP 43 Determining Moisture (Water) or Volatile Distillates Content of Bituminous Paving Mixtures
- CP 55 Reducing Field Samples of Hot Mix Asphalt to Testing Size

2.2 Colorado Laboratory Procedures:

CP-L 5115 Preparing and Determining the Density of Bituminous Mixture Test Specimens Compacted by the Superpave Gyrotory Compactor

2.3 AASHTO Procedures:

T 40 Sampling Bituminous Materials

2.4 Manufacturer's Instruction Manual

3. SIGNIFICANCE AND USE

3.1 This method can be used for rapidly determining the asphalt content of asphalt paving mixtures. Testing can be completed in a matter of minutes so that adjustments, if necessary, can be made in the asphalt metering system with a limited amount of mix production. The procedure is useful in the determination of asphalt content only, as it does not provide extracted aggregate for gradation analysis.

3.2 This procedure determines the asphalt binder content of a test sample by comparing the measured asphalt binder content with previously established correlation data. The asphalt binder content is expressed as a percentage of the mass of the asphalt mixture.

3.3 Accurate results are dependent upon proper correlation of the nuclear gauge to the material being tested. This procedure is sensitive to the type and gradation of the aggregate, hydrated lime and the percentage and source of the asphalt binder.

3.4 This procedure measures the total amount of hydrogen in a sample, including hydrogen present in the form of water. Unless the test sample is completely free of moisture, the percentage of moisture must be determined as outlined in Section 10.2 and a correction shall be made to compensate for the moisture.

3.5 This procedure may be used with reclaimed asphalt pavement (RAP) incorporated into the mixture, if approved by the Region Materials Engineer, provided that the RAP is of uniform gradation, asphalt content, and asphalt type. When RAP is used, the RAP should be mixed in the correlation samples at the same rate that will be used in the asphalt concrete mixture being tested.

4. APPARATUS

4.1 Nuclear Asphalt Content (AC) Gauge consisting of the following items:

4.1.1 Neutron Source - Encapsulated and sealed radioactive source, such as Americium-241:Beryllium (Am-241:Be).

4.1.2 Thermal neutron detector, such as Helium-3.

4.1.3 Read-Out Instrument displaying at a minimum, the percent of asphalt binder to the nearest 0.01 percent;

4.1.4 Sample Pans - Three or more stainless-steel pans. Dimensions as specified by the gauge manufacturer.

4.1.4.1 Sample pans with excessive asphalt cement residue, visible damage, or deformity shall not be used.

4.1.4.2 When cleaning agents are used on the sample pans they shall be washed with water and dried prior to use.

NOTE 1: The residue left by the cleaning agents may contain hydrogen that can affect nuclear gauge readings.

4.2 Variability of the AC Gauge at 6 percent asphalt content shall be no greater than 0.05 percent for a 4-minute count.

4.2.1 The variability of the AC Gauge is determined from the slope of the correlation curve and the standard deviation of the count rate. Variability is calculated as follows:

$$v = \frac{s.d.}{s}$$

Where:

- v = AC Gauge variability, in percent asphalt,
- s.d. = Standard Deviation, in counts per automatically timed period,
- s = Slope, in counts per percent asphalt.

The standard deviation is calculated from 20 individual automatically timed readings (per manufacturer's instructions for operation of the equipment). Counts are taken on a sample with asphalt cement content within ± 0.5 percent of the mix design.

4.2.2 The range of control mix shall be between 2 and 14 percent asphalt cement by weight.

4.3 All equipment (i.e. sample pans, gauge chamber, etc.) shall be maintained in a clean and undamaged condition.

4.4 Other Apparatus:

4.4.1 Balance - Capable of weighing to 15 kg (33 lb), readable to 0.1 g.

4.4.2 Oven - Capable of heating to $350^{\circ}\text{F} \pm 5^{\circ}$ ($177^{\circ}\text{C} \pm 3^{\circ}$).

4.4.3 Straightedge - Steel, approximately 18 in. (450 mm) in length.

4.4.4 Plywood - 3/4 in. (20 mm) or heavier, or metal plate 3/8 in. (10 mm) or heavier having an area slightly larger than the top of the sample pans or wooden survey stake longer than the width of the sample pan.

4.4.5 Assorted spoons, spatulas, and mixing bowls.

4.4.6 Thermometer - Temperature range of 50°F to 500°F (10°C to 300°C).

5. PRECAUTIONS

5.1 The nuclear asphalt content gauge may be sensitive to outside influence and therefore:

5.1.1 Any other source of neutron radiation shall be kept at least 33 ft (10 m) from the equipment.

5.1.2 The space within 3 foot of the AC gauge shall be kept free of hydrogenous materials such as coffee cups, water, oil, WD40, asphalt, or plastic materials.

5.1.3 All personnel shall be kept at least 3 feet away from the AC gauge during testing.

5.1.4 The AC gauge shall not be located within 3 ft of any water supply tanks, fuel tanks, or other liquid containers subject to fluctuating liquid levels.

5.2 Moving the AC gauge to a different location may cause a change in the background radiation measurements. New background measurements and possibly a new correlation will be necessary prior to use.

6. SAMPLING

6.1 Obtain samples of aggregate in accordance with CP 30. Reduce samples of aggregate to testing size according to CP 32.

6.2 Obtain samples of asphalt binder in accordance to AASHTO T 40.

6.3 Obtain samples of the freshly produced HMA in accordance with CP 41. Reduce samples of HMA to testing size according to CP 55.

7. STANDARDIZATION

7.1 All nuclear devices are subject to long-term aging of the radioactive source, detectors, and other electronic systems, which may change the relationship between count rate and asphalt content. Because of this aging, new correlation curves shall be run each construction season. Changes in the surroundings of the asphalt content gauge (Section 5.1.1 to 5.2) may also produce increases or decreases in count rate.

In order to minimize these effects, background counts must be taken at least once per day.

7.2 Turn the Asphalt Content Gauge on and allow a 20 minute warm up period before using the gauge. Perform a background test of at least 8 minutes with an empty chamber and record the background count on the Nuclear Asphalt Content Gauge Log.

For Troxler gauges a variation of less than or equal to 1 percent from the previous background count is acceptable. If the variation is greater than 1 percent, check for conditions identified in Section 5.1.1 to 5.2 and repeat the test. If the variation remains, follow Section 7.4.

For CPN gauges a CHI value (acronym from gauge display) of 1.00 ± 0.25 is acceptable. If the CHI value is outside the range check for conditions identified in Subsection 5.1.1 to 5.2 and then repeat the test. If the CHI value remains outside the range follow Subsection 7.4.

7.3 Verify gauge stability by performing a statistical stability test on all new or repaired AC Gauges prior to use and once per month when the gauge is in use. A failing statistical stability test should be repeated after ensuring that the chamber is empty and checking for the conditions identified in Sections 5.1.1 to 5.2. If the test still fails, follow Section 7.4.

7.4 If an AC Gauge has failed either the background test or the statistical stability test, contact the On-Site Radiation Safety Officer, follow the guidelines of your organization, or contact the manufacturer of the gauge for guidance.

NOTE 2: If the equipment is being used either continuously or intermittently during the day, it is best to leave the power on during the day to prevent having to repeat the background count. This may also provide more stable and consistent results.

8. CORRELATION PAN PREPARATION

8.1 This method is sensitive to the type of aggregate, percentage and source of asphalt cement, aggregate gradation, and all additives, including hydrated lime. Accordingly, a correlation must be developed for each mix type.

The correlation will be established with three or more points. A baseline dry aggregate count must also be taken to determine whether changes in aggregate properties are affecting the asphalt cement content determinations.

8.1.1 Sample the aggregate at the plant in accordance with Section 6.1. The aggregate shall be oven dried at $300^{\circ}\text{F} \pm 15^{\circ}$ ($149^{\circ}\text{C} \pm 8^{\circ}$) to constant weight. The aggregate may be a composite generated from individual components by percentage of weight according to the mix design or a cold feed combined aggregate sample (without hydrated lime added) from an HMA production facility. The cold feed combined aggregates' conformance to the mix design gradation targets shall be verified prior to correlation. Enough aggregate shall be obtained for a minimum of one dry aggregate and three mix samples. Approximately 65 lb (30 kg) total will be required.

8.1.2 Hydrated lime, if required by the mix design, shall be added to the aggregate in the laboratory.

8.2 Dry Aggregate Count:

8.2.1 A dry aggregate count should be made often enough to ensure that changes in aggregate do not occur unnoticed (approximately once per week). If a change greater than ± 0.5 percent occurs, a new correlation shall be run.

8.2.2 Place the dry hot aggregate in a tared sample pan in two equal layers.

8.2.3 Use a spatula to distribute the aggregate uniformly, so that the coarse and fine aggregate do not segregate.

NOTE 3: Too much spading can cause the fines to migrate to the bottom, resulting in excessive sample weight.

8.2.4 Raise and drop the pan approximately one inch, four times. Be sure that the pan bottom strikes evenly.

8.2.5 Fill the pan with the second layer slightly above the top rim.

8.2.6 Raise and drop the pan approximately one inch, four times.

8.2.7 Place a straightedge firmly across the rim and use a sawing motion to strike off the surface of the sample, so that it is flush with the rim. Gaps between the straight edge and the sample shall be filled with fine aggregate and the sample leveled. Do not compact the sample. Obtain and record the temperature and weight of the sample.

8.2.8 Obtain a 16-minute sample count following the gauge manufacturer's instructions. This count will be used to determine if changes occur in the aggregate used during construction.

8.3 There are two methods used to prepare the sample pans used for correlation. Method A is used when each laboratory prepares and tests the pans. Method B is used when the sample pans are prepared in the Contractor's lab and then used for the correlation curve generation in a CDOT lab. The Region Materials Engineer will designate which method will be used.

Method A

8.3.1 Heat all bowls, sample pans, tools, aggregate, and asphalt binder to the mixing temperature listed in CP-L 5115 for the asphalt binder being used. An initial or "butter" mix is required to condition the mixing equipment. Mix a minimum of three asphalt concrete samples to cover the approximate range of the design asphalt content. Mix one at the design asphalt content, one at 1.0 percent above and one at 1.0 percent below, or at other percentages as required to cover the range of expected use. Use the same source, grade and type of asphalt binder that will be used in the asphalt concrete mixture to be tested. All elements of the mix design must be utilized, including hydrated lime.

NOTE 4: It is recommended that the design optimum asphalt content sample be mixed and placed in the sample pan first to determine the test weight for all samples.

8.3.2 Fill the sample pan one-half full, evenly distributing the sample in the pan.

8.3.3 Level the asphalt concrete mixture with a trowel or spatula.

8.3.4 Fill the remainder of the pan so that the asphalt concrete mixture is mounded above the top of the pan. Record the weight of the asphalt

concrete mixture in the pan. This is the weight that all correlation and test samples will be measured.

8.3.5 Use a metal plate, plywood, or survey stake to consolidate the asphalt concrete mixture until it is even with the top edge of the pan. Make sure that excessive voids are not visible in the corners of the pan. All specimens shall be compacted at a temperature between 250°F - 300°F (121°C - 149°C).

NOTE 5: For AC gauges that do not have temperature compensation capability, obtain and record the temperature of the sample. This is the temperature $\pm 10^\circ\text{F}$ ($\pm 6^\circ\text{C}$) at which all samples and correlation pans will be measured.

8.3.6 Prepare the remainder of the correlation sample pans following the procedures of 8.3.1 thru 8.3.5. Use the same weight of asphalt concrete mixture in each pan.

Method B

8.3.7 CDOT personnel will witness the Contractor's laboratory prepare the correlation sample pans following the procedures of 8.3.1 thru 8.3.6.

8.3.8 When CDOT personnel can not witness the Contractor's laboratory prepare the correlation sample pans; CDOT personnel will prepare a sample at optimum AC content following the procedures of 8.3.1 thru 8.3.5.

8.3.8.1 At the completion of procedures 9.1 thru 9.5 the CDOT prepared sample pan will be tested following the procedures of 10.9 and 10.10. If the gauge result varies by more than 0.20% from the optimum AC content, a new gauge correlation is required.

9. CORRELATION GENERATION:

9.1 Follow the gauge manufacturer's procedures to start a new correlation.

NOTE 6: Most gauge manufacturers use the term calibration instead of correlation for preparing a correlation curve.

9.2 Place the sample pan in the gauge and set the count time for a 16-minute count.

Proceed following manufacturer's instructions for operation of the equipment and the sequence of operation.

9.3 Repeat Section 9.2 for the remainder of the correlation samples.

9.4 Prepare a correlation curve by plotting the correlation asphalt concrete mixture sample readings versus asphalt content on linear graph paper, choosing convenient scale factors for counts and asphalt content. Connect the points with a straight line. On most gauges the equation (slope and intercept) for this line is generated internal to the gauge. A correlation will be considered acceptable if the correlation factor is greater than or equal to 0.9990.

$$\text{Correlation factor} = \sqrt{1 - \frac{\sum_i (Y_i - \hat{Y}_i)^2}{\sum_i (Y_i - \bar{Y})^2}}$$

Where:

Y_i = Actual percent asphalt values for each sample,

\hat{Y}_i = Calculated percent asphalt values from curve,

\bar{Y} = Mean value of the actual percentages asphalt,

i = Number of correlation samples.

9.5 At the conclusion of procedure 9.4 perform an additional background count to compare with the original background count performed in section 7.2. A variation of greater than 1.0 percent from the previous background count is unacceptable.

NOTE 7: The formula to calculate the slope and intercept of a straight line is

$$y = mx + b$$

The slope, m , is calculated using the following equation.

$$\text{Slope}(m) = \frac{y_2 - y_1}{x_2 - x_1}$$

The intercept, b, is calculated using the following equation.

$$b = y_1 - mx_1$$

Where for Troxler Gauges:

- x_1 = Measured count of Point 1/1000,
- x_2 = Measured count of Point 2/1000,
- y_1 = Percent AC of Point 1,
- y_2 = Percent AC of Point 2.

Where for CPN Gauges:

- x_1 = Percent AC of Point 1,
- x_2 = Percent AC of Point 2,
- y_1 = Measured count of Point 1,
- y_2 = Measured count of Point 2.

10. DETERMINING ASPHALT CONTENT OF HMA SAMPLES

10.1 Sample the HMA in accordance with Section 6.3.

10.2 The sample portion to be tested should provide approximately 17.6 lb. (8 kg) per test unit.

10.3 The test sample shall be checked for moisture content. The percentage moisture determined must be subtracted from the asphalt content percentage as indicated by the nuclear AC gauge. Determine the amount of moisture in the mixture in accordance with CP 43 and CP 55.

10.4 Adjust the test sample temperature to 250 °F - 300 °F (121 °C - 149 °C).

10.5 Fill the sample pan one-half full; evenly distribute the sample in the pan.

10.6 Level the asphalt concrete mixture with a trowel or spatula.

10.7 Fill the remainder of the pan until the weight of the asphalt concrete mixture in the pan is equal to plus or minus 5 grams of the mass of mix in the samples used for correlation in Section 8.3.4. Record the weight of the asphalt concrete mixture in the pan.

10.8 Use a metal plate, plywood, or survey stake to compact the asphalt concrete mixture until it is even with the top of the pan.

NOTE 8: For AC gauges that do not have temperature compensation capability, obtain and record the temperature of the sample. The starting test temperature shall be 180 °F to 290 °F (82 °C to 143 °C) and within ± 10 °F (± 6 °C) of the correlation temperature.

10.9 Place the sample in the gauge. Set the gauge to take a single 16-minute count. Follow the manufacturer's instructions to obtain sample asphalt content.

10.10 Correct asphalt content for moisture content.

11. REPORT

11.1 The results are reported on the following CDOT forms:

11.1.1 CDOT Form #772, Nuclear Asphalt Content Gauge Log (Example in Chapter 800).

11.1.2 CDOT Form #599, Nuclear Asphalt Content Correlation (Example in Chapter 800).

11.1.3 CDOT Form #106, Asphalt Tests (Example in Chapter 800).

Chapter 200

Soils - 10

DEFINITION

Soils, as defined by most engineers and technicians involved in highway construction, includes all unconsolidated earthen particles, which overlie bedrock. Usually, particles, which are retained on the No. 4 sieve, are referred to as rock. Since most soil tests are conducted on minus No. 4 material, the term soil will be used in this context. The characteristics or types of soil are determined primarily by particle size, shape, and gradation, and to a lesser extent by mineral composition and organic content. Engineering characteristics of soil are also dependent on the volume and distribution of voids and the amount of water that occupies these spaces. Definitions for various terms used in Chapter 200 are given on Pages 12 and 13.

SOURCE

All soil is derived from bedrock, so it is very helpful to know from what type of rock soils originate. All rocks on earth are grouped into three main classes, according to the way they were formed:

1. **Igneous** - Result from cooling and solidification of molten material, either above or below the earth's surface. Examples include granite, basalt, gabbro, felsite, etc.
2. **Sedimentary** - Result from rock fragments (sediments) being moved by wind, water, and other agents, which over a period of time (millions of years) become compacted and cemented to form rock. Examples include sandstone, shale, limestone, etc.
3. **Metamorphic** - Result from igneous and sedimentary rocks, which are greatly changed in character by temperature, pressure, and other factors working within the earth's crust. Examples include marble, gneiss, schist, slate, etc.

COMPOSITION

Natural soil deposits are a result of mechanical and chemical erosion of bedrock. The character of a soil deposit is dependent upon the source rock, type and severity of mechanical erosion, and chemical action.

The composition of the soil in a particular deposit is dependent upon the type of bedrock (source material) from which it originated. It is likely that source rock, such as granite, will produce granular soil and that source rock, such as shale, will produce clayey soil. Occasionally; granites, containing orthoclase feldspar, are chemically weathered to form clay. Also, shales are sometimes mechanically weathered to form angular gravel. However, in most instances, the source rock is the dominant factor in determining the type of soil that is formed.

The size, shape and gradation of material within a soil deposit is a result of distance and method the material traveled from its source. Usually material that travels a short distance, such as stream terrace deposits within mountain areas tend to be coarse grained and more angular than material deposited hundreds of miles from the source rock. Stream deposited material tends to be graded and rounded; whereas, wind deposited material tends to be of uniform particle size and angular.

LAND FORMS

Although more useful to the Soils Engineer and the Region Materials Section, especially when running soil profiles or searching for borrow and aggregate sites, the recognition of different types of soil deposits (and/or land forms) is extremely important. Soil deposits consist of either residual or transported soil. Residual soil is merely altered or weathered bedrock that lies in place directly above its parent rock. Most soil has been transported away from the parent rock by water, wind, or ice to create a particular landform. By recognizing and properly locating different landforms, the type of soil can be determined without excessive testing. Landforms of particular interest (those most likely to be encountered in Colorado) are listed below.

Stream or River Terrace - Consisting of material, which is usually clean, medium to coarse sandy gravel, sub-angular to rounded, and fair to good gradation.

Alluvial Fan - Consists of silt, sand, gravel, cobbles, and boulders, which are usually angular and poorly, graded.

Sand Dune - Consists of clean sand, which is usually fine, and of fairly uniform size.

Loess Deposit - Consists of wind blown silt.

Glacial Moraine - Consists of poorly graded material containing nearly all particle sizes ranging from clay to boulders.

In recognizing such landforms it is very helpful to have some knowledge of the geological processes that produced them. Many landforms can be located on topographic maps and aerial photographs prior to going into the field. Experience in and/or having had a course in aerial photographic interpretation is invaluable in learning to identify landforms properly.

CHARACTERISTICS

Physical characteristics of soils may be described by particle size, gradation, shape, surface area, and density. Soil particles range from a minimum diameter of 0.00001 mm to a maximum diameter of 5 mm. Gradation may range from good to poor. Good gradation means even distribution of all particle sizes. Poor gradation refers to uniform material (one particle size) or to uneven distribution of particle sizes. Shape of soil particles is usually described as bulky or platy. Bulky particles may be angular or rounded. Surface area may be defined as the aggregate surface area of the particles per unit mass. The most common unit used is cm^2 per gram of solids. Density of soil masses are given by unit weight (mass) (lbs. per cu.ft.(kg/m^3)) and the density of individual particles by specific gravity (ratio of unit weight (mass) of solids to that of water).

The physical properties described above have a profound effect on the engineering strength value of soil masses. Large, angular, bulky, well graded soil particles usually contribute to relatively high strength values. This is especially true if these conditions are accompanied by high density.

High density is associated with low void ratios, low surface areas, high specific gravity, and optimum moisture. Relatively low strength is usually associated with fine, platy, poorly graded soil particles with high surface area and low specific gravity. Low soil strength is synonymous with high void ratios (low density) and excessive moisture.

CLASSIFICATION

There are many different methods of soil classification. There is not a uniform system used by all government and private agencies. However, some type of textural classification, which is dependent on particle size, shape, and gradation is used by all soils engineers.

The Colorado Department of Transportation uses the AASHTO method of Engineering Soil Classification, which groups soils according to their load carrying capacity and service characteristics. Designations are A-1, A-2, A-3, A-4, A-5, A-6, and A-7. Generally speaking, the higher numbers indicate poorer quality. Soils classified as A-1, A-2, and A-3 are considered granular material (35% or less passing the No. 200 sieve). Soils classified as A-4, A-5, A-6, and A-7 (35% or more passing the No. 200 sieve) are considered silt-clay materials.

SOIL SURVEY

Preliminary Soil Surveys are conducted prior to new alignments and most widening projects. The purpose of these surveys is to locate the various soil types within proposed roadways above and below profile grade elevations. The extent of each soil type is noted and each type is identified by the AASHTO classification method. The condition of sub-soils upon which embankments will be constructed is determined. This involves moisture content, density, and ground water distribution. Applicable procedures are located on pages 58 thru 77 of this Chapter.

Region Soil Survey Sampling Checklist

Preliminary Soil Profile

(see FMM Chapter 200 for details)

Sampling of Boring Materials

1. Take one sample per soil type containing at least 33 lbs (15 kg) of -#4 materials for **Classification**.
2. Soil samples taken in each boring will be **visually classified and similarized** in the Region.
3. Soil samples will be logged on the Form #555 by Region personnel prior to shipment to the Central Laboratory.
4. Test holes will be logged individually in numerical order following the convention noted in the Soil Survey / Preliminary Soil Profile, Subsection 6.4.
5. Samples that are similar will be logged after the initially encountered soil type.
6. There will not be more than 1 mile between similarized soil samples.
7. Soil samples for **Sulfate** tests will be collected for **each** soil type in **each** boring.
8. Soil samples for **Sulfate** tests will be collected with a minimum of 5 lbs.
9. Sulfate samples will be sealed in a container or bag, marked with the Test No. and logged on Form #555 by placing an "S" in the Sulfate column. A copy of Form #157 and Form #555 will be included in the Sulfate submittal to be sent to the Central Laboratory Chemical Unit.

Materials Ownership and Forms

1. The soil samples will be logged on the most current Preliminary Soil Survey Form #555.
2. Form #157 will be completed with specified soil tests by Region personnel.
3. Form #157 and Form #555 will be included in the sample bag with the tag (Form #633) marked appropriately.
4. Electronic Form #555 shall be e-mailed to Central Lab Soils Program lab manager.
5. Soil samples will be sent to Region or Central Lab Soil Program for analysis.
6. Samples for **Sulfate** tests will be tagged (Form #633) and sent to Region or Central Lab's Chemical Unit with a copy of the Form #157.

Soil Survey of Constructed Roadbeds

(see CP 24 for details)

New & Widened Roadways and Sampling of Boring Materials

1. Borings will be drilled in final subgrade prior to pavement overlay.
2. A minimum of one boring per 1,000 linear feet of completed 2-lane roadway will be done.
3. Minimum depth of 2 feet below finished subgrade is required.
4. Take one sample per soil type containing at least 33 lbs (15 kg) of -#4 materials for **classification**.

Materials Ownership and Documentation

1. **Field or Region Lab** will use CP 20, CP 21, and Form #564 to complete the soil classification.
2. **Field or Region** will follow CP 24 and mathematically scalp the gradation on the appropriate sieve and determine if there are significant variations in the material from the preliminary soil survey.
3. **If there are significant variations from the preliminary soil survey**, all +3/8, +#4, and -#4 material will be separated and retained in separate bags.
4. The sample material with a Form #157 requesting an R-value will be sent to the Region Lab (*) or Central Lab.
5. The soil classification on Form # 564 will also be sent to the Region Lab or Central Lab.
6. If **no** significant variations are found, record on Form #219 for project documentation.

Borrow Pits

(see Standard Specifications for Road & Bridge Construction for details)

Contractor Source: The cost of complying with Section 106.02, (b) *Contractor Source* requirements, including sampling, testing, and corrective action by the Contractor, shall be included in the work.
CDOT reserves the right to verify the contractor's source.

Materials Ownership, Sampling, and Forms (FMM QA Schedule)

1. If embankment will support concrete pavement or will be chemically stabilized, during production, one soil sample per 2000 yds³ or fraction thereof, will be tested for sulfate from the designated source by CDOT project or Region personnel.
2. Results will be documented on Forms #157 and #323.
3. During qualification of a borrow source, one 5 lb. sample of soil, per soil type, will be submitted to the Chemical Unit of the Central Laboratory for sulfate content.

Notes:

1. Region Lab/Soils Program will perform classification of soils.
2. Chemical Unit will perform chemical analysis of soil samples for sulfates.
3. Chemical Unit will provide the Project with the chemical analysis on qualification of borrow sources.
4. For the preliminary soil survey, the Chemical Unit will provide the Region Materials Program with the chemical analysis reports and forward the results to the Soils Program.
5. The Soils Program will input the chemical results onto the electronic Form #555, and forward the completed preliminary soil survey to the Region Materials Program.
6. * If the Region Lab has the ability to perform CP-L 3101 and CP-L 3102 then no sample needs to be sent to the Central Lab.

Region Soil Survey Drilling Checklist

Reconnaissance of Drill Site

	<u>Yes</u>	<u>No</u>	<u>N/A</u>
1. Was a reconnaissance survey of the area to be drilled performed?	<input type="checkbox"/>	<input type="checkbox"/>	<input type="checkbox"/>
2. Have landowner clearances and locates been obtained?	<input type="checkbox"/>	<input type="checkbox"/>	<input type="checkbox"/>
3. Have temporary easements been obtained?	<input type="checkbox"/>	<input type="checkbox"/>	<input type="checkbox"/>
4. Have drilling methods been determined?	<input type="checkbox"/>	<input type="checkbox"/>	<input type="checkbox"/>
5. Have roadway condition and type of pavement been noted?	<input type="checkbox"/>	<input type="checkbox"/>	<input type="checkbox"/>
6. Have rock outcrops been noted?	<input type="checkbox"/>	<input type="checkbox"/>	<input type="checkbox"/>
7. Have survey cross sections or profiles been performed?	<input type="checkbox"/>	<input type="checkbox"/>	<input type="checkbox"/>
8. Is there drilling for existing roadway?	<input type="checkbox"/>	<input type="checkbox"/>	<input type="checkbox"/>
9. Is there drilling for new or extension of roadway surface?	<input type="checkbox"/>	<input type="checkbox"/>	<input type="checkbox"/>
10. Have structures and culverts been identified?	<input type="checkbox"/>	<input type="checkbox"/>	<input type="checkbox"/>
11. Has the Soil Survey Field Report, Form # 554 been completed?	<input type="checkbox"/>	<input type="checkbox"/>	<input type="checkbox"/>
12. Have Corrosion/Resistance samples been taken?	<input type="checkbox"/>	<input type="checkbox"/>	<input type="checkbox"/>

Preliminary Soil Survey

General

- | | | | |
|---|--------------------------|--------------------------|--------------------------|
| 1. Preliminary Soil Survey, Form #555 worksheet available and used? | <input type="checkbox"/> | <input type="checkbox"/> | <input type="checkbox"/> |
| 2. Borings drilled in roadway? | <input type="checkbox"/> | <input type="checkbox"/> | <input type="checkbox"/> |
| 3. Borings drilling in shoulder? | <input type="checkbox"/> | <input type="checkbox"/> | <input type="checkbox"/> |
| 4. Boring drilled in R.O.W.? | <input type="checkbox"/> | <input type="checkbox"/> | <input type="checkbox"/> |
| 5. 1 boring per 1,000 linear feet of 2-lane roadway minimum? | <input type="checkbox"/> | <input type="checkbox"/> | <input type="checkbox"/> |
| 6. 1 boring per 500 linear feet of 2-lane roadway in cut areas minimum? | <input type="checkbox"/> | <input type="checkbox"/> | <input type="checkbox"/> |
| 7. Is the finished grade known? | <input type="checkbox"/> | <input type="checkbox"/> | <input type="checkbox"/> |
| 8. Depth of boring minimum of 1-3 feet below finished roadway grade? | <input type="checkbox"/> | <input type="checkbox"/> | <input type="checkbox"/> |
| 9. Is the finished grade unknown? | <input type="checkbox"/> | <input type="checkbox"/> | <input type="checkbox"/> |
| 10. Depth of boring minimum of 1-3 feet into subgrade material? | <input type="checkbox"/> | <input type="checkbox"/> | <input type="checkbox"/> |
| 11. Additional drilling performed after the finished grade is known? | <input type="checkbox"/> | <input type="checkbox"/> | <input type="checkbox"/> |
| 12. Water table encountered and noted? | <input type="checkbox"/> | <input type="checkbox"/> | <input type="checkbox"/> |
| 13. Drilling adjacent to Wetlands? | <input type="checkbox"/> | <input type="checkbox"/> | <input type="checkbox"/> |
| 14. Ground water wells established? | <input type="checkbox"/> | <input type="checkbox"/> | <input type="checkbox"/> |
| 15. In-situ samples taken? | <input type="checkbox"/> | <input type="checkbox"/> | <input type="checkbox"/> |

See next page

Cut Areas

- | | | | |
|---|--------------------------|--------------------------|--------------------------|
| 1. Boring location similar to Figure SS-1 in Chapter 200 of FMM? | <input type="checkbox"/> | <input type="checkbox"/> | <input type="checkbox"/> |
| 2. Boring depth similar to Figure SS-3 in Chapter 200 of FMM? | <input type="checkbox"/> | <input type="checkbox"/> | <input type="checkbox"/> |
| 3. Depth of boring minimum of 3 feet below finished roadway grade? | <input type="checkbox"/> | <input type="checkbox"/> | <input type="checkbox"/> |
| 4. Additional drilling performed in cut sections needed? | <input type="checkbox"/> | <input type="checkbox"/> | <input type="checkbox"/> |

Fill Areas

- | | | | |
|---|--------------------------|--------------------------|--------------------------|
| 1. Depth of fill up to 20 feet? | <input type="checkbox"/> | <input type="checkbox"/> | <input type="checkbox"/> |
| 2. Boring location similar to Figure SS-2 in Chapter 200 of FMM? | <input type="checkbox"/> | <input type="checkbox"/> | <input type="checkbox"/> |
| 3. Depth of fill greater than 20 feet? | <input type="checkbox"/> | <input type="checkbox"/> | <input type="checkbox"/> |
| 4. Boring depth 5 feet into hard substratum? | <input type="checkbox"/> | <input type="checkbox"/> | <input type="checkbox"/> |
| 5. Boring depth similar to Figure SS-4 in Chapter 200 of FMM? | <input type="checkbox"/> | <input type="checkbox"/> | <input type="checkbox"/> |

** If suspicious material is encountered during drilling*

- *Stop Drilling*
- *Do not move the drill rig*
- *Secure area and provide traffic control if necessary*
- *Contact Region Environmental and/or Region Safety Coordinator*

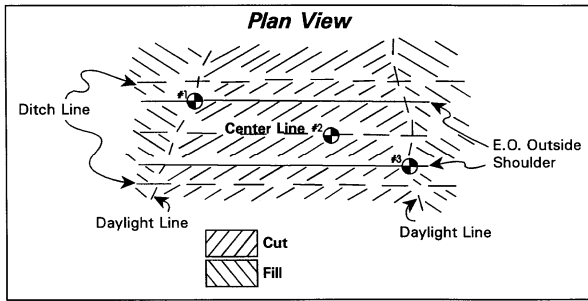

Figure SS-1

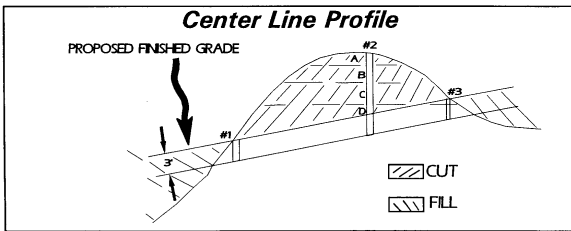

Figure SS-2

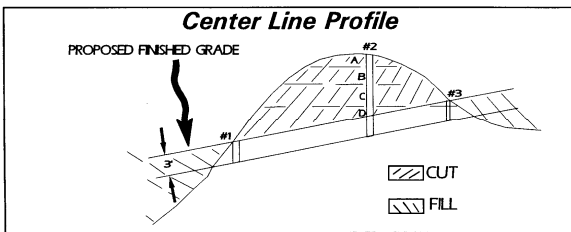

Figure SS-3

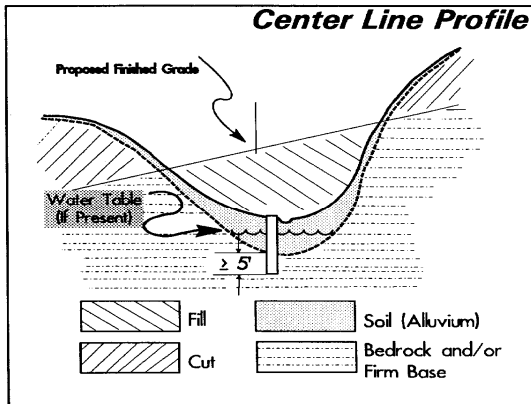

Figure SS-4

LABORATORY TESTS

To accurately classify soil by the AASHTO method, a series of standard tests must be performed:

- Dry Preparation of Disturbed Soil Samples - CP 20
- Mechanical Analysis of Soils - CP 21
- Liquid Limit of Soils - AASHTO T 89
- Plastic Limit and Plasticity Index of Soils - AASHTO T 90

A chart indicating soil classification by the AASHTO method can be found on the Page 18 Table of Contents. Although this method separates soils into specific types according to gradation and Atterberg Limits characteristics, further testing is needed to obtain specific soil strength values such as R-values, cohesion, angle of internal friction, etc.

Other laboratory tests to determine engineering values are as follows:

- Compaction - AASHTO T 99 (Standard)
- Compaction - AASHTO T 180 (Modified)
- Consolidation/Swell Potential – AASHTO T 216
- Expansion Pressure and Resistance Values - AASHTO T 190
- Triaxial Compression - AASHTO T 234
- Direct Shear Test - AASHTO T 236
- Permeability - AASHTO T 215

EXPANSIVE SOILS

Soils considered to be expansive are those which exhibit a high volume change with an increase in moisture content. These soils usually occur in bedrock formations, are dense and fairly dry, and normally have a high liquid limit and plastic index. Problems from expansive soils usually occur in cut areas and in the transition from cut to fill areas. Embankments constructed from the same type of soil which has been

reworked and compacted at 95% of maximum dry density at optimum moisture as determined by AASHTO T 99, have not known much distress.

The problems caused by expansive or swelling soils have been of great concern to highway engineers for many years and is the subject of continued research. Some of the remedial measures, which have met with success in cut areas of expansive soils are:

1. The use of a membrane directly on the finished sub-grade through cut sections. The membrane is usually placed in the ditch section and up the back slope to an elevation equal to that of the wearing course.
2. The placement of plant mix bituminous base directly on the sub-grade. Membranes are sometimes used in the ditch section in conjunction with this procedure to provide better drainage.
3. The sub-excavation of expansive material and backfilling with impermeable material at 95% of maximum dry density and close to optimum moisture as determined in accordance with AASHTO T 99. It has been found that clean granular material should not be used to backfill sub-excavations, as it tends to collect water thereby wetting the sub-grade and increasing the swell potential.

When expansive soils are encountered on a project the Region Materials Engineer should be contacted. More information on swelling soils is available in the Soil Survey portion of this Chapter.

Soil sampling and test methods appear in the CP portion of the Field Materials Manual. Examples and explanations of CDOT Forms can be located in the Table of Contents on Page 18 along with many useful charts, nomographs, and instructions.

UNSTABLE SOILS

Soil, when tested in accordance with AASHTO T 190, as modified by CP-L 3101 will be analyzed for stability using CP-L 3102. Soil is unstable when the following criteria are met (see FIGURE 200-1):

- The decrease of R-value from 400 psi to 300 psi is 10 or greater, and
- The optimum moisture of AASHTO T 99 or T 180 is greater than the exudation moisture at 300 psi.

The statement 'This material meets the criteria as "unstable" as defined in Subsection 3.4 of CP-L 3102.' will be written in the notes section on Form #323.

Projects where unstable soil is used, with moisture control during construction, should be carefully monitored. A test section should be considered. The unstable soil should be compacted at a moisture content of 1% to 2% below optimum moisture.

Other potential remediation alternatives for unstable soil may include the following:

- Mechanical improvement, including the use of a geosynthetics such as geotextile or geogrid.
- Chemical treatment such as cement, fly ash or cement/fly ash combination.

Region Materials should be contacted when unstable soils are encountered on a project.

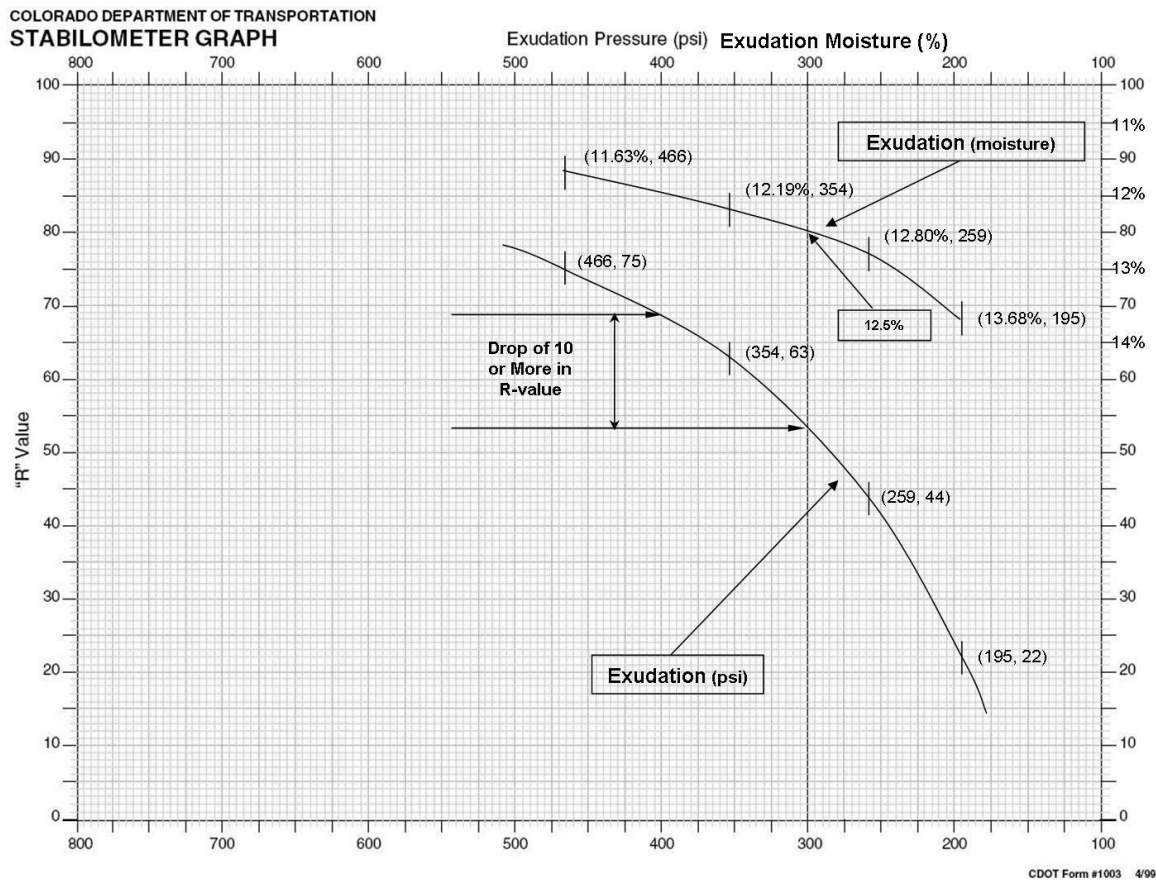

FIGURE 200-1

ITEM 203 COMPACTION

Proper compaction of embankments is necessary to provide a stable base for roadway pavement. It must be understood that the foundation soil directly beneath the embankment has to be strong enough to support it. Insufficient strength of foundation soil could cause damage by shear failure, slip outs, or displacement of underlying soft material by outward plastic flow. Highly compressible soil in the foundation could result in excessive settlement.

Embankment strength is dependent upon three basic conditions: (1) Moisture Content, (2) Compactive Effort, and (3) Soil Characteristics. The soils engineer has reasonable control over the first two, but usually has no way of altering the material being placed in the embankment. Because of this, it is essential that embankment material be accurately classified using the AASHTO method and that the soil samples tested truly represent the material being used.

Optimum moisture and maximum density values are determined according to either AASHTO T 99 (Standard) or AASHTO T 180 (Modified) as called for in the plans. These values are determined by the Central Laboratory on representative samples taken during the preliminary soil survey and are provided to field personnel prior to construction. It is the responsibility of the Engineer to assure that the optimum moisture and maximum density of the in-place embankment material meet the requirements in Subsection 203.07 of the Standard Specifications.

Procedure

Roadway embankment material must be placed in horizontal layers. Material placed in lifts shall not exceed eight inches (200 mm) in thickness prior to compaction. When material consists predominately of rock over eight inches (200 mm), lift thickness may equal the average rock dimension but shall not exceed three feet (1 m). Rocky material should be uniformly distributed throughout the embankment to assure thorough consolidation.

Embankment material, which contains more than 50% (by weight (mass)) of particles retained on the No. 4 sieve, is considered rock embankment. Rock embankment shall be

compacted according to Subsection 203.08 of the Standard Specifications.

Field Equipment

Type of compaction equipment to be used by the Contractor is optional unless otherwise specified on the plans. The Contractor, however, must meet density and percent moisture requirements. Common types of compaction equipment used are:

- **Sheepsfoot Roller** - Used with silt and clay.
- **Rubber Tired Rollers** - Used with granular or cohesive soils.
- **Smooth-Wheel Rollers** - Used with base coarse materials and for finishing operations.
- **Vibratory Rollers** - Used with granular soils.

Roller Hours

When "Roller Hours" are specified on a project, estimated yardage (volume) shall be documented on CDOT Form #212. The estimated yardage (volume) shall be placed in the appropriate section as instructed on the CDOT Form # 212 (example in this chapter) and shall be marked "for information only". In-place density tests should be taken for documentation when practical. A brief statement on the type, weight (mass), and effectiveness of the roller should be included under "Remarks". To identify the CDOT Form # 212 as an "information only report", write "Roller Hours" in the space provided after "other" (under modified AASHTO T 180).

Field Tests

A minimum of one moisture density test must be taken for each 2000 cubic yards (1500 m³) of embankment material placed. Changes in embankment material may require more tests. The following test methods are acceptable and are published in this Field Materials Manual:

- CP 80 In-Place Density and Moisture Content of Soil and Soil-Aggregate by the Nuclear Method

- CP 22 Determining Density of Soil and Soil Aggregate Mixtures In-Place by the Sand Replacement Method
- CP 23 Determining Maximum Dry Density and Optimum Moisture of the Total Sample of Soil-Rock Mixture
- CP 25 Calculation of Percent Relative Compaction of Soils and Soil-Rock Mixtures

Results of these field tests must be recorded and retained in project files on CDOT Form #212. Moisture content and relative compaction requirements are listed in Subsection 203.07 of the Standard Specifications.

Zero Air Voids Density

The Zero Air Voids Density Tabulation shown in this Chapter represents the dry density that would be obtained at the various moisture contents if there were no air voids present, i.e., when all voids between soil particles are filled with moisture. At a given moisture content and specific gravity, the zero air voids density represents the maximum density that can be obtained in the given soil.

The in-place dry density and the in-place moisture from the test results on CDOT Form #212 should be checked against the zero air voids density. For clays and silts a specific gravity of 2.70 may be used and 2.65 for other materials. The in-place dry density should never exceed the zero air voids density at the in-place moisture and the specific gravity of the material. If it does, some of the data is erroneous. To avoid using incorrect density values, the tester should check the Zero Air Voids Density Tabulation (Page 10) whenever a percent relative compaction figure of 105% or more is calculated.

ITEM 206 STRUCTURE BACKFILL

Section 206 of the Standard Specifications lists two classes of Structure Backfill. They are: Class 1, which is graded, granular material meeting the requirements of Subsection 703.08 (a), and Class 2 which shall be composed of suitable material developed on the project. Field personnel are to indicate on the CDOT Form #157, accompanying the sample, which method of determining maximum density (AASHTO T 99 or T 180) is applicable to the material submitted.

The density required for Class 1 Structure Backfill will be not less than 95% of maximum

density determined in accordance with AASHTO T 180. More information on Structure Backfill, Class 1 appears in Chapter 300 of this Manual.

The density required for Class 2 Structure Backfill shall conform to Subsection 203.07 and unless otherwise designated, the type of compaction shall be the same as that specified for the project. If not specified, or if there is no contract pay item, Class 2 Structure Backfill shall be placed in accordance with AASHTO T 180.

It has become a policy of the CDOT that in the event a Contractor elects to substitute aggregate base course for Class 2 Structure Backfill, the maximum density determination and percent relative compaction will be the same as for Class 1 Structure Backfill.

NOTE: When using Class 2 Structure Backfill that is composed of an appreciable amount of plus Number 4 material, Subsection 206.03, paragraph 3 should be strictly adhered to. See also Subsection 703.08, paragraph (b) for further requirements when plus Number 4 material is present. This is very important, in order not to cause any damage to the structure. Class 1 Backfill material should be used if there is any doubt about placing the Class 2 material in the 6" (150 mm) lift required. The use of "too rocky to test" in lieu of the actual testing should be used very sparingly; therefore, it may apply when more than 50% of the material is retained on the 3/4" sieve. Almost all Class 2 Backfill should be tested.

ZERO AIR VOIDS DENSITY TABULATION, TABLE 200-1

Moisture, % of Dry Wt.	Dry Density (ZAVD)					
	@ 2.65 SP. GR.		@ 2.70 SP. GR.		@ 2.75 SP. GR.	
	lb/ft ³	kg/m ³	lb/ft ³	kg/m ³	lb/ft ³	kg/m ³
9.0	133.5	2138.4	135.5	2170.5	137.6	2204.1
9.5	132.1	2116.0	134.1	2148.1	136.1	2180.1
10.0	130.7	2093.6	132.7	2125.6	134.6	2156.1
10.5	129.4	2072.8	131.3	2103.2	133.2	2133.6
11.0	128.3	2055.1	129.9	2080.8	131.7	2109.6
11.5	126.7	2029.5	128.6	2060.0	130.3	2087.2
12.0	125.5	2010.3	127.3	2039.1	129.0	2066.4
12.5	124.2	1989.5	126.0	2018.3	127.7	2045.5
13.0	123.0	1970.3	124.7	1997.5	126.4	2024.7
13.5	121.8	1951.0	123.5	1978.3	125.1	2003.9
14.0	120.6	1931.8	122.3	1959.0	123.9	1984.7
14.5	119.5	1914.2	121.1	1939.8	122.7	1965.4
15.0	118.3	1895.0	120.0	1922.2	121.5	1946.2
15.5	117.2	1877.3	118.8	1903.0	120.3	1927.0
16.0	116.1	1859.7	117.7	1885.4	119.2	1909.4
16.5	115.1	1843.7	116.6	1867.7	118.0	1890.2
17.0	114.0	1826.1	115.5	1850.1	117.0	1874.1
17.5	113.0	1810.1	114.4	1832.5	115.8	1854.9
18.0	112.0	1794.0	113.4	1816.5	114.8	1838.9
18.5	111.0	1778.0	112.4	1800.5	113.7	1821.3
19.0	110.0	1762.0	111.4	1784.4	112.7	1805.3
19.5	109.0	1746.0	110.4	1768.4	111.7	1789.2
20.0	108.1	1731.6	109.4	1752.4	110.7	1773.2
20.5	107.2	1717.2	108.5	1738.0	109.7	1757.2
21.0	106.2	1701.1	107.5	1722.0	108.8	1742.8
21.5	105.3	1686.7	106.6	1707.6	107.8	1726.8
22.0	104.5	1673.9	105.7	1693.1	106.9	1712.4
22.5	103.6	1659.5	104.8	1678.7	106.0	1697.9
23.0	102.7	1645.1	103.9	1664.3	105.1	1683.5
23.5	101.9	1632.3	103.1	1651.5	104.2	1669.1
24.0	101.1	1619.5	102.2	1637.1	103.4	1656.3
24.5	100.3	1606.6	101.4	1624.3	102.5	1641.9
25.0	99.5	1593.8	100.6	1611.4	101.7	1629.1
25.5	98.7	1581.0	99.8	1598.6	100.9	1616.2
26.0	97.9	1568.2	99.0	1585.8	100.1	1603.4
26.5	97.2	1557.0	98.2	1573.0	99.3	1590.6
27.0	96.4	1544.2	97.4	1560.2	98.5	1577.8
27.5	95.7	1533.0	96.7	1549.0	97.7	1565.0
28.0	94.9	1520.1	96.0	1537.8	97.0	1553.8
28.5	94.2	1508.9	95.2	1524.9	96.2	1541.0
29.0	93.5	1497.7	94.5	1513.7	95.5	1529.7
29.5	92.8	1486.5	93.8	1502.5	94.7	1516.9
30.0	92.1	1475.3	93.1	1491.3	94.0	1505.7
30.5	91.4	1464.1	92.4	1480.1	93.3	1494.5
31.0	90.8	1454.5	91.7	1468.9	92.6	1483.3
31.5	90.1	1443.2	91.0	1457.7	91.9	1472.1
32.0	89.5	1433.6	90.4	1448.1	91.3	1462.5
32.5	88.8	1422.4	89.7	1436.8	90.6	1451.3
33.0	88.2	1412.8	89.1	1427.2	90.0	1441.6
33.5	87.5	1401.6	88.5	1417.6	89.3	1430.4
34.0	87.0	1393.6	87.8	1406.4	88.7	1420.8
34.5	86.4	1384.0	87.2	1396.8	88.1	1411.2
35.0	85.8	1374.4	86.6	1387.2	87.4	1400.0
35.5	85.2	1364.8	86.0	1377.6	86.8	1390.4

ITEM 206 FILTER MATERIAL

It is extremely difficult to write standard specifications that would produce an ideal filter material covering all conditions for backfill around sub-drains. A protective filter is a pervious material that will allow the free infiltration of water but will prevent the entrance of soil into the filter. A standard specification for such a material cannot be anymore than a good guide for the average conditions encountered, and often, engineering experience, intelligently applied, will indicate that some slight deviation from a standard specification is desirable.

A good standard specification covering the average condition would include a material equivalent to a good concrete sand. Experience has proven that coarse backfill is definitely not a proper material to be used in some sub-drain trenches.

The Basic Problem

Much of the problem of selecting the right aggregates for drainage systems stems from the need of satisfying two conflicting requirements. (1) The aggregates must have pores that are large enough to permit water to flow readily through the layer. (2) Drainage layers in contact with soil must be fine enough to prevent the trench soil from washing through the pores of the aggregate with resultant clogging of the system (usually the pores will not clog if the 15% size of the filter is not more than 5 times the 85% size of the soil). Meeting both requirements with one material sometimes can be nearly impossible. If it should become necessary to choose between one requirement or the other, the first one should have precedence. One solution in difficult cases is the use of graded filters having two or more layers. One layer or zone of aggregate should be fine enough to hold the soil in place. In addition, one or more coarser layers may be used to provide the needed water removing capacity. Graded filters of two or more layers are very common in dams. However, a desire to simplify construction has led to the widespread use of a single layer for most pavement drainage.

Water-Removing Capabilities

Drainage materials for highways and airports often are considered "pervious" or "free draining" if their permeability is about 5 ft. (1.5 m) a day. Most aggregate being used in drainage systems probably is about this pervious. Fine concrete aggregate is rather widely used as a drainage material. If on the coarse side of Standard AASHTO Specifications, fine concrete aggregate can have a permeability of 10 to 20 ft. (3 m to 6 m) per day perhaps higher. However, on the fine side of AASHTO Specifications, its permeability may be in the vicinity of 1 ft. (300 mm) per day and possibly as low as 0.1 ft (30 mm).

On the other hand, clean pea gravel can have a permeability of many thousand ft. (meters) per day. Not only is the permeability of drainage aggregates highly variable but the needs of drainage systems also vary widely.

It is believed that the needs of projects should be approximated in some manner before designs are established and aggregate qualities adopted.

A rational analysis can be helpful in answering important questions, such as: "What are the water-removing capabilities of various aggregate?" "What aggregate is needed for a particular job?" and, "What features of a design will perform a drainage job most economically?"

Some of the possibilities of a rational analysis of filter performance are illustrated in Figure 200-2. Five classes of aggregate are rated in terms of three different drainage conditions. The aggregates vary from the finest graded AASHTO concrete sand to 1/2 in. (12.7 mm) gravel. Permeabilities vary from 1 to 80,000 ft. (0.3 m to 24 500 m) a day. The kinds of aggregates and their assumed permeabilities are given at the bottom of Figure 200-2.

The top bar graph in 200-2 compares the five aggregates on the basis of the speed with which water can flow horizontally in a pervious base. (Basic Problems, Water-Removing Capabilities, and Graphs, Figures 200-2 and 200-3 are based on empirical values from investigations by the U.S. Waterways Experiment Station. The following conclusions were published in the Vicksburg Report.

Filter Material

From the laboratory study of the filter materials and also from the observations of their performance in the flume tests, the following conclusions were made:

- a. A fine material will not wash through a filter material if the 15% size of the filter material is less than 5 times as large as the 85% size of the fine base materials.
- b. In addition to meeting the above size specifications, the grain size curves for filter and base materials should be approximately parallel in order to minimize washing of the fine base material into the filter material.
- c. Filter materials should be packed densely in order to reduce the possibility of any change in the gradation due to movement of the fines.
- d. A filter material is no more likely to fail when flow is in an upward direction than otherwise, unless the seepage pressure becomes sufficient to cause flotation or a "quick" condition of the filter.
- e. A well-graded filter material is less susceptible to running through the drainpipe openings than a uniform material of the same average size. However, even a filter material having a wide range of gradation cannot be used successfully over a drainpipe having large openings, since enough fine particles to cause serious clogging will move out of the well graded material into the pipe.

Underdrains

Tests on the rate-of-surface infiltration through the filter into the pipes indicate the following:

- a. The rate of infiltration through the filter bed was not materially limited or affected by any of the pipes tested, as long as they did not become clogged.
- b. Large openings in the drainpipe resulted in a somewhat higher rate of infiltration, but also increased the tendency for filter material to collect in and clog the pipe.

- c. Drainpipes with perforations around only half, or less, of their circumference drain the filter more rapidly than when the perforations are up, but less material will wash in when the perforations are down.

The tendencies for the filter material to wash into and clog the pipe are of primary importance in comparing the various commercial pipes. Tests performed to determine the amount of materials washed into underdrain pipes show the following:

- a. Perforated drainpipes having many small openings, preferably on the underside of the pipe only, and porous concrete pipes, are less subject to infiltration of small gravel and sand than other types of drainpipe. The smallest quantities of filter material were washed into the porous concrete, the perforated metal and the perforated concrete pipes. The quantity of material washed into the perforated clay with perforations all around the circumference was excessive.
- b. The perforated metal and perforated concrete pipe should be placed with perforations down.
- c. In the tests of the plain concrete and the clay skip pipes, both of which had drainage concentrated at the joints, serious quantities of the filter materials washed into the pipe.
- d. The porous concrete with a bevel or lap joint and the perforated concrete and clay with a bell and spigot joint should be placed with the joints tight and preferably sealed with mortar.
- e. The porous concrete pipe will also drain without clogging in clean, medium fine sands without other filter media, providing the joints are tight.

When it is feasible to design and use a graded filter, consisting of several larger layers with coarse gravel near the openings of the pipe, pipes with the larger openings would probably operate satisfactorily. Another guide for the design of a good filter material is shown in Figure 200-4. Figure 200-4 uses the term "Uniformity Coefficient". This term with "Effective Size" is associated mainly with sanitary engineering. The American Water Works Association defines both

terms and can provide additional information.

Effective Size D_{10} (diameter at the 10% finer point on the gradation curve) is widely known as an effective size.

Uniformity Coefficient (C_u) is the ratio of the diameter at the 60% finer point and that at the 10% finer point of the gradation curve.

$$C_u = \frac{D_{60}}{D_{10}} \text{ *this is a requirement in certain specifications*}$$

Recommended Filter Classes

The CDOT Standard Specifications, Section 206, refers to several classes of filter material. Subsection 703.09 tabulates the grading specifications for three classes: Class A, Class B, and Class C.

Class A has a permeability of approximately 10,000 to 100,000 ft. (3000 to 30 500 m) per day.

Class B has a permeability of approximately 100 to 1,000 ft. (30 to 300 m) per day.

Class C has a permeability of approximately 1 ft. to 10 ft. (0.3 to 3 m) per day.

The Project Engineer should select the class of filter material required for the project based on the following criteria:

First, select a representative sample of the trench soil and determine the gradation of the minus 3" (75 mm) portion. Then, select the class filter according to the following table:

RECOMMENDED FILTER CLASSES, TABLE 200-2

Sieve Size or Designation	Percentage of soil passing designated sieves (1)		
	Use Class 1, B or C (2)	Use Class B or C (2)	Use Class C
No. 10 No. 40	less than 85, & less than 25	less than 85	more than 85
(1) Based on the minus 3" (75 mm) portion of the soil adjacent to the filter material. (2) To drain large quantities of water, use the most open grading recommended.			

This table is based on the following criteria: The D15 size of the filter should not be more than five times the D85 size of the soil.

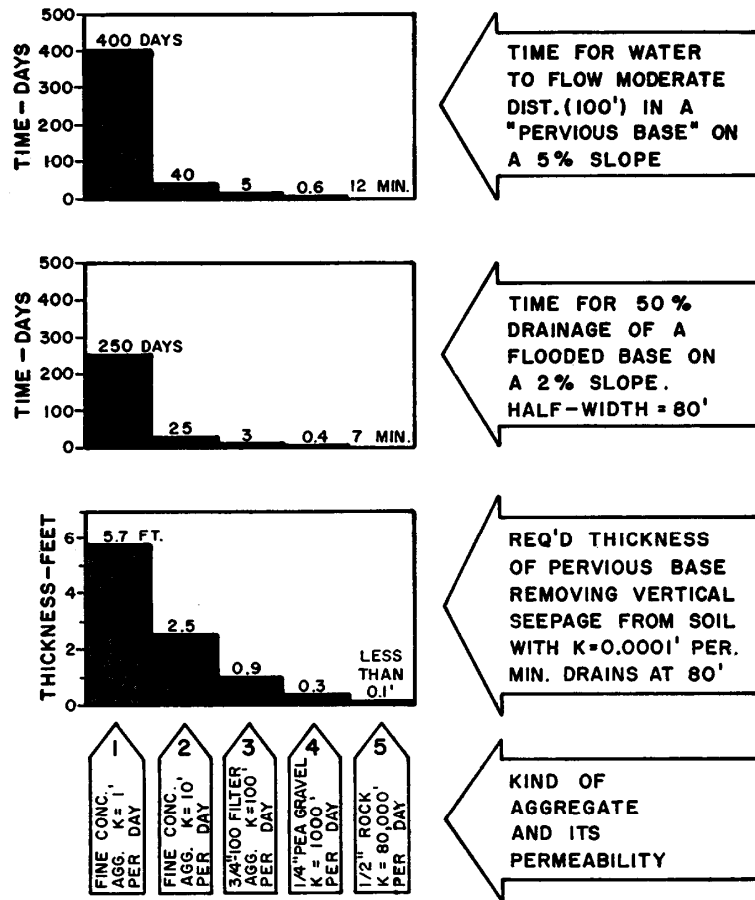

Fig. 1 A comparison of potential performance of several drainage aggregates.

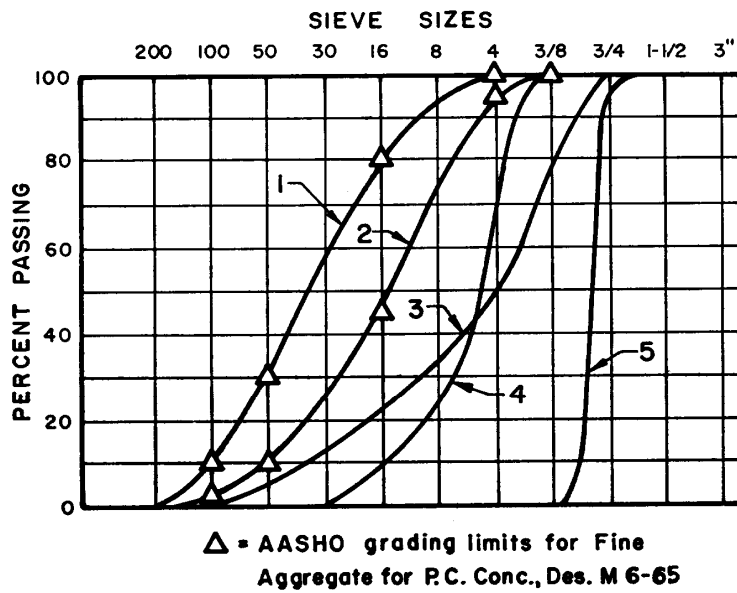

Fig. 2 Grain size curves for five aggregates analyzed in Fig. 1.

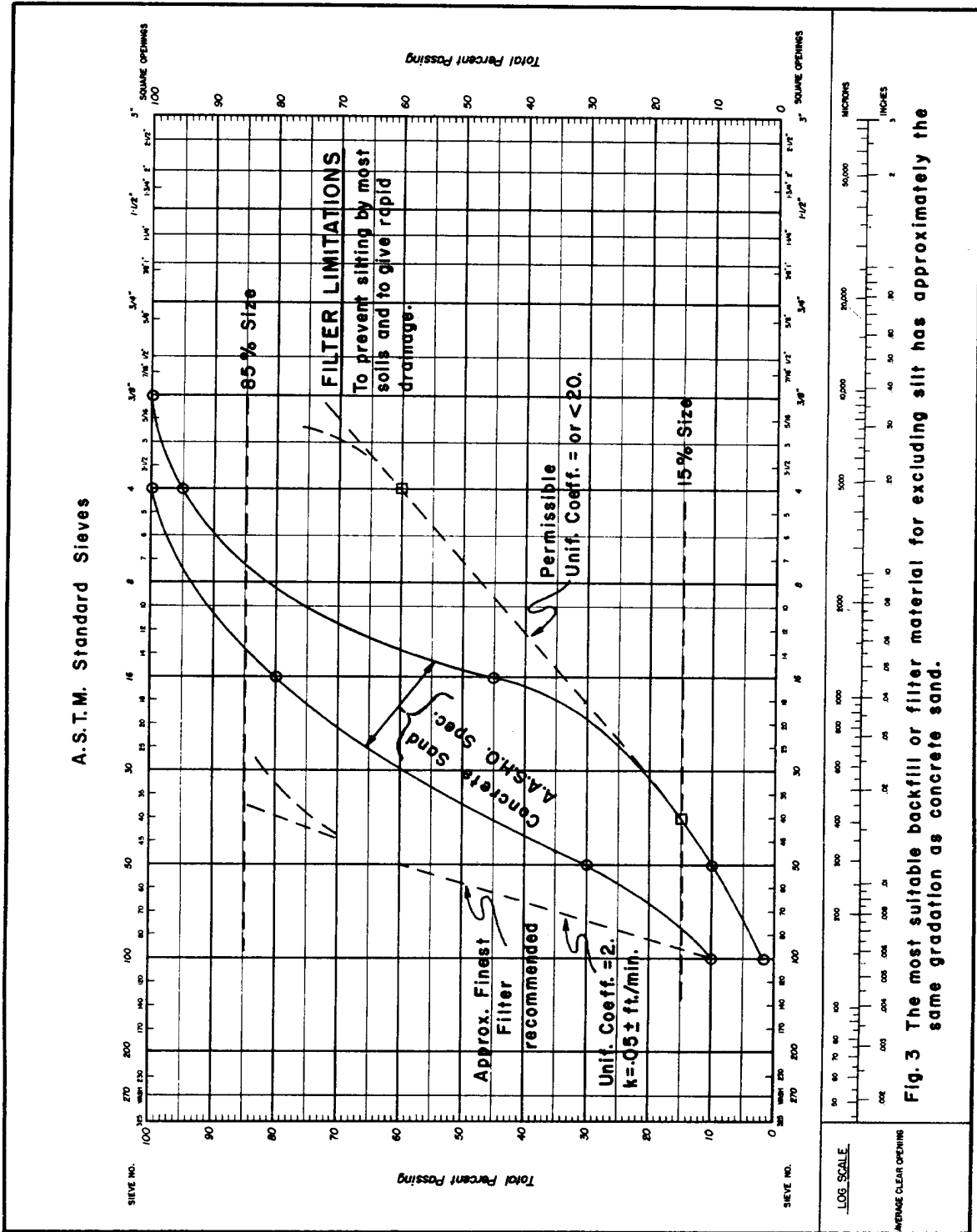

Fig. 3 The most suitable backfill or filter material for excluding silt has approximately the same gradation as concrete sand.

FIGURE 200-4

DEFINITIONS

Alluvial Fan - Deposit formed at the base of a steep valley or canyon wall by steep gradient tributary action. Material usually consists of heterogeneous angular rock and soil.

Angle of Internal Friction - An angle whose tangent is equal to the frictional shear strength of soil divided by the confining stress exerted on that soil. Cohesionless soils tend to exhibit high Angle of Internal Friction (ϕ) values.

Boulders - All rocks larger than 10 inches in diameter.

Clay - A very fine-grained soil, which passes the No. 200 screen and has a Plastic Index of 11 or more.

Cobbles - Rocks, which range from 3 to 10 inches in diameter.

Cohesion - The capacity of sticking or adhering together. That part of a soils' shear strength, which does not depend on inter-particle friction. Cohesion is the major factor contributing to the shear strength of clay soils.

Compaction - The process of increasing the density of a material by mechanical means, such as, tamping, rolling, vibration, etc.

Consolidation - The process of decreasing the thickness of a soil layer by applying a vertical load.

Degree of Saturation - The ratio of the volume of water to the void volume in a given soil mass.

Density - The mass of a substance per unit volume, usually expressed in pounds per cubic foot (pcf).

Embankment - A raised structure, consisting of soil, aggregate or rock. Usually the material is compacted and is used to support roadway pavement.

Erosion - The removal and transportation of soil or rock by water, ice and gravity.

Escarpment - A steep face terminating highlands abruptly

Glacial Moraine - Deposit of heterogeneous material left by glacial action. Material ranges in size from clay to large boulders.

Gradation - Indicates the range and relative distribution of particles in soil or aggregate.

Gravel - A granular material, which is retained on the No. 10 screen and has a maximum particle size of 3 inches.

Hygroscopic Moisture - Hygroscopic material is soil that readily absorbs water usually from the atmosphere; therefore hygroscopic moisture is the moisture absorbed from the atmosphere. In most cases, the water can be removed from the material by heating.

Internal Friction - The property of individual soil particles to resist movement along adjacent surface areas.

Land forms - Distinct shapes of the earth's surface that have been formed by erosion and deposition of rock or soil. Common examples are stream terraces, alluvial fans, glacial moraines, and sand dunes.

Liquid Limit - The moisture content at which a soil changes from the plastic state of consistency to the liquid state of consistency.

Loess Deposit - A homogeneous, unstratified accumulation of wind blown silt with subordinate amounts of very fine-grained sand.

Maximum Density - The unit dry weight (pounds per cubic foot, (pcf)) of a soil compacted at optimum moisture and at a specific compactive effort.

Optimum Moisture - Percent moisture of a soil, which will yield a maximum dry unit weight for a specified compactive effort.

Permeability - The rate at which a material allows transmission of water.

pH - A measure of the activity of hydrogen ions in a solution. When in balance (pH 7) the soil is said to be neutral. The pH scale covers a continuum

ranging from 0 (very acidic) to 14 (very alkaline or basic).

Plastic Index - The numerical difference between the liquid limit and the plastic limit of a soil.

Plasticity - Property of material to be remolded without crumbling under certain moisture conditions.

Plastic Limit - The moisture content at which a soil changes from the semi-solid state of consistency to the plastic state of consistency.

Poorly Graded - Particles sizes of a soil mass that are not evenly distributed.

Pore Water Pressure - The stress imparted by water against soil particles within a saturated soil mass.

Porosity - The ratio of void space of a material to the total volume of its mass, usually expressed as a percent.

Rock - Any naturally formed consolidated aggregate or mass of minerals, which cannot be excavated by manual methods alone. (Pieces of rock, which pass the No. 4 screen, are considered soil particles.)

Sand - A granular soil, which passes the No. 10 screen and is retained on the No. 200 screen.

Sand Dunes - Ridges of mounds formed by wind blown sand. These deposits of sand consist of clean, uniform sand grains.

Silt - A very fine-grained soil, which passes the No. 200 screen and has a Plastic Index of 10 or less.

Residual Soil - Material that is produced by the weathering of bedrock and accumulates or remains in contact with parent rock.

Soil - A loosely cemented, heterogeneous, earthen material, which is composed of particles surrounded by voids of various sizes. Voids may be filled with air, water and gas, or any combination of the same. Particles of soil are produced by physical or chemical disintegration of rock.

Specific Gravity (Absolute) - The ratio of the unit weight of solid matter in a soil to that of distilled water at 68°F (20°C).

Specific Gravity (Apparent) - The ratio of the weight of soil particles (including permeable and impermeable voids) to that of water.

Specific Gravity (Bulk) - The ratio of the weight of a specific volume of soil particles to the same volume of water.

Stream Terrace - Mostly granular material, which has been deposited by stream action to form a level, topped surface with an escarpment on one side.

Stratified - Soil deposited in layers with different and distinct characteristics.

Swelling Soil - Material, which exhibits the ability to increase in volume with an increase in water content. Soils with high swell potential usually contain montmorillonite.

Testable Material - Soils and rock mixtures having 50% or more by weight, at field moisture content, of minus 4 material and the top size material being less than 6 inches in diameter.

Transported Soil - Accumulation of material, which has been transported from its parent rock by water, wind or ice.

Void Ratio - The ratio of the volume of void space to the total volume of the particles within a mass.

CDOT Forms - Applicable for Soils, Examples and Instructions

Form	Title	Page
# 157	Field Report for Sample Identification or Materials Documentation	20
# 24	Moisture - Density Relation	21 - 22
# 31	In-Place Moisture and Density Determination by the Sand Method	23 - 24
# 212	Field Report on Compaction of Earthwork	25
# 219	Soil Survey of the Completed Roadbed	26
# 323	Laboratory Report on Item 203 / Gradation Report.....	27 - 28
# 548	Nomograph - to Correct for Percent Rock	29 - 34
# 564	Soils and Aggregates Sieve Analysis When Splitting on the No.4 Sieve	35 - 38
# 584	Moisture - Density Relation Graph	39
# 626	Field Laboratory Test Results	40
# 647	Density Sand Calibration	41 - 42
# 901	Laboratory Optimum Dry Density	43
# 1003	Stabilometer Graph	44
# 1007	Gradation Chart.....	45
# 1030	Stabilometer Test	46
# 1045	Gradation Worksheet	47
# 1297	Moisture - Density Report.....	48 - 50
	Soil Classification Tables	51 - 56
# 554	Soil Survey Field Report.....	68
# 555	Preliminary Soil Survey	69 - 70
# 157	Field Report for Sample Identification or Materials Documentation	71

COLORADO DEPARTMENT OF TRANSPORTATION FIELD REPORT FOR SAMPLE IDENTIFICATION OR MATERIALS DOCUMENTATION Metric units <input type="checkbox"/> yes <input checked="" type="checkbox"/> no				Field sheet No. 120227		Date 2/23/03	
				Project No. IM0253-151		Project location I-25, SH 7 to WCR 16	
Project code (SA#) 11925			Function 3200		Region 4	Part. P	
Sample submitted: <small>(ie.: Soil, ABC, Hydrated lime, HMA, concrete cores, steel, etc.)</small>				Field office phone number 303-828-0386			
Soil				Field office FAX number 303-828-0430			
				Item 203		Class Spec.(R-50)	
Special provisions applicable: <input checked="" type="checkbox"/> yes <input type="checkbox"/> no				Previously used on Project No.:			
Previous CDOT Form #157 F/S No.(s):				<input checked="" type="checkbox"/> CDOT Form #633 (sack) <input type="checkbox"/> CDOT Form #634 (can)			
<ul style="list-style-type: none"> ● Sample Identification: Quantity & Unit of material submitted, describe tests required, precise location sample removed from (stationing), etc. ● Materials Documentation: Field inspected (describe appearance, weight/dimensions, model/serial number), COC &/or CTR provided, etc. 							
Submitting (2) sacks of soil (203 R-50 Special)							
Please run the following tests: T-99 A							
◆ Specific Gravity							
R-Value (min 50)							
Classification							
◆ Gradation							
◆ Atterberg Limits							
Sample taken at:							
NB I-25 195+00 West shoulder							
APL/QML Acceptance: APL Ref. No.		Product name:			Date checked:		
APL/QML Acceptance: APL Ref. No.		Product name:			Date checked:		
Preliminary <input type="checkbox"/>		Construction <input checked="" type="checkbox"/>		Maintenance <input type="checkbox"/>		Emergency <input type="checkbox"/>	
					Date needed ASAP		
Contractor Kraemer and Sons				Supplier Varra Co.			
Sampled from <small>(Pit, roadway, windrow, stock, etc.)</small> Windrow				Pit name or owner Varra Co.			
Quantity represented 1/source/project		Previous quantity 1/source/project		Total quantity to date 2000 C.Y.			
Sample submitted: <input checked="" type="checkbox"/> Yes <input type="checkbox"/> No		Shipped to: <input checked="" type="checkbox"/> Central lab <input type="checkbox"/> Region lab		Via Geocal		Date 2/24/03	
Sampled or inspected by (Name) D. Elsbernd			(Title) QA Tech		Lab phone number 303-828-2644		
Supervisor <small>(Pro./Res./Mats. Engr./Maint. Supt.)</small> Corey Stewart			Title P.E. I		Address 1050 Lee Hill Rd. Boulder, Co. 80302		
Distribution: White copy - Staff Materials Branch <small>(submit white copy only if sample or information is directed to Staff Materials)</small> Canary copy - Region Materials Engineer Pink copy - Resident Engineer				CDOT Form #157 9/07			
Previous editions may be used until supplies are exhausted							

CDOT FORM # 24 INSTRUCTIONS

This form is primarily a work sheet designed for field use. In addition to the optimum moisture and density determination, the data required in plotting the multi-purpose nomograph on CDOT Form # 548 to correct optimum moisture and density and soil classification can be calculated (Instructions included in this chapter).

For further explanation refer to the circled numbers on the example of CDOT Form # 24. Details for these circled reference points are as follows:

- 1 The detailed test procedure for this section of CDOT Form # 24 will be found in AASHTO T 99 or AASHTO T 180, whichever is applicable.

NOTE 1: AASHTO T 99 (aka Standard Proctor) or AASHTO T 180 (aka Modified Proctor) require three points to form a curve, with four points being the most common to fully depict a break in the moisture curve.

- 2 This section is used to calculate the sieve analysis of the minus No. 4 portion of the sample as well as to record the Atterberg limits and classification of the minus No. 4. (See CP 21 and example of CDOT Form # 564). It should be clearly understood that only the Minus No. 4 sieve analysis and the classification of the Minus No. 4 are used when making the previously mentioned multi-purpose nomograph. If the classification of the total sample is desired for another purpose (such as the "As Constructed Soil Survey") enter it above in Soil Class Total Sample line.

- 3 This section is used to calculate the bulk specific gravity and absorption of the plus No. 4 rock. This data is used in the rock and moisture correction formula and is required when making the multi-purpose nomograph.

The method of performing these tests is in CP 23 or AASHTO T 85. For aggregates that have a total absorption of more than 2 percent by the above method, the following method for determining "Field Absorption" will be performed and the results used in the moisture correction calculations.

Formula:

$$\text{Field absorption} = \frac{C_1 - A_1}{A} \times 100$$

Where: C_1 = Weight in grams of specimen from test area prior to drying.
 A_1 = Weight in grams of oven dry specimen

NOTE 2: The specimen for C_1 is obtained from the embankment after it has been subjected to the wetting and compaction procedures normal for area. The intention is to determine as nearly as possible the actual moisture content of the rock in-place. The surface of the specimen should be cleaned of all surface coatings with a wire brush prior to weighing.

COLORADO DEPARTMENT OF TRANSPORTATION		MOISTURE - DENSITY RELATION		Date 9/25/03		Project No. IM 0253-151		Proj. location I-25, SH7 to WCR 16		Region	
Type of Compaction Standard AASHTO T 99 <input checked="" type="checkbox"/> Method A		Modified AASHTO T 180 <input type="checkbox"/> Method _____		Project code (SA#) 11925		Station 121+00		Test No. 587		Lab No. 15	
Field Sheet No. 143222		% Soil 70		% Rock _____		Soil class. total sample A-4-(2)		Soil class. total sample A-4-(2)		Soil class. total sample A-4-(2)	
Maximum dry density 115.0		Maximum dry density 115.0		Maximum dry density 115.0		Maximum dry density 115.0		Maximum dry density 115.0		Optimum moisture 16.5	
% Pass. _____		% Pass. _____		% Pass. _____		% Pass. _____		% Pass. _____		% Pass. _____	

Sieve analysis of - #4 (2)			
Sieve	Mass	Indiv. %	% Pass.
#4	0.0	0.00	100.0
#10	40.0	7.80	92.2
#40	33.0	6.40	85.8
#200	30.0	5.80	80.0
- #200	443.0	80.00	
Total	546.0	100.00	
Liquid limit	35		
Plastic index	7		
- #4 Soil classification A-4(6)			

Bulk sp. gr. and absorption of rock (3)	
A ₁ = Oven dry Mass in air	1675.0
B ₁ = S. D. Mass in air	1708.5
Mass H ₂ O & beaker	1246.0
Mass of beaker	584.0
M = Mass of H ₂ O	657.0
$\frac{A_1}{M} = 2.55$	
Sp. Gr. X 1,000 =	159.1
Pcf X .9 =	143.2
Absorption = $\frac{B_1 - A_1}{A_1} \times 100 =$	2.0

Trial No.	Sample mass	Water added	Moisture samples	Percent moisture	Compacted wet mass	Density, $\frac{\text{lb}}{\text{ft}^3}$ / $\frac{\text{Kg}}{\text{m}^3}$	
						Wet	Dry
1	10#	350	Wet 245.6 Dry 217.2 Loss 28.4	13.1	4.18	125.4	110.8
2		90	Wet 237.7 Dry 206.9 Loss 30.8	14.9	4.35	130.5	113.7
3		80	Wet 261.5 Dry 225.0 Loss 36.5	16.2	4.45	133.5	114.9
4		75	Wet 254.0 Dry 215.4 Loss 38.6	17.9	4.44	133.2	113.0
5			Wet _____ Dry _____ Loss _____				
6			Wet _____ Dry _____ Loss _____				

Remarks	Title E/PS Tech I
Tested by J. J. Grinder	

Previous editions are obsolete and may not be used. GDOT Form #24 3/05

CDOT Form # 31 Instructions

The field work sheet is used when determining the in-place moisture and density of soil or aggregates and calculating the percent relative compaction. Also included on this work sheet are the formulas and the spaces to calculate the percent rock, the maximum dry density and optimum moisture corrected for the percent rock and the trial compaction cylinder data.

USE CP 25 FOR CALCULATING PERCENT RELATIVE COMPACTION.

Moisture sample from test hole (H, I, J, and K.)

When the material from the test hole contains an appreciable percent age of rock, the total sample is weighed and dried to determine the percent moisture. (See CP 22 and CP 23.) In this case the same data will be used for the percent rock calculation. When a small representative moisture sample can be obtained from the test hole material, the weight in grams will be used in these spaces.

Optimum moisture and maximum dry-density (M and N)

Tests containing less than 5 percent rock require no rock correction for optimum moisture or maximum dry density. When no corrections are made, report these figures in the right hand column. This will make it easier when transferring the data to CDOT Form # 212.

Classification of material from test site (Q)

This classification should reflect the change (due to percent rock) from the classification of the material on which the moisture-density curve was run. The directions for making this adjustment are given in the instructions for making a multi-purpose nomograph to correct for percent rock. These instructions are included in Chapter 200.

Rock correction calculations for maximum dry density and optimum moisture

Material from the test hole containing 5 to approximately 50 percent rock and maximum nominal size not exceeding 3 in. shall have the maximum dry density and optimum moisture of the minus No. 4 corrected to a total sample basis in accordance with CP 23.

When using a nomograph, instead of calculating corrected maximum dry density and optimum moisture, fill in only the lines for "pcf Maximum Dry Density Corrected for Rock" and "Corrected Optimum Moisture." Then, so it will be known, write "Nomograph Used."

COLORADO DEPARTMENT OF TRANSPORTATION IN-PLACE MOISTURE AND DENSITY DETERMINATION BY THE SAND METHOD	Project No. IM 0253-151	Project code (SA#) 11925
	Test # 16	Date 6/30/03
	Station 864+00 10' R+ CL	Ft. below finished grade 2.0

A. Density of Sand	90.68	REPORT THE DATA IN THIS COLUMN ON CDOT FORM #212	
B. Weight of Sand Out	17.00		
C. Weight of Sand Back	7.58		
D. Weight of Sand Used	9.42		
E. Volume of Test Hole (D ÷ A)	0.1039		
F. Weight of Material from Test Hole	13.89		
G. Wet Density of Material from Test Hole (F ÷ E)		133.5	
H. Wet Weight of Moisture Sample from Test Hole	13.87		
I. Dry Weight of Moisture Sample from Test Hole	12.47		
J. Moisture Loss (H - I)	1.40		
K. Percent Moisture in Material from Test Hole $\{(J \div I) \times 100\}$			11.2
L. Dry Density of Material from Test Hole $\{(G \div 100 + K) \times 100\}$			120.1
M. Optimum Moisture 16.5 % Corrected for Rock			12.2
N. Maximum Dry Density 115.0 pcf. Corrected for Rock			123.5
O. Percent Relative Compaction $\{(L \div N) \times 100\}$ Standard AASHTO T 99, Method A Modified AASHTO T 180, Method _____ Curve No. 5			97.2
P. Percent Plus No. 4 Sieve (Rock)			30
Q. Classification of Material from Test Site			A-2-4

CALCULATIONS FOR PERCENT ROCK

Wet weight total sample **13.87** ÷ (100 + **11.2** % H₂O) x 100 = Dry weight total sample **12.47**

Wet weight rock _____ ÷ (100 + _____ % H₂O in Rock) x 100 = Dry weight rock _____

Dry weight rock **3.74** ÷ Dry weight total sample **12.47** = **30** % + #4 and **70** % - #4

ROCK CORRECTION FORMULA AND CALCULATIONS

(% - #4 x Maximum dry density of - #4) PLUS % + #4 x (0.9 x weight/cubic feet of + #4 rock)

% - #4 **0.70** x **115.0** = **80.5**

% + #4 **0.30** x (0.9 x **159.1**) = **43.0**

Total **123.5** pcf Maximum dry density corrected for rock

OPTIMUM MOISTURE CORRECTION 16.5 % H ₂ O in - #4 x 70 % - #4 = 11.6 % 2.0 % H ₂ O in + #4 x 30 % + #4 = 0.6 % Corrected optimum moisture: 12.2 %	COMPACTION CYLINDER MOISTURE DATA R Wet Weight 263.0 S Dry Weight 226.9 T Loss (R - S) 36.1 % Moisture by Dry Weight: 15.9 % $\{(T \div S) \times 100\}$
---	--

COMPACTION CYLINDER DENSITY DATA

Gross weight **14.79**

Tare weight **10.32** (Factor) (Wet density)

Net weight **4.47** x **30** = **134.1** ÷ 100 + **15.9** % H₂O x 100 = **115.7** pcf Dry Density

Remarks:

Tested by John Doe	Title E/PS Tech III
---------------------------	----------------------------

COLORADO DEPARTMENT OF TRANSPORTATION FIELD REPORT ON COMPACTION OF EARTHWORK		Project No. IM-0253-151 Field sheet #						
Item # 203, R50 Spec <input checked="" type="checkbox"/> Standard (AASHTO T 99) <input type="checkbox"/> Modified (AASHTO T 180)		Location I-25, SH 7 to WCR 16						
Station or Location		Project code (SA#) 11925 Region 4 Date 9/9/10						
Test #	Date	Sulfate % or class	AASHTO Classification	Plus #4 matl. %	Relative compaction %	Moisture % Opt.	In place	*Cubic yards (m ³) represented
118A	6/5/10		A - 1 - B	49	98	9.6	6.2	2000
118B	6/6/10		A - 1 - B	54	99	9.6	5.4	2000
119	6/10/10		A - 1 - B	52	95	9.6	4.1	2000
120	6/14/10		A - 1 - B	67	96	9.6	5.6	2000
121	6/17/10		A - 1 - A (0)	41	100	9.7	3.4	2000
122	6/20/10		A - 1 - A	49	100	9.7	3.6	2000
123	6/20/10		A - 1 - A (0)	44	100	9.7	3.5	2000
124	6/25/10		A - 1 - B	42	100	8.4	3.9	2000
125	6/27/10		A - 1 - B	14	100	8.4	4.6	2000
Sheet Total 20,000								
Remarks 118B over 50% rock, untestable per 203.05								
Final report <input type="checkbox"/> yes <input checked="" type="checkbox"/> no <input type="checkbox"/> Total quantity tested (final report only)				Resident or Project Engineer Vic Mackie Title P.E. I				
Distribution: White - region project file Yellow - region Materials Engineer								
* Cubic yards (m ³) represented are estimated (use linear feet (m) or square yards (m ²) for item 306)								
CDOT Form #212 1/10 Previous editions are obsolete and may not be used								

COLORADO DEPARTMENT OF TRANSPORTATION
Gradation Report

Project ID 11925	Location SH 7, TO WCR 16		
Project IM 0253-151	Source WINDROW	Report Date	3/12/2004
F.S. # 149152	Region 04	Construction	3200
Engineer C.K. Su, Soils and Rockfall Program Manager		Working Days	13
Comments R-Value >= 50			

Test #	Lab #	SP?	Station	Depth	LL	PL	PI	%Moist	R-Val	Group Class(GI)	mr
	2004-0047	Yes	195 + 00 West Shoulder	0.0' - 1.0'	NV	NP	NP	0.2	79	A-1-b(0)	33975

<u>Gradations:</u>										<u>Proctor:</u>		<u>Lab Performing Work:</u>				
mm	75	25	19	9.5	#4	#10	#40	#200			MDD :	117.3	Atterberg :	CDOT	T180	:
in	3	1	3/4	3/8							OMC :	11.4	Direct Shear :		Mechanical Analysis :	CDOT
%Pass			100	99	93	80	33	7.4			SpG :	2.59	R-Value :	CDOT	Other	:
As Run			100	99	93	80	33	7.4			Abs :	1.1	T99 :	CDOT		

This form is generated by the central laboratory

<u>Key</u>		SP? = Meets special provision requirements?		MDD = Maximum Dry Density		Page 1 of 1	
LL = Liquid Limit (AASHTO T89)	R-Val = Stab R-Value (CP-L3101)			OMC = Optimum Moisture Content			
PL = Plastic Limit (AASHTO T90)	mr = Resilient Modulus (psi)			SpG = Bulk Specific Gravity			
PI = Plastic Index (AASHTO T90)	GI = Group Index			Abs = Absorption			

CDOT #323 11/2002

CDOT FORM # 548 INSTRUCTIONS

The purpose of any nomograph is usually to eliminate the necessity of performing time consuming mathematical calculations. This is of special interest to field materials personnel needing results as quickly as possible. With this in mind, CDOT Form # 548 has been developed and the instructions for plotting a nomograph are given as well as the directions for its use.

This nomograph combines, on one graph, the corrections for maximum dry density, optimum moisture and soil classification. The procedure and reason for correcting the maximum dry density and optimum moisture of the minus No. 4 curve for the percent rock in the density test are in Colorado Procedure 21 and the instructions for CDOT Form # 31.

The reasons for correcting the soil classification for rock are not as well understood; therefore the following explanation is given: It has been common practice to classify the total sample, including rock, when running a moisture-density curve. The curve, of course, is run only on the minus No. 4 portion of the sample, but has been identified by the classification of the total sample. In a soil-rock mixture the probability of an in-place density test having the same percent of rock as the sample on which the curve was run and classification made is quite unlikely.

In some instances when the classification changes from an A-4 to A-2-4 (or vice versa), the required percent relative compaction changes 5 percent. For example, assume the following sample was selected for a moisture-density curve and soil classification:

Minus No. 4	= 50 percent
Minus No. 200	= 33 percent
Liquid Limit	= 37
Plastic Index	= 9
Classification	= A-2-4(0)

This same material with no plus No. 4 would have 66 percent minus No. 200 and classify A-4 (5).

The classification changes from an A-4 to an A-2-4 at 35 percent minus No. 200. To find the percent rock at which this change occurs, divide 35 by the percent minus No. 200 in the minus No. 4 (66%) and subtract from 100 or:

$$35/66 = 53$$

$$100 - 53 = 47\% \text{ rock}$$

Between 0 and 47 percent rock the Group Index

will change regressively from 5 to 0. This change would not affect the percent compaction required, but the correct Group Index makes the report (CDOT Form # 212) more accurate.

Calculating the correct Group Index or classification change for each in-place density of a soil-rock material would be very time consuming. However, it is quite a simple procedure to incorporate these changes in the nomograph as will be shown.

The instructions and example for CDOT Form # 24 explains that the Form has been designed especially for use when plotting a multi-purpose nomograph on CDOT Form # 548. The example of CDOT Form # 24 shows the same data as will be used in the following instructions. This nomograph should be plotted at the same time a moisture-density curve is made on soils, which it is anticipated will contain rock in the amount that will require corrections to be made.

EXAMPLE:

Required Data:

Optimum dry density of minus No. 4	= 115.0
Optimum moisture of minus No. 4	= 16.5
* Bulk specific gravity of plus No. 4	= 2.55
Field moisture (absorption) of plus No. 4	= 2.0
** Percent minus No. 200 in minus No. 4	= 80
Liquid Limit	= 35
Plastic Index	= 7

* Bulk specific gravity of $2.55 \times 62.4 = 159.1$ lbs/cu ft

** If the moisture-density curve has been run in the field the material will have been classified and the percent minus No. 200 in the minus No. 4 will be known. If the Materials Section supplied the curve, the sieve analysis and classification of the total sample will be found on the Preliminary Soil Survey report, CDOT Form # 555. The percent minus No. 200 in the total sample can be converted to percent minus No. 200 in the minus No. 4 by dividing the percent minus No. 200 by the percent minus No. 4 x 100.

ROCK CORRECTION:

Locate the maximum dry density of the minus No. 4 soil on scale 1. Locate the density of the plus No. 4 rock or bulk specific gravity of the plus No. 4 rock on scale 2. Connect these points with a

straight line. Locate the percentage of the total sample retained on the No. 4 sieve on scale 5 and project vertically to intersect the sloping line between scales 1 and 2. This point of intersection read on scale 1 is the maximum dry density, corrected for rock.

MOISTURE CORRECTION:

Locate the optimum moisture of the minus No. 4 soil on scale 3 and the field absorption of the plus No. 4 rock on scale 4. Connect these points with a straight line. Locate the percentage of the total sample retained on the No. 4 sieve on scale 5 and project vertically to intersect the sloping line between scales 3 and 4. This point of intersection, read on scale 3 is the optimum moisture, corrected for rock.

CLASSIFICATION AND GROUP INDEX:

To obtain the actual Group Index for the material from a field density test, the percent minus No. 200 must be known. By starting with the percent minus No. 200 in the minus No. 4 (0% rock) the percent minus No. 200 can be calculated for any percent plus No. 4 rock as follows: Subtract the percent rock from 100 and multiply the difference by the percent minus No. 200 in the minus No. 4. Using CDOT Form # 548-A, make this calculation for each 10 percent increase in rock to 60 percent as shown in the following example:

Percent rock at which the total sample will contain 35% minus No. 200

100 minus (35/percent minus No. 200 in the minus No. 4)

$$100 - (35 / 80 \%) = 56 \%$$

* Round off Partial Group Index for liquid limit to 2 places. Place the classification with the actual group indices in the spaces provided on scale 5 of CDOT Form # 548. It will be noted that the exact point of Group Index change may not fall on the even 10 percent lines, however it is close enough. Also, when there are two or more changes in group index within 10 percent change in rock, interpolation will be necessary.

Plot a separate nomograph using CDOT Form # 548 for each moisture-density curve, which requires these corrections to be made.

The percentage of plus No. 4 material from the test hole as determined by CP 23, Section 3.5, is plotted on the nomograph and the corrected values for maximum dry density, optimum moisture and classification or Group Index determined.

It should be understood that the use of the nomograph, or calculating by formula, in no way relieves the test person of the necessity of determining the proper minus No. 4 moisture-density curve on which these corrections are made. See CDOT Form # 31 instructions for the proper procedure.

Minus No. 4 Soils Data	% - No. 200 <i>80</i>	L.L. <i>35</i>	P.I. <i>7</i>	Classification <i>A-4(6)</i>
---------------------------	--------------------------	-------------------	------------------	---------------------------------

100 minus Percent + No. 4	90	80	70	60	50	40
Percent - No. 200 in - No. 4	<i>80</i>	<i>80</i>	<i>80</i>	<i>80</i>	<i>80</i>	<i>80</i>
Corrected Percent - No. 200	<i>72</i>	<i>64</i>	<i>56</i>	<i>48</i>	<i>40</i>	<i>32</i>
Partial G.I. For L.L.	<i>6.48</i>	<i>5.08</i>	<i>3.68</i>	<i>2.28</i>	<i>0.88</i>	<i>0</i>
Partial G.I. For P.I.	<i>-1.71</i>	<i>-1.47</i>	<i>-1.23</i>	<i>-0.99</i>	<i>-0.75</i>	<i>-0.51</i>
Group Index	<i>4.77</i>	<i>3.61</i>	<i>2.45</i>	<i>1.29</i>	<i>.13</i>	<i>0</i>
Classification	<i>A-4(5)</i>	<i>A-4(4)</i>	<i>A-4(2)</i>	<i>A-4(1)</i>	<i>A-4(0)</i>	<i>A-2-4(0)</i>

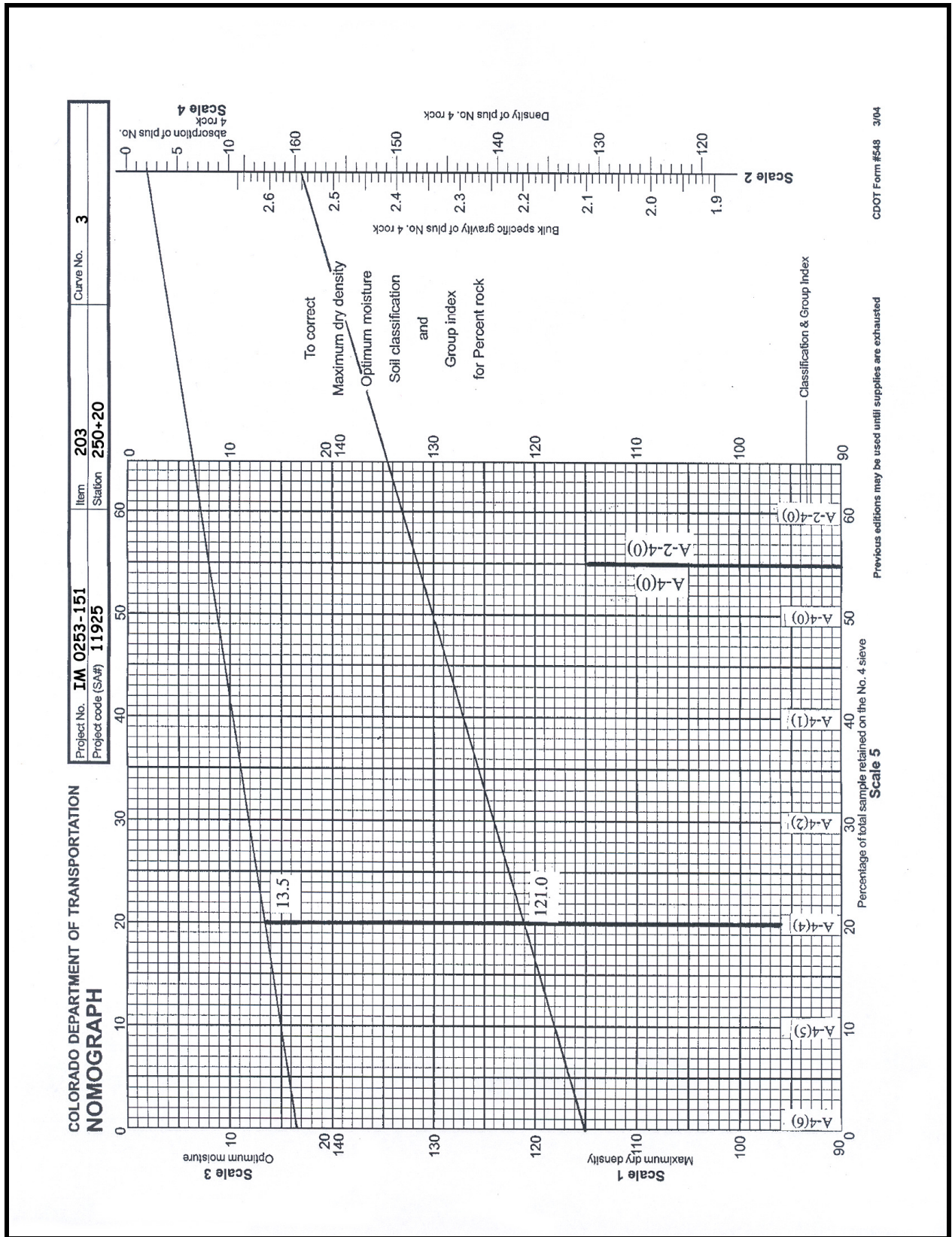

Previous editions may be used until supplies are exhausted

CDOT Form #548 3/04

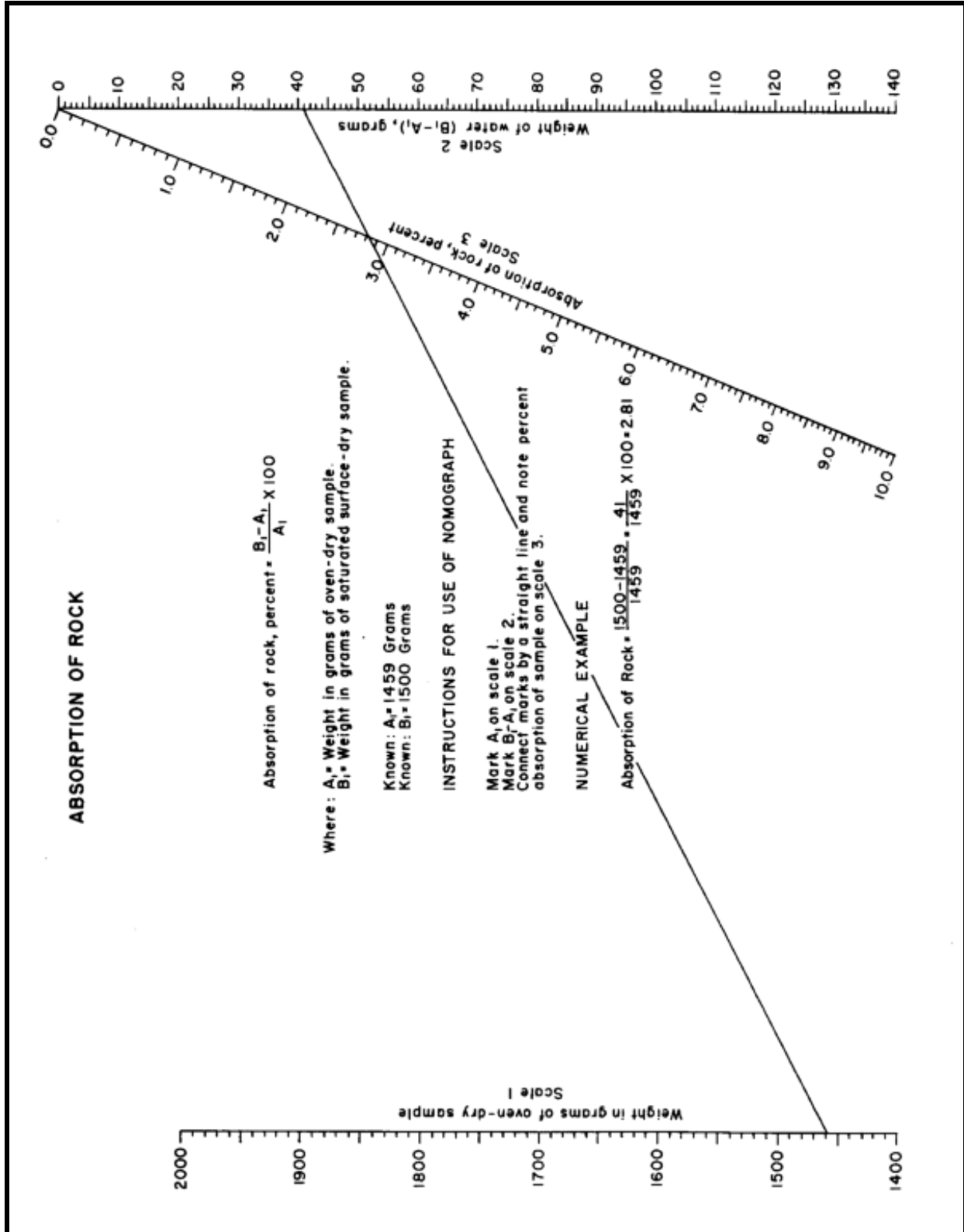

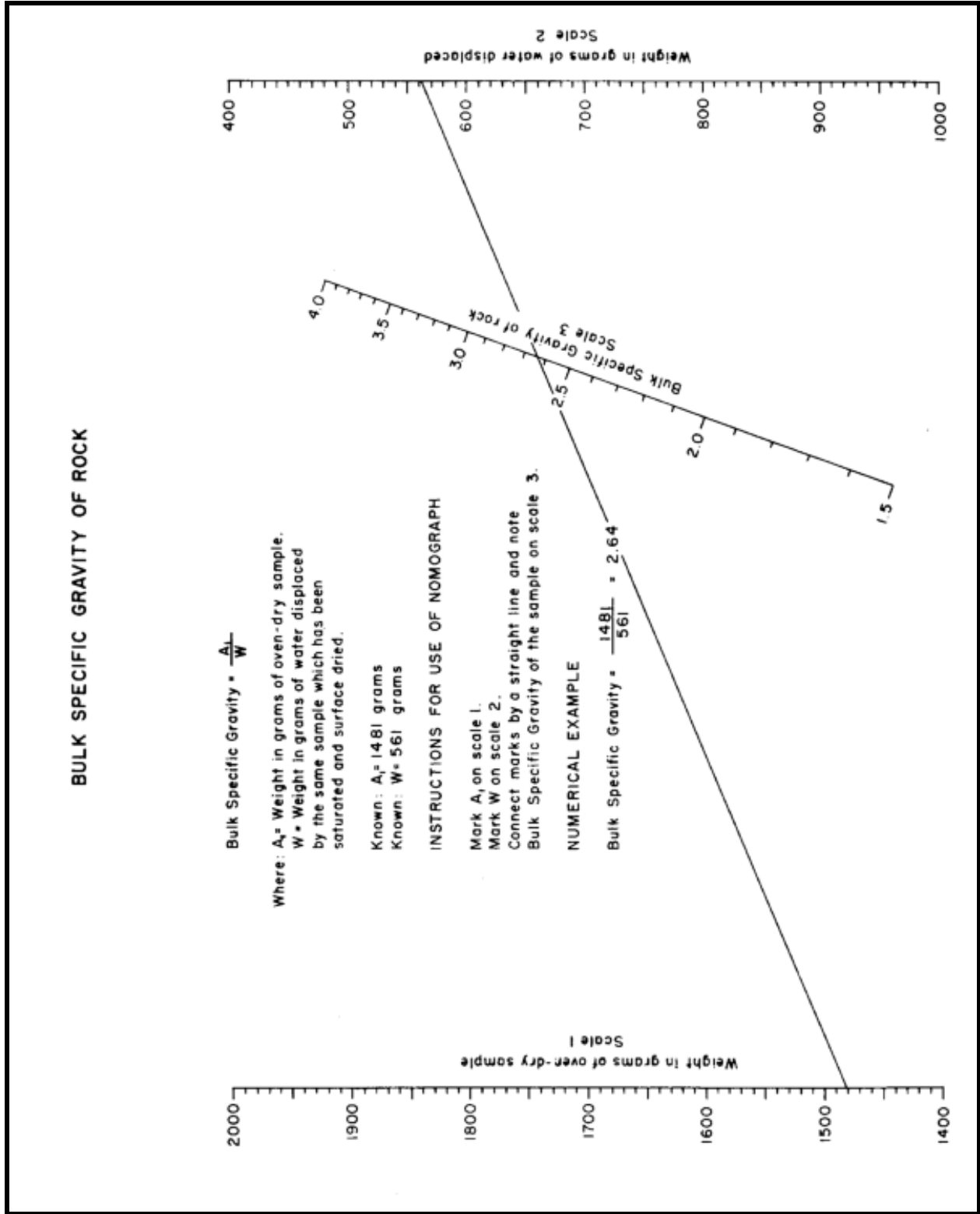

Pages 35-56 are missing from this chapter. These pages will be added at a later date.

Soil Survey / Preliminary Soil Profile

Procedure for Preliminary Survey: Overview	56
Soil Survey	57
CDOT Forms # 554, #555, and #157; Examples and Instructions	66
Soil Identification and Description	71
Rock Identification and Description.....	72
Rock Classification Table.....	73
Determination of Need for Culvert Protection	74
Sulfate, Severity of Potential Exposure Table.....	76

PROCEDURE FOR PRELIMINARY SURVEY: OVERVIEW

1. Scope

1.1 This set of guidelines generally follows the current practices CDOT personnel use for obtaining soil profiles. It is intended to establish standardized procedures for use by the Region Materials personnel in the performance of uniform and adequate soils investigations. It is not a design manual.

2. Problem Types of Concern

2.1 The recommendations presented herein are oriented toward the solution of such problems as:

- Pavement design
- Slope design
- Slope appearance
- Cost
- Landslides
- Embankment subsidence and settlement
- Excavation characteristics
- Expansive materials
- Drainage
- Compaction characteristics

2.2 All of these problems are directly related to:

- The character and distribution of soil and rock bodies, both inside and outside of the right-of-way.
- The influence of surface and sub-surface water on these materials.

3. Use of Soil Profiles

3.1 With the proper amount and type of samples and field information, the designers are provided with data denoting the types of materials to be encountered, the vertical and horizontal boundaries of the changes in these materials, and their strength and deformation characteristics. Adequate preliminary investigation will help prevent uneconomical over-design and unforeseen failure resulting from under-design.

4. Standard Investigations

4.1 Proper investigations to achieve these goals cannot be dictated by a rigidly prescribed set of procedures, although certain basic requirements must be satisfied in each investigation. Both the detail and extent of the investigation will vary depending on the individual problem, the nature of the project under consideration, and the allowable risk of failure.

5. More Extensive Investigations

5.1 Investigations may sometimes need to go beyond the minimum soil profile recommendation presented within this document. Projects in special problem areas or in areas of rough terrain are the most likely to require more extensive investigations. Such studies are especially recommended for high-speed, multi-lane facilities in rough terrain. The Region Geologist and/or the Geotechnical Unit of the Central Laboratory or by outside consultants will conduct these studies.

6. Soil Survey Classification

6.1 Soil surveys may be classified as reconnaissance or preliminary, depending upon the type of information developed and the stage of project development during which each is performed.

7. Reconnaissance Soil Surveys

7.1 Reconnaissance surveys are general in nature and are performed during Phase II (Corridor Location study) of project development under the CDOT Action Plan.

7.1.1 The information developed during these surveys is used in preparation of Environmental Impact Statements for proposed projects. These surveys are performed only if the necessary information cannot be obtained from existing data, such as soil maps, test reports from previous projects in the area, etc.

7.1.2 Information required from reconnaissance surveys:

- a) AASHTO classification of all major soil types present in the corridor.
- b) Identification of landforms or geologic formations with which each is associated.
- c) Description of specific engineering problems associated with each.

7.1.3 This information will be included in the soils and geology reconnaissance report prepared for each project and should be developed through joint effort of Region Materials Personnel and the Geologist assigned to the project.

7.1.4 The field survey, if required, will consist only of identifying the major soils present and obtaining representative bulk samples of each.

7.1.5 Usually, no line will have been established at this point in the project development and sample locations may be selected without regard for line and grade.

7.1.6 Samples may be taken by the most convenient method available. The primary considerations in sampling will be that the samples

are representative of the major soil types and large enough to permit accurate laboratory classification.

7.1.7 The survey may be performed either by Region Materials Personnel or by the Geologist concerned, as determined by mutual agreement.

8. Preliminary Soil Surveys

Preliminary soil surveys are performed during Phase III (Preliminary Design) of project development under the CDOT Action Plan. The information developed during these surveys is used in project design and preparation of cost estimates and must therefore be as accurate as possible. These surveys are performed on all new alignments and most widening projects.

8.1 The information required from preliminary soil surveys is described in detail in *The Soil Survey* section of these guidelines, together with recommended procedures for obtaining the information.

8.2 One of the most important items to be determined during the survey is the relationship between soil boundaries and the line and grade of the proposed project. If soil survey personnel do not know the location of line and grade at the time of the investigation, they cannot be certain that the soil conditions encountered in the test holes represent conditions to be encountered during construction. In particular, they cannot be sure that the soil conditions have been sampled to below finished grade if they do not know where finished grade will be located.

8.3 It is important to identify the presence of sulfates in soils at project locations. This can be determined by visiting the following website:

<http://websoilsurvey.nrcs.usda.gov/app/>

This website can provide soil engineering properties as well as approximate location, depth, and concentrations of sulfates.

8.4 Once the presence of sulfates on project locations is suspected the preliminary soils survey needs to address the sampling and testing of soil layers in these locations. During the preliminary soil survey, 1 sample, per soil type, will be tested per 1000 linear feet of two-lane roadway or fraction thereof. The boring depth for the preliminary soils survey will be a minimum of 1 – 3 feet below the

proposed finished grade. The sample size will be a minimum of 5 lbs. per soil type. Where water is present at drainages, a minimum 1 pint sample will be taken. CP-L 2103 will be used in the testing of sulfates in water or soil and can be performed in the field or by the Region Lab if adequate facilities and equipment are available.

SOIL SURVEY

1. Soil and Rock Classification and Description

1.1 Soil and rock materials encountered in test holes or surface outcrops should be identified and described as indicated in Appendices B through D of these guidelines. Accurate descriptions of soil or rock encountered in the field are important to the economic planning of the project design. Avoid complicated descriptions (not relevant to design or construction problems).

2. Sampling Methods

2.1 Test holes can be drilled or dug by hand, power auger, power rotary drill, backhoe, or any other practical method. In any case, it is of the utmost importance to use the method which will insure the attainment of representative, uncontaminated samples whether bulk samples, undisturbed samples, core samples, drill cutting samples, or split-spoon samples. Care should be taken to make sure that loose, sloughed soil or rock in the bottom of the test holes is not mixed in with samples representing the given depth. Where uncertainty exists as to the reliability of a sample, it is better that it be discarded.

NOTE 1: In the following paragraphs, the term "drilled" is used to mean any appropriate method for advancing a test hole.

3. Horizontal Distribution of Test Holes

3.1 Test holes will be spaced no farther apart than 500 feet in continuous cut sections and no farther apart than 1000 feet under any circumstance.

3.2 In addition, test holes should be drilled wherever there is any variation in soil or geological conditions, base gravels, and/or pavement thicknesses.

3.3 Time should be taken to obtain a sufficient number of test holes to outline sub-surface complexities.

3.4 During the design phase of the project, if it is determined that additional data or samples are needed, such will be obtained and a supplemental report submitted.

4. Proposed Widening Projects

4.1 On roadway widening projects, holes along the edge of the pavement will usually yield sufficient information.

4.2 Since there is, at times, considerable lag between the time of the preliminary soil profile and actual construction, holes drilled through the existing pavement should be held to a minimum. Such holes present maintenance problems, and excessive drilling in the traffic flow presents needless hazards.

4.3 Test holes can usually be drilled on the shoulder of the present road close enough to the pavement to obtain thickness measurements and required samples.

4.4 When taking soil surveys on proposed widening jobs, attention should be given to areas where CMP, RCCP, or box culverts may be extended, replaced, or added. Quite often these areas will require muck removal. Such requirement for muck excavation should be reported with respect to stationing, distance from survey line, and approximate depth. If it is not practical to drill test holes in the muck, it may be possible to get a rough estimate of depth by probing with a bar or rod.

5. Proposed New Line and/or Grade

These guidelines should be followed if:

- Different soil conditions are anticipated
- Cuts are to be made

5.1 For cut sections, test holes should be spaced as shown in Figure SS-1. At locations 1 and 3, test holes should be drilled on proposed outside shoulder line (edge of pavement) at the daylight line between cut and fill. An additional test hole should be drilled at location 2 (highest elevation of terrain on center line). For embankments whose maximum height will be more than 20 feet, test holes should be drilled on centerline, as shown in Figure SS-2.

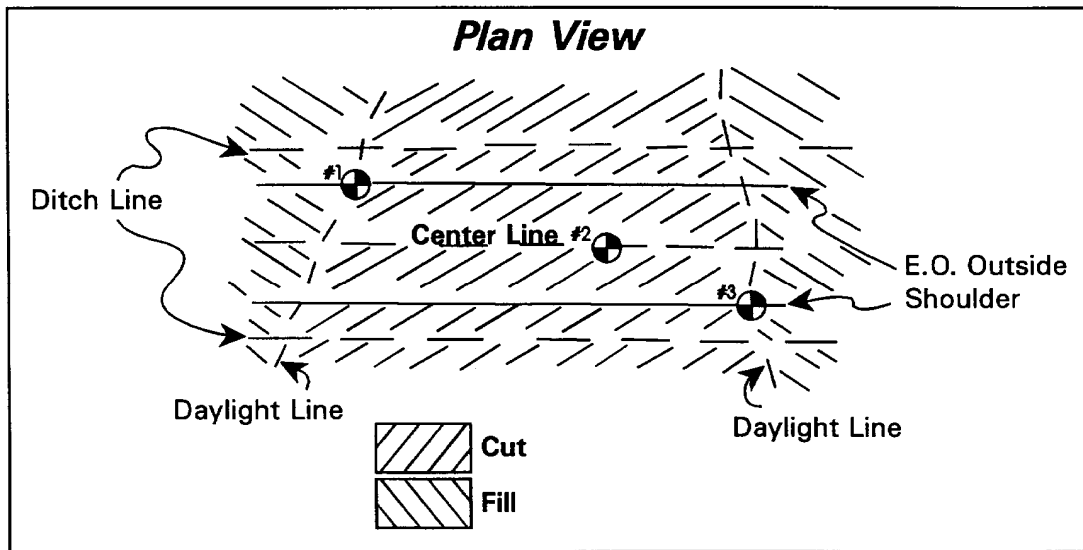

Figure SS-1. Recommended location of test holes in cut section.

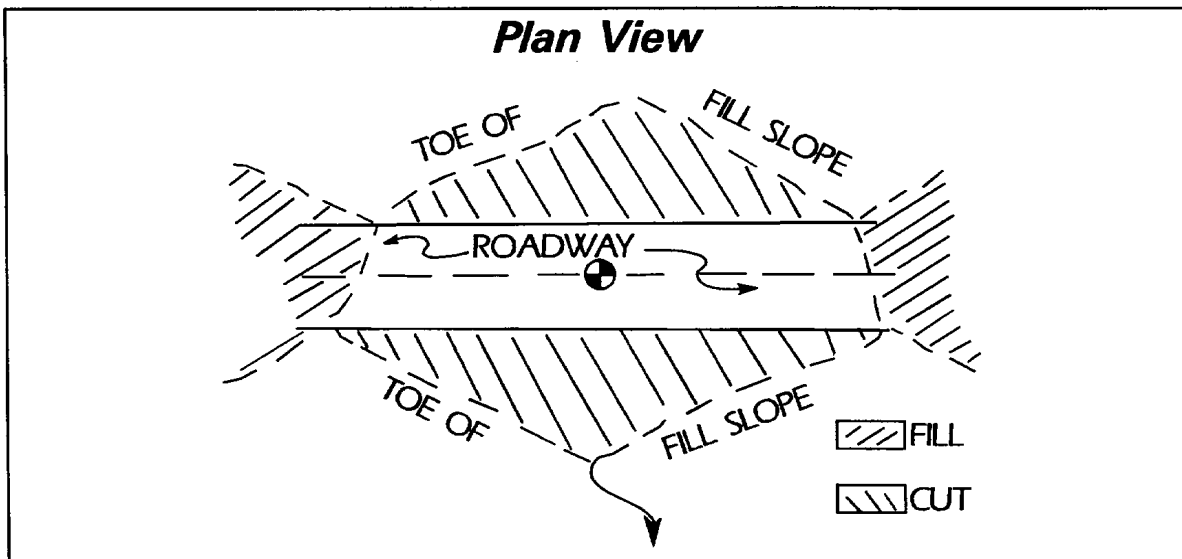

Figure SS-2. Recommended location of test holes in fill section.

6. Test Hole Depths and Sampling Recommendations

6.1 Test holes shall extend at least 3 feet below finished grade. If that depth is greater than the depth capability of the equipment available to Region personnel, the Geotechnical Section of the Central Laboratory or commercial drilling contractors will be requested to provide drilling

services. Such services would be performed under supervision of Region personnel, assisted by Central Laboratory Geologists if desired.

6.2 If topsoil is going to be required on the project, the lateral extent and depth of material, which could be utilized for topsoil, should be noted on the CDOT Form # 554.

6.3 A sample should be taken for each soil encountered except for the material, which might be used as topsoil. If the same soil is found in more than one hole, it may be similarized to a soil already sampled. However, care should be exercised in similarizing soils and additional samples should be taken where doubt exists. Similarization will be limited to one mile.

6.4 Test holes should be numbered consecutively from Hole #1, preferably beginning at the smaller station. Each soil layer encountered in the test hole shall be identified by the hole number followed by letter A, B, C, etc. In Hole #1, the first layer would be 1-A, the second 1-B, etc. Each layer shall be sampled in bulk or similarized. A bulk sample should be composed of at least one full sack and should weigh at least 33 lbs.

6.5 For proposed cut sections the depths of test holes and sampling requirements should be as shown in Figure SS-3. As per test hole location 2, Figure SS-3, soil and/or rock layers A, B, C, and D should be separately sampled or similarized.

6.6 For embankments whose proposed maximum height is more than 20 feet, the depths of test holes and the sampling recommendations should be as shown in Figure SS-4. Unless the bedrock or firm base as diagramed in Figure SS-4 is too hard for the drilling method being employed, all test holes (such as Location #1, Figure SS-4) should penetrate at least 5 feet into the hard substratum. Where the depth from existing ground to the top of the substratum is more than 20 feet, such as at major river crossings, this recommendation can be waived. However, in such cases the desirability of drilling to hard bedrock should be considered in at least one test hole. Test borings for major structures as logged by the Geotechnical Section of the Central Laboratory will be suitable for this purpose if available.

6.7 Where alluvial soils as shown in Figure SS-4 are composed of soft, compressible, fine-grained materials, it may be advisable to request a foundation investigation by the Geotechnical Section of the Central Laboratory.

6.8 For at-grade sections all test holes shall extend at least 3 feet below existing ground. All soils shall be sampled in bulk or similarized.

7. Hydrological Conditions

7.1 The distribution and mode of occurrence of surface and sub-surface water should be noted and included as part of all reports.

7.2 Where free water is encountered in any test hole, the water level is to be checked and noted on the CDOT Form # 555 along with the date and hour of the observation.

7.3 In cases where a high water table is suspected, it is recommended that the test hole be drilled or dug at least to the elevation of the water table and preferably a few feet below. Where possible, the hole is to be left open for a period of at least 24 hours and the water level, date, and hour recorded.

7.4 The location of all springs should be determined both horizontally and vertically with respect to centerline and grade line. The location of lakes, ponds, swampy areas, and reservoirs should be noted. Notes should especially be taken if the water is expected to influence the stability of pavements, cut slopes, or embankments.

7.5 The normal annual precipitation at the project site should be determined from the most recent isohyetal map.

8. Piping

Piping (definition): *Mechanical movement of particles due to seepage*

8.1 Areas requiring culverts, foundations, and ditch linings should be investigated to determine whether the soil is subject to piping.

8.2 Piping often occurs in silts, fine sands, and loosely compacted material.

8.3 Concentration of seepage into a few channels may cause piping.

8.4 If the preliminary investigation indicates conditions and soils that could cause piping, the Staff Hydraulics Unit should be requested to make a thorough investigation.

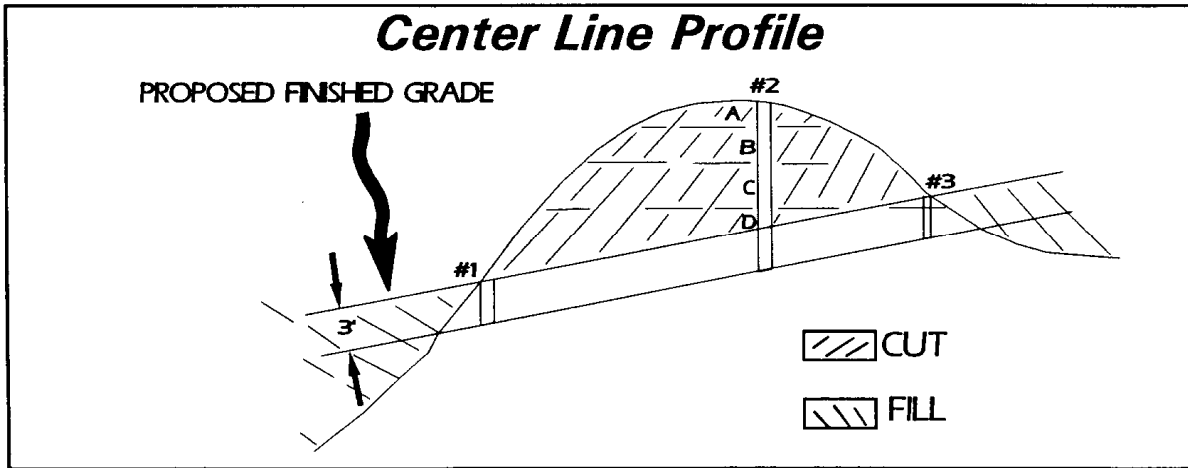

Figure SS-3. Recommended depth of test holes in cut sections.

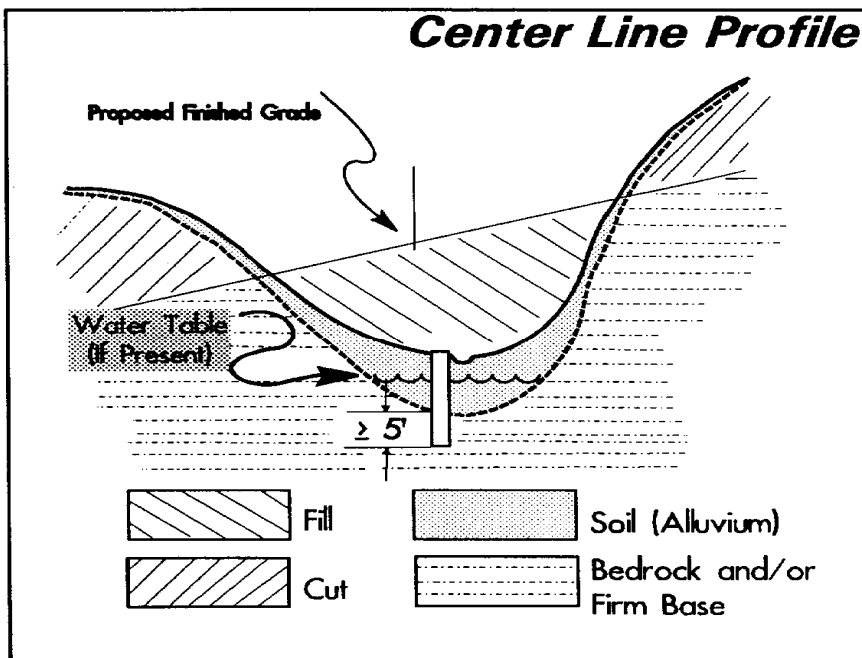

Figure SS-4. Recommended depths of test holes in fill.

9. Condition of Existing Pavements

9.1 The condition of existing concrete or asphalt pavements should be taken into account for stabilization and may be noted on a station-to-station basis on the CDOT Form # 903. This information is used for assignment of strength coefficients.

9.2 Type and thickness of existing pavement and type of stabilization previously used should also be reported.

10. Frost

10.1 In areas of severe frost action, the soil should be checked for frost susceptibility.

10.2 If necessary, recommendation should be made for the removal and replacement of frost-susceptible soil with non-frost heaving material. Non-frost heaving material should be replaced to a depth of one third-to one half the estimated frost penetration.

10.3 The ground water table (perched tables or aquifers included) should be checked in areas of severe frost action. The bottom of ditch linings should be kept at least three feet above the water table (unless the foundation materials are free draining sands or gravels).

11. Adjacent Terrain

11.1 This information is used primarily by the CDOT Staff Hydraulics Unit in determining rainfall runoff factors in the design of drainage structures.

11.2 Rather than noting conditions on a station-to-station basis, a general statement relative to the project as a whole should be made.

11.3 If there are distinct breaks over the length of the project, each type of terrain should be noted. Such designations as rolling grassland, steep timbered slopes, paved commercial etc. are appropriate.

12. Regional Factor

12.1 Deleted

13. Excavation Characteristics

13.1 During the investigation, notes should be kept concerning the estimated excavation characteristics of all soil or rock materials encountered.

13.2 Materials should be classified as:
a) Common excavation
b) Ripping required, or
c) Pre-blasting required

13.3 It is often necessary to construct shallow embankments from cuts or borrow pits containing boulders too large to be buried in the fills. The disposal of such boulders can be a problem on each project where this condition occurs. If such oversized material is encountered during the investigation, it should be noted on the CDOT Form # 555 in order that the Project Manager can include a NOTE in the plans that this material will usually become the property of the Prime Contractor, and it is required that he dispose of the material as per local laws and applicable State regulations.

14. Embankment Foundations

14.1 The construction of highways over weak, compressible soils presents some of the more difficult problems in soil mechanics.

14.2 If embankments are constructed over foundation soils having insufficient strength to support the added load, shear failure or slip-outs may occur, or the underlying soft material may displace by outward plastic flow.

14.3 If the foundation soil is highly compressible, excessive settlement of the embankment may occur, resulting in damage or destruction of the pavement, damage to structures, or hazards to traffic due to distortion of the profile and cross section of the roadbed. Such settlement may occur even if the strength of the foundation is high enough to preclude shear failure.

14.4 For the above reasons, it is recommended that Region personnel request that a foundation investigation be performed by the Geotechnical Section of the Central Laboratory where embankments more than 20 feet in height will be constructed on soft foundation soils.

15. Swelling Soils

15.1 Swelling soils are common in Colorado and are frequently encountered during highway construction. To minimize damage to roadways from swelling action, it is necessary that these soils be recognized when encountered in the field and that the boundaries of the soils along the project be determined during the preliminary soil survey.

15.2 A detailed map showing boundaries of swelling soil areas classified by amount of swell potential has been published by the Colorado Land Use Commission and has been distributed to all CDOT Regions. This map should be consulted prior to commencing any soils survey, whether reconnaissance or preliminary.

15.3 It is sometimes difficult to identify swelling soils visually, but the following criteria are often helpful:

15.3.1 *Texture* - When dry, the natural surface exposures of swelling soils usually exhibit an irregular or pebbly texture resembling Popcorn.

15.3.2 *Plasticity* - All swelling soils are plastic and most are highly plastic. The presence of plasticity can be determined in the field by moistening a sample and attempting to roll a thread in the palm of the hand.

15.3.3 *Bentonite Clay* - A common clay causing swell in soils is bentonite, which usually occurs in shales, either as fine particles invisible to the naked eye or as thin, light colored bands which contrast with the darker color of the shale and are oriented parallel to the bedding. The bands range in color from light tan to light greenish gray and may range in thickness from a fraction of an inch to as much as two or three inches. Pieces of this material will adhere to the tongue and will break down in a matter of minutes if dropped into water.

15.4 If any of these characteristics are noted during the soil survey (particularly in those areas indicated on the map) or if the possibility of swell is suspected for any other reason, notation to this effect should be made on the CDOT Form # 554.

15.5 Even though a soil contains expansive clays, it may not swell if the in-place moisture is high enough. It is therefore important to know the actual moisture content of the soil in order to

assess the possibility of problems due to swell. For this reason, if swelling soils are identified or suspected during the soil survey, moisture samples should be taken at or slightly below the elevation of the proposed grade line in those areas where the soils are present.

15.6 Problems due to expansive soils usually occur in cut areas and in transitions from cut to fill areas. They could also occur in fill areas where moderate to high swelling soils are used for fill. These soils are usually identified by:

- The liquid limit
- Plasticity index
- Expansion pressure
- Swell-consolidation

15.7 The liquid limit and plasticity index usually correlate with swell potential in the laboratory. However, they may not be related to the swell potential in the field because of moisture content, density, and chemicals in the in-situ soil.

15.8 Many potential high-swelling soils in areas of high ground water have taken on enough moisture so that additional swelling is not a problem. But certain dry, dense and often un-weathered soils must be treated to lesson swell potential.

15.9 Remedial measures for cut areas in swelling soil will normally consist of one of the following:

15.9.1 **Sub-excavation of potential expansive soil.** Dry dense un-weathered shales and dry dense clays.

Backfilling with impermeable soil at 95 percent of maximum dry density and at optimum moisture in accordance with AASHTO Designation T 99. This treatment should carry through the cut area and transitions from cut to fill until the depth of fill is approximately equal to the depth of treatment.

Soil with a plasticity index of over 50 should be placed in the bottom of the fills less than 50 feet high or wasted (disposed of offsite).

The backfill soil should be uniform and all lenses or pockets of very high swelling soil should be removed and replaced with the predominant type of soil, which has a plasticity

index under 50. Drainage ditches must be below the sub-grade level in the cut areas and must have enough grade to allow rapid runoff of surface water.

15.9.2 Treatment of the Sub-Grade. With swelling retarding chemicals such as lime, flyash or lime/fly ash combination.

The reactivity of the chemicals to the sub-grade should be first determined. It is widely known that sulfate-bearing material when introduced with lime will induce further heaving of the sub-grade.

The depth of the treatment should be determined using the sub-grade information such as thickness and swelling potential of the swelling material. The amount of chemicals to be introduced will be determined by the trial mix results obtained in the Soils/Rockfall Unit of the Central Laboratory.

15.9.3 A combination of the above two methods. The type of treatment should be based on a thorough investigation. When a choice of treatments is available, the most economical treatment should be used.

15.9.3.1 Depth of sub-grading may be reduced by having a trained soil technician or engineer check the soil as it is being excavated.

15.9.3.2 The zones or pockets containing the worst material would be excavated according to the table below and replaced with a material similar to the better surrounding material which required less depth of treatment.

Better material obtained from the borrow area should always be used in the upper fill. If swelling soil is the only available borrow source for the upper fill, treatment of the top few inches of the sub-grade by the chemicals should be considered. Moisture control during construction should be carefully observed. It is recommended that all swelling soils to be used as fill be compacted to moisture contents at or above optimum moisture.

Suggested Treatment Below Normal Subgrade Elevation

Projects on Interstate and Primary System	
Plasticity Index	Depth of Treatment
10 to 20	2 feet
20 to 30	3 feet
30 to 40	4 feet
40 to 50	5 feet
*Over 50	6 feet

Projects on Secondary and State Systems	
Plasticity Index	Depth of Treatment
10 to 30	2 feet
30 to 50	3 feet
*Over 50	4 feet

** Excavate and waste, replace with better impermeable material.*

If a treatment is determined to be necessary, then the type of treatment shall be determined by the Region Materials Engineer or it may be advisable to request additional analysis by the Soils/Rockfall Unit of the Central Laboratory.

Mathematically Scalping a Gradation

(Instructions for when a Preliminary Soil Survey has been performed.)

When less than 75 percent is passing the 3/4 inch sieve, divide the 3/8 inch sieve percent by the 1 inch sieve percent and then multiply the quotient by 100. The result will yield the "as run" gradation reported on CDOT Form #555. Perform this calculation on each successive sieve. When more than 75 percent is passing the 3/4 inch sieve, use the 3/4 inch sieve percent as a divisor and then perform the same calculation on each successive sieve.

	< 75%							
Sieve	3	1	3/4	3/8	#4	#10	#40	#200
% Passing	100	66	61	50	45	41	28	16
As Run		100	100	76	68	62	42	24

Scalp
(50 / 66) * 100 = 76

	> 75%							
Sieve	3	1	3/4	3/8	#4	#10	#40	#200
% Passing	100	99	98	95	90	80	57	21
As Run		100	100	97	92	82	58	21

Scalp
(95 / 98) * 100 = 97

Cumulative Setup for a R-Value

	< 75%							
Sieve	3	1	3/4	3/8	#4	#10	#40	#200
% Passing	100	66	61	50	45	41	28	16
As Run		100	100	76	68	62	42	24

	R-value Setup	Scalp
	(50 / 66) * 100 = 76	
100	76 68	
	X X	
	12 12	

+ 3/8	288	(100-76) * 12 = 288
+ #4	384	(100-68) * 12 = 384
- #4	1200	

			> 75%						
Sieve	3	1	3/4	3/8	#4	#10	#40	#200	
% Passing	100	99	(98)	(95)	90	80	57	21	
As Run		100	100	97	92	82	58	21	

	R-value Setup	(95 / 98) * 100 = 97
100	97 92	
	X X	
	11 11	
+ 3/8	33	(100-97) * 11 = 33
+ #4	88	(100-92) * 11 = 88
- #4	1100	

CDOT Forms #554, #555, and #157: Examples and Instructions

CDOT Form # 554 shall be used as the first sheet on each Soil Survey.

Full distribution, as indicated on the form, will be made at the time samples are transmitted to the Central Laboratory.

The report number from the CDOT Form # 554 shall be placed on all of CDOT Form # 555 sheets included in the Soil Survey.

The CDOT Form # 555 may be used in place of the field notebook. However, the electronic Form #555 shall be e-mailed to the Soils Program Laboratory Manager when samples have been submitted to the Central laboratory.

The Region office may elect to type the information from the field notebook or original CDOT Form # 555 onto another Form # 555. A hard copy of CDOT Form #554 and #555 shall accompany samples submitted to the Central Laboratory.

A copy of CDOT Form # 555 may be made for Region Materials Laboratory files. No other distribution of the partially completed Form # 555 is necessary.

When samples have been processed in the Central Laboratory, the CDOT Form # 555 will be completed and distributed.

Distribution of photocopies will be made as indicated on CDOT Form # 554.

Serial # 1267			
COLORADO DEPARTMENT OF TRANSPORTATION SOIL SURVEY FIELD REPORT			Report 000023
			Project # IM 0253-151
Location I-25, SH 7 to WCR 16			
Function 3200	Part P	Project code (SA#) 11925	Region 4 Date 5/5/02
Begin station 189+00	End station 569+00	Length 5.3	KM. → MI.
Equations (stations) 212+00 Bk = 212+10 Ah			
Structures (stations) 240+00, E-12-B, Crow Creek;			
312+00, E-17-A, Deer Creek; 640+00, E-18-F, Dry Wash			
Type of construction New Alignment			Compaction type: T99
No. of test holes 25	No. of samples 17	Proposed pavement type Flexible	
Adjacent terrain data Rolling Hills			
Perform tests for swelling soil Yes		Water sample 1	
Are old uncoated culverts corroding? Yes If yes, or area does not contain uncoated pipe, either descriptive documentation, samples or both are required per "Soil Survey Procedure" in the Design Manual.			
Record number and type of samples submitted for corrosion analysis. If submitted on separate CDOT Form #157, give report No.		1	Water
		2	Soil
Type of drilling equipment used 4" Auger		Resident Engineer Dave Forsyth	
Comments Swampy area between Sta. 345+50 - 348+25.			
Existing landslide on hillside @ Sta. 350+00 30' Lt.			
Centerline located adjacent to pond between			
Sta. 410+25 - 410+00.			
All excavation will be common except rock outcrop between			
Sta. 470+20 & 472+50 which will require blasting.			
Large boulders (2'-3') embedded in grade @ Sta. 514+00			
Sampled by Fidel Gonzales		Title E/PS Tech III	Supervisor (Proj./Res./Matis.) signature Corey Stewart / P.E. I
White - Staff Materials & Geotechnical Yellow - Resident Engineer's Office (Project file) Pink - Region Materials office		Address 1050 Lee Hill Rd. Boulder, Co. 80302	

CDOT Form #554 1/01

COLORADO DEPARTMENT OF TRANSPORTATION PRELIMINARY SOIL SURVEY														
Note 1: If samples are submitted leave sieve analysis section blank. Note 3: Sulfate content expressed as percent (dry soil), or ppm in water. Note 2: Comments should be placed in the description column of the form. Note 4: R-values referenced are noted 'Survey by Group Class' portion of this report.										Form #157 No. 120227	Form #554 No. 1267	Date: 02/23/03		
										Project No. IM 0253-151	CLASSIFICATION AND GROUP INDEX	MOIST. %	M _r PSI	
										Project location I-25 SH 7 to WCR 16	LIQUID LIMIT	PLASTIC INDEX		
										Project code (SA#) 11925				
STATION AND LOG	TEST NO.	DESCRIPTION	SULFATE CONTENT (SO ₄)	R-VAL REF	Per CP 24, Section 4					CLASSIFICATION AND GROUP INDEX	MOIST. %	M _r PSI		
					3/4"	3/8"	#4	#10	#40				#200	
MP 97 to 103.5														
M.P. 97+20 8' Lt.														
0" to 5"	1A	HMA												
5" to 18"	1B	ABC									0.7			
18" to 40" (refusal)	1C	Red Gravelly Silt	0.02								0.8			
M.P. 98+00 6' Rt.														
0" to 5"	2A	HMA												
5" to 16"	2B	ABC Similar to 1B												
16" to 30" (refusal)	2C	Brown Gravelly Silt	0.00								1.1			
M.P. 99+00 8' Rt.														
0" to 8"	3A	HMA												
8" to 12"	3B	ABC Similar to 1B												
12" to 28" (refusal)	3C	Similar to 2C	0.00											
M.P. 100+20 7' Lt.														
0" to 7"	4A	HMA												
7" to 18"	4B	ABC Similar to 1B												
18" to 48"	4C	Similar to 1C	0.02											
M.P. 101+20 7' Rt.														
0" to 7"	5A	HMA												
7" to 18"	5B	ABC Similar to 1B												
18" to 48"	5C	Silty Sandy Gravel	0.00								1.6			
M.P. 102+00 6' Rt.														
0" to 6"	6A	HMA												
6" to 16"	6B	ABC Similar to 1B												
16" to 24"	6C	Similar to 2C	0.00											
24" to 48"	6D	Clay	0.20								0.8			

CDOT Form #555 04/09

- Materials and Geotechnical
- Region Materials Engineer
- Resident Engineer

**COLORADO DEPARTMENT OF TRANSPORTATION
PRELIMINARY SOIL SURVEY**

Note 1: If samples are submitted leave sieve analysis section blank
 Note 2: Comments should be placed in the description column of the form
 Note 3: Sulfate content expressed as percent (dry soil), or ppm in water.

Form #157 No.	Form #554 No.	Date:
120227	1267	02/23/03
Project No.	IM 0253-151	
Project location	I-25 SH 7 to WCR 16	
Project code (SA#)	11925	

STATION AND LOG	TEST NO.	DESCRIPTION	SULFATE CONTENT (SO ₄)	MAX. SIZE	PERCENT PASSING							LIQUID LIMIT	PLASTIC INDEX	CLASSIFICATION AND GROUP INDEX	MOIST. %	M _r PSI
					3"	1"	3/4"	3/8"	#4	#10	#40					
M.P. 97+20 8' Lt.		M Job MP 97 to 103.5 (Int. w/ SH 62)														
0" to 5"	1A	HMA														
5" to 18"	1B	ABC SAMPLE			100	87	64	49	29	19	28	8	A-2-4(0)	0.7	28853	
18" to 40" (refusal)	1C	Red Gravelly Silt SAMPLE	0		100	86	74	62	48	33	26	11	A-2-6(0)	0.8	25317	
M.P. 98+00 6' Rt.																
0" to 5"	2A	HMA														
5" to 16"	2B	ABC Similar to 1B														
16" to 30" (refusal)	2C	Brown Rocky Silt SAMPLE	0		100	76	59	50	36	22	28	11	A-2-6(0)	1.1	19492	
M.P. 99+00 8' Rt.																
0" to 8"	3A	HMA														
8" to 12"	3B	ABC Similar to 1B														
12" to 28" (refusal)	3C	Similar to 2C	0													
M.P. 100+20 7' Lt.																
0" to 7"	4A	HMA														
7" to 18"	4B	ABC Similar to 1B														
18" to 48"	4C	Similar to 1C	0													
M.P. 101+20 7' Rt.																
0" to 7"	5A	HMA														
7" to 18"	5B	ABC Similar to 1B														
18" to 48"	5C	Silty, Sandy Gravel SAMPLE	0		100	90	82	75	65	43	31	16	A-6(2)	1.6	5448	
M.P. 102+00 6' Rt.																
0" to 6"	6A	HMA														
6" to 16"	6B	ABC Similar to 1B														
16" to 24"	6C	Similar to 2C	0													
24" to 48"	6D	Clay SAMPLE	1		100	53	39	33	24	6.8	25	9	A-2-4(0)	0.8	32883	

CDOT Form #555 05/06

Materials and Geotechnical
 Region Materials Engineer
 Resident Engineer

SOIL IDENTIFICATION AND DESCRIPTION

1.1 For engineering purposes soil is defined as any naturally occurring unconsolidated material composed of mineral grains with gases or liquids occupying the inter-granular spaces.

1.2 A complete soil identification for engineering purposes includes (a) a description of grain size, (b) color, (c) consistency, (d) moisture content, and (e) other descriptive factors, preferably in that order.

1.2.1 *Grain Size Distribution:* The soil should be primarily identified by the dominant grain size fraction present. The sub-dominant grain size fractions present may be noted as modifiers of the dominant grain size. Example: Sand, silty; gravel, sandy.

1.2.2 *Color:* Without the use of a standard color chart, soil color cannot be precisely determined due primarily to different lighting under different weather conditions. Moreover, the same soil sample will shade differently with varying moisture content. Accordingly field notes as to color should be broad and general unless the soils exhibit some unique color shade such as a distinct red or green.

1.2.3 *Consistency:* Consistency of a soil can be defined as that soil's resistance to penetration. It is related to the soil's density, degree of cementation, and moisture content. The strength and consolidation characteristics of all soils are strongly and directly related to consistency. If "extremely soft clayey soils" or "loose sands and gravel" are encountered in test holes, notation to this effect should be included in the field logs.

1.2.4 *Moisture Content:* For engineering purposes the field moisture content, especially in fine-grained soils, is very important. The moisture has a very strong influence on such engineering properties as compaction, shear strength, slope stability, and consolidation under embankment loads. It is recommended that the field moisture content of all soils encountered, whether sampled or not, be estimated and noted on the CDOT Form # 555 as follows:

1) Cohesive Soils

a) Dry - loose or crumbly, cannot be formed into a pellet.

b) Moist - can be formed into a pellet.

c) Wet - exudes free moisture when squeezed.

2) **Granular Soils** The above tests cannot always be successfully applied to granular materials since these soils often will not form into pellets. In such cases, the moisture content must be visually estimated, using the terms "dry", "moist", or "wet".

1.2.5 *Other Descriptive Factors:* Soils often possess other characteristics not described by the above four factors which may influence the engineering behavior of the material and should be reported. These include, but are not limited to the following:

1.2.5.1 *Unusual structure:* "Honeycomb" texture or inter-bedded thin layers of alternating fine and coarse material may indicate low strength.

1.2.5.2 *Presence of roots or decayed organic material at depth in a test hole.* May indicate a buried soil horizon. These usually have low strength.

1.2.5.3 *Presence of unusual minerals.* Whitish streaks or crack fillings of caliche indicate the presence of sulfate minerals, which may be detrimental to concrete or metal structures. Streaks, coatings, or crack-fillings of reddish-brown or yellowish-brown iron minerals indicate that ground water has been present in the past and therefore could return.

1.2.5.4 *Presence of man-made material . . .* such as broken glass, cinders, concrete, and metal fragments, etc, indicates that the soil is actually fill. While constructed fills such as highway embankments usually have adequate strength, other types of fills, particularly old dumps, may be very weak and may grow weaker with time if they contain large amounts of degradable or compressible material (tin cans, paper, plastic, etc.).

1.2.5.5 *Oversize Material*: If materials such as gravel, cobbles, or boulders are present but in relatively small amounts, they may be mentioned separately.

Example of the system of description:

- ◆ Clay, sandy, brown, soft, wet.
- ◆ Silt, sandy, light tan, firm, moist.
- ◆ Contains streaks of caliche and occasional 1' - 2' boulders.

ROCK IDENTIFICATION AND DESCRIPTION

Rock (Definition)- For engineering purposes rock is defined as a naturally occurring mineralogical aggregate, which in an intact, unfractured sample will yield a laboratory unconfined compressive strength greater than or equal to 200 psi.

Rock (Description) - A complete rock description for engineering purposes includes:

Classification Reference is made to the Rock Classification Table. This is a relatively simple but practical system which can be used by the field person, whether geologist, engineer, or technician.

Color

As for soils (See *Soil Identification and Description*, 1.2.2)

Hardness and Degree of Cementation

Soft - Can be scratched with a fingernail.

Moderately Hard - Can be scratched easily with a knife but cannot be scratched with a fingernail.

Hard - Difficult to scratch with a knife.

Very Hard - Cannot be scratched with a knife

Partings in the Rock

Including fractures, faults, and joints:

Intact - No partings.

Widely fractured - Partings more than 10 feet apart.

Closely fractured - Partings less than 10 feet apart but more than 6 inches apart.

Brecciated partings - Less than 6 inches apart.

Moisture content - Moisture content in rock cannot be determined by simple tests such as those used for soil, but should be estimated visually. As with soils, the terms dry, moist, and wet are adequate for field description.

Rock Classification Table

Sedimentary Rocks	* Coarse-grained	Conglomerate Sandstone	Dominant grain size is boulders or gravel. Dominant grain size is sand.
	** Fine-grained	Shale Limestone	Thin-bedded. Dominant grain size is clay and silt. Usually light-colored, composed of calcite and/or dolomite (will usually effervesce with dilute HCl).
Igneous and Metamorphic Rocks	* Coarse-grained	Gneiss Schist Marble Granite Diorite Gabbro	Composed of alternating bands of different colored minerals. Major component is mica-layered structure. Coarse-grained limestone. Granular, ranging in color from light to medium gray to salmon pink. Contains approximately equal proportions of dark and light colored minerals. Granular dark gray to black.
	** Fine	Rhyolite Quartzite Andesite Basalt	Nearly white to light gray. Composed entirely of quartz. Medium gray. Dark gray to black (sometimes porous or vesicular).

*** * Fine-grained:** Individual crystals or fragments, which compose the rock, *cannot* be seen with the unaided eye.

*** Coarse-grained:** Individual crystals or fragments, which compose the rock, *can* be seen with unaided eye.

DETERMINATION OF NEED FOR CULVERT PROTECTION

1. Field Observations and Sampling

1.1 The best time to observe, sample, or report conditions indicating the need for corrosion protection of culverts is on the preliminary soil survey (CDOT Form # 554). However, completed soil surveys should be reviewed where it seems necessary. If additional samples are required, submit on a CDOT Form # 157.

1.2 Past performance of culvert material is the best source of information. The local Maintenance Foreman can provide a history of culvert performance in the area. Observation of culverts on projects in adjacent areas of similar soil conditions will also provide useful information. Uncoated galvanized pipe, which shows no corrosion after at least two years of service, does not require soil or water sampling. However, a coated pipe, which shows no corrosion, may be in an environment that would attack an uncoated pipe. Samples of both the soil in contact with the pipe and the water going through it would provide this information.

1.3 The condition of the interior of a culvert tells only part of the story. In most cases, the corrosive substances are in the soil in contact with the pipe, rather than in the water. Therefore, to truly appraise the amount of corrosive attack, it is necessary to expose and examine some of the exterior of the pipe. The presence of extensive rust spots would indicate a serious condition. A soil sample should be taken near the corrosion to determine if it is due to a high or low pH, or to some corrosive salts. The extent and location of the corrosion would be noted on the CDOT Form # 554.

1.4 Crystals, encrustations and alkali deposits in the streambed near the waterline, are signs of a possibly corrosive water. Stains on the rocks are usually associated with minerals, therefore a tailing dump or mine drainage should be looked for upstream. If found, it should be noted on the CDOT Form # 554.

1.5 Water that seeps out of the ground or from some layer in an embankment will probably have variations in the amount of dissolved salts from season to season, depending on the volume of water moving through the soil and the amount

and availability of soluble mineral matter. It may be necessary to sample such water in spring, summer, and fall to be sure.

1.6 Alkali deposits on the soil, soils from Mancos and Pierre Shales, and fine silty soils should be suspected.

1.7 The Central Laboratory recommends that all suspected soils and water be sampled. The accompanying CDOT Form # 554 or # 157 should mention the conditions that prompted the sampling, and the exact location in reference to the proposed or existing culvert.

1.8 Soil and water samples will be run in the Laboratory to determine pH, hardness, alkali content, etc. Recommendations from the Laboratory concerning required protective action may be based on evaluation of one or several of these test results and their interactions.

1.8.1 Unusual stains, encrustations of salt, or alkali, even unpleasant odors, should be mentioned on the CDOT Form # 554 or # 157, as these are indicative of conditions which may cause culvert corrosion. The possible existence of an abrasive condition should also be noted. A serious problem should be discussed with the Hydraulics Unit for a possible solution.

1.9 A water sample should be at least a pint in volume and be in a clean, uncontaminated container. The soil sample should weigh at least a pound and be sent in a plastic bag.

1.10 On the basis of field observations and laboratory tests (where deemed necessary) the Region shall recommend to the Staff Design Engineer the types of culvert to be used and their location.

2. Corrosion Resistance Levels

2.1 Table 624-1 in Section 624 of the Standard Specifications shows six Corrosion Resistance levels, which are described below. Actually there are two more. The first is where there is no corrosive situation, and this may be thought of as CR-0. Here any pipe in Item 617 may be used, unless there is some other reason for selecting a specific type of pipe. The other condition is the possibility of abrasion. This situation is rare enough and varied enough to be considered individually. It would be advisable to

consult with the Hydraulics Unit for special design recommendations.

2.2 *pH* - This test is made to determine the acidity of a soil or water. A pH of 7 is indicative of neutral conditions. Values less than 7.0 are "acid" and those greater are defined as "alkaline."

2.3 *Alkali or Sulfate Content* - The term "alkali" is a bit of a misnomer as it is generally applied to all white deposits on or in a soil. For our purpose of evaluation it refers to "water-soluble" sulfates. Generally "alkali" concentration in soil greater than 0.1% (or 150 ppm for water) requires some special protection to reduce corrosion. Conditions of

"alkali" content in excess of 0.2% for soil, (and 2000 ppm for water), receive recommendations for maximum protection.

2.4 *Anions* - Presence of chloride and other "anions" in water are also significant as they directly attack unprotected culvert materials under appropriate conditions.

2.5 *Other Tests* - Other tests may be run. The significance of these or any of the above tests can vary with different conditions, and are not intended as absolute guides.

GUIDELINES FOR SELECTION OF CORROSION RESISTANCE LEVELS

SOIL				WATER		
CR LEVEL	Sulfate (SO4) % max	Chloride (CL) % max	pH	Sulfate (SO4) ppm max	Chloride (Cl) ppm max	pH
*CR 0	0.05	0.05	6.0-8.5	250	250	6.0-8.5
CR 1	0.15	0.15	6.0-8.5	250	250	6.0-8.5
CR 2	0.05	0.05	6.0-8.5	500	500	6.0-8.5
CR 3	0.15	0.15	6.0-8.5	500	500	6.0-8.5
CR 4	0.50	1.00	5.0-9.0	1000	1000	5.0-9.0
CR 5	1.00	1.50	5.0-9.0	2000	2000	5.0-9.0
CR 6	>1.00	>1.50	<5.0 or >9.0	>2000	>2000	<5.0 or >9.0

*No special corrosion protection recommended when values are within these limits.

Concrete pipe used when the pH of either the soil or water is less than 5 shall be coated in accordance with Section 706.07.

This chart is to be used as an aid in the selection of a CR level. Observations of field conditions should always be considered in making the final decision.

Table – Sulfate, Severity of Potential Exposure

Requirements to protect against damage to concrete by sulfate attack from external sources of sulfate.

Severity of potential exposure	Water-soluble sulfate (SO₄), percent, dry soil	Sulfate (SO₄) in water, ppm	Water cement ratio, maximum	Cementitious material requirements
Class 0 exposure	0.00 to 0.10	0 to 150	No special requirements for sulfate resistance	Class 0 requirements
Class 1 exposure	Greater than 0.10 and less than 0.20	Greater than 150 and less than 1500	0.45	Class 1 requirements
Class 2 exposure	0.20 and greater, but less than 2.0	1500 and greater, but less than 10,000	0.45	Class 2 requirements
Class 3 exposure	2.0 or greater	10,000 or greater	0.45	Class 3 requirements

This table is to be used when concrete structures are included in projects where sulfates may be present. Refer to the Standard Specifications, Section 601, "Sulfate Resistant Concrete" and Section 701, "Structural Concrete" for additional information.

Liquid Limit Determination from Blow Counts & Water Contents

Note: This mathematical formula replaces Chart 1, Pages 1 thru 8, from previous Field Materials Manuals.

LL = Liquid Limit

W_N = Moisture Content of Sample at N blows

N = Number of blows to close ½ inch gap of material in the liquid limit cup is between 22 to 28 blows

$$LL = (W_N) (N/25)^{.121}$$

N	$(N/25)^{.121}$	N	$(N/25)^{.121}$
22	0.985	26	1.005
23	0.990	27	1.009
24	0.995	28	1.014
25	1.000		

Example:

$$LL = (W_N)(N/25)^{.121}$$

Where:

W_N = 16.3% moisture

N = 26 blows to closure

$$LL = (16.3)(26/25)^{.121}$$

From the above table find N = 26, then use the corresponding number next to 26 and below $(N/25)^{.121}$

This number is 1.005

Multiply W_N (16.3) x (1.005)

LL = 16.38

Round to the nearest 0.1, or 16.4

Round this to the nearest whole number, or 16

Liquid Limit = 16

Partial Group Index for L.L.
(F-35)[0.2+0.005(LL-40)]

		% Passing #200																				
LL	35	36	37	38	39	40	41	42	43	44	45	46	47	48	49	50	51	52	53	54	55	56
20	0	0.100	0.200	0.300	0.400	0.500	0.600	0.700	0.800	0.900	1.000	1.100	1.200	1.300	1.400	1.500	1.600	1.700	1.800	1.900	2.000	2.100
21	0	0.105	0.210	0.315	0.420	0.525	0.630	0.735	0.840	0.945	1.050	1.155	1.260	1.365	1.470	1.575	1.680	1.785	1.890	1.995	2.100	2.205
22	0	0.110	0.220	0.330	0.440	0.550	0.660	0.770	0.880	0.990	1.100	1.210	1.320	1.430	1.540	1.650	1.760	1.870	1.980	2.090	2.200	2.310
23	0	0.115	0.230	0.345	0.460	0.575	0.690	0.805	0.920	1.035	1.150	1.265	1.380	1.495	1.610	1.725	1.840	1.955	2.070	2.185	2.300	2.415
24	0	0.120	0.240	0.360	0.480	0.600	0.720	0.840	0.960	1.080	1.200	1.320	1.440	1.560	1.680	1.800	1.920	2.040	2.160	2.280	2.400	2.520
25	0	0.125	0.250	0.375	0.500	0.625	0.750	0.875	1.000	1.125	1.250	1.375	1.500	1.625	1.750	1.875	2.000	2.125	2.250	2.375	2.500	2.625
26	0	0.130	0.260	0.390	0.520	0.650	0.780	0.910	1.040	1.170	1.300	1.430	1.560	1.690	1.820	1.950	2.080	2.210	2.340	2.470	2.600	2.730
27	0	0.135	0.270	0.405	0.540	0.675	0.810	0.945	1.080	1.215	1.350	1.485	1.620	1.755	1.890	2.025	2.160	2.295	2.430	2.565	2.700	2.835
28	0	0.140	0.280	0.420	0.560	0.700	0.840	0.980	1.120	1.260	1.400	1.540	1.680	1.820	1.960	2.100	2.240	2.380	2.520	2.660	2.800	2.940
29	0	0.145	0.290	0.435	0.580	0.725	0.870	1.015	1.160	1.305	1.450	1.595	1.740	1.885	2.030	2.175	2.320	2.465	2.610	2.755	2.900	3.045
30	0	0.150	0.300	0.450	0.600	0.750	0.900	1.050	1.200	1.350	1.500	1.650	1.800	1.950	2.100	2.250	2.400	2.550	2.700	2.850	3.000	3.150
31	0	0.155	0.310	0.465	0.620	0.775	0.930	1.085	1.240	1.395	1.550	1.705	1.860	2.015	2.170	2.325	2.480	2.635	2.790	2.945	3.100	3.255
32	0	0.160	0.320	0.480	0.640	0.800	0.960	1.120	1.280	1.440	1.600	1.760	1.920	2.080	2.240	2.400	2.560	2.720	2.880	3.040	3.200	3.360
33	0	0.165	0.330	0.495	0.660	0.825	0.990	1.155	1.320	1.485	1.650	1.815	1.980	2.145	2.310	2.475	2.640	2.805	2.970	3.135	3.300	3.465
34	0	0.170	0.340	0.510	0.680	0.850	1.020	1.190	1.360	1.530	1.700	1.870	2.040	2.210	2.380	2.550	2.720	2.890	3.060	3.230	3.400	3.570
35	0	0.175	0.350	0.525	0.700	0.875	1.050	1.225	1.400	1.575	1.750	1.925	2.100	2.275	2.450	2.625	2.800	2.975	3.150	3.325	3.500	3.675
36	0	0.180	0.360	0.540	0.720	0.900	1.080	1.260	1.440	1.620	1.800	1.980	2.160	2.340	2.520	2.700	2.880	3.060	3.240	3.420	3.600	3.780
37	0	0.185	0.370	0.555	0.740	0.925	1.110	1.295	1.480	1.665	1.850	2.035	2.220	2.405	2.590	2.775	2.960	3.145	3.330	3.515	3.700	3.885
38	0	0.190	0.380	0.570	0.760	0.950	1.140	1.330	1.520	1.710	1.900	2.090	2.280	2.470	2.660	2.850	3.040	3.230	3.420	3.610	3.800	3.990
39	0	0.195	0.390	0.585	0.780	0.975	1.170	1.365	1.560	1.755	1.950	2.145	2.340	2.535	2.730	2.925	3.120	3.315	3.510	3.705	3.900	4.095
40	0	0.200	0.400	0.600	0.800	1.000	1.200	1.400	1.600	1.800	2.000	2.200	2.400	2.600	2.800	3.000	3.200	3.400	3.600	3.800	4.000	4.200
41	0	0.205	0.410	0.615	0.820	1.025	1.230	1.435	1.640	1.845	2.050	2.255	2.460	2.665	2.870	3.075	3.280	3.485	3.690	3.895	4.100	4.305
42	0	0.210	0.420	0.630	0.840	1.050	1.260	1.470	1.680	1.890	2.100	2.310	2.520	2.730	2.940	3.150	3.360	3.570	3.780	3.990	4.200	4.410
43	0	0.215	0.430	0.645	0.860	1.075	1.290	1.505	1.720	1.935	2.150	2.365	2.580	2.795	3.010	3.225	3.440	3.655	3.870	4.085	4.300	4.515
44	0	0.220	0.440	0.660	0.880	1.100	1.320	1.540	1.760	1.980	2.200	2.420	2.640	2.860	3.080	3.300	3.520	3.740	3.960	4.180	4.400	4.620
45	0	0.225	0.450	0.675	0.900	1.125	1.350	1.575	1.800	2.025	2.250	2.475	2.700	2.925	3.150	3.375	3.600	3.825	4.050	4.275	4.500	4.725
46	0	0.230	0.460	0.690	0.920	1.150	1.380	1.610	1.840	2.070	2.300	2.530	2.760	2.990	3.220	3.450	3.680	3.910	4.140	4.370	4.600	4.830
47	0	0.235	0.470	0.705	0.940	1.175	1.410	1.645	1.880	2.115	2.350	2.585	2.820	3.055	3.290	3.525	3.760	3.995	4.230	4.465	4.700	4.935
48	0	0.240	0.480	0.720	0.960	1.200	1.440	1.680	1.920	2.160	2.400	2.640	2.880	3.120	3.360	3.600	3.840	4.080	4.320	4.560	4.800	5.040
49	0	0.245	0.490	0.735	0.980	1.225	1.470	1.715	1.960	2.205	2.450	2.695	2.940	3.185	3.430	3.675	3.920	4.165	4.410	4.655	4.900	5.145
50	0	0.250	0.500	0.750	1.000	1.250	1.500	1.750	2.000	2.250	2.500	2.750	3.000	3.250	3.500	3.750	4.000	4.250	4.500	4.750	5.000	5.250
51	0	0.255	0.510	0.765	1.020	1.275	1.530	1.785	2.040	2.295	2.550	2.805	3.060	3.315	3.570	3.825	4.080	4.335	4.590	4.845	5.100	5.355
52	0	0.260	0.520	0.780	1.040	1.300	1.560	1.820	2.080	2.340	2.600	2.860	3.120	3.380	3.640	3.900	4.160	4.420	4.680	4.940	5.200	5.460
53	0	0.265	0.530	0.795	1.060	1.325	1.590	1.855	2.120	2.385	2.650	2.915	3.180	3.445	3.710	3.975	4.240	4.505	4.770	5.035	5.300	5.565
54	0	0.270	0.540	0.810	1.080	1.350	1.620	1.890	2.160	2.430	2.700	2.970	3.240	3.510	3.780	4.050	4.320	4.590	4.860	5.130	5.400	5.670
55	0	0.275	0.550	0.825	1.100	1.375	1.650	1.925	2.200	2.475	2.750	3.025	3.300	3.575	3.850	4.125	4.400	4.675	4.950	5.225	5.500	5.775
56	0	0.280	0.560	0.840	1.120	1.400	1.680	1.960	2.240	2.520	2.800	3.080	3.360	3.640	3.920	4.200	4.480	4.760	5.040	5.320	5.600	5.880
57	0	0.285	0.570	0.855	1.140	1.425	1.710	1.995	2.280	2.565	2.850	3.135	3.420	3.705	3.990	4.275	4.560	4.845	5.130	5.415	5.700	5.985
58	0	0.290	0.580	0.870	1.160	1.450	1.740	2.030	2.320	2.610	2.900	3.190	3.480	3.770	4.060	4.350	4.640	4.930	5.220	5.510	5.800	6.090
59	0	0.295	0.590	0.885	1.180	1.475	1.770	2.065	2.360	2.655	2.950	3.245	3.540	3.835	4.130	4.425	4.720	5.015	5.310	5.605	5.900	6.195
60	0	0.300	0.600	0.900	1.200	1.500	1.800	2.100	2.400	2.700	3.000	3.300	3.600	3.900	4.200	4.500	4.800	5.100	5.400	5.700	6.000	6.300
61	0	0.305	0.610	0.915	1.220	1.525	1.830	2.135	2.440	2.745	3.050	3.355	3.660	3.965	4.270	4.575	4.880	5.185	5.490	5.795	6.100	6.405
62	0	0.310	0.620	0.930	1.240	1.550	1.860	2.170	2.480	2.790	3.100	3.410	3.720	4.030	4.340	4.650	4.960	5.270	5.580	5.890	6.200	6.510
63	0	0.315	0.630	0.945	1.260	1.575	1.890	2.205	2.520	2.835	3.150	3.465	3.780	4.095	4.410	4.725	5.040	5.355	5.670	5.985	6.300	6.615
64	0	0.320	0.640	0.960	1.280	1.600	1.920	2.240	2.560	2.880	3.200	3.520	3.840	4.160	4.480	4.800	5.120	5.440	5.760	6.080	6.400	6.720
65	0	0.325	0.650	0.975	1.300	1.625	1.950	2.275	2.600	2.925	3.250	3.575	3.900	4.225	4.550	4.875	5.200	5.525	5.850	6.175	6.500	6.825
66	0	0.330	0.660	0.990	1.320	1.650	1.980	2.310	2.640	2.970	3.300	3.630	3.960	4.290	4.620	4.950	5.280	5.610	5.940	6.270	6.600	6.930
67	0	0.335	0.670	1.005	1.340	1.675	2.010	2.345	2.680	3.015	3.350	3.685	4.020	4.355	4.690	5.025	5.360	5.695	6.030	6.365	6.700	7.035
68	0	0.340	0.680	1.020	1.360	1.700	2.040	2.380	2.720	3.060	3.400	3.740	4.080	4.420	4.760	5.100	5.440	5.780	6.120	6.460	6.800	7.140
69	0	0.345	0.690	1.035	1.380	1.725	2.070	2.415	2.760	3.105	3.450	3.800	4.140	4.485	4.830	5.175	5.520	5.865	6.210	6.555	6.900	7.245
70	0	0.350	0.700	1.050	1.400	1.750	2.100	2.450	2.800	3.150	3.500	3.850	4.200	4.550	4.900	5.250	5.600	5.950	6.300	6.650	7.000	7.350
71	0	0.355	0.710	1.065	1.420	1.775	2.130	2.485	2.840	3.195	3.550	3.905	4.260	4.615	4.970	5.325	5.680	6.035	6.390	6.745	7.100	7.455
72	0	0.360	0.720	1.080	1.440	1.800	2.160	2.520	2.880	3.240	3.600	3.960	4.320	4.680	5.040	5.400	5.760	6.120	6.480			

Partial Group Index for L.L.
(F-35)[0.2+0.005(LL-40)]

% Passing #200

LL	57	58	59	60	61	62	63	64	65	66	67	68	69	70	71	72	73	74	75	76	77	78
20	2.200	2.300	2.400	2.500	2.600	2.700	2.800	2.900	3.000	3.100	3.200	3.300	3.400	3.500	3.600	3.700	3.800	3.900	4.000	4.100	4.200	4.300
21	2.310	2.415	2.520	2.625	2.730	2.835	2.940	3.045	3.150	3.255	3.360	3.465	3.570	3.675	3.780	3.885	3.990	4.095	4.200	4.305	4.410	4.515
22	2.420	2.530	2.640	2.750	2.860	2.970	3.080	3.190	3.300	3.410	3.520	3.630	3.740	3.850	3.960	4.070	4.180	4.290	4.400	4.510	4.620	4.730
23	2.530	2.645	2.760	2.875	2.990	3.105	3.220	3.335	3.450	3.565	3.680	3.795	3.910	4.025	4.140	4.255	4.370	4.485	4.600	4.715	4.830	4.945
24	2.640	2.760	2.880	3.000	3.120	3.240	3.360	3.480	3.600	3.720	3.840	3.960	4.080	4.200	4.320	4.440	4.560	4.680	4.800	4.920	5.040	5.160
25	2.750	2.875	3.000	3.125	3.250	3.375	3.500	3.625	3.750	3.875	4.000	4.125	4.250	4.375	4.500	4.625	4.750	4.875	5.000	5.125	5.250	5.375
26	2.860	2.990	3.120	3.250	3.380	3.510	3.640	3.770	3.900	4.030	4.160	4.290	4.420	4.550	4.680	4.810	4.940	5.070	5.200	5.330	5.460	5.590
27	2.970	3.105	3.240	3.375	3.510	3.645	3.780	3.915	4.050	4.185	4.320	4.455	4.590	4.725	4.860	4.995	5.130	5.265	5.400	5.535	5.670	5.805
28	3.080	3.220	3.360	3.500	3.640	3.780	3.920	4.060	4.200	4.340	4.480	4.620	4.760	4.900	5.040	5.180	5.320	5.460	5.600	5.740	5.880	6.020
29	3.190	3.335	3.480	3.625	3.770	3.915	4.060	4.205	4.350	4.495	4.640	4.785	4.930	5.075	5.220	5.365	5.510	5.655	5.800	5.945	6.090	6.235
30	3.300	3.450	3.600	3.750	3.900	4.050	4.200	4.350	4.500	4.650	4.800	4.950	5.100	5.250	5.400	5.550	5.700	5.850	6.000	6.150	6.300	6.450
31	3.410	3.565	3.720	3.875	4.030	4.185	4.340	4.495	4.650	4.805	4.960	5.115	5.270	5.425	5.580	5.735	5.890	6.045	6.200	6.355	6.510	6.665
32	3.520	3.680	3.840	4.000	4.160	4.320	4.480	4.640	4.800	4.960	5.120	5.280	5.440	5.600	5.760	5.920	6.080	6.240	6.400	6.560	6.720	6.880
33	3.630	3.795	3.960	4.125	4.290	4.455	4.620	4.785	4.950	5.115	5.280	5.445	5.610	5.775	5.940	6.105	6.270	6.435	6.600	6.765	6.930	7.095
34	3.740	3.910	4.080	4.250	4.420	4.590	4.760	4.930	5.100	5.270	5.440	5.610	5.780	5.950	6.120	6.290	6.460	6.630	6.800	6.970	7.140	7.310
35	3.850	4.025	4.200	4.375	4.550	4.725	4.900	5.075	5.250	5.425	5.600	5.775	5.950	6.125	6.300	6.475	6.650	6.825	7.000	7.175	7.350	7.525
36	3.960	4.140	4.320	4.500	4.680	4.860	5.040	5.220	5.400	5.580	5.760	5.940	6.120	6.300	6.480	6.660	6.840	7.020	7.200	7.380	7.560	7.740
37	4.070	4.255	4.440	4.625	4.810	4.995	5.180	5.365	5.550	5.735	5.920	6.105	6.290	6.475	6.660	6.845	7.030	7.215	7.400	7.585	7.770	7.955
38	4.180	4.370	4.560	4.750	4.940	5.130	5.320	5.510	5.700	5.890	6.080	6.270	6.460	6.650	6.840	7.030	7.220	7.410	7.600	7.790	7.980	8.170
39	4.290	4.485	4.680	4.875	5.070	5.265	5.460	5.655	5.850	6.045	6.240	6.435	6.630	6.825	7.020	7.215	7.410	7.605	7.800	7.995	8.190	8.385
40	4.400	4.600	4.800	5.000	5.200	5.400	5.600	5.800	6.000	6.200	6.400	6.600	6.800	7.000	7.200	7.400	7.600	7.800	8.000	8.200	8.400	8.600
41	4.510	4.715	4.920	5.125	5.330	5.535	5.740	5.945	6.150	6.355	6.560	6.765	6.970	7.175	7.380	7.585	7.790	7.995	8.200	8.405	8.610	8.815
42	4.620	4.830	5.040	5.250	5.460	5.670	5.880	6.090	6.300	6.510	6.720	6.930	7.140	7.350	7.560	7.770	7.980	8.190	8.400	8.610	8.820	9.030
43	4.730	4.945	5.160	5.375	5.590	5.805	6.020	6.235	6.450	6.665	6.880	7.095	7.310	7.525	7.740	7.955	8.170	8.385	8.600	8.815	9.030	9.245
44	4.840	5.060	5.280	5.500	5.720	5.940	6.160	6.380	6.600	6.820	7.040	7.260	7.480	7.700	7.920	8.140	8.360	8.580	8.800	9.020	9.240	9.460
45	4.950	5.175	5.400	5.625	5.850	6.075	6.300	6.525	6.750	6.975	7.200	7.425	7.650	7.875	8.100	8.325	8.550	8.775	9.000	9.225	9.450	9.675
46	5.060	5.290	5.520	5.750	5.980	6.210	6.440	6.670	6.900	7.130	7.360	7.590	7.820	8.050	8.280	8.510	8.740	8.970	9.200	9.430	9.660	9.890
47	5.170	5.405	5.640	5.875	6.110	6.345	6.580	6.815	7.050	7.285	7.520	7.755	7.990	8.225	8.460	8.695	8.930	9.165	9.400	9.635	9.870	10.105
48	5.280	5.520	5.760	6.000	6.240	6.480	6.720	6.960	7.200	7.440	7.680	7.920	8.160	8.400	8.640	8.880	9.120	9.360	9.600	9.840	10.080	10.320
49	5.390	5.635	5.880	6.125	6.370	6.615	6.860	7.105	7.350	7.595	7.840	8.085	8.330	8.575	8.820	9.065	9.310	9.555	9.800	10.045	10.290	10.535
50	5.500	5.750	6.000	6.250	6.500	6.750	7.000	7.250	7.500	7.750	8.000	8.250	8.500	8.750	9.000	9.250	9.500	9.750	10.000	10.250	10.500	10.750
51	5.610	5.865	6.120	6.375	6.630	6.885	7.140	7.395	7.650	7.905	8.160	8.415	8.670	8.925	9.180	9.435	9.690	9.945	10.200	10.455	10.710	10.965
52	5.720	5.980	6.240	6.500	6.760	7.020	7.280	7.540	7.800	8.060	8.320	8.580	8.840	9.100	9.360	9.620	9.880	10.140	10.400	10.660	10.920	11.180
53	5.830	6.095	6.360	6.625	6.890	7.155	7.420	7.685	7.950	8.215	8.480	8.745	9.010	9.275	9.540	9.805	10.070	10.335	10.600	10.865	11.130	11.395
54	5.940	6.210	6.480	6.750	7.020	7.290	7.560	7.830	8.100	8.370	8.640	8.910	9.180	9.450	9.720	9.990	10.260	10.530	10.800	11.070	11.340	11.610
55	6.050	6.325	6.600	6.875	7.150	7.425	7.700	7.975	8.250	8.525	8.800	9.075	9.350	9.625	9.900	10.175	10.450	10.725	11.000	11.275	11.550	11.825
56	6.160	6.440	6.720	7.000	7.280	7.560	7.840	8.120	8.400	8.680	8.960	9.240	9.520	9.800	10.080	10.360	10.640	10.920	11.200	11.480	11.760	12.040
57	6.270	6.555	6.840	7.125	7.410	7.695	7.980	8.265	8.550	8.835	9.120	9.405	9.690	9.975	10.260	10.545	10.830	11.115	11.400	11.685	11.970	12.255
58	6.380	6.670	6.960	7.250	7.540	7.830	8.120	8.410	8.700	8.990	9.280	9.570	9.860	10.150	10.440	10.730	11.020	11.310	11.600	11.890	12.180	12.470
59	6.490	6.785	7.080	7.375	7.670	7.965	8.260	8.555	8.850	9.145	9.440	9.735	10.030	10.325	10.620	10.915	11.210	11.505	11.800	12.095	12.390	12.685
60	6.600	6.900	7.200	7.500	7.800	8.100	8.400	8.700	9.000	9.300	9.600	9.900	10.200	10.500	10.800	11.100	11.400	11.700	12.000	12.300	12.600	12.900
61	6.710	7.015	7.320	7.625	7.930	8.235	8.540	8.845	9.150	9.455	9.760	10.065	10.370	10.675	10.980	11.285	11.590	11.895	12.200	12.505	12.810	13.115
62	6.820	7.130	7.440	7.750	8.060	8.370	8.680	8.990	9.300	9.610	9.920	10.230	10.540	10.850	11.160	11.470	11.780	12.090	12.400	12.710	13.020	13.330
63	6.930	7.245	7.560	7.875	8.190	8.505	8.820	9.135	9.450	9.765	10.080	10.395	10.710	11.025	11.340	11.655	11.970	12.285	12.600	12.915	13.230	13.545
64	7.040	7.360	7.680	8.000	8.320	8.640	8.960	9.280	9.600	9.920	10.240	10.560	10.880	11.200	11.520	11.840	12.160	12.480	12.800	13.120	13.440	13.760
65	7.150	7.475	7.800	8.125	8.450	8.775	9.100	9.425	9.750	10.075	10.400	10.725	11.050	11.375	11.700	12.025	12.350	12.675	13.000	13.325	13.650	13.975
66	7.260	7.590	7.920	8.250	8.580	8.910	9.240	9.570	9.900	10.230	10.560	10.890	11.220	11.550	11.880	12.210	12.540	12.870	13.200	13.530	13.860	14.190
67	7.370	7.705	8.040	8.375	8.710	9.045	9.380	9.715	10.050	10.385	10.720	11.055	11.390	11.725	12.060	12.395	12.730	13.065	13.400	13.735	14.070	14.405
68	7.480	7.820	8.160	8.500	8.840	9.180	9.520	9.860	10.200	10.540	10.880	11.220	11.560	11.900	12.240	12.580	12.920	13.260	13.600	13.940	14.280	14.620
69	7.590	7.935	8.280	8.625	8.970	9.315	9.660	10.005	10.350	10.695	11.040	11.385	11.730	12.075	12.420	12.765	13.110	13.455	13.800	14.145	14.490	14.835
70	7.700	8.050	8.400	8.750	9.100	9.450	9.800	10.150	10.500	10.850	11.200	11.550	11.900	12.250	12.600	12.950	13.300	13.650	14.000	14.350	14.700	15.0

Partial Group Index for L.L.
(F-35)[0.2+0.005(LL-40)]

% Passing #200

LL	79	80	81	82	83	84	85	86	87	88	89	90	91	92	93	94	95	96	97	98	99	100
20	4.400	4.500	4.600	4.700	4.800	4.900	5.000	5.100	5.200	5.300	5.400	5.500	5.600	5.700	5.800	5.900	6.000	6.100	6.200	6.300	6.400	6.500
21	4.620	4.725	4.830	4.935	5.040	5.145	5.250	5.355	5.460	5.565	5.670	5.775	5.880	5.985	6.090	6.195	6.300	6.405	6.510	6.615	6.720	6.825
22	4.840	4.950	5.060	5.170	5.280	5.390	5.500	5.610	5.720	5.830	5.940	6.050	6.160	6.270	6.380	6.490	6.600	6.710	6.820	6.930	7.040	7.150
23	5.060	5.175	5.290	5.405	5.520	5.635	5.750	5.865	5.980	6.095	6.210	6.325	6.440	6.555	6.670	6.785	6.900	7.015	7.130	7.245	7.360	7.475
24	5.280	5.400	5.520	5.640	5.760	5.880	6.000	6.120	6.240	6.360	6.480	6.600	6.720	6.840	6.960	7.080	7.200	7.320	7.440	7.560	7.680	7.800
25	5.500	5.625	5.750	5.875	6.000	6.125	6.250	6.375	6.500	6.625	6.750	6.875	7.000	7.125	7.250	7.375	7.500	7.625	7.750	7.875	8.000	8.125
26	5.720	5.850	5.980	6.110	6.240	6.370	6.500	6.630	6.760	6.890	7.020	7.150	7.280	7.410	7.540	7.670	7.800	7.930	8.060	8.190	8.320	8.450
27	5.940	6.075	6.210	6.345	6.480	6.615	6.750	6.885	7.020	7.155	7.290	7.425	7.560	7.695	7.830	7.965	8.100	8.235	8.370	8.505	8.640	8.775
28	6.160	6.300	6.440	6.580	6.720	6.860	7.000	7.140	7.280	7.420	7.560	7.700	7.840	7.980	8.120	8.260	8.400	8.540	8.680	8.820	8.960	9.100
29	6.380	6.525	6.670	6.815	6.960	7.105	7.250	7.395	7.540	7.685	7.830	7.975	8.120	8.265	8.410	8.555	8.700	8.845	8.990	9.135	9.280	9.425
30	6.600	6.750	6.900	7.050	7.200	7.350	7.500	7.650	7.800	7.950	8.100	8.250	8.400	8.550	8.700	8.850	9.000	9.150	9.300	9.450	9.600	9.750
31	6.820	6.975	7.130	7.285	7.440	7.595	7.750	7.905	8.060	8.215	8.370	8.525	8.680	8.835	8.990	9.145	9.300	9.455	9.610	9.765	9.920	10.075
32	7.040	7.200	7.360	7.520	7.680	7.840	8.000	8.160	8.320	8.480	8.640	8.800	8.960	9.120	9.280	9.440	9.600	9.760	9.920	10.080	10.240	10.400
33	7.260	7.425	7.590	7.755	7.920	8.085	8.250	8.415	8.580	8.745	8.910	9.075	9.240	9.405	9.570	9.735	9.900	10.065	10.230	10.395	10.560	10.725
34	7.480	7.650	7.820	7.990	8.160	8.330	8.500	8.670	8.840	9.010	9.180	9.350	9.520	9.690	9.860	10.030	10.200	10.370	10.540	10.710	10.880	11.050
35	7.700	7.875	8.050	8.225	8.400	8.575	8.750	8.925	9.100	9.275	9.450	9.625	9.800	9.975	10.150	10.325	10.500	10.675	10.850	11.025	11.200	11.375
36	7.920	8.100	8.280	8.460	8.640	8.820	9.000	9.180	9.360	9.540	9.720	9.900	10.080	10.260	10.440	10.620	10.800	10.980	11.160	11.340	11.520	11.700
37	8.140	8.325	8.510	8.695	8.880	9.065	9.250	9.435	9.620	9.805	9.990	10.175	10.360	10.545	10.730	10.915	11.100	11.285	11.470	11.655	11.840	12.025
38	8.360	8.550	8.740	8.930	9.120	9.310	9.500	9.690	9.880	10.070	10.260	10.450	10.640	10.830	11.020	11.210	11.400	11.590	11.780	11.970	12.160	12.350
39	8.580	8.775	8.970	9.165	9.360	9.555	9.750	9.945	10.140	10.335	10.530	10.725	10.920	11.115	11.310	11.505	11.700	11.895	12.090	12.285	12.480	12.675
40	8.800	9.000	9.200	9.400	9.600	9.800	10.000	10.200	10.400	10.600	10.800	11.000	11.200	11.400	11.600	11.800	12.000	12.200	12.400	12.600	12.800	13.000
41	9.020	9.225	9.430	9.635	9.840	10.045	10.250	10.455	10.660	10.865	11.070	11.275	11.480	11.685	11.890	12.095	12.300	12.505	12.710	12.915	13.120	13.325
42	9.240	9.450	9.660	9.870	10.080	10.290	10.500	10.710	10.920	11.130	11.340	11.550	11.760	11.970	12.180	12.390	12.600	12.810	13.020	13.230	13.440	13.650
43	9.460	9.675	9.890	10.105	10.320	10.535	10.750	10.965	11.180	11.395	11.610	11.825	12.040	12.255	12.470	12.685	12.900	13.115	13.330	13.545	13.760	13.975
44	9.680	9.900	10.120	10.340	10.560	10.780	11.000	11.220	11.440	11.660	11.880	12.100	12.320	12.540	12.760	12.980	13.200	13.420	13.640	13.860	14.080	14.300
45	9.900	10.125	10.350	10.575	10.800	11.025	11.250	11.475	11.700	11.925	12.150	12.375	12.600	12.825	13.050	13.275	13.500	13.725	13.950	14.175	14.400	14.625
46	10.120	10.350	10.580	10.810	11.040	11.270	11.500	11.730	11.960	12.190	12.420	12.650	12.880	13.110	13.340	13.570	13.800	14.030	14.260	14.490	14.720	14.950
47	10.340	10.575	10.810	11.045	11.280	11.515	11.750	11.985	12.220	12.455	12.690	12.925	13.160	13.395	13.630	13.865	14.100	14.335	14.570	14.805	15.040	15.275
48	10.560	10.800	11.040	11.280	11.520	11.760	12.000	12.240	12.480	12.720	12.960	13.200	13.440	13.680	13.920	14.160	14.400	14.640	14.880	15.120	15.360	15.600
49	10.780	11.025	11.270	11.515	11.760	12.005	12.250	12.495	12.740	12.985	13.230	13.475	13.720	13.965	14.210	14.455	14.700	14.945	15.190	15.435	15.680	15.925
50	11.000	11.250	11.500	11.750	12.000	12.250	12.500	12.750	13.000	13.250	13.500	13.750	14.000	14.250	14.500	14.750	15.000	15.250	15.500	15.750	16.000	16.250
51	11.220	11.475	11.730	11.985	12.240	12.495	12.750	13.005	13.260	13.515	13.770	14.025	14.280	14.535	14.790	15.045	15.300	15.555	15.810	16.065	16.320	16.575
52	11.440	11.700	11.960	12.220	12.480	12.740	13.000	13.260	13.520	13.780	14.040	14.300	14.560	14.820	15.080	15.340	15.600	15.860	16.120	16.380	16.640	16.900
53	11.660	11.925	12.190	12.455	12.720	12.985	13.250	13.515	13.780	14.045	14.310	14.575	14.840	15.105	15.370	15.635	15.900	16.165	16.430	16.695	16.960	17.225
54	11.880	12.150	12.420	12.690	12.960	13.230	13.500	13.770	14.040	14.310	14.580	14.850	15.120	15.390	15.660	15.930	16.200	16.470	16.740	17.010	17.280	17.550
55	12.100	12.375	12.650	12.925	13.200	13.475	13.750	14.025	14.300	14.575	14.850	15.125	15.400	15.675	15.950	16.225	16.500	16.775	17.050	17.325	17.600	17.875
56	12.320	12.600	12.880	13.160	13.440	13.720	14.000	14.280	14.560	14.840	15.120	15.400	15.680	15.960	16.240	16.520	16.800	17.080	17.360	17.640	17.920	18.200
57	12.540	12.825	13.110	13.395	13.680	13.965	14.250	14.535	14.820	15.105	15.390	15.675	15.960	16.245	16.530	16.815	17.100	17.385	17.670	17.955	18.240	18.525
58	12.760	13.050	13.340	13.630	13.920	14.210	14.500	14.790	15.080	15.370	15.660	15.950	16.240	16.530	16.820	17.110	17.400	17.690	17.980	18.270	18.560	18.850
59	12.980	13.275	13.570	13.865	14.160	14.455	14.750	15.045	15.340	15.635	15.930	16.225	16.520	16.815	17.110	17.405	17.700	17.995	18.290	18.585	18.880	19.175
60	13.200	13.500	13.800	14.100	14.400	14.700	15.000	15.300	15.600	15.900	16.200	16.500	16.800	17.100	17.400	17.700	18.000	18.300	18.600	18.900	19.200	19.500
61	13.420	13.725	14.030	14.335	14.640	14.945	15.250	15.555	15.860	16.165	16.470	16.775	17.080	17.385	17.690	17.995	18.300	18.605	18.910	19.215	19.520	19.825
62	13.640	13.950	14.260	14.570	14.880	15.190	15.500	15.810	16.120	16.430	16.740	17.050	17.360	17.670	17.980	18.290	18.600	18.910	19.220	19.530	19.840	20.150
63	13.860	14.175	14.490	14.805	15.120	15.435	15.750	16.065	16.380	16.695	17.010	17.325	17.640	17.955	18.270	18.585	18.900	19.215	19.530	19.845	20.160	20.475
64	14.080	14.400	14.720	15.040	15.360	15.680	16.000	16.320	16.640	16.960	17.280	17.600	17.920	18.240	18.560	18.880	19.200	19.520	19.840	20.160	20.480	20.800
65	14.300	14.625	14.950	15.275	15.600	15.925	16.250	16.575	16.900	17.225	17.550	17.875	18.200	18.525	18.850	19.175	19.500	19.825	20.150	20.475	20.800	21.125
66	14.520	14.850	15.180	15.510	15.840	16.170	16.500	16.830	17.160	17.490	17.820	18.150	18.480	18.810	19.140	19.470	19.800	20.130	20.460	20.790	21.120	21.450
67	14.740	15.075	15.410	15.745	16.080	16.415	16.750	17.085	17.420	17.755	18.090	18.425	18.760	19.095	19.430	19.765	20.100	20.435	20.770	21.105	21.440	21.775
68	14.960	15.300	15.640	15.980	16.320	16.660	17.000	17.340	17.680	18.020	18.360	18.700	19.040	19.380	19.720	20.060	20.400	20.740	21.080	21.420	21	

Partial Group Index for P.I.
.01(F-15)(PI-10)

P.I.	% Passing #200																
	16	17	18	19	20	21	22	23	24	25	26	27	28	29	30	31	32
0	-0.100	-0.200	-0.300	-0.400	-0.500	-0.600	-0.700	-0.800	-0.900	-1.000	-1.100	-1.200	-1.300	-1.400	-1.500	-1.600	-1.700
1	-0.090	-0.180	-0.270	-0.360	-0.450	-0.540	-0.630	-0.720	-0.810	-0.900	-0.990	-1.080	-1.170	-1.260	-1.350	-1.440	-1.530
2	-0.080	-0.160	-0.240	-0.320	-0.400	-0.480	-0.560	-0.640	-0.720	-0.800	-0.880	-0.960	-1.040	-1.120	-1.200	-1.280	-1.360
3	-0.070	-0.140	-0.210	-0.280	-0.350	-0.420	-0.490	-0.560	-0.630	-0.700	-0.770	-0.840	-0.910	-0.980	-1.050	-1.120	-1.190
4	-0.060	-0.120	-0.180	-0.240	-0.300	-0.360	-0.420	-0.480	-0.540	-0.600	-0.660	-0.720	-0.780	-0.840	-0.900	-0.960	-1.020
5	-0.050	-0.100	-0.150	-0.200	-0.250	-0.300	-0.350	-0.400	-0.450	-0.500	-0.550	-0.600	-0.650	-0.700	-0.750	-0.800	-0.850
6	-0.040	-0.080	-0.120	-0.160	-0.200	-0.240	-0.280	-0.320	-0.360	-0.400	-0.440	-0.480	-0.520	-0.560	-0.600	-0.640	-0.680
7	-0.030	-0.060	-0.090	-0.120	-0.150	-0.180	-0.210	-0.240	-0.270	-0.300	-0.330	-0.360	-0.390	-0.420	-0.450	-0.480	-0.510
8	-0.020	-0.040	-0.060	-0.080	-0.100	-0.120	-0.140	-0.160	-0.180	-0.200	-0.220	-0.240	-0.260	-0.280	-0.300	-0.320	-0.340
9	-0.010	-0.020	-0.030	-0.040	-0.050	-0.060	-0.070	-0.080	-0.090	-0.100	-0.110	-0.120	-0.130	-0.140	-0.150	-0.160	-0.170
10	0.000	0.000	0.000	0.000	0.000	0.000	0.000	0.000	0.000	0.000	0.000	0.000	0.000	0.000	0.000	0.000	0.000
11	0.010	0.020	0.030	0.040	0.050	0.060	0.070	0.080	0.090	0.100	0.110	0.120	0.130	0.140	0.150	0.160	0.170
12	0.020	0.040	0.060	0.080	0.100	0.120	0.140	0.160	0.180	0.200	0.220	0.240	0.260	0.280	0.300	0.320	0.340
13	0.030	0.060	0.090	0.120	0.150	0.180	0.210	0.240	0.270	0.300	0.330	0.360	0.390	0.420	0.450	0.480	0.510
14	0.040	0.080	0.120	0.160	0.200	0.240	0.280	0.320	0.360	0.400	0.440	0.480	0.520	0.560	0.600	0.640	0.680
15	0.050	0.100	0.150	0.200	0.250	0.300	0.350	0.400	0.450	0.500	0.550	0.600	0.650	0.700	0.750	0.800	0.850
16	0.060	0.120	0.180	0.240	0.300	0.360	0.420	0.480	0.540	0.600	0.660	0.720	0.780	0.840	0.900	0.960	1.020
17	0.070	0.140	0.210	0.280	0.350	0.420	0.490	0.560	0.630	0.700	0.770	0.840	0.910	0.980	1.050	1.120	1.190
18	0.080	0.160	0.240	0.320	0.400	0.480	0.560	0.640	0.720	0.800	0.880	0.960	1.040	1.120	1.200	1.280	1.360
19	0.090	0.180	0.270	0.360	0.450	0.540	0.630	0.720	0.810	0.900	0.990	1.080	1.170	1.260	1.350	1.440	1.530
20	0.100	0.200	0.300	0.400	0.500	0.600	0.700	0.800	0.900	1.000	1.100	1.200	1.300	1.400	1.500	1.600	1.700
21	0.110	0.220	0.330	0.440	0.550	0.660	0.770	0.880	0.990	1.100	1.210	1.320	1.430	1.540	1.650	1.760	1.870
22	0.120	0.240	0.360	0.480	0.600	0.720	0.840	0.960	1.080	1.200	1.320	1.440	1.560	1.680	1.800	1.920	2.040
23	0.130	0.260	0.390	0.520	0.650	0.780	0.910	1.040	1.170	1.300	1.430	1.560	1.690	1.820	1.950	2.080	2.210
24	0.140	0.280	0.420	0.560	0.700	0.840	0.980	1.120	1.260	1.400	1.540	1.680	1.820	1.960	2.100	2.240	2.380
25	0.150	0.300	0.450	0.600	0.750	0.900	1.050	1.200	1.350	1.500	1.650	1.800	1.950	2.100	2.250	2.400	2.550
26	0.160	0.320	0.480	0.640	0.800	0.960	1.120	1.280	1.440	1.600	1.760	1.920	2.080	2.240	2.400	2.560	2.720
27	0.170	0.340	0.510	0.680	0.850	1.020	1.190	1.360	1.530	1.700	1.870	2.040	2.210	2.380	2.550	2.720	2.890
28	0.180	0.360	0.540	0.720	0.900	1.080	1.260	1.440	1.620	1.800	1.980	2.160	2.340	2.520	2.700	2.880	3.060
29	0.190	0.380	0.570	0.760	0.950	1.140	1.330	1.520	1.710	1.900	2.090	2.280	2.470	2.660	2.850	3.040	3.230
30	0.200	0.400	0.600	0.800	1.000	1.200	1.400	1.600	1.800	2.000	2.200	2.400	2.600	2.800	3.000	3.200	3.400
31	0.210	0.420	0.630	0.840	1.050	1.260	1.470	1.680	1.890	2.100	2.310	2.520	2.730	2.940	3.150	3.360	3.570
32	0.220	0.440	0.660	0.880	1.100	1.320	1.540	1.760	1.980	2.200	2.420	2.640	2.860	3.080	3.300	3.520	3.740
33	0.230	0.460	0.690	0.920	1.150	1.380	1.610	1.840	2.070	2.300	2.530	2.760	2.990	3.220	3.450	3.680	3.910
34	0.240	0.480	0.720	0.960	1.200	1.440	1.680	1.920	2.160	2.400	2.640	2.880	3.120	3.360	3.600	3.840	4.080
35	0.250	0.500	0.750	1.000	1.250	1.500	1.750	2.000	2.250	2.500	2.750	3.000	3.250	3.500	3.750	4.000	4.250
36	0.260	0.520	0.780	1.040	1.300	1.560	1.820	2.080	2.340	2.600	2.860	3.120	3.380	3.640	3.900	4.160	4.420
37	0.270	0.540	0.810	1.080	1.350	1.620	1.890	2.160	2.430	2.700	2.970	3.240	3.510	3.780	4.050	4.320	4.590
38	0.280	0.560	0.840	1.120	1.400	1.680	1.960	2.240	2.520	2.800	3.080	3.360	3.640	3.920	4.200	4.480	4.760
39	0.290	0.580	0.870	1.160	1.450	1.740	2.030	2.320	2.610	2.900	3.190	3.480	3.770	4.060	4.350	4.640	4.930
40	0.300	0.600	0.900	1.200	1.500	1.800	2.100	2.400	2.700	3.000	3.300	3.600	3.900	4.200	4.500	4.800	5.100
41	0.310	0.620	0.930	1.240	1.550	1.860	2.170	2.480	2.790	3.100	3.410	3.720	4.030	4.340	4.650	4.960	5.270
42	0.320	0.640	0.960	1.280	1.600	1.920	2.240	2.560	2.880	3.200	3.520	3.840	4.160	4.480	4.800	5.120	5.440
43	0.330	0.660	0.990	1.320	1.650	1.980	2.310	2.640	2.970	3.300	3.630	3.960	4.290	4.620	4.950	5.280	5.610
44	0.340	0.680	1.020	1.360	1.700	2.040	2.380	2.720	3.060	3.400	3.740	4.080	4.420	4.760	5.100	5.440	5.780
45	0.350	0.700	1.050	1.400	1.750	2.100	2.450	2.800	3.150	3.500	3.850	4.200	4.550	4.900	5.250	5.600	5.950
46	0.360	0.720	1.080	1.440	1.800	2.160	2.520	2.880	3.240	3.600	3.960	4.320	4.680	5.040	5.400	5.760	6.120
47	0.370	0.740	1.110	1.480	1.850	2.220	2.590	2.960	3.330	3.700	4.070	4.440	4.810	5.180	5.550	5.920	6.290
48	0.380	0.760	1.140	1.520	1.900	2.280	2.660	3.040	3.420	3.800	4.180	4.560	4.940	5.320	5.700	6.080	6.460
49	0.390	0.780	1.170	1.560	1.950	2.340	2.730	3.120	3.510	3.900	4.290	4.680	5.070	5.460	5.850	6.240	6.630
50	0.400	0.800	1.200	1.600	2.000	2.400	2.800	3.200	3.600	4.000	4.400	4.800	5.200	5.600	6.000	6.400	6.800

Note: The Partial Group Index will be a negative value when the P.I. is less than 10 and positive when the P.I. is greater than 10.

Partial Group Index for P.I.
.01(F-15)(PI-10)

P.I.	% Passing #200																
	33	34	35	36	37	38	39	40	41	42	43	44	45	46	47	48	49
0	-1.800	-1.900	-2.000	-2.100	-2.200	-2.300	-2.400	-2.500	-2.600	-2.700	-2.800	-2.900	-3.000	-3.100	-3.200	-3.300	-3.400
1	-1.620	-1.710	-1.800	-1.890	-1.980	-2.070	-2.160	-2.250	-2.340	-2.430	-2.520	-2.610	-2.700	-2.790	-2.880	-2.970	-3.060
2	-1.440	-1.520	-1.600	-1.680	-1.760	-1.840	-1.920	-2.000	-2.080	-2.160	-2.240	-2.320	-2.400	-2.480	-2.560	-2.640	-2.720
3	-1.260	-1.330	-1.400	-1.470	-1.540	-1.610	-1.680	-1.750	-1.820	-1.890	-1.960	-2.030	-2.100	-2.170	-2.240	-2.310	-2.380
4	-1.080	-1.140	-1.200	-1.260	-1.320	-1.380	-1.440	-1.500	-1.560	-1.620	-1.680	-1.740	-1.800	-1.860	-1.920	-1.980	-2.040
5	-0.900	-0.950	-1.000	-1.050	-1.100	-1.150	-1.200	-1.250	-1.300	-1.350	-1.400	-1.450	-1.500	-1.550	-1.600	-1.650	-1.700
6	-0.720	-0.760	-0.800	-0.840	-0.880	-0.920	-0.960	-1.000	-1.040	-1.080	-1.120	-1.160	-1.200	-1.240	-1.280	-1.320	-1.360
7	-0.540	-0.570	-0.600	-0.630	-0.660	-0.690	-0.720	-0.750	-0.780	-0.810	-0.840	-0.870	-0.900	-0.930	-0.960	-0.990	-1.020
8	-0.360	-0.380	-0.400	-0.420	-0.440	-0.460	-0.480	-0.500	-0.520	-0.540	-0.560	-0.580	-0.600	-0.620	-0.640	-0.660	-0.680
9	-0.180	-0.190	-0.200	-0.210	-0.220	-0.230	-0.240	-0.250	-0.260	-0.270	-0.280	-0.290	-0.300	-0.310	-0.320	-0.330	-0.340
10	0.000	0.000	0.000	0.000	0.000	0.000	-0.000	-0.000	-0.000	-0.000	-0.000	-0.000	-0.000	-0.000	-0.000	-0.000	-0.000
11	0.180	0.190	0.200	0.210	0.220	0.230	0.240	0.250	0.260	0.270	0.280	0.290	0.300	0.310	0.320	0.330	0.340
12	0.360	0.380	0.400	0.420	0.440	0.460	0.480	0.500	0.520	0.540	0.560	0.580	0.600	0.620	0.640	0.660	0.680
13	0.540	0.570	0.600	0.630	0.660	0.690	0.720	0.750	0.780	0.810	0.840	0.870	0.900	0.930	0.960	0.990	1.020
14	0.720	0.760	0.800	0.840	0.880	0.920	0.960	1.000	1.040	1.080	1.120	1.160	1.200	1.240	1.280	1.320	1.360
15	0.900	0.950	1.000	1.050	1.100	1.150	1.200	1.250	1.300	1.350	1.400	1.450	1.500	1.550	1.600	1.650	1.700
16	1.080	1.140	1.200	1.260	1.320	1.380	1.440	1.500	1.560	1.620	1.680	1.740	1.800	1.860	1.920	1.980	2.040
17	1.260	1.330	1.400	1.470	1.540	1.610	1.680	1.750	1.820	1.890	1.960	2.030	2.100	2.170	2.240	2.310	2.380
18	1.440	1.520	1.600	1.680	1.760	1.840	1.920	2.000	2.080	2.160	2.240	2.320	2.400	2.480	2.560	2.640	2.720
19	1.620	1.710	1.800	1.890	1.980	2.070	2.160	2.250	2.340	2.430	2.520	2.610	2.700	2.790	2.880	2.970	3.060
20	1.800	1.900	2.000	2.100	2.200	2.300	2.400	2.500	2.600	2.700	2.800	2.900	3.000	3.100	3.200	3.300	3.400
21	1.980	2.090	2.200	2.310	2.420	2.530	2.640	2.750	2.860	2.970	3.080	3.190	3.300	3.410	3.520	3.630	3.740
22	2.160	2.280	2.400	2.520	2.640	2.760	2.880	3.000	3.120	3.240	3.360	3.480	3.600	3.720	3.840	3.960	4.080
23	2.340	2.470	2.600	2.730	2.860	2.990	3.120	3.250	3.380	3.510	3.640	3.770	3.900	4.030	4.160	4.290	4.420
24	2.520	2.660	2.800	2.940	3.080	3.220	3.360	3.500	3.640	3.780	3.920	4.060	4.200	4.340	4.480	4.620	4.760
25	2.700	2.850	3.000	3.150	3.300	3.450	3.600	3.750	3.900	4.050	4.200	4.350	4.500	4.650	4.800	4.950	5.100
26	2.880	3.040	3.200	3.360	3.520	3.680	3.840	4.000	4.160	4.320	4.480	4.640	4.800	4.960	5.120	5.280	5.440
27	3.060	3.230	3.400	3.570	3.740	3.910	4.080	4.250	4.420	4.590	4.760	4.930	5.100	5.270	5.440	5.610	5.780
28	3.240	3.420	3.600	3.780	3.960	4.140	4.320	4.500	4.680	4.860	5.040	5.220	5.400	5.580	5.760	5.940	6.120
29	3.420	3.610	3.800	3.990	4.180	4.370	4.560	4.750	4.940	5.130	5.320	5.510	5.700	5.890	6.080	6.270	6.460
30	3.600	3.800	4.000	4.200	4.400	4.600	4.800	5.000	5.200	5.400	5.600	5.800	6.000	6.200	6.400	6.600	6.800
31	3.780	3.990	4.200	4.410	4.620	4.830	5.040	5.250	5.460	5.670	5.880	6.090	6.300	6.510	6.720	6.930	7.140
32	3.960	4.180	4.400	4.620	4.840	5.060	5.280	5.500	5.720	5.940	6.160	6.380	6.600	6.820	7.040	7.260	7.480
33	4.140	4.370	4.600	4.830	5.060	5.290	5.520	5.750	5.980	6.210	6.440	6.670	6.900	7.130	7.360	7.590	7.820
34	4.320	4.560	4.800	5.040	5.280	5.520	5.760	6.000	6.240	6.480	6.720	6.960	7.200	7.440	7.680	7.920	8.160
35	4.500	4.750	5.000	5.250	5.500	5.750	6.000	6.250	6.500	6.750	7.000	7.250	7.500	7.750	8.000	8.250	8.500
36	4.680	4.940	5.200	5.460	5.720	5.980	6.240	6.500	6.760	7.020	7.280	7.540	7.800	8.060	8.320	8.580	8.840
37	4.860	5.130	5.400	5.670	5.940	6.210	6.480	6.750	7.020	7.290	7.560	7.830	8.100	8.370	8.640	8.910	9.180
38	5.040	5.320	5.600	5.880	6.160	6.440	6.720	7.000	7.280	7.560	7.840	8.120	8.400	8.680	8.960	9.240	9.520
39	5.220	5.510	5.800	6.090	6.380	6.670	6.960	7.250	7.540	7.830	8.120	8.410	8.700	8.990	9.280	9.570	9.860
40	5.400	5.700	6.000	6.300	6.600	6.900	7.200	7.500	7.800	8.100	8.400	8.700	9.000	9.300	9.600	9.900	10.200
41	5.580	5.890	6.200	6.510	6.820	7.130	7.440	7.750	8.060	8.370	8.680	8.990	9.300	9.610	9.920	10.230	10.540
42	5.760	6.080	6.400	6.720	7.040	7.360	7.680	8.000	8.320	8.640	8.960	9.280	9.600	9.920	10.240	10.560	10.880
43	5.940	6.270	6.600	6.930	7.260	7.590	7.920	8.250	8.580	8.910	9.240	9.570	9.900	10.230	10.560	10.890	11.220
44	6.120	6.460	6.800	7.140	7.480	7.820	8.160	8.500	8.840	9.180	9.520	9.860	10.200	10.540	10.880	11.220	11.560
45	6.300	6.650	7.000	7.350	7.700	8.050	8.400	8.750	9.100	9.450	9.800	10.150	10.500	10.850	11.200	11.550	11.900
46	6.480	6.840	7.200	7.560	7.920	8.280	8.640	9.000	9.360	9.720	10.080	10.440	10.800	11.160	11.520	11.880	12.240
47	6.660	7.030	7.400	7.770	8.140	8.510	8.880	9.250	9.620	9.990	10.360	10.730	11.100	11.470	11.840	12.210	12.580
48	6.840	7.220	7.600	7.980	8.360	8.740	9.120	9.500	9.880	10.260	10.640	11.020	11.400	11.780	12.160	12.540	12.920
49	7.020	7.410	7.800	8.190	8.580	8.970	9.360	9.750	10.140	10.530	10.920	11.310	11.700	12.090	12.480	12.870	13.260
50	7.200	7.600	8.000	8.400	8.800	9.200	9.600	10.000	10.400	10.800	11.200	11.600	12.000	12.400	12.800	13.200	13.600

Note: The Partial Group Index will be a negative value when the P.I. is less than 10 and positive when the P.I. is greater than 10.

Partial Group Index for P.I.
.01(F-15)(PI-10)

P.I.	% Passing #200																
	50	51	52	53	54	55	56	57	58	59	60	61	62	63	64	65	66
0	-3.500	-3.600	-3.700	-3.800	-3.900	-4.000	-4.100	-4.200	-4.300	-4.400	-4.500	-4.600	-4.700	-4.800	-4.900	-5.000	-5.100
1	-3.150	-3.240	-3.330	-3.420	-3.510	-3.600	-3.690	-3.780	-3.870	-3.960	-4.050	-4.140	-4.230	-4.320	-4.410	-4.500	-4.590
2	-2.800	-2.880	-2.960	-3.040	-3.120	-3.200	-3.280	-3.360	-3.440	-3.520	-3.600	-3.680	-3.760	-3.840	-3.920	-4.000	-4.080
3	-2.450	-2.520	-2.590	-2.660	-2.730	-2.800	-2.870	-2.940	-3.010	-3.080	-3.150	-3.220	-3.290	-3.360	-3.430	-3.500	-3.570
4	-2.100	-2.160	-2.220	-2.280	-2.340	-2.400	-2.460	-2.520	-2.580	-2.640	-2.700	-2.760	-2.820	-2.880	-2.940	-3.000	-3.060
5	-1.750	-1.800	-1.850	-1.900	-1.950	-2.000	-2.050	-2.100	-2.150	-2.200	-2.250	-2.300	-2.350	-2.400	-2.450	-2.500	-2.550
6	-1.400	-1.440	-1.480	-1.520	-1.560	-1.600	-1.640	-1.680	-1.720	-1.760	-1.800	-1.840	-1.880	-1.920	-1.960	-2.000	-2.040
7	-1.050	-1.080	-1.110	-1.140	-1.170	-1.200	-1.230	-1.260	-1.290	-1.320	-1.350	-1.380	-1.410	-1.440	-1.470	-1.500	-1.530
8	-0.700	-0.720	-0.740	-0.760	-0.780	-0.800	-0.820	-0.840	-0.860	-0.880	-0.900	-0.920	-0.940	-0.960	-0.980	-1.000	-1.020
9	-0.350	-0.360	-0.370	-0.380	-0.390	-0.400	-0.410	-0.420	-0.430	-0.440	-0.450	-0.460	-0.470	-0.480	-0.490	-0.500	-0.510
10	-0.000	-0.000	-0.000	-0.000	-0.000	-0.000	-0.000	0.000	0.000	0.000	0.000	0.000	0.000	0.000	0.000	0.000	0.000
11	0.350	0.360	0.370	0.380	0.390	0.400	0.410	0.420	0.430	0.440	0.450	0.460	0.470	0.480	0.490	0.500	0.510
12	0.700	0.720	0.740	0.760	0.780	0.800	0.820	0.840	0.860	0.880	0.900	0.920	0.940	0.960	0.980	1.000	1.020
13	1.050	1.080	1.110	1.140	1.170	1.200	1.230	1.260	1.290	1.320	1.350	1.380	1.410	1.440	1.470	1.500	1.530
14	1.400	1.440	1.480	1.520	1.560	1.600	1.640	1.680	1.720	1.760	1.800	1.840	1.880	1.920	1.960	2.000	2.040
15	1.750	1.800	1.850	1.900	1.950	2.000	2.050	2.100	2.150	2.200	2.250	2.300	2.350	2.400	2.450	2.500	2.550
16	2.100	2.160	2.220	2.280	2.340	2.400	2.460	2.520	2.580	2.640	2.700	2.760	2.820	2.880	2.940	3.000	3.060
17	2.450	2.520	2.590	2.660	2.730	2.800	2.870	2.940	3.010	3.080	3.150	3.220	3.290	3.360	3.430	3.500	3.570
18	2.800	2.880	2.960	3.040	3.120	3.200	3.280	3.360	3.440	3.520	3.600	3.680	3.760	3.840	3.920	4.000	4.080
19	3.150	3.240	3.330	3.420	3.510	3.600	3.690	3.780	3.870	3.960	4.050	4.140	4.230	4.320	4.410	4.500	4.590
20	3.500	3.600	3.700	3.800	3.900	4.000	4.100	4.200	4.300	4.400	4.500	4.600	4.700	4.800	4.900	5.000	5.100
21	3.850	3.960	4.070	4.180	4.290	4.400	4.510	4.620	4.730	4.840	4.950	5.060	5.170	5.280	5.390	5.500	5.610
22	4.200	4.320	4.440	4.560	4.680	4.800	4.920	5.040	5.160	5.280	5.400	5.520	5.640	5.760	5.880	6.000	6.120
23	4.550	4.680	4.810	4.940	5.070	5.200	5.330	5.460	5.590	5.720	5.850	5.980	6.110	6.240	6.370	6.500	6.630
24	4.900	5.040	5.180	5.320	5.460	5.600	5.740	5.880	6.020	6.160	6.300	6.440	6.580	6.720	6.860	7.000	7.140
25	5.250	5.400	5.550	5.700	5.850	6.000	6.150	6.300	6.450	6.600	6.750	6.900	7.050	7.200	7.350	7.500	7.650
26	5.600	5.760	5.920	6.080	6.240	6.400	6.560	6.720	6.880	7.040	7.200	7.360	7.520	7.680	7.840	8.000	8.160
27	5.950	6.120	6.290	6.460	6.630	6.800	6.970	7.140	7.310	7.480	7.650	7.820	7.990	8.160	8.330	8.500	8.670
28	6.300	6.480	6.660	6.840	7.020	7.200	7.380	7.560	7.740	7.920	8.100	8.280	8.460	8.640	8.820	9.000	9.180
29	6.650	6.840	7.030	7.220	7.410	7.600	7.790	7.980	8.170	8.360	8.550	8.740	8.930	9.120	9.310	9.500	9.690
30	7.000	7.200	7.400	7.600	7.800	8.000	8.200	8.400	8.600	8.800	9.000	9.200	9.400	9.600	9.800	10.000	10.200
31	7.350	7.560	7.770	7.980	8.190	8.400	8.610	8.820	9.030	9.240	9.450	9.660	9.870	10.080	10.290	10.500	10.710
32	7.700	7.920	8.140	8.360	8.580	8.800	9.020	9.240	9.460	9.680	9.900	10.120	10.340	10.560	10.780	11.000	11.220
33	8.050	8.280	8.510	8.740	8.970	9.200	9.430	9.660	9.890	10.120	10.350	10.580	10.810	11.040	11.270	11.500	11.730
34	8.400	8.640	8.880	9.120	9.360	9.600	9.840	10.080	10.320	10.560	10.800	11.040	11.280	11.520	11.760	12.000	12.240
35	8.750	9.000	9.250	9.500	9.750	10.000	10.250	10.500	10.750	11.000	11.250	11.500	11.750	12.000	12.250	12.500	12.750
36	9.100	9.360	9.620	9.880	10.140	10.400	10.660	10.920	11.180	11.440	11.700	11.960	12.220	12.480	12.740	13.000	13.260
37	9.450	9.720	9.990	10.260	10.530	10.800	11.070	11.340	11.610	11.880	12.150	12.420	12.690	12.960	13.230	13.500	13.770
38	9.800	10.080	10.360	10.640	10.920	11.200	11.480	11.760	12.040	12.320	12.600	12.880	13.160	13.440	13.720	14.000	14.280
39	10.150	10.440	10.730	11.020	11.310	11.600	11.890	12.180	12.470	12.760	13.050	13.340	13.630	13.920	14.210	14.500	14.790
40	10.500	10.800	11.100	11.400	11.700	12.000	12.300	12.600	12.900	13.200	13.500	13.800	14.100	14.400	14.700	15.000	15.300
41	10.850	11.160	11.470	11.780	12.090	12.400	12.710	13.020	13.330	13.640	13.950	14.260	14.570	14.880	15.190	15.500	15.810
42	11.200	11.520	11.840	12.160	12.480	12.800	13.120	13.440	13.760	14.080	14.400	14.720	15.040	15.360	15.680	16.000	16.320
43	11.550	11.880	12.210	12.540	12.870	13.200	13.530	13.860	14.190	14.520	14.850	15.180	15.510	15.840	16.170	16.500	16.830
44	11.900	12.240	12.580	12.920	13.260	13.600	13.940	14.280	14.620	14.960	15.300	15.640	15.980	16.320	16.660	17.000	17.340
45	12.250	12.600	12.950	13.300	13.650	14.000	14.350	14.700	15.050	15.400	15.750	16.100	16.450	16.800	17.150	17.500	17.850
46	12.600	12.960	13.320	13.680	14.040	14.400	14.760	15.120	15.480	15.840	16.200	16.560	16.920	17.280	17.640	18.000	18.360
47	12.950	13.320	13.690	14.060	14.430	14.800	15.170	15.540	15.910	16.280	16.650	17.020	17.390	17.760	18.130	18.500	18.870
48	13.300	13.680	14.060	14.440	14.820	15.200	15.580	15.960	16.340	16.720	17.100	17.480	17.860	18.240	18.620	19.000	19.380
49	13.650	14.040	14.430	14.820	15.210	15.600	15.990	16.380	16.770	17.160	17.550	17.940	18.330	18.720	19.110	19.500	19.890
50	14.000	14.400	14.800	15.200	15.600	16.000	16.400	16.800	17.200	17.600	18.000	18.400	18.800	19.200	19.600	20.000	20.400

Note: The Partial Group Index will be a negative value when the P.I. is less than 10 and positive when the P.I. is greater than 10.

Partial Group Index for P.I.
.01(F-15)(PI-10)

P.I.	% Passing #200																
	67	68	69	70	71	72	73	74	75	76	77	78	79	80	81	82	83
0	-5.200	-5.300	-5.400	-5.500	-5.600	-5.700	-5.800	-5.900	-6.000	-6.100	-6.200	-6.300	-6.400	-6.500	-6.600	-6.700	-6.800
1	-4.680	-4.770	-4.860	-4.950	-5.040	-5.130	-5.220	-5.310	-5.400	-5.490	-5.580	-5.670	-5.760	-5.850	-5.940	-6.030	-6.120
2	-4.160	-4.240	-4.320	-4.400	-4.480	-4.560	-4.640	-4.720	-4.800	-4.880	-4.960	-5.040	-5.120	-5.200	-5.280	-5.360	-5.440
3	-3.640	-3.710	-3.780	-3.850	-3.920	-3.990	-4.060	-4.130	-4.200	-4.270	-4.340	-4.410	-4.480	-4.550	-4.620	-4.690	-4.760
4	-3.120	-3.180	-3.240	-3.300	-3.360	-3.420	-3.480	-3.540	-3.600	-3.660	-3.720	-3.780	-3.840	-3.900	-3.960	-4.020	-4.080
5	-2.600	-2.650	-2.700	-2.750	-2.800	-2.850	-2.900	-2.950	-3.000	-3.050	-3.100	-3.150	-3.200	-3.250	-3.300	-3.350	-3.400
6	-2.080	-2.120	-2.160	-2.200	-2.240	-2.280	-2.320	-2.360	-2.400	-2.440	-2.480	-2.520	-2.560	-2.600	-2.640	-2.680	-2.720
7	-1.560	-1.590	-1.620	-1.650	-1.680	-1.710	-1.740	-1.770	-1.800	-1.830	-1.860	-1.890	-1.920	-1.950	-1.980	-2.010	-2.040
8	-1.040	-1.060	-1.080	-1.100	-1.120	-1.140	-1.160	-1.180	-1.200	-1.220	-1.240	-1.260	-1.280	-1.300	-1.320	-1.340	-1.360
9	-0.520	-0.530	-0.540	-0.550	-0.560	-0.570	-0.580	-0.590	-0.600	-0.610	-0.620	-0.630	-0.640	-0.650	-0.660	-0.670	-0.680
10	0.000	0.000	0.000	0.000	0.000	0.000	0.000	0.000	-0.000	-0.000	-0.000	-0.000	-0.000	-0.000	-0.000	-0.000	-0.000
11	0.520	0.530	0.540	0.550	0.560	0.570	0.580	0.590	0.600	0.610	0.620	0.630	0.640	0.650	0.660	0.670	0.680
12	1.040	1.060	1.080	1.100	1.120	1.140	1.160	1.180	1.200	1.220	1.240	1.260	1.280	1.300	1.320	1.340	1.360
13	1.560	1.590	1.620	1.650	1.680	1.710	1.740	1.770	1.800	1.830	1.860	1.890	1.920	1.950	1.980	2.010	2.040
14	2.080	2.120	2.160	2.200	2.240	2.280	2.320	2.360	2.400	2.440	2.480	2.520	2.560	2.600	2.640	2.680	2.720
15	2.600	2.650	2.700	2.750	2.800	2.850	2.900	2.950	3.000	3.050	3.100	3.150	3.200	3.250	3.300	3.350	3.400
16	3.120	3.180	3.240	3.300	3.360	3.420	3.480	3.540	3.600	3.660	3.720	3.780	3.840	3.900	3.960	4.020	4.080
17	3.640	3.710	3.780	3.850	3.920	3.990	4.060	4.130	4.200	4.270	4.340	4.410	4.480	4.550	4.620	4.690	4.760
18	4.160	4.240	4.320	4.400	4.480	4.560	4.640	4.720	4.800	4.880	4.960	5.040	5.120	5.200	5.280	5.360	5.440
19	4.680	4.770	4.860	4.950	5.040	5.130	5.220	5.310	5.400	5.490	5.580	5.670	5.760	5.850	5.940	6.030	6.120
20	5.200	5.300	5.400	5.500	5.600	5.700	5.800	5.900	6.000	6.100	6.200	6.300	6.400	6.500	6.600	6.700	6.800
21	5.720	5.830	5.940	6.050	6.160	6.270	6.380	6.490	6.600	6.710	6.820	6.930	7.040	7.150	7.260	7.370	7.480
22	6.240	6.360	6.480	6.600	6.720	6.840	6.960	7.080	7.200	7.320	7.440	7.560	7.680	7.800	7.920	8.040	8.160
23	6.760	6.890	7.020	7.150	7.280	7.410	7.540	7.670	7.800	7.930	8.060	8.190	8.320	8.450	8.580	8.710	8.840
24	7.280	7.420	7.560	7.700	7.840	7.980	8.120	8.260	8.400	8.540	8.680	8.820	8.960	9.100	9.240	9.380	9.520
25	7.800	7.950	8.100	8.250	8.400	8.550	8.700	8.850	9.000	9.150	9.300	9.450	9.600	9.750	9.900	10.050	10.200
26	8.320	8.480	8.640	8.800	8.960	9.120	9.280	9.440	9.600	9.760	9.920	10.080	10.240	10.400	10.560	10.720	10.880
27	8.840	9.010	9.180	9.350	9.520	9.690	9.860	10.030	10.200	10.370	10.540	10.710	10.880	11.050	11.220	11.390	11.560
28	9.360	9.540	9.720	9.900	10.080	10.260	10.440	10.620	10.800	10.980	11.160	11.340	11.520	11.700	11.880	12.060	12.240
29	9.880	10.070	10.260	10.450	10.640	10.830	11.020	11.210	11.400	11.590	11.780	11.970	12.160	12.350	12.540	12.730	12.920
30	10.400	10.600	10.800	11.000	11.200	11.400	11.600	11.800	12.000	12.200	12.400	12.600	12.800	13.000	13.200	13.400	13.600
31	10.920	11.130	11.340	11.550	11.760	11.970	12.180	12.390	12.600	12.810	13.020	13.230	13.440	13.650	13.860	14.070	14.280
32	11.440	11.660	11.880	12.100	12.320	12.540	12.760	12.980	13.200	13.420	13.640	13.860	14.080	14.300	14.520	14.740	14.960
33	11.960	12.190	12.420	12.650	12.880	13.110	13.340	13.570	13.800	14.030	14.260	14.490	14.720	14.950	15.180	15.410	15.640
34	12.480	12.720	12.960	13.200	13.440	13.680	13.920	14.160	14.400	14.640	14.880	15.120	15.360	15.600	15.840	16.080	16.320
35	13.000	13.250	13.500	13.750	14.000	14.250	14.500	14.750	15.000	15.250	15.500	15.750	16.000	16.250	16.500	16.750	17.000
36	13.520	13.780	14.040	14.300	14.560	14.820	15.080	15.340	15.600	15.860	16.120	16.380	16.640	16.900	17.160	17.420	17.680
37	14.040	14.310	14.580	14.850	15.120	15.390	15.660	15.930	16.200	16.470	16.740	17.010	17.280	17.550	17.820	18.090	18.360
38	14.560	14.840	15.120	15.400	15.680	15.960	16.240	16.520	16.800	17.080	17.360	17.640	17.920	18.200	18.480	18.760	19.040
39	15.080	15.370	15.660	15.950	16.240	16.530	16.820	17.110	17.400	17.690	17.980	18.270	18.560	18.850	19.140	19.430	19.720
40	15.600	15.900	16.200	16.500	16.800	17.100	17.400	17.700	18.000	18.300	18.600	18.900	19.200	19.500	19.800	20.100	20.400
41	16.120	16.430	16.740	17.050	17.360	17.670	17.980	18.290	18.600	18.910	19.220	19.530	19.840	20.150	20.460	20.770	21.080
42	16.640	16.960	17.280	17.600	17.920	18.240	18.560	18.880	19.200	19.520	19.840	20.160	20.480	20.800	21.120	21.440	21.760
43	17.160	17.490	17.820	18.150	18.480	18.810	19.140	19.470	19.800	20.130	20.460	20.790	21.120	21.450	21.780	22.110	22.440
44	17.680	18.020	18.360	18.700	19.040	19.380	19.720	20.060	20.400	20.740	21.080	21.420	21.760	22.100	22.440	22.780	23.120
45	18.200	18.550	18.900	19.250	19.600	19.950	20.300	20.650	21.000	21.350	21.700	22.050	22.400	22.750	23.100	23.450	23.800
46	18.720	19.080	19.440	19.800	20.160	20.520	20.880	21.240	21.600	21.960	22.320	22.680	23.040	23.400	23.760	24.120	24.480
47	19.240	19.610	19.980	20.350	20.720	21.090	21.460	21.830	22.200	22.570	22.940	23.310	23.680	24.050	24.420	24.790	25.160
48	19.760	20.140	20.520	20.900	21.280	21.660	22.040	22.420	22.800	23.180	23.560	23.940	24.320	24.700	25.080	25.460	25.840
49	20.280	20.670	21.060	21.450	21.840	22.230	22.620	23.010	23.400	23.790	24.180	24.570	24.960	25.350	25.740	26.130	26.520
50	20.800	21.200	21.600	22.000	22.400	22.800	23.200	23.600	24.000	24.400	24.800	25.200	25.600	26.000	26.400	26.800	27.200

Note: The Partial Group Index will be a negative value when the P.I. is less than 10 and positive when the P.I. is greater than 10.

Partial Group Index for P.I.
.01(F-15)(PI-10)

P.I.	% Passing #200																
	84	85	86	87	88	89	90	91	92	93	94	95	96	97	98	99	100
0	-6.900	-7.000	-7.100	-7.200	-7.300	-7.400	-7.500	-7.600	-7.700	-7.800	-7.900	-8.000	-8.100	-8.200	-8.300	-8.400	-8.500
1	-6.210	-6.300	-6.390	-6.480	-6.570	-6.660	-6.750	-6.840	-6.930	-7.020	-7.110	-7.200	-7.290	-7.380	-7.470	-7.560	-7.650
2	-5.520	-5.600	-5.680	-5.760	-5.840	-5.920	-6.000	-6.080	-6.160	-6.240	-6.320	-6.400	-6.480	-6.560	-6.640	-6.720	-6.800
3	-4.830	-4.900	-4.970	-5.040	-5.110	-5.180	-5.250	-5.320	-5.390	-5.460	-5.530	-5.600	-5.670	-5.740	-5.810	-5.880	-5.950
4	-4.140	-4.200	-4.260	-4.320	-4.380	-4.440	-4.500	-4.560	-4.620	-4.680	-4.740	-4.800	-4.860	-4.920	-4.980	-5.040	-5.100
5	-3.450	-3.500	-3.550	-3.600	-3.650	-3.700	-3.750	-3.800	-3.850	-3.900	-3.950	-4.000	-4.050	-4.100	-4.150	-4.200	-4.250
6	-2.760	-2.800	-2.840	-2.880	-2.920	-2.960	-3.000	-3.040	-3.080	-3.120	-3.160	-3.200	-3.240	-3.280	-3.320	-3.360	-3.400
7	-2.070	-2.100	-2.130	-2.160	-2.190	-2.220	-2.250	-2.280	-2.310	-2.340	-2.370	-2.400	-2.430	-2.460	-2.490	-2.520	-2.550
8	-1.380	-1.400	-1.420	-1.440	-1.460	-1.480	-1.500	-1.520	-1.540	-1.560	-1.580	-1.600	-1.620	-1.640	-1.660	-1.680	-1.700
9	-0.690	-0.700	-0.710	-0.720	-0.730	-0.740	-0.750	-0.760	-0.770	-0.780	-0.790	-0.800	-0.810	-0.820	-0.830	-0.840	-0.850
10	-0.000	-0.000	-0.000	-0.000	-0.000	-0.000	-0.000	-0.000	0.000	0.000	0.000	0.000	-0.000	0.000	-0.000	0.000	-0.000
11	0.690	0.700	0.710	0.720	0.730	0.740	0.750	0.760	0.770	0.780	0.790	0.800	0.810	0.820	0.830	0.840	0.850
12	1.380	1.400	1.420	1.440	1.460	1.480	1.500	1.520	1.540	1.560	1.580	1.600	1.620	1.640	1.660	1.680	1.700
13	2.070	2.100	2.130	2.160	2.190	2.220	2.250	2.280	2.310	2.340	2.370	2.400	2.430	2.460	2.490	2.520	2.550
14	2.760	2.800	2.840	2.880	2.920	2.960	3.000	3.040	3.080	3.120	3.160	3.200	3.240	3.280	3.320	3.360	3.400
15	3.450	3.500	3.550	3.600	3.650	3.700	3.750	3.800	3.850	3.900	3.950	4.000	4.050	4.100	4.150	4.200	4.250
16	4.140	4.200	4.260	4.320	4.380	4.440	4.500	4.560	4.620	4.680	4.740	4.800	4.860	4.920	4.980	5.040	5.100
17	4.830	4.900	4.970	5.040	5.110	5.180	5.250	5.320	5.390	5.460	5.530	5.600	5.670	5.740	5.810	5.880	5.950
18	5.520	5.600	5.680	5.760	5.840	5.920	6.000	6.080	6.160	6.240	6.320	6.400	6.480	6.560	6.640	6.720	6.800
19	6.210	6.300	6.390	6.480	6.570	6.660	6.750	6.840	6.930	7.020	7.110	7.200	7.290	7.380	7.470	7.560	7.650
20	6.900	7.000	7.100	7.200	7.300	7.400	7.500	7.600	7.700	7.800	7.900	8.000	8.100	8.200	8.300	8.400	8.500
21	7.590	7.700	7.810	7.920	8.030	8.140	8.250	8.360	8.470	8.580	8.690	8.800	8.910	9.020	9.130	9.240	9.350
22	8.280	8.400	8.520	8.640	8.760	8.880	9.000	9.120	9.240	9.360	9.480	9.600	9.720	9.840	9.960	10.080	10.200
23	8.970	9.100	9.230	9.360	9.490	9.620	9.750	9.880	10.010	10.140	10.270	10.400	10.530	10.660	10.790	10.920	11.050
24	9.660	9.800	9.940	10.080	10.220	10.360	10.500	10.640	10.780	10.920	11.060	11.200	11.340	11.480	11.620	11.760	11.900
25	10.350	10.500	10.650	10.800	10.950	11.100	11.250	11.400	11.550	11.700	11.850	12.000	12.150	12.300	12.450	12.600	12.750
26	11.040	11.200	11.360	11.520	11.680	11.840	12.000	12.160	12.320	12.480	12.640	12.800	12.960	13.120	13.280	13.440	13.600
27	11.730	11.900	12.070	12.240	12.410	12.580	12.750	12.920	13.090	13.260	13.430	13.600	13.770	13.940	14.110	14.280	14.450
28	12.420	12.600	12.780	12.960	13.140	13.320	13.500	13.680	13.860	14.040	14.220	14.400	14.580	14.760	14.940	15.120	15.300
29	13.110	13.300	13.490	13.680	13.870	14.060	14.250	14.440	14.630	14.820	15.010	15.200	15.390	15.580	15.770	15.960	16.150
30	13.800	14.000	14.200	14.400	14.600	14.800	15.000	15.200	15.400	15.600	15.800	16.000	16.200	16.400	16.600	16.800	17.000
31	14.490	14.700	14.910	15.120	15.330	15.540	15.750	15.960	16.170	16.380	16.590	16.800	17.010	17.220	17.430	17.640	17.850
32	15.180	15.400	15.620	15.840	16.060	16.280	16.500	16.720	16.940	17.160	17.380	17.600	17.820	18.040	18.260	18.480	18.700
33	15.870	16.100	16.330	16.560	16.790	17.020	17.250	17.480	17.710	17.940	18.170	18.400	18.630	18.860	19.090	19.320	19.550
34	16.560	16.800	17.040	17.280	17.520	17.760	18.000	18.240	18.480	18.720	18.960	19.200	19.440	19.680	19.920	20.160	20.400
35	17.250	17.500	17.750	18.000	18.250	18.500	18.750	19.000	19.250	19.500	19.750	20.000	20.250	20.500	20.750	21.000	21.250
36	17.940	18.200	18.460	18.720	18.980	19.240	19.500	19.760	20.020	20.280	20.540	20.800	21.060	21.320	21.580	21.840	22.100
37	18.630	18.900	19.170	19.440	19.710	19.980	20.250	20.520	20.790	21.060	21.330	21.600	21.870	22.140	22.410	22.680	22.950
38	19.320	19.600	19.880	20.160	20.440	20.720	21.000	21.280	21.560	21.840	22.120	22.400	22.680	22.960	23.240	23.520	23.800
39	20.010	20.300	20.590	20.880	21.170	21.460	21.750	22.040	22.330	22.620	22.910	23.200	23.490	23.780	24.070	24.360	24.650
40	20.700	21.000	21.300	21.600	21.900	22.200	22.500	22.800	23.100	23.400	23.700	24.000	24.300	24.600	24.900	25.200	25.500
41	21.390	21.700	22.010	22.320	22.630	22.940	23.250	23.560	23.870	24.180	24.490	24.800	25.110	25.420	25.730	26.040	26.350
42	22.080	22.400	22.720	23.040	23.360	23.680	24.000	24.320	24.640	24.960	25.280	25.600	25.920	26.240	26.560	26.880	27.200
43	22.770	23.100	23.430	23.760	24.090	24.420	24.750	25.080	25.410	25.740	26.070	26.400	26.730	27.060	27.390	27.720	28.050
44	23.460	23.800	24.140	24.480	24.820	25.160	25.500	25.840	26.180	26.520	26.860	27.200	27.540	27.880	28.220	28.560	28.900
45	24.150	24.500	24.850	25.200	25.550	25.900	26.250	26.600	26.950	27.300	27.650	28.000	28.350	28.700	29.050	29.400	29.750
46	24.840	25.200	25.560	25.920	26.280	26.640	27.000	27.360	27.720	28.080	28.440	28.800	29.160	29.520	29.880	30.240	30.600
47	25.530	25.900	26.270	26.640	27.010	27.380	27.750	28.120	28.490	28.860	29.230	29.600	29.970	30.340	30.710	31.080	31.450
48	26.220	26.600	26.980	27.360	27.740	28.120	28.500	28.880	29.260	29.640	30.020	30.400	30.780	31.160	31.540	31.920	32.300
49	26.910	27.300	27.690	28.080	28.470	28.860	29.250	29.640	30.030	30.420	30.810	31.200	31.590	31.980	32.370	32.760	33.150
50	27.600	28.000	28.400	28.800	29.200	29.600	30.000	30.400	30.800	31.200	31.600	32.000	32.400	32.800	33.200	33.600	34.000

Note: The Partial Group Index will be a negative value when the P.I. is less than 10 and positive when the P.I. is greater than 10.

Chapter 300

Bases - 09

The design and construction of a pavement structure may include one or more base courses. A base course is a layer of material below the wearing surface of a pavement. Bases may be constructed of gravels, mixtures of soil and aggregate, mixtures of asphalt and aggregate, mixtures of cement and aggregate or soil, or other innovative materials. Bases may be made of unbound materials, such as gravel, or bound materials, such as lime treated subgrade.

Base courses under rigid pavements provide a drainage layer, reduce pumping, provide protection against frost damage, and provide support for the heavy equipment usually used for placing rigid pavements. There is some increase in structural capacity when a base is placed under a rigid pavement, but it is typically not a significant amount.

Base courses under flexible pavements provide a significant increase in structural capacity. Pavement design of flexible pavement depends on the wheel loads being distributed over a greater area as the depth of the pavement structure increases. There are the added benefits of improved drainage and protection against frost damage.

ITEM 206 STRUCTURE BACKFILL, CLASS 1 ITEM 304 AGGREGATE BASE COURSE

Compaction of unbound bases is important for the stability of the pavement it supports. A standard is established in the laboratory with a sample of the base material before construction. The maximum dry density is determined. During construction measurements of the field compacted density are compared to the maximum dry density determined in the laboratory. The requirements for compaction of aggregate base course (ABC) are shown in Subsection 304.06 of the Standard Specifications for Road and Bridge Construction. Another granular material, Structure Backfill Class 1 has similar requirements as shown in Subsection 206.03.

Two methods to determine maximum dry density of soils are AASHTO T 99 and AASHTO

T 180. AASHTO T 99 is similar to ASTM D 698 and is commonly referred to as the Proctor Test, as it was first proposed by R. R. Proctor in 1933. AASHTO T 99 uses a 2.5 kg (5.5 lb.) rammer dropped from 305 mm (12 in.) When a 101.60 mm (4 in.) mold is used, three layers are compacted with 25 blows on each layer. When a 52.40 mm (6 in.) mold is used, three layers are compacted with 56 blows on each layer. AASHTO T 99 results in a compactive effort of 600 kN-m/m³ (12,400 ft-lbf/ft³). AASHTO T 180 is similar to ASTM D 1557 and is commonly referred to as the Modified Proctor Test. AASHTO T 180 uses a 4.54 kg (10 lb.) rammer dropped from 457 mm (18 in.). When a 101.60 mm (4 in.) mold is used, five layers are compacted with 25 blows on each layer. When a 52.40 mm (6 in.) mold is used, five layers are compacted with 56 blows on each layer. This results in a compactive effort of 2700 kN-m/m³ (56,000 ft-lbf/ft³). Comparing compactive efforts, AASHTO T 180 produces four and a half times the compactive effort that a sample receives compacted according to AASHTO T 99.

AASHTO T 99 is the appropriate standard for compaction of cohesive soils, particularly if there is the potential for swelling when saturated. AASHTO T 180 is appropriate for granular soils, such as aggregate base course and Structure Backfill, Class 1.

There are four methods of determining moisture-density relationships by AASHTO T 180:

- Method A uses a 101.60 mm (4 in.) mold and the fraction of the soil passing a 4.75 mm (No. 4) sieve. AASHTO states that this is applicable to soil mixtures that have 40% or less retained on a 4.75 mm (No. 4) sieve. ASTM D 1557 Method A is similar but limits application to soil mixtures that have 20% or less retained on a 4.75 mm (No. 4) sieve and 30% or less retained on a 19.0 mm (¾ in.) sieve.
- Method B uses a 152.40 mm (6 in.) mold and the fraction of the soil passing a 4.75 mm (No. 4) sieve. AASHTO states that this is applicable to soil mixtures that have

- 40% or less retained on a 4.75 mm (No. 4) sieve. ASTM D 1557 has no method similar to AASHTO Method B.
- Method C uses a 101.60 mm (4 in.) mold and the fraction of the soil passing a 19.0 mm ($\frac{3}{4}$ in.) sieve. AASHTO states that this is applicable to soil mixtures that have 30% or less retained on a 19.0 mm ($\frac{3}{4}$ in.) sieve. ASTM D 1557 is not similar. ASTM D 1557 Method B uses a 101.60 mm (4 in.) mold and the fraction of the soil passing a 9.5 mm ($\frac{3}{8}$ in.) sieve and is applicable to soil mixtures that have 20% or less retained on a 9.5 mm ($\frac{3}{8}$ in.) sieve and 30% or less retained on a 19.0 mm ($\frac{3}{4}$ in.) sieve.
- Method D uses a 152.40 mm (6 in.) mold and the fraction of the soil passing a 19.0 mm ($\frac{3}{4}$ in.) sieve. AASHTO states that this is applicable to soil mixtures that have 30% or less retained on a 19.0 mm ($\frac{3}{4}$ in.) sieve. ASTM D 1557 Method C is similar and also limits application to soil mixtures that have 30% or less retained on a 19.0 mm ($\frac{3}{4}$ in.) sieve.

The following table shows a comparison of the seven compaction test methods described above.

	AASHTO T 180 A	AASHTO T 180 B	AASHTO T 180 C	AASHTO T 180 D	ASTM D 1557 A	ASTM D 1557 B	ASTM D 1557 C
Mold	101.60 mm (4 in.)	152.40 mm (6 in.)	101.60 mm (4 in.)	152.40 mm (6 in.)	101.60 mm (4 in.)	101.60 mm (4 in.)	152.40 mm (6 in.)
Layers	5	5	5	5	5	5	5
Blows/Layer	25	56	25	56	25	25	56
Material Max. Sieve	4.75 mm (No. 4)	4.75 mm (No. 4)	19.0 mm ($\frac{3}{4}$ in.)	19.0 mm ($\frac{3}{4}$ in.)	4.75 mm (No. 4)	9.5 mm ($\frac{3}{8}$ in.)	19.0 mm ($\frac{3}{4}$ in.)
Application Lower Limit	None	None	None	None	None	20% 4.75 mm (No. 4)	20% 9.5 mm ($\frac{3}{8}$ in.)
Application Upper Limit Retained on Sieve	40% 4.75 mm (No. 4)	40% 4.75 mm (No. 4)	30% 19.0 mm ($\frac{3}{4}$ in.)	30% 19.0 mm ($\frac{3}{4}$ in.)	20% 4.75 mm (No. 4) and 30% 19.0 mm ($\frac{3}{4}$ in.)	20% 9.5 mm ($\frac{3}{8}$ in.) and 30% 19.0 mm ($\frac{3}{4}$ in.)	30% 19.0 mm ($\frac{3}{4}$ in.)

The gradation requirements for Class 1 Structure Backfill and ABC are shown in Subsections 703.08 and 703.03 respectively. A review of the gradation requirements shows that many granular materials will meet the gradation requirements and exceed the limits of application stated in AASHTO T 180 and ASTM D 1557.

AASHTO and ASTM have similar methods of correcting the maximum dry density and optimum moisture for mixtures of soil and rock:

- AASHTO T 224 Correction for Coarse Particles in the Soil Compaction Test
- ASTM D 4718 Correction of Unit Weight and Water Content for Soils Containing Oversize Particles

AASHTO T 224 is applicable to the same limits of application for the four methods in AASHTO T 180. ASTM D 4718 is applicable for mixtures of soil and rock with 40% or less retained on a 4.75 mm (No. 4) sieve and 30% or less retained on a 19.0 mm (¾ in.) sieve. The formula for correcting the maximum dry density in both methods is the same:

$$MDD = (100 D_f \times D_c) / (D_f \times P_c + D_c \times P_f)$$

Where:

- MDD = Corrected Maximum Dry Density, kg/m³ (pcf);
- D_f = Maximum dry density of fine particles (minus No. 4), kg/m³ (pcf);
- D_c = 1000 * bulk specific gravity (oven dry basis) of coarse particles, kg/m³, or 62.4 x bulk specific gravity (oven dry basis) of coarse particles, pcf.;
- P_c = Percent coarse particles by weight (plus No. 4);
- P_f = Percent fine particles by weight (minus No. 4).

Realizing the limitations of the available test procedures and equipment, Colorado has developed a different correction formula in Colorado Procedure 23 (CP 23):

$$MDD = (P_f \times D_f + P_c \times 0.9 D_c) / 100$$

CP 23 has worked well with AASHTO T 180 for providing control of compaction during construction of ABC, Class 1 Structure Backfill and other granular materials on CDOT projects.

The standard practice within the Department follows:

- 45 kg (110 lbs.) of granular material are sampled and sent to the laboratory before construction begins. This would typically require two standard sample bags.
- The material is separated into two fractions, material retained on a 4.75 mm (No. 4) sieve and material passing a 4.75 mm (No. 4) sieve.
- The specific gravity and absorption of the material retained on a 4.75 mm (No. 4) sieve is determined according to AASHTO T 85 Specific Gravity and Absorption of Coarse Aggregate.
- The maximum dry density and optimum moisture of the material passing a 4.75 mm (No. 4) sieve is determined according to AASHTO T 180 Moisture-Density Relations of Soils using a 4.54 kg (10 lb.) Rammer and a 457 mm (18 in.) Drop, Method A.
- A Form #548 Nomograph can be generated. This can make field calculations easier. Soil classification is not needed for material with gradation requirements, such as ABC and Class 1 Structure Backfill.

As construction begins and proceeds, the control of compaction follows according to the plans, specifications and the Frequency Guide Schedule for Minimum Materials Sampling, Testing and Inspection. Each field test must include a separation of the sample into the two fractions, material retained on a 4.75 mm (No. 4) sieve and material passing a 4.75 mm (No. 4) sieve. Compaction is determined according to CP 25, Calculation of Percent Relative Compaction of Soils and Soil-Rock Mixtures. CP 23 is used to correct the maximum dry density and optimum moisture for soil-rock mixtures with more than 5% material retained on a 4.75 mm (No. 4) sieve.

ITEM 308 PORTLAND CEMENT & FLY ASH

Sources of portland cement and/or fly ash are listed on the Department's Approved Product List. To verify a specific cementitious material that may be considered for a project first see if the supplier / manufacturer of the cement or fly ash is on the Qualified Manufacturers List, in accordance with CP 11, at the web site address of: www.dot.state.co.us/App_APL/QML.cfm.

Secondly, you can verify through the Approved Products List web site address of: http://www.dot.state.co.us/App_APL/.

If you wish to add a cement or fly ash source go to the same web site and follow the instructions within Notice to Manufacturers.

CDOT Forms - Applicable for Bases, Examples and Instructions

Form	Title	Page
# 157	Field Report For Sample Identification or Materials Documentation	6 - 10
# 6	Field Tests of Base Aggregate, Fillers, Paving and Miscellaneous Aggregates.....	11 - 12
# 38	Aggregate Test Report	13
# 194	Structure Backfill Density Report.....	14
# 564	Soils and Aggregate Sieve Analysis When Splitting On the No. 4 Sieve.....	15 - 16
# 565	Sieve Analysis For Aggregate Not Split On the No. 4 Sieve.....	17 - 18
# 633	Sample Tag (Sacks)	19
# 1126	Stabilometer Record of Item 304 Aggregate Base Course	20
# 1296	Granular Materials Moisture – Density Report.....	21 - 23

COLORADO DEPARTMENT OF TRANSPORTATION FIELD REPORT FOR SAMPLE IDENTIFICATION OR MATERIALS DOCUMENTATION Metric units <input type="checkbox"/> yes <input checked="" type="checkbox"/> no				Field sheet No. 120227		Date 5/6/02	
				Project No. IM 0253-151		Project location I-25, SH 7 to WCR 16	
Project code (SA#) 11925		Function 3200		Region 4		Part. P	
Sample submitted: <small>(ie.: Soil, ABC, Hydrated lime, HMA, concrete cores, steel, etc.)</small>				Field office phone number 303-828-0386			
Structure Backfill				Field office FAX number 303-828-0430			
Item 206		Class 1		Grading		Special provisions applicable: <input checked="" type="checkbox"/> yes <input type="checkbox"/> no	
Previously used on Project No.:				Previous CDOT Form #157 F/S No.(s):		<input checked="" type="checkbox"/> CDOT Form #633 (sack) <input type="checkbox"/> CDOT Form #634 (can)	
<ul style="list-style-type: none"> ● Sample Identification: Quantity & Unit of material submitted, describe tests required, precise location sample removed from (stationing), etc. ● Materials Documentation: Field inspected (describe appearance, weight/dimensions, model/serial number), COC &/or CTR provided, etc. 							
Submitting (2) sacks of Structure Backfill material.							
Perform the following tests for compliance w/Specifications.							
Gradation							
Atterberg Limits							
M/D Curve W/Rock Correction							
APL/QML Acceptance: APL Ref. No.		Product name:				Date checked:	
APL/QML Acceptance: APL Ref. No.		Product name:				Date checked:	
Preliminary <input type="checkbox"/>		Construction <input checked="" type="checkbox"/>		Maintenance <input type="checkbox"/>		Emergency <input type="checkbox"/>	
						Date needed ASAP	
Contractor Kraemer and Sons				Supplier Kraemer and Sons			
Sampled from <small>(Pit, roadway, windrow, stock, etc.)</small> Stockpile				Pit name or owner Varra			
Quantity represented 1/source/project		Previous quantity N/A		Total quantity to date N/A			
Sample submitted: <input checked="" type="checkbox"/> Yes <input type="checkbox"/> No		Shipped to: <input checked="" type="checkbox"/> Central lab <input type="checkbox"/> Region lab		Via Geocal		Date 5/6/02	
Sampled or inspected by (Name) Raymie Parington				Title Technician		Lab phone number 720-371-0767	
Supervisor <small>(Pro./Res./Mats. Engr./Maint. Supt.)</small> Corey Stewart				Title P.E. I		Address 1050 Lee Hill Rd. Boulder, Co. 80302	
Distribution: White copy - Staff Materials Branch <small>(submit white copy only if sample or information is directed to Staff Materials)</small> Canary copy - Region Materials Engineer Pink copy - Resident Engineer						CDOT Form #157 9/07	
Previous editions may be used until supplies are exhausted							

COLORADO DEPARTMENT OF TRANSPORTATION FIELD REPORT FOR SAMPLE IDENTIFICATION OR MATERIALS DOCUMENTATION Metric units <input type="checkbox"/> yes <input checked="" type="checkbox"/> no				Field sheet No. 120227		Date 1/2/02	
				Project No. IM0253-151		Project location I-25, SH 7 to WCR 16	
Project code (SA#) 11925		Function 3200		Region 4		Part. P	
Sample submitted: (i.e.: Soil, ABC, Hydrated lime, HMA, concrete cores, steel, etc.)						Field office phone number 303-828-0386	
Filter Material						Field office FAX number 303-828-0430	
Item 206		Class A		Grading		Special provisions applicable: <input checked="" type="checkbox"/> yes <input type="checkbox"/> no	
Previously used on Project No.:				Previous CDOT Form #157 F/S No.(s):		<input checked="" type="checkbox"/> CDOT Form #633 (sack) <input type="checkbox"/> CDOT Form #634 (can)	
<ul style="list-style-type: none"> ● Sample Identification: Quantity & Unit of material submitted, describe tests required, precise location sample removed from (stationing), etc. ● Materials Documentation: Field inspected (describe appearance, weight/dimensions, model/serial number), COC &/or CTR provided, etc. 							
Submitting (1) sack of Filter Material (Class A).							
Test For Gradation							
APL/QML Acceptance: APL Ref. No.		Product name:				Date checked:	
APL/QML Acceptance: APL Ref. No.		Product name:				Date checked:	
Preliminary <input type="checkbox"/>		Construction <input checked="" type="checkbox"/>		Maintenance <input type="checkbox"/>		Emergency <input type="checkbox"/>	
						Date needed ASAP	
Contractor Kraemer and Sons				Supplier Pipeline Construction			
Sampled from (Pit, roadway, windrow, stock, etc.) Stock				Pit name or owner Varra Co. Pit #115			
Quantity represented 1/source/project		Previous quantity N/A		Total quantity to date 1/source/project			
Sample submitted: <input checked="" type="checkbox"/> Yes <input type="checkbox"/> No		Shipped to: <input checked="" type="checkbox"/> Central lab <input type="checkbox"/> Region lab		Via CDOT		Date 1/3/02	
Sampled or inspected by (Name) Fidel Gonzalez		(Title) E/PS Tech II		Lab phone number 303-828-2644			
Supervisor (Pro./Res./Matis. Engr./Maint. Supt.) Corey Stewart		Title P.E. I		Address 1050 Lee Hill Rd. Boulder, Co. 80302			
Distribution: White copy - Staff Materials Branch (submit white copy only if sample or information is directed to Staff Materials) Canary copy - Region Materials Engineer Pink copy - Resident Engineer						CDOT Form #157 9/07	
Previous editions may be used until supplies are exhausted							

COLORADO DEPARTMENT OF TRANSPORTATION FIELD REPORT FOR SAMPLE IDENTIFICATION OR MATERIALS DOCUMENTATION		Field sheet No. 120227	Date 10/4/02		
		Project No. IM0253-151	Project location I-25, SH 7 WCR 16		
Metric units <input type="checkbox"/> yes <input checked="" type="checkbox"/> no		Project code (SA#) 11925	Function 3200	Region 4	Part. P
		Sample submitted: <small>(i.e. Soil, ABC, Hydrated lime, HMA, concrete cores, steel, etc.)</small>			
Aggregate Base Course		Field office phone number 303-828-0386		Field office FAX number 303-828-0430	
Item 304	Class 6	Grading	Special provisions applicable: <input checked="" type="checkbox"/> yes <input type="checkbox"/> no		
Previously used on Project No.:		Previous CDOT Form #157 F/S No.(s):		<input checked="" type="checkbox"/> CDOT Form #633 (sack) <input type="checkbox"/> CDOT Form #634 (can)	
<ul style="list-style-type: none"> ● Sample Identification: Quantity & Unit of material submitted, describe tests required, precise location sample removed from (stationing), etc. ● Materials Documentation: Field inspected (describe appearance, weight/dimensions, model/serial number), COC &/or CTR provided, etc. 					
Submitting (6) sacks of 304 ABC Class 6 For:					
*Gradation					
*R Value (min 78)					
*T180D					
*Atterberg Limits					
* As per the project specials and the CDOT FMM.					
APL/QML Acceptance: APL Ref. No.		Product name:		Date checked:	
APL/QML Acceptance: APL Ref. No.		Product name:		Date checked:	
Preliminary <input type="checkbox"/>		Construction <input checked="" type="checkbox"/>		Maintenance <input type="checkbox"/>	
		Emergency <input type="checkbox"/>		Date needed 10/11/02	
Contractor Kraemer and Sons		Supplier Hamms Operation			
Sampled from <small>(Pit, roadway, windrow, stock, etc.)</small> Benched Stockpile		Pit name or owner Hamms Operation			
Quantity represented 1/source/project		Previous quantity 1/source/project		Total quantity to date 1/source/project	
Sample submitted: <input checked="" type="checkbox"/> Yes <input type="checkbox"/> No		Shipped to: <input checked="" type="checkbox"/> Central lab <input type="checkbox"/> Region lab		Via Geocal	
Date 10/4/02		Lab phone number 303-828-2644			
Sampled or inspected by (Name) Dave Buck		(Title) QA Tech		Address 1050 Lee Hill Rd. Boulder, Co. 80302	
Supervisor <small>(Pro./Res./Mats. Engr./Maint. Supt.)</small> Corey Stewart		Title P.E. I			
Distribution: White copy - Staff Materials Branch <small>(submit white copy only if sample or information is directed to Staff Materials)</small> Canary copy - Region Materials Engineer Pink copy - Resident Engineer					
CDOT Form #157 9/07 Previous editions may be used until supplies are exhausted					

COLORADO DEPARTMENT OF TRANSPORTATION FIELD REPORT FOR SAMPLE IDENTIFICATION OR MATERIALS DOCUMENTATION				Field sheet No. 120227	Date 7/28/03
Metric units <input type="checkbox"/> yes <input checked="" type="checkbox"/> no				Project No. IM0253-151	Project location I-25, SH 7 to WCR 16
Project code (SA#) 11925		Function 3200	Region 4	Part. P	
Sample submitted: <small>(i.e.: Soil, ABC, Hydrated lime, HMA, concrete cores, steel, etc.)</small> Aggregate Base Course				Field office phone number 303-828-0386	
				Field office FAX number 303-828-0430	
Item 304	Class 6	Grading		Special provisions applicable: <input checked="" type="checkbox"/> yes <input type="checkbox"/> no	
Previously used on Project No.:		Previous CDOT Form #157 F/S No.(s):		<input checked="" type="checkbox"/> CDOT Form #633 (sack) <input type="checkbox"/> CDOT Form #634 (can)	
<ul style="list-style-type: none"> ● Sample Identification: Quantity & Unit of material submitted, describe tests required, precise location sample removed from (stationing), etc. ● Materials Documentation: Field inspected (describe appearance, weight/dimensions, model/serial number), COC &/or CTR provided, etc. 					
Submittin (2) sacks of Aggregate Base Course to be tested as follows:					
Gradation, (CP-31), Atterberg Limits, (T-89 and T-90).					
APL/QML Acceptance: APL Ref. No.		Product name:		Date checked:	
APL/QML Acceptance: APL Ref. No.		Product name:		Date checked:	
Preliminary <input type="checkbox"/> Construction <input checked="" type="checkbox"/> Maintenance <input type="checkbox"/> Emergency <input type="checkbox"/>				Date needed ASAP	
Contractor Kraemer and Sons			Supplier Cat Construction		
Sampled from <small>(Pit, roadway, windrow, stock, etc.)</small> Belt			Pit name or owner Goose Haven		
Quantity represented 2000 Tons		Previous quantity 4000 Tons		Total quantity to date 6000 Tons	
Sample submitted: <input checked="" type="checkbox"/> Yes <input type="checkbox"/> No		Shipped to: <input checked="" type="checkbox"/> Central lab <input type="checkbox"/> Region lab		Via Geocal	
				Date 7/30/03	
Sampled or inspected by (Name) R. Partington		(Title) Technician		Lab phone number 303-828-2644	
Supervisor <small>(Pro./Res./Matts. Engr./Maint. Supt.)</small> Corey Stewart		Title P.E. I		Address 1050 Lee Hill Rd. Boulder, Co. 80302	
Distribution: White copy - Staff Materials Branch <small>(submit white copy only if sample or information is directed to Staff Materials)</small> Canary copy - Region Materials Engineer Pink copy - Resident Engineer				CDOT Form #157 9/07	
Previous editions may be used until supplies are exhausted					

COLORADO DEPARTMENT OF TRANSPORTATION FIELD REPORT FOR SAMPLE IDENTIFICATION OR MATERIALS DOCUMENTATION			Field sheet No. 120227	Date 7/9/03
Metric units <input type="checkbox"/> yes <input checked="" type="checkbox"/> no			Project No. IM0253-151	Project location I-25, SH 7 to WCR 16
Project code (SA#) 11925		Function 3200	Region 4	Part. P
Sample submitted: <small>(ie.: Soil, ABC, Hydrated lime, HMA, concrete cores, steel, etc.)</small> Hydrated Lime			Field office phone number 303-828-0386	
			Field office FAX number 303-828-0430	
Item 307	Class	Grading	Special provisions applicable: <input checked="" type="checkbox"/> yes <input type="checkbox"/> no	
Previously used on Project No.:		Previous CDOT Form #157 F/S No.(s):		<input type="checkbox"/> CDOT Form #633 (sack) <input checked="" type="checkbox"/> CDOT Form #634 (can)
<ul style="list-style-type: none"> ● Sample Identification: Quantity & Unit of material submitted, describe tests required, precise location sample removed from (stationing), etc. ● Materials Documentation: Field inspected (describe appearance, weight/dimensions, model/serial number), COC &/or CTR provided, etc. <p style="text-align: center;">Submitting one can of Hydrated Lime for Gradation.</p> <p style="text-align: center;">CTR for chemical testing is retained in the project files and a copy was sent to the Region 4 Materials Engineer for review. This lime is listed on CDOT's QML.</p> <p style="text-align: center;">mix #142010</p>				
APL/QML Acceptance: APL Ref. No.		Product name:		Date checked:
APL/QML Acceptance: APL Ref. No.		Product name:		Date checked:
Preliminary <input type="checkbox"/> Construction <input checked="" type="checkbox"/> Maintenance <input type="checkbox"/> Emergency <input type="checkbox"/>			Date needed ASAP	
Contractor Kraemer and Sons		Supplier Pete Lein		
Sampled from <small>(Pit, roadway, windrow, stock, etc.)</small> Hopper		Pit name or owner Distel Plant		
Quantity represented 1st 10 K	Previous quantity 0	Total quantity to date 1st 10K		
Sample submitted: <input checked="" type="checkbox"/> Yes <input type="checkbox"/> No	Shipped to: <input checked="" type="checkbox"/> Central lab <input type="checkbox"/> Region lab	Via Geocal	Date 7/9/03	
Sampled or inspected by (Name) D. Elsbernd		(Title) QA Tech	Lab phone number 303-828-2644	
Supervisor <small>(Pro./Res./Mats. Engr./Maint. Supt.)</small> Corey Stewart		Title P.E. I	Address 1050 Lee Hill Rd. Boulder, Co. 80302	
Distribution: White copy - Staff Materials Branch <small>(submit white copy only if sample or information is directed to Staff Materials)</small> Canary copy - Region Materials Engineer Pink copy - Resident Engineer				CDOT Form #157 9/07
Previous editions may be used until supplies are exhausted				

Colorado Department of Transportatio
AGGREGATE TEST REPORT

Field Sheet No: 149102
Date Submitted 12/23/2003
Item Number: 304

Project ID: 11925
Project: IM 0253-151
Location: SH 7 to WCR 16
Date Sent: 12/24/2003
Pit Owner: DUNES PARK
Region: 04

Aggregate Test Report

Sampled From: WINDROW
Materials Description: CLASS 3 ABC
Central Lab Test No.: 2003937X
Project ID:

SPECIFICATIONS

(Grading AASHTO - T27)

Passing	6	Inch	100%	6	Inch (152.4 mm)
Passing	4	Inch	100%	4	Inch (101.6 mm)
Passing	3	Inch	100%	3	Inch (76.2 mm)
Passing	2 1/2	Inch	100%	2 1/2	Inch (63.5 mm)
Passing	2	Inch	86%	2	Inch (50.8 mm)
Passing	1 1/2	Inch	80%	1 1/2	Inch (38.1 mm)
Passing	1	Inch	72%	1	Inch (25.4 mm)
Passing	3/4	Inch	67%	3/4	Inch (19.0 mm)
Passing	1/2	Inch	61%	1/2	Inch (12.7 mm)
Passing	3/8	Inch	57%	3/8	Inch (9.51 mm)
Passing	#4		47%	#4	(4.75 mm)
Passing	#8		35%	#8	(2.36 mm)
Passing	#16		23%	#16	(1.18 mm)
Passing	#30		14%	#30	(600 mu)
Passing	#50		7%	#50	(300 mu)
Passing	#100		4%	#100	(150 mu)
Passing	#200		3.3%	20 MAX. #200	(75 mu)

Fractured Faces (CP45):

Abrasion (%Wear) (T96):

Liquid Limit (T89): NV

Plastic Limit (T90):

Plastic Index (T90): NP

"R" Value (T190):

* Indicates Deviation from
Specification Requirements.

Fine Aggregate Bulk sp.g.: App. sp.g.: % Abs.:

Course Aggregate Bulk sp.g.: App. sp.g.: % Abs.:

Remarks:

cc:

Central Laboratory
Regional Materials Engineer

Glenn Frieler
Concrete/ Physical Properties Program Manager

CDOT FORM # 38
1/2000

COLORADO DEPARTMENT OF TRANSPORTATION STRUCTURE BACKFILL DENSITY REPORT	Project No. IM 0253-151	
	Proj. location I-25, SH 7 to WCR 16	
	Date 2/14/03	Region 4
	Project code (SA#) 11925	

Major Structures

Number of Structures: (1 test/200 cu. yds.; minimum 1/structure)	Class 1 (cu. yds.)	No. of tests	Class 2 (cu. yds.)	No. of tests
2				
Total cu. yds. structure backfill: 1910	1350	7	560	3

Cross Drains

Number of Cross Drains: (1 test/200 cu. yds.; minimum 1/structure)	Class 1 (cu. yds.)	No. of tests	Class 2 (cu. yds.)	No. of tests
8				
Total cu. yds. structure backfill: 1800	1800	10		

Side Drains

Number of Side Drains: (1 test/200 cu. yds.; minimum 1/structure)	Class 1 (cu. yds.)	No. of tests	Class 2 (cu. yds.)	No. of tests
6				
Total cu. yds. structure backfill: 750	450	6	300	6

Other

	Class 1 (cu. yds.)	No. of tests	Class 2 (cu. yds.)	No. of tests

Remarks

Signed Fidel Gonzalez	Title E/PS Tech III
------------------------------	----------------------------

Resident Engineer, Materials & Geotechnical Branch (Documentation Unit)

CDOT Form #194 3/04

COLORADO DEPARTMENT OF TRANSPORTATION	Project no. IM 0253-151
SOILS AND AGGREGATES SIEVE ANALYSIS	Project code (SA#) 11925
WHEN SPLITTING ON THE No. 4 SIEVE	Item 304 Class 1

Pit name Goose Haven	Station 385+80	Test no. 3	Sample weight 49.70	Date 10/10/03
-----------------------------	-----------------------	-------------------	----------------------------	----------------------

Sieve	Wet wt.	Dry wt.	Individual percentage	Percent passing	Specs	Liquid limit	Moisture correction
						NV	
						Plastic limit NP	Plus #4 moisture sample
						Plastic index NP	Wet weight 1587.0
2 1/2	—	—	0.0	100.0	100	Soil class. N/A	Dry weight 1545.0
2	—	—	0.0	100.0	95-100		Loss 42.0
1 1/2	1.92	1.87	3.9	96.1		"R" value 80	% moisture 2.7
1	10.28	10.01	20.8	75.3		Sampled by	Minus #4 moisture sample
3/4	4.26	4.15	8.6	66.7			Wet weight 584.0
1/2	4.24	4.13	8.6	58.1		Tested by	Dry weight 560.0
3/8	1.57	1.53	3.2	54.9			Loss 24.0
+ #4	4.83	4.70	9.8	45.1	30-60		% moisture 4.3
- #4	22.60	21.67	45.1	40.2			
Total	49.70	48.06	100.0	17.5			
				# 8			
				# 50			
				# 200			
				9.3	5-12		

Minus #4 wash				
Wet weight (grams)	Sieve	Weight (grams)	Individual percentage	Percent passing
	# 8	61	10.9	89.1
	# 50	282	50.3	38.8
	#200	101	18.1	20.7
	- #200	116	20.7	
560	Total	560	100.0	

Weighing Individually

NOTE: Save all material until calculations are completed in case a check is necessary

Pit name	Station	Test no. 3	Sample weight 49.70	Date 10/10/03
----------	---------	-------------------	----------------------------	----------------------

Sieve	Wet wt.	Dry wt.	Individual percentage	Percent passing	Specs	Liquid limit	Moisture correction
						NV	
						Plastic limit NP	Plus #4 moisture sample
						Plastic index NP	Wet weight 1587.0
2 1/2	—	—	0.0	100	100	Soil class. N/A	Dry weight 1545.0
2	—	—	0.0	100	95-100		Loss 42.0
1 1/2	1.92	1.87	3.9	96.1		"R" value 80	% moisture 4.3
1	12.20	11.88	24.7	75.3		Sampled by	Minus #4 moisture sample
3/4	16.46	16.03	33.3	66.7			Wet weight 584
1/2	20.70	30.16	41.9	58.1		Tested by	Dry weight 560
3/8	22.27	21.68	45.1	54.9			Loss 24
+ #4	27.10	26.39	54.9	45.1	30-60		% moisture 4.3
- #4	22.60	21.67	45.1	40.2			
Total	49.70	48.06	100	17.5			
				# 8			
				# 50			
				# 200			
				9.3	5-12		

Minus #4 wash				
Wet weight (grams)	Sieve	Weight (grams)	Individual percentage	Percent passing
	# 8	61	10.9	89.1
	# 50	343	61.2	38.8
	#200	444	79.3	20.7
	- #200	116	20.7	
560	Total	560	100.0	

Weighing Accumulatively

COLORADO DEPARTMENT OF TRANSPORTATION		Project no. IM 0253-151
SOILS AND AGGREGATES SIEVE ANALYSIS		Project code (SA#) 11925
WHEN SPLITTING ON THE No. 4 SIEVE		Item 304 Class 1

Pit name Goose Haven	Station 410+10	Test no. 4	Sample weight 22.35	Date 10/10/03
-----------------------------	-----------------------	-------------------	----------------------------	----------------------

Sieve	Wet wt.	Dry wt.	Individual percentage	Percent passing	Specs	Liquid limit	Moisture correction
						NV	
						NP	Plus #4 moisture sample
						NP	Wet weight
2 1/2				100	100	NP	Dry weight
2		0.66	3.0	97.0	95-100	Soil class. N/A	Loss
1 1/2		3.32	15.0	82.0		"R" value 80	% moisture
1		1.44	6.5	75.5		Sampled by	Minus #4 moisture sample
3/4		1.62	7.3	68.2		80	Wet weight 490.0
1/2		2.58	11.7	56.5		Tested by	Dry weight 478.0
3/8		1.48	6.7	49.8			Loss 12.0
+ #4		1.05	4.8	45.0	30-60		% moisture 2.5
- #4	10.20	9.95	45.0	37.9			
Total	22.35	22.10	100.0	24.9			
				#200 7.2	5-12		

Minus #4 wash				
Wet weight (grams)	Sieve	Weight (grams)	Individual percentage	Percent passing
	# 8	75	15.7	84.3
	# 50	138	28.9	55.4
Dry weight (grams)	#200	189	39.5	15.9
	- #200	76	15.9	
478	Total	478	100.0	

Weighing Individually

NOTE: Save all material until calculations are completed in case a check is necessary

Pit name Goose Haven	Station 410+10	Test no. 4	Sample weight 22.35	Date 10/10/03
-----------------------------	-----------------------	-------------------	----------------------------	----------------------

Sieve	Wet wt.	Dry wt.	Individual percentage	Percent passing	Specs	Liquid limit	Moisture correction
						NV	
						NP	Plus #4 moisture sample
						NP	Wet weight
2 1/2				100	100	NP	Dry weight
2		0.66	3.0	97.0	95-100	Soil class. N/A	Loss
1 1/2		3.98	18.0	82.0		"R" value 80	% moisture
1		5.42	24.5	75.5		Sampled by	Minus #4 moisture sample
3/4		7.04	31.8	68.2		80	Wet weight 490.0
1/2		9.62	43.5	56.5		Tested by	Dry weight 478.0
3/8		11.10	50.2	49.8			Loss 12.0
+ #4		12.15	55.0	45.0	30-60		% moisture 2.5
- #4	10.20	9.95	45.0	37.9			
Total	22.35	22.10	100.0	24.9			
				#200 7.2	5-12		

Minus #4 wash				
Wet weight (grams)	Sieve	Weight (grams)	Individual percentage	Percent passing
	# 8	75	15.7	84.3
	# 50	213	44.6	55.4
Dry weight (grams)	#200	402	84.1	15.9
	- #200	76	15.9	
478	Total	478	100.0	

Weighing Accumulatively

CDOT FORM # 565 INSTRUCTIONS

This form is a field work sheet for use when testing aggregates in accordance with CP 31 Method B when the maximum nominal particle size is less than 3/4 in (19.0 mm).

This procedure allows for the total dry weight (mass) of the specimen, before washing, to be determined by either drying the total specimen or correcting it to dry weight (mass) using a moisture specimen of the same gradation and approximate weight (mass) as the specimen for wash.

Example No. 1 illustrates using a separate moisture specimen to correct the wet weight (mass) of the wash specimen to dry weight (mass). **Example No. 2** illustrates drying the total specimen to be washed and sieved. The percent moisture may be calculated if desired.

When correcting to dry weight (mass) by the use of a moisture specimen, it is very important that the specimen for wash and the specimen for moisture be taken and weighed at the same time. Also, that the samples be as nearly identical in weight (mass) and gradation as poss

COLORADO DEPARTMENT OF TRANSPORTATION SIEVE ANALYSIS FOR AGGREGATES NOT SPLIT ON THE No. 4 SIEVE					Project no. IM 0253-151		Project code (SA#) 11925		
					Proj. location I-25 SH 7 to WCR 16				
					Pit name Goose Haven				
					Item 203		Class R-50 (spec)		
Station 2588+15 13' lt.		Test# 13		Station 3000+00 5' rt		Test# 14			
Specimen wt (dry) B 772.2		Date 6/5/02		Specimen wt (dry) B 15962.9		Date 6/5/03			
Sieve	Weight	Percent retained	Percent passing	Specs	Sieve	Weight	Percent retained	Percent passing	Specs
2"1					2"1	341.1	2.1	97.9	
1 1/2"					1 1/2"	758.1	4.7	93.3	
1"					1"	1617.7	10.1	89.9	
3/4"					3/4"	2103.2	13.2	86.8	
1/2"					1/2"	2698.7	16.9	83.1	
3/8"					3/8"	2967.9	18.6	81.4	
#4	0.3	0	100		#4	3503.7	21.9	78.1	
#10	39.8	5.2	94.8		#10	4150.4	26.0	74.0	
#16	84.8	11.0	89.0		#16	4868.7	30.5	69.5	
#40	258.2	33.4	66.6		#40	7662.2	48.0	25.0	
#50	379.0	49.1	50.9		#50	9609.7	60.2	39.8	
#100	577.9	74.8	25.2		#100	12818.2	80.3	19.7	
#200	668.6	86.6	13.4		#200	14286.8	89.5	10.5	
-#200	5.7				-#200	10.5			
TOTAL	674.3				TOTAL	14297.3			
Gradation Sample		Moisture Sample			Gradation Sample		Moisture Sample		
Pan ID					Pan ID				
Pan weight					Pan weight				
Wet weight + Pan					Wet weight + Pan				
Wet weight		A			Wet weight		A		
Dry weight + Pan					Dry weight + Pan				
Dry weight		B			Dry weight		B		
Dry wash weight	H ₂ O Loss				Dry wash weight	H ₂ O Loss			
-#200	% H₂O	8.0			-#200	% H₂O	8.0		
Wet weight + (100 + % H ₂ O) x 100 = Dry weight					Wet weight + (100 + % H ₂ O) x 100 = Dry weight				
A 834.0 + (100 + 8.0) x 100 = B 772.2					A 17239.9 + (100 + 8.0) x 100 = B 15962.9				
Sampled by		Tested by			Sampled by		Tested by		
Dave Buck		John Assad			Dave Buck		John Assad		

NOTE: Save all material until calculations are complete in case check is necessary.

Project	<i>IM 0253-151</i>	S.A./Project Code (#'s)	<i>11925</i>
Field report #	<i>120027</i>	Test #	<i>4A</i>
Station & Depth	<i>Cooley Morrison Quarry (3/4 Rock)</i>		
Sack	<i>1</i>	of	<i>8</i> sacks, for Item # <i>403</i>

CDOT Form #633 3/01

To
COLORADO DEPARTMENT OF TRANSPORTATION
Materials and Geotechnical Branch
4670 Holly st. Unit A
Denver, Colorado 80216-6408

Project	<i>IM 0253-151</i>	S.A./Project Code (#'s)	<i>11925</i>
Field report #	<i>120027</i>	Test #	<i>4 A</i>
Station	<i>Cooley Morrison Quarry (3/4 Rock)</i>		
Depth	<i>5'</i>		
Sack	<i>1</i>	of	<i>8</i> sacks, for
Item #	<i>403</i>		

DETACH STUB AND PLACE IN SACK

Project	<i>IM 0253-151</i>	S.A./Project Code (#'s)	<i>11925</i>
Field report #	<i>120027</i>	Test #	<i>1 B</i>
Station & Depth	<i>Aggregate Industries Pit (Crusher Fines)</i>		
Sack	<i>8</i>	of	<i>8</i> sacks, for Item # <i>403</i>

CDOT Form #633 3/01

To
COLORADO DEPARTMENT OF TRANSPORTATION
Materials and Geotechnical Branch
4670 Holly st. Unit A
Denver, Colorado 80216-6408

Project	<i>IM 0253-151</i>	S.A./Project Code (#'s)	<i>11925</i>
Field report #	<i>120027</i>	Test #	<i>1 B</i>
Station	<i>Aggregate Industries Pit (Crusher Fines)</i>		
Depth	<i>5'</i>		
Sack	<i>8</i>	of	<i>8</i> sacks, for
Item #	<i>403</i>		

DETACH STUB AND PLACE IN SACK

COLORADO DEPARTMENT OF TRANSPORTATION STABILOMETER RECORD OF ITEM 304 ABC				Project No. IM 0253-151		Region 4	
				Project code (SA#) 11925			
				Proj. location I-25 SH 7 to WCR 16			
Pit name Goose Haven		Date 3/21/01		Field sample # 130152		Lab # 13A	
Represents 304		LL NV	PL	PI NP	SE	Class 6	
GRADATION				Stabilometer "R" value: 78			
As run		Set up		% moisture at _____ lbs. per cu. ft.			
Seive size	% passing	Scalp		% Moisture - #4 Material 0.85 X			
4" _____				Weight of - #4 Material _____ =			
3" _____				Weight of H ₂ O _____ +			
2½" _____				Initial H ₂ O added 50 =			
2" _____				Total initial H ₂ O _____ (A)			
1½" _____				COMPACTION			
1" _____				Cylinder #	3	4	5
¾" _____	100	100		H ₂ O added (B)	65	75	70
½" _____	89	89	11 %	Exudation pressure, lbs	10000	2960	5700
¾" _____	73	73	27 %	Exudation pressure, PSI	796	236	454
½" _____	47	47	53 %	Ht. of briquette (H)	2.41	2.40	2.42
#4 _____	36			Wt. cylinder & wet sample	3275	3282	3281
#8 _____	29			Cylinder tare	2115	2117	2116
#16 _____	18			Wet wt. of sample (W _w)	1160	1165	1165
#50 _____	13			¹ Weight of H ₂ O (C)			
#100 _____	9			² Dry wt. (D)			
#200 _____				³ % Moisture (M)			
				⁴ Density			
				Height correction by wt.			
Set up weights				STABILOMETER			
-¾" + ½"		121		Total load	PSI		
-½" + ¾"		297		1000	80		
-¾" + #4		583		2000	160	15	23 16
-#4		1100		Displacement turns		5.52	4.38 5.24
				"R" value		81(80)	77(76) 81(80)
				Drainage			
				Exp. pressure dial reading			
¹ (A) + (B) = (C) ² (W _w) - (C) = (D) ³ (C) + (D) = (M) ⁴ $\frac{(W_w) \times 30.3}{(100 + M) \times H}$							

CDOT Form #1126 3/04

COLORADO DEPARTMENT OF TRANSPORTATION
Granular Material Moisture - Density Report

Rock Correction Chart:

-4 Material

%+4	%H2O	Dry Density	%+4	%H2O	Dry Density	%+4	%H2O	Dry Density
0	8.3	131.4	20	6.9	134.0	40	5.5	136.6
1	8.2	131.6	21	6.8	134.2	41	5.4	136.7
2	8.2	131.7	22	6.8	134.3	42	5.4	136.9
3	8.1	131.8	23	6.7	134.4	43	5.3	137.0
4	8.0	132.0	24	6.6	134.5	44	5.2	137.1
5	8.0	132.1	25	6.6	134.7	45	5.2	137.2
6	7.9	132.2	26	6.5	134.8	46	5.1	137.4
7	7.8	132.3	27	6.4	134.9	47	5.0	137.5
8	7.8	132.5	28	6.4	135.1	48	4.9	137.6
9	7.7	132.6	29	6.3	135.2	49	4.9	137.8
10	7.6	132.7	30	6.2	135.3	50	4.8	137.9
11	7.5	132.9	31	6.1	135.4	51	4.7	138.0
12	7.5	133.0	32	6.1	135.6	52	4.7	138.1
13	7.4	133.1	33	6.0	135.7	53	4.6	138.3
14	7.3	133.3	34	5.9	135.8	54	4.5	138.4
15	7.3	133.4	35	5.9	136.0	55	4.5	138.5
16	7.2	133.5	36	5.8	136.1	56	4.4	138.7
17	7.1	133.6	37	5.7	136.2	57	4.3	138.8
18	7.1	133.8	38	5.7	136.3	58	4.2	138.9
19	7.0	133.9	39	5.6	136.5	59	4.2	139.0

Optimum Moisture: 8.3

Maximum Dry Density: 131.4

COLORADO DEPARTMENT OF TRANSPORTATION

Granular Material Moisture - Density Curve

Moisture Density Curve

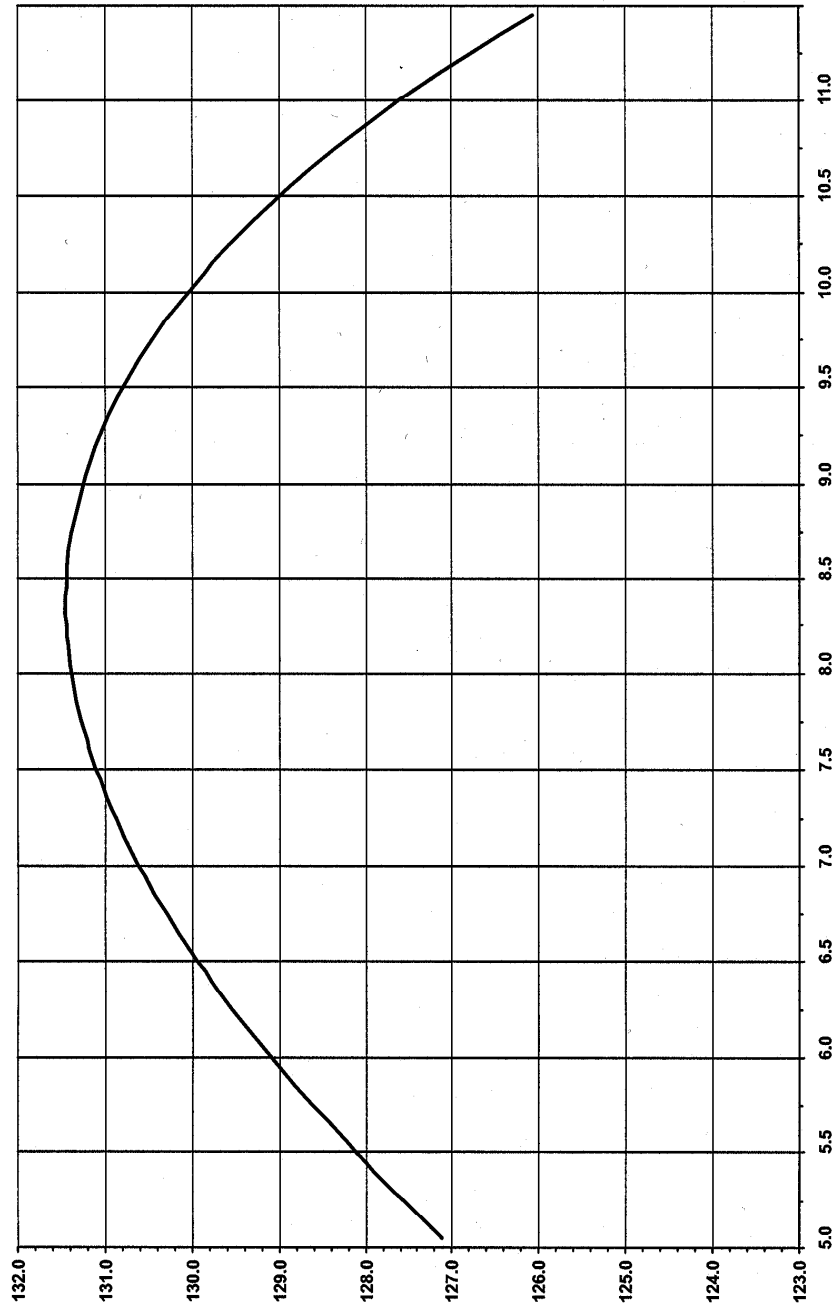

Labno: 2002-0522

Optimum Moisture: 8.3

Maximum Dry Density: 131.4

(CDOT #1296 9/2002)

Chapter 400

Asphalt - 11

Bituminous Mixtures & Binders

Bituminous materials are used by CDOT for a variety of purposes. The bituminous material (normally referred to as asphalt cement or binder) may be combined with aggregate to bind the aggregate together and thus form a durable pavement. Binder may also be sprayed on a surface to protect the surface. Binders at room temperature are too viscous (stiff) to mix with aggregate or to be sprayed. Mixing is achieved by reducing viscosity by one of three approaches: Hot Mix Asphalt (HMA) is produced by heating the binder, to reduce viscosity, then combining the hot binder with hot, dry aggregate. Until recently HMA was referred to as HBP or Hot Bituminous Pavement by CDOT. Colorado changed to be consistent with the current national terminology. A second method for lowering viscosity to improve mixing involves combining binder with water and emulsifier to produce an emulsion. In the third approach, asphalt cement is combined with solvent to produce lower viscosity material called cutback asphalt. Cutback can be readily mixed with aggregate. Heating, emulsification, or solvents may also be used to facilitate spraying of a binder.

HMA

Of the three mixing approaches, HMA provides the strongest and most durable pavements. Combining hot asphalt cement with hot dry aggregate provides the strongest bond between the binder and aggregate. However, drying the aggregate plus heating the aggregate and binder requires considerable energy. In addition, the HMA must be transported, placed and compacted before it becomes too cool for proper compaction.

Emulsions

Emulsions can be stored and used at lower temperatures than binder for use in HMA. Emulsions can also be used with wet, cool aggregate. These emulsion properties allow energy savings and more flexibility in application.

Cutbacks

Cutbacks contain solvents, which could be used for fuel, petrochemicals, or some other more effective use of a non-renewable resource. A more serious problem with cutbacks is that the solvents can be absorbed through the skin or may be breathed after evaporation. Many solvents used in cutbacks present health hazards and some solvents are highly flammable and thus are a fire hazard. Solvents in cutbacks also contribute to air pollution and the formation of ozone. Health, safety, and environmental regulations have eliminated almost all use of cutbacks for highway construction by CDOT.

ITEM 403 - HOT MIX ASPHALT

Superpave - The Strategic Highway Research Program (SHRP) was established by Congress in 1987 as a five-year research program to improve the performance and durability of U.S. roads and to make those roads safer for both motorists and highway workers. \$50 million of the SHRP research funds were used for the development of performance based asphalt specifications that directly relate laboratory analysis with field performance.

Superpave (Superior Performing Asphalt Pavements) is a product of the SHRP asphalt research. The Superpave system represents an improved system for specifying asphalt binders and mineral aggregates, developing asphalt mix designs, and analyzing and establishing pavement performance prediction. The Superpave binder specifications and mix design system include various test equipment, test methods, and materials criteria.

Superpave is a performance-based system. The tests and analysis have direct relationships to field performance.

ITEM 403 - SUPERPAVE MIX DESIGN

One outcome of the SHRP research was the development of the Superpave gyratory compactor (SGC). The SGC compacts mixtures at an angle of 1.25° , which has been determined to better simulate field compaction.

Mixes that are designed with the SGC take into account the amount of traffic the roadway is expected to experience throughout its design life. Binder selection is based on climate, traffic loading, and traffic flow. The asphalt content that yields 4% air voids at the design number of gyrations, N_{design} , becomes the target asphalt content.

An excellent discussion of the Superpave mix design can be found in the Asphalt Institute Manual SP-2, *Superpave Mix Design*. When using the 0.45 Power-Chart, CDOT defines the maximum density gradation line as a straight line passing from the origin to one sieve size larger than the nominal maximum aggregate size.

ITEM 411 - PERFORMANCE GRADED BINDERS (PG BINDERS)

The asphalt cements under the Superpave system are called binders because the intent of the specifications was to address both modified and unmodified asphalt cements. One feature of the Superpave binder specification is that all of the binders have to meet the same criteria, but the temperature at which they meet the criteria is related to the climate in the project area. For instance, using the Superpave specifications binders can be chosen to address low temperature cracking in the high mountains, or rut resistance in the eastern plains with the same test values, but the test temperature would be different to reflect the different project climates. For example, a performance binder designation listed as PG 58-28 would mean that the binder will meet the high service temperature requirements (rutting) up to a pavement temperature of 58°C and that the binder will meet the low temperature requirements down to a pavement service temperature of -28°C . The recommended pavement service temperatures for all Colorado weather stations can be found in CDOT's Pavement Design Manual along with instructions for the selection of PG binders.

Some of the tests and equipment in the Superpave system are as follows:

Dynamic Shear Rheometer (DSR) - Used to measure rut resistance properties at high pavement service temperatures, and fatigue cracking properties at intermediate service temperatures.

Bending Beam Rheometer (BBR) - Used to measure binder properties at low temperatures to determine if a binder has the required properties for resistance to thermal cracking.

Direct Tension Device (DTD) - Used to measure binder strength at low temperatures to determine resistance to low temperature cracking.

Rolling Thin Film Oven (RTFO) - Used to simulate the aging, which occurs to the asphalt binder in the mixing plant. Most of the rut resistance measurements are made on the binder in this condition.

Pressure Aging Vessel (PAV) - Used to age asphalt binder in the lab to simulate the aging, which takes place in the pavement after 5 to 7 years. Most of the measurements to determine fatigue and thermal cracking resistance are made on samples following this aging procedure.

An excellent discussion of the background and testing of PG binders is found in the Asphalt Institute Manual SP-1, *Superpave Asphalt Binder Specification*.

ITEM 403 - HOT MIX ASPHALT

European Rutting Machines

Rutting and stripping data from project produced mixes is being gathered to identify good and poor performing mixes, as well as to develop specifications to help determine and produce better performing mixes for Colorado.

Two different pieces of equipment are being used in the Central Laboratory to measure rutting potential, the Hamburg Wheel-Tracking Device and the French Rutting Tester. The Hamburg Device also provides a severe test for stripping. As reflected in the Schedule for Sampling and Testing (Item 403), the choice of which rut tester to use is determined by the Region Materials Engineer.

The following are descriptions of the two rutting devices.

Hamburg Wheel-Tracking Device (HWTDT)

The Hamburg Wheel-Tracking Device was obtained following the European Tour in 1990 by CDOT and has been used in a large quantity of research concerning stripping by CDOT. The HWTDT was manufactured by Helmut-Wind Inc. of Hamburg Germany and is a very severe test for stripping and rutting of an asphalt mix.

A pair of samples (lab compacted slabs or field cores of 10" diameter) is tested simultaneously. The slabs/cores are submerged under water with the temperature varying from 45° to 55°C (113° to 131°F) depending on the PG binder. A steel wheel, 47 mm (1.85 in) wide, loads the samples with 705 N (158 lbs) and the wheel makes 50 passes over each sample per minute. The maximum velocity of the wheel is 340 mm/sec (1.1 ft/sec) in the center of the sample. Each sample is loaded for 10,000 passes or until 15 mm of deformation occurs. Approximately 3 1/2 hours are required for a test.

The results from the HWTDT include the creep slope, stripping slope, and the stripping inflection point. The creep slope relates to rutting from plastic flow. It is the inverse of the rate of deformation in the linear region of the deformation curve, after post compaction effects have ended and before the onset of stripping. The stripping slope is the inverse of the rate of deformation in the linear region of the deformation curve, after stripping begins and until the end of the test. It is the number of passes required to create a 1 mm impression from stripping and is related to moisture damage. The stripping inflection point is the number of passes at the intersection of the creep slope and the stripping slope. It is also related to moisture damage.¹

The CDOT specification is a maximum impression of 4 mm after 10,000 passes. The Figure 400-1 shows a plot of a Hamburg sample.

French Rutting Tester (FRT)

The French Rutting Tester was also obtained following the European Tour in 1990, and has been used extensively to predict rutting. The research on 33 pavements with known rutting

performance has shown that this equipment is excellent at predicting rutting from plastic flow. The FRT test slabs 500 mm by 180 mm (19.7 x 7.1 inches), which can be 20 to 100 mm thick (0.8 to 3.9 inches).

Two slabs can be tested simultaneously. The slabs are loaded by a pneumatic tire inflated to 87 psi (0.6 Mpa). The tire loads the sample at 1 cycle per second (one cycle is two passes).

The entire chamber is heated to a temperature range between 113° to 140°F (45° to 60°C), depending on the PG binder.

FRT tests can be made on lab compacted slabs, or field slabs of 8" x 20" cut from the roadway. The rut depth is calculated as the difference between the original slab height and the slab height after testing is completed. It is reported in millimeters. The CDOT specification is less than 5 mm rutting in 10,000 cycles.

The FRT has been shown to be a very good predictor of rut susceptibility from plastic flow when the test temperature is adjusted to the conditions found in the project area.

¹ Report #CDOT-DTD-94-1

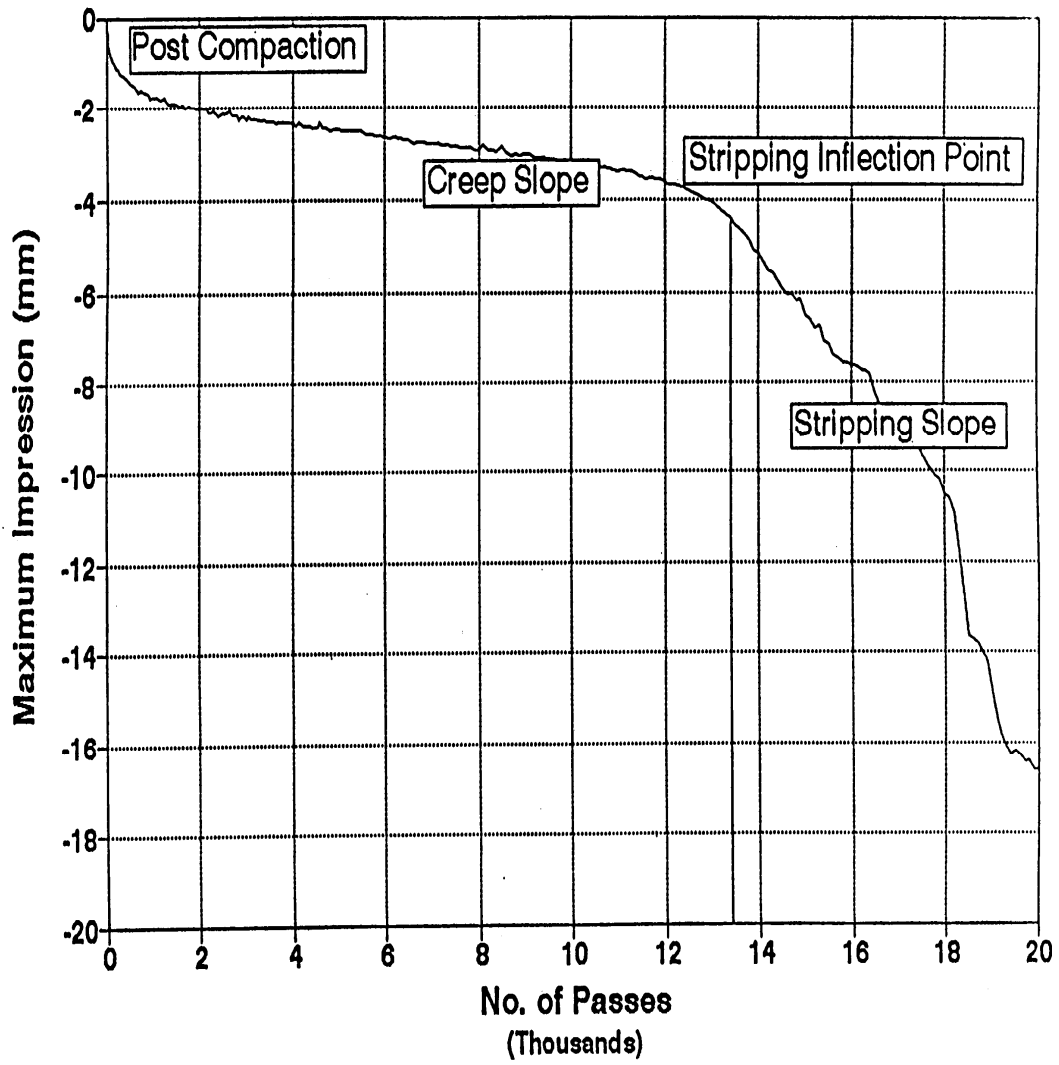

Definition of the Hamburg Wheel-Tracking Results.

FIGURE 400-1

ITEM 411 - BITUMINOUS MATERIALS

Acceptance Procedure for Asphalt Cements / Performance Graded Asphalt Binders, Liquid Asphalt Materials, Emulsified Asphalts, and Asphalt Rejuvenating Agents.

Wherever the word Asphalt Cements is used, it is construed to mean either, Asphalt Cements or Performance Graded Asphalt Binders.

It is the responsibility of project personnel to set up a predetermined random sampling schedule. All samples, whether QA or IA, are to be submitted to the Central Laboratory and accompanied by the appropriate form.

NOTE: All sample containers must be properly labeled (CDOT Form # 634) or identified by permanent ink marker with the following:

- ◆ Project Code #
- ◆ Field Sheet #
- ◆ Can #
- ◆ Date
- ◆ Material Type
- ◆ Lot #

Asphalt and binder acceptance/verification (QA) samples shall be taken at the contractor's plant.

Samples of these materials will normally be taken by the Contractor's personnel in the presence of the CDOT project personnel or their designated agent for acceptance/verification.

When the IA Schedule calls for an Independent Assurance (IA) sample, the sample shall be split. The sampling process is to be witnessed by the IA Tester or non-project personnel. A split sample for Item 411 is defined as two samples collected one immediately after the other. **Note:** Designate on the CDOT Form #411, PG Binder / Emulsion Submittal Form, that this is an IA sample and correlate the IA sample number with the QA sample number.

Samples shall be taken from the pipeline(s) through which the material is flowing by insertion of a sampling device or other similar efficient method immediately prior or before discharge into the HMA final mixing area or apparatus. The sampling device should be conveniently located for sampling access by contractor's project personnel. See AASHTO T 40 for additional information about sampling of AC

type material. Note: The sampling device would normally be located in the line from the storage tank to the HMA plant mixing area.

Random Sampling and the Lot System

Statistical methods are employed to evaluate quality assurance of materials because it is impractical, if not impossible, to test all the materials incorporated into a highway project. To meet the requirements of the CDOT statistical acceptance procedure the following method will be utilized:

Normally, samples 1 through 5 will be designated Lot No. 1, samples 6 through 10 will be designated Lot No. 2, samples 11 through 15 will be designated Lot No. 3, etc. At the discretion of the Project Engineer, a lot may be assigned as stated in the "Establishing Lots and Process Control on the Project" in the Appendix Chapter and also they may refer to the CP 75, Stratified Random Sampling of Materials, and the section "Sampling and Testing Definitions."

In the Central Laboratory a sample from each lot will be randomly selected to represent that lot. If the tested sample conforms to specification requirements, the lot is acceptable. If the tested sample fails to meet specification requirements, then the other samples of that lot will be tested.

The test results for the lot will then be analyzed by the Project Engineer for acceptance at full contract price, price reduction, or rejection according to Subsection 105.03 of the Standard Specifications.

Do not use the price reduction formulas shown in Subsection 105.03 of the Standard Specifications on metric projects unless the specific metric notation is included.

Reporting Project Acceptance/Verification Samples for Undiluted Emulsion

Under this program, the field tester will continue to collect a COC for the material delivered to the project and file it in the project files. The tester will fill in the pertinent field data on CDOT Form # 411, PG Binder / Emulsion Submittal Form.

Asphalt Emulsion Overview

Binder and water do not normally mix well. Even if thoroughly mixed, the droplets of binder quickly recombine (coalesce) to become separate from the water. The mixture of binder and water are made more permanent by using an emulsifier to suspend the binder droplets within the water. The emulsifier bonds to the surface of the binder droplets, causing them to repel each other and thus not coalesce.

Emulsions are manufactured to yield a viscosity low enough for the emulsion to disperse throughout an aggregate or be sprayed on a surface. After application, the emulsion sets or breaks as the asphalt droplets coalesce, the water evaporates, and the binder coats the aggregate or sprayed surface. Time required for the emulsion to break is influenced by many factors including: emulsion characteristics, temperature, humidity, aggregate gradation, and aggregate surface properties.

Emulsion Production

Emulsions are produced by mixing binder with water containing an emulsifier in a colloid mill. The mill contains a moving rotor and a stationary stator separated by a small gap. The mill creates small droplets of binder, kept separate by the emulsifier, and dispersed in the water. This process is augmented by heating both the binder and the water. In some cases the water is heated above boiling, requiring the process to take place under pressure. Additional additives may be added during the process to modify the properties of the emulsion or the residual binder left after curing. Polymers and adhesion promoters are added to improve the performance of the residual binder. For example, polymers improve binder properties such as cohesion, resistance to cracking at low temperatures, and resistance to flow at high temperatures. Thickeners and several other chemicals may be added to improve the properties of the emulsion. For the most part, these chemicals stabilize emulsion viscosity or reduce settlement.

TABLE 400-I

COMPARISON OF EMULSION PROPERTIES		
Property	Anionic Emulsion	Cationic Emulsion
Breaking Time	Long	Short
Adhesion of Deposited Bitumen	Bad, except on calcareous aggregates	Excellent on all aggregates
Condition of Aggregate	Must be dry	Must be wet

Emulsion Testing

Testing of emulsions serves several purposes. Some of the tests such as charge and reactivity are used to classify emulsions. Classification allows the user to choose the right emulsion for the intended application. Other tests ensure that the storage and handling of the emulsion will not be a problem. Still other tests evaluate performance related properties of the emulsion. Some of these performance related test results are also used in classification. Tests can be conducted on the emulsion or on the binder that remains when the water is removed. The common tests conducted on emulsions used by CDOT are the following:

1. Particle Charge

Emulsions are classified as anionic (negatively charged) or cationic (positively charged) depending on the charge of the particles surrounding the binder droplets. Particle charge is determined by inserting electrodes into the emulsion, applying a current, and noting which electrode is coated by binder. Emulsion charge can influence how the emulsion residue coats aggregate of certain mineral composition.

2. Reactivity

Emulsions are classified as rapid-setting, medium-setting, or slow-setting based on how quickly they set or break. Rapid-setting emulsions set quickly when applied to clean, relatively large aggregate, such as chips used in chip seals. Medium-setting emulsions set more slowly when applied to clean relatively large aggregate. Medium-setting emulsions can be mixed with aggregates low in fines such as open-graded mixes. Slow-setting emulsions set slowly when combined with aggregates containing substantial amounts of fines. These emulsions can be used to produce cold mixes using uniformly graded aggregates similar to those used in HMA.

Reactivity can be measured in several ways. The emulsion can be mixed with standard aggregates and the amount of coating determined. Coalescence when exposed to fine quartz sand or cement also indicates reactivity. In another reactivity test, solutions that cause emulsions to break are added in increments. The amount of solution required to cause coalescence or

breaking indicates reactivity and is called "demulsibility".

3. Sieve Test

The sieve test determines if there are large particles in the emulsion, which could clog spray nozzles. The amount of binder retained on the No. 20 sieve is determined. The maximum allowed amount is normally 0.1%.

4. Storage Stability

If the density of the binder droplets is different from the water density, the droplets will tend to float to the top or settle to the bottom (more typical). If this is excessive, the non-uniformity can cause construction problems. Glass cylinders are filled with emulsion and allowed to sit for 24 hours. Samples are obtained from the top and bottom of the cylinder and the residue percentage compared to the percentage for the entire cylinder. The percentage of binder residue for the top and bottom cannot vary from the overall by more than 1%.

5. Emulsion Viscosity

The viscosity of the emulsion affects handling and use. The emulsion must be pumpable and flow easily through pipes. It must also coat aggregate effectively, without being too thick to coat or so thin that it runs off too quickly.

Emulsion viscosity is measured by determining the time required for flow of the emulsion out of a cup with a standard opening. The test is called Saybolt Furol. The temperature for this test is determined by the class of emulsion and relates to the temperature of typical use of a given class.

Examination of Emulsion Residue

The percentage and properties of the residue remaining when the water is removed from the emulsion are critical to performance. There must be an adequate amount of binder with the correct physical properties for the emulsion to perform well. The water may be removed by evaporation or by distillation. CDOT determines the percent residue and obtains residue for testing by evaporation. If the emulsion fails any test, this process is repeated using distillation for water removal. The CDOT approach parallels the

AASHTO standards, which allow evaporation for acceptance only.

Penetration is determined for binder residue of all emulsions. Ductility is determined for binder residue of all non-polymerized emulsions. Toughness and tenacity are usually determined for polymerized cationic emulsions. The float test is conducted only on high float emulsions. For polymerized, high-float emulsions, the ductility and elastic recovery are determined.

1. Binder Content

The emulsion must have an adequate amount of residual binder remaining after the water evaporates. This residue does the job, the water is just a carrier, which evaporates or runs off. Normally, minimum binder residue is 57% for slow-setting emulsions and 65% for both rapid-setting and medium-setting emulsions.

2. Penetration

The penetration test is a measure of the consistency of binder. This test measures the depth of penetration of a standard, loaded needle in a fixed time. Stiff binders have a lower penetration because the needle penetrates less.

3. Solubility in Trichloroethylene

Solubility in trichloroethylene is a measure of the purity of the binder. The soluble portion of the binder provides the cementing properties. The insoluble portion is composed of salts, free carbon, or minerals, which do not help in binding. In this test, the binder is dissolved in trichloroethylene and filtering separates the soluble and insoluble portions.

4. Ductility

Ductility is a measure of the ability of a binder to be extended into a fine thread. A standard sized briquette is extended under controlled conditions until the thread breaks. The elongation when the thread breaks is the ductility. Binders with inadequate ductility are too brittle and result in mixtures that are more susceptible to cracking, raveling, or poor bonding.

5. Elastic Recovery

Elastic recovery is a test used by CDOT (CP-L 2211) to measure the elasticity of the

residue for polymerized, anionic emulsions. The Methods A and B prescribe elongating the specimen to specified lengths, and at a specified rate. The sample is then cut either immediately, or after five minutes, and allowed to recover for a one-hour period. Percent of elongation recovered by this contraction is the elastic recovery. Failure of this test indicates the polymer is ineffective.

6. Toughness & Tenacity

The toughness and tenacity test is used by CDOT (CP-L 2210) to measure stretching properties imparted to the residue of cationic emulsion by polymers. A tension head is lowered into a heated sample of the binder and the combination is cooled in a water bath to a standard temperature. The head is then pulled upward until the binder forms a long, thin thread, which finally breaks. The areas under two portions of the stress-strain curve are used to calculate the toughness and tenacity. Failure of this test indicates the polymer is ineffective.

7. Float Test

The float test measures the ability of a binder to resist softening at a high temperature (60°C). In this test, a hole in a small test "boat" is plugged with the binder being tested. The boat is floated on a hot water bath causing the plug of asphalt to soften, allowing entry of water, which sinks the boat. The time in seconds, required for the boat to sink, is the float test result. High float emulsions must have a minimum float time of 1200 seconds (20 minutes).

Classification Nomenclature for Emulsions

The series of letters and numbers used to classify emulsions contain a wealth of information about the properties of the emulsion. These properties determine the appropriate use for each emulsion.

For example, consider the emulsions classified as:

- a - "CSS-1h"**
- b - "HFMS-2sP"**

- **a - C** in this location would indicate a cationic emulsion. All cationic emulsions start with a "C", if there is not a "C", the emulsion is anionic or non-ionic.

- **b - HF** indicates the float properties of the emulsion. All high float emulsions must pass the float test. No letter C in this location would indicate that this is not a cationic emulsion; hence b above is an anionic emulsion.
- **a - SS** indicates a slow setting emulsion. An **RS** in this location would indicate a rapid setting emulsion and a **MS** in this location would indicate a medium setting emulsion, such as b listed above.
- The **1** or **2** following the **SS** and the **MS** in the above examples give an indication of the emulsion viscosity (Saybolt-Furol). **2** indicates a higher viscosity than a **1**.
- **h** indicates the binder residue is hard, as measured by the penetration test on the residue. **s** indicates the binder residue is soft and no letter indicates a penetration range between an **s** and an **h**.
- **P** indicates the binder is polymerized. No **P** at the end indicates a non-polymer modified binder.
- **R** indicates the binder is modified with latex. No **R** at the end indicates a non-latex modified binder.

Emulsion Applications

Tack Coats - Tack coats are used on lower lifts of HMA to provide a bond to the HMA layer above and to avoid slippage. Slippage can cause severe distress for pavements, so an effective tack coat is critical. CDOT specifies CSS-1h and SS-1h for tack coats. Other asphalt emulsions may be used for tack coats. However, it is very important that the tack coat results in sufficient residual binder to provide a good bond. In addition, there should not be an excessive delay between application of the tack coat and paving. During the delay traffic can pick up the binder or track dirt on the binder, which will reduce bonding. Pave as soon as possible after the emulsion has set to prevent contamination (dust, dirt, etc.) or pickup by tires.

Prime Coats - Prime coats are used on aggregate base courses to provide good adhesion to the HMA layer placed above. Property requirements for prime coats are in the Specification Book. (The material to be used for prime coats is specified in the project plans, and historically both cutback and emulsified asphalts have been used. Emulsions are becoming the

most common because of the environmental problems with cutback asphalts.)

Chip Seals - A chip seal (cover coat) consists of a spray bar application of emulsion, topped by chips dropped by a spreader. Light, pneumatic tire rolling seats the chips. The chips are clean, 3/8" aggregate. Single-sized, hard aggregates are desirable for chip seals. A fog seal, applied after the chip seal has completely cured, provides a uniform appearance and better chip retention. CRS-2P and HFRS-2P emulsions are used for chip seals. The rapid set (RS) grabs the chip quickly and the polymer (P) in the binder holds the chip better. It is desirable to use the same emulsion for the fog coat that was used in the chip seal for better compatibility and chip retention.

Cold In-Place Recycling - Cold in-place recycling consists of: 1) roto-milling off the surface of an existing pavement, 2) adding additional binder to the millings, 3) mixing and then spreading the combination on the surface, and finally 4) compacting to an adequate density. HMA is normally placed over the cold in-place recycle layer. Emulsions are used to add the binder since this is a cold process. HFMS-2sP is normally used for cold in-place recycle. The soft binder(s) helps soften the hard oxidized existing pavement and the polymer (P) helps with adhesion and crack resistance.

Specification Requirements for Emulsion Properties

Specifications for properties of emulsions used by CDOT are found in three locations:

1. Standard Specifications

Specifications for some commonly used emulsions are found in tables in Subsection 702.03 of the Specification Book as modified by the Standard Special Provisions. These include: seal coats, prime coats, penetrating priming stabilizers, recycling agents, and rejuvenating agents.

2. AASHTO (American Association of State Highway and Transportation Officials)

AASHTO standards apply for all non-polymer emulsions used by CDOT. These are referenced in the Specification Book, Standard Special Provision, or Project Special Provisions.

Note that some of the references include modifications of the AASHTO standards.

3. Maintenance Bid

Each year, binder suppliers bid for the privilege of supplying binders for CDOT maintenance use (Maintenance Bid). Bids are based on binder property specifications provided by CDOT. Non-polymer emulsions are based on reference to AASHTO. Property specifications for polymer emulsions are defined in detail in the Maintenance Bid. These specifications are now organized into a table. An example of that table follows. Note that this table is revised each year. Specific requirements for a particular year should be determined by obtaining a copy of the Maintenance Bid for that year.

Examples of Emulsion Property Tables

The following pages include examples of emulsion property tables. These are examples only and should not be used to determine specification compliance. Property requirements for non-polymer emulsions should be obtained by reference to the applicable year of AASHTO. Property requirements for emulsions used by CDOT Maintenance should be obtained by reference to the applicable Maintenance Bid.

Colorado DOT Emulsion Requirements*

Property	Cationic						Anionic			AASHTO
	CSS-1	CSS-1h	CMS-2	CMS-2h	CRS-2	SS-1	AEP	SS-1h		
<i>Tests on Emulsion:</i>										
Viscosity Sabolt-Furol, s	Temp, °C									
	min	25	25	50	50	50	50	25	25	T-59
	max	20	20	50	50	100	20	20	20	
Storage stability, 24 hr, % max	100	100	450	450	400	100	150	100	100	
Storage stability, 24 hr, % max	1	1	1	1	1	1		1	1	T-59
Particle Charge	Positive	Positive	Positive	Positive	Positive	Positive				T-59
Sieve test, % max	0.1	0.1	0.1	0.1	0.1	0.1		0.1	0.1	T-59
Residue by distillation, % min	57	57	65	65	65	57	65	57	57	T-59
<i>Tests on residue:</i>										
Penetration, 25°C, 100g, 5s, min	100	40	100	40	100	100		40	40	T-49
Penetration, 25°C, 100g, 5s, max	250	120	250	90	250	200		120	120	
Ductility, 25°C, 5 cm/min, cm, min	40	40	40	40	40	40		40	40	T-51
Solubility, in trichloroethylene% min	97.5	97.5	97.5	97.5	97.5	97.5	97.5	97.5	97.5	T-44
Typical Use	MTCE	Tack Coat	MTCE	MTCE	MTCE	MTCE	Prime	Tack Coat	Tack Coat	

* Partial list of requirements for quick reference only. – See AASHTO M140 and M 208 for complete requirements.

TABLE 400-2

Colorado DOT Emulsion Requirements*

Property		High Float				AASHTO
		HFMS -2	HFMS-2h	HFMS-2s	HFRS-2	
Tests on Emulsion:						
Viscosity Sabolt- Furol, s	Temp, °C	25	25	25	50	T-59
	min	100	100	50	75	
	max				400	
Storage stability, % max		1	1	1	1	T-59
Sieve test, % max		0.10	0.10	0.10	0.10	T-59
Residue by distillation, %		65	65	65	63	T-59
Tests on residue:						
Penetration, 25°C, 100g, 5s, min		100	40	200	100	T-49
Penetration, 25°C, 100g, 5s, max		200	90		200	
Ductility, 25°C, 5 cm/min, cm, min		40	40	40	40	T-50
Solubility, in trichloroethylene% min		97.5	97.5	97.5	97.5	T-44
Float Test, 60°C, s min		1200	1200	1200	1200	T-50
Typical Use		Maintenance	Maintenance	Maintenance	Maintenance	

*Partial list of requirements for quick reference only. – See AASHTO M 140 for complete requirements.

TABLE 400-3

Colorado DOT Specifications for Polymer Modified Emulsions

Polymerized emulsions shall be an emulsified blend of polymerized asphalt, water, and emulsifiers. The asphalt cement shall be polymerized prior to emulsification and shall contain a minimum of three (3.0) percent polymer by weight of asphalt cement. The emulsion standing undisturbed for a minimum of 24 hours shall show no white, milky separation but shall be smooth and homogeneous throughout. The emulsion shall be pumpable and suitable for application through a distributor. The emulsified blend shall conform to the requirements listed in the table of properties below. The "Standard" column of the table lists the American Association of State Highway and Transportation Officials (AASHTO) or Colorado Procedure-Laboratory standard that defines the procedure for the test on that line. For example: T 59 is an AASHTO standard and CP-L 2211 is a Colorado Procedure-Laboratory (CP-L) Standard. CP-L's are found in the Colorado Department of Transportation's (CDOT's) Laboratory Manual of Test Procedures.

Footnotes for Table 400-4

¹ CP-L 2212 is a rapid evaporation test for determining percent residue of an emulsion and providing material for tests on residue. CP-L 2212 is for acceptance only. If the percent residue or any test on the residue fails to meet specifications, the tests will be repeated using the distillation test in accordance with AASHTO T 59 to determine acceptability.

² For high float emulsions the distillation and evaporation tests will in be in accordance with AASHTO T 59 or CP-L 2112 respectively with modifications to include $205^{\circ}\text{C} \pm 5^{\circ}$ ($400^{\circ}\text{F} \pm 10^{\circ}$) maximum temperature to be held for 15 minutes.

³ When CRS-2P or HFRS-2P are used for chip seals, compatibility of the aggregate (chips) and the emulsion may be determined for information in accordance with CP-L 2213. This test is a visual estimate of the coating of the aggregate by the emulsion binder after mixing of the emulsion and aggregate.

Properties for CDOT Polymer Modified Emulsions

Property	CMS-2P	CMS-2hp	CRS-2P ³	CMS-2Sp	HFMS-2P	HFMS-2Hp	HFMS-2P ³	HFMS-2Sp	RS-1P	Standard
<i>Tests on emulsion:</i>										
Viscosity, Sabolt- Furol @ 50 °	min	50	50	50	50	50	50	50	50	T-59
	max	450	450	450	450	450	450	450	300	
Storage stability, 24	1.0	1.0	1.0	1.0	1.0	1.0	1.0	1.0	1.0	T-59
Particle Charge Test	Positive	Positive	Positive	Positive	Positive					T-59
Sieve Test, % Max	0.10	0.10	0.10	0.10	0.10	0.10	0.10	0.10	0.10	T-59
Demulsibility, 0.02 N CaCl ₂ , % min			40				40		60	T-59
Oil Distillate by volume, % max or	3.0	3.0	3.0	12	3.0	3.0	3.0	1.0-7.0	3.0	T-59
Residue by distillation/ evaporation ¹ , % min	65	65	65	65	65 ²	65 ²	65 ²	65 ²	65	T-59 CPL-2212
<i>Tests on residue:</i>										
Penetration, 25°C, 100g, 5s, min	70	60	70	150	70	60	70	150	150	T-49
Penetration, 25°C, 100g, 5s, max	150	100	150	300	150	100	150	300	300	
Ductility, 25°C, 5 cm/min, cm, min					75	75	75		75	T-51
Solubility, in trichloroethylene%	97.5	97.5	97.5	97.5	97.5	97.5	97.5	97.5	97.5	T-44
Elastic Recovery					58	58	58	50	45	CPL-2211
Test Temp °C					25	25	25	4	10	
Min.										
Float Test, 60°C, s min					1200	1200	1200	1200		T-50
Toughness, in-lbs, min	70	70	70	70						CPL-2210
Tenacity, in-lbs, min	45	45	45	45						CPL-2210
Typical Use	MTCE	MTCE	Chipseal ₃	MTCE	MTCE	MTCE	Chipseal ₃	In place Recycle	MTCE	

TABLE 400-4

**CDOT Forms - Applicable for Flexible Pavements, Bituminous, and the Eurolab,
Examples and Instructions**

Form	Title	Page
# 157	Field Report for Sample Identification or Materials Identification	17 - 18
# 6	Field Tests of Base Aggregates, Fillers, Paving and Miscellaneous Aggregates	19
# 43	Job Mix Formula.....	20- 21
# 58	Field Report of Asphalt Content & Maximum Specific Gravity of Hot Mix Asphalt.....	22
# 67	Asphalt Cement Results and Final Quantity.....	23
# 69	Field Report of Hot Mix Asphalt Density.....	24
# 106	Asphalt Tests	25
# 360	Project Produced Hot Mix Asphalt	26
# 411	PG Binder / Emulsion Submittal Form	27 - 30
# 429	Laboratory Design for HMA - Superpave Gyrotory Compactor	31 - 37
# 582	Hot Mix Asphalt Density Test	38
# 634	Sample Label (cans)	39
# 1094	Asphalt Mix Design Graph.....	40
# 1290	Longitudinal Joint Data.....	41
# 1304	HMA Sample Submittal	42 - 43
# 1346	HMA Segregation Data	44 - 45

COLORADO DEPARTMENT OF TRANSPORTATION FIELD REPORT FOR SAMPLE IDENTIFICATION OR MATERIALS DOCUMENTATION				Field sheet No. 120227	Date 4/8/02
Metric units <input type="checkbox"/> yes <input checked="" type="checkbox"/> no				Project No. IM0253-151	Project location I-25, SH 7 to WCR 16
		Project code (SA#) 11925	Function 3200	Region 4	Part. P
Sample submitted: <small>(ie.: Soil, ABC, Hydrated lime, HMA, concrete cores, steel, etc.)</small>				Field office phone number 303-828-0386	
Aggregate for HMA Design Mix				Field office FAX number 303-828-0430	
Item 403	Class	Grading All	Special provisions applicable: <input checked="" type="checkbox"/> yes <input type="checkbox"/> no		
Previously used on Project No.:		Previous CDOT Form #157 F/S No.(s):		<input checked="" type="checkbox"/> CDOT Form #633 (sack) <input type="checkbox"/> CDOT Form #634 (can)	
<ul style="list-style-type: none"> ● Sample Identification: Quantity & Unit of material submitted, describe tests required, precise location sample removed from (stationing), etc. ● Materials Documentation: Field inspected (describe appearance, weight/dimensions, model/serial number), COC &/or CTR provided, etc. 					
Sack	Material Name	Pit Name	Comments		
1	RAP	East Longmont	Aggregate will be used in HMA Design Mix for this		
2	Crusher Fines	Lyons	project, Mix Designs to follow. Please run aggregate		
3	Natural Fines	Platte Valley	specific gravity, absorption and plastic index as per		
4	3/4" Rock	East Longmont	CP 52 mix design submittal specifications. 7 sacks of		
5	Crusher Fines	Morrison	aggregate submitted.		
6	Granite Sand	Morrison			
7	Concrete Sand	Thornton			
APL/QML Acceptance: APL Ref. No.		Product name:		Date checked:	
APL/QML Acceptance: APL Ref. No.		Product name:		Date checked:	
Preliminary <input type="checkbox"/>		Construction <input checked="" type="checkbox"/>		Maintenance <input type="checkbox"/>	
				Emergency <input type="checkbox"/>	
				Date needed Rush	
Contractor Kraemer and Sons			Supplier Aggregate Industries		
Sampled from <small>(Pit, roadway, windrow, stock, etc.)</small> Mini Stockpile			Pit name or owner See Above		
Quantity represented 1st		Previous quantity 0		Total quantity to date 1/source/project	
Sample submitted: <input checked="" type="checkbox"/> Yes <input type="checkbox"/> No		Shipped to: <input checked="" type="checkbox"/> Central lab <input type="checkbox"/> Region lab		Via CDOT	
				Date 4/8/02	
Sampled or inspected by (Name) D. Elsbernd		(Title) Technician		Lab phone number 303-828-2644	
Supervisor <small>(Pro./Res./Matis. Engr./Maint. Supt.)</small> Corey Stewart		Title P.E. I		Address 1050 Lee Hill Rd. Boulder, Co. 80302	
Distribution: White copy - Staff Materials Branch <small>(submit white copy only if sample or information is directed to Staff Materials)</small> Canary copy - Region Materials Engineer Pink copy - Resident Engineer				CDOT Form #157 9/07	
Previous editions may be used until supplies are exhausted					

CDOT Form #157, HMA Mix Design

Notes: Sack Tags (CDOT Form # 633): Sack # from Field Sheet must be listed.
Please send two full sacks of aggregate (three for grading SG).
Fill in all blanks on this form.
CDOT must witness sampling, and Contractor samples the material.

COLORADO DEPARTMENT OF TRANSPORTATION FIELD REPORT FOR SAMPLE IDENTIFICATION OR MATERIALS DOCUMENTATION				Field sheet No. 120227	Date 7/9/03
Metric units <input type="checkbox"/> yes <input checked="" type="checkbox"/> no		Project No. IM0253-151	Project location I-25, SH 7 to WCR 16		
Project code (SA#) 11925	Function 3200	Region 4	Part. P		
Sample submitted: (i.e.: Soil, ABC, Hydrated lime, HMA, concrete cores, steel, etc.) Hydrated Lime				Field office phone number 303-828-0386	
				Field office FAX number 303-828-0430	
Item 307	Class	Grading	Special provisions applicable: <input checked="" type="checkbox"/> yes <input type="checkbox"/> no		
Previously used on Project No.:		Previous CDOT Form #157 F/S No.(s): <input type="checkbox"/> CDOT Form #633 (sack) <input checked="" type="checkbox"/> CDOT Form #634 (can)			
<ul style="list-style-type: none"> ● Sample Identification: Quantity & Unit of material submitted, describe tests required, precise location sample removed from (stationing), etc. ● Materials Documentation: Field inspected (describe appearance, weight/dimensions, model/serial number), COC &/or CTR provided, etc. <p>Submitting one can of Hydrated Lime for Gradation.</p> <p>CTR for chemical testing is retained in the project files and a copy was sent to the Region 4 Materials Engineer for review. This lime if from a pre-approved source.</p> <p style="text-align: center;">mix #142010</p>					
APL/QML Acceptance: APL Ref. No.		Product name:		Date checked:	
APL/QML Acceptance: APL Ref. No.		Product name:		Date checked:	
Preliminary <input type="checkbox"/> Construction <input checked="" type="checkbox"/> Maintenance <input type="checkbox"/> Emergency <input type="checkbox"/>				Date needed ASAP	
Contractor Kraemer and Sons			Supplier Pete Lein		
Sampled from (Pit, roadway, windrow, stock, etc.) Hopper			Pit name or owner Distel Plant		
Quantity represented 1st 10k		Previous quantity 0		Total quantity to date 1st 10k	
Sample submitted: <input checked="" type="checkbox"/> Yes <input type="checkbox"/> No		Shipped to: <input checked="" type="checkbox"/> Central lab <input type="checkbox"/> Region lab		Via Geocal	Date 7/9/03
Sampled or inspected by (Name) D. Elsbernd		(Title) QA Tech		Lab phone number 303-828-2644	
Supervisor (Pro./Res./Mats./Engr./Maint. Supt.) Corey Stewart		Title P.E. I		Address 1050 Lee Hill Rd. Boulder, Co. 80302	
Distribution: White copy - Staff Materials Branch (submit white copy only if sample or information is directed to Staff Materials) Canary copy - Region Materials Engineer Pink copy - Resident Engineer				CDOT Form #157 9/07	
Previous editions may be used until supplies are exhausted					

INSTRUCTIONS FOR CDOT FORM # 43

PURPOSE: To authorize a Job Mix Formula for the HMA specified in the Contract Special Provisions or to make a change during construction from a previously authorized CDOT Form # 43.

AUTHORITY FOR THIS REPORT:

Subsection 401.02 of the Standard Specifications authorizes the Engineer to modify in writing the Job Mix Formula specified in the Contract Special Provisions and, when necessary, to establish a new Job Mix Formula.

METHOD OF PREPARATION:

An approved asphalt mix design obtained in accordance with CP 52 is used to write a Form #43.

If aggregates are submitted to the Central Lab for a mix design check, please follow the steps listed in CP 52.

Upon receipt of an approved asphalt mix design the Region Materials Engineer and the Engineer will prepare a Form #43 and distribute for signatures.

If the Region Materials Engineer and the Engineer make a change in the Form #43 from the mix design, the change shall be discussed with the Central Laboratory and the date of such discussion entered on the Form #43. The Form #43 shall then be completed and the signatures of Region Materials Engineer and the Engineer obtained. Then it shall be delivered to the Contractor's authorized representative whose signature documents that the Contractor received and agrees with the Form #43.

If, after the initial Form #43 has been distributed and the construction of the pavement has begun, there develops a sound reason why the Engineer should establish a new Job Mix Formula, such shall be done by filling out another Form #43. Consultation will be made with all CDOT personnel concerned before making this second change.

The Job Mix Formula shall be made out in its entirety and distributed as a matter of documentation before the Contractor begins the production of HMA.

**COLORADO DEPARTMENT OF TRANSPORTATION
JOB MIX FORMULA N(des)**

Mix Design: 142011
Date: 4/25/2003

Project: IM 0253-151
Location: SH 7 to WCR 16
Region: 04 Project Code (SA#): 11925
From Project No: _____
From Project SA#: _____

This Job Mix Formula defines the specified gradation, asphalt cement content, and admixture dosage for the grading and project shown.

Contractor: Kraemer and Sons
Supplier: Kiewit
Plant: Agg Ind - Distel - Longmont
Pit: Lyons Quarry/Morrison Quarry/Distel
Grading & Compaction: S 75
% RAP: .00 % Lime: 1.00

- Components:
1. 34 3/4" Rock - Lyons Quarry
 2. 25 Crusher Fines - Morrison Quarry
 3. 20 Fines - Distel Pit
 4. 20 Concrete Sand - Distel Pit
 5. 1 Hydrated Lime - Pete Lien
 6. _____
 7. _____
 8. _____

Remarks: Aggregates submitted for CP 52 testing with CDOT Form 157 - FS #142010

Gradation (% Passing)

Specification Voids Acceptance

Seive mm (in)	% Pass Min	% Pass Max
37.5 (1 1/2):		
25.0 (1):	100	100
19.0 (3/4):	90	100
12.5 (1/2):	77	89
9.5 (3/8):	66	78
4.75 - #4:	55	65
2.36 - #8:	44	54
1.18 - #16:		
600 mic - #30:	22	30
300 mic - #50:		
150 mic - #100:		
75 mic - #200:	4.10	8.10

% AC: 5.90 +/- .3
Grade of AC: PG 64-28
Source of AC: KOCH
Max. Sp. Gr. at % AC: 2.441 +/- .01
Bulk Sp. Gr. of Combined Agg: 2.623
Bulk Sp. Gr. of Fine Agg: 2.632
Angularity (T 304): 45.0
% Agg Absorp (SSD): 0.8

Property	Voids Data at		Tolerance
	Nds	Target Value	
Stability	26		Minimum
% Voids	3.00	+/-	1.2
% VMA	min 13.8	max	16.2
% VFA	min 65	max	80

Distribution:
Staff Materials
Region Materials Engineer
Resident Engineer (2)
Contractor
CDOT Form #43 Revised 4/21/98

New Mix design with no change
 Staff Materials was called and concurs with change or reapproval

Called SCHIEBELB Date 4/19/2004
Staff Materials Representative

Signed _____ Date _____
Project Engineer: STEWARTC

Signed _____ Date _____
Regional Materials Engineer: DEWITTG

Signed _____ Date _____
Contractors Representative:

Asphalt Cement Results and Final Quantity - PG 64-28

Colorado Department of Transportation
Bituminous Unit 303-398-6529
4670 Holly St. Unit A
Denver, Co. 80216-6408

Test Methods: AASHTO-ASTM

Subaccount: 11925PG64-28A
Project: IM 0253-151
Location: I-25, SH-7 TO WCR-16
Region: 4
Grade: PG64-28
Refinery: KOCH DENVER

FS#	Lot#	# of Cans	# of Samp	Date Samp	Spec Grav	Brook Visc	DSR		Duct	Tough	Tenac	LOH	RTFO		RTFO Duct	BBR		Dir Tens
							Min	Max					Min	Max		Min	Max	
31177	1	5	2	5/27/2003			1.40	1.40	50	1100/p	222.0	1.00	2.54	20.0	118	0.300	1.0	

Total number of samples on this project: 5

Total number of assurance samples on this project: 0

Total tons of Mix / Binder covered: 5000

Final pay quantity: _____ tons of Mix / Binder

Approved by: _____

Distribution: Region Materials Engineer
Region Documentation Unit
Project File

COLORADO DEPARTMENT OF TRANSPORTATION ASPHALT TESTS		Gradation test #: 1																																																																						
		Asphalt content test #: 03																																																																						
Project no.: IM 0253-151	Project code (SA#): 11925	Location: I-25, SH 7 to WCR 16																																																																						
AC gauge #: 8163	Calibration #: 103341	Calibration temp.: 250 F																																																																						
Supplier: Kiewit	Item: 403	Grading: S(100)																																																																						
Date: 9/14/03	Time: 10:53 am	Field temp.: 260 F																																																																						
Background cnt.: 2085	Scale ticket #: 60831	IAT#: 1 Rep: 3rd 10k: 1st																																																																						
Job Mix % AC: 5.50 Meas. count: 3075 Gauge % AC: 5.71 % Moisture: 0.12 Corr. % AC: 5.59	Sample moisture correction Tare: 852.3 Wet wt.: 580.2 Dry wt.: 579.5 Loss: 0.7 % Moisture: 0.12	Sieve analysis $\left[\frac{2027.2}{100 + 2.4} \right] \times 100 = 1979.7$ Dry wt. (before wash) <table border="1" style="width:100%; border-collapse: collapse;"> <thead> <tr> <th>Sieve</th> <th>Weight</th> <th>% Ret.</th> <th>% Pass</th> <th>Specs</th> </tr> </thead> <tbody> <tr><td>1</td><td></td><td></td><td></td><td></td></tr> <tr><td>3/4</td><td style="text-align: center;">0</td><td></td><td></td><td style="text-align: center;">100</td></tr> <tr><td>1/2</td><td style="text-align: center;">114.6</td><td style="text-align: center;">5.8</td><td style="text-align: center;">94</td><td style="text-align: center;">90 - 100</td></tr> <tr><td>3/8</td><td style="text-align: center;">410.6</td><td style="text-align: center;">20.7</td><td style="text-align: center;">79</td><td style="text-align: center;">71 - 83</td></tr> <tr><td>#4</td><td style="text-align: center;">997.5</td><td style="text-align: center;">50.4</td><td style="text-align: center;">50</td><td style="text-align: center;">42 - 52</td></tr> <tr><td>#8</td><td style="text-align: center;">1295.3</td><td style="text-align: center;">65.4</td><td style="text-align: center;">35</td><td style="text-align: center;">27 - 37</td></tr> <tr><td>#16</td><td style="text-align: center;">1477.3</td><td style="text-align: center;">74.6</td><td style="text-align: center;">25</td><td></td></tr> <tr><td>#30</td><td style="text-align: center;">1625.1</td><td style="text-align: center;">82.1</td><td style="text-align: center;">18</td><td style="text-align: center;">13 - 21</td></tr> <tr><td>#50</td><td style="text-align: center;">1748.1</td><td style="text-align: center;">88.3</td><td style="text-align: center;">12</td><td></td></tr> <tr><td>#100</td><td style="text-align: center;">1826.9</td><td style="text-align: center;">92.3</td><td style="text-align: center;">8</td><td></td></tr> <tr><td>#200</td><td style="text-align: center;">1867.9</td><td style="text-align: center;">94.4</td><td style="text-align: center;">5.6</td><td style="text-align: center;">3 - 7</td></tr> <tr><td>-#200</td><td style="text-align: center;">1954.1</td><td></td><td></td><td></td></tr> <tr><td></td><td style="text-align: center;">1954.1</td><td colspan="3" style="text-align: right;">Total sieve wt. (TSW)</td></tr> </tbody> </table>	Sieve	Weight	% Ret.	% Pass	Specs	1					3/4	0			100	1/2	114.6	5.8	94	90 - 100	3/8	410.6	20.7	79	71 - 83	#4	997.5	50.4	50	42 - 52	#8	1295.3	65.4	35	27 - 37	#16	1477.3	74.6	25		#30	1625.1	82.1	18	13 - 21	#50	1748.1	88.3	12		#100	1826.9	92.3	8		#200	1867.9	94.4	5.6	3 - 7	-#200	1954.1					1954.1	Total sieve wt. (TSW)		
Sieve	Weight	% Ret.	% Pass	Specs																																																																				
1																																																																								
3/4	0			100																																																																				
1/2	114.6	5.8	94	90 - 100																																																																				
3/8	410.6	20.7	79	71 - 83																																																																				
#4	997.5	50.4	50	42 - 52																																																																				
#8	1295.3	65.4	35	27 - 37																																																																				
#16	1477.3	74.6	25																																																																					
#30	1625.1	82.1	18	13 - 21																																																																				
#50	1748.1	88.3	12																																																																					
#100	1826.9	92.3	8																																																																					
#200	1867.9	94.4	5.6	3 - 7																																																																				
-#200	1954.1																																																																							
	1954.1	Total sieve wt. (TSW)																																																																						
Dry aggregate count: 1993																																																																								
Form #43 Max. specific gravity: 2.478																																																																								
	Flask #1 Flask #2																																																																							
A) Sample weight	1044.4 1070.1																																																																							
B) Flask + water + lid	3275.7 3305.6																																																																							
C) Sample + flask + water + lid	3898.3 3943.5																																																																							
RICE (Max SpG)	2.476 2.476																																																																							
RICE average 2.476	[A/(A + B - C) = Max SpG]																																																																							
Fractured Faces (FF)	Moisture correction for Aggregates																																																																							
A) Total wt. 997.5	Tare: 632.4																																																																							
B) Fract. agg. 979.8	Wet wt.: 1873.1																																																																							
(B/A) x 100 = 98 %FF	Dry wt.: 1828.7																																																																							
	Loss: 44.4																																																																							
	% Moisture: 2.476																																																																							
Form #43 % Aggregate absorption: 2.30																																																																								
Sampled by: D. Elsbernd																																																																								
Company: Geocal																																																																								
Tested by: Fidel Gonzales																																																																								
Title: E/PS Tech III																																																																								
Company: CDOT																																																																								
		Dry weight (after wash): 1954.8 % difference = (Dry wt. - TSW) / Dry wt. x 100 = 0.04 %																																																																						
		Remarks:																																																																						

CDOT Form #106 4/04

Colorado Department of Transportation
PROJECT PRODUCED HOT MIX ASPHALT

Sample No: 1
Field Sheet No: 144734
Date Received: 5/27/2003 07:45:00
Sample Desc: 1st Rep, FS #144734
Remarks: Final Report

Project No: IM0253-151
Location: SH 7 TO WCR 16
SubAcct. No: 11925
Mix Design: New
Region: 04
Tested By: R4 Lab

SuperPave Item 403

Form 43 Date: 4/25/2003
Form 43 No: 142011
Grading: S
N(des): 75

Refinery: KOCH
Binder: PG 64-28
Contractor: Kraemer and Sons
Pit: Lyons Quarry/Morrison Quarry/L

Voids Properties

Excluded Specimen No: 0

	Specimen:	Status	Specifications
% AC:	5.97	Pass	5.90 +/- 0.3
Max Sp. Gr.:	2.429	Inside Band	2.441 +/- 0.01

	Specimen 1:	Specimen 2:	Specimen 3:	Average	Status	Specifications
Bulk SG:	2.370	2.380	2.377	2.376		
Ht. N (Design):	62.3	62.2	62.2	62.2		
Voids @ N(des):	2.4	2.0	2.2	2.2	Pass	3.00 +/- 1.2
VMA @ N(des):	15.0	14.7	14.8	14.8	Pass	13.8 - 16.2
VFA @ N(des):	83.8	86.3	85.4	85.2	Fail	65 - 80

Gradation Results

Sieve mm (in)	Job Mix		Test Results	
	% Pass Min	% Pass Max	Status	% Pass
37.5 (1 1/2)			N/A	100
25.0 (1)	100.00	100.00	Pass	100
19.0 (3/4)	90.00	100.00	Pass	98
12.5 (1/2)	77.00	89.00	Pass	80
9.5 (3/8)	66.00	78.00	Pass	72
4.75 - #4	55.00	65.00	Pass	60
2.36 - #8	44.00	54.00	Pass	49
1.18 - #16			N/A	37
600 mic. - #30	22.00	30.00	Pass	25
300 mic. - #50			N/A	15
150 mic. - #100			N/A	10
75 mic. - #200	4.10	8.10	Pass	7.1

Aggregate Properties

N(des): 75		Gradation By: SB/LI	
	Test Result	Status	Job Mix
Angularity T 304:	45.1	Pass	45.0
Bulk SG of Aggregate:	2.623		
Bulk SG of Fine Aggregate:	2.632		

Stability Results

Excluded Specimen No: 0
Stability Compacted By: DT
Stabilometer Run By: SB

	Status
Specimen 1:	38
Specimen 2:	40
Specimen 3:	40
Average:	39
	Pass

Lottman Results

Lottman Compacted By: IRETONL
Lottman Loads By: SB

	Average	Status	Job Mix
Wet Avg. T.S.:	61.0		
Dry Avg. T.S.:	58.3	Pass	30
% Voids:	6.8		
% Saturation:	95		
T.S. Retained:	105	Pass	70

Instructions for CDOT Form # 411

INSTRUCTIONS:

Project number - Enter the project code number assigned to the project.

Date submitted D, M, Y - Date the samples are submitted.

Material - Grade of the material such as 58-28 or HFMS-2P.

Refinery name and location - See list below for abbreviations.

COBITCO Inc. Emulsions	Denver, CO	COBIT	Sinclair Wyoming Refining Company	Sinclair, WY	SINCS
Ergon Asphalt & Emulsions, Inc.	EI Dorado, KS	ERGON	Suncor Energy [commodity]	Commerce City, CO	SUNCCO
Frontier Refining Inc.	Cheyenne, WY	FRONT	Suncor Energy [polymer]	Commerce City, CO	SUNCCP
Holly Asphalt Company	Albuquerque, NM	HOLLY	Suncor Energy [emulsion]	Commerce City, CO	SUNCCO
Jebro Inc.	Souix City, IA	JEBRO	Suncor Energy	Fruita, CO	SUNF
Mountain States Materials	Cheyenne, WY	MSM	Suncor Energy	Grand Junction, CO	SUNGJ
NuStar LP	Pena Blanca, NM	NUSTAR	Suncor Energy	Pueblo, CO	SUNP
Paramount Asphalt Company LLC.	Fermeil, NV	PARA	Valero Energy Corporation	Santa Fe, NM	VALNM
Peak Asphalt LLC.	Rawlins, WY	PEAK	Valero Energy Corporation	Sunray, TX	VALTX
Sinclair Wyoming Refining Company	Casper, WY	SINCC	Western Refining	EI Paso, TX	WESTTX

Field lot no. - The number of the lot represented. See the *Field Materials Manual*, Ch 400 and Appendix.

Sample no. - These numbers will run consecutively throughout the project. Assurance samples will be numbered consecutively by the Region Materials personnel.
Note which field sample correlates to the assurance sample.

Tons or gallons - 1000 tons per sample for PG binders; 5000 gallons minimum per sample or amount shown on contractor's bill of lading for emulsions.

Tank - For emulsions, enter tank number, if available.

Date sampled or batch no. - Date the PG sample is taken; date the refinery made the sample of emulsion, or date sample is taken.

Fill in field tester's name, Resident Engineer's or consultant's name, address and phone numbers.

Note 1: Assurance samples - Please note on the field sheet and can label which Field Sample is also the Assurance Sample. Assurance samples must be signed on fieldsheets.

Note 2: All sample containers must be properly labeled (CDOT Form #634) or identified by permanent ink marker with the following:
(See shaded areas of CDOT Form #411)

- ▲ Project code #
- ▲ Field sheet #
- ▲ Can #
- ▲ Date sampled
- ▲ Material type
- ▲ Lot #

**COLORADO DEPARTMENT OF TRANSPORTATION
PG BINDER/EMULSION SUBMITTAL**

Project number IM-0253-151	Location I-25, SH 7 to WCR 16	Region 4
Field sheet 119002		

Project Code (SA#)	Date submitted		Refinery name & location	Field lot no.
	D	M		
11925	4	6	10	2
			SS	
			64-22	

Sample no.	Tons or gallons	Tank (Emuls)	Date submitted or Batch no.		Material	Refinery name & location	Field lot no.	Submitted by:
			D	M				
1	1000		13	3	10	6000		Fidel Gonzales
2	1000		13	3	10	3000		Corey Stewart
3	1000		13	3	10			
4						4500		
5								
6								
7								

Previous sheet:

This sheet:

Total:

Final (please check when final)
Special provisions applicable:
 yes no
If yes, attach a copy to this submittal.

Submitted by:	Fidel Gonzales
CDOT Resident Engineer/Consultant:	Corey Stewart
Address:	1050 Lee Hill Rd. Boulder, Co. 80302
Phone:	303-817-2631
FAX #:	970-330-2097

Remarks

**COLORADO DEPARTMENT OF TRANSPORTATION
PG BINDER/EMULSION SUBMITTAL**

Project number IM-0253-151	Location I-25, SH 7 to WCR 16	Region 4
Field sheet 119002		

Project Code (SA#) 11925	Date submitted	Material 64-22	Refinery name & location SS	Field lot no. 2
	D M Y 4 6 10			

Sample no.	Tons or gallons	Tank (Emuls)	Date submitted or Batch no.		Previous sheet:	Submitted by:
			D	M		
1	7		13	3	10	Fidel Gonzales CDOT Resident Engineer/Consultant: Corey Stewart Address: 1050 Lee Hill Rd. Boulder, Co. 80302 Phone: 303-817-2631 FAX #: 970-330-2097
2	•8		13	3	10	
3	9		13	3	10	
4						
5						
6						
7						
Total:					9000	

Remarks

* Sample #8 Correlates To IAT #1

Final (please check when final)
 Special provisions applicable:
 yes no
 If yes, attach a copy to this submittal.

**COLORADO DEPARTMENT OF TRANSPORTATION
PG BINDER/EMULSION SUBMITTAL**

Field sheet **119002**

Project number IM-0253-151	Location I-25, SH 7 to WCR 16	Region 4
--------------------------------------	---	--------------------

Project Code (SA#) 11925	Date submitted	Material 64-22	Refinery name & location SS	Field lot no.
	D M Y 4 6 10			

Sample no.	Tons or gallons	Tank (Emuls)	Date submitted or Batch no.			Previous sheet:	Submitted by:
			D	M	Y		
1	1000		13	3	10	<input type="checkbox"/> T or <input type="checkbox"/> G	Mike Ellis CDOT Resident Engineer/Consultant: Corey Stewart
2						<input type="checkbox"/> T or <input type="checkbox"/> G	Address: 3971 Service Rd. Evans, Co 80620
3						<input type="checkbox"/> T or <input type="checkbox"/> G	
4						<input type="checkbox"/> T or <input type="checkbox"/> G	
5						<input type="checkbox"/> T or <input type="checkbox"/> G	
6						<input type="checkbox"/> Final (please check when final) Special provisions applicable: <input type="checkbox"/> yes <input type="checkbox"/> no If yes, attach a copy to this submittal.	
7						Total: <input type="checkbox"/> T or <input type="checkbox"/> G Phone: 303-817-2631 FAX #: 970-330-2097	

Remarks : IAT # 1 correlates to field sample # 8 on field sheet # 119009

ASSURANCE TEST
By *[Signature]*
REGION 6 MATERIALS LAB

Directions for CDOT Form # 429

Form # 429 was written in Excel 97 and consists of six pages of information that is pertinent to asphalt mix designs. Shaded areas will require input. Other areas contain standard information or information that will be calculated from the data that is input.

Worksheets

The first page deals with aggregate information. Choose the worksheet tab that best fits the asphalt mix design being reported. Tabs vary by Superpave grade, nominal maximum size, and the use of Reclaimed Asphalt Product (RAP). These tabs will be seen at the bottom of the spreadsheet when Form # 429 is opened in Excel.

The second page will carry over the Lab name from the first page. The Maximum Specific Gravity will be automatically calculated at different asphalt contents if the maximum specific gravity at the optimum asphalt content is supplied. Much of the information on this page will be calculated by the worksheet. Again, shaded areas must be input.

Check the specifications for accuracy. Some of the specifications are dependent on the traffic ESALs and will vary within a Superpave gradation.

Graphs

The graphs will be created automatically from the input information. Some colors print better than other colors. Feel free to change the lines on the graphs to colors that are easily viewed by the users. This is easily done by right clicking on the series of data to be changed. Be sure the changes are acceptable to the Region Materials Engineer receiving this Form # 429.

Miscellaneous

Unshaded fields are protected without a password. To unprotect go to Tools and Unprotect document.

If asphalt mix information is already being calculated with an Excel spreadsheet, this Form #429 spreadsheet can be linked to other Excel spreadsheets so that information is automatically entered.

Your lab name goes here.		Lab No. 21		
Laboratory Design for Hot Mix Asphalt - Superpave Compactor				
Sample Identification:		CDOT Form 429 3/05		
Field Sheet No. 96032	Date Received 2/23/2003	Region 4		
Subaccount No. 11653	Project C 0761-168	Hudson East		
Item 403: Contractor/Supplier	Grading AC source & Grade	Gyr. (N _{design}) 100		
Pit Name	SMA	Koch Denver PG75-28		
Aggregate Sampled by (CP-30)				
Type of Aggregate	Rock	Fines	Con Sand	
Aggregate Source	Agg. Ind. Morrison	Clark Pit	Clark Pit	
			Lime	
			Pete Lein	
Percent in Mix	28	53	18	1
Passing 1 1/2 (37.5)	100	100	100	100
Passing 1 (25.0)	100	100	100	100
Passing 3/4 (19.0)	100	100	100	100
Passing 1/2 (12.5)	100	99	100	100
Passing 3/8 (9.5)	85	100	98	100
Passing 4 (4.75)	10	70	70	100
Passing 8 (2.36)	5	50	64	100
Passing 16 (1.18)	4	43	40	100
Passing 30 (0.60)	3	30	20	100
Passing 50 (0.30)	3	19	8	100
Passing 100 (0.15)	2	13	5	100
Passing 200 (0.075)	1.7	9.0	4.4	98.8
Plastic or Non-Plastic (T 90)	NP	NP	NP	
Aggregate Bulk SpG (T 84 & T 85)	2.610	2.560	2.552	2.380
Aggregate App. SpG (T 84 & T 85))	2.660	2.600	2.588	2.380
Agg Water Abs (%) (T 84 & T 85)	0.7%	0.9%	1.0%	
Aggregate Eff. SpG (T 84 & T 85)				
Fine Agg. Bulk SpG. (T 84)				
Coarse Agg. Bulk SpG. (T 85)				
Binder SpG.				
Fractured Faces (CP 45)				
Sod. Sulf. Sound. Loss (T 104)				
LA Abrasion (T 96)				
Plasticity of Mineral Filler (T 90)				
				100 min
				12 max
				30 max
				4% max

<p>Your lab name goes here. Laboratory Design for Hot Mix Asphalt - Superpave Compactor</p>	<p>Lab No. 21 CDOT Form 429 3/05</p>																																																																																				
<p>Mix Design A.C. Content Determination Results:</p> <table style="width: 100%; border-collapse: collapse;"> <tr> <td style="width: 30%;">Rice =</td> <td style="width: 10%; text-align: center;">2.431</td> <td style="width: 10%; text-align: center;">@</td> <td style="width: 10%; text-align: center;">5.60</td> <td style="width: 10%; text-align: center;">%AC</td> <td style="width: 30%;"></td> </tr> <tr> <td>A.C. Content (percent)</td> <td style="text-align: center;">4.50</td> <td></td> <td style="text-align: center;">5.00</td> <td style="text-align: center;">5.50</td> <td style="text-align: center;">6.00 %</td> </tr> <tr> <td>Rice Data (CP-51)</td> <td style="text-align: center;">2.470</td> <td></td> <td style="text-align: center;">2.452</td> <td style="text-align: center;">2.435</td> <td style="text-align: center;">2.417</td> </tr> </table> <p>Specimen SpG. Data (CP-L 5115 & CP-L 5106):</p> <table style="width: 100%; border-collapse: collapse;"> <tr> <td style="width: 30%;">Bulks at Nites</td> <td style="width: 10%; text-align: center;">2.070</td> <td style="width: 10%; text-align: center;">2.113</td> <td style="width: 10%; text-align: center;">2.120</td> <td style="width: 10%; text-align: center;">2.121</td> <td style="width: 30%;"></td> </tr> <tr> <td>Bulks at Nides</td> <td style="text-align: center;">2.273</td> <td style="text-align: center;">2.322</td> <td style="text-align: center;">2.330</td> <td style="text-align: center;">2.348</td> <td></td> </tr> <tr> <td>Height at Nides</td> <td style="text-align: center;">66.1</td> <td style="text-align: center;">64.8</td> <td style="text-align: center;">64.6</td> <td style="text-align: center;">64.4</td> <td></td> </tr> </table> <p>Voids Data:</p> <table style="width: 100%; border-collapse: collapse;"> <tr> <td style="width: 30%;">Voids at Ndes</td> <td style="width: 10%; text-align: center;">8.0</td> <td style="width: 10%; text-align: center;">5.3</td> <td style="width: 10%; text-align: center;">4.3</td> <td style="width: 10%; text-align: center;">2.9 %</td> <td style="width: 30%;"></td> </tr> <tr> <td>Voids at Ninit</td> <td style="text-align: center;">16.2</td> <td style="text-align: center;">13.8</td> <td style="text-align: center;">12.9</td> <td style="text-align: center;">12.2 %</td> <td></td> </tr> </table> <p>Other Data:</p> <table style="width: 100%; border-collapse: collapse;"> <tr> <td style="width: 30%;">VMA at Ndes (CP 48)</td> <td style="width: 10%; text-align: center;">16.5</td> <td style="width: 10%; text-align: center;">15.2</td> <td style="width: 10%; text-align: center;">15.3</td> <td style="width: 10%; text-align: center;">15.1 %</td> <td style="width: 30%;"></td> </tr> <tr> <td>VFA at Ndes (percent)</td> <td style="text-align: center;">52</td> <td style="text-align: center;">65</td> <td style="text-align: center;">72</td> <td style="text-align: center;">81 %</td> <td></td> </tr> <tr> <td>Aggregate Eff. SpG(T 84 & T 85)</td> <td style="text-align: center;">2.644</td> <td style="text-align: center;">2.644</td> <td style="text-align: center;">2.644</td> <td style="text-align: center;">2.644</td> <td></td> </tr> <tr> <td>Effective Asphalt Content</td> <td style="text-align: center;">3.87</td> <td style="text-align: center;">4.37</td> <td style="text-align: center;">4.87</td> <td style="text-align: center;">5.38</td> <td></td> </tr> <tr> <td>Dust to A.C. Ratio (CP 50)</td> <td style="text-align: center;">1.56</td> <td style="text-align: center;">1.38</td> <td style="text-align: center;">1.24</td> <td style="text-align: center;">1.12</td> <td></td> </tr> <tr> <td>Stability (CP-L 5106)</td> <td style="text-align: center;">38</td> <td style="text-align: center;">36</td> <td style="text-align: center;">33</td> <td style="text-align: center;">31</td> <td></td> </tr> </table> <p>Voids Specs: 3.0 - 4.0% For Info</p> <p>Specs: > 17.0%</p> <p>0.6 - 1.2 Fine, 0.8-1.6 Coarse</p>		Rice =	2.431	@	5.60	%AC		A.C. Content (percent)	4.50		5.00	5.50	6.00 %	Rice Data (CP-51)	2.470		2.452	2.435	2.417	Bulks at Nites	2.070	2.113	2.120	2.121		Bulks at Nides	2.273	2.322	2.330	2.348		Height at Nides	66.1	64.8	64.6	64.4		Voids at Ndes	8.0	5.3	4.3	2.9 %		Voids at Ninit	16.2	13.8	12.9	12.2 %		VMA at Ndes (CP 48)	16.5	15.2	15.3	15.1 %		VFA at Ndes (percent)	52	65	72	81 %		Aggregate Eff. SpG(T 84 & T 85)	2.644	2.644	2.644	2.644		Effective Asphalt Content	3.87	4.37	4.87	5.38		Dust to A.C. Ratio (CP 50)	1.56	1.38	1.24	1.12		Stability (CP-L 5106)	38	36	33	31	
Rice =	2.431	@	5.60	%AC																																																																																	
A.C. Content (percent)	4.50		5.00	5.50	6.00 %																																																																																
Rice Data (CP-51)	2.470		2.452	2.435	2.417																																																																																
Bulks at Nites	2.070	2.113	2.120	2.121																																																																																	
Bulks at Nides	2.273	2.322	2.330	2.348																																																																																	
Height at Nides	66.1	64.8	64.6	64.4																																																																																	
Voids at Ndes	8.0	5.3	4.3	2.9 %																																																																																	
Voids at Ninit	16.2	13.8	12.9	12.2 %																																																																																	
VMA at Ndes (CP 48)	16.5	15.2	15.3	15.1 %																																																																																	
VFA at Ndes (percent)	52	65	72	81 %																																																																																	
Aggregate Eff. SpG(T 84 & T 85)	2.644	2.644	2.644	2.644																																																																																	
Effective Asphalt Content	3.87	4.37	4.87	5.38																																																																																	
Dust to A.C. Ratio (CP 50)	1.56	1.38	1.24	1.12																																																																																	
Stability (CP-L 5106)	38	36	33	31																																																																																	
<p>Optimum A.C. Content Results</p> <table style="width: 100%; border-collapse: collapse;"> <tr> <td style="width: 30%;">Optimum A.C. Content (percent)</td> <td style="width: 10%; text-align: center;">5.60</td> <td style="width: 10%;"></td> <td style="width: 10%;"></td> <td style="width: 10%;"></td> <td style="width: 30%;">Voids at Optimum A.C. (percent)</td> <td style="text-align: center;">4.0</td> </tr> <tr> <td>Rice at Optimum A.C.</td> <td style="text-align: center;">2.431</td> <td></td> <td></td> <td></td> <td>VMA at Optimum A.C. (percent)</td> <td style="text-align: center;">15.5</td> </tr> </table>		Optimum A.C. Content (percent)	5.60				Voids at Optimum A.C. (percent)	4.0	Rice at Optimum A.C.	2.431				VMA at Optimum A.C. (percent)	15.5																																																																						
Optimum A.C. Content (percent)	5.60				Voids at Optimum A.C. (percent)	4.0																																																																															
Rice at Optimum A.C.	2.431				VMA at Optimum A.C. (percent)	15.5																																																																															
<p>Lottman Moisture Sensitivity Results (CP-L 5109, Method B)</p> <table style="width: 100%; border-collapse: collapse;"> <tr> <td style="width: 30%;">Asphalt Content (percent)</td> <td style="width: 10%; text-align: center;">5.60</td> <td style="width: 10%;"></td> <td style="width: 10%;"></td> <td style="width: 10%;"></td> <td style="width: 30%;"></td> </tr> <tr> <td>Tensile Strength Ratio</td> <td style="text-align: center;">78 %</td> <td></td> <td></td> <td></td> <td style="text-align: center;">> 70</td> </tr> <tr> <td>Avg. Dry Tensile Strength (psi)</td> <td style="text-align: center;">54</td> <td></td> <td></td> <td></td> <td style="text-align: center;">(372KPa)</td> </tr> <tr> <td>Avg. Cond. Tensile Strength (psi)</td> <td style="text-align: center;">42</td> <td></td> <td></td> <td></td> <td style="text-align: center;">(291KPa)</td> </tr> <tr> <td>Avg. Specimen Voids (percent)</td> <td style="text-align: center;">7.2</td> <td></td> <td></td> <td></td> <td style="text-align: center;">6.0 - 8.0%</td> </tr> <tr> <td>Avg. Saturation (percent)</td> <td style="text-align: center;">74</td> <td></td> <td></td> <td></td> <td></td> </tr> </table> <p>Lottman Specs:</p>		Asphalt Content (percent)	5.60					Tensile Strength Ratio	78 %				> 70	Avg. Dry Tensile Strength (psi)	54				(372KPa)	Avg. Cond. Tensile Strength (psi)	42				(291KPa)	Avg. Specimen Voids (percent)	7.2				6.0 - 8.0%	Avg. Saturation (percent)	74																																																				
Asphalt Content (percent)	5.60																																																																																				
Tensile Strength Ratio	78 %				> 70																																																																																
Avg. Dry Tensile Strength (psi)	54				(372KPa)																																																																																
Avg. Cond. Tensile Strength (psi)	42				(291KPa)																																																																																
Avg. Specimen Voids (percent)	7.2				6.0 - 8.0%																																																																																
Avg. Saturation (percent)	74																																																																																				
<p>Bill Schiebel Asphalt Pavement Engineer</p>		<p>Distribution: RME HQ</p>	<p>Report Date: 5/10/2003</p>																																																																																		

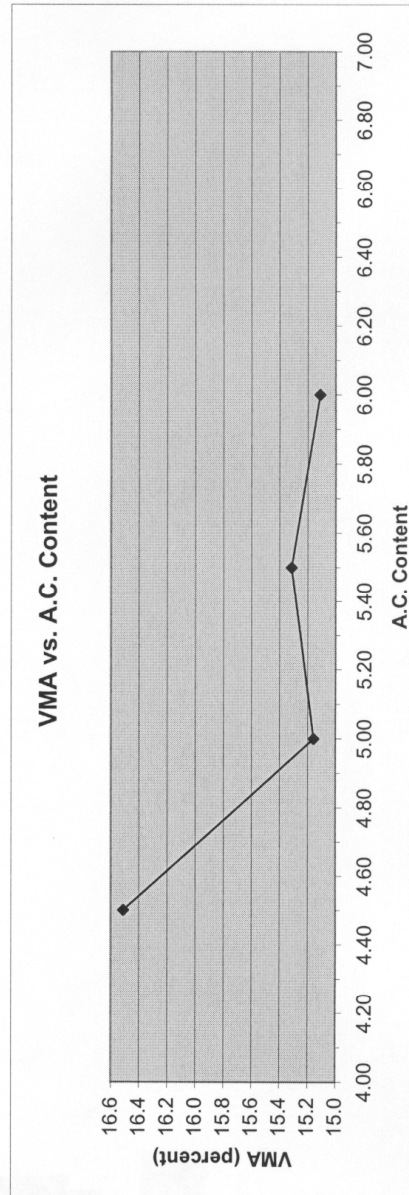
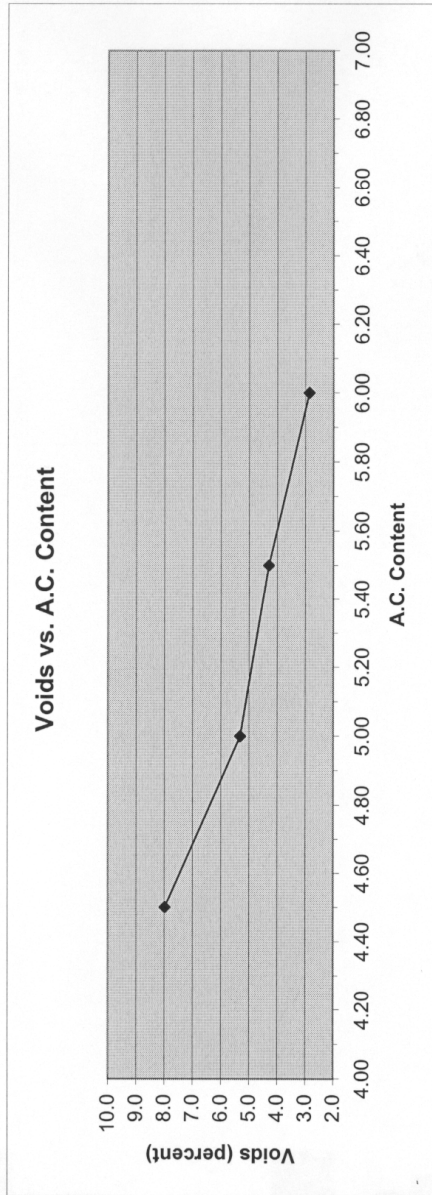

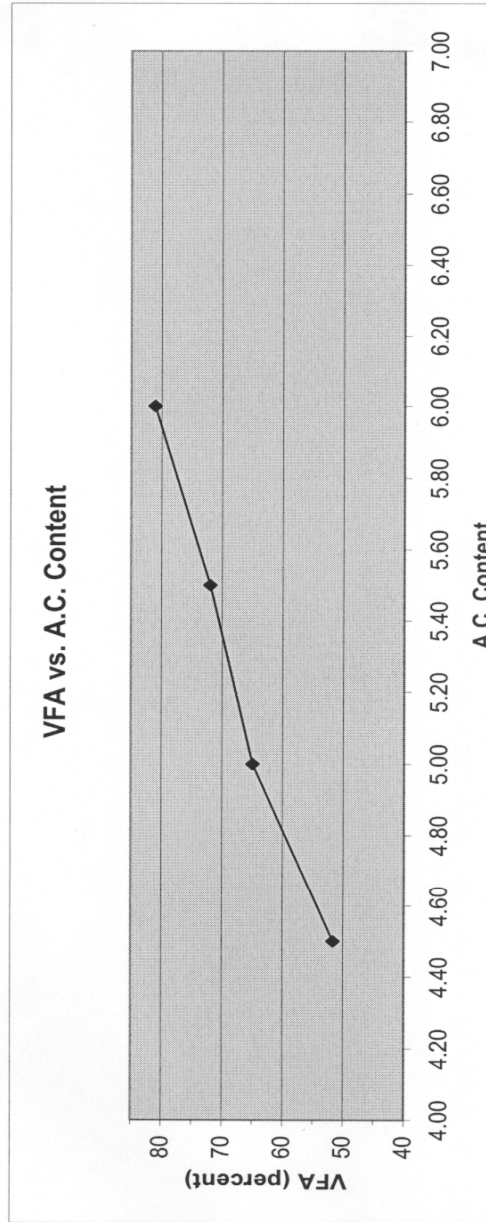
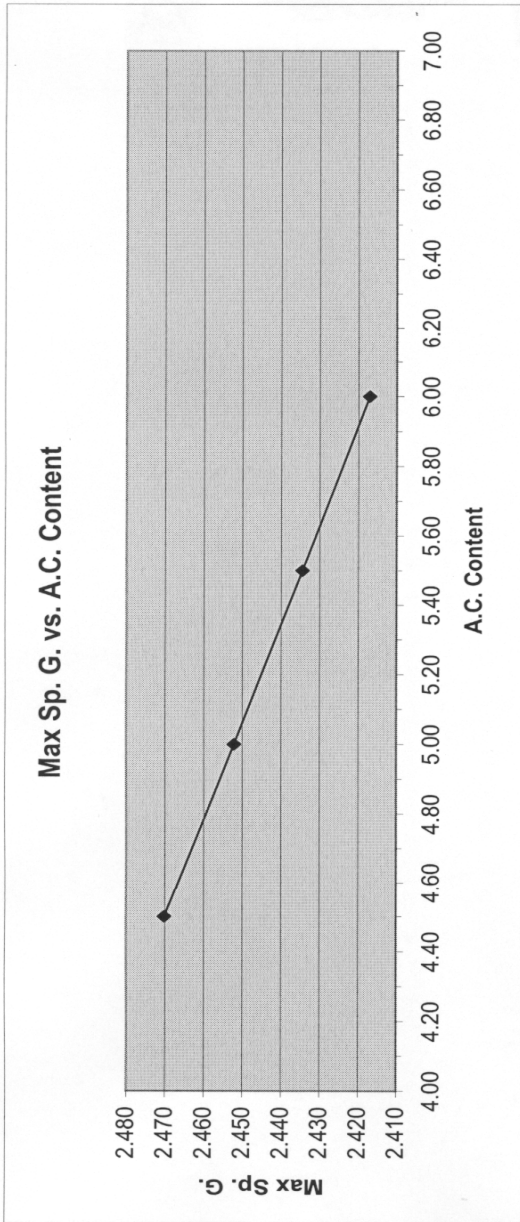

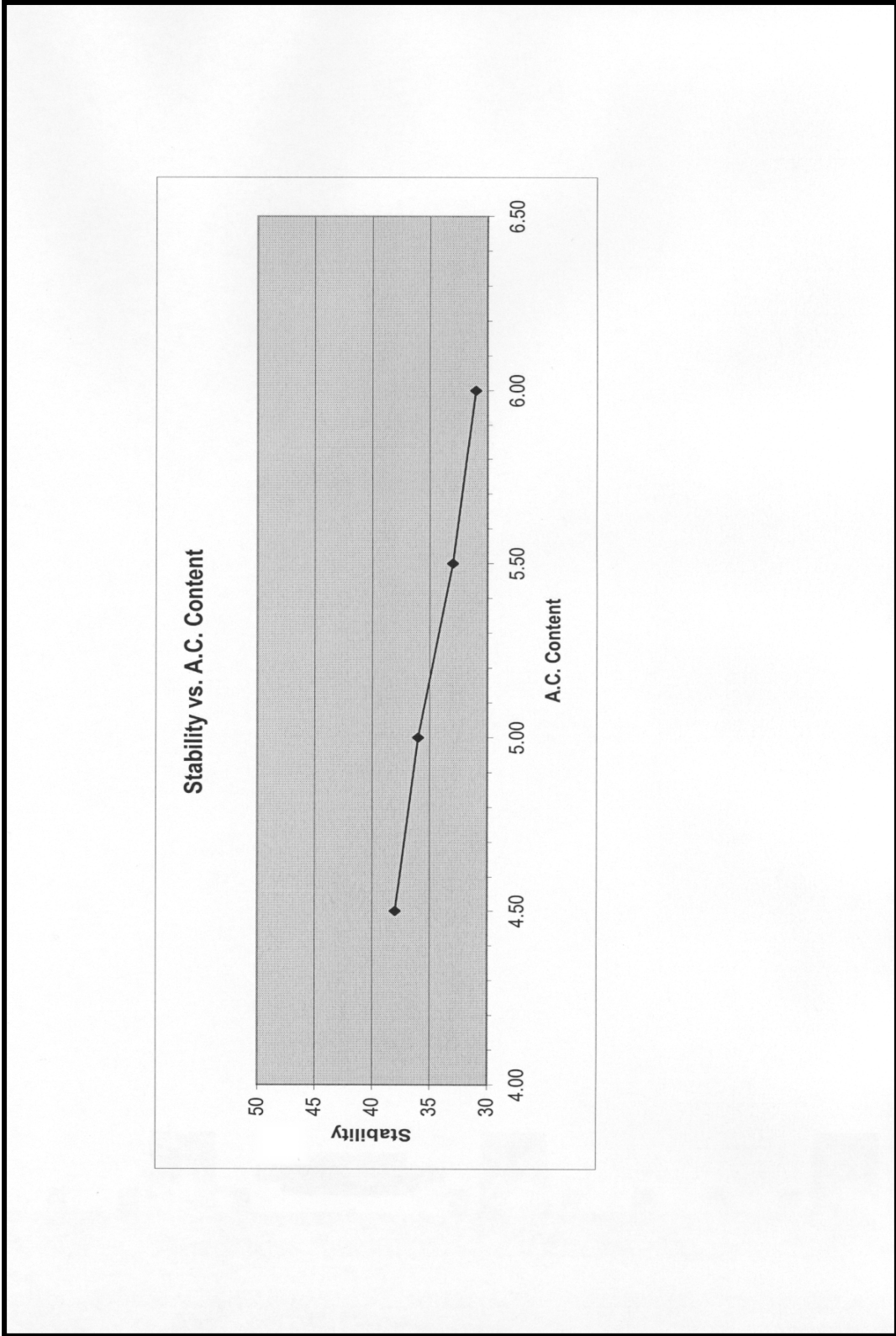

CDOT Form 429 3/05

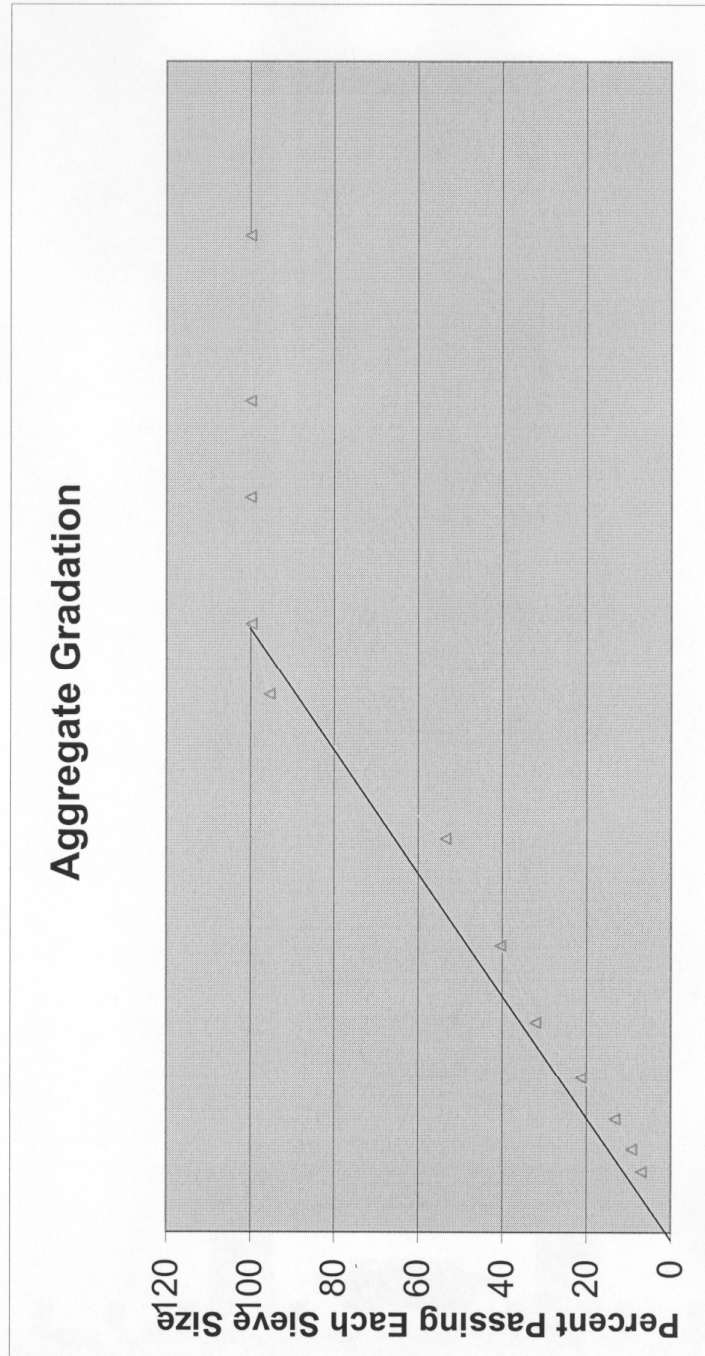

COLORADO DEPARTMENT OF TRANSPORTATION HOT MIX ASPHALT DENSITY TEST		Project no. IM 0253-151	
		Project code (SA#) 11925	
		Sheet no. 1 of 1	

Test number	1	2	3		
Station	255+95	1296+00	1299+60		
Distance rt. or lt. \mathcal{C}	Rt. 3'	Lt. 4'	Rt. 5'		
Course	bottom	middle	top		
Date placed	5/21/03	5/22/03	5/22/03		
Date retrieved (sampled)	5/21/03	5/22/03	5/22/03		
Dry weight in air (A)	994.6	1149.8	1155.6		
Sat. surf. dry wt. (B)	997.3	1151.6	1159.3		
Weight in H ₂ O (C)	567.2	663.1	654.8		
Wt. of H ₂ O displaced	0	0	0		
Bulk Specific Gravity	2.312	2.354	2.291		
Lab Specific Gravity*	2.444	2.444	2.444		
% Relative Compaction	94.6	69.3	93.7		
Test number					
Station					
Distance rt. or lt. \mathcal{C}					
Course					
Date placed					
Date retrieved (sampled)					
Dry weight in air (A)					
Sat. surf. dry wt. (B)					
Weight in H ₂ O (C)					
Wt. of H ₂ O displaced					
Bulk Specific Gravity					
Lab Specific Gravity*					
% Relative Compaction					

* This value must agree with CDOT Form #43 in effect at time of test
 Note: Report % Relative Compaction (% Lab Density), etc. on CDOT Form #69

Bulk Specific Gravity = $\frac{A}{B - C}$ = (Wt. of displaced H₂O). See CP 44 in Field Materials Manual.

Remarks

Sampled by D. Elsbernd	Tested by D. Elsbernd	Date 5/23/03
-------------------------------	------------------------------	---------------------

Project Code (SA#) **11925** FS # **11902**

Can # **1-3** Date **4/6/03**

Material type **PG 64-22** Lot # **17**

COLORADO DEPARTMENT OF TRANSPORTATION
Materials & Geotechnical Branch
4670 N. Holly Street, Unit A
Denver, Colorado 80216-6408

CDOT Form #634
3/06

Project Code (SA#) **11925** FS # **119003**

Can # **1-5** Date **4/6/03**

Material type **HFRS-2P** Lot # **6**

COLORADO DEPARTMENT OF TRANSPORTATION
Materials & Geotechnical Branch
4670 N. Holly Street, Unit A
Denver, Colorado 80216-6408

CDOT Form #634
3/06

COLORADO DEPARTMENT OF TRANSPORTATION
ASPHALT MIX DESIGN GRAPH

Project no.	Project code (SA#)
IM 0253-151	11925
Proj. location	Field sheet no.
I-25, SH 7 to WCR 16	120001

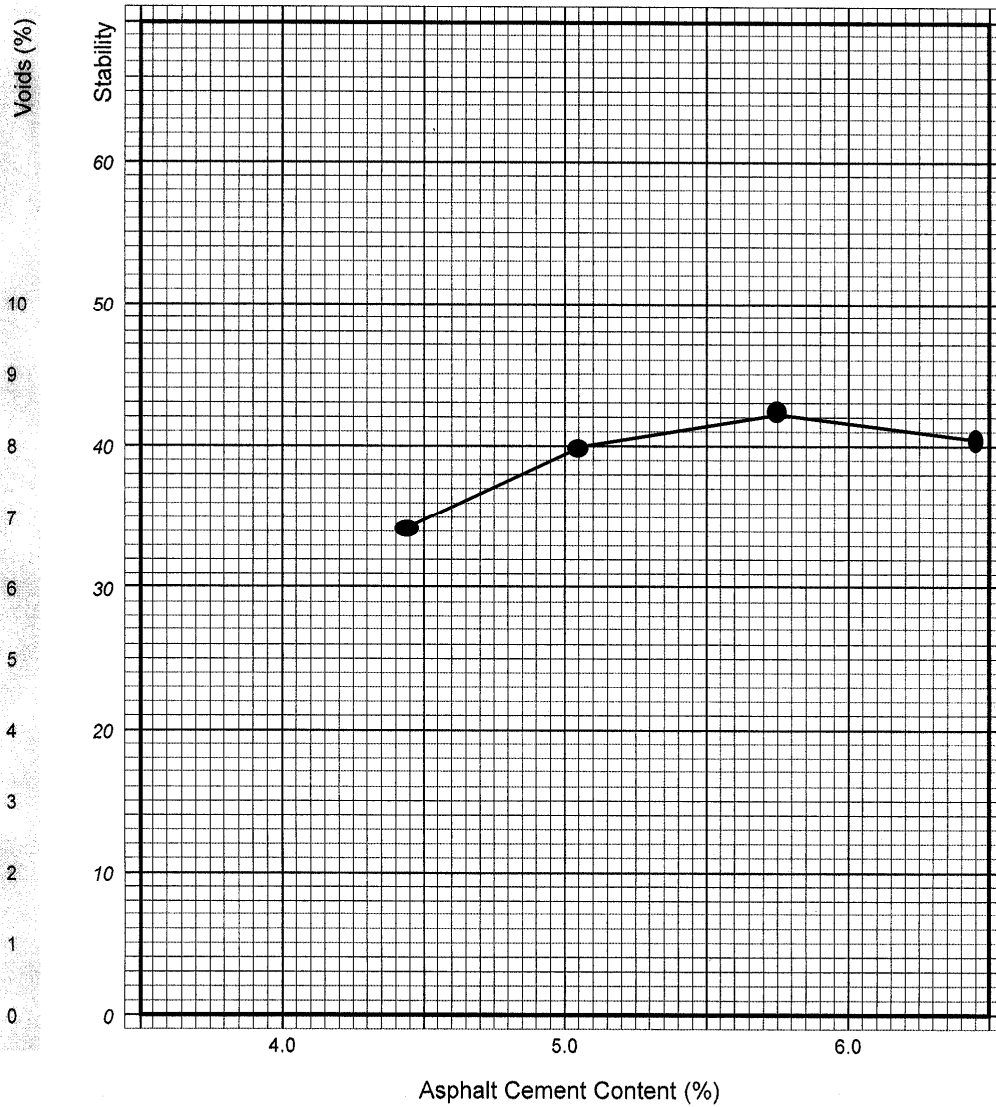

COLORADO DEPARTMENT OF TRANSPORTATION LONGITUDINAL JOINT DATA							
Project code (SA#) 11925		Project no. IM-0253-151		Item 403		Design 12554	
Date 5/29/10		Paving contractor Kiewit		Day or night paving Day		Avg. lift thickness 2.25"	
Region 4	Proj. location I-25, SH 7 to WCR 16			HMA Grading (S, SX, SG) S		Design gyrations (50,75,100) (100)	
Test number	1	2	3	4	5	6	7
Station	2+00	20+55	10+57				
Distance from outside edge of pavement	15"	15'	15'				
Layer	Bottom	Bottom	Bottom				
Date placed	5/29/10	5/29/10	5/30/10				
Core represents x linear ft.							
Date cored	5/30/10	5/30/10	6/2/10				
*Dry weight in air (A)	3384.5	2401.4	2849.8				
*Sat. surf. dry wt. (B)	3405.3	2412.0	2866.6				
*Weight in H ₂ O (C)	1864.8	1364.3	1603.4				
Bulk specific gravity A/(B-C)	2.197	2.292	2.256				
Form #43 Max. specific gravity value (Rice)	Lt. of joint	Rt. of joint	2.446 2.446	2.446 2.446	2.446 2.510		
	Average of left & Right		2.446	2.446	2.456		
% relative compaction at longitudinal joint	89.8	93.7	91.0				
Average daily mat density	93.5	94.2	94.1				
Joint tack used? (Y/N) (note if special sealant used)	Yes	See Note	Yes				

*Follow procedure outlined in CP 44

Comments: (ie. joint configuration, compaction method, etc.)
For joint core #1, Contractor using 1' vertical w/3:1 taper mad w/screed shoe.
For joint core #2, Contractor cut 3' off for vertical face. Tried cafcso rubberized sealant before paving hot side of joint. Joint #3 is the same as joint #1.

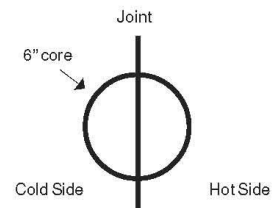

Tester Richard Ramirez	Supervisor Fidel Gonzales
Title E/PS Tech II	Project trailer phone # 303-555-1458

CDOT Form #1290 1/10

COLORADO DEPARTMENT OF TRANSPORTATION HMA SAMPLE SUBMITTAL		Project No. IM-0253-151	Location I-25, SH & to WCR 16	Date submitted 3/5/10	Serial No.
		Project Code (SA#) 11925	Function 3200	Participating Form 43#: 124	Form 43 date: 2/10/10
		Region 4	Function P		
Contractor Kraemer and Sons		HMA Supplier La Farge	Previously used SA# & FS#: N/A	Special Provisions applicable <input type="checkbox"/> no <input type="checkbox"/> yes:	
P/I name or owner Goose Haven		Contact person Hank Williams	Contact phone # 303-555-1879	Contact FAX # 303-555-1880	
Item # (if not 403)	Field Rice Value 2.444	Field Test No. 5	Quantity represented 1st 10k	Previous quantity 0	Total quantity to date 8000 ton
Sampled from (CP 41)	Grading <input checked="" type="checkbox"/> S <input type="checkbox"/> SMA <input type="checkbox"/> SX <input type="checkbox"/> SG <input type="checkbox"/> Other:	Gyrations <input type="checkbox"/> 50 <input checked="" type="checkbox"/> 100 <input type="checkbox"/> 75 <input type="checkbox"/> 125 <input type="checkbox"/> Other:	Grading <input checked="" type="checkbox"/> PG58-28 <input type="checkbox"/> PG64-28 <input type="checkbox"/> Other: <input type="checkbox"/> PG58-34 <input type="checkbox"/> PG70-28 <input type="checkbox"/> PG64-22 <input type="checkbox"/> PG76-28		
AC & belt cut submitted <input type="checkbox"/> yes <input checked="" type="checkbox"/> no	<input type="checkbox"/> Hamburg Rutter	<input checked="" type="checkbox"/> French Rutter			
Comments					
Number of cans submitted Central lab 2	Region lab 0	Date sampled 3/5/10	Via (state, contractor, or courier) State Vehicle	Date shipped 3/5/10	Shipped by Tod Gonser
Sampled by Fidel Gonzales		Title EPS Tech III		Lab phone # 303-828-2644	
Supervisor Corey Stewart		Title P.E. I		Lab address 1050 Lee Hill Rd. Boulder, Co. 80302	
Distribution: White - Staff Materials (if sample is directed to Staff Materials) Canary - Region Materials Engineer Pink - Project file					

COLORADO DEPARTMENT OF TRANSPORTATION HMA SAMPLE SUBMITTAL		Project No. IM-0253-151		Location I-25, SH 7 to WCR 16		Date submitted 3/5/10		Serial No.			
Project Code (SA#) 11925		Function 3200		Region 4		Participating Form 43# 124		Form 43 date: 2/10/10			
Contractor Kraemer and Sons		HMA Supplier La Farge		Previously used SA# & FS# N/A		Special Provisions applicable <input type="checkbox"/> no <input type="checkbox"/> yes:		Contact FAX # 303-555-1880			
Pit name or owner Goose Haven		Contact person Hank Williams		Contact phone # 303-555-1879		Contact FAX # 303-555-1880					
Item # (if not 403) 2.444		Field Rice Value 5		Quantity represented 1st 10k		Previous quantity 0		Total quantity to date 8000 tons			
Sampled from (CP 41) <input type="checkbox"/> Plant <input type="checkbox"/> Windrow <input type="checkbox"/> Auger <input checked="" type="checkbox"/> Roadway		Grading <input checked="" type="checkbox"/> S <input type="checkbox"/> SMA <input type="checkbox"/> SX <input type="checkbox"/> SG <input type="checkbox"/> Other:		Gyrations <input type="checkbox"/> 50 <input checked="" type="checkbox"/> 100 <input type="checkbox"/> 75 <input type="checkbox"/> 125 <input type="checkbox"/> Other:		Grading <input checked="" type="checkbox"/> PG58-28 <input type="checkbox"/> PG64-28 <input type="checkbox"/> PG58-34 <input type="checkbox"/> PG70-28 <input type="checkbox"/> PG64-22		<input type="checkbox"/> Other:			
AC & belt cut submitted <input checked="" type="checkbox"/> yes <input type="checkbox"/> no		<input type="checkbox"/> Hamburg Rutter		<input checked="" type="checkbox"/> French Rutter							
Comments											
Number of cans submitted Central lab 1		Region lab 0		Date sampled 3/6/10		Via (state, contractor, or courier) State Vehicle		Date shipped 3/6/10		Shipped by Todd Gonser	
Sampled by		Fidel Gonzales		Title E/PS Tech III		Lab phone # 303-828-2644					
Supervisor		Corey Stewart		Title P.E. II		Lab address 1050 Lee Hill Rd. Boulder, Co. 80302					

CDOT Form #1304 1/10

Distribution: White - Staff Materials (if sample is directed to Staff Materials)
Canary - Region Materials Engineer
Pink - Project file

**COLORADO DEPARTMENT OF TRANSPORTATION
HMA SEGREGATION DATA**

Project Code (SA#) 12345	Mix Design 12345SX	Region 4	Date 5/22/06	Ave Lift Thickness 2.5"
Paving Contractor Kiewit		HMA Grading (S, SX, SMA) SX	Gyrations (50, 75, 100) 100	Binder Grade (58-28, 64-22, etc.) 76-28
Truck Type End Dump		Delivery System Make and Model IR MC-330 MTV	Paver Make and Model Blaw Knox AP 51	

Look for a temperature difference of 25 degrees or more across the width of the mat within a 3 foot band.
 Exclude outside 1 foot of mat.
 Only one area per delivered truck will be counted toward the number of low density areas.
 Mark where you start taking readings. There's no penalty unless there are 4 areas within 500 tons of mix, so tonnage must be tracked.
 If you don't track the tickets and want to calculate tonnage, use 110 pounds per square yard per inch.
 Tonnage of starting ticket: _____ or mark for start of study: **X on SB CL** _____
 Approximate length of paving per truck: Length in feet = (tonnage on truck)/[(width in feet)(depth in inches)(.0061)]
 Industry best practices are listed on the back of this worksheet.

Identifying mark of "cold" area	Location of "cold" area from CL or edge of pavement	Station	Temperature of "cold" area	Temperature of adjacent "hot" area	% Relative Compaction of "cold" area (from CDOT Form #428)	Notes Painted an "X" on the pavement at the CL near the green mailbox.
Orange paint, "1"	52" from CL	1021 + 20	245° F	287° F	92.2%	123 feet from starting "X"
Orange Paint, "2"	31" from CL		253° F	285° F	92.3 %	60 feet from "1"
Orange Paint, "3"	38" from edge of pavement	Near 1024 + 00	241° F	281° F	91.1 %	219 feet from "2"
Orange Paint, "4"	51" from CL		230° F	280° F	90.7 %	630 feet from "3"
Orange Paint, "5"	49" from edge of pavement		249° F	280° F	92.4%	477 feet from "4"
Orange Paint, "6"	44" from edge of pavement		244° F	284° F	91.1%	300 feet from "5"
						1809 feet total
1639 feet (500 tons) occurred	between	"5" and "6".	Do	not count reading	#6.	
Just two low density readings	in 500 tons.	Contractor is	within segregation	spec.	guidelines.	

Notes:
 About 20 tons per truck. Count no two readings within: $20 / [(20' \text{ wide})(2.5" \text{ compacted})(.0061)] = 65.6 \text{ feet}$
 500 tons is a length of: $500 \text{ tons} / (20' \text{ wide})(2.5" \text{ deep})(.0061) = 1639 \text{ feet}$.
 There can be no more than 4 densities below 92.0% in 1639 feet.

Tester/Title George Forman/ EPST I	Phone Number 303.421.8745	Supervisor David Bradshaw
--	-------------------------------------	-------------------------------------

Best Practices for Minimizing Segregation

1. Aggregate Stockpiles

- A. Build in layers.
- B. Avoid any procedure that allows aggregate to be pushed or dumped over the side of a stockpile.
- C. Separate to prevent intermingling.
- D. Aggregate Handling:
 - (1) Loader operator works full face of stockpile.
 - (2) Install dividers on cold feed bins to prevent material from flowing into an adjacent bin.
 - (3) Do not pile aggregate so high that it flows over the dividers.

2. Loading Surge Silo: (If plant has batcher or gob hopper at top of silo.)

- A. Adjust conveying devices to deposit material in center of batcher or gob hopper.
- B. Keep gates on batcher or gob hopper closed unless dropping load of mix.
- C. Close gates on batcher or gob hopper before it is empty to prevent material from dribbling into silo.

3. Loading Trucks:

- A. Keep gates on bottom of silo closed so material does not dribble into trucks.
- B. Take care to center trucks (Left to Right) when loading.
- C. Consider loading trucks in multiple drops with first drop at rear, second drop at front, and then alternate dumps.
- D. If the mix is prone to segregate you should avoid loading trucks by slowly driving forward while dropping mix.

4. Dumping Trucks:

- A. To provide a surge of material to the paver, when using end dump trucks, the box should be raised until the mix moves to the rear before opening the tailgate.
- B. If any mix is spilled on the roadway in front of the paver while dumping the truck, this mix should be removed from the roadway before the paver starts forward.

5. Laydown Operations:

- A. Only dump wings of the hopper at the end of the day and then waste this material. Do not knock cold material off the wings and into the hopper.
- B. To provide consistent flow of material to the screed, the operator should avoid gradual deceleration or gradual acceleration.
The paver should be stopped and started quickly at normal operating speed.
- C. Keep hopper more than half full at all times.
- D. Auger height should be adjusted so bottom of auger is at least two (2) inches above the finished surface of the mat.
- E. Adjust feed sensors to keep material near the center of the auger at all times.
- F. Correctly adjust the lead and trail crown of the screed so that the surface of the HMA behind the paver is uniform in appearance and texture.
- G. Install reverse fins at the center of auger to tuck the proper amount of material under the gear box.
- H. Adjust flow gates at rear of the hopper so that:
 - (1) The slat conveyors run continuously.
 - (2) The amount of material furnished to the augers allows them to run nearly 100% of the time.
- I. The risk of causing thermal segregation is increased when paving in cooler temperatures.

6. Windrow Elevators:

- A. When using pick up machines, they should be adjusted such that all the HMA is removed from the surface.

Chapter 500

Structures - 09

ITEM 502, PILING

Acceptable welding rods for splicing H piles and pipe piles are E7016 and E7018. These identifying numbers will be found on the electrodes and on their container. Welding is usually performed at the project construction site.

There is a standard special revision to Section 502 of the Standard Specifications, for Piling, requiring the use of a Pile Driving Analyzer (PDA) when piling is to be driven on a project.

ITEM 506, GABIONS AND SLOPE MATTRESS

Gabions

A necessary feature of the rock basket is the weave of the wire fabric, which must "give" in all directions and not unravel if a wire should break. Field personnel will inspect for compliance with the Non-Raveling Construction requirement in Subsection 712.09 of the Standard Specifications.

ITEM 509, STRUCTURAL STEEL

Fabrication

The Staff Bridge Fabrication Inspectors are responsible for the testing, inspection, and documentation of shop fabricated structural steel bridges. They will obtain and review mill test reports, welding procedure reports, and welder qualifications, and assure compliance with project specifications. This will be documented on the final inspection report issued for shop fabricated structural steel bridges.

Field Welding

If any field welding of fabricated structural steel components becomes necessary, the Bridge Design Inspection Unit should be consulted for guidance and assistance. They will also provide guidance in determining defective welds that are not detectable by visual inspection.

Shear Studs

Shear studs are usually inspected during the shop fabrication of structural steel bridges.

Field welded shear studs are inspected by striking the stud with a hammer until it is bent to 45°. Two studs per 100 will be tested. The studs tested that show no sign of failure should be left in the bent position. Studs bent during handling should be left in the bent position. Any studs that are broken off should be replaced by field welding. Additional studs should be tested when a failure occurs. Contact the Staff Bridge Fabrication Inspectors for assistance when excessive failures occur.

Bolts

Rotational capacity tests are required at the job site. Refer to the CDOT Construction Manual. Document the results of this test in Project Files.

ITEM 509 STRUCTURAL STEEL (GALVANIZED) - MISCELLANEOUS

Field inspection in some cases cannot be accomplished on a piece-by-piece basis, as it arrives on the project, depending on the size and configuration of the material. Therefore, it is possible for field personnel, during installation to find places that are not adequately galvanized. It is allowable to touch up inadequate or damaged galvanizing with one full brush coat of zinc rich paint meeting the requirements of the Department of Defense DOD-P-21035A, according to 509.27(h) of the Standard Specifications. A Certificate of Compliance is required indicating that the zinc rich paint meets the above specification.

ITEM 510 STRUCTURAL PLATE (GALVANIZED)

Not pre-tested, but field inspected. A word of caution regarding the storage of galvanized structural plate. Zinc will convert into "white rust" rapidly when it becomes wet in the absence of air. A rapid loss of zinc may occur when curved sheets are stacked together in such a way that water can get between the sheets and not drain. It is

possible to loose the entire protective coating of zinc over large areas in a short period of time under the right conditions of moisture and warmth. To prevent this, the sheets should be stored under cover or stacked so water will drain away rather than be trapped between the sheets.

ITEM 515, WATERPROOFING MEMBRANE

Bridge Deck, All Types

Section 515 of the CDOT's Standard Specifications describe the types of waterproofing membranes which may be used as protection from de-icing salt on concrete bridge decks. In addition, the Standard Specification gives detailed application procedures for membrane types, the protective covering, and hot mix asphalt overlay. These requirements must be strictly adhered to in order to obtain the best possible waterproofing system.

COLORADO DEPARTMENT OF TRANSPORTATION FIELD REPORT FOR SAMPLE IDENTIFICATION OR MATERIALS DOCUMENTATION Metric units <input type="checkbox"/> yes <input checked="" type="checkbox"/> no				Field sheet No. 120227		Date 4/4/02	
				Project No. IM0253-151		Project location I-25, SH 7 to WCR 16	
Project code (SA#) 11925		Function 3200		Region 4		Part. P	

Sample submitted: <small>(ie.: Soil, ABC, Hydrated lime, HMA, concrete cores, steel, etc.)</small>				Field office phone number 303-828-0386			
Rip-Rap				Field office FAX number 303-828-0430			
Item 506		Class		Grading		Special provisions applicable: <input checked="" type="checkbox"/> yes <input type="checkbox"/> no	
Previously used on Project No.:				Previous CDOT Form #157 F/S No.(s):		<input checked="" type="checkbox"/> CDOT Form #633 (sack) <input type="checkbox"/> CDOT Form #634 (can)	
<ul style="list-style-type: none"> ● Sample Identification: Quantity & Unit of material submitted, describe tests required, precise location sample removed from (stationing), etc. ● Materials Documentation: Field inspected (describe appearance, weight/dimensions, model/serial number), COC &/or CTR provided, etc. 							
<p>Submitting One (1) sack of Rip-Rap to Geocal main lab</p> <p>to perform specific gravity test as per CDOT Field</p> <p>Materials Manual. The Rip-Rap for 6", 9", 12" and 18"</p> <p>are all provided from the same source listed below. One</p> <p>specific gravity test will cover all sizes as per head tester.</p>							
APL/QML Acceptance: APL Ref. No.		Product name:				Date checked:	
APL/QML Acceptance: APL Ref. No.		Product name:				Date checked:	
Preliminary <input type="checkbox"/>		Construction <input checked="" type="checkbox"/>		Maintenance <input type="checkbox"/>		Emergency <input type="checkbox"/>	
						Date needed ASAP	
Contractor Kraemer and Sons				Supplier Cat Construction			
Sampled from <small>(Pit, roadway, windrow, stock, etc.)</small> Stockpile				Pit name or owner Spec-Agg. Pit			
Quantity represented 1/source/project		Previous quantity 1/source/project		Total quantity to date			
Sample submitted: <input checked="" type="checkbox"/> Yes <input type="checkbox"/> No		Shipped to: <input type="checkbox"/> Central lab <input checked="" type="checkbox"/> Region lab		Via Geocal		Date 4/4/02	
Sampled or inspected by (Name) D. Buck				(Title) Q.A. Tech		Lab phone number 303-828-2644	
Supervisor <small>(Pro./Res./Matis. Engr./Maint. Supt.)</small> Corey Stewart				Title P.E. I		Address 1050 Lee Hill Rd. Boulder, Co. 80302	

Distribution: White copy - Staff Materials Branch
(submit white copy only if sample or information is directed to Staff Materials)
 Canary copy - Region Materials Engineer
 Pink copy - Resident Engineer

CDOT Form #157 9/07

Previous editions may be used until supplies are exhausted

COLORADO DEPARTMENT OF TRANSPORTATION FIELD REPORT FOR SAMPLE IDENTIFICATION OR MATERIALS DOCUMENTATION Metric units <input type="checkbox"/> yes <input checked="" type="checkbox"/> no				Field sheet No. 120227		Date 9/8/03	
				Project No. IM0253-151		Project location I-25, SH 7 to WCR 16	
Project code (SA#) 11925		Function 3200		Region 4		Part. P	
Sample submitted: <small>(ie.: Soil, ABC, Hydrated lime, HMA, concrete cores, steel, etc.)</small>				Field office phone number 303-828-0386			
Gabions				Field office FAX number 303-828-0430			
Item 506		Class		Grading		Special provisions applicable: <input checked="" type="checkbox"/> yes <input type="checkbox"/> no	
Previously used on Project No.:			Previous CDOT Form #157 F/S No.(s):			<input type="checkbox"/> CDOT Form #633 (sack) <input type="checkbox"/> CDOT Form #634 (can)	
<ul style="list-style-type: none"> ● Sample Identification: Quantity & Unit of material submitted, describe tests required, precise location sample removed from (stationing), etc. ● Materials Documentation: Field inspected (describe appearance, weight/dimensions, model/serial number), COC &/or CTR provided, etc. <p style="text-align: center;">This material has been field inspected and accepted.</p> <p style="text-align: center;">The material meets the requirements of 712.09. The Gabions conform with the dimensions shown on the Plans and Special Provisions.</p>							
APL/QML Acceptance: APL Ref. No.		Product name:				Date checked:	
APL/QML Acceptance: APL Ref. No.		Product name:				Date checked:	
Preliminary <input type="checkbox"/>		Construction <input checked="" type="checkbox"/>		Maintenance <input type="checkbox"/>		Emergency <input type="checkbox"/>	
Contractor Kraemer and Sons		Supplier Rocky Mtn. Gabion Company					
Sampled from <small>(Fill, roadway, windrow, stock, etc.)</small>				Pit name or owner			
Quantity represented 350 Cu. Yd.		Previous quantity 0		Total quantity to date 350 Cu. Yd.			
Sample submitted: <input type="checkbox"/> Yes <input checked="" type="checkbox"/> No		Shipped to: <input type="checkbox"/> Central lab <input type="checkbox"/> Region lab		Via		Date 9/8/03	
Sampled or inspected by (Name) Mark Stadig		(Title) E/PS Tech III		Lab phone number 303-828-2644			
Supervisor <small>(Pro./Res./Matis. Engr./Maint. Supt.)</small> Corey Stewart		Title P.E. I		Address 1050 Lee Hill Rd. Boulder, Co. 80302			
Distribution: White copy - Staff Materials Branch <small>(submit white copy only if sample or information is directed to Staff Materials)</small> Canary copy - Region Materials Engineer Pink copy - Resident Engineer				CDOT Form #157 9/07			
Previous editions may be used until supplies are exhausted							

Chapter 600

Concrete & Item 600 - 10

ITEM 601 STRUCTURAL CONCRETE

CONCRETE DESIGN MIXES

All concrete placed on the project shall conform to a design mix, which has been approved by the Region Materials Engineer (RME) or CDOT Central Materials Laboratory's Concrete & Physical Properties (CPP) Unit. The design mix is defined by the proportions and sources of all ingredients in the concrete.

The Contractor (or Supplier) will establish and is responsible for the concrete design mix proportions and source of all ingredients for each class of concrete used. The RME or CPP Unit may verify any or all properties of the submitted mix design prior to approval. When a trial mix check is requested, aggregate sources will be sampled by the Contractor and the samples submitted to the CPP Unit.

CDOT Form #1188 which accompanies the samples shall contain the following information:

1. Supplier name and location.
2. Source, location and type of cement.
3. Company, plant location and type of each aggregate.
4. Brand and name of admixtures.

The concrete Table 601-1 in Section 601 of the Standard Specification or in the Special Provisions for the project gives the data for each class of concrete. The column "Concrete Class" lists each class of concrete and the required field compressive strength. The cement content for each class of concrete is the minimum amount or range that will be used for designing the concrete mix.

For all classes of concrete, the compressive strength of the laboratory trial mix shall be at least 15% greater than the required field compressive strengths.

When a concrete mix design is approved, a CDOT Form #1373 will be issued for the project.

Approved mix designs will be placed on the Pre-Approved Concrete Mix Designs list located at:

http://www.dot.state.co.us/App_APL/Pre-Approved_Concrete_Mix_Designs.pdf

Mix designs are approved for two years from the date the mix was trialed or when the aggregate tests were sampled, whichever occurs first.

REFERENCING PRE-APPROVED MIX DESIGNS

Projects may choose to reference existing pre-approved concrete mix designs. The concrete mix designs used on CDOT projects are to be referenced in the following manner:

1. Cross-reference the contractors mix design number with the CDOT mix design number on the Pre-Approved Concrete Mix Design list..
2. Document the Concrete Mix Design on a CDOT Form # 1188, listing:
 - a. The CDOT mix number.
 - b. Copy of the Contractor's mix design coversheet.
3. Mixes must be reviewed and approved by the RME or CPP Unit prior to use.

Upon review of the referenced design mix and approval of the concrete mix design, a CDOT Form #1373 will be issued for the project and sent to the Project Engineer.

REVIEW OF CONTRACTOR'S MIX DESIGN

Mix approval is required before concrete placement begins. Acceptance or rejection will be determined following the procedures of CP 62.

AGGREGATES

A minimum of three-60 lb. sacks of the coarse (1-1/2 in. to 3/4 in.); three-60 lb. sacks of intermediate (3/4 in. to plus #4); and three-60 lb. sacks of sand

(minus #4) per class of concrete are required when mix design checks are performed.

One additional sack of each aggregate will be required for Class H, HT S50, and P mixes.

Aggregate Tests Required for Design Mixes

The following test will be performed by the Contractor:

- (1) specific gravity
- (2) absorption
- (3) organic impurities in sand
- (4) sieve analysis
- (5) sand equivalent
- (6) L.A. abrasion
- (7) percent passing the No. 200 sieve
- (8) fineness modulus
- (9) unit weight and voids in aggregate
- (10) potential alkali reactivity
- (11) soundness by the sodium sulfate method.

COMPRESSIVE STRENGTH TESTING

Determination of compressive strength of concrete cylinders shall be done in accordance with ASTM C 39. This method consists of applying a compressive axial load to molded cylinders or cores at a rate within the prescribed range until failure occurs. The compressive strength of the specimen is calculated by dividing the maximum load attained during the test by the cross-sectional area of the specimen. The following details, from the test procedure, are noted:

1. Initial cure of specimens in accordance with T 23 as modified.
2. Testing machine. Calibration of the testing machine shall be performed at intervals not to exceed 13 months. Recalibration is required upon installation or relocation of the machine, or whenever there is reason to doubt the accuracy of test results. The diameter of the sphere of the top loading head on the machine shall be at least 75% of the diameter of the specimen to be tested.
3. Concrete specimens shall not be tested if any individual cylinder diameter differs from other diameters of the same cylinder by more than 2%. No cylinder shall depart from perpendicularity to the axis by more than 0.5°; top of cylinder may not deviate by more than 1/16 inch in 12 inches. When neoprene caps are used,

each end of the cylinder shall be planed within 0.125 inches across any diameter and no depression in the concrete surface deeper than 0.125 inches is tolerated. The diameter used for calculating the cross-sectional area of cylinder shall be determined to the nearest 0.01 inches by averaging two diameters measured at right angles about mid-height of the specimen. Cylinder length shall be measured to the nearest 0.05 inch when length-to-diameter ratio is less than 1.8, or more than 2.2.

4. Procedure. Test the cylinders as molded in the field. The loading rate shall be within the range of 20 to 50 psi/second. During the first half of the anticipated load, a higher rate of loading is allowed. When using neoprene caps an additional three to five seconds of load is applied to ensure completion of the test and avoidance of premature breaks.

5. Neoprene Pads. Only one side of the pad shall be used when testing the cylinders. Each pad shall not be used to test more than 100 cylinders. Record the number of tests for each pad. The neoprene pad's shore hardness shall be the following for the specified compressive strengths:

- 50 for 1500 – 6000 psi
- 60 for 2500 – 7000 psi
- 70 for 4000 – 7000 psi

QUALITY ASSURANCE PROGRAM FOR CDOT CONCRETE CYLINDER TESTING

Introduction

This defines a quality assurance program for testing of concrete cylinders. This program assures the conformance of CDOT equipment and procedures to ASTM Standards by the following:

1. Equipment checks using a standard checklist.
2. Procedure checks using a standard checklist.
3. Inter-Lab (Round Robin) testing with all labs testing replicate specimens at the same time.
4. Training offered by the Concrete Unit of Staff Materials & Geotechnical Branch.
5. ACI certification of CDOT employees.

Cylinders shall be tested with equipment that has been checked and found to be in conformance with ASTM criteria. Testing shall be conducted by an employee who is certified as an ACI Concrete Laboratory Testing Tech I or ACI Concrete Strength Testing Technician.

Equipment

The cylinder testing equipment will be examined, using the equipment checklist, a minimum of once a year or when the equipment is moved. The person checking the equipment must meet one of the following criteria:

1. Examined by CCRL (Cement and Concrete Reference Laboratory) for procedures and equipment.
2. Trained by the Concrete Unit of Staff Materials & Geotechnical Branch.

Procedures

The person will be observed conducting the test by a proctor using the procedures checklist a minimum of once a year. The proctor checking the procedures must meet one of the following criteria:

1. Examined by CCRL for procedures and equipment.
2. Trained by the Concrete Unit of Staff Materials & Geotechnical Branch.
3. Certified as an ACI Concrete Laboratory Testing Tech I or ACI Concrete Strength Testing Technician.

Inter-Lab Testing (Round Robin)

The Concrete Unit will mold replicate cylinders and distribute these to each Region concrete testing facility. All cylinders will be tested at approximately the same time. The Concrete Unit will compile the results and distribute a brief report. Excessive deviations will be investigated.

Training

The Concrete Unit will conduct training for Region personnel who perform concrete cylinder testing. Classes will be approximately 4 hours and

will normally have four trainees per class. The training will be conducted by an employee that has been examined by CCRL.

ACI Certification

American Concrete Institute (ACI) offers one-day certifications. These certifications include testing of concrete cylinders and a complete battery of tests conducted on concrete aggregate and concrete. ACI Certifications are offered through the Colorado Ready Mixed Concrete Association. CRMCA may be contacted at 303-290-0303 or <http://www.crmca.org/>.

Documentation

Region Materials Laboratories will maintain documentation on equipment calibration, equipment checks, procedure checks, employee training, employee ACI certification, and Inter-Lab results.

The Concrete Unit of the Central Laboratory will maintain documentation of equipment and procedure checks conducted by the Concrete Unit and Inter-Lab results.

UNIT WEIGHT, YIELD, AND GRAVIMETRIC AIR CONTENT OF CONCRETE

AASHTO T 121

The unit weight of the concrete may be determined by AASHTO T 121. Since a specified measure may not be available, the unit weight of fresh concrete may be found by weighing the one-quarter cu. ft. base of an air meter after it is filled and struck off and before the air test is made. Weigh the filled base to the nearest 0.1 lb. subtract the tare weight of the empty base and multiply the weight of the concrete by four to obtain the weight per cu. ft..

Refer to AASHTO T 121 for full details of the test procedure and calculations for determining the following: Unit weight (pounds per cubic foot), yield (volume of concrete produced per batch), relative yield (ratio of the actual volume to the volume as designed for the batch), and air content (percentage of voids in the concrete).

Equipment and Documentation Checklist for Compression Testing of Concrete Cylinders

Date _____ Location _____

Inspection Team _____

Compression Machine

Mfg & Model _____

Capacity _____

Installation Date _____

Calibration Date _____

_____ Calibration interval did not exceed 13 months or calibrated since moved.

_____ Loading head free moving (4° in any direction).

_____ Head diameter: [3% > specimen, 6 1/2" (165 mm) maximum for a 4" (102 mm) cylinder & 10" (254 mm) maximum for a 6" (152 mm) cylinder].

_____ Head radius > radius of sphere.

Other Equipment Noted and Available

_____ Condition of neoprene pads and extrusion controllers.

_____ Water temperature of cylinder storage area ($73.4^\circ\text{F} \pm 3^\circ$ ($23^\circ\text{C} \pm 1.7^\circ$)).

_____ Temperature recording device operating.

_____ Water saturated with lime.

Documentation/Records on File

_____ Compression machine calibration documentation immediately available.

_____ Water temperature, neoprene pad durometer, and neoprene pad usage recorded (100 uses per pad maximum).

_____ Number of cylinders measured for determination of average diameter (1 in 10 or 3 per day, whichever is greater).

_____ Diameter, load, and psi of cylinders recorded.

Procedure Checklist for Compression Testing of Concrete Cylinders

Date _____ Location _____

Proctor _____

Proctor Credentials _____

Employee Observed _____

Employee Training and Certification _____

Procedure

_____ Remove specimen from moist storage, maintain moisture.

_____ Measure diameter to nearest 0.01 in (.25 mm) by averaging two diameters measured at right angles to each other, using calipers, at mid-height of specimen.

OR

_____ One measurement mid-height of specimen using pi tape.

_____ Wipe clean bearing surfaces of upper and lower blocks.

_____ Center the cylinder to the spherical head.

_____ Bring top block to bear gently and uniformly on specimen while rotating the movable portion by hand.

_____ Load the cylinder (20 to 50 psi/sec. or 0.14 to 0.34 MPa /sec for hydraulically operated machines).

_____ Take cylinders to failure (additional 3-5 seconds may be required to ensure completion of break).

_____ Record maximum load.

_____ Calculate the compressive strength and report to the required precision (nearest 10 psi (0.1 MPa)).

Comments: _____

EXCESSIVE WATER DEMAND

Water-cement ratios, which exceed the specified maximum may result from one of the following:

1. Incorrect batch weights, due to mathematical errors or scales out of adjustment.
2. Stockpiles of aggregate drying to less than a saturated surface-dry condition, requiring more water than the design. Water added to the batch to bring the aggregates to SSD shall not be included in the w/cm ratio calculation.
3. High mix temperatures causing loss of workability and premature stiffening of the mix.

It is the Contractor's responsibility to maintain water-cement ratios at or below the specified maximum. A water reducer may solve the problem.

MAKING AND CURING CONCRETE CYLINDERS IN THE FIELD

Acceptance / Verification (QA) Cylinders

Test cylinders made for determination of compliance with strength specifications are referred to as "acceptance cylinders". These cylinders are tested at 28 days after casting for all classes of concrete except H & HT which are tested at 56 days.

Acceptance cylinders made at the job site shall be made and cured in accordance with AASHTO T 23.

Design Cylinders

Test cylinders made for checking the adequacy of laboratory mixture proportions for strength are referred to as "design cylinders".

Information Cylinders

Test cylinders made for determining form removal time or when a structure may be put into service are referred to as "information cylinders".

Information cylinders shall be cured, in the same manner as the structure. Do not expose these cylinders to direct sunlight or do not store where they may be disturbed by Contractor personnel. They shall remain in the molds until the form work of the structure is removed or until they are shipped to the Laboratory. Information cylinders are for the purpose of determining relative structure strength and are not to replace design cylinders.

Numbering and Marking Cylinders

See the instructions and examples of CDOT Form # 82 in this chapter for the correct method of numbering cylinders. Mark the identifying number and information on the cylinders with red or black grease pencil, crayon or waterproof felt tipped pen. Do not scratch numbers on the end of the cylinders as it will make them difficult to cap and will affect test results.

DOCUMENTATION AND TRANSFER OF CONCRETE TEST CYLINDERS

Field sheet Numbering System

The CDOT Form # 82, Concrete Cylinder Transmittal, is used to document and provide information for concrete cylinders submitted for compressive strength testing. Each Form # 82 is assigned a field sheet control number. The Reproduction Branch is responsible for assigning the established numbers prior to printing.

Concrete Cylinder Transport

Concrete specimens being transported prior to 48 hours after molding shall be left in the molds. Upon arrival at the designated testing facility, cylinders shall be removed from the molds and stored in a suitable curing area. Specimens to be transported after 48 hour age shall be removed from the molds in 24 ± 8 hours. Curing shall be in saturated limewater @ $73.4^{\circ}\text{F} \pm 3^{\circ}$ until the time of transport. During transportation, the specimens must be protected and kept moist with cushioning material in padded boxes or suitable protective containers. Moisture loss shall be prevented by wrapping the specimens in plastic, wet sand or burlap. The project tester or designated project representative will be responsible for proper transfer of the specimens. When the cylinders are

received by the laboratory the field sheet number shall be recorded in the laboratory log book. The cylinders shall be removed from the molds and marked with the project number, cylinders set number, and break dates. It will be the responsibility of the Engineer or his designee to complete this process.

Reporting Test Results

The cylinder test information is entered in a computerized program from the CDOT Form # 82, Concrete Cylinder Transmittal Report. Compressive test results and cylinder measurements are performed on the specified break dates with compressive strength test results reported on a computerized CDOT Form # 192, Report of Concrete Tests. The test results are sent to Project and Region personnel. It is the responsibility of the Engineer in charge of the laboratory to ensure the proper testing and reporting of compressive strength test results.

TECHNICAL COMPLAINTS

Questions or problems should be directed to the Concrete/Physical Properties Unit Program Manager at 303-398-6541. The evaluation process will include an investigation ensuring that correct procedures were adhered to in the following areas:

1. Paperwork
2. Testing procedures
3. Machine Calibration and settings

A verbal reply will be issued, written replies upon request.

AIR ENTRAINMENT

Definition

Air entrainment is the introduction of air that causes the development of a system of microscopic air bubbles in concrete during mixing.

Measurement

Determination of air content at the job site shall be made in accordance with AASHTO T 152 and the apparent air content reported. Do not

correct the air meter reading for air in the aggregate, but report total percent air.

The following may affect the quantity and quality of entrained air in concrete.

- 1. Fly Ash**
Fly Ash may substantially increase the amount of air entraining agent required to produce the required air content. Fly ash with a high loss of ignition (LOI) have a high content of carbon and it usually causes the greatest air reduction.
- 2. Temperature**
Rising temperatures generally require increased amounts of air entraining agents.
- 3. Water**
An increase in the water-cement ratio may increase the air content of the concrete. Contaminants present in many water sources, especially streams, can cause highly variable air content in the water.
- 4. Mixing**
A normal dosage of A.E.A. that does not produce adequate air entrainment may indicate inadequate mixing. Trucks with worn blades will not entrain satisfactory amounts of air within the specified number of mixing revolutions. However, prolonged mixing may increase concrete temperature and further reduce air content. The addition of more air-entraining agent to a truck on the job site is allowed.
- 5. Cement**
The ability of the mortar to entrain air will decrease with the increase of the fineness of the cement, and with an increase in the cement content of the mortar. A change in brand or source of cement may require a change in the amount of air entraining agent, some as much as four times normal dosage.
- 6. Fine Aggregate**
Changes in the sand may alter the volume of air entrainment in the mortar. An increase in quantity of very fine particles (minus No. 30 plus No. 100

sieve) will tend to increase the volume of air in the mortar.

7. **Pumping Concrete**

Pumping concrete may reduce the air content of the concrete. Several factors in the pump configuration may influence the quantity of air loss. It is the responsibility of the Contractor to ensure that the air content leaving the pump be within the specified limits.

AIR ENTRAINING AGENTS (A.E.A.)

Pre-Approved Acceptance. The amount shown on the laboratory design mix is merely a guide and may require adjustment.

ADMIXTURES, GENERAL

Pre-Approved Acceptance. Admixtures of any type or amount should not be considered a substitute for good concreting practices and should be used only after evaluation of its effects on a particular concrete mix under the conditions of the use intended. Admixtures are required to conform to applicable AASHTO or ASTM specifications. When using an admixture, attention should be given to the instruction provided by the manufacturer.

Check the Approved Products List at www.dot.state.co.us/App_APL/ for approved brands.

Surface Retarders

To produce exposed aggregate textures, surface retarders may be used. Sample panels may be constructed on the job site using the design mix and surface retarder, if required by contract documents. This will not only provide a measure of the effectiveness of the retarder but will give a preview of the color and texture of the final result. It is important, as with other admixtures, to follow manufacturer's instruction. Sample panels, if required, should be a minimum of 2' X 2' for 3/4" exposed coarse aggregate. If larger sized coarse aggregate is required, the panel dimensions should be increased. Most surface retarders require an initial curing period prior to removal of the matrix.

Workability Agents and Pumping Aids

Improved workability is important for concrete placed in heavily reinforced members or placed by pumping or tremie methods. Frequently, increasing the cement content or the amount of fine aggregate will give the desired workability. One of the best workability agents is entrained air. It acts as a "lubricant" and is especially effective in improving workability and preventing segregation.

Finely divided materials are also used as admixtures to improve workability of mixes deficient in material passing the No. 50 and No. 100 sieves. These materials may be chemically inert or pozzolanic. Inert materials include ground quartz, ground limestone, hydrated lime, and talc. Pozzolans include fly ash, volcanic glass, diatomaceous earths, and some clays and shales heat-treated or raw.

Fly ash from an approved source may be used as a cement replacement in all classes of concretes, provided a design mix has been run using the substitution. Class C Fly Ash should not be used in concrete that may be subjected to sulfate exposure in soil or water.

Monomolecular Film Coatings / Water Fog Sprays

Monomolecular Film Coatings may be applied to concrete slabs or other flatwork as a method to effectively retard surface evaporation. When placing bridge deck concrete or roadway concrete pavement, a film coating shall only be used ahead of the finishing machine during emergency situations, such as a breakdown of the finishing machine. Under these conditions, this type of application is considered to be equivalent to water fog spray.

Accordingly, its usage shall be subject to the established construction guidelines, per approval of the Engineer. A monomolecular film coating may be used after the finishing operation to prevent evaporation until the wet curing material is in place. The film shall be applied as a fine mist in small quantities.

Prefomed Expansion Joint Material

Damage may occur during shipping, handling, and/or storage on the project. Therefore, immediately prior to use, project personnel shall inspect the material for physical

damage, dryness, bleaching, etc. Any portion of a shipment may be rejected prior to use at the direction of project personnel.

ITEM 602 REINFORCING STEEL (EPOXY COATED)

NOTE: Only producers of epoxy-coated reinforcing steel, in accordance with CP 11, that are on CDOT's Qualified Manufacturers List can be used:

www.dot.state.co.us/App_APL/QML.cfm

COC Acceptance. Bars shall meet the requirements of Subsection 709.01 prior to coating. Epoxy coated bars shall meet the requirements of the latest edition of AASHTO M 284.

Coated bars shall be tied with coated tie wires and placed on plastic supports or fully coated steel supports.

Field inspect epoxy-coated steel carefully. Document field inspection, attach mill test reports to the CDOT Form # 157. Retain all copies in the field Project Files.

ITEM 602 REINFORCING STEEL

NOTE: Only Reinforcing Steel Mills, in accordance with CP 11, that are on CDOT's Qualified Manufacturers List can be used:

www.dot.state.co.us/App_APL/QML.cfm

Field inspections, by the Engineer, should indicate that the reinforcing steel is clean and if Epoxy-Coated, that the coating is not chipped, cracked, or scratched. The steel should also be checked for proper size and grade using information listed below.

The CDOT Staff Bridge Branch uses several different strengths of reinforcing steel for design purposes. It is necessary for field forces to watch the bar list on the bridge plans for higher strength grades, find their exact locations on the bridge plans, and be sure the correct steel is being used in that location.

Grade 60 has a yield strength of 60,000 psi and has either a "60" on the bar or a single continuous longitudinal line through at least five

spaces offset from the center of the barside. This grade may be substituted on an equal basis for Grade 40 without prior approval. However, make note of this in the project records if substitution is made.

[Grade 400 has a yield strength of 400 MPa and has either a "4" on the bar or a single continuous longitudinal line through at least five spaces offset from the center of the barside. This grade may be substituted on an equal basis for Grade 300 without prior approval. However, make note of this in the project records if substitution is made.]

Grade 75 has a yield strength of 75,000 psi and has either a "75" on the base or two continuous longitudinal line through at least five spaces offset each direction from the center of the bar.

[Grade 500 has a yield strength of 500 MPa and has either a "5" on the base or two continuous longitudinal line through at least five spaces offset each direction from the center of the bar.]

An effort should be made to note in the project diary and on appropriate CDOT forms the grades of reinforcing steel used and especially note when different grades were used in special locations.

Concrete blocks or chairs for support of reinforcing steel need not be tested or documented unless there is reason to believe they lack conformance with CRSI recommended practices.

Certain items contain reinforcing steel, which is not included in the quantities of Item 602. These include precast, concrete bridge caissons, drop inlets, manholes, sign footings, slope and ditch pavements, and dowels in concrete pavement. When totaling up the pay quantity for these items, be sure the steel for these items is not included in reporting Item 602.

WIRE MESH

Wire mesh: Field inspect. Document in the Project Files.

TABLE OF GAGE MEASUREMENTS

The term "gage" is used by the metal industry to denote a nominal dimension. This table defines those dimensions. Galvanized sheet steel is, of course, thicker than bare sheet steel. This difference is caused by the application of a double surface coating of zinc representing 2 to 2.5 oz. per sq. ft.

Wire gage is the diameter of the finished product whether galvanized or bare. The galvanizing on wire may vary from a thin film to as much as 2 oz. per sq. ft. of area. In the case of chain link fence wire, a 2 oz. coating may contribute as much as 0.007 in. to the diameter.

The figures in the Table 600-1 pertain to actual thicknesses and diameters, but may vary because of manufacturer's tolerances. For example, culvert sheets may be 0.006 to 0.009 in. undersize. Multi-plate sheets may be as much as 0.012 in. undersize. Wire can vary as much as \pm 0.005 in. from the given diameter. To determine spelter thickness, consider 1 oz. per sq. ft. of zinc coating to be 0.0017 in. thick.

- ITEM 603 Culverts**
- 604 Sewer Pipe**
- 617 Culvert Pipe**
- 624 Corrosion Resistant Culverts**

SHEET STEEL		WIRE GAGE		SHEET STEEL		WIRE GAGE	
Bare <u>Inches</u>	Galv <u>Inches</u>	Diameter <u>Inches</u>		Bare <u>mm</u>	Galv <u>mm</u>	Diam. <u>mm</u>	
.2758	.280	1	.283	7.005	7.112	1	7.188
.2451	.249	3	.244	6.225	6.325	3	6.197
.2145	.218	5	.207	5.448	5.537	5	5.258
---	---	6	.192	---	---	6	4.877
.1838	.188	7	.177	4.668	4.775	7	4.496
.1793	---	7	.170	4.554	---	7	4.318
.1644	.168	8	.162	4.176	4.267	8	4.115
---	---	9	.148	---	---	9	3.759
.1345	.138	10	.135	3.416	3.505	10	3.429
---	---	11	.120	---	---	11	3.048
.1046	.109	12	.105	2.657	2.769	12	2.667
---	---	12	.099	---	---	12	2.515
.0747	.079	14	.080	1.897	2.007	14	2.032
---	---	14	.076	---	---	14	1.930
.0598	.064	16	.0625	1.152	1.626	16	1.588
.0478	.052	18	.0475	1.214	1.321	18	1.207
.0359	.040	20	.0348	0.912	1.016	20	0.884
.0299	.034	22	.0286	0.760	0.864	22	0.726

Table 600-1

CORRUGATED METAL PIPE

Final acceptance is based on field inspection by Project Personnel.

SPELTER DAMAGE REPAIR

Zinc rich paint conforming to Department of Defense DOD-P-21035A should be used for repainting damaged spelter. A Certificate of Compliance is required that indicates that the zinc rich paint meets the above referenced specification.

CONCRETE CULVERT PIPE

NOTE: Only Precast Concrete Manufacturers, in accordance with CP 11, that are on CDOT's Qualified Manufacturers List can be used: www.dot.state.co.us/App_APL/QML.cfm

Inspection of the individual pieces of the lot is left to the supplier and the field personnel. The field inspection is to be done in accordance with AASHTO M 170.

After final pay quantities are known, document them on a CDOT Form # 157.

VITRIFIED CLAY PIPE

The project field personnel should inspect the pipe and document information in the Project Files.

PIPE JOINT SEALING COMPOUND

Most joints will require some type of sealing material. The choice is limited to either performed plastic sealing compound or bituminous mastic. Both must meet AASHTO M 198 specification. Portland cement grout is not allowed. Rubber gaskets are required for siphon and sanitary sewers and also may be used without further approval on storm sewers and culverts.

The performed plastic sealing compound is supplied with removable paper strips between layers. A primer is required. Instructions require the primer to dry hard before applying the joint sealer. It is strongly recommended that the primer

be applied by the contractor at the jobsite rather than by the pipe manufacturer in his plant. This helps keep dirt off the primer surface and coats any chipped surfaces. Cold and wet weather require special installation procedures.

Acceptable products are: Ram-Nek, Synco Flex, Phlex Rope Type II, Chemesco TC-40, Rub 'R-Nek, Kent Seal No. 2, Con-Seal 102, Con-Seal 202, and E-Z Stik. On the CDOT Form #157 that accompanies the sample list trade name, manufacturer, and any analysis or specification data found on the label.

ITEM 604, MANHOLES

Manholes will have stamped on each section the date of manufacture and name or trademark of the fabricator. Inspect these sections for the same characteristics listed and explained under Concrete Culvert Pipe. Document in the Project Files that the material was field inspected and acceptable, and add a statement to the effect that the material was in good condition when installed.

ITEM 606 GUARD RAIL

Treated Timber Posts & Galvanized Steel Posts

The Central Laboratory personnel do not pre-inspect timber posts and blocks. Galvanized steel posts also are not pre-inspected. Project personnel will inspect all posts upon arrival on the project regardless of their source. This inspection will be documented on CDOT Form # 157, an example of which appears at the end of this chapter. See Special Notice to Contractors for additional information.

Final acceptance is based on field inspection by project personnel.

Type 3 W-Beam Guard Rail

When either the weathering steel or galvanized steel arrives on the job, it must be stored in such a way that water will not get in between the stacked rails. Water in a confined area, as it would be between these rails, causes a rapid loss of galvanizing in the form of white rust and definite kind of rusting in the weathering steel that leads to flaking and pitting, as well as an

uneven rust pattern. The acceptance documentation can be done on the same CDOT Form # 157 as used for acceptance of the posts. See example at the end of this Chapter.

ITEM 606 END ANCHORS

For individual components of end anchors, and types, refer to the M & S Standards for description of parts on each type. Further details are shown in the Standard Specifications, Section 710 and Subsection 710.09. The acceptance documentation can be done on the same CDOT Form # 157 as used for acceptance / verification of the posts. List the above information on the CDOT Form # 157.

ITEM 607 FENCES

Treated Timber Posts

Central Laboratory personnel do not pre-inspect timber posts. Project personnel will inspect posts and note the source, field inspect for compliance, and document on CDOT Form # 157

ITEM 613 LIGHTING*

Luminaires

Many manufacturers of luminaires that comply with our specification are "nationally known brands". It must be understood that they also manufacture luminaires that do not meet our specification and therefore, it is necessary to check the ratings of the luminaires furnished against the requirements of the plans and specifications. Document this inspection on a CDOT Form # 157. See Special Notice to Contractors for additional information.

Metal Light Standards (pole and arms)*

Many suppliers are capable of providing approved standards. Because the standards received on the job were made by a company previously approved, does not imply that they meet the requirements of the plans and specifications, since they also supply poles and arms in other sizes and to other specifications. It is necessary to check all features against the requirements of the plans and specifications. Document this

inspection on a CDOT Form # 157. See Special Notice to Contractors.

* See the Schedule for Item 613

ITEM 614 TRAFFIC CONTROL DEVICES

Sign Posts

Structural Steel: These posts have the break-away feature which requires the bolts to be torqued. The upper, or fuse plate bolts, are normally shop tightened. Therefore, field checking of these fuse plate bolts should be necessary. The lower or break-away bolts are tightened more than the required torque so that during shipment and erection, the two parts stay attached. Therefore, it is necessary after erection, for the contractor to loosen these break-away bolts and retighten them with torque wrench to the torque values shown on the plans. (Standard Drawing S-614-5). Be careful not to over tighten them. It is very important to burr the threads of the break-away bolts to prevent the nuts for loosening. **Be sure to check the torque of all bolts because if they are not tightened properly, the sign will not function as designed.** Document in Project Files.

Flashing Yellow Beacons

Be sure that all features required by the standard drawing and the specifications are met by the models supplied.

Anchor Bolts for Sign Bridge Structure

The anchor bolts for wide flange posts and sign structures that go into these footings are part of the sign structure but are shipped ahead of them. Small structure anchor bolts and regular bolts should be field inspected and documented in Project Files. See Special Notice to Contractors.

ITEM 615 WATER CONTROL DEVICES

Drawing M-615-A requires the use of a joint sealer meeting Federal Specification SS-S-168 or approved equivalent to make the adjustable elbows watertight. A very successful sealer has been Perma Gum. Other acceptable equivalents are TC 40, Flash Patch, Ram Nek, and CS 208 which, although they do not precisely meet SS-S-168, are considered an acceptable equivalent.

ITEM 624 CORROSION RESISTANT CULVERTS

There are several different types of culvert materials available, some of them new, and each with different corrosive resistant characteristics. To take economic advantage of this, six different levels of corrosive conditions have been defined and the available culvert materials designated as useable or not useable for each level, so the contractor can select the most economical material.

Most projects will have no corrosive problems. However, when they are encountered, they should be recognized during the soil survey. The decision on what corrosive condition exists is properly made by the Region Materials Engineer, but should be done with the help of both the Project Engineer and the Resident Engineer. The CDOT Form # 554 must document all reasons for this decision so that it can be justified. The Soils Survey portion of Chapter 200 gives details on what to look for and when to suspect the existence of a corrosive condition. When the condition is not clear, samples of either or both the soil and water involved should be tested. A recommendation can then be determined based on the analysis of these test results.

CDOT Forms - Applicable for the Concrete Chapter, Examples and Instructions

Form	Title	Page
# 1188	Concrete Mix Submittal [including Contractor's supplemental documentation].....	15-24
# 157	Field Report for Sample Identification or Materials Documentation.....	25-35
# 46	Concrete Truck Mixer Inspection Certification	36
# 82	Concrete Specimen Transmittal.....	37-39
# 156	Concrete Test Results Summary	40
# 192	Report of Concrete Tests	41-43
# 193	Inspection- Quality Assurance Acceptance Report.....	44
# 196-A	Physical Test Report	45
# 199	Concrete Core Tests	46
# 276	Report of Concrete Placed.....	47
# 281	Concrete Batched and Placed	48
# 389	Field Report for Joint Sealant Testing.....	49
# 1372	Reinforcing Bar Physical Test Report	50-52
# 1373	Concrete Mix Design Report.....	53
# 1375	Concrete Field Tests Report	54

COLORADO DEPARTMENT OF TRANSPORTATION CONCRETE MIX SUBMITTAL <input type="checkbox"/> Metric units <input checked="" type="checkbox"/> English units This submittal form shall be used to submit a concrete mix design for review by the Concrete Unit of Staff Materials. No CDOT Form #157 is needed.	Project code (SA#) 11925
	Project No. IM 0253-151
	Proj. location SH 7 to WCR 16
	Region 4 Date 9/8/03
	Contractor Kraemer and Sons
	Concrete supplier Western Ash

Project contact person for this mix submittal:	Name Hank Williams	Phone# (303) 828-2647 FAX# (303) 828-0430
--	------------------------------	--

Status

New mix

Resubmittal of existing mix. Existing CDOT mix number: _____

Item

412 - Pavement 601 - Structural

503 - Caisson [Other: _____

Class

B P D (Bridge Deck) _____ DT _____

BZ S D (Superstructure) _____ [Other: _____

The Contractor is required to **submit the following information for mix approval**. Please indicate what information is attached:

Mix design proportions (cement, fly ash, aggregates, and; pounds per cubic yard or kilograms per cubic meter)

Source of each ingredient (supplier and type of cement and fly ash; pit names and sizes of aggregates; manufacturer and type of admixtures)

Trial mix data (slump, air content, unit weight, design yield, trial mix yield, water/cement ratio, and 28 day compressive strengths from trial mix conducted by Contractor. Include 28 day flexural strengths for paving concrete)

Aggregate test data (gradations, -#200, fineness modulus, specific gravities, absorptions, for each aggregate, plus sand equivalent for fine aggregate and LA Abrasion for coarse aggregate)

Attach index of project special provisions, index of standard special provisions and applicable specifications.

Explanation

(Please explain any information not supplied at this time. For example: The compressive strengths are not yet available, but will be phoned in next week.)

Original - Project Files

Materials & Geotechnical Branch - with attachments

Region Mats Engr. - with attachments

CDOT Form #1188 3/04



Mulligan Testing Laboratories

1301 South Birch Street, Denver, CO 80222

Freddy's Ready Mix Concrete Co. ID No.: 42352
Trial Date: 02-10-2003
CDOT Concrete Class D

MIX DESIGN MATERIALS:

Material	Per Cubic Yard
Sand	1152 lbs.
Cement (I/II)	512 lbs.
Fly Ash (Class F)	128 lbs.
Aggregate Size # 67	1802 lbs.
Water	261.5 lbs. (33.0 gal.)
Water Reducing Agent	25.8 oz.
Air Entrainment Agent	2.7 oz.

The above weights are based upon aggregates in a saturated, surface dry condition. Batch plant corrections must be made for moisture in aggregates.

PHYSICAL PROPERTIES:

Unit Weight:	141.1 pcf
Yield:	1.01
Water/Cement Ratio:	0.41
Air Content:	6.2 %
Slump:	3.50 in.

COMPRESSIVE STRENGTH RESULTS:

(From laboratory trial)

Cylinder Break Time	Cylinder Number							Average Strength (psi)
	1	2	3	4	5	6	7	
3-Day	4040	4220	-	-	-	-	-	4130
7-Day	-	-	4720	4680	-	-	-	4700
28-Day	-	-	-	-	5730	5300	5380	5470



Material Suppliers and Sources:

Material	Company	Source
Fine Aggregate:	Blarney Sand & Gravel	Shamrock Pit East
Coarse Aggregate:	Blarney Sand & Gravel	Shamrock Pit West
Cement (Type I/II):	Celtic Cement Co.	Guffey, Colorado
Fly Ash (Class F):	Finnegan Fly Ash Co.	McClure, Colorado
Water Reducing Agent:	Antrim Admixtures Co.	Antrim H2O
Air Entrainment Agent:	Antrim Admixtures Co.	Antrim Super Air

Coarse Aggregate

Sieve Analysis

Sieve	% Passing	Spec
1"	100	100
3/4"	92	90-100
1/2"	54	
3/8"	41	20-55
#4	6	0-10
#8	3	0-5
#200	0.8	0-1.5

Specific Gravity: 2.64
Absorption: 0.9 %
Sodium Soundness: 1 % loss

L.A. Abrasion: 42 % loss
Voids & Unit Weight: 38%; 103 pcf
ASTM C1260: 0.182 % expansion

Fine Aggregate

Sieve Analysis

Sieve	% Passing	Spec
3/8"	100	100
#4	99	95 - 100
#8	94	80 - 100
#16	70	50 - 85
#30	50	25 - 60
#50	22	10 - 60
#100	8	2 - 10
#200	2.4	0 - 3.0

Specific Gravity: 2.65
Absorption: 0.7 %
Sodium Soundness: 1 % loss
Fineness Modulus: 2.61

Sand Equivalent: 83
Organic Impurities: Plate # 1
ASTM C1260: 0.071 % expansion





Mulligan Testing Laboratories

1301 South Birch Street, Denver, CO 80222

March 24, 2003

Freddy's Ready Mix Concrete Company
Attention: Frederick Fletcher
52 Wesley Avenue
Bailey, CO 80421

Dear Mr. Fletcher,

This letter reports the results of the potential reactivity tests (mortar bar method), which our lab performed for you. The materials were received at our facility in March 2003. The aggregates were defined as "Shamrock Pit Aggregates." The mix was compiled of 63.4% coarse aggregates and 36.6% fine aggregates. Along with the aggregates, Celtic cement Type I/II and Finnegan Class F fly ash were submitted.

The aggregate samples were prepared and tested in conformance with ASTM C 1260, "Potential Alkali Reactivity of Aggregates (Mortar Bar Method)". Since the coarse aggregate did not meet the CDOT requirement for expanding no more than 0.10% after 16 days, the aggregates, cement and fly ash were combined in proportion to the mix design and tested according to CPL 4202 "Determining the Potential Alkali Reactivity of Cementitious Materials and Aggregate (Accelerated Mortar Bar Method)". The 16-day expansion for the mix was 0.056%. These results are presented in Tables 1, 2 and 3 and graphed in Figure One.

This data signifies that the potential for deleterious behavior of this concrete mix is low. Please feel free to contact me with any questions you may have regarding this report.

Sincerely,

Patrick Mulligan
Laboratory Manager
Mulligan Testing Laboratories

Enclosures



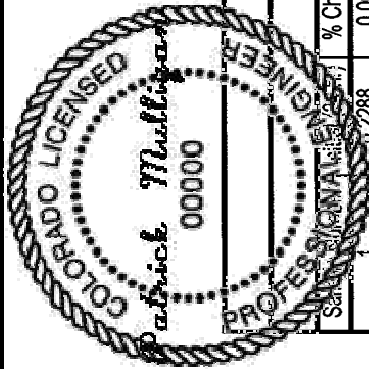

Table 1 - ASR Sand Test

Sample Number	Initial (24 hr)	% Change	Zero (48 hr)	3-Day Reading	% Change	7-Day Reading	% Change	10-Day Reading	% Change	14-Day Reading	% Change
1	0.2288	0.0000	0.2296	0.2311	0.015	0.2336	0.040	0.2355	0.059	0.2398	0.102
2	0.2304	0.0000	0.2314	0.2336	0.022	0.2351	0.037	0.2364	0.050	0.2377	0.063
3	0.2265	0.0000	0.2276	0.2299	0.023	0.2307	0.031	0.2316	0.040	0.2324	0.048
Average	-	0.000	-	-	0.020	-	0.036	-	0.050	-	0.071

Table 2 - ASR Gravel Test

Sample Number	Initial (24 hr)	% Change	Zero (48 hr)	3-Day Reading	% Change	7-Day Reading	% Change	10-Day Reading	% Change	14-Day Reading	% Change
1	0.3688	0.0000	0.3604	0.3657	0.053	0.3694	0.090	0.3738	0.134	0.3789	0.185
2	0.3484	0.0000	0.3492	0.3511	0.019	0.3536	0.044	0.3598	0.106	0.3654	0.162
3	0.3622	0.0000	0.3648	0.3694	0.046	0.3733	0.085	0.3797	0.149	0.3848	0.200
Average	-	0.000	-	-	0.039	-	0.073	-	0.130	-	0.182

Table 3 - ASR Mix Test

Sample Number	Initial (24 hr)	% Change	Zero (48 hr)	3-Day Reading	% Change	7-Day Reading	% Change	10-Day Reading	% Change	14-Day Reading	% Change
1	0.2128	0.0000	0.2185	0.2201	0.016	0.2213	0.028	0.2230	0.045	0.2253	0.068
2	0.1731	0.0000	0.1764	0.1778	0.014	0.1787	0.023	0.1800	0.036	0.1811	0.047
3	0.2034	0.0000	0.2093	0.2112	0.019	0.2122	0.029	0.2136	0.043	0.2145	0.052
Average	-	0.000	-	-	0.016	-	0.027	-	0.041	-	0.056

Figure 1 - Potential Alkali Reactivity

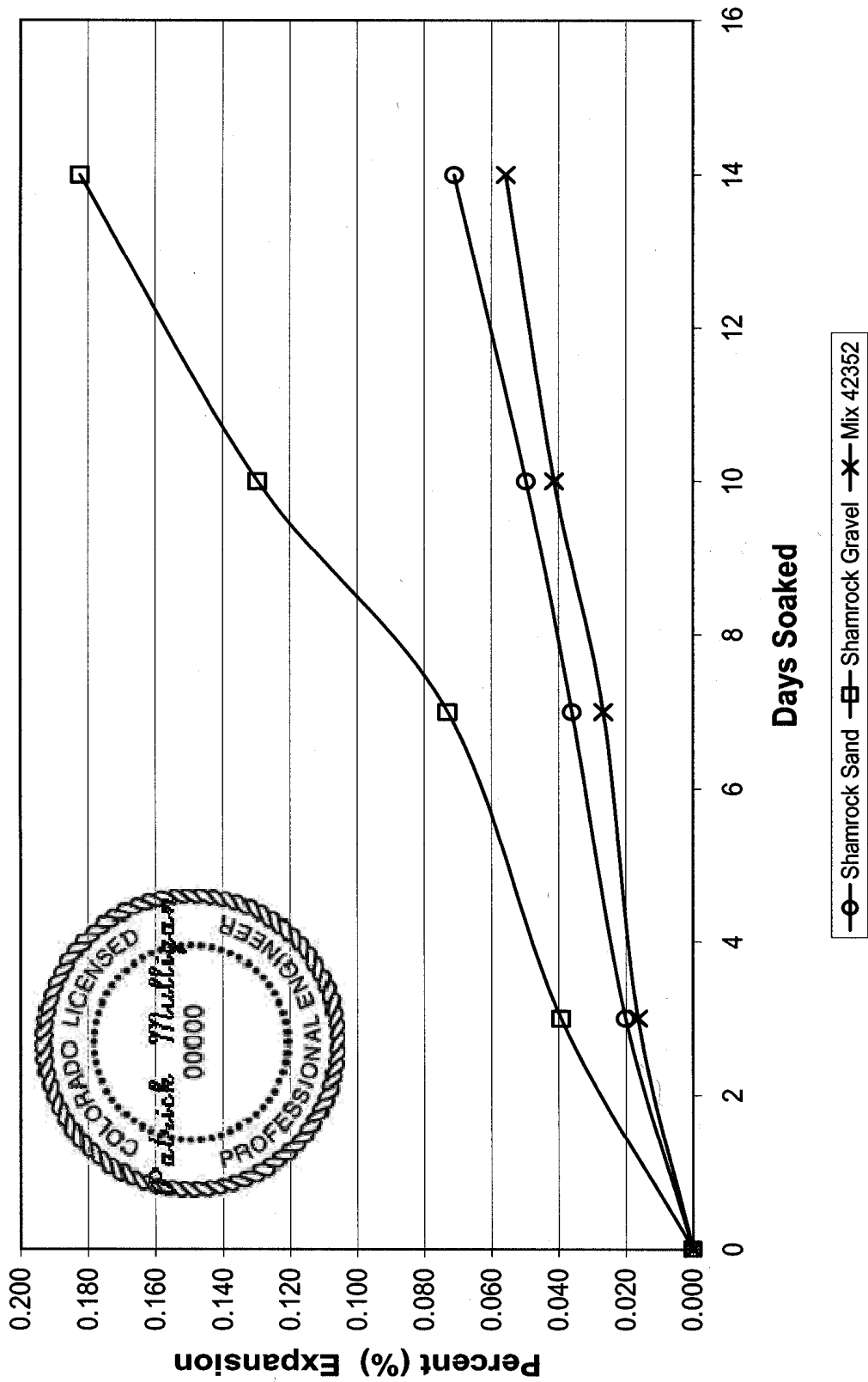



CELTIC CEMENT COMPANY
3000 East Donegal Drive
Guffey, CO 80820

Material Certification Report

Material:	Hydraulic Cement, Portland Cement
Type:	I/II (ASTM C150)
Test Period:	February 1, 2003 to March 1, 2003

General Information

Supplier:	Celtic Cement Company
Address:	3000 East Donegal Drive, Guffey, CO 80820
Telephone:	303-555-1258
Source Location:	Guffey, Colorado

Celtic Cement meets the specifications of ASTM C1157 for Type GU cement and ASTM C150 for Type I/II cement. While permitted additions may result in differing compound calculations, the physical properties of the cement are virtually unchanged.

Test Results for ASTM Requirements

Item	Physical		Result
	C150	C1157	
Air Content (%)	12 (max)	-	7
Blaine Fineness (m ² /kg)	280 (min)	-	378
+45 μm (No. 325) Sieve (%)	-	-	1.5
-45 μm (No. 325) Sieve (%)	-	-	98.5
Autoclave Expansion (%)	0.80 (max)	0.80 (max)	0.03
Compressive Strength psi (Mpa)			
3 day	1740 (12.0) (min)	1450 (10.0) (min)	4250 (29.3)
7 day	2760 (19.0) (min)	2470 (17.0) (min)	5600 (38.6)
Initial Vicat (minutes)	45-375	45-420	95
Final Vicat (minutes)	-	-	225
Motar Bar Expansion	-	0.020 (max)	0.000

Chemical		
Item	Limit (%)	Result (%)
SiO ₂	20.0 (min)	21.00
Al ₂ O ₃	6.0 (max)	4.80
Fe ₂ O ₃	6.0 (max)	3.20
CaO	-	64.10
MgO	6.0 (max)	1.10
SO ₃	3.0 (max)	2.90
Loss on Ignition	3.0 (max)	1.30
Insoluble Residue	0.75 (max)	0.59
Potential Compounds:		
C ₃ S	-	56.00
C ₂ S	-	18.00
C ₃ A	8 (max)	7.00
C ₄ AF	-	10.00

Note: The preceding information is based on average test data during the stated test period. This data is typical of cement shipped by Celtic Cement, however, individual shipments may vary slightly.

Test Results for ASTM Optional Requirements

Chemical (C150)

Item	Result (%)
Equivalent Alkalies (%)	0.76

Finnegan Fly Ash Company **FFA**
 1200 O'Connell Street, McClure, CO 80463

Material Certification Report

Material:	Class F Fly Ash
Test Period:	March 21, 2003
Procedure:	ASTM C618-00

General Information

Supplier:	Finnegan Fly Ash Company
Address:	1200 O'Connell Street, McClure, CO 80463
Telephone:	303-555-1258
Source Location:	McClure, Colorado

All tests have been made in strict accordance with the current standards of the American Society for Testing and Materials covering the material specified.

Test Results for ASTM Requirements

Physical Analysis		
Item	Result	Specifications
Fineness, amt retained on #325 sieve, %	16.10	34.00 (max)
Variation, points from average	2.20	5.00 (max)
Density, g/cm ³	1.99	-
Variation from average, %	0.01	5.00 (max)
Strength Activity Index, with Portland Cement		
@ 7 days, % of cement control	79.52	-
@ 28 days, % of cement control	84.75	75.00 (min)
Water Requirement		
% of cement control	97.11	105.00 (max)
Soundness, autoclave expansion or contraction, %	0.03	0.80 (max)

Chemical Analysis		
Item	Results (%)	Specifications
Silicon Dioxide, SiO ₂	61.74	-
Aluminum Oxide, Al ₂ O ₃	25.96	-
Ferric Oxide, Fe ₂ O ₃	4.66	-
SiO ₂ +Al ₂ O ₃ +Fe ₂ O ₃	92.36	70.00 (min)
Calcium Oxide, CaO	2.28	-
Magnesium Oxide, MgO	0.96	-
Sulfur Trioxide, SO ₃	0.07	5.00 (max)
Moisture Content	0.08	3.00 (max)
Loss on Ignition	0.38	5.00 (max)
Available Alkalis as Na ₂ O	0.71	1.50 (max)
Sodium Oxide, Na ₂ O	1.38	-
Potassium Oxide, K ₂ O	1.09	-
R Factor	-0.58	-

**COLORADO DEPARTMENT OF TRANSPORTATION
CONCRETE MIX DESIGN REPORT**

CDOT MIX NUMBER: 2003000

PROJECT CODE : 12345	CONCRETE CLASS : D
PROJECT NO. : MR 2854-012	SULFATE RESISTANCE CLASS : 2 AND LOWER
LOCATION : West of Bailey	FIELD STRENGTH : 4500 psi
REGION : 1	LAB DESIGN STRENGTH : 5175 psi
ITEM NUMBER : 601	CONCRETE SUPPLIER : Freddy's Ready Mix
SUPPLIER MIX ID : 777	CONTRACTOR : Carmody Construction

CONCRETE MIX PROPORTIONS (SSD BATCH WEIGHTS FOR 1 CUBIC YARD)

CEMENT : 512 lb	CEMENT SOURCE : Celtic (Guffey)	TYPE : I/II
FLY ASH : 128 lb	FLY ASH SOURCE : Finnegan (McClure)	CLASS : F
SILICA FUME : lb	SILICA FUME SOURCE :	
COARSE : 1802 lb	COARSE AGG. SOURCE : Blarney, Shamrock Pit Size 57/67	
INTERMEDIATE : lb	INT. AGG. SOURCE :	
FINE (SAND) : 1152 lb	FINE AGG. SOURCE : Blarney, Shamrock Pit	
AIR ENTRAINER : 2.7 oz	AIR ENTRAINER SOURCE : Antrim, Super-Air	
WATER REDUCER : 25.8 oz	WATER REDUCER SOURCE : Antrim, H2O	
ADMIXTURE : oz	ADMIXTURE SOURCE :	
ADMIXTURE : oz	ADMIXTURE SOURCE :	
WATER : 262 lb		

PHYSICAL PROPERTIES OF TRIAL BATCH COMPRESSIVE STRENGTH (PSI) FLEXURAL STRENGTH (PSI)

TRIAL DATE : 2/10/2003	SLUMP : 3.50 "	7-DAY	14-DAY	28-DAY	56-DAY	7-DAY	28-DAY
UNIT WEIGHT : 141.1 lbs/ft ³	AIR CONTENT : 6.20 %	4720		5730			
W / C RATIO : 0.41	RELATIVE YIELD : 1.01	4680		5300			
AASHTO PP34 RING TEST :	DAYS			5380			
ASTM C1202; 56-DAY PERMEABILITY :	COULOMBS						

COARSE, INTERMEDIATE, AND FINE AGGREGATE TEST RESULTS

COARSE DATE : 2/10/2003	INTERMEDIATE DATE :	FINES DATE : 2/10/2003
MEETS GRADATION? : YES	MEETS GRADATION? :	MEETS GRADATION? : YES
SPECIFIC GRAVITY (SSD) : 2.64	SPECIFIC GRAVITY (SSD) :	SPECIFIC GRAVITY (SSD) : 2.65
ABSORPTION (%) : 0.9	ABSORPTION (%) :	ABSORPTION (%) : 0.7
LA ABRASION (%) : 42.0	LA ABRASION (%) :	FINENESS MODULUS : 2.65
CP-L4201 (%) : 0.18	CP-L4201 (%) :	SAND EQUIVALENT : 83
AGG. SOUNDNESS (%) : 1	AGG. SOUNDNESS (%) :	CP-L4201 (%) : 0.071
UNIT WEIGHT (PCF) : 103	UNIT WEIGHT (PCF) :	AGG. SOUNDNESS (%) : 1
VOIDS (%) : 38	VOIDS (%) :	ORGANIC IMPURITIES : Plate 1

CP-L4202 RESULT(%) : 0.05 CP-L4202 Mix design proportions
 CP-L4202 DATE : 2/10/2003 MITIGATIVE :
 MEASURES

COMMENTS :

CDOT PROJECT COPY

REVIEWED BY : Miranda Roskop REVIEW DATE : 3/26/2003

PLEASE CONTACT CDOT CONCRETE AND PHYSICAL PROPERTIES LAB AT 303-398-6542 WITH ANY QUESTIONS

CDOT Form #1373 1/08

**COLORADO DEPARTMENT OF TRANSPORTATION
CONCRETE MIX DESIGN REPORT**

CDOT MIX NUMBER: 2003000

PROJECT CODE : 12345	CONCRETE CLASS : D
PROJECT NO. : MR 2854-012	SULFATE RESISTANCE CLASS : 2 AND LOWER
LOCATION : West of Bailey	FIELD STRENGTH : 4500 psi
REGION : 1	LAB DESIGN STRENGTH : 5175 psi
ITEM NUMBER : 601	CONCRETE SUPPLIER : Freddy's Ready Mix
SUPPLIER MIX ID : 777	CONTRACTOR : Carmody Construction

PHYSICAL PROPERTIES OF TRIAL BATCH		COMPRESSIVE STRENGTH (PSI)				FLEXURAL STRENGTH (PSI)	
TRIAL DATE	SLUMP	7-DAY	14-DAY	28-DAY	56-DAY	7-DAY	28-DAY
: 2/10/2003	: 3.50 "	4720		5730			
UNIT WEIGHT : 141.1 lbs/ft ³	AIR CONTENT : 6.20 %	4680		5300			
W / C RATIO : 0.41	RELATIVE YIELD : 1.01						
AASHTO PP34 RING TEST :	DAYS			5380			
ASTM C1202; 56-DAY PERMEABILITY :	COULOMBS						

COMMENTS :

CONTRACTOR COPY

REVIEWED BY : Miranda Roskop

REVIEW DATE : 3/26/2003

PLEASE CONTACT CDOT CONCRETE AND PHYSICAL PROPERTIES LAB AT 303-398-6542 WITH ANY QUESTIONS
CDOT Form #1373 1/08

COLORADO DEPARTMENT OF TRANSPORTATION FIELD REPORT FOR SAMPLE IDENTIFICATION OR MATERIALS DOCUMENTATION				Field sheet No. 120227	Date 11/28/02
Metric units <input type="checkbox"/> yes <input checked="" type="checkbox"/> no				Project No. IM0253-151	Project location I-25, SH 7 to WCR 16
		Project code (SA#) 11925	Function 3200	Region 4	Part. P
Sample submitted: <small>(ie.: Soil, ABC, Hydrated lime, HMA, concrete cores, steel, etc.)</small> Cores				Field office phone number 303-828-0386	Field office FAX number 303-828-0430
Item 412	Class PFA	Grading Mix #98034	Special provisions applicable: <input checked="" type="checkbox"/> yes <input type="checkbox"/> no		
Previously used on Project No.: Air 7.1/Slump 5.5		Previous CDOT Form #157 F/S No.(s): Placed on 10/25/02		<input type="checkbox"/> CDOT Form #633 (sack) <input type="checkbox"/> CDOT Form #634 (can)	
<ul style="list-style-type: none"> ● Sample Identification: Quantity & Unit of material submitted, describe tests required, precise location sample removed from (stationing), etc. ● Materials Documentation: Field inspected (describe appearance, weight/dimensions, model/serial number), COC &/or CTR provided, etc. 					
Submitting (3) cores for Compressive Strength.					
Time cored was 3 PM. Date 11/28/02					
Please call head tester @ 303-555-2525					
A) 93+780					
B) 93+785					
C) 93+775					
Cored at 35 days					
APL/QML Acceptance: APL Ref. No.		Product name:		Date checked:	
APL/QML Acceptance: APL Ref. No.		Product name:		Date checked:	
Preliminary <input type="checkbox"/>		Construction <input checked="" type="checkbox"/>		Maintenance <input type="checkbox"/>	
		Emergency <input type="checkbox"/>		Date needed ASAP	
Contractor Kraemer and Sons			Supplier LaFarge		
Sampled from <small>(Pit, roadway, window, stock, etc.)</small> Roadway			Pit name or owner		
Quantity represented		Previous quantity		Total quantity to date	
Sample submitted: <input checked="" type="checkbox"/> Yes <input type="checkbox"/> No		Shipped to: <input checked="" type="checkbox"/> Central lab <input type="checkbox"/> Region lab		Via Geocal	
				Date 11/29/02	
Sampled or inspected by (Name) D. Elsbernd		(Title) Q. A. Tech		Lab phone number 303-828-2644	
Supervisor <small>(Pro./Res./Mats. Engr./Maint. Supt.)</small> Corey Stewart		Title P. E. I		Address 1050 Lee Hill Rd. Boulder, Co. 80302	
Distribution: White copy - Staff Materials Branch <small>(submit white copy only if sample or information is directed to Staff Materials)</small> Canary copy - Region Materials Engineer Pink copy - Resident Engineer				CDOT Form #157 9/07	
Previous editions may be used until supplies are exhausted					

COLORADO DEPARTMENT OF TRANSPORTATION FIELD REPORT FOR SAMPLE IDENTIFICATION OR MATERIALS DOCUMENTATION Metric units <input type="checkbox"/> yes <input checked="" type="checkbox"/> no				Field sheet No. 120227		Date 11/28/02	
				Project No. IM0253-151		Project location I-25, SH 7 to WCR 16	
Project code (SA#) 11625		Function 3200		Region 4		Part. P	
Sample submitted: <small>(ie. Soil, ABC, Hydrated lime, HMA, concrete cores, steel, etc.)</small>						Field office phone number 303-828-0386	
Cores						Field office FAX number 303-828-0430	
Item 412		Class B		Grading Column A		Special provisions applicable: <input checked="" type="checkbox"/> yes <input type="checkbox"/> no	
Previously used on Project No.: Air 7.1/Slump 5.5			Previous CDOT Form #157 F/S No.(s): Mix #2001049			<input type="checkbox"/> CDOT Form #633 (sack) <input type="checkbox"/> CDOT Form #634 (can)	
<ul style="list-style-type: none"> ● Sample Identification: Quantity & Unit of material submitted, describe tests required, precise location sample removed from (stationing), etc. ● Materials Documentation: Field inspected (describe appearance, weight/dimensions, model/serial number), COC &/or CTR provided, etc. 							
Submitting (3) cores for Compressive Strength.							
Time cored 5:00 PM Date 3/12/01							
1) 832+88.10							
2) 832+90							
3) 833+00							
Cored at 33 Days							
APL/QML Acceptance: APL Ref. No.		Product name:				Date checked:	
APL/QML Acceptance: APL Ref. No.		Product name:				Date checked:	
<input type="checkbox"/> Preliminary		<input checked="" type="checkbox"/> Construction		<input type="checkbox"/> Maintenance		<input type="checkbox"/> Emergency	
						Date needed ASAP	
Contractor Kraemer and Sons				Supplier Ready Mix			
Sampled from <small>(Pit, roadway, windrow, stock, etc.)</small> Roadway				Pit name or owner			
Quantity represented Placed 2/7/01		Previous quantity Removed 3/12/02		Total quantity to date			
Sample submitted: <input checked="" type="checkbox"/> Yes <input type="checkbox"/> No		Shipped to: <input checked="" type="checkbox"/> Central lab <input type="checkbox"/> Region lab		Via Geocal		Date 3/12/01	
Sampled or inspected by (Name) D. Elsbernd		(Title) Q.A. Tech		Lab phone number 303-828-2644			
Supervisor <small>(Pro./Res./Mats. Engr./Maint. Supt.)</small> Corey Stewart		Title P.E. I		Address 1050 Lee Hill Rd. Boulder, Co. 80302			
Distribution: White copy - Staff Materials Branch <small>(submit white copy only if sample or information is directed to Staff Materials)</small> Canary copy - Region Materials Engineer Pink copy - Resident Engineer						CDOT Form #157 9/07	
Previous editions may be used until supplies are exhausted							

COLORADO DEPARTMENT OF TRANSPORTATION FIELD REPORT FOR SAMPLE IDENTIFICATION OR MATERIALS DOCUMENTATION Metric units <input type="checkbox"/> yes <input checked="" type="checkbox"/> no				Field sheet No. 120227		Date 4/5/03	
				Project No. IM0253-151		Project location I-25, SH 7 to WCR 16	
Project code (SA#) 11925		Function 3200		Region 4		Part. P	
Sample submitted: <small>(i.e.: Soil, ABC, Hydrated lime, HMA, concrete cores, steel, etc.)</small>				Field office phone number 303-828-0386		Field office FAX number 303-828-0430	
Reinforcing Steel							
Item 602		Class		Grading		Special provisions applicable: <input type="checkbox"/> yes <input checked="" type="checkbox"/> no	
Previously used on Project No.:				Previous CDOT Form #157 F/S No.(s):		<input type="checkbox"/> CDOT Form #633 (sack) <input type="checkbox"/> CDOT Form #634 (can)	
<ul style="list-style-type: none"> ● Sample Identification: Quantity & Unit of material submitted, describe tests required, precise location sample removed from (stationing), etc. ● Materials Documentation: Field inspected (describe appearance, weight/dimensions, model/serial number), COC &/or CTR provided, etc. 							
<p>The Material has been field inspected and is acceptable. Mill Test Reports are on file.</p> <p>The Steel Mill is on the CDOT QML.</p>							
APL/QML Acceptance: APL Ref. No.		Product name:			Date checked:		
APL/QML Acceptance: APL Ref. No.		Product name:			Date checked:		
Preliminary <input type="checkbox"/>		Construction <input checked="" type="checkbox"/>		Maintenance <input type="checkbox"/>		Emergency <input type="checkbox"/>	
Contractor Kraemer and Sons		Supplier Banner Rebar					
Sampled from <small>(Pit, roadway, windrow, stock, etc.)</small>				Pit name or owner			
Quantity represented 12,591 lb		Previous quantity 47,082 lb		Total quantity to date 59,673 lb			
Sample submitted: <input type="checkbox"/> Yes <input checked="" type="checkbox"/> No		Shipped to: <input type="checkbox"/> Central lab <input type="checkbox"/> Region lab		Via		Date	
Sampled or inspected by (Name) Mark Stadig			(Title) E/PS Tech III		Lab phone number 303-828-2644		
Supervisor <small>(Pro./Res./Mats. Engr./Maint. Supt.)</small> Corey Stewart			Title P. E. I		Address 1050 Lee Hill Rd. Boulder, Co. 80302		
Distribution: White copy - Staff Materials Branch <small>(submit white copy only if sample or information is directed to Staff Materials)</small> Canary copy - Region Materials Engineer Pink copy - Resident Engineer				CDOT Form #157 9/07			
Previous editions may be used until supplies are exhausted							

COLORADO DEPARTMENT OF TRANSPORTATION FIELD REPORT FOR SAMPLE IDENTIFICATION OR MATERIALS DOCUMENTATION Metric units <input type="checkbox"/> yes <input checked="" type="checkbox"/> no				Field sheet No. 120227		Date 9/9/02	
				Project No. IM0253-151		Project location I-25, SH 7 to WCR 16	
Project code (SA#) 11925		Function 3200		Region 4		Part. P	
Sample submitted: <small>(ie.: Soil, ABC, Hydrated lime, HMA, concrete cores, steel, etc.)</small>				Field office phone number 303-828-0386		Field office FAX number 303-828-0430	
Epoxy Coated Reinforcing Steel							
Item 602		Class		Grading		Special provisions applicable: <input type="checkbox"/> yes <input checked="" type="checkbox"/> no	
Previously used on Project No.:				Previous CDOT Form #157 F/S No.(s):		<input type="checkbox"/> CDOT Form #633 (sack) <input type="checkbox"/> CDOT Form #634 (can)	
<ul style="list-style-type: none"> ● Sample Identification: Quantity & Unit of material submitted, describe tests required, precise location sample removed from (stationing), etc. ● Materials Documentation: Field inspected (describe appearance, weight/dimensions, model/serial number), COC &/or CTR provided, etc. 							
This Material has been field inspected and is acceptable.							
Mill Test Reports are on file.							
Epoxy Powder Coating is on the Approved Products List.							
The supplier is on the QML.							
APL/QML Acceptance: APL Ref. No.		Product name:				Date checked:	
APL/QML Acceptance: APL Ref. No.		Product name:				Date checked:	
Preliminary <input type="checkbox"/>		Construction <input checked="" type="checkbox"/>		Maintenance <input type="checkbox"/>		Emergency <input type="checkbox"/>	
						Date needed	
Contractor Kraemer and Sons				Supplier Rio Grande			
Sampled from <small>(Pit, roadway, windrow, stock, etc.)</small>				Pit name or owner			
Quantity represented 63,858 lb		Previous quantity 14,076 lb		Total quantity to date 77,934 lb			
Sample submitted: <input type="checkbox"/> Yes <input checked="" type="checkbox"/> No		Shipped to: <input type="checkbox"/> Central lab <input type="checkbox"/> Region lab		Via		Date	
Sampled or inspected by (Name) Mark Stadig				(Title) E/PS Tech III		Lab phone number 303-828-2644	
Supervisor <small>(Pro./Res./Matis. Engr./Maint. Supt.)</small> Corey Stewart				Title P.E. I		Address 1050 Lee Hill Rd. Boulder, Co. 80302	
Distribution: White copy - Staff Materials Branch <small>(submit white copy only if sample or information is directed to Staff Materials)</small> Canary copy - Region Materials Engineer Pink copy - Resident Engineer						CDOT Form #157 9/07	
Previous editions may be used until supplies are exhausted							

COLORADO DEPARTMENT OF TRANSPORTATION FIELD REPORT FOR SAMPLE IDENTIFICATION OR MATERIALS DOCUMENTATION				Field sheet No. 120227	Date 8/7/01
				Project No. IM0253-151	Project location I-25, SH 7 to WCR 16
Metric units <input type="checkbox"/> yes <input checked="" type="checkbox"/> no		Project code (SA#) 11925	Function 3200	Region 4	Part. P
Sample submitted: <small>(ie.: Soil, ABC, Hydrated lime, HMA, concrete cores, steel, etc.)</small>				Field office phone number 303-828-0386	
Reinforced Concrete Pipe				Field office FAX number 303-828-0430	
Item 603	Class	Grading	Special provisions applicable: <input type="checkbox"/> yes <input checked="" type="checkbox"/> no		
Previously used on Project No.: Yes		Previous CDOT Form #157 F/S No.(s): 95277		<input type="checkbox"/> CDOT Form #633 (sack) <input type="checkbox"/> CDOT Form #634 (can)	
<ul style="list-style-type: none"> ● Sample Identification: Quantity & Unit of material submitted, describe tests required, precise location sample removed from (stationing), etc. ● Materials Documentation: Field inspected (describe appearance, weight/dimensions, model/serial number), COC &/or CTR provided, etc. 					
Summary of final quantities of R.C.P. used on this project. The material has					
field inspected and is acceptable. No shipping/handling damage noted.					
Manufacturer has provided C.O.C.					
◆ Quantities are as follows:					
Diameter		Class		Total Lin. Ft.	
12"		V		48	
15"		IV		330	
30"		III		328	
The supplier is on the QML.					
APL/QML Acceptance: APL Ref. No.		Product name:		Date checked:	
APL/QML Acceptance: APL Ref. No.		Product name:		Date checked:	
Preliminary <input type="checkbox"/>		Construction <input checked="" type="checkbox"/>		Maintenance <input type="checkbox"/>	
Emergency <input type="checkbox"/>				Date needed	
Contractor La Farge			Supplier Carder Concrete		
Sampled from <small>(Pit, roadway, windrow, stock, etc.)</small>			Pit name or owner		
Quantity represented		Previous quantity		Total quantity to date See Above	
Sample submitted: <input type="checkbox"/> Yes <input checked="" type="checkbox"/> No		Shipped to: <input type="checkbox"/> Central lab <input type="checkbox"/> Region lab		Via Date	
Sampled or inspected by (Name) Mark Stadig		(Title) E/PS Tech III		Lab phone number 303-828-2644	
Supervisor <small>(Pro./Res./Mats. Engr./Mant. Supt.)</small> Corey Stewart		Title P.E. I		Address 1050 Lee Hill Rd. Boulder, Co. 80302	
Distribution: White copy - Staff Materials Branch <small>(submit white copy only if sample or information is directed to Staff Materials)</small> Canary copy - Region Materials Engineer Pink copy - Resident Engineer				CDOT Form #157 9/07	
Previous editions may be used until supplies are exhausted					

COLORADO DEPARTMENT OF TRANSPORTATION FIELD REPORT FOR SAMPLE IDENTIFICATION OR MATERIALS DOCUMENTATION Metric units <input type="checkbox"/> yes <input checked="" type="checkbox"/> no				Field sheet No. 120227		Date 8/7/03	
				Project No. IM0253-151		Project location I-25, SH 7 to WCR 16	
Project code (SA#) 11925		Function 3200		Region 4		Part. P	

Sample submitted: <small>(i.e.: Soil, ABC, Hydrated lime, HMA, concrete cores, steel, etc.)</small>			Field office phone number 303-828-0386		
Corrugated Steel Pipe			Field office FAX number 303-828-0430		
Item 603	Class	Grading	Special provisions applicable: <input type="checkbox"/> yes <input checked="" type="checkbox"/> no		
Previously used on Project No.:		Previous CDOT Form #157 F/S No.(s):		<input type="checkbox"/> CDOT Form #633 (sack) <input type="checkbox"/> CDOT Form #634 (can)	
<ul style="list-style-type: none"> ● Sample Identification: Quantity & Unit of material submitted, describe tests required, precise location sample removed from (stationing), etc. ● Materials Documentation: Field inspected (describe appearance, weight/dimensions, model/serial number), COC &/or CTR provided, etc. 					
Summary of final quantities of CSP and End Sections used on this project. The material has been field inspected and is acceptable. Manufacturer has provided a C.O.C.					
Total Lin. Ft.					
CSP	24"	14			
CSP	30"	32			
CSP	36"	12			
SES	30"	4 each			

APL/QML Acceptance: APL Ref. No.		Product name:		Date checked:	
APL/QML Acceptance: APL Ref. No.		Product name:		Date checked:	
Preliminary <input type="checkbox"/>		Construction <input checked="" type="checkbox"/>		Maintenance <input type="checkbox"/>	
		Emergency <input type="checkbox"/>		Date needed	
Contractor Kraemer and Sons			Supplier Marquo Inc.		
Sampled from <small>(Pit, roadway, windrow, stock, etc.)</small>			Pit name or owner		
Quantity represented		Previous quantity		Total quantity to date	
Sample submitted: <input type="checkbox"/> Yes <input checked="" type="checkbox"/> No		Shipped to: <input type="checkbox"/> Central lab <input type="checkbox"/> Region lab		Via	
Date					
Sampled or inspected by (Name) Mark Stadig		(Title) E/PS Tech III		Lab phone number 303-828-2644	
Supervisor <small>(Pro./Res./Matis. Engr./Maint. Supt.)</small> Corey Stewart		Title P.E. I		Address 1050 Lee Hill Rd. Boulder, Co. 80302	

Distribution: White copy - Staff Materials Branch
 (submit white copy only if sample or information is directed to Staff Materials)
 Canary copy - Region Materials Engineer
 Pink copy - Resident Engineer

CDOT Form #157 9/07

Previous editions may be used until supplies are exhausted

COLORADO DEPARTMENT OF TRANSPORTATION FIELD REPORT FOR SAMPLE IDENTIFICATION OR MATERIALS DOCUMENTATION Metric units <input type="checkbox"/> yes <input checked="" type="checkbox"/> no		Field sheet No. 120227	Date 7/25/03	
		Project No. IM0253-151	Project location I-25, SH 7 to WCR 16	
Project code (SA#) 11925		Function 3200	Region 4	Part. P

Sample submitted: <small>(i.e. : Soil, ABC, Hydrated lime, HMA, concrete cores, steel, etc.)</small>		Luminaires and Light Standards		Field office phone number 303-828-0386								
				Field office FAX number 303-828-0430								
Item 613	Class	Grading	Special provisions applicable: <input type="checkbox"/> yes <input type="checkbox"/> no									
Previously used on Project No.:		Previous CDOT Form #157 F/S No.(s):		<input type="checkbox"/> CDOT Form #633 (sack) <input type="checkbox"/> CDOT Form #634 (can)								
<ul style="list-style-type: none"> ● Sample Identification: Quantity & Unit of material submitted, describe tests required, precise location sample removed from (stationing), etc. ● Materials Documentation: Field inspected (describe appearance, weight/dimensions, model/serial number), COC &/or CTR provided, etc. <p style="text-align: center;">Materials have been field inspected and are acceptable. Certificates of Compliance are on file.</p> <table style="width:100%; border-collapse: collapse;"> <thead> <tr> <th style="width: 50%; text-align: center;">Item:</th> <th style="width: 50%; text-align: center;">Final Quantity:</th> </tr> </thead> <tbody> <tr> <td style="text-align: center;">Light Standard Steel</td> <td style="text-align: center;">13 Each</td> </tr> <tr> <td style="text-align: center;">Concrete Foundation Pad</td> <td style="text-align: center;">13 Each</td> </tr> <tr> <td style="text-align: center;">Luminaire HPS (400 W)</td> <td style="text-align: center;">13 Each</td> </tr> </tbody> </table>					Item:	Final Quantity:	Light Standard Steel	13 Each	Concrete Foundation Pad	13 Each	Luminaire HPS (400 W)	13 Each
Item:	Final Quantity:											
Light Standard Steel	13 Each											
Concrete Foundation Pad	13 Each											
Luminaire HPS (400 W)	13 Each											
APL/QML Acceptance: APL Ref. No.		Product name:		Date checked:								
APL/QML Acceptance: APL Ref. No.		Product name:		Date checked:								
Preliminary <input type="checkbox"/> Construction <input checked="" type="checkbox"/> Maintenance <input type="checkbox"/> Emergency <input type="checkbox"/>		Date needed										
Contractor Kraemer and Sons		Supplier Acme Electric										
Sampled from <small>(Pit, roadway, windrow, stock, etc.)</small>		Pit name or owner										
Quantity represented		Previous quantity	Total quantity to date									
Sample submitted: <input type="checkbox"/> Yes <input checked="" type="checkbox"/> No		Shipped to: <input type="checkbox"/> Central lab <input type="checkbox"/> Region lab		Via								
Date												
Sampled or inspected by (Name) Mark Stadig		(Title) E/PS Tech III	Lab phone number 303-828-2644									
Supervisor (Pro./Res./Mats. Engr./Maint. Supt.) Corey Stewart		Title P.E. I	Address 1050 Lee Hill Rd. Boulder, Co. 80302									

Distribution: White copy - Staff Materials Branch
 (submit white copy only if sample or information is directed to Staff Materials)
 Canary copy - Region Materials Engineer
 Pink copy - Resident Engineer

CDOT Form #157 9/07

Previous editions may be used until supplies are exhausted

COLORADO DEPARTMENT OF TRANSPORTATION FIELD REPORT FOR SAMPLE IDENTIFICATION OR MATERIALS DOCUMENTATION Metric units <input type="checkbox"/> yes <input checked="" type="checkbox"/> no				Field sheet No. 120227		Date 9/13/02	
				Project No. IM0253-151		Project location I-25, SH 7 to WCR 16	
Project code (SA#) 11925		Function 3200		Region 4		Part. P	
Sample submitted: <small>(i.e.: Soil, ABC, Hydrated lime, HMA, concrete cores, steel, etc.)</small>				Field office phone number 303-828-0386		Field office FAX number 303-828-0430	
5 Samples of Prestressing Steel Wire							
Item 618		Class		Grading		Special provisions applicable: <input type="checkbox"/> yes <input checked="" type="checkbox"/> no	
Previously used on Project No.:				Previous CDOT Form #157 F/S No.(s):		<input type="checkbox"/> CDOT Form #633 (sack) <input type="checkbox"/> CDOT Form #634 (can)	
<ul style="list-style-type: none"> ● Sample Identification: Quantity & Unit of material submitted, describe tests required, precise location sample removed from (stationing), etc. ● Materials Documentation: Field inspected (describe appearance, weight/dimensions, model/serial number), COC &/or CTR provided, etc. <p style="text-align: center;">See attached C.O.C.'s for samples submitted for Post-Tension Steel/Wire Strand.</p> <ul style="list-style-type: none"> ◆ (2) Heat #618922 (white) ◆ (1) Heat #R133932 (orange) ◆ (1) Heat #618919 (pink) ◆ (1) Heat #618122 (blue) <p style="text-align: center;">Visually inspected By Dave Buck when taking samples for testing.</p>							
APL/QML Acceptance: APL Ref. No.		Product name:				Date checked:	
APL/QML Acceptance: APL Ref. No.		Product name:				Date checked:	
Preliminary <input type="checkbox"/>		Construction <input checked="" type="checkbox"/>		Maintenance <input type="checkbox"/>		Emergency <input type="checkbox"/>	
				Date needed 9/18/08			
Contractor Kraemer and Sons				Supplier Insted Wire Products			
Sampled from <small>(Pit, roadway, windrow, stock, etc.)</small> Coils				Pit name or owner N/A			
Quantity represented 24 Coils		Previous quantity 0		Total quantity to date 24 Coils			
Sample submitted: <input checked="" type="checkbox"/> Yes <input type="checkbox"/> No		Shipped to: <input checked="" type="checkbox"/> Central lab <input type="checkbox"/> Region lab		Via Geocal		Date	
Sampled or inspected by (Name) Dave Buck		(Title) QA Tech		Lab phone number 303-828-2644			
Supervisor <small>(Pro./Res./Matis. Engr./Mairt. Supt.)</small> Corey Stewart		Title P.E. I		Address 1050 Lee Hill Rd. Boulder, Co. 80302			
Distribution: White copy - Staff Materials Branch <small>(submit white copy only if sample or information is directed to Staff Materials)</small> Canary copy - Region Materials Engineer Pink copy - Resident Engineer				CDOT Form #157 9/07			
Previous editions may be used until supplies are exhausted							

COLORADO DEPARTMENT OF TRANSPORTATION FIELD REPORT FOR SAMPLE IDENTIFICATION OR MATERIALS DOCUMENTATION				Field sheet No. 120227	Date 9/25/02
Metric units <input type="checkbox"/> yes <input checked="" type="checkbox"/> no		Project No. IM0253-151	Project location I-25, SH 7 to WCR 16		
		Project code (SA#) 11925	Function 3200	Region 4	Part. P
Sample submitted: <small>(i.e.: Soil, ABC, Hydrated lime, HMA, concrete cores, steel, etc.)</small>				Field office phone number 303-828-0386	
Post-Tension Cable Tendons				Field office FAX number 303-8280430	
Item 618	Class	Grading	Special provisions applicable: <input type="checkbox"/> yes <input checked="" type="checkbox"/> no		
Previously used on Project No.:		Previous CDOT Form #157 F/S No.(s):		<input type="checkbox"/> CDOT Form #633 (sack) <input type="checkbox"/> CDOT Form #634 (can)	
<ul style="list-style-type: none"> ● Sample Identification: Quantity & Unit of material submitted, describe tests required, precise location sample removed from (stationing), etc. ● Materials Documentation: Field inspected (describe appearance, weight/dimensions, model/serial number), COC &/or CTR provided, etc. 					
2 Coils field inspected as per CDOT Standards. By Dave Buck and Monte Malik.					
Submitting 2 Strands of cable from lot #132375-1 and lot #132375-5 of heat					
6-34872 for all required testing as per the Standards & the CDOT FMM.					
APL/QML Acceptance: APL Ref. No.		Product name:		Date checked:	
APL/QML Acceptance: APL Ref. No.		Product name:		Date checked:	
Preliminary <input type="checkbox"/>		Construction <input checked="" type="checkbox"/>		Maintenance <input type="checkbox"/>	
		Emergency <input type="checkbox"/>		Date needed ASAP	
Contractor Kraemer and Sons			Supplier Insted Wire Products		
Sampled from <small>(Pit, roadway, windrow, stock, etc.)</small> Coils			Pit name or owner N/A		
Quantity represented 1 Heat		Previous quantity 4 Heats		Total quantity to date 5 Heats	
Sample submitted: <input checked="" type="checkbox"/> Yes <input type="checkbox"/> No		Shipped to: <input checked="" type="checkbox"/> Central lab <input type="checkbox"/> Region lab		Via Geocal	
				Date 9/25/02	
Sampled or inspected by (Name) Dave Buck		(Title) QA Tech		Lab phone number 303-828-2644	
Supervisor (Pro./Res./Mats. Engr./Maint. Supt.) Corey Stewart		Title P.E. I		Address 1050 Lee Hill Rd. Boulder, Co. 80302	
Distribution: White copy - Staff Materials Branch <small>(submit white copy only if sample or information is directed to Staff Materials)</small> Canary copy - Region Materials Engineer Pink copy - Resident Engineer				CDOT Form #157 9/07	
Previous editions may be used until supplies are exhausted					

COLORADO DEPARTMENT OF TRANSPORTATION FIELD REPORT FOR SAMPLE IDENTIFICATION OR MATERIALS DOCUMENTATION Metric units <input checked="" type="checkbox"/> yes <input type="checkbox"/> no				Field sheet No. 120227		Date 3/8/02	
				Project No. IM0253-151		Project location I-25, SH 7 to WCR 16	
Project code (SA#) 11925		Function 3200		Region 4		Part. P	
Sample submitted: <small>(ie.: Soil, ABC, Hydrated lime, HMA, concrete cores, steel, etc.)</small>				Field office phone number 303-828-0386			
Pavement Marking Materials				Field office FAX number 303-828-0430			
Item 627		Class		Grading		Special provisions applicable: <input checked="" type="checkbox"/> yes <input type="checkbox"/> no	
Previously used on Project No.:			Previous CDOT Form #157 F/S No.(s):			<input type="checkbox"/> CDOT Form #633 (sack) <input type="checkbox"/> CDOT Form #634 (can)	
<ul style="list-style-type: none"> ● Sample Identification: Quantity & Unit of material submitted, describe tests required, precise location sample removed from (stationing), etc. ● Materials Documentation: Field inspected (describe appearance, weight/dimensions, model/serial number), COC &/or CTR provided, etc. 							
Materials have been field inspected and are acceptable. Materials used are on the Approved Products List. Certified Test Reports for Glass Beads are on file.							
Item:				Final Quantity:			
Epoxy Pavement Marking				2130 Liters			
Glass Beads				6390 Kg.			
Preform Pavement Marking(Type B)				150 Sq. Meters			
APL/QML Acceptance: APL Ref. No.		Product name:				Date checked:	
APL/QML Acceptance: APL Ref. No.		Product name:				Date checked:	
Preliminary <input type="checkbox"/>		Construction <input checked="" type="checkbox"/>		Maintenance <input type="checkbox"/>		Emergency <input type="checkbox"/>	
Contractor Kraemer and Sons				Supplier Kolbe Striping			
Sampled from <small>(Pit, roadway, windrow, stock, etc.)</small>				Pit name or owner			
Quantity represented		Previous quantity		Final			
Sample submitted: <input type="checkbox"/> Yes <input checked="" type="checkbox"/> No		Shipped to: <input type="checkbox"/> Central lab <input type="checkbox"/> Region lab		Via		Date 3/8/02	
Sampled or inspected by (Name) Fidel Gonzales			(Title) E/PS Tech III		Lab phone number 303-828-2644		
Supervisor <small>(Pro./Res./Matis. Engr./Maint. Supt.)</small> Corey Stewart			Title P.E. I		Address 1050 Lee Hill Rd. Boulder, Co. 80302		
Distribution: White copy - Staff Materials Branch <small>(submit white copy only if sample or information is directed to Staff Materials)</small> Canary copy - Region Materials Engineer Pink copy - Resident Engineer				CDOT Form #157 9/07			
Previous editions may be used until supplies are exhausted							

COLORADO DEPARTMENT OF TRANSPORTATION CONCRETE TRUCK MIXER INSPECTION CERTIFICATION	Project code (SA#)	11925	Date	5/8/03
	Project No.	IM 0253-151		
	Proj. location	I-25, SH 7 to WCR 16		
	Concrete company	Varra Co. Plant #1		

Unit number	252	251	250	247	248	245	239
Rated mixing capacity (1)	ok	ok	ok	ok	ok	ok	ok
Blade wear (2)	ok	ok	ok	ok	ok	ok	ok
Free of Hardened concrete (3)	ok	ok	ok	ok	ok	ok	ok
Revolution counter	ok	ok	ok	ok	ok	ok	ok
Water gauges	ok	ok	ok	ok	ok	ok	ok
Meets operating speed requirements	ok	ok	ok	ok	ok	ok	ok
Date inspected	5/9/03	5/9/03	5/9/03	5/9/03	5/9/03	5/9/03	5/9/03
INSPECTED BY (company employee)	Greg M.	Greg M.	Greg M.	Greg M.	Greg M.	Greg M.	Greg M.

(1) Rated mixing capacity cannot exceed 63% of gross volume of drum

(2) Blade wear cannot exceed more than 25 mm (one inch) of the original height. For typical blade configurations see "x" dimensions below.

Mixer blade types:

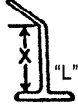

"L"



"Straight"

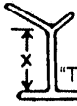

"T"

(3) The drum cannot have an appreciable accumulation of hardened concrete inside.

I certify the truck mixers listed above were inspected and met the requirements for conformance with the AASHTO M157 specifications.

I DECLARE UNDER PENALTY OF PERJURY IN THE SECOND DEGREE, AND ANY OTHER APPLICABLE STATE OR FEDERAL LAWS, THAT THE STATEMENTS MADE ON THIS DOCUMENT ARE TRUE AND COMPLETE TO THE BEST OF MY KNOWLEDGE.

Concrete company's principal executive, signature and title

Completed and checked by CDOT personnel	
Batch plant scale certification (Certifiers name and date)	Batch plant water meter certification date
Signed	Title
Remarks:	

Distribution:

- original - Region laboratory
- 1st copy - Resident/Project Engineer
- 2nd copy - Concrete company

CDOT Form #46 3/04

INSTRUCTIONS FOR CDOT FORM #82, CONCRETE SPECIMEN TRANSMITTAL

- ◆ Under **Item #** list the Item for which this concrete was placed.
- ◆ List the 281 ticket number of the load or suppliers ticket no. from which cylinders were made.
- ◆ Design cylinder set numbers for each project and class of concrete will be numbered consecutively beginning with No. 1.
- ◆ Fill in the areas for; Concrete class (A, B, D, etc.), Days cured, Break dates, and No. of cylinders.

Example, Design

Mark Cylinders as indicated	Set no.	Conc. class	Days cured	Break date	No. of cylinders
Mix Design Cylinders marked	1	A	7	8/16/99	2
Mix Design Cylinders marked	1	A	28	9/6/99	3
Mix Design Cylinders marked					
Total					5
Set no./class	Field Cylinder	Days cured	Break date	No. of cylinders	
Information Cylinders marked	X				
Information Cylinders marked	X				
Information Cylinders marked	X				

Example, Information

Mark Cylinders as indicated	Set no.	Conc. class	Days cured	Break date	No. of cylinders
Mix Design Cylinders marked					
Mix Design Cylinders marked					
Mix Design Cylinders marked					
Total					
Set no./class	Field Cylinder	Days cured	Break date	No. of cylinders	
Information Cylinders marked	1 X	10	8/19/99	1	
Information Cylinders marked	1 X	10	8/19/99	1	
Information Cylinders marked	X				

Structural strength "Information" cylinders will be marked with the same set number as the Design cylinders from the same batch; Set No./Concrete class, Days cured, and Break date. Normally "X" cylinders will be cast at the same time as design cylinders and cured under the same conditions as the structure. In the column under "Days Cured" indicate the test data desired (7, 11, 14, 21, etc days cured) with the appropriate break date entered in the next column, and number of cylinders.

Note: Use separate Form # 82's for Design and Information cylinders.

Under **QUANTITIES REPRESENTED** list the measurement applicable to the Pay Item. Report the previous placement quantity of the item under "To Date". Under "This Placement" list the quantity represented by the current Form #82 including any small quantity that did not require cylinders, then list the total quantity of this class of concrete to date. Enter the specification for Compressive Strength Required.

FIELD SHEET NO. 120123

COLORADO DEPARTMENT OF TRANSPORTATION CONCRETE SPECIMEN TRANSMITTAL		Project No. IM 0253-151	Region 6	Project code (SA#) 11925	Proj. location I-25, SH 7 to WCR 16
Ready Mix Supplier: <input type="checkbox"/> English <input type="checkbox"/> Metric Ready Mixed		Date 11/05/03	Station 135789	Resident Engineer D. Forsyth	CDOT Mix # 2007004
Applicable CDOT Form #281 Field Sheet # OR Suppliers ticket #:		Unit weight 143.4 lbs/ft³ (kg/m³)	Yield 1.01	Concrete temperature 78 °F (°C)	
Slump 3.00 inches (mm)	Entrained air 6.1 %	Date molded 11/5/03	Cured hrs. 10:45 am	Days in molds 1	Days at structure site 72 °F (°C)
Cylinders for design adequacy		Date molded	Cured hrs.	Days at structure site	Shipped to
Cylinders for structural strength information					<input type="checkbox"/> Central lab <input type="checkbox"/> Region lab
Mark Cylinders as indicated					
Specimen Identification	Set no.	Conc. class	Days cured	Break date	No. of cylinders
1	1	D	7	11/12/03	2
1	1	D	28	12/3/03	3
Specimen Identification					
Specified strength (PSI/MPa)					
4500					
Specimen type: <input checked="" type="checkbox"/> 4 x 8 cylinder <input type="checkbox"/> Beam <input type="checkbox"/> Splitting <input type="checkbox"/> Cube <input type="checkbox"/> Tensile					
Quantity represented cubic yards/meters					
Previous	This placement	To date			
0	100 CU YD	100 CU YD			
Field Comments:					
I.A.T./Remarks:					

Lab comments:

Cast by: **T. Jones** Transported by: (Name/Title/Company) **T. Jones E/PST I CDOT** Phone number **303-555-1234** FAX number **303-555-4321**

Distribution: White - (Original with sample) - Central/Region Lab Canary - Project File Pink - Region (only if IAT sample) Previous editions are obsolete and may not be used CDOT Form #82 8/07

COLORADO DEPARTMENT OF TRANSPORTATION												
CONCRETE TEST RESULTS SUMMARY												
Note: Field tester to fill out form Metric units <input type="checkbox"/> yes <input checked="" type="checkbox"/> no												
Project No. IM 0253-151			Proj. location I-25, SH 7 to WCR 16			Region 4			Project code (SA#) 11925			
Item 412	Class P	Design mix no. 2002112	Batch plant Lawson			Date 9/30/03						
Specifications:		Slump	inches/mm maximum			% total air	Compressive strength		Psi/MPa			
.43 W/C Ratio		3				4	(Flexural) 570					
Date placed	Ticket no.	Cu. yd./Cu. m Batched	Placed	Temp.	Slump	% total air	Unit mass	Yield	Calculated w/c ratio	Cylinders casted F.S. no.	S. E.	Action taken to document deviations from specifications (including quantities with price reduction calculations attached)
9/30/03	1	8	8	72 f	2.25	6.2	142.2	1.00	.42	10021	84	
9/30/03	2	8	8	72 f	1.25	6.3	142.4	1.02	.43	10021	83	
9/30/03	3	8	8	72 f	1.75	6.4	143.3	1.03	.42	10023	84	
9/30/03	4	8	8	72 f	1.75	6.4	143.4	1.02	.41	10022	85	
9/30/03	5	8	8	72 f	1.50	6.7	141.0	1.01	.43	10022	86	
Remarks												
Distribution: original - Project file						Project Engineer signature						

STATE OF COLORADO
DEPARTMENT OF TRANSPORTATION

PROJECT NO : STA 145A-037
PROJECT CODE : 15201
LOCATION : Keystone Hill
REGION : 5
FIELD SHEET : 116216
SUPPLIER : Contractor on Site

DATE TRANSMITTED : 6/06/2007 (final)

REPORT OF CONCRETE TESTS

Item No. : 503
Concrete Class : Grout Micropiles
Date Molded : 5/8/2007
Slump : N/A
Cylinder Set No. : 11G

Placed at : Sta. 602+54
Portion : Micropiles

Air : N/A

Unit Weight : N/A

Specimen Number	Date Tested	Age (Days)	Cubes	Cross - Sectional Area	Maximum Load (Lbs)	Compressive Strength (PSI)
11G	05/11/07	3	2"x 2"	4 sq. in.	16238	4060
11G	05/11/07	3	2"x 2"	4 sq. in.	18521	4630
11G	05/11/07	3	2"x 2"	4 sq. in.	16438	4110
11G	06/06/07	28	2"x 2"	4 sq. in.	20587	5147
11G	06/06/07	28	2"x 2"	4 sq. in.	22620	5655
11G	06/06/07	28	2"x 2"	4 sq. in.	18186	4547**

Average Break Strength:

3-day : 4270 psi
28-day : 5400 psi**

Remarks : Cubes tested in accordance with AASHTO T - 106.

****NOTE: Last cube out of allowable tolerance, average calculated off 2 cubes.**

COMPRESSIVE STRENGTH REQUIRED: 3 day: 2500 psi, 28 day: 4000psi

MICHAEL COGGINS

Tested By : Robin S. DiFerdinando (3-day)
Patrick R. Murphy (28-day)

REGION MATERIALS ENGINEER

Cc : Project Engineer
Region Materials Engineer
Resident Engineer
Contractor
Project File

CDOT Form 192
Revised 11/06

STATE OF COLORADO
DEPARTMENT OF TRANSPORTATION

DATE TRANSMITTED : 5/4/2007

PROJECT NO : STA 145A-037
PROJECT CODE : 15201
LOCATION : Keystone Hill
REGION : 5
FIELD SHEET : 116211
SUPPLIER : Telluride S & G

REPORT OF CONCRETE TESTS

Item No. : 504
Concrete Class : Shotcrete
Date Molded : 4/19/2007
Slump : 1 " (visual)
Cylinder Set No. : 47 A

Placed at : None Given
Portion :

Air : 7.0 %

Unit Weight : 131.4

Specimen Number	Date Tested	Age (Days)	Diameter	Cross - Sectional Area	Maximum Load (Lbs)	Compressive Strength (PSI)
(Field):						
47 A	4/23/07	4	4"	12.57 sq. in.	49568	3940
47 A	4/23/07	4	4"	12.57 sq. in.	49045	3893
(Region):						
47 A	4/23/07	4	4"	12.57 sq. in.	51260	4078
47 A	4/23/07	4	4"	12.57 sq. in.	51109	4066

Average Break Strength:

(Field) 4-day : 3920 psi

(Region) 4-day : 4070 psi

Remarks : Cylinders tested in accordance with ASTM C-39.

COMPRESSIVE STRENGTH REQUIRED: N/A

INFORMATION ONLY

(Region)
Tested By : Patrick Murphy

MICHAEL COGGINS

REGION MATERIALS ENGINEER

Cc : Project Engineer
Region Materials Engineer
Resident Engineer
Project File

CDOT Form 192
Revised 11/06

STATE OF COLORADO

PROJECT NO : STA 062A-011

DEPARTMENT OF TRANSPORTATION

PROJECT CODE : 14556

DATE TRANSMITTED : 6/6/2007

LOCATION : Amelia Street

REGION : 5

FIELD SHEET : 108064

SUPPLIER : United Companies

REPORT OF CONCRETE TESTS

Item No. : 601

Placed at : 11+79 55' Rt.

Concrete Class : B

Portion :

Date Molded : 5/10/2007

Slump : 3.5"

Air : 5.0 %

Unit Weight : 137.6

Cylinder Set No. : 1B

Specimen Number	Date Tested	Age (Days)	Diameter	Cross - Sectional Area	Maximum Load (Lbs)	Compressive Strength (PSI)
1B	5/17/07	7	4"	12.57 sq. in.	40801	3246
1B	5/17/07	7	4"	12.57 sq. in.	38683	3077
1B	6/6/07	28	4"	12.57 sq. in.	54445	4331
1B	6/6/07	28	4"	12.57 sq. in.	52892	4208
1B	6/6/07	28	4"	12.57 sq. in.	52045	4140

Average Break Strength:

7-day : 3160 psi

28-day : 4230 psi

Remarks : Cylinders tested in accordance with ASTM C-39.

COMPRESSIVE STRENGTH REQUIRED: 3000 psi

MICHAEL COGGINS

Tested By : Robin S. DiFerdinando (7-day)
Patrick R. Murphy (28-day)

REGION MATERIALS ENGINEER

Cc : Project Engineer
Region Materials Engineer
Resident Engineer
Project File

CDOT Form 192
Revised 11/06

COLORADO DEPARTMENT OF TRANSPORTATION INSPECTION – QUALITY ASSURANCE ACCEPTANCE REPORT	Project No.: IM 0253-151
	Project Code: 11925
	Proj. Location: SH 7 to WCR 16
	Date: 1/19/03
	Report No.: 12

Colorado Department of Transportation
Staff Bridge Design Branch
4201 E. Arkansas Avenue, Room 330
Denver, Colorado 80222

Pay Item Number	618
Pay Item Description	Prestressed Conc. Box/ 32" - 48" Depth
Pay Item Units	Square Foot (SF)
Number of Units QA Inspected	8080 SF
Contract Unit Price	35 \$ Per SF
Structure Number & Construction Phase	D-17-CT
Fabricator	Rocky Mountain Prestress
Prime Contractor	Kraemer and Sons

The above referenced Items were inspected, tested, and accepted by the Contractors Quality Control Unit (QC). CDOT Staff Bridge Design performed random Quality Assurance Inspections and Testing (QA) to the extent necessary to verify that an acceptable product is furnished in accordance with the Contract. The Items were found by QA to be in reasonable conformance with the plans and specifications.

Mark A. Leonard
CDOT Staff Bridge Design Engineer

Dana E. Christensen
Professional Engineer II

Distribution:
Leonard
Inspection File
Quarterly Report File

By: _____
Quality Assurance Inspector

CDOT Form #193 04/04

**COLORADO DEPARTMENT OF TRANSPORTATION
UNCOATED SEVEN-WIRE STEEL STRAND PHYSICAL TEST REPORT**

Field Sheet No. 176767 Project Code 13579
 Sample Number 2008001 Project Number C 2706-033
 Sample Date 1/4/2008 Project Location I-270 Phase VI
 Region 6

Reel Number	Size	Yield Strength (lbf)	Breaking Strength (lbf)	Modulus of Elasticity (psi)	Elongation in 24" (%)	Nominal Steel Area of Strand (sq. in.)	Nominal Weight of Strand (lb/100 ft.)
4465	15	54,600	61,024	3.059E+07	>3.5	0.217	752
4465	15	54,995	61,330	2.825E+07	>3.5	0.217	755

Strand Designation Number	Nominal Diameter (in)	Minimum Yield Strength (lbf)	Minimum Breaking Strength (lbf)	Minimum Elongation in 24"
9	3/8"	20700	23000	3.5%
13	1/2"	37170	41300	3.5%
13a	0.520"	40500	45000	3.5%
15	0.600"	52740	58600	3.5%

Remarks: Tested in accordance with AASHTO T244

Tested By: Kelvin Jiron Report Date: 1/8/2008 Glenn Frieler
 Concrete Physical Properties Engineer
 CDOT FORM 196-A
 Rev. 1/2008

STATE OF COLORADO
Colorado Department of Transportation

Project ID: 12183
Field Sheet #: 99986
Project: IMD 0704-183(B)
Location: I 70 WASH TO BRIGHTON
PHASEIII

Report Date: 5/1/2001

CONCRETE CORE TEST

Item: 412
Class: PFA
Portion: PAVEMENT
Aggregate Size: N/G

Date Placed: 11/28/2000
Date Removed: 11/29/2000
Date Tested: 12/1/2000
Cure Time: 35
Moisture Condition: DRY
Age: 35

CORE ID	TRIM LENGTH (in.)	CAP LENGTH (in.)	DIAMETER (IN.)	MAX LOAD (lbs.)	STRENGTH (PSI)	FRACTUR TYPE	UNIT WEIGHT	CORRECT. FACTOR
01	10.90	11.08	5.55	88400	3654	CONE/SHEAR	10.90	1.00
02	10.87	11.10	5.55	87800	3629	SHEAR	10.87	1.00
03	11.12	11.23	5.62	96900	3906	SHEAR	11.12	1.00

Remarks: Cores were tested in accordance with CP 65-91.

Tested by:

cc:
Central Laboratory
Regional Materials Engineer

Glenn Frieler
Concrete/ Physical Properties
Program Manager

CDOT FORM 199
Rev. 04/01

COLORADO DEPARTMENT OF TRANSPORTATION CONCRETE BATCHED AND PLACED		Project No. IM 0253-151		
		Project code (SA#) 11925		
		Proj. location I-25, SH 7 to WCR 16		
		Date 1/24/02		
		Contractor Kraemer and Sons		
Supplier Ready Mix	Truck # 0299	Cu. Yds. 10.00	Design # 2000139	Class. D-Spec

Design weights and total batch weights (adjusted for moisture)

	Cement	Fly ash	Fine	Medium	Coarse	Water	Air E.A.	Admixture
1 CU. YD. Design Wt.	1 type 633 lb	3 type 70 lb	500 lb	1485 lb	881 lb	266 gal	1 type 18.0 oz	5 type 85.0 oz
Total adjusted batch Wt.	6485 lb	740 lb	4980 lb	15160 lb	9140 lb	1896 gal	180.0 oz	848 oz
Moisture in coarse agg.	4.0 %		Moisture in medium agg.		Moisture in fine agg.		2.50 %	
Time charged	11:10		Discharged time 12:40		Truck water meter reading at plant			

Field mixing			Batch water		
Mixing revolutions on job	20		In agg.	86.43	gals.
Gallons of water added	0		At plant	227.19	gals.
Cubic yds. in truck	10		Total batch	313.62	gals.
Equivalent batch gallons	313.62		Max allowed per batch.	381.48	gals.
Equivalent batch gals. = $\frac{\text{Batch cu. yds.}}{\text{cu. yds. in Truck}} \times \text{gals. water added}$			Total allowed 67.86 gals.		

Water permitted: $\frac{7225.0}{\text{(Batch Wt. Cement - lbs.)}} \times \frac{.44}{\text{(Maximum water Cement ratio)}} \times .12 = 381.48$ gals. (Maximum allowed per batch)

When taken	% total air 6.2	Slump 3.0	Mix temperature 70 f	Cyl. set # 6
	Yield 1.04	(Nomograph)	RPM range 10-12	RPM used 12
1. Placed at	Bridge Deck F 17-UK		Portion Span C	
2. Air temp maximum	55 f		Minimum 45	Weather Clear
Lines 1 & 2 represent ticket #			Thru	
Remarks				
Plant inspector			Job inspector	

1st: Project copy

2nd: Book copy

CDOT Form #281 3/04

COLORADO DEPARTMENT OF TRANSPORTATION FIELD REPORT FOR JOINT SEALANT TESTING	Project No. IM 0253-151	Date 4/8/03
	Project code (SA#) 11925	Proj. location I-25, SH 7 to WCR 16

Project specific location of test

4 lane highway		2 lane highway	
WB <input type="checkbox"/> or SB <input checked="" type="checkbox"/>	WB <input type="checkbox"/> or SB <input checked="" type="checkbox"/>	EB <input type="checkbox"/> or NB <input type="checkbox"/>	EB <input type="checkbox"/> or NB <input type="checkbox"/>
X	X		
12	15	feet	feet
Station 178+00		Sealant material Dow Corning 890 Self Leveling	Placement date 3/8/03 Temp 75 °F
Test method <input type="checkbox"/> CP 67-02 Method A <input checked="" type="checkbox"/> CP 67-02 Method B			
Test number 1		<input checked="" type="checkbox"/> Pass <input type="checkbox"/> Fail	

Project specific location of test

4 lane highway		2 lane highway	
WB <input type="checkbox"/> or SB <input checked="" type="checkbox"/>	WB <input type="checkbox"/> or SB <input checked="" type="checkbox"/>	EB <input type="checkbox"/> or NB <input type="checkbox"/>	EB <input type="checkbox"/> or NB <input type="checkbox"/>
X	X		
12.5	12	feet	feet
Station 185+50		Sealant material Dow Corning 890 Self Leveling	Placement date 3/8/03 Temp 75 °F
Test method <input type="checkbox"/> CP 67-02 Method A <input checked="" type="checkbox"/> CP 67-02 Method B			
Test number 1		<input checked="" type="checkbox"/> Pass <input type="checkbox"/> Fail	

Project specific location of test

4 lane highway		2 lane highway	
WB <input type="checkbox"/> or SB <input checked="" type="checkbox"/>	WB <input type="checkbox"/> or SB <input checked="" type="checkbox"/>	EB <input type="checkbox"/> or NB <input type="checkbox"/>	EB <input type="checkbox"/> or NB <input type="checkbox"/>
	X		
12	12	feet	feet
Station 202+25		Sealant material Dow Corning 890 Self Leveling	Placement date 3/8/03 Temp 76 °F
Test method <input type="checkbox"/> CP 67-02 Method A <input checked="" type="checkbox"/> CP 67-02 Method B			
Test number 1		<input checked="" type="checkbox"/> Pass <input type="checkbox"/> Fail	

Tester

**COLORADO DEPARTMENT OF TRANSPORTATION
REINFORCING BAR PHYSICAL TEST REPORT**

Field Sheet No.: 1234
 Sample Number: 1234
 Sample Date: 9/18/2007

Project Code: 1
 Project No.: SCM
 Project Location: Colorado School of Mines
 Region: _____

Manufacturer: Ameristeel
 Plant: Charlotte
 Heat Number: _____

Bar Grade: 60
 Bar Type: S
 Bar Size: 3

Bar	Yield Strength (psi)	Tensile Strength (psi)	Elongation (%)	Reduction of Area (%)	Unit Weight (lbs/ft)	Bar Diameter (Inches)
1	59,102	81,342	14.78	46.77	0.366	0.392
2	57,962	80,426	16.19	45.55	0.366	0.393
ASTM A 615 SPECS	Minimum	Minimum	Minimum			
Grade 40	40,000	60,000	*A	N/A	N/A	N/A
Grade 60	60,000	90,000	*B	N/A	N/A	N/A

*A: 11 for bar size #3; 12 for bar sizes #4 to #6

*B: 9 for bar sizes #3 to #6; 8 for bar sizes #7 to #8; 7 for bar sizes #9 to #18

Remarks: Tested in accordance with ASTM A 370

Tested by: Kelvin Jiron Report Date: 9/19/2007

Glenn Frieler
 Concrete Physical Properties Engineer
 CDOT FORM 1372
 Rev. 1/2007

**COLORADO DEPARTMENT OF TRANSPORTATION
REINFORCING BAR PHYSICAL TEST REPORT**

Field Sheet No.: 1234
 Sample Number: 1234
 Sample Date: 9/18/2007

Project Code: 1
 Project No.: SCM
 Project Location: Colorado School of Mines
 Region: _____

Manufacturer: Ameristeel
 Plant: Charlotte
 Heat Number: _____

Bar Grade: 60
 Bar Type: S
 Bar Size: 3

Bar	Yield Strength (psi)	Tensile Strength (psi)	Elongation (%)	Reduction of Area (%)	Unit Weight (lbs/ft)	Bar Diameter (Inches)
1	59,102	81,342	14.78	46.77	0.366	0.392
2	57,962	80,426	16.19	45.55	0.366	0.393
ASTM A 706 SPECS	Range	Minimum	Minimum			
	60,000 - 78,000	80,000	*A	N/A	N/A	N/A

*A: 14 for bar sizes #3 to #6; 12 for bar sizes #7 to #11; 10 for bar sizes #14 and #18

Remarks: Tested in accordance with ASTM A 370

Tested by: Kelvin Jiron Report Date: 9/19/2007

Glenn Frieler
 Concrete Physical Properties Engineer
 CDOT FORM 1372
 Rev. 1/2007

**COLORADO DEPARTMENT OF TRANSPORTATION
REINFORCING BAR PHYSICAL TEST REPORT**

Field Sheet No.: 1234
 Sample Number: 1234
 Sample Date: 9/18/2007

Project Code: 1
 Project No.: SCM
 Project Location: Colorado School of Mines
 Region: _____

Manufacturer: Ameristeel
 Plant: Charlotte
 Heat Number: _____

Bar Grade: 60
 Bar Type: S
 Bar Size: 3

Bar	Yield Strength (psi)	Tensile Strength (psi)	Elongation (%)	Reduction of Area (%)	Unit Weight (lbs/ft)	Bar Diameter (Inches)
1	59,102	81,342	14.78	46.77	0.366	0.392
2	57,962	80,426	16.19	45.55	0.366	0.393
ASTM A 722 SPECS	Minimum	Minimum	Minimum			
	120,000	150,000	7.0	N/A	N/A	N/A

Remarks: Tested in accordance with ASTM A 370

Glenn Frieler
 Concrete Physical Properties Engineer
 CDOT FORM 1372
 Rev. 1/2007

Tested by: Kelvin Jiron Report Date: 9/19/2007

COLORADO DEPARTMENT OF TRANSPORTATION
APPROVED CONCRETE MIX DESIGN REPORT

CDOT MIX NUMBER: 2008000

PROJECT ID : 95487	CONCRETE CLASS : B
PROJECT NO. : IM 25-558	SULFATE RESISTANCE CLASS : 2 AND LOWER
LOCATION : I-25	FIELD STRENGTH : 3500 psi
REGION : 2	LAB DESIGN STRENGTH : 4025 psi
ITEM NUMBER : 601	CONCRETE SUPPLIER : Prieve Concrete Co.
SUPPLIER MIX ID : 448774	CONTRACTOR : Frieler Construction Company

CONCRETE MIX PROPORTIONS (SSD BATCH WEIGHTS FOR 1 CUBIC YARD)

CEMENT : 350 lb	CEMENT SOURCE : Holcim (Portland)	CEMENT TYPE : 1/II
FLY ASH : 150 lb	FLY ASH SOURCE : Boral (Denver Terminal)	FLY ASH CLASS : F
SILICA FUME : 1b	SILICA FUME SOURCE :	
COARSE : 1200 lb	COARSE AGG. SOURCE : CDOT Pit; Size # 57/67	
INTERMEDIATE : 1b	INT. AGG. SOURCE :	
FINE (SAND) : 1700 lb	FINE AGG. SOURCE : CDOT Pit	
AIR ENTRAINER : 15.0 oz	AIR ENTRAINER SOURCE : CDOT AE	
WATER REDUCER : 60.0 oz	WATER REDUCER SOURCE : CDOT Special WRA	
ADMIXTURE : oz	ADMIXTURE SOURCE :	
ADMIXTURE : oz	ADMIXTURE SOURCE :	
WATER : 200 lb		

PHYSICAL PROPERTIES OF TRIAL BATCH COMPRESSIVE STRENGTH (PSI) FLEXURAL STRENGTH (PSI)

TRIAL DATE : 1/3/2008	SLUMP : 1.00 "	7-DAY	14-DAY	28-DAY	56-DAY	7-DAY	28-DAY
UNIT WEIGHT : 140.0 lbs/ft ³	AIR CONTENT : 7.00 %	3200	3940	4210			
W / C RATIO : 0.40	RELATIVE YIELD : 1.00	3410	3870	4130			
AASHTO PP34 RING TEST :	DAYS			4180			
ASTM C1202; 56-DAY PERMEABILITY :	COULOMBS						

COARSE, INTERMEDIATE, AND FINE AGGREGATE TEST RESULTS

COARSE DATE : 1/3/2008	INTERMEDIATE DATE :	FINES DATE : 1/3/2008
MEETS GRADATION? : YES	MEETS GRADATION? :	MEETS GRADATION? : YES
SPECIFIC GRAVITY (SSD) : 2.50	SPECIFIC GRAVITY (SSD) :	SPECIFIC GRAVITY (SSD) : 2.51
ABSORPTION (%) : 1.5	ABSORPTION (%) :	ABSORPTION (%) : 2.9
LA ABRASION (%) : 10.0	LA ABRASION (%) :	FINENESS MODULUS : 3.00
CP-L4201 (%) : 0.37	CP-L4201 (%) :	SAND EQUIVALENT : 99
AGG. SOUNDNESS (%) : 1	AGG. SOUNDNESS (%) :	CP-L4201 (%) : 0.49
UNIT WEIGHT (PCF) : 100	UNIT WEIGHT (PCF) :	AGG. SOUNDNESS (%) : 1
VOIDS (%) : 40	VOIDS (%) :	ORGANIC IMPURITIES : Clear

CP-L4202 RESULT(%) : 0.02	CP-L4202 : Mix design proportions
CP-L4202 DATE : 1/3/2008	MITIGATIVE : MEASURES

COMMENTS :

REVIEWED BY : Eric Prieve

REVIEW DATE : 1/3/2008

PLEASE CONTACT CDOT CONCRETE AND PHYSICAL PROPERTIES LAB AT 303-398-6542 WITH ANY QUESTIONS

CDOT Form #1373 1/08

Chapter 700

Paints - 08

ITEM 708 PAINTS

General. This specification covers ready-mixed paint. Paint shall be easily mixed. The mixed paint shall be free from agglomerates, skins and foreign matter and shall be of suitable consistency for the method of application. Paint shall have satisfactory spreading qualities and give a smooth, continuous coating free from breaks or sags. Paint shall be able to withstand one year of storage without detrimental deterioration. In a 3/4 full, tightly closed container, paint shall show no skinning after 48 hours.

Color where designated by number refers to Federal Standard 595B. All proportions specified herein shall be by weight.

Structural Steel Bridge Paint - All structural steel shall be painted as follows:

Inorganic Zinc-Rich Polyurethane System. The primer shall be an approved inorganic zinc-rich primer conforming to the requirements of Table I of the STEEL STRUCTURES PAINTING COUNCIL SPECIFICATION NO. 20 (SSPC-PAINT 20) (Nov. 1, 1982). The vehicle of this primer shall be SSPC-Paint 20, Type I-C.

The primer shall be applied according to the manufacturer's recommendations with a minimum dry film thickness of 80 micrometers (3 mils).

The manufacturer shall certify in writing to the Engineer that the SSPC-SP 6 steel cleaning is compatible with the primer used.

The topcoat shall be an approved high-build polyurethane enamel with a minimum dry film thickness of 80 micrometers (3 mils). To prevent bubbling, a mist coat shall be applied prior to application of the topcoat.

Epoxy-Coating for Steel Reinforcing Bars & Steel Dowel Bars – All steel reinforcing bars and steel dowel bars shall be painted in accordance with CP 11 Part II, Sub-Part 2: Epoxy-Coated Steel Reinforcing Bars and Epoxy-Coated Steel Dowel Bars Section 13, copied below:

13. FABRICATION & JOBSITE HANDLING

13.1 The coated bars to be fabricated by the Fabricator or field fabricated by the Contractor after application of the coating shall meet the following:

13.1.1 Contact points, such as drive rollers, shear contacts, mandrels and backup barrels on benders shall be protected with a suitable covering to minimize damage during the fabrication process.

13.1.2 The Fabricator shall be responsible for repair to the coating due to damage during shipment, storage, or fabrication at the Fabricator's facility.

13.1.3 The Contractor shall be responsible for repair to the coating due to damage during shipment, storage, fabrication, or placement at the construction jobsite.

13.2 Coating damaged due to fabrication or handling shall be repaired with patching material. The patching or repairing shall be performed in accordance with the written recommendations of the patching material Supplier.

13.3 Patching or repair material shall be compatible with the coating, inert in concrete, and feasible for repairs. The patching or repair material shall conform to AASHTO M 317 - Standard Specification for Epoxy-Coated Reinforcing Bars: Handling Requirements for Fabrication and Job Site.

COLORADO DEPARTMENT OF TRANSPORTATION FIELD REPORT FOR SAMPLE IDENTIFICATION OR MATERIALS DOCUMENTATION Metric units <input type="checkbox"/> yes <input checked="" type="checkbox"/> no				Field sheet No. 120227		Date 9/9/02	
				Project No. IM 0253-151		Project location I-25, SH 7 to WCR 16	
Project code (SA#) 11925		Function 3200		Region 4		Part. P	
Sample submitted: <small>(ie.: Soil, ABC, Hydrated lime, HMA, concrete cores, steel, etc.)</small>				Field office phone number 303-828-0386		Field office FAX number 303-828-0430	
Bridge Paint							
Item 708		Class		Grading		Special provisions applicable: <input checked="" type="checkbox"/> yes <input type="checkbox"/> no	
Previously used on Project No.:				Previous CDOT Form #157 F/S No.(s):		<input type="checkbox"/> CDOT Form #633 (sack) <input type="checkbox"/> CDOT Form #634 (can)	
<ul style="list-style-type: none"> ● Sample Identification: Quantity & Unit of material submitted, describe tests required, precise location sample removed from (stationing), etc. ● Materials Documentation: Field inspected (describe appearance, weight/dimensions, model/serial number), COC &/or CTR provided, etc. 							
<p>Bridge paint was field inspected and approved. Certificates of Compliance are on file for primer and finish coat. Meets requirement of Standard Specifications and Special Provisions.</p> <ul style="list-style-type: none"> <li style="text-align: center;">◆ Devran 224HS Primer Coat <li style="text-align: center;">◆ Devthane 378 Finish Coat 							
APL/QML Acceptance: APL Ref. No.		Product name:			Date checked:		
APL/QML Acceptance: APL Ref. No.		Product name:			Date checked:		
Preliminary <input type="checkbox"/>		Construction <input checked="" type="checkbox"/>		Maintenance <input type="checkbox"/>		Emergency <input type="checkbox"/>	
Contractor Kraemer and Sons				Supplier Devoe Coatings			
Sampled from <small>(Pit, roadway, windrow, stock, etc.)</small>				Pit name or owner			
Quantity represented 8,254 gal		Previous quantity 0		Total quantity to date 8,254 gal			
Sample submitted: <input type="checkbox"/> Yes <input checked="" type="checkbox"/> No		Shipped to: <input type="checkbox"/> Central lab <input type="checkbox"/> Region lab		Via		Date 9/9/02	
Sampled or inspected by (Name) James Garcia			(Title) E/PS Tech III		Lab phone number 303-828-2644		
Supervisor <small>(Pro./Res./Mats. Engr./Maint. Supt.)</small> Corey Stewart			Title P.E. I		Address 1050 Lee Hill Rd. Boulder, Co. 80302		
Distribution: White copy - Staff Materials Branch <small>(submit white copy only if sample or information is directed to Staff Materials)</small> Canary copy - Region Materials Engineer Pink copy - Resident Engineer						CDOT Form #157 9/07	
Previous editions may be used until supplies are exhausted							

Chapter 800

Radiation Safety & Nuclear Gauge Operation - 11

1. GENERAL CDOT NUCLEAR INFORMATION

1.1 Training of Nuclear Gauge Operators

RSO's - Each Region Materials Engineer (RME) has appointed three properly trained individuals to act as the On-Site Radiation Safety Officers (RSO's). They will operate in coordination with the CDOT RSO to ensure full compliance with the Radioactive Materials License.

Dept. Of Health Documents - The CDOT's nuclear program is guided by two principle documents, both issued by the Colorado Department of Public Health and Environment:

- 1) "Rules and Regulations Pertaining to Radiation Control"
- 2) "The Radioactive Materials License"

Operator Training - All current or potential Nuclear Gauge Operators must complete the CDOT "School of Radiological Safety and Nuclear Gauge Operation." After successfully passing the course,

the individual may begin supervised instruction in testing with a nuclear gauge.

Operator I.D. Card - A "CDOT Nuclear Gauge Operator Identification" card will be issued immediately after the On-Site RSO certifies that the individual is technically qualified to utilize a designated gauge and has acted in a manner equal to the responsibilities required by the CDOT Radioactive Materials License.

Recurrent Training - The U.S. Department of Transportation (49 CFR) stipulates that anyone who transports hazardous materials or prepares these materials for transport must receive training at intervals not to exceed three years.

1.2 Radiological Safety

Health Risks - Nuclear Gauges contain radioactive source material and are potentially dangerous if used improperly. However, research findings indicate no radiological health hazard exists for operators of nuclear gauges when appropriate safety precautions are observed.

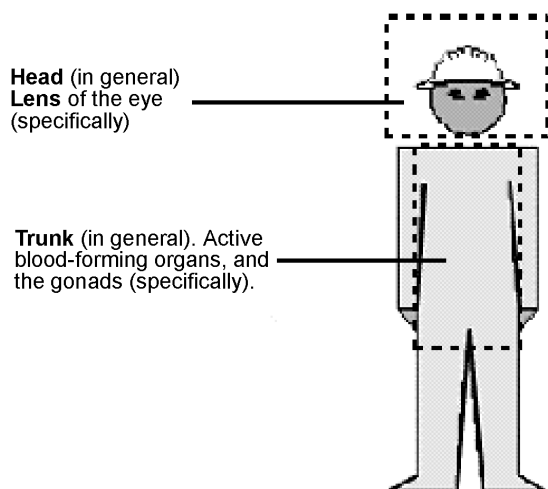

Personal Monitoring Devices

The personnel dosimetry devices used by CDOT are categorized as "Whole Body" - the head and trunk in general. The areas of specific concern are the lens of the eyes, active blood-forming organs, and the gonads.

The maximum legal occupational dose (exposure) per year is 0.05 Sieverts (Sv) [5 REMs] to the "Whole Body".

Reducing Exposure - Radiation exposure is significantly reduced by:

- 1) Decreasing **time** spent near a gauge
- 2) Increasing **distance** from the gauge
- 3) Allowing the **shielding** incorporated in the design and construction of the gauge to be utilized as intended.

Leak Wipes –Leak Wipes are to be performed annually on Troxler & CPN gauges and semi-annually on InstroTek gauges to ensure the integrity of the sealed sources (the radioactive source capsules that are double encapsulated). Leak Wipes are also performed if a nuclear gauge has been involved in an accident or a nuclear gauge operator has an unexplainably high radiation exposure on his/her personnel dosimeter. Personnel monitoring is the determination of the amount of ionizing radiation to which an individual has been exposed.

ALARA - The CDOT operates under the concept of ALARA, As Low As Reasonably Achievable. Legal limits are not as important as minimizing radiation exposure.

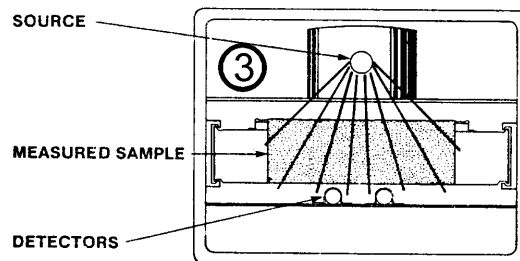
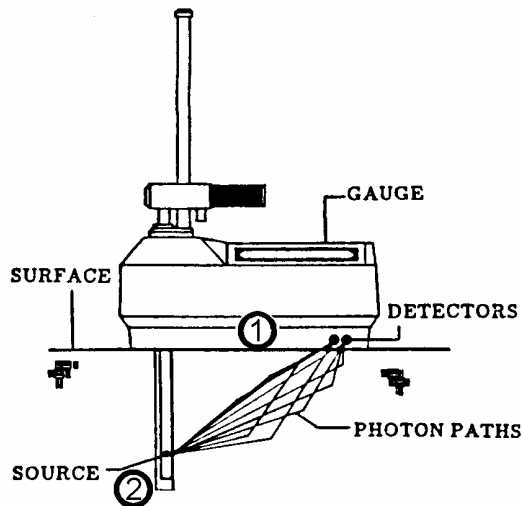

1.3 Nuclear Gauge Type and Radiological Description

(1) Troxler Moisture/Density (M/D) Gauge:

① Americium-241:Beryllium (AM-241:BE)

1.48 GigaBecquerel (GBq) [40 milliCuries (mCi)]

Alpha & Neutron Radiation

② Cesium-137 (CS-137)

0.30 GigaBecquerel (GBq) [8.0 milliCuries (mCi)]

Beta & Gamma Radiation

(2) CPN Moisture/Density (M/D) Gauge:

① Americium-241:Beryllium (AM-241:BE)

1.85 GigaBecquerel (GBq) [50 milliCuries (mCi)]

Alpha & Neutron Radiation

② Cesium-137 (CS-137)

0.37 GigaBecquerel (GBq) [10 milliCuries (mCi)]

Beta & Gamma Radiation

(3) InstroTek Moisture/Density (M/D) Gauge:

① Americium-241:Beryllium (AM-241:BE)

1.48 GigaBecquerel (GBq) [40 milliCuries (mCi)]

Alpha & Neutron Radiation

② Cesium-137 (CS-137)

0.37 GigaBecquerel (GBq) [10.0 milliCuries (mCi)]

Beta & Gamma Radiation

(4) Troxler & CPN Asphalt Content (AC) Gauge:

③ Americium-241:Beryllium (AM-241:BE)

3.7 GBq [100 mCi]

Alpha and Neutron Radiation

The Nuclear Lab of the Staff Materials Laboratory maintains copies of all personnel monitoring exposure records, leak test analysis records, correspondence with the Colorado Department of Health, Rules and Regulations Pertaining to Radiation Control, and the Radioactive Materials License.

CONTACT:
STAFF MATERIALS LABORATORY
NUCLEAR LAB
RADIATION SAFETY OFFICER
303/303-6542
4670 N. Holly Street, Unit A
Denver, CO 80216

1.4 Compliance With The Following Points Are Required.

Governing Documents - The following documents shall be adhered to by all CDOT personnel in regards to Radiation Safety and Nuclear Gauge Operation:

- Colorado Department of Public Health and Environment Documents:
 - * Rules and Regulations Pertaining to Radiation Control
 - * Radioactive Materials License
- CDOT Radiation Safety Officer Guide
- CDOT's "Transporting and Storage Rules for Nuclear Gauges"

Securing and Control of Radioactive Material – The Regions shall take the following steps to secure nuclear materials. The On-Site RSOs and RME shall ensure the following:

A) Radioactive material shall be stored in facilities that are secured as required in the documents above. The only personnel authorized to issue nuclear gauges are the On-Site RSOs and RME.

B) The On-Site RSOs and RME shall keep a written log of the location of each nuclear gauge. This log shall detail the check-in and check-out date, the project location in which the gauge will be stored, and responsible gauge user. The log shall be available to the CDOT RSO.

C) The On-Site RSOs, RME, and CDOT RSO shall yearly review and approve the Regions' procedures for securing radioactive material, gauge check in/out and monitoring procedures.

Age - Nuclear gauge operation is prohibited by any CDOT personnel who have not attained the age of 19.

Personnel Monitoring Device - All nuclear gauge operators are required to wear their personnel monitoring device during work hours. CDOT utilizes ThermoLuminescent Dosimeters (TLD's) capable of detecting both gamma and neutron radiation.

Identification - A "Nuclear Gauge Operators I.D." card must be possessed by any CDOT personnel operating a gauge while unsupervised.

Shielded Compartments - Under no circumstances should field personnel enter or attempt to enter the gauge's shielded compartment containing the radioactive source or attempt to remove the source rod.

M/D "Safe" Position - Moisture/Density Gauges should not be placed outside of the safe position until actual testing is ready to begin. This is the "safe" position only for gamma radiation; neutron radiation is always emitted from the bottom of the base.

Safe Distance from Gauges - Do not position your body within 6 feet of the nuclear gauge for more than a few minutes at a time, regardless of whether the source is shielded or unshielded.

Restricted Areas – A restricted area is an area in which CDOT has control over access. In the restricted area an individual can receive a maximum exposure of 0.05 Sieverts (Sv) [5 REM] per year. In unrestricted areas, those CDOT cannot control the access to, the maximum dose to the public is 0.02 milliSieverts (2 millIREM) per hour and 1.0 mSv (100 mREM) per year.

Minors are prohibited from being within a restricted area. Non-gauge operators may be within a restricted area for only a few minutes at a time. The entire test trailer is a restricted area, as well as 2 meters around a gauge if outside of a building.

Storing Nuclear Gauges – All nuclear gauges shall be stored in such a way that two physical locks must be defeated to take the gauge. When a gauge is stored at a project trailer, it has to be stored in a locked cabinet, or the case has to be chained and locked to a permanent structure in the trailer. The gauge case shall also be locked. For

AC gauges that are chained to the bench, lock the front of the gauge when not in use. AC gauges that are used in Region labs shall be locked to the bench or an anchor in the wall, if they will not be supervised at all times. The front door shall also be locked when it is not in use. At the Region storage vaults, keep the doors closed and locked at all times. If you leave your vehicle unattended with a gauge in it, you still need 2 locks. Two chains don't count because cutting the hasp on the case will allow someone to take the gauge. There are transportation cases that the gauge case fits into. You can use them. You can also satisfy the 2 lock rule by locking the gauge case to something inside the vehicle (such as the steering wheel) and then locking the vehicles doors.

Proper Placarding - A test trailer or Region Materials Lab must be placarded so that an individual approaching the facility or room will see the "CAUTION RADIOACTIVE MATERIALS" placard, the *completed* "CDOT NUCLEAR INCIDENT PROCEDURES" sheet (Page 9), and the Colorado Department of Health's "NOTICE TO EMPLOYEES" sheet (Page 10).

Completing Nuclear Logs - The "NUCLEAR MOISTURE/DENSITY GAUGE LOG" CDOT Form #746 and the "NUCLEAR ASPHALT CONTENT GAUGE LOG" CDOT Form #772 must be completed, specifically with the operator's full name, every day in which either gauge is operated. They must be returned to Staff Materials-Nuclear Lab upon completing the last line on the Form and always by the end of the calendar year. (Pages 12-13).

Transporting Nuclear Gauges - A nuclear gauge may only be transported within a DOT Type "A" carrying case. It shall be securely fastened to the vehicle to prevent it from shifting. In the open bed of a pickup truck, the gauge case shall be locked. In vans, SUVs, and cars the vehicle's compartment doors shall be locked. In all vehicles, the gauge case shall be locked, and the gauge shall be stored as far away from the driver as possible. A gauge shall not be transported in the passenger compartment. Gauges shall not be transported outside of Colorado.

Nuclear Gauge Binder - The binder must be accessible to the driver at all times while the vehicle is transporting a nuclear gauge. If the gauge is stored in the vehicle and it is not being transported, place the red gauge binder on the driver's seat or in a pocket on the driver's side door. Four documents must be kept in the gauge binder: Bill of Lading, Source Certificate, Nuclear Incident Procedures, and CDOT's Radioactive Materials License.

Reporting Unsafe Conditions - Any apparent unsafe situation involving the use or storage of nuclear gauges shall be reported directly and immediately to the CDOT RSO.

Gauge Operation During Pregnancy - All female nuclear gauge operators must notify the RSO at Staff Materials immediately once she decides to "declare Her Pregnancy" (Page 11).

2. SAMPLE DOCUMENTS

2.1	CDOT Nuclear Gauge Reference Information. (Color photographs).....	Page 5
2.2	Nuclear Gauge Reference Information.....	Page 6
2.3	On-Site Radiation Safety Officer Emergency Notification Telephone Directory.....	Page 7
2.4	Certificate of Acceptance for Radiological Safety and Nuclear Gauge Operation.	Page 8
2.5	CDOT Nuclear Incident Procedure.....	Page 9
2.6	Colorado Department of Health - Notice to Employees.	Page 10
2.7	Nuclear Gauge Operation During Pregnancy.....	Page 11
2.8	CDOT Form # 746: Nuclear Moisture/Density Gauge Log.....	Page 12
2.9	CDOT Form # 772: Nuclear Asphalt Content Gauge Log.....	Page 13

2.1 CDOT Nuclear Gauge Reference Information

CDOT's Nuclear Gauges



Troxler 3440 Moisture/Density

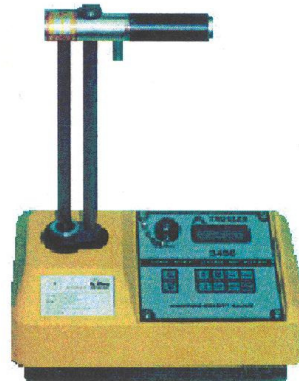

Troxler 3430 Moisture Density



CPN AC-2R Asphalt Content



CPN MC-3 Moisture/Density



Troxler 3241-C Asphalt Content



InstroTek 3500 Xplorer

2.2 Nuclear Gauge Reference Information

NUCLEAR GAUGE REFERENCE INFORMATION

PROPER SHIPPING NAME, CLASSIFICATION, LABELING and MARKING:

USA DOT 7A TYPE A RADIOACTIVE MATERIAL, SPECIAL FORM, UN 3332 RQ
TYPE A PACKAGE, RADIOACTIVE YELLOW II, $TI \leq 0.5$

SPECIAL FORM CERTIFICATE: Radioactive materials used in these gauges have been certified as "SPECIAL FORM" by a recognized "COMPETENT AUTHORITY".

LEAK TEST: The Colorado Department of Transportation performs a leak test on each nuclear gauge semi-annually to reveal that the removable activity is less than 0.005 micro curies.

PROPERTY OF CDOT DECAL: The decal has been affixed to all nuclear gauge shells and their respective US DOT 7A TYPE A carrying cases.



PROPERTY OF



COLORADO DEPARTMENT OF TRANSPORTATION

Staff Materials Laboratory
4670 Holly Street, Unit A
Denver, Colorado 80216-6408
303-398-6542
Colorado State Patrol Hazmat Office
(303) 239-4546

CDOT Form #1247

CDOT NUCLEAR GAUGE SPECIFICATIONS

MOISTURE/DENSITY (M/D) GAUGE: Troxler 3400 series, InstroTek 3500 & CPN MC-3

RADIONUCLIDE: Cesium-137 (Ce-137)

ACTIVITY: Troxler: 0.30 GigaBecquerels (GBq) [8.0 milliCuries (mCi)]

CPN & Instrotek: 0.37 GBq (10 mCi)

Sealed Source located in the tip of the source rod.

RADIONUCLIDE: Americium-241:Beryllium (Am-241:Be)

ACTIVITY: Troxler & Instrotek: 1.48 GBq (40mCi)

CPN: 1.85 GBq (50 mCi)

Sealed Source located in the center of the base.

ASPHALT CONTENT (AC) GAUGE: Troxler 3241-C & CPN AC-2R

RADIONUCLIDE: Am-241:Be

ACTIVITY: 3.70 GBq (100 mCi)

Troxler: *Sealed Source located in top center above chamber.*

CPN: *Sealed Source located on bottom center below chamber.*

EMERGENCY ASSISTANCE-RADIATION SAFETY OFFICERS ONLY!

COLORADO DEPARTMENT OF PUBLIC HEALTH & ENVIRONMENT:

LABORATORY & RADIATION SERVICES DIV: Days 303-692-3428

EMERGENCY MANAGEMENT UNIT: Nights/Weekends/Holidays 877-518-5608

TROXLER ELECTRONIC LABORATORIES, INC.:

EMERGENCY ASSISTANCE: 24 HOURS, EVERY DAY 919-549-9539

2.3 ON-SITE RADIATION SAFETY OFFICER EMERGENCY NOTIFICATION TELEPHONE DIRECTORY

<u>REGION</u>	<u>PERSONNEL</u>	<u>OFFICE LOCATION</u>	<u>WORK PHONE</u>	<u>HOME PHONE</u>
1	Brent Loomis	Denver	303-398-6804	
	Dan Falls	Denver	303-398-6806	
	Leslie Kochis	Limon	719-775-8004	
2	Robert Bergles	Pueblo	719-546-5776	
	Christine Genger	Colorado Springs	719-634-2323	
	Kelly Melgoza	Lamar	719-336-3228	
3	Trevor Woolley	Grand Junction	970-683-6371	
	Cecil Cubbison	Glenwood Springs	970-683-6376	
	Andy Rosedahl	Grand Junction	970-683-6374	
4	Steve Gonser	Evans	970-381-0213	
	Joe Burrows	Boulder	303-546-5647	
	Mike Ellis	Evans	970-350-2383	
5	Patrick Murphy	Durango	970-759-5300	
	Robert Byrd	Alamosa	719-587-6520	
	Russel Ebel	Durango	970-385-8364	
6	Matt McMechen	Denver	303-398-6704	
	Terry Evans	Denver	303-398-6773	
	Mike Dock	Denver	303-981-7068	
HQ	Paul Smith	Denver	303-398-6547	
	Eric Prieve	Denver	303-398-6542	
	Ed Trujillo	Denver	303-398-6530	

Revised 5-14-2010

3. CDOT Forms - Applicable for Nuclear Gauge Testing, Examples and Instructions

# 427	Nuclear Soils Moisture/Density Test	Page 14-15
# 428	Nuclear Asphalt Density Test.....	Page 16-17
# 469	Nuclear Asphalt Density Correction	Page 18-19
# 599	Nuclear Asphalt Content Correlation.....	Page 20-21
# 106	Nuclear Asphalt Content Test	Page 22-23

2.4 Certificate of Acceptance for Radiological Safety and Nuclear Gauge Operation

STATE OF COLORADO

DEPARTMENT OF TRANSPORTATION
Materials and Geotechnical Branch
4670 Holly Street, Unit A
Denver, Colorado 80216



Certificate of Acceptance as a Nuclear Gauge Operator

_____ has satisfactorily completed the "CDOT School of Radiological Safety & Nuclear Gauge Operation" on _____ presented by Eric Prieve, or has completed a training course in the safe use and handling of portable nuclear gauges which has been accepted by the U. S. Nuclear Regulatory Commission or Agreement State on _____ by _____.

The above stated individual has also completed a minimum of 8 hours of instruction and supervised hands-on operation of a Moisture/Density gauge and/or Asphalt Content Gauge. I certify that this individual is technically qualified to utilize a _____ gauge, and has acted in a manner equal to the responsibilities required by CDOT's Radioactive Materials License, Colorado 308-01.

ON-SITE RADIATION SAFETY OFFICER

DATE

_____ has met the requirements contained within the CDOT Radioactive Materials License and hereby is designated as a CDOT Nuclear Gauge Operator. The CDOT Nuclear Gauge Operator has been issued a CDOT Nuclear Gauge Operator Identification Card (CDOT Form #774). The above stated individual shall attend recurrent training at intervals not to exceed 3 years to retain his/her status as a CDOT Nuclear Gauge Operator.

CDOT RADIATION SAFETY OFFICER

DATE

2.5 CDOT Nuclear Incident Procedures

STATE OF COLORADO

DEPARTMENT OF TRANSPORTATION

Materials & Geotechnical Branch
4670 Holly Street
Denver, Colorado 80216-6437



CDOT NUCLEAR INCIDENT PROCEDURES
(Required to be posted: Nuclear Gauge Storage, Nuclear Gauge Binders)

1. I, _____, am the individual with primary responsibility for the Nuclear Gauge(s) assigned to this location. My Home Phone / Cellular number is _____.

2. I, _____, as Project Engineer share responsibility and liability for the physical security of all assigned nuclear gauges to this location.

3. **PROPER SHIPPING NAME AND HAZARD CLASS:**

USA DOT 7A TYPE A RADIOACTIVE MATERIAL, SPECIAL FORM, NON FISSLE OR FISSLE EXCEPTED, UN3332

4. **POTENTIAL HAZARDS, TO HEALTH:**

- (a) Radiation presents minimal risk to nuclear gauge operators and emergency response personnel.
- (b) Nuclear Gauges in undamaged "Type A" carrying cases are safe. Damaged packages may cause external radiation hazard.
- (c) U.S. DOT "Type A" carrying cases contain non-life endangering amount of radio nuclides. Radioactive source capsules may be released in moderately severe accidents.
- (d) Contamination and internal radiation hazards from inhalation, ingestion, or breaks in skin are not expected, but not impossible if special form source capsule is breached.

5. **RADIATION SAFETY OFFICERS (RSO'S) - Within CDOT TO CONTACT:**

	Location	RSO	Work Phone	Home Phone
1-On-Site		_____	_____	_____
2-On-Site		_____	_____	_____
3-On-Site		_____	_____	_____
4-Staff	Denver	Paul Smith	303-398-6547	303-319-9557

6. **MISSING GAUGE:**

Call the first available RSO, do not telephone the police.

7. **MINOR DAMAGE - [SOURCE CAPSULE(S) REMAIN WITHIN THE NUCLEAR GAUGE]:**

- (a) Inspect from 1 meter away. Turn with a long handled tool.
- (b) If damage is slight, move the gauge to the safety of the test trailer or lab. Call the first available RSO.
- (c) If the source rod on a M/D Gauge is bent (will not retract), place gauge over a five gallon bucket filled with wet soil, shielding the rod and the neutron source area (center, base).
- (d) Relocate gauge/bucket to trailer or lab. Call first available RSO.

8. **MAJOR DAMAGE - [SOURCE CAPSULE(S) SEPARATED FROM NUCLEAR GAUGE]:**

- (a) Establish control. Do not allow the accident site to expand.
- (b) Emergency response actions. First aid &/or extinguishing fire are highest priority. Advise medical personnel that victim may be contaminated with low level radioactive material.
- (c) Rope off restricted area, minimum 6 meter (20 feet) radius from outer edge of nuclear gauge debris.
- (d) Let no vehicles involved leave the site.
- (e) Let only emergency response personnel enter.
- (f) Maintain control of restricted area until officially released. Call first available RSO.

RH 10.2 POSTING OF NOTICES TO WORKERS

The Radioactive Materials License, the Rules and Regulations Pertaining to Radiation Control, and all communication both to and from the Colorado Department of Public Health and Environment may be examined at the CDOT Staff Materials Laboratory, 4670 Holly Street., Denver, Colorado 80216-6437.



Colorado Department
of Public Health
and Environment

COLORADO DEPARTMENT OF PUBLIC HEALTH AND ENVIRONMENT
Hazardous Materials and Waste Management Division
Radiation Management Program

NOTICE TO EMPLOYEES

STANDARDS FOR PROTECTION AGAINST RADIATION (PART 4); NOTICES, INSTRUCTIONS AND REPORTS TO WORKERS; INSPECTIONS (PART 10); EMPLOYEE PROTECTION



Colorado Department
of Public Health
and Environment

HAZARDOUS MATERIALS AND WASTE MANAGEMENT DIVISION COLORADO DEPARTMENT OF PUBLIC HEALTH AND ENVIRONMENT

Within Colorado, the Radiation Management Program of the Hazardous Materials and Waste Management Division (the Division) is the regulatory agency responsible for licensing and inspecting the use of radioactive materials and registering and inspecting radiation producing machines.

HAZARDOUS MATERIALS AND WASTE MANAGEMENT DIVISION RESPONSIBILITIES

The Division's primary responsibility is to ensure that workers and the public are protected from unnecessary or excessive exposure to radiation. The Division does this by establishing requirements in the State of Colorado *Rules and Regulations Pertaining to Radiation Control*, 6 Code of Colorado Regulations (CCR) 1007-1 (the Regulations).

EMPLOYER RESPONSIBILITIES

Any individual conducting activities licensed or registered by the Colorado Department of Public Health and Environment (the Department), Hazardous Materials and Waste Management Division, must comply with the Department's requirements. If a violation of the Department's requirements occurs, the license or registration can be modified, suspended or revoked and/or the licensee or registrant can be fined.

Your employer must post or make available Department radiation regulations and must post Department Notices of Violation involving radiological working conditions.

EMPLOYEE RESPONSIBILITY

For your own protection and the protection of your co-workers, you should know how Department requirements relate to your work and should obey them. If you observe violations of the requirements, you should report them.

REPORTING VIOLATIONS

If you believe that violations of the Department rules or of the terms of the license have occurred, you should report them immediately to your supervisor. If you believe that adequate corrective action is not being taken, you may report this to a Department inspector or to the Division.

WORKING IN A RADIATION AREA

If you work with or in the vicinity of radioactive materials or radiation producing machines, the amount of radiation exposure that you may receive is limited by the Regulations. These limits are contained in Part 4 of the Regulations. While these are the maximum allowable limits, your employer should also keep radiation exposure as far below those limits as is "reasonably achievable".

OBTAINING A RECORD OF WORKER RADIATION EXPOSURE

If the Regulations require that your radiation exposure be monitored, your employer is required to advise you annually of your dose. In addition, if you terminate employment with the licensee or registrant, you may request your radiation exposure record, a report of your radiation exposure during the current year.

IDENTIFYING VIOLATIONS OF DEPARTMENT REQUIREMENTS

The Department conducts regular inspections at licensed and registered facilities to assure compliance with Department requirements. In addition, licensees and registrants are required to perform audits, surveys and/or measurements to assure compliance.

CONTACTING A DEPARTMENT INSPECTOR

Your employer may not prevent you from talking with a Department inspector and you may talk privately with an inspector and request that your identity remain confidential.

REQUESTING AN INSPECTION

If you believe that your employer has not corrected violations involving radiological working conditions, you may request an inspection. Your request should be addressed to the Hazardous Materials and Waste Management Division, Colorado Department of Public Health and Environment, and must describe the alleged violation in detail. You or your representative must sign the request.

CONTACTING THE DEPARTMENT

Call the Division. Department staff would like to talk to you if you are concerned about radiation safety or other aspects of licensed or registered activities.

CAN I BE FIRED FOR RAISING A SAFETY ISSUE?

Federal law prohibits an employer from firing or otherwise discriminating against you for bringing safety concerns regarding radioactive material to the attention of your employer or the Department. You may not be fired or discriminated against because you:

- ask the Department to enforce its rules against your employer;
- refuse to engage in activities which violate Department requirements;
- provide information or are about to provide information to the Department or your employer about violations of the Department's safety concerns;
- are about to ask for, or testify, help or take part in, a Department, Congressional, or any Federal or State proceeding.

*NOTE: Federal law provisions do not apply to workers using only radiation producing machines (x-ray machines).

WHAT FORMS OF DISCRIMINATION ARE PROHIBITED?

It is unlawful for an employer to fire you or to discriminate against you with respect to pay, benefits, or working conditions because you help the Department or raise a safety issue.

HOW AM I PROTECTED FROM DISCRIMINATION?

If you believe that you have been discriminated against for bringing violations or safety concerns to the Department or your employer, you may file a complaint with the U.S. Department of Labor pursuant to Section 211 of the Energy Reorganization Act of 1974 (42 U.S.C. 5851). To do so you may directly contact the Occupational Safety and Health Administration (OSHA) Regional Office to receive your complaint. Your complaint must describe the firing or discrimination and must be filed within 180 days of the occurrence.

Send complaints to:

Department of Labor/OSHA
1999 Broadway, Suite 1690
P.O. Box 46550
Denver, Colorado 80201-6550

or contact the OSHA office by telephone at (303) 844-1600 or by fax at (303) 844-1616.

WHAT CAN THE DEPARTMENT OF LABOR DO?

The Department of Labor will notify the employer that a complaint has been filed and will investigate the case.

If the Department of Labor finds that your employer has unlawfully discriminated against you, it may order that you be reinstated, receive back pay, or be compensated for any injury suffered as a result of the discrimination.

WHAT CAN THE HAZARDOUS MATERIALS AND WASTE MANAGEMENT DIVISION DO?

If the Department of Labor or Division finds that unlawful discrimination has occurred, the Division may issue a Notice of Violation to your employer. The Division may suspend, modify, or revoke your employer's license or registration.

2.7 Nuclear Gauge Operation During Pregnancy

STATE OF COLORADO

DEPARTMENT OF TRANSPORTATION
Materials & Geotechnical Branch
4670 Holly Street
Denver, Colorado 80216
303-398-6542



Dear _____:

The Colorado Department of Public Health states, a woman has the right to or not to declare her pregnancy. The Colorado Department of Transportation (CDOT) policy regarding nuclear gauge operation during pregnancy is to allow a woman to make an informed decision. A declaration of pregnancy remains confidential, and employment status can not be effected by this decision.

The Colorado Department of Public Health and Environment's "Rules and Regulations Pertaining to Radiation Control," provides a technical reference for our Radioactive Materials License. An employee working within a restricted area may receive a maximum occupational dose of 5.0 REM (5000-milliREM) of exposure per year. An individual in an unrestricted area, may receive a maximum of 100-milliREM of exposure per year. The National Council of Radiation Protection and Measurement recommends that the embryo/fetus does not receive more than 500 milliREM of exposure during the full 9-month pregnancy. Troxler Electronic Laboratories, manufacturer of CDOT nuclear gauges, states that under average conditions a full time employee working with Troxler moisture density gauges and/or asphalt content gauges will receive less than 200 milliREM of exposure per year. CDOT records indicate that very few employees have exceeded half of Troxler's 200-milliREM value for their lifetime exposure.

I, _____, have read the preceding paragraph and I am aware that if I have any questions CDOT's Radiation Safety, Eric Prieve, is available for consultation.

I will maintain my status as an active nuclear gauge operator through my pregnancy, at least until the time when other health concerns prevent my continued involvement in these activities. The estimated date of conception is _____.

(signature)

(date)

I wish to be removed temporarily as an active nuclear gauge operator until my child is born. The estimated date of conception is _____.

(signature)

(date)

Please return this letter with your original signature to the CDOT Nuclear Office. A letter indicating the date of birth of your child is required.

Sincerely,

Eric Prieve
CDOT Radiation Safety Officer

3. SAMPLE DOCUMENTS, FORM INSTRUCTIONS AND EXAMPLES

CDOT FORM #427 INSTRUCTIONS

The Nuclear Soils Moisture/Density Test form is a field work sheet used to calculate the in-place dry density and the in-place percent moisture of soil and soil-aggregate. This is the designated form to be used with CP 80, In-Place Density and Moisture Content of Soil and Soil-Aggregate by the Nuclear Method.

Record the moisture reading and the density reading after each one-minute test interval. When recording the moisture readings record the percent moisture not the moisture pounds per cubic foot (PCF). When recording the density reading record the dry density, not the wet density. After you have obtained your four readings average the results.

Curve Values: Obtained from Form #1274, Report from Central Lab.

The W/R (with Rock) values are derived from the same report once the % retained on no.4 sieve (rock) has been determined.

% Relative Compaction: Divide the In-Place Dry Density by the Maximum Dry Density (W/R if applicable), and then multiply by 100.

Calculations for Percent Rock: The Wet Weight Total Sample is collected from beneath the Moisture/Density Gauge. The Wet Weight Rock is the Dry Weight Total Sample multiplied by the % Retained on No. 4 Sieve.

Rock Correction Formula: The wt./cu.ft. of + #4 rock is the specific gravity of the + #4 x 62.4, the weight of a cubic foot of water (i.e. SpG. of 2.588 x 62.4 = 161.5)

Compaction Cylinder Moisture & Density Data: Derived from the utilization of CP 25.

CDOT FORM # 428 INSTRUCTIONS

The Nuclear Asphalt Density Test form is a field work sheet used to calculate the percent relative compaction of the in-place hot mix asphalt pavements. This is the designated form to be used with CP 81, Density of In-Place Bituminous Pavement by the Nuclear Method.

Record the density reading after each one-minute test interval. When recording the density reading record the wet density, not the dry density. After you have obtained your four readings average the results.

T 166 or T 209: List the Laboratory Maximum Specific Gravity under the appropriate test procedure and N/A (not applicable) under the other procedure. Obtained from CDOT Form #43. Convert the Laboratory Maximum Specific Gravity to Laboratory Maximum Density by multiplying the Laboratory Maximum Specific Gravity by 62.4 lbs/cu. ft.

Adjusted Field Density: The field density plus the correction factor from CDOT Form #469.

% Relative Compaction: Obtained by dividing the adjusted field density by the laboratory maximum density.

COLORADO DEPARTMENT OF TRANSPORTATION NUCLEAR ASPHALT DENSITY TEST					
Project No. IM 0253-151		Project code (SA#) 11925		Tested by: (name) D. Elsbernd	
Item 403	Grading S (75)	T 166 N/A	T 209 2.485	CDOT equipment number G-1	Standard count density
Test number <u>3</u> Station <u>2559+95 Rt.</u> Course <u>Bottom</u> Roller pass no. <u>2-4-2</u>			Test number <u>4</u> Station <u>0+50 Lt.</u> Course <u>Top</u> Roller pass no. <u>Last</u>		
Backscatter: Counts _____ Wet Density <u>142.5</u> Counts _____ Wet Density <u>141.9</u> Counts _____ Wet Density <u>142.4</u> turned 180° Counts _____ Wet Density <u>142.0</u> 4) _____ 4) _____ CPM _____ WD avg <u>142.2</u>			Backscatter: Counts _____ Wet Density <u>141.7</u> Counts _____ Wet Density <u>142.3</u> Counts _____ Wet Density <u>142.0</u> turned 180° Counts _____ Wet Density <u>141.6</u> 4) _____ 4) _____ CPM _____ WD avg <u>141.9</u>		
Density count _____ = _____ ratio Reference standard count _____ Field density <u>142.2</u> + Correction factor (CDOT Form #469) <u>1.7</u> Adjusted field density <u>143.9</u>			Density count _____ = _____ ratio Reference standard count _____ Field density <u>141.9</u> + Correction factor (CDOT Form #469) <u>1.7</u> Adjusted field density <u>143.6</u>		
Adjusted field density <u>143.9</u> + Laboratory Maximum density <u>155.1</u> = % relative compaction <u>92.78</u> %			Adjusted field density <u>143.6</u> + Laboratory Maximum density <u>155.1</u> = % relative compaction <u>92.59</u> %		
Test number _____ Station _____ Course _____ Roller pass no. _____ Backscatter: Counts _____ Wet Density _____ Counts _____ Wet Density _____ Counts _____ Wet Density _____ turned 180° Counts _____ Wet Density _____ 4) _____ 4) _____ CPM _____ WD avg _____			Test number _____ Station _____ Course _____ Roller pass no. _____ Backscatter: Counts _____ Wet Density _____ Counts _____ Wet Density _____ Counts _____ Wet Density _____ turned 180° Counts _____ Wet Density _____ 4) _____ 4) _____ CPM _____ WD avg _____		
Density count _____ = _____ ratio Reference standard count _____ Field density _____ + Correction factor (CDOT Form #469) _____ Adjusted field density _____ Adjusted field density _____ + Laboratory Maximum density _____ = % relative compaction _____ %			Density count _____ = _____ ratio Reference standard count _____ Field density _____ + Correction factor (CDOT Form #469) _____ Adjusted field density _____ Adjusted field density _____ + Laboratory Maximum density _____ = % relative compaction _____ %		
Remarks					

CDOT Form #428 4/07

CDOT FORM # 469 INSTRUCTIONS

The Nuclear Asphalt-Density Correction form is a field work sheet used to perform the calculations necessary for the correlation of density readings from a nuclear gauge to cores. These correlations are required by specifications for Compaction Test Sections and Check Testing Programs. This is the designated form to be used with CP 82, Field Correction of the In-Place Measurement of Density of Bituminous Pavement by the Nuclear Method. Density measurements can have a profound effect on payment to the Contractor and the long-term performance of an asphalt pavement; for these reasons, it is important that all nuclear gauges used on a paving project be correlated to the same set of cores.

Gauge #1 - Owner: If the gauge belongs to the Colorado Department of Transportation, enter CDOT; however, if it belongs to a consulting engineering company, enter the name as it appears on the Radioactive Materials License.

Gauge #1 - ID# & SN: A non-CDOT ID# is that which is listed on the CDOT generated calibration table. The SN (Serial Number) is the gauge serial number, not the radioactive source serial number.

Gauge #2 - Owner: Whether the nuclear gauge is owned by the Paving contractor or by its designated agent, this name must be as it appears on the Radioactive Materials License.

Gauge #2 - ID# & SN: The ID# listed must be unique to their gauge inventory and the SN is the gauge serial number, not the radioactive source serial number.

Station & Transverse Location: Required information that must be provided.

Nuclear Gauge #2 SpG: The Contractor or the Contractor's consultant tester may pursue quality control through the use of a nuclear gauge; however, if quality control is accomplished through other means then it must be noted under the comment section.

Correction Factor: The value must be carried out to the third decimal place, just as the nuclear gauge SpG's are recorded to the third decimal place. This value will be used on CDOT Form #428.

Gauge Operator: Nuclear gauge #1 & #2, name must be entered.

Supervisor: Nuclear gauge #1 & #2, name must be entered.

Nuclear gauge #2: The make & model of the gauge must be entered between the line for company name and supervisor.

**COLORADO DEPARTMENT OF TRANSPORTATION
NUCLEAR ASPHALT - DENSITY CORRECTION**

Project code (SA#) 11925	Project No. IM 0253-151	Item 403	Mix design # 142011
Date 5/27/03	Proj. location I25, SH 7 to WCR 16	Job Mix - % A.C. 5.9	Lab SpG 2.441
Region 4	Paving Contractor Kiewit Western	Grading S(75)	Course Top 1.5"
Gauge #1 - Owner Geocal	Gauge #1 - ID# & SN G-1	Gauge #2 - Owner Kiewit	Gauge #2 - ID# & SN K-2

Core #	Station	Transverse location	CP 44 (or CP-L 5103) (A) Oven dry wt.	CP 44 (or CP-L 5103) (B) Sat surf dry wt.	CP 44 (or CP-L 5103) (C) Immersed wt.	CP 44 (or CP-L 5103) A/(B-C) Bulk SpG	Density Bulk SpG x 62.4 lb/ft ³	Nuclear Gauge #1 Wet density	Nuclear Gauge #2 Wet density	
1	2536+60	10' Rt.	599.1	600.1	342.0	2.325	145.1	143.5	142.2	
2	2536+60	7' Rt.	689.7	690.6	393.8	2.324	145.0	144.0	141.8	
3	2537+20	9' Rt.	731.6	733.1	415.2	2.301	143.6	143.6	141.5	
4	2537+20	4' Rt.	519.5	520.2	294.4	2.301	143.6	143.2	141.0	
5	2539+70	11' Rt.	510.1	510.5	287.0	2.0282	142.4	142.1	140.3	
6	2539+71	3' Rt.	698.7	699.2	394.3	2.292	143.0	143.0	141.7	
7	2542+00	5' Rt.	627.3	628.1	350.8	2.262	141.1	141.7	140.4	
Totals							16.087	1003.8	1001.1	988.9
Average (Total/7)							2.298	(E) 143.4	(F1) 143.0	(F2) 141.3
Correction Factor (E-F)								+0.4	+2.1	

Comments
Top Mat 1.5"

Nuclear gauge #1		Nuclear gauge #2	
Intended gauge use <input checked="" type="checkbox"/> QA <input type="checkbox"/> QC		Intended gauge use <input type="checkbox"/> QA <input checked="" type="checkbox"/> QC	
Gauge operator D. Elsbernd		Gauge operator H. Owens	
<input type="checkbox"/> CDOT or company (name) Geocal		<input type="checkbox"/> CDOT or company (name) Kiewit	
Lab tester for CP 44 D. Elsbernd		H. Owens	
Supervisor D. Scott		Supervisor L. Krause	

CDOT FORM # 599 INSTRUCTIONS

The Nuclear Asphalt Content Correlation form is a field work sheet used to correlate a nuclear asphalt content gauge to the actual quantity of asphalt cement in a mix. This is one of the designated forms to be used with CP 85, Asphalt Cement Content of Asphalt Concrete Mixtures by the Nuclear Method.

Section 8 of CP 85, Correlation, describes the procedure to be followed to perform a correlation and the CDOT Form #599 guides the user in its completion by showing the relevant formulas.

The Standard Deviation, #K, is generated by the AC Gauge and displayed for each sample pan. The correlation Slope and Intercept, #M, are also generated automatically by the AC Gauge and must be appropriately recorded. The Correlation Factor must be greater than or equal to 0.9990 to be considered acceptable, and the AC Gauge also automatically generates this value.

Note: The Slope as generated by the AC Gauge is not the same value as you would determine through mathematical calculation. In the example, the Slope is 3.995; however, if you were to perform the math the slope would be .003995.

**COLORADO DEPARTMENT OF TRANSPORTATION
NUCLEAR ASPHALT CONTENT CORRELATION**

Aggregate source	Distel Pit	Date	5/3/03	Correlation no.	728.1
Asphalt: grade & source	PG 64-22 Koch	Grading	S (75)	Supplier	Kiewit
Project No.	IM 0253-151	Project code (SA#)	11925	Form 43 #	25589
Background count	Start 1975 Finish 1976	Gauge No.	X-2	Job mix formula % AC	5.9

Dry Aggregate Information

A. Base weight _____ g A' Base weight (mix) 7100 g
 B. Gauge count on dry aggregate _____

Correlation

	Cor. Pan 1	Cor. Pan 2	Cor. Pan 3	Cor. Pan 4	
C. Weight of dry aggregate	<u>8000</u> g	<u>8000</u> g	<u>8000</u> g	<u>8000</u> g	
D. Percent asphalt required	<u>4.9</u> %	<u>5.9</u> %	<u>6.9</u> %	<u>7.9</u> %	
E. Weight of asphalt required ($\frac{C \times D}{100 - D}$)	<u>412.2</u> g	<u>501.6</u> g	<u>592.9</u> g	<u>684.2</u> g	
F. Desired weight of mix (C + E)	<u>8412.2</u> g	<u>8501.6</u> g	<u>8592.9</u> g	<u>8684.2</u> g	
G. Actual weight of aggregate and asphalt	<u>8412.2</u> g	<u>8501.6</u> g	<u>8592.9</u> g	<u>8684.2</u> g	
H. Actual weight of asphalt in mix (G - C)	<u>412.2</u> g	<u>501.6</u> g	<u>592.9</u> g	<u>684.2</u> g	
I. Actual % of asphalt in mix ($\frac{H}{G} \times 100$)	<u>4.9</u> %	<u>5.9</u> %	<u>6.9</u> %	<u>7.9</u> %	
J. Gauge count on mix sample	<u>2927</u>	<u>3200</u>	<u>3488</u>	<u>3776</u>	
K. Deviation	<u>-.009</u>	<u>+.018</u>	<u>-.009</u>	<u>-.009</u>	
L. Correlation temperature	_____				
M. Slope	<u>3.995</u>	Intercept	<u>-6.729</u>	Correlation factor	<u>.9993</u>

Tested by:	D Elsbernd	Witnessed by:	Steve Gonser
Remarks:	A/C Oven is Calibrated @ 7100 grams	Check pan by:	D. Elsbernd
		AC mixed at, %	5.9
		Gauge count:	3200
		% AC by gauge:	5.91

CDOT Form #599 4/07

CDOT FORM #106 INSTRUCTIONS

The Asphalt Test form is a field work sheet used to determine apparent asphalt content and correct for moisture content, in addition to recording in one location a variety of test results. This is one of the designated forms to be used with CP 85, Asphalt Cement Content of Asphalt Concrete Mixtures by the Nuclear Method.

Section 8 of CP 85, Correlation Pan Preparation, describes the procedure to be followed to determine the asphalt content of a sample of production bituminous mixture.

The Gauge % AC and the Measure Count are shown on the scaler display. In the Moisture Correction for the Mix, divide the sample weight loss by the dry mass, and multiple by 100 to obtain the % Moisture. The Corrected % AC is the percent asphalt determined by the AC Gauge minus the percent moisture retained in the mix.

Perform the Moisture Correction for Aggregate and the Sieve Analysis as required by the Schedule for Minimum Materials Sampling, Testing, and Inspection. Testing for asphalt content and testing of aggregate gradation will often not coincide as in this example.

COLORADO DEPARTMENT OF TRANSPORTATION ASPHALT TESTS		Gradation test #: 1																																																																							
		Asphalt content test #: 03																																																																							
Project no.: IM 0253-151	Project code (SA#): 11925	Location: T-25 SH 7 to WCR 16	Station: 125+34																																																																						
AC gauge #: 8163	Correlation #: 103341	Correlation temp: 250 F	Base weight: 6800 g																																																																						
Supplier: Kiewit	Item: 403	Grading: S(100)	Course: Top																																																																						
Date: 9/14/03	Time: 10:53 am	Field temp.: 260 F	Test temp.: 252 F																																																																						
Background cnt.: 2085	Scale ticket #: 60831	IAT#: 1	Rep: 3rd 10k: 1st																																																																						
Job Mix % AC: <u>5.50</u>	Sample moisture correction Tare: <u>852.3</u>	Sieve analysis $\frac{[2027.2 / (100 + 2.4)] \times 100 = 1979.7}{\text{Wet wt.} \quad \% \text{ moisture} \quad \text{Dry wt. (before wash)}}$ <table border="1" style="width:100%; border-collapse: collapse;"> <thead> <tr> <th>Sieve</th> <th>Weight</th> <th>% Ret.</th> <th>% Pass</th> <th>Specs</th> </tr> </thead> <tbody> <tr><td>1</td><td></td><td></td><td></td><td></td></tr> <tr><td>3/4</td><td><u>0</u></td><td></td><td></td><td><u>100</u></td></tr> <tr><td>1/2</td><td><u>114.6</u></td><td><u>5.9</u></td><td><u>94</u></td><td><u>90-100</u></td></tr> <tr><td>3/8</td><td><u>410.6</u></td><td><u>21.0</u></td><td><u>79</u></td><td><u>71-83</u></td></tr> <tr><td>#4</td><td><u>997.5</u></td><td><u>51.0</u></td><td><u>49</u></td><td><u>42-52</u></td></tr> <tr><td>#8</td><td><u>1295.3</u></td><td><u>66.3</u></td><td><u>34</u></td><td><u>27-37</u></td></tr> <tr><td>#16</td><td><u>1477.3</u></td><td><u>75.6</u></td><td><u>24</u></td><td></td></tr> <tr><td>#30</td><td><u>1625.1</u></td><td><u>83.2</u></td><td><u>17</u></td><td><u>13-21</u></td></tr> <tr><td>#50</td><td><u>1748.1</u></td><td><u>89.5</u></td><td><u>11</u></td><td></td></tr> <tr><td>#100</td><td><u>1826.9</u></td><td><u>93.4</u></td><td><u>7</u></td><td></td></tr> <tr><td>#200</td><td><u>1867.9</u></td><td><u>95.6</u></td><td><u>4.4</u></td><td><u>3-7</u></td></tr> <tr><td>-#200</td><td><u>86.2</u></td><td></td><td></td><td></td></tr> <tr><td></td><td><u>1954.1</u></td><td colspan="3">Total sieve wt. (TSW)</td></tr> </tbody> </table>		Sieve	Weight	% Ret.	% Pass	Specs	1					3/4	<u>0</u>			<u>100</u>	1/2	<u>114.6</u>	<u>5.9</u>	<u>94</u>	<u>90-100</u>	3/8	<u>410.6</u>	<u>21.0</u>	<u>79</u>	<u>71-83</u>	#4	<u>997.5</u>	<u>51.0</u>	<u>49</u>	<u>42-52</u>	#8	<u>1295.3</u>	<u>66.3</u>	<u>34</u>	<u>27-37</u>	#16	<u>1477.3</u>	<u>75.6</u>	<u>24</u>		#30	<u>1625.1</u>	<u>83.2</u>	<u>17</u>	<u>13-21</u>	#50	<u>1748.1</u>	<u>89.5</u>	<u>11</u>		#100	<u>1826.9</u>	<u>93.4</u>	<u>7</u>		#200	<u>1867.9</u>	<u>95.6</u>	<u>4.4</u>	<u>3-7</u>	-#200	<u>86.2</u>					<u>1954.1</u>	Total sieve wt. (TSW)		
Sieve	Weight			% Ret.	% Pass	Specs																																																																			
1																																																																									
3/4	<u>0</u>					<u>100</u>																																																																			
1/2	<u>114.6</u>			<u>5.9</u>	<u>94</u>	<u>90-100</u>																																																																			
3/8	<u>410.6</u>	<u>21.0</u>	<u>79</u>	<u>71-83</u>																																																																					
#4	<u>997.5</u>	<u>51.0</u>	<u>49</u>	<u>42-52</u>																																																																					
#8	<u>1295.3</u>	<u>66.3</u>	<u>34</u>	<u>27-37</u>																																																																					
#16	<u>1477.3</u>	<u>75.6</u>	<u>24</u>																																																																						
#30	<u>1625.1</u>	<u>83.2</u>	<u>17</u>	<u>13-21</u>																																																																					
#50	<u>1748.1</u>	<u>89.5</u>	<u>11</u>																																																																						
#100	<u>1826.9</u>	<u>93.4</u>	<u>7</u>																																																																						
#200	<u>1867.9</u>	<u>95.6</u>	<u>4.4</u>	<u>3-7</u>																																																																					
-#200	<u>86.2</u>																																																																								
	<u>1954.1</u>	Total sieve wt. (TSW)																																																																							
Meas. count: <u>3075</u>	Wet wt.: <u>580.2</u>																																																																								
Gauge % AC: <u>5.71</u>	Dry wt.: <u>579.5</u>																																																																								
% Moisture: <u>0.12</u>	Loss: <u>0.7</u>																																																																								
Corr. % AC: <u>5.59</u>	% Moisture: <u>0.12</u>																																																																								
Dry aggregate count: 1993	Form #43 Max. specific gravity: 2.478																																																																								
	<table border="1" style="width:100%; border-collapse: collapse;"> <thead> <tr> <th></th> <th>Flask #1</th> <th>Flask #2</th> </tr> </thead> <tbody> <tr> <td>A) Sample weight</td> <td><u>1044.4</u></td> <td><u>1070.1</u></td> </tr> <tr> <td>B) Flask + water + lid</td> <td><u>3275.7</u></td> <td><u>3305.6</u></td> </tr> <tr> <td>C) Sample + flask + water + lid</td> <td><u>3898.3</u></td> <td><u>3943.5</u></td> </tr> <tr> <td>RICE (Max SpG)</td> <td><u>2.276</u></td> <td><u>2.476</u></td> </tr> <tr> <td>RICE average <u>2.476</u></td> <td colspan="2">[A/(A + B - C) = Max SpG]</td> </tr> </tbody> </table>		Flask #1	Flask #2	A) Sample weight	<u>1044.4</u>	<u>1070.1</u>	B) Flask + water + lid	<u>3275.7</u>	<u>3305.6</u>	C) Sample + flask + water + lid	<u>3898.3</u>	<u>3943.5</u>	RICE (Max SpG)	<u>2.276</u>	<u>2.476</u>	RICE average <u>2.476</u>	[A/(A + B - C) = Max SpG]																																																							
	Flask #1	Flask #2																																																																							
A) Sample weight	<u>1044.4</u>	<u>1070.1</u>																																																																							
B) Flask + water + lid	<u>3275.7</u>	<u>3305.6</u>																																																																							
C) Sample + flask + water + lid	<u>3898.3</u>	<u>3943.5</u>																																																																							
RICE (Max SpG)	<u>2.276</u>	<u>2.476</u>																																																																							
RICE average <u>2.476</u>	[A/(A + B - C) = Max SpG]																																																																								
Fractured Faces (FF)	Moisture correction for Aggregates																																																																								
A) Total wt. <u>997.5</u>	Tare: <u>632.4</u>																																																																								
B) Fract. agg. <u>979.8</u>	Wet wt.: <u>1873.1</u>																																																																								
(B/A) x 100 = <u>98</u> %FF	Dry wt.: <u>1828.7</u>																																																																								
	Loss: <u>44.4</u>																																																																								
	% Moisture: <u>2.4</u>																																																																								
Form #43 % Aggregate absorption: 2.30																																																																									
Sampled by: D. Elsbernd																																																																									
Company: Geocal																																																																									
Tested by: Fidel Gonzales																																																																									
Title: E/PS Tech III																																																																									
Company: CDOT																																																																									
Remarks:																																																																									

CDOT Form #106 4/06

Job Safety Analysis (JSA) – Materials Index – 12

Job Safety Analysis (JSA) documents are posted on CDOT's internal web site only within the referenced address of <http://internal/infoexchg/organizations.cfm> and under the section Manuals / Publications.

Questions or perceived errors should be directed to the applicable Region Materials Engineer or Program Manager within the Central Laboratory.

AASHTO Test Methods:

- R 28
- T 59
- T 84
- T 85
- T 96
- T 240
- T 313
- T 331
- T 334

ASTM Test Methods:

- A 370 (Rebar)
- A 370 (Strand)
- C 39
- C 78
- C 114
- C 138 / C 231
- C 143
- C 151
- C 185
- C 452
- C 496
- C 535
- C 617
- C 1260
- D 244

CDOT Miscellaneous:

- Continuous Sampler Penetration
- FWD Testing
- Hard Rock Coring
- Soil (Auger) Drilling
- Soil Profile
- Standard Penetration Test

CP Test Methods:

- CP 20
- CP 21
- CP 30
- CP 31
- CP 31A / CP 31B
- CP 32
- CP 34 / CP 35
- CP 34
- CP 37
- CP 41A
- CP 41B
- CP 41C
- CP 43
- CP 44
- CP 45
- CP 46
- CP 51
- CP 53
- CP 55
- CP 58
- CP 61
- CP 66
- CP 67
- CP 68
- CP 80
- CP 81
- CP 82
- CP 85

CP-L Test Methods:

- CP-L 2103
- CP-L 2104
- CP-L 2212
- CP-L 3101
- CP-L 3103
- CP-L 4209
- CP-L 4211
- CP-L 5106
- CP-L 5109
- CP-L 5115
- CP-L 5120
- CP-L 5301
- CP-L 5302 / CP-L 5304
- CP-L 5303
- CP-L 5305

Accessing AASHTO Online for the First Time

For first time users of the AASHTO link, please use the following 6 steps.

Step 1. Go to the CDOT internal website and click on the Organizations button.

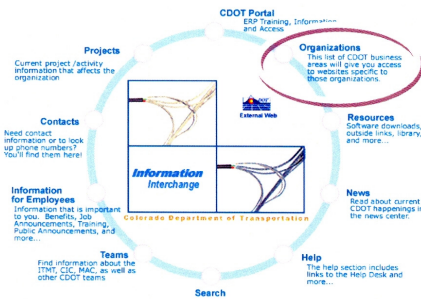

Step 2. In the Organizations, under the Materials & Geotechnical Section, click on the new AASHTO link.

Chief Engineer Objectives Report Quality Improvement Council (QIC) Transportation Finance and Implementation Panel Transportation Commission Resolutions Executive Safety Committee					
Region 1	Region 2	Region 3	Region 4	Region 5	Region 6
Staff Branches					
ITS Branch COTRIP ITS Branch Home Page ITS Regional Architectures ITS Standards and Specifications ITS Guidelines and Policies ITS Performance Measures Ramp Meters Benefits Traveler Information Telephone System Courtesy Patrol Benefits Manufacturing Documents and Manuals Incident Management Plans ITS Ag-Builds		Materials & Geotechnical AASHTO Standards and Specifications new ASTM Standards (click the "Generic Logon" link only) Approved Products List Debris Flow Response Guideline Pavement Management Project Materials Specs & Related Items Checklist Rockfall Emergency Response Procedure Program Support Construction Bids and Info Construction Cost Estimates & Market Analysis Project Development Transportation Engineering Training Program CAD/CAM & Engineering Innovation Design and Construction Innovative Contracting and Design-Build NGS State Geotech Advisor Right of Way Manual Survey Manual R.O.W. Plan Authorization/Revision Notification Safety and Traffic Engineering Office of Traffic Engineering Office of Transportation Safety Traffic Safety Enforcement Statistics Utilities Program Staff Bridge Bridges CDOT Management Contacts Phone Listing E-Mail Distribution Listings FHWA Contact List			

Step 3. Once at the IHS site, click on the blue font Not Registered/New User? This will start the login ID process.

Home | [Subscriber Login](#) | [How To Subscribe](#) | [Standards Store](#)

IHS The Source for Critical Information and Insight™

User Login

Welcome Guest
[Forgot your username or password?](#)
[Not Registered/New User?](#)

Account: Colorado Department of Transportation
Account ID: 5971061001
Session: - - -

Your User Login information is needed because we have not been able to detect who you are.
Please enter your username and password. Thank you for your patience.

Username:
Password:
Submit Reset

[Privacy](#) | [Legal](#) | [Terms and Conditions](#)

Step 4. Type in your first name,
last name,
email address (firstname.lastname@dot.state.co.us).
Then click on “Use Email as Username.”
Then type in codot as the password.
re-enter codot on the Re-Enter Password line.
Hit the submit button once these 6 lines have been completed.

Home | [Subscriber Login](#) | [How To Subscribe](#) | [Standards Store](#)

IHS The Source for Critical Information and Insight™

Registration

Welcome to IHS! Please take a moment to complete this one-time user registration. Please create a unique, personal username and password that is different than the company login that you have been supplied. The username you create will only be used to protect your profile information. You will continue to use your company login or portal to access these services.

This information is considered confidential. Your email is needed in order to replace forgotten passwords. For details, please review the [IHS Privacy Policy](#).

Already registered? [Log in ...](#)

Create your User Profile:

First Name:
Last Name:
Email Address:
Username:
Password:
Re-Enter Password:

[Click to use Email as Username](#)

Submit Reset

All fields are required.

[Privacy](#) | [Legal](#) | [Terms and Conditions](#)

Step 5. To Access the AASHTO Specifications and Standards, click on the IHS Standard Expert line.

The screenshot shows the IHS website interface. At the top, there is a navigation bar with links: Home | Subscriber Login | How To Subscribe | Handbooks Store. Below this is the IHS logo and the tagline "The Source for Critical Information and Insight™".

The main content area is divided into several sections:

- Main Menu:** Contains links for "Welcome, anthony [User ID: 1287565]", "Login as a different user", "Update your profile", and "Subscriber Logout".
- Account Information:** Lists "Account: Colorado Department of Transportation", "Account ID: 12875651001", "Revision: 49596840", and "Exp. ID: 6/12/25, 17:34".
- Select a product from your current subscription:** This section contains a red arrow pointing to the link "IHS Standards Expert".
- Other Applications and Products:** A list of various services including ASME BPVC Advantage, CyberRegs™, IEEE Product Compliance, ASTM Digital Library, SAE Digital Library, SAE TechnKnowledge Centers, Parts Universe, Parts Universe with Fasteners, 4DOnline Comet, PUMS, BOM Optimizer, 4DOnline BOM Manager, TACTRAC COMET, TACTRAC Look-UP, IHS HRC eCatalog, CatalogPress, CatalogPress Lite, Fasteners eCatalog, HAYSTACK GOLD, H-Series Handbooks, AN-DATA, ESDU, Reference Linking Maintenance Tool, and Support and Downloads.

At the bottom left, there is a disclaimer: "The IHS Web site, the database services, and other information provided through this Web site are made available to users subject to the Subscriber's compliance without modification of the IHS Internet Terms and Conditions and notices contained herein. By accessing or using this site or the IHS database services, the Subscriber agrees to be bound by the IHS Internet Terms and Conditions and notices."

Step 6. Have fun using this new site.

For those needing additional help navigating in the website, watch for a training announcement in the Public Announcements.

Accessing ASTM Online

To access the ASTM link, please use the following 5 steps.

Step 1. Go to the CDOT internal website and click on the Organizations button.

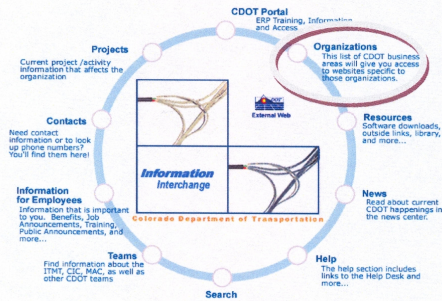

Step 2. In the Organizations, under the Materials & Geotechnical Section, click on the new ASTM link.

Chief Engineer Objectives Report Quality Improvement Council (QIC) Transportation Finance and Implementation Panel Transportation Commission Resolutions Executive Safety Committee					
Region 1	Region 2	Region 3	Region 4	Region 5	Region 6
Staff Branches					
ITS Branch COTRIP ITS Branch Home Page ITS Regional Architectures ITS Standards and Specifications ITS Guidelines and Policies ITS Performance Measures Ramp Meters Benefits Traveler Information Telephone System Courtesy Patrol Benefits Miscellaneous Documents and Manuals Incident Management Plans ITS As-Built		Materials & Geotechnical AASHTO Standards and Specifications NEW ASTM Standards (click the "Generic Login" link only) NEW Approved Products List Debris Flow Response Checklist Pavement Management Project Materials Specs & Related Items Checklist Rockfall Emergency Response Procedure Program Support Construction Bids and Info Construction Cost Estimates & Market Analysis Project Development Transportation Engineering Training Program CDD & Engineering Innovation Design and Construction Innovative Contracting and Design-Build NCS State Geodetic Advisor Right of Way Manual Survey Manual R.O.W. Plan Authorization/Revision Notification Safety and Traffic Engineering Office of Traffic Engineering Office of Transportation Safety Traffic Safety Enforcement Statistics Utilities Program Staff Bridge Bridges CDOT Management Contacts Phone Listings E-Mail Distribution Listings FHWA Contact List			
Maintenance and Operations Maintenance Web Portal Equipment Services Maintenance Engineering Maintenance Management System (NMS) Occupational Safety and Health Permit Office (Truck Permits) Property Management Real Estate Management System (REMS)					
Manuals/Publications Field Materials Manual, 2009 Field Materials Manual, 2008 Field Materials Manual, 2007 Field Materials Manual, 2006 Field Materials Manual, 2005 Field Materials Manual, 2004 Laboratory Manual of Test Procedures Pavement Design Manual (2002) Workplace Safety Manual					

Step 3. Once at the ASTM site, click on the Generic Logon.

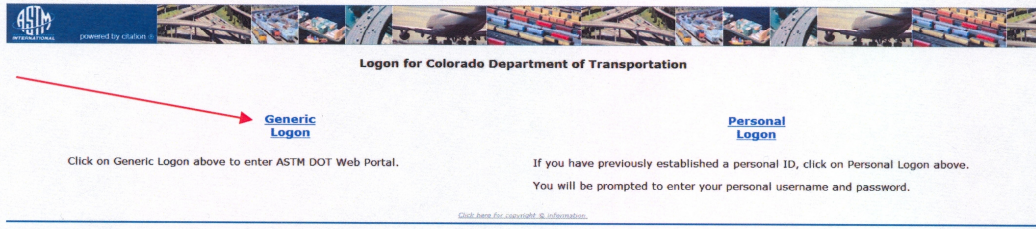

For those needing enhanced capabilities within the ASTM portal, Please contact Jay Goldbaum @ (303) 398-6561 to access the Personal Logon functionality.

Step 4. Once in the portal, type in the ASTM you are searching for.

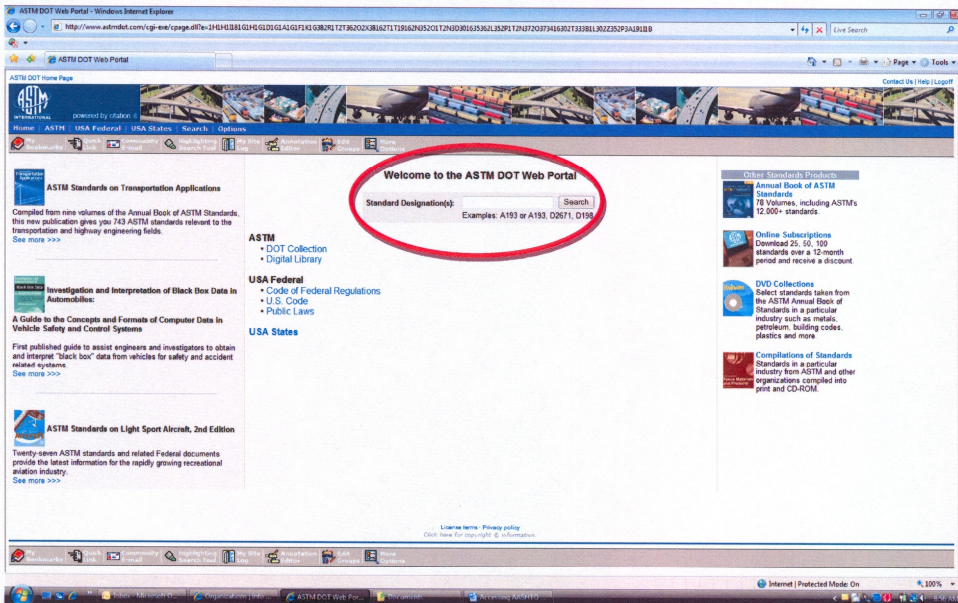

Step 5. Have fun using this new site.

For those needing additional help navigating in the website, watch for a training announcement to be coming soon.

{Page 6 was intentionally left blank.}

Quality Control & Quality Assurance Software - 12

INTRODUCTION

The following contains information on the Quality Control / Quality Assurance (QC/QA) computer programs used by CDOT to calculate the Incentive/Disincentive Payments (I/DP) on paving projects. The calculations are based on Standard Specifications 105.05 and 105.06 and Standard Special Provisions Revisions to Sections 105 and 106 Conformity to the Contract of Hot Mix Asphalt (Voids Acceptance). Quality Levels are calculated according to CP 71.

PROGRAMS

The current version of the programs will always be available at the download sites. Notices of new or revised programs will be distributed via CDOT's Public Announcements. The current versions of the programs at the time of this writing are as follows:

Hot Mix Asphalt (HMA):

Asphalt03 version 4.0.1 – Version 4.0.1 of Asphalt03 is CDOT's latest computer program used for the calculation of I/DPs on projects containing Hot Mix Asphalt (HMA) which utilize gradation acceptance as the testing criteria.

Voids03 version 4.0.1 – Version 4.0.1 of Voids03 is CDOT's latest computer program used for the calculation of I/DPs on projects containing Hot Mix Asphalt (HMA) which utilize voids acceptance as the testing criteria and contain the paving specification, Revision to Sections 105 & 106, Conformity to the Contract of Hot Mix Asphalt (Voids Acceptance).

Portland Cement Concrete Pavement (PCCP):

Concrete03 version 4.0.1 – Version 4.0.1 of Concrete03 is CDOT's latest computer program used for the calculation of I/DPs on projects that contain Portland Cement Concrete Pavement.

DOWNLOADING AND INSTALLING THE PROGRAM

NOTE 1: All of the computer programs are now Windows XP and Windows 7 compatible. Contact CDOT's Help Desk at 303-757-9317 for assistance.

Installation, CDOT Computer:

Click the **Windows** button

Click **Control Panel**

Double click **Programs and Features**

On the left side of the window, click **Install a program from the network**.

The list may take a minute or two to populate. When it does, locate and click on the program.

Click the **Install** button towards the top of the window.

Follow the instructions that appear to complete the installation.

If you have problems with the install contact the Help Desk at 303-757-9317.

Non-CDOT Computer:

The QC/QA programs can be downloaded from CDOT's external web site. The direct address is: [Http://www.dot.state.co.us/ECSU/Download.asp](http://www.dot.state.co.us/ECSU/Download.asp)

Select the program from the list and download the install file.

Follow the instructions that appear to complete the installation.

If you have problems with the install contact CDOT's Help Desk at 303-757-9317.

TRANSFERRING A PROJECT'S FINAL DATA TO THE *PAVEMENT DESIGN PROGRAM*

The Pavement Design Program (PDP) of the Materials & Geotechnical Branch is to receive an electronic copy of the data for all reviewed and Finalized projects, see the Documentation Chapter of this Manual for details. All of the data is entered into a data base which is used to evaluate the specifications and generate yearly reports.

Transferring the Data File:

All of the 03 programs automatically create a data file for the project whenever a Final report is generated. The data file will be saved in the program's Export directory.

For example, if using Asphalt03 the data files will be saved in the following directory: C:\Program Files\Asphalt03\Export. The naming convention used by the program is: Project Code (Subaccount)_Final.QA1. After the project has been reviewed and accepted submit the data file to the Pavement Design Program (PDP) of the Materials & Geotechnical Branch. E-mail the data file to Veronica.DeLuccie@dot.state.co.us ; however, if this is not possible then copy it to a CD and mail it to the CDOT's Pavement Design Program c/o Veronica DeLuccie.

USER'S GUIDES

User's Guides are available for each of the QC/QA programs. Revisions and updates to the guides will be maintained on CDOT's web site. Each of the 03 programs also contains a link to the website from within the program. To view the guide, go to "User's Guide" under "Help" on the menu bar in the program. The User's Guides are also available from CDOT's External web site at: www.dot.state.co.us/ECSU/Documents.asp
Check the User's Guide revision date periodically for any updates.

CONTACT

If you have any questions about these programs:
Contact Veronica DeLuccie at (303) 398-6528
E-mail: Veronica.DeLuccie@dot.state.co.us

Inspections: Central Laboratory of the Regions

- Protocol for Open Laboratory Review of a CDOT Materials Testing Laboratory
- Protocol for the Inspection of Region Materials Laboratories by the Central Materials Laboratory
- Protocol for Round Robin Materials Testing of CDOT Region & Consultant Laboratories
- Protocol for the Audit of Region Materials IA Sampling and Testing Program by the Central Materials Laboratory
- Protocol for the Audit of Region Materials Finals Materials Review and Acceptance Process by the Central Materials Laboratory

PROTOCOL FOR OPEN LABORATORY REVIEW OF A CDOT MATERIALS TESTING LABORATORY

PURPOSE: To provide an established protocol for the review and observation by non-CDOT personnel of CDOT Laboratory techniques and procedures, and to foster a resolution of materials issues on CDOT projects.

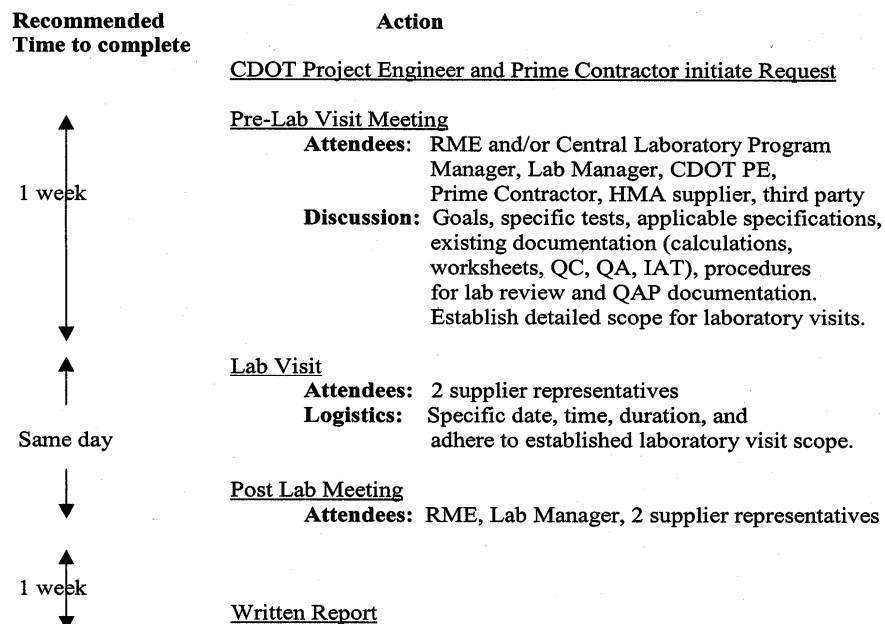

Protocol for the Inspection of Region Materials Laboratories by the Central Materials Laboratory - 2012

AUTHORITY: The Code of Federal Regulations (CFR) requires that for all State DOTs the Central Laboratories be AASHTO accredited and all laboratories conducting acceptance tests must be qualified. CDOT implements this requirement by having the Central Laboratory inspect Region Materials Laboratories, and by having Region laboratories inspect project (Field) laboratories. The Central Laboratory may also inspect project (Field) labs. This program is documented in the QA Procedures Chapter, Subsection 9.2.1.2, in the Field Materials Manual, which is reviewed and approved by the FHWA.

OVERVIEW: Each year a team from the Central Laboratory inspects each Region Materials Laboratory. Checklists are filled out during these inspections recording equipment condition, calibration, serial number, etc. A report is written documenting the results of the inspection. Checklists are included as attachments to the Final Report

TEAM MEMBERSHIP: The Concrete & Physical Properties Program will lead the inspection team. The team will be comprised of personnel from the Asphalt Pavement, Soils, and Concrete / Physical Properties programs. The Program Manager may delegate leadership to a PE I or Scientist II or higher within that Program. Experienced technicians from each Program are also on the team. The Team Leader and the other Program Managers will agree on the selection of technicians for the team.

SCHEDULING INSPECTIONS: The Team Leader schedules the inspections with the Regions at mutually convenient times and dates. Mobile Lab Trailers will not be inspected if they have been removed from active service. These trailers will be inspected after they are returned to service.

INSPECTION CHECKLISTS: Each of the three Programs is responsible for

developing and maintaining worksheets that associate with the CDOT Form #520 to assist in and document the inspection.

CONDUCT OF INSPECTIONS: The team inspects the laboratory equipment and may observe the conduct of tests using appropriate checklists. Any equipment, which is not properly calibrated, correlated, does not meet applicable standards, or is not in good working condition, is noted. Each technician focuses on equipment appropriate to their specialty area. General use equipment such as balances and ovens are also checked.

REPORTING OF INSPECTION RESULTS: The Team Leader writes reports documenting the results of the Region's inspection. The report lists non-conformities in equipment and procedures, recommends any action needed to address problems or non-conformities, and reports the latest round robin results. Draft reports will be distributed to the Region Materials Engineers for comments prior to distribution. Each Final Report, with the attachments, is then distributed. The Reports will be distributed by June 30th.

Region Materials Engineers will submit a written response to the Central Laboratory Branch Manager within one month of receiving the lab inspection report. Round robin testing must be performed and scores of 2, 1, or 0 must be addressed. The procedures that each individual lab within the Region is qualified to perform will be listed on the MAC website under Lab Accreditations.

DISTRIBUTION LIST:
RTD - Direct Recipient
Director of Staff Services
Region Materials Engineer
FHWA
Chief Engineer
Documentation Unit

COLORADO DEPARTMENT OF TRANSPORTATION		
REPORT ON CENTRAL LABORATORY TO REGION LAB INSPECTION		
This inspection is designed to cover apparatus and documentation used in CDOT Region Laboratories. Equipment was inspected according to applicable CDOT, ASTM and AASHTO specifications.		
Region	Location	Date

Region personnel present during inspection	Central Laboratory personnel present during inspection
Name and title	Name and title

General	Rating	Equip ID# (Y/N/NA)
1. Lab cleanliness & housekeeping? (Good/Fair/Poor)		
2. Equipment cleanliness & functionality? (Good/Fair/Poor)		
3. Region Quality Manual present, current & complete? (Y/N)		
4. Scales: Certified & level? (Y/N/NA)		
5. Ovens: Accurate or temperature corrected? (Y/N/NA)		
6. Thermometers: Certified or verified? (Y/N/NA)		
7. Sieves in good condition & within specification? (Y/N/NA)		
8. Sieving adequacy performed annually for coarse & fine aggregate? (Y/N/NA)		
9. Tester certifications present and complete? (Y/N)		
10. Current CDOT Field Materials Manuals, Laboratory Manual of Test Procedures, & CDOT Forms? (Y/N/NA)		
Comments		

Aggregates Applicable <input type="checkbox"/> Y/ <input type="checkbox"/> N	Rating	Equip ID# (Y/N/NA)
1. Aggregate splitter in good condition, correct size & number of openings? (Y/N/NA)		
2. Coarse specific gravity equipment within specifications? (Y/N/NA):		
3. Fine specific gravity equipment within specifications? (Y/N/NA)		
4. Sand equivalence equipment within specification? (Y/N/NA)		
5. L.A. Abrasion machine & Spheres within specification? (Y/N/NA)		
6. Fine Aggregate Angularity apparatus within specification? (Y/N/NA)		
7. Fine Aggregate Angularity cylinder calibrated & logged? (Y/N/NA)		
8. Lime wash water pressure set at 10 PSI? (Y/N/NA)		
9. Micro Deval equipment within specification? (Y/N/NA)		
Comments		

Concrete	Applicable <input type="checkbox"/> Y/ <input type="checkbox"/> N	Rating	Equip ID# (Y/N/NA)
1. Curing tank at correct temperature? (Y/N/NA)			
Recording thermometer present & accurate? (Y/N/NA)			
Curing tank water saturated with lime? (Y/N/NA)			
Curing tank water is being circulated? (Y/N/NA)			
Curing tank water fully immerses specimens? (Y/N/NA)			
2. Concrete testing equipment:			
Air meter calibrated & accurate? (Y/N/NA)			
Slump cone dimensions accurate? (Y/N/NA)			
Strike off plate for unit weight within specification? (Y/N/NA)			
Tamping rods and mallets within specification? (Y/N/NA)			
Cylinder molds within specification & source documented? (Y/N/NA)			
Beam molds within specification? (Y/N/NA)			
3. Concrete compression machine:			
Certified within the last 12 months? (Y/N/NA)			
Platen & head meet specification? (Y/N/NA)			
Compression head rotates & tilts freely at least 4° in any direction? (Y/N/NA)			
Compression head inscribed concentric circles within specification? (Y/N/NA)			
Condition of retainer rings within specification? (Y/N/NA)			
Neoprene pad use logged? (Y/N/NA)			
Neoprene pad's shore hardness recorded & meets specification? (Y/N/NA)			
Beam apparatus within specification? (Y/N/NA)			
Comments			

Asphalt	Applicable <input type="checkbox"/> Y/ <input type="checkbox"/> N	Rating	Equip ID# (Y/N/NA)
1. Square splitting pan for asphalt within specification? (Y/N/NA)			
Square sided scoop for asphalt within specification?(Y/N/NA)			
2. Maximum specific gravity (Rice) set up within specification? (Y/N/NA)			
Manometer free of air? (Y/N/NA)			
Pump oil free of water? (Y/N/NA)			
Desiccating crystals free of water? (Y/N/NA)			
Flasks calibrated and logged? (Y/N/NA)			
Vacuum pump pressure at 28 ± 2 mm Hg? (Y/N/NA)			
3. Bulk specific gravity equipment:			
a. Tank at correct temperature? (Y/N/NA)			
b. Suspension wire of small diameter? (Y/N/NA)			
4. SuperPave compactor checked? (Y/N/NA)			
Gyratory compactor angle checked with TMA? (Y/N/NA)			
5. Gyratory compactor molds within specification? (Y/N/NA)			
6. Gyratory ram head diameter & base plate within tolerance? (Y/N/NA)			
7. Compression testing machine certified &/or checked within the last 12 months? (Y/N/NA)			
8. Program correct for Stabilities & Lottmans? (Y/N/NA)			
9. Ignition furnace has correct settings programmed? (Y/N/NA)			
10. Freezer within specification? (Y/N/NA)			
11. Incubator within specification? (Y/N/NA)			
12. Water baths within specification? (Y/N/NA)			
13. Stabilometer checked and within specification? (Y/N/NA)			
Comments			

Soils Applicable <input type="checkbox"/> Y/ <input type="checkbox"/> N	Rating	Equip ID# (Y/N/NA)
1. Compaction equipment:		
Compaction base of sufficient mass? (Y/N/NA):		
T99 manual rammer within specification? (Y/N/NA)		
T99 mechanical hammer within specification? (Y/N/NA)		
T180 manual hammer within specification? (Y/N/NA)		
T180 mechanical hammer within specification? (Y/N/NA)		
6" molds within specifications? (Y/N/NA)		
4" molds within specifications? (Y/N/NA)		
Straightedge (strike-off bars) within specifications? (Y/N/NA)		
2. Atterberg Equipment:		
Liquid limit device within specification? (Y/N/NA):		
Grooving tool within specification? (Y/N/NA)		
3. R-value equipment:		
Kneading compactor calibrated at required intervals? (Y/N/NA)		
Tampers foot meets dimensional limits? (Y/N/NA)		
Molds, dimensions within specifications? (Y/N/NA)		
4. Nuclear M/D gauges calibrated within 2 years & checked within 1 year? (Y/N/NA)		
5. Sulfate test equipment:		
Sulfate standard not expired & at proper concentration? (Y/N/NA)		
Correction curve generated for current batch of BaCl & not older than 6 months? (Y/N/NA)		
Glass test vials clear & unclouded? (Y/N/NA)		
Colorimeter set to correct program or proper colorimeter used? (Y/N/NA)		
BaCl reagent not expired? (Y/N/NA)		
Comments		

Distribution:

- Materials and Geotechnical Branch Manager
- Materials and Geotechnical Program Managers
- Region Materials Engineer

Asphalt Laboratory Equipment		Passed		Applicable
Procedure	Description	Yes	No	(O Y / O N)
HMA-1	Low Temperature Oven and Freezer			
HMA-2	SuperPave Gyratory Compactor Mold			
HMA-3	SuperPave Gyratory Compactor Ram Head			
HMA-4	Stabilometer			
HMA-5	Troxler Gyratory Compactor True Mold Angle			
HMA-6	Maximum Specific Gravity and Lottman System			
HMA-7	Water Baths			
HMA-8	Troxler Gyratory Compactor Pressure			
HMA-9	Troxler Gyratory Compactor CDI Angle			
HMA-10	Troxler Gyratory Compactor Height Calibration & Rotation			
HMA-11	United Press Load Cell Calibration			
HMA-12	Troxler Gyratory Compactor Region Load Cell Pressure			
G-1	Balance			
G-2	Oven Temperature			
None	Square splitting pan for asphalt			
None	Square sided scoop for asphalt			
None	Ignition furnace has correct setting programmed?			
Comments				

Addendum CDOT Form #520 8/10

CDOT Form #520 Addendum

Note: This page replaces CDOT Form #520 Page 3.

{This page was intentionally left blank.}

Equipment Calibration, Verification, and Check Information			
<i>Testing Area</i>	<i>Items(s)</i>	<i>Calibration/Verification Interval</i>	<i>Calibration/Verification Procedure</i>
General	Balances, Scales and Weights	12 Mo.	Certified Contractor or G-1
General	Test Thermometers	6 Mo.	Certified Contractor or G-3 & G-4
General	Mechanical Shakers	12 Mo.	A-1
General	Sieves	6 Mo.	A-2
General	Oven	6 Mo.	G-2
Concrete/PP Unit	Air Meters	3 Mo.	ASTM C 231
Concrete/PP Unit	Capping Material	3 Mo.	AASHTO T 231
Concrete/PP Unit	Compression Testing Machine	12 Mo.	Certified Contractor ASTM C 39
Concrete/PP Unit	Beam Apparatus	12 Mo.	Certified Contractor AASHTO T 97
Concrete/PP Unit	Conical Mold & Tamper	24 Mo.	ASTM C 128
Concrete/PP Unit	Single Use Molds	Once per shipment.	AASHTO M 205
Concrete/PP Unit	Beam Molds	12 Mo	AASHTO T 23
Concrete/PP Unit	L.A. Machine	24 Mo.	AASHTO T 96
Concrete/PP Unit	Moist Room	Verify Temp with Recording Thermometer	ASTM C 511
Concrete/PP Unit	Slump Cones	12 Mo.	ASTM C 143
Concrete/PP Unit	Steel Balls	24 Mo.	AASHTO T 96
Concrete/PP Unit	Unit Weight Measures	12 Mo.	ASTM C 29
Concrete/PP Unit	Unbonded Caps	Each Shipment	ASTM C 1231
Concrete/PP Unit	M/D Gauge, Calibration Checks	12 Mo.	CP-L 5303
Flex. Pvmt	Compression Testing Machine	12 Mo.	Certified Contractor or HMA-11
Flex. Pvmt	Molds, Superpave	12 Mo.	HMA-2
Flex. Pvmt	Superpave Gyrotory Compactor, Verify Ram Pressure, Angle of Gyration, Frequency of Gyration, LVDT	12 Mo.	HMA-5, 8, 9, 10
Flex. Pvmt	Superpave Gyrotory Compactor, Verify Ram Head and Base Plate	12 Mo.	HMA-2 & 3
Flex. Pvmt	Superpave Gyrotory Compactor Calibration Load Cell	12 Mo.	Certified Contractor or HMA-12
Flex Pvmt	Water Bath	12 Mo	HMA-7
Flex. Pvmt	Vacuum System	12 Mo.	HMA-6
Flex. Pvmt	Molds, Followers, Calibration Cylinders	12 Mo.	HMA-4
Flex. Pvmt	Ignition Oven Internal Scale	12 Mo.	Certified Contractor or G-1
Flex. Pvmt	Vacuum / Pressure Measuring Gauges	12 Mo.	Certified Contractor or HMA-6
Soils Unit	California Kneading Compactor	12 Mo.	Certified Contractor
Soils Unit	Compression or Loading Device	12 Mo.	Certified Contractor
Soils Unit	Grooving Tool	12 Mo.	AASHTO T 89
Soils Unit	Hydrometers	24 Mo.	AASHTO T 88
Soils Unit	Liquid Limit Device	12 Mo.	AASHTO T 89
Soils Unit	Manual Hammer	12 Mo.	AASHTO T 99 / AASHTO T 180
Soils Unit	Mechanical Compactor (Hammer)	12 Mo	AASHTO T 99/ AASHTO T 180
Soils Unit	Metal Follower	12 Mo.	AASHTO T 190
Soils Unit	Molds	12 Mo.	AASHTO T 99/AASHTO T 180/AASHTO T 190
Soils Unit	Standard Metal Specimen	12 Mo.	AASHTO T 190
Soils Unit	Straight edge	6 Mo.	AASHTO T 99 / AASHTO T 180
Soils Unit	R-Value Equipment	12Mo.	AASHTO T 190
Soils Unit	Vacuum System	24 Mo.	AASHTO T 100

Protocol for Round Robin Materials Testing of CDOT Region & Consultant Laboratories

SCOPE: Round robins are conducted every year in the winter. It provides all participating labs the opportunity to look at their procedures and results in relation to other test labs.

PARTICIPANTS:

The Lab Manager contacts all of the previous year's participants to find their interest in the round robin. New labs may also be invited to participate. The Regions are contacted for information about consultant test labs that should be included. With a clear idea of the number of participants and the quantity of samples that will be needed, the various laboratories obtain enough materials for the round robin testing, plus 10% for retesting.

MATERIALS:

Flexible Pavement:

A typical project mix design is chosen for the Round Robin. Flexible Pavement personnel sample aggregates for the testing. A binder supplier is contacted to supply the binder. The mix design is run in the Flexible Pavement Unit to be sure that material changes will not affect the mix design. Slight gradation changes may be made to produce a reasonable mix, and the final mix design is produced.

Soils:

A typical soil sample is chosen for the Round Robin. Soils lab personnel acquire soils for the testing.

Concrete & Physical Properties:

A concrete mix is chosen for the round robin. A local concrete supplier is contacted to supply the mix.

Along with the concrete sample, samples for CP 37 *Plastic Fines in Graded Aggregates and Soils by the Sand Equivalent Test* and CP-L4102 *Specific Gravity and Absorption of Fine Aggregate* will be distributed.

SAMPLE PREPARATION:

Flexible Pavement:

Flexible Pavement personnel run the

aggregates through the Physical Properties Lab. Aggregate and binder are reduced for the ignition oven correction factor that is run by each lab. Flex personnel then mix the Hot Mix Asphalt (HMA) to within 1 gram of the mix design binder content. Mixing times and temperatures are tightly controlled and kept constant between cans of mix. Approximately 8000 grams are distributed, with the correction factor materials, to each round robin participant.

Required round robin tests may include:

- AC content (CP-L 5120)
- Gradation from burn-off (AASHTO T 30)
- Maximum specific gravity (CP 51)
- Bulk specific gravity (CP 44)
- Air voids (AASHTO T 269)
- Stability (CP-L 5106)
- Tensile strength ratio (CP-L 5109)

Directions and a worksheet for reporting results are also provided. The directions specify heating times and temperatures, CPs and CP-Ls to use, what samples to split out of each can, and a phone number for questions.

Alternate methods of round robin sample preparation may be implemented, with the approval of the MAC. Alternate methods may include plant mixed samples, unmixed samples, samples provided as individual aggregate components with a batch sheet, samples procured from a third party, samples delivered as individual test sizes, or a variation thereof.

Soils:

Soils lab personnel split the field material over the #4 screen and process the coarse aggregates. Soil and aggregates are recombined for the mechanical analysis. A moisture content sample is packaged separately and included with the material for Atterburg Limits. Ten pound samples of minus #4 material are split for proctor density. For the R-Value test, a 4800-gram sample of minus #4 will be provided. When a sulfate content test sample is requested, a 500 gram sample of minus #40 material and/or a vial of sulfate solution will be provided. The sulfate sample will be tested using CP-L 2103. Directions and a worksheet for reporting results are provided. The directions specify the test methods to be used, the accuracy used in reporting results,

and a phone number to call with questions.

Concrete & Physical Properties:

Cylinders will be cast and cured according to AASHTO T 23 *Making and Curing Concrete Test Specimens in the Field*. The cylinders will be cured at the Central Laboratory and distributed to the participants. The participants will cure the cylinders and break the cylinders on the designated date according to ASTM C 39 *Compressive Strength of Cylindrical Concrete Specimens*.

The fine aggregate is sampled in accordance to AASHTO T 2 *Sampling Aggregates* from the stockpile and reduced in accordance to AASHTO T 248 *Reducing Samples of Aggregate to Testing Size* to approximately 1,500-gram samples.

NOTIFICATION OF RESULTS:

Round Robin Participants receive an electronic letter that thanks them for their participation, informs them of their laboratory number and explains what they are receiving. For labs with concerning results, a statement expressing our desire to figure out where they went wrong is included. Participants receive a report with just their lab's results and their consequent ratings. Their rating is determined through application of standard deviations to the data average. The AMRL method is followed. Scores that are greater than 3 standard deviations from the mean will not be used to calculate the statistics. The rating system is described as follows:

Rating 5 is for test results within ± 1.0 standard deviation.

Rating 4 is for test results between ± 1.0 to ± 1.5 standard deviations.

Rating 3 is for test results between ± 1.5 to ± 2.0 standard deviations.

Rating 2 is for test results between ± 2.0 to ± 2.5 standard deviations.

Rating 1 is for test results between ± 2.5 to ± 3.0 standard deviations.

Rating 0 is for test results greater than ± 3.0 standard deviations.

The best possible AMRL rating is 5, and the worst possible rating is 0. Any AMRL rating that is 2 or less is judged to be marginal and needs to be either addressed or investigated during the lab inspection.

REPORT:

Participants receive an electronic round robin report. The report contains the following: cover sheet with CDOT logo, our address, and the year and type of round robin results.

Table of Contents:

- Introduction that names all round robin participants,
- General sampling and testing procedures that are used,
- Data evaluation section that explains the AMRL rating system that was used,
- The results section briefly describes what tests were run and what two standard deviations includes (95.5 % of the test results),
- State what procedural differences exist from last year's round robin,
- The acknowledgment thanks all that helped with the round robin,
- Tables with test results and ratings for all labs, although the labs are only identified through the can numbers that they received. Further, the results are put into a table containing only CDOT data and ratings and into a table containing only Industry data and ratings, when applicable,
- Graphs of the distribution of test results for each test performed and a scatter plot if applicable.

MISCELLANEOUS:

If a participating lab has one or more individual test ratings of two or less, they are contacted and informed of their ratings. New test material may provided so that the lab may rerun the material, if the material is not time sensitive. Their original results will be used in the round robin report.

All lab results will be kept confidential. The latest round robin results will be included in the Region Lab Inspection Report.

Inviting all labs doing CDOT work may be impractical, as much work is needed to sample the materials. Using local materials helps to ease this problem.

It's possible that Region Mobile labs won't be up and running in the winter when the round robin material is distributed. Material for the Mobile labs is still sent out. When the lab is operating, the round robin material will be tested and the results will be submitted to the Central

Laboratory to be compared to the round robin data and for inclusion in the Region Materials Inspection Report. While it would then be too late to include the Mobile lab's data in the round robin report, the Region could look at the round robin data to gain feedback about their equipment and procedures.

DISTRIBUTION:

- 1) Reports to industry are sent to the management of industry labs.
- 2) Reports to CDOT Regions are sent to the Region Materials Engineer for review and internal distribution.
- 3) Program Managers retain reports concerning their Unit.
- 4) The Documentation Unit receives an electronic copy for file retention and posting on the web site.

Protocol for the Audit of Region Materials IA Sampling and Testing Program by the Central Materials Laboratory

AUTHORITY: The Code of Federal Regulations (23 CFR Part 637) require that for all State DOTs (SHA) an Independent Assurance Program be implemented. The “Independent Assurance samples and tests or other procedures shall be performed by qualified testing personnel employed by the SHA or its designated agent” (637.205 Policy). The Central Materials Laboratory ensures compliance by performing biennial audits of the Regions’ IA programs. The QA Program Chapter, Subsection 6.11.1, of the Field Materials Manual, which is reviewed and approved by the FHWA, documents this Inspection.

OVERVIEW: Every two years a team from the Central Laboratory and the FHWA reviews the Independent Assurance Program established by the Region. A report is written documenting the results of the audit.

TEAM MEMBERSHIP: The team will consist of the Pavement Design Program Manager and the Documentation Unit Representative. The Program Manager may delegate leadership to another Professional Engineer within the Unit. The FHWA may provide a representative to accompany and participate in the audit.

SCHEDULING AUDITS: The Team Leader contacts each of the Region Materials Engineers and schedules the inspections at mutually convenient times and dates. The RME should ensure the availability of the Region’s IA Tester(s). It is advisable to avoid the busiest months of the construction season.

AUDIT QUESTIONNAIRE: Prior to the audits a questionnaire will be distributed to the Region to assist and facilitate the review. This document may include issues raised at the previous IA Testers Meeting.

CONDUCT OF AUDITS: The team shall meet with the Region Materials Engineer and the technician(s) involved with the Independent Assurance Program. The program is reviewed following the established audit questionnaire. Additional questions and/or concerns will be addressed as they arise.

REPORTING OF AUDIT RESULTS: The Team Leader shall write a report documenting the results of each Region’s audit. Each Region’s report provides an overall assessment of the Region’s assurance program and identifies any deficiencies. Innovative features, which improve the effectiveness of the program, should also be noted. Draft reports will be distributed to the Region Materials Engineers for comments prior to them being submitted to the MAC for approval. Each Final Report, with the questionnaire, is then distributed. The Reports must be written and distributed by June 30th.

DISTRIBUTION LIST:

- FHWA - Direct Recipient
- Chief Engineer
- Director of Staff Services
- Region Transportation Director
- Program Engineer
- Resident Engineer
- Region Materials Engineer

Protocol for the Audit of Region Materials Final Materials Review and Acceptance Process by the Central Materials Laboratory

AUTHORITY: The Code of Federal Regulations (23 CFR Part 637) require that for all State DOTs (SHA) a quality assurance program shall provide for an acceptance program and an independent assurance (IA) program. The Central Materials Laboratory ensures compliance by performing biennial audits of the Region's project documentation. A review of required CDOT Forms and Documents within the completed Project's File is mandated to ensure compliance with the Documentation Chapter of the Field Materials Manual.

OVERVIEW: Every two years a team from the Central Laboratory and the FHWA perform a Quality Audit of two randomly selected projects that have been completed during the previous two years within each of the Regions. A report is written documenting the results of the audit.

TEAM MEMBERSHIP: The team will consist of the Pavement Design Program Manager and the Documentation Unit Representative. The Program Manager may delegate leadership to another Professional Engineer within the Unit. The FHWA will be invited, and may provide a representative to accompany and participate in the audit.

SCHEDULING AUDITS: The Team Leader contacts each Region Materials Engineer and schedules the audits at mutually convenient times and dates. The RME should ensure the availability of the Region's Materials Documentation Coordinator or the Region's Finals Engineer, if applicable. It is advisable to avoid the busiest months of the construction season, and to schedule in conjunction with the IA Sampling and Testing Program Audit.

AUDIT CHECKLIST: The Documentation Unit will develop and maintain a checklist to assist in and document the audit.

CONDUCT OF AUDITS: The team shall meet with the Region Materials Engineer and the Region's Materials Documentation Coordinator, and/or the Region Finals Engineer. The Project Files will be reviewed to ensure compliance with the Finals Materials Documentation Checking Procedure as stated in the Documentation chapter of the Field Materials Manual. Review of all documentation from throughout the duration of the project is acceptable. Review of the Management of Consultant Materials Testing (CP 16) is optional based on Region requirements.

REPORTING OF AUDIT RESULTS: The Team Leader shall write a report documenting the results of each Region's audit. Each Region's report provides an overall assessment of the Region's Final Materials Review and Acceptance Process and identifies any deficiencies. Innovative features, which improve the effectiveness of the program, should also be noted. Draft reports will be distributed to the Region Materials Engineers for comments prior to them being submitted to the MAC for approval. Each Final Report is then distributed. The Reports must be written and distributed by June 30th.

DISTRIBUTION LIST:

- FHWA - Direct Recipient
- Chief Engineer
- Director of Staff Services
- Region Transportation Director
- Program Engineer
- Resident Engineer
- Region Materials Engineer

Appendix - Table of Contents - 12

Appendix Title	Page
A Materials Advisory Committee (MAC) Charter.....	2
A Independent Assurance (IA) Testers Committee Charter.....	4
A Flexible Pavement Operators' Group (FPOG) Charter.....	6
 B Task Force Management Guide	 8
C Personnel Roster, Staff & Region Materials	11
D Definitions.....	15
E Acronyms.....	19
F Significant Publications.....	23
G Colorado Procedures - Laboratory <i>Numeric Order</i>	24
H Metric Conversion Tables.....	26
I Materials Testing Accuracy Criteria.....	28
J Laboratory Test Time.....	31
K Establishing Lots or Process Control on the Project.....	33
L Random Sampling.....	34
M Sample Processing Procedure.....	35
N Use of Laboratory Check Tests on More Than One Project.....	36
O CDOT Forms – Materials Related.....	37

Appendix A - Materials Advisory Committee (MAC) Charter - 2011

PURPOSE

To oversee the Field Materials Manual, the Laboratory Manual of Test Procedures, Pavement Design Manual, MAC Task Forces and Task Groups To review and approve all changes in the Schedules and test procedures in these manuals. To develop, review, approve, and propose to the Specification Committee specifications addressing materials problems and needs. To develop and implement programs, procedures, and policies to maintain the quality and statewide uniformity of materials incorporated into CDOT construction projects.

MEMBERSHIP

Voting Members:	Votes
CDOT Materials Engineer (Chairman).....	...1
Region Materials Engineers.....	...6
Central Laboratory Program Managers*.....	...2
<u>Total Votes</u>	<u>9</u>

* Note: Two of the six Program Managers from the Central Materials Laboratory, designated by the Materials & Geotechnical Branch Manager or per the respective specialty area.

Advisory members:

Representatives from Project Development, Standards & Specifications, Maintenance, FHWA, etc.

MEETINGS

Every two months, in odd months, on the 2nd Wednesday of the month (if possible). The meeting facilitation responsibilities will rotate among the six Regions. The host Region Materials Engineer (RME) will make arrangements for and preside at the meeting. The CDOT Materials Engineer will designate a person to be the Secretary of the MAC: to assist the Host Region, to create and distribute the Agenda, to take notes at the Meetings, write the Minutes, distribute the Minutes and the Executive Summary, and maintain the MAC on Teams web site.

SCOPE

1. Review and approve changes to the following:
 - Quality Assurance Program
 - Documentation, Field & Final Materials
 - Special Notice to Contractors
 - Frequency Guide Schedule for Minimum Materials Sampling, Testing, and Inspection
 - Frequency Schedule for Independent Assurance Evaluation
 - Independent Assurance Sampling
 - Colorado Procedures (CP's)
 - Colorado Procedures - Laboratory (CP-L's)
 - MAC Task Group Charters

2. Provide oversight for the Field Materials Manual, Laboratory Manual of Test Procedures, Pavement Design Manual, materials research, Pavement Management System implementation, and sampling & testing of maintenance material.

3. Review, discuss, develop, and approve specifications addressing materials problems or needs. Specifications approved by the MAC are then forwarded to the Specification Committee for consideration.

GUIDELINES FOR MATERIALS ADVISORY COMMITTEE (MAC) MEETINGS

Overview - The focus of MAC meetings will be to conduct the responsibilities of the MAC as designated under the **Purpose** and **Scope** Sections of the Materials Advisory Committee Charter.

Conduct of Meeting - The host Region Materials Engineer (RME) will preside over the meeting and act as the meeting facilitator. The agenda topics will be handled in order and discussion shall remain focused on the current topic. Additional topics added after the meeting agenda has been distributed, will be discussed after the meeting agenda items have been addressed if time permits. Discussion on each topic will move toward a swift and efficient resolution of the problem with the Host acting as a facilitator if necessary. If substantial work is anticipated to resolve specific items, a task

group can be formed to develop an action plan, which will resolve the question. When discussion on any topic begins to stray from the topic or significantly exceeds the allotted time for that topic, the presiding RME shall push for a resolution or move to the next Agenda item.

Who Attends - Attendance will be **Voting** and **Advisory** members of the Committee, as shown in the Charter. Guests (Contractors, suppliers, etc.) will attend only if invited by a MAC member for a specific Agenda topic only.

Agenda Topics - Only persons eligible to be voting members of the MAC may place topics on the agenda. Anyone else must work through these members to establish an agenda topic. The presenter of each topic shall lead the discussion on their topic and ask for a vote if necessary.

Agenda Topic Votes - Only Voting members of the MAC may "Make a Motion" or "Second a Motion". Only voting members may participate in E- Votes (Votes by E- Mail). Votes require 5 in affirmation. *Abstaining from a vote is not a passive act. Missing voting members must designate a proxy to the MAC Secretary.*

Appropriate Topics & Discussion - Topics will normally address items listed under **Purpose** and **Scope** of the MAC Charter. Topics that are brief updates without the possibility of discussion can be posted in the Agenda without discussion.

Prioritization of MAC Agenda Items - Agenda items for the upcoming meeting need to be submitted during the Topic Solicitation period. Each agenda item will be given a number. The priority for the Agenda is:

- 1) The **Minutes** from the previous MAC Meeting will be approved by Vote.
- 2) The **Agenda** for the current MAC Meeting will be accepted or amended, if necessary, by the membership.
- 3) The **E-Vote Summaries** from between the MAC Meetings will be announced by the Host. If the topic needs any discussion it will need to be an Agenda item.
- 4) **Task Force Business.** Task Forces need to inform the Committee of their current status. Informational updates

with discussion and votes are frequently necessary.

- 5) **Task Group Business.** Task Groups need to inform the Committee of their current status. Informational updates with discussion and votes are frequently necessary.
- 6) **Old Business.** This will include items that were on the last MAC agenda but were not addressed because of lack of time. This will also include items that were not resolved at the previous MAC meeting because additional data needed to be gathered. Items not discussed during the previous two MAC meetings shall be considered new business if the topic is resumed.
- 7) **Education & Research.** Guest speakers, video presentations, etc. will occasionally be on the Agenda to assist in the sharing of relevant current information.
- 8) **Guests** that come for one topic and then leave shall be assigned a time slot, most likely after lunch. The guests' schedule will be taken into consideration. Discretion will be used when an excessive amount of time, minor importance, or more than one topic is requested. In some instances guests may be placed at the end of the agenda.
- 9) **New Business.** This will be prioritized by the Staff Materials Engineer based on the importance of the agenda item and associated with related topics.
- 10) **Additional Business.** Items that are received after the deadline for submittal. Unless these are "emergency" items, they will be placed at the end of the agenda and discussed in a priority order as time permits.

Appendix A - Independent Assurance Testers (IAT) Committee Charter

PURPOSE

To review and aid in the development of the Independent Assurance (IA) Program and the Frequency Schedule for Independent Assurance Evaluation in the Field Materials Manual.

To receive and review procedures for testing materials used in the Field and recommend any necessary changes for implementation to the Materials Advisory Committee.

To establish and maintain statewide consistency between Quality Assurance and Independent Assurance Testers.

To establish and maintain consistency in the use of the Field Materials Manual.

MEMBERSHIP

Voting Members:

A member of the Documentation Unit of Staff Materials and one IA tester from each of the six Regions will be allowed to vote. Regions with more than one IA Tester shall share a vote.

Advisory Members:

FHWA and CDOT employees with experience or expertise in the tests performed by Field personnel or the Central Laboratory.

MEETINGS

Meetings will be on an annual basis and usually in January. The meeting will be held at a time close to the Materials Advisory Committee (MAC) meeting. If requested by the Committee, additional meetings may be required. The Pavement Design Program Engineer will host the meeting each calendar year. A member of the Documentation Unit will assist the Host, to create and distribute the Agenda, to take notes at the meetings, and produce and distribute the Minutes.

SCOPE

To share information and ideas related to sampling and testing of material incorporated into CDOT projects.

To review new ideas, develop and approve (by simple majority) suggested changes to the Field Materials Manual, specifications, or procedures addressing materials problems or needs. Suggested changes will be forwarded to the MAC for consideration.

GUIDELINES FOR THE INDEPENDENT ASSURANCE TESTERS COMMITTEE MEETINGS

Overview - The focus of the IAT Meeting will be to conduct the responsibilities of the IAT Committee as designated under the **Purpose** and **Scope** sections of the Independent Assurance Tester Committee Charter.

Conduct of Meeting - The Chairperson will preside over the meeting. The agenda topics will be handled in order and discussion shall remain focused on the current topic. Additional topics added after the meeting agenda has been distributed, will be discussed after the meeting agenda items have been addressed if time permits. Discussion on each topic will move toward a swift and efficient resolution of the problem. If substantial work is anticipated to resolve specific items, a task force can be formed to develop an action plan, which will resolve the question. When discussion on any topic begins to stray from the topic, the Chairperson shall push for a resolution or move to the next agenda item.

Who Attends - Attendance will be **Voting** and **Advisory** members of the Committee, as shown in the Charter. Guests (Contractors, suppliers, etc.) will attend only if invited by an IAT member for a specific Agenda topic.

Agenda Topics - Only persons eligible to be voting members of the IAT Committee may place topics on the agenda. Anyone else must work through these members to establish an agenda topic. The presenter of each topic shall lead the discussion on their topic and ask for a vote if necessary.

Agenda Topic Votes - Only Voting members of the IAT may "Make a Motion" or "Second a Motion". Only voting members may participate in E- Votes (Votes by E- Mail).

Appropriate Topics & Discussion - Topics will normally address items listed under **Purpose** and **Scope** of the IAT Charter. Topics that are informational and require no decision, such as updates, shall generally be avoided. These can be handled by E-Mail.

Prioritization of IAT Agenda Items - Agenda items for the upcoming meeting need to be submitted at least 20 calendar days prior to the meeting. Each agenda item will be given a number. The priority for the Agenda is:

- 1) The **Minutes** from the previous IAT meeting will be approved by vote.
- 2) The **Agenda** for the current IAT meeting will be approved by vote.
- 3) The **E-Votes Summary** will be submitted for IAT Minute inclusion.
- 4) Matters considered "**emergency**" items as determined by the Chairperson shall have the top priority.
- 5) **Task Group Business.** Task Groups need to inform the Committee of current status. Informational updates with discussion and votes are frequently necessary.

- 6) **Guests** that come for one topic and then leave shall be assigned a time slot, most likely after lunch. The guests' schedule will be taken into consideration. Discretion will be used when an excessive amount of time, minor importance, or more than one topic is requested. In some instances guests may be placed at the end of the agenda.
- 7) **Old Business.** This will include items that were on the last IAT agenda but were not addressed because of lack of time. This will also include items that were not resolved at the previous IAT meeting because additional data needed to be gathered. Items not addressed at the last IAT meeting shall be considered new business.
- 8) **Education & Research.** Guest speakers, video presentations, etc. will occasionally be on the Agenda to assist in the sharing of relevant current information.
- 9) **New Business.** This will be prioritized by the Chairperson based on the importance of the agenda item and then associated with related topics.
- 10) **Additional Business.** Items that are **received after the deadline** for submittal. Unless these are "emergency" items, they will be placed at the end of the agenda and discussed as time permits.

Appendix A - Flexible Pavement Operators' Group (FPOG) Charter

PURPOSE

To review needed changes in the testing of flexible pavement and to share information with other flexible pavement testers. To review and aid in the development of Colorado Procedures (CPs) and Colorado Procedures - Laboratory (CP-Ls) that pertain to flexible pavement.

MEMBERSHIP

Voting Members:

Members of Staff Materials Flexible Pavement Unit and flexible pavement testers from the six Regions. Every tester who attends the FPOG meeting is allowed to vote. The total number of votes varies from meeting to meeting.

Advisory Members:

A Flexible Pavement Engineer and, as needed, CDOT employees with flexible pavement experience.

MEETINGS

Twice a year, usually in October and February. The meetings will take place in Glenwood Springs. Regions will rotate hosting the meeting. The host Region will provide a Chairman to preside at the meeting and to make arrangements for the meeting. The Flexible Pavement advisory member will serve as Secretary to assist the Host Region, to create and distribute the Agenda, to take notes at the meetings, and produce and distribute the Minutes.

SCOPE

To share information and ideas related to the testing of flexible pavements

To review ideas and approve (by simple majority) suggested changes to the following:

Colorado Procedures (CPs)
Colorado Procedures - Laboratory (CP-Ls)

The Flexible Pavement advisory member then presents these approved changes to the MAC for the MAC's consideration.

GUIDELINES FOR FLEXIBLE PAVEMENT OPERATORS' GROUP (FPOG) MEETINGS

Overview - The focus of FPOG meetings will be to conduct the responsibilities of the FPOG as designated under the **Purpose** and **Scope** sections of the Flexible Pavement Operators' Group Charter.

Conduct of Meeting - The Chairman from the host Region will preside over the meeting. The agenda topics will be handled in order and discussion shall remain focused on the current topic. Additional topics added after the meeting agenda has been distributed, will be discussed after the meeting agenda items have been addressed if time permits. Discussion on each topic will move toward a swift and efficient resolution of the problem. If substantial work is anticipated to resolve specific items, a task force can be formed to develop an action plan, which will resolve the question. When discussion on any topic begins to stray from the topic, the Chairman shall push for a resolution or move to the next agenda item.

Who Attends - Attendance will be **Voting** and **Advisory** members of the FPOG, as shown in the Charter. The RME from the host Region is encouraged to attend. Guests (Contractors, suppliers, etc.) will attend only if invited by a FPOG member for a specific Agenda topic.

Agenda Topics - Any FPOG member may place topics on the agenda. Anyone else must work through these members to establish an agenda topic. The presenter of each topic shall lead the discussion on their topic and ask for a vote if necessary.

Agenda Topic Votes – Only Voting members of the FPOG may “Make a Motion” or “Second a Motion”. Only voting members may participate in E- Votes (Votes by E- Mail).

Appropriate Topics & Discussion - Topics will normally address items listed under **Purpose** and **Scope** of the FPOG Charter. Topics that are informational and require no decision, such as updates, shall generally be avoided. These can be handled by E-Mail.

Prioritization of FPOG Agenda Items - Agenda items for the upcoming meeting need to be submitted at least 10 calendar days prior to the meeting to the Flexible Pavement advisory member at Staff Materials. Each agenda item will be given a number. The priority for the Agenda is:

- 1) The **Minutes** from the previous FPOG meeting will be approved by vote.
- 2) The **Agenda** for the current FPOG meeting will be approved by vote.
- 3) The **E-Vote Summary** will be submitted for FPOG Minute inclusion.
- 4) Matters considered "**emergency**" items as determined by the Chairman shall have the top priority.

- 5) **Task Force Business.** Task Forces need to inform the Flexible Pavement Operators' Group of current status. Informational updates with discussion and votes are frequently necessary.
- 6) **Guests** that come for one topic and then leave shall be assigned a time slot, most likely after lunch. The guests' schedule will be taken into consideration. Discretion will be used when an excessive amount of time, minor importance, or more than one topic is requested. In some instances guests may be placed at the end of the agenda.
- 7) **Old Business.** This will include items that were on the last FPOG agenda but were not addressed because of lack of time. This will also include items that were not resolved at the previous FPOG meeting because additional data needed to be gathered. Items not addressed at the last FPOG meeting shall be considered new business.
- 8) **Education & Research.** Guest speakers, video presentations, etc. will occasionally be on the Agenda to assist in the sharing of relevant current information.
- 9) **New Business.** This will be prioritized by the Chairman based on the importance of the agenda item and associated with related topics.
- 10) **Additional Business.** Items that are **received after the deadline** for submittal. Unless these are “emergency” items, they will be placed at the end of the agenda and discussed as time permits.

Appendix B- Task Force Management Guide

OVERVIEW The activities of a task force must be managed to accomplish the purpose of the task force. Keep the focus on the purpose of the task force and accomplish the tasks necessary to achieve this purpose with a series of action items. Various materials committees (MAC, AIF Steering, CDOT-ACPA Co-op, etc.) establish the purpose of each task force. At the first meeting of the task force make sure that this purpose is clearly understood by all task force members. Avoid expanding the purpose or scope of the task force without first consulting the committee that established the task force. The committee may decide that new problems identified by the task force are low priority or should be addressed by another task force.

PROBLEM SOLVING The activities of a task force are basically problem solving. Keep in mind the steps in problem solving, which are:

- Identify the problem
- Generate solutions
- Evaluate the advantages and disadvantages of each solution and make a decision
- Implement the solution
- Consider evaluating the solution one or two years later to make additional tweaks

PRIORITIES At the first meeting the task force should clarify priorities. Often there is an urgent need for a quick fix to the current specification followed by a longer-term effort to gather information and affect a more permanent reworking of the specification. As the work of the task force progresses make sure that the list of priorities is kept up-to-date.

IMPLEMENTATION TIMELINES Give consideration to timelines at which the final products will impact CDOT projects. The schedule of the Specification Committee is:

Specification Committee Schedule	
Meeting Dates	Quarterly Releases
March	February
June	May
September	August
December	November

Generally speaking, items approved by the MAC at its September Meeting, will be able to impact projects the following construction season. If urgent changes are needed, then items approved at the November MAC may make it into projects. This is possible, but not desirable. Items approved at the January MAC Meeting and beyond will not impact CDOT projects until the following construction season.

SCHEDULING It is not advisable to have meetings during the busy summer construction season for CDOT or industry representatives. However, after considering the implementation needs and the importance of the changes, meetings in the summer months may occur. Be sure to check with the CDOT and Industry Co-chairs for guidance on summer meetings.

It is in everyone's best interest to have as complete and comprehensive a product as possible. However, that is not realistic in many cases. It is often better to make incremental improvements. Several task forces have come up with an improved product. After experimenting with it on projects, the lessons learned are documented and a "Part 2" effort can be undertaken.

AGENDA Distribute a detailed agenda at least a week before each meeting. Start the agenda with a reminder of the date, time, and place of the meeting. Include a description of any decisions that need to be made with each topic. The last topic is establishing the date, time, and place of the next meeting.

SUPPORTING INFORMATION Distribute information to be discussed at least a week before the meeting so members have time to study that information. This information may be test data, research reports, etc. You shouldn't expect task force members to digest information just received and immediately make decisions.

CONDUCT OF THE MEETING As the person conducting the meeting, make sure that the discussion follows the agenda. New topics that arise may be discussed at the end of the meeting. Keep the discussion focused on the purpose of the task force. Try to base decisions on data. Sometimes data will indicate that a perceived problem does not exist. Try to draw out input from the quiet members of the task force. They may have valuable ideas. In addition, it is important to have buy-in by all task force members into whatever decisions the task force makes. Avoid having aggressive task force members dominate the discussion. The products of the task force should not only be workable but also should be a consensus that both industry and CDOT can be comfortable with. Within CDOT it is critical that task force products have statewide buy-in. A recurring problem with CDOT standards is lack of uniformity of statewide application that undermines the integrity and credibility of these standards.

Keep in mind that the Materials Advisory Committee and Specification Committee must approve any specification changes desired by the task force. The task force must develop the rationale and data needed to convince these technical committees.

Get commitments from task force member to do what needs to be done to accomplish the purpose of the task force (action items). At the end of the meeting, review these action items. Define clearly who will do what by when. Finally, determine the date, time and place of the next meeting, if possible.

MINUTES Someone should take notes at the meeting and produce detailed minutes. It is best for the note taker to not be the person conducting the meeting. It's too much for one person. Good minutes help avoid rehashing the same items at each meeting. Include in the minutes, decisions made on each topic. It is also good to describe areas of disagreement and any action that will be taken to resolve the disagreement. Include action items, listing who will do what by when. The final item in the minutes is the date, time, and place of the next meeting. Distribute minutes to task force members within two weeks of the meeting. It's often good to send minutes to your supervisor to keep them informed and to let them know what you're up to.

DOCUMENT TASK FORCE RESULTS Document the findings and changes made by the task force. This will be useful in the future to clarify the rational behind CDOT specifications and standards. Documentation should include the purpose of the task force, problems identified, data collected, references reviewed, and finally changes made to CDOT specifications and standards. The MAC secretary shall maintain copies of this final report documenting task force results.

Some examples of successful products have been:

- Specifications and standards that are forwarded to the Specification Committee,
- Project selection guidelines that are forwarded to the Materials Advisory Committee and included in the Pavement Design Manual,
- Colorado procedures and practices that are forwarded to the Materials Advisory Committee and included in the Field Materials Manual,
- Research needs statements that are forwarded to the Research Branch for consideration as a formal research problem statement or a quick study, or

Information that is important enough to be shared broadly within CDOT is forwarded to the Project Development Area Engineers for distribution as a Construction Bulletin.

The Task Force Process and Best Practices

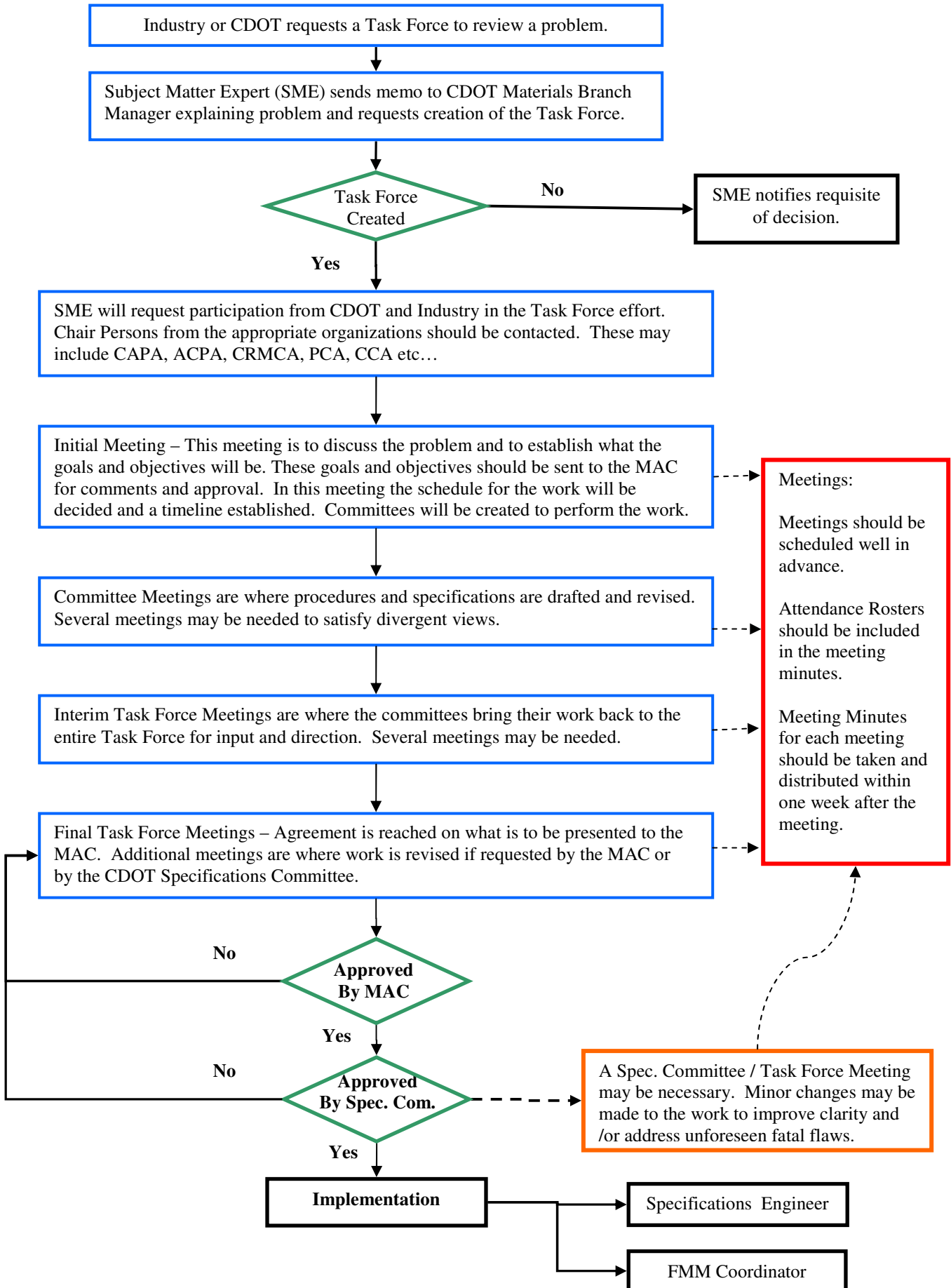

Appendix C - Personnel Roster, Staff Materials & Region Materials

<u>Office/ Name</u>	<u>Title</u>	<u>Telephone</u>
Materials & Geotechnical Branch		
Zufall, Jim	Materials & Geotechnical Engineer	303-398-6501
Kelley, Beverly	Program Assistant	303-398-6502
	FAX	303-398-6504
Asphalt Pavement Program		
Olson, Steve	Asphalt Pavement Engineer	303-398-6526
Lam, Johnny	Support Engineer	303-398-6527
Tchouban, Bryan	European Pavement Lab Technician	303-398-6532
Trujillo, Ed	Bituminous & European Lab Manager	303-398-6530
Vacant	Flexible Pavement Lab Manager	303-398-6533
Concrete & Physical Properties Program		
Kropp, Patrick	Concrete & Phy Prop. & Etc. Engineer	303-398-6541
Prieve, Eric	Radiation Safety Officer (RSO) & Support Engineer	303-398-6542 (Cell) 303-204-8926
Stanford, Michael	Concrete Pavement Lab Manager	303-398-6543
Dunn, Tim	Lead Lab Technician	303-398-6544
Smith, Paul	Pavement Deflection Technician (FWD) & M/D Gauge Calibration Tech,	303-398-6547
Jiron, Kelvin	High Speed Profiler (HSP)	303-398-6548
Roalofs, Scott	Chemist	303-398-6509
	FAX	303-398-6540
<p>Item 206 Class 1, Filter A,B,C, & Bed Course Item 304 Class 1-7 Item 403 HMA Aggregates Item 412 Concrete Aggregates</p>		
Pavement Design Program		
Goldbaum, Jay	Pavement Design Engineer	303-398-6561
Locander, Robert	Pavement Design Support Engineer	303-398-6562
DeLuccie, Veronica	QC / QA Program Manager	303-398-6528
	SiteManager Materials Trainer	
Kacinski, John	Pavement Design Support Engineer	303-398-6564
Kotzer, David	Materials Publication Manager & Product Evaluation Coordinator (PEC)	303-398-6566
Hernandez, Tony	Materials Documentation Manager (Accreditations & Form #250s)	303-398-6563

Appendix C - Personnel Roster, Staff Materials & Region Materials

<u>Office/ Name</u>	<u>Title</u>	<u>Telephone</u>
<u>Pavement Management Program</u>		
Henry, Stephen	Pavement Management Engineer	303-398-6576
Farrokhyar, Ali	Project Level Pavement Management Engineer	303-398-6577
Chavez, Eric	Network Level Pavement Manager	303-398-6565
<u>Soils & Rockfall Program</u>		
Su, Cheng Kuang	Soils & Rockfall Engineer	303-398-6586
Hotchkiss, Alan	Soils Scientist	303-398-6587
Granahan, Paul	Lab Manager	303-398-6590
Ortiz, Ty	Rockfall Engineer	303-398-6588
Item 203 Embankment		
Item 206 Class 2		
Item 307 Lime Treated Subgrade		
Item 504 MSE		
<u>Geotechnical Program</u>		
Liu, Hsing Cheng	Geotechnical Program Engineer	303-398-6601
Wenzel, Richard	Geotechnical Engineer	303-398-6512
Thomas, David	Geologist	303-398-6604
Ksouri, Ilyess	Geotechnical Engineer	303-398-6606
Conroy, Laura	Geotechnical Engineer	303-398-6603
Novak, David	Drill Crew Foreman	303-365-7142

Central Materials Laboratory, 4670 North Holly Street, Unit A, Denver CO 80216- 6408

<u>Region 1</u>			
Schiebel, Bill	Materials Engineer	Region 1	303-398-6801
		(Cell)	303-829-9491
Hussain, Shamshad	Asst. Materials Engineer	Region 1	303-398-6802
		(Cell)	303-916-0890
Minter, Janet	Pavement Manager	Region 1	303-398-6803
Loomis, Brent	IAT Lab	Region 1	303-398-6804
		(Cell)	303-919-0649
Gallegos, Michael	Region 1 Lab Manager	Region 1	303-398-6805
		(Cell)	303-918-6134
Falls, Dan	Region 1 Lab Technician	Region 1	303-398-6806
		(Cell)	303-910-8264
	FAX		303-398-6810

Region 1 Materials Laboratory, 4670 North Holly Street, Unit B, Denver CO 80216- 6408

Appendix C - Personnel Roster, Staff Materials & Region Materials

<u>Office/ Name</u>	<u>Title</u>	<u>Location</u>	<u>Telephone</u>
<u>Region 2</u>			
Zamora, Richard	Materials Engineer	1019 Erie (Cell)	719-546-5778 719-251-7833
Wieden, Craig	Asst. Materials Engineer	1019 Erie (Cell)	719-546-5779 719-251-7838
Bergles, Robert "Buster"	Region 2 Lab Manager	1019 Erie (Cell)	719-546-5776 719-251-7834
Walters, Frank	Region 2 Pavement Manager	1019 Erie	719-546-5776
Raebel, Richard "Rick"	IAT Lab	1019 Erie (Cell)	719-546-5776 719-251-9112
Sawvell, Jane	Administrative Assistant	1019 Erie	719-546-5794
Vacant	Region 2 Lab Technician	1019 Erie (Cell)	719-546-5776 719-251-7834
Jeff Ward	Mobile Lab Technician		719-546-5776
		(Cell)	719-251-7825
Goure, Steve	Colorado Springs Lab	*	719-227-3207
		(Cell)	719-492-1431
Melgoza, Kelly	Lamar Lab	2402 S. Main (Microwave)	719-336-3228 719-688-5447
		(Cell)	719-688-2095
Materials Lab FAX		1019 Erie	719-546-5777
Colorado Springs FAX		*	719-227-3298
Lamar FAX		2402 S. Main	719-546-5701

Region 2 Materials Laboratory (Pueblo) 1019 Erie, Pueblo Colorado, 81001
*** Region 2 (Colorado Springs) 1480 Quail Lake Loop, Colorado Springs Co. 80906**
Region 2 (Lamar) 2402 S. Main, Lamar Co. 81052

<u>Region 3</u>			
Goodrich, Rex	Materials Engineer	222 S. 6 th St.	970-683-6222
		(Cell)	970-250-3358
Vacant	Asst. Materials Engineer	222 S. 6 th St.	970-683-6223
		(Cell)	970-778-5858
Cubbison, Cecil	IAT Lab	606 S. 9 th St.	970-683-6376
		(Cell)	970-250-4261
Heidelmier, Bob	Pavement Manager	222 S. 6 th St.	970-683-6224
		(Cell)	970-216-3326
Vacant	Finals Engineer	222 S 6 th St.	970-683-6372
		(Cell)	970-250-2260
Rosedahl, Andy	Region 3 Lab	606 S 9 th St.	970-683-6374
		(Cell)	970-250-4769
Shafer, Jacob	Region 3 Lab	606 S 9 th St.	970-683-6370
Sisco, Richard	Region 3 Lab	606 S 9 th St.	970-683-6377
		(Cell)	970-210-6274
Spor, Corinne	Administrative Assistant	222 S. 6 th St.	970-683-6221
Vacant	Region 3 Lab	606 S 9 th St.	970-683-6375
		(Cell)	970-250-4789
Woolley, Trevor	IAT Lab	606 S. 9 th St.	970-683-6371
		(Cell)	970-250-2407

Appendix C – Personnel Roster, Staff Materials & Region Materials

FAX (Woolley, Cubbison)	970-683-6378
FAX (Rosedahl, Shafer, Sisco)	970-683-6379
FAX (Goodrich, Smith, Hiedelmeier, Spor)	970-683-6227
FAX (Vacant)	970-683-6369

Region 3 222 S. 6th St. Grand Junction Co. 81501
Region 3 (Materials Lab) 606 S. 9th St. Grand Junction Co. 81501

<u>Office/ Name</u>	<u>Title</u>	<u>Location</u>	<u>Telephone</u>
Region 4			
DeWitt, Gary	Region Materials Engineer	Region 4	970-350-2379
Chapman, Rick	Asst. Materials Engineer	Region 4	970-350-2380
Gary Strome	Pavement Management	Region 4	970-350-2382
Gonser, Todd	PE 1	Region 4	970-305-2381
Gonser, Steve	Lab Manager	Region 4	970-350-2384
Ellis, Mike	IAT Lab	Region 4	970-350-2383
Vacant	Lab Technician	Region 4	970-350-2385
FAX		Region 4	970-350-2390

Region 4 3971 W. Service Rd., Evans Co. 80620-2623

Region 5			
Coggins, Mike	Materials Engineer	Durango (Cell)	970-385-1625 970-759-5301
Shanks, Robert	Pavement Management	Durango	970-385-1627
Murphy, Patrick	IAT Lab Manager	Durango (Cell)	970-385-1624 970-759-5300
Jeff Reichle	Lab Technician	Durango	970-385-1628
Byrd, Robert	IAT Lab	Alamosa (Cell)	719-587-6520 719-588-3031
FAX		Durango	970-385-1629
FAX		Alamosa	719-587-6521

Region 5 20581 US Highway 160 Durango Co. 81301
Region 5 (Alamosa) 1205 West Ave. Alamosa, Co. 81101

Region 6			
Ghaeli, Masoud	Materials Engineer	Region 6 (Cell)	303-398-6701 303-358-8449
Chang, Jan	Pavement Design	Region 6	303-398-6702
Mero, Bob	Pavement Management	Region 6	303-398-6703
McMechen, Matt	IAT / Lab Manager	Region 6 (Cell)	303-398-6704 303-829-2212
Meyer, Ken	IAT / Lab Technician	Region 6 (Cell)	303-398-6705 303-918-2894
Lyubinin, Mark	Lab Technician	Region 6	303-398-6706
FAX			303-398-6714

Region 6 Materials Laboratory, 4670 North Holly Street, Unit C, Denver CO 80216- 6408

Appendix D - Definitions

NOTE: Definitions applicable to a specific material can be found in the respective chapter.

Acceptance Program - All factors that comprise CDOT's determination of the quality of the product as specified in the contract requirements. These factors include verification sampling, testing, and inspection.

Accredited Laboratory - A laboratory that is accredited by the AASHTO Accreditation Program.

Anionic - Negatively charged, i.e. emulsions

Batch - A unit or subdivision of a lot, such as a mixer load of concrete, a batch of bituminous mix, or a square yard of base course.

Bias - Constant error in one direction, which causes the average test result to be offset from the true average value.

Calibration - The act or process of determining the relationship between a set of standard units of measure and the output of an instrument or test procedure

Cationic - Positively charged, i.e. emulsions

Central Laboratory Check Samples and Tests. Random representative samples submitted to CDOT's Central and/or Region Laboratory to additionally evaluate quality of field produced products and materials, and to perform tests not within the capabilities of the Field and/or Region Laboratories.

Check Sample - A Replicate Sample, usually from Project Samples or Verification Samples, which is submitted to the Central or Region Laboratory for an independent check. Independent checks on HBP include: Hveem Stability (CP-L 5105), Lottman (CP-L 5109), and Air Voids (CP-L 5105). For Superpave mixes S, SX, and SG independent checks include: volumetric properties at N_{design} and Hveem Stability (CP-L 5106). The purpose of these samples is for the Central or Region Laboratory to verify acceptability and quality of field

produced material and to perform tests that are not within the capabilities of the field.

Coefficient of Variation - The Standard Deviation divided by the mean.

$$CV = \frac{\sigma}{\bar{X}}$$

Comparative Sample - One of several samples resulting from a closely controlled small Batch or increment which has been thoroughly mixed and then reduced by quartering or splitting into a number of Replicate Samples. For CDOT purposes the Central Laboratory will make Groups of Comparative Samples on various materials. One or more will be sent to each participating Region Laboratory for testing to determine acceptability of procedures, methods, and equipment.

Control Chart - Chart or graph, usually conspicuously displayed in the field materials laboratory where an up-to-date plot of Control and Verification Test results is kept.

Control Sample - A sample taken during the process from any of the components for a manufactured (constructed) product before being incorporated into the final mixture, or a sample taken from the final mixture or product before the material has reached its final position and condition in the completed construction.

Correlation - A statistical relation between two or more variable such that systematic changes in the value of one variable are accompanied by systematic changes in the other.

Designated Agent - An employee or employees of the State, local agency, or a consultant or independent laboratory which is employed, paid by, and / or directly accountable to CDOT or a public agency excluding the contractors' or vendors' personnel.

F-test - Compares the population variances.

Group - Replicate Test Specimens taken from the same Batch Sample.

Independent Assurance Program (IA) - Activities that are unbiased and an independent evaluation of all the sampling and testing procedures and testing equipment, and in some cases the witnessing of certain specified samples and sampling techniques used in the acceptance program.

Independent Assurance Sampling-Testing and Witnessing of Testing or Sampling - A sample taken and tested, or a sample that is witnessed only at a random location or time, the point to be designated by: Region Laboratory personnel, or project personnel, or CDOT's designated agent not associated with Project Verification Sampling and Testing; or the Contractor's (or his representative) not associated with Project Quality Control Sampling and Testing; or by an FHWA Engineer. The person who designates the point for sampling and who performs the actual test may physically do the sampling or project testing personnel may do the sampling in the presence of the IA person. Certain specified IA samples may be witnessed only. These samples are to be taken in the presence of both the project and IA personnel. These samples shall be taken by contractor's personnel or his representative. For more details and information, see the CDOT, Quality Assurance Program for Construction and Materials Sampling and Testing.

Lot - An isolated quantity of material from a single source. A measured amount of construction material assumed to be produced by the same process.

Mix Verification Testing – After the mix design has been approved and production commences, the Department will perform a minimum of three volumetric verification tests to verify that the field produced HMA conforms to the approved mix design.

Nominal – Representative value of a measurable property determined under a set of conditions, by which a product may be described.

Nominal Maximum - The size of aggregate in the smallest sieve opening through which the entire amount of specification aggregate is permitted to pass.

NOTE: For Item 403, Nominal Maximum size should be defined as: one sieve size

larger than the first sieve to retain more than ten percent of the aggregate.

Nominal Value – A value assigned for convenient designation; existing in name only. An example being “2 by 4” lumber and one-inch pipe.

Practice – A definitive procedure for performing one or more specific operations or functions that does not produce a test result.

Precision - A generic concept related to the closeness of agreement between test results obtained under prescribed like conditions from the measurement process being evaluated.

Professional Engineer Seals – Obtained or used by license holders in the State of Colorado and shall be capable of leaving an impression representation on the engineering work. For size and type specifications, see Subsection 5.5.1 of the Bylaws and Rules from the Colorado State Board of Licensure for Professional Engineers and Professional Land Surveyors.

Professional Engineer Stamps – Obtained or used by license holders in the State of Colorado and shall be capable of leaving a permanent ink impression. The permanent inked impression can be done with a variety of stamps including the traditional rubber stamp and pad, self-inking and pre-inked stamp all leaving a permanent inked impression. For size and type specifications, see Subsection 5.5.1 of the Bylaws and Rules from the Colorado State Board of Licensure for Professional Engineers and Professional Land Surveyors.

Proficiency Samples - Homogeneous samples that are distributed and tested by two or more laboratories.

Quality Assurance (QA) - All those planned and systematic actions necessary to provide confidence that a product or service will satisfy given requirements for quality.

Quality Control (QC) - All contractor/vendor operational techniques and activities that are performed or conducted to fulfill contract requirements.

Qualified Laboratories - Laboratories that participate in a qualification program, approved by CDOT that shall include provisions for

checking testing equipment and maintaining records of all equipment calibrations and equipment checks. All testing equipment used to conduct testing shall conform to the standards specified in the testing procedure.

Random Sample - A sample drawn from a Lot in which each increment in the lot has an equal probability of being chosen.

Random Sample, Stratified - When a Lot is subdivided into approximately equal Sub-lots and samples are selected from each sub-lot by a Random process.

Reasonable Conformance - When construction and materials substantially comply with the plans and specifications. Clearly stated acceptance plans assist the Project Engineer in making his decision as to reasonable conformance.

Recycled Pavement - When used in the context of cold in-place recycled pavement or hot in-place recycled pavement, the asphaltic material is reworked within the foot-print of the roadway without removing it off site.

Repeatability - The range within which repeated measurements are made by the same operator on the same apparatus on Replicate Test Specimens. Essentially, the precision of the test.

Replicate Samples or Test Specimens - Multiple Samples or Test Specimens as nearly identical as possible, under the stated conditions, usually from a thoroughly mixed larger sample that has been reduced in size by quartering or splitting.

Reproducibility - The range within which check measurements by different operators on different apparatus should agree under definitely stated conditions. Usually performed on Test Specimens from Replicate Samples.

Sample - A small part of a Sub-lot or Batch, which represents the whole. A sample may be divided into several Test Specimens.

Split Sample - A sample taken and evenly divided to be tested by two or more individuals or laboratories.

Standard Deviation (s) - A measure of the dispersion of measurements from their average; the square root of the quantity of individual deviations from the mean, squared, summed, and divided by the number of samples minus 1.

$$s = \sqrt{\frac{\sum(\bar{X} - X)^2}{n - 1}}$$

Standardization - The adjustment of an instrument, prior to use, to an arbitrary reference value, or to a device that has been calibrated.

State personnel - An employee or employees of CDOT.

Sub-lot - The largest, clearly identifiable subdivision of a Lot. Usually specified in the Field Materials Manual Sampling Schedule as the largest quantity that may be represented by a single sample.

System Basis, IA - A system where the minimum frequency is based on a unit of material production and/or a unit of time.

t-test - Compares the population means.

Test Method - A definitive procedure for the identification, measurement, and evaluation of one or more qualities, characteristics, or properties of a material, product, system or service that produces a test result.

Test Portion - The part of a material sample required for testing.

Test Specimen - That part of a material Sample that is prepared and tested. Usually obtained by reducing the sample by quartering, splitting, or taking an aliquot (usually a liquid portion removed from the whole) quantity.

Variation - Differences, due to any cause, in measured values of a measurable characteristic.

Vendor - A supplier of materials incorporated into the project, which is not the contractor. May or may not be the Manufacturer.

Verification Sampling and Testing - Sampling and testing performed to validate the quality of the product for acceptance.

Verification Sample - A sample used to make a decision as to the acceptability of the material being sampled. Reasonable Conformance and amount of payment will be based on this sample. The specifications designate the point of verification sampling. Refer to the Schedule.

Viscosity - Low viscosity = more fluid, High viscosity = more stiff

Witness – To witness is to observe an act of work, verifying that the work was performed and performed correctly. After observation, witness is to testify by written and verbal communication protocols to CDOT Engineer in charge.

Appendix E - Acronyms

3R	Resurfacing, Restoration, Rehabilitation
AAP	AASHTO Accreditation Program
AASHTO	American Association of State Highway and Transportation Officials
ABC	Aggregate Base Course
ACI	American Concrete Institute
ACPA	American Concrete Pavement Association
ACPA	American Concrete Pipe Association
AI	Asphalt Institute
AIF	Asphalt Industry Forum
AMRL	AASHTO Materials Reference Laboratory
APA	Asphalt Pavement Analyzer
APL	Approved Product List
ARA	Asphalt Rejuvenating Agent
ASTM	American Society of Testing and Materials
ATSSA	American Traffic Safety Services Association
BMP	Best Management Practices
CAGE	Colorado Association Geotechnical Engineers
CAPA	Colorado Asphalt Pavement Association
CBC	Concrete Box Culvert
CCA	Colorado Contractors Association
CCRL	Cement and Concrete Reference Laboratory
CDOT	Colorado Department of Transportation
CDPHE	Colorado Department of Public Health and Environment
CFR	Code of Federal Regulations
CIP	Complete-in-Place
CIPR	Cold-in-Place Recycle
CIR	Cold-in-Place Recycle
COC	Certificate of Compliance
CMO	Contract Modification Order
CP	Colorado Procedure
CP-L	Colorado Procedure – Laboratory
CPM	Counts Per Minute
CRS	Colorado Revised Statutes
CRSI	Concrete Reinforcing Steel Institute
CTP	Check Testing Program
CTR	Certified Test Reports
CTS	Compaction Test Section

D/A	Dust to Asphalt
DMS	Dynamic Message Sign
DRB	Dispute Resolution Board
DSR	Dynamic Shear Rheometer
EIS	Environmental Impact Statement
EPA	Environmental Protection Agency
FAA	Fine Aggregate Angularity
FAPG	Federal Aid Policy Guide
FDR	Full Depth Reclamation
FHWA	Federal Highway Administration
FIPI	Finding In the Public Interest
FIR	Field Inspection Review
FMM	Field Materials Manual
FOR	Final Office Review
FPOG	Flexible Pavement Operators Group
FQC	Field Quality Control
FWD	Falling Weight Deflectometer
HAZMAT	Hazardous Material
HBP	Hot Bituminous Pavement
HIPR	Hot-in-Place Recycle
HIR	Hot-in-Place Recycle
HITEC	Highway Innovative Technology Evaluation Center
HMA	Hot Mix Asphalt
HRI	Half-Car Roughness Index
HSP	High Speed Profiler
IA	Independent Assurance Program
IAT	Independent Assurance Sampling and Testing
I/D P	Incentive/Disincentive Payment
IGA	Inter-Governmental Agreement
IRI	International Roughness Index
JMF	Job Mix Formula
JSA	Job Safety Analysis
LabCAT	Laboratory for Certification of Asphalt Technicians
LA	Local Agency
LACA	Local Agency Certification Acceptance
LCCA	Life Cycle Cost Analysis
LIMS	Laboratory Information Management System
LMTP	Laboratory Manual of Test Procedures

LOI	Loss on Ignition
LOS	Level of Service
MAC	Materials Advisory Committee
MCR	Minor Contract Revision
MOA	Memorandum of Agreement
MOU	Memorandum of Understanding
MQL	Moving Quality Level
MSDS	Materials Safety Data Sheets
MUTCD	Manual on Uniform Traffic Control Devices
NCAT	National Center for Asphalt Technology
NCHRP	National Cooperative Highway Research Program
NDT	Non-Destructive Testing
NEPA	National Environmental Protection Act
NHS	National Highway System
NICET	National Institute for Certification of Engineering Technologies
NIST	National Institute of Standards and Technology
NOV	Notice of Violation
NPCA	National Precast Concrete Association
NPS	Non-Project Specific
NTPEP	National Transportation Product Evaluation Program
OGFC	Open Grade Friction Course
PCCP	Portland Cement Concrete Pavement
PF	Pay Factor
PG	Performance Graded
PPM	Parts Per Million
ProMIS	Project Management Information System
PS&E	Plans, Specifications and Estimate
PSI	Preliminary Site Investigation
QA	Quality Assurance
QAP	Quality Assurance Program
QC	Quality Control
QCP	Quality Control Plan
QIC	Quality Implementation Council
QL	Quality Level
QML	Qualified Manufacturers List
QPM	Quality Pavement Management
RAP	Reclaimed Asphalt Pavement (previously Recycled)
RAS	Reclaimed Asphalt Shingles

RE	Resident Engineer
RECP	Rolled Erosion Control Product
RMAEC	Rocky Mountain Asphalt Education Center
RME	Region Materials Engineer
ROD	Record of Decision
ROW	Right of Way
RSAR	Roadway Surface Accomplishment Report
RSO	Radiation Safety Officer
RTD	Region Transportation Director
RTFO	Rolling Thin Film Oven
SHRP	Strategic Highway Research Program
SMA	Stone Matrix Asphalt
SOW	Scope of Work
SpG	Specific Gravity
SSD	Saturated Surface Dry
SUPERPAVE	Superior Performing Asphalt Pavements
TCLP	Toxicity Characteristic Leaching Procedure
TCP	Traffic Control Plan
TRM	Turf Reinforcement Mat
VCA	Voids in Coarse Aggregate
VFA	Voids Filled with Asphalt
VMA	Voids in the Mineral Aggregate
VMA	Viscosity Modifying Admixture
VTM	Voids in Total Mix
WASHTO	Washington Association of State Highway and Transportation Officials
WAQTC	Western Alliance for Quality Transportation Construction
WCTG	Western Cooperative Test Group

Appendix F - Significant Publications

- ◆ AASHTO, Guide for Design of Pavement Structures
- ◆ Asphalt Institute, Performance Graded Asphalt Binder Specifications and Testing Superpave Series No. 1 (SP-1)
- ◆ Asphalt Institute, Superpave Level 1 Mix design
- ◆ Asphalt Institute, Superpave Series No. 2 (SP-2)
- ◆ Department of Natural Resources, Construction Materials Rules and Regulations
- ◆ CDOT, Construction Manual
- ◆ CDOT, Cost Data Books
- ◆ CDOT, Local Agency Manual
- ◆ CDOT, Life Cycle Cost Analysis State-of-the-Practice
- ◆ CDOT, M & S Standards
- ◆ CDOT, Pavement Design Manual (PDM)
- ◆ CDOT, Pipe Material Selection Policy
- ◆ CDOT, Laboratory Manual of Test Procedures (LMTP)
- ◆ CDOT, Standard Specifications for Road and Bridge Construction
- ◆ Metropolitan Government Pavement Engineers Council (MGPEC) Pavement Design Standards and Construction Specification Manual
- ◆ Portland Cement Association, Design and Control of Concrete Mixes, Thirteenth Edition

Colorado Procedures - Laboratory *Numeric Order*

CP-Ls 2100 Chemical Unit Testing

- CP-L 2103 Determining the Sulfate Ion Content in Water or Water-Soluble Sulfate Ion Content in Soil
- CP-L 2104 Determining the Water-Soluble Chloride Ion Content in Soil

CP-Ls 2200 Bituminous Testing

- CP-L 2202 Protective Covering Qualities for Bridge Deck Waterproofing Membrane
- CP-L 2203 Pliability and Thickness of Prefabricated Reinforced Membrane
- CP-L 2210 Determining Toughness and Tenacity of Rubberized Asphaltic Materials
- CP-L 2211 Elastic Recovery
- CP-L 2212 Residue by Evaporation of Asphalt Emulsion
- CP-L 2213 Coating of Bitumen-Aggregate Mixtures
- CP-L 2214 Verification of Binder Acidity or Alkalinity
- CP-L 2215 Effect of Heat and Air on a Moving Film of Asphalt

CP-Ls 3100 Soils Testing

- CP-L 3101 Resistance R-Value and Expansion Pressure of Compacted Soils or Aggregates by Means of Hveem Stabilometer
- CP-L 3102 Determination of Resistance Value at Equilibrium
- CP-L 3103 Specific Gravity of Soils
- CP-L 3104 Determining the Durability of Shales for Use as Embankments

CP-Ls 3200 Geology Testing

- CP-L 3201 Continuous Penetration

CP-Ls 4100 Concrete Testing

- CP-L 4101 Preparing Concrete Blocks for Testing Sealants, for Joints and Cracks
- CP-L 4102 Specific Gravity and Absorption of Fine Aggregate

CP-Ls 4200 Physical Properties Testing

- CP-L 4201 DELETED > Replaced by ASTM C 1260
- CP-L 4202 DELETED > Replaced by ASTM C 1567
- CP-L 4209 Physical Testing of Quicklime, Hydrated Lime, and Limestone
- CP-L 4211 Resistance of Coarse Aggregate to Degradation by Abrasion in the Micro-Deval Apparatus
- CP-L 4215 Determination of Percent Moisture in Rock Salt
- CP-L 4216 Determination of Salt Content of Sanding Materials

CP-Ls 5100 Flexible Pavement Testing

- CP-L 5100 HMA Testing Troubleshooting Guide
- CP-L 5101 Verification of Laboratory Equipment Used to Test Bituminous Mixtures
- CP-L 5106 Resistance to Deformation of Bituminous Mixtures by Means of Hveem Apparatus

CP-Ls 5100 Flexible Pavement Testing (continued)

- CP-L 5109 Resistance of Compacted Bituminous Mixture to Moisture Induced Damage
- CP-L 5110 Resilient Modulus Test (MR)
- CP-L 5111 Determining the Percent of Recycling Agent to Use for Cold Recycling of Asphalt Concrete
- CP-L 5112 Hamburg Wheel-Track Testing of Compacted Bituminous Mixtures
- CP-L 5114 French Rut Testing of Compacted Bituminous Mixtures
- CP-L 5115 Preparing and Determining the Density of Bituminous Mixture Test Specimens Compacted by the Superpave Gyratory Compactor
- CP-L 5116 Linear Kneading Compaction of Bituminous Mixtures
- CP-L 5117 Superpave Design for Hot Mix Asphalt
- CP-L 5120 Determination of the Asphalt Binder Content of Bituminous Mixtures by the Ignition Method
- CP-L 5140 Mix Design for Hot In-Place Recycling of Asphalt Pavements
- CP-L 5145 Contractor Asphalt Mix Design Approval Procedures Utilizing RAP Millings from the Same Project
- CP-L 5150 Adjusting Moisture Requirement to Hydrate Lime in Asphalt Mixes

CP-Ls 5300 Nuclear Unit Testing

- CP-L 5301 Leak Wipe Procedure for Nuclear Gauges
- CP-L 5302 Calibration of CDOT Nuclear Moisture / Density Gauges
- CP-L 5303 Calibration Check of CDOT Nuclear Moisture / Density Gauges
- CP-L 5304 Calibration of CDOT Nuclear Thin Layer Density Gauges
- CP-L 5305 Leak Wipe Analysis for Nuclear Gauges
- CP-L 5306 Certification of Consultant Nuclear Moisture / Density and Thin Layer Density Gauges

Note: CP-Ls 5900 series, Inspection, was transferred to the Staff Bridge Branch for their posting prior to the printing of the 2005 Laboratory Manual of Test Procedures publication.

Appendix H - Metric Conversion Tables

Conversion Factors - U.S. to Metric S.I.

Quantity	U.S.	Metric Unit (SI)	Multiply by
Length	mile	kilometer (km)	1.609 344
	yard	meter (m)	0.914 4
	foot	meter (m)	0.304 8
	foot	millimeter (mm)	304.8
	inch	millimeter (mm)	25.4
Area	acre	Hectares (ha)	0.404 685 6
	square yard	square meter (m ²)	0.836 127 36
	square foot	square meter (m ²)	0.092 903 04
	square inch	square millimeter (mm ²)	645.16
Volume	cubic yard	cubic meter (m ³)	0.764 555
	cubic foot	cubic meter (m ³)	0.028 316 8
	cubic inch	cubic millimeter (mm ³)	16 387.064
	gallon	Liter (L)	3.785 41
Mass	ton	metric ton (t)	0.907 184
	pound	kilogram (kg)	0.453 592
	ounce	gram (g)	28.3495
Temperature	EFahrenheit	ECelsius	(EF-32) 5/9
Pressure	psi	kilopascals (kPa)	6.894 76

Conversion Factors - Metric S.I. to U.S.

Quantity	Metric Unit (SI)	U.S.	Multiply by
Length	kilometer (km)	mile	0.621 371
	meter (m)	yard	1.093 6
	meter (m)	foot	3.280 84
	millimeter (mm)	foot	0.003 28
	millimeter (mm)	inch	0.039 37

Area	Hectares (ha)	acre	2.471 054
	square meter (m ²)	square yard	1.195 99
	square meter (m ²)	square foot	10.763 91
	square millimeter (mm ²)	square inch	0.001 55
Volume	cubic meter (m ³)	cubic yard	1.307 95
	cubic meter (m ³)	cubic foot	35.314 72
	cubic millimeter (mm ³)	cubic inch	0.000 061
	Liter (L)	gallon	0.264 172
Mass	metric ton (t)	ton	1.102 31
	kilogram (kg)	pound	2.204 62
	gram (g)	ounce	0.035 274
Temperature	ECelsius	EFahrenheit	(EC x 1.8) + 32
Pressure	kilopascals (kPa)	psi	0.145 038

Metric Decimal Prefixes

Prefix	Magnitude	Expression
kilo	10 ³	1000 (one thousand)
milli	10 ⁻³	0.001 (one thousandth)

For a more information on Metric S.I. units see CDOT's *Metric Conversion Manual*. Other good references include AASHTO R1-91 and ASTM E 380-92.

Sieve Sizes, English versus Metric

<u>English</u>	<u>Metric</u>
3"	76.2 mm
2 ½ "	63.5 mm
2 "	50.8 mm
1 ½ "	38.1 mm
1 "	25.4 mm
¾ "	19.0 mm
½ "	12.7mm
⅜ "	9.51 mm
# 4	4.75 mm
# 8	2.36 mm
# 16	1.18 mm
# 30	600 mu
# 50	300 mu
# 100	150 mu
# 200	75 mu

Appendix I - Materials Testing Accuracy Criteria

The following table is the official testing accuracy criteria for the Colorado Department of Transportation and shall be strictly adhered to.

	MEASURE TO NEAREST	REPORT TO NEAREST
SOILS		
Sieve Analysis		
(Except - #200)	1.0 g	1%
Minus No. 200	0.1 g	0.1%
Atterberg Limits	0.01 g	1%
Density	-----	0.1 lb/ft ³ (1 kg/m ³)
Relative Compaction	0.1 lb/ft ³ (1 kg/m ³)	1%
Moisture Content		
D/M Gauge	0.1 lb/ft ³ (1 kg/m ³)	0.1%
Dry Weight	0.1 g	0.1%
BASE AGGREGATES		
Sieve Analysis		
(Except - #200)	1.0 g	1%
Minus No. 200	0.1 g	0.1%
Atterberg Limits	0.1 g	1%
Density	-----	0.1 lb/ft ³ (1 kg/m ³)
Relative Compaction	0.1 lb/ft ³ (1 kg/m ³)	1%
Moisture Content		
D/M Gauge	0.1 lb/ft ³ (1 kg/m ³)	0.1%
Dry Weight	0.1 g	0.1%
CONCRETE		
Sieve Analysis		
(Except - #200)	1.0 g	1%
Minus No. 200	0.1 g	0.1%
*Sand Equivalent	0.1 %	1 % *
Moisture in Aggregate	0.1 g	0.1%
Air Content	-----	0.1%
Fineness Modulus	-----	0.01
Slump	-----	1/4 inch (5 mm)
Compressive Strength	1 psi (0.01 MPa)	10 psi (0.1 MPa)
Flexural Strength	1 psi (0.01 MPa)	5 psi (0.05 MPa)
Thickness	0.05 in (1.3 mm)	0.1 in (2.5 mm)
BITUMINOUS PVMT.		
Moisture in Mix	0.1 g	0.1%
Sieve Analysis		
(Except - #200)	1.0 g	1%
Minus No. 200	0.1 g	0.1%
Asphalt Content		
(Methods A, B, D, F, and G) ...	0.1 g	0.01%
(Method E)	1.0 g	0.01%
Hveem Stability	-----	1
Voids in Mineral Aggregate	-----	0.1%
Air Voids	-----	0.1%
Lottman TSR	-----	0.01
Lottman Dry TS	1 lb.f (1 N)	1 psi (1 KPa)
Filler	0.1 g	0.1%
Specific Gravity	0.1 g	0.001
Specific Gravity		
D/M Gauge	-----	0.001
Relative Compaction	0.01	0.1%

* [Report to the next highest whole number per CP 37.]

UNDERSTANDING CALCULATIONS AND ROUNDING IN MS EXCEL

UNDERSTANDING THE DIFFERENCE BETWEEN DISPLAYED VALUES AND UNDERLYING VALUES

A Microsoft Excel® numeric cell entry can maintain precision to only a maximum of 15 digits. This means you can enter numbers longer than 15 digits into a cell, but Excel converts any digits after 15 to zeros.

The values that appear in formatted cells are called *displayed values*; the values that are stored in cells and appear in the formula bar are called *underlying values*. The number of digits that appear in a cell, its displayed value, depends on the width of the column and any formatting that you have applied to the cell.

When performing calculations, Excel always uses the underlying value, not the displayed value.

UNDERSTANDING THE ROUND FUNCTION

MS Excel® ROUND function rounds a number to a specified number of decimal places, rounding digits less than 5 down and digits greater than or equal to 5 up. For example, the formula =ROUND(123.4567,3) returns 123.457. The number 123.457 is now the underlying value. Therefore, when performing calculations, the rounding function changes the values of the numbers that are operate on.

UNDERSTANDING CDOT FORMS

CDOT paper worksheet forms were made to conserve space and paper. The forms may have one or more test methods/procedures incorporated into the forms. Because of space limitations, it is not referenced to which method/procedure the test results are being reported. It is up to the material tester to determine which test methods/procedures are being tested to and documented. Rounding, of intermediate results, is to be performed if the result is referencing a specific stand-alone test method/procedure that was reported previously. For example, if a moisture content has a designated AASHTO or ASTM test method/procedure, the results were rounded and documented previously. The following

calculations on the form are to use the rounded moisture content. Then the final reported result is to be rounded and reported. If the moisture content was not reported previously, but was calculated as an intermediate result, then use the underlying value.

Caution is needed when developing computerized worksheets using MS Excel® from CDOT forms. Each stand-alone AASHTO, ASTM, CDOT CP or CPL has a rounded reported result. Computerized worksheets are to be analyzed that incorporate stand-alone test methods/procedures or if the intermediate result (underlying value) is to be used.

ROUNDING OF TEST DATA FOR DETERMINING CONFORMANCE WITH SPECIFICATIONS

When calculating a test result from observed values and test data, rounding of intermediate values and quantities shall be avoided. As far as practicable with the calculating device used, carry out all calculations with the observed values exactly and round only the final result, which is reported as specified. Any final results used in further calculations shall be considered an intermediate quantity and the unrounded value is used.

EXAMPLE:

Find final results for Moisture Content, Dry Density and Percent Compaction:

- A = Observed wet weight of the moisture sample
= 182.4 gr.
- B = Observed dry weight of the moisture sample
= 166.8 gr.
- MD = Moisture/density relationship
= 115.4 pcf
- WD = Observed wet density value
= 119.3 pcf
- MC = Moisture Content (%)
- DD = Dry density (pcf)
- C = compaction (%)

$$MC = \frac{(A - B) * 100}{B} = \frac{(182.4 - 166.8) * 100}{166.8} = 9.4\%$$

Unrounded is 9.35252

$$DD = \frac{(WD * 100)}{(100 + MC)} = \frac{(119.3 * 100)}{(100 + 9.35252)} = 109.1 \text{ pcf}$$

Unrounded is 109.09671

$$C = \frac{DD}{MD} = \frac{109.09671}{115.4} = 94.53 \rightarrow 95\%$$

% compaction, a passing test

Recalculated using rounded MC:

$$DD = \frac{(WD * 100)}{(100 + MC)} = \frac{(119.3 * 100)}{(100 + 9.4)} = 109.0 \text{ pcf}$$

Unrounded is 109.04936

Recalculated using rounded DD:

$$C = \frac{DD}{MD} = \frac{109.0}{115.4} = 94.45 \rightarrow 94\%$$

% compaction less than 94 thus, a failing test

Caution When you change the precision of the calculations in a workbook by using the displayed (formatted) values, Excel permanently changes any constant values on the worksheets in the workbook. If you later choose to calculate with full precision, the original underlying values cannot be restored. It is advised to use full precision. If it is desired to use precision as displayed follow these default settings for the Excel workbook.

Excel 2003:

1. On the **Tools** menu, click **Options**, and then click the **Calculation** tab.
2. Under **Workbook options**, select the **Precision as displayed** check box.

Excel 2007:

1. Click the **Office Button**, click **Excel Options**, and then click the **Advance** tab in the left column.
2. Under **When calculating this workbook**, select the **Set precision as displayed** check box.

Appendix J - Laboratory Test Time

Time listed is the interval from sample submittal at the Materials and Geotechnical Branch to the issuance of a report. Time spent while the sample is in transit is not included. Time spent while the report is in transit is not included. Test Time does not include weekends or state holidays.

ITEM NO.	DESCRIPTION	TEST TIME (WORKING DAYS)
203	EMBANKMENT	
	Gradation, Atterberg Limits, Moisture-Density Curve, Specific Gravity, R Value, and Classification.....	16
	(This test time excludes a preliminary soil survey with more than 10 samples. Call for actual turnaround time.)	
	Sulfate testing.....	5
	Chloride testing.....	15
	Soil Resistivity testing.....	6
	pH testing.....	5
	Pipe Type Material Selection testing.....	15
206	STRUCTURE BACKFILL, BED COURSE & FILTER MATERIAL	
	Class 1: Gradation, Atterberg limits, Moisture-Density Curve and Specific Gravity.....	13
	Class 2: Gradation, Atterberg Limits, Moisture-Density Curve and Specific Gravity.....	14
	Bed Course: Gradation.....	5
	Filter Materials: Gradation.....	5
	Sulfate testing per the Schedule	5
	Chloride testing.....	15
	Soil Resistivity testing.....	6
	pH testing.....	5
301	PLANT MIX BITUMINOUS BASE	
	Asphalt Content, Gradation, Stability, Lottman	7
	Gradation, Atterberg Limits, Specific Gravity	10
	Gradation, Atterberg Limits, Specific Gravity, Abrasion, Fractured Faces	12
	EuroLab: French and /or German Wheel Tracking Devices	9
	Mix Design.....	27
304	AGGREGATE BASE COURSE	
	Gradation, Atterberg Limits, Moisture-Density Curve	15
	Gradation, Atterberg Limits, Moisture-Density Curve, Abrasion	16
	Gradation, Atterberg Limits, Moisture-Density Curve, and R-Value.....	20
	Gradation, Atterberg Limits, Moisture-Density Curve, Abrasion and R-Value	21
307	HYDRATED LIME & LIME TREATED SUBGRADE	
	Hydrated Lime: Gradation	5
	Lime Treated Subgrade: Gradation, Atterberg Limits, PH, Optimum Lime Content, Moisture-Density Curve, and Unconfined Compression	20

ITEM NO.	DESCRIPTION	TEST TIME (WORKING DAYS)
403	HOT MIX ASPHALT PAVEMENT	
	Asphalt Content, Gradation, Stability, Lottman	7
	Gradation, Atterberg Limits, Specific Gravity	10
	Gradation, Atterberg Limits, Specific Gravity, Abrasion, Fractured Faces	12
	EuroLab: French and /or German Wheel Tracking Devices	9
409	COVER COAT MATERIAL	
	Gradation, Abrasion, Fractured Faces	6
411	BITUMEN	
	Asphalt Cement (not performance graded), Emulsion.....	5
	Performance Graded Asphalt Binder, Verification Testing	3
	Performance Graded Asphalt Binder, Complete Testing.....	6
412	PORTLAND CEMENT CONCRETE PAVEMENT	
	Aggregate Gradation & Abrasion	6
	Compressive Strength of Information Cylinders	1
	Compressive Strength at 7 Days	5
	Compressive Strength at 28 Days	20
	Compressive Strength of Drilled Cores.....	2
	Flexural Strength at 28 Days.....	20
	Mix Design, Review.....	3
	Sand Equivalent	5
504	MECHANICALLY STABILIZED EARTH WALLS	
	Gradation, Atterberg Limits, Moisture-Density Curve, Classification, Specific Gravity, and Direct Shear	14
506	RIPRAP	
	Specific Gravity	3
515	WATERPROOFING MEMBRANE	
	Various Laboratory Tests	11
601	STRUCTURAL CONCRETE	
	Aggregate, Gradation & Abrasion	6
	Aggregate Soundness with Sodium Sulfate.....	10
	Compressive Strength of Information Cylinders	1
	Compressive Strength at 7 Days	5
	Compressive Strength at 28 Days	20
	Compressive Strength of Drilled Cores.....	2
	Mix Design, Review.....	3
602	REINFORCING STEEL	
	Prestressing Strand.....	6

Appendix K - Establishing Lots or Process Control on the Project

A lot is any well-defined quantity of material produced by essentially the same process through continuous production.

The standard size lot consists of 5 samples, but a lot may include as few as 3 or as many as 7 samples due to changes in production or when total quantities require more or less than 5 tests.

Establishing lots is not difficult when the production process and materials sources are uniform. When production begins under good process control and there is little need for plant adjustment, the first 5 samples should be used to establish the quantity represented by the first lot. Thereafter, each lot should contain 5 samples. More than a single day's run may be included if there is no significant change in the production process or raw material.

When the production process is erratic or out-of-control, establishing lots becomes a problem.

Often, the first few samples at the beginning of the production run will be erratic or off-target, and several major adjustments may be required before production is resumed. In such cases, these first few samples should be Lot No. 1. Then, after production levels out, 5 sample lots are to be used.

After the 5 sample lots have become routine, only a major production change or a quantity of material for which more or less than 5 samples are required should be cause for altering the number of tests.

Appendix L - Random Sampling

The most important factor in obtaining information for the purpose of enforcing specifications is the action of sampling. It must be understood that unless the samples are chosen by probability sampling, the statistical methods may not be entirely applicable. Stratified Random Sampling should be used for this process. This is a method of random sampling that causes the samples to be spread more uniformly throughout the lot.

A predetermined schedule for random sampling should be developed for each project. If requested, the Central Laboratory will supply a schedule for random sampling. A random sampling schedule can also be developed using ASTM D3665 and/or ASTM E105 prior to start of testing. See also CP 75.

It is realized that where scattered piecework is being done, such as tapers and gores, it may not always be possible to strictly conform to the above procedure. Judgment must be used and a reasonable attempt made to select samples without bias. Bituminous materials ordinarily shipped to the project in tank trucks are sampled in a slightly different manner than for most other materials. See Chapter 400 of the Field Materials Manual for a detailed description of the sampling and acceptance verification plan.

The location or time of sampling must be selected by a random method. This means the location or time of sampling must be predetermined without bias, such as by the use of a table of random numbers. Every load, ton, or square yard in the sub-lot must have an equal probability of being chosen. This means the sample location or time chosen must be accessible. It is not possible to obtain a probability sample from a stockpile of aggregates because samples cannot be taken from the interior of the pile. To sample such material properly, it must be sampled at randomly determined intervals either as it is placed in the pile or removed from the pile.

Appendix M - Sample Processing Procedure

Samples which are received, tested, and reported by the CENTRAL LABORATORY, are processed in the following manner:

IDENTIFICATION

All materials and samples must be logged-in at the receiving dock. Samples must be identified as to DATE RECEIVED, ITEM NUMBER, PROJECT NUMBER, PROJECT CODE, and NUMBER OF SAMPLES.

SELECTION

The selection of samples is handled by field project personnel. Staff Materials is responsible for the testing of samples submitted by field personnel. The only exceptions to this are samples of asphalt cement and liquid asphalt. In this case, one sample out of five is selected at random. If this sample meets specifications, the other four are discarded. If not, the other four samples are tested and reported.

CONDITIONING

Samples which require conditioning will be conditioned per the appropriate test procedure.

STORAGE

Samples will be stored in the proper environment prior to testing. An example of this is concrete cylinders, which must be stored (cured) in a 100% humidity environment.

RETENTION

Samples of all materials will be retained until no further question remains as to the properties of the material.

DISPOSAL

All materials which are not hazardous will be placed in the large roll-on / roll-off trash receptacle immediately behind the Laboratory. Materials which are hazardous will be handled per Staff Materials procedure for handling hazardous materials.

Appendix N - Use of Laboratory Check Tests on More Than One Project

Results of Laboratory Check Tests can be used and referenced to more than one project if the following criteria are met:

The source (pit, plant, supplier and design mix) of material must be the same.

Construction must occur at approximately the same time on each project.

Example: Placing asphalt pavements on two separate projects from the same supplier. (Asphalt cement, portland cement, ARA additives, etc.)

Document the referenced laboratory check test on a CDOT Form #157 listing:

- The Project Number from which the tests was referenced.
- Check Test ID Number (unique for this activity)
- The plant where the material was produced.
- All of the ingredients in the product.
- The date the material was placed (on both projects).
- The Design Mix Number (if applicable).

Appendix O – 2012 FMM CDOT Materials Forms List

FORM #	TITLE	REVISION DATE	EXAMPLES	OBTAIN FROM
6	Field Tests of Base Aggregates, Fillers, Paving and Misc. Aggregates.....	3/05	Chap 300 P 11 **	Bid Plans
24	Moisture-Density Relation	3/05	Chap 200 P 22	Forms Cat.
30	Certified Nuclear Gauge Label	2/07	LMTP, Nuclear	N/A
31	In-Place Moisture and Density Determination by the Sand Method	9/03	Chap 200 P 24	Forms Cat.
38	Aggregate Test Report	1/00	Chap 300 P 13	N/A
43	Job-Mix Formula (Report)	4/98	Chap 400 P 23	N/A
46	Concrete Truck Mixer Inspection Certification	3/04	Chap 600 P 36	Forms Cat.
58	Field Report of AC and Max Sp Gr (RICE) of Hot Mix Asphalt	4/05	Chap 400 P 24	Bid Plans
67	Asphalt Cement Results and Final Quantity (Report)	5/01	Chap 400 P 25	N/A
69	Field Report of Hot Mix Asphalt Density.....	1/10	Chap 400 P 26	Bid Plans
82	Concrete Specimen Transmittal.....	4/04	Chap 600 P 38	Bid Plans
105	Speed Memo	7/02		Forms Cat.
106	Asphalt Tests	4/06	Chap 800 P 22 **	Forms Cat.
156	Concrete Test Results Summary	1/10	Chap 600 P 40	Forms Cat.
157	Field Report for Sample Identification or Materials Documentation	9/07	All Chapters	Bid Plans
192	Report of Concrete Tests (Report).....	1/00	Chap 600 P 41	N/A
193	Inspection – Quality Assurance Acceptance Report (Report)	4/04	Chap 600 P 44	N/A
194	Structure Backfill Density Report.....	3/04	Chap 300 P 14	Forms Cat.
196-A	Physical Test Report Prestressing Strand (Report)	1/00	Chap 600 P 45	N/A
199	Concrete Core Test (Report).....	4/01	Chap 600 P 46	N/A
211	Materials Documentation Request	3/04	Documentation P 17	Forms Cat.
212	Field Report on Compaction of Earthwork	1/10	Chap 200 P 25	Bid Plans
219	Soil Survey of the Completed Roadbed	3/05	Chap 200 P 26	Forms Cat.
250	Materials Documentation Record	7/09	Documentation P 18	N/A
266	Inspector’s Progress Report.....	7/02		Forms Cat.
267	Foundation Boring Log	3/04	LMTP, Geology	Forms Cat.
276	Report of Concrete Placed.....	9/03	Chap 600 P 47	Forms Cat.
281	Concrete Batched and Placed.....	3/04	Chap 600 P 48	Forms Cat.

Note 1: Personalizing or altering the originators CDOT Forms is not authorized.

Note 2: Forms that are serialized, that is Forms with unique Field sheet numbers, (Number is in **Bold**) must originate from Forms Management at Headquarters. Any form with a false or duplicate Serial / Field Sheet Number will not be processed.

Note 3: All Forms that state Forms Cat below the Obtain From header, are available on the Forms Catalog. The web address to view or obtain these forms is www.dot.state.co.us/FormsMgmt/ These are PDF Writeable forms, that can either be filled in on your computer or you may wish to print the blank forms for field completion.

Appendix O – 2012 FMM CDOT Materials Forms List

FORM #	TITLE	REVISION DATE	EXAMPLES	OBTAIN FROM
323	Laboratory Report on Item 203 (Embankment or Borrow)	4/06	Chap 200 P 27	Forms Cat.
325	Final Estimate Data	7/91	Documentation, Ref.	Forms Cat.
334	Penetrometer Log	3/04	LMTP, Geology	Forms Cat.
360	Superpave Project Produced Hot Mix Asphalt (Report)	1/01	Chap 400 P 28	N/A
379	Project Independent Assurance Sampling Schedule	5/09	Documentation P 21	Forms Cat.
389	Field Report for Joint Sealant Testing	3/04	Chap 600 P 49	Forms Cat.
411	PG Binder/ Emulsion Submittal Form	1/10	Chap 400 P 30	Bid Plans
427	Nuclear Soils Moisture/Density Test	3/04	Chap 800 P 15	Forms Cat.
428	Nuclear Asphalt Density Test	4/07	Chap 800 P 17	Forms Cat.
429	Laboratory Design for HMA- Superpave Gyratory Compactor (Report)	4/01	Chap 400 P 34	N/A
469	Nuclear Asphalt Density Correction	4/07	Chap 800 P 19	Forms Cat.
473	Letter of Materials Certification (Page 1 & 2)	4/09	Documentation P 22	Forms Cat.
520	Report on Central Laboratory- Region Lab Inspection	11/06	Inspections P 4	Forms Cat.
548	Nomograph to Correct for Percent Rock	3/04	Chap 200 P 32	Forms Cat.
549	Leak Test Envelope	6/91	LMTP, Nuclear	N/A
554	Soils Survey Field Report	1/01	Chap 200 P 68	Bid Plans
555	Preliminary Soil Survey	4/09	Chap 200 P 69	Forms Cat.
564	Soils and Aggregate Sieve Analysis When Splitting on the No. 4 Sieve	4/07	Chap 200 P 36 *	Forms Cat.
565	Sieve Analysis for Aggregates Not Split on the No. 4 Sieve	4/07	Chap 300 P 11	Forms Cat.
582	Hot Mix Asphalt Density Test	4/05	Chap 400 P 40	Forms Cat.
584	Moisture-Density Relation Graph	3/04	Chap 200 P 39	Forms Cat.
585	Flexible Pavement Field Design Work Sheet	3/05	PDM	Forms Cat.
586	Overlay Design by Component Analysis	3/04	PDM	Forms Cat.
595	Pre-Approved Product Evaluation Request & Summary	1/10	www.dot.state.co.us/App_APL/	
599	Nuclear Asphalt Content Correlation	4/07	Chap 800 P 21	Forms Cat.
626	Field Laboratory Test Results	3/04	Chap 200 P 40	Bid Plans
633	Sample Tag (for Sacks)	3/01	Chap 300 P 19	Bid Plans
634	Sample Label (for Cans)	3/06	Chap 400 P 41	Bid Plans
647	Density Sand Calibration	3/04	Chap 200 P 42	Forms Cat.
722	Nuclear Equipment Density Calibration Check	9/03	LMTP, Nuclear	Forms Cat.

- Note 1:** Personalizing or altering the originators CDOT Forms is not authorized.
- Note 2:** Forms that are serialized, that is Forms with unique Field sheet numbers, (Number is in **Bold**) must originate from Forms Management at Headquarters. Any form with a false or duplicate Serial / Field Sheet Number will not be processed.
- Note 3:** All Forms that state Forms Cat below the Obtain From header, are available on the Forms Catalog. The web address to view or obtain these forms is www.dot.state.co.us/FormsMgmt/. These are PDF Writeable forms, that can either be filled in on your computer or you may wish to print the blank forms for field completion.

Appendix O – 2012 FMM CDOT Materials Forms List

FORM #	TITLE	REVISION DATE	EXAMPLES	OBTAIN FROM
723	Nuclear Equipment Moisture/ Density Calibration Sheet	9/03	LMTP,Nuclear	Forms Cat.
746	Nuclear Moisture/Density Gauge Log	9/03	Chap 800 P 12	Forms Cat.
772	Nuclear Asphalt Content Gauge Log.....	9/03	Chap 800 P 13	Forms Cat.
774	Nuclear Gauge Operator Identification (Card)	1/93	N/A	N/A
901	Laboratory Optimum Dry Density	3/04	Chap 200 P 43	Forms Cat.
903	Structural Layer Coefficients of Existing Pavements	3/04	PDM	Forms Cat.
1003	Stabilometer Graph	2/09	Chap 200 P 44	Forms Cat.
1007	Gradation Chart.....	3/04	Chap 200 P 45	Forms Cat.
1030	Stabilometer Test	7/03	Chap 200 P 46	Forms Cat.
1045	Gradation Worksheet	3/04	Chap 200 P 47	Forms Cat.
1074	Equipment Inspection Decal	12/00	N/A	N/A
1094	Asphalt Mix Design Graph.....	3/04	Chap 400 P 42	Forms Cat.
1126	Stabilometer Record of Item 304 ABC	3/04	Chap 300 P 20	Forms Cat.
1151	Nuclear Equipment Statistical Stability / Drift Test	9/03	LMTP,Nuclear	Forms Cat.
1188	Concrete Mix Submittal	3/04	Chap 600 P 15	Forms Cat.
1199	Finals Materials Documentation Checklist (Page 1 & 2)	4/09	Documentation P 24	Forms Cat.
1247	Nuclear Gauge Property Decal	4/97	Chap 800 P 12	N/A
1290	Longitudinal Joint Data	1/10	Chap 400 P 43	Forms Cat.
1296	Granular Materials Moisture-Density Report	9/02	Chap 300 P 21	N/A
1297	Soil Moisture - Density Report	9/02	Chap 200 P 48	N/A
1304	HMA Sample Submittal	1/10	Chap 400 P 44	Bid Plans
1322	CP 16, Pre-Testing Meeting Agenda.....	4/07	CP 16 P 2	Forms Cat.
1323	CP 16, Weekly Meeting Agenda	8/04	CP 16 P 6	Forms Cat.
1324	CP 16, Evaluation of Materials Testing	8/04	CP 16 P 8	Forms Cat.

Note 1: Personalizing or altering the originators CDOT Forms is not authorized.

Note 2: Forms that are serialized, that is Forms with unique Field sheet numbers, (Number is in **Bold**) must originate from Forms Management at Headquarters. Any form with a false or duplicate Serial / Field Sheet Number will not be processed.

Note 3: All Forms that state Forms Cat below the Obtain From header, are available on the Forms Catalog. The web address to view or obtain these forms is www.dot.state.co.us/FormsMgmt/ These are PDF Writeable forms, that can either be filled in on your computer or you may wish to print the blank forms for field completion.

Appendix O – 2012 FMM CDOT Materials Forms List

FORM #	TITLE	DATE	EXAMPLES	FROM
1333	Inspector's Report of Caisson Installation.....	2/05	LMTP, Geology	Forms Cat.
1334	Geological Boring Log.....	2/05	LMTP, Geology	Forms Cat.
1346	HMA Segregation Data.....	2/06	Chap 400 P 46	Forms Cat.
1372	Reinforcing Bar Physical Test Report (Report).....	1/07	Chap 600 P 50	Forms Cat.
1373	Concrete Mix Design Report (Report).....	1/08	Chap 600 P 23,53	Forms Cat.
1375	Concrete Field Tests Report (Report).....	10/07	Chap 600 P 54	Forms Cat.

Note 1: Personalizing or altering the originators CDOT Forms is not authorized.

Note 2: Forms that are serialized, that is Forms with unique Field sheet numbers, (Number is in **Bold**) must originate from Forms Management at Headquarters. Any form with a false or duplicate Serial / Field Sheet Number will not be processed.

Note 3: All Forms that state Forms Cat below the Obtain From header, are available on the Forms Catalog. The web address to view or obtain these forms is www.dot.state.co.us/FormsMgmt/. These are PDF Writeable forms, that can either be filled in on your computer or you may wish to print the blank forms for field completion.

Note 4: Bid Plans (303) 757-9313

* : Examples of this Form is also in Chapter 300.

** : Examples of this Form is also in Chapter 400.