



COLORADO

Department of Education

School Finance and
Operations Division

Annual Inspection

&

Maintenance

Resource Guide

2018

SCHOOL TRANSPORTATION UNIT
201 East Colfax Avenue, Room 209, Denver, CO 80203
303-866-6655/303-866-6656

<http://www.cde.state.co.us/transportation>



Intentionally left blank



Table of Contents

Introduction.....	5
Vehicle Inspection Program	7
Annual Inspection Requirements	9
PM Brake Inspection and Documentation Requirements.....	11
Brake inspector Requirements.....	12
Certification	13
Introduction to the Hands-On Performance Test	19
Records, Documentation, and Retention	39
Forms	43
STU-13 CDE Annual Inspector Test Answer Sheet.....	43
STU-19 Hands-On Test check list	43
STU-20 Application for Annual Inspector Qualification or Recertification.....	44
STU-22 Application for Inspecting Site Certification	44
STU-24 CDE Brake Inspector's Qualification Certificate	45
STU-25 Affidavit of Annual Inspection	45
STU-26 CDE Annual Inspection/Preventive Maintenance Checklist	46
STU-27 Trailer Annual Inspection/Preventive Maintenance Checklist.....	46
STU-30 Hands-On Tester Qualification Recertification	49
Section A. Road Test inspection	A-2
Chart A-1. Steering Wheel Play (Lash) Measurements Chart.....	A-4
Chart A-2. FMVSS.111 Mirror Adjustment	A-12
Chart A-3. FORD Warning Lights / Buzzer.....	A-23
Chart A-4. NAVISTAR Brake Failure Warning System Checks.....	A-24
Chart A-5. Ford Normal Brake System Conditions	A-25
Section B. Under Hood Inspection.....	B-2
Chart B-1. Belt Inspection	B-13
Chart B-2. Pulley Inspection.....	B-14
Chart B-3. Checking Belt Tension	B-16
Section C. Interior Inspection	C-2
Chart C-1. First Aid Kit	C-7
Chart C-2. Body Fluid Cleanup Kit.....	C-8
Section D. Under Vehicle Inspection.....	D-2
Chart D-1. Tightening Steering Column Joint Bolts.....	D-3



Chart D-2. Steering Joints D-12

Section E. Around Vehicle E-2

Chart E-1. Service Door, Stop Arm, Amber and Red Warning Lights..... E-14

Chart E-2. Measuring Push Rod Travel E-18

Chart E-3. Air Brake Adjustment Chart..... E-19

Chart E-4. Tire Wear E-21

Section T: Trailer Inspection T-2

Appendix A. Regulation 1 CCR 301-26 (2018) Rules for the Operation, Maintenance, and Inspection of School Transportation Vehicles Effective date Jan 01, 2018 A-1

Appendix B. Regulation 1 CCR 301-25 (2015) Colorado Minimum Standards Governing School Transportation Vehicles Effective date April 30, 2015 B-1

Appendix C. Regulation 1 CCR 301-25 (2007) Colorado Minimum Standards Governing School Transportation Vehicles Effective date September 01, 2007 C-1

Appendix D. Regulation 1 CCR 301-25 (1998) Colorado Minimum Standards Governing School Transportation Vehicles Effective date February 01, 1999 D-1

Appendix E. Regulation 1 CCR 301-25 (1993) Colorado Minimum Standards Governing School Transportation Vehicles Effective date October 01, 1993 E-1

Appendix F. Colorado Racking Load Test F-1

Appendix G. Glossary.....G-1

Appendix H. Additional ResourcesH-1



Introduction

The Colorado Department of Education (CDE) School Transportation Unit has promulgated this resource guide to assist public school districts, charter schools, as well as Boards of Cooperative Educational Services (BOCES) with developing policies and procedures for the safe transportation of students. These guidelines provide manufacturer recommendations, industry standards and best practices which are consistent with the Colorado Minimum Standards Governing School Transportation Vehicles, 1 CCR 301-25 and the Colorado Rules for the Operation, Maintenance and Inspection of School Transportation Vehicles 1 CCR 301-26. This publication is intended to serve as a transportation provider resource toward compliance with legislation and regulations.

Acknowledgements

Colorado Department of Education School Transportation Unit

Jennifer Okes
Chief Operating Officer
School Finance Division
Okes_j@cde.state.co.us

Brian P. Vasina
Transportation Analyst
Vasina_b@cde.state.co.us

Colorado State Pupil Transportation Association (CSPTA)
Fleet Service Committee

Special thanks to Amanda Crissup
Boulder Valley School District Transportation

<http://www.cde.state.co.us/transportation>



Intentionally left blank



Colorado Department of Education School Finance and Operations Division Transportation Unit

Vehicle Inspection Program

This program is established to ensure reasonable and adequate standards of safety and inspection of vehicles used to provide transportation and support student programs. The CDE Transportation Unit shall be responsible for administering and monitoring this inspection program to ensure compliance.

This guide is structured to provide the information, form instruction, and criteria for operating a comprehensive Vehicle Inspection Program. Along with program requirements, this guide contains information for record keeping, forms for reporting and recording the inspections, and procedures for inspecting the various vehicle components/systems.

This guide should clarify many of the gray areas that occur when operating a Vehicle Inspection Program. However, this guide will not answer all technical or interpretive questions nor will it eliminate the need for trained personnel to exercise professional judgment when performing vehicle inspections.

The emphasis of ALL vehicle inspections is "SAFETY" and in every case, the districts, charter schools, certified outside inspection sites, and inspectors must exercise judgment to ensure the greatest degree of safety for vehicle operators, passengers, and other motorists.

Resources used in the preparation of this guide are as follows:

- 1 CCR 301-25 Colorado Minimum Standards Governing School Transportation Vehicles
<http://www.cde.state.co.us/transportation/1ccr15>
- National Standards for School Buses and Operations
<http://www.nasdpts.org/ncstonline/Documents/NCST%202015%20Specifications%20and%20Procedures%2011.1.16.pdf>
- Federal Motor Vehicle Safety Standards
<https://www.gpo.gov/fdsys/pkg/CFR-2011-title49-vol6/pdf/CFR-2011-title49-vol6-part571.pdf>
- Service and Repair Manuals from various school bus body and chassis manufacturers'
- Other Industry Standards for Maintenance and Repair Procedures



State Statute:

Colorado law provides for the State Board of Education to adopt and enforce regulations governing the safe operation of school buses used for the transportation of students pursuant to Sections 22-51-107, 22-51-108 and 42-4-1904 C.R.S.

Inspection and Preventive maintenance requirements can be found in the following two documents:

- 1 CCR 301-25 Colorado Minimum Standards Governing School Transportation Vehicles
<http://www.cde.state.co.us/transportation/1ccr15>
- 1 CCR 301-26 Colorado Rules for the Operation, Maintenance and Inspection of School Transportation Vehicles
<http://www.sos.state.co.us/CCR/GenerateRulePdf.do?ruleVersionId=6941&fileName=1%20CCR%20301-26>

Exemptions:

4204-R-1.03 The Commissioner, or designee, may provide an exemption to the Rules for the Operation, Maintenance and Inspection of School Transportation Vehicles to the extent the Commissioner finds an exemption to be appropriate.

Penalties:

4204-R-3.02 CDE shall revoke or suspend the certificate for a school transportation annual inspector, school transportation annual inspector hands-on testers or inspection sites under the following circumstances:

- 3.02(a) A school transportation annual inspector, school transportation annual inspector hands-on testers or inspection site does not meet the requirements outlined in these rules.
- 3.02(b) School transportation annual inspections or hands-on tests have not been properly conducted.

Any school district not in compliance with these rules and regulations shall not be entitled to any transportation fund reimbursement pursuant to Section 22-51-107, C.R.S. as amended.



Annual Inspection Requirements

A CDE Inspection Site Certificate is required at each facility/location where annual inspections for school transportation vehicles are performed. The district or service provider shall post the CDE Inspection Site Certificate at the inspection site.

School districts and service providers shall ensure all school transportation vehicles and trailers pursuant to 1 CCR 301-26-R-12.11 have a CDE annual inspection conducted by a CDE certified annual inspector.

Recently purchased school transportation vehicles shall successfully pass a CDE annual inspection completed by a qualified and certified CDE annual inspector prior to transporting students.

All annual inspection criteria of school transportation vehicles must meet or exceed manufacturer's specifications and the Colorado Minimum Standards 1 CCR 301-25. The annual inspection shall be documented and shall include at a minimum all fields listed on the CDE Annual Inspection and Preventive Maintenance Requirements Form (STU-26).

All annual inspection criteria of trailers must meet or exceed manufacturer's specifications and shall include at a minimum all fields listed on the CDE Trailer Annual Inspection and Preventive Maintenance Requirements Form (STU-27). This applies only to trailers that will be towed by a small vehicle transporting students to the extent that trailering is a necessary component of a district sponsored program.

Annual inspection results shall be documented on the CDE Affidavit of Annual Inspection for School Transportation Vehicles Form (STU-25). A copy of the current Affidavit is maintained inside the vehicle and a copy is placed in the vehicle file.

During the annual inspection, all four wheels shall be pulled for full inspection of the foundation brake system. The three exceptions (which are a minimum standard, some inspection facilities require a higher standard) are:

- a. School transportation vehicles with fewer than 4,000 miles since the previous annual inspection shall have two different wheels pulled (one front and one rear) than those pulled for the previous inspection.
- b. School transportation vehicles equipped with a retarder meeting the specifications outlined in 1 CCR 301-25-R-33.00, shall have two different wheels pulled (one front and one rear) than those pulled for the previous inspection.
- c. Trailers pursuant to 1 CCR 301-26-R-12.11 shall have 50 percent of the wheels pulled different than those pulled for the previous inspection.



If personnel not certified as an inspector are assisting a certified inspector, those individuals may inspect vehicle components/systems provided the certified inspector ensures they are properly trained in inspection procedures and the associated repair/out of service criteria. In such cases, the certified inspector remains responsible for the proper inspection of all items.

For the purposes of this program:

- Use of the term "vehicles" shall be understood to include all school buses, multifunction buses, and small vehicles used for the transportation of students.
- Use of the term "inspection" shall be understood to mean a full and complete CDE Annual Inspection.
- An "inspection" cannot be completed on a vehicle that is nonoperational.



PM Brake Inspection and Documentation Requirements

11.11 The preventive maintenance inspection interval for hydraulic brake systems shall not exceed 6,000 miles and shall include, at a minimum, inspection and documentation of:

Hydraulic Brake System Checks

Required

Master cylinder Fluid Level and Clarity [] Inspect for Brake Fluid Leakage []

Adequate pedal reserve [] Proper Hydraulic/Vacuum Assist Operation [] Parking Brake Operation []

11.10 The preventive maintenance inspection interval on air disc brake systems shall not exceed 6,000 miles and shall include, at a minimum; inspection and documentation of:

Air Disc Brake System Checks

Required

Air Disc Brake Rotor Inspection [] Mechanical wear indicator Inspection []

Running Clearance Inspection []

Optional (Recommended)

Governor Cut-in PSI _____ Cut-out PSI _____ Warning Lamp & Buzzer Operation []

Application Test [] Check Valve Test [] SR-1 Valve Test [] Park brake Test [] Service Brake Test []

11.09 The preventative maintenance inspection on air drum brake systems shall include, at a minimum, that the brake rod travel has been measured and documented. The applied pressure method shall be used.

11.09(a) The inspection interval shall not exceed 4,000 miles for buses equipped with a manual slack adjuster air brake system.

11.09(b) The inspection interval shall not exceed 6,000 miles for buses equipped with an automatic slack adjuster air brake system.

Air Drum Brake System Checks

Required

Air Drum Brake Rod Travel RF _____ LF _____ RR _____ LR _____

Optional (recommended)

Governor Cut-in PSI _____ Cut-out PSI _____ Warning Lamp & Buzzer Operation []

Application Test [] Check Valve Test [] SR-1 Valve Test [] Park brake Test []

Service Brake Test []



Brake inspector Requirements

4204-R-11.00 Maintenance and Repair

11.12 If brake adjustment or repair is needed, the work shall be completed by or supervised by a DOT or equivalent qualified brake inspector meeting the requirements of the Federal Motor Carrier Safety Regulations, 49 CFR section 396.25 (2015). Only the Federal Motor Carrier Safety Regulations adopted as of October 1, 2015 apply to this rule; later amendments do not apply. The federal regulations incorporated by reference in this rule are available for public inspection during regular business hours from the Colorado Department of Education, 201 E. Colfax Ave., Denver, Colorado 80209. In addition, these regulations are available at <https://www.ecfr.gov/>.

Equivalency to the requirements of 49 CFR 396.25 would be, for example, an ASE Certification for the type of braking system that is being worked on.

A brake inspector qualification form (STU-24) meeting the requirements of 49 CFR 396.25, can be found on the forms page on the CDE website at <http://www.cde.state.co.us/transportation/transform.htm>

- Guidance Q&A

Question 1: Does a CDL with an airbrake endorsement qualify a person as a brake inspector under [§396.25](#)?

Guidance: No.



Certification

Certification for the CDE Vehicle Inspection Program is divided into three categories:

- CDE Annual Inspector
- CDE Hands-On Tester
- CDE Inspection Site

Certifications for the categories of CDE Annual Inspector and CDE Hands-On Tester shall be valid for three (3) years from date of issue and require re-certification every three (3) years thereafter. Site Certifications are valid as long as the site meets 1 CCR 301-26, 4204-R-9.00 requirements.

CDE Annual Inspector

This certification ensures that the Inspector is knowledgeable of 1 CCR 301-25 Colorado Minimum Standards Governing School Transportation Vehicles, 1 CCR 301-26 Colorado Rules For The Operation, Maintenance And Inspection Of School Transportation Vehicles, the requirements for record keeping, and that they have a general knowledge of how to conduct an actual vehicle inspection. This certification requires the individual score a passing grade on a closed book written test and pass a CDE Hands-On Test. The CDE Annual Inspector Candidate must submit a CDE Application for CDE Annual Inspector Qualification or Recertification Form (STU-20) to CDE verifying all requirements have been satisfied.

CDE Annual Inspector Qualification requirements from 1 CCR 301-26, 4204-R-6.00

6.01 School transportation annual inspector is a person qualified to perform annual inspections on a school transportation vehicle and one who will ensure the vehicle complies with CDE regulations.

6.02 School transportation annual inspectors shall meet or exceed the following requirements:

6.02(a) The school transportation annual inspector shall be in possession of a valid driver's license with the proper class and endorsements for the size and type of vehicle(s) to be inspected.

6.02(b) The school transportation annual inspector shall provide a Brake Inspector Qualification Certificate meeting the requirements of 49 CFR 396.25 to the school district or service provider.

6.02(c) The school transportation annual inspector shall have at least two years verifiable experience in the maintenance of light, medium or heavy-duty vehicles.



- 6.02(d) The school transportation annual inspector shall successfully pass the CDE initial hands-on performance test.
- 6.02(d)(1) A certified school transportation annual inspector hands-on tester must proctor the hands-on performance test.
- 6.02(e) The school transportation annual inspector shall successfully pass the CDE annual inspector qualification written test initially, and every three years thereafter pass the CDE annual inspector recertification written test.
- 6.02(e)(1) A representative of the district or service provider, other than a school transportation annual inspector candidate, shall grade the written test.
- 6.03 A school district or service provider with an Inspection Site Certificate shall submit a CDE Application for CDE Annual Inspector Qualification or Recertification Form (STU-20) verifying the above requirements have been satisfied. CDE will issue an Annual Inspector Certificate.
- 6.04 If any of the above requirements become invalid, the annual inspector certificate is invalid until the requirement(s) is made valid.
- 6.05 If a school transportation annual inspector has an expired certificate, the certificate can be recertified as follows:
- 6.05(a) If the certificate has been expired less than six months, then the CDE Annual Inspector Recertification Written Test is required.
- 6.05(b) If the certificate has been expired between six and 12 months, then the CDE Annual Inspector Qualification Written Test is required.
- 6.05(c) If the certificate has been expired for more than one year, then both the CDE Annual Inspector Qualification Written Test and the CDE hands-on performance test are required.

Annual Inspector Qualification File requirements (IQF)

Required Documents

- a. Current Copy of Operator License 6.02(a)
- b. Brake Inspector Qualification Certificate 49 CFR 396.25 and 6.02(b)
- c. Documentation verifying two (2) years of experience (resume, job History) 6.02(c)
- d. CDE initial hands-on performance test (score sheet) 6.02(d)
- e. CDE Annual Inspector written test (graded answer sheet) 6.02(e)

Suggested Documents

- a. Copy of STU-20 Application
- b. Copy of qualification letter
- c. Copy of Certificate



CDE Hands-On Tester

This certification ensures the CDE Hands-On Tester has the qualifications and knowledge to proctor the CDE Hands-On Test to a CDE annual inspector candidate. Certification requires a minimum of two years of experience as a CDE Annual Inspector, to have satisfactorily completed a four-hour CDE school transportation annual inspector hands-on tester training, and to have completed a four-hour brake training in the last three years or have maintained an ASE School Bus or Medium/Heavy Duty Truck or Transit Bus Brake Certification. The CDE Annual Inspector Hands-On Tester Candidate must submit a CDE Application for CDE Annual Inspector Qualification or Recertification Form (STU-30) to CDE verifying that all requirements have been satisfied.

CDE Annual Inspector Hands-On Tester Qualification requirements from 1 CCR 301-26, 4204-R-7.00

- 7.02 School transportation annual inspector hands-on testers shall meet or exceed the following requirements:
- 7.02(a) The school transportation annual inspector hands-on tester shall have maintained a CDE Annual Inspector certificate for a minimum of two years.
 - 7.02(b) The school transportation annual inspector hands-on tester shall have satisfactorily completed a four-hour CDE school transportation annual inspector hands-on tester training.
 - 7.02 (c) The school transportation annual inspector hands-on testers shall have completed a four-hour brake training in the last three years or have maintained an ASE School Bus or Medium/Heavy Duty Truck or Transit Bus Brake Certification.
 - 7.02(d) The school transportation annual inspector hands-on tester candidate shall submit a CDE Application for Certification or Recertification of CDE Annual Inspector Hands-On Tester Form (STU-30) verifying that the above criteria have been satisfied. CDE will issue an Annual Inspector Hands-On Tester Certificate.
 - 7.02(e) The school transportation annual inspector hands-on tester shall conduct at least two hands-on tests every three years or attend a CDE school transportation annual inspector hands-on recertification training to recertify as a school transportation annual inspector hands-on tester.
- 7.03 If any of the above requirements become invalid, the hands-on tester certificate is invalid until the requirement(s) is made valid.



Hands-On Tester Qualification File requirements

Required Documents

- a. Copy of a current Annual Inspector Certificate showing that the tester has maintained a CDE Annual Inspector certificate for a minimum of two years prior to application. 7.02(a)
- b. Evidence that the tester has satisfactorily completed a four-hour CDE school transportation annual inspector hands-on tester training. 7.02(b)
- c. Evidence that the tester has completed a four-hour brake training in the last three years or have maintained an ASE School Bus or Medium/Heavy Duty Truck or Transit Bus Brake Certification. 7.02 (c)
- d. If the Annual Inspector Hands on Tester has recertified, evidence that they have attended a recertification class or have proctored two hands-on tests shall be in this file.

Hands-On Tester Documentation Files

The Hands-On Tester should maintain a separate file for each applicant that has been tested. The file should include copies of the:

1. Hands-On Test Checklist STU-19
2. The Hands-on test score sheet STU-21
3. STU-20 Application showing that all requirements except Hands-On Test have been completed and signed by a supervisor. (The Hands-On Tester Does Not complete score line or initial this document upon completion of the test. This is done by the applicant's supervisor.)

The applicant should keep their original copy of the STU-20 and get a copy of the Hands-On test score sheet STU-21 for their IQF.



CDE Site Certification

The site certification verifies that the school district shop or independently owned repair facility has met the basic health and safety requirements to qualify as a CDE Inspection site, and that the proper tools and equipment are available at the time that a CDE Annual Inspection is being done. The district or service provider shall submit a request for an inspection site certificate on the CDE Application for Inspecting Site Certification Form (STU-22) indicating that all criteria have been satisfied.

CDE Site Certificate Requirements from 1 CCR 301-26, 4204-R-9.00

- 9.02 The inspection site shall meet or exceed the following criteria to acquire and maintain an inspection site certification:
- 9.02(a) The inspection site shall be large enough to accommodate the vehicle, equipment and tools necessary to perform the inspection.
 - 9.02(b) The inspection site shall have a floor surface or pad adequate to safely support the maximum weight of the largest vehicle to be inspected.
 - 9.02(c) The inspection site shall have adequate lighting and ventilation.
 - 9.02(d) The inspection site or inspector shall, at the time of inspection, have the equipment and tools necessary to properly complete the annual inspection.
 - 9.02(e) The inspection site or inspector shall have tools designed and calibrated to take accurate readings of appropriate measurements, such as brakes and tires.
- 9.03 The district or service provider shall submit a request for an inspection site certificate on the CDE Application for Inspecting Site Certification Form (STU-22) that the above criteria have been satisfied.
- 9.04 The district or service provider shall post the CDE Inspection Site Certificate at the inspection site.



Study materials and documents needed to prepare for annual inspector certification testing and qualification

Study materials for the hands-on test are listed in numbers 1 and 2 below, and may be found in this section, beginning on the next page. The introduction to the hands-on performance test, and the Guide for the Operational Check of Air System listed in 1 and 2 below, and the STU-19 cannot be used by the applicant for reference during the hands-on test. The applicant may use the STU-26 Checklist for reference and to demonstrate proper documentation.

The written test questions are based on the rules listed in numbers 3 and 4 below. The written test is a closed book test. CDE rules listed below can be found in the rules appendix of this guide or at the CDE website at <http://www.cde.state.co.us/transportation/transregulations.htm>

Copies of the current forms listed below can be located on the CDE website at <http://www.cde.state.co.us/transportation/forms>

1. Introduction to the hands-on performance test
2. Guide for the Operational Check of Air System One Way Check Valves, Double Check Valve & SR-1 Valve
3. Rules for the Operation Maintenance and Annual Inspection of School Transportation Vehicles 1 CCR 301-26
4. Colorado Minimum Standards Governing School Transportation Vehicles 1 CCR 301-25 (Current Version)
5. STU-13 CDE Annual Inspector Test Answer Sheet
6. STU-19 Hands-On Test Checklist
7. STU-20 Application for CDE Annual Inspector Qualification or Recertification
8. STU-21 Hands-On Test Score Sheet
9. STU-24 CDE Brake Inspector's Qualification Certificate
10. STU-25 Affidavit of Annual Inspection for School Transportation Vehicles
11. STU-26 CDE Annual Inspection / Preventative Maintenance Checklist
12. STU-27 Trailer Inspection Checklist



Introduction to the Hands-On Performance Test

Revised September, 2015

Since the purpose of this test is to determine the applicant's knowledge of what areas to inspect and how the applicant would know if something did not meet inspection standards, the score shall not be deducted or the test shall not be terminated if certain items to be checked are not applicable to the bus or vehicle being inspected.

The applicant must know about the vehicle mechanics and be able to recognize components. The applicant must know if the bus being inspected is safe and meets inspection criteria established by the Colorado Department of Education.

The applicant needs to verbalize all items, procedures, and criteria, to confirm to the tester what the applicant is inspecting.

Since it is vital that the applicant be familiar with references, the applicant shall be allowed to use any reference available except for this Introduction when taking the hands-on test. (The CSPTA Reference Manual for School Bus Technicians, and service manuals are OK). The CDE annual inspection form is recommended.

Portions of the test will require one item, as a minimum, to be inspected where there are several items the same (tires & wheels, seats, windows, etc.). The applicant will be required to inspect just one item, with the understanding that an actual inspection would require every item to be inspected.

AIR BRAKES

Description: Applicant's procedures to be followed in the AIR BRAKES hands-on test.

Note: Air brake check procedures vary from vehicle to vehicle and mechanic to mechanic. Different applicants may have learned different procedures. However, all procedures must be designed to see that the correct safety devices operate at the correct times.

Scoring Standard: Applicant should be able to perform and document (when needed) the following AIR BRAKE SYSTEM checks.

1. Inside brake check

Items to be tested:

- A. Warning Light/ Buzzer
- B. Park brake valve operation (PP-1)
- C. Air system build up time
- D. Cut-in & cut-out pressures
- E. Air consumption on one full application
- F. Air loss on full application held for 1 minute
- G. ABS system operation and light



Procedure for testing listed items above

- a. Fanning off the air pressure with the brake pedal, the applicant should note that both the warning light and buzzer do come on and at what pressure. (approximately 60 psi \pm 10).
- b. Fanning off more air pressure, the applicant should note that the PP-1 valve pops and at what pressure. (should be 20 - 40 psi).
- c. With the engine off, fan off, all the air in the system. The applicant should restart the engine and set an RPM of approximately 1200 - 1500 and note the time to rebuild the system to 120 psi (approximately 4 minutes).
- d. Restart the engine and rebuild air system to cut-out pressure. With the engine running, Fan off air pressure to the cut-in pressure and note. (should be a minimum of 85 psi).
- e. With primary & secondary air at system cut-out pressure applicant should (engine off, key on) make one full brake application. (Air consumption should be noted (10 psi \pm 2)).
- f. Holding the brake application for 1 minute, the applicant should note the air drop. (Not more than 3 psi).
- g. With foot on the brake pedal, turn key on, listen for each valve to exhaust. Foot off brake pedal, turn key off then turn back on, listen for all ABS solenoids cycling. After tests, ABS light should cancel (some models may differ). Perform any other tests as required by manufacturer.

2. Air Brake Valves check:

Items to be tested:

- A. One-way valves
- B. Two-way valves
- C. SR-1 valve/system
- D. Safety valve

Procedure for testing items above

Note: Procedures for testing items above are one suggestion only. The applicants, school districts, or manufacturer's procedures may differ, and still be as effective.

- a. With the primary and secondary air at system cut-out pressure & engine off, the applicant should drain wet tank (noting that primary & secondary tanks remain at full pressure).
- b. Applicant then should drain the secondary tank (noting that the primary tank remains at full pressure). Restart the engine & rebuild the air system to cut-out pressure. With the engine off, applicant should drain the Primary tank (noting that the secondary tank remains at full pressure).
- c. Now with an assistant applying the brakes the applicant should watch to see that the primary brakes (rear) apply (noting that the SR-1 valve/system is working).
- d. With system pressure building the applicant should pull out the safety valve to make sure that it releases air.



3. Air brake checks (under bus)

Items to be checked:

- A. Air dryer (if applicable)
- B. Tanks (wet (supply), primary, & secondary)
- C. Hoses (routing and condition) and ABS wiring

Procedure for inspecting the items above shall be visual and the applicant should verbalize items such as: proper drain, proper mounting, condition, hoses have proper routing.

- a. The applicant should verbalize the fact that if there is no air dryer that the wet tank shall have a water ejection valve & a safety valve.

4. Air brake checks (under the hood)

- A. Air compressor
- B. Drive belt (if applicable)
- C. Compressor, governor and line mountings
- D. Coolant lines & fittings
- E. Oil lines & fittings
- F. Filter system
- G. General condition and leaks

Procedure for the listed items above shall be visual & verbal

- a. If the compressor is not belt driven the applicant should verbalize this fact.

5. Air brake checks (foundation)

- A. Shoes or pads
- B. Measurement and documentation of shoes and/or pads
- C. Mounting
- D. Drums or rotors
- E. Measurement and documentation of drums or rotors
- F. Brake chambers
- G. Slack adjusters (automatic test failure if not commented, not adjusting auto adjuster)
- H. Calipers (Air gap, and piston movement/free-play)
- I. ABS tone ring and sensor

Procedure for the listed items above shall be visual & verbal as well as showing the ability to demonstrate how to measure both shoes/pads and drums/rotors.

- a. Applicant should visually inspect the shoes/pads and verbalize items like: wear, cracking, heat problems, and contamination, or shoes/pads loose from the base.
- b. Applicant should demonstrate the measurement of shoes/pads and either document or verbalize doing so.
- c. Applicant should physically and visually inspect the shoe/pad mounting and verbalize items like: hold down pins, springs, anti-rattle springs or clips, rollers, s-cams, and s-cam bushings.
- d. Applicant should physically and visually inspect drums/rotors and verbalize items like: cracks, hard spots, heat discolored, or belled.



- e. Applicant should demonstrate the proper method of measuring the drums/rotors checking for out-of-roundness, run-out, and over/under sizing, and either document or verbalize doing so according to manufacturer specifications.
- f. Applicant should visually inspect the brake chamber/caliper and verbalize items like: mounting condition, sizing/matching, dents, connectors, and lines.
- g. Applicant should visually inspect the slack adjusters and verbalize items like: splines, clevis locknuts, 90° angle.
- h. Applicant should visually inspect the brake caliper, dust boot, mounting bolts, and caliper slide for proper operation and seal condition.
- i. Visually inspect ABS tone ring and sensor for mounting, corrosion and overall condition.

6. Air brake checks (adjustment)

- A. Applicant will demonstrate how to adjust brakes
- B. Applicant will demonstrate or verbalize documentation of chamber rod travel
- C. Applicant will demonstrate or verbalize documentation of the air gap check

Procedure for the air drum brake adjustment check shall be the applied method

- a. Applicant should verbalize the fact that a system has automatic slack adjusters. The applicant should demonstrate or verbalize the proper adjustment procedure for either type of slack adjuster (manual vs automatic). This includes verbalizing that automatic slack adjusters are NOT to be adjusted.
- b. Applicant should demonstrate the proper method of measuring and documenting rod travel.

Procedure for the air disc brake air gap check and adjustment

- a. Applicant shall demonstrate or verbalize the manufacturer procedure for checking the pad to rotor clearance and documentation. This will include the proper adjustment procedure.
- b. Applicant should demonstrate and verify that the caliper moves freely.

HYDRAULIC BRAKES

Description: Applicant's procedures to be followed in the hydraulic brake hands-on test.

Note: Hydraulic brake check procedures vary from vehicle to vehicle, and mechanic to mechanic. Different applicants may have learned different procedures. However, all procedures must be designed to see that the correct safety devices operate at the correct times.

Scoring standard: Applicant should be able to perform and document (when needed) the following hydraulic brake checks.



1. Hydraulic brakes check (inside cab)

Items to be checked:

- A. Warning light/gauge (if applicable)
- B. Warning buzzer (if applicable)
- C. Power assist system
- D. ABS light (if applicable)
- E. Parking brake pedal or hand lever

Procedure for testing the above items

- a. The applicant should check that all warning lights work.
- b. The applicant should check that the buzzer system works (if applicable)
 - (1) If equipped with an electric booster, the applicant should check that the electric motor runs when the brake is applied (key on or off).
- c. The applicant should be able to check the operation of the power assist system.
 - (1) Check for proper pedal effort and pedal drop
 - (2) Check for assist in pedal operation
- d. The applicant should check to see that the ABS light comes on with initial start and goes off shortly (if applicable)
- e. The applicant should check that the parking brake pedal or hand lever does apply the park brake and does return to off position freely. Bring the engine to 1,000 RPM with the park brake applied. The vehicle should not move.

2. Hydraulic brake checks (valves)

Items to be checked: (all if applicable)

- A. Load leveling valve
- B. Proportioning or Combination valve
- C. ABS valve or system
- D. Pressure valve for electric/hydraulic boost

Procedures for testing the items above

- a. The applicant should check to see that all lines and linkage to the load-leveling valve are intact and free to operate.
- b. The applicant should check to see that all lines and wiring to the proportioning or combination valve are intact.
- c. The applicant should check to see that all lines and wiring to the ABS valve or system are intact.
- d. The applicant should check that the electric motor on the power assist does run when the brake pedal is applied. (Key off or on, engine not running).

3. Hydraulic brake checks (under bus)

Items to be checked:

- A. Lines
- B. Parking brake cables
- C. Parking brake



Procedure for testing items above

- a. The applicant should check for proper mounting, securement, condition, and leaks.
- b. The applicant should check for proper mounting, routing, and condition.
- c. The applicant should visually check the overall condition and adjustment of the parking brake.

4. Hydraulic brake checks (under the hood)

- A. Master cylinder for fluid level and leaks and fluid condition
- B. Lines for leaks, routing, and condition
- C. Power assist system for proper mounting and condition

The procedure for inspection of the items above shall be visual & the applicant should verbalize what the applicant is seeing.

5. Hydraulic brake checks (foundation)

- A. Shoes and/or pads
- B. Measurement and documentation of shoes and/or pads
- C. Mounting hardware
- D. Calipers and wheel cylinders
- E. Drums or rotors
- F. Measurement and documentation of drums or rotors
- G. Self-adjusters
- H. ABS tone ring and sensor
- I. ABS Integrated Traction Control/Stability Control and related dash indicators.

Procedures for testing the items above shall be visual & verbal as well as showing the ability to demonstrate how to measure shoes, pads, drums, and rotors.

- a. Applicant should physically and visually inspect the shoes/pads and verbalize items like: wear, cracking, heat problems, contamination, or loose from the base.
- b. Applicant should demonstrate the measurement the shoes/pads and either document or verbalize doing so.
- c. Applicant should physically and visually inspect the shoe and/or pad mounting and verbalize items like: Hold down pins, springs, anti-rattle springs or clips, and all remaining hardware.
- d. Applicant should physically and visually inspect the calipers and wheel cylinders and verbalize items like: leakage, corroded slides, worn bushings, and any other hardware problems.
- e. Applicant should physically and visually inspect drums or rotors and verbalize items like: cracks, hard spots, heat discolored, belled, out of round, warped, out of parallelism, or excessive run out.
- f. Applicant should demonstrate the proper method of measuring the drums/rotors and document readings and compare to manufacturer specification. This should include demonstration of the calibration of the brake drum/rotor micrometer.
- g. Applicant should visually inspect and verbalize that the self-adjuster is all-intact and that it is operational.
- h. Visually inspect ABS tone ring and sensor for mounting, corrosion and overall condition.



6. Hydraulic brake (adjustment)

- A. Applicant will demonstrate how to adjust brake according to manufacturer specification and document.

Procedure for adjusting shall be one of an industry standard with the end result being a firm brake pedal with adequate brake pedal reserve, and no brake drag.

EXHAUST

Description: Applicant should be able to check the following components.

Scoring Standard: Applicant should be able to perform the following exhaust checks.

1. Hangers and shields

Items to be checked:

- A. Hangers and shields condition
- B. Hangers and shields security
- C. Proper distance

Procedure for testing items above:

- a. Check all hangers and shields for severe rust, corrosion, and free from bends or other damage that may affect the performance of the hanger or shield.
- b. Check all hangers and shields for security to ensure performance / noise reduction.
- c. Check that the exhaust system is properly shielded where required.

2. Muffler, Manifold, Turbo, Emissions System

Items to be checked:

- A. Exhaust or oil leaks
- B. Cracks
- C. Gaskets/donuts
- D. Emissions System

Procedure for testing items above:

- a. Check for exhaust leaks at the muffler & manifold. Check for exhaust and oil leaks at the turbo (if applicable).
- b. Check for cracks in the manifold or turbo (if applicable), and check the muffler for seam cracks, or any other opening.
- c. Check the manifold or turbo gaskets (if applicable), check the exhaust pipe flange gasket (donut) for proper sealing.
- d. Check all emissions related components for leakage and sealing.

3. Exhaust pipe; tailpipe & header pipe(s)

Items to be checked:

- A. Length
- B. Leaks (visually inspection only)
- C. Condition
- D. Routing
- E. Clamps



Procedure for testing items above:

- a. Check that the exhaust pipe meets 1 CCR 301-25 (Colorado Minimum Standards) Section 20.00.
- b. Check the entire length of the exhaust pipe for leaks.
- c. Check the condition of the entire exhaust pipe.
- d. Check that the entire exhaust system is routed properly.
- e. Check all the exhaust system clamps.

STEERING & SUSPENSION

Description: Applicant should be able to check the following components.

Scoring standard: Applicant should be able to perform the following STEERING & SUSPENSION checks.

1. Steering

Items to be checked:

- A. Steering wheel
- B. Steering column and shaft
- C. Steering box
- D. Steering pump
- E. Pitman arm
- F. Drag link
- G. Steering knuckle
- H. Tie rod and tie rod ends
- I. Wheel bearings/king-pins or ball joints
- J. Castle nuts/cotter pins
- K. Steering stabilizer shock
- L. Steering radius stops

Procedure for testing items above:

- a. Applicant should check (verbalize) for cracks, security, proper position and free play. Applicant should know how to find the free play criteria as listed in 49 CFR 570.60 <https://www.gpo.gov/fdsys/pkg/CFR-2010-title49-vol6/pdf/CFR-2010-title49-vol6-sec570-60.pdf>
- b. Check for absence or looseness of U-bolts of positioning parts; worn, faulty or repair-welded U-joints. Check the shaft bearing condition.
- c. Check for leakage, hose condition, mounting security.
- d. Check the mounting, belt tension and condition, fluid level, hose condition and overall satisfactory operation of the system.
- e. Check for security, cracks, and no welded repairs.
- f. Check the play in the ball & socket joints, there should not be any movement of a stud nut under steering load, or any motion other than rotational of more than manufacturer specification.
- g. Check security and overall condition.
- h. Check for loose or missing clamps or clamp bolts, looseness in any threaded joint. Check ball socket joints as per item in procedure (f).



- i. Check wheel bearings and king-pins for excessive play and freedom of movement. Verbally describe the inspection of the bearings if the hub was removed.
- j. Check security and cotter pin placement.
- k. Check security, damage, and leakage (if applicable).
- l. Check proper adjustment. (Tires not rubbing or chafing on turns. No binding.)

2. Suspension

Items to be checked (one front and one rear axle):

- A. Springs
- B. Rubber spring or air suspension (if applicable)
- C. U-bolts
- D. Spring hangers, spacers, pins and bushings
- E. Shocks
- F. Stabilizer bars

Procedure for testing above items:

- a. Check for cracked, broken or missing leaves or coils. Check for leaves displaced in a manner that could result in contact with a tire, rim, brake drum, frame, etc.
- b. Check for deflated suspension (system failure, leaks, ride height, etc.). Check for broken or missing rubber springs and shifting or chafing of components.
- c. Check for torque, cracks, broken, loose, or missing U-bolts (verbalize the procedure for inspection of torque).
- d. Check for excessive wear, cracks, breaks, looseness, or missing.
- e. Check for integrity of rubber bushings or isolators and to see that the shock is not broken, bent or leaking and that the shock is secure.
- f. Check bushings and security of fasteners.

TIRES AND WHEELS

Description: Applicant should be able to check the following components.

Scoring Standard: Applicant should be able to perform the following TIRE AND WHEEL checks

1. Tread depth and inflation

Items to be checked:

- A. Tread depth
- B. Inflation pressure

Procedure for testing items above:

- a. Measure tread depth in 32nds of an inch. The measurement should be made in a major tread groove, in the area observed to have the least tread, but not at a wear bar. The applicant should know minimum allowable tread depth according to DOT specifications and documents.
- b. Measure inflation pressure, and compare the reading to the tire manufacturer's requirements, and vehicle manufacturer's specifications and document. The applicant



needs only to do one tire from each axle but should understand that all tires are required for an actual inspection.

2. Tire Matching

Items to be checked:

- A. Correct placement of radial or bias tires
- B. Tire sizes on each axle
- C. Size and tire tread on same axle

Procedure for testing items above:

- a. The applicant should check that radial and bias ply tires have not been mixed on the same axle. Different axles are OK.
- b. The applicant should check that tire sizes are matched on the same axle. Different axles are OK.
- c. The applicant should check that tire size and tire tread match between tires on the same axle.

3. Tire and wheel condition

Items to be checked:

- A. Tires
- B. Lug nuts
- C. Wheels (rims)
- D. Valve stem caps
- E. Date code on tire (Age of casing)

Procedure for testing items above:

- a. Applicant should check tires for cracks, cuts, bulges, bruises or excessive curbing.
- b. Applicant should check lug nuts for rusting (between the nut and wheel), and tightness.
- c. Applicant should check the wheel for cracks, broken welds, or excessive run out due to a bent rim. Also, that the wheels on the same axle are the same size and width.
- d. The applicant should check that valve stem caps are installed.
- e. Compare and consider casing age and industry standard.

IDENTIFICATION & BODY

Description: Applicant should be able to check the following components.

Scoring standard: Applicant should be able to perform the following IDENTIFICATION & BODY checks.

1. Lettering and paint

Items to be checked:

- A. Lettering size
- B. Clarity
- C. Paint colors
- D. ID coloring
- E. Placement



Procedure for testing items above:

- a. Check all lettering for size and location per 1 CCR 301-25 (Colorado Minimum Standards).
- b. Check lettering for clarity.
- c. Check that body and bumper colors are in accordance with 1 CCR 301-25 (Colorado Minimum Standards).
- d. Check that ID lettering for condition and that it is in the appropriate colors and reflective backgrounds (when required). Check the retroreflective tape at emergency exits and on sides of the bus for condition and compliance with FMVSS 108.
- e. Check for proper placement of all lettering and identification.

2. Body Interior

Items to be checked:

- A. Seats and panels
- B. Flooring
- C. Step well area
- D. Windows
- E. Interior storage

Procedure for testing items above:

- a. Check all seat cushions, seat backs, and panels for cuts, tears, and protruding sharp edges. Check that all seat cushions are securely fastened. Check seat frames for security. Check seat foam for integrity.
- b. Check flooring for rips or tears. Check for floor molding that has become loose.
- c. Check the step well area for non-skid flooring where required. Check the handrail for security, sharp protrusions and areas that may grab loose clothing.
- d. Check windows for use of approved safety glass with a visible permanent mark. Check the windows for proper opening distance.
- e. Check interior storage areas for proper securement (mounted to the floor, ceiling etc.), no sharp projections, etc.

3. Body Exterior

Items to be checked:

- A. Bumpers and tow hooks
- B. Body panels
- C. Hood latches

Procedure for testing items above:

- a. Check bumpers for security, and proper construction. Bumpers should be free from severe bends or crimping.
- b. Check the body panels and rub-rails for damage that may affect the integrity of the structure. Check for sharp or protruding edges.
- c. Check that the hood latches hold the hood secure.



EMERGENCY EQUIPMENT

Description: Applicant's procedures to be followed in the EMERGENCY EQUIPMENT hands-on test.

Scoring Standard: Applicant should demonstrate knowledge of the equipment involved.

1. Emergency Reflectors

Items to be checked:

- A. Triangles
- B. Triangle storage box
- C. Triangle storage box mounting

Procedure for testing items above:

- a. The applicant should check the operation of the triangles and visually check the condition of each (a sealed box shall indicate a previous inspection and will not need to be unsealed).
- b. Check the storage box for condition and operation of the lid.
- c. Check the storage box mounting for being secure and in a location easy to locate.

2. Fire Extinguisher

Items to be checked:

- A. Fire extinguisher size and rating
- B. Operating mechanism
- C. Mounting
- D. Pressure gauge

Procedure for testing items above:

- a. Check the fire extinguisher for size, type, and rating.
 - (1) School Bus 5-pound dry chemical, approved by UL, with a total rating of not less than 2A10BC.
 - (2) Small Vehicle 2.5-pound dry chemical, approved by UL, with a total rating of not less than 1A10BC.
- b. Check the operating mechanism for a safety pin, and a seal that will break easily and not interfere with the operation of the extinguisher once broken.
- c. Check the mounting bracket for operation, and that it securely holds the extinguisher.
- d. Check the pressure gauge for readability without removal from the bracket, and that the reading indicates charged. Look for current extinguisher inspection tag. (this is not required but is considered best practice.)

3. First Aid Kits

Items to be checked:

- A. Location
- B. Contents
- C. Mounting
- D. Kit size (rating)
- E. Number of kits required



Procedure for testing items above:

- a. Check that the kits are in plain view (not obstructed or covered), or that the location is properly or clearly identified.
- b. Check that the contents are as they should be or are sealed indicating that they have been previously checked.
- c. Check that the kits are securely mounted, and the mounting is operable.
- d. Check that the kit size matches the year of manufacture for the vehicle (24 unit kits are appropriate for all vehicles).
- e. Check that the kit requirements meet minimum standards in place at date of manufacture.

4. Body Fluid Cleanup Kit

Items to be checked:

- A. Location
- B. Contents
- C. Mounting

Procedure for testing items above:

- a. Check that kit is in plain view, or that the location is properly identified.
- b. Check that contents are as they should be or are sealed indicating that they have been previously checked.
- c. Check that kit is securely mounted, and the mounting is operable.

EMERGENCY EXITS & DOORS

Description: Applicant should be able to check the following components.

Scoring standard: Applicant should be able to perform the following EMERGENCY EXITS & DOORS checks.

1. Alarms

Items to be checked:

- A. Driver audible
- B. Switch condition
- C. Switch enclosure

Procedure for testing items above:

- a. Check that the alarm (buzzer) is audible to the driver when seated in the driver's seat when an emergency exit is opened.
- b. Check the condition of the switch. Check the plunger, contacts, and case.
- c. Check that the switch is enclosed and secure.

2. Ignition interlock systems (if applicable)

Items to be checked:

- A. Back emergency door switches
- B. Side emergency door switches and wheelchair lift doors and switches
- C. Emergency door and starter interlock warning buzzers
- D. Circuit wiring and solenoids



Procedures for testing items above:

a. Momentarily start engine and shut off, then with the back-door vandal lock secured, restart the engine. If the rear door switch is working, the engine should not restart.

(1) Check the switch for secure mounting and covering.

(2) Check that the emergency door buzzers sound when attempting a restart.

b. Secure the vandal lock on the side emergency door (if applicable). Attempt to restart the engine. If the side emergency door switch is working, the engine should not restart.

(1) Check the switch for secure mounting and covering.

(2) Check that the emergency door and starter interlock buzzers sound when attempting a restart.

(3) Repeat this procedure for each side emergency exit as applicable.

c. By checking the performance of the interlock system as outlined above, you will have checked the operation of the circuit wiring and solenoids.

(1) Check the interlock solenoid(s) for secure mounting.

(2) Check the interlock wiring for proper routing (free from chafing and cuts).

3. Emergency exits

Items to be checked:

A. Seals

B. Latches

C. Head bumper

D. Door assembly and glass

E. Aisle width at the door

F. Flip seat (if applicable)

G. Hold-open device

Procedure for testing items above:

a. Check seals of all doors, windows, and roof escape hatches for contact and leaks.

b. Check all latches for security and integrity.

c. Check the head bumper pad for proper placement, cuts, tears, and security.

d. Check the door for damage that may affect the integrity of the structure. Check the glass for approved type safety glass with a visible permanent mark, and good visibility.

e. Check for unobstructed aisle width at all emergency exits.

f. Check for proper flip seat operation (if applicable).

g. Check hold-open device for proper operation.



FUEL SYSTEMS

Description: Applicant must be able to check the following components.

Scoring Standard: Applicant should be able to perform and document (if needed) the following FUEL SYSTEM checks.

1. Fuel tank

Items to be checked:

- A. Tank mounting
- B. Leakage
- C. Tank venting
- D. Fuel filler cap
- E. Tank drain plug
- F. Fuel door interlock switch (Alt. Fuel If applicable.)
- G. Tank certification date (Alt. Fuel If applicable.)

Procedure for checking items listed above:

- a. Check fuel tank for a secure mounting in an approved cage. Tank mounting should be free from wedged rocks or iron that could rub and possibly penetrate the tank.
- b. The tank should be checked for any visible leakage.
- c. Check the tank for proper venting outside the passenger area of the bus.
- d. Check the fuel filler cap for leakage and proper placement outside the passenger area of the bus.
- e. Check the fuel tank drain plug for leakage and proper placement. Check the size of the plug and check that it does not protrude beyond the cage.
- f. Check that fuel door interlock switch works properly. With fuel door open, bus should not start.
- g. Check certification date

2. Fuel lines and filters

Items to be checked:

- A. Lines/filters
- B. Mounting
- C. Condition

Procedure for checking items listed above:

- a. Thoroughly check all fuel lines/filters for leakage.
- b. Check that all fuel lines/filters are properly mounted and secure.
- c. Check the condition of all lines/filters that they are free from cracking, kinks, chafing, crimping, or wear.

3. System Leaks

Items to be checked:

- A. Carburetor or injection pump for leaks
- B. Carburetor or injection pump mounting
- C. Transfer pump for leaks and mounting



Procedure for checking items listed above:

- a. Carburetor or injection pump should be checked for fuel, oil, or air leaks.
- b. Check that the carburetor or injection pump is securely mounted.
- c. Check the transfer pump (electric or mechanical) for leakage and secure mounting.

LIGHTING

Description: Applicant's procedures to be followed in the LIGHTING hands-on test.

Scoring Standard: Applicant should be able to perform (when needed) the following LIGHTING checks. LED lamps failure above approximately 25 percent LED's not working. (This is in keeping with the national standard with NCST.)

1. Switches

Items to be checked:

- A. Operation
- B. Mounting

Procedure for testing items listed above:

- a. Check to see that the switches operate in a characteristic manner, free from binding, and have defined detents to hold in position.
- b. Check that the switches are mounted securely.

2. Eight-way lights (complete system)

Items to be tested:

- A. Flashing frequency
- B. Visibility
- C. Operation and sequencing
- D. Pilot or indicator lights
- E. Stop sign and diaphragm (if applicable)

Procedure for testing items listed above:

- a. Check to see that the lights flash on completely and off completely between 60 and 120 flashes per minute.
- b. Check the lenses and bulbs for cleanliness and brightness, the lights should be able to be seen at a distance of 500 feet. Check visors and the black background for aiding visibility in sunshine.
- c. Check that the start switch engages the 8-way light system. (door open or closed) Check that the door switch properly sequences the 8-way lights from yellow to red when the door is opened and red to off when the door is re-closed. Check that the door switch sequences the lights directly to red if the door *was* already open. Check that the override switch sequences the lights directly to red if engaged. Check that the cancel switch turns the 8-way light system off if engaged. Check that the master switch does not allow the 8-way light system to engage when in the off position. Checks in italics are if applicable.
- d. Check the indicator lights (or pilot lights) for sequencing and operation.
- e. Check the stop sign lights for visibility of lenses, flashing frequency, and reflectorized material (not faded). Check that the stop sign is operational.



3. Lights

Items to be checked:

- A. Head lights
- B. Tail lights
- C. License plate lights
- D. Brake lights
- E. 4-way hazards lights
- F. Back up lights
- G. Interior lights
- H. Reflectors
- I. Clearance lights
- J. Turn signal lights
- K. Light monitor
- L. Strobe light (if applicable)

Procedure for checking items listed above:

- a. Check the headlights for proper illumination, alignment, and high beam/low beam operation. Check for proper and secure mounting.
- b. Check tail lights for proper illumination, lenses, and mounting. Check the lenses cleanliness and proper type.
- c. Check the license plate light for illumination and mounting. Check the lenses for cleanliness.
- d. Check that the brake lights illuminate at the proper time. (either when the brake pedal is applied and/or when the retarder/secondary braking system is engaged). Check the lenses for cleanliness and proper type. The retarder was required to be wired into the brake light system 10/1/93 (Colorado Minimum Standards).
- e. Check that the 4-way hazard lights illuminate the turn signal lenses only. Check that the 4-way hazard lights are independent of other lighting systems, and that they are usable with the key on or off. Check the lenses for cleanliness and proper type.
- f. Check that the backup lights illuminate at the proper time (when the transmission has been placed in reverse and the key is on). The controlling switch may be either mechanical or hydraulic. Check the lenses for cleanliness and proper type.
- g. Check all dome and step well lights for proper illumination. Check all instrumentation, all indicator lights, all switch lights for proper illumination.
- h. Check the reflectors for proper type, color, cleanliness, and the degree of fading.
- i. Check clearance lights for proper lenses (color and type). Check for illumination and cleanliness.
- j. Check that the turn signal lights self-cancel after completing a turn. Check the lenses for cleanliness and proper type.
- k. If equipped, check that all indicators function.
- l. Check for proper function, mounting, and color.



Special Needs Equipment

Special needs equipment (if equipped)

- Lift - interlock (after Jan 2005)

- Tie-downs

- Track floor & wall

- CPS restraints - integrated seats

- Other equipment tie-downs (Oxygen)

- Decals

- Belt cutter

- FMVSS 210 ready seat frames

- Air conditioning



Guide for the Operational Check of the Air System One Way Check Valves, Double Check Valve & SR-1 Valve

Listed below are the recommended procedures to perform these checks.

1) With the primary and secondary air pressure at system cut - out pressure and the engine off, the technician should drain the wet tank. The primary and secondary tanks should remain at full pressure.

2) Chock the wheels and release the spring brake. The technician should drain the secondary air tank. The primary air tank should remain at full pressure. The park brake valve should not pop out or set.

3) Restart the engine and build the air pressure to system cut out pressure.

4) With the engine off and the wheels chocked, ensure that the spring brake is released. The technician should drain the primary air tank. The secondary air tank should remain at full air pressure. The park brake valve should not pop out of set.

5) With an assistant applying the brakes the technician should watch to see that the primary brakes (rear) apply. This is checking to ensure that the SR-1 valve is working. There should be air available to make 3 - 5 brake applications before the spring brakes set.

If the park brake valve pops out or sets during test steps #2 or #4 the double check valve is defective and should be replaced.

If the air pressure drops in any of the tanks other than the one being drained during steps #1, #2, or #4, one of the one-way check valves is defective and should be replaced.

The green needled air pressure gauge or the (F) on Bluebird TC models indicate the primary air gauge / tank. The red needled air pressure gauge or the (R) on Bluebird TC models indicates the secondary air gauge/tank.





Records, Documentation, and Retention

Vehicle Inspection Forms: The CDE Annual Inspector shall utilize CDE Form STU-26 or equivalent or STU-27 or equivalent to record any defects, deficiencies, adjustments made, parts replaced, or repaired during the inspections. The forms section of this document provides further guidance pertaining to proper completion of the forms. A repair order must accompany the checklist documenting the repairs made, adjusted measurements, and parts used for all repairs. For the inspection to be valid, at least one certified inspector must be participating.

Once the inspector(s) completes the inspection form; the original will be placed in the appropriate vehicle file folder at the inspection site along with the accompanying repair order or service invoice, and a copy of the STU-25 Affidavit. Electronic filing systems or fleet management systems may be used for all documentation, however, utilizing a backup filing method is encouraged.

The result of the inspection shall be documented on the CDE Affidavit of Annual Inspection for School Transportation Vehicles Form (STU-25). One copy must be placed in the vehicle, and a copy also placed in the vehicle file.

Rules from 1 CCR 301-26 Colorado Rules for The Operation, Maintenance and Inspection of School Transportation Vehicles pertaining to Documentation and Records

4.02 School districts and service providers shall maintain separate files for each school transportation vehicle operator, school transportation paraprofessional, and school transportation annual inspector with written documentation evidencing all listed requirements indicated in Rule 5.00, Rule 6.00, and Rule 7.00, as applicable. Training documentation shall include the trainer name, date of the training, description of the training, duration of each topic covered and the signature of all attendees.

Clarification: It is not required that districts, charters, or service providers duplicate required items in the IQF and DQF files if the files are combined.

10.02 Annual inspection results shall be documented on the CDE Affidavit of Annual Inspection for School Transportation Vehicles Form (STU-25).

10.02(a) A copy of the current Affidavit is maintained inside the vehicle and a copy is placed in the vehicle file.

10.03 All annual inspection criteria of school transportation vehicles must meet or exceed manufacturer's specifications. The annual inspection shall be



documented and shall include at a minimum all fields listed on the CDE Annual Inspection and Preventive Maintenance Requirements Form (STU-26).

- 10.04 All annual inspection criteria of trailers must meet or exceed manufacturer's specifications and shall include at a minimum all fields listed on the CDE Trailer Annual Inspection and Preventive Maintenance Requirements Form (STU-27).
- 11.02 School districts and service providers shall have a system to document preventative maintenance, reported defects and repairs made to school transportation vehicles.
- 11.03 School districts and service providers shall maintain separate files for each school transportation vehicle with documentation of all annual inspections, all preventative maintenance and all reported damage, defects or deficiencies and the corresponding repair and maintenance performed.

11.05 Documentation for reported defects must include all the following:

- 11.05(a) Name of the school district or service provider.
 - 11.05(b) Date and time report was submitted.
 - 11.05(c) All damage, defects or deficiencies of the school transportation vehicle.
 - 11.05(d) Name of the individual who prepared the report.
- 11.06 Following a reported damage, defect or deficiency of a school transportation vehicle, school districts, service providers or a representative agent must repair reported damage, defects or deficiencies, or document that no repair is necessary, ensuring vehicle is in safe and proper operating condition prior to transporting students.



RECORD RETENTION REQUIREMENTS FROM THE STATE ARCHIVES RECORDS MANAGEMENT MANUAL SCHOOL FOR DISTRICTS

SCHEDULE 8 TRANSPORTATION RECORDS

General Description: Records generally relating to operation and maintenance of the school district's transportation program. The specified retention period applies to the information contained within the record, regardless of the physical format of the record (paper, microfilm, computer disk or tape, optical disk, etc.).

Duplicate Copies: Provided that no retention period is specified for duplicate copies, retain those that are created for administrative purposes for 1 year, and retain those created for convenience or reference purposes until no longer needed or for 1 year, whichever is first. Duplicate copies should not be retained longer than the record copy.

1. Driver Qualification File - to include but not limited to:
 - a. CDE school bus driver annual written test
 - b. CDE small vehicle driver annual written test
 - c. Driving performance test
 - d. DOT medical report
 - e. Motor vehicle record check
 - f. First aid certificate
 - g. Commercial driving license (CDL) copy

Retention 6 years.

2. Driver Qualification File Continued - new hires:
 - a. Pre-service training record outline
 - b. Mountain driving written test
 - c. Adverse weather driving written test
 - d. CDL skills test

Retention until driver resigns, is terminated or retires.

3. Vehicle Maintenance File - to include but not limited to:
 - a. Annual inspection form
 - b. Vehicle repair form
 - c. Preventive maintenance inspection form

Retention Life of the vehicle or 10 years.

4. Daily Pre-Trip Inspection Sheets that verify the driver has completed the required inspections.

Retention 6 months.



5. Emergency Evacuation Drills that document the driver's knowledge and application of evacuation procedures.

Retention 3 years.

6. Emergency Evacuation Talk Checklist that spell out the correct and proper procedures for students and teachers to follow in the event of an emergency.

Retention: 6 months.

7. Transportation Service Hours that detail the schedule of service for the district's vehicles.

Retention 6 months.

8. Drug and Alcohol Test Results that are required of transportation section employees.

Retention 5 years.

9. In-Service Training Record that documents the annual training provided to each driver and maintenance person.

Retention 6 years.

10. Fingerprint Reports from the Colorado Bureau of Investigation and FBI.

Retention Until driver resigns, is terminated or retires.

11. Annual Inspector Files that verify an inspector's competence in certain areas.

- a. Initial certification
- b. Hands on score sheets
- c. Inspector written test
- d. Re-certification sticker
- e. Brake inspector qualifications

Retention Until inspector resigns, is terminated or retires.



Forms

All forms can be found on the Transportation pages of the CDE website. It is recommended that forms are downloaded from the transportation page of the website as needed. Sourcing forms from the website ensures users have the most current form and are in compliance.

EDAC STAMP

Note: EDAC is the Educational Data Advisory Committee. Required forms receive approval and are issued a new EDAC approval stamp annually. The EDAC stamp is located at the bottom right corner of the document. The stamp is dated for the school year in which it is to be used.

Forms not requiring the EDAC process and stamp have a revision date at the bottom right of the document. To be sure that you are using the most current form please download all forms only when needed from the forms page on the CDE School Transportation website. Forms are updated annually on July 1.

STU-13 CDE Annual Inspector Test Answer Sheet

This form is to be used for the Annual Inspector written test process.

Instructions for completing the various sections of this form are as follows:

The applicant completes the lines with their name and the test date. A supervisor shall grade the test, fill in their name and fill in the score and specific test number. This form shall be used to document answers for either the initial 100 question qualification test or the 50-question recertification test.

A completed and graded copy shall be kept in the IQF (inspector qualification file).

STU-19 Hands-On Test check list

The form is for use by the Annual Inspector Hands-On Tester to assist in documenting scoring during the testing process. This form mirrors the guide to the hands-on test.

Instructions for completing the various sections of this form are as follows:

Heading - The Hands-On Tester shall complete the form including name of the applicant, date, a description of the vehicle (body, chassis, and model year), the vehicle unit number/id #, and the vehicle type (A, B, C, D, MFB, or small vehicle).

Body - The Hands-On Tester should mark each line or item as it is verbalized by the technician taking the test. Additional notes taken during test should be detailed and complete. When the test is complete, the score is tallied and transcribed onto the STU-21 Score sheet.

The completed copy should be kept in an applicant test file by the Hands-On Tester.



STU-20 Application for Annual Inspector Qualification or Recertification

The completed application must be submitted to CDE via email documenting that the applicant for CDE Annual Inspector has met all the requirements of 1CCR 301-26 to inspect school transportation vehicles or that the applicant qualifies for recertification.

Instructions for completing the various sections of this form are as follows:

Heading - Print the applicant's name. It is important that the name be legible; this will assist in proper spelling on the certificate. In the event this form is being used for recertification, the inspector number shall be included. Fill in the inspection site name, mailing address of the inspection site. Also include the applicant's current phone number and a current email address, along with the supervisor's email address. (The certificate and accompanying letter from CDE is sent to the applicant and their supervisor via email. These documents are no longer mailed.)

Supervisor verification - The five sections, 6.02(a) through 6.02(e), indicating the required qualifications must be initialed (or checked if using the form electronically). Dates, scores and the Hands-On Testers number must be completed as required. The supervisor completes the form by filling in the applicant's name, certifying that they have met the requirements, printing their name, then signing and dating the document.

A copy should be kept in the IQF (inspector qualification file) and a copy submitted to CDE via email.

STU-22 Application for Inspecting Site Certification

This application is submitted via email to CDE to verify that the inspection site meets the requirements of 1CCR 301-26. It is only necessary to submit this form once, as long as the inspection site has not moved or had major renovations. The district or service provider shall post the CDE Inspection Site Certificate at the inspection site. Posting a copy is acceptable.

Instructions for completing the various sections of this form are as follows:

Heading - Print the inspecting site name and mailing address. Complete the line requiring the site physical address only if different from the mailing address. The shop phone number(s), a contact name and email address are also required.

Supervisor verification - Five sections must be initialed, 9.02(a) through 9.02(e), indicating the required qualifications are complete (or checked if using the form electronically), and the form must be signed and dated by the site supervisor. The site supervisors name should be printed legibly on the line preceding the signature line.

The name of the inspection site must be printed in the blank provided in the certification statement.

A copy should be kept on file at the inspection site and a copy submitted to CDE.



STU-24 CDE Brake Inspector's Qualification Certificate

This form or an equivalent meeting the requirements of 49 CFR Part 396.25 is required to be maintained in the qualification file of the annual inspector, technician, or other district or service provider employee that is responsible for the inspection, maintenance, service or repairs of any brakes on district, charter school, or service provider's vehicles.

"Brake Inspector" means any employee of a district or service provider who is responsible for ensuring all brake inspections, maintenance, service, or repairs to any school transportation vehicle, subject to the district or service provider's control, meets CDE and applicable Federal standards.

No school district, charter school, or service provider shall require or permit any employee who does not meet minimum brake inspector qualifications to be responsible for the inspection, maintenance, service or repairs of any brakes on its vehicles.

The brake inspector's qualification certificate may be filled out by the inspector but must be signed by a supervisor certifying that the inspector meets the stated requirements.

Instructions for completing the various sections of this form are as follows:

Statement - The inspector's name shall be printed in the certification statement blank provided.

Qualifications - The inspector shall place a check mark in each line indicating the duties that the applicant is qualified to perform, inspect, maintain, repair, or service.

Requirements - The inspector shall then place a check mark in the line preceding each requirement that applies.

Signature - The signature line, date, driver license number, endorsement line and license expiration date shall be completed.

Supervisor verification - The supervisor shall insert the inspector's name in the statement verifying qualification.

A copy shall be kept in the IQF (inspector qualification file).

STU-25 Affidavit of Annual Inspection

The annual inspection result shall be documented on the CDE Affidavit of Annual Inspection for School Transportation Vehicle Form (STU-25).

Instructions for completing the various sections of this form are as follows:

Fill in the inspection site name, physical address, unit number, body manufacturer, chassis manufacturer, vehicle model year, and license plate number. Indicate the inspection result by placing a check mark on the appropriate line. The Inspector shall sign, date, and document their inspector number for this form to be valid.

A copy of the current Affidavit is maintained inside the vehicle and a copy in the vehicle file.



STU-26 CDE Annual Inspection/Preventive Maintenance Checklist & STU-27 Trailer Annual Inspection/Preventive Maintenance Checklist

This form or equivalent shall be used for each vehicle inspection completed. This form is not valid without the signature of at least one CDE Certified Annual Inspector.

Instructions for completing the various sections of this form are as follows:

Heading - Fill in completely the inspection site name, model year of the vehicle, body manufacturer, chassis manufacturer, license plate number, and inspector number(s). The inspector(s) signature line is to be signed (not initialed) by everyone participating in the actual inspection. A person who is merely turning on lights or shaking the steering wheel is not actually participating in the inspection. If the form is being used for an annual inspection, then the odometer reading for the previous annual inspection should be used. If the form is being used for a preventive maintenance inspection, then the previous PM mileage should be documented (an annual inspection is also considered a PM for the purpose of brake inspection documentation). Previous inspection date and odometer reading must be completed unless the vehicle is new to the district or service provider. Also required is current inspection odometer reading, date the inspection was started, date the inspection was completed, and the unit number of the vehicle.

Status Code - As each numbered item is inspected, a process code shall be placed in the "Codes Required" column depending on the inspection results. The inspection procedures for the various "Inspection Items" along with the "Repair" or "Out Of Service" criteria can be found in the Technicians' Guide. Only one code should be placed on the line. Example 1: The code 1 is placed in this column if the item(s) inspected meets all requirements of FMVSS and the manufacturer, is in proper working order and exhibits no signs of defects. Example 2: If an item is both inspected and adjusted, a "2" for adjusted should be placed on that line. Codes and their number equivalent are found at the bottom of the form. Because this form is provided for documenting both annual and preventive maintenance inspections, the "*" found in this column indicates the item(s) on that line are required only during an annual inspection. If any code is used other than the code for inspected or N/A, additional information and documentation should be included on an attached repair order.

Inspector Initials - The column for inspector(s) initials is only required to be completed if there is more than one inspector participating in the inspection. A technician without Annual Inspector credentials should not initial in this column. It is the responsibility of the CDE Certified Annual Inspector to complete this form.

Inspection Items - This section includes five (5) main categories (Road Test Inspection, Under Hood Inspection Interior Inspection, Under Vehicle Inspection, Around Vehicle Inspection) based on the vehicle area to be inspected. This simplifies the method of grouping the items. Under each of the main categories, there are specific items listed that are to be inspected.



Comments - Inspection line items with a code other than “1” for inspected, should have some further comment(s) or clarification about that item on a repair order that accompanies the inspection form. When documenting further comments, ensure that the technician can readily identify the item for which the comments apply. One method of doing this is to list the section letter and item number from the form.

A copy of the completed form and the attached repair order shall be placed in the vehicle file.

Specific Line information for the STU-26

A-8 Governor cut in and cut out pressures should be documented. If the measured pressure requires adjustment, repair, or a part replacement to achieve a proper reading, that should be documented on the attached repair order along with the adjusted cut in and cut out pressures.

A-9 Gauge Pressure loss should be documented. If pressure loss is excessive, the resulting repair/adjustment and retested reading should be documented on the attached repair order.

A-11 Buzzer and light actuation and park brake valve actuation should be documented. Repair/adjustment and retested reading should be documented on the attached repair order.

B-6 Coolant freeze point should be documented. If the coolant is changed or adjusted, that information and the new reading should be documented on the attached repair order.

E-8 Air brake equipped vehicles equipped with slack adjusters must have the appropriate line checked indicating the type of slack adjuster. Slack adjuster measurements should be precise. Usually measuring to the 1/16 of an inch is adequate (rounding off is not good documentation). The applied method is required. Measurements found to be out of spec should be documented, and the repaired measurement documented on the attached repair order.

E-10 Tire pressure should be measured and adjusted per the manufacturer recommendation.

E-11 Tread depth measurements should be documented as observed. Rotation or replacement and corresponding readings shall be documented on the attached repair order.

E-16 The pad or shoe location is indicated in the line after LF, RF, etc. and prior to the colon (:). The pad or shoe measurement follows the colon. Example: a vehicle with disc brakes would have a reading such as: LF O : 10/32, indicating that the measurement is of the left front outer pad. Pad or shoe replacement and corresponding readings shall be documented on the attached repair order.



E-17 Complete the lines indicating manufacturer specification, document measurements from the previous year annual inspection as well as current measurements. If the vehicle is newly purchased, indicate this by a note on the repair order. If the vehicle was last inspected by another shop or district, an effort should be made to attain this information for complete documentation. If the information is not available, note this on the repair order. Drum or rotor replacement and corresponding readings shall be documented on the attached repair order.

E-18 Air disc brake pad to rotor clearance should be documented as observed. If initial measurements are not within specifications, final measurements and repairs should be documented on the repair order.

Specific Line information STU-27

T-9 Pad or shoe location is indicated in the line after LF, RF, etc. and prior to the colon (:), with pad or shoe measurement following the colon. Example: a vehicle with disc brakes would have a reading such as: LF O : 10/32, indicating the measurement is of the left front outer pad. Pad or shoe replacement and corresponding readings shall be documented on the attached repair order.

T-10 Complete the lines indicating manufacturer specification, document the measurements from the previous year annual inspection as well as the current measurements. If the vehicle is newly purchased, make a note on the repair order to indicate this. If the vehicle was last inspected by another shop or district, an effort should be made to attain this information for complete documentation. If the information is not available, then note this on the repair order. Drum or rotor replacement and corresponding readings shall be documented on the attached repair order.

T-11 Tire pressure should be measured and adjusted per the manufacturer recommendation, to include the spare(s).

T-13 Lug nut torque should be verified and documented.



STU-30 Hands-On Tester Qualification Recertification

The application shall be submitted to CDE documenting the CDE Hands-On Tester has met all 1CCR 301-26 requirements to proctor the Hands-On test and that the applicant qualifies for recertification.

Instructions for completing the various sections of this form are as follows:

Heading - Print the applicant's name (legibly, to assist in correct certificate spelling), and direct contact phone number. If the form is being used for recertification, fill in the Hands-On Tester number. Include the annual inspector number, mailing address, an email address, the name of the inspection site and the site phone number.

Qualification verification - The five sections, 7.02(a) through 7.02(e) indicating the required qualifications must be initialed (or checked if using the form electronically). Dates of annual inspector qualification, training or certification must be completed as required. The applicant shall sign and date the application.

A copy should be kept on file by the Hands-On Tester.



COLORADO
Department of Education
School Finance and
Operations Division

CDE Annual Inspection

Procedures, Repair Criteria, & Out of Service Criteria

Section A: Pre-Road Test Inspection

	Section A. Road Test Inspection	
Inspection Procedure:	Repair If:	Out of Service If:

Section A. Road Test inspection

NOTE: This Manual is laid out to logically coincide with the inspection of front engine vehicles. Rear engine vehicles may have to be inspected in a different sequence; all componentry and procedures apply.

<p>1. Driver's Seat and Seat Belt a) Check driver's seat and belt for specifications (type / adjustability), operation, condition, and mounting.</p>	<p>Seat adjustment binds or is difficult to operate.</p> <p>Seat adjustment is loose, or adjustment hardware is missing.</p> <p>Seat upholstery or foam is deteriorated or damaged.</p> <p>Seat upholstery is wrong type (vinyl/cloth).</p> <p>Seat bottom is loose in frame or miss-positioned.</p> <p>Seat belt retractor covers or belt covers are damaged or loose.</p>	<p>Driver's seat will not adjust as designed.</p> <p>Seat mounting is unstable, loose at floor, or seat mounting hardware is missing.</p> <p>Driver's seat belt missing or not an approved type.</p> <p>Seat frame is exposed due to deterioration of upholstery or foam.</p> <p>Mounting of retractors or belt guides not secure.</p> <p>Seat belt webbing or stitching is frayed or damaged.</p> <p>Seat belt is routed improperly.</p> <p>Seat belt does not extend or retract freely.</p> <p>Seat belt buckle and tongue assembly does not latch or release.</p> <p>Non-OEM extenders have been added to belt or belt mounting.</p>
<p>b) Check under seat storage compartment if equipped.</p>		<p>Compartment or drawer not secured.</p>

	Section A. Road Test Inspection	
Inspection Procedure:	Repair If:	Out of Service If:
<p>2. Steering</p> <p>a. Play</p> <p>Check for play in steering system at steering wheel:</p> <p>1) Visual check - from inside bus with engine running, rotate steering wheel lightly from side to side until turning motion can be observed at tires. Note free play (lash) at steering wheel outer diameter. Note: Procedure must be performed with vehicle on ground.</p>		<p>Free play (lash) exceeds amounts specified in Chart 1.</p>
<p>2) To check power assist operation, run engine at fast idle (approximately 1000-1200 rpm) and turn steering wheel full right then full left and feel for binding, jamming, or belt slippage.</p>		<p>Power assist is inadequate or there is binding, jamming, or slippage.</p>
<p>3) Visually check condition of steering wheel.</p>	<p>Steering wheel plastic is cracked.</p>	<p>Steering wheel is loose on column.</p> <p>Steering wheel is non-OEM design.</p> <p>Plastic is missing so that metal steering wheel reinforcement is exposed.</p> <p>Any portion of the metal steering wheel components are cracked or broken.</p>

Section A. Road Test Inspection		
Inspection Procedure:	Repair If:	Out of Service If:
2. Steering b. Column: 1) Check steering column inside bus for up and down play (parallel to shaft), side to side play (perpendicular to shaft), and for proper mounting.	Rubber boot at bulkhead (if equipped) is torn, ripped, or missing.	Side to side play in steering column exceeds ¼ inch or up and down play exceeds 1 inch. Column assembly mounting (including floor mounting plate) or fasteners are loose. Any modification or other condition that interferes with free movement of any steering component.
2) Check operation of tilt and telescoping functions (if equipped).	Does not tilt or telescope.	Does not latch securely in place.

Chart A-1. Steering Wheel Play (Lash) Measurements Chart

Lash may not exceed the following:

Steering Wheel Size	Play (Lash) Manual Steering	Play (Lash) Power Steering
16 inches or less	2 inches	4 ½ inches
18 inches	2 ¼ inches	4 ¾ inches
20 inches	2 ½ inches	5 ¼ inches
22 inches	2 ¾ inches	5 ¾ inches

	Section A. Road Test Inspection	
Inspection Procedure:	Repair If:	Out of Service If:
<p>3. Instruments/Gauges, Indicators Lights, Warning Systems, Horns a. Gauges</p> <p>Check from driver's position the OEM location, visibility, readability, illumination, operation, accuracy, and condition of following gauges and warnings:</p>	Gauges don't sweep during instrument cluster check. (refer to manufacturer's specifications)	Instrument Cluster Inoperative
1) Speedometer and odometer	Odometer doesn't work or is not working properly. Odometer is unreadable.	Speedometer is known not to work or is confirmed to be inaccurate Speedometer is unreadable or damaged.
2) Oil pressure	Oil pressure gauge is inaccurate, damaged or difficult to read.	Oil gauge does not function or is unreadable. Oil pressure gauge or tube leaks.
3) Temperature	Temperature gauge is inaccurate, damaged or difficult to read.	Temperature gauge does not function or is or unreadable.
4) Fuel	Fuel gauge is inaccurate, damaged or difficult to read.	Fuel gauge does not function or is or unreadable.
5) Voltmeter or ammeter	Voltmeter / ammeter is inaccurate, damaged or difficult to read.	Voltmeter / ammeter does not function or is or unreadable.
6) Air pressure		Air pressure gauge(s) are known to be inaccurate, are unreadable or not working.
7) Tachometer (if equipped)	Inoperative	
8) Hourmeter (if equipped)	Inoperative	
9) Transmission Temperature Gauge (if equipped)	Inoperative	
10) Vacuum	Vacuum gauge is known to be inaccurate, is unreadable or not working.	

	Section A. Road Test Inspection	
Inspection Procedure:	Repair If:	Out of Service If:
3. Instruments/Gauges, Indicators Lights, Warning Systems, Horns b. Indicators, Dash Lights Check for presence and operation of following indicators:	Light bulb for the following gauge or indicators is inoperative:	Light bulb for the following gauge or indicators is inoperative:
1) Low air pressure or vacuum warning light	Low air pressure warning light does not engage at 60 psi. (high or low)	Low air pressure or vacuum light inoperative.
2) High beam indicator light	High beam indicator inoperative.	
3) Left and right turn signal and 4-way hazard	Left or right turn signal or 4-way hazard inoperative.	
4) Check all dash and control panel lights for illumination at gauges and switches.	Oil pressure / Temperature / Fuel / Voltmeter Ammeter / Shift Indicator light is inoperative One or more lights for control switches are inoperative. One or more panel lights is inoperative.	All dash or control panel lights are inoperative. Speedometer lights are inoperative.
c. Engine Warning Lights and Buzzer Check for presence and operation of the following warning lights on all diesel buses and buzzer on 1990 and later.		
1) High coolant temperature dash warning light and buzzer.		High water temperature dash warning light or buzzer is inoperative.
2) Low oil pressure dash warning light and buzzer.		Low oil pressure dash warning light or buzzer is inoperative.

	Section A. Road Test Inspection	
Inspection Procedure:	Repair If:	Out of Service If:

<p>3. Instruments/Gauges, Indicators Lights, Warning Systems, Horns d. Ignition Switch</p> <p>1) Check that switch only operates by key.</p>		Key sticks in switch. Switch operates without key.
<p>2) Should be mounted securely in OEM location.</p>	Loose.	Not mounted in OEM location.
<p>3) Should operate freely in each function (i.e., start, run, off, and accessory position).</p>		Engine will not crank or start. Switch sticks in any position. Doesn't function properly in start, run, off, or accessory position or is intermittent in any position.
<p>e. Fast Idle Switch Check operation of switch.</p>	Switch On does not engage.	Switch Off does not disengage fast idle.
<p>f. Dash Decals 1) Warning: Electric hydro-max brake booster must be functional with Ignition switch off (if applicable). Regen decal, Ether start</p>	Regen decal, or ether start missing	If decal is missing on buses equipped with hydro-max braking systems and electrical emergency booster motor.
<p>2) Wait to Start - Glow Plugs, Grid heater.</p>	Decal is missing or not legible on buses equipped with glow plug or grid heater systems. Light does not illuminate during instrument panel light check.	
<p>3) Do not move bus with lift down decal.</p>	If decal is missing or not legible.	
<p>g. Horn(s) Check for operation of horn(s) and for location and condition of horn switch.</p>	Horn sounds only one tone.	<p>Horn(s) does not operate properly.</p> <p>Horn button is not mounted in original OEM location.</p> <p>Horn button sticks or is intermittent such as when steering wheel is rotated.</p>

	Section A. Road Test Inspection	
Inspection Procedure:	Repair If:	Out of Service If:
3. Instruments/Gauges, Indicators Lights, Warning Systems, Horns h. Backup Alarm Check for operation and condition of alarm and alarm decals.	Decal missing or not legible Backup alarm inoperable.	
i. Shifter - Automatic Transmission 1) Check that shifter operates easily and Touch-Pad operates normally.	Does not shift easily into all gears.	Will not shift into all gear positions.
2) Correctly indicates the gear that the transmission is in.	Slightly misaligned but indicates correct gear.	Indicates wrong gear.
3) LED correctly indicates transmission gear	Some LED's out but can still determine which gear transmission is in.	LED's out and/or cannot determine which gear transmission is in.
4) Has a functional detent mechanism with a loose knob or handle.		Detent is non-functional. Knob or handle does not shift easily into all gears.
5) Check Markings on touch-pad.	Touch-pad numbers faded or worn. Touch-pad cracked.	Buttons on touch-pad unreadable.
j. Shifter - Manual Transmission 1) Check that shifter operates easily	Does not shift easily into all gears.	Will not shift into all gears. Hangs between gears.
2) Condition of lever and knob.	Bent lever or knob cracked. Loose knob. Pattern worn off knob (floor shift only).	Lever not securely attached. Knob missing or indicates wrong pattern.
k. Neutral Safety Switch Check for functional neutral safety switch that allows starter to operate only in park or neutral.	Out of adjustment.	Starter will engage in any gear other than park or neutral.

Section A. Road Test Inspection		
Inspection Procedure:	Repair If:	Out of Service If:
<p>4. Windshield, Mirrors, Driver visor and hardware a. Windshield</p> <p>Inspect windshield for cracks and other damage.</p>	<p>Windshield leaking around the gasket or seal.</p>	<p>Windshield Glazing. (Not including a 2-inch border at the top, a 1-inch border at each side and the area below the topmost portion of the steering wheel.) Any crack, discoloration or vision reducing matter except: (1) coloring or tinting applied at time of manufacture; (2) any crack not over 1/4 inch wide, if not intersected by any other crack; (3) any damaged area not more than 3/4 inch in diameter, if not closer than 3 inches to any other such damaged area</p> <p>Crack in the windshield greater than twelve (12) inches in length.</p> <p>Any glass missing.</p> <p>Any laminated windshield glass broken or splintered which might cause injury when touched.</p>
<p>b. Windshield Visibility/Fogging</p> <p>1) Check windshield and windows for fogging, reduced visibility, or improper level of tinting.</p>	<p>Glass fogging around edges, but less than two (2) inches.</p>	<p>Windshield is fogged more than two (2) inches in from the outer border.</p> <p>Any windshield or window fogging or clouding results in reduced visibility of a mirror.</p> <p>Any reduced visibility through windshield or any windows within driver's immediate field of vision.</p>
<p>2) Check windshield and windows for objects or signs obstructing driver's vision.</p>	<p>Tinting on windshield or windows to the side of the driver which is not 70% light transmission or clearer.</p> <p>Tinting on any windows behind driver's location which is not at least 28% light transmission or clearer.</p>	<p>Any object obstructing or interfering with driver's vision to the front, sides (to include the first two windows behind the front barriers), or rear.</p>

	Section A. Road Test Inspection	
Inspection Procedure:	Repair If:	Out of Service If:
<p>c. Latches and Window Operation Check latches and windows for condition and operation.</p>	<p>Latches are broken.</p> <p>Latches difficult to operate.</p> <p>Windows do not stay closed.</p>	<p>Any loose or damaged window hardware protruding into the passenger compartment.</p>
<p>4. Windshield, Mirrors, Driver visor and hardware d. Mirrors - general</p> <p>Inspect for condition and operation of mirrors.</p>	<p>Mirror mounting loose; mirror does not remain where positioned by driver.</p>	<p>Mirrors broken or cracked adversely affecting driver's field of vision.</p>
<p>e. Mirrors - Rear view</p> <p>Check exterior rearview mirrors for specifications, condition, mounting, adjustment.</p>	<p>Loose mounting brackets.</p>	<p>Any exterior rearview mirror is broken, cracked, or loose in frame.</p> <p>Either mirror does not give driver a clear view down to lower outside edge of rear tire at ground level, on both sides to the rear.</p> <p>Any bracket is broken or mirror mounting is insecure.</p> <p>Reflective surface is deteriorated.</p> <p>Any mirror does not meet applicable specification as to type and size.</p> <p>Any bus does not have the same mirror system on each side.</p>

	Section A. Road Test Inspection	
Inspection Procedure:	Repair If:	Out of Service If:
<p>4. Windshield, Mirrors, Driver visor and hardware</p> <p>f. Mirrors - Convex</p> <p>Check convex crosswalk and side-view mirrors for specifications (correct type, size, and location) condition, mounting, and adjustment.</p>	<p>Any mirror is out of adjustment.</p>	<p>Required convex mirrors not present.</p> <p>Any mirror cracked, broken, or loose.</p> <p>Any reflective surface is deteriorated.</p> <p>Mirror mounting system loose / broken.</p> <p>Mirrors do not meet specifications for bus manufacture date.</p> <p>Mirrors do not give driver a clear view of the area around the front of the bus.</p>
<p>g. Mirrors - Interior</p> <p>Check interior rearview mirror for size, condition and mounting.</p>	<p>Any portion of reflective surface is obstructed by sun visor or stickers.</p>	<p>Mirror does not meet minimum size/design requirements.</p> <p>Mirror does not have rounded corners and protected edges.</p> <p>Any reflective surface is deteriorated.</p> <p>Driver's view of images in mirror is not clear due to distortion or other causes.</p> <p>Mirror mounting system loose / broken.</p>
<p>h. Cross view mirrors</p> <p>Cross view mirrors are for pedestrians, vehicles may not appear properly.</p>	<p>Lens is cracked, broken, loose, or damaged.</p>	<p>Mirror does not meet minimum size/design requirements.</p> <p>Mirror does not have rounded corners and protected edges.</p> <p>Driver's view of images in mirror is not clear due to distortion or other causes.</p> <p>Mirror mounting system excessively loose / broken.</p>

	Section A. Road Test Inspection	
Inspection Procedure:	Repair If:	Out of Service If:

Chart A-2. FMVSS.111 Mirror Adjustment

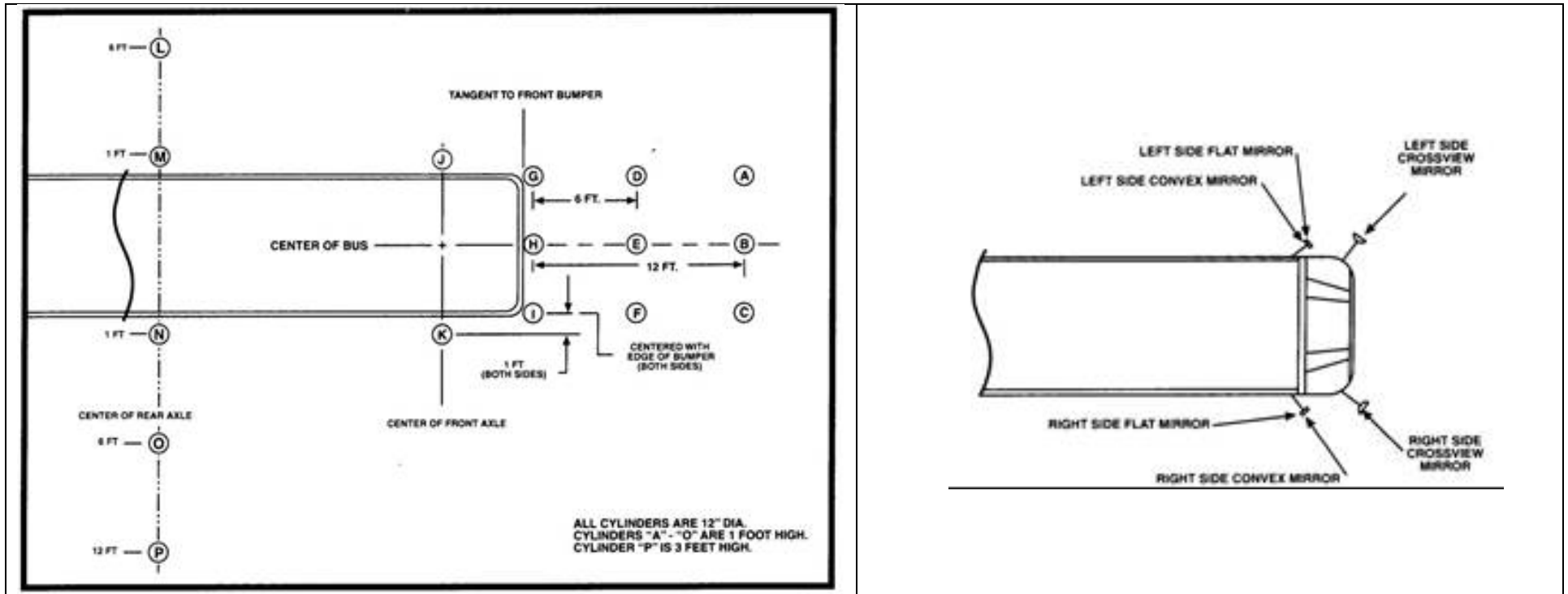

REAR VIEW MIRRORS (SYSTEM A) Used together, left side flat mirror and left side convex mirror must provide a view of "M" and, continuing from there, 200 feet rearward of the mirror surface. Used together, right side flat mirror and right side convex mirror must provide a view of cylinder "N" and, continuing from there, 200 feet rearward of the mirror surface.

CROSSVIEW MIRRORS (SYSTEM B) Any cylinders "A-P" can be viewed using either of the crossview mirrors, but all must be visible. Only those cylinders that the driver can view by direct vision and are forward of the front bumper may be excluded.

	Section A. Road Test Inspection	
Inspection Procedure:	Repair If:	Out of Service If:
4. Windshield, Mirrors, Driver visor and hardware i. Driver visor Inspect driver's sun visor for condition and operation.	Driver's sun visor is clouded, loose, dirty or has unauthorized stickers.	Driver's sun visor cannot be adjusted or will not stay in position. Driver's sun visor is cracked, broken, or damaged. Sun visor is missing.
5. Windshield Wipers & Washers a. Wiper Operation Inspect both wipers for: 1) Swept area field of view.	Wiper goes past perimeter of glass.	Either wiper does not effectively clear driver's field of vision.
2) Proper operation of both wipers on high and low speeds and condition and mounting of switch(es) and knob(s).	Either wiper does not operate on low speed. Switch(es) mounting loose or knob(s) loose.	Either wiper does not operate properly at high speed. Knob(s) missing.
3) Condition and mounting of wiper motor and linkage.	Either wiper motor or linkage is visibly damaged or loose.	
4) Inspect for proper washer operation.	Washer does not operate, is improperly adjusted or out of fluid.	
b. Wiper Park Inspect for parked position of wipers when turned off.		When turned off, either wiper does not automatically return to parked position out of driver's line of sight.
c. Wiper Blades Inspect blades for condition, mounting, and tension.		Either blade is damaged, deteriorated, loose, or does not hold proper tension against windshield.

Section A. Road Test Inspection		
Inspection Procedure:	Repair If:	Out of Service If:
<p>6. Air system build time Check air system build time from fully depleted to fully-charged.</p>		Depleted to fully charge time exceeds 4 minutes.
<p>7. Retarder indicator lights Inspect lights for condition and operation.</p>	Any light is inoperative or damaged.	
<p>8. Air Brake System Governor Check and record governor cut in psi and cut out psi.</p>	Out of adjustment (if it can be adjusted).	Cannot be adjusted. PSI does not meet manufacturer's specifications.
<p>9. Air Brake System</p>	NOTE: If vehicle is equipped with Anti-Lock Braking System, refer to manufacturer's service manual for inspection criteria.	
<p>a. Gauge(s) For vehicles equipped with air brakes check for presence of two air pressure gauges (or single gauge with dual needles). One gauge or needle should indicate air pressure available to the primary brake system and one to the secondary brake system. Check Low Pressure Warning Device actuates at proper gauge reading.</p>		Any gauge is missing or cannot be read. Gauge is not accurate. Any gauge is not in OEM location. More than 15 psi difference in dual air brake system (dual gauges). Low Pressure Warning Device missing, inoperative, or does not operate at 55 psi and below, or 1/2 the governor cut-out pressure, whichever is less.
<p>b. Consumption Check for consumption with full brake application.</p>		Excessive consumption (per manufacturer's spec).
<p>c. Air leaks With a fully charged air system, engine off and full brake application -observe air loss.</p>		Air loss of 3 psi or more (per air system test procedure).

	Section A. Road Test Inspection	
Inspection Procedure:	Repair If:	Out of Service If:
<p>10. Service Brake a. Operation</p> <p>Check for proper operation and adjustment of service brake as follows: Pedal free travel, adequate pedal height and reserve, ABS booster operations (Hydraulic) and brake action/operation (hydraulic and air)</p>		<p>Brake action erratic.</p> <p>No pedal free travel.</p> <p>Inadequate pedal height or reserve.</p>
<p>b. Condition</p> <p>Check air brake pedal assembly for adjustment, mounting, condition, operation, and rubber cover pad (if originally equipped).</p>	<p>Rubber cover pad is worn through or is worn smooth in any area.</p>	<p>Rubber cover pad is missing (If originally equipped).</p> <p>Any part of pedal and assembly is damaged, loose, missing, or has been modified.</p> <p>Pedal is equipped with any type of extender block.</p>
<p>c. Service Brake Hydraulic Brakes</p> <p>NOTE: Since there are four (4) distinct types of hydraulic brake systems in use on school transportation vehicles, this guide will cover each system individually. It is imperative that you know the type of system you will be inspecting to ensure that the proper inspection procedure is used. The four (4) types of systems are:</p> <p>System 1. Standard Vacuum Assisted Hydraulic Brakes</p> <p>System 2. Hydraulic Power Assisted Hydraulic Brake with Accumulator Backup</p> <p>System 3. Hydraulic Power Assisted Hydraulic Brakes with Electric Pump Backup and Driveshaft Park Brake Systems</p> <p>System 4. Hydraulic Power Assisted Hydraulic Brakes with Spring Set (hydraulically released) Parking Brakes (Ford Maxibrake)</p>		

	Section A. Road Test Inspection	
Inspection Procedure:	Repair If:	Out of Service If:
System 1. Standard Vacuum Assisted Hydraulic Brakes		
a) Inspect for Visible leaks in hydraulic brake system.		Any leaks found.
b) Check brake pedal reserve (distance from floor) upon firm brake application (engine running).		Brake pedal (reserve) is less than one (1") inch from floor.
c) Check brake pedal fade (pedal falls to floor when held down with engine running or with engine off).		Any brake pedal fade.
d) Check vacuum gauge operation and low vacuum light and buzzer (if equipped) with full vacuum below eight (8) in of mercury (hg).		Vacuum gauge (if equipped) is inoperative, inaccurate or not clearly visible. Low vacuum indicator light or buzzer inop.
e) Check for brake warning light illumination with ignition key in "Start" position. Check brake failure warning light not on during normal operation.		Brake failure warning light does not light when key is moved to start position. Brake failure warning light comes on (or stays on) during normal operation (with / without brakes applied).
f) Check for vacuum drop when brakes not applied.		Vacuum reserve drops (with engines off).
g) Check vacuum assist (booster) operation. With engine off apply brakes several times. Depress and hold brake pedal while starting engine. Pedal should "fall away" slightly, indicating increased pressure applied by assist unit.		Vacuum assist system malfunctions (pedal does not "fall away" slightly when engine is started).
h) Brake Reserve Turn engine off and apply brakes. There should be enough reserve in the vacuum system to allow at least one (1) power- assisted brake application.		Vacuum reserve is insufficient to allow at least one (1) brake application.

	Section A. Road Test Inspection	
Inspection Procedure:	Repair If:	Out of Service If:
<p>System 1. Standard Vacuum Assisted Hydraulic Brakes</p> <p>i) Check all brake hardware components inside bus for secure mounting, routing, and condition. including:</p> <p>(1) Pushrod and clevis assembly.</p>		Brake pedal assembly, pushrod, and clevis, or emergency brake control assembly is not securely mounted, has loose, missing or worn hardware or is damaged.
(2) Brake pedal assembly and rubber cover.	Rubber cover is worn through or worn smooth in any area.	Rubber cover is missing (if originally equipped) or worn through or worn smooth in any area or any type of "extender block".
(3) Emergency brake control assembly.	Park brake doesn't hold or functions improperly.	Emergency brake control is hard to operate or doesn't latch and release properly.
<p>j) Parking Brake Operation:</p> <p>With vehicle stopped (engine running), apply park brake. When engine torque is applied or by placing transmission selector in gear (automatic transmission) and accelerating the engine to a fast idle (approximately 1,200 RPM), vehicle should not move forward.</p>		<p>Parking brake doesn't hold or functions improperly.</p> <p>Adjustment is needed (lever type with adjustment knob). Repair prior to leaving vehicle.</p>

	Section A. Road Test Inspection	
Inspection Procedure:	Repair If:	Out of Service If:
<p>System 2. Hydraulic Power Assisted Hydraulic Brakes with Accumulator Backup</p> <p>a) Inspect for any visible leaks in brake or hydraulic assist system.</p>		Any brake or hydraulic assist fluid leaks are found.
b) Check brake pedal reserve upon one (1) firm brake application (engine off, accumulator depleted).		Brake pedal does not have at least 1-½inch reserve (distance from floor).
c) Check brake pedal fade (test minimum 1 ½ minutes, engine off). Firmly apply brake pedal and hold.		Pedal falls to floor (fades) when held down (engine off) indicating brake system leak.
d) Check brake warning light illumination with ignition key in "Start" position. Check brake failure warning light is not on during normal operation (with / without brakes held).		Brake failure warning light does not light when key is moved to the start position or stays on during normal operation.
e) Power assist check: With engine off apply foot brake several times, then hold down. Start engine; the pedal should fall, then push back against your foot. Listen for engine drive belt. Release brake pedal. Turn engine off. Depress brake pedal. Accumulator should hold enough pressure to allow two (2) assisted brake applications.		Power assist unit is malfunctioning (pedal doesn't fall or push back). Engine drive belt is squealing.

	Section A. Road Test Inspection	
Inspection Procedure:	Repair If:	Out of Service If:
System 2. Hydraulic Power Assisted Hydraulic Brakes with Accumulator Backup		
<p>f) Check all brake hardware components inside bus for secure mounting, routing, and condition, including:</p> <p>Pushrod and clevis assembly</p> <p>Brake pedal assembly and rubber cover pad (if originally equipped)</p> <p>Emergency brake control assembly</p>		<p>Brake pedal assembly, pushrod, and clevis, or emergency brake control assembly is insecurely mounted, has loose, missing, or worn hardware, or is damaged.</p> <p>Rubber pedal cover pad is missing (if originally equipped) or worn out.</p> <p>Pedal is equipped with any type of "extender block".</p> <p>Emergency brake control is hard to operate or doesn't latch and release properly.</p>
<p>g) Parking Brake Operation:</p> <p>With vehicle stopped: (engine running), apply parking brake. When engine torque is applied by partially engaging clutch in second gear and reverse (manual transmission) or by placing transmission selector in "Drive" and "Reverse" (automatic transmission) and accelerating the engine to a fast idle (approximately 1,200 RPM), vehicle should not move.</p>		<p>Park brake doesn't hold or functions improperly.</p>

	Section A. Road Test Inspection	
Inspection Procedure:	Repair If:	Out of Service If:
System 3. Hydraulic Power Assisted Hydraulic Brakes with electric pump backup and driveshaft park brake system		
a) Inspect for any visible leaks in the brake or hydraulic assist system.		Any leaks are found in the brake or hydraulic assist system.
b) Check brake warning and backup systems using the appropriate chassis manufacturer's procedure In Chart.		The brake system does not pass entire test in appropriate chart.
c) Check brake pedal reserve (distance from floor) upon one (1) firm brake application (engine off, hydraulic boost depleted).		Brake pedal (reserve) is less than one (1) inch from floor.
d) Check brake pedal fade (continues to fall to floor after initial firm application) with engine off.	Rubber cover pad is worn through or worn smooth in any area.	There is any brake pedal fade (falling away) after initial firm application.
e) Check all brake hardware components inside bus for secure mounting, routing, and condition, including: Pushrod and clevis assembly Brake pedal assembly and rubber cover (if originally equipped) Emergency brake control assembly		Brake pedal assembly, pushrod, and clevis, or emergency brake control assembly is insecurely mounted, has loose, missing, or worn hardware, or is damaged. Rubber pedal cover pad is missing (if originally equipped) or worn out. Pedal is equipped with any type of "extender block". Emergency brake control is hard to operate or doesn't latch and release properly.

	Section A. Road Test Inspection	
Inspection Procedure:	Repair If:	Out of Service If:
System 3. Hydraulic Power Assisted Hydraulic Brakes with electric pump backup and driveshaft park brake system		
f) Check Parking Brake: With vehicle stopped (engine running), apply park brake. When engine torque is applied by partially engaging clutch in second gear and reverse (manual transmission) or by placing transmission selector in "Drive" and "Reverse" (automatic transmission) and accelerating the engine to a fast idle (approximately 1,200 R.P.M.), vehicle should not move.		Emergency brake control is hard to operate or doesn't latch and release properly. Adjustment is needed, (lever type with adjustment knob), do so now. Parking brake doesn't hold or functions improperly.
System 4. Hydraulic Power Assisted Hydraulic Brakes with Spring Set (Hydraulically released). Parking Brakes (Ford Maxi brake)		
a) Inspect for any visible leaks in the brake or power assist system.		Any leaks found in either system.
b) Check brake warning and backup system using Chart 3.		The brake systems do not pass all test in Chart 3.
c) Check brake pedal travel Push brake pedal down as far as possible.		Brake pedal travels more than half way down.
d) Check for brake pedal fade Pedal fall away to floor when held down (with engine running and with engine off), indicating brake system leaks.		Any brake pedal fade

	Section A. Road Test Inspection	
Inspection Procedure:	Repair If:	Out of Service If:
System 4. Hydraulic Power Assisted Hydraulic Brakes with Spring Set (Hydraulically released). Parking Brakes (Ford Maxi brake)		
<p>e) Check Parking Brake System</p> <p>With engine running, release parking brake. Check to ensure brakes are released (bus will move). Turn engine off. System must hold pressure for at least five (5) minutes. With vehicle stopped and engine running), apply park brake. When engine torque is applied by partially engaging clutch in second gear and reverse (manual transmission) or by placing transmission selector in "Drive" and "Reverse" (automatic transmission) and accelerating the engine to a fast idle (approximately 1,200 R.P.M.), vehicle should not move.</p>		<p>Parking brake system will not hold pressure (i.e., with released brakes) for at least five (5) minutes.</p> <p>Vehicle will move with parking brakes applied.</p>
<p>f) brake hardware and components</p> <p>Check all brake hardware and components inside the bus for secure mounting, routing, and condition, including:</p> <p>Brake pedal assembly and rubber cover pad (if originally equipped)</p> <p>Brake pedal pushrod and clevis assembly</p> <p>Emergency brake control assembly</p>	<p>Brake pedal rubber cover pad is loose or worn through or worn smooth in any area.</p>	<p>Rubber pedal cover pad is missing (if originally equipped) or worn out. Pedal is equipped with any "extender block".</p> <p>Brake pedal assembly, pushrod, and clevis, or emergency brake control assembly is insecurely mounted, has loose, missing, or worn hardware, or is damaged.</p>

	Section A. Road Test Inspection	
Inspection Procedure:	Repair If:	Out of Service If:

Chart A-3. FORD Warning Lights / Buzzer

FORD			
Normal Operation			
MODE	Indicator		
	Brake Lamp	Brake Elec. Mtr. Lamp	Buzzer
1a. Engine Off / Ignition Off no brake applied	Off	Off	Off
1b. Engine Off / Ignition Off brake applied	Off	On	On
2. Engine Off / Ignition On or START with or without brake applied	On	On	On
3. Engine ON with or without brake applied	Off	Off	Off
GMC			
1. Engine OFF - Ignition OFF a) No brake applied b) Brake applied	Off On	Off Off	Off Off
2. Engine OFF - Ignition ON with or without brake applied.	On	On	On
3. Engine OFF - Ignition on START with or without brake applied.	On	Off	On
4. Engine ON with or without brake applied.	Off	Off	Off

	Section A. Road Test Inspection	
Inspection Procedure:	Repair If:	Out of Service If:

Chart A-4. NAVISTAR Brake Failure Warning System Checks

Navistar	
CONDITION	NORMAL OPERATION
PARKING BRAKE LIGHT	
Key switch in START position with parking brake released (bulb check)	Light ON
Key switch ON with parking brake applied.	Light ON
BRAKE PRESSURE LIGHT	
Key switch OFF	Light OFF, Electric hydraulic pump operates when service brakes are applied.
Key switch in ON position and engine not operating (pump and bulb check).	Light ON, And electric hydraulic pump operations (some vehicles). SEE NAVISTAR MANUAL.
	Light ON, Electric hydraulic pump operates when service brakes are applied.
Key switch in ON position and engine operating with service brakes applied.	Light OFF
Key switch in START position.	Light ON Momentarily and electric hydraulic pump operates.
Key switch in ON position and engine operating with service brakes applied.	Light OFF

	Section A. Road Test Inspection	
Inspection Procedure:	Repair If:	Out of Service If:

Chart A-5. Ford Normal Brake System Conditions

Ford																					
Controls											Indicators										
Engine		Ignition			Service Brake		Parking Brake				Service Brake		Electric* Pump				Parking Brake				
							Off		On				Light		Buzzer		Light		Buzzer**		
Off	On	Off	On	Start	Off	On	Part Rel	Full Rel	Part Set	Full Set	Off	On	Off	On	Off	On	Off	On	Off	On	
X		X			X			X	OR	X	X		X		X		X		X		
X		X				X		X	OR	X				X		X	X		X		
X				X	X or X					X		X				X		X		X	
	X		X		X or X					X	X		X		X			X	X		
	X		X		X or X		X			X	X		X		X			X	X		
	X		X		X or X			X			X		X		X			X		X	
	X		X		X or X				X		X		X		X					X	

* Whenever ignition switch is in START position, Hydro-Max electric pump will cycle momentarily.

**Parking brake buzzer will sound momentarily during application of parking brake in cold ambient conditions.

	Section A. Road Test Inspection	
Inspection Procedure:	Repair If:	Out of Service If:

11. Parking Brake, Air		
a. Park Brake Check for proper operation and adjustment of park brake as follows: With vehicle stopped, apply park brake. When engine torque is applied by placing transmission selector in "Drive" and "Reverse" (automatic transmission) and accelerating the engine to a fast idle (approximately 1000-1200 RPM), vehicle should not move.	Vehicle moves after speeding up the engine (transmission in gear) with parking brake applied.	Vehicle moves after speeding up the engine (transmission in gear) with parking brake applied. No brakes on the vehicle are applied upon actuation of the parking brake control, including driveline hand controlled parking brakes.
b. Parking Brake Lever/Knob	Pin or knob loose.	Missing knob or lever. Knob is broken or cracked.
c. PP-1 (pop-off style) Check emergency brake control valve. Check condition, location, mounting, and type of valve and knob. With pressure above 45 psi, apply and release valve to check operation.	Label identifying valve is missing or unreadable.	Valve not mounted securely (In original position). Not OEM type. Inoperative. Leaks.
d. PP-1 park brake control valve		Park brake pop-off valve fails to "pop out" between 20 to 40 psi
e. Brake Valves Inspect all brake system valves for securement and condition.	Mounting loose.	Any audible air leak from any brake valve. Any brake valve is cracked, damaged, or not mounted securely. Any valve exhaust port is obstructed.

	Section A. Road Test Inspection	
Inspection Procedure:	Repair If:	Out of Service If:
11. Parking Brake, Air		
<p>e. Low Air Warning:</p> <p>Check operation of low air warning buzzer and light. With ignition key switch in run position (engine off), pump air brake pedal to drop air pressure.</p> <p>Low air warning buzzer and light should activate at approximately 60 psi.</p>		Light or buzzer is inoperative. Light or buzzer fails to operate by 60 psi.
12. Registration, Insurance Card		
a. Registration		
<p>Check for a valid registration certificate in the vehicle.</p>	Registration certificate is not on bus, is invalid, not legible.	Registration certificate is not on bus, is invalid, not legible.
b. Insurance Card		
<p>Check for a valid insurance card in a mounted transparent holder.</p>	Insurance Card is not on bus, is invalid, not legible.	Insurance Card is not on bus, is invalid, not legible.
c. STU-25		
<p>Check for previous annual inspection form.</p>	Previous annual inspection form is not on bus or not legible.	Previous annual inspection form is not on bus or not legible.

	Section A. Road Test Inspection	
Inspection Procedure:	Repair If:	Out of Service If:
13. Pre-Inspection Road Test Record any abnormalities with following equipment during road test:		
a. Ignition / Starting Check for starting, proper idle, stalling.	Rough or low idle.	Engine will not start or is difficult to start. Engine stalls. Starter drags, noisy or does not engage properly.
b. Engine operation Check for missing or hesitation, performance when accelerating and excessive smoke. Check engine for any unusual noises, knocks, or rattles.	Engine smoking abnormally. Noise source determined not to be harmful to engine.	Engine is misfiring, skipping, or there is excessive hesitation upon acceleration. Source of noise could result in engine failure.
c. Note oil pressure indication.		Oil pressure not normal Oil pressure malfunction light illuminated.
d. Check governor performance and shutdown of engine.		Engine will not shut down. Governor does not limit engine rpm.
e. Clutch		Any unusual noise or vibration is observed.
f. Transmission		Any unusual noise or vibration is observed.

	Section A. Road Test Inspection	
Inspection Procedure:	Repair If:	Out of Service If:
13. Pre-Inspection Road Test		
Record any abnormalities with any of following equipment during road test:		
g. Steering		Any unusual noise or vibration is observed.
h. Brakes		Any unusual noise or vibration is observed.
i. Defroster(s)		
Inspect windshield defroster system for: 1) Airflow, heat, and coverage area.	Airflow is insufficient to keep windshield clear	Airflow is not present at any defroster outlet.
2) Blower operation, condition, and control switches.	Any defroster blower does not work on low speed, is noisy, or vibrates. Blower switches are damaged or loose.	Any defroster blower does not work on high speed.
3) Condition of ductwork, diffusers, and fresh air control (if equipped).	Any ductwork or diffusers are loose or damaged. Fresh air control (if equipped) does not function.	Any diffuser missing or blocked.
4) Condition of ductwork and heater box.	Heater ductwork or heater box components are missing, damaged, loose, or obstructed.	Any portion of heating system within passenger area creates sharp edges, projections, or other hazards to passengers or driver.

	Section A. Road Test Inspection	
Inspection Procedure:	Repair If:	Out of Service If:
13. Pre-Inspection Road Test		
Record any abnormalities with any of following equipment during road test:		
j. Heaters		
1) Inspect heater system for heating performance, water control valve operation (interior).	Not producing adequate heat. Water control valve hard to operate.	Vehicle does not produce any heat. Control valve stuck closed.
2) Blower operation, condition, and control switches.	Heater blowers do not work on any speeds, are noisy, or vibrate. Blower switches are damaged, loose, or blower operates intermittently	
3) System + hose leakage, condition, and hose shielding (shielding required for exposed hoses on interior of all buses).		Heater cores, hoses, or valves have visible leakage. Heater hoses are cracked, swollen or badly chafed. Shielding is missing or does not completely cover hoses.
4) Condition of ductwork and heater box.	Heater ductwork or heater box components are missing, damaged, loose, or obstructed	Any portion of heating system within passenger area creates sharp edges, projections, or other hazards to passengers or driver
k. Driver Auxiliary Fan(s)	Fan is not present. Fan mounting is loose or fan won't stay in adjustment	Fan not OEM approved. (i.e. plastic blade).
Inspect auxiliary fan(s) for:		
1) Presence of fan, mounting and condition.		
2) Blade condition.	Fan blade is damaged.	
3) Protective cage mounting and condition.	Protective cage is loose or damaged	Protective cage is missing.
4) Operation and switch.	Fan does not operate, one (1) speed does not function, or fan is noisy or vibrates. Switch is loose or damaged.	
l. Gauges and Instrumentation		Any unusual indication.

End of Section



COLORADO
Department of Education
School Finance and
Operations Division

CDE Vehicle Inspection

Procedures, Repair Criteria, & Out of Service Criteria

Section B: Under Hood Inspection

	Section B: Under Hood Inspection	
Inspection Procedure:	Repair If:	Out of Service If:

Section B. Under Hood Inspection

NOTE: This Manual is laid out to logically coincide with the inspection of front engine vehicles. Rear engine vehicles may have to be inspected in a different sequence; all componentry and procedures apply.

1. Cable Operation: E-brake, choke, throttle, kill cable, accelerator linkage and return spring		
a. Cables Check all cables for operation, tension, and condition. Check that cables move freely. 1) E-brake 2) Choke 3) Throttle 4) Return spring 5) Ether start cable/starting system	Improper tension. Improper routing. Cable does not freely move or operate normally.	Any cable is frayed, cracked, damaged or missing. Control knob or entire manual choke assembly is missing. Cable is disconnected or broken. Choke doesn't operate.
b. Accelerator 1) Check accelerator pedal, control design, and pedal assembly are OEM.	Pedal cover (as originally equipped) is worn through or smooth in any area.	Pedal and assembly not mounted securely. Pedal, control design, and mounting not OEM.
2) Inspect pedal assembly and linkage for loose or missing hardware.	Pivot pin does not move freely or is excessively worn.	Loose or missing hardware.
3) Check for smooth operation of pedal assembly and linkage in the accelerating and coast position.		Accelerator control and linkage sticks or doesn't operate freely.
4) Inspect for unauthorized pedal modifications.		Pedal built up with extender or block(s), or not of OEM design.
c. Engine Shutdown 1) Only OEM approved ignition controlled shutdown acceptable.		Not OEM or OEM-approved.
2) Check for free operation of shutdown over full range with minimum effort.	Cable is sticking or hard to operate. Instruction decal/label damaged or missing.	Engine can be started in shut down position, or it does not stop engine.

	Section B: Under Hood Inspection	
Inspection Procedure:	Repair If:	Out of Service If:
<p>2. Brake, fuel, cooling and lubricant lines, fittings and electrical wiring</p> <p>Check routing, securement, and condition (signs of chafing, kinking, deterioration) of all wiring and any electrical cable. Check hoses and lines for leaks in system.</p> <p>Note: Wiring must be in OEM condition. Wire must be replaced with proper size, type, and color. Routing should be OEM, properly secured, and in harness or loom where applicable.</p>		
<p>a. Brake lines</p> <p>Visually check condition, operation, routing and securement of all brake lines, electrical wiring and components.</p>	<p>Improper tension.</p> <p>There is any loose, damaged, or corroded wiring connector or terminal end.</p> <p>Air brake lines and fittings are not DOT approved.</p>	<p>Any cable is frayed, cracked, damaged or missing.</p> <p>Hose with any damage extending through the outer reinforcement ply.</p> <p>Any component is loose or missing.</p> <p>Any brake line or hose is leaking, cracked, broken or crimped.</p> <p>Any unsecured or poorly routed wiring that could cause potential short or fire due to abrasion or heat damage.</p> <p>Any burnt wiring or wiring with missing insulation (other than ground straps).</p> <p>Any repair has been made using improper gauge wiring or method.</p> <p>Any fitting not meeting DOT requirements.</p>

	Section B: Under Hood Inspection	
Inspection Procedure:	Repair If:	Out of Service If:
<p>2. Brake, fuel, cooling and lubricant lines, fitting and electrical wiring</p> <p>b. Fuel System and Lines</p> <p>Visually check condition, operation, and securement of all fuel system components, including pumps, fuel lines and routing, and accelerator return springs.</p>	<p>Evidence of contamination in the fuel water separator (if equipped).</p>	<p>Any unsecured, or poorly routed, or loose fuel line or hose that could cause potential fire due to abrasion or heat damage.</p> <p>Any fuel system connection or component is stripped, loose, cracked, or leaking.</p> <p>Any fuel system component is damaged or not mounted securely.</p> <p>Any evidence of fuel leaking internally and contaminating oil or coolant (pump, tubes, etc.).</p> <p>Any electric or mechanical shutdown that does not operate properly.</p> <p>Any accelerator return spring is weak, broken, or missing.</p>
<p>c. Cooling</p> <p>Visually check condition, operation, routing and securement of all cooling electrical wiring and components.</p>	<p>Improper tension.</p> <p>There is any loose, damaged, or corroded wiring connector or terminal end.</p>	<p>Any cable/wire is frayed, cracked, damaged or missing.</p> <p>Any component is loose or missing.</p>
<p>d. Lubricant</p> <p>Visually check condition, operation, routing and securement of all lubricant electrical wiring and components.</p>	<p>Improper tension.</p> <p>There is any loose, damaged, or corroded wiring connector or terminal end.</p>	<p>Any cable/wire is frayed, cracked, damaged or missing.</p> <p>Any component is loose or missing.</p>

	Section B: Under Hood Inspection	
Inspection Procedure:	Repair If:	Out of Service If:
3. Exhaust System Components Check routing, securement, and condition (signs of chafing, kinking, deterioration) of all Exhaust System electrical wiring, and inspect all mounting and shields.		
a. Exhaust electrical wiring	Any loose, damaged, or corroded wiring connector or terminal end.	Any cable/wire is frayed, cracked, damaged or missing. Any component missing.
b. Exhaust mounting and shields The tailpipe shall be flush with but not extend more than one inch beyond the perimeter of the body for side exit or the bumper for rear exit.	Any component loose, missing hardware, or damaged.	Any component missing. Any exhaust leakage.
c. Turbo Inspect turbo and plumbing for leaks, mounting, connections, and condition.	Evidence of oil seepage. Heat shield is damaged or missing.	Any leak is observed on air, exhaust, or oil. Any mounting or connection is loose. Any unusual noise or vibration is observed.
d. DPF System Inspect DPF system for mounting, connections and condition.	Any component loose, missing hardware, damaged, corroded wiring connector or terminal end.	Any leaks in the system. Any mounting is loose.

	Section B: Under Hood Inspection	
Inspection Procedure:	Repair If:	Out of Service If:
<p>4. Air Compressor, Filter, Filter Element Check routing, securement, and condition (signs of chafing, kinking, and deterioration) of all air compressor, air filter components, electrical wiring, mounting.</p> <p>a. Air Compressor and Filter</p> <p>Check securement and condition of air compressor and filter assembly.</p>	<p>Air compressor air filter (if equipped) is dirty.</p>	<p>Any loose, leaking or damaged hose or plumbing between engine air filtration system and compressor (on vehicles that share filter).</p> <p>Any portion of air compressor, compressor air filter, filter/compressor mounting bracketry, filter cover fastener is cracked, loose, or missing.</p> <p>Any oil or coolant leaks from compressor or plumbing.</p> <p>Any problem with piggy-backed power steering pumps either mounting or leaks.</p>
<p>b. Air filter</p> <p>Check securement and condition of air compressor and filter assembly.</p>	<p>Air filter is dirty.</p>	<p>Air filter housing, mounting or component is damaged.</p>
<p>c. Components - Air Cleaner</p> <p>1) Check air cleaner assembly (housing, lid, piping, gasket(s), seal, clamps, and hoses for securement, condition, and filter restriction. Check for presence of wing nut and seal (if equipped}).</p> <p>Note: Do not disturb large two-stage air filters to check condition of element. If loosened or removed it must be replaced.</p>		<p>Air filter restriction exceeds manufacturer's specifications.</p> <p>Any portion of air cleaner assembly or mounting is loose or damaged, including piping, nuts, bolts or clamps.</p> <p>There are any worn or damaged seals or gaskets.</p> <p>There are any air or vacuum leaks or missing components.</p>
<p>2) Air Restriction Gauge (diesel engines)</p> <p>Check for presence and condition.</p>		<p>Any gauge found missing or damaged.</p>

Section B: Under Hood Inspection		
Inspection Procedure:	Repair If:	Out of Service If:
<p>4. Air Compressor, Filter, Filter Element 3) Charge Air Cooler:</p> <p>Check charge air cooler assembly, mounting, and plumbing for securement and condition (if equipped).</p>	<p>Any portion of the cooler mounting system is cracked, damaged, or has loose or missing fasteners.</p>	<p>Any portion of the cooler is cracked or leaking. Any plumbing connections are loose, damaged, or missing.</p>
<p>5. Windshield washer fluid reservoir a. Fluid Reservoir Condition</p> <p>Check routing, securement, and condition (signs of chafing, kinking, and deterioration) of all windshield washer components, electrical wiring, mounting.</p>	<p>Any component cracked, damaged, or has loose or missing fasteners.</p> <p>There is any loose, damaged, or corroded wiring connector or terminal end.</p>	<p>Any component cracked, loose or leaking.</p> <p>Any plumbing connections loose, damaged, or missing.</p> <p>Any cable/wire is frayed, cracked, damaged or missing</p>
<p>b. Windshield Washer System</p> <p>Check windshield washer components, electrical wiring, mounting.</p>	<p>Any component cracked, damaged, or has loose or missing fasteners.</p> <p>There is any loose, damaged, or corroded wiring connector or terminal end.</p>	<p>Any component cracked, loose or leaking.</p> <p>Any plumbing connections loose, damaged, or missing.</p> <p>Any cable/wire is frayed, cracked, damaged, or missing.</p>
<p>6. Radiator Mounting, Core, Cap, Water Pump, Fan, Clamps, Hoses and Shutters Check routing, securement, and condition (chafing, kinking, and deterioration) of all radiator components, belts, hoses, electrical wiring, mounting.</p> <p>Record coolant freeze point _____ (minimum -30° F).</p>	<p>If freeze point is above -30° F.</p>	<p>Any component damaged, cracked, loose, leaking, or inoperative.</p>

	Section B: Under Hood Inspection		
Inspection Procedure:	Repair If:	Out of Service If:	
<p>6. Radiator Mounting, Core, Cap, Water Pump, Fan, Clamps, Hoses and Shutters</p> <p>a. Radiator Mounting</p> <p>Check radiator assembly and mounting for securement and condition.</p>	<p>Any portion of radiator mounting system is cracked, damaged, or has loose or missing fasteners.</p>	<p>Any portion of radiator is cracked or leaking.</p>	
<p>b. Radiator Core</p> <p>Check radiator core for securement and condition.</p>		<p>Core is damaged, cracked or leaking.</p>	
<p>c. Radiator Cap</p> <p>Check condition of radiator cap.</p> <p>WARNING: ALWAYS USE PROPER ROCEDURES WHEN REMOVING RADIATOR CAP.</p>	<p>Radiator cap is hard to open or close.</p> <p>Radiator cap is of the wrong pressure rating.</p> <p>Any visible damage to the pressure seat or vacuum relief seat of the cap.</p>	<p>Radiator cap is missing or does not function properly.</p>	
<p>d. Reservoir (pressurized)</p> <p>Check coolant reservoir (including deaerating tank) and sight glass (if equipped) for mounting and condition.</p>	<p>Sight glass (if OEM equipped) has been replaced with plug.</p> <p>Sight glass is damaged or clouded.</p>	<p>Any portion of coolant reservoir or mounting system is missing, cracked or damaged, is leaking, or has loose or missing fasteners.</p>	
<p>e. Coolant Recovery Tank (non-pressurized)</p> <p>Check condition, securement and operation.</p>	<p>Any problem with tank, connections or missing parts.</p>		

	Section B: Under Hood Inspection	
Inspection Procedure:	Repair If:	Out of Service If:
<p>6. Radiator Mounting, Core, Cap, Water Pump, Fan, Clamps, Hoses and Shutters</p> <p>f. Water Pump</p> <p>Check condition of water pump and pulley.</p>	<p>There is evidence of coolant seepage from water pump, seal, gasket surface, or weep hole.</p> <p>Water pump fasteners are loose, damaged, or missing.</p>	<p>Water pump is noisy, bearing is damaged, or coolant is dripping out.</p>
<p>g. Fan</p> <p>Check fan blade and fan clutch/drive assembly for securement and condition.</p>	<p>Hydraulic drive type fan always remains in the "on position".</p>	<p>Fan has any cracked, bent, or broken blades.</p> <p>Any portion of fan mounting is loose.</p> <p>Fan clutch is seized or loose.</p> <p>Any leak, mounting, rotation or function problem with hydraulic motor. Electric fan does not operate.</p> <p>Hydraulic solenoid valve inoperative.</p> <p>Wiring for fan (electric) or solenoid (hydraulic) is not secured, loose, damaged, or missing.</p>
<p>h. Fan Shroud</p> <p>Check fan shroud for mounting and condition.</p>	<p>Any portion of fan shroud or shroud mounting is cracked, damaged, or has loose, or missing fasteners.</p>	<p>Fan shroud is missing.</p>
<p>i. Heater Booster Pump</p> <p>Check for operation and condition of heater booster pump and plumbing {if equipped}.</p>	<p>Booster pump is inoperative</p>	<p>Booster pump is leaking.</p> <p>Booster pump mounting is loose or has missing fasteners.</p>

	Section B: Under Hood Inspection		
Inspection Procedure:	Repair If:	Out of Service If:	
<p>6. Radiator Mounting, Core, Cap, Water Pump, Fan, Clamps, Hoses and Shutters</p> <p>j. Hoses NOTE: Includes all engine compartment hose types, including power steering, coolant, air compressor intake, vacuum, brake hydraulic assist, engine oil, and transmission hoses.</p>			
<p>1) Clamp(s) and Connections: Visually and physically check that hose connections or clamp(s) are tight.</p>	<p>Any hose connection or clamp(s) is loose or is too tight digging into hose.</p> <p>Any silicone hose does not have a constant torque type clamp on it.</p>	<p>Any hose connection or clamp(s) is stripped or damaged.</p>	
<p>2) Condition: Visually inspect all hoses for cuts, abrasions and wear, oil saturation, dry rotting, or "ballooning."</p>	<p>Any silicone hose has been exposed to diesel fuel by contaminated coolant.</p>	<p>Any hose is cut, abraded, worn, oil saturated, dry-rotted, or "ballooned" to the point that failure is imminent.</p>	
<p>3) Routing: Visually inspect routing and securement of all hoses.</p>	<p>Any hose is misrouted or unsecured so that heat damage, abrasion, or cuts could cause long-term failure.</p>	<p>Any hose is misrouted or unsecured so that heat damage, abrasion, or cuts could cause imminent failure.</p>	
<p>4) Type: Confirm hose is of the proper type for the application.</p>		<p>Any hose is found to be of the improper type for the application.</p>	

	Section B: Under Hood Inspection	
Inspection Procedure:	Repair If:	Out of Service If:
<p>7. Alternator, tensioner, all drive belts and pulleys</p> <p>Check routing, securement, and condition (signs of chafing, kinking, and deterioration) of all alternator components, belts, and mounting.</p> <p>a. Alternator Check securement and condition of alternator assembly.</p>	<p>Alternator is noisy.</p> <p>Any mounting hardware missing.</p> <p>Battery wire does not have a rubber insulating boot over the connection on the back of the alternator if equipped.</p>	<p>Any portion of the alternator, mounting bracketry, or fastener is cracked, loose, or missing.</p> <p>Alternator is not charging.</p> <p>Pulley or fan is loose, bent or does not run true.</p> <p>Bearings are worn or damaged.</p>
<p>b. Belt(s)</p> <p>1) Tension. Visually and physically check all drive belts for proper tension. Note: If available, use tension gauge. If gauge is not available, use a ruler to measure deflection of the belt(s) up and down at the widest point between the drive and driven pulley(s). (See illustrations)</p>	<p>Any belt exceeds tension reading recommended by manufacturer, if a tension gauge is used.</p> <p>Using ruler method, any belt is less than ½ inch deflection (too tight) when firm pressure is applied.</p>	<p>Any belt tensioner does not pivot or move freely and apply spring pressure on belt.</p> <p>Tension on any belt is too loose (based on specifications of type tension gauge used).</p> <p>Tension on any belt (using ruler method) is too loose when firm pressure is applied (greater than ¾ inch deflection)</p>
<p>2) Condition: Visually inspect belt(s) for glazing, oil contamination, dry rotting, cuts, and separation of plies. Check belts for twisting or distortion.</p>	<p>Any belt is glazed or cracked.</p>	<p>Any belt is oil saturated, dry-rotted, or cut or plies of belt(s) are separated.</p> <p>Any belt is twisted or distorted.</p>
<p>3) Routing: Visually inspect belt(s) for rubbing or contact with objects other than pulleys and for routing around correct pulleys.</p>		<p>Any belt is making contact with objects other than the pulley(s).</p> <p>Any belt is routed around incorrect pulley(s).</p>

	Section B: Under Hood Inspection		
Inspection Procedure:	Repair If:	Out of Service If:	
<p>7. Alternator, tensioner, all drive belts and pulleys</p> <p>4) Belt Alignment: Visually inspect belts for proper alignment.</p>	<p>Any belt is not inline. (Less than 1/16 inch per foot)</p>	<p>Belt misalignment is excessive and could result in failure. (More than 1/16 inch per foot)</p>	

	Section B: Under Hood Inspection	
Inspection Procedure:	Repair If:	Out of Service If:

Chart B-1. Belt Inspection

1. Inspect all used drive belts (including those being replaced) for the following conditions. Note: For an installed belt, gently twist the belt about 90 degrees to see the sidewalls and bottom.
2. Inspect for glazing (shiny sidewalls). Glazing caused by friction created when a loose belt slips in the pulleys. It can also be caused by oil or grease on the pulleys.
3. Inspect for separating layers. Oil, grease, or belt dressings can cause the belt to fall apart in layers. If engine parts are leaking, repair the oil leaks. Do not use belt dressings on any belt.
4. Check for jagged or streaked sidewalls resulting from foreign object (sand/small gravel) in pulley, or a rough pulley wall surface
5. Check for tensile breaks (breaks in the cord body). Cut belts are usually caused by large foreign objects in the pulley or by prying or forcing the belt during installation or removal.
6. On poly-V belts check for uneven ribs. Foreign objects in pulley will erode under cord ribs, causing belt to lose gripping power.
7. Inspect for cracks. Small, irregular cracks are usually signs of an old belt.

Replace belt if any of above conditions are found. Replace both belts in a set simultaneously; matched belts must be from same manufacturer.



Glazing



Separating Layers



Streaking Sidewalls



Tensile Break



Uneven Ribs



Cracks

	Section B: Under Hood Inspection	
Inspection Procedure:	Repair If:	Out of Service If:

Chart B-2. Pulley Inspection

1. Check all pulley bearings for roughness. Replace bearings if they are rough.
2. Inspect all pulleys for foreign objects, oil, or grease in grooves. Use nonflammable cleaning solvent to remove oils. Use a wire brush to remove rust, and a file to remove burrs.
3. Inspect pulleys for wear on inner walls. Hold a small straightedge against the inside of the pulley walls or use fingernail to find grooves in the inner walls. If grooves are found, replace the pulley.
4. Check alignment of pulleys. Use thin straightedge that is longer than longest span between pulleys. Place straightedge into the V-grooves of two pulleys at a time. Straightedge should be parallel to outer edges of pulleys; if not, pulleys are misaligned. Pulley misalignment must not be more than 1/16inch per foot (1.5 mm for each 30.5 mm) of distance between pulley centers. If there is misalignment of pulleys, adjust the pulleys or brackets if their positions are adjustable. Replace bent or broken pulleys, pulley brackets, or shafts.
5. Check drive component mounting parts for loose fasteners, cracks, or damage. Tighten loose fasteners. Repair/replace cracked/damaged brackets.

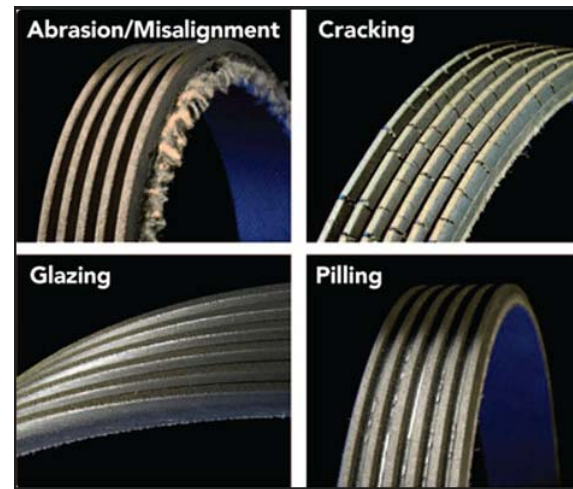
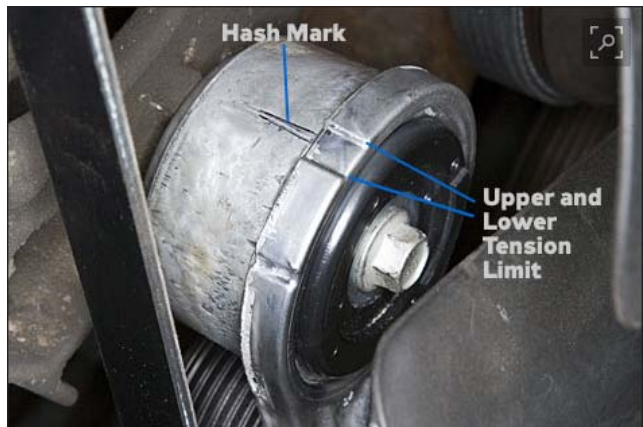

	Section B: Under Hood Inspection	
Inspection Procedure:	Repair If:	Out of Service If:

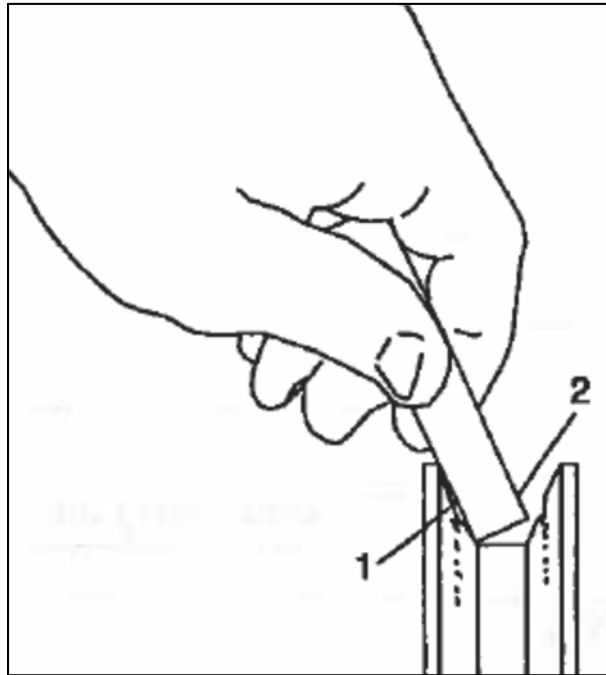

1. Groove in Pulley

2. Small Straightedge

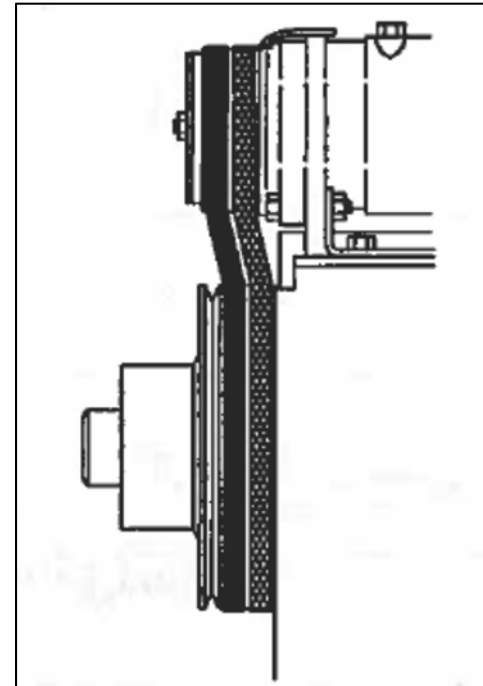

Side view of Misaligned Pulleys

	Section B: Under Hood Inspection	
Inspection Procedure:	Repair If:	Out of Service If:

Chart B-3. Checking Belt Tension

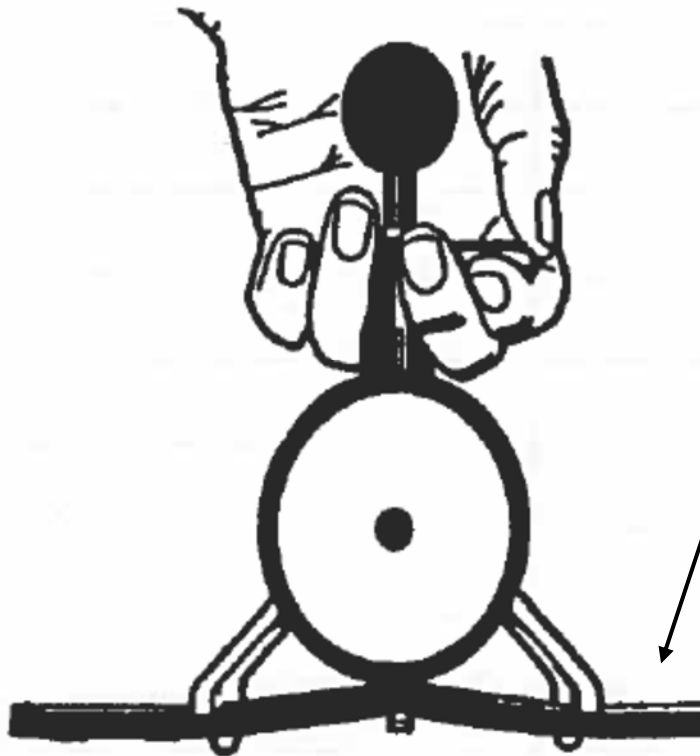

Checking Belt Tension Gauge Method

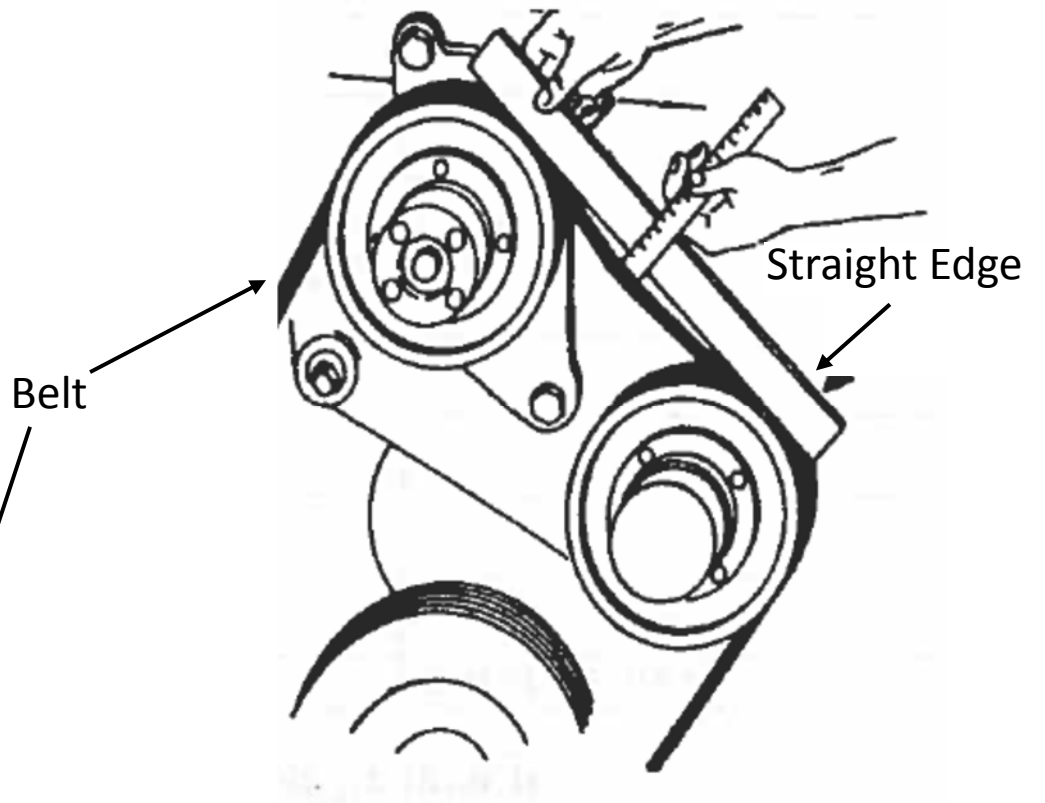

Measuring Belt Tension Rule Method

	Section B: Under Hood Inspection	
Inspection Procedure:	Repair If:	Out of Service If:

<p>8. Fluid level and conditions</p> <p>a. Brake Fluid</p> <p>Check brake fluid and brake power-assist hydraulic fluid (if equipped) for level and condition.</p>		<p>Level of brake fluid in either side of master cylinder reservoir is low or below "Add" mark (if equipped).</p> <p>Brake fluid or power-assist fluid shows evidence of contamination.</p> <p>Brake power-assist hydraulic fluid is below cold "Add" mark.</p> <p>Cap is missing or seal is damaged or missing.</p>
<p>b. Power Steering Fluid</p> <p>Check power steering fluid level and condition.</p>		<p>Power steering fluid is below cold "Add" mark.</p> <p>Power steering fluid shows evidence of contamination.</p> <p>Cap is missing or seal is damaged or missing.</p>
<p>c. Oil</p> <p>Check level and condition of oil.</p>		<p>No oil is observed on dipstick.</p> <p>There is evidence of fuel or water contamination in the oil or an overfill condition.</p> <p>Dipstick is missing.</p> <p>Oil level is at or below add mark.</p> <p>Cap is missing or seal is damaged or missing.</p>
<p>d. Transmission Fluid</p> <p>Check level and condition of transmission fluid. (Observe proper procedure when checking level)</p>	<p>Transmission fluid shows need of servicing (discoloration and/or burnt smell).</p>	<p>Transmission fluid shows evidence of excessive contamination or an overfill condition.</p> <p>Transmission fluid is not present on dipstick.</p> <p>Transmission fluid is at or below "Add" mark.</p>
<p>e. Windshield Washer Fluid</p> <p>Check windshield washer fluid level.</p>	<p>Reservoir is low or washer does not spray windshield.</p>	

	Section B: Under Hood Inspection	
Inspection Procedure:	Repair If:	Out of Service If:
<p>8. Fluid level and conditions</p> <p>f. Coolant</p> <p>Check coolant (antifreeze) level and condition.</p>	<p>Coolant level in radiator or reservoir is low but still visible in tank.</p> <p>Coolant shows evidence of rust and corrosion contamination.</p>	<p>Coolant level in radiator or reservoir is low and not visible in tank.</p> <p>Coolant shows evidence of excessive oil or fuel contamination.</p>
<p>9. Steering column, shaft, clamp bolts and universal joints</p> <p>Inspect steering column for any looseness in bolts, clamps, positioning parts or universal joints.</p>	<p>Steering shaft is in contact with any other component (hoses, wires, etc.).</p>	<p>Loose or missing U-bolts or other positioning parts.</p> <p>Any worn, faulty, or obviously repair-welded universal joints.</p> <p>Any modification or other condition that interferes with free movement of any steering component.</p>
<p>10. Power steering system and components</p> <p>Check securement and condition of power steering pump.</p>	<p>Pump has wrong type cap on reservoir (vented or not vented).</p>	<p>Any portion of power steering pump, mounting bracketry or fastener is cracked, loose, or missing.</p>
<p>Check securement and condition of power steering components.</p>		<p>Any component damaged, loose, or missing.</p> <p>Any mounting or connection is loose.</p>
<p>11. Brake master cylinder, fluid level</p> <p>Check securement and condition of brake master cylinder.</p> <p>Check fluid for level and clarity and condition.</p>		<p>Any master cylinder mounting brackets or fasteners is cracked, loose, or missing.</p> <p>Fluid level is below 25% or add mark.</p> <p>Low fluid warning light on and/or inoperative.</p> <p>Fluid lines or connections leaking, restricted, crimped, cracked or broken</p>

End of Section



COLORADO
Department of Education
School Finance and
Operations Division

CDE Vehicle Inspection

Procedures, Repair Criteria, & Out of Service Criteria

Section C: Interior Inspection

	Section C: Interior Inspection	
Inspection Procedure:	Repair If:	Out of Service If:

Section C. Interior Inspection

NOTE: This Manual is laid out to logically coincide with the inspection of front engine vehicles. Rear engine vehicles may have to be inspected in a different sequence; all componentry and procedures apply.

1. Heaters, Defrosters, Interior Lighting, Electrical Accessories Check all components for specification, condition, and operation.		
a. Heaters Inspect heater system for: 1) Heating performance and water control valve (interior).	Not producing adequate heat. Water control valve hard to operate.	Water control valve inoperative when closed. Water control valve leaks
2) Blower operation, condition, and control switches.	Heater blowers do not work on any speeds, are noisy, or vibrate. Blower switches are damaged, loose, or blower operates intermittently.	
3) Inspect for hose leakage, condition, and hose shielding.	Shielding is missing or does not completely cover hoses.	Heater cores, hoses, or valves have visible leakage. Heater hoses are cracked, swollen or badly chafed.
4) Condition of ductwork and heater box.	Heater ductwork or heater box components are missing, damaged, loose, or obstructed.	Any portion of heating system within passenger area creates sharp edges, projections, or other hazards to passengers or driver
b. Defrosters Inspect windshield defroster system for: 1) Airflow, heat, and coverage area.		Airflow is not present at all defroster outlets.
2) Blower operation, condition, and control switches.	Any defroster blower does not work on low speed, is noisy, or vibrates. Blower switches are damaged or loose.	Any defroster blower does not work on high speed.

	Section C: Interior Inspection	
Inspection Procedure:	Repair If:	Out of Service If:
<p>1. Heaters, Defrosters, Interior Lighting, Electrical Accessories</p> <p>b. Defrosters</p> <p>3) Condition of ductwork, diffusers, and fresh air control (if equipped).</p>	<p>Any ductwork or diffusers are loose or damaged.</p> <p>Fresh air control (if equipped) does not function.</p>	<p>Any diffuser missing or blocked.</p>
<p>4) Condition of ductwork and heater box.</p>	<p>Heater ductwork or heater box components are missing, damaged, loose, or obstructed.</p>	<p>Any portion of heating system within passenger area creates sharp edges, projections, or other hazards to passengers or driver.</p>
<p>c. Driver Auxiliary Fan(s)</p> <p>Inspect auxiliary fan(s) for:</p> <p>1) Presence of fan, mounting and condition.</p>	<p>Fan is not present. Fan mounting is loose, or fan won't stay in adjustment</p>	<p>Fan not OEM or CDE approved. (i.e. plastic blade).</p>
<p>2) Blade condition.</p>	<p>Fan blade is damaged.</p>	
<p>3) Protective cage mounting and condition.</p>	<p>Protective cage is loose or damaged</p>	<p>Protective cage is missing.</p>
<p>4) Operation and switch.</p>	<p>Fan does not operate, one (1) speed does not function, or fan is noisy or vibrates. Switch is loose or damaged.</p>	
<p>d. Dome and Stepwell Lights</p> <p>Check dome and stepwell lights for condition and operation.</p>	<p>Any lens is cracked, broken, or dirty.</p> <p>Any dome light is out.</p> <p>Stepwell light is on when door is closed.</p> <p>Switch mounting is loose, or knob is missing.</p>	<p>Loose lens or fixture.</p> <p>Lens broken so that light or fixture is exposed.</p> <p>Dome lights do not function.</p> <p>Stepwell light is not functioning.</p> <p>Stepwell light does not activate as designed.</p>

	Section C: Interior Inspection	
Inspection Procedure:	Repair If:	Out of Service If:
<p>2. Windshield, Side & Rear Windows a. Glass Cracks Inspect windshield and all windows for cracks and other damage.</p>		<p>Any cracks in windshield in driver's direct field of vision (area swept by wiper) greater than six (6) inches in length or any star cracks greater than two (2) inches in diameter.</p> <p>Any crack in the windshield or any window, greater than twelve (12) inches in length.</p> <p>Any laminated windshield or laminated window glass missing, broken or splintered which might cause injury when touched.</p> <p>Any window to the side or behind driver's location which is not laminated or tempered safety glass.</p> <p>Any crack in non-laminated safety glass.</p>
<p>b. Visibility/Fogging 1) Check windshield and windows for fogging, reduced visibility, or improper level of tinting.</p>	<p>Glass fogging around edges, but less than two (2) inches.</p>	<p>Windshield or any window is fogged more than two (2) inches in from outer border.</p> <p>Any windshield or window fogging or clouding which results in reduced visibility of a mirror.</p> <p>Any reduced visibility through windshield or any windows.</p>
<p>2) Check windshield and windows for objects or signs obstructing driver's vision.</p>	<p>Tinting exists on windshield or windows to the side of driver which is not 70% light transmission or clearer.</p> <p>Tinting exists on any windows behind driver's location which is not at least 28% light transmission or clearer.</p>	<p>Any object obstructing or interfering with driver's vision to the front, sides, or rear.</p>

Section C: Interior Inspection		
Inspection Procedure:	Repair If:	Out of Service If:
<p>2. Windshield, Side & Rear Windows c. Latches and Window Operation</p> <p>Check latches and windows for condition and operation.</p>	<p>Latches are broken.</p> <p>Latches are difficult to operate, or any window does not move up and down freely.</p> <p>Windows do not stay closed.</p>	<p>Any loose or damaged window hardware protruding into passenger compartment.</p>
<p>3. Emergency Door / Windows / Hatches</p> <p>a. Emergency Door Inspect for operation and condition of emergency doors, door latch, door hold open feature (if equipped), and door seal.</p>	<p>Rear door opens too far, damaging lights.</p> <p>Door handle, latch, or mounting hardware is loose</p> <p>Mounting of guard for inside rear door handle is loose.</p> <p>Hold open device (if equipped) is non-operational, bent, damaged or loose.</p> <p>Side emergency door seal damaged or does not effectively prevent water, and/or dirt from entering bus.</p> <p>Cover or padding on bar over door torn or damaged</p> <p>Emergency door exit decal/label damaged.</p>	<p>Any emergency door latch does not operate smoothly and easily when closing or opening the door. (Latch mechanism requires more than 40 pounds of pressure to release.)</p> <p>Door does not open at least 90 degrees. Inside door handle is not equipped with a guard</p> <p>Any vandal lock system is inoperable.</p> <p>Rear emergency door seal damaged or does not effectively prevent exhaust, water, and/or dirt from entering bus.</p> <p>Padded bar over door missing or damaged</p> <p>Emergency door exit not properly labeled.</p>
<p>b. Push out windows Check condition and operation of push out windows (if equipped).</p>	<p>Emergency door exit decal/label damaged.</p>	<p>Emergency window latch does not latch window securely or window does not open easily.</p> <p>Emergency door exit not properly labeled.</p>
<p>c. Roof Hatches Check operation of roof hatches (if equipped).</p>	<p>Roof hatch does not open to ventilation position.</p> <p>Roof hatch seal is damaged or dislodged.</p>	<p>Roof hatch does not open easily to full "emergency open" position from the inside or the outside.</p>

	Section C: Interior Inspection	
Inspection Procedure:	Repair If:	Out of Service If:
3. Emergency Door / Windows / Hatches d. Buzzers Check operation of buzzers for emergency doors, emergency exit windows, and roof hatches.	Buzzer gives false alarms.	Buzzer system for any emergency door, exit window, or any roof hatch does not function or is not audible at driver's location.
e. Labeling and Pad 1) Inspect for label and opening instructions for emergency door, emergency windows, and emergency exit/ventilator (roof hatch).	Any emergency exit does not have legible operating instructions on inside of exit.	Emergency exits not clearly labeled inside bus as "Emergency Door" or "Emergency Exit".
2) Inspect emergency door header pad.	Pad is loose or cover is torn.	Pad is missing
4. Emergency Equipment a. Fire Extinguisher: Check for presence of fire extinguisher and:		No fire extinguisher on bus.
1) Check Manufacturer's label		Labeling not legible to determine size and type.
2) Rating: check for proper U.L. (Underwriters Laboratory) rating.		Fire extinguisher is not the proper size or type.
3) Pressure: check gauge		Pressure above or below green zone.
4) Mounting: check for accessibility and secure mounting.	Bracket mount to panel is loose.	Fire extinguisher not accessible to driver or excessive damage to any parts of extinguisher.
5) Nozzle (if applicable), check for loose, obstructed or damaged parts.		Nozzle or hose loose, missing, obstructed or excessive damage to any parts of extinguisher.
6) Safety Pin: check for presence of safety pin and tamper proof seal.	Seal is broken or missing.	Safety pin is missing. Tamper-proof seal not of approved type. (i.e., Material cannot be broken easily).

	Section C: Interior Inspection	
Inspection Procedure:	Repair If:	Out of Service If:
4. Emergency Equipment b. First Aid Kit	Not labeled.	Not present. Box not moisture and dust proof, won't seal, won't stay latched or contents inaccessible due to condition of box.
1) Check box and condition.		
2) Check for presence of tamper proof seal.	Seal broken; inspect contents, replace.	Tamper proof seal not of approved type (i.e. material cannot be broken easily) or missing.
3) Mounting: Check accessibility and mounting of kit. Should be placed in the driver's area and be easily accessible.	Loose mounting or bracket.	Not mounted or inaccessible.
4) Contents: If seal is broken, check that all contents are Intact and sterile (for content list, see Chart C-1)	Contents are missing or incomplete.	Contents are not individually sealed or sterile. Contents not of proper type or incomplete (except Band-Aids).

Chart C-1. First Aid Kit

Chart 1: First Aid Kit	Unit Quantity
Adhesive Tape	1
1 inch bandage compress (e.g., Band-Aid)	2
2 inch bandage compress	1
3 inch bandage compress	1
4 inch bandage compress	1
3 inch x 3 inch plain gauze pads	1
Gauze roller bandage 2 inch wide	2
Plain absorbent gauze - ½ square yard	4
Plain absorbent gauze - 24 inch x 72 inch	3
Triangular bandages	4
Scissors, tweezers	1
Space rescue blanket	1
Non-latex disposable gloves, pair	1
CPR mask or mouth to mouth airway	1
Caution: Replace gloves on an annual basis. Be aware that people can be allergic to latex.	

	Section C: Interior Inspection	
Inspection Procedure:	Repair If:	Out of Service If:

Chart C-2. Body Fluid Cleanup Kit

Chart 2: Body Fluid Cleanup Kit	Quantity
Antiseptic towelette	1
Disinfectant towelette	1
Absorbing powder (capable of ½ gallon absorption)	1
Non-latex disposable gloves, pair	1
Disposable wiper towels	2
Disposable scoop bag with closure mechanism and scraper	1
Moisture and dustproof kit of sufficient capacity to store the required items.	1

4. Emergency Equipment c. Body Fluid Cleanup Kit 1) Check kit and condition	Not labeled	Container not present, not moisture / dust proof, won't seal, or stay latched, contents inaccessible.
2) Check for presence of tamper proof seal	Seal broken, inspect contents.	Tamper proof seal not of approved type (i.e. material cannot be broken easily)
3) Check accessibility. Should be mounted in the driver's area and easily accessible.	Loose mounting or bracket.	Not easily accessible to driver/not secured.
4) Contents: If seal is broken, Check that all contents are intact and sterile (see contents list Chart C-2).		Contents not proper type, incomplete, or missing.
d. Webbing Cutter Check for presence of a durable webbing cutter securely mounted in the driver's compartment and within easy reach of the driver.	No durable webbing cutter is present. Webbing cutter is not securely mounted in driver's compartment and within easy reach of the driver.	No durable webbing cutter is present. Webbing cutter is not securely mounted in driver's compartment and within easy reach of the driver.

Section C: Interior Inspection		
Inspection Procedure:	Repair If:	Out of Service If:
5. Triangle Reflectors, Box Mounting and Seal 1) Check for proper type and condition of emergency roadside reflectors.	Vehicle not equipped with self-standing, triangular, 17" tall reflectors. Any reflectors are broken, deformed or unusable.	Vehicle not equipped with self-standing, triangular, 17" tall reflectors. Any reflectors are broken, deformed or unusable.
2) Check quantity: three (3) required.	Fewer than three (3) reflectors are present.	Fewer than three (3) reflectors are present.
3) Check accessibility, mounting and condition of box. Must be securely mounted and easily accessible to the driver or in a location plainly indicated by appropriate markings.	Storage box broken or won't remain latched. Box not accessible or not securely mounted forward of passenger compartment.	Storage box broken or won't remain latched. Box not accessible or not securely mounted forward of passenger compartment.
4) Check for presence of tamper proof seal.	Seal broken; inspect contents. Tamper proof seal not of approved type (i.e. material cannot be broken easily).	Seal broken or missing.
6. Video System, Public Address (PA) System, 2-way Radio (if equipped)		
a. Video System Check for operation, mounting and condition.	Mounting is loose.	
b. PA System Check for operation, mounting and condition	Mounting is loose.	
c. 2-way Radio Check for operation, mounting and condition. Inspect phone, radio and antenna for mounting, location and routing of wiring.	Mounting is loose. Driver must move out of the normal driving position to operate radio.	Wiring or connectors are improperly insulated, installed, routed, or secured so as to create potential for a short. Disconnect must be performed before bus can operate.
d. Child Reminder Alarm Check system for proper operation.	System is inoperative.	

	Section C: Interior Inspection	
Inspection Procedure:	Repair If:	Out of Service If:
7. Seats, Cushions, Barriers, Step Well, Hand Rails, Flip Seats		
a. Frames 1) Inspect passenger seat frames for condition of welds, tubing, and hardware		<p>Seat frames or welds are broken or cracked.</p> <p>Any seat back frame is repaired using non-OEM hardware.</p> <p>Any seat frame hardware has been added or modified to result in projections or sharp edges.</p> <p>Deteriorated hardware.</p>
2) Check for presence of non-O.E.M. seat frames.		There are any non-OEM seat frames installed.
3) Check for presence and condition of passenger restraining belts		Restraining belts are non-functional.
b. Mounting Inspect condition of passenger seat mounting and spacing.	<p>Seat fasteners are loose or not torqued to specifications.</p> <p>Improper seat spacing in track seating.</p>	<p>Seat mounting at floor or seat rail is loose.</p> <p>Seat mounting fasteners are of lower grade or different type than OEM fasteners for the specific locations.</p>
c. Barriers Inspect seat back/barrier foam for specifications and condition.	Original thickness or density of any seat back foam around frame has been significantly reduced due to wear, deterioration, or other factors.	<p>Seat back padding is wrong type for specific year model bus</p> <p>Foam envelope is split, delaminated, or there is no padding between any portion of seat back frame and covering.</p> <p>Any bus does not have a padded safety barrier in front of any passenger seat that does not have another seat in front of it.</p>

	Section C: Interior Inspection	
Inspection Procedure:	Repair If:	Out of Service If:
<p>7. Seats, Cushions, Barriers, step Well, Hand Rails, Flip Seats</p> <p>d. Cuts/Upholstery Damage Inspect seat and safety barrier upholstery for condition and specifications.</p>	<p>Seat upholstery is cut, torn, or ripped.</p> <p>Seat upholstery is not repaired properly.</p> <p>Any upholstery has been replaced with non-OEM type material.</p>	<p>Seat upholstery is missing.</p>
<p>e. Bottoms Inspect seat bottoms for securement and condition.</p>	<p>Seat brackets or latches are loose.</p>	<p>Any seat bottom padding or cushion has significant deterioration or damage.</p> <p>Any seat bottom is not securely anchored to seat frame.</p> <p>Any seat bottom has a protruding edge or plywood is broken.</p>
<p>f. Modesty Panels and Stanchions</p>	<p>Stanchion padding is missing or is loose (Special Needs buses).</p> <p>Stanchion padding is missing or is damaged so that metal is exposed.</p>	
<p>g. Optional Infant/Toddler Seating Check condition and operation of system.</p>		<p>Seat does not operate or function properly according to manufacturer's operational procedures or is past effective usage date.</p>
<p>h. Flip-Up Seats Check condition and operation of flip-up seats</p>		<p>Seat does not automatically return to an upright position when not in use.</p> <p>Any sharp edges, or loose or protruding hardware that could injure or snag passengers.</p> <p>Seat or hardware malfunction that could trap arm or leg between seat or back.</p>

	Section C: Interior Inspection	
Inspection Procedure:	Repair If:	Out of Service If:
<p>7. Seats, Cushions, Barriers, step Well, Hand Rails, Flip Seats</p> <p>i. Stepwell</p> <p>1) Check specification and condition of stepwell</p>	<p>Step tread is not secure or sealed at inside edge where It meets next step.</p> <p>Stepwell tread is worn smooth less than four (4) inches in width when measured one inch (1”) or more from the edge.</p>	<p>Step tread is not secure or sealed elsewhere on step. Any tripping hazard.</p> <p>Stepwell tread ribbing is worn smooth more than four (4) inches in width when measured one inch (1”) or more from the edge.</p> <p>Sheet metal in stepwell is rusted through, has holes or structure has weakened and step(s) flex when weight is applied.</p>
<p>j. Hand Rail(s)</p> <p>Check for presence and secure mounting of grab rail(s). Check for catch points.</p>	<p>Mounting hardware is loose.</p>	<p>Handrail and/or any hardware is missing, entrance damaged or has unauthorized modification. Does not pass string and nut test.</p>
<p>8. Special Needs Equipment</p> <p>a: Wheelchair securement components</p> <p>Inspect wheelchair and occupant securement (tie-down) system for condition, mounting, proper type, and location.</p>	<p>Track is filled with dirt.</p>	<p>Wheelchair tie down track or fasteners are loose, broken, or damaged.</p> <p>Wheelchair or occupant securement straps are broken, frayed, or will not operate.</p> <p>Securement system for buses built prior to 1991 is not aisle facing track and belt system (4-way tie system).</p> <p>Securement systems for buses built after 1991 is not forward-facing wheelchair and occupant securement system meeting specifications.</p> <p>Wheelchair or occupant securement track is mounted using lag bolts or sheet metal screws.</p>
<p>b. Occupant securements</p> <p>Inspect booster seats, vests, securement storage bags, oxygen bottle mounts, and other accessories.</p>	<p>Any items not properly secured.</p>	

	Section C: Interior Inspection	
Inspection Procedure:	Repair If:	Out of Service If:
<p>8. Special Needs Equipment</p> <p>c. Buzzer Check operation according to specifications.</p>		
<p>d. Wheelchair and occupant securement Inspect tie-down system for condition, mounting, proper type, and location.</p>	<p>Track is filled with dirt or debris.</p>	<p>Wheelchair tie down track or fasteners are loose, broken, or damaged.</p> <p>Wheelchair or occupant securement straps are broken, frayed, or will not operate.</p> <p>Securement systems are not forward-facing wheelchair and occupant securement systems that meet FMVSS specifications.</p> <p>Wheelchair or occupant securement track is mounted using lag bolts or sheet metal screws.</p>

	Section C: Interior Inspection	
Inspection Procedure:	Repair If:	Out of Service If:
9. Inspect Bulkhead, Interior, and Service Door a. Bulkhead Inspect bulkhead / firewall for any cracks, unsealed openings, and sound insulation materials.	Sound deadening/insulation package is unsecured or deteriorated.	Any open hole or unsealed area in bulkhead / firewall.
b. Dog House/Engine Cover, if equipped Inspect dog house/engine cover for seals, soundproofing, weather stripping, prop-rod.	Soundproofing is not present or is deteriorated. Prop-rod does not support dog house/engine cover safely. Latch is hard to operate or does not secure dog house/engine cover properly.	Seals or weather stripping allow air/fume leaks into driver's compartment.
c. Interior Wiring 1) Inspect visible wiring for mounting, condition, chafing, abrasion, corrosion, loose connectors, or improper repairs.	Wiring or connectors are unsecured, corroded, improperly routed, or interfere with driver's controls.	Any wire or connector is cut or severely chafed, or conductor is exposed or routed against a sharp edge. Any connection is not secure.
2) Inspect fuse/electrical panel and cover/door for mounting, condition and components.	Fuse/electrical panel and cover/door is not mounted securely or corroded but not in danger of shorting or failing.	Fuse/electrical panel and cover/door is not mounted securely or corroded and in danger of shorting or failing. Panel is not covered, or cover/door will not remain closed.
d. Floor Inspect floor covering, aisle, and cove molding strips for condition, adhesion and/or fastening	Rubber floor covering is loose, deteriorated, or cracked. Cove molding is loose, or fasteners are missing.	There are any unsealed holes or cracks through to underside of bus. Aisle not equipped with 12-inch-wide ribbed rubber. Any aisle molding strip not securely fastened to floor or any aisle or cove molding presents a sharp edge or protrusion or tripping hazard. Any damage to rubber floor which could cause a tripping hazard.

Section C: Interior Inspection		
Inspection Procedure:	Repair If:	Out of Service If:
<p>9. Inspect Bulkhead, Interior, and Service Door</p> <p>e. Service Door</p> <p>1) Check service door assembly for operation, adjustment, condition, mounting, and fit.</p>	<p>Door does not seal properly, or seals are damaged, ripped, or deteriorated.</p>	<p>Door jams, binds, or is difficult to close or open.</p> <p>Door assembly is damaged, or mounting is loose.</p> <p>Glass has been replaced with Plexiglas, is broken, or is cracked.</p> <p>Door glass is fogged more than one (1) inch in from border, or visibility through glass is poor.</p> <p>Door is equipped with any lock except factory approved system.</p> <p>Door seals are not present.</p> <p>Door will not open or close completely.</p>
<p>2) Check door hinge and hinge screws.</p>	<p>Hinge screws loose.</p>	<p>Hinge or pin condition interfering with operation of door.</p>
<p>3) Check manual service door control and rod assembly for over-center or latching device, condition, mounting, and operation.</p>	<p>Control, rod hardware, or mounting is loose.</p> <p>Door control doesn't operate freely.</p>	<p>Manual control will not lock over-center, or latching mechanism is inoperative.</p> <p>Door control requires excessive force to operate.</p>
<p>4) Check air powered service door control assembly for leaks, operation, insecure door, in closed position, and emergency release.</p>	<p>Air powered system leaks. Door operates too slowly or too harshly.</p>	<p>Air door emergency release does not function, or control is broken.</p> <p>Air door does not function properly, or at all.</p>
<p>5) Check manual service door control and rod assembly for over-center or latching device, condition, mounting, and operation.</p>	<p>Control, rod hardware, or mounting is loose.</p> <p>Door control doesn't operate freely.</p>	<p>Manual control will not lock over-center, or latching mechanism is inoperative.</p> <p>Door control requires excessive force to operate.</p>
<p>6) Check air/electric powered service door control assembly for leaks, operation, insecure door, in closed position, and emergency release.</p>		

	Section C: Interior Inspection	
Inspection Procedure:	Repair If:	Out of Service If:
<p>9. Inspect Bulkhead, Interior, and Service Door f. Overhead Pad Check bus for pad that is a minimum three (3) inches wide, high density foam rubber padded safety cushion, mounted directly above the inside of the service door.</p>	Pad is loose, or cover is torn.	Pad is missing or damaged.
<p>10. Sharp Projections and securement of accessories a. Check all interior sidewall, rear, ceiling, and driver's area paneling for secure fastening, projections or sharp edges, and condition.</p>		<p>Interior paneling has any projections or sharp edges. Any missing panels.</p>
<p>b. Cleanliness Inspect interior for cleanliness.</p>	<p>Bus is dirty. Advise district. There is graffiti or unauthorized stickers on interior panels.</p>	Bus is dirty and unsafe to operate. Advise district.
<p>c. General Condition, Interior, Loose Objects Check that all objects within the bus are secured.</p>	<p>Loose objects are present and are not properly secured. Any loose or missing attachment screws on any maintenance access panel.</p>	<p>Any carpeting or non-OEM floor mats. Any aerosol cans or other containers of flammable, hazardous, or volatile chemicals or liquids are on bus.</p>
<p>d. Trash Cans/Brooms 1) Check that approved trash cans are properly secured (if present).</p>	Trash can is damaged.	Trash can is not properly secured.
<p>2) Check that brooms (if present) are properly secured in approved locations.</p>	Broom securement clips are loose.	Broom not properly secured.

End of Section

[Type here]



CDE Vehicle Inspection

Procedures, Repair Criteria, & Out of Service Criteria

Section D: Under Vehicle Inspection

	Section D: Under Vehicle Inspection	
Inspection Procedure:	Repair If:	Out of Service If:

Section D. Under Vehicle Inspection

Note: Depending on the vehicle style, some items in this section may be inspected while performing the engine compartment inspection.

1. Steering System		
<p>a. Steering Shaft:</p> <p>1) Check steering shaft outside vehicle for up and down play (parallel to shaft), side to side play (perpendicular to shaft), and for proper mounting and condition. Check for binding.</p> <p>2) Column shaft and hardware.</p> <p>3) Column U-joints or flexible coupling (as equipped). Grease zerks.</p> <p>4) Coupling at gear box.</p>	<p>Pot joint, (shell coupling, trunnion), if equipped, is loose, bent, broken or damaged in any way.</p>	<p>Side to side play in steering column or up and down play is excessive.</p> <p>Column assembly mounting (including floor mounting plate) or fasteners are loose.</p> <p>Steering column U-joint (if equipped) is loose, damaged, or noisy after lubrication.</p> <p>Any column U-bolt, pinch bolt, shear pins, or other column fasteners, or input shaft coupling is loose, damaged, or missing.</p> <p>Column U-joint (if equipped) is loose, damaged, or noisy after lubrication.</p> <p>Flexible coupling, if equipped (rag joint) has loose or missing fasteners, damaged flexible disc, or elongated holes.</p> <p>Splines are worn or damaged.</p> <p>Binding in any portion of the steering system.</p>

	Section D: Under Vehicle Inspection	
Inspection Procedure:	Repair If:	Out of Service If:

Chart D-1. Tightening Steering Column Joint Bolts

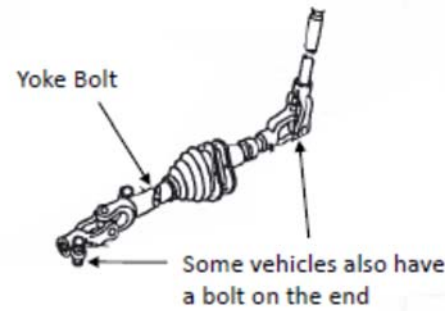
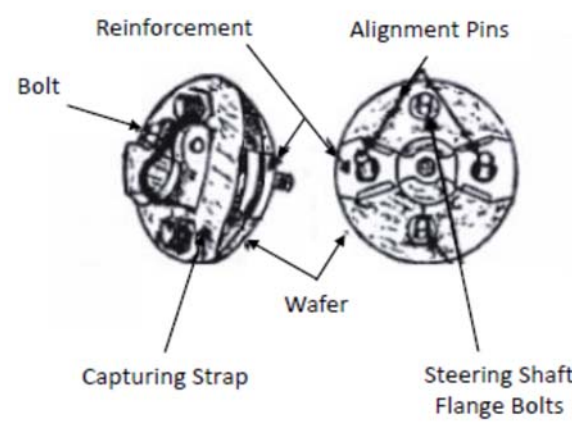
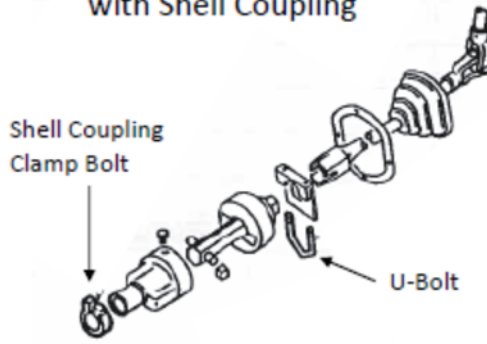
<p>Figure 1 Typical Column with Yoke or U Joint</p> 	<p>Figure 2 Typical Flexible Type Steering Coupling</p> 
<p>Figure 3 Typical Column with Shell Coupling</p> 	<p>TIGHTENING STEERING COLUMN JOINT BOLTS</p> <p>WARNING: FAILURE TO MAINTAIN STEERING SYSTEM IN PROPER CONDITION MAY CAUSE REDUCED STEERING ABILITY RESULTING IN PERSONAL INJURY AND PROPERTY DAMAGE.</p> <p>As good maintenance practice, it is recommended that steering column joint bolts be checked for tightness every 80,000 km (50,000 miles) or annually, whichever occurs first. Torque to manufacturer's specifications.</p>

	Section D: Under Vehicle Inspection	
Inspection Procedure:	Repair If:	Out of Service If:

<p>1. Steering System NOTE: for items “b” through “g”; Steering Gear Box and other external components are checked using following procedure:</p> <ol style="list-style-type: none"> 1) Vehicle should be on ground (not suspended). 2) With engine running have assistant move steering wheel back and forth repeatedly to load steering components. 3) Visually observe the following external steering and related suspension and frame components for looseness while assistant works steering (also see specific procedures under each component). 4) Have assistant carefully operate steering to full left and right tum and check for power assist pop-off and steering stops. 5) As follow-up to the above steering check, also perform a visual and hands-on check of each of the listed components. 		
<p>b. Steering Gear Box and Mounting</p> <p>Check mounting, condition, and tightness of steering gear box, and check frame, frame braces, and associated rivets or fasteners for looseness and condition.</p>	<p>Steering gear box is damp at or near seals showing signs of seepage but no visible fluid is observed.</p>	<p>Steering gear box is loose on frame, or fasteners or lock tabs are loose or missing.</p> <p>Mounting holes have visible cracks or are elongated.</p> <p>Steering gear box has any visible leaks.</p> <p>Any up-down or side to side motion of either shaft is observed (bearing or bushing wear).</p> <p>There is any binding in steering gear box.</p>

	Section D: Under Vehicle Inspection	
Inspection Procedure:	Repair If:	Out of Service If:
<p>1. Steering System</p> <p>c. Pitman Arm Check pitman arm for looseness or misalignment at sector shaft splines and looseness at all joints.</p> <p>Check looseness of pinch bolt and fasteners and condition of pitman arm.</p> <p>Check cotter pins, bolt fasteners, and grease zerks.</p>	<p>Pitman arm grease fitting (if originally equipped) is loose or missing.</p>	<p>Any play is observed between pitman arm and sector shaft.</p> <p>Pinch bolt at sector shaft is loose or missing.</p> <p>Pitman arm to sector shaft timing marks are misaligned.</p> <p>Pitman arm ball-joint (if equipped) has more than 1/16 inch play (axial, i.e., in and out play between the ball stud and socket) or is in excess of manufacturer's specifications.</p> <p>Pitman arm ball-joint (if equipped) has loose or missing nut, or cotter pin is missing.</p> <p>Pitman arm is cracked or damaged.</p>
<p>d. Drag Link:(if equipped) Check drag link ends, shaft, and fasteners for looseness and condition.</p>	<p>Drag link end has more than 1/16 inch and less than 1/8 inch axial play.</p> <p>Any drag link end grease fitting (as equipped) is loose, or missing, or will not take grease.</p> <p>Drag link end boot is damaged or missing.</p> <p>Drag link needs lubrication.</p>	<p>Drag link ball stud is loose in pitman arm or upper steering arm.</p> <p>Any nut is loose or missing, or cotter pin is missing.</p> <p>Drag link shaft is damaged or bent.</p> <p>Drag link end has more than 1/8 inch axial play or is in excess of manufacturer's specifications.</p> <p>Adjustable (length) drag link has loose clamp or damage to the threads or has any movement or play in the shaft.</p> <p>Any drag link that is installed improperly.</p>

	Section D: Under Vehicle Inspection	
Inspection Procedure:	Repair If:	Out of Service If:
<p>1. Steering System</p> <p>e. Steering Arm Check upper steering arm (Ackerman arm) and left and right side lower steering arms for securement and condition.</p>		<p>Any steering arm has been bent, is cracked, or is damaged.</p> <p>Any steering arm attachment point is loose, or any fasteners or cotter pin is missing.</p>
<p>Check condition and securement of steering stops and lock nuts.</p>		<p>Either steering stop or lock is loose, damaged, or missing.</p>
<p>f. Tie Rod and Ends Check tie rod ends, tie rod, dust boots, and clamps or fasteners (as equipped) for looseness, damage, and condition.</p>	<p>Tie rod end dust boot is cut, damaged, or missing.</p> <p>Tie rod end needs lubrication.</p> <p>Any tie rod end grease fitting is loose, or missing, or will not take grease.</p> <p>Any tie rod end has more than 1/16 inch and less than 1/8 inch axial play.</p>	<p>Tie rod clamps, fasteners, or cotter pin is stripped, missing, or loose.</p> <p>Any clamp (as equipped) is miss-positioned.</p> <p>Any tie rod or end is cracked or damaged.</p> <p>Any tie rod is bent, cracked, broken or threads are damaged in any way.</p> <p>Any tie rod end has more than 1/8 inch axial play or is in excess of manufacturer's specifications.</p> <p>Tie rod end ball stud is loose in steering arm or idler arm.</p>
<p>g. Idler Arm Check idler arm assembly (as equipped) for looseness, damage, binding and condition.</p>	<p>Idler arm needs lubrication.</p> <p>Idler arm grease fitting is loose or missing or will not take grease.</p> <p>Idler arm up and down play is greater than 1/8 inch total (1/16 Inch either direction) but less than 1/4 inch.</p>	<p>Any idler arm fasteners are loose or missing.</p> <p>Idler arm is cracked, or damaged, or cotter pin is missing.</p> <p>Idler arm up and down play is greater than 1/4 inch total (1/8 inch either direction) or is in excess of manufacturer's specifications.</p>

	Section D: Under Vehicle Inspection	
Inspection Procedure:	Repair If:	Out of Service If:
<p>1. Steering System</p> <p>h. Alignment</p> <p>1) Check for obvious or abnormal front tire wear.</p>	<p>Any front tire wear indicates an alignment problem.</p>	
<p>2) Check for visible alignment problems.</p>	<p>Any visible alignment problems not caused by faulty components.</p>	
<p>2. Front Suspension, Rear Suspension, Springs, Cross members, Shackles, Shock, Frame brackets</p> <p>a. Wheel Bearings</p> <p>Inspect front wheel bearings and related components for condition and proper adjustment of bearings. Grasp tire and attempt to rock wheel to check for movement.</p> <p>NOTE: It is important to correctly identify source of any play. To determine if play is in wheel bearings, have an assistant fully apply brakes while rechecking play. If movement disappears with brakes applied, then play was in wheel bearings.</p>	<p>There is minor grease seepage around dust cover.</p> <p>Dust cover fasteners are missing or loose.</p>	<p>Any noise, binding, or roughness discovered in bearings.</p> <p>Wheel bearing end play exceeds manufacturer's specifications (maximum of .010 inches in and out play measured at bearing hub).</p> <p>There is grease or oil leaking or dripping around dust covers.</p> <p>Dust cover is damaged or missing.</p>
<p>b. I-Beam</p> <p>Inspect I-beam axle assembly.</p>		<p>I-beam has been cut, modified, or is damaged.</p> <p>There is any bluing or other evidence that I-beam has been heated.</p>

	Section D: Under Vehicle Inspection	
Inspection Procedure:	Repair If:	Out of Service If:
<p>2. Front Suspension, Rear Suspension, Springs, Cross members, Shackles, Shock, Frame brackets</p> <p>c. King Pins 1) Inspect King Pin assemblies for condition and play as follows: Grasp tire at top and attempt to move the wheel assembly in and out.</p> <p>NOTE: Wheel bearings must be adjusted properly. Wheel bearing play may be eliminated by locking brakes before checking King Pins.</p>	<p>One locking pin (draw key) Is loose (dual).</p> <p>End cap O-rings or bolts are loose or missing</p>	<p>Locking pin (draw key) is missing, backing out, or loose (single, both for dual).</p> <p>King Pin movement is in excess of manufacturers specification.</p>
<p>2) Visually inspect thrust bearing area for uneven gap, improper installation, wear, or damage.</p> <p>NOTE: Do not tighten King Pin lock (If equipped) or grease King Pin before inspecting King Pin assembly.</p>		<p>Vertical (up and down) play in King Pin assembly is greater than .030", and/or thrust bearing is damaged or missing.</p> <p>If side play at outside edge of tire is greater than 1/4 inch.</p>
<p>d. Shackles Inspect condition of shackles, spring hangers, and pinch bolts.</p> <p>NOTE: Shackles types vary from manufacturer and year models. (Bolted, pinned, pinch pinned, combination etc.).</p>	<p>Any spring shackle is bent.</p>	<p>Any front spring shackle or hanger is cracked or broken.</p> <p>Any front spring shackle or hanger has significant side wear at spring eye.</p> <p>Any front spring shackle or hanger is worn, or pinch bolt is stripped or missing, so that spring pin cannot be clamped tightly.</p> <p>Any front spring or shackle eye bolt is loose, worn, broken, damaged or missing.</p>

Section D: Under Vehicle Inspection		
Inspection Procedure:	Repair If:	Out of Service If:
<p>2. Front Suspension, Rear Suspension, Springs, Cross members, Shackles, Shock, Frame brackets</p> <p>e. Spring Mounts Inspect spring mount bracket(s) for condition and securement.</p>	<p>Any slipper type pad (insulator) that has significant wear, damage, or is missing.</p>	<p>Any front spring mount is broken or cracked.</p> <p>Any front spring mount-to-frame fastener is loose or missing.</p> <p>Frame cracked at any spring or shock mount.</p>
<p>f. Pins and Bushings Inspect front spring pins and bushings for wear and lubrication. Check for wear with front axle loaded, look for off center spring eye, rubbing shackle, or non-symmetric joint.</p> <p>NOTE: If any questionable condition found, jack front of bus up and identify source of play or movement</p>	<p>Zerk (grease) fitting is damaged or missing.</p> <p>Inner sleeve or rubber bushing type spring pin assembly(ies) is worn through, or rubber bushing is excessively worn (rubber is compacted or deteriorated resulting in free play between rubber and spring eye or inner sleeve).</p>	<p>Total free play (up and down) of pins and bushings is beyond manufacturers specifications.</p> <p>Any pin is loose, damaged, or worn, or cannot be properly clamped by pinch type shackles. On vehicles equipped with bolt instead of pin, bolt is loose, damaged or worn or the nut is not a locking type or is missing.</p> <p>Pin is cutting into spring, shackle, or mount.</p>
<p>g. A-Frames and Bushings: (upper and/or lower control arms, struts) Inspect A-frames and bushings for condition and securement.</p>	<p>Rubber bushing(s) is split, badly deteriorated or badly extruded from suspension joints.</p>	<p>Rubber bushing(s) is missing.</p> <p>Any A-frame, control arm, or strut assembly is bent, missing, broken, or any fasteners or U-bolt(s) are loose or missing.</p> <p>Any A-frame, bushing, or pivot arm has more than .050" free play at pivot point.</p> <p>Mounting of assemblies is not secure.</p>
<p>h. Ball Joints Inspect ball joint(s) for condition, securement, and lubrication.</p>	<p>Zerk (grease) fitting is missing, damaged, loose or won't take grease.</p>	<p>Any ball joint has more than 3/32 inch axial play.</p> <p>Any ball joint nut is loose or missing, or cotter pin is missing.</p> <p>Ball joint to A-frame mounting is cracked or loose or has been welded.</p>

	Section D: Under Vehicle Inspection	
Inspection Procedure:	Repair If:	Out of Service If:
<p>2. Front Suspension, Rear Suspension, Springs, Cross members, Shackles, Shock, Frame brackets</p> <p>i. U-Bolts Inspect spring U-bolts for condition and securement.</p>		<p>There is rust underneath U-bolt nuts indicating possibility of looseness.</p> <p>Any U-bolt, seating plate, shock mount bracket, or nut is loose or missing, cracked, or stripped.</p>
<p>j. Shocks Inspect shocks for condition and securement.</p>	<p>There is wetness around shock body due to leaking shock fluid.</p> <p>Any shock mounting, or fastener is loose.</p>	<p>Any shock or mount is missing, cracked, or broken.</p>
<p>k. Springs Inspect front springs for condition, securement, and alignment.</p>	<p>There are any loose, missing, broken or worn spring clips.</p> <p>Missing insulators between leaf springs or on ends of coil springs.</p> <p>Any coil or leaf spring has weakened and causing vehicle to lean excessively.</p> <p>Either front spring saddle (if equipped) is worn out or missing.</p> <p>Rubber bumper is missing or damaged.</p> <p>Ride height not adjusted properly (air suspension) or outside of manufacturer's specifications.</p>	<p>Any leaf spring is broken, cracked, or missing.</p> <p>Spring eye is worn or spread such that bushings are loose in spring eye.</p> <p>Any coil spring(s) is broken, insecurely mounted, non-OEM type or non-OEM blocks or spacers are installed.</p> <p>There is any misalignment of spring leaves or other evidence that center pin is loose or broken.</p> <p>Either front coil or leaf spring is worn so that rubber frame bumper is damaged or worn due to frequent bottoming of front suspension.</p> <p>Any alignment wedge is loose or damaged.</p> <p>On any air bag type spring assembly, air bag is damaged or leaking. Any problem with ride height control valve other than adjustment.</p>

	Section D: Under Vehicle Inspection	
Inspection Procedure:	Repair If:	Out of Service If:
<p>2. Front Suspension, Rear Suspension, Springs, Cross members, Shackles, Shock, Frame brackets</p> <p>l. Anti-roll bar/Sway bar (If equipped) Inspect for mounting and condition.</p>	<p>Rubber mounting bushings are cracked, compressed or deteriorated to the point of allowing movement of bar.</p>	<p>Bar is bent, broken or missing.</p> <p>Any mounting hardware is broken or missing.</p> <p>Any rubber bushings or grommets are missing.</p>
<p>m. Wheel Seals Check for condition and leakage.</p>	<p>Excessive seepage.</p>	<p>Either front wheel seal is damaged or leaking.</p>
<p>n. Vehicle frame Check frame rails, extensions, modular sections, cross-members, braces, gussets, liners, and all fasteners for damage, condition and mounting.</p>		<p>Frame, frame braces, and associated rivets or fasteners are loose, damaged, or missing.</p> <p>Frame, extensions, liners, or modular sections are damaged, cracked, or broken.</p> <p>Frame braces or cross-members are damaged, cracked, or broken.</p> <p>Rivets or other fasteners at frame braces or cross-members are loose or missing.</p> <p>Any axle or suspension component is loose beyond specifications prescribed elsewhere in this manual.</p> <p>Any unauthorized modifications (welding, drilling, etc.)</p>

	Section D: Under Vehicle Inspection	
Inspection Procedure:	Repair If:	Out of Service If:

Chart D-2. Steering Joints

STEERING JOINTS

Figure 4 Checking the Rod and Drag Link End Movement

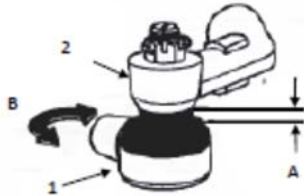

- A Movement in the axial direction must be less than 1/16 inch
- B Tie Rod/drag link free to rotate within steering arm socket
- 1 Tie Rod/drag link end
- 2 Steering Arm

Figure 5 Checking Idler Movement

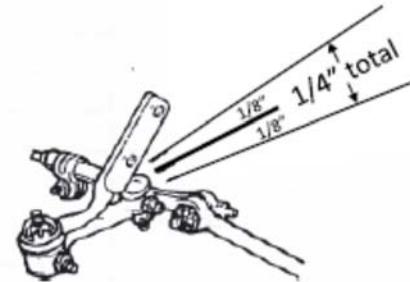

	Section D: Under Vehicle Inspection	
Inspection Procedure:	Repair If:	Out of Service If:
<p>3. Air Ride Suspension System (if installed)</p> <p>Inspect Air Ride Suspension System:</p>		
<p>a. Springs: Inspect air bag type spring assembly, for condition, securement, leaking, function, and alignment.</p> <p>Check ride height.</p>	<p>There are any loose, missing, broken or worn components.</p> <p>Vehicle is leaning excessively.</p> <p>Either rear spring saddle (if equipped) is worn out or missing.</p> <p>Rubber frame bumper is missing.</p> <p>Ride height not adjusted properly (air suspension) or outside of manufacturer's specifications.</p>	<p>Any leaf spring(s) is broken, cracked, or missing</p> <p>Any non-OEM type or non-OEM blocks or spacers are installed.</p> <p>There is any misalignment of spring leaves or other evidence that center pin is loose or broken.</p> <p>Either spring is worn so that rubber frame bumper is damaged or worn due to frequent bottoming of rear suspension.</p> <p>Any alignment shim or wedge is loose or damaged.</p> <p>Any air bag type spring assembly, air bag, air lines, and/or valve are damaged or leaking. Any problem with ride height control valve other than adjustment.</p> <p>Air ride pivot pins or bushings are loose.</p>
<p>b. Antiroll bar/Sway bar (if equipped)</p> <p>Inspect for mounting and condition.</p>	<p>Rubber mounting bushings are cracked, compressed or deteriorated to the point of allowing movement of bar.</p>	<p>Bar is bent, broken or missing.</p> <p>Any mounting hardware is broken or missing.</p> <p>Any rubber bushings or grommets are missing.</p>

	Section D: Under Vehicle Inspection	
Inspection Procedure:	Repair If:	Out of Service If:
<p>3. Air Ride Suspension System</p> <p>c. U-Bolts</p> <p>Inspect spring U-bolts for condition and securement.</p>	<p>Any U-bolt is misaligned.</p>	<p>There is rust underneath U-bolt nuts indicating possibility of looseness.</p> <p>Any U-bolt is cracked, stripped, broken or missing.</p> <p>Any U-bolt is not OEM size, type and/or design.</p> <p>Any U-bolt seating plate, shock mount bracket, or nut, is loose, missing, cracked, or stripped.</p>
<p>d. Shocks</p> <p>Inspect rear shocks for condition and securement.</p>	<p>There is any wetness around shock body due to leaking shock fluid.</p> <p>Any shock mounting or fastener is loose.</p>	<p>Any shock or mount is cracked, broken or missing.</p>
<p>e. Shackles</p> <p>Inspect rear suspension shackles, spring hangers, and hanger pinch bolts for condition and securement.</p> <p>NOTE: Shackle types vary by manufacturer and year models. Bolted, pinned, pinch-pinned, combination, etc.</p>		<p>Any rear spring shackle or hanger is cracked or broken.</p> <p>Any rear spring shackle or hanger is worn to the point, or pinch bolt is stripped or missing, so that spring pin cannot be clamped tightly.</p> <p>Any rear spring shackle or hanger has significant side wear at spring eye.</p> <p>Any rear spring or shackle eye bolt is loose, worn, broken, damaged or missing.</p>

Section D: Under Vehicle Inspection		
Inspection Procedure:	Repair If:	Out of Service If:
<p>3. Air Ride Suspension System</p> <p>f. Pins and Bushings</p> <p>Inspect rear spring pins and bushings for wear and lubrication (same as front). For other types of pin and bushing configurations, see manufacturer's Service Manual. NOTE: If questionable condition is found, jack up rear of bus and identify source of play or movement.</p>	<p>Any Zerk (grease) fitting is damaged or missing.</p> <p>Inner sleeve or rubber bushing type spring pin assembly(ies) is worn through, or rubber bushing is excessively worn (rubber is compacted or deteriorated, resulting in free play between rubber and spring eye or inner sleeve).</p>	<p>Pin is cutting into spring, shackle, or mount.</p> <p>Any pin is loose, damaged, or worn, or cannot be properly clamped by pinch type shackles. On Vehicles equipped with bolt instead of pin, bolt is loose, damaged or worn or the nut is not a locking type or is missing.</p> <p>Rear spring pin bushing (metal type bushing) is worn through.</p> <p>Total free play (up and down) of pin and bushing exceeds 1/8 inch.</p> <p>On system using two pins and bushings, combined free play exceeds 1/4 inch.</p>
<p>g. Hangers</p> <p>Inspect hangers for mounting and condition.</p>	<p>Any front spring shackle or hanger is worn, bent, or pinch bolt is stripped or missing, so that spring pin cannot be clamped tightly.</p>	<p>Any spring hanger or bracket is cracked or broken, or any mounting fastener is loose or missing,</p>
<p>h. Control arms/rods</p> <p>Inspect rear axle control, torque, stabilizer, etc. arms/rods (if equipped) for condition and mounting.</p>	<p>Rubber mounting bushings are cracked, compressed or deteriorated to the point of allowing movement of bar.</p>	<p>Any part of a torque, radius or tracking component assembly or any part used for attaching the same to the vehicle frame or axle that is cracked, loose, broken or missing.</p> <p>Any mounting hardware is broken or missing.</p> <p>Any rubber bushings or grommets are missing.</p>
<p>i. Seals</p> <p>Inspect rear wheel seals and gaskets for condition and leakage.</p>	<p>There is wetness or leaking of gear oil around axle flange.</p>	<p>Either rear wheel seal is damaged or leaking.</p> <p>Any axle flange stud or nut is loose or missing.</p>

	Section D: Under Vehicle Inspection	
Inspection Procedure:	Repair If:	Out of Service If:
<p>4. Axle Pinion, Transmission Flange</p> <p>a. Driveshafts Inspect driveshafts and damper for condition.</p>	<p>Any vibration felt during road test.</p>	<p>Any driveshaft balancing weight (if originally equipped) is missing.</p> <p>Any driveshaft is bent or seriously dented.</p> <p>Any loose, damaged, or leaking damper.</p> <p>There are any cracks or other damage to driveshaft, which could cause structural failure.</p> <p>There is any foreign matter wrapped around driveshaft.</p>
<p>b. Yokes Inspect driveshaft yokes for condition and lubrication.</p>	<p>Driveshaft splines are unlubricated.</p> <p>Dust cap on yoke is loose or missing.</p> <p>Zerk (grease) fitting is missing or clogged.</p> <p>Packing in dust cap is missing.</p>	<p>Any yoke has significant play in splines.</p> <p>Any yoke is cracked or damaged.</p>
<p>c. Midshaft (Midship) Bearings Inspect midshaft (midship) bearings and rubber insulators for condition and securement.</p>	<p>Midshaft (midship) bearing rubber inner insulator is deteriorated, damaged, or oil soaked.</p> <p>Midshaft (midship) bearing support is misaligned.</p>	<p>Bearing outer race is loose in insulator, or inner race is loose on shaft.</p> <p>There is significant play in midshaft (midship) bearing.</p> <p>There is any missing or damaged hardware or fasteners in midshaft (midship) bearing or support assembly.</p>

	Section D: Under Vehicle Inspection	
Inspection Procedure:	Repair If:	Out of Service If:
<p>4. Axle Pinion, Transmission Flange</p> <p>d. Driveshaft Park Brake</p> <p>Inspect driveshaft park brake assembly for condition, mounting, securement, and adjustment of linings, drum, linkage, and all other related hardware.</p>		<p>Lining is worn beyond allowable limits.</p> <p>Lining is contaminated with grease or oil.</p> <p>Lining is broken, cracked, or loose.</p> <p>Drum is cracked or has excessive heat damage or scoring of friction surface.</p> <p>Any actuating or mounting hardware or fastener is damaged, loose, or missing.</p> <p>Park brake is not adjusted per manufacturer's specifications.</p>
<p>e. Differential</p> <p>Inspect differential assembly for condition and leakage.</p>	<p>Differential gasket or pinion seal is seeping.</p>	<p>Any external differential hardware or fasteners are loose or missing.</p> <p>Differential pinion yoke has end play or side play exceeding manufacturer's specifications.</p> <p>Pinion/yoke end nut is loose or missing.</p> <p>Differential gasket or pinion seal is leaking.</p>
<p>f. Vent</p> <p>Inspect condition of axle housing vent.</p>	<p>Axle vent is not functional.</p> <p>Vent cap is clogged.</p> <p>Vent hose (if originally equipped) is cracked, clogged, or missing.</p>	<p>Vent is leaking excessively or is missing.</p>
<p>g. Axle Housing</p>		<p>Any portion of axle housing is cracked or bent.</p> <p>Any portion of axle housing is leaking lubricant due to cracks, porous metal, or defective weld.</p> <p>There is any leakage at or around axle housing ends.</p>

	Section D: Under Vehicle Inspection	
Inspection Procedure:	Repair If:	Out of Service If:
<p>5. U-Joints, carrier bearings and guards</p> <p>a. U-Joints</p> <p>Prior to lubrication, inspect U-joints or constant velocity (CV) joints (if equipped) for condition, phasing (alignment of joints), lubrication, and presence of all hardware.</p>	<p>Driveshaft is out of phase.</p> <p>U-joints or constant velocity joints are dry of lubrication, or Zerk (grease) fitting (if equipped) is missing, clogged, or inaccessible.</p>	<p>There is missing hardware or fasteners in any U-joint or CV joint assembly.</p> <p>Any U-joint has significant cross-shaft-to-bearing cup play, or CV joint has significant play.</p> <p>Any U-joint or CV joint shows evidence of significant rusting of bearings.</p> <p>Any bearing cup is loose in yoke.</p> <p>Any mismatched or wrong type cup straps or bolts.</p>
<p>b. Guards</p> <p>Inspect for presence and condition of driveshaft guards (if originally equipped).</p>	<p>Any driveshaft guard is bent or damaged (not rubbing).</p>	<p>Any driveshaft guard is missing or has loose or damaged mounting fasteners or is rubbing shaft.</p>
<p>6. Air Tanks and Dryer</p> <p>a. Air Dryer</p> <p>1) Check dryer for securement and condition.</p>	<p>Dryer has loose or missing mounting bolts but not in danger of falling off.</p> <p>Canister portion of dryer is bent or damaged but is not leaking or loose.</p>	<p>Dryer has loose or missing mounting bolts and is in danger of falling off.</p> <p>Canister portion of dryer is bent or damaged and is leaking or loose.</p>
<p>2) Check dryer fittings, plumbing and electrical connections on heating element.</p> <p>Note: Loops or low spots in air lines can collect water and freeze.</p>	<p>Electrical connection for heating element is loose or damaged.</p> <p>Air line to dryer is improperly routed.</p>	<p>Any air line connection is loose or has an audible leak.</p>

Section D: Under Vehicle Inspection		
Inspection Procedure:	Repair If:	Out of Service If:
<p>6. Air Tanks and Dryer</p> <p>3) Check purge valve for operation and contamination.</p> <p>Note: There may be dampness and oil residue on and around valve. A slight leak is acceptable from valve during charging cycle or if shut down prior to purge cycle.</p>		<p>Valve is contaminated by solid material (desiccant, cloth, rubber, metal, etc.), which would prevent it from seating.</p> <p>Valve continues to leak after purge cycle.</p>
<p>b. Drain Air Reservoirs</p> <p>1) With air system fully charged, check manual operation of safety relief valve.</p> <p>2) Partially open manual petcock valve on the first (wet) tank.</p> <p>3) Allow any moisture (water) or contamination to drain.</p>	<p>There is excessive moisture in reservoir. (desiccant type air dryer equipped vehicles only).</p> <p>Refer to service manual for guidelines on allowable water volume.</p>	<p>Safety relief valve leaks or does not release pressure.</p> <p>There is excessive sludge or oil contamination in the reservoir.</p> <p>Reservoir leaks due to corrosion or is cracked.</p>
<p>7. Transmission</p> <p>a. Transmission Bolts Inspect transmission assembly and mounting fasteners for condition and securement.</p>		<p>Transmission is not mounted securely to flywheel housing.</p> <p>There is any external indication that any torque converter bolt(s) are loose or missing.</p>

	Section D: Under Vehicle Inspection	
Inspection Procedure:	Repair If:	Out of Service If:
<p>7. Transmission</p> <p>b. Linkage Inspect transmission linkage for routing, condition, and securement.</p> <p>Note: Mechanical modulator cable should have 1/16 to 1/8 Inch clearance at full throttle.</p>	<p>Modulator cable or vacuum hose routed subject to excessive heat or abrasion.</p> <p>Any linkage hardware or fasteners loose.</p> <p>Dust/moisture boots on cable missing or torn.</p> <p>Modulator cable is exposed or casing is damaged.</p> <p>Modulator cable is out of adjustment.</p> <p>Modulator vacuum hose is deteriorated or loose.</p>	<p>Linkage is bent, damaged, binding, or severely misadjusted.</p> <p>Any linkage hardware or fasteners are missing or loose.</p> <p>Any linkage hardware or fasteners are damaged so as to cause a sticking or binding condition.</p> <p>Modulator vacuum hose is leaking or not connected.</p> <p>Air modulator or airline leaking.</p>
<p>c. Lines Inspect transmission lines, and associated wiring for routing, securement and condition.</p>	<p>Any transmission line or wiring is unsecured or routed where it is subject to excessive heat or abrasion.</p> <p>Any transmission line of improper type.</p>	<p>Any transmission line is kinked.</p> <p>Any transmission line or fitting is leaking.</p> <p>Any transmission line or wire is worn or deteriorated to the point that failure could occur.</p>
<p>d. Filter Inspect transmission external filter assembly (if equipped) for securement and condition.</p>	<p>External filter mounting is insecure or has loose or missing fasteners.</p> <p>Filter monitor indicates need for change.</p> <p>Filter canister is damaged (not leaking).</p>	<p>Body of transmission filter is cracked or damaged and is leaking.</p> <p>Any hose, line, or connection is cracked or damaged and is leaking.</p>
<p>e. Cooler Inspect transmission cooler.</p>	<p>Transmission cooler fins are bent.</p>	<p>Any external leak or transmission fluid in cooling system (internal leak).</p>

	Section D: Under Vehicle Inspection	
Inspection Procedure:	Repair If:	Out of Service If:
<p>8. Fuel System, Fuel Tank(s)</p> <p>a. Fuel System and Tank(s)</p> <p>Inspect fuel tank assembly for leaks.</p>		<p>There is any fuel leakage from the tank, connections, or cap.</p> <p>The fuel tank has any cracks or fuel cap is missing.</p> <p>Any connection(s) are loose at the tank.</p>
<p>b. Mounting</p> <p>Inspect fuel tank mounting system and barrier (if equipped) for securement and condition.</p>		<p>Any portion of fuel tank mounting system (including support brackets, retaining straps, and chassis frame) is missing, loose, cracked, or broken.</p> <p>Any fuel tank mounting fasteners are loose or missing.</p> <p>Barrier assembly (if originally equipped) is damaged, insecurely mounted, or missing.</p> <p>Fuel tank is not OEM, been modified, or extra tank(s) have been added.</p>
<p>c. Hoses</p> <p>Inspect all fuel lines, hoses, and under-bus fuel system components, for routing, securement, and condition (including vents, fill, and crossover).</p>	<p>EVAP emissions leaks.</p>	<p>Any fuel line or hose is unsecured or is routed subject to excessive heat or abrasion.</p> <p>Any fuel line or hose is deteriorated or damaged (including cracks or any damage which may cause potential leakage) or clamps are loose or missing.</p> <p>Any under-bus fuel system filter, water separator, or other components are insecurely mounted, cracked, or damaged.</p>

	Section D: Under Vehicle Inspection	
Inspection Procedure:	Repair If:	Out of Service If:
<p>8. Fuel System</p> <p>d. Wiring</p> <p>Inspect fuel tank sender unit wiring for securement, routing, and condition.</p>	<p>Any portion of sending unit wiring (including ground) or connections is unsecured or is routed subject to excessive heat or abrasion.</p>	<p>Any wiring or connection has damaged or missing insulation.</p>
<p>e. Electric Fuel Pump</p> <p>Inspect electric fuel pump wiring for securement, routing, and condition.</p>	<p>Any portion of fuel pump wiring (including ground) or connections is unsecured.</p>	<p>Any portion of fuel pump wiring (including ground) or connections is poorly routed or subject to excessive heat or abrasion.</p> <p>Any wiring or connection has damaged or missing insulation.</p>
<p>9. Body to Frame clamps, Insulators, Cowl hold-down bolts</p> <p>a. Body Mounts</p> <p>Inspect for securement and condition of all body mounts, chassis cowl mounts, and frame pads. Body mounts include any J-bolt, U-bolt, shear bolt or clamp type mounts used to secure body to chassis frame.</p>	<p>Padding between frame rails and floor sills is missing or grossly misaligned.</p> <p>Any isolators (donuts) are split, cracked or deteriorated so as not to be effective.</p>	<p>Note: Any combination of the following conditions are found for 25% or more of the body mounts: (if less than 25% then repair)</p> <p>Originally installed body mount or cowl mount is missing.</p> <p>Body mount has missing hardware.</p> <p>Body mount is cracked, damaged or stripped.</p> <p>Body mount is loose or misaligned.</p> <p>Isolators (donuts) are missing.</p>
<p>b. Floor</p> <p>Inspect condition of floor structure, sills, and braces.</p>	<p>There are any minor cracks in floor sills or braces or in welds.</p>	<p>There are any holes or cracks in floor sheet metal creating an opening to the passenger compartment.</p> <p>Entire cross section of any floor sill or brace is broken.</p> <p>There is any broken weld or mounting of a floor sill or brace resulting in complete separation more than one (1) foot in length.</p>

	Section D: Under Vehicle Inspection	
Inspection Procedure:	Repair If:	Out of Service If:
<p>9. Body to Frame clamps, Insulators, Cowl hold-down bolts</p> <p>c. Outriggers Inspect body outriggers and hardware for condition and securement.</p>	<p>Any installed (as required by manufacturer) outrigger is missing.</p> <p>Any body outrigger is cracked, has a broken weld, or has loose or missing hardware.</p>	<p>Outrigger is loose or hanging from bus body.</p>
<p>d. Braces Inspect for condition and securement of all chassis and body braces.</p>	<p>Any bumper brace is broken, cracked, or missing.</p> <p>There is any cracked brace underneath the body.</p>	<p>Braces are loose or hanging from bus body or frame.</p>
<p>e. Skirts Inspect body skirts and gussets for securement and condition.</p>	<p>Any body skirt, brace, or gusset has cracked or broken sheet metal or mounting points.</p>	<p>Any skirt, brace, or gusset is bent, damaged or deformed to the point of being hazardous.</p>
<p>10. Engine and Transmission Mounts</p> <p>a. Engine/Transmission Mounts Inspect engine and transmission mounts for condition and securement.</p>	<p>Replace mount if any of the following conditions exist:</p> <p>Hard rubber surface covered with heat check cracks.</p> <p>Rubber cushion separated from metal plate mount center.</p> <p>Rubber cushion split through the center.</p>	<p>Any mounting fasteners are loose, missing, or broken.</p> <p>Any mount cracked or has missing cushion.</p>
<p>b. Starter Mounting Inspect starter for securement and condition. Check for presence of heat shield (if equipped).</p>	<p>Heat shield is loose or missing (if equipped).</p>	<p>Any starter mounting bolt, stud, or nut loose, damaged, broken, or missing.</p> <p>Starter or heat shield damaged or loose.</p> <p>Note: Heat shield damage or looseness could short positive terminal to ground or damage any other component.</p>

Section D: Under Vehicle Inspection		
Inspection Procedure:	Repair If:	Out of Service If:
<p>11. Brake, Fuel, Cooling and Lubricant Lines</p> <p>Check Fittings, Electrical Connections, Proper routing, condition</p>		
<p>a. Brake hoses</p> <p>1) Inspect flexible brake hoses for condition, securement, and routing.</p>	<p>Separator bracket on dual hoses loose or out of position.</p>	<p>Any brake flex hose or connection is leaking fluid or air pressure.</p> <p>Any brake flex hose is kinked, cracked, collapsed, bulging, has damaged plies or cord, or is damaged below outer covering.</p> <p>Any brake flex hose supporting brackets are damaged or have loose fasteners.</p> <p>Any brake flex hose is rubbing on or routed against other components.</p> <p>Any brake hose fittings are damaged or rusted so as to weaken the crimp.</p>
<p>2) Inspect air and hydraulic brake lines for routing, securement, and condition.</p>	<p>Brake line bracket(s) or securement system is loose or missing and line is not in contact with any other component.</p>	<p>Any brake line is bent, crimped, or damaged restricting or leaking air pressure or hydraulic fluid.</p> <p>Any brake line or connection is leaking air pressure or hydraulic fluid.</p> <p>Any brake line is rubbing on other components or is abraded.</p> <p>Any brake line is not OEM material or DOT approved size or type.</p>
<p>3) Inspect Heater hoses</p>	<p>Heater hoses are cracked, swollen or badly chafed.</p>	<p>Heater hoses are cracked, swollen or badly chafed.</p>

	Section D: Under Vehicle Inspection	
Inspection Procedure:	Repair If:	Out of Service If:
<p>11. Brake, Fuel, Cooling and Lubricant Lines</p> <p>4) Inspect electrical wiring</p>	Rubbing, chafing, damaged, unsecured	Any wire is worn or deteriorated to the point that failure could occur.
5) Inspect hydraulic cooler lines, oil lines, and fittings	Lines or fittings are cracked, chafed, leaking	Lines or fittings are cracked, chafed, leaking
<p>12. Optional Equipment: Auto-Chains, Sanders, Coolant Heaters</p> <p>Inspect for adjustment, leaks and operation</p>	<p>Adjust as needed.</p> <p>Any equipment inoperative.</p>	<p>Any leaks.</p> <p>Exhaust leak, fuel leak, or coolant leak from coolant heater.</p>
<p>13. Exhaust Systems</p> <p>a. Exhaust Leaks:</p> <p>With engine running and at operating temperature, inspect exhaust system for leaks, condition, and securement.</p>	Any physical damage to exhaust system that is adding restriction or back pressure but no leak.	<p>Any leakage which is audible or can be felt around any portion of the exhaust system including manifold(s), pipe sections, or any junction.</p> <p>Any leakage in the DEF or DPF systems.</p>
<p>b. Mounting</p> <p>Inspect mounting of the exhaust system.</p>	<p>Any exhaust system hanger which is not securely mounted.</p> <p>Any originally installed exhaust hanger, which is missing, broken, or detached from exhaust system or frame mounting point.</p> <p>Any exhaust pipe or clamp is loose.</p>	Any clamp is missing.
<p>c. Mufflers</p> <p>Inspect for presence and condition of the muffler.</p>	Significant physical damage to the muffler.	<p>Muffler is leaking.</p> <p>Muffler is missing.</p>

	Section D: Under Vehicle Inspection	
Inspection Procedure:	Repair If:	Out of Service If:
<p>13. Exhaust Systems d. Tailpipe Inspect condition of tailpipe</p> <p>The tailpipe shall be flush with but not extend more than one inch beyond the perimeter of the body for side exit or the bumper for rear exit</p> <p>Inspect condition of the diffuser if equipped.</p>	<p>Any physical damage to tail pipe that is adding restriction or back pressure but no leak.</p> <p>Tailpipe extends more than 1 beyond bumper.</p> <p>Diffuser damaged</p>	<p>Tailpipe is leaking.</p> <p>Tailpipe does not extend at least to edge of rear bumper or rearmost OEM mounting position.</p> <p>Exhaust discharges under occupant compartment.</p> <p>Tailpipe exits the right side of the bus body, beneath any fuel filler location, or beneath any emergency door or lift door</p> <p>Diffuser missing</p>
<p>e. Catalytic converter: Inspect for presence and condition of converter if applicable.</p>	<p>Any physical damage to converter that is adding restriction or back pressure but no leak.</p>	<p>Converter is leaking.</p> <p>Converter is missing.</p>
<p>14. Clutch a. Clutch Operation</p> <p>Check pedal, linkage, clutch, and throw-out bearing for wear, slippage, and abnormal noises in the engaged and released positions.</p>	<p>Loose nuts and bolts.</p> <p>Noisy throw-out bearing.</p> <p>Clutch out of adjustment.</p>	<p>Cannot adjust clutch to specs.</p> <p>Excessively noisy throw out bearing.</p> <p>Clutch slipping, grabbing, or has excessive chatter when engaging clutch.</p> <p>Binding or sticking clutch linkage or return spring.</p> <p>Hard to shift transmission.</p>
<p>b) Pedal Wear Visually check clutch pedal pad for wear.</p>	<p>Worn pedal cover pad.</p>	<p>Missing pedal cover pad.</p>

	Section D: Under Vehicle Inspection	
Inspection Procedure:	Repair If:	Out of Service If:
<p>14. Clutch c) Clutch master and slave cylinders 1) Check for hydraulic leaks and operation (if equipped).</p>		Leaking master or slave cylinder or line and/or inoperable.
<p>2) Clutch Adjustment</p> <p>Check "free play" travel of clutch pedal. This is the first easy movement of clutch pedal and should be no more than 1-1/2 and no less than 3/4 inch travel.</p>	Free play is out of adjustment.	<p>Clutch slips, grabs, or chatters after adjusting "free play" travel.</p> <p>No adjustments can be made (if it is an adjustable clutch).</p>
<p>15. Driveline Retarder (Secondary Braking Systems, e.g. exhaust brake, transmission brake)</p> <p>Check for condition and operation.</p>	Any leaks, missing or broken or inoperative components.	Any component damaged which could result in a vehicle breakdown.
<p>16. Air Brake Chambers a. Brake hoses 1) Inspect flexible brake hoses for condition, securement, and routing.</p> <p>Note: Replacement fittings must be DOT-approved fittings.</p>	Separator bracket on dual hoses loose or out of position.	<p>Any brake flex hose or connection is leaking fluid or air pressure.</p> <p>Any brake flex hose is kinked, cracked, collapsed, bulging, has damaged plies or cord, or is damaged below outer covering.</p> <p>Any brake flex hose supporting brackets are damaged or have loose fasteners.</p> <p>Any brake flex hose is rubbing on or routed against other components.</p> <p>Any brake hose fittings are damaged or rusted so as to weaken the crimp.</p>

	Section D: Under Vehicle Inspection	
Inspection Procedure:	Repair If:	Out of Service If:
<p>16. Air Brake Chambers a. Brake hoses 2) Inspect air brake lines for routing, securement, and condition.</p>	<p>Brake line bracket(s) or securement system is loose or missing and line is not in contact with any other component.</p>	<p>Any brake line is bent, crimped, or damaged, restricting or leaking air pressure or hydraulic fluid.</p> <p>Any brake line or connection is leaking air pressure or hydraulic fluid.</p> <p>Any brake line is rubbing on other components or is abraded.</p> <p>Any brake line is not OEM or DOT compliant material, size, or type.</p>
<p>b. Brake Chambers: Inspect brake chamber assembly(ies) securement, condition, and proper size. Check for caging bolt dust cover/cap. Check that brake chambers match left and right. Check operation of spring brake (parking brake).</p>	<p>Any missing or damaged spring brake caging bolts.</p> <p>Brake chamber dust cover is missing.</p>	<p>Any brake chamber mounting bracket is cracked, bent, or broken.</p> <p>Any brake chamber or mounting fastener is damaged or loose.</p> <p>Any brake chamber is not original size, or size of chambers is not matched left and right (both sides same size).</p> <p>Any leak is detected in chamber.</p> <p>Any wear to chamber or rod (where rod exits chamber).</p> <p>Any spring brake chamber is bent, damaged or corroded and may lose containment of spring.</p> <p>Spring brake won't apply or release.</p>

End of Section



COLORADO
Department of Education
School Finance and
Operations Division

CDE Vehicle Inspection

Procedures, Repair Criteria, & Out of Service Criteria

Section E: Around Vehicle Inspection

	Section E: Around Vehicle Inspection	
Inspection Procedure:	Repair If:	Out of Service If:

Section E. Around Vehicle

E. Around Vehicle 1. Body Condition, Bumpers, Tow hooks, Numbering, Lettering		
a. Body Damage Check body exterior for accident damage, scratches, dents, etc.	<p>Body has small dents, scratches, etc.</p> <p>Body has small rust spots or water leaks.</p> <p>Rubber fender extension is missing, loose, or torn</p> <p>Mud flaps loose, torn, or missing</p>	<p>Any body part damaged or dislocated creating a protrusion or sharp edge.</p> <p>Body panels, rivets, or other components loose, damaged or corroded to the point where joint strength or body structural integrity is compromised.</p> <p>Body panels/parts missing.</p>
b. Bumpers Check bumpers for mounting, condition, color, body seal and end caps (rear bumper).	<p>Bumper end caps missing.</p> <p>Bumper is equipped with unauthorized stickers or decals.</p> <p>Bumper not adjusted properly. (i.e. interferes with hood opening)</p> <p>Bumper not black (bus).</p>	<p>Bumper is bent away from body or has protruding metal.</p> <p>Bumper mounting system has cracked, broken, or bent brackets, braces, welds, or missing or loose fasteners.</p> <p>Bumper is cracked, torn, or broken.</p> <p>Bumper is not OEM or approved type.</p>
c. Paint Check paint on body and trim for required coloration and condition.	<p>Paint is severely faded, discolored, rusted, or damaged.</p> <p>Trim, rub rails, bumpers, warning light hoods or background are not black (buses).</p>	
d. Tow Hooks Inspect for condition.	Loose	Damaged or missing.

	Section E: Around Vehicle Inspection	
Inspection Procedure:	Repair If:	Out of Service If:
<p>1. Body Condition, Bumpers, Tow hooks, Numbering, Lettering</p> <p>e. Reflective Markings (if equipped): Check reflective markings for coloration, reflectivity, condition, and presence around any emergency exit (door, window, or roof hatch) along both sides at floor line and around rear perimeter of bus.</p>	<p>Reflective markings faded, discolored damaged or peeling.</p> <p>Side reflective markings faded, discolored, damaged or peeling.</p>	<p>Any required reflective markings missing.</p> <p>Any emergency exit, roof hatch, or rear perimeter reflective markings missing, faded, or discolored.</p>
<p>f. Lettering: Check all lettering for required type, size, location, and color.</p> <p>Only signs and lettering specifically permitted by state law or regulation and any marking necessary for safety and identification shall appear on the outside of the bus.</p>	<p>Fuel type lettering not present.</p> <p>Any handicapped symbol (if required) is not reflective white on blue background, minimum six inches by six inches (6"x6").</p> <p>Any damaged lettering that is difficult to read.</p>	<p>Bus not equipped with following required lettering in readable condition:</p> <ol style="list-style-type: none"> 1) Eight inch (8") "SCHOOL BUS" front and rear. 2) Five inch (5") minimum school district or service provider name on left and right sides of body. 3) Handicapped symbol on all sides. 4) Minimum two inch (2") lettering "Emergency Door" at top or above door. 5) Emergency door(s) (all years) and emergency window(s) or hatch(es) and labeled "Emergency Exit" or "Emergency Door" on inside and outside. 6) Any required lettering (except handicapped symbol) not black.

Section E: Around Vehicle Inspection		
Inspection Procedure:	Repair If:	Out of Service If:
1. Body Condition, Bumpers, Tow hooks, Numbering, Lettering g. Cleanliness Check exterior of bus for cleanliness.	Exterior is dirty.	Vehicle is dirty to the point visibility through any window or light lens is significantly reduced.
2. Exit Doors a. Main door Inspect door for condition, operation, mounting, and seal	Hinge, door, latch, and/or seal loose, damaged, or difficult to open, but still functional. Lettering (outside) missing	Hinge, door, and/or latch damaged and do not function or are missing.
b. Emergency exit door 1) Inspect door for condition, operation, mounting, and seal 2) Check emergency door for operations from exterior of bus.	Emergency doors equipped with a link or strap that prevents the door from opening too far and causing damage. Link or strap should be working, not damaged, tight, and should not interfere with door operation. Hold open device (if equipped) is non-operational, bent, damaged or loose. Side emergency door seal damaged or does not effectively prevent water and/or dirt from entering bus.	Emergency door(s) difficult to fully open (at least 90 degrees) from outside of bus. Emergency door(s) latch mechanism requires more than 40 pounds of force to release. Emergency door(s) exterior handle is not OEM style and mounting. Rear emergency door seal damaged or does not effectively prevent exhaust, water and/or dirt from entering bus.

	Section E: Around Vehicle Inspection	
Inspection Procedure:	Repair If:	Out of Service If:
<p>3. Component doors, hinges and latches</p> <p>a. Compartment</p> <p>1) Inspect panel(s) and components for mounting, routing and placement. Inspect visible wiring for mounting, condition, chafing/abrasion, corrosion, loose connectors, or improper repairs.</p>	<p>Wiring or connectors are unsecured, corroded, or improperly routed.</p> <p>Any panel or component is not properly mounted or loose but not in danger of shorting or failing.</p>	<p>Any wire or connector cut or severely chafed, or conductor exposed or routed against a sharp edge and in danger of shorting or failing.</p> <p>Any connection of any connector not secure and in danger of shorting or failing.</p> <p>Any panel or component not properly mounted or loose and in danger of shorting or failing.</p> <p>Any component or circuit not protected by a fuse, circuit breaker or fusible link.</p>
<p>2) Inspect compartment light(s) for condition and operation.</p>	<p>Light does not function, or lens is missing or damaged.</p>	<p>Damage or condition that could result in a short.</p>
<p>b. Door</p> <p>Inspect door for condition, operation, mounting, and seal</p>	<p>Hinge, door, latch, and/or seal loose or damaged but still functional.</p> <p>Lettering (outside) or wiring diagram (inside) missing</p>	<p>Hinge, door, and/or latch damaged and do not function or are missing.</p>
<p>c. Engine Hood</p> <p>1) Check engine hood for operation, condition, and safety latch.</p> <p>2) Check operation of starter interlock switch if applicable (rear engine).</p>	<p>Hood or hood latch is misaligned, out of adjustment, loose or damaged.</p> <p>Fiberglass hoods, fender extensions and/or cowls show signs of unusual wear.</p> <p>Any hood socket, rubber cone or wedge, or hinge is missing, loose or damaged.</p> <p>Any rubber/plastic hood bumper or gasket is missing, loose or damaged.</p> <p>Any hood hold open feature (rod, strut, self-locking support, etc.) is missing, loose or damaged.</p>	<p>Hood cannot be opened as designed.</p> <p>Hood latch does not secure hood.</p> <p>Hood support cables are loose, broken, or missing (tilt hood).</p> <p>Interlock switch does not function as designed or has been bypassed.</p>

Section E: Around Vehicle Inspection		
Inspection Procedure:	Repair If:	Out of Service If:
<p>3. Component doors, hinges, latches</p> <p>d. Windshield Folding Steps and Grab Handles Check condition and mounting of windshield folding steps and grab handles.</p>	<p>Any windshield step or grab handle is loose or missing.</p> <p>Folding steps do not operate properly.</p>	<p>Any windshield step or grab handle is broken.</p>
<p>4. Exterior Lights, Mirrors, Reflectors <u>All required lighting devices and reflectors shall be operable to pass annual inspection.</u></p> <p>a. Headlights</p> <p>1) Check all headlights for brightness, operation, condition of sealed beams, type and visible misalignment.</p> <p>2) Check Daytime Running Lights (if equipped) for proper operation.</p>	<p>Left and right sealed beams are of different type (halogen vs. conventional).</p> <p>Trim rings not present.</p> <p>Upon visible inspection, there is any obvious misalignment of headlights due to adjustment.</p> <p>Daytime Running Lights fail to function properly.</p> <p>Visible condensation inside sealed beam headlight assembly.</p>	<p>Either sealed beam does not light on low and high.</p> <p>Any sealed beam lens fogged, cracked, or light is dim.</p> <p>Lights go out after being on a short time, or operation is intermittent.</p> <p>Upon visible inspection, there is any obvious misalignment of headlights due to loose, damaged, or missing adjustment or mounting hardware.</p>
<p>3) Check high beam indicator operation</p>	<p>High beam indicator doesn't light.</p>	
<p>4) Check dimmer switch</p>	<p>Dimmer switch sticks, difficult to operate.</p>	<p>Dimmer switch doesn't function.</p>
<p>5) Check headlight switch.</p>	<p>Headlight switch is damaged, not securely mounted, or knob is missing.</p>	<p>Headlight switch does not function</p>
<p>6) Dash light brightness control.</p>	<p>Inoperative and dash lights illuminate.</p>	<p>Inoperative and dash lights do not illuminate.</p>

Section E: Around Vehicle Inspection		
Inspection Procedure:	Repair If:	Out of Service If:
<p>4. Exterior Lights, Mirrors, Reflectors</p> <p>b. Turn Signals Check turn signals and lenses for operation, condition, and specifications.</p>	<p>Any front, rear, or side-mounted turn signal lens is cracked and white light is visible.</p> <p>Turn signal indicators do not properly indicate right and left signal.</p> <p>Turn signal switch does not cancel or return to neutral position.</p>	<p>Any front, rear, or side-mounted turn signal does not flash or is dim.</p> <p>Turn signal does not flash between 60 and 120 times per minute.</p> <p>Turn signal switch does not initiate turn signals or will not maintain set position.</p> <p>Any front mounted turn signal lens not amber.</p> <p>Any turn signal lens has darkened, faded, or is dirty significantly affecting visibility or color of the light.</p> <p>Any front, rear, or side-mounted turn signal lens is damaged, and white light is visible.</p>
<p>c. Hazard lights Check four-way hazard lights and lenses for operation and condition.</p>	<p>Any lens cracked or dirty.</p> <p>Either indicator fails to function properly.</p>	<p>Any four-way hazard light fails to function. Hazard lights do not flash between 60 and 120 times per minute.</p> <p>Switch does not function or (pre-1995) will not maintain set position when steering wheel is turned.</p> <p>Switch damaged, not securely mounted, or knob/button is missing.</p>
<p>d. Stepwell Lights</p> <p>Check for operation of stepwell lights (interior and exterior).</p>	<p>Either stepwell light fails to operate.</p>	

	Section E: Around Vehicle Inspection	
Inspection Procedure:	Repair If:	Out of Service If:
<p>4. Exterior Lights, Mirrors, Reflectors e. Brake Lights Check brake lights and lens(es) for operation, condition, and specifications.</p>	<p>Any brake light lens cracked and white light visible.</p> <p>High mount brake light fails to function (if equipped).</p>	<p>After brake pedal is released, brake light switch sticks, or lights stay on.</p> <p>Any brake light lens damaged and white light is visible.</p> <p>Any brake light lens not red or not proper type meeting SAE specification or lens has darkened, faded, or is dirty, significantly affecting visibility or color of the light.</p>
<p>f. Tail Lights Check tail light(s) and lens(es) for operation, condition, and specifications.</p>	<p>Any tail light lens cracked and white light visible.</p>	<p>Any tail light lens damaged and white light is visible.</p> <p>Any tail light lens not red or is not proper type meeting SAE specifications.</p> <p>Any tail light lens has darkened, faded, or is dirty, significantly affecting the visibility or color of the light.</p>
<p>g. Backup Lights Check backup lights and lens(es) for proper operation and condition.</p>	<p>One of the installed backup lights (2 light system) fails to function.</p> <p>Any backup lens is cracked.</p>	<p>All the installed backup lights fail to function.</p> <p>Backup light(s) stays on all the time or stays on in any gear position other than reverse.</p>

	Section E: Around Vehicle Inspection	
Inspection Procedure:	Repair If:	Out of Service If:
<p>4. Exterior Lights, Mirrors, Reflectors h. Backup Alarm</p> <p>1) Check for presence of back up alarm.</p> <p>2) Check operation of alarm by placing transmission in reverse (automatic transmission - engine running) and listening for alarm sound.</p>	<p>Alarm mounting loose.</p> <p>Backup alarm does not sound (if equipped).</p>	
<p>i. Park Lights</p> <p>Check park lights and lens(es) for proper operation and condition.</p>	<p>Park light(s) fail to function.</p> <p>Any park light lens is cracked or damaged.</p>	
<p>j. Clearance and Marker lights</p> <p>Check light(s) and lens(es) for operation, condition, and location.</p>	<p>When viewed from front, rear, or side more than one light is not working.</p> <p>Any clearance lens is not amber if in front of the rear wheels or red if at or behind the rear wheels.</p> <p>Any clearance light lens has darkened, faded, or is dirty, significantly affecting the visibility or color of the light.</p> <p>Any clearance light switch is hard to operate, sticks, or knob is missing.</p> <p>Any clearance light lens is damaged or white light is visible.</p>	<p>When viewed from front, rear, or side: none of the lights are working when viewed from that direction.</p>

	Section E: Around Vehicle Inspection	
Inspection Procedure:	Repair If:	Out of Service If:
<p>4. Exterior Lights, Mirrors, Reflectors k. License plate light(s) 1) Check license plate and light(s) and lens(es) for condition and operation.</p>	<p>License plate light(s) inoperative. License plate loose not legible or missing.</p>	
<p>l. Strobe Light Check roof mounted white flashing strobe light for operation, location, condition and protective guard.</p>	<p>Protective guard is loose. (if equipped) Strobe light is missing or does not function. (if equipped)</p>	
<p>m. Reflectors Check reflectors for condition and location.</p>	<p>Any OEM installed reflector on either side, front, or rear of bus is missing, loose, damaged, cracked, or faded.</p>	
<p>n. Student Warning Lights Check student warning lights for operation and condition (see Chart).</p>	<p>Either student warning light pilot light fails to function. Any student warning light hood is damaged but does not obstruct visibility of the light. Any student warning light hood is missing.</p>	<p>Any amber or red light does not function. Amber/red lights (front and rear) do not alternately flash (side to side). Any student warning light is not red (outer) or amber (inner) or is not proper type. Any student warning light lens is damaged, and white light is visible or is not proper type. Any student warning light lens has darkened, faded, is misaligned or dirty, affecting the color of the light or reducing the visibility to less than 500 feet in bright sunlight. Student warning lights do not function according to all conditions in Chart. Any student warning light hood is damaged so that it obstructs visibility of the light.</p>

Section E: Around Vehicle Inspection		
Inspection Procedure:	Repair If:	Out of Service If:
<p>4. Exterior Lights, Mirrors, Reflectors</p> <p>o. Mirrors Check all exterior mirrors, mounting and brackets for tightness and condition.</p>	<p>Mirror brackets bent or broken or mounting insecure and mirror will remain properly adjusted.</p> <p>Damage to the reflective material of the mirror's surface.</p>	<p>Mirror brackets bent or broken or mounting insecure and mirror will not stay in adjusted position or cannot be adjusted.</p> <p>Cross view mirrors do not extend beyond leading edge of the vehicle.</p>
<p>5. Batteries and Tie-downs</p> <p>a. Batteries Check for condition and type.</p>	<p>Batteries are wrong type for vehicle, or in multi battery sets are not matched.</p> <p>Battery top or sides corroded, greasy, dirty or wet with electrolyte.</p> <p>Electrolyte is low (if applicable).</p>	<p>Battery cracked or damaged.</p> <p>Battery will not start vehicle.</p>
<p>b. Tie-down Check for tightness, condition, and type of battery hold-down.</p>	<p>Tie-down assembly or tray corroded or damaged but battery is secure.</p>	<p>Tie-down assembly or tray loose, corroded, or damaged causing insecure mounting of battery.</p> <p>Tie-down is a flexible strap or other non-rigid design.</p> <p>Tie-down/Batteries are mounted and could short out against tie-down and/or a body/chassis component.</p>
<p>c. Battery Terminals Check terminals for type, cleanliness, tightness, and condition.</p>	<p>Terminals are dirty, corroded or loose and/or have missing parts.</p>	
<p>d. Battery Cables Check cable assemblies for routing, securement, condition, and size.</p>	<p>Cable is corroded.</p> <p>Negative cable or insulation cracked or damaged.</p> <p>Negative cable is misrouted, unsecured, or grommet is missing to allow it to abrade on any metal or sharp edge.</p> <p>Cable appears to be of excessive length.</p> <p>Flat braided engine ground cable is frayed, corroded.</p>	<p>Positive cable insulation is cracked or damaged.</p> <p>Positive cable is misrouted, unsecured, or grommet is missing to allow it to abrade on any metal or sharp edge.</p> <p>Cable is routed against the exhaust or any other extremely hot surface.</p> <p>Cable is smaller than original equipment size.</p> <p>Flat braided engine ground cable ends are not secure.</p>

	Section E: Around Vehicle Inspection	
Inspection Procedure:	Repair If:	Out of Service If:
<p>e. Battery Tray Check battery tray for operation, condition, and securement.</p>	<p>Battery slide tray is corroded or dirty, or hard to slide in and out.</p>	<p>Battery slide tray securement device or tray stop is missing or nonfunctional.</p> <p>Battery tray does not slide in and out.</p> <p>Battery slide tray or box is damaged or deteriorated reducing security of battery(ies).</p> <p>Battery box door does not open or will not stay latched.</p>
<p>6. Stop Arm, Student Crossing Arm, Child Safety Alarm</p> <p>a. Stop Arm</p> <p>Check stop arm for specifications, operation, and condition (see Chart).</p>	<p>Wiring-ground strap is loose or not properly routed and secured.</p> <p>Any lens is cracked and no white light is visible.</p> <p>Ground strap is broken.</p> <p>Hinge or bushing(s) is worn or needs lubrication.</p> <p>Stop arm assembly or blade mounting is loose.</p> <p>Retraction is slow.</p> <p>Any stop arm (paint or decal) is significantly faded or discolored.</p>	<p>Wiring: insulation missing exposing copper or wire(s) is broken.</p> <p>Any lens is cracked, damaged, broken, or missing and white light is visible.</p> <p>Any stop arm light does not flash or does not flash between 60 and 120 times per minute.</p> <p>Any light does not function.</p> <p>Lights do not flash alternately.</p> <p>Stop arm does not extend to approximately 90° (degrees) or retract.</p> <p>Any stop arm has an air or vacuum leak.</p> <p>Stop arm not of proper type and specifications:</p> <ol style="list-style-type: none"> 1) Octagonal, red w/ white border (all). 2) Flashing red lights (all). 3) High intensity reflectivity.

Section E: Around Vehicle Inspection		
Inspection Procedure:	Repair If:	Out of Service If:
<p>6. Stop Arm, Student Crossing Arm, Child Safety Alarm</p> <p>b. Student Crossing Arm (if equipped)</p> <p>Check front bumper mounted student crossing arm for operation, condition, and mounting.</p>	<p>Hinge or bushing(s) is worn or needs lubrication.</p> <p>Arm assembly or blade mounting is loose.</p> <p>Loop-rod/arm is distorted, or U-bolts are loose.</p> <p>Blade is not approved type.</p>	<p>Arm does not extend to approximately 90° (degrees) and retract.</p> <p>Any arm has an air or vacuum leak.</p> <p>Arm does not operate according to all the conditions in Chart 1.</p> <p>Loop-rod/arm is missing or broken.</p>
<p>c. Child Safety Alarm (if equipped)</p> <p>Check operation of child safety alarm.</p>	<p>Does not activate automatically when stop arm/crossing gate begin retraction.</p> <p>Does not deactivate automatically after a brief time period.</p> <p>Does not operate as described in chart.</p>	

	Section E: Around Vehicle Inspection	
Inspection Procedure:	Repair If:	Out of Service If:

Chart E-1. Service Door, Stop Arm, Amber and Red Warning Lights

CHART D-1. SERVICE DOOR, STOP ARM, AMBER AND RED WARNING LIGHTS							
CONTROL SWITCH, and SERVICE DOOR IN THE FOLLOWING POSITIONS:			CONDITION OF STOP ARM(S), STOP ARM LIGHTS, AMBER WARNING LIGHTS AND RED WARNING LIGHTS MUST BE:				
ITEM	MOMENTARY SWITCH POSITION (ON or OFF)	SERVICE DOOR POSITION	STOP ARM, STOP ARM LIGHTS	AMBER WARNING and PILOT LIGHTS	RED WARNING and PILOT LIGHTS	CROSSING CONTROL ARM	CHILD SAFETY ALARM (IF EQUIPPED)
1	OFF	CLOSED	RETRACTED, OFF	OFF	OFF	RETRACTED	OFF
2	OFF	OPEN	RETRACTED, OFF	OFF	OFF	RETRACTED	OFF
3	ON	CLOSED	RETRACTED, OFF	ON	OFF	RETRACTED	OFF
3.1	OFF	OPEN	EXTENDED, ON	OFF	ON	EXTENDED	OFF
3.2	OFF	CLOSED	RETRACTED, OFF	OFF	ON	RETRACTED	ON
3.3	OFF	CLOSED	RETRACTED, OFF	OFF	OFF	RETRACTED	OFF
4	FAIL-SAFE ON	EITHER	EXTENDED, ON	OFF	ON	EXTENDED	OFF
<p>Items 3 through 3.3 are to occur in sequence once the system momentary switch is activated. By opening and closing the door control, the rest of sequence 3.3 will automatically occur after a brief time delay.</p>							

	Section E: Around Vehicle Inspection	
Inspection Procedure:	Repair If:	Out of Service If:

<p>7. Wheelchair Lift, Door & Securement System</p> <p>a. Operate lift through complete cycle and inspect for proper operation, condition, safety features, manual backup system, fluid leaks, mounting, barrier operation, warning light, buzzer operation, and overall mechanical condition. Check that vehicle does not go into gear with lift deployed.</p> <p>As of July 2005, FMVSS 403 requires the following additional safety features and design elements on passenger-and-wheelchair lifts:</p> <ul style="list-style-type: none"> • Handrails • Threshold warning signal • Retaining barriers • Interlocks ("to prevent accidental movement of a lift and the vehicle on which a lift is installed") • Minimum platform dimensions • Maximum size limits for platform protrusions and gaps between the platform and the vehicle floor or ground <p>FMVSS 404 requires vehicles to use FMVSS 403-compliant lifts that are installed according to manufacturer instructions, and that commercial vehicles use lifts with certain size and cyclic-load requirements.</p>	<p>Dome light at inside lift area is inoperative.</p> <p>Lift door or latch does not smoothly operate.</p> <p>Evidence of fluid leaks.</p> <p>Light at exterior of lift is operative (if equipped).</p> <p>Lift control cable or wiring is damaged or routed improperly.</p>	<p>Lift platform end barrier or handrail (if equipped) does not raise and lower reliably to the proper position. Barrier does not lock into position or is damaged.</p> <p>Lift does not fold, unfold, raise and lower properly, or jerks and binds.</p> <p>Lift is not mounted securely to the vehicle.</p> <p>There is excessive side play in the lift mechanism when the platform is partially or fully extended.</p> <p>Door switch (to prevent lift operation when the lift door is closed), or other safety override features do not function.</p> <p>Any part of the lift mechanism or hardware is damaged, missing, or not secure including cams, clips, pins, rollers, and platform fasteners.</p> <p>Manual backup system does not function properly.</p> <p>Lift cylinders, hoses, pump, etc. leak.</p>
--	--	--

	Section E: Around Vehicle Inspection	
Inspection Procedure:	Repair If:	Out of Service If:
7. Wheelchair Lift, Door & Securement System b. Lift Buzzer: Operation according to specifications.		Lift door warning buzzer or light does not operate according to specifications.
c. Wheelchair Lift, Door & Securement System Symbols	Missing or damaged.	

	Section E: Around Vehicle Inspection	
Inspection Procedure:	Repair If:	Out of Service If:
<p>8. Slack Adjusters and Pushrods</p> <p>a. Slack Adjusters</p> <p>Inspect slack adjusters and S-cam assemblies for wear, condition, operation, and securement.</p>		<p>Slack adjuster is not mounted properly, or anchor bracket is loose or damaged (Haldex).</p> <p>Any portion of slack adjuster or S-cam is missing, broken, cracked, or badly worn.</p> <p>S-cam shaft and/or S-cam bushing total wear (up and down) is greater than .030 inch.</p> <p>Manual adjusters have a problem with the locking mechanism on the adjusting bolt.</p> <p>S-cam snap ring is broken or missing.</p> <p>Any slack adjuster is not adjusted or operating properly.</p>
<p>b. Pushrods</p> <p>Inspect pushrod assembly(ies) for condition, securement, and alignment.</p> <p>Check and record brake chamber pushrod travel at all four-wheel positions</p>	<p>Auto slack does not self-adjust.</p>	<p>Any portion of pushrod assembly (locknut, pushrod, clevis and pin, or cotter pin) is loose, missing, or damaged.</p> <p>Pushrod is rubbing against body of chamber, or chamber is misaligned.</p> <p>Pushrod on left and right sides are not mounted in identical (same) slack adjuster location hole (same effective slack adjuster length).</p> <p>Pushrod length is not the same on each side.</p> <p>Any damage or condition, which prevents proper adjustment of S-cam.</p> <p>Adjusted stroke (pushrod travel) of any slack adjuster is at or beyond stroke limits in chart.</p>

	Section E: Around Vehicle Inspection	
Inspection Procedure:	Repair If:	Out of Service If:

Chart E-2. Measuring Push Rod Travel

Brake chamber push rod travel shall not exceed those specifications relating to maximum stroke at which brakes should be readjusted. Performance of the brake push rod travel inspection should be done with the brake application air pressure in the range of 80-90 pounds per square inch {psi), when measuring total stroke to determine proper brake adjustment.

CAUTION: Chock wheels before commencing this Inspection as vehicle emergency brake(s) must be released.

- 1) With brakes off mark push rod at chamber. 2) Apply brakes, measure distance of mark from chamber.

Note: When brakes properly adjusted and fully applied, slack adjuster should be at an angle of 90° or greater, measured from centerline of adjuster to push rod.

"Long Stroke" Clamp-Type Brake Chamber Data				"Standard Stroke" Clamp-Type Brake Chamber Data			
Type	Outside Diameter	Brake Adjustment Limits (inches)		Type	Outside Diameter	Brake Adjustment Limits (inches)	
16	6-3/8	2.0	Should be as short as possible without lining-to-drum contact	6	4-1/2	1-1/4	Should be as short as possible without lining-to-drum contact
20	6-25/32	2.0		9	5-1/4	1-3/8	
24	7-7/32	2.0		12	5-4/16	1-3/8	
24*	7-7/32	2.5		16	6-3/8	1-3/4	
30	8-3/32	2.5		20	6-25/32	1-3/4	
				24	7-7/32	1-3/4	
			30	8-3/32	2		
			36	9	2-1/4		

* For 3" maximum stroke type 24 chambers

	Section E: Around Vehicle Inspection	
Inspection Procedure:	Repair If:	Out of Service If:

Chart E-3. Air Brake Adjustment Chart

AIR BRAKE ADJUSTMENT CHART	
Chamber Type	Maximum Legal Stroke
12	1 3/8 inches
16	1 3/4 inches
24	1 3/4 inches
30	2 inches

Section E: Around Vehicle Inspection		
Inspection Procedure:	Repair If:	Out of Service If:
<p>9. Tires</p> <p>Check for condition, wear, damage, inflation, tread depth, matching</p>	<p>Note any tire wear. Weather checked.</p>	<p>Damage that would result in failure.</p> <p>Has a cut where the ply or belt material is exposed. Tires not matching.</p> <p>Has body ply or belt material exposed through the tread or sidewall.</p> <p>Has any tread or sidewall separation.</p> <p>A tube-type radial tire without radial tube stem markings. These markings include a red band around the tube stem, the word “radial” embossed in metal stems, or the word “radial” molded in rubber stems.</p> <p>Boot, blowout patch or other ply repair.</p>
<p>10. Tire inflation</p> <p>Check for inflation PSI as observed.</p> <p>(If replacing the OEM tires, check the vehicle placard, owner’s manual or tire guide for recommended air pressure.)</p>	<p>Adjust if under or over inflated.</p>	<p>More than 10 Psi low.</p> <p>Obvious leak.</p> <p>Flat.</p>
<p>11. Tire Tread Depth</p> <p>Check that tread depth meets minimum requirement.</p>	<p>Tread depth will not remain in compliance until the next service.</p>	<p>Steer tires measure less than 4/32nds. Drive tires measure less than 2/32nds.</p>
<p>12. Wheels</p> <p>Check size, width, type, valve stems, studs, lug nuts.</p>	<p>Any wheel component damaged.</p>	<p>Any wheel component damaged. Cracked or broken or has elongated bolt holes. Any loose, missing, broken, cracked, stripped or otherwise ineffective fasteners. Any welded repair.</p>

	Section E: Around Vehicle Inspection	
Inspection Procedure:	Repair If:	Out of Service If:

Chart E-4. Tire Wear

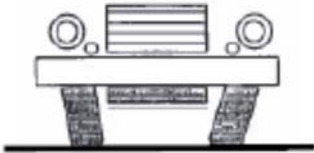
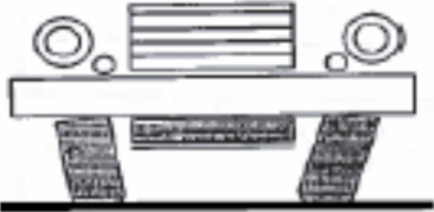
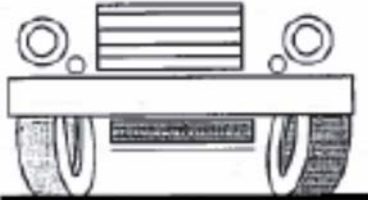
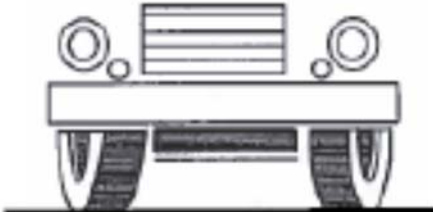
<p style="text-align: center;">Uneven Tire Wear</p> <p>The following conditions may cause spotty or uneven wear:</p> <ul style="list-style-type: none"> • Unequal caster or camber • Bent suspension parts • Wheels out-of-balance • Out of round brake drums • Brakes drag • Other mechanical conditions <p>Locate the mechanical condition that causes uneven wear.</p> <p>Correct the condition.</p>	<p style="text-align: center;">Misalignment Wear</p> <p>Too much toe-in or toe-out on the front axle tires causes misalignment wear. The tires revolve with a side motion, which scrapes off the tread rubber.</p> <p>The scraping action against the face of the tire causes a small feather edge of rubber to appear on one side of the tread. This feathering is an indication of misalignment.</p> <p>If misalignment is severe, rubber will be scraped off both tires. If misalignment is slight, only one tire will be affected.</p> <p>In order to correct misalignment, adjust toe-in or verify that entire front-end alignment settings are correct. Refer to Front Toe Adjustment In Front Wheel Alignment.</p>	<p style="text-align: center;">Side wear</p> <p>Side wear may be caused by the following:</p> <ul style="list-style-type: none"> • Incorrect wheel camber • Under inflation • High cambered roads • Excessive cornering speed <p>Incorrect wheel camber and under-inflation are the most common causes of side wear.</p> <div style="text-align: center;">  </div>
<div style="text-align: center;">  </div>	<div style="text-align: center;">  </div>	<div style="text-align: center;">  </div>

	Section E: Around Vehicle Inspection	
Inspection Procedure:	Repair If:	Out of Service If:
<p>13. Linings Drums, and Brake Components a. Check linings, drums, and brake components. Inspect linings and foundation brake hardware for contamination, wear, damage, and securement.</p>		<p>Loose, missing or broken mechanical components including: shoes, linings, pads, spring, anchor pins, spiders, cam rollers, pushrods, and air chamber mounting bolts.</p> <p>Brakes worn beyond allowable limits.</p> <p>Cracked. Loose or missing liners.</p> <p>Oil or grease contamination.</p> <p>Audible air leaks at brake chamber.</p>
<p>b. Brake Rotors Inspect brake rotor(s) for mounting, thickness, and condition.</p>	<p>Glazed or out of round.</p>	<p>Rotor mounting not secure.</p> <p>Rotor has cracks (other than heat checks) or other mechanical defects.</p> <p>Friction surface contaminated with oil, grease, or brake fluid.</p> <p>Any rotor friction surface significantly grooved or damaged.</p>
<p>c. Drums Inspect the brake drum(s) for condition.</p>	<p>Glazed or out of round.</p>	<p>Any crack (other than heat checks) in any drum.</p> <p>Any grease, oil, or brake fluid on inside of drum.</p> <p>Drum not secure to hub, or fasteners are loose.</p>
<p>d. Wheel Cylinders or Calipers Inspect wheel cylinder(s) or caliper(s) for leaks, mounting, and condition.</p>	<p>Any caliper dust boot is damaged or missing.</p>	<p>Any wheel cylinder or caliper is not securely mounted or has loose or missing fasteners.</p> <p>Any wheel cylinder or caliper is leaking.</p> <p>There is uneven lining or pad wear, rotor or drum damage, or evidence of dragging, or other evidence that any wheel cylinder or caliper may be sticking.</p>

Section E: Around Vehicle Inspection		
Inspection Procedure:	Repair If:	Out of Service If:
<p>14. Wheel Seals</p> <p>Check front and rear wheels seals for leakage.</p>	<p>Seepage.</p>	<p>Leaking.</p>
<p>15. Hydraulic Brakes</p> <p>a. Hydraulic Wheel Cylinders or Calipers</p> <p>Inspect wheel cylinder(s) or caliper(s) for leaks, mounting, and condition.</p>	<p>Any caliper or wheel cylinder dust boot is damaged or missing.</p>	<p>Any wheel cylinder or caliper is not securely mounted or has loose or missing fasteners.</p> <p>Any wheel cylinder or caliper is leaking.</p> <p>There is uneven lining or pad wear, rotor or drum damage, or evidence of dragging, or other evidence that any wheel cylinder or caliper may be sticking.</p>
<p>b. Brake Lines</p> <p>Inspect hydraulic brake lines for routing, securement, and condition.</p>	<p>Brake line bracket(s) or securement system is loose or missing and line is not in contact with any other component.</p>	<p>Any brake line is bent, crimped, or damaged restricting or leaking hydraulic fluid.</p> <p>Any brake line or connection is leaking hydraulic fluid.</p> <p>Any brake line is rubbing on other components or is abraded.</p> <p>Any brake line is not OEM material, size, or type.</p>

	Section E: Around Vehicle Inspection	
Inspection Procedure:	Repair If:	Out of Service If:
<p>15. Hydraulic Brakes</p> <p>c. Hydrovac Booster (vacuum type) Inspect booster system for securement and condition.</p>		<p>Any visible hydraulic brake fluid leakage.</p> <p>Any audible vacuum leakage.</p> <p>Any brake line or vacuum hose is routed subject to excessive heat or abrasion.</p> <p>Any brake line or hose deteriorated or damaged that failure may occur (cord frayed, wall thickness thin, rubber contaminated with oil, crimped, blistered, cracked, rusted, corroded)</p> <p>Any brake line or hose connection is loose.</p> <p>Any booster not mounted securely, cracked or damaged.</p> <p>Any vent port not properly plumbed or is obstructed or filter is clogged.</p>
<p>d. Hydraulic Booster Inspect booster system for securement and condition. Check for fluid leaks.</p>		<p>Any visible fluid leak.</p> <p>Any booster not mounted securely, cracked or damaged.</p> <p>Any brake line deteriorated or damaged that failure may occur.</p>
<p>e. Reservoir Mounting Inspect reservoirs (vacuum tanks) for securement and condition.</p>		<p>Any reservoir mounting strap or fastener is cracked, loose, or missing.</p> <p>Any leaking, damaged, or cracked tank.</p>
<p>f. Brake Adjustment: 1) For hydraulic drum brakes, check condition.</p>		<p>Any damage or condition, which prevents proper adjustment of hydraulic drum brakes.</p>

Section E: Around Vehicle Inspection		
Inspection Procedure:	Repair If:	Out of Service If:
16. Brake shoe / pad lining Measure shoes or pads per manufacture procedure/industry standard and document		Below manufacturer specification
17. Brake drum / rotor reading Check for condition and integrity. Document manufacturer specification, measurements at previous annual, and current measurements.		
18. Air Disc Brake pad to rotor clearance Measure and document pad to rotor clearance	Clearance does not meet manufacturer's specification.	Clearance does not meet manufacturer's specification.
19. Post inspection road test Record any abnormalities during road test:		
a. Ignition / Starting Check for starting, proper idle, stalling.	Rough or low idle.	Engine will not start or is difficult to start. Engine stalls. Starter drags, noisy or does not engage properly. Teeth missing from Bendix or flywheel.
b. Engine operation Check for missing or hesitation, performance when accelerating and excessive smoke. Check engine for any unusual noises, knocks, or rattles.	Engine smoking abnormally. Noise source determined not to be harmful to engine.	Engine is misfiring, skipping, or there is excessive hesitation upon acceleration. Source of noise could result in engine failure.

Section E: Around Vehicle Inspection		
Inspection Procedure:	Repair If:	Out of Service If:
c. Note oil pressure indication		Oil pressure not normal Oil pressure malfunction light illuminated.
d. Check governor performance and shutdown of engine.		Engine will not shut down. Governor does not limit engine rpm.
e. Clutch		Any unusual noise or vibration is observed.
f. Transmission		Any unusual noise or vibration is observed.
g. Steering		Any unusual noise or vibration is observed.
h. Brakes		Any unusual noise or vibration is observed.
i. Heaters Inspect heater system for: 1) Heating performance and water control valve (interior).	Not producing adequate heat. Water control valve hard to operate.	Leaking

End of Section



CDE Vehicle Inspection

Procedures, Repair Criteria, & Out of Service Criteria

Section T: Trailer Inspection

	Section T: Trailer Inspection	
Inspection Procedure:	Repair If:	Out of Service If:

Section T: Trailer Inspection

Section T: Trailers 1. Pre-inspection Road Test Check for proper tracking. Check for brake pull. Check that wheels are true.	Wheel wobble.	Any brake pull or tracking issues.
a. Trailer Damage Check body exterior for accident damage, scratches, dents, etc.	Trailer has small dents, scratches, etc. Trailer has small rust spots or water leaks. Mud flaps loose, torn, or missing (if equipped).	Any body part damaged or dislocated creating a protrusion or sharp edge. Trailer body panels, rivets, or other components loose, damaged or corroded to the point where joint strength or body structural integrity is compromised. Trailer body panels/parts missing.
2. Lights Check all lights, lenses and reflectors:		
a. Brake lights	Light dim or intermittent. Less than full illumination.	Light inoperative.
b. Tail lights	Light dim or intermittent. Less than full illumination.	Light inoperative.
c. Turn Signals	Light dim or intermittent. Less than full illumination.	Light inoperative.
d. Clearance lights	Light dim or intermittent. Less than full illumination.	Light inoperative.
e. License plate lights	Light dim or intermittent. Less than full illumination.	Light inoperative.
f. Interior dome lights	Light dim or intermittent. Less than full illumination.	Light inoperative.
g. Optional lighting	Light inoperative.	
h. Lenses	Lens cracked.	Lens broken.
i. Reflectors		Reflector broken or missing.
j. Reflective tape	Damaged	Missing

	Section T: Trailer Inspection	
Inspection Procedure:	Repair If:	Out of Service If:
3. License Plate, registration, CDE inspection paperwork, insurance documents Check for current and valid license plate and paperwork for specific trailer.		Missing or expired paperwork.
4. Hitch Coupler Check hitch coupler components for condition and operation:		
a. Ball latch system	Damage.	Broken or inoperative.
b. Safety Chains and connections	Damage.	Broken or inoperative.
c. Safety Pins	Damage.	Broken or inoperative.
d. Electrical plug and cable	Damage.	Broken or inoperative.
5. Trailer Jack System Check for operation, condition, mounting or damage.	Damage.	Broken or inoperative.
6. Break-Away Braking System Check break-away braking system components for condition and operation.		Broken, inoperative, or missing breakaway braking device.
a. Indicator light	Light inoperative.	Damage or defect.
b. Battery condition	Needs charge; dirty, loose, or corroded terminals; wet cells that need to be topped off; or not properly secured.	Battery that tests bad.
c. Switch cable	Frayed.	Broken.

	Section T: Trailer Inspection	
Inspection Procedure:	Repair If:	Out of Service If:
<p>7. Electric Braking System Check electric braking system components for condition and operation.</p>	<p>Frayed, unsecured, or weathered wires; loose or corroded connections; junction box condition.</p> <p>Surface of magnets is not grooved or worn beyond manufacturer's specifications.</p> <p>Magnets are unsecured.</p>	<p>Broken wires or inoperative magnets.</p> <p>Absence of braking action on any wheel required to have brakes.</p>
<p>8. Hydraulic Braking System Check hydraulic braking system components for condition and operation.</p>	<p>Brake lines are bent or rubbing.</p> <p>Wheel cylinder or caliper dust cover are torn.</p>	<p>Absence of braking action on any wheel required to have brakes.</p> <p>Brake lines are leaking, broken, or restricted.</p> <p>Wheel cylinder or caliper are leaking or unsecured.</p> <p>Surge components are frozen or inoperative.</p>
<p>9. Brake Shoe/Pad Lining Check condition and document measurements. (Measure from the shoe table.)</p> <p>Inspect linings and foundation brake hardware for contamination, wear, damage, and securement.</p>		<p>Lining at or below manufacturer's minimum specification.</p> <p>Lining or rivets loose.</p> <p>Lining contaminated, cracked, or has adverse wear.</p> <p>Oil or grease contamination.</p> <p>Loose, missing or broken mechanical components including: shoes, linings, pads, spring, or anchor pins.</p>
<p>10. Brake Drum/Rotor Check condition and document measurements.</p>	<p>Excessive run out</p>	<p>Measurement at or below manufacturer's minimum Specification.</p> <p>Drum or rotor cracked.</p>

	Section T: Trailer Inspection		
Inspection Procedure:	Repair If:	Out of Service If:	
<p>11. Tires Inspect for load range, tread depth, valve stems, condition, wear, and damage.</p> <p>All tires inflation pressure: _____ psi</p> <p>Spare tire inflation pressure: _____ psi</p>	<p>Tread depth nearly minimum</p> <p>Missing valve caps</p> <p>Weather checked.</p>	<p>Tread depth below minimum.</p> <p>Damage to tires or valve stems, or damage that would result in failure.</p> <p>Has body ply or belt material exposed through the tread or sidewall.</p> <p>Has any tread or sidewall separation.</p> <p>Has a cut where the ply or belt material is exposed.</p> <p>A tube-type radial tire without radial tube stem markings. These markings include a red band around the tube stem, the word “radial” embossed in metal stems, or the word “radial” molded in rubber stems.</p>	
<p>12. Wheel Hubs and Bearings Check wheel hub and bearings system components for condition and operation.</p>	<p>Weeping seal or weeping bearing cap.</p> <p>Damaged studs and wheel mounting nuts.</p> <p>Loose lug nuts.</p>	<p>Loose bearing or hub.</p> <p>Stripped studs and mounting nuts.</p>	
<p>13. Wheels Check wheel components for condition and operation.</p>	<p>Paint is cracked or flaking.</p>	<p>Damaged, cracked, bent, or dented.</p>	
<p>14. Frame / Axle / Suspension Check frame / axle / suspension components for condition and operation</p>	<p>Excessive rust.</p>	<p>Cracked, bent, broken frame, leaf springs, torsion bars, or axle.</p> <p>Worn, bent, or cracked leaf spring bushings and hardware.</p> <p>Worn, bent, or cracked U-bolts and hardware.</p>	

Section T: Trailer Inspection		
Inspection Procedure:	Repair If:	Out of Service If:
15. Ramps and Doors Check ramp and door components for condition and operation.	Bent ramps.	Damage, inoperative, or defect. Broken welds or cracked frame on ramp. Broken hinges. Door or ramp won't secure.
16. Floor, Decking, Side Panels, Walls, Roof Check floor, decking, side panels, wall and roof components for condition and operation.	Damaged flooring. Leaking roof. Loose cargo holds.	Holes in flooring. Broken cargo holds.
17. Post Inspection Road Test Check all components for proper operation during road test. Check for proper tracking. Check for brake pull. Check that wheels are true.	Wheel wobble.	Any brake pull or tracking issues.
18. Tow Vehicle. 1. Hitch, ball, safety chain, weight load compatible with trailer.		Towing equipment does not meet towing requirements. Any damage to hitch, ball, safety chain. Missing hitch pin securements.
a. Electrical connections	Frayed, unsecured, or weathered wires; loose or corroded connections.	Electrical connections inoperative.
b. Brake connection (if equipped) Check controller operation (if equipped).	Frayed, unsecured, or weathered wires; loose or corroded connections.	Electrical connections inoperative.
c. Pulling capacity of towing vehicle compatible with weight of trailer.		Towing vehicle does not meet towing requirements.

END OF SECTION

Appendix A. Regulation 1 CCR 301-26 (2018) Rules for the Operation, Maintenance, and Inspection of School Transportation Vehicles Effective date Jan 01, 2018



COLORADO
Department of Education
School Finance and
Operations Division

DEPARTMENT OF EDUCATION
Colorado State Board of Education

COLORADO RULES FOR THE OPERATION, MAINTENANCE AND INSPECTION OF SCHOOL TRANSPORTATION VEHICLES

1 CCR 301-26

4204-R-1.00 Statement of Basis and Purpose

- 1.01 Colorado law provides for the State Board of Education to adopt and enforce regulations governing the safe operation of school buses used for the transportation of students pursuant to Sections 22-51-108 and 42-4-1904, C.R.S.
- 1.02 The purpose of these rules is to adopt and enforce regulations governing the reasonable and adequate standards of safety for the operation, maintenance and inspection of school transportation vehicles that promote the welfare of the students and afford reasonable protection to the public. These rules are designed to align with federal standards, reflect current industry practices, and incorporate recommendations from school district and service provider transportation professionals.
- 1.03 The Commissioner, or designee, may provide an exemption to the Rules for the Operation, Maintenance and Inspection of School Transportation Vehicles to the extent the Commissioner finds an exemption to be appropriate.
- 1.04 These rules shall become effective January 1, 2018 for all student transportation.

4204-R-2.00 Applicability of Rules

- 2.01 These rules and regulations apply to the operation, maintenance and inspection of all public school transportation conducted by:
 - 2.01(a) A school district or charter school for routes (home to school, school to school, and school to home);
 - 2.01(b) A school district or charter school for activity trips (school related events);
 - 2.01(c) A company or individual hired by a district or charter school (service provider) for routes (home to school, school to school, and school to home).

- 2.02 These rules are not intended to include:
- 2.02(a) Private motor vehicles used exclusively to carry members of the owner's household; or
 - 2.02(b) Transportation arrangements not authorized by the district including but not limited to sharing of actual gasoline expense or participation in a car pool; or
 - 2.02(c) The operations of vehicles in bona fide emergency situations consistent with policies of the local board of education; or
 - 2.02(d) Transportation conducted by a company or individual for activity trips (school related events), including service providers, parent volunteers, and coaches or teachers using a private motor vehicle; or
 - 2.02(e) Route transportation provided by a company or individual as part of their operation as a common carrier under the jurisdiction of the US Department of Transportation or Public Utilities Commission, including RTD, taxi cab services, Uber services, and Lyft services.
- 2.03 These rules shall not preclude a school district or service provider from establishing a more rigid standard or policy when deemed necessary by the local board of education or service provider.

4204-R-3.00 Non-Compliance

- 3.01 CDE will perform periodic School Transportation Advisory Reviews (STAR) of school districts, charter schools and service providers to evaluate and assist with compliance of these rules.
- 3.01(a) CDE will provide school districts, charter schools and service providers written notification of the STAR findings.
 - 3.01(b) Upon receipt of the written notification of STAR findings, school districts, charter schools or service providers shall respond in writing to outline corrective actions if necessary.
- 3.02 CDE shall revoke or suspend the certificate for a school transportation annual inspector, school transportation annual inspector hands-on tester or inspection site under the following circumstances:
- 3.02(a) A school transportation annual inspector, school transportation annual inspector hands-on tester or inspection site does not meet the requirements outlined in these rules.
 - 3.02(b) School transportation annual inspections or hands-on tests have not been properly conducted.

4204-R-4.00 School District, Charter School and Service Provider Employment Responsibilities

- 4.01 School districts, charter schools and service providers shall outline job responsibilities and develop job qualification standards for each school transportation vehicle operator and school transportation paraprofessionals, consistent with federal and state regulations. A copy of these requirements shall be provided to each school transportation vehicle operator and paraprofessional upon employment.
- 4.02 School districts, charter schools and service providers shall maintain separate files for each school transportation vehicle operator, school transportation paraprofessional, and school transportation annual inspector with written documentation evidencing all listed requirements indicated in Rule 5.00, Rule 6.00 and Rule 7.00, as applicable. Training documentation shall include the trainer name, date of the training, description of the training, duration of each topic covered and the signature of all attendees.
- 4.02(a) If a school transportation vehicle operator, school transportation paraprofessional, or school transportation annual inspector works for more than one school district, charter school, service provider, or operator of an inspection site, each shall maintain a file with documentation in accordance with this rule.
- 4.03 School districts, charter schools and service providers shall ensure all employees required to possess a commercial driver's license (CDL) shall be in a US DOT approved substance abuse testing program.
- 4.04 School districts, charter schools and service providers shall not permit a school transportation vehicle operator to transport students, while the operator's ability or alertness is so impaired, through fatigue, illness or any other cause, as to make it unsafe for the operator to transport students.
- 4.05 School districts, charter schools and service providers shall have written emergency procedures and/or contingency plans to be followed in the event of a traffic accident, vehicle breakdown, unexpected school closing, unforeseen route change or relocation of a student stop in an emergency.
- 4.06 School district, charter schools and service providers shall ensure that documentation outlining transportation related services and requirements, including required use of Child Safety Restraint Systems and medical and behavioral information as it relates to student transportation, is available to applicable school transportation vehicle operators and paraprofessionals prior to providing transportation services.

4204-R-5.00 School Transportation Vehicle Operator Requirements

- 5.01 School transportation vehicle route operators (transporting students to and from school or from school to school) driving a School Bus with the capacity of 16 or greater passengers (counting the driver) and school transportation vehicle operators, other than route operators, driving vehicles with the capacity of 16 or greater passengers (counting the driver), including a School Bus, Multifunction Bus and Motor Coach Bus, shall meet or exceed the following requirements:

- 5.01(a) The operator shall possess a valid commercial driver's license (CDL) with the proper class and endorsements for size and type of vehicle(s) to be driven and the associated Medical Examination Report required pursuant to the Federal Motor Carrier Safety Regulations, 49 CFR section 391.43 (2015). Only the Federal Motor Carrier Safety Regulations adopted as of October 1, 2015 apply to this rule; later amendments do not apply. The federal regulations incorporated by reference in this rule are available for public inspection during regular business hours from the Colorado Department of Education, 201 E. Colfax Ave., Denver, Colorado 80209. In addition, these regulations are available at <https://www.ecfr.gov/>.
- 5.01(b) The operator shall be a minimum of 18 years of age.
- 5.01(c) The district or service provider shall obtain a motor vehicle record of each operator prior to transporting students and annually thereafter.
- 5.01(d) The operator shall be given and/or have access to the CDE School Bus/Multifunction Bus/Motor Coach Bus Operator Guide prior to transporting students.
- 5.01(e) The operator shall receive a minimum of six hours of in-service training annually which may include required training in 1 CCR 301-26-R-5.00. A portion of this annual in-service requirement may occur during the school year.
- 5.01(f) The operator shall successfully pass a CDE School Bus/Multifunction Bus/Motor Coach Bus Operator written test for the current school year prior to transporting students and annually thereafter.
- 5.01(g) The operator shall successfully pass a driving performance test including a pre-trip inspection prior to transporting students and annually thereafter. This test shall be conducted in a vehicle, which is similar in type and size to the vehicle the applicant is assigned to operate. Districts have the option to re-test at their discretion.
- 5.01(h) The operator shall receive pre-service training on the type of vehicle(s) to be driven, the type of duties they may be required to perform and in student confidentiality requirements prior to transporting students.
- 5.01(i) The operator shall have written documentation evidencing that they have received first aid training, including cardiopulmonary resuscitation and universal precautions within 90 calendar days after initial employment. If the operator holds a current first aid, cardiopulmonary resuscitation certificate it will meet the requirements of this section. Operators shall receive first aid training and/or re-certification every two (2) years thereafter.
- 5.01(j) The operator shall receive training regarding the proper use and maintenance of Child Safety Restraint Systems (CSRS) and proper wheelchair securement, when the operator is engaged in transportation involving these systems and devices prior to transporting students.

- 5.02 School transportation vehicle route operators (transporting students to and from school or from school to school) driving vehicles with the capacity of 15 or fewer passengers (counting the driver), including Type A Multifunction Bus and Small Vehicle, shall meet or exceed the following requirements:
- 5.02(a) The operator shall possess a valid driver's license.
 - 5.02(b) The operator shall be a minimum of 18 years of age.
 - 5.02(c) The operator shall have a current physical examination (not to exceed two years) consistent with the requirements of the Federal Motor Carrier Safety Regulations, 49 CFR section 391.43 (2015). Only the Federal Motor Carrier Safety Regulations adopted as of October 1, 2015 apply to this rule; later amendments do not apply. The federal regulations incorporated by reference in this rule are available for public inspection during regular business hours from the Colorado Department of Education, 201 E. Colfax Ave., Denver, Colorado 80209. In addition, these regulations are available at <https://www.ecfr.gov/>.
 - 5.02(d) The district or service provider shall obtain a motor vehicle record of each operator prior to transporting students and annually thereafter.
 - 5.02(e) The operator shall be given and/or have access to the CDE Type A Multifunction Bus /Small Vehicle Route Driver Guide prior to transporting students.
 - 5.02(f) The operator shall receive a minimum of six hours of in-service training annually which may include required training in 1 CCR 301-26-R-5.00. A portion of this annual in-service requirement may occur during the school year.
 - 5.02(g) The operator shall successfully pass a CDE Type A Multifunction Bus/Small Vehicle Route Operator written test for the current school year prior to transporting students and annually thereafter.
 - 5.02(h) The operator shall successfully pass a driving performance test including a pre-trip inspection prior to transporting students and annually thereafter. This test shall be conducted in a vehicle, which is similar in type and size to the vehicle the applicant is assigned to operate. Districts have the option to re-test at their discretion.
 - 5.02(i) The operator shall receive pre-service training on the type of vehicle(s) to be driven, the type of duties they may be required to perform and in student confidentiality requirements prior to transporting students.
 - 5.02(j) The operator shall have written documentation evidencing that they have received first aid training, including cardiopulmonary resuscitation and universal precautions within 90 calendar days after initial employment. If the operator holds a current first aid, cardiopulmonary resuscitation certificate it will meet the requirements of this section. Operators shall receive first aid training and/or re-certification every two (2) years thereafter.

- 5.02(k) The operator shall receive training regarding the proper use and maintenance of Child Safety Restraint Systems (CSRS) and proper wheelchair securement, when the operator is engaged in transportation involving these systems and devices prior to transporting students.
- 5.03 School transportation vehicle operators, other than route operators, driving vehicles with the capacity of 15 or fewer passengers (counting the driver), including Type A Multifunction Bus and Small Vehicle, shall meet or exceed the following requirements:
- 5.03(a) The operator shall possess a valid driver's license.
- 5.03(b) The operator shall be a minimum of 18 years of age.
- 5.03(c) The district or service provider shall obtain a motor vehicle record of each operator prior to transporting students and annually thereafter.
- 5.03(d) The operator shall be given and/or have access to the CDE Type A Multifunction Bus /Small Vehicle Operator Guide prior to transporting students.
- 5.03(e) The operator shall successfully pass a Type A CDE Multifunction Bus/Small Vehicle Operator written test for the current school year prior to transporting students and annually thereafter.
- 5.03(f) The operator shall annually complete the CDE Multifunction/Small Vehicle Operators Medical Information Form (STU-17). Any yes annotations shall require a doctor's release.
- 5.03(g) The operator shall receive pre-service training on the type of vehicle(s) to be driven, the type of duties they may be required to perform and in student confidentiality requirements prior to transporting students.
- 5.03(h) The operator shall be given and/or have access to first aid information, including cardiopulmonary resuscitation and universal precautions.
- 5.03(i) The operator shall successfully pass a driving performance test including a pre-trip inspection prior to transporting students. This test shall be conducted in a vehicle, which is similar in type and size to the vehicle the applicant is assigned to operate. Districts have the option to re-test in subsequent years at their discretion.
- 5.03(j) Prior to driving a school transportation vehicle pursuant to 1 CCR 301-26-R-12.11, operators shall receive training on towing a trailer.
- 5.04 School transportation paraprofessional is a person assigned to assist a school transportation vehicle operator control behavior of students in the bus and/or ensure the safety of students getting on and off the school transportation vehicle.
- 5.04(a) The school transportation paraprofessional shall receive pre-service training for the type of duties they may be required to perform prior to assisting with transporting students.

- 5.05 School transportation vehicle operators and school transportation paraprofessionals are required to be able to perform all essential functions including emergency evacuations when transporting students as determined by the school district or service provider job qualification standards.
- 5.05(a) The employing school district or service provider has the authority to require at any time a medical evaluation of a school transportation vehicle operator or school transportation paraprofessional for any condition that could impair the employee's ability to operate a vehicle safely, assist student(s) as required by their position, and/or perform other required job duties, and may take appropriate action on the outcome of such evaluation.
- 5.05(b) School transportation vehicle operators and school transportation paraprofessionals that have medical conditions which result in temporary loss of performance abilities shall provide return to work documentation from their physician, and any other requirements per district policy to the employing school district/service provide prior to returning to their assigned duties.

4204-R-6.00 School Transportation Annual Inspector Requirements

- 6.01 School transportation annual inspector is a person qualified to perform annual inspections on a school transportation vehicle to confirm the vehicle complies with CDE regulations.
- 6.02 School transportation annual inspectors shall meet or exceed the following requirements:
- 6.02(a) The school transportation annual inspector shall be in possession of a valid driver's license with the proper class and endorsements for the size and type of vehicle(s) to be inspected.
- 6.02(b) The school transportation annual inspector shall provide to the school district or service provider a Brake Inspector Qualification Certificate meeting the requirements of the Federal Motor Carrier Safety Regulations, 49 CFR section 396.25 (2015). Only the Federal Motor Carrier Safety Regulations adopted as of October 1, 2015 apply to this rule; later amendments do not apply. The federal regulations incorporated by reference in this rule are available for public inspection during regular business hours from the Colorado Department of Education, 201 E. Colfax Ave., Denver, Colorado 80209. In addition, these regulations are available at <https://www.ecfr.gov/>.
- 6.02(c) The school transportation annual inspector shall have at least two years verifiable experience in the maintenance of light, medium or heavy duty vehicles.
- 6.02(d) The school transportation annual inspector shall successfully pass the CDE initial hands-on performance test.
- 6.02(d)(1) A certified school transportation annual inspector hands-on tester must proctor the hands-on performance test.

6.02(e) The school transportation annual inspector shall successfully pass the CDE annual inspector qualification written test initially, and every three years thereafter pass the CDE annual inspector recertification written test.

6.02(e)(1) A representative of the district or service provider, other than a school transportation annual inspector candidate, shall grade the written test.

6.03 A school district, charter school, service provider or operator of an inspection site may submit a CDE Application for CDE Annual Inspector Qualification or Recertification Form (STU-20) to CDE verifying that the above requirements have been satisfied. CDE will issue an Annual Inspector Certificate.

6.04 If any of the above requirements become invalid, the annual inspector certificate is invalid until the requirement(s) is made valid.

6.05 If a school transportation annual inspector has an expired certificate, the certificate can be recertified as follows:

6.05(a) If the certificate has been expired less than six months, then the CDE Annual Inspector Recertification Written Test is required.

6.05(b) If the certificate has been expired between six and 12 months, then the CDE Annual Inspector Qualification Written Test is required.

6.05(c) If the certificate has been expired for more than one year, then both the CDE Annual Inspector Qualification Written Test and the CDE hands-on performance test are required.

4204-R-7.00 Annual Inspector Hands-On Tester

7.01 School transportation annual inspector hands-on tester is a person qualified to proctor hands-on tests to annual inspector candidates.

7.02 School transportation annual inspector hands-on testers shall meet or exceed the following requirements:

7.02(a) The school transportation annual inspector hands-on tester shall have maintained a CDE Annual Inspector certificate for a minimum of two years.

7.02(b) The school transportation annual inspector hands-on tester shall have satisfactorily completed a four hour CDE school transportation annual inspector hands-on tester training.

7.02 (c) The school transportation annual inspector hands-on testers shall have completed a four hour brake training in the last three years or have maintained an ASE School Bus or Medium/Heavy Duty Truck or Transit Bus Brake Certification.

7.02(d) The school transportation annual inspector hands-on tester candidate shall submit a CDE Application for Certification or Recertification of CDE Annual Inspector Hands-On Tester Form (STU-30) verifying that the above criteria have been satisfied. CDE will issue an Annual Inspector Hands-On Tester Certificate.

7.02(e) The school transportation annual inspector hands-on tester shall conduct at least two hands-on tests every three years or attend a CDE school transportation annual inspector hands-on recertification training to recertify as a school transportation annual inspector hands-on tester.

7.03 If any of the above requirements become invalid, the hands-on tester certificate is invalid until the requirement(s) is made valid.

4204-R-8.00 Pre-trip/Post-trip Vehicle Inspections

8.01 Each school transportation vehicle shall have a daily pre-trip and post-trip inspection performed and documented by the school transportation vehicle operator or a district, charter school or service provider authorized transportation employee. A daily pre-trip inspection shall be completed prior to a vehicle being placed in service. A daily post-trip inspection shall be completed at the end of daily operation of each vehicle.

8.02 The pre-trip and post-trip inspection requirements for school transportation vehicles, other than small vehicles, shall include at a minimum all items listed on the CDE School Transportation Vehicle (School Bus/Multifunction Bus/Motor Coach Bus) – Pre-Trip and Post Trip Requirements Form (STU-9).

8.03 The pre-trip and post-trip inspection requirements for school transportation small vehicles shall include at a minimum all items listed on the CDE School Transportation Vehicle (Small Vehicle) – Pre-Trip and Post Trip Requirements Form (STU-8).

8.04 School districts and service providers shall have a procedure in place to verify that students are not left on an unattended school transportation vehicle.

4204-R-9.00 Inspection Site Certification

9.01 A CDE Inspection Site Certificate is required at each facility/location where annual inspections for school transportation vehicles are performed.

9.02 The inspection site shall meet or exceed the following criteria to acquire and maintain an inspection site certificate.

9.02(a) The inspection site shall be large enough to accommodate the vehicle, equipment and tools necessary to perform the inspection.

9.02(b) The inspection site shall have a floor surface or pad adequate to safely support the maximum weight of the largest vehicle to be inspected.

9.02(c) The inspection site shall have adequate lighting and ventilation.

9.02(d) The inspection site or inspector shall, at the time of inspection, have the equipment and tools necessary to properly complete the annual inspection.

9.02(e) The inspection site or inspector shall have tools designed and calibrated to take accurate readings of appropriate measurements, such as brakes and tires.

9.03 The operator of an inspection site shall submit a request for an inspection site certificate on the CDE Application for Inspecting Site Certification Form (STU-22) that the above criteria have been satisfied.

9.04 The operator of an inspection site shall post the CDE Inspection Site Certificate at the inspection site.

4204-R-10.00 Annual Inspection

10.01 School districts, charter schools and service providers shall ensure all school transportation vehicles and trailers pursuant to 1 CCR 301-26-R-12.11 have a CDE annual inspection conducted by a CDE certified annual inspector.

10.01(a) Recently purchased school transportation vehicles shall successfully pass a CDE annual inspection prior to transporting students.

10.02 Annual inspection results shall be documented on the CDE Affidavit of Annual Inspection for School Transportation Vehicles Form (STU-25).

10.02(a) A copy of the current Affidavit is maintained inside the vehicle and a copy is placed in the vehicle file.

10.03 All annual inspection criteria of school transportation vehicles must meet or exceed manufacturer's specifications. The annual inspection shall be documented and shall include at a minimum all fields listed on the CDE Annual Inspection and Preventive Maintenance Requirements Form (STU-26).

10.04 All annual inspection criteria of trailers must meet or exceed manufacturer's specifications and shall include at a minimum all fields listed on the CDE Trailer Annual Inspection and Preventive Maintenance Requirements Form (STU-27).

10.05 During the annual inspection, all four wheels shall be pulled for full inspection of the foundation brake system. The three exceptions are:

10.05(a) School transportation vehicles with less than 4,000 miles since the previous annual inspection shall have two wheels (one front and one rear) pulled different than those pulled for the previous inspection.

10.05(b) School transportation vehicles equipped with a retarder meeting the specifications outlined in 1 CCR 301-25-R-33.00, shall have two wheels (one front and one rear) pulled which are different than those pulled for the previous inspection.

10.05(c) Trailers pursuant to 1 CCR 301-26-R-12.11 shall have 50 percent of the wheels pulled different than those pulled for the previous inspection.

4204-R-11.00 Maintenance and Repair

- 11.01 School districts, charter schools and service providers must ensure all school transportation vehicles are systematically inspected, maintained and repaired to ensure that school transportation vehicles are in safe and proper operating condition.
- 11.02 School districts, charter schools and service providers shall have a system to document preventative maintenance, reported defects and repairs made to school transportation vehicles.
- 11.03 School districts, charter schools and service providers shall maintain separate files for each school transportation vehicle with documentation of all annual inspections, all preventative maintenance and all reported damage, defects or deficiencies and the corresponding repair and maintenance performed.
- 11.04 Any identified damage, defect or deficiency of a school transportation vehicle must be reported to the school district, charter schools or service provider which:
- 11.04(a) Could affect the safety of operation of the school transportation vehicle, or
 - 11.04(b) Could result in a mechanical breakdown of the school transportation vehicle, or
 - 11.04(c) Results in noncompliance with Colorado Minimum Standards Governing School Transportation Vehicles (1 CCR 301-25) and/or manufacturer's specifications.
- 11.05 Documentation for reported defects must include all of the following:
- 11.05(a) The name of the school district, charter school or service provider.
 - 11.05(b) Date and time the report was submitted.
 - 11.05(c) All damage, defects or deficiencies of the school transportation vehicle.
 - 11.05(d) The name of the individual who prepared the report.
- 11.06 Following a reported damage, defect or deficiency of a school transportation vehicle, school districts, charter schools and service providers or a representative agent must repair the reported damage, defects or deficiencies, or document that no repair is necessary, ensuring that the vehicle is in safe and proper operating condition prior to transporting students.
- 11.07 School districts, charter schools and service providers shall not transport students in a school transportation vehicle which is not in safe and proper operating condition. A school transportation vehicle shall be designated as "out-of-service" by a school district, charter schools or service provider, a school transportation annual inspector or the CDE School Transportation Unit.

- 11.07(a) Exemption - Any school transportation vehicle discovered to be in an unsafe condition while being operated on the highway, roadway or private road may be continued in operation only to the nearest place where repairs can safely be affected. Such operation shall be conducted only if it is less hazardous to the public than to permit the vehicle to remain on the highway, roadway or private road.
- 11.08 Following a school transportation vehicle being placed "out-of-service", a school district, charter school, service provider or a representative agent must make required repairs, ensuring that the vehicle is in safe and proper operating condition prior to transporting students. In the event of being placed "out-of-service" during an annual inspection, the school transportation vehicle must successfully pass a CDE annual inspection prior to transporting students.
- 11.09 The preventative maintenance inspection on air drum brake systems shall include, at a minimum, that the brake rod travel has been measured and documented. The applied pressure method shall be used.
- 11.09(a) The inspection-interval shall not exceed 4,000 miles for buses equipped with a manual slack adjuster air brake system.
- 11.09(b) The inspection-interval shall not exceed 6,000 miles for buses equipped with an automatic slack adjuster air brake system.
- 11.10 The preventive maintenance inspection interval on air disc brake systems shall not exceed 6,000 miles and shall include, at a minimum; inspection and documentation of:
- 11.10(a) Inspect the pad thickness by checking the mechanical wear indicators.
- 11.10(b) Inspect the visible part of the rotors for cracks, excessive wear, damage, etc.
- 11.10(c) Inspect running clearance. If the caliper has no movement or appears to move greater than the distances indicated by the manufacturer, then a full wheel removal inspection will be necessary.
- 11.11 The preventive maintenance inspection interval for hydraulic brake systems shall not exceed 6,000 miles and shall include, at a minimum, inspection and documentation of:
- 11.11(a) Proper parking brake operation.
- 11.11(b) Proper brake fluid level and clarity.
- 11.11(c) Adequate pedal reserve.
- 11.11(d) Proper hydraulic/vacuum assist operation.
- 11.11(e) Visual inspection for brake fluid leakage.

- 11.12 If brake adjustment or repair is needed, the work shall be completed by or supervised by a DOT or equivalent qualified brake inspector meeting the requirements of the Federal Motor Carrier Safety Regulations, 49 CFR section 396.25 (2015). Only the Federal Motor Carrier Safety Regulations adopted as of October 1, 2015 apply to this rule; later amendments do not apply. The federal regulations incorporated by reference in this rule are available for public inspection during regular business hours from the Colorado Department of Education, 201 E. Colfax Ave., Denver, Colorado 80209. In addition, these regulations are available at <https://www.ecfr.gov/>.

4204-R-12.00 Operation of a School Transportation Vehicle

- 12.01 A school transportation vehicle shall not be operated in a manner which is unsafe or likely to cause an accident or damage of the vehicle.
- 12.02 A school transportation vehicle shall not be placed in motion on a roadway, highway or private road with the passenger entry door/service door open.
- 12.03 A school transportation vehicle's headlights or daytime running headlights shall be activated while the vehicle is in operation.
- 12.04 A school transportation vehicle shall not be fueled while students are on board, except in instances when unloading the students would present a greater hazard or peril to their safety.
- 12.05 Use of tobacco products as defined in Section 18-13-121(5), C.R.S., use or possession of illegal controlled substances, use or possession of alcohol and use or possession of marijuana or cannabinoid product, except as otherwise allowed by law, aboard any school transportation vehicle shall be prohibited at all times.
- 12.06 A school transportation vehicle operator shall not consume food unless the vehicle is stopped at a safe location with the park/emergency brake set.
- 12.07 When a school transportation vehicle is equipped with a roof mounted strobe lamp, the use of the strobe lamp is permitted only when the vehicle presents a hazard to other motorists, such as loading or unloading students in inclement weather or to enhance visibility of the vehicle when barriers inhibit such visibility.
- 12.08 A school transportation vehicle operator may use the strobe, in addition to the four-way hazard lamps, to warn other motorists that the vehicle is not in motion or is being operated at a speed of twenty-five miles per hour or less.
- 12.09 The school transportation vehicle operator shall use extreme caution when backing. Before backing on a roadway, highway or private property, the horn or audible warning device shall be sounded and four-way hazard lamps actuated or there shall be a person outside the vehicle giving direction.
- 12.09(a) Backing a school transportation vehicle when students are outside of the vehicle at a student stop is prohibited.

- 12.10 School transportation vehicles including Type A, B, C and D School Bus, Multifunction Bus and Motor Coach Bus shall not be operated with a trailer or other vehicle attached while students are being transported.
- 12.11 School transportation small vehicles, with the capacity of 15 or fewer passengers (counting the driver), may tow trailers while students are being transported to the extent that trailering is a necessary component of a district sponsored program.

4204-R-13.00 Authorized Passengers

- 13.01 Only district or charter school personnel, students enrolled in a district or charter school, or law enforcement officials or individuals that have received prior authorization from the school district, charter schools or service provider may be passengers on any school transportation vehicle.
- 13.02 The number of passengers transported on any school transportation vehicle shall not exceed the maximum seating capacity of the vehicle. Small vehicle capacity shall not exceed the number of safety belts as designed by the vehicle manufacturer.
- 13.03 Passengers shall not be permitted to stand in any school transportation vehicle while the vehicle is in motion. This does not preclude authorized persons (such as school transportation paraprofessionals) from completing their duties as required.
- 13.04 School districts and service providers shall consider the size of the passengers when determining the number of passengers that can safely occupy a school transportation vehicle seat.

4204-R-14.00 Safety Restraints

- 14.01 A school transportation vehicle operator shall have the safety belt fastened, worn correctly and properly adjusted prior to the school transportation vehicle being placed in motion.
- 14.02 All passengers in a school transportation vehicle under 10,000 lbs. GVWR shall have their safety belts fastened, worn correctly and properly adjusted prior to the school transportation vehicle being placed in motion.

4204-R-15.00 Transportation of Miscellaneous Items

- 15.01 A school transportation vehicle operator shall make a reasonable and prudent determination that all carry-on items are properly handled in order to minimize the danger to all others.
- 15.02 All baggage, articles, equipment or medical supplies not held by individual passengers shall be secured in a manner which assures unrestricted access to all exits by occupants, does not restrict the driver's ability to operate the bus and protects all occupants against injury resulting from falling or displacement of any baggage, article or equipment. Oxygen cylinders secured to a wheelchair shall be considered to be in compliance with this subsection, provided they do not impede access to any exit.
- 15.03 All chemicals and cleaning supplies carried on a school transportation vehicle must meet the following precautions:

15.03(a) Container is non-breakable.

15.03(b) Container is labeled with contents.

15.03(c) Pressurized aerosols are prohibited.

15.03(d) Container is secured in a bracket, or in a closed compartment in the driver's area or a compartment on the exterior of the bus.

15.03(e) Containers and quantities of products must be no more than 32 ounces in size.

15.04 Interior-decorations shall not be located within the driver's area (which includes the space in front of the front barriers including the step-well, dash, walls and ceiling, the windshield, the entry door, the driver's side window, and all windows in front of the front barrier), the first two passenger windows on both sides of the vehicle and all windows on the rear of the vehicle. Other decorations within the passenger compartment shall not:

15.04(a) Cover any required lettering.

15.04(b) Impede the aisle or any emergency exit.

15.04(c) Hang from the walls and/or ceiling.

4204-R-16.00 Maximum Driving Time for School Transportation Vehicle Operators

16.01 The school transportation vehicle operator, including small vehicle operators, shall not drive nor shall the school district or service provider permit or require an operator to drive:

16.01(a) In excess of 10 hours or after being on-duty 14 hours until completing 10 hours off-duty. This would include on-duty time for all employers. Ten hours off-duty may be consecutive or accumulated in two or more periods of off-duty time with one period having a minimum of 6 consecutive hours off-duty.

16.01(b) After being on-duty for more than 70 hours in any seven consecutive days.

16.02 In place of section 16.00 of these rules, the school district or service provider may comply with the Federal Motor Carrier Safety Regulations, 49 CFR section 391.43 (2015). Only the Federal Motor Carrier Safety Regulations adopted as of October 1, 2015 apply to this rule; later amendments do not apply. The federal regulations incorporated by reference in this rule are available for public inspection during regular business hours from the Colorado Department of Education, 201 E. Colfax Ave., Denver, Colorado 80209. In addition, these regulations are available at <https://www.ecfr.gov/>.

16.03 Definitions:

16.03(a) Adverse driving conditions - In case of emergency, an operator may complete the trip without being in violation if such trip reasonably could have been completed absent the emergency.

16.03(b) Day - Means any 24-consecutive hour period beginning at the time designated by the school district or service provider.

16.03(c) On-duty time - Includes all time worked for any and all employers, including all driving and non-driving duties.

16.03(d) Off-duty time - School transportation vehicle operators may consider waiting time at special events, meal stops and school related events as off-duty if the following criteria are met: (Compensated waiting time does not necessitate on-duty time.)

16.03(d)(1) The operator shall be relieved of all duty and responsibility for the care and custody of the vehicle, its accessories and students, and

16.03(d)(2) The operator shall be at liberty to pursue activities of his/her choice including leaving the premises on which the bus is located.

16.04 All school transportation vehicle operators shall document that they are in compliance with this section, hours of service.

16.04(a) An operator's daily log, or equivalent, shall be completed for the trip in the operator's own handwriting, when the trip requires a scheduled or unscheduled overnight stay away from the work reporting location.

4204-R-17.00 Route Planning – Student Loading and Discharge

17.01 School transportation small vehicles, Type A Multifunction Buses with 15 or fewer passenger capacity (counting the driver) and School Buses (Types A, B, C, and D) may be used to transport students to and from school. Multifunction Buses Type B, C and D and Motor Coach Buses shall not be used to transport students to and from school.

17.02 The location of student stops shall consider factors including:

17.02(a) Ages of the students.

17.02(b) Visibility.

17.02(c) Lateral clearance.

17.02(d) Student access.

17.02(e) Control of other motorists.

17.02(e)(1) Student stops for Type A Multifunction Buses with 15 or fewer passenger capacity (counting the driver) and school transportation small vehicles should be located off of the roadway whenever possible.

- 17.03 School transportation vehicle operators shall stop at least 10 feet away from students at each designated stop. The school transportation vehicle operator shall apply the parking brake and shift the vehicle into neutral or park prior to opening the service door of a bus or passenger door(s) of a small vehicle.
- 17.04 The school transportation vehicle operator shall stop as far to the right of the roadway, highway or private road as possible before discharging or loading passengers, allowing sufficient area to the right and front of the vehicle but close enough to the right to prevent traffic from passing on the right so students may clear the vehicle safely while in sight of the operator.
- 17.04(a) Exception: The school transportation vehicle operator may block the lane of traffic when passengers being received or discharged are required to cross the roadway.
- 17.05 Student stops shall not be located on the side of any major thoroughfare whenever access to the destination of the passenger is possible by the use of a road or street which is adjacent to the major thoroughfare.
- 17.06 If students are required to cross a roadway, highway or private road on which a student stop is being performed, they are prohibited from crossing a roadway, highway or private road constructed or designed to permit three or more separate lanes of vehicular traffic in either direction or with a median separating multiple lanes of traffic. This does not include crossing the roadway, highway or private road with the assistance of a traffic controls signal or with the assistance of a crossing guard.
- 17.07 Four-way hazard lamps shall be used on private property such as parking lots.
- 17.08 Alternating flashing red warning signal lamps shall not be activated within 200 feet of an intersection if the intersection is controlled by a traffic control signal.
- 17.09 Routes shall be planned as to:
- 17.09(a) Eliminate, when practical, railroad crossings.
- 17.09(b) Have stops be a minimum of 200 feet apart since alternating flashing amber warning signal lamps must be activated a minimum of 200 feet in advance of the stop.
- 17.09(b)(1) Exception: Student stops located in areas where wildlife may create a high risk of threat to students' safety while they are waiting and/or walking to a student stop, may designate student stops less than 200 feet apart upon detailed written approval by the school district board of education or governing body of a charter school and/or their designee. A copy of the written approval shall be kept in the school transportation office and route operators shall be given written notice of the exception and have it indicated on route sheets.

- 17.10 In determining the length of routes, districts, charter schools and service providers must make an effort to minimize student ride times while considering student educational needs and the geographic boundaries, terrain, traffic congestion, and financial resources within the district. A local board of education or the governing body of a charter school may establish a maximum student ride time.
- 17.11 Pursuant to Section 42-4-1903(2), C.R.S., school transportation vehicle operators are not required to actuate the alternating flashing red warning signal lamps on a school bus when the student stop is at a location where the local traffic regulatory authority has by prior written designation declared such actuation unnecessary and when discharging or loading passengers who require the assistance of a lift device and no passenger is required to cross the roadway. Further, Type A Multifunction Buses with 15 or fewer passenger capacity (counting the driver) and school transportation small vehicles do not have the functionality to control traffic. In these instances, the school transportation vehicle operator shall stop as far to the right off the roadway as possible to reduce obstruction to traffic, activate the four-way hazard warning lamps a minimum of 200 feet prior to the student stop, continue to display the four-way hazard warning lamps until the process of discharging or loading passengers has been completed, and deactivate the four-way hazard lamps before resuming motion. Students are prohibited from crossing any lanes of traffic to access the student stop or after disembarking.
- 17.12 School transportation vehicle operators shall not relocate a student stop without approval of the school district or service provider.
- 17.13 School transportation vehicle operators of School Buses, Multifunction Buses and Motor Coach Buses, whether transporting students or not, shall apply the following procedures during the process of approaching, stopping and crossing railroad tracks:
- 17.13(a) Activate the four-way hazard lamps not less than 200 feet from the railroad crossing to alert other motorists of the pending stop for the crossing.
- 17.13(b) Stop the bus within 50 feet but not less than 15 feet from the nearest rail.
- 17.13(c) When stopped, the bus should be as far to the right of the roadway as possible and should not form two lanes of traffic unless the highway is marked for four or more lanes of traffic.
- 17.13(d) Use a prearranged signal to alert students to the need for quiet aboard the bus when approaching railroad tracks. Turn off all noise making equipment (fans, heater, radio, etc.)
- 17.14 After quietness aboard the stopped bus has been achieved, bus operators shall open the service door and operator window. The bus operator shall listen and look in both directions along the track(s) for any approaching train(s) and for signals indicating the approach of a train.
- 17.14(a) If the tracks are clear, the bus operator shall close the service door and may then proceed in a gear low enough to permit crossing the tracks without having to manually shift gears. The bus operator shall cancel the four-way hazard lamps after the bus has cleared the tracks.

- 17.14(b) When two or more tracks are to be crossed, the bus operator shall not stop a second time unless the bus is completely clear of the first crossing and has at least 15 feet clearance in front and at least 15 feet clearance to the rear.
- 17.14(c) Before crossing the tracks, the bus operator shall verify that there is enough space after the tracks for the bus plus 15 feet if it is necessary to stop after crossing the tracks.
- 17.15 School transportation vehicle operators of School Buses, Multifunction Buses and Motor Coach Buses are not required to stop at crossings only controlled by a red, amber, green traffic control signal when it is in the green position or when the crossing is controlled by a police officer or human flag person, or when the crossing is marked with an official "exempt" sign placed on the railroad crossing light post or cross bucks post.

4204-R-18.00 Emergency Evacuation Drills

- 18.01 Emergency evacuation drills shall be conducted with students by all school transportation vehicle operators and school transportation paraprofessionals at least twice during each school year.
- 18.01(a) One drill shall be conducted in the fall and the second drill conducted in the spring.
- 18.01(b) Substitute and Multifunction operators of 16 or greater capacity (counting the driver) vehicles shall be trained how to conduct the emergency evacuation drills.
- 18.02 Students on school related events shall receive emergency evacuation instruction prior to departure.
- 18.03 School district, charter schools and service providers shall maintain records documenting that the required evacuation drills were conducted and/or evacuation instruction was given.

Intentionally Left Blank

Appendix B. Regulation 1 CCR 301-25 (2015) Colorado Minimum Standards
Governing School Transportation Vehicles Effective date April 30, 2015

DEPARTMENT OF EDUCATION

Colorado State Board of Education

COLORADO MINIMUM STANDARDS GOVERNING SCHOOL TRANSPORTATION VEHICLES

1 CCR 301-25

[Editor's Notes follow the text of the rules at the end of this CCR Document.]

GENERAL

2251-R-1.00 Statement of Basis and Purpose.

The statutory authority for the Colorado Minimum Standards Governing School Transportation Vehicles (hereinafter referred to as "these rules" or "Minimum Standards"), adopted by the State Board of Education on (April 30, 2015) (hereinafter referred to as "effective date"), is found in sections 22-51-108 and 42-4-1904, C.R.S.

The purpose of these rules is to provide reasonable and adequate standards of safety for school transportation vehicles that promote the welfare of the students and afford reasonable protection to the public. The purpose of the amendments approved on (*insert effective date*) is to update the minimum standards to align with recent federal standard and reflect current industry practices, to streamline and consolidate rules and eliminate rules which are redundant of and potentially contradictory to federal standards, and to reduce regulatory burdens for school districts and charter schools.

The Commissioner, or designee, may provide an exemption to these Minimum Standards to the extent the Commissioner finds an exemption to be appropriate.

2251-R-2.00 References.

FMVSS-Federal Motor Vehicle Safety Standards
49 C.F.R. Part 571, Current Revision
National Highway Traffic Safety Administration
U.S. Department of Transportation

2251-R-3.00 Responsibility of Suppliers.

- 3.01 Dealers, distributors and manufacturers of school buses and multifunction buses each have a responsibility to comply with the Minimum Standards on or after the effective date of these rules.
- 3.02 Dealers, distributors or manufacturers which supply school buses and multifunction buses for use in the State of Colorado which do not meet the specifications of these rules shall be notified of noncompliance and a general notice will be sent to all school districts and school transportation operations within the State of Colorado advising that equipment supplied by such dealer, distributor, or manufacturer is not in compliance with the Minimum Standards.

3.02(a) If a dealer, distributor, or manufacturer has been notified of non-compliance in accordance with subsection 3.02 of these rules and replaces or modifies the equipment

to meet the Minimum Standards, a notification of compliance will be issued from the Colorado Department of Education (CDE) within 30 days after proof of compliance.

2251-R-4.00 Effective Date.

4.01 Except as indicated in 4.01(a), school transportation vehicles manufactured, per the date listed on the certification plate, on or after the effective date of these rules, for the purpose of transporting Colorado students shall meet or exceed the Minimum Standards.

4.01(a) Under federal law (49 USC 30112(a)), a new over-the-road motor coach (motor coach) bus may not be sold for the purpose of transporting school-age students to and from school or to school related events unless it meets all FMVSS requirements for school buses. Upon passage of a local board of education resolution, a school district may purchase a used over-the-road motor coach (motor coach) bus and/or attain a short-term rental of a motor coach bus from a contract carrier for the transportation of students to school related events. Such resolution shall specify that consideration was given to the standards of safety to promote the welfare of students, including recommendations of national transportation organizations. In no event shall a motor coach bus be used for the transportation of students to and from school or school to school. A board resolution is not necessary for transporting students on common carriers.

4.02 School transportation vehicles currently transporting Colorado students may continue in use.

4.03 Only school transportation vehicles that were manufactured, per the date listed on the certification plate, within the previous 20 years, may be purchased, leased, contracted, or otherwise obtained for the purpose of transporting Colorado students. These vehicles must meet Colorado minimum standards that were in effect at the time of manufacture.

2251-R-5.00 Definitions.

5.01 School District means a public school district organized pursuant to article 30 of title 22 of Colorado Revised Statutes or a board of cooperative services (BOCES) organized pursuant to article 5 of title 22 of Colorado Revised Statutes.

5.02 Local Board of Education means the board of education of a school district or the governing board of a BOCES.

5.03 Charter school means a public school organized pursuant to Section 22-30.5-103(2) of the Colorado Revised Statutes.

5.04 School Transportation Vehicle means every motor vehicle which is owned by a school district or charter school and operated for the transportation of students to and from school, from school to school, or to school related events or which is privately owned and operated for compensation provided that such transportation service is sponsored and approved by the local board of education or school's governing board.

- 5.04(a) This does not include informal or intermittent arrangements, such as sharing of actual gasoline expense or participation in a car pool.
- 5.04(b) Exemption: Vehicles that carry students as part of their operation as a common carrier under the jurisdiction of United States Department of Transportation or Public Utilities Commission are not included within the definition of school transportation vehicle.
- 5.05 A School Bus shall be a motor vehicle, built to FMVSS and school bus standards contained herein, designed for transporting students on either to and from school, from school to school, or to school related events.
- 5.05(a) TYPE A --Type "A" school bus is a conversion or body constructed utilizing a cutaway front-section vehicle with a left side driver's door and a gross vehicle weight rating (GVWR) of 21,500 pounds or less.
- 5.05(b) TYPE B --Type "B" school bus is a body constructed and installed upon a stripped chassis. Part of the engine is beneath and/or behind the windshield and beside the driver's seat. The entrance door is behind the front wheels.
- 5.05(c) TYPE C --Type "C" school bus is constructed utilizing a chassis with a hood and fender assembly. This includes the cutaway truck chassis, including cab, with or without a left side driver door, and with a GVWR greater than 21,500 pounds. The entrance door is behind the front wheels.
- 5.05(d) TYPE D --Type "D" school bus is constructed utilizing a stripped chassis, the engine may be behind the windshield and beside the driver's seat; it may be at the rear of the bus, behind the rear wheels. The entrance door is ahead of the front wheels.
- 5.06 Small Vehicle shall be a motor vehicle, which does not meet the requirements of a Type A, B, C or D school bus, designed for general purpose use. A small vehicle shall meet or exceed section 20.05 of these rules. These vehicles may be used to carry students to and from school, from school to school, or to school related events.
- 5.06(a) Small vehicles shall bear name of school district/service provider plainly visible on each side.
- 5.07 Multifunction bus shall be a motor vehicle, built to federal multifunctional school activity bus standards, designed for transporting students.
- 5.07(a) Multifunction buses shall also meet the standards contained in the Minimum Standards with the exception of:
- 5.07(a)(1) Color, as required by section 15.00 of these rules
- 5.07(a)(2) Lettering "SCHOOL BUS", as required by section 26.01 of these rules

- 5.07(a)(3) Lettering "STOP ON FLASHING RED" as required by section 26.06 of these rules
- 5.07(a)(4) Alternately flashing warning signal lamps, as required by section 29.07 of these rules
- 5.07(a)(5) Stop signal arm, as required by section 38.00 of these rules
- 5.07(a)(6) Retro-reflective material color, as required by section 15.02 of these rules.

2251-R-6.00 Testing and Certification.

- 6.01 School bus manufacturers shall provide annual certification to the Colorado Department of Education that their product(s) meet or exceed the Minimum Standards and all applicable FMVSS in effect at the time of manufacture. School bus manufacturers shall record and report to CDE the test results as required by Section 16 - Construction. All school bus bodies that meet applicable FMVSS and are in compliance with the Minimum Standards shall be certified by the school bus manufacturer by the attachment of a plate or decal.
- 6.02 It shall be the school district's/charter school's responsibility to ascertain whether all school buses purchased, leased, or under contract to the school district/charter school meet all specifications of the Minimum Standards. This verification should be obtained at the time of delivery, in addition to the statement of compliance in the purchase bid, contract for or lease agreement.
- 6.03 When selling a school transportation vehicle, it is the school district's/charter school's responsibility to eliminate the school district's/charter schools full name from the vehicle.
- 6.04 Used school bus dealers shall register with the Colorado Department of Education, School Transportation Unit, certifying that only school transportation vehicles meeting or exceeding Colorado Minimum Standards will be sold. There shall be no fee to register.
- 6.05 All school transportation vehicles must meet and continue to meet all applicable FMVSS in effect on the date of manufacture, per the date listed on the certification plate.

2251-R-7.00 Bus Delivery Requirements.

- 7.01 The bus manufacturer shall provide the following materials and information for direct delivery to the customer upon request:
 - 7.01(a) Line set tickets for each individual unit including chassis and body,
 - 7.01(b) A copy of the pre-delivery service performed and verified by a checkout form for each individual unit,
 - 7.01(c) Warranty book and statement of warranty for each individual unit,

7.01(d) Service manual (hard copy or electronic copy) for each individual unit or identical units for all major components of the bus (e.g., body, chassis, transmission, etc.), and

7.01(e) Parts manual (hard copy or electronic copy) for each individual unit or identical units for all major components of the bus (e.g., body, chassis, transmission, etc.).

BUS BODY AND CHASSIS

2251-R-8.00 Aisle

- 8.01 Minimum aisle clearance between seats and to all emergency doors shall be 12 inches at seat level.
- 8.02 On forward control (front engine) Type D buses, the aisle passage area shall not be less than 12 inches, measured from floor level up, between engine cover and any other object. Hold down fastening devices used on engine cover shall be designed to prevent hooking or catching on shoes or clothing.

2251-R-9.00 Axles.

- 9.01 Rear axle shall be single-speed.

2251-R-10.00 Battery

- 10.01 On Type B, C and D, a drawer-type pull out tray shall be provided to facilitate servicing or removal of battery(ies) not used for the motive propulsion of the bus. The battery(ies) shall be enclosed by a vented compartment, provided with drain ports, a hold down carrier mounted so as to avoid blocking filler ports and a latching device to prevent accidental opening. Undercoating shall be provided and applied to battery box. Battery tray is to be equipped with a safety device to keep tray from sliding completely out.
- 10.02 On Type A buses equipped with more than one battery, all batteries should be positioned in one location.
- 10.03 Batteries should be equipped with sufficient battery cable to allow the drawer-type pull out tray to fully extend.

2251-R-11.00 Brakes.

11.01 Type C and D buses shall be equipped with full compressed air brake systems. Both air drum brake and air disc break applications are acceptable.

11.02 Air brakes:

11.02(a) Compressors: On buses using full compressed air brakes for service, emergency, and parking brakes, the compressor shall be a standard production model with a minimum 12 cubic foot per minute displacement.

11.02(b) Moisture ejection valve: An automatic heated, moisture ejection valve or air drying system shall be properly installed. This is made to automatically eject moisture, sludge, and/or foreign matter and maintain clean, dry air lines.

11.02(c) Control requirements: Control valve of the parking brake system shall be designed and constructed to conform to the following:

11.02(c)(1) The parking brake control valve shall be visible to the driver and shall be mounted on the dash panel within 15 inches to the right of the steering column.

2251-R-12.00 Bumpers.

12.01 Front bumper shall:

12.01(a) Be at least 3/16 inch thick of pressed steel channel, one piece construction with minimum of eight inch width (high), except Type A buses under 14,500 GWVR.

12.01(b) Be of extended design to offer maximum protection of fender lines without permitting snagging or hooking.

12.01(c) Be attached to the frame and extend forward of grille, head lamps, fender or hood sections to provide maximum protection.

12.01(c) Be of sufficient strength to ensure that the front of the bus may be lifted by means of a bumper type jack without permanent deformation of the bumper.

12.02 Rear bumper shall:

12.02(a) Be of pressed steel channel or equivalent material, at least 3/16-inch thick, and shall be a minimum of 8 inches wide (high) on Type A buses, and shall be a minimum of 9 ½ inches wide (high) on Type B, C and D buses.

12.02(b) Be wrapped around back corners of bus and extend forward at least 12 inches from rear-most point of body at floor line.

12.02(c) Be fastened to chassis frame side rails in such a manner as to develop full strength of bumper section from rear or side impact. Bracing materials shall have an impact ratio comparable to that of bumper material and shall be fastened at the ends and radii of the bumper, attached to the side of the frame only, and not to body at any point.

12.02(d) Extend beyond rear-most part of body surface at least one inch, measured at floor lines.

12.02(e) Not allow any spaces, projections, or cut-outs that will permit a hand hold or foot hold.

- 12.02(f) Have the front ends enclosed by end caps or other protective metal or have the ends rounded or tucked in, and shall be free from sharp edges or projections likely to cause injury or snagging.
- 12.02(g) Have a gasket, rubber or equivalent, installed to close opening between the top of the rear bumper and body metal.
- 12.02(h) Be of sufficient strength to permit being pushed by another vehicle of similar size. The bumper shall be of sufficient strength to ensure that the rear of the bus may be lifted by means of a bumper type jack without permanent deformation of the bumper.

2251-R-13.00 Color.

- 13.01 All exterior metal shall be painted National School Bus Yellow (NSBY) with the exception of:
 - 13.01(a) Lettering and numbering shall be black, white, or yellow for bumper area.
 - 13.01(b) Bumpers and frame shall be black
 - 13.01(c) Rub rails may be black or yellow at purchaser option
 - 13.01(d) Background area for alternating flashing warning lamps shall be black
 - 13.01(e) The roof of the bus may be painted white, not to extend below the drip rails on the sides of the body.
 - 13.01(f) Student window frames, posts and service door frame may be black.
- 13.02 Retro-Reflective material shall be installed on the bus conforming to the requirements of FMVSS 131.
 - 13.02(a) Rear of bus body: strips of between 1 and 2 inch Retro-Reflective NSBY material shall be applied horizontally above the rear windows and above the rear bumper, extending from the rear emergency exit perimeter marking outward to the left and right rear corners of the bus, with vertical strips applied at the corners connecting the horizontal strips.
 - 13.02(b) "School Bus" signs: Shall be marked with Retro-Reflective NSBY material comprising background for lettering of the front and/or rear "school bus" signs.
 - 13.02(c) Sides of bus body: Shall be marked with Retro-Reflective NSBY material at least 1 ¾ inches in width, extending the length of the bus body and located (vertically) as close as practicable to the floor line.

2251-R-14.00 Construction.

- 14.01 All metal surfaces that will be painted shall be (in addition to above requirements) chemically cleaned, etched, zinc-phosphate-coated and zinc-chromate or epoxy primed or conditioned by equivalent process. Particular attention shall be given to lapped surfaces, welded connections of structural members, cut edges, punched or drilled hole areas in sheet metal, closed or box sections, unvented or undrained areas and surfaces subject to abrasion during vehicle operation.
- 14.02 The floor shall be at least 14 gauge mill applied zinc-coated steel sheet and shall be on one plane. There shall be a main floor cross member of at least 10 gauge steel or equivalent extending the full width of the floor plate and permanently attached. There shall be a minimum of two intermediate floor cross members of at least 16 gauge steel equally between the main floor cross members and permanently attached.
- 14.02(a) Type A buses 14,500 GVWR or less may use other metal or material with strength and corrosion resistance at least equivalent to all-steel construction as certified by the bus body manufacturer.
- 14.03 Subfloor shall be either 5 ply nominal 5/8 inches thick plywood, or a material of equal or greater strength and insulation R value and it will equal or exceed properties of exterior-type softwood plywood C-D grade, as specified in National Bureau of Standards (NBS) Product Standard 1-83. Type A buses, 14,500 GVWR or less, shall have nominal ½ inch thick plywood or equivalent material equal to or exceeding properties listed above.
- 14.04 Ceiling Panels: If the ceiling is constructed to contain lap joints, the forward panel shall be lapped by the rear panel and the exposed edges shall be beaded, hemmed, or flanged or otherwise treated to eliminate sharp edges.
- 14.05 All body components shall be designed and constructed so as to avoid the entrapment of moisture and dust.
- 14.06 All openings between chassis and passenger-carrying compartment made for any reason must be sealed.
- 14.07 On Type B, C, and D buses, the bus body shall meet the test standards of the Kentucky Pole test.
- 14.08 In addition to complying with FMVSS 220 test procedures, the body manufacturers shall record and report the downward vertical movement of the force at 0, 25, 50, 75, and 100% of the maximum force (both loading and unloading). The expected force deflection curve is illustrated schematically in Figure 1a. Low load nonlinearities may indicate joint conformation; high load nonlinearities may indicate yielding structural members.
- 14.08(a) A second load cycle shall be performed following the procedure given in the first paragraph. The expected force-deflection curve is illustrated schematically in Figure 1b. Any hysteresis following the initial shakedown will be revealed by this second cycle.

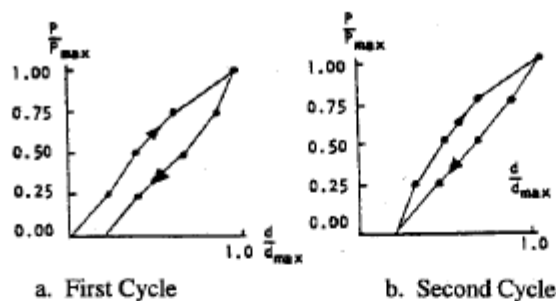

Figure 1. Static Load Test Load-Deflection Curves

14.09 A diagonal (racking) load test shall be performed on Type A, B, C and D school buses to assure adequate shear stiffness and strength of the bus body. Details of the test are provided below. A two cycle loading sequence shall be conducted following the procedure described in Section 14.08.

14.09(a) Requirements: When a force equal to 1 ½ times the GVW is applied to the edge of the roof of the vehicle's body structure through a force application plate as specified in (b),
Test Procedures:

14.09(a)(1) The diagonal movement of the force at any point on the application plate shall not exceed 5 1/8 inches; and

14.09(a)(2) Each emergency exit of the vehicle provided in accordance with FMVSS 217 shall be capable of operation as specified in that standard during the full application of the force and after release of the force.

14.09(b) Test Procedures: Each vehicle shall be capable of meeting the requirements of (1) and (2) when tested in accordance with the procedures set forth below.

14.09(b)(1) The vehicle shall be supported on a rigid surface along the lower edge of the frame or along the body sills in the absence of a frame.

14.09(b)(2) The load shall be applied through a force application plate that is flat and rigid. The dimensions of the plate shall be chosen to assure that the plate edges never make contact with the vehicle skin during testing. A typical width is 18 inches. A typical length is 20 inches less than the length of the vehicle's roof measured along its longitudinal centerline.

14.09(b)(3) Place the force application plate in contact with the edge of the vehicle roof. Orient the plate so that its flat, rigid surface is perpendicular to a diagonal line connecting the most distant points on an interior cross section of the vehicle. The rear edge of the plate shall be positioned approximately 20 inches from the rear edge of the vehicle roof. A temporary stand may be used to support the plate until a force is applied.

14.09(b)(4) Apply an evenly distributed force in a diagonally downward direction through the force application plate at any rate not more than 0.5 inch per second, until a force of 500 pounds has been applied.

14.09(b)(5) Apply additional force in a diagonally downward direction through the force application plate at a rate of not more than 0.5 inch per second until the force specified in (a) has been applied and maintain this application of force.

14.09(b)(6) Measure the diagonal movement of any point on the force application plate which occurred during the application of force in accordance with (5) and open the emergency exits as specified in (a)(2).

14.09(b)(7) Release all diagonal force applied through the force application plate and operate the emergency exits as specified in 14.09(a)(2).

14.09(c) Test Conditions: The following conditions apply to the requirements specified in (3).

14.09(c)(1) Temperature: The ambient temperature is any level between 32 degrees Fahrenheit and 90 degrees Fahrenheit.

14.09(c)(2) Windows and Doors: Vehicle windows, doors and emergency exits are in the fully-closed position and latched but not locked.

14.09(d) An alternative method of testing for the racking load test shall be as follows:

14.09(d)(1) The racking load shall be applied along a line connecting the most distant points on a transverse cross section of the bus interior. It produces a shear distortion of the cross section as shown in figure 2.

A representative method of loading which employs a hydraulic jack to load a two-frame test assembly is illustrated in figure 2.

The maximum jack load for the two-frame assembly is determined by the following formula:

$J = 2P$ J - maximum jack load for two-frame test assembly

$P = \text{load/frame}$

where $P = \text{DVW divided by } N$

DVW - dynamic vehicle weight

N - total number of bus body frames

and $\text{DVW} = \text{DF} \times \text{GVW}$

DF - dynamic factor, not less than 1.5

GVW - gross vehicle weight

Thus, for a $DF = 1.5$, a $GVW = 22,000$ pounds-force (lbf), and $N = 11$, the dynamic vehicle weight is $DVW = 33,000$ lbf, the load/frame is $P = 3000$ lbf and the maximum jack load is $J = 6000$ lbf.

14.09(d)(2) When a complete bus body is rack-loaded, the total load DVW must be distributed uniformly along the bus body. One method is to mount a series of hydraulic jacks along the length of the bus interior. Seats may be removed to facilitate jack mounting. The rack load will be considered to be uniformly distributed when the variation in the hydraulic jack readings is less than 10 percent. A maximum load for DVW shall be the sum of all jack readings.

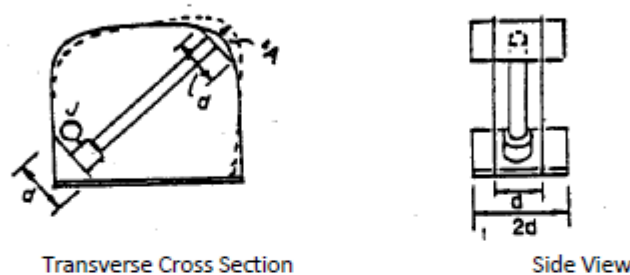

Figure 2. Arrangement of Hydraulic Jack for Rack-Loading of Two-Frame Assembly

14.09(d)(2)(A) The test may be performed on a complete bus body or on a representative section composed of at least two complete frames (body posts plus roof bows) and floor. Standard seats may be installed in the test section in a manner identical to that of the full bus body. Fabrication procedures for the test assembly shall be identical to normal bus body production.

14.09(d)(2)(B) A two-cycle loading sequence shall be conducted, with intermediate and final load and deflection readings recorded according to the procedure described.

14.09(d)(2)(C) The maximum deflection in line with the jack (A, maximum) shall not exceed 4 inches.

14.09(d)(3) Manufacturers shall specify which testing method was used and submit appropriate certification information as called for in 6.02.

2251-R-15.00 Cooling System.

15.01 Permanent ethylene-glycol base or environmentally safe equivalent anti-freeze shall be provided to protect the cooling system to -30 degrees Fahrenheit when tested at normal engine temperature.

15.02 Cooling system shall be equipped with a visual fluid level indicator.

2251-R-16.00 Defrosters.

16.01 A defroster system shall be installed of sufficient capacity to keep windshield area, left front side window to rear of driver's vision, and service door glass area free of condensation or ice.

16.02 The defrosting system shall conform to the requirements of the Society of Automotive Engineers, Inc. (SAE) J1945.

16.03 Adjustable 6 inch auxiliary fans may be installed to complement the defroster system used by the manufacturer. Such fans shall be controlled individually by two-speed switches located on control panel. Fan blades shall be covered with a protective cage.

16.03(a) The fans shall be located so as to not interfere with the driver's horizontal line of sight vision.

2251-R-17.00 Doors.

17.01 Service door shall be power or manually operated, under control of the driver, and so designed to afford easy release and prevent accidental opening. When manual lever is used, no parts shall come together so as to shear or crush fingers.

17.02 Manual door controls shall not require more than 25 pounds of force to operate at any point throughout the range of operation as tested on a 10% grade both uphill and downhill. Power door controls shall be located within easy access of driver.

17.03 Service door shall be located on right side of bus opposite driver and within driver's direct view.

17.04 Power operated doors shall be equipped with a separate manual emergency release, readily accessible in the door area, either above the service door, to the side of the service door or on the dash, so that the door may be opened in event of an emergency. The release shall be plainly labeled with instruction for use.

17.05 There shall be a head bumper pad installed on the inside at the top of the entrance door. The pad shall be approximately 3 inches wide (high), at least 1 inch thick, and extend across the entire top of the entrance door opening.

2251-R-18.00 Drive Shaft.

18.01 Each drive shaft or section thereof shall be equipped with adequate metal guard(s) to prevent whipping through floor or dropping to ground, if broken.

2251-R-19.00 Emergency Exits.

19.01 All emergency exits shall conform to FMVSS 217.

- 19.02 The minimum number of emergency exits is shown in the following table. A district may choose to have more emergency exits installed. Emergency doors may be installed in place of emergency windows.

EMERGENCY EXITS TABLE

BUS CAPACITY	ROOF HATCH	LEFT SIDE EMERGENCY WINDOW	RIGHT SIDE EMERGENCY WINDOW
1 – 45	1	0	0
46 – 70	2	1	1
71 - above	2	2	2

- 19.03 Emergency door:

19.03(a) Emergency door(s) shall be equipped with a 3-point latch mechanism. The inside door handle shall be designed with a guard for protection against accidental release.

19.03(b) Exterior door handle shall be of permanent hitch-proof design and mounted with enough clearance to permit opening without touching door surface.

19.03(c) All emergency door openings shall be completely weather stripped. No obstruction shall be higher than 1/4 inch across the bottom of any emergency door opening.

19.03(d) A head bumper pad shall be installed over the emergency door on the inside of the bus body. The pad shall be approximately 3 inches wide (high), at least 1 inch thick, and extend across the entire top of the emergency door opening. Padding shall be of the same materials as the padding used over the service door.

2251-R-20.00 Emergency Equipment.

- 20.01 The bus shall be equipped with at least one pressurized, 5-pound, dry-chemical fire extinguisher, with a total rating of not less than 2A10BC. The operating mechanism shall be sealed with a type of seal that will not interfere with use of the fire extinguisher.

20.01(a) Fire extinguisher shall be securely mounted in an extinguisher bracket (automotive type) and located in full view of and readily accessible to the driver. A pressure gauge shall be so mounted on the extinguisher as to be easily read without removing the extinguisher from its mounted position.

- 20.02 First Aid Kit: The bus shall carry one first aid kit which shall be securely mounted in full view of the driver or with the location plainly indicated by appropriate markings. Additional kits may be installed. The kit(s) shall be mounted for easy removal.

20.02(a) The kit shall be sealed. The seal verifies the integrity of the contents without opening the kit. The seal shall be designed to allow easy access to the kit's contents.

Contents of the 24 unit First Aid Kit:

Item	Unit(s)
Adhesive Tape	1
1 inch adhesive bandage	2
2 inch bandage compress	1
3 inch bandage compress	1
4 inch bandage compress	1
3 inch x 3 inch plain gauze pads	1
Gauze roller bandage 2 inch wide	2
Plain absorbent gauze – ½ square yard	4
Plain absorbent gauze – 24 inch x 72 inch	3
Triangular bandages	4
Scissors, tweezers	1
Space rescue blanket	1
Non-latex disposable gloves, pair.	1
CPR mask or mouth to mouth airway	1

Moisture and dustproof kit of sufficient capacity to store the required items.

- 20.03 Emergency Reflectors: All buses shall carry three (3) emergency triangle reflectors in compliance with Section 42-4-230, C.R.S. and with FMVSS 125, contained in a securely mounted case easily accessible to the driver or in a location plainly indicated by appropriate markings.
- 20.04 Body fluid cleanup kit: Each school bus shall have one removable body fluid clean-up kit accessible to the driver.

Contents of the Basic Body Fluid Clean-up Kit:

Item	Unit(s)
Antiseptic towelette	1
Disinfectant towelette	1
Absorbing powder (capable of ½ gallon absorption)	1
Non-latex disposable gloves, pair	1
Disposable wiper towels	2
Disposable scoop bag with closure mechanism and scraper	

Moisture and dustproof container of sufficient capacity to store the required items.

- 20.05 Each bus shall be equipped with one durable webbing cutter having a full width handgrip and a protected blade. The cutter shall be mounted in a location accessible to the seated driver.
- 20.06 Small vehicles shall carry the following emergency equipment:
- 20.06(a) Three (3) emergency triangle reflectors in a securely mounted case,
- 20.06(b) One 24 unit first aid kit as found in 20.02,

20.06(c) One securely mounted, 2 ½ pound, dry chemical fire extinguisher with a minimum rating of 1A10BC,

20.06(d) One durable webbing cutter having a full width handgrip and a protected blade. The cutter shall be mounted in a location accessible to the seated driver.

20.06(e) One basic body fluid clean-up kit as found in 20.04,

20.07 Emergency equipment shall be securely mounted. Emergency equipment shall be clearly visible or in a location plainly indicated by appropriate markings.

2251-R-21.00 Exhaust System.

21.01 Tailpipe shall not exit the right side of the bus body.

21.02 Exhaust system shall be insulated in a manner to prevent any damage to any fuel system component.

21.03 There shall be a switch to manually start the diesel particulate filter regeneration process.

21.04 The tailpipe shall be flush with but not extend more than one inch beyond the perimeter of the body for side exit or the bumper for rear exit except when not needed by an electric powered bus.

21.05 Tailpipe shall not exit beneath any fuel filler location or beneath any emergency door or lift door.

2251-R-22.00 Floor Coverings.

22.01 Floor in under seat area, including tops of wheel housings, driver's compartment, and toe board shall be covered with fire-resistant rubber floor covering or equivalent having a minimum overall thickness of .125 inch.

22.02 Floor covering in aisle shall be aisle-type, fire-resistant rubber or equivalent, non-skid, wear resistant, and ribbed. Minimum overall thickness shall be .1875 inch measured from tops of ribs.

22.03 Floor covering shall be permanently bonded to floor and must not crack when subjected to sudden changes in temperature. Bonding or adhesive material shall be waterproof and shall be of type recommended by manufacturer of floor-covering material. All seams must be sealed with waterproof sealer.

22.04 Cove molding shall be used along the side walls and rear corners. All floor seam separations shall be properly bonded or secured.

22.05 The entrance step treads, including the edge at floor level, shall be of the same quality as the aisle material. Step treads shall have an integral white or yellow nosing of 1 ½ inch or more or

use diagonal stripes. Treads shall be permanently bonded to the metal steps and sealed to prevent water from getting underneath the step tread.

- 22.06 A sealed and insulated plate shall be provided when required to access fuel tank sending unit. The plate shall not be installed under flooring material. Type A buses 14,500 GVWR and under are exempt.

2251-R-23.00 Frame.

- 23.01 No holes shall be permitted in the chassis rails except when drilled at the manufacturing plant or authorized by the manufacturer.
- 23.02 Welding to frame side rails necessary by design to strengthen, modify or alter basic vehicle configuration shall be authorized and documented by the manufacturer.

2251-R-24.00 Fuel System.

- 24.01 All fuel tank specifications shall conform to FMVSS 301, FMVSS 303, FMVSS 305, National Fire Protection Association code 52, and/or National Fire Protection Association code 58, as applicable.
- 24.02 Engine supply line shall not be mounted below fuel tank.
- 24.03 The fuel fill cap opening in the body skirt shall be equipped with a hinged cover held closed by a spring or other conveniently operated device except when not needed by an electric powered bus. Type A buses under 14,500 GVWR are exempt.

2251-R- 25.00 Heating System.

- 25.01 All school buses shall be equipped with two or more hot water heaters capable of delivering water to the system at a rate of six gallons per minute using an ambient temperature of 0 degree Fahrenheit to +10 degrees Fahrenheit and maintaining passenger compartment temperature of 50 degrees Fahrenheit. One of the heaters shall be located in the rear half of the bus on or behind the rear wheel axle line.
- 25.01(a) Lift equipped buses may place the rear heater under the last row of seats or wall mount. The front heater may be wall mounted.
- 25.02 Buses shall be equipped with front heater(s) and integrated defroster system of capacity to provide heat for the front part of the bus (including driver's compartment) and to keep windshield area, service door glass, driver's left glass area and step well clear of moisture, ice and snow.
- 25.03 Heater cores and fans shall be completely encased but designed to permit servicing heater assembly by removing all or part of the case.

- 25.04 Heater hose installation in the engine compartment shall include two shut-off valves shutting off coolant completely when necessary.
- 25.04(a) One shut-off valve mounted between the water pump outlet and heater hose connection.
- 25.04(b) One shut-off valve mounted between the motor block and the return heater hose connection.
- 25.04(c) Heater hoses shall be adequately supported to guard against excessive wear due to vibration. Hoses shall not rub against the chassis, body or other edges.
- 25.05 The body manufacturer shall add the required amount of permanent ethylene glycol base or environmentally safe equivalent anti-freeze after heaters have been connected to protect cooling system of bus to -30 degrees Fahrenheit tested at normal engine temperature.
- 25.06 A heater water flow regulating valve shall be installed for convenient operation by the driver.

2251-R-26.00 Identification.

- 26.01 School buses shall bear words "SCHOOL BUS" in black letters at least 8 inches high on both front and rear of body. Lettering shall be placed without impairment of its visibility. All lettering shall conform to Standard Alphabets for Highway Signs, Series B 2000. Lettering shall have a retro-reflective NSBY material background (see 15.02B)
- 26.02 School buses shall bear name of school district/service provider on each side of the bus. The lettering must be black, standard, unshaded letters, 5 inches in height. If there is insufficient space due to the length of the name of the school district, terms such as community, consolidated, and district may be abbreviated.
- 26.03 The manufacturer's original rated capacity of the vehicle shall be printed to the left of the entrance door on the lower skirt in 2 inch characters. The word "capacity" may be abbreviated. (Example: Cap. 48)
- 26.04 The numbering of individual buses for identification purposes is permissible.
- 26.05 Lettering and numerals shall be painted or may be pressure sensitive marking of similar performance quality.
- 26.06 "STOP" shall be printed on the rear of the bus in letters at least 8 inches high. "ON FLASHING RED" shall be printed below "STOP," in letters at least 4 ½ inches high. An LED message panel giving safety messages to alert motorists may be used instead of the above lettering. These letters shall be placed in area(s) visible to the approaching motorist.
- 26.07 The school district logo may be placed above the side window drip line or along the side of the bus, but shall not interfere with any required lettering.

- 26.08 Only signs and lettering specifically permitted by state law or regulation, and any marking necessary for safety and identification, shall appear on the outside of the bus.
- 26.08(a) Advertising, approved by the local board of education or charter school's governing board, may appear only on the side(s) of the bus in the following areas:
- 26.08(a)(1) The location and securement of the advertising shall have prior written CDE approval.
- 26.08(a)(2) The signs shall not extend from the body so as to allow a handhold or present a danger to pedestrians.
- 26.08(a)(3) The signs shall not interfere with the operation of any door, window, required lettering, lamps, reflectors or other device.
- 26.08(a)(4) The signs shall not be placed on side emergency door(s).
- 26.08(a)(5) Advertising signs shall not interfere with retro-reflective tape on the side of the bus.

26.09 The exterior of the Battery compartment shall be labeled with the word "Battery".

26.10 Identification of fuel type shall be located outside and adjacent to the fuel filler opening.

2251-R-27.00 Insulation.

27.01 Bus body shall be fully insulated in the roof including roof bows and all body panels. Insulation 1 inch minimum thickness shall be fiber-glass or equivalent and fire resistant.

2251-R-28.00 Interior.

28.01 Inside body height shall be 72 inches or more, measured metal to metal at any point on longitudinal center line from front vertical bow to rear vertical bow. Type A school buses of 14,500 GVWR or less shall have 62 inches or more inside height, measured metal to metal. Neither measurement shall include air conditioning units.

28.02 Interior of bus shall be free of all projections likely to cause injury.

2251-R-29.00 Lamps and Signals.

29.01 All lamps, signals, reflectors and their installation shall conform to the requirements of the Society of Automotive Engineers, Inc. (SAE) J1945. No lettering, symbols or arrows, except manufacturer's markings, shall be on any lens.

29.02 Tail and stop (brake) lamps:

29.02(a) Bus shall be equipped with four combination red stop/tail lamps. Two combination stop lamps shall have a lens diameter of at least 7 inches or 38.48 square inches. Two combination tail lamps shall have a lens diameter of at least 4 inches or 12 ½ square inches.

29.02(b) If the bus is equipped with a retarder, the four stop lamps shall be illuminated when the retarder is activated.

29.03 Interior lamps: Interior lamps shall be provided which adequately illuminate aisle. A separate lamp shall be provided in step well.

29.04 Back-up lamps: Back-up lamps of minimum diameter 7 inch or 38.48 square inches, or 4 inch LED shall be provided.

29.05 Turn signal lamps:

29.05(a) The bus shall be equipped with two amber turn signals in front and two amber turn signals in the rear. Rear turn signals shall be at least 7 inches or a total of 38.48 square inches in diameter.

29.05(b) Type D buses will still be required to be equipped with two amber turn signals in front with a minimum diameter of 7 inches or 38.48 square inches.

29.05(c) On buses over 30 feet, a minimum of one additional turn signal shall be mounted on each side below window and behind the service door axis plane.

29.06 School bus alternately flashing warning signal lamps:

Definition: School bus alternately flashing warning signal lamps mounted at the same horizontal level intended to identify vehicle as school bus and to inform other users of highway that such vehicle is stopped or about to stop on roadway to take on or discharge school children.

29.06(a) The amber flashing warning signal lamps shall be energized manually by a switch mounted on the driver control panel. The flashing warning signal lamp system shall be a sequential mode type.

29.06 (b) The flashing warning signal lamp system shall have two pilot or indicator lights; one shall show amber light when the amber signal lamps are flashing and the other shall show red light when the red signal lamps are flashing.

29.06 (c) The areas around the lens of each alternately flashing signal lamp shall be black.

29.06 (d) Visors shall be provided and securely mounted above the dual-lamp flashing warning signals to adequately shade and protect the dual-lamp assemblies from sunlight above but not to obstruct the rear and side effectiveness of the warning lamps. LED warning signal lamps are not required to use visors.

- 29.07 Type D rear engine buses shall have two hazard lamps each visible to the rear when the engine door is open. The lamps shall be wired to be illuminated when the main hazard lamp circuit is energized.
- 29.08 A white flashing strobe light may be installed on the roof of a school bus. Amber lens may be used upon approval of local traffic regulatory authority. Light shall have a single clear lens emitting light 360 degrees around its vertical axis and may not extend above the roof more than 8 inches. A manual switch and a pilot light must be included to indicate when light is in operation. Lamp must not be capable of activating emergency traffic control light switches.

2251-R-30.00 Mirrors.

- 30.00 Exterior mirrors shall meet FMVSS 111.

2251-R-31.00 Mounting, Body, and Chassis.

- 31.01 Insulation material shall be placed at all attachment points between body and chassis frame on all buses, and shall be so attached to the chassis frame or body to prevent movement under severe operating conditions.
- 31.02 Body front shall be attached and sealed to the chassis cowl to prevent entry of moisture and gases.

2251-R-32.00 Overall Size.

- 32.01 Overall length of school buses shall not exceed 40 feet pursuant to Section 42-4-504 C.R.S.
- 32.02 Overall width of the school bus shall not exceed 8 feet, except under the provisions of Section 42-4-502 (5)(a) C.R.S.

2251-R-33.00 Retarder (optional, see Section 42-4-1901, C.R.S.)

- 33.01 Retarder manufacturers shall certify that their product system shall maintain the speed of the bus loaded to maximum GVW at 19.0 miles per hour on a 7 percent grade for 3.6 miles.
- 33.02 School buses equipped with electro-magnetic retarder(s) shall have increased electrical system capacity commensurate with the needs of the retarder system.
- 33.03 Indicator light(s) shall indicate when retarder is in operation.

2251-R-34.00 Rub Rails.

- 34.01 There shall be one rub rail located on each side of bus at approximately seat level which shall extend from rear side of entrance door completely around bus body (except for emergency and/or access door) to point of curvature near outside cowl on left side.

- 34.02 There shall be one rub rail located at approximately floor line which shall cover same longitudinal areas as upper rub rail, except at wheel housing, and shall extend at least to radii of right and left rear corners.
- 34.03 There shall be one rub rail located on each side of bus at the bottom of the side skirts, or a side skirt stiffener of equivalent strength.
- 34.04 Rub rails shall be attached at each body post and all other upright structural members.
- 34.05 Rub rails shall be 4 inches or more in width, 16-gauge steel, or equivalent strength, constructed in corrugated or ribbed fashion and shall be self-draining.
- 34.06 Rub rails shall be applied to the outside of the body panels. Pressed-in or snap-on rub rails do not satisfy this requirement.

2251-R-35.00 Seats/Restraining Barriers.

- 35.01 Type A school buses shall be equipped with restraining barriers conforming to FMVSS 222.
- 35.02 No bus shall be equipped with jump seats or portable seats.
- 35.03 Forward-most pupil seat on right side of bus shall be located not to interfere with driver's vision. The seat shall not be farther forward than the barrier behind driver or rear of driver's seat when adjusted to its rear-most position.
- 35.04 Use of a flip seat at any side emergency door location in conformance with FMVSS 222, including required aisle width to side door, is acceptable. Any flip seat shall be free of sharp projections on the underside of the seat bottom. The underside of the flip-up seat bottoms shall be padded or contoured to reduce the possibility of snagged clothing or injury during use. Flip seats shall be constructed to prevent passenger limbs from becoming entrapped between the seat back and the seat cushion when in the upright position. The seat cushion shall be designed to rise to a vertical position automatically when not occupied.
- 35.05 School bus student seats and seat spacing shall meet FMVSS 222.
- 35.06 School bus seat materials shall meet FMVSS 302.

2251-R-36.00 Steering Gear Assembly.

- 36.01 All school bus chassis, in all passenger capacities shall be equipped with heavy-duty, truck-type integral power steering. Power steering components shall be compatible with the GVW rating.
- 36.02 No changes shall be made in steering apparatus that are not authorized in writing by manufacturer.
- 36.03 There shall be a clearance of at least 2 inches between steering wheel and any other surface or control.

2251-R-37.00 Steps.

- 37.01 First service door step shall be not less than 10 inches from the ground (12 inch for Type D) and not more than 14 inches from the ground (16 inches for Type D).
- 37.02 Step risers shall not exceed a height of 10 inches. When plywood is used on the top step, the riser height may be increased by the thickness of the wood.
- 37.03 An assist hand rail not less than 20 inches in length designed to provide maximum loading assistance, shall be provided in an unobstructed location inside doorway.
- 37.04 Surface of steps shall be of non-skid material.

2251-R-38.00 Stop Signal Arm.

- 38.01 The stop signal arm shall meet FMVSS 131.
- 38.02 Rubber spacers shall be installed on either the side of the bus or the stop arm so as to prevent sign from making abrasive contact with the side of the bus.
- 38.03 Wind guard shall be provided to keep sign in retracted position.

2251-R-39.00 Storage Compartment.

- 39.01 A metal container of adequate strength and capacity for the storage of tire chains, tow chains, and such tools as may be necessary for minor emergency repairs while bus is in route may be provided. The storage container may be located either inside or outside the passenger compartment. If inside, the storage compartment shall be securely fastened to prevent the contents from spilling and shall have a latched or secured cover other than a seat cushion.

2251-R-40.00 Sun Visor.

- 40.01 An interior, adjustable, sun visor shall be installed not less than 6 inches wide and 30 inches long. Type A school buses 14,500 GVWR or less shall have a sun visor according to manufacturer's standard size.

2251-R-41.00 Tires and Rims.

- 41.01 Minimum tire and rim sizes shall be in accordance with FMVSS 120.
- 41.02 Dual rear tires shall be provided on Type B, C and D school buses.
- 41.03 All wheels shall be one-piece disc type. Split or multi-piece rims are not acceptable.

2251-R-42.00 Tow Hooks.

- 42.01 Two front heavy duty tow hooks or two eyes shall be furnished and factory installed, except on Type A and B buses. Hooks shall not extend beyond the front bumper on any school bus.
- 42.02 Two rear heavy-duty tow hooks or eyes shall be fastened securely to the rear of the frame and shall not protrude beyond outer edge of the bumper.

2251-R-43.00 Undercoating.

- 43.01 The entire underside of the bus body, including floor sections, cross members, and below floor line side panels, shall be coated with rust-proofing material meeting or exceeding performance requirements of Society of Automotive Engineers, Inc. (SAE) J1945.
- 43.02 The undercoating material shall be applied with suitable airless or conventional spray equipment as per manufacturer recommended film thickness and shall show no evidence of voids in the cured film.
- 43.03 The undercoating material shall not cover any exhaust components of the chassis.

2251-R-44.00 Ventilation.

- 44.01 Buses in excess of 20 feet in length shall be equipped with a multi-speed powered exhaust roof ventilator or powered vent fan in roof hatch, mounted in the rear half of the bus.

2251-R-45.00 Windshield Wipers and Washers.

- 45.01 The wipers shall be operated by one or more air or electric motors. If one motor is used, the wipers shall work in tandem to give full sweep of windshield.
- 45.02 All wiper controls shall be located within easy reach of the driver and designed to move blades from the driver's direct view when in stop position.
- 45.03 For Type A over 14,500 GVWR, B, C and D buses, the system reservoir capacity shall be a minimum of one gallon.

2251-R-46.00 Wiring.

46.01 Wiring: All wiring shall conform to the requirements of the Society of Automotive Engineers, Inc. (SAE) J1945.

46.01(a) An appropriate identifying diagram (color plus a name or number code) for all chassis electrical circuits shall be provided to the body manufacturer for distribution to the end user.

46.01(b) A body wiring diagram, sized to be easily read, shall be furnished with each bus body or affixed to an area convenient to the electrical accessory control panel.

46.01(c) Each wire passing through metal openings shall be protected by a grommet.

SPECIALLY EQUIPPED BUSES

2251-R-47.00 Specially Equipped Buses.

- 47.01 Equipping buses to accommodate students with disabilities is dependent upon the needs of the passengers. Buses equipped with equipment to accommodate the student needs are not to be considered a separate class of school bus, but a regular school bus equipped for special accommodations. It is recognized by the entire industry that the field of special transportation is characterized by varied needs for individual cases and by a rapidly emerging technology. A flexible, "common-sense" approach to the adoption and enforcement of specifications is prudent.
- 47.02 Buses equipped for transporting students with special transportation needs shall comply with applicable FMVSS.
- 47.02(a) Buses with power lifts shall comply with FMVSS 403, Platform Lift Systems for Motor Vehicles, and FMVSS 404, Platform Lift Installation in Motor Vehicles
- 47.02(b) A ramp device may be used in lieu of a mechanical lift if the ramp meets all the requirements of the Americans with Disabilities Act (ADA) as found in 36 CFR § 1192.23, Vehicle Ramp.
- 47.02(c) Buses with power lifts or ramps shall display the international symbol of accessibility on all four sides of the bus. The symbols shall be a minimum of 6 inches and not exceed 12 inches. Such emblems shall be white on blue background.
- 47.02(d) The term wheelchair tiedown and occupant restraint system (WTORS) is used to refer to the total system that secures the wheelchair and restrains the wheelchair occupant. A wheelchair tiedown and occupant restraint system installed in specially equipped buses shall be designed, installed, and operated for use with forward-facing wheelchair-seated passengers and shall comply with all applicable requirements of FMVSS 222, School Bus Passenger Seating and Crash Protection and FMVSS 302 Flammability of Interior Materials.

Editor's Notes

History

Entire rule eff. *(insert effective date)*

Appendix C. Regulation 1 CCR 301-25 (2007) Colorado Minimum Standards Governing School Transportation Vehicles Effective date September 01, 2007

Colorado State Board of Education
Department of Education 1 Colorado Code of Regulations 301-25

Adopted: 11-21-72, with numerous subsequent amendments temporary regulation amendments 2-16-78 and 5-10-78, repealed and readopted 1-4-79, amended 8-9-79, 10-4-79, 1-10-80, 3-13-80, 4-10-80, 10-9-80, 8-12-82, 9-13-84, 7-9-87, amended 7-14-88, 6-10-93, 11-14-96, 11-12-98, 5-10-07.

Attorney General Opinions: 2-23-78, 1-15-79, 7-17-87, 7-25-88, 6-17-93, 12-3-96, 11-30-98, 5/17/07.

Statutory Authority: 22-51-108, 22-2-107 (1)(c) and 42-4-1903 (1) (2) (3), C.R.S.

COLORADO MINIMUM STANDARDS GOVERNING SCHOOL TRANSPORTATION VEHICLES

2251-R-1.00 Statement of Basis and Purpose

The statutory authority for the Amendments to the Colorado Minimum Standards Governing School Transportation Vehicles (hereinafter "these rules"), adopted by the State Board of Education on May 10, 2007, is found in sections 22-51-108 and 42-4-1903 (1) (2) (3), C.R.S.

The purpose of these amendments is to upgrade the rules for Colorado minimum standards governing school transportation vehicles. The amendments will improve the safety of the students riding the school bus and the mechanical efficiency of the school bus. They are designed to meet or exceed changing needs of operation, the national recommended minimum standards, new federal safety and emission standards and utilize state-of-the-art industry advances.

2251-R-2.00 References

FMVSS-

Federal Motor Vehicle Safety Standards
49 C.F.R. Part 571, Current Revision
National Highway Traffic Safety Administration
U.S. Department of Transportation

SAE-

Society of Automotive Engineers, Inc.
Standards, Current Revision

UL-

Underwriters Laboratories, Inc.
Standard 299-82, Current Revision

FED. SPEC.-

Federal Specification TT-C-520b
Current Revision
General Services Administration
Specification and Consumer Information

NCST-

National School Transportation Specifications And Procedures Revision 2005
Recommendations Of The Fourteenth National Congress On School Transportation
The Missouri Safety Center, Warrensburg, Missouri

NBS-

National Bureau of Standards
Voluntary Product Standard 1-83, Current Revision
Office of Standards Reference Materials

SAHS-

Standard Alphabets for Highway Signs - Series B
Federal Highway Administration, Current Revision
U.S. Government Printing Office

NFPA-

National Fire Protection Association
Volume 2, National Fire Codes, Current Revision

2251-R-3.00 Responsibility of Suppliers

- 3.01 School transportation vehicle dealers, distributors, and manufacturers each have a responsibility to comply with these rules after the effective date of these rules, September 1, 2007.
- 3.02 Dealers, distributors, or manufacturers which supply school transportation vehicles for use in the State of Colorado which do not meet the specifications herein stated shall be notified of noncompliance and a general notice will be sent to all school districts and school transportation operations within the State of Colorado advising that equipment supplied by such dealer, distributor, or manufacturer is not in compliance with these rules, September 1, 2007.
- 3.02 (a) If a dealer, distributor, or manufacturer has been notified of non-compliance in accordance with subsection 3.02 and replaces or modifies the equipment to meet these rules, September 1, 2007, a notification of compliance will be issued from the Colorado Department of Education within 30 days after proof of compliance.

2251-R-4.00 Effective Date of Specification

- 4.01 School transportation vehicles manufactured on or after the effective date of these rules, September 1, 2007, for the purpose of transporting Colorado students shall meet or exceed these minimum standards contained herein.

- 4.02 School transportation vehicles transporting Colorado students may continue in use.
- 4.03 Only those buses that were manufactured, within the previous 20 years, may be purchased, leased, contracted, or otherwise obtained for the purpose of transporting Colorado students. These buses must meet Colorado minimum standards that were in effect at the time of manufacture.
- 4.04 Only those small vehicles manufactured after September 1, 1994, may be purchased, leased, contracted, or otherwise obtained for the purpose of transporting Colorado students.

2251-R-5.00 School Transportation Vehicle Definitions

- 5.01 School Transportation Vehicle means every motor vehicle which is owned by a public or governmental agency and operated for the transportation of students to or from school or school related events or which is privately owned and operated for compensation provided that such transportation service is sponsored and approved by the local board of education or school governing agency.
 - 5.01 (a) This does not include informal or intermittent arrangements, such as sharing of actual gasoline expense or participation in a car pool.
 - 5.01 (b) Vehicles that carry students as part of their operation as a common carrier under the jurisdiction of us department of transportation or public utilities commission are not included within the definition of school transportation vehicle.
- 5.02 A School Bus shall be a motor vehicle with motive power, built to FMVSS and the school bus standards contained herein, designed for carrying students on either routes or activity trips.
 - 5.02 (a) **TYPE A**--Type "A" school bus is a conversion or body constructed upon a van-type compact truck or a front-section vehicle chassis, designed for carrying passengers with driver side door and GVWR of 21,000 pounds or less.
 - 5.02 (b) **TYPE B**--Type "B" school bus is a conversion or body constructed and installed upon a van or front-section vehicle chassis, or stripped chassis, with a gross vehicle weight rating of more than 10,000 pounds, designed for carrying passengers. Part of the engine is beneath and/or behind the windshield and beside the driver's seat. The entrance door is behind the front wheels.
 - 5.02 (c) **TYPE C**--Type "C" school bus is a body installed upon a flat back cowl chassis with a gross vehicle weight rating of more than 10,000 pounds, designed for carrying passengers. All of the engine is in front of the windshield and the entrance door is behind the front wheels.
 - 5.02 (d) **TYPE D**--Type "D" school bus is a body installed upon a chassis, with the engine mounted in the front or rear, with a gross vehicle weight rating of more than 10,000 pounds, designed for carrying passengers. The engine may be behind the windshield and beside the driver's seat; it may be at the rear of the

bus, behind the rear wheels. The entrance door is ahead of the front wheels.

- 5.03 Small Vehicle shall be a motor vehicle with motive power, which does not meet the requirements of a Type A, B, C, or D school bus. These vehicles shall not transport more than the manufacturer's designated capacity. A small vehicle shall meet or exceed section 59.05 of these rules. These vehicles may be used to carry students on route or activity trips.

The preceding definition is not intended to include private motor vehicles used exclusively to carry members of the owner's household.

- 5.03 (a) Small vehicles shall bear name of school district/service provider plainly visible to each side.

- 5.04 Multifunction bus shall be a motor vehicle with motive power, built to federal multifunctional school activity bus standards, designed for carrying students. These buses may be used to carry students on activity trips. Multifunction buses of 15 or less capacity may also be used on route.

- 5.04 (a) Multifunction buses shall also meet the standards contained herein with the exception of:

16.00 Color: chassis

54.00 Color: body

63.01 Lettering "SCHOOL BUS"

63.06 Lettering "STOP ON FLASHING RED"

67.07 Alternately flashing warning signal lamps

77.00 Stop signal arm

2251-R-6.00 Testing and Certification

- 6.01 Chassis manufacturers shall provide annual certification to the Colorado Department of Education that their product(s) meet these rules and all applicable FMVSS standards.
- 6.02 School bus body manufacturers shall provide annual certification to the Colorado Department of Education that their product(s) meet or exceed these rules and all applicable FMVSS in effect at the time of manufacture. Body manufacturers shall record and report to CDE the test results called for in Section 55 - Construction, of these rules. All school bus bodies shall meet applicable FMVSS and compliance with these standards shall be certified by the body manufacturer by the attachment of a plate or decal.
- 6.03 It will be the district's/service provider's responsibility to ascertain whether all school buses purchased, leased, or under contract to the district meet all specifications of these rules. This verification should be obtained at the time of delivery, in addition to the statement of compliance in the purchase bid, contract for or lease agreement.
- 6.04 When selling a school bus, it is the district's responsibility to eliminate the district's name from the sides of the bus.
- 6.05 Used school bus dealers shall register with the Colorado Department of Education

certifying that only school transportation vehicles meeting or exceeding Colorado standards will be sold. There shall be no fee to register.

6.06 All school transportation vehicles must meet and continue to meet applicable FMVSS.

2251-R-7.00 Chassis and Body Delivery Requirements

7.01 The chassis and body manufacturer shall provide the following materials and information for direct delivery to the customer upon request:

7.01 (a) Line set tickets for each individual unit.

7.01 (b) A copy of the pre-delivery service performed and verified by a checkout form for each individual unit.

7.01 (c) Warranty book and statement of warranty for each individual unit.

7.01 (d) Service manual for each individual unit or identical units.

7.01 (e) Parts manual for each individual unit or identical units.

2251-R-8.00 (rule number reserved)

2251-R-9.00 (rule number reserved)

2251-R-10.00 (rule number reserved)

2251-R-11.00 (rule number reserved)

THE BUS CHASSIS

2251-R-12.00 Air Cleaner

12.01 The engine intake air cleaner shall be furnished and properly installed by the chassis manufacturer to meet engine specifications.

2251-R-13.00 Axles

13.01 The front axle and rear differential, including suspension assemblies, shall have a gross axle weight rating at ground, at least equal to that portion of the load as would be imposed by the chassis manufacturer's maximum gross vehicle weight rating.

13.02 Rear axle shall be single-speed.

2251-R-14.00 Brakes

14.01 All braking systems shall comply with FMVSS.

14.01 (a) The braking system capacity shall be commensurate with the braking requirements of the GVWR.

14.02 Vehicles with a maximum designed capacity of greater than 54 shall be equipped with full compressed air brake systems.

- 14.03 Air brakes: The following standards apply to air brake systems:
- 14.03 (a) Compressors: On buses using full compressed air brakes for service, emergency, and parking brakes, the compressor shall be a standard production model with a minimum 12 cubic foot per minute displacement.
 - 14.03 (b) Three reservoirs or chambers (wet, primary, secondary) with a total capacity, which is equal to or greater than 12 times the total volume of all brake actuators at full travel.
 - 14.03 (c) Moisture ejection valve: An automatic heated, moisture ejection valve or air drying system shall be properly installed. This is made to automatically eject moisture, sludge, and/or foreign matter and maintain clean, dry air lines.
 - 14.03 (d) Control requirements: Control valve of the parking brake system shall be designed and constructed to conform with the following:
 - 14.03 (d)(1) The parking brake control valve shall be visible to the driver and shall be mounted on the dash panel within 15 inches to the right of the steering column.
- 14.04 Anti-lock brake system shall control all four wheel positions individually.

2251-R-15.00 Bumper, Front

- 15.01 Front bumper on all Type A, B and C school buses shall be furnished by the chassis manufacturer.
- 15.02 Front bumper of Type D school buses shall be furnished by the body manufacturer.
- 15.03 Front bumper shall be at least 3/16 inch thick of pressed steel channel, one piece construction or optional 3-piece breakaway construction and a minimum of eight inches wide (high) except Type A buses.
- 15.04 Front bumper shall be of extended design to offer maximum protection of fender lines without permitting snagging or hooking.
- 15.05 Front bumper shall be attached to the frame and extend forward of grille, head lamps, fender, or hood sections to provide maximum protection.
- 15.06 The bumper shall be of sufficient strength to ensure that the front of the bus may be lifted by means of a bumper type jack without permanent deformation of the bumper. Type A buses may use standard construction bumper.

2251-R-16.00 Color: Chassis

- 16.01 Frame and bumper shall be painted black.

- 16.02 Cowl and fenders shall be painted National School Bus Yellow as defined in NCST.
- 2251-R-17.00 Cooling System
- 17.01 Permanent ethylene-glycol base or environmentally safe equivalent anti-freeze shall be provided by chassis manufacturer to protect the cooling system to -30 degrees Fahrenheit (F) when tested at normal engine temperature and shall not be diluted by body company.
- 17.02 Cooling system shall be equipped with a coolant recovery system.
- 17.03 Cooling system shall be equipped with a visual fluid level indicator.
- 2251-R-18.00 Drive Shaft
- 18.01 Each drive shaft or section thereof shall be equipped with adequate metal guard or guards to prevent whipping through floor or dropping to ground if broken.
- 2251-R-19.00 Electrical System
- 19.01 The electrical system {including battery(ies) and alternator} shall be commensurate with all electrical needs of the bus, including accessories.
- 19.02 Battery and all cable required to complete circuits without splicing, even when drawer is extended for battery servicing, shall be provided by the chassis manufacturer and mounted for delivery to body plant.
- 2251-R-20.00 Exhaust System
- 20.01 Exhaust pipe, muffler, and tail pipe shall not pass through the passenger portion of the bus body.
- 20.02 Exhaust system must meet federal standards.
- 20.03 Tailpipe shall not exit the right side of the bus body.
- 20.04 Exhaust system shall be insulated from fuel tank and fuel tank connections by securely attached metal shield at any point where it is 12 inches or less from the fuel tank or fuel tank connections, except diesel fuel.
- 20.05 There shall be a switch inaccessible to the driver to manually start the diesel particulate filter regeneration process.
- 2251-R-21.00 Fenders, Front
- 21.01 Total spread of outer edges of front fenders measured at fender line shall exceed total spread of front tires when front wheels are in straight ahead position.
- 21.02 Front fenders shall be braced and free from any body attachment.

2251-R-22.00 Frame

- 22.01 Frame shall be designed to correspond with or exceed standard practice performance criteria for truck of same general load specifications used for severe service.
- 22.02 No holes shall be permitted in the chassis rails except those drilled at the chassis plant or authorized by the chassis manufacturer.
- 22.03 Welding to frame side rails which is necessary by design to strengthen, modify or alter basic vehicle configuration shall be performed and guaranteed by the body or chassis manufacturer making the modification.

2251-R-23.00 Fuel System

- 23.01 All fuel tank specifications shall conform to FMVSS 301.
- 23.02 Fuel tank shall be filled and vented entirely outside the passenger compartment.
- 23.03 Fuel filter with replaceable element shall be installed between fuel tank and engine.
- 23.04 Engine supply line shall not be mounted below fuel tank.

2251-R-24.00 Heating System

- 24.01 Engine design shall provide inlet and outlet holes in accessible locations for attachment of bus heating system water lines. Heater outlets shall be of sufficient size to accommodate circulation of all coolant with no reduction of coolant lines.

2251-R-25.00 Horn

- 25.01 Bus shall be equipped with horn(s) of standard make, each horn capable of producing complex sound in band of audio frequencies from 250 to 2000 cycles per second and having total sound level of 110 decibels as rated by horn manufacturer.

2251-R-26.00 Instruments and Instrument Panel

- 26.01 Chassis shall be equipped with the following non-glare instruments and gauges. Lights in lieu of gauges are not acceptable.
 - 26.01 (a) Standard speedometer with seven digit odometer,
 - 26.01 (b) Voltmeter with a graduated scale to 16 volts.
 - 26.01 (c) Oil pressure gauge.
 - 26.01 (d) Water temperature gauge.
 - 26.01 (e) Fuel gauge.

- 26.01 (f) Upper-beam headlamp indicator.
 - 26.01 (g) Tachometer. The tachometer is not required for Type A and B school buses.
 - 26.01 (h) Left and right turn-signal indicator.
 - 26.01 (i) Chassis with air brake systems shall be equipped with a visible gauge and audible low-pressure indicator to warn driver if air pressure in brake system falls below 60 PSI.
 - 26.01 (j) Chassis with air brake systems shall have a labeled visual indicator of park brake application visible to driver.
 - 26.01 (k) Chassis with a hydraulic assist-brake system shall be equipped with warning signals, readily audible and visible to the driver, that will provide continuous warning in the event of a loss of fluid flow from primary source or loss of electric source powering the back-up system.
- 26.02 All instruments shall be easily readable by driver and accessible for maintenance.

2251-R-27.00 Lamps and Signals

- 27.01 All lamps and their installation shall conform to current standards and recommended practices of applicable SAE and FMVSS standards.

2251-R-28.00 Openings

- 28.01 All openings made by chassis manufacturer in floorboard and fire-wall shall be sealed by the chassis manufacturer to prevent gases from entering driver's compartment. Boot for the accelerator pedal, gear shift, and parking brake, when required, shall be supplied by the chassis manufacturer.

2251-R-29.00 Power or Gradeability

- 29.01 The gross vehicle weight of any school bus shall not exceed 165 pounds per certified net horsepower of the engine at manufacturer's recommended maximum revolutions per minute (RPM).

2251-R-30.00 Retarder (optional)

- 30.01 Retarder manufacturers shall certify that their product system shall maintain the speed of the bus loaded to maximum GVW at 20 miles per hour on a 7 percent grade for 3.5 miles.
- 30.02 School buses equipped with electro-magnetic retarder(s) shall have increased electrical system capacity commensurate with the needs of the retarder system.
- 30.03 Pilot light(s) shall indicate when retarder is in operation.

2251-R-31.00 Steering Gear Assembly

- 31.01 All school bus chassis in all passenger capacities shall be equipped with heavy-duty, truck-type integral power steering. Power steering components shall be compatible with the GVW rating for each capacity as shown in chassis manufacturer's literature.
- 31.02 No changes shall be made in steering apparatus that are not approved and guaranteed by chassis manufacturer.
- 31.03 There shall be a clearance of at least two inches between steering wheel and any other surface or control.
- 31.04 Chassis manufacturers shall provide and cover steering wheel column with a temporary plastic covering or equivalent, in order to provide protection from precipitation from time of manufacture until body is mounted.

2251-R-32.00 Suspension System

- 32.01 Capacity of suspension assemblies shall be commensurate with chassis manufacturer's gross vehicle weight rating.

2251-R-33.00 Tires and Rims

- 33.01 Minimum tire and rim sizes shall be in accordance with FMVSS 120.
- 33.02 Dual rear tires shall be provided on Type B, C, and D school buses.
- 33.03 All wheels shall be one piece disc type. Split or multi-piece rims are not acceptable.

2251-R-34.00 Tow Hooks Front

- 34.01 Two heavy duty tow hooks or two eyes on Type C and D buses shall be furnished and factory installed, except on Type A and B buses. Hooks shall not extend beyond the front bumper on any school bus.

2251-R-35.00 Undercoating

- 35.01 Chassis manufacturer shall coat undersides of steel or metallic front fenders with rust-proofing compound for which compound manufacturer has issued notarized certification of compliance to chassis builder that compound meets or exceeds all performance and qualitative requirements of Fed. Spec. using modified test.

2251-R-36.00 Wiring

- 36.01 All wiring shall conform to current applicable recommended practices of SAE.
- 36.02 All wiring shall use a standard color, number, or function coding and each chassis shall have available at no cost to the district/service provider, a wiring diagram that coincides with the wiring of the chassis. Type A bus chassis may be exempt from this requirement.

- 36.03 Chassis manufacturer shall install an accessible terminal strip or plug on the body side of the cowl, or at an accessible location in the engine compartment of vehicles designed without a cowl, that shall contain the following terminals for the body connections. Factory terminal strip from chassis manufacturer on Type A bus will be acceptable.
- 36.03 (a) main 100 amp body circuit
 - 36.03 (b) tail lamps
 - 36.03 (c) right turn signal
 - 36.03 (d) left turn signal
 - 36.03 (e) stop lamps
 - 36.03 (f) back up lamps
 - 36.03 (g) instrument panel lights

- 2251-R-37.00 (rule number reserved)
- 2251-R-38.00 (rule number reserved)
- 2251-R-39.00 (rule number reserved)
- 2251-R-40.00 (rule number reserved)
- 2251-R-41.00 (rule number reserved)
- 2251-R-42.00 (rule number reserved)
- 2251-R-43.00 (rule number reserved)
- 2251-R-44.00 (rule number reserved)
- 2251-R-45.00 (rule number reserved)
- 2251-R-46.00 (rule number reserved)
- 2251-R-47.00 (rule number reserved)
- 2251-R-48.00 (rule number reserved)
- 2251-R-49.00 (rule number reserved)

THE BUS BODY

2251-R-50.00 Aisle

- 50.01 Minimum aisle clearance between seats shall be 12 inches at seat level and 15 inches at top of seats. This includes the aisles to all emergency doors.
- 50.02 The aisle to any side emergency exit door shall be unobstructed at all times by any type of barrier, seat, wheelchair or tiedown, unless a flip seat is installed and occupied. A flip seat in the unoccupied (up) position shall not obstruct the 12 inch minimum aisle to any side emergency exit door. The track of a track seating system shall be exempt from this requirement.
- 50.03 On forward control (front engine) Type D buses, the aisle passage area shall not be less than 12 inches, measured from floor level up, between engine cover and any other object.

Hold down fastening devices used on engine cover shall be designed to prevent hooking or catching on shoes or clothing.

2251-R-51.00 Battery

- 51.01 Body manufacturer shall provide, a drawer-type pull out tray to facilitate servicing or removal of battery(ies). The battery(ies) shall be enclosed by a vented compartment constructed of mill-applied zinc steel provided with drain ports, hold down carrier mounted so as to avoid blocking filler ports and latching device to prevent accidental opening. Under-coating shall be provided and applied to battery box. Battery tray is to be equipped with a safety device to keep tray from sliding completely out to prevent battery from being dropped.

2251-R-52.00 Bumper, Rear

- 52.01 Rear bumper shall be of pressed steel channel or equivalent material, at least 3/16-inch thick, and shall be a minimum of 8 inches wide (high) on Type A buses, and shall be a minimum of 9 1/2" wide (high) on Type B, C, and D buses.
- 52.02 Rear bumper shall be wrapped around back corners of bus and extend forward at least 12 inches from rear-most point of body at floor line.
- 52.03 Bumper shall be fastened to chassis frame side rails in such a manner as to develop full strength of bumper section from rear or side impact. Bracing materials shall have an impact ratio comparable to that of bumper material and shall be fastened at the ends and radii of the bumper, attached to the side of the frame only and not to body at any point.
- 52.04 Rear bumper shall extend beyond rear-most part of body surface at least one inch, measured at floor lines.
- 52.05 No spaces, projections, or cut-outs that will permit a hand hold or foot hold shall be permitted.
- 52.06 Front ends of the bumper shall be enclosed by end caps or other protective metal or shall have the ends rounded or tucked in and shall be free from sharp edges or projections likely to cause injury or snagging.
- 52.07 A gasket, rubber or equivalent, shall be installed to close opening between the top of the rear bumper and body metal.
- 52.08 The bumper shall be of sufficient strength to permit being pushed by another vehicle of similar size. The bumper shall be of sufficient strength to ensure that the rear of the bus may be lifted by means of a bumper type jack without permanent deformation of the bumper. Type A buses may use standard construction bumper.

2251-R-53.00 Capacity

- 53.01 Capacities and seat spacing shall conform to and be in full compliance with applicable FMVSS.

2251-R-54.00 Color

- 54.01 All exterior metal shall be painted National School Bus Yellow (NSBY) as specified in NCST with the exception of those areas listed below:
- 54.01 (a) Lettering and numbering (black, white, or yellow for bumper area)
 - 54.01 (b) Bumpers (black)
 - 54.01 (c) Rubrails may be black or yellow at purchaser option.
 - 54.01 (d) Background area for warning light system. (black)
 - 54.01 (e) The roof of the bus may be painted white not to extend below the drip rails on the sides of the body.
 - 54.01 (f) Student window frames, posts and service door frame may be black.
- 54.02 Retro-Reflective material shall be installed on the bus. Material shall be of reflective NSBY conforming to the requirements of FMVSS 571.131, Table 1. Retro-Reflective materials and markings shall include the following:
- 54.02 (a) Rear of bus body: strips of at least 1.75 inch Retro-Reflective NSBY material shall be applied horizontally above the rear windows and above the rear bumper extending from the rear emergency exit perimeter marking outward to the left and right rear corners of the bus with vertical strips applied at the corners connecting these horizontal strips.
 - 54.02 (b) "School Bus" signs: Shall be marked with Retro-Reflective NSBY material comprising background for lettering of the front and/or rear "school bus" signs.
 - 54.02 (c) Sides of bus body: Shall be marked with Retro-Reflective NSBY material at least 1.75 inches in width, extending the length of the bus body and located (vertically) as close as practicable to the floor line.

2251-R-55.00 Construction

- 55.01 All metal surfaces that will be painted shall be (in addition to above requirements) chemically cleaned, etched, zinc-phosphate-coated and zinc-chromate or epoxy primed or conditioned by equivalent process. In providing for these requirements, particular attention shall be given to lapped surfaces, welded connections of structural members, cut edges, punched or drilled hole areas in sheet metal, closed or box sections, unvented or undrained areas and surfaces subject to abrasion during vehicle operation.
- 55.02 The floor shall be at least 14 gauge mill applied zinc-coated steel sheet and shall be on one plane. There shall be a main floor cross member of at least 10 gauge steel or equivalent placed at each side post extending the full width of the floor plate and permanently

attached. There shall be a minimum of two intermediate floor cross members of at least 16 gauge steel equally between the main floor cross members and permanently attached.

55.02(a) Type A buses may use other metal or material with strength and corrosion resistance at least equivalent to all-steel construction as certified by the bus body manufacturer.

55.03 In addition to complying with the test procedures described in FMVSS 220, the body manufacturers shall record and report the downward vertical movement of the force at 0, 25, 50, 75, and 100% of the maximum force (both loading and unloading). The expected force deflection curve is illustrated schematically in Figure 1a. Low load nonlinearities may indicate joint conformation; high load nonlinearities may indicate yielding in structural members.

55.03 (a) A second load cycle shall be performed following the procedure given in the first paragraph. The expected force-deflection curve is illustrated schematically in Figure 1b. Any hysteresis following the initial shakedown will be revealed by this second cycle.

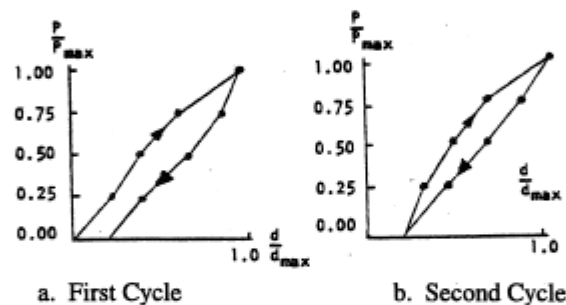

Figure 1. Static Load Test Load-Deflection Curves

55.04 A diagonal (racking) load test shall be performed on Type A, B, C, D school buses to assure adequate shear stiffness and strength of the bus body. Details of the test are provided below.

A two cycle loading sequence shall be conducted following the procedure described in Section 55.04.

55.04 (a) Requirements: When a force equal to 1-1/2 times the GVW is applied to the edge of the roof of the vehicle's body structure through a force application plate as specified in (b), Test Procedures:

55.04 (a)(1) The diagonal movement of the force at any point on the application plate shall not exceed 5 1/8 inches; and

55.04 (a)(2) Each emergency exit of the vehicle provided in accordance with FMVSS 217 shall be capable of operation as specified in that standard during the full application of the force and after

release of the force.

55.04 (b) Test Procedures: Each vehicle shall be capable of meeting the requirements of (1) and (2) when tested in accordance with the procedures set forth below.

55.04 (b)(1) The vehicle shall be supported on a rigid surface along the lower edge of the frame or along the body sills in the absence of a frame.

55.04 (b)(2) The load shall be applied through a force application plate that is flat and rigid. The dimensions of the plate shall be chosen to assure that the plate edges never make contact with the vehicle skin during testing. A typical width is 18 inches, and a typical length is 20 inches less than the length of the vehicle's roof measured along its longitudinal centerline.

55.04 (b)(3) Place the force application plate in contact with the edge of the vehicle roof. Orient the plate so that its flat, rigid surface is perpendicular to a diagonal line connecting the most distant points on an interior cross section of the vehicle. The rear edge of the plate shall be positioned approximately 20 inches from the rear edge of the vehicle roof. A temporary stand may be used to support the plate until a force is applied.

55.04 (b)(4) Apply an evenly distributed force in a diagonally downward direction through the force application plate at any rate not more than 0.5 inch per second, until a force of 500 pounds has been applied.

55.04 (b)(5) Apply additional force in a diagonally downward direction through the force application plate at a rate of not more than 0.5 inch per second until the force specified in (a) has been applied, and maintain this application of force.

55.04 (b)(6) Measure the diagonal movement of any point on the force application plate which occurred during the application of force in accordance with (5) and open the emergency exits as specified in (a)(2).

55.04 (b)(7) Release all diagonal force applied through the force application plate and operate the emergency exits as specified in (a)(2).

55.04 (c) Test Conditions: The following conditions apply to the requirements specified in (3).

55.04 (c)(1) Temperature: The ambient temperature is any level between 32 degrees F and 90 degrees F.

55.04 (c)(2) Windows and Doors: Vehicle windows, doors, and emergency

exits are in the fully-closed position, and latched but not locked.

55.04 (d) An alternative method of testing for the racking load test shall be as follows:

The racking load shall be applied along a line connecting the most distant points on a transverse cross section of the bus interior. It produces a shear distortion of the cross section as shown in figure 2.

A representative method of loading which employs a hydraulic jack to load a two-frame test assembly is illustrated in figure 2.

The maximum jack load for the two-frame assembly is determined by the following formula:

$$J = 2P \quad J - \text{maximum jack load for two-frame test assembly} \\ P = \text{load/frame}$$

where $P = \text{DVW divided by } N$
DVW - dynamic vehicle weight
N - total number of bus body frames

and $\text{DVW} = \text{DF} \times \text{GVW}$
DF - dynamic factor, not less than 1.5
GVW - gross vehicle weight

Thus, for a $\text{DF} = 1.5$, a $\text{GVW} = 22,000$ pounds-force (lbf) and $N = 11$, the dynamic vehicle weight is $\text{DVW} = 33,000$ lbf, the load/frame is $P = 3000$ lbf and the maximum jack load is $J = 6000$ lbf.

When a complete bus body is rack-loaded, the total load DVW must be distributed uniformly along the bus body. This may be accomplished by mounting a series of hydraulic jacks along the length of the bus interior. Seats may be removed to facilitate jack mounting. The rack load will be considered to be uniformly distributed when the variation in the hydraulic jack readings is less than 10 percent. A maximum load the sum of all jack readings shall equal DVW.

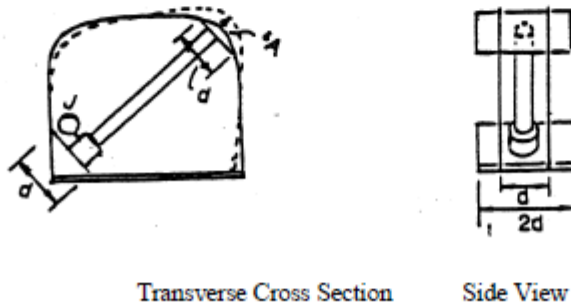

Figure 2. Arrangement of Hydraulic Jack for Rack-Loading of Two-Frame Assembly

The test may be performed on a complete bus body or on a representative section composed of at least two complete frames (body posts plus roof bows) and floor. Standard seats may be installed in the test section in a manner identical to that of the full bus body. Fabrication procedures for the test assembly shall be identical to those used in normal bus body production.

A two-cycle loading sequence shall be conducted, with intermediate and final load and deflection readings recorded according to the procedure described.

The maximum deflection in line with the jack (A, maximum) shall not exceed 4 inches.

Manufacturers shall specify which testing method was used and submit appropriate certification information as called for in 6.02.

55.05 Subfloor shall be either 5 ply nominal 5/8 inches thick plywood, or a material of equal or greater strength and insulation R value and it will equal or exceed properties of exterior-type softwood plywood C-D grade, as specified in NBS Product Standard 1-83. Type A buses shall have nominal 1/2 inch thick plywood or equivalent material equal to or exceeding properties listed above.

55.06 Ceiling Panels: If the ceiling is so constructed to contain lap joints, the forward panel shall be lapped by the rear panel and the exposed edges shall be beamed, hemmed, or flanged or otherwise treated to eliminate sharp edges.

55.07 All body components shall be designed and constructed so as to avoid the entrapment of moisture and dust.

55.08 All openings between chassis and passenger-carrying compartment made for any reason by body manufacturer must be sealed.

2251-R-56.00 Defrosters

56.01 A defroster system shall be installed of sufficient capacity to keep windshield area, left frontside window to rear of driver's vision, and service door glass area free of condensation or ice.

56.02 Adjustable 6 inch auxiliary fans may be installed to complement the defroster system used by the manufacturer. Such fans shall be controlled individually by two-speed switches located on control panel. Fan blades shall be covered with a protective cage.

The fans shall be located so as to not interfere with the driver's horizontal line of sight vision.

56.03 The defrosting system shall conform to SAE Standards.

2251-R-57.00 Doors

- 57.01 Service door shall be power or manually operated, under control of the driver, and so designed to afford easy release and to prevent accidental opening. When manual lever is used, no parts shall come together so as to shear or crush fingers.
- 57.02 Manual door controls shall not require more than 25 pounds of force to operate at any point throughout the range of operation as tested on a 10% grade both uphill and downhill. Power door controls shall be located within easy access of driver.
- 57.03 Service door shall be located on right side of bus opposite driver and within driver's direct view.
- 57.04 Power operated doors shall be equipped with a separate manual emergency release, readily accessible in the door area above or to the side of the service door or on dash, so that the door may be opened in the case of emergency. The release shall be plainly labeled with instruction for use.
- 57.05 There shall be a head bumper pad installed on the inside at the top of the entrance door. This pad shall be approximately 3 inches wide (high), at least 1 inch thick, and extend across the entire top of the entrance door opening.

2251-R-58.00 Emergency Exits

- 58.01 All emergency exits shall conform to FMVSS 217.
- 58.02 Emergency door:
 - 58.02 (a) Emergency door(s) shall be equipped with a 3-point latch mechanism. Emergency door latch shall be equipped with suitable electric plunger-type switch connected with buzzer located in driver's compartment. Switch shall be enclosed in metal case and wires leading from switch shall be concealed in bus body. Switch shall be so installed that plunger contacts farthest edge of slide bar in such manner that any movement of slide bar will immediately close circuit on switch and activate buzzer.
 - 58.02 (b) Ignition interlock for the vandal locks shall conform to FMVSS.
 - 58.02 (c) Exterior door handle shall be of permanent hitch-proof design and mounted with enough clearance to permit opening without touching door surface and may be equipped with a lock that will not prevent opening from inside.
 - 58.02 (d) All emergency door openings shall be completely weather stripped. There shall be no obstruction higher than 1/4 inch across the bottom of any emergency door opening.
 - 58.02 (e) Operation instructions for opening of door shall be lettered or decaled on the inside of the emergency door.

- 58.02 (f) Emergency door shall bear words either "EMERGENCY EXIT" or "EMERGENCY DOOR" both inside and outside clearly visible in letters at least 2 inches high. Words shall be placed directly above the door or on the upper portion of the door.
- 58.02 (g) On all buses except rear engine transit school buses (Type D), and buses with a raised rear storage compartment, an emergency door shall be located in the rear of the bus body and centered with respect to the body. Door shall have a minimum horizontal opening of 24 inches and minimum vertical opening of 48 inches measured from floor level. Rear emergency door shall be hinged on right side and shall open outward.
- 58.02 (h) Rear emergency door shall contain upper and lower glass panels that comply with FMVSS 205. Glass in emergency door shall provide maximum area of visibility for safe operation of bus.
- 58.02 (i) There shall be a head bumper pad installed over the emergency door on the inside of the bus body. This pad shall be approximately 3 inches wide (high), at least 1 inch thick, and extend across the entire top of the emergency door opening. Padding shall be of the same materials as the padding used over the service door.
- 58.02 (j) Side emergency door: If engine or storage compartment is so located as to make it impossible to place door in center of rear end, the emergency door shall be located in the rear half of the left side of the bus body. The door shall not be located to reduce size of opening by wheel well. The door shall be hinged on the front side.
- 58.03 Rear emergency window: If engine or storage compartment is so located as to require a side emergency door, an emergency window shall be installed in the rear of the bus.
 - 58.03 (a) The emergency window glass shall meet FMVSS 205. Glass shall be tempered unless specified laminated by the purchaser.
 - 58.03 (b) The rear emergency window shall be hinged from top and provided with a hold open control to insure against accidental closing during an emergency.
 - 58.03 (c) Emergency window in rear shall be equipped with latch on the inside and with a handle of hitch proof design that will permit opening from the outside.
- 58.04 All designated emergency windows shall bear words "EMERGENCY EXIT" in letters at least 2 inches high both inside and outside the window. Lettering shall be placed so as to be clearly visible both inside the bus and outside directly above, below, or on the window.
 - 58.04 (a) All designated emergency windows, when not fully latched, shall activate a signal audible to the driver.
 - 58.04 (b) Emergency side windows shall be hinged at the front side.

- 58.05 The number of emergency exits a school bus shall be equipped with is shown in the following table. All other factors not listed in this section concerning the emergency exits shall be according to FMVSS 217. A district may choose to have more emergency exits installed.

Additional emergency doors may be installed in place of emergency windows according to FMVSS 217.

EMERGENCY EXITS TABLE

BUS CAPACITY	ROOF HATCH	LEFT SIDE EMERGENCY WINDOW	RIGHT SIDE EMERGENCY WINDOW
1-45	1	0	0
46-70	2	1	1
71-above	2	2	2

2251-R-59.00 Emergency Equipment

- 59.01 The bus shall be equipped with at least one pressurized 5-pound dry-chemical fire extinguisher of a type approved by UL, with a total rating of not less than 2A10BC. The operating mechanism shall be sealed with a type of seal that will not interfere with use of the fire extinguisher.

59.01 (a) Fire extinguisher shall be mounted in the extinguisher manufacturer's bracket (automotive type) and located in the driver's compartment in full view of and readily accessible to the driver. A pressure gauge shall be so mounted on the extinguisher as to be easily read without removing the extinguisher from its mounted position.

- 59.02 First Aid Kit: The bus shall carry a first aid kit which shall either be mounted securely in full view or the location plainly indicated by appropriate markings, in the drivers compartment. Additional kits may be installed. The kit(s) shall be mounted in such a manner that they can be removed, if necessary.

59.02 (a) The kit shall be sealed. The seal verifies the integrity of the contents without opening the kit. The seal shall be designed to allow easy access to the kits contents.

Contents of the 24 unit First Aid Kit:

Item	Unit(s)
Adhesive Tape	1
1" adhesive bandage	2
2" bandage compress	1
3" bandage compress	1
4" bandage compress	1
3" x 3" plain gauze pads	1
Gauze roller bandage 2" wide	2
Plain absorbent gauze - 1/2 square yard	4
Plain absorbent gauze - 24" x 72"	3

Triangular bandages	4
Scissors, tweezers	1
Space rescue blanket	1
Non-latex disposable gloves, pair.	1
CPR mask or mouth to mouth airway	1

Moisture and dustproof kit of sufficient capacity to store the required items.

59.03 Emergency Reflectors (Section 42-4-230, C.R.S.): All buses shall carry three (3) emergency triangle reflectors in compliance with FMVSS 125, contained in a securely mounted case easily accessible to the driver.

59.04 Body fluid cleanup kit: Each school bus shall have a removable body fluid clean-up kit accessible to the driver.

Contents of the Basic Body Fluid Clean-up Kit:

Item	Unit(s)
Antiseptic towelette	1
Disinfectant towelette	1
Absorbing powder (capable of ½ gallon absorption)	1
Non-latex disposable gloves, pair	1
Disposable wiper towels	2
Disposable scoop bag with closure mechanism and scraper	1

Moisture and dustproof container of sufficient capacity to store the required items.

59.05 Small vehicles shall carry the following emergency equipment:

59.05 (a) Three (3) emergency triangle reflectors in a securely mounted case.

59.05 (b) One 24 unit first aid kit meeting the same list as the school bus.

59.05 (c) One securely mounted 2 1/2 pound dry chemical fire extinguisher of a type approved by UL, with a minimum rating of 1A10BC.

2251-R-60.00 Floor Coverings

60.01 Floor in underseat area, including tops of wheel housings, driver's compartment, and toeboard shall be covered with fire-resistant rubber floor covering or equivalent having a minimum overall thickness of .125 inch.

60.02 Floor covering in aisle shall be aisle-type fire-resistant rubber or equivalent, non-skid, wear resistant, and ribbed. Minimum overall thickness shall be .1875 inch measured from tops of ribs.

60.03 Floor covering must be permanently bonded to floor and must not crack when subjected to sudden changes in temperature. Bonding or adhesive material shall be waterproof and shall be of type recommended by manufacturer of floor-covering material. All seams

must be sealed with waterproof sealer.

- 60.04 Cove molding shall be used along the side walls and rear corners and all floor seam separations shall be properly bonded or secured.
- 60.05 The entrance step treads, including the edge at floor level, shall be of the same quality as the aisle material. Step treads shall have an integral white nosing of 1-1/2 inch or more or use diagonal stripes. Treads shall be permanently bonded to the metal steps and sealed to prevent water from getting underneath the step tread.
- 60.06 A sealed and insulated plate shall be provided to access fuel tank sending unit. This plate shall not be installed under flooring material. Type A buses are exempt.

2251-R-61.00 Fuel Fill Cap Cover

- 61.01 The fuel fill cap opening in the body skirt shall be equipped with a hinged cover held closed by a spring or other conveniently operated device. Type A buses are exempt.

2251-R-62.00 Heating System

- 62.01 All school buses shall be equipped with two or more hot water heaters capable of delivering water to the system at a rate of six gallons per minute using an ambient temperature of 0 degree F to +10 degrees F and maintaining passenger compartment temperature of 50 degrees F. One of the heaters shall be located in the rear half of the bus on or behind the rear wheel axle line.

62.01(a) Lift equipped buses may place the rear heater under the last row of seats.

- 62.02 Buses shall be equipped with front heater(s) and integrated defroster system of capacity to provide heat for the front part of the bus (including driver' compartment) and to keep windshield area, service door glass, driver's left glass area, and stepwell clear of moisture, ice and snow.

- 62.03 Multi-speed switches shall operate all heater fans independently.

- 62.04 Heater cores and fans shall be completely encased but designed to permit servicing heater assembly by removing all or part of case.

- 62.05 Heater hose installation in the engine compartment shall include two shut-off valves able to shut off coolant completely when necessary.

62.05 (a) One mounted between the water pump outlet and heater hose connection.

62.05 (b) One mounted between the motor block and the return heater hose connection.

62.05 (c) Heater hoses shall be adequately supported to guard against excessive wear due to vibration. Hoses shall not rub against the chassis, body or other edges.

- 62.06 The body manufacturer shall add the required amount of permanent ethylene glycol base or environmentally safe equivalent anti-freeze after heaters have been connected to protect cooling system of bus to -30 degrees F tested at normal engine temperature.
- 62.07 There shall be a heater water flow regulating valve installed for convenient operation by the driver.

2251-R-63.00 Identification

- 63.01 Body shall bear words "SCHOOL BUS" in black letters at least 8 inches high on both front and rear of body. Lettering shall be placed as high as possible without impairment of its visibility. Lettering shall conform to SAHS.
- 63.02 School buses shall bear name of school district/service provider on each side in black, standard unshaded letters, 5 inches in height. If there is insufficient space due to the length of the name of the school district, terms such as community, consolidated, and district may be abbreviated.
- 63.03 The manufacturer's rated pupil seating capacity shall be printed to the left of the entrance door on the lower skirt in 2 inch characters. The word capacity may be abbreviated. (Example: Cap. 48)
- 63.04 The numbering of individual buses for identification purposes is permissible.
- 63.05 Lettering and numerals shall be painted or may be pressure sensitive marking of similar performance quality.
- 63.06 "STOP" shall be printed on the rear of the bus in letters at least 8 inches high. "ON FLASHING RED" shall be printed below "STOP," in letters at least 5 inches high. Letters shall be placed in area(s) visible to the approaching motorist.
- 63.07 The school district logo may be placed above the side window dripline or along the side of the bus but shall not interfere with any required lettering.
- 63.08 Only signs and lettering specifically permitted by state law or regulation, and any marking necessary for safety and identification, shall appear on the outside of the bus.
 - 63.08 (a) Advertising, approved by the local school board, may appear only on the side(s) of the bus in the following areas:
 - 63.08 (a)(1) The location and securement of the advertising shall have prior CDE approval.
 - 63.08 (a)(2) The signs shall not extend from the body so as to allow a handhold or present a danger to pedestrians.
 - 63.08 (a)(3) The signs shall not interfere with the operation of any door, window, required lettering, lamps, reflectors or other device.

63.08 (a)(4) The signs shall not be placed on side emergency door(s).

63.09 Battery compartment shall be labeled with the word "Battery".

63.10 Identification of fuel type shall be located adjacent to the fuel filler opening.

2251-R-64.00 Inside Height

64.01 Inside body height shall be 72 inches or more, measured metal to metal at any point on longitudinal center line from front vertical bow to rear vertical bow. Type A school buses shall have 62 inches or more inside height, measured metal to metal.

2251-R-65.00 Insulation

65.01 Bus body shall be fully insulated in the roof including roof bows and all body panels. Insulation 1 inch minimum thickness shall be of fiber-glass or equal and shall be fire resistant.

2251-R-66.00 Interior

66.01 Interior of bus shall be free of all projections likely to cause injury.

2251-R-67.00 Lamps and Signals

67.01 All lamps, signals, reflectors and their installation shall conform to standards and recommendations of SAE and meet FMVSS. There shall be no lettering, symbols or arrows, except manufacturer's markings, on any lens.

67.02 Tail and stop (brake) lamps:

67.02 (a) Bus shall be equipped with four combination red stop/tail lamps. Two combination stop lamps shall have a lens diameter of at least 7 inches or 38.48 square inches, and shall have light intensity at least equal to Class A, Type I turn-signal units as established by SAE. Two combination tail lamps shall have a lens diameter of at least 4 inches.

67.02 (b) If the bus is equipped with a retarder, the four stop lamps shall be illuminated when the retarder is activated.

67.03 License plate lamp: Bus shall be equipped with rear license plate illuminator. This lamp may be combined with one of the tail lamps.

67.04 Interior lamps: Interior lamps shall be provided which adequately illuminate aisle. A separate lamp shall be provided in stepwell.

67.05 Back-up lamps: Back-up lamps of minimum diameter 7 inch or 38.48 square inches, or 4 inch led shall be provided.

67.06 Turn signal lamps:

- 67.06 (a) The bus shall be equipped with two amber turn signals in front and two amber turn signals in the rear. Both front and rear signals shall be at least 7 inches or a total of 38.48 square inches in diameter and meet the specifications of SAE. Type A buses may be equipped with chassis manufacturer's front turn signal lamps.
- 67.06 (b) The four-way hazard switch shall activate the turn signal lamps only. This operation shall be independent of any other light system.
- 67.06 (c) On buses over 30 feet, a minimum of one additional turn signal shall be mounted on each side below window, behind the service door axis plane.

67.07 School bus alternately flashing warning signal lamps:

Definition: School bus alternately flashing warning signal lamps mounted at the same horizontal level, intended to identify vehicle as school bus and to inform other users of highway that such vehicle is stopped or about to stop on roadway to take on or discharge school children.

- 67.07 (a) All school buses shall be equipped with four red warning signal lamps designed to conform to SAE standards, and four amber warning signal lamps designed to conform to FMVSS.
- 67.07 (b) Right and left lamps shall flash alternately. Each lamp shall flash not less than 60 nor more than 120 flashes per minute.
- 67.07 (c) Flashing warning lamps are to have a signal area of not less than 7 inch (38.48 square inches) diameter per lens. The lamps shall give a distinct warning illumination of entire lens area when lighted for a distance of 500 feet when the bus is in bright sunlight.
- 67.07 (d) The amber flashing warning signal lamps shall be energized manually by a switch mounted on the driver control panel. The red flashing warning signal lamps shall be energized as set forth by FMVSS. The lamp units and switch systems shall also comply with the above standard. The flashing warning signal lamp system shall be a sequential mode type.
- 67.07 (e) The flashing warning signal lamp system shall have two pilot or indicator lights; one shall show amber light when the amber signal lamps are flashing and the other shall show red light when the red signal lamps are flashing.
- 67.07 (f) The vision of the front signal lamps to the front and rear signal lamps to the rear shall be unobstructed by any part of the vehicle.
- 67.07 (g) The area around the lens of each alternately flashing signal lamp shall be black.

- 67.07 (h) Visors shall be provided and securely mounted above the dual-lamp flashing warning signals to adequately shade and protect the dual-lamp assemblies from sunlight above but not to obstruct the rear and side effectiveness of the warning lamps. LED warning signal lamps are exempt.
- 67.08 Type D rear engine buses shall have 2 hazard lamps each visible to the rear when the engine door is open. These lamps shall be wired to be illuminated when the main hazard lamp circuit is energized.
- 67.09 A white flashing strobe light meeting SAE standards may be installed on the roof of a school bus. Amber lens may be used upon approval of local traffic regulatory authority. Light shall have a single clear lens emitting light 360 degrees around its vertical axis and may not extend above the roof more than 8 inches. A manual switch and a pilot light must be included to indicate when light is in operation. Lamp must not be capable of activating emergency traffic control light switches.
- 2251-R-68.00 Mirrors
- 68.01 Interior mirror: Interior mirror shall be either laminated glass or glass bonded to a backing that retains the glass in the event of breakage. Mirror shall have rounded corners and protected edges. Type A bus shall have a minimum of 6" x 16" mirror and Type B, C, and D buses shall have a minimum of a 6" x 30" mirror.
- 68.02 Exterior mirrors: Each school bus shall be equipped with a system of exterior mirrors including crossover mirrors in compliance with FMVSS 111. This system of mirrors shall be rigidly braced so as to reduce vibration.
- 2251-R-69.00 Mounting, Body, and Chassis
- 69.01 Chassis frame shall support rear body cross member. Bus body shall be attached to chassis frame at each main floor sill, except where chassis components interfere, in such manner as to prevent shifting or separation of the body from the chassis under severe operating conditions.
- 69.02 Insulation material shall be placed at all contact points between body and chassis frame on all buses, and shall be so attached to the chassis frame or body that it will not move under severe operating conditions.
- 69.03 Body front shall be attached and sealed to the chassis cowl to prevent entry of moisture and gases.
- 2251-R-70.00 Overall Length
- 70.01 Overall length of school buses shall not exceed 40 feet {Section 42-4-504 C.R.S.}.
- 2251-R-71.00 Overall Width
- 71.01 Overall width of the school bus shall not exceed 8 feet, except under the provisions of Section 42-4-502 (5)(a) C.R.S.

2251-R-72.00 Rub Rails

- 72.01 There shall be one rub rail located on each side of bus approximately at seat level which shall extend from rear side of entrance door completely around bus body (except for emergency and/or access door) to point of curvature near outside cowl on left side.
- 72.02 There shall be one rub rail located approximately at floor line which shall cover same longitudinal areas as upper rub rail, except at wheel housing, and shall extend at least to radii of right and left rear corners.
- 72.03 There shall be one rub rail located on each side of bus at the bottom of the side skirts, or a side skirt stiffener of equivalent strength.
- 72.04 Rub rails shall be attached at each body post and all other upright structural members.
- 72.05 Rub rails shall be 4 inches or more in width, shall be of 16-gauge steel, or suitable material of equivalent strength and shall be constructed in corrugated or ribbed fashion and shall be self-draining.
- 72.06 Rub rails shall be applied outside body panels. Pressed-in or snap-on rub rails do not satisfy this requirement.

2251-R-73.00 Seat Belt for Driver

- 73.01 A Type 2 lap belt/shoulder harness seat belt shall be provided for the driver. The assembly shall be equipped with an emergency locking retractor (ELR) for the continuous belt system. The lap portion of the belt shall be guided or anchored where practical to prevent the driver from sliding sideways under it.
- 73.02 Adjustability of the mounting point for the driver seat belt pillar loop shall be provided to accommodate all heights and weights of bus drivers without interference with the driver's face or neck.
- 73.03 Each bus shall be equipped with a durable webbing cutter having a full width handgrip and a protected blade. The cutter shall be mounted in a location accessible to the seated driver.

2251-R-74.00 Seats/Restraining Barriers

- 74.01 All seating and restraining barrier design and construction must meet the provisions of FMVSS 222. Type A school buses shall be equipped with restraining barriers conforming to FMVSS 222.
- 74.02 Lap belt ready seat frames shall be reinforced to meet FMVSS 210.
- 74.03 All seats shall be forward facing and shall be securely fastened to that part of the school bus body that supports them.

- 74.04 No bus shall be equipped with jump seats or portable seats.
- 74.05 Forward-most pupil seat on right side of bus shall be located so as not to interfere with driver's vision, not farther forward than barrier behind driver or rear of driver's seat when adjusted to its rear-most position.
- 74.06 Seat material shall comply with FMVSS 302.
- 74.07 Passenger seat cushion retention system shall be employed to prevent passenger seat cushions from disengaging from seat frames or flipping forward in event of accident. Each seat cushion retention system shall be capable of withstanding vertical static load equal to minimum of 5 times weight of cushion.
- 74.08 Use of a flip seat at any side emergency door location in conformance with FMVSS 222, including required aisle width to side door, is acceptable. Any flip seat shall be free of sharp projections on the underside of the seat bottom. The underside of the flip-up seat bottoms shall be padded or contoured to reduce the possibility of snagged clothing or injury during use. Flip seats shall be constructed to prevent passenger limbs from becoming entrapped between the seat back and the seat cushion when in the upright position. The seat cushion shall be designed to rise to a vertical position automatically when not occupied.
- 74.09 If track seating is installed, the manufacturer shall supply minimum and maximum seat spacing dimensions for the bus that comply with FMVSS 222. This information shall be on a label affixed to the bus.

2251-R-75.00 Steps

- 75.01 First step at service door shall be not less than 10 inches (12 inch for Type D) and not more than 14 inches (16 inches for Type D) from ground, based on standard chassis specifications.
- 75.02 Step risers shall not exceed a height of 10 inches. When plywood is used on the top step, the riser height may be increased by the thickness of the wood.
- 75.03 An assist grab rails not less than 20 inches in length designed to provide maximum loading assistance shall be provided in an unobstructed location inside doorway.
- 75.04 Surface of steps shall be of non-skid material.

2251-R-76.00 (reserved)

2251-R-77.00 Stop Signal Arm

- 77.01 The stop signal arm shall meet FMVSS 131.
- 77.02 The stop signal arm shall be reflectorized in accordance with FMVSS 131.

- 77.03 Rubber spacers shall be installed on either the side of the bus or the stop arm so as to prevent sign from making abrasive contact with the side of the bus.
- 77.04 Wind guard shall be provided to keep sign in retracted position.
- 2251-R-78.00 Storage Compartment
 - 78.01 A metal container of adequate strength and capacity for the storage of tire chains, tow chains, and such tools as may be necessary for minor emergency repairs while bus is en route may be provided. Such storage container may be located either inside or outside the passenger compartment, but, if inside, it shall be secured and it shall have cover other than seat cushion that shall be securely fastened to it in such a manner as to prevent the contents from spilling in case the bus overturns.
- 2251-R-79.00 Sun Visor
 - 79.01 An interior, adjustable, sun visor shall be installed not less than 6 inches wide and 30 inches long. Type A school buses shall have a sun visor according to manufacturer's standard.
- 2251-R-80.00 Tail Pipe
 - 80.01 The tail pipe may be flush with but shall not extend more than one inch beyond the perimeter of the body for side exit or the bumper for rear exit.
 - 80.02 Tailpipe shall not exit beneath any fuel filler location or beneath any emergency door or lift door.
- 2251-R-81.00 Tow Hooks Rear
 - 81.01 The school bus shall be equipped with two heavy-duty tow hooks or eyes fastened securely to the rear of the frame and shall not protrude beyond outer edge of the bumper.
- 2251-R-82.00 Undercoating
 - 82.01 Entire underside of bus body, including floor sections, cross members, and below floor line side panels, shall be coated with rust-proofing compound for which compound manufacturer has issued notarized certification of compliance to bus body manufacturer that compound meets or exceeds all performance requirements of Federal Specification.
- 2251-R-83.00 Ventilation
 - 83.01 Buses, in excess of 20 feet in length, shall be equipped with a multi-speed powered exhaust roof ventilator or powered vent fan in roof hatch, mounted in the rear half of the bus.
- 2251-R-84.00 Wheel Housings
 - 84.01 Wheel house openings shall be of full-open type.

- 84.02 Wheel housings shall be designed to support seat and passenger loads and shall be attached to floor sheets in such manner as to prevent any dust, water, or fumes from entering the body.
- 84.03 Inside height of wheel housings above floor line shall not exceed 12 inches.
- 84.04 Wheel housings shall provide clearance for installation and use of tire chains on single and dual power wheels.
- 84.05 The wheel housing opening shall allow for easy tire removal and service.
- 84.06 No part of a raised wheel housing shall extend into the emergency door opening.

2251-R-85.00 Windshield and Windows

- 85.01 All glass in windshield, windows, and doors shall be of approved safety glass, and of a quality to prevent distortion of view in any direction as specified in FMVSS.
- 85.02 Each full side window shall provide unobstructed emergency opening at least 9 inches high and 22 inches wide, obtained by lowering of window. If full drop windows are used, they shall be blocked so that when, in a down position, the opening between the window header and top of glass is not more than 12 inches.

2251-R-86.00 Windshield Washers

- 86.01 The bus shall be equipped with windshield washers that shall conform to FMVSS and body manufacturer's recommendations.
- 86.02 For Type C and D buses, the system reservoir capacity shall be a minimum of one gallon.

2251-R-87.00 Windshield Wipers

- 87.01 A windshield wiping system, two-speed or more, shall be provided.
- 87.02 The wipers shall be operated by one or more air or electric motors. If one motor is used, the wipers shall work in tandem to give full sweep of windshield.
- 87.03 All wiper controls shall be located within easy reach of the driver and designed, when in stop position, to move blades from the driver's direct view.

2251-R-88.00 Wiring

- 88.01 All wiring shall conform to current standards of SAE.
- 88.02 Circuits:
 - 88.02 (a) Wiring shall be arranged in at least nine regular circuits, as follows:
 - 88.02 (a)(1) Head, tail, stop, and instrument panel lamps

- 88.02 (a)(2) Clearance lamps
- 88.02 (a)(3) Dome and step-well lamps
- 88.02 (a)(4) Starter motor
- 88.02 (a)(5) Ignition and emergency door signal
- 88.02 (a)(6) Turn signal lamps
- 88.02 (a)(7) Alternately flashing warning signal lamps
- 88.02 (a)(8) Horn
- 88.02 (a)(9) Heaters and defrosters
- 88.02 (b) Any of above combination circuits may be subdivided into additional independent circuits.
- 88.02 (c) All other electrical functions (such as electric-type windshield wipers) shall be provided with independent and properly protected circuits.
- 88.02 (d) Each body circuit shall be color or number coded and a diagram of circuits shall be attached to the body in a readily accessible location. Number coding is permitted only if the number is a permanent part of the insulation and is repeated at intervals of not more than 6 inches.
- 88.03 Each circuit shall have adequate circuit protection.
- 88.04 All wires shall be installed within body. They shall be insulated so as to protect them from external damage and minimize dangers from short circuits. Whenever wires pass through body member, additional protection in form of appropriate type of insert shall be provided.
- 88.05 Wires not enclosed within body shall be enclosed in a protective jacket and fastened securely at intervals of not more than 18 inches. All joints shall be soldered or joined by equal effective connectors. The protective jackets shall be assembled to provide maximum protection against moisture and dust.

2251-R-89.00 (rule number reserved)

SPECIALLY EQUIPPED BUSES

2251-R-90.00 Introduction

- 90.01 This section applies to school buses and multifunction buses.

Equipping buses to accommodate students with disabilities is dependent upon the needs of the passengers. Buses may be fitted with various equipment to accommodate those needs. Buses so equipped are not to be considered a separate class of school bus, but simply a regular school bus equipped for special accommodations. Transportation considerations and needs of a student entitled to transportation as a related service should be addressed in the student's individual education program (IEP).

The specifications in this section are intended to be supplementary to specifications in the chassis and body sections. In general, specially equipped buses shall meet all the requirements of the preceding sections plus those listed in this section. It is recognized by the entire industry that the field of special transportation is characterized by varied needs for individual cases and by a rapidly emerging technology for meeting those needs. A flexible, "common-sense" approach to the adoption and enforcement of specifications for these vehicles, therefore, is prudent.

2251-R-91.00 Aisles

- 91.01 All buses equipped with a power lift or ramp shall provide a minimum 30 inch aisle leading from any wheelchair to at least one emergency door and to the lift area.

2251-R-92.00 Definition

- 92.01 A specially equipped bus is any bus designed, equipped, or modified to accommodate students with special transportation needs.

2251-R-93.00 General Requirements

- 93.01 Buses equipped for transporting students with special transportation needs shall comply with FMVSS.
- 93.02 In the instance where a regular service entrance cannot be accessed, the bus shall be equipped with a power lift, unless a ramp is needed for unusual circumstances related to passenger needs.

2251-R-94.00 Identification

- 94.01 Buses with power lifts or ramps shall display the International Symbol of Accessibility on all four sides of the bus. The symbols shall be a minimum of 6 inches and not exceed 12 inches. Such emblems shall be white on blue background.

2251-R-95.00 Lift Equipped Entrance

- 95.01 There shall be adequate illumination for normal operation of the lift, to include the lift and adjacent area, both when deployed at the vehicle floor level and at ground level.
- 95.02 A drip molding shall be installed above the opening to effectively divert water from entrance.
- 95.03 Door posts and headers from entrance shall be reinforced sufficiently to provide support

and strength equivalent to the areas of the side of the bus not used for lift equipped entrance.

- 95.04 A single door or double doors may be used for the lift equipped entrance.
- 95.04 (a) A single door shall be hinged to the forward side of the entrance, unless doing so would obstruct the service entrance. If, due to the above condition, the door is hinged to the rearward side doorway, the door shall utilize a safety mechanism which will prevent the door from swinging open should the primary door latch fail.
- 95.04 (b) If double doors are used, the system shall be designed to prevent the door(s) from being blown open by the wind resistance created by the forward motion of the bus, and/or incorporate a safety mechanism to provide secondary protection should the primary latching mechanism(s) fail.
- 95.05 All doors shall have positive fastening devices to hold doors in the open position.
- 95.06 All doors shall be weather sealed.
- 95.07 The forward-mounted door shall have at least three-point fastening devices.
- 95.08 Door materials, panels and structural strength shall be equivalent to the service and emergency doors. Color, rub rail extensions, lettering and other exterior features shall match adjacent sections of the body.
- 95.09 Each door shall have windows set in rubber that are visually similar in size and location to adjacent non-door windows. Glazing shall be of same type and tinting (if applicable) as standard fixed glass in other body locations.
- 95.10 Door(s) shall be equipped with a device that will actuate and maintain an audible or flashing signal located in the driver's compartment when door(s) is not securely closed and ignition is in "on" position.
- 95.11 A switch shall be installed so that the lifting mechanism will not operate when the lift platform door(s) is closed.
- 95.12 Lift equipped entrance doors shall be equipped with padding at the top edge of the door opening. Padding shall be at least 3 inches wide and 1 inch thick and extend the full width of the door opening.

2251-R-96.00 Power Lift

- 96.01 General: Vehicle lifts and installation shall comply with the requirements set forth in FMVSS 403, *PLATFORM LIFT SYSTEMS FOR MOTOR VEHICLES*, and FMVSS 404, *PLATFORM LIFT INSTALLATION IN MOTOR VEHICLES*.
- 96.02 Design load: The design load of the lift shall be 800 pounds at a minimum. Working parts, such as cables, pulleys and shafts, which can be expected to wear, and upon which

the lift depends for support of the load, shall have a safety factor of at least six, based on the ultimate strength of the material. Non-working parts, such as platform, frame and attachment hardware, that would not be expected to wear, shall have a safety factor of at least three, based on the ultimate strength of the material.

- 96.03 Lift capacity: The lifting mechanism and platform shall be capable of operating effectively with a wheelchair and occupant mass of 800 pounds at a minimum.
- 96.04 In addition, controls, emergency operations, platforms, platform barriers, handrails, etc shall comply with FMVSS 403.
- 96.05 Documentation: The following information shall be provided with each vehicle equipped with a lift:
 - 93.05 (a) A phone number where information may be obtained about installation, repairs and parts. (Detailed written instructions and a parts list shall be available upon request.)
- 96.06 Training materials: The lift manufacturer shall make training materials available to insure proper use and maintenance of the lift. These may include instructional videos, classroom curriculum, system test results or other related materials.

2251-R-97.00 Ramps

- 97.01 If a ramp is used, it shall be of sufficient strength and rigidity to support wheel chair (electric or other), occupant, and attendant. It shall be equipped with protective flange on each longitudinal side to keep wheelchair on ramp.
- 97.02 Floor of ramp shall be covered with non-skid material.
- 97.03 Ramp shall be of weight, equipped with handle or handles, to permit one person to put ramp in place and to return it to storage place.
- 97.04 A ramp device may be used in lieu of a mechanical lift if the ramp meets all the requirements of the Americans with Disabilities Act (ADA) as found in 36 CFR § 1192.23, *VEHICLE RAMP*.
- 97.05 A ramp device that does not meet the specifications of ADA, but does meet the specifications of 97.01 through 97.04 of this section may be installed and used, only when a power lift system is not adequate to load and unload students.
- 97.06 Ramps used for emergency evacuation purposes may be installed in raised floor buses by manufacturers.

2251-R-98.00 Restraining Devices

- 98.01 Lap belt ready seat frames shall be reinforced to meet FMVSS. All child restraint systems, child restraint anchorage systems, seat belt assemblies and seat belt assembly anchorages shall meet FMVSS.

2251-R-99.00 Seating Arrangements

- 99.01 To accommodate special devices for passenger requirements, flexibility is permitted in seat spacing, not to exceed FMVSS.

2251-R-100.00 Securement and Restraint System for Wheelchairs and Wheelchair Seated Occupants

For purposes of understanding the various aspects and components of this section, the term *securement and tiedown* and the phrases *securement system or tiedown system* are used exclusively in reference to the devices that anchor the wheelchair to the vehicle. The term *restraint* and the phrase *restraint system* are used exclusively in reference to the equipment that is intended to limit the movement of the wheelchair occupant in a crash or sudden maneuver. The term *WHEELCHAIR TIEDOWN AND OCCUPANT RESTRAINT SYSTEM (WTORS)* is used to refer to the total system that secures the wheelchair and restrains the wheelchair occupant.

- 100.01 A wheelchair tiedown and occupant restraint system installed in specially equipped buses shall be designed, installed, and operated for use with forward-facing wheelchair-seated passengers and shall comply with all applicable requirements of FMVSS 222.
- 100.02 WTORS, including the anchorage track, floor plates, pockets or other anchorages, shall be provided by the same manufacturer or shall be certified to be compatible by manufacturers of all equipment/systems used.
- 100.03 Wheelchair securement positions shall be located such that wheelchairs and their occupants do not block access to the lift door.
- 100.04 The WTORS, including the storage device, shall meet the flammability standards established in FMVSS 302.
- 100.05 The following information shall be provided with each bus equipped with a securement and restraint system:
- 100.05 (a) Phone number where information can be obtained about installation, repair and parts. (Detailed written instructions and a parts list shall be available upon request.)
- 100.05 (b) Detailed instructions regarding use, including a diagram showing the proper placement of the wheelchair/mobility aids and positioning of securement devices and occupant restraints, including correct belt angles.
- 100.06 The WTORS manufacturer shall make training materials available to ensure the proper use and maintenance of the WTORS. These may include instructional videos, classroom curriculum, system test results or other related materials.
- 100.07 Wheelchair securement/tiedowns shall comply with FMVSS 222.
- 100.08 Each wheelchair position in a specially equipped bus shall have a minimum clear floor area of 30 inches laterally by 48 inches longitudinally. Additional floor area may be

required for some wheelchairs. Consultation between the user and the manufacturer is recommended to ensure that adequate area is provided.

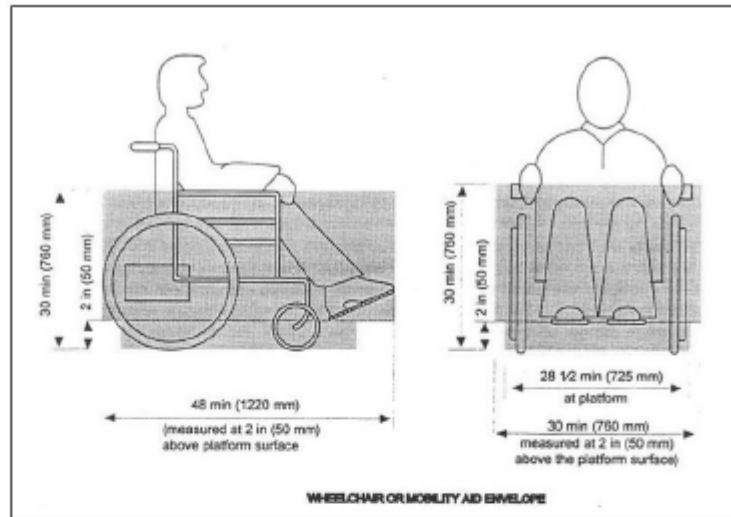

100.09 If longitudinal track systems are used, four rows of tracking must be installed.

2251-R-101.00 Service Entrance

101.01 On power lift equipped vehicles, steps shall be the full width of the step well, excluding the thickness of the doors in the open position.

101.02 Suitable hand rails shall be provided on both sides of entrance area to assist passengers during ingress and egress. This device shall allow for easy grasping or holding and shall have no openings or pinch points that might entangle clothing, accessories or limbs.

2251-R-102.00 Support Equipment and Accessories

102.01 Each bus shall be equipped with a durable webbing cutter having a full width handgrip and a protected blade. The cutter shall be mounted in a location accessible to the seated driver.

Appendix D. Regulation 1 CCR 301-25 (1998) Colorado Minimum Standards
Governing School Transportation Vehicles Effective date February 01, 1999

Colorado State Board of Education
Department of Education

1 Colorado Code of Regulations 301-25

Adopted: 11-21-72, with numerous subsequent amendments temporary regulation amendments 2-16-78 and 5-10-78, repealed and readopted 1-4-79, amended 8-9-79, 10-4-79, 1-10-80, 3-13-80, 4-10-80, 10-9-80, 8-12-82, 9-13-84, 7-9-87, amended 7-14-88, 6-10-93, 11-14-96, 11-12-98.

Attorney General Opinions: 2-23-78, 1-15-79, 7-17-87, 7-25-88, 6-17-93, 12-3-96, 11-30-98.

Statutory Authority: 22-51-108, 22-2-107 (1)(c) and 42-4-1903 (1) (2) (3), C.R.S.

**COLORADO MINIMUM STANDARDS GOVERNING
SCHOOL TRANSPORTATION VEHICLES**

2251-R-1.00 Statement of Basis and Purpose.

The statutory authority for the Amendments to the Colorado Minimum Standards Governing School Transportation Vehicles (hereinafter "these rules"), adopted by the State Board of Education on November 11, 1998, is found in sections 22-51-108 and 42-4-1903 (1) (2) (3), C.R.S.

The purpose of this Amendment is to establish minimum standards for school transportation vehicles purchased for use in Colorado. These standards are necessary to improve the safety of the children riding the school bus and the mechanical efficiency of the school bus. The new standards meet or exceed the national recommended minimum standards and utilize state-of-the-art industry advances.

2251-R-2.00 References

FMVSS-
Federal Motor Vehicle Safety Standards
49 C.F.R. Part 571, Current Revision
National Highway Traffic Safety Administration
U.S. Department of Transportation

SAE-
Society of Automotive Engineers, Inc.
Standards, Current Revision
400 Commonwealth Drive
Warrendale, PA 15096

UL-
Underwriters Laboratories, Inc.
Standard 299-82, Current Revision
333 Pfingsten Road
Northbrook, IL 60062

FED. SPEC.-

Federal Specification TT-C-520b
Current Revision
General Services Administration
Specification and Consumer Information
Distribution Center
Building 197
Washington, D.C. 20407

NSSB-

National Standards for School Buses, Revision 1995
Recommendations of the Twelfth National Conference on
School Transportation, issued by the National Safety Council
444 North Michigan Avenue
Chicago, Illinois 60611

NBS-

National Bureau of Standards
Voluntary Product Standard 1-83, Current Revision
Office of Standards Reference Materials
Washington, D.C. 20234

SAHS-

Standard Alphabets for Highway Signs - Series B
Federal Highway Administration, Current Revision
U.S. Government Printing Office
Washington, D.C. 20234

NFPA-

National Fire Protection Association
Volume 2, National Fire Codes, Current Revision
Batterymarch Park, Quincy, MA 02269

For information regarding how the incorporated material may be obtained or examined, contact:

Colorado Department of Education
School Transportation Unit
201 East Colfax Avenue, Room 202
Denver, CO 80203

2251-R-3.00 Responsibility of Suppliers.

- 3.01 School transportation vehicle dealers distributors, and manufacturers each have a responsibility to comply with these rules after the effective date of these rules, February 1, 1999.

- 3.02 Dealers, distributors, or manufacturers which supply school transportation vehicles for use in the State of Colorado which do not meet the specifications herein stated shall be notified of noncompliance and a general notice will be sent to all school districts and school transportation operations within the State of Colorado advising that equipment supplied by such dealer, distributor, or manufacturer is not in compliance with these rules, February 1, 1999.
- 3.03 If a dealer, distributor, or manufacturer has been notified of non-compliance in accordance with subsection 3.02 and replaces or modifies the equipment to meet these rules, February 1, 1999, a notification of compliance will be issued from the Colorado Department of Education within 30 days after proof of compliance.

2251-R-4.00 Effective Date of Specification.

- 4.01 School transportation vehicles manufactured on or after the effective date of these rules, February 1, 1999, for the purpose of transporting Colorado school children shall meet or exceed these minimum standards contained herein.
- 4.02 School transportation vehicles manufactured before the effective date of these rules, which have been used exclusively for the purpose of transporting school children and which met or exceeded the Colorado Standards at the time, may continue in use.
- 4.03 Only those buses which were manufactured after January 1, 1978, may be purchased, leased, contracted, or otherwise obtained for the purpose of transporting Colorado school children. These buses must have met Colorado minimum standards in effect at the time of manufacture.
- 4.04 Only those small vehicles manufactured after September 1, 1994, may be purchased, leased, contracted, or otherwise obtained for the purpose of transporting Colorado school children.

2251-R-5.00 School Transportation Vehicle Definitions.

- 5.01 School Transportation Vehicle means every motor vehicle which is owned by a public or governmental agency and operated for the transportation of children to or from school or which is privately owned and operated for compensation but it does not include informal or intermittent arrangements, such as sharing of actual gasoline expense or participation in a car pool, for the transportation of children to or from school.
- 5.02 A School Bus shall be a motor vehicle with motive power, built to school bus standards, designed for carrying passengers, which at any time would be used to carry school children, providing that such transportation is sponsored and approved by the local board of education or school governing agency. Vehicles that carry school children as part of their operation as a common carrier under the jurisdiction of US Department of Transportation or Public Utilities Commission are not included within the definition of school bus.
 - 5.02 (a) **TYPE A--**Type "A" school bus is a conversion or body constructed upon a van-type compact truck or a front-section vehicle chassis, designed for carrying passengers.

- 5.02 (b) **TYPE B**--Type "B" school bus is a conversion or body constructed and installed upon a van or front-section vehicle chassis, or stripped chassis, with a gross vehicle weight rating of more than 10,000 pounds, designed for carrying passengers. Part of the engine is beneath and/or behind the windshield and beside the driver's seat. The entrance door is behind the front wheels.
 - 5.02 (c) **TYPE C**--Type "C" school bus is a body installed upon a flat back cowl chassis with a gross vehicle weight rating of more than 10,000 pounds, designed for carrying passengers. All of the engine is in front of the windshield and the entrance door is behind the front wheels.
 - 5.02 (d) **TYPE D**--Type "D" school bus is a body installed upon a chassis, with the engine mounted in the front, midship, or rear, with a gross vehicle weight rating of more than 10,000 pounds, designed for carrying passengers. The engine may be behind the windshield and beside the driver's seat; it may be at the rear of the bus, behind the rear wheels, or midship between the front and rear axles. The entrance door is ahead of the front wheels.
- 5.03 Small Vehicle shall be a motor vehicle with motive power, which does not meet the requirements of a Type A, B, C, or D school bus. These vehicles shall not transport more than the manufacturer's designated capacity. A small vehicle shall meet or exceed section 59.06 of these rules. These vehicles would be used to carry school children, provided that such transportation service is sponsored and approved by the local board of education or school governing agency. The preceding definition is not intended to include private motor vehicles used exclusively to carry members of the owner's household.
- 5.04 Activity Bus shall be a motor vehicle with motive power, designed for carrying passengers. The activity bus shall be used to carry school children exclusively to and from school related activities or events, provided that such transportation is sponsored and approved by the local board of education. The activity bus shall travel from one location to a second location without stopping to load or unload passengers or control traffic on a public highway. The preceding definition is not intended to preclude the use of school buses on school related activities or events.
- 5.04 (a) The body shall bear the words "ACTIVITY BUS" in letters at least 8 inches high on both the front and rear. The lettering shall be placed as high as possible without impairment of its visibility. Lettering shall conform to SAHS.
 - 5.04 (b) Activity buses shall bear name of school or company on each side at least 5 inches in height.
- 2251-R-6.00 Testing and Certification.
- 6.01 Chassis manufacturers shall provide certification to the Colorado Department of Education that their product(s) meet these rules and all applicable FMVSS standards. Written certification shall be provided 30 days before or after July 1, of each calendar year.

- 6.02 School bus body manufacturers shall provide certification to the Colorado Department of Education that their product(s) meet or exceed these rules and all applicable FMVSS in effect at the time of manufacture. Written certification shall be provided 30 days before or after July 1 of each calendar year. Body manufacturers shall record and report to CDE the test results called for in Section 55 - Construction, of these rules. All school bus bodies shall meet applicable FMVSS and compliance with these standards shall be certified by the body manufacturer by the attachment of a plate or decal.
- 6.03 It will be the district's responsibility to ascertain whether all school buses purchased, leased, or under contract to the district meet all specifications of these rules. This verification should be obtained at the time of delivery, in addition to the statement of compliance in the purchase bid, contract for or lease agreement.
- 6.04 When selling a school bus, it is the district's responsibility to eliminate the district's name from the sides of the bus.

2251-R-7.00 Chassis and Body Delivery Requirements.

- 7.01 The chassis and body manufacturer shall provide the following materials and information for direct delivery to the customer:
 - 7.01 (a) Line set tickets for each individual unit.
 - 7.01 (b) A copy of the pre-delivery service performed and verified by a checkout form for each individual unit.
 - 7.01 (c) Warranty book and statement of warranty for each individual unit.
 - 7.01 (d) Service manual for each individual unit or identical units.
 - 7.01 (e) Parts manual for each individual unit or identical units.

- 2251-R-8.00 (rule number reserved)
- 2251-R-9.00 (rule number reserved)
- 2251-R-10.00 (rule number reserved)

THE BUS CHASSIS

2251-R-11.00 Air Cleaner.

- 11.01 The engine intake air cleaner shall be furnished and properly installed by the chassis manufacturer to meet engine specifications.

2251-R-12.00 Axles.

- 12.01 The front axle and rear differential, including suspension assemblies, shall have a gross axle weight rating at ground, at least equal to that portion of the load as would be imposed by the chassis manufacturer's maximum gross vehicle weight rating.

12.02 Rear axle shall be single-speed.

2251-R-13.00 Brakes.

13.01 All braking systems shall comply with FMVSS.

13.02 Vehicles with a rated capacity of greater than 54 shall be equipped with full compressed air brake systems.

13.03 Air brakes: The following standards apply to air brake systems:

13.03 (a) Compressors: On buses using full compressed air brakes for service, emergency, and parking brakes, the compressor shall be a standard production model with a minimum 12 cubic foot per minute displacement.

13.03 (b) Three reservoirs or chambers (wet, primary, secondary) with a total capacity which is equal to or greater than 12 times the total volume of all brake actuators at full travel.

13.03 (c) Moisture ejection valve: An automatic heated, moisture ejection valve or air drying system shall be properly installed. This is made to automatically eject moisture, sludge, and/or foreign matter and maintain clean, dry air lines.

13.03 (d) Control requirements: Control valve of the parking brake system shall be designed and constructed to conform with the following:

13.03 (d)(1) The parking brake control valve shall be visible to the driver and shall be mounted on the dash panel within 15 inches to the right of the steering column.

13.04 Anti-lock brake system shall control all four wheel positions individually.

2251-R-14.00 Bumper, Front.

14.01 Front bumper on all Type A, B and C school buses shall be furnished by the chassis manufacturer.

14.02 Front bumper of Type D school buses shall be furnished by the body manufacturer.

14.03 Front bumper shall be at least 3/16 inch thick of pressed steel channel, one piece construction or optional 3-piece breakaway construction and a minimum of eight inches wide (high) except type a buses with a GVW less than 10,000 pounds.

14.04 Front bumper shall be of extended design to offer maximum protection of fender lines without permitting snagging or hooking.

14.05 Front bumper shall be attached to the frame and extend forward of grille, head lamps, fender, or hood sections to provide maximum protection.

- 2251-R-15.00 (rule number reserved)
- 2251-R-16.00 Color: Chassis.
- 16.01 Frame and bumper shall be painted black.
 - 16.02 Cowl and fenders shall be painted National School Bus Yellow as defined in NSSB.
- 2251-R-17.00 Cooling System
- 17.01 Permanent ethylene-glycol base or environmentally safe equivalent anti-freeze shall be provided by chassis manufacturer to protect the cooling system to -30 degrees Fahrenheit (F) when tested at normal engine temperature and shall not be diluted by body company.
 - 17.02 Cooling system shall be equipped with a coolant recovery system.
 - 17.03 Cooling system shall be equipped with a visual fluid level indicator.
- 2251-R-18.00 Drive Shaft.
- 18.01 Each drive shaft or section thereof shall be equipped with adequate metal guard or guards to prevent whipping through floor or dropping to ground if broken.
- 2251-R-19.00 Electrical System
- 19.01 The electrical system (including battery(ies) and alternator) shall be commensurate with all electrical needs of the bus, including accessories.
 - 19.02 Battery and all cable required to complete circuits without splicing, even when drawer is extended for battery servicing, shall be provided by the chassis manufacturer and mounted for delivery to body plant.
- 2251-R-20.00 Exhaust System
- 20.01 Exhaust pipe, muffler, and tail pipe shall be outside the passenger portion of the bus body and attached to chassis. Exhaust back pressure shall not exceed engine manufacturer maximum requirement.
 - 20.02 Muffler shall be heavy-duty truck type of aluminized or stainless steel, or ceramic coated to offer maximum resistance to corrosion or oxidation.
 - 20.03 Diameter of tail pipe shall not be reduced after it leaves muffler.
 - 20.04 Exhaust system shall be insulated from fuel tank and fuel tank connections by securely attached metal shield at any point where it is 12 inches or less from the fuel tank or fuel tank connections, except diesel fuel.

- 2251-R-21.00 Fenders, Front.
- 21.01 Total spread of outer edges of front fenders measured at fender line shall exceed total spread of front tires when front wheels are in straight ahead position.
 - 21.02 Front fenders shall be braced and free from any body attachment.
- 2251-R-22.00 Frame.
- 22.01 Frame shall be designed to correspond with or exceed standard practice performance criteria for truck of same general load specifications used for severe service.
 - 22.02 No holes shall be permitted in the chassis rails except those drilled at the chassis plant or authorized by the chassis manufacturer.
 - 22.03 Welding to frame side rails which is necessary by design to strengthen, modify or alter basic vehicle configuration shall be performed and guaranteed by the body or chassis manufacturer making the modification.
- 2251-R-23.00 Fuel Tank.
- 23.01 All fuel tank specifications shall conform with FMVSS 301.
 - 23.02 Fuel tank shall be filled and vented entirely outside the passenger compartment.
 - 23.03 Fuel filter with replaceable element shall be installed between fuel tank and engine.
 - 23.04 Engine supply line shall not be mounted below fuel tank.
- 2251-R-24.00 Heating System.
- 24.01 Engine design shall provide inlet and outlet holes in accessible locations for attachment of bus heating system water lines. Heater outlets shall be of sufficient size to accommodate circulation of all coolant with no reduction of coolant lines.
- 2251-R-25.00 Horn.
- 25.01 Bus shall be equipped with dual horns of standard make, each horn capable of producing complex sound in band of audio frequencies from 250 to 2000 cycles per second and having total sound level of 110 decibels as rated by horn manufacturer.
- 2251-R-26.00 Instruments and Instrument Panel.
- 26.01 Chassis shall be equipped with the following non-glare instruments and gauges. Lights in lieu of gauges are not acceptable.
 - 26.01 (a) Standard speedometer with seven digit odometer,

- 26.01 (b) Voltmeter with a graduated scale to 16 volts.
- 26.01 (c) Oil pressure gauge.
- 26.01 (d) Water temperature gauge.
- 26.01 (e) Fuel gauge.
- 26.01 (f) Upper-beam headlamp indicator.
- 26.01 (g) Tachometer. The tachometer is not required for Type A and B school buses.
- 26.01 (h) Left and right turn-signal indicator.
- 26.01 (i) Chassis with air brake systems shall be equipped with a visible gauge and audible low-pressure indicator to warn driver if air pressure in brake system falls below 60 PSI.
- 26.01 (j) Chassis with air brake systems shall have a labeled visual indicator of park brake application visible to driver.
- 26.01 (k) Chassis with a hydraulic assist-brake system shall be equipped with warning signals, readily audible and visible to the driver, that will provide continuous warning in the event of a loss of fluid flow from primary source or loss of electric source powering the back-up system.

26.02 All instruments shall be easily readable by driver and accessible for maintenance.

2251-R-27.00 Lamps and Signals.

27.01 All lamps and their installation shall conform to current standards and recommended practices of applicable SAE and FMVSS standards.

2251-R-28.00 Openings.

28.01 All openings made by chassis manufacturer in floorboard and fire-wall shall be sealed by the chassis manufacturer to prevent gases from entering driver's compartment. Boot for the accelerator pedal, gear shift, and parking brake, when required, shall be supplied by the chassis manufacturer.

2251-R-29.00 (rule number reserved)

2251-R-30.00 Power or Gradeability.

30.01 The gross vehicle weight of any school bus shall not exceed 165 pounds per certified net horsepower of the engine at manufacturer's recommended maximum revolutions per minute (RPM).

2251-R-31.00 Retarder (optional)

- 31.01 Retarder manufacturers shall certify that their product system shall maintain the speed of the bus loaded to maximum GVW at 20 miles per hour on a 7 percent grade for 3.5 miles.
- 31.02 School buses equipped with electro-magnetic retarder(s) shall have increased electrical system capacity commensurate with the needs of the retarder system.
- 31.03 Pilot lights shall indicate when retarder is in operation.

2251-R-32.00 Suspension System

- 32.01 Capacity of suspension assemblies shall be commensurate with chassis manufacturer's gross vehicle weight rating.
- 32.02 If leaf-type rear springs are used, they shall be of progressive type.

2251-R-33.00 Steering Gear Assembly

- 33.01 All school bus chassis in all passenger capacities shall be equipped with heavy-duty, truck-type integral power steering. Power steering components shall be compatible with the GVW rating for each capacity as shown in chassis manufacturer's literature.
- 33.02 No changes shall be made in steering apparatus which are not approved and guaranteed by chassis manufacturer.
- 33.03 There shall be a clearance of at least two inches between steering wheel and any other surface or control.
- 33.04 Chassis manufacturers shall provide and cover steering wheel column with a temporary plastic covering or equivalent, in order to provide protection from precipitation from time of manufacture until body is mounted.

2251-R-34.00 Tires and Rims

- 34.01 Minimum tire and rim sizes shall be in accordance with FMVSS 120.
- 34.02 Dual rear tires shall be provided on Type B, C, and D school buses.
- 34.03 All wheels shall be one piece disc type. Split or multi-piece rims are not acceptable.

2251-R-35.00 Tow Hooks Front

- 35.01 Two heavy duty tow hooks or two eyes on Type C and D buses shall be furnished and factory installed, except on Type A and B buses. Hooks shall not extend beyond the front bumper on any school bus.

2251-R-36.00 Transmission.

36.01 Manual type transmission shall be synchromesh for forward gear ratios 2nd and above.

2251-R-37.00 Undercoating.

37.01 Chassis manufacturer shall coat undersides of steel or metallic front fenders with rust-proofing compound for which compound manufacturer has issued notarized certification of compliance to chassis builder that compound meets or exceeds all performance and qualitative requirements of Fed. Spec. using modified test.

2251-R-38.00 Wiring.

38.01 All wiring shall conform to current applicable recommended practices of SAE.

38.02 All wiring shall use a standard color, number, or function coding and each chassis shall be delivered with a wiring diagram that coincides with the wiring of the chassis.

38.03 Chassis manufacturer shall install a readily accessible terminal strip or plug on the body side of the cowl, or at an accessible location in the engine compartment of vehicles designed without a cowl, that shall contain the following terminals for the body connections. Factory terminal strip from chassis manufacturer on Type A bus will be acceptable.

38.03 (a) main 100 amp body circuit

38.03 (b) tail lamps

38.03 (c) right turn signal

38.03 (d) left turn signal

38.03 (e) stop lamps

38.03 (f) back up lamps

38.03 (g) instrument panel lights

2251-R-39.00 (rule number reserved)

2251-R-40.00 (rule number reserved)

2251-R-41.00 (rule number reserved)

2251-R-42.00 (rule number reserved)

2251-R-43.00 (rule number reserved)

2251-R-44.00 (rule number reserved)

2251-R-45.00 (rule number reserved)

2251-R-46.00 (rule number reserved)

2251-R-47.00 (rule number reserved)

2251-R-48.00 (rule number reserved)

2251-R-49.00 (rule number reserved)

THE BUS BODY

- 2251-R-50.00 Aisle.
- 50.01 Minimum aisle clearance between seats shall be 12 inches at seat level and 15 inches at top of seats. This includes the aisles to all emergency doors.
 - 50.02 On forward control (front engine) Type D buses, the aisle passage area shall not be less than 12 inches, measured from floor level up, between engine cover and any other object. Hold down fastening devices used on engine cover shall be designed to prevent hooking or catching on shoes or clothing.
- 2251-R-51.00 Battery.
- 51.01 Body manufacturer shall provide, at customer option, a drawer-type pull out tray to facilitate servicing or removal of battery(ies). The battery(ies) shall be enclosed by a vented compartment constructed of mill-applied zinc steel provided with drain ports, hold down carrier mounted so as to avoid blocking filler ports and latching device to prevent accidental opening. Under-coating shall be provided and applied to battery box. Battery tray is to be equipped with a safety device to keep tray from sliding completely out to prevent battery from being dropped. Battery compartment shall be labeled with the word "Battery".
- 2251-R-52.00 Bumper, Rear.
- 52.01 Rear bumper shall be of pressed steel channel or equivalent material, at least 3/16-inch thick, and shall be a minimum of 8 inches wide (high) on Type A buses, and shall be a minimum of 9 1/2" wide (high) on Type B, C, and D buses.
 - 52.02 Rear bumper shall be wrapped around back corners of bus and extend forward at least 12 inches from rear-most point of body at floor line.
 - 52.03 Bumper shall be fastened to chassis frame side rails in such a manner as to develop full strength of bumper section from rear or side impact. Bracing materials shall have an impact ratio comparable to that of bumper material and shall be fastened at the ends and radii of the bumper, attached to the side of the frame only and not to body at any point.
 - 52.04 Rear bumper shall extend beyond rear-most part of body surface at least one inch, measured at floor lines.
 - 52.05 No spaces, projections, or cut-outs that will permit a hand hold or foot hold shall be permitted.
 - 52.06 Front ends of the bumper shall be enclosed by end caps or other protective metal or shall have the ends rounded or tucked in and shall be free from sharp edges or projections likely to cause injury or snagging.
 - 52.07 A gasket, rubber or equivalent, shall be installed to close opening between the top of the rear bumper and body metal.

2251-R-53.00 Capacity.

- 53.01 Capacities and seat spacing shall conform to and be in full compliance with applicable FMVSS.

2251-R-54.00 Color.

- 54.01 All exterior metal shall be painted National School Bus Yellow (NSBY) as specified in NSSB with the exception of those areas listed below:

54.01 (a) Lettering and numbering (black, white, or yellow for bumper area)

54.01 (b) Bumpers (black)

54.01 (c) Rubrails may be black or yellow at purchaser option

54.01 (d) Background area for warning light system. (black)

54.01 (e) The roof of the bus may be painted white not to extend below the drip rails on the sides of the body except that front and rear roof caps shall remain NSBY.

- 54.02 Reflective material shall be installed on the bus. Material shall be of reflective NSBY conforming to the requirements of FMVSS 571.131, TABLE 1. Reflective materials and markings shall include the following:

54.02 (a) Rear of bus body: strips of at least 1.75 inch reflective NSBY material shall be applied horizontally above the rear windows and above the rear bumper extending from the rear emergency exit perimeter marking outward to the left and right rear corners of the bus with vertical strips applied at the corners connecting these horizontal strips.

54.02 (b) "School Bus" signs: Shall be marked with reflective NSBY material comprising background for lettering of the front and/or rear "school bus" signs.

54.02 (c) Sides of bus body: Shall be marked with reflective NSBY material at least 1.75 inches in width, extending the length of the bus body and located (vertically) as close as practicable to the floor line.

2251-R-55.00 Construction.

- 55.01 All metal surfaces that will be painted shall be (in addition to above requirements) chemically cleaned, etched, zinc-phosphate-coated and zinc-chromate or epoxy primed or conditioned by equivalent process. In providing for these requirements, particular attention shall be given to lapped surfaces, welded connections of structural members, cut edges, punched or drilled hole areas in sheet metal, closed or box sections, unvented or undrained areas and surfaces subject to abrasion during vehicle operation.

- 55.02 The floor shall be at least 14 gauge mill applied zinc-coated steel sheet and shall be on one plane. There shall be a main floor cross member of at least 10 gauge steel or equivalent placed at each side post extending the full width of the floor plate and permanently attached. There shall be a minimum of two intermediate floor cross members of at least 16 gauge steel equally between the main floor cross members and permanently attached.
- 55.03 In addition to complying with the test procedures described in FMVSS 220, the body manufacturers shall record and report the downward vertical movement of the force at 0, 25, 50, 75, and 100% of the maximum force (both loading and unloading). The expected force deflection curve is illustrated schematically in Figure 1a. Low load nonlinearities may indicate joint conformation; high load nonlinearities may indicate yielding instructional members.
- 55.03 (a) A second load cycle shall be performed following the procedure given in the first paragraph. The expected force-deflection curve is illustrated schematically in Figure 1b. Any hysteresis following the initial shakedown will be revealed by this second cycle.

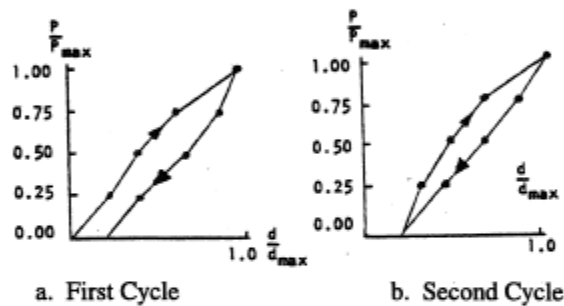

Figure 1. Static Load Test Load-Deflection Curves

- 55.04 A diagonal (racking) load test shall be performed on Type A, B, C, D school buses to assure adequate shear stiffness and strength of the bus body. Details of the test are provided below.
- A two cycle loading sequence shall be conducted following the procedure described in Section 55.04.
- 55.04 (a) Requirements: When a force equal to 1-1/2 times the GVW is applied to the edge of the roof of the vehicle's body structure through a force application plate as specified in (b), Test Procedures:
- 55.04 (a)(1) The diagonal movement of the force at any point on the application plate shall not exceed 5 1/8 inches; and
- 55.04 (a)(2) Each emergency exit of the vehicle provided in accordance with FMVSS 217 shall be capable of operation as specified in that standard during the full application of the force and after release of the force.

- 55.04 (b) Test Procedures: Each vehicle shall be capable of meeting the requirements of (1) and (2) when tested in accordance with the procedures set forth below.
- 55.04 (b)(1) The vehicle shall be supported on a rigid surface along the lower edge of the frame or along the body sills in the absence of a frame.
- 55.04 (b)(2) The load shall be applied through a force application plate that is flat and rigid. The dimensions of the plate shall be chosen to assure that the plate edges never make contact with the vehicle skin during testing. A typical width is 18 inches, and a typical length is 20 inches less than the length of the vehicle's roof measured along its longitudinal centerline.
- 55.04 (b)(3) Place the force application plate in contact with the edge of the vehicle roof. Orient the plate so that its flat, rigid surface is perpendicular to a diagonal line connecting the most distant points on an interior cross section of the vehicle. The rear edge of the plate shall be positioned approximately 20 inches from the rear edge of the vehicle roof. A temporary stand may be used to support the plate until a force is applied.
- 55.04 (b)(4) Apply an evenly distributed force in a diagonally downward direction through the force application plate at any rate not more than 0.5 inch per second, until a force of 500 pounds has been applied.
- 55.04 (b)(5) Apply additional force in a diagonally downward direction through the force application plate at a rate of not more than 0.5 inch per second until the force specified in (a) has been applied, and maintain this application of force.
- 55.04 (b)(6) Measure the diagonal movement of any point on the force application plate which occurred during the application of force in accordance with (5) and open the emergency exits as specified in (a)(2).
- 55.04 (b)(7) Release all diagonal force applied through the force application plate and operate the emergency exits as specified in (a)(2).
- 55.04 (c) Test Conditions: The following conditions apply to the requirements specified in (3).
- 55.04 (c)(1) Temperature: The ambient temperature is any level between 32 degrees F and 90 degrees F.
- 55.04 (c)(2) Windows and Doors: Vehicle windows, doors, and emergency exits are in the fully-closed position, and latched but not locked.

55.04 (d) An alternative method of testing for the racking load test shall be as follows:

The racking load shall be applied along a line connecting the most distant points on a transverse cross section of the bus interior. It produces a shear distortion of the cross section as shown in figure 2.

A representative method of loading which employs a hydraulic jack to load a two-frame test assembly is illustrated in figure 2. The maximum jack load for the two-frame assembly is determined by the following formula:

$$J = 2P \quad J - \text{maximum jack load for two-frame test assembly} \\ P = \text{load/frame}$$

where $P = \text{DVW divided by } N$
DVW - dynamic vehicle weight
N - total number of bus body frames

and $\text{DVW} = \text{DF} \times \text{GVW}$
DF - dynamic factor, not less than 1.5
GVW - gross vehicle weight

Thus, for a DF = 1.5, a GVW = 22,000 pounds-force (lbf) and N= 11, the dynamic vehicle weight is DVW = 33,000 lbf, the load/frame is P = 3000 lbf and the maximum jack load is J = 6000 lbf.

When a complete bus body is rack-loaded, the total load DVW must be distributed uniformly along the bus body. This may be accomplished by mounting a series of hydraulic jacks along the length of the bus interior. Seats may be removed to facilitate jack mounting. The rack load will be considered to be uniformly distributed when the variation in the hydraulic jack readings is less than 10 percent. A maximum load the sum of all jack readings shall equal DVW.

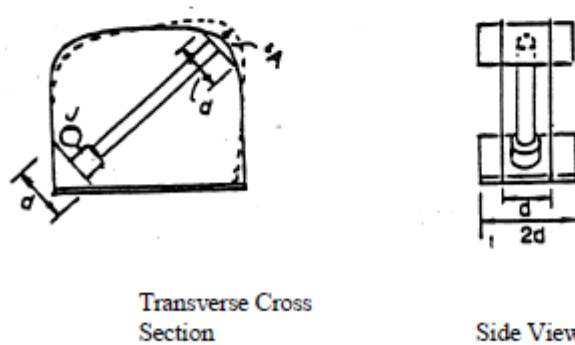

Figure 2. Arrangement of Hydraulic Jack for Rack-Loading of Two-Frame Assembly

The test may be performed on a complete bus body or on a representative section composed of at least two complete frames (body posts plus roof bows) and floor. Standard seats may be installed in the test section in a manner identical to that of the full bus body. Fabrication procedures for the test assembly shall be identical to those used in normal bus body production.

A two-cycle loading sequence shall be conducted, with intermediate and final load and deflection readings recorded according to the procedure described.

The maximum deflection in line with the jack (A, maximum) shall not exceed 4 inches.

Manufacturers shall specify which testing method was used and submit appropriate certification information as called for in 6.02.

- 55.05 Subfloor shall be either 5 ply nominal 5/8 inches thick plywood, or a material of equal or greater strength and insulation R value and it will equal or exceed properties of exterior-type softwood plywood C-D grade, as specified in NBS Product Standard 1-83. Type A buses shall have nominal 1/2 inch thick plywood or equivalent material equal to or exceeding properties listed above.
- 55.06 Ceiling Panels: If the ceiling is so constructed to contain lap joints, the forward panel shall be lapped by the rear panel and the exposed edges shall be beamed, hemmed, or flanged or otherwise treated to eliminate sharp edges.
- 55.07 All body components shall be designed and constructed so as to avoid the entrapment of moisture and dust.
- 55.08 All openings between chassis and passenger-carrying compartment made for any reason by body manufacturer must be sealed.

2251-R-56.00 Defrosters.

- 56.01 A defroster system shall be installed of sufficient capacity to keep windshield area, left frontside window to rear of driver's vision, and service door glass area free of condensation or ice.
- 56.02 Adjustable 6 inch auxiliary fans may be installed to complement the defroster system used by the manufacturer. Such fans shall be controlled individually by two-speed switches located on control panel. Fan blades shall be covered with a protective cage.

The fans shall be located so as to not interfere with the driver's horizontal line of sight vision.
- 56.03 The defrosting system shall conform to SAE Standards.

2251-R-57.00 Doors.

- 57.01 Service door shall be power or manually operated, under control of the driver, and so designed to afford easy release and to prevent accidental opening. When manual lever is used, no parts shall come together so as to shear or crush fingers.
- 57.02 Manual door controls shall not require more than 25 pounds of force to operate at any point throughout the range of operation. Power door controls shall be located within easy access of driver.
- 57.03 Service door shall be located on right side of bus opposite driver and within driver's direct view.
- 57.04 Power operated doors shall be equipped with a separate manual emergency release, readily accessible in the door area above or to the side of the service door or on dash, so that the door may be opened in the case of emergency. The release shall be plainly labeled with instruction for use.
- 57.05 There shall be a head bumper pad installed on the inside at the top of the entrance door. This pad shall be approximately 3 inches wide (high), at least 1 inch thick, and extend across the entire top of the entrance door opening.

2251-R-58.00 Emergency Exits.

- 58.01 Emergency door(s) shall be equipped with a 3-point latch mechanism.. Emergency door latch shall be equipped with suitable electric plunger-type switch connected with buzzer located in driver's compartment. Switch shall be enclosed in metal case and wires leading from switch shall be concealed in bus body. Switch shall be so installed that plunger contacts farthest edge of slide bar in such manner that any movement of slide bar will immediately close circuit on switch and activate buzzer. A separate interior handle shall be provided to pull the door shut from the inside.
 - 58.01(a) When flip-up seat is located next to emergency door, the inside door handle must be enclosed or protected by a safety guard to prevent accidental opening.
- 58.02 Exterior door handle shall be of permanent hitch-proof design and mounted with enough clearance to permit opening without touching door surface and may be equipped with a lock which will not prevent opening from inside.
- 58.03 All emergency door openings shall be completely weather stripped. There shall be no obstruction higher than 1/4 inch across the bottom of any emergency door opening.
- 58.04 Operation instructions for opening of door shall be lettered or decaled on the inside of the emergency door.
- 58.05 Emergency door shall bear words "EMERGENCY EXIT" both inside and outside in letters at least 2 inches high. Words shall be placed directly above the door or on the upper portion of the door.

- 58.06 On all buses except rear engine transit school buses (Type D), and buses with a raised rear storage compartment, an emergency door shall be located in the rear of the bus body and centered with respect to the body. Door shall have a minimum horizontal opening of 24 inches and minimum vertical opening of 48 inches measured from floor level. Rear emergency door shall be hinged on right side and shall open outward.
- 58.07 Rear emergency door shall contain upper and lower glass panels which comply with FMVSS 205. Glass in emergency door shall provide maximum area of visibility for safe operation of bus.
- 58.08 There shall be a head bumper pad installed over the emergency door on the inside of the bus body. This pad shall be approximately 3 inches wide (high), at least 1 inch thick, and extend across the entire top of the emergency door opening. Padding shall be of the same materials as the padding used over the service door.
- 58.09 Side emergency door: If engine or storage compartment is so located as to make it impossible to place door in center of rear end, the emergency door shall be located in the rear half of the left side of the bus body. The door shall not be located to reduce size of opening by wheel well. The door shall be hinged on the front side.
- 58.10 Rear emergency window: If engine or storage compartment is so located as to require a side emergency door, an emergency window shall be installed in the rear of the bus and shall meet FMVSS 217.
- 58.10 (a) The emergency window glass shall meet FMVSS 205. Glass shall be tempered unless specified laminated by the purchaser.
- 58.10 (b) The rear emergency window shall be hinged from top and provided with a hold open control to insure against accidental closing during an emergency.
- 58.10 (c) Emergency window in rear shall be equipped with latch on the inside and with a handle of hitch proof design which will permit opening from the outside.
- 58.11 All designated emergency windows shall bear words "EMERGENCY EXIT" in letters at least 2 inches high both inside and outside the window. Lettering shall be placed so as to be clearly visible to passengers inside the bus and outside directly above, below, or on the window.
- 58.12 All designated emergency windows shall be equipped with a buzzer. When not fully latched, it shall activate a signal audible to the driver.
- 58.13 Ignition interlock for the vandal locks shall conform to FMVSS.
- 58.14 Emergency side windows shall be hinged at the front side.

2251-R-59.00 Emergency Equipment.

- 59.01 The bus shall be equipped with at least one pressurized 5-pound dry-chemical fire extinguisher of a type approved by UL, with a total rating of not less than 2A10BC. The operating mechanism shall be sealed with a type of seal that will not interfere with use of the fire extinguisher.
- 59.02 Fire extinguisher shall be mounted in the extinguisher manufacturer's bracket (automotive type) and located in the driver's compartment in full view of and readily accessible to the driver. A pressure gauge shall be so mounted on the extinguisher as to be easily read without removing the extinguisher from its mounted position.
- 59.03 First Aid Kit(s): The bus shall carry a first aid kit or kits which shall either be mounted securely in full view or the location plainly indicated by appropriate markings, in the drivers compartment. The kit(s) shall be mounted in such a manner that they can be removed if necessary. Buses with a manufacturer's rated seating capacity of 36 or less shall be equipped with one 24 unit kit. Buses rated more than 36 capacity shall be equipped with two 24 unit kits.

Contents of the 24 unit First Aid Kit:

Item	Unit(s)
Adhesive Tape.....	1
1" adhesive bandage	2
2" bandage compress	1
3" bandage compress	1
4" bandage compress	1
3" x 3" plain gauze pads.....	1
Gauze roller bandage 2" wide.....	2
Plain absorbent gauze - 1/2 square yard	4
Plain absorbent gauze - 24" x 72"	3
Triangular bandages	4
Scissors, tweezers	1
Space rescue blanket	1
Latex Or equivalent disposable gloves, pair.....	1
CPR mask or mouth to mouth airway.....	1
Moisture and dustproof kit of sufficient capacity to store the required items.	

- 59.04 Emergency Reflectors (Section 42-4-230, C.R.S.): All buses shall carry three (3) emergency triangle reflectors in compliance with FMVSS 125, contained in a securely mounted case easily accessible to the driver.
- 59.05 Body fluid cleanup kit: Each school bus shall have a removable body fluid clean-up kit accessible to the driver.

Contents of the Basic Body Fluid Clean-up Kit:

Item	Unit(s)
Antiseptic towelette.....	1
Disinfectant towelette.....	1
Absorbing powder (capable of ½ gallon absorption).....	1
latex (or equivalent) disposable gloves, pair.....	1
Disposable wiper towels.....	2
Disposable scoop bag with closure mechanism and scraper.....	1
Moisture and dustproof container of sufficient capacity to store the required items.	

59.06 Small vehicles shall carry the following emergency equipment:

- 59.06 (a) Three (3) emergency triangle reflectors in a securely mounted case.
- 59.06 (b) One 24 unit first aid kit meeting the same list as the school bus.
- 59.06 (c) One securely mounted 2 1/2 pound dry chemical fire extinguisher of a type approved by UL, with a minimum rating of 1A10BC.

2251-R-60.00 Floor Coverings.

- 60.01 Floor in underseat area, including tops of wheel housings, driver's compartment, and toeboard shall be covered with fire-resistant rubber floor covering or equivalent having a minimum overall thickness of .125 inch.
- 60.02 Floor covering in aisle shall be aisle-type fire-resistant rubber or equivalent, non-skid, wear resistant, and ribbed. Minimum overall thickness shall be .1875 inch measured from tops of ribs.
- 60.03 Floor covering must be permanently bonded to floor and must not crack when subjected to sudden changes in temperature. Bonding or adhesive material shall be waterproof and shall be of type recommended by manufacturer of floor-covering material. All seams must be sealed with waterproof sealer.
- 60.04 Cove molding shall be used along the side walls and rear corners and all floor seam separations shall be properly bonded or secured.
- 60.05 The entrance step treads, including the edge at floor level, shall be of the same quality as the aisle material. Step treads shall have an integral white nosing of 1-1/2 inch or more or use diagonal stripes. Treads shall be permanently bonded to the metal steps and sealed to prevent water from getting underneath the step tread.
- 60.06 A secured and insulated plate shall be provided to access fuel tank sending unit. Type A buses are exempt.

2251-R-61.00 Fuel Fill Cap Cover.

- 61.01 The fuel fill cap opening in the body skirt shall be equipped with a hinged cover held closed by a spring or other conveniently operated device. Type A buses are exempt.

2251-R-62.00 Heating System.

- 62.01 All school buses shall be equipped with two or more hot water heaters capable of delivering water to the system at a rate of six gallons per minute using an ambient temperature of 0 degree F to +10 degrees F and maintaining passenger compartment temperature of 50 degrees F. One of the heaters shall be located in the rear half of the bus on or behind the rear wheel axle line.

62.01(a) Lift equipped buses may place the rear heater under the last row of seats.

- 62.02 Buses shall be equipped with front heater(s) and integrated defroster system of capacity to provide heat for the front part of the bus (including driver' compartment) and to keep windshield area, service door glass, driver's left glass area, and stepwell clear of moisture, ice and snow.

- 62.03 Hot water heaters shall bear the name plate rating in accordance with NSSB.

- 62.04 Multi-speed switches shall operate all heater fans independently.

- 62.05 Heater cores and fans shall be completely encased but designed to permit servicing heater assembly by removing all or part of case.

- 62.06 Heater hose installation in the engine compartment shall include two shut-off valves able to shut off coolant completely when necessary.

62.06 (a) One mounted between the water pump outlet and heater hose connection.

62.06 (b) One mounted between the motor block and the return heater hose connection.

62.06 (c) Heater hoses shall be adequately supported to guard against excessive wear due to vibration. Hoses shall not rub against the chassis, body or other edges.

- 62.07 The body manufacturer shall add the required amount of permanent ethylene glycol base or environmentally safe equivalent anti-freeze after heaters have been connected to protect cooling system of bus to -30 degrees F tested at normal engine temperature.

- 62.08 There shall be a heater water flow regulating valve installed for convenient operation by the driver.

2251-R-63.00 Identification.

- 63.01 Body shall bear words "SCHOOL BUS" in black letters at least 8 inches high on both front and rear of body. Lettering shall be placed as high as possible without impairment of its visibility. Lettering shall conform to SAHS.

- 63.02 School buses shall bear name of school district or company on each side in black, standard unshaded letters, 5 inches in height. If there is insufficient space due to the length of the name of the school district, terms such as community, consolidated, and district may be abbreviated.
- 63.03 The manufacturer's rated pupil seating capacity shall be printed to the left of the entrance door on the lower skirt in 2 inch characters. The word capacity may be abbreviated. (Example: Cap. 48) The capacity shall also be shown inside above the windshield.
- 63.04 The numbering of individual buses for identification purposes is permissible.
- 63.05 Lettering and numerals shall be painted or may be pressure sensitive marking of similar performance quality.
- 63.06 "STOP" shall be printed on the rear of the bus in letters at least 8 inches high. "ON FLASHING RED" shall be printed below "STOP," in letters at least 5 inches high. Letters shall be placed in area(s) visible to the approaching motorist.
- 63.07 The school district logo may be placed above the side window dripline.
- 63.08 Only signs and lettering specifically permitted by state law or regulation, and any marking necessary for safety and identification, shall appear on the outside of the bus.
 - 63.08 (a) Advertising, approved by the local school board, may appear only on the side(s) of the bus in the following areas:
 - 63.08 (a)(1) The location and securement of the advertising shall have prior CDE approval.
 - 63.08 (a)(2) The signs shall not extend from the body so as to allow a handhold or present a danger to pedestrians.
 - 63.08 (a)(3) The signs shall not interfere with the operation of any door, window, required lettering, lamps, reflectors or other device.
 - 63.08 (a)(4) The signs shall not be placed on side emergency door(s).

2251-R-64.00 Inside Height.

- 64.01 Inside body height shall be 72 inches or more, measured metal to metal at any point on longitudinal center line from front vertical bow to rear vertical bow. Type A school buses shall have 62 inches or more inside height, measured metal to metal.

2251-R-65.00 Insulation.

- 65.01 Bus body shall be fully insulated in the roof including roof bows and all body panels. Insulation 1 inch minimum thickness shall be of fiber-glass or equal and shall be fire resistant.

2251-R-66.00 Interior.

66.01 Interior of bus shall be free of all projections likely to cause injury.

2251-R-67.00 Lamps and Signals.

67.01 All lamps, signals, reflectors and their installation shall conform to standards and recommendations of SAE and meet FMVSS. There shall be no lettering, symbols or arrows, except manufacturer's markings, on any lens.

67.02 Tail and stop (brake) lamps:

67.02 (a) Bus shall be equipped with four combination red stop/tail lamps. Two combination stop lamps shall have a lens diameter of at least 7 inches or 38.48 square inches, and shall have light intensity at least equal to Class A, Type I turn-signal units as established by SAE. Two combination tail lamps shall have a lens diameter of at least 4 inches.

67.02 (b) If the bus is equipped with a retarder, the four stop lamps shall be illuminated when the retarder is activated.

67.03 License plate lamp: Bus shall be equipped with rear license plate illuminator. This lamp may be combined with one of the tail lamps.

67.04 Interior lamps: Interior lamps shall be provided which adequately illuminate aisle. A separate lamp shall be provided in stepwell.

67.05 Back-up lamps: Back-up lamps of 7 inch or 38.48 square inches, minimum diameter shall be provided.

67.06 Turn signal lamps:

67.06 (a) The bus shall be equipped with two amber turn signals in front and two amber turn signals in the rear. Both front and rear signals shall be at least 7 inches or 38.48 square inches, in diameter and meet the specifications of SAE.

67.06 (b) The four-way hazard switch shall activate the turn signal lamps only. This operation shall be independent of any other light system.

67.06 (c) On buses over 30 feet, a minimum of one additional turn signal shall be mounted on each side below window, behind the service door axis plane.

67.07 School bus alternately flashing warning signal lamps:

Definition: School bus alternately flashing warning signal lamps mounted at the same horizontal level, intended to identify vehicle as school bus and to inform other users of highway that such vehicle is stopped or about to stop on roadway to take on or discharge school children.

- 67.07 (a) All school buses shall be equipped with four red warning signal lamps designed to conform to SAE standards, and four amber warning signal lamps designed to conform to that standard except for color and except the candle power requirement shall be 2-1/2 times greater. The school bus shall have two (2) double-lamp assemblies at the front of the vehicle and two (2) double-lamp assemblies at the rear of the vehicle. Double-lamp assemblies shall display one amber lamp and one red lamp.
 - 67.07 (b) Right and left lamps shall flash alternately. Each lamp shall flash not less than 60 nor more than 120 flashes per minute.
 - 67.07 (c) Flashing warning lamps are to have a signal area of not less than 7 Inch diameter per lens. The lamps shall give a distinct warning illumination of entire lens area when lighted for a distance of 500 feet when the bus is in bright sunlight.
 - 67.07 (d) The amber flashing warning signal lamps shall be energized manually by a switch mounted on the driver control panel. The red flashing warning signal lamps shall be energized as set forth by FMVSS. The lamp units and switch systems shall also comply with the above standard. The flashing warning signal lamp system shall be a sequential mode type.
 - 67.07 (e) The flashing warning signal lamp system shall have two pilot or indicator lights; one shall show amber light when the amber signal lamps are flashing and the other shall show red light when the red signal lamps are flashing.
 - 67.07 (f) The vision of the front signal lamps to the front and rear signal lamps to the rear shall be unobstructed by any part of the vehicle. The area around the lens of each alternately flashing signal lamp and extended outward approximately 3 inches shall be painted black. In installations where there is not a flat vertical portion of the body immediately surrounding entire lens of lamp, a circular band of black approximately 3 inches wide, immediately below and to both sides of the lens, shall be painted on the body or roof area against which signal lamp is seen from a distance of 500 feet along the axis of vehicle.
 - 67.07 (g) Visors shall be provided and securely mounted above the dual-lamp flashing warning signals to adequately shade and protect the dual-lamp assemblies from sunlight above but not to obstruct the rear and side effectiveness of the warning lamps.
- 67.08 Type D rear engine buses shall have 2 hazard lamps each visible to the rear when the engine door is open. These lamps shall be wired to be illuminated when the main hazard lamp circuit is energized.

67.09 A white flashing strobe light meeting SAE standards may be installed on the roof of a school bus. Amber lens may be used upon approval of local traffic regulatory authority. Light shall have a single clear lens emitting light 360 degrees around its vertical axis and may not extend above the roof more than 8 inches. A manual switch and a pilot light must be included to indicate when light is in operation. Lamp must not be capable of activating emergency traffic control light switches.

2251-R-68.00 Mirrors.

68.01 Interior mirror: Interior mirror shall be either clear view laminated glass or clear view glass bonded to a backing which retains the glass in the event of breakage. Mirror shall have rounded corners and protected edges. Type A bus shall have a minimum of 6" x 16" mirror and Type B, C, and D buses shall have a minimum of a 6" x 30" mirror.

68.02 Exterior mirrors: Each school bus shall be equipped with a system of exterior mirrors including crossover mirrors (as defined in FMVSS). This system of mirrors shall be rigidly braced so as to reduce vibration.

2251-R-69.00 Mounting, Body, and Chassis.

69.01 Chassis frame shall support rear body cross member. Bus body shall be attached to chassis frame at each main floor sill, except where chassis components interfere, in such manner as to prevent shifting or separation of the body from the chassis under severe operating conditions.

69.02 Insulation material shall be placed at all contact points between body and chassis frame on all buses, and shall be so attached to the chassis frame or body that it will not move under severe operating conditions.

69.03 Body front shall be attached and sealed to the chassis cowl to prevent entry of moisture and gases.

2251-R-70.00 Overall Length.

70.01 Overall length of school buses shall not exceed 40 feet {Section 42-4-504 C.R.S.}.

2251-R-71.00 Overall Width.

71.01 Overall width of the school bus shall not exceed 96 inches, except under the provisions of Section 42-4-502 C.R.S.

2251-R-72.00 Rub Rails.

72.01 There shall be one rub rail located on each side of bus approximately at seat level which shall extend from rear side of entrance door completely around bus body (except for emergency and/or access door) to point of curvature near outside cowl on left side.

72.02 There shall be one rub rail located approximately at floor line which shall cover same longitudinal areas as upper rub rail, except at wheel housing, and shall extend at least to radii of right and left rear corners.

- 72.03 There shall be one rub rail located on each side of bus at the bottom of the side skirts, or a side skirt stiffener of equivalent strength.
 - 72.04 Rub rails shall be attached at each body post and all other upright structural members.
 - 72.05 Rub rails shall be 4 inches or more in width, shall be of 16-gauge steel, or suitable material of equivalent strength and shall be constructed in corrugated or ribbed fashion and shall be self-draining.
 - 72.06 Rub rails shall be applied outside body panels. Pressed-in or snap-on rub rails do not satisfy this requirement.
- 2251-R-73.00 Seat Belt for Driver.
- 73.01 A type 2 lap belt/shoulder harness seat belt shall be provided for the driver. The assembly shall be equipped with an emergency locking retractor (ELR) for the continuous belt system. The lap portion of the belt shall be guided or anchored where practical to prevent the driver from sliding sideways under it.
 - 73.02 Adjustability of the mounting point for the driver seat belt pillar loop shall be provided to accommodate all heights and weights of bus drivers without interference with the driver's face or neck.
- 2251-R-74.00 Seats/Restraining Barriers.
- 74.01 All seating and restraining barrier design and construction must meet the provisions of FMVSS 222. Type A school buses shall be equipped with restraining barriers conforming to FMVSS 222.
 - 74.02 Lap belt ready seat frames shall be reinforced to meet FMVSS.
 - 74.03 All seats shall be forward facing and shall be securely fastened to that part of the school bus body which supports them.
 - 74.04 No bus shall be equipped with jump seats or portable seats.
 - 74.05 Forward-most pupil seat on right side of bus shall be located so as not to interfere with driver's vision, not farther forward than barrier behind driver or rear of driver's seat when adjusted to its rear-most position.
 - 74.06 Seat material shall comply with FMVSS 302.
 - 74.07 Backs of all seats of similar size shall be of same width at top and of same height from floor and shall slant at same angle with floor.
 - 74.08 Passenger seat cushion retention system shall be employed to prevent passenger seat cushions from disengaging from seat frames or flipping forward in event of accident. Each seat cushion retention system shall be capable of withstanding vertical static load equal to minimum of 5 times weight of cushion.

- 74.09 Use of a flip seat at any side emergency door location in conformance with FMVSS 222, including required aisle width to side door, is acceptable. Any flip seat shall be free of sharp projections on the underside of the seat bottom. The underside of the flip-up seat bottoms shall be padded or contoured to reduce the possibility of snagged clothing or injury during use. Flip seats shall be constructed to prevent passenger limbs from becoming entrapped between the seat back and the seat cushion when in the upright position. The seat cushion shall be designed to rise to a vertical position automatically when not occupied.

2251-R-75.00 Steps.

- 75.01 First step at service door shall be not less than 10 inches (12 inch for Type D) and not more than 14 inches (16 inches for Type D) from ground, based on standard chassis specifications.
- 75.02 Step risers shall not exceed a height of 10 inches. When plywood is used on the top step, the riser height may be increased by the thickness of the wood.
- 75.03 An assist grab rail not less than 20 inches in length designed to provide maximum loading assistance shall be provided in an unobstructed location inside doorway.
- 75.04 Surface of steps shall be of non-skid material.

2251-R-76.00 Stirrup Steps.

- 76.01 There shall be a least one folding stirrup step or recessed foothold and suitably located handles on each side of the front of the body for easy accessibility for cleaning the windshield and lamps except when windshield and lamps are easily accessible from the ground. Steps are permitted in or on the front bumper, in lieu of the stirrup steps, if the windshield and lamps are easily accessible for cleaning from that position.

2251-R-77.00 Stop Signal Arm.

- 77.01 The stop signal arm shall be a flat 18 inch octagon, exclusive of brackets for mounting. The stop signal arm shall contain two alternately flashing red lamps, one located near the top and one located near the bottom of the sign which show both to the front and to the rear. The flashing red lamps shall be connected to the alternately flashing warning signal lamps master control system. The arm shall meet applicable FMVSS requirements.
- 77.02 It shall have the word "STOP" printed on both sides in white letters at least 6 inches high, with a brush stroke of approximately 7/8 inch width, on a bright red background. The outer edge shall be painted white 1/2 inch wide.
- 77.03 The stop signal arm shall be reflectorized in accordance with FMVSS 131.
- 77.04 The sign shall be mounted outside the bus on the driver side below the driver window. Rubber spacers shall be installed on either the side of the bus or the stop arm so as to prevent sign from making abrasive contact with the side of the bus.

- 77.05 Wind guard shall be provided to keep sign in retracted position.
- 2251-R-78.00 Storage Compartment.
- 78.01 A metal container of adequate strength and capacity for the storage of tire chains, tow chains, and such tools as may be necessary for minor emergency repairs while bus is en route may be provided. Such storage container may be located either inside or outside the passenger compartment, but, if inside, it shall be secured and it shall have cover other than seat cushion which shall be securely fastened to it in such a manner as to prevent the contents from spilling in case the bus overturns.
- 2251-R-79.00 Sun Visor.
- 79.01 An interior, adjustable, double bracketed sun visor shall be installed not less than 6 inches wide and 30 inches long. Type A school buses shall have a sun visor according to manufacturer's standard.
- 2251-R-80.00 Tail Pipe.
- 80.01 Tail pipe shall not extend beyond body perimeter, after the body is attached to the chassis, and shall also comply with Section 20, subsections 20.01 through 20.04 of these rules.
- 80.02 Tailpipe shall not exit beneath any fuel filler location or beneath any emergency door or lift door.
- 2251-R-81.00 Tow Hooks Rear.
- 81.01 The school bus shall be equipped with two heavy-duty tow hooks or eyes fastened securely to the rear of the frame and shall not protrude beyond outer edge of the bumper.
- 2251-R-82.00 Undercoating.
- 82.01 Entire underside of bus body, including floor sections, cross members, and below floor line side panels, shall be coated with rust-proofing compound for which compound manufacturer has issued notarized certification of compliance to bus body manufacturer that compound meets or exceeds all performance requirements of Fed. Spec.
- 2251-R-83.00 Ventilation.
- 83.01 Buses, in excess of 20 feet in length, shall be equipped with a multi-speed powered exhaust roof ventilator, mounted in the rear half of the bus.
- 2251-R-84.00 Wheel Housings.
- 84.01 Wheel house openings shall be of full-open type.
- 84.02 Wheel housings shall be designed to support seat and passenger loads and shall be attached to floor sheets in such manner as to prevent any dust, water, or fumes from entering the body.
- 84.03 Inside height of wheel housings above floor line shall not exceed 12 inches.

- 84.04 Wheel housings shall provide clearance for installation and use of tire chains on single and dual power wheels.
- 84.05 The wheel housing opening shall allow for easy tire removal and service.
- 84.06 No part of a raised wheel housing shall extend into the emergency door opening.
- 2251-R-85.00 Windshield and Windows.
 - 85.01 All glass in windshield, windows, and doors shall be of approved safety glass, so mounted that permanent mark is visible, and of sufficient quality to prevent distortion of view in any direction as specified in FMVSS.
 - 85.02 Each full side window shall provide unobstructed emergency opening at least 9 inches high and 22 inches wide, obtained by lowering of window. If full drop windows are used, they shall be blocked so that when, in a down position, the opening between the window header and top of glass is not more than 12 inches.
 - 85.03 Push-out type, split-sash windows may be used.
 - 85.04 All exposed edges of glass shall be banded.
- 2251-R-86.00 Windshield Washers.
 - 86.01 The bus shall be equipped with windshield washers which shall conform to FMVSS and body manufacturer's recommendations.
 - 86.02 For Type C and D buses, the system reservoir capacity shall be a minimum of one gallon.
- 2251-R-87.00 Windshield Wipers.
 - 87.01 A windshield wiping system, two-speed or more, shall be provided.
 - 87.02 The wipers shall be operated by one or more air or electric motors of sufficient power to operate wipers. If one motor is used, the wipers shall work in tandem to give full sweep of windshield.
 - 87.03 All wiper controls shall be located within easy reach of the driver and designed, when in stop position, to move blades from the driver's direct view.
- 2251-R-88.00 Wiring.
 - 88.01 All wiring shall conform to current standards of SAE.

88.02 Circuits:

- 88.02 (a) Wiring shall be arranged in at least nine regular circuits, as follows:
 - 88.02 (a)(1) Head, tail, stop, and instrument panel lamps,
 - 88.02 (a)(2) Clearance lamps,
 - 88.02 (a)(3) Dome and step-well lamps,
 - 88.02 (a)(4) Starter motor,
 - 88.02 (a)(5) Ignition and emergency door signal,
 - 88.02 (a)(6) Turn signal lamps,
 - 88.02 (a)(7) Alternately flashing warning signal lamps,
 - 88.02 (a)(8) Horn,
 - 88.02 (a)(9) Heaters and defrosters.
 - 88.02 (b) Any of above combination circuits may be subdivided into additional independent circuits.
 - 88.02 (c) All other electrical functions (such as electric-type windshield wipers) shall be provided with independent and properly protected circuits.
 - 88.02 (d) Each body circuit shall be color or number coded and a diagram of circuits shall be attached to the body in a readily accessible location. Number coding is permitted only if the number is a permanent part of the insulation and is repeated at intervals of not more than 6 inches.
- 88.03 A separate fuse or circuit breaker shall be provided for each circuit except starter motor and ignition circuits.
- 88.04 All wires shall be installed within body. They shall be insulated and protected by covering of fibrous loom or equivalent which will protect them from external damage and minimize dangers from short circuits. Whenever wires pass through body member, additional protection in form of appropriate type of insert shall be provided.
- 88.05 Wires not enclosed within body shall be enclosed in a protective jacket and fastened securely at intervals of not more than 18 inches. All joints shall be soldered or joined by equal effective connectors. The protective jackets shall be assembled to provide maximum protection against moisture and dust.

2251-R-89.00 (rule number reserved)

SPECIALLY EQUIPPED SCHOOL BUSES

2251-R-90.00 Introduction.

- 90.01 Equipping buses to accommodate students with special needs is dependent upon the needs of the passengers. Buses may be fitted with various equipment to accommodate those needs. Buses so equipped are not to be considered a separate class of school bus, but simply a regular school bus equipped for special accommodations. Special transportation considerations and needs of a student entitled to transportation as a related service should be addressed in the student's individual education program (IEP).

The specifications in this section are intended to be supplementary to specifications in the chassis and body sections. In general, specially equipped buses shall meet all the requirements of the preceding sections plus those listed in this section. It is recognized by the entire industry that the field of special transportation is characterized by varied needs for individual cases and by a rapidly emerging technology for meeting those needs. A flexible, "common-sense" approach to the adoption and enforcement of specifications for these vehicles, therefore, is prudent.

2251-R-91.00 Definition.

- 91.01 A specially equipped school bus is any school bus designed, equipped, or modified to accommodate students with special transportation needs.

2251-R-92.00 General Requirements.

- 92.01 School buses equipped for transporting students with special transportation needs shall comply with FMVSS.
- 92.02 In the instance where a regular service entrance cannot be accessed, the bus shall be equipped with a power lift, unless a ramp is needed for unusual circumstances related to passenger needs.

2251-R-93.00 Power Lift.

- 93.01 Load. The working load of the lift shall be at least 600 pounds, with a minimum peak load of 800 pounds. Working parts such as cables, pulleys, and shafts, which can be expected to wear, and upon which the lift depends for support of the load, shall have a safety factor of at least 6, based on the ultimate strength of the material. Non-working parts, such as platform, frame, and attachment hardware which would not be expected to wear, shall have a safety factor of at least 3, based on the ultimate strength of the material.
- 93.02 School buses with a power lift shall have increased electrical system capacity commensurate with the needs of the lift system.

- 93.03 Controls. Controls shall be provided that enable the operator to activate the lift mechanism from either inside or outside the bus. The lift shall deploy to all levels (i.e., ground, curb, and intermediate positions) normally encountered in the operating environment. Where provided, each control for deploying, lowering, raising, and stowing the lift and lowering the roll-off barrier shall be of a momentary contact type requiring continuous manual pressure by the operator and shall not allow improper lift sequencing when the lift platform is occupied. The controls shall allow reversal of the lift operation sequence, such as raising or lowering a platform that is part way down, without allowing an occupied platform to fold or retract into the stowed position.
- 93.04 Emergency operation. The lift shall incorporate an emergency method of deploying, lowering to the ground level with a lift occupant, and raising and stowing the empty lift if the power to the lift fails. No emergency method, manual or otherwise, shall be capable of being operated in a manner that could be hazardous to the lift occupant or to the operator when operated according to manufacturer's instructions and shall not permit the platform to be stowed or folded when occupied. No manual emergency operation shall require more than 2 minutes to lower an occupied wheelchair to ground level.
- 93.05 Platforms, when occupied, shall have provisions to prevent their deploying, falling, or folding any faster than 12 inches per second and have provisions to prevent their dropping of an occupant in the event of a single failure of any load carrying component.
- 93.06 Platform barriers. The lift platform shall be equipped with barriers to prevent any of the wheels of a wheelchair or mobility aid from rolling off the platform during its operation. A movable barrier or inherent design feature shall prevent a wheelchair or mobility aid from rolling off the edge closest to the vehicle until the platform is in its fully raised position.
- 93.06 (a) Each side of the lift platform which extends beyond the vehicle in its raised position shall have a barrier a minimum 1.5 inches high. Such barriers shall not interfere with maneuvering into or out of the aisle.
- 93.06 (b) The loading-edge barrier (outer barrier), which functions as a loading ramp when the lift is at ground level, shall be sufficient when raised or closed, or a supplementary system shall be provided to prevent a power wheelchair or mobility aid from riding over or defeating it. The outer barrier of the lift shall automatically raise or close, or a supplementary system shall automatically engage, and remain raised, closed, or engaged at all times that the platform is more than 3 inches above ground level and the platform is occupied. Alternatively, a barrier or system may be raised, lowered, opened, closed, engaged, or disengaged by the lift operator, provided an interlock or inherent design feature prevents the lift from rising unless the barrier is raised or closed or the supplementary system is engaged.
- 93.07 Handrails. Platforms on lifts shall be equipped with handrails on two sides, which move in tandem with the lift, and which shall be graspable and provide support to standee through the entire lift operation. Handrails shall be placed to provide a minimum 1.5 inch knuckle clearance from the nearest adjacent surface. Handrails shall not interfere with wheelchair or mobility aid maneuverability when entering or leaving the vehicle.

- 2251-R-94.00 Ramps.
- 94.01 If a ramp is used, it shall be of sufficient strength and rigidity to support wheel chair (electric or other), occupant, and attendant. It shall be equipped with protective flange on each longitudinal side to keep wheelchair on ramp.
 - 94.02 Floor of ramp shall be covered with non-skid material.
 - 94.03 Ramp shall be of weight, equipped with handle or handles, to permit one person to put ramp in place and to return it to storage place.
 - 94.04 Provisions shall be made to secure ramp to side of bus for use without danger of detachment and ramp shall be connected to bus at floor level in such a manner as to permit easy access of wheels of wheelchair to floor of bus.
 - 94.05 Ramp shall be at least 80 inches in length.
- 2251-R-95.00 Aisles.
- 95.01 All school buses equipped with a power lift or ramp shall provide a 30 inch aisle leading from any wheelchair/mobility aid position to at least one emergency door and to the lift area.
- 2251-R-96.00 Identification.
- 96.01 Buses with power lifts or ramps shall display the international symbol of accessibility on all four sides of the bus. The symbols shall be a minimum of 6 inches and not exceed 12 inches.
- 2251-R-97.00 Restraining Devices.
- 97.01 Lap belt ready seat frames shall be reinforced to meet FMVSS. All restraining devices shall conform to FMVSS.
- 2251-R-98.00 Seating Arrangements.
- 98.01 To accommodate special devices for passenger requirements, flexibility is permitted in seat spacing, not to exceed FMVSS. All seating shall be forward-facing.
- 2251-R-99.00 Securement and Restraint System for Wheelchair/mobility Aid and Occupant.
- 99.01 For purposes of better understanding the various aspects and components of this section, the term "securement" or phrase "securement system" is used exclusively in reference to the device(s) which secure the wheelchair/mobility aid. The term "restraint" or phrase "restraint system" is used exclusively in reference to the device(s) used to restrain the occupant of the Wheelchair/mobility aid. The phrase "securement and restraint system" is used to refer to the total system which secures and restrains both the wheelchair/mobility aid and the occupant.

- 99.02 Securement and restraint system. The wheelchair/mobility aid securement and occupant restraint system shall be designed, installed, and operated to accommodate passengers in a forward-facing orientation within the bus and shall comply with all applicable requirements of FMVSS.
- 99.03 The securement and restraint system, including the system track, floor plates, pockets, or other anchorages shall be provided by the same manufacturer, or be certified to be compatible by manufacturers of all equipment/systems used. The system shall be installed so as to allow full use of all positions of the system anchorages.
- 99.04 When a wheelchair/mobility aid securement device and an occupant restraint share a common anchorage, including occupant restraint designs that attach the occupant restraint to the securement device or the wheelchair/mobility aid, the anchorage shall be capable of withstanding the loads of both the securement device and occupant restraint applied simultaneously, in accordance with FMVSS.
- 99.05 When a wheelchair/mobility aid securement device (webbing or strap assembly) is shared with an occupant restraint, the wheelchair/mobility aid securement device (webbing or strap assembly) shall be capable of withstanding a force twice the amount as specified in FMVSS.
- 99.06 The bus body floor and sidewall structures where the securement and restraint system anchorages are attached shall have equal or greater strength than the load requirements of the system(s) being installed.
- 99.07 The securement and restraint system shall incorporate an identification scheme which shall allow for the easy identification of the various components and their functions. It shall consist of one of the following, or combination thereof:
- 99.07 (a) The wheelchair/mobility aid securement device (webbing or strap assemblies) and the occupant restraint belt assemblies shall be of contrasting color or color shade.
- 99.07 (b) The wheelchair/mobility aid securement device (webbing or strap assemblies) and the occupant restraint belt assemblies shall be clearly marked to indicate the proper wheelchair orientation in the vehicle, and the name and location for each device or belt assembly, i.e., front, rear, lap belt, shoulder belt, etc.
- 99.08 The securement and restraint system shall be located and installed such that when an occupied wheelchair/mobility aid is secured, it is not adjacent to the lift.
- 99.09 Each securement device (webbing or strap assembly) and restraint belt assembly shall be permanently and legibly marked or incorporate a non-removable label or tag which states that it conforms to all applicable FMVSS requirements.
- 99.10 The following information shall be provided with each vehicle equipped with a securement and restraint system:
- 99.10 (a) Detailed instructions regarding installation, repair, and a parts list.

99.10 (b) Detailed instructions regarding use, including a diagram showing the proper placement of the wheelchair/mobility aid securement devices and occupant restraints, including correct belt angles.

99.11 The system manufacturer shall make available training materials to ensure the proper use and maintenance of the wheelchair/mobility aid securement and occupant restraint system. These may include instructional videos, classroom curriculum, system test results, or other related materials.

99.12 Wheelchair/mobility aid securement system. Each securement system location shall consist of a minimum of four anchorage points. A minimum of two anchorage points shall be located in front of the wheelchair/mobility aid and a minimum of two anchorage points shall be located in the rear. The securement anchorages shall be attached to the floor of the vehicle and shall not interfere with passenger movement or present any hazardous condition.

99.12 (a) The securement system shall secure the wheelchair/mobility aid in such a manner that the attachments or coupling hardware will not become detached when any wheelchair/mobility aid component deforms, when one or more tires deflate, and without intentional operation of a release mechanism (e.g., a spring clip on a securement hook).

99.13 Dynamic testing. The wheelchair/mobility aid securement and occupant restraint system shall be subjected to, and successfully pass, a dynamic sled test as spelled out in the current NSSB.

2251-R-100.00 Special Service Entrance.

100.01 There shall be adequate illumination for normal operation of the lift, to include the lift and adjacent area, both when deployed at the vehicle floor level and at ground level.

100.02 A drip molding shall be installed above the opening to effectively divert water from entrance.

100.03 Door posts and headers from entrance shall be reinforced sufficiently to provide support and strength equivalent to the areas of the side of the bus not used for special service entrance.

100.04 A single door or double doors may be used for the special service entrance.

100.04 (a) A single door shall be hinged to the forward side of the entrance unless doing so would obstruct the regular service entrance. If, due to the above condition, the door is hinged to the rearward side of the doorway, the door shall utilize a safety mechanism which will prevent the door from swinging open should the primary door latch fail.

100.04 (b) If double doors are used, the system shall be designed to prevent the door(s) from being blown open by the wind resistance created by the forward motion of the bus, and/or incorporate a safety mechanism to provide secondary protection should the primary latching mechanism(s) fail.

100.05 All doors shall have positive fastening devices to hold doors in the open position.

- 100.06 All doors shall be weather sealed.
- 100.07 When dual doors are provided, the rear door shall have at least a one-point fastening device to the header. The forward-mounted door shall have at least three-point fastening devices. One shall be to the header, one to the floor line of the body, and the other shall be into the rear door. The door and hinge mechanism shall be of a strength that is greater than or equivalent to the emergency exit door.
- 100.08 Door materials, panels and structural strength shall be equivalent to the conventional service and emergency doors. Color, rub rail extensions, lettering and other exterior features shall match adjacent sections of the body.
- 100.09 Each door shall have windows set in rubber which are visually similar in size and location to adjacent non-door windows. Glazing shall be of same type and tinting (if applicable) as standard fixed glass in other body locations.
- 100.10 Door(s) shall be equipped with a device that will actuate and maintain an audible or flashing signal located in the driver's compartment when door(s) is not securely closed and ignition is in "on" position.
- 100.11 A switch shall be installed so that the lifting mechanism will not operate when the lift platform door(s) is closed.
- 100.12 Special service entrance doors shall be equipped with padding at the top edge of the door opening. Padding shall be at least 3 inches wide and 1 inch thick and extend the full width of the door opening.

2251-R-101.00 Support Equipment and Accessories.

- 101.01 Each bus which is set to accommodate wheelchair/mobility aids, safety vests, car seats, or other similar assistive or restraint devices shall have a durable webbing cutter with a protected blade. The cutter shall be properly secured in a location within reach of the driver while belted into his/her driver's seat.

2251-R-102.00 Emergency Waiver of Specifications.

- 102.01 The Colorado Board of Education may temporarily waive specific non-statutory standard(s) when the Board finds that vehicles meeting the minimum standards are not available, and also find that the safety of children would not be adversely affected by the nonconformity.

102.01 (a) Any agency or district applying for temporary waiver shall provide the Board with:

102.01 (a)(1)Reasons for temporary waiver of the standards,

102.01 (a)(2)Statement of the specific variation from the minimum standards,

102.01 (a)(3)Compensating factors with respect to non-conformity.

Intentionally left blank

Appendix E. Regulation 1 CCR 301-25 (1993) Colorado Minimum Standards
Governing School Transportation Vehicles Effective date October 01, 1993

Colorado State Board of Education
Department of Education

1 Colorado Code of Regulations 301-25

Adopted: 11-21-72, with numerous subsequent amendments temporary regulation amendments 2-16-78 and 5-10-78, repealed and readopted 1-4-79, amended 8-9-79, 10-4-79, 1-10-80, 3-13-80, 4-10-80, 10-9-80, 8-12-82, 9-13-84, 7-9-87, amended 7-14-88, 6-10-93.

Attorney General Opinions: 2-23-78, 1-15-79, 7-17-87, 7-25-88, 6-17-93.

Statutory Authority: 22-51-108, 22-2-107 (1)(c) and 42-4-613 (1) (2) (3), C.R.S.

**COLORADO MINIMUM STANDARDS GOVERNING
SCHOOL TRANSPORTATION VEHICLES**

2251-R-1.00 Statement of Basis and Purpose.

The statutory authority for the Amendments of 2251-R-2.00 through 107.00 the Colorado Minimum Standards Governing School Transportation Vehicles (hereinafter "these rules"), adopted by the State Board of Education on June 10, 1993 is found in sections 22-51-108 and 42-4-613 (1) (2) (3), C.R.S.

The purpose of this Amendment is to establish minimum standards for school transportation vehicles purchased for use in Colorado. These standards are necessary to improve the safety of the children riding the buses and the mechanical efficiency of the bus. The new standards meet or exceed the national recommended minimum standards and utilize state-of-the-art industry advances.

2251-R-2.00

FMVSS-

Federal Motor Vehicle Safety Standards
49 C.F.R. Part 571, Revision 1986
National Highway Traffic Safety Administration
U.S. Department of Transportation

1 CCR 301-25

SAE-

Society of Automotive Engineers, Inc.
Standards, Revision 1986
400 Commonwealth Drive
Warrendale, PA 15096

UL-

Underwriters Laboratories, Inc.
Standard 299-82, Revision March 1985
333 Pfingsten Road
Northbrook, IL 60062

FED. SPEC.-

Federal Specification TT-C-520b
Revision February 1973
General Services Administration
Specification and Consumer Information
Distribution Center
Building 197
Washington, D.C. 20407

NSSB-

National Standards for School Buses, Revision 1990
Recommendations of the Eleventh National Conference on
School Transportation, issued by the National Safety Council
444 North Michigan Avenue
Chicago, Illinois 60611

NBS-

National Bureau of Standards
Voluntary Product Standard 1-83, Revision May 1984
Office of Standards Reference Materials
Washington, D.C. 20234

SAHS-

Standard Alphabets for Highway Signs - Series B
Federal Highway Administration - Revision April 1984
U.S. Government Printing Office
Washington, D.C. 20234

NFPA-

1 CCR 301-25

National Fire Protection Association
Volume 2, National Fire Codes, Revision 1985
Batterymarch Park, Quincy, MA 02269

For information regarding how the incorporated material may be obtained or examined, contact:

Colorado Department of Education
School Transportation Unit
201 East Colfax Avenue, Room 209
Denver, CO 80203

2251-R-3.00 Responsibility of Suppliers.

- 3.01 School transportation vehicle dealers distributors, and manufacturers each have a responsibility to comply with these rules after the effective date of these rules, October 1, 1993.
- 3.02 Dealers, distributors, or manufacturers which supply school transportation vehicles for use in the State of Colorado which do not meet the specifications herein stated shall be notified of noncompliance and a general notice will be sent to all school districts and school transportation operations within the State of Colorado advising that equipment supplied by such dealer, distributor, or manufacturer is not in compliance with these rules, October 1, 1993.
- 3.03 If a dealer, distributor, or manufacturer has been notified of non-compliance in accordance with subsection 3.02 and replaces or modifies the equipment to meet these rules, October 1, 1993, a notification of compliance will be issued from the Colorado Department of Education within 30 days after proof of compliance.

2251-R-4.00 Effective Date of Specification.

- 4.01 School transportation vehicles manufactured on or after the effective date of these rules, October 1, 1993, for the purpose of transporting Colorado school children shall meet or exceed these minimum standards contained herein.
- 4.02 School transportation vehicles manufactured before the effective date of these rules, which have been used exclusively for the purpose of transporting school children and which met or exceeded the Colorado Standards at the time, may continue in use.
- 4.03 Only used buses manufactured after January 1, 1978, may be purchased, leased, or contracted, for the purpose of transporting Colorado school children. These buses must have

met Colorado minimum standards in effect at the time of manufacture.

2251-R-5.00 School Transportation Vehicle Definitions, Section 42-1-102(69), C.R.S.

- 5.01 "School Bus" means every motor vehicle which is owned by a public or governmental agency and operated for the transportation of children to or from school or which is privately owned and operated for compensation but it does not include informal or intermittent arrangements, such as sharing of actual gasoline expense or participation in a car pool, for the transportation of children to or from school.

A School Bus shall be a motor vehicle with motive power, built to school bus standards, designed for carrying passengers, which at any time would be used to carry school children, students, and school personnel, providing that such transportation is sponsored and approved by the local board of education or school governing agency. Vehicles that only carry school children along with other passengers as part of the operation of a common carrier under the jurisdiction of Interstate Commerce Commission and Public Utilities Commission are not included within the definition of school bus.

- 5.02 **TYPE A**--Type "A" school bus is a conversion or body constructed upon a van-type compact truck or a front-section vehicle chassis, with a gross vehicle weight rating of 10,000 pounds or less, designed for carrying passengers.

- 5.03 **TYPE B**--Type "B" school bus is a conversion or body constructed and installed upon a van or front-section vehicle chassis, or stripped chassis, with a gross vehicle weight rating of more than 10,000 pounds, designed for carrying passengers. Part of the engine is beneath and/or behind the windshield and beside the driver's seat. The entrance door is behind the front wheels.

5.03 (a) Vans or other vehicles adapted for school transportation use are not acceptable without modifications of sides and roof for added structural strength. Vehicles shall meet all current applicable FMVSS.

- 5.04 **TYPE C**--Type "C" school bus is a body installed upon a flat back cowl chassis with a gross vehicle weight rating of more than 10,000 pounds, designed for carrying passengers. All of the engine is in front of the windshield and the entrance door is behind the front wheels.

- 5.05 **TYPE D**--Type "D" school bus is a body installed upon a chassis, with the engine mounted in the front, midship, or rear, with a gross vehicle weight rating of more than 10,000 pounds, designed for carrying passengers. The engine may be behind the windshield and beside the driver's seat; it may be at the rear of the bus, behind the rear wheels, or midship between the

front and rear axles. The entrance door is ahead of the front wheels.

- 5.06 Small vehicle shall be a motor vehicle with motive power, which does not meet the requirements of a Type A, B, C, or D school bus, and which shall not transport more than the manufacturer's designated capacity. These vehicles shall meet or exceed FMVSS and sections 59.01(a), 59.03 and 59.04 of these rules which at any time would be used to carry school children, students and school personnel; provided that such transportation service is sponsored and approved by the local board of education or school governing agency. The preceding definition is not intended to include private motor vehicles used exclusively to carry members of the owner's household.
- 5.07 Activity bus shall be a motor vehicle with motive power, designed for carrying passengers meeting or exceeding the Colorado Minimum Standards Governing School Transportation Vehicles except Sections:

2251-R-16.00 Color: Chassis
53.00 Capacity
54.00 Color - body
77.00 Stop Arm Signal

And the following Subsections:

2251-R-63.01 "SCHOOL BUS" Identification
63.02 School name
63.04 Vehicle numbering
63.06 "STOP ON FLASHING RED" Lettering
67.07 (a-g) School bus alternating flashing warning signal lamps
74.01 Seating design and construction
74.05 Seating material

The activity bus shall be used to carry school children, students and school personnel exclusively to and from school related activities or events, provided that such transportation is sponsored and approved by the local board of education. The activity bus shall travel from one location to a second location without stopping to load or unload passengers or control traffic on a public highway. The preceding definition is not intended to preclude the use of school buses on school related activities or events.

- 5.07 (a) The body shall bear the words "ACTIVITY BUS" in letters at least 8 inches high on both the front and rear. The lettering shall be placed as high as possible without impairment of its visibility. Lettering shall conform to SAHS.
- 5.07 (b) All activity bus seat design, attachment, construction, and material shall meet all

1 CCR 301-25

manufacturer's standard coach (non-school bus) seating requirements or FMVSS 222.

- 5.07 (c) Activity buses shall bear name of school or company on each side at least 5 inches in height.

2251-R-6.00 Testing and Certification.

- 6.01 Chassis manufacturers shall provide certification to the Colorado Department of Education that their product(s) meet these rules and all applicable FMVSS standards. Written certification shall be provided 30 days before or after July 1, of each calendar year.
- 6.02 School bus body manufacturers shall provide certification to the Colorado Department of Education that their product(s) meet or exceed these rules and all applicable FMVSS in effect at the time of manufacture. Written certification shall be provided 30 days before or after July 1 of each calendar year. Body manufacturers shall record and report to CDE the test results called for in Section 55 - Construction, of these rules. All school bus bodies shall meet applicable FMVSS and compliance with these standards shall be certified by the body manufacturer by the attachment of a plate or decal.
- 6.03 It will be the district's responsibility to ascertain whether all school buses purchased, leased, or under contract to the district meet all specifications of these rules. This verification should be obtained at the time of delivery, in addition to the statement of compliance in the purchase bid, contract for or lease agreement.
- 6.04 When selling a school bus, it is the district's responsibility to eliminate the district's name from the sides of the bus.

2251-R-7.00 Chassis and Body Delivery Requirements.

- 7.01 The chassis manufacturer shall provide the following materials and information for direct delivery to the customer:
 - 7.01 (a) Line set tickets for each individual unit.
 - 7.01 (b) A copy of the pre-delivery service performed and verified by a checkout form for each individual unit.
 - 7.01 (c) Warranty book and statement of warranty for each individual unit.
 - 7.01 (d) Service manual for each individual unit or identical units.

7.01 (e) Parts manual for each individual unit or identical units.

2251-R-8.00 Rule Number Reserved.

2251-R-9.00 Rule Number Reserved.

2251-R-10.00 Rule Number Reserved

THE BUS CHASSIS

2251-R-11.00 Air Cleaner.

11.01 The engine intake air cleaner shall be furnished and properly installed by the chassis manufacturer to meet engine specifications.

2251-R-12.00 Axles.

12.01 The front axle and rear differential, including suspension assemblies, shall have a gross axle weight rating at ground, at least equal to that portion of the load as would be imposed by the chassis manufacturer's maximum gross vehicle weight rating.

12.02 Rear axle shall be full-floating type.

12.03 Rear axle shall be single-speed.

2251-R-13.00 Brakes.

13.01 All braking systems shall comply with FMVSS 105, 106, 116, 121.

13.02 Vehicles with a rated capacity of greater than 54 shall be equipped with full compressed air brake systems.

13.03 Air brakes: The following standards apply to air brake systems:

13.03 (a) Compressors: On buses using full compressed air brakes for service, emergency, and parking brakes, the compressor shall be a standard production model with a minimum 12 cubic foot per minute displacement.

13.03 (b) Three reservoirs or chambers (wet, primary, secondary) with a total capacity which is equal to or greater than 12 times the total volume of all brake actuators at full travel.

1 CCR 301-25

13.03 (c) Moisture ejection valve: An automatic heated, moisture ejection valve or air drying system shall be properly installed. This is made to automatically eject moisture, sludge, and/or foreign matter and maintain clean, dry air lines.

13.03 (d) Control requirements: Control valve of the parking brake system shall be designed and constructed to conform with the following:

13.03 (d)(1) The parking brake control valve shall be visible to the driver and shall be mounted on the dash panel within 15 inches to the right of the steering column.

2251-R-14.00 Bumper, Front.

14.01 Front bumper on all Type A, B and C school buses shall be furnished by the chassis manufacturer.

14.02 Front bumper of Type D school buses shall be furnished by the body manufacturer.

14.03 Front bumper shall be at least 3/16 inch thick of pressed steel channel, one piece construction or optional 3-piece breakaway construction and a minimum of eight inches wide (high).

14.04 Front bumper shall be of extended design to offer maximum protection of fender lines without permitting snagging or hooking.

14.05 Front bumper shall be attached to the frame and extend forward of grille, head lamps, fender, or hood sections to provide maximum protection.

14.06 Front bumper shall be of sufficient strength to permit pushing of vehicle of equal weight without permanent distortion to bumper, chassis, or body.

2251-R-15.00 Clutch.

15.01 Clutch torque capacity shall be commensurate with or greater than the maximum rated engine torque output.

2251-R-16.00 Color: Chassis.

16.01 Frame and bumper shall be painted black.

1 CCR 301-25

- 16.02 Cowl and fenders shall be painted National School Bus Yellow as defined in NSSB.
- 16.03 Hood shall be painted non-reflective National School Bus Yellow as defined in NSSB.
- 16.04 Any wheels and rims that are not iron-gray or galvanized shall be painted black.

2251-R-17.00 Cooling System.

- 17.01 The cooling system fan shall be heavy-duty reinforced type. Fan may be controlled by thermostatically actuated clutch.
- 17.02 The cooling system radiator shall be of sufficient capacity to cool the engine at all speeds in all gears. Thermostatic controls shall be high temperature type.
- 17.03 On all chassis requiring hoses or extensions to fill radiators, the hose or extensions shall be so designed to permit adding of coolant without trapping air.
- 17.04 Permanent ethylene-glycol base or environmentally safe equivalent anti-freeze shall be provided by chassis manufacturer to protect the cooling system to -30 degrees Fahrenheit (F) when tested at normal engine temperature and shall not be diluted by body company.
- 17.05 Type C and D Buses equipped with an automatic transmission, shall have a heavy-duty cooling system with increased capacity in the radiator, fan, and other necessary components, to provide for the additional cooling required by the automatic transmission. External oil filter on oil return line between cooling system and transmission shall be provided.
- 17.06 Cooling system shall be equipped with a coolant recovery system.
- 17.07 Cooling system shall be equipped with a visual fluid level indicator.

2251-R-18.00 Drive Shaft.

- 18.01 Each drive shaft or section thereof shall be equipped with adequate metal guard or guards to prevent whipping through floor or dropping to ground if broken.

2251-R-19.00 Electrical System.

- 19.01 The electrical system {including battery(ies) and alternator} shall be commensurate with all electrical needs of the bus, including accessories. Alternator shall be capable of producing a minimum of 50% of its maximum rated output at the engine manufacturer's recommended idle speed.

1 CCR 301-25

2251-R-20.00 Exhaust System.

- 20.01 Exhaust pipe, muffler, and tail pipe shall be outside the passenger portion of the bus body and attached to chassis. Exhaust back pressure shall not exceed engine manufacturer maximum requirement.
- 20.02 Muffler shall be heavy-duty truck type of aluminized or stainless steel, or ceramic coated to offer maximum resistance to corrosion or oxidation.
- 20.03 Tail pipe shall be constructed of seamless or electrically welded tubing of 16 gauge steel or equivalent, and shall extend at least five inches beyond chassis frame with sufficient length to reach the bumper, but not to extend beyond rear bumper. Where frame extends to rear bumper, 5 inch extension not required. Type A school buses may have exhaust pipe routed to right or left behind rear axle.
- 20.04 Diameter of tail pipe shall not be reduced after it leaves muffler.
- 20.05 The rear end of tail pipe must be located at least 20 inches to the right or left of the centerline of the chassis.
- 20.06 Exhaust system shall be insulated from fuel tank and fuel tank connections by securely attached metal shield at any point where it is 12 inches or less from the fuel tank or fuel tank connections. (Gasoline engines only)

2251-R-21.00 Fenders, Front.

- 21.01 Total spread of outer edges of front fenders measured at fender line shall exceed total spread of front tires when front wheels are in straight ahead position.
- 21.02 Front fenders shall be braced and free from any body attachment. Trailing edge of front fender shall extend to bottom of front body section. Fender extensions are acceptable.

2251-R-22.00 Frame.

- 22.01 Frame shall be designed to correspond with or exceed standard practice performance criteria for truck of same general load specifications used for severe service.
- 22.02 Frame side members shall be one-piece construction between front hanger of front spring, and rear hanger of rear spring.
- 22.03 Extension of frame lengths shall not be for the purpose of extending wheelbase. All frame

1 CCR 301-25

attachments beyond the wheelbase must receive prior approval in writing from the Colorado Department of Education. Approval(s) will be granted only after receiving certifications that extensions equal or exceed strength of solid frame rail sections and are warranted for 10 years by manufacturers.

22.04 No holes shall be permitted in the chassis rails except those drilled at the chassis plant or authorized by the chassis manufacturer.

22.05 Welding to frame side rails which is necessary by design to strengthen, modify or alter basic vehicle configuration shall be performed and guaranteed by the body or chassis manufacturer making the modification.

2251-R-23.00 Fuel Tank

23.01 All fuel tank specifications shall conform with FMVSS 301 and provisions outlined below:

23.01 (a) Fuel tank shall be filled and vented entirely outside the passenger compartment.

23.01 (b) Fuel filter with replaceable element shall be installed between fuel tank and engine.

23.01 (c) Drain plug of at least 1/4 inch diameter shall be located in the lowest level of the tank.

23.01 (d) Engine supply line shall not be mounted below fuel tank.

23.01 (e) The actual draw or usable capacity shall be a minimum of 83% of the tank's rated capacity.

2251-R-24.00 Heating System

24.01 Engine design shall provide inlet and outlet holes in accessible locations for attachment of bus heating system water lines. Heater outlets shall be of sufficient size to accommodate circulation of all coolant with no reduction of coolant lines.

2251-R-25.00 Horn

25.01 Bus shall be equipped with dual horns of standard make, each horn capable of producing complex sound in band of audio frequencies from 250 to 2000 cycles per second and having total sound level of 110 decibels within these frequency limits when measured at point on axis of horn, three feet from exit of horn.

1 CCR 301-25

2251-R-26.00 Instruments and Instrument Panel.

26.01 Chassis shall be equipped with the following non-glare instruments and gauges. Lights in lieu of gauges are not acceptable.

26.01 (a) Standard speedometer with seven digit odometer,

26.01 (b) Voltmeter with a graduated scale to 16 volts.

26.01 (c) Oil pressure gauge.

26.01 (d) Water temperature gauge.

26.01 (e) Fuel gauge.

26.01 (f) Upper-beam headlamp indicator.

26.01 (g) Tachometer. The tachometer is not required for Type A and B school buses.

26.01 (h) Left and right turn-signal indicator.

26.01 (i) Chassis with air brake systems shall be equipped with a visible gauge and audible low-pressure indicator to warn driver if air pressure in brake system falls below 60 PSI. (see BRAKES, Section 13)

26.01 (j) Chassis with air brake systems shall have a labeled visual indicator of park brake application visible to driver.

26.01 (k) Chassis with a hydraulic assist-brake system shall be equipped with warning signals, readily audible and visible to the driver, that will provide continuous warning in the event of a loss of fluid flow from primary source or loss of electric source powering the back-up system.

26.02 All instruments shall be easily readable by driver and accessible for maintenance.

2251-R-27.00 Lamps and Signals.

27.01 All lamps and their installation shall conform to current standards and recommended practices of applicable SAE and FMVSS standards.

1 CCR 301-25

2251-R-28.00 Openings.

28.01 All openings made by chassis manufacturer in floorboard and fire-wall shall be sealed by the chassis manufacturer to prevent gases from entering driver's compartment. Boot for the accelerator pedal, gear shift, and parking brake, when required, shall be supplied by the chassis manufacturer.

2251-R-29.00 Overall Length.

29.01 Overall length of bus shall not exceed 40 feet {Section 42-4-404(2), C.R.S.}.

2251-R-30.00 Power or Gradeability.

30.01 The gross vehicle weight of any school bus shall not exceed 165 pounds per certified net horsepower of the engine at manufacturer's recommended maximum revolutions per minute (RPM).

2251-R-31.00 Retarder (optional)

31.01 Rule Number Reserved

31.02 School buses equipped with electro-magnetic retarder(s) shall have increased electrical system capacity commensurate with the needs of the retarder system.

31.03 Pilot lights shall indicate when retarder is in operation.

2251-R-32.00 Springs.

32.01 Capacity of suspension assemblies shall be commensurate with chassis manufacturer's gross vehicle weight rating.

32.02 If leaf-type rear springs are used, they shall be of progressive type.

2251-R-33.00 Steering Gear Assembly.

33.01 All school bus chassis in all passenger capacities shall be equipped with heavy-duty, truck-type integral power steering. Power steering components shall be compatible with the GVW rating for each capacity as shown in chassis manufacturer's literature.

33.02 No changes shall be made in steering apparatus which are not approved and guaranteed by chassis manufacturer.

1 CCR 301-25

- 33.03 There shall be a clearance of at least two inches between steering wheel and any other surface or control.
- 33.04 Chassis manufacturers shall provide and cover steering wheel column with a temporary plastic covering or equivalent, in order to provide protection from precipitation from time of manufacture until body is mounted.

2251-R-34.00 Tires and Rims.

- 34.01 Minimum tire and rim sizes shall be in accordance with FMVSS 120.
- 34.02 Dual rear tires shall be provided on Type B, C, and D school buses.
- 34.03 All wheels shall be one piece disc type. Split or multi-piece rims are not acceptable.

2251-R-35.00 Tow Hooks.

- 35.01 Two heavy duty tow hooks or two eyes on Type D buses shall be furnished and factory installed, except on Type A and B buses. Hooks shall not extend beyond the front bumper on any school bus.

2251-R-36.00 Transmission.

- 36.01 Manual type transmission shall be synchromesh for forward gear ratios 2nd and above.

2251-R-37.00 Undercoating.

- 37.01 Chassis manufacturer shall coat undersides of steel or metallic front fenders with rust-proofing compound for which compound manufacturer has issued notarized certification of compliance to chassis builder that compound meets or exceeds all performance and qualitative requirements of Fed. Spec. using modified test.

2251-R-38.00 Wiring.

- 38.01 General--all wiring shall conform to current applicable recommended practices of SAE.
 - 38.01 (a) All wiring shall use a standard color and number coding and each chassis shall be delivered with a wiring diagram that coincides with the wiring of the chassis.
- 38.02 Chassis manufacturer shall install a readily accessible terminal strip or plug on the body side of the cowl, or at an accessible location in the engine compartment of vehicles designed without a cowl, that shall contain the following terminals for the body connections:

1 CCR 301-25

- (1) main 100 amp body circuit
- (2) tail lamps
- (3) right turn signal
- (4) left turn signal
- (5) stop lamps
- (6) back up lamps
- (7) instrument panel lights

38.02(a) Factory terminal strip from chassis manufacturer on Type A bus will be acceptable.

2251-R-39.00 Rule number reserved

2251-R-40.00 Rule number reserved

2251-R-41.00 Rule number reserved

2251-R-42.00 Rule number reserved

2251-R-43.00 Rule number reserved

2251-R-44.00 Rule number reserved

2251-R-45.00 Rule number reserved

2251-R-46.00 Rule number reserved

2251-R-47.00 Rule number reserved

2251-R-48.00 Rule number reserved

2251-R-49.00 Rule number reserved

THE BUS BODY

2251-R-50.00 Aisle.

50.01 Minimum aisle clearance between seats shall be 12 inches at seat level and 15 inches at top of seats. This includes the aisles to all emergency doors.

50.02 On forward control (front engine) Type D buses, the aisle passage area shall not be less than

1 CCR 301-25

12 inches, measured from floor level up, between engine cover and any other object. Hold down fastening devices used on engine cover shall be designed to prevent hooking or catching on shoes or clothing.

2251-R-51.00 Battery.

51.01 Battery and all cable required to complete circuits without splicing, even when drawer is extended for battery servicing, shall be provided by the chassis manufacturer and mounted for delivery to body plant.

51.02 Body manufacturer shall provide, at customer option, a drawer-type pull out tray to facilitate servicing or removal of battery(ies). The battery(ies) shall be enclosed by a vented compartment constructed of mill-applied zinc steel provided with drain ports, hold down carrier mounted so as to avoid blocking filler ports and latching device to prevent accidental opening. Under-coating shall be provided and applied to battery box. Battery tray is to be equipped with a safety device to keep tray from sliding completely out to prevent battery from being dropped. Battery compartment shall be labeled with the word "Battery".

2251-R-52.00 Bumper, Rear.

52.01 Rear bumper shall be of pressed steel channel or equivalent material, at least 3/16-inch thick, and shall be a minimum of 8 inches wide (high) on Type A buses, and shall be a minimum of 9 1/2" wide (high) on Type B, C, and D buses, and of sufficient strength to permit being pushed by another vehicle without permanent distortion.

52.02 Rear bumper shall be wrapped around back corners of bus and extend forward at least 12 inches from rear-most point of body at floor line.

52.03 Bumper shall be fastened to chassis frame side rails in such a manner as to develop full strength of bumper section from rear or side impact. Bracing materials shall have an impact ratio comparable to that of bumper material and shall be fastened at the ends and radii of the bumper, attached to the side of the frame only and not to body at any point.

52.04 Rear bumper shall extend beyond rear-most part of body surface at least one inch, measured at floor lines.

52.05 No spaces, projections, or cut-outs that will permit a hand hold or foot hold shall be permitted.

52.06 Front ends of the bumper shall be enclosed by end caps or other protective metal or shall have the ends rounded or tucked in and shall be free from sharp edges or projections likely to cause injury or snagging.

1 CCR 301-25

52.07 A gasket, rubber or equivalent, shall be installed to close opening between the top of the rear bumper and body metal.

2251-R-53.00 Capacity.

53.01 Capacities and seat spacing shall conform to and be in full compliance with applicable FMVSS.

2251-R-54.00 Color.

54.01 All exterior metal shall be painted National School Bus Yellow as specified in NSSB with the exception of those areas listed below.

54.01 (a) Lettering and numbering (black, white, or yellow for bumper area)

54.01 (b) Bumpers (black)

54.01 (c) Rubrails may be black or yellow at purchaser option

54.01 (d) Background area for warning light system. (black)

54.01 (e) The roof of the bus may be painted white not to extend below the drip rails on the sides of the body except that front and rear roof caps shall remain National School Bus Yellow.

54.02 Reflective material may be installed on the bus. Material, if used, shall be automotive engineering grade or better, meeting initial reflectance values in FHWA FP-85 and retaining at least 50% of those values for a minimum of six years. Reflective materials and markings, if used, shall include any or all of the following:

54.02 (a) Front and/or rear bumper: may be marked diagonally 45 degrees down to centerline of pavement with 2 inch wide strips of non-contrasting reflective material.

54.02 (b) Rear of bus body: may be marked with a strip of reflective National School Bus Yellow material not to exceed 12 inches width to be applied to the back of the bus, extending from the left lower corner of the "school bus" lettering, across to left side of the bus, then vertically down to the top of the bumper, across the bus on a line immediately above the bumper to the right side, then vertically up to a point even with the strip placement on the left side, and concluding with a

1 CCR 301-25

horizontal strip terminating at the right lower corner of the "school bus" lettering.

54.02 (c) "School Bus" signs: may be marked with reflective National School Bus Yellow material comprising background for lettering of the front and/or rear "school bus" signs.

54.02 (d) Sides of bus body: may be marked with reflective National School Bus Yellow material not to exceed 12" in width, extending the length of the bus body and located (vertically) as close as practicable to the beltline.

2251-R-55.00 Construction

55.01 All bus body construction components shall be of prime commercial quality mill applied, zinc coated steel or material of at least equivalent strength. Such items shall include structural members, inside panels, floor panels, and joints.

55.02 All metal surfaces that will be painted shall be (in addition to above requirements) chemically cleaned, etched, zinc-phosphate-coated and zinc-chromate or epoxy primed or conditioned by equivalent process. In providing for these requirements, particular attention shall be given to lapped surfaces, welded connections of structural members, cut edges, punched or drilled hole areas in sheet metal, closed or box sections, unvented or undrained areas and surfaces subject to abrasion during vehicle operation.

55.03 The floor shall be at least 14 gauge mill applied zinc-coated steel sheet and shall be on one plane. There shall be a main floor cross member of at least 10 gauge steel or equivalent placed at each side post extending the full width of the floor plate and permanently attached. There shall be a minimum of two intermediate floor cross members of at least 16 gauge steel equally between the main floor cross members and permanently attached.

55.04 In addition to complying with the test procedures described in FMVSS 220, the body manufacturers shall record and report the downward vertical movement of the force at 0, 25, 50, 75, and 100% of the maximum force (both loading and unloading). The expected force deflection curve is illustrated schematically in Figure 1a. Low load nonlinearities may indicate joint conformation; high load nonlinearities may indicate yielding in structural members.

55.04 (a) A second load cycle shall be performed following the procedure given in the first paragraph. The expected force-deflection curve is illustrated schematically in Figure 1b. Any hysteresis following the initial shakedown will be revealed by this second cycle.

Pix of 1 a

a. First Cycle b. Second Cycle

Figure 1. Static Load Test Load-Deflection Curves

- 55.05 A diagonal (racking) load test shall be performed on Type A, B, C, D school buses to assure adequate shear stiffness and strength of the bus body. Details of the test are provided below.
- A two cycle loading sequence shall be conducted following the procedure described in Section 55.04.
- 55.05 (a) Requirements: When a force equal to 1-1/2 times the GVW is applied to the edge of the roof of the vehicle's body structure through a force application plate as specified in (b), Test Procedures:
- 55.05 (a)(1) The diagonal movement of the force at any point on the application plate shall not exceed 5 1/8 inches; and
- 55.05 (a)(2) Each emergency exit of the vehicle provided in accordance with FMVSS 217 shall be capable of operation as specified in that standard during the full application of the force and after release of the force.
- 55.05 (b) Test Procedures: Each vehicle shall be capable of meeting the requirements of (1) and (2) when tested in accordance with the procedures set forth below.
- 55.05 (b)(1) The vehicle shall be supported on a rigid surface along the lower edge of the frame or along the body sills in the absence of a frame.
- 55.05 (b)(2) The load shall be applied through a force application plate that is flat and rigid. The dimensions of the plate shall be chosen to assure that the plate edges never make contact with the vehicle skin during testing. A typical width is 18 inches, and a typical length is 20 inches less than the length of the

vehicle's roof measured along its longitudinal centerline.

55.05 (b)(3) Place the force application plate in contact with the edge of the vehicle roof. Orient the plate so that its flat, rigid surface is perpendicular to a diagonal line connecting the most distant points on an interior cross section of the vehicle. The rear edge of the plate shall be positioned approximately 20 inches from the rear edge of the vehicle roof. A temporary stand may be used to support the plate until a force is applied.

55.05 (b)(4) Apply an evenly distributed force in a diagonally downward direction through the force application plate at any rate not more than 0.5 inch per second, until a force of 500 pounds has been applied.

55.05 (b)(5) Apply additional force in a diagonally downward direction through the force application plate at a rate of not more than 0.5 inch per second until the force specified in (a) has been applied, and maintain this application of force.

55.05 (b)(6) Measure the diagonal movement of any point on the force application plate which occurred during the application of force in accordance with (5) and open the emergency exits as specified in (a)(2).

55.05 (b)(7) Release all diagonal force applied through the force application plate and operate the emergency exits as specified in (a)(2).

55.05 (c) Test Conditions: The following conditions apply to the requirements specified in (4).

55.05 (c)(1) Temperature: The ambient temperature is any level between 32 degrees F and 90 degrees F.

55.05 (c)(2) Windows and Doors: Vehicle windows, doors, and emergency exits are in the fully-closed position, and latched but not locked.

55.05 (d) An alternative method of testing for the racking load test shall be as follows:

The racking load shall be applied along a line connecting the most distant points on a transverse cross section of the bus interior. It produces a shear distortion of the cross section as shown in figure 2.

A representative method of loading which employs a hydraulic jack to load a two-

A two-cycle loading sequence shall be conducted, with intermediate and final load and deflection readings recorded according to the procedure described.

The maximum deflection in line with the jack (A, maximum) shall not exceed 4 inches.

Manufacturers shall specify which testing method was used and submit appropriate certification information as called for in 6.02.

- 55.06 Subfloor shall be either 5 ply nominal 5/8 inches thick plywood, or a material of equal or greater strength and insulation R value and it will equal or exceed properties of exterior-type softwood plywood C-D grade, as specified in NBS Product Standard 1-83. Type A vehicles shall have nominal 1/2 inch thick plywood or equivalent material equal to or exceeding properties listed above.
- 55.07 Ceiling Panels: If the ceiling is so constructed to contain lap joints, the forward panel shall be lapped by the rear panel and the exposed edges shall be beamed, hemmed, or flanged or otherwise treated to minimize sharp edges.
- 55.08 All body components shall be designed and constructed so as to avoid the entrapment of moisture and dust.
- 55.09 All openings between chassis and passenger-carrying compartment made for any reason by body manufacturer must be sealed.

2251-R-56.00 Defrosters.

- 56.01 A defroster system shall be installed of sufficient capacity to keep windshield area, left frontside window to rear of driver's vision, and service door glass area free of condensation or ice.
- 56.02 Adjustable 6 inch auxiliary fans may be installed to complement the defroster system used by the manufacturer. Such fans shall be controlled individually by two-speed switches located on control panel. Fan blades shall be covered with a protective cage.
- 56.03 The defrosting system shall conform to SAE Standards.

2251-R-57.00 Doors.

- 57.01 Service door shall be power or manually operated, under control of the driver, and so designed to afford easy release and to prevent accidental opening. When manual lever is

1 CCR 301-25

used, no parts shall come together so as to shear or crush fingers.

- 57.02 Service door shall be located on right side of bus opposite driver and within driver's direct view.
- 57.03 Service door shall have minimum horizontal opening of 24 inches and minimum vertical opening of 68 inches. Type A buses shall have a minimum door opening area of 1200 square inches.
- 57.04 There shall be no door to the left of the driver on Type C or D buses. Type A and B buses may be equipped with chassis manufacturer's standard door.
- 57.05 Service door may be of split type, folding type, or section type. Split type door includes any sectional door which divides and opens inward or outward. If one section of split type door opens inward and other outward, front section shall open outward. The door shall be equipped with a flexible material on the vertical closing edge(s), designed to protect passengers' fingers.
- 57.06 All door glass shall comply with FMVSS 205. Glass in service door shall provide maximum area of visibility for operation of bus.
- 57.07 Power operated doors shall be equipped with a separate manual emergency release, readily accessible in the door area above or to the side of the service door or on dash, so that the door may be opened in the case of emergency. The release shall be plainly labeled with instruction for use.
- 57.08 There shall be a head bumper pad installed on the inside at the top of the entrance door. This pad shall be approximately 3 inches wide (high), at least 1 inch thick, and extend across the entire top of the entrance door opening.

2251-R-58.00 Emergency Exits

- 58.01 Emergency door(s) shall be equipped with a 3-point latch mechanism. Type A buses shall be equipped with the standard latch. Emergency door latch shall be equipped with suitable electric plunger-type switch connected with buzzer located in driver's compartment. Switch shall be enclosed in metal case and wires leading from switch shall be concealed in bus body. Switch shall be so installed that plunger contacts farthest edge of slide bar in such manner that any movement of slide bar will immediately close circuit on switch and activate buzzer. A separate interior handle shall be provided to pull the door shut from the inside.

58.01(a) When flip-up seat is located next to emergency door, the inside door handle

1 CCR 301-25

must be enclosed or protected by a safety guard to prevent accidental opening.

- 58.02 Exterior door handle shall be of permanent hitch-proof design and mounted with enough clearance to permit opening without touching door surface and may be equipped with a lock which will not prevent opening from inside.
- 58.03 All emergency door openings shall be completely weather stripped.
- 58.04 Operation instructions for opening of door shall be lettered or decaled on the inside of the emergency door.
- 58.05 Emergency door shall bear words "EMERGENCY EXIT" both inside and outside in letters at least 2 inches high. Words shall be placed directly above the door or on the upper portion of the door.
- 58.06 On all buses except rear engine transit school buses (Type D), an emergency door shall be located in the rear of the bus body and centered with respect to the body. Door shall have a minimum horizontal opening of 24 inches and minimum vertical opening of 48 inches measured from floor level. Rear emergency door shall be hinged on right side and shall open outward.
- 58.07 Rear emergency door shall contain upper and lower glass panels which comply with FMVSS 205. Glass in emergency door shall provide maximum area of visibility for safe operation of bus.
- 58.08 There shall be a head bumper pad installed over the emergency door on the inside of the bus body. This pad shall be approximately 3 inches wide (high), at least 1 inch thick, and extend across the entire top of the emergency door opening. Padding shall be of the same materials as the padding used over the service door.
- 58.09 Side emergency door: If engine or storage compartment is so located as to make it impossible to place door in center of rear end, the emergency door shall be located in the rear half of the left side of the bus body. The door shall not be located to reduce size of opening by wheelwell. The door shall be hinged on the front side.
- 58.10 Rear emergency window: If engine or storage compartment is so located as to require a side emergency door, an emergency window shall be installed in the rear of the bus and shall be no smaller than 16 inches in height and 54 inches in width.
 - 58.10 (a) The emergency window shall meet FMVSS 205. Glass shall be tempered unless specified laminated by the purchaser.

- 58.10 (b) Emergency window shall be hinged from top and provided with a hold open control to insure against accidental closing during an emergency.
- 58.10 (c) Emergency window in rear shall be equipped with latch on the inside and with a handle of hitch proof design which will permit opening from the outside.
- 58.11 All designated emergency windows shall bear words "EMERGENCY EXIT" in letters at least 2 inches high both inside and outside the window. Lettering shall be placed no more than three inches directly above window.
- 58.12 All designated emergency windows shall be equipped with a buzzer. When not fully latched, it shall activate a signal audible to the driver.
- 58.13 Ignition interlock for the vandal locks shall conform to FMVSS.

2251-R-59.00 Emergency Equipment

- 59.01 The bus shall be equipped with at least one pressurized 5-pound dry-chemical fire extinguisher of a type approved by UL, with a total rating of not less than 2A10BC. The operating mechanism shall be sealed with a type of seal that will not interfere with use of the fire extinguisher.
 - 59.01 (a) The small vehicle shall be equipped with one securely mounted 2 1/2 pound dry chemical fire extinguisher of a type approved by UL, with a minimum rating of 1A10BC.
- 59.02 Fire extinguisher shall be mounted in the extinguisher manufacturer's bracket (automotive type) and located in the driver's compartment in full view of and readily accessible to the driver. A pressure gauge shall be so mounted on the extinguisher as to be easily read without removing the extinguisher from its mounted position.
- 59.03 First Aid Kit(s): The bus and small vehicle shall carry a first aid kit or kits which shall either be mounted securely in full view or the location plainly indicated by appropriate markings, in the drivers compartment. The kit(s) shall be mounted in such a manner that they can be removed if necessary. Small vehicles and buses with a manufacturer's rated seating capacity of 36 or less shall be equipped with one 24 unit kit. Buses rated more than 36 capacity shall be equipped with two 24 unit kits.

Contents of the 24 unit First Aid Kit:

Item	Unit(s)
Adhesive Tape.....	1
1" adhesive bandage	2
2" bandage compress	1
3" bandage compress.....	1
4" bandage compress.....	1
3" x 3" plain gauze pads.....	1
Gauze roller bandage 2" wide.....	2
Plain absorbent gauze - 1/2 square yard	4
Plain absorbent gauze - 24" x 72"	3
Triangular bandages	4
Scissors, tweezers.....	1
Space rescue blanket	1
Latex disposable gloves, pair.....	1
CPR mask or mouth to mouth airway.....	1
Moisture and dustproof kit of sufficient capacity to contain materials of the Colorado first aid kit	1

59.04 Emergency Reflectors (Section 42-4-227, C.R.S.)

59.04 (a) All buses and small vehicles shall carry three (3) emergency triangle reflectors in compliance with FMVSS 125, contained in a securely mounted case.

2251-R-60.00 Floor Coverings.

- 60.01 Floor in underseat area, including tops of wheel housings, driver's compartment, and toeboard shall be covered with fire-resistant rubber floor covering or equivalent having a minimum overall thickness of .125 inch.
- 60.02 Floor covering in aisle shall be aisle-type fire-resistant rubber or equivalent, non-skid, wear resistant, and ribbed. Minimum overall thickness shall be .1875 inch measured from tops of ribs.
- 60.03 Floor covering must be permanently bonded to floor and must not crack when subjected to sudden changes in temperature. Bonding or adhesive material shall be waterproof and shall be of type recommended by manufacturer of floor-covering material. All seams must be sealed with waterproof sealer.
- 60.04 Cove molding shall be used along the side walls and rear corners and all floor seam separations shall be covered with durable metal stripping.

1 CCR 301-25

60.05 The entrance step treads, including the edge at floor level, shall be of the same quality as the aisle material. Step treads shall have an integral white nosing of 1-1/2 inch or more or use diagonal stripes. Treads shall be permanently bonded to the metal steps and sealed to prevent water from getting underneath the step tread.

60.06 A secured and insulated plate shall be provided to access fuel tank sending unit. Type A buses are exempt.

2251-R-61.00 Fuel Fill Cap Cover.

61.01 The fuel fill cap opening in the body skirt shall be equipped with a hinged cover held closed by a spring or other conveniently operated device. Type A vehicles are exempt.

2251-R-62.00 Heating System

62.01 All school buses shall be equipped with two or more hot water heaters capable of delivering water to the system at a rate of six gallons per minute using an ambient temperature of 0 degree F to +10 degrees F and maintaining passenger compartment temperature of 50 degrees F. One of the heaters shall be located in the rear half of the bus on or behind the rear wheel axle line.

62.01(a) Lift equipped buses may place the rear heater under the last row of seats.

62.02 Buses shall be equipped with front heater(s) and integrated defroster system of capacity to provide heat for the front part of the bus (including driver' compartment) and to keep windshield area, service door glass, driver's left glass area, and stepwell clear of moisture, ice and snow.

62.03 Hot water heaters shall bear the name plate rating in accordance with NSSB.

62.04 Two speed switches shall operate all heater fans independently.

62.05 Heater cores and fans shall be completely encased but designed to permit servicing heater assembly by removing all or part of case.

62.06 Heater hose installation in the engine compartment shall include two shut-off valves able to shut off coolant completely when necessary.

62.06 (a) One mounted between the water pump outlet and heater hose connection.

62.06 (b) One mounted between the motor block and the return heater hose connection.

1 CCR 301-25

62.06 (c) Heater hoses shall be adequately supported to guard against excessive wear due to vibration. Hoses shall not rub against the chassis, body or other edges.

62.07 The body manufacturer shall add the required amount of permanent ethylene glycol base or environmentally safe equivalent anti-freeze after heaters have been connected to protect cooling system of bus to -30 degrees F tested at normal engine temperature.

62.08 There shall be a heater water flow regulating valve installed for convenient operation by the driver.

2251-R-63.00 Identification

63.01 Body shall bear words "SCHOOL BUS" in black letters at least 8 inches high on both front and rear of body. Lettering shall be placed as high as possible without impairment of its visibility. Lettering shall conform to SAHS.

63.02 School buses shall bear name of school district or company on each side in black, standard unshaded letters, 5 inches in height. If there is insufficient space due to the length of the name of the school district, terms such as community, consolidated, and district may be abbreviated.

63.03 The manufacturer's rated pupil seating capacity shall be printed to the left of the entrance door on the lower skirt in 2 inch characters. The word capacity may be abbreviated. (Example: Cap. 48) The capacity shall also be shown on the inside upper portion of the entrance door or inside above the windshield.

63.04 The numbering of individual buses for identification purposes is permissible.

63.05 Lettering and numerals shall be painted or may be pressure sensitive marking of similar performance quality.

63.06 "STOP" shall be printed on the rear of the bus in letters at least 8 inches high. "ON FLASHING RED" shall be printed below "STOP," in letters at least 5 inches high. Letters shall be placed in area(s) visible to the approaching motorist.

63.07 The school district logo may be placed above the side window dripline.

63.08 Only signs and lettering specifically permitted by state law or regulation, and any marking necessary for safety and identification, shall appear on the outside of the bus.

63.08 (a) Advertising, approved by the local school board, may appear only on the side(s) of the bus in the following areas:

1 CCR 301-25

1. The signs shall be below the seat level rub rail.
2. The signs shall be at least three inches from any required lettering, lamp, wheelwell, or reflector behind the service door or stop signal arm.
3. The signs shall not extend from the body so as to allow a handhold or present a danger to pedestrians.
4. The signs shall not interfere with the operation of any door, window or other device.
5. The signs shall not be placed on side emergency door(s).

2251-R-64.00 Inside Height.

- 64.01 Inside body height shall be 72 inches or more, measured metal to metal at any point on longitudinal center line from front vertical bow to rear vertical bow. Type A school buses shall have 62 inches or more inside height, measured metal to metal.

2251-R-65.00 Insulation.

- 65.01 Bus body shall be fully insulated in the roof including roof bows and all body panels. Insulation 1 inch minimum thickness shall be of fiber-glass or equal and shall be fire resistant.

2251-R-66.00 Interior.

- 66.01 Interior of bus shall be free of all projections likely to cause injury.

2251-R-67.00 Lamps and Signals.

- 67.01 All lamps, signals, reflectors and their installation shall conform to standards and recommendations of SAE and meet FMVSS.

67.02 Tail and stop (brake) lamps:

- 67.02 (a) Bus shall be equipped with four combination red stop/tail lamps. Two combination stop lamps shall have a lens diameter of at least 7 inches or 38.48 square inches, and shall have light intensity at least equal to Class A, Type I turn-signal units as established by SAE. Two combination tail lamps shall have a lens diameter of at least 4 inches.
- 67.02 (b) If the bus is equipped with a retarder, the four stop lamps shall be illuminated when the retarder is activated.

1 CCR 301-25

- 67.02 (c) There shall not be lettering, symbols or arrows, except manufacturer's markings, on the lens.
- 67.03 License plate lamp: Bus shall be equipped with rear license plate illuminator. This lamp may be combined with one of the tail lamps.
- 67.04 Interior lamps: Interior lamps shall be provided which adequately illuminate aisle. A separate lamp shall be provided in stepwell.
- 67.05 Back-up lamps: Back-up lamps of 7 inch or 38.48 square inches, minimum diameter shall be provided.
- 67.06 Turn signal lamps:
- 67.06 (a) The bus shall be equipped with two amber turn signals in front and two amber turn signals in the rear. Both front and rear signals shall be at least 7 inches in diameter and meet the specifications of SAE.
- 67.06 (b) There shall not be lettering, symbols or arrows, except manufacturer's markings, on the lens.
- 67.06 (c) The four-way hazard switch shall activate the turn signal lamps only. This operation shall be independent of any other light system.
- 67.06 (d) Type C and D buses shall have turn signal lamp(s) mounted with its axis substantially parallel to longitudinal axis of vehicle. Rear lamps shall be mounted as near to the right and left side of bus as possible but in no case shall outer edge of lamps be more than 10 inches from outer body width line. They shall be mounted below rear windows but in no case shall distance from top edge of lamp to lower edge of window exceed 10 inches. Front amber lamps shall be mounted on windshield line not to exceed 5 inches.
- 67.06 (e) On buses over 30 feet, a minimum of one additional turn signal shall be mounted on each side below window, behind the service door axis plane.
- 67.07 School bus alternately flashing warning signal lamps:
- Definition: School bus alternately flashing warning signal lamps mounted at the same horizontal level, intended to identify vehicle as school bus and to inform other users of highway that such vehicle is stopped or about to stop on roadway to take on or discharge school children.

- 67.07 (a) All school buses shall be equipped with four red warning signal lamps designed to conform to SAE standards, and four amber warning signal lamps designed to conform to that standard except for color and except the candle power requirement shall be 2-1/2 times greater. The school bus shall have two (2) double-lamp assemblies at the front of the vehicle and two (2) double-lamp assemblies at the rear of the vehicle. Double-lamp assemblies shall display one amber lamp and one red lamp.
- 67.07 (b) Right and left lamps shall flash alternately. Each lamp shall flash not less than 60 nor more than 120 flashes per minute.
- 67.07 (c) Flashing warning lamps are to have a signal area of not less than 28 square inches per lens. There shall not be lettering, except manufacturer's markings, on the lens. The lamps shall give a distinct warning illumination of entire lens area when lighted for a distance of 500 feet when the bus is in bright sunlight.
- 67.07 (d) The amber flashing warning signal lamps shall be energized manually by a switch mounted on the driver control panel. The red flashing warning signal lamps shall be energized as set forth by FMVSS. The lamp units and switch systems shall also comply with the above standard. The flashing warning signal lamp system shall be a sequential mode type.
- 67.07 (e) The flashing warning signal lamp system shall have two pilot or indicator lights; one shall show amber light when the amber signal lamps are flashing and the other shall show red light when the red signal lamps are flashing.
- 67.07 (f) The red lamps shall be mounted on the outer side of the amber lamps in the front and rear assemblies. Each signal lamp shall be mounted with its axis substantially parallel to the longitudinal axis of the vehicle. The front and rear warning signal lamp assemblies shall be spaced as far apart laterally as practicable, but in no case shall the spacing between lamp centers be less than 40 inches. The signal lamps shall be mounted at the front on the same horizontal center line and above the windshield, and at the rear on the same horizontal center line so that the lower edge of the lens is not lower than the top line of the side window opening. The vision of the front signal lamps to the front and rear signal lamps to the rear shall be unobstructed by any part of the vehicle. The area around the lens of each alternately flashing signal lamp and extended outward approximately 3 inches shall be painted black. In

installations where there is not a flat vertical portion of the body immediately surrounding entire lens of lamp, a circular band of black approximately 3 inches wide, immediately below and to both sides of the lens, shall be painted on the body or roof area against which signal lamp is seen from a distance of 500 feet along the axis of vehicle. Each lamp shall be mounted with its aiming plane vertical and normal to the vehicle axis.

67.07 (g) Visors shall be provided and securely mounted above the dual-lamp flashing warning signals to adequately shade and protect the dual-lamp assemblies from sunlight above but not to obstruct the rear and side effectiveness of the warning lamps.

67.08 Type D rear engine buses shall have 2 amber hazard lamps of no less than 38.48 square inches each visible to the rear when the engine door is open. These lamps shall be wired to be illuminated when the main hazard lamp circuit is energized.

67.09 A white flashing strobe light meeting SAE standards may be installed on the roof of a school bus. Amber lens may be used upon approval of local traffic regulatory authority. Light shall have a single clear lens emitting light 360 degrees around its vertical axis and may not extend above the roof more than 8 inches. A manual switch and a pilot light must be included to indicate when light is in operation. Lamp must not be capable of activating emergency traffic control light switches.

2251-R-68.00 Mirrors.

68.01 Interior mirror: Interior mirror shall be either clear view laminated glass or clear view glass bonded to a backing which retains the glass in the event of breakage. Mirror shall have rounded corners and protected edges. Type A bus shall have a minimum of 6" x 16" mirror and Type B, C, and D buses shall have a minimum of a 6" x 30" mirror.

68.02 Exterior mirrors: Each school bus shall be equipped with a system of exterior mirrors (as defined in FMVSS).

Rear vision mirror: The mirror system shall be capable of providing a view along the left and right sides of the vehicle which will provide the driver with a view of the rear tires at ground level, a minimum distance of 200 feet to the rear of the bus and at least 12 feet perpendicular to the side of the bus at a distance of 32 feet back from the front bumper.

68.03 Crossview mirror system: The crossview mirror system shall provide the driver with indirect vision of an area of ground level from the front bumper forward and the entire width of the bus to a point where the driver can see by direct vision. The cross view system shall also provide the driver with in-direct vision of the area at ground level around the left and right

1 CCR 301-25

front corners of the bus to include the front tires and service entrance on all types of buses to a point where it overlaps with the rear vision mirror system.

This system of mirrors shall be easily adjustable but be rigidly braced so as to reduce vibration.

2251-R-69.00 Mounting, Body, and Chassis.

69.01 Chassis frame shall support rear body cross member. Bus body shall be attached to chassis frame at each main floor sill, except where chassis components interfere, in such manner as to prevent shifting or separation of the body from the chassis under severe operating conditions.

69.02 Insulation material shall be placed at all contact points between body and chassis frame on Type B, C, and D buses, and shall be so attached to the chassis frame or body that it will not move under severe operating conditions.

69.03 Body front shall be attached and sealed to the chassis cowl to prevent entry of moisture and gases.

2251-R-70.00 Overall Length.

70.01 Overall length of school buses shall not exceed 40 feet {Section 42-4-404(2) C.R.S.}.

2251-R-71.00 Overall Width.

71.01 Overall width of the school bus shall not exceed 96 inches, except under the provisions of Sections 42-4-402(1) and (5) C.R.S.

2251-R-72.00 Rub Rails.

72.01 There shall be one rub rail located on each side of bus approximately at seat level which shall extend from rear side of entrance door completely around bus body (except for emergency and/or access door) to point of curvature near outside cowl on left side. On Type A school buses, the left and right rub rails may stop at the radii of the right and left rear corners.

72.02 There shall be one rub rail located approximately at floor line which shall cover same longitudinal areas as upper rub rail, except at wheel housing, and shall extend at least to radii of right and left rear corners.

1 CCR 301-25

- 72.03 There shall be one rub rail located on each side of bus at the bottom of the side skirts, or a side skirt stiffener of equivalent strength.
- 72.04 Rub rails shall be attached at each body post and all other upright structural members.
- 72.05 Rub rails shall be 4 inches or more in width, shall be of 16-gauge steel, or suitable material of equivalent strength and shall be constructed in corrugated or ribbed fashion and shall be self-draining.
- 72.06 Rub rails shall be applied outside body panels. Pressed-in or snap-on rub rails do not satisfy this requirement.

2251-R-73.00 Seat Belt for Driver.

- 73.01 A type 2 lap belt/shoulder harness seat belt shall be provided for the driver. The assembly shall be equipped with an emergency locking retractor (ELR) for the continuous belt system. The lap portion of the belt shall be guided or anchored where practical to prevent the driver from sliding sideways under it.

2251-R-74.00 Seats/Restraining Barriers.

- 74.01 All seating and restraining barrier design and construction must meet the provisions of FMVSS 222.
- 74.02 All seats shall be forward facing and shall be securely fastened to that part of the school bus body which supports them.
- 74.03 No bus shall be equipped with jump seats or portable seats.
- 74.04 Forward-most pupil seat on right side of bus shall be located so as not to interfere with driver's vision, not farther forward than barrier behind driver or rear of driver's seat when adjusted to its rear-most position.
- 74.05 Seat material shall comply with FMVSS 302.
- 74.06 Backs of all seats of similar size shall be of same width at top and of same height from floor and shall slant at same angle with floor.
- 74.07 Passenger seat cushion retention system shall be employed to prevent passenger seat cushions from disengaging from seat frames or flipping forward in event of accident. Each seat cushion retention system shall be capable of withstanding vertical static load equal to

1 CCR 301-25

minimum of 5 times weight of cushion.

74.08 Type A school buses shall be equipped with restraining barriers conforming to FMVSS 222.

2251-R-75.00 Steps.

75.01 First step at service door shall be not less than 10 inches (12 inch for Type D) and not more than 14 inches (16 inches for Type D) from ground, based on standard chassis specifications.

75.02 Service door entrance may be equipped with two-step or three-step stepwell. Riser in each case shall be approximately equal; however, with plywood floor on steel, differential may be increased by thickness of plywood used. Type A school buses are exempt.

75.03 Steps shall be enclosed to prevent accumulation of ice and snow.

75.04 Steps shall not protrude beyond side body line.

75.05 An assist grab rail not less than 20 inches in length designed to provide maximum loading assistance shall be provided in an unobstructed location inside doorway.

75.06 Surface of steps shall be of non-skid material.

2251-R-76.00 Stirrup Steps.

76.01 There shall be a least one folding stirrup step or recessed foothold and suitably located handles on each side of the front of the body for easy accessibility for cleaning the windshield and lamps except when windshield and lamps are easily accessible from the ground. Steps are permitted in or on the front bumper, in lieu of the stirrup steps, if the windshield and lamps are easily accessible for cleaning from that position.

2251-R-77.00 Stop Signal Arm.

77.01 The stop signal arm shall be a flat 18 inch octagon, exclusive of brackets for mounting. The stop signal arm shall contain two alternately flashing red lamps, one located near the top and one located near the bottom of the sign which show both to the front and to the rear. The flashing red lamps shall be connected to the alternately flashing warning signal lamps master control system. The arm shall meet applicable FMVSS requirements.

77.02 The arm shall be constructed of aluminum alloy with a minimum gauge of .080, and temper of 5052-H34 or equivalent.

1 CCR 301-25

- 77.03 It shall have the word "STOP" printed on both sides in white letters at least 6 inches high, with a brush stroke of approximately 7/8 inch width, on a bright red background. The outer edge shall be painted white 1/2 inch wide.
- 77.04 The stop signal arm shall be reflectorized in accordance with FMVSS 131.
- 77.05 The sign shall be mounted outside the bus on the driver side below the driver window. Rubber spacers shall be installed on either the side of the bus or the stop arm so as to prevent sign from making abrasive contact with the side of the bus.
- 77.06 It shall have a driver controlled mechanism, which will positively hold the sign in an extended position. Wind guard shall be provided to keep sign in retracted position.
- 77.07 An additional vacuum reserve tank with a minimum capacity of 1,000 cubic inches with check valve is required for vacuum-controlled arm.
- 77.08 The control mechanism must be mounted so the driver will remain in normal driving position while operating the stop signal arm.
- 2251-R-78.00 Storage Compartment.
 - 78.01 A metal container of adequate strength and capacity for the storage of tire chains, tow chains, and such tools as may be necessary for minor emergency repairs while bus is enroute may be provided. Such storage container may be located either inside or outside the passenger compartment, but, if inside, it shall have cover other than seat cushion which shall be securely fastened to it in such a manner as to prevent the contents from spilling in case the bus overturns.
- 2251-R-79.00 Sun Shield.
 - 79.01 An interior transparent, adjustable, double bracketed sun visor shall be installed not less than 6 inches wide and 30 inches long. Type A and B school buses shall have a sun visor commensurate with appropriate GVW requirements.
- 2251-R-80.00 Tail Pipe.
 - 80.01 Tail pipe shall not extend beyond rear bumper, after the body is attached to the chassis, and shall also comply with Section 20, subsections 20.01 through 20.06 of these rules.
- 2251-R-81.00 Tow Hooks.
 - 81.01 The school bus shall be equipped with two heavy-duty tow hooks or eyes fastened securely to

1 CCR 301-25

the rear of the frame and shall not protrude beyond outer edge of the bumper.

2251-R-82.00 Undercoating.

82.01 Entire underside of bus body, including floor sections, cross members, and below floor line side panels, shall be coated with rust-proofing compound for which compound manufacturer has issued notarized certification of compliance to bus body builder that compound meets or exceeds all performance requirements of Fed. Spec. using modified test procedures for following requirements:

82.01 (a) Salt spray resistance - pass test modified to 5 percent salt and 1,000 hours,

82.01 (b) Abrasion resistance - pass,

82.01 (c) Fire resistance - pass.

82.02 Test panels are to be prepared in accordance with paragraph 4.6.12 of Fed. Spec. with modified procedure requiring that tests be made on a 48-hour air cured film at thickness recommended by compound manufacturer.

82.03 Undercoating compound shall be applied with suitable airless or conventional spray equipment to recommended film thickness and shall show no evidence of voids in cured film.

2251-R-83.00 Ventilation.

83.01 Buses, except Type A buses, shall be equipped with a two-speed powered exhaust roof ventilator, mounted approximately two-thirds of the way back of the front roof header. Two roof hatches may be used in lieu of ventilator.

2251-R-84.00 Wheel Housings.

84.01 Wheel house openings shall be of full-open type.

84.02 Wheel housings shall be designed to support seat and passenger loads and shall be attached to floor sheets in such manner as to prevent any dust, water, or fumes from entering the body.

84.03 Inside height of wheel housings above floor line shall not exceed 12 inches.

84.04 Wheel housings shall provide clearance for installation and use of tire chains on single and dual power wheels.

1 CCR 301-25

84.05 The wheelhousing opening shall allow for easy tire removal and service.

84.06 No part of a raised wheelhousing shall extend into the emergency door opening.

2251-R-85.00 Windshield and Windows.

85.01 All glass in windshield, windows, and doors shall be of approved safety glass, so mounted that permanent mark is visible, and of sufficient quality to prevent distortion of view in any direction as specified in FMVSS.

85.02 Glass in windshield shall be heat-absorbent, laminated safety glass with 0.030 inch plastic interliner. Windshield shall be large enough to permit driver to see roadway clearly, shall be slanted to reduce glare, and shall be installed between front corner posts that are so designed and placed as to afford minimum obstruction to driver's view of roadway.

85.03 Each full side window shall provide unobstructed emergency opening at least 9 inches high and 22 inches wide, obtained by lowering of window. If full drop windows are used, they shall be blocked so that when, in a down position, the opening between the window header and top of glass is not more than 12 inches.

85.04 Push-out type, split-sash windows may be used.

85.05 All exposed edges of glass shall be banded.

2251-R-86.00 Windshield Washers.

86.01 The bus shall be equipped with windshield washers which shall conform to FMVSS and body manufacturer's recommendations.

2251-R-87.00 Windshield Wipers.

87.01 A windshield wiping system, two-speed or more, shall be provided.

87.02 The wipers shall be operated by one or more air or electric motors of sufficient power to operate wipers. If one motor is used, the wipers shall work in tandem to give full sweep of windshield.

87.03 All wiper controls shall be located within easy reach of the driver and designed, when in stop

position, to move blades from the driver's direct view.

2251-R-88.00 Wiring.

88.01 All wiring shall conform to current standards of SAE.

88.02 Circuits:

88.02 (a) Wiring shall be arranged in at least nine regular circuits, as follows:

88.02 (a)(1) Head, tail, stop, and instrument panel lamps,

88.02 (a)(2) Clearance lamps,

88.02 (a)(3) Dome and step-well lamps,

88.02 (a)(4) Starter motor,

88.02 (a)(5) Ignition and emergency door signal,

88.02 (a)(6) Turn signal lamps,

88.02 (a)(7) Alternately flashing warning signal lamps,

88.02 (a)(8) Horn,

88.02 (a)(9) Heaters and defrosters.

88.02 (b) Any of above combination circuits may be subdivided into additional independent circuits.

88.02 (c) All other electrical functions (such as electric-type windshield wipers) shall be provided with independent and properly protected circuits.

88.02 (d) Each body circuit shall be color or number coded and a diagram of circuits shall be attached to the body in a readily accessible location. Number coding is permitted only if the number is a permanent part of the insulation and is repeated at intervals of not more than 6 inches.

88.03 A separate fuse or circuit breaker shall be provided for each circuit except starter motor and ignition circuits.

1 CCR 301-25

88.04 All wires shall be installed within body. They shall be insulated and protected by covering of fibrous loom or equivalent which will protect them from external damage and minimize dangers from short circuits.

Whenever wires pass through body member, additional protection in form of appropriate type of insert shall be provided.

88.05 Wires not enclosed within body shall be enclosed in a protective jacket and fastened securely at intervals of not more than 18 inches. All joints shall be soldered or joined by equal effective connectors.

The protective jackets shall be assembled to provide maximum protection against moisture and dust.

2251-R-89.00 Rule Number Reserved

2251-R-90.00 Rule Number Reserved

VEHICLES FOR TRANSPORTING CHILDREN WITH DISABILITIES

2251-R-91.00 General Requirements.

91.01 Vehicles constructed for transporting children with disabilities shall comply generally with these rules but, because of use of special equipment, certain modifications in these minimum standards must be made. This section lists, with respect to vehicles constructed or modified for children with disabilities, standards for special equipment and exceptions required in these rules. Wheelchair lift buses may have the universal handicapped wheelchair emblem affixed in two locations; one under the stop arm signal device and one on the rear of the vehicle. Such emblem shall not exceed 12 inch dimension.

2251-R-92.00 Special Service Door.

92.01 Special door opening shall be located on right side of bus and far enough to rear to prevent door, when open, from obstructing front right service door. Door opening shall be not less than 35 inches in width.

92.02 Door may be made of one or two panels; if door is two panels, they shall be of approximately equal width, equipped with hinges and hinged to side of bus and each panel shall open outward. Forward panel shall be provided with overlapping flange to close space where door panels meet and weather seal shall be provided to close all door edges.

1 CCR 301-25

- 92.03 Door shall be equipped with at least one-point fastening device on rear panel to floor or header and at least two-point fastening device to floor and header on forward door panel, both manually operated.
- 92.04 Door shall be equipped with device that will actuate audible or visible signal located in driver's compartment when doors are not securely closed.
- 92.05 Each door shall contain fixed or movable window aligned with lower line of other windows on bus.
- 92.06 Each door panel shall open outward and positive fastening device shall be installed to hold door in open position.
- 92.07 Door panels shall be constructed to be equivalent in strength and materials to other school bus doors.
- 92.08 When ramps are used, door panels shall extend below floor line to cover container opening.
- 92.09 Door posts and headers shall be reinforced sufficiently to provide support and strength equivalent to areas of side of bus not used for service doors. Outriggers from chassis shall be installed at front and rear of door opening to support floor with same strength as other floor portions.

2251-R-93.00 Ramp.

- 93.01 If ramp is used, it shall be of sufficient strength and rigidity to support wheel chair (electric or other), occupant, and attendant. It shall be equipped with protective flange on each longitudinal side to keep wheelchair on ramp.
- 93.02 Floor of ramp shall be covered with non-skid material.
- 93.03 Ramp shall be of weight, equipped with handle or handles, to permit one person to put ramp in place and to return it to storage place.
- 93.04 Provisions shall be made to secure ramp to side of bus for use without danger of detachment and ramp shall be connected to bus at floor level in such manner s to permit easy access of wheels of wheelchair to floor of bus.
- 93.05 Ramp shall be at least 80 inches in length.
- 93.06 Dustproof and waterproof enclosed container shall be provided if ramp is stored under floor.

1 CCR 301-25

2251-R-94.00 Power Lift.

- 94.01 If power lift is used, it shall be of sufficient capacity to lift wheelchair (electric or other), occupant, and attendant.
- 94.02 Power lift shall be mounted on chassis frame, or bus floor.
- 94.03 Power lift platform shall be of sufficient width to accommodate all standard wheelchair dimensions.
- 94.04 Power lift platform shall be covered with non-skid material.
- 94.05 All edges of the platform shall be designed to restrain the wheelchair and to prevent the operator's feet from being entangled during the raising and lowering process.
- 94.06 Self-adjusting steel or equivalent ramp of sufficient width to minimize incline to lift platform shall be attached to lift platform. Ramp shall be equipped with skid-resistant surface.
- 94.07 Lift mechanism shall not be operable when doors are closed.
- 94.08 When the lift mechanism is in the fully up position, it shall be locked in position mechanically.
- 94.09 Control shall be provided that enables the operator to activate the lift mechanism from either inside or outside the bus.
- 94.10 Lift mechanism shall be so equipped that it may be manually operated in the event of power failure. The lift mechanism shall be prevented from falling while in operation due to a power failure.
- 94.11 The lift mechanism shall be equipped with adjustable limit switches or by-pass valves to prevent excessive pressure from building in the hydraulic system when the platform reaches the full up or full down position.

2251-R-95.00 Stanchions.

- 95.01 Stanchions, guard rail, and guard panel shall be installed at both rear and front edges of special service door opening, extending into bus. If power lift is used, chain shall be installed between stanchion posts to enclose area of power lift.

1 CCR 301-25

2251-R-96.00 Fastening Devices for Wheelchairs.

96.01 Positive fastening devices shall be provided, attached to floor, to walls, or both, that will securely hold wheelchairs in position when in bus.

2251-R-97.00 Seat Restraining Devices.

97.01 All seat belt assemblies shall comply with FMVSS 209 and 210.

2251-R-98.00 Aisles.

98.01 Aisles leading to emergency door shall be wide enough to permit passage of wheelchair.

2251-R-99.00 Special Lamp.

99.01 Lamp shall be placed inside bus, over special service door, and shall be operated by a switch/push button from the door area.

2251-R-100.00 Grab Handles.

100.01 Grab handles shall be provided on each side of front right service door on buses constructed for transportation of children with disabilities.

2251-R-101.00 Emergency Waiver of Specifications.

101.01 The Colorado Board of Education may temporarily waive specific non-statutory standard(s) when the Board finds that vehicles meeting the minimum standards are not available, and also find that the safety of children would not be adversely affected by the nonconformity.

101.01 (a) Any agency or district applying for temporary waiver shall provide the Board with:

101.01 (a)(1) Reasons for temporary waiver of the standards,

101.01 (a)(2) Statement of the specific variation from the minimum standards,

101.01 (a)(3) Compensating factors with respect to non-conformity.

Intentionally Left Blank

Appendix F. Colorado Racking Load Test

Background

After a 1971 school bus rollover crash in Gunnison, Colorado, the Colorado Rack Test was developed to test structural integrity in the event of a school bus rollover. The Colorado Rack Test simulates a rollover crash by applying a constant load along the full length of the school bus body. When testing for Colorado Rack compliance, the test requires that two prescribed cycles of load be applied to the body immediately above the passenger windows. During testing, the bus structure cannot deflect more than 5 1/8 inches when measured diagonally and all emergency exits must be functional during the full application of the force and after the release of the force.

Requirements

In addition to complying with FMVSS 220 School Bus Rollover Protection test procedures, school buses transporting students from home to school, school to school, school to home, and a school district or charter schools for activity trips (school related events) must meet the requirements of Colorado Minimum Standards Governing School Transportation Vehicles 1 CCR 301-25 and Colorado Operations, Maintenance and Annual Inspection Rules for School Transportation Vehicles 1 CCR 301-26.

Per 1 CCR 301-26 the CDE rules are not intended to include:

Route transportation provided by a company or individual as part of their operation as a common carrier under the jurisdiction of the US Department of Transportation or Public Utilities Commission, including RTD, taxi cab services, Uber services, and Lyft services.

A company or individual hired by a district or charter school (service provider) for activity trips (school related events). They may fall under the jurisdiction of DOT or PUC, and their vehicles only have to meet the requirements of FMVSS.

State Statute

Section 22-51-108 - Rules - The state board of education shall promulgate rules for the administration of this article. Such rules shall include reasonable and adequate standards of safety in the maintenance and operation of buses, the maintenance of records by school districts, the state charter school institute, and facility schools, the length of bus routes, the number of children to be transported in the various types of buses, and such other rules pertaining to pupil transportation as will promote the welfare of the students and afford reasonable protection to the public.

Section 42-4-1904 - Regulations for school buses - regulations on discharge of passengers - penalty - exception (1) The state board of education, by and with the advice of the executive director of the department, shall adopt and enforce regulations not inconsistent with this article to govern the operation of all school buses used for the transportation of schoolchildren and to govern the discharge of passengers from such school buses. Such regulations shall prohibit the driver of any school bus used for the transportation of schoolchildren from discharging any passenger from the school bus which will result in the passenger's immediately crossing a major thoroughfare, except for two-lane highways when such crossing can be done in a safe manner, as determined by the local school board in consultation with the local traffic regulatory authority, and shall prohibit the discharging or loading of passengers from the school bus onto the side of any major thoroughfare whenever access to the destination of the passenger is possible by the use of a road or street which is adjacent to the major thoroughfare. For the purposes of this section, a "major thoroughfare" means a freeway, any U.S. highway outside any incorporated limit, interstate highway, or highway with four or more lanes, or a highway or road with a median separating multiple lanes of traffic. Every person operating a school bus or responsible for or in control of the operation of school buses shall be subject to said regulations. (2) Any person operating a school bus under contract with a school district who fails to comply with any of said regulations is guilty of breach of contract, and such contract shall be cancelled after notice and hearing by the responsible officers of such district. (3) Any person who violates any provision of this section is guilty of a misdemeanor and, upon conviction thereof, shall be punished by a fine of not less than five dollars nor more than one hundred dollars, or by imprisonment in the county jail for not more than one year, or by both such fine and imprisonment. (4) The provisions of this section shall not apply in the case of public transportation programs for pupil transportation under section 22-51-104 (1) (c), C.R.S.

Minimum Standards 1 CCR 301-25

1 CCR 301-25 2251-R-4.03 Only school transportation vehicles that were manufactured, per the date listed on the certification plate, within the previous 20 years, may be purchased, leased, contracted, or otherwise obtained for the purpose of transporting Colorado students. These vehicles must meet Colorado minimum standards that were in effect at the time of manufacture.

1 CCR 301-25 2251-R-14.09 A diagonal (racking) load test shall be performed on Type A, B, C and D school buses to assure adequate shear stiffness and strength of the bus body.

1 CCR 301-25 2251-R-14.09(d) (3) Manufacturers shall specify which testing method was used and submit appropriate certification information as called for in 6.02.

1 CCR 301-25 2251-R-6.02 It shall be the school district's/charter school's responsibility to ascertain whether all school buses purchased, leased, or under contract to the school district/charter school meet all specifications of the Minimum Standards. This verification should be obtained at the time of delivery, in addition to the statement of compliance in the purchase bid, contract for or lease agreement.

1 CCR 301-25 2251-R-3.02 Dealers, distributors or manufacturers which supply school buses and multifunction buses for use in the State of Colorado which do not meet the specifications of these rules shall be notified of noncompliance and a general notice will be sent to all school districts and school transportation operations within the State of Colorado advising that equipment supplied by such dealer, distributor, or manufacturer is not in compliance with the Minimum Standards.

1 CCR 301-25 2251-R-6.04 Used school bus dealers shall register with the Colorado Department of Education, School Transportation Unit, certifying that only school transportation vehicles meeting or exceeding Colorado Minimum Standards will be sold. There shall be no fee to register.

1 CCR 301-25 2251-R-6.01 School bus manufacturers shall provide annual certification to the Colorado Department of Education that their product(s) meet or exceed the Minimum Standards and all applicable FMVSS in effect at the time of manufacture. School bus manufacturers shall record and report to CDE the test results as required by Section 16 - Construction. All school bus bodies that meet applicable FMVSS and are in compliance with the Minimum Standards shall be certified by the school bus manufacturer by the attachment of a plate or decal.

Certified Models List

Available at <http://www.cde.state.co.us/transportation/>

Bus manufacturers not listed on the CDE website in the Certified Model List have not certified to the Colorado Department of Education that their product(s) meet or exceed the Minimum Standards and all applicable FMVSS in effect at the time of manufacture, may not be purchased by school districts, charter schools, or contractors for the use of transporting students to and from school in the state of Colorado and will not pass the CDE annual inspection per 1 CCR 301-25 2251-R-6.01.

Because the bus make and model are on the Certified Manufacturers list posted on the CDE website, it does not always mean that a particular bus is built to meet the Colorado standards, just that it can be. If the listed make and model was originally built for and originally purchased in another state, it is the district, charter school, or service provider, and annual inspectors' responsibility to verify that the bus meets all Colorado Minimum Standards.

Colorado Racking Test and Kentucky Pole Test Verification listed by Manufacturer

The following information is provided to assist in identifying that a bus meets Rack and Load and Kentucky Pole Test requirements as specified in rule. It has been broken down by manufacturer. Information was provided by the manufacturers. Due to the ever changing climate in school bus manufacturing, some of the manufacturers listed have been consolidated by Company ownership, although still listed separately for ease of use of the document.

All known current manufacturers are listed. Those not currently certified for use in Colorado are included, with the indication of such.

Manufacturer

Bluebird:

All Type C and D models of bluebird buses 1982 and newer meet the rack and load requirements. Micro Birds manufactured by Blue Bird between 1982 and 2009, inclusive, also meet the rack and load requirements. Buses built prior to 1982 will need to be verified by contacting the local dealer with the vehicle body # or VIN number.

Certification Decal example below.

Location: Right hand side of the front bulkhead, below the FMVSS Certification Label

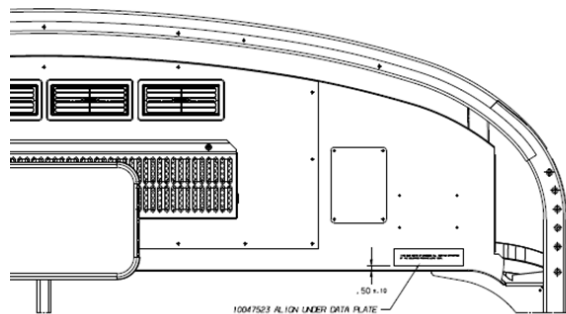
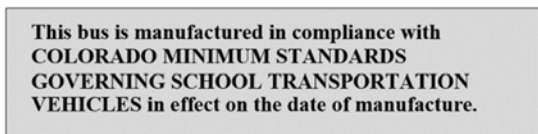

Collins Bus: The three Collins school bus brands sell a common product line differentiated largely by brand engineering.

The option code found on a line set ticket for the Colorado rack requirement is code 225. If the Colorado certification decal is not present and you do not have a copy of the line set ticket contact the Collins Inside Sales Representatives at (800)533-1850

Certification Decal example below. _____ Location: Installed on the front bulkhead by the FMVSS (Same with the exception of the state name) _____
Certification Label



Corbeil Bus Corporation:

Corbeil Bus Corporation was created from the acquisition of predecessor Les Entreprises Michel Corbeil by Collins Industries in 2007.

Certification Decal example below. _____ Location :

No available example at time of printing.

Mid Bus: The company was acquired by Collins Bus Corporation in 1998.

Certification Decal example below. (2002 Model year) _____ Location: Installed above the driver door to the left of the driver _____

No indication on decal of what state standards.

This could be identified by determining the state of origin.

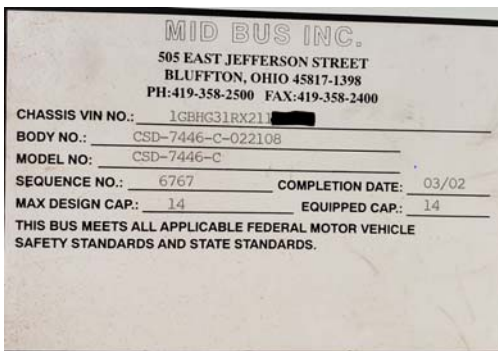

GreenPower Motor Company: Currently not certified for use in Colorado
GreenPower exclusively builds all-electric vehicles

IC Bus LLC:

(Am Tran) In 1991, the company was acquired by Navistar International. In 2000, the company was rebranded as International Truck and Bus (some vehicles continued with AmTran branding). In 2002, the name was changed again to IC Corporation, and today is known as IC Bus.

Check the line set sheet for Option Code. Option codes for pre 2004 vehicles is G45ACCP; Option Code 2004 and newer vehicles to present is 47ARJ. If the certification decal is present, this is verification of rack and load compliance.

If you do not have a copy of the order form or line set ticket, or the bus is lacking the certification decal, you may also contact your local dealer to verify if the bus has the required option code. This will require providing the last eight characters of the vehicle VIN. #

Certification Decal example below. Location: Label would be aft of the entrance door above first passenger window

Pre-2014

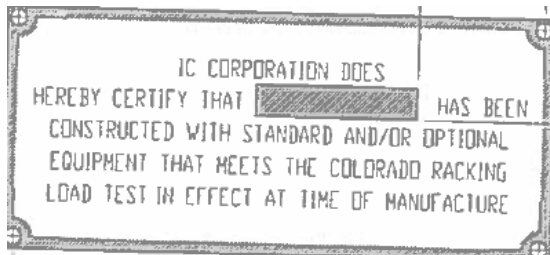

Current

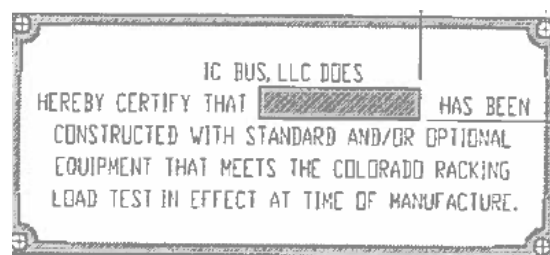

Note: There are two earlier versions of this plate, pre-2012, and pre-2002 with the difference being only the company name.

Lyon Electric Company: Currently not certified for use in Colorado

Previously known as Lion Bus/Autobus Lion, Lion Electric Company renamed itself in 2017 as part of its focus on electric vehicle production.

Micro Bird:

(Girardin Minibus Inc.) Girardin forms part of the Micro Bird joint venture with Blue Bird Corporation. As part of Micro Bird, Girardin is a manufacturer of bus bodies for minibuses for cutaway van chassis.

The option for Rack and Load is RLD and has been offered since 1999. RLD only appears on the order, and is not printed on the vehicle or documents provided with the vehicle. The best way to validate whether or not a vehicle is compliant, is to identify that the certification decal on vehicles produced after September 2017 is present in the bus or send the VIN or Body number - both appear on the certification label - to normes@microbird.com or to Marie.claude.gagnon@microbird.com or contact your local dealer.

If the current certification decal is present, this is verification of rack and load compliance.

Certification decal examples below. Location: Applied under the certification label, top left over the windshield on the bulkhead.

Sept 2017 to current Model Year



MFD BY: CORP.MICRO BIRD INC.

VIN:

BODY NUMBER

THIS BUS MEETS ALL APPLICABLE PROVISIONS OF COLORADO MINIMUM STANDARDS GOVERNING SCHOOL TRANSPORTATION AS IN EFFECT ON THE DATE OF MANUFACTURE.

Post-2010

Note: No reference to Colorado Standards
Call for verification

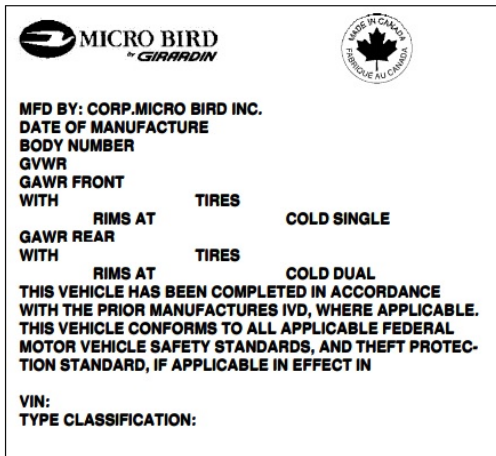

Pre-2010

Note: No reference to Colorado Standards
Call for verification



Starcraft Bus: Currently not certified for use in Colorado

Type A School bus/MFSAB

Thomas Built Buses:

Thomas Built Buses has not offered compliance with the Colorado Rack and Load test as standard on all of their products, year after year. Thomas Built Buses has offered Colorado Rack and Load compliant vehicles as standard on some models, but only for certain years.

With so many variables, the best solution at this time will be to request from Thomas Built Buses, certification on an individual unit basis. Thomas Built Buses can supply a letter for that specific bus, if it was manufactured in compliance. Contact Ricky Stanley at (336)841-5927 or your local Thomas dealer.

Certification Decal example below. Location: This tag would be located beside the federal label in the driver's area.



Titan: Currently not certified for use in Colorado

Certification Decal example below. Location: Plate will be mounted on front bulkhead or panel above and to the right of the drivers' seat.



Trans Tech:

The Colorado Rack & Load Test certification is an available option on the SST & CST (School Bus / MFSAB) body model Series as of model year 2013 to present.

If the Colorado certification decal is not present in the bus, verification may be attained by contacting Trans Tech Bus with the VIN # at (845) 988-2333.

Option codes found on a line set ticket for the Colorado rack requirement.

BODY STRUCTURE:		
CODE	QTY	DESCRIPTION
03-0003	1	COLORADO RACK PACKAGE

Certification Decal example below. Location: Decal will be located in driver's area, in the vicinity of the mirror located directly above driver seat

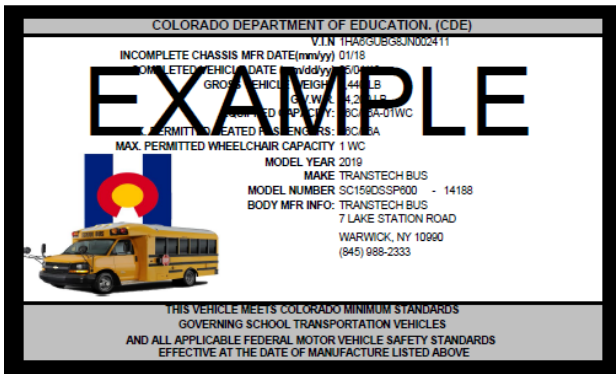

US Bus:

In November 2007, U.S. Bus Corporation was reorganized and re-located to Warwick, New York. Acquired by Trans Tech Bus. It is unknown if the rack and load requirement was an option from this manufacturer or if all units produced met the standard. There is no way to verify if these vehicle meets the rack and load requirements if the certification decal is not present, as records for specific VINS are not available.

Van Con: **Currently not certified for use in Colorado**

Van Con exclusively manufactures school buses on cutaway van chassis.

Kentucky Pole Test

Background

The Kentucky Pole Test will test the strength of the school bus roof in case of a pole, or another sharp object impacts the bus during a rollover. A school bus will pass this test if the body panels of the bus remain intact, and that the roof does not bend more than 10 inches into the passenger compartment.

Kentucky Pole Test originated after a Governor's Task Force on School Bus Safety recommended enhanced school-bus design following the death of 24 children, their driver and two adult chaperones when the church bus they were riding in was struck head-on by a drunk driver. The resulting bus fire killed the 27 passengers, and 34 others sustained injuries when emergency evacuation through the rear door was hindered. The Kentucky Pole Test was developed in 1989.

During the test, a school bus rollover is simulated with an eight-inch diameter pole impacting the roof with enough force to cause the roof to bend into the passenger compartment between eight to 10 inches. Throughout this test, the body panels cannot separate. While this test was developed for the state of Kentucky, the test is widely utilized throughout multiple North American states and provinces as a required specification.

This requirement was added to the Colorado Minimum Standards Governing School Transportation Vehicles 1 CCR 301-25 in the standards that went into effect April 30, 2015. Prior to that there was no requirement for Colorado school buses to meet this standard.

Requirements

Minimum Standards 1 CCR 301-25

2251-R-14.07 On Type B, C, and D buses, the bus body shall meet the test standards of the Kentucky Pole test.

Kentucky Pole Test Verification listed by Manufacturer

Bluebird:

All models of Bluebird buses built October 1990 and later meet the test standards of the Kentucky Pole test.

Collins:

N/A

IC Bus:

All models of IC buses built 1992 and later meet the test standards of the Kentucky Pole test.

Micro bird:

N/A

Thomas:

All models of Thomas buses built 2004 and later meet the test standards of the Kentucky Pole test.

Trans Tech:

Option code not shown on line set. Requirements are met and exceeded as part of the standard design of the trans tech safety cage/body.

Titan: Currently not certified for use in Colorado

GreenPower Motor Company: Currently not certified for use in Colorado

Lion Electric Company: Currently not certified for use in Colorado

Starcraft Bus: Currently not certified for use in Colorado

Van Con: Currently not certified for use in Colorado

N/A

Colorado Racking Load Test Test Requirements

14.08 In addition to complying with FMVSS 220 test procedures, the body manufacturers shall record and report the downward vertical movement of the force at 0, 25, 50, 75, and 100% of the maximum force (both loading and unloading). The expected force deflection curve is illustrated schematically in Figure 1a. Low load nonlinearities may indicate joint conformation; high load nonlinearities may indicate yielding structural members.

14.08(a) A second load cycle shall be performed following the procedure given in the first paragraph. The expected force-deflection curve is illustrated schematically in Figure 1b. Any hysteresis following the initial shakedown will be revealed by this second cycle.

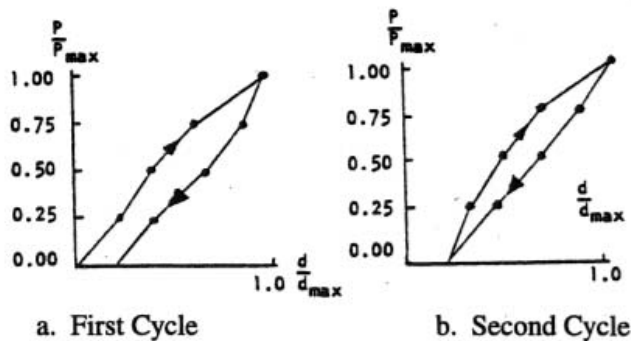

Figure 1. Static Load Test Load-Deflection Curves

14.09 A diagonal (racking) load test shall be performed on Type A, B, C and D school buses to assure adequate shear stiffness and strength of the bus body. Details of the test are provided below. A two cycle loading sequence shall be conducted following the procedure described in Section 14.08.

14.09(a) Requirements: When a force equal to 1 ½ times the GVW is applied to the edge of the roof of the vehicle's body structure through a force application plate as specified in (b), Test Procedures:

14.09(a) (1) The diagonal movement of the force at any point on the application plate shall not exceed 5 1/8 inches; and

14.09(a) (2) Each emergency exit of the vehicle provided in accordance with FMVSS 217 shall be capable of operation as specified in that standard during the full application of the force and after release of the force.

14.09(b) Test Procedures: Each vehicle shall be capable of meeting the requirements of (1) and (2) when tested in accordance with the procedures set forth below.

14.09(b) (1) The vehicle shall be supported on a rigid surface along the lower edge of the frame or along the body sills in the absence of a frame.

14.09(b) (2) The load shall be applied through a force application plate that is flat and rigid. The dimensions of the plate shall be chosen to assure that the plate edges never make contact with the vehicle skin during testing. A typical width is 18 inches. A typical length is 20 inches less than the length of the vehicle's roof measured along its longitudinal centerline.

14.09(b) (3) Place the force application plate in contact with the edge of the vehicle roof. Orient the plate so that its flat, rigid surface is perpendicular to a diagonal line connecting the most distant points on an interior cross section of the vehicle. The rear edge of the plate shall be positioned approximately 20 inches from the rear edge of the vehicle roof. A temporary stand may be used to support the plate until a force is applied.

14.09(b) (4) Apply an evenly distributed force in a diagonally downward direction through the force application plate at any rate not more than 0.5 inch per second, until a force of 500 pounds has been applied.

14.09(b) (5) Apply additional force in a diagonally downward direction through the force application plate at a rate of not more than 0.5 inch per second until the force specified in (a) has been applied and maintain this application of force.

14.09(b) (6) Measure the diagonal movement of any point on the force application plate which occurred during the application of force in accordance with (5) and open the emergency exits as specified in (a) (2).

14.09(b) (7) Release all diagonal force applied through the force application plate and operate the emergency exits as specified in 14.09(a) (2).

14.09(c) Test Conditions: The following conditions apply to the requirements specified in (3).

14.09(c) (1) Temperature: The ambient temperature is any level between 32 degrees Fahrenheit and 90 degrees Fahrenheit.

14.09(c) (2) Windows and Doors: Vehicle windows, doors and emergency exits are in the fully-closed position and latched but not locked.

14.09(d) An alternative method of testing for the racking load test shall be as follows:

14.09(d) (1) The racking load shall be applied along a line connecting the most distant points on a transverse cross section of the bus interior. It produces a shear distortion of the cross section as shown in figure 2. A representative method of loading which employs a hydraulic jack to load a two frame test assembly is illustrated in figure 2. The maximum jack load for the two-frame assembly is determined by the following formula:

$J = 2P$ J - maximum jack load for two-frame test assembly

$P = \text{load/frame}$ where $P = \text{DVW}$ divided by N

DVW - dynamic vehicle weight

N - total number of bus body frames and $\text{DVW} = \text{DF} \times \text{GVW}$

DF - dynamic factor, not less than 1.5

GVW - gross vehicle weight

Thus, for a $\text{DF} = 1.5$, a $\text{GVW} = 22,000$ pounds-force (lbf), and $N = 11$, the dynamic vehicle weight is $\text{DVW} = 33,000$ lbf, the load/frame is $P = 3000$ lbf and the maximum jack load is $J = 6000$ lbf.

14.09(d) (2) When a complete bus body is rack-loaded, the total load DVW must be distributed uniformly along the bus body. One method is to mount a series of hydraulic jacks along the length of the bus interior. Seats may be removed to facilitate jack mounting. The rack load will be considered to be uniformly distributed when the variation in the hydraulic jack readings is less than 10 percent. A maximum load for DVW shall be the sum of all jack readings.

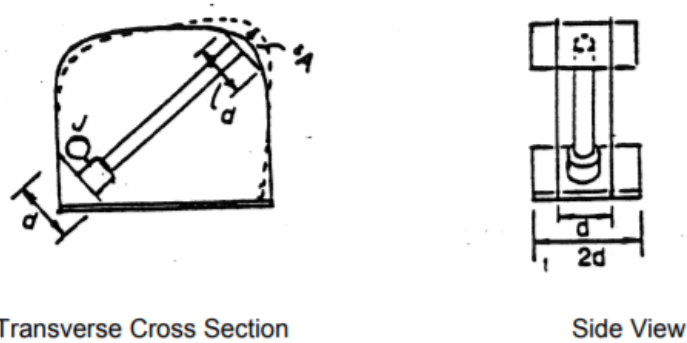

Figure 2. Arrangement of Hydraulic Jack for Rack-Loading of Two-Frame Assembly

14.09(d)(2)(A) The test may be performed on a complete bus body or on a representative section composed of at least two complete frames (body posts plus roof bows) and floor. Standard seats may be installed in the test section in a manner identical to that of the full bus body. Fabrication procedures for the test assembly shall be identical to normal bus body production.

14.09(d) (2) (B) A two-cycle loading sequence shall be conducted, with intermediate and final load and deflection readings recorded according to the procedure described.

14.09(d) (2) (C) The maximum deflection in line with the jack (A, maximum) shall not exceed 4 inches.

14.09(d) (3) Manufacturers shall specify which testing method was used and submit appropriate certification information as called for in 6.02.

Kentucky Pole Test Test Requirements

The body shall be impacted at any point along the roof line on the outside surface, using an eight (8) inch diameter cylinder, forty-eight (48) inches long at a thirty (30) to forty-five (45) degree angle, one (1) to three (3) inches above the top window line. The cylinder shall impact the roofline with the forty-eight (48) inches dimension in a vertical plane with a force not to exceed ten (10) inches maximum to eight (8) inches minimum penetration of the body panels into the passenger compartment after impact.

Appendix G. Glossary

ABS - Anti-lock Braking System
ASE - Automotive Service Excellence
CCR - Code of Colorado Regulations
CDE – Colorado Department of Education
CDL - Commercial Driver's License
CFR – Code of Federal Regulations
CRS - Colorado Revised Statutes
CSPTA - Colorado State Pupil Transportation Association
CV Joint - Constant-velocity joint
DPF - Diesel Particulate Filters
DQF – Driver Qualification File
DOT – Department of Transportation
EDAC - Educational Data Advisory Committee
EVAP - Evaporative Emission Control System
FBI – Federal Bureau of Investigation
FMVSS - Federal Motor Vehicle Safety Standards
ID – Identification
IQF – Inspector Qualification File
LED – Light emitting Diode
LF – Left Front
LR – Left Rear
OEM - Original Equipment Manufacturer
PSI – Pounds per Square Inch
RF – Right Front
RPM – Revolutions per minute
RR – Right Rear
U Joint - Universal Joint

Appendix H. Additional Resources

If clicking on the link does not properly redirect you to the site or gives you an error message, try copying and pasting to the search bar of your browser.

FMVSS's <https://one.nhtsa.gov/cars/rules/import/fmvss/index.html>

SBMTC Application of Federal Motor Vehicle Safety Standards by Type of Motor Vehicle or Item of Motor Vehicle Equipment <http://www.nasdpts.org/Documents/PubFMVSS-2005.pdf>

SBMTC Mini Guide to the Federal Motor Vehicle Safety Standards and Related Regulations <http://www.nasdpts.org/Documents/PubSBMTCMiniGuide04.pdf>

SBMTC School Bus Technical Reference <http://www.nasdpts.org/Documents/PubSBMTC-TechRef.pdf>

School Bus Seating Capacity <http://www.nasdpts.org/Documents/Paper-SeatingCapacity.pdf>

Motor Coach <http://www.nasdpts.org/Non/MotorCoach.html>

"FMCSA - Look Before You Book" <https://www.fmcsa.dot.gov/safety/look-you-book/look-you-book>

Vans <http://stnonline.com/non-conforming-vans>

NASDPTS Position Papers <http://www.nasdpts.org/Papers/index.html>

Colorado School District Self Insurance Pool <https://www.cdsip.org/>

National Congress on School Transportation <http://www.nasdpts.org/ncstonline/index.html>

USDOT Dockets and Regulations <https://www.transportation.gov/regulations>

Federal Laws <https://www.congress.gov//>

Federal Register <https://www.govinfo.gov/help/cfr>

National Transportation Safety Board <https://www.nts.gov/Pages/default.aspx>

National Highway Traffic Safety Administration <https://www.nhtsa.gov/>

Federal Motor Carrier Safety Administration <https://www.fmcsa.dot.gov/>

EPA's Clean School Bus USA Program <https://www.epa.gov/cleandiesel/clean-school-bus>

Colorado Department of Transportation <http://www.cotrip.org/home.htm>

Motor Carrier Safety Unit – CSP <https://www.colorado.gov/csp>

Colorado Legal Resources <http://www.lexisnexis.com/hottopics/Colorado/>

Electronic Code of Federal Regulations <https://www.ecfr.gov/cgi-bin/searchECFR?ob=r&idno=&q1=exhaust+system&r=&SID=ab50dda13297012b805c06b96b78347b&mc=true>

Appendix G to Subchapter B of Chapter III - Minimum Periodic Inspection Standards <https://www.gpo.gov/fdsys/pkg/CFR-2011-title49-vol5/pdf/CFR-2011-title49-vol5-subtitleB-chapIII-subchapB-appG.pdf>

End of Document